

# *2007 Owner's Manual*

# ENTOURAGE



**HYUNDAI**

*Drive your way™*

## WARRANTIES FOR YOUR HYUNDAI VEHICLE

**Please consult your Owner's Handbook & Warranty Information booklet for your vehicle's specific warranty coverage.**

## RESPONSIBILITY FOR MAINTENANCE

The maintenance requirements for your new Hyundai are found in Section 6. As the owner, it is your responsibility to see that all maintenance operations specified by the manufacturer are carried out at the appropriate intervals. When the vehicle is used in severe driving conditions, more frequent maintenance is required for some operations. Maintenance requirements for severe operating conditions are also included in Section 6.

# HYUNDAI



## ENTOURAGE

**OWNER'S MANUAL**

**Operation  
Maintenance  
Specifications**

**All information in this Owner's Manual is current at the time of publication. However, Hyundai reserves the right to make changes at any time so that our policy of continual product improvement may be carried out.**

**This manual applies to all Hyundai models and includes descriptions and explanations of optional as well as standard equipment. As a result, you may find material in this manual that does not apply to your specific vehicle.**

### **CAUTION: MODIFICATIONS TO YOUR HYUNDAI**

Your Hyundai should not be modified in any way. Such modifications may adversely affect the performance, safety or durability of your Hyundai and may, in addition, violate conditions of the limited warranties covering the vehicle. Certain modifications may also be in violation of regulations established by the U.S. Department of Transportation and other federal or state agencies.

### **TWO-WAY RADIO OR CELLULAR TELEPHONE INSTALLATION**

Your vehicle is equipped with electronic fuel injection and other electronic components. It is possible for an improperly installed/adjusted two-way radio or cellular telephone to adversely affect electronic systems. For this reason, we recommend that you carefully follow the radio manufacturer's instructions or consult your Hyundai dealer for precautionary measures or special instructions if you choose to install one of these devices.

## **SAFETY AND VEHICLE DAMAGE WARNING**

This manual includes information titled as WARNING, CAUTION and NOTICE.  
These titles indicate the following:

### **WARNING**

**This indicates that a condition may result in harm, serious injury or death to you or other persons if the warning is not heeded. Follow the advice provided with the warning.**

### **CAUTION**

***This indicates that a condition may result in damage to your vehicle or its equipment if the caution is not heeded. Follow the advice provided with the caution.***

### **\* NOTICE**

**This indicates that interesting or helpful information is being provided.**

## FOREWORD

Thank you for choosing Hyundai. We are pleased to welcome you to the growing number of discriminating people who drive Hyundais. The advanced engineering and high-quality construction of each Hyundai we build is something of which we're very proud.

Your Owner's Manual will introduce you to the features and operation of your new Hyundai. It is suggested that you read it carefully because the information it contains can contribute greatly to the satisfaction you receive from your new car.

The manufacturer also recommends that all service and maintenance on your car be performed by an authorized Hyundai dealer. Hyundai dealers are prepared to provide high-quality service, maintenance and any other assistance that may be required.

## HYUNDAI MOTOR COMPANY

**Note** : Because future owners will also need the information included in this manual, if you sell this Hyundai, please leave the manual in the vehicle for their use. Thank you.

### CAUTION

***Severe engine and transaxle damage may result from the use of poor quality fuels and lubricants that do not meet Hyundai specifications. You must always use high quality fuels and lubricants that meet the specifications listed on Page 8-3 in the Vehicle Specifications section of the Owner's Manual and which also appear in the Service Station Information on the back cover of the Owner's Manual.***

Copyright 2006 Hyundai Motor Company. All rights reserved. No part of this publication may be reproduced, stored in any retrieval system or transmitted in any form or by any means without the prior written permission of Hyundai Motor Company.

## Guide to Hyundai Genuine Parts

### 1. What are Hyundai Genuine Parts?

Hyundai Genuine Parts are the same parts used by Hyundai Motor Company to manufacture vehicles. They are designed and tested for the optimum safety, performance, and reliability to our customers.

### 2. Why should you use genuine parts?

Hyundai Genuine Parts are engineered and built to meet rigid manufacturing requirements. Using imitation, counterfeit or used salvage parts is not covered under the Hyundai New Vehicle Limited Warranty or any other Hyundai warranty.

In addition, any damage to or failure of Hyundai Genuine Parts caused by the installation or failure of an imitation, counterfeit or used salvage part is not covered by any Hyundai Warranty.

### 3. How can you tell if you are purchasing Hyundai Genuine Parts?

Look for the Hyundai Genuine Parts Logo on the package (see below).

Hyundai Genuine Parts exported to the United States are packaged with labels written only in English.

Hyundai Genuine Parts are only sold through authorized Hyundai Dealerships.

To find the closest authorized dealer call 1-800-826-CARS

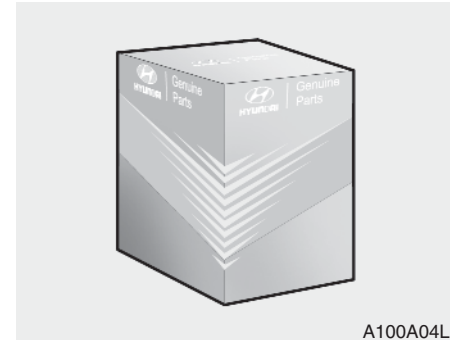
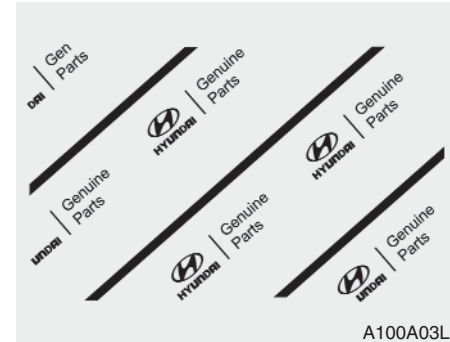





---

***TABLE OF CONTENTS*** ■

Introduction	1
Your vehicle at a glance	2
Features of your vehicle	3
Driving your vehicle	4
What to do in an emergency	5
Maintenance	6
Consumer information	7
Specifications	8
Index	9

---

---

# Introduction

1

**How to use this manual / 1-2**

**Fuel requirements / 1-2**

**Vehicle break-in process / 1-3**

**Vehicle data collection and event data recorders / 1-4**

## HOW TO USE THIS MANUAL

We want to help you get the greatest possible driving pleasure from your vehicle. Your Owner's Manual can assist you in many ways. We strongly recommend that you read the entire manual. In order to minimize the chance of death or injury, you must read the WARNING and CAUTION sections spread throughout the manual.

Illustrations complement the words in this manual to best explain how to enjoy your vehicle. By reading your manual, you learn about features, important safety information, and driving tips under various road conditions.

The general layout of the manual is provided in the Table of Contents. A good place to start is the index; it has an alphabetical listing of all information in your manual.

Sections: This manual has eight sections plus an index. Each section begins with a brief list of contents so you can tell at a glance if that section has the information you want.

You'll find various WARNING's, CAUTION's, and NOTICE's information in this manual. These were prepared to enhance your personal safety. You should carefully read and follow ALL procedures and recommendations provided in these WARNING's, CAUTION's and NOTICE's.

### WARNING

**A WARNING indicates a situation in which harm, serious bodily injury or death could result if the warning is ignored.**

### CAUTION

**A CAUTION indicates a situation in which damage to your vehicle could result if the caution is ignored.**

### \* NOTICE

**A NOTICE indicates interesting or helpful information is being provided.**

## FUEL REQUIREMENTS

### Use Unleaded Gasoline

Unleaded gasoline with a Pump Octane Rating of 87 (Research Octane Number 91) or higher must be used in your Hyundai.

For improved vehicle performance, premium unleaded fuel with an Pump Octane Rating of 91 (Research Octane Number 95) or higher is recommended.

### CAUTION

- **Do not "top off" after the nozzle automatically shuts off when refueling.**
- **Tighten the cap until it clicks, otherwise the "🔧" light will illuminate.**
- **Always check that the fuel cap is installed securely to prevent fuel spillage in the event of an accident.**

### What About Gasohol?

Gasohol (a mixture of 90% unleaded gasoline and 10% ethanol or grain alcohol) may be used in your Hyundai. However, if your engine develops driveability problems, the use of 100% unleaded gasoline is recommended. Fuels with unspecified quantities of alcohol, or alcohols other than ethanol, should not be used.

## Use of MTBE

Hyundai recommends that fuels containing MTBE (Methyl Tertiary Butyl Ether) over 15.0% vol. (Oxygen Content 2.7% weight) should not be used in your Hyundai.

Fuel containing MTBE over 15.0% vol. (Oxygen Content 2.7% weight) may reduce vehicle performance and produce vapor lock or hard starting.

## Do Not Use Methanol

Fuels containing methanol (wood alcohol) should not be used in your Hyundai. This type of fuel can reduce vehicle performance and damage components of the fuel system.

### CAUTION

***Your Hyundai's New Vehicle Limited Warranty may not cover damage to the fuel system and any performance problems that are caused by the use of fuels containing methanol or fuels containing MTBE (Methyl Tertiary Butyl Ether) over 15.0% vol. (Oxygen Content 2.7% weight.)***

## Gasolines for Cleaner Air

To help contribute to cleaner air, Hyundai recommends that you use gasolines treated with detergent additives, which help prevent deposit formation in the engine. These gasolines will help the engine run cleaner and enhance performance of the Emission Control System.

## Operation in Foreign Countries

If you are going to drive your Hyundai in another country, be sure to:

- Observe all regulations regarding registration and insurance.
- Determine that acceptable fuel is available.

## VEHICLE BREAK-IN PROCESS

### During the First 1,200 Miles (2,000 Km)

No formal "break-in" procedure is required with your new Hyundai. However, you can contribute to the economical operation and durability of your Hyundai by observing the following recommendations during the first 1,200 miles (2,000 km).

- Don't drive faster than 55 MPH (88 km/h).
- While driving, keep your engine speed (rpm, or revolutions per minute) between 2,000 rpm and 4,000 rpm.
- Use moderate acceleration. Don't start quickly or depress the accelerator pedal fully.
- For the first 200 miles (300 km), try to avoid hard stops.
- Whether going fast or slow, vary your speed from time to time.
- Don't let the engine idle longer than 3 minutes at one time.
- Don't tow a trailer during the first 1,200 miles (2,000 km) of operation.

### VEHICLE DATA COLLECTION AND EVENT DATA RECORDERS

Your Hyundai vehicle is equipped with many high technology, electronically controlled systems that help to ensure your vehicle operates properly and provides the performance that you expect. These systems utilize computers to monitor the operation of various systems and components and help to control their operation. These computerized system operations are wide-ranging and involve components to reduce emissions, to continuously evaluate the readiness of the airbag and seat belt pretensioner systems, to determine when the airbag and seat belt pre-tensioner systems should be deployed and then to activate the deployment, and if equipped, to operate anti-lock braking, traction control and electrical stability control to assist the driver to control the vehicle in difficult driving situations. These systems electronically store information that is useful to service technicians when they need to diagnose and repair these systems.

Additional information is stored only when a crash occurs that results in the deployment of the airbags or seat belt pre-tensioners. This type of data storage is done by devices called event data recorders(EDR).

After a crash event, the airbag and seat belt pre-tensioner computer system, known as the Supplemental Restraint System Control Module (SRSCM) or Airbag Control Unit (ACU), may record some information about the condition of the vehicle and how it was being operated. This information consists of data related to seat belt usage and if there was diagnostic information in the airbag or seat belt systems at the time that a crash occurred, and if the ACU sensed that a crash of sufficient severity occurred to require seat belt pre-tensioner or airbag deployment.

To retrieve this information, special equipment is needed and access to the vehicle or the device that stores the data is required. Hyundai will not access information about a crash event or share it with others except:

- in response to an official request of police or similar government office, or
- with the consent of the vehicle owner or, if the vehicle is leased, with the consent of the lessee, or
- as part of Hyundai's defense of litigation, or
- as required by law.

---

## Your vehicle at a glance

2

**Interior overview / 2-2**

**Instrument panel overview / 2-3**

---

## INTERIOR OVERVIEW



1. Door lock/unlock button .....3-13
2. Driver position memory system\* .....3-56
3. Seat adjust knob\* .....3-40
4. Outside rearview mirror control switch .....3-105
5. Power rear quarter window switches\* .....3-26
6. Power window switches .....3-26
7. Central door lock switch .....3-13
8. Power window lock switch .....3-28
9. Fuel filler lid release button .....3-30
10. Instrument panel illumination .....3-112
11. Room light main control switch .....3-125
12. Power adjustable pedal control switch\* .....3-58
13. Steering wheel tilt .....3-103
14. Parking brake release lever .....4-19
15. Fuse box .....6-27
16. Hood release lever .....3-29
17. Parking brake pedal .....4-19
18. Brake pedal .....4-17
19. Accelerator pedal .....4-6
20. Seat .....3-37

\* : if equipped

## INSTRUMENT PANEL OVERVIEW



1. Driver's air bag .....	3-79
2. Light control / Turn signals .....	3-129
3. Instrument cluster.....	3-109
4. Wiper/Washer.....	3-132
5. Auto cruise controls* .....	4-14
6. Audio controls* .....	3-181
7. Steering wheel .....	3-102
8. Ignition switch.....	4-5
9. Digital clock .....	3-180
10. Climate control system* .....	3-138
11. Hazard warning flasher switch ...	3-137
12. Seat warmer* .....	3-45
13. Shift lever .....	4-7
14. Cigar lighter* .....	3-175
15. Power outlet.....	3-179
16. Ashtray* .....	3-175
17. Passenger's air bag.....	3-79
18. Storage compartment.....	3-171
19. Vent controls.....	3-142
20. Glove box .....	3-173
21. Sunglass holder .....	3-174
22. Sunvisor .....	3-178
23. Power sliding door and power tailgate controls* .....	3-17
24. Sunroof* .....	3-33
25. Conversation mirror.....	3-108
26. Trip computer* .....	3-113
27. Day/night rearview mirror .....	3-107

\* : if equipped

OVQ026002N



**Keys / 3-3**  
**Remote keyless entry / 3-4**  
**Theft-alarm system / 3-7**  
**Immobilizer system / 3-9**  
**Door locks / 3-11**  
**Power sliding door and power tailgate / 3-17**

## Features of your vehicle

3

**Window / 3-26**  
**Hood / 3-29**  
**Fuel filler lid / 3-30**  
**Sunroof / 3-33**  
**Seat / 3-37**  
**Driver position memory system / 3-56**  
**Power adjustable pedals / 3-58**  
**Seat belts / 3-59**  
**Child restraint system / 3-71**  
**Air bags-advanced restraint system / 3-78**  
**Steering wheel / 3-102**  
**Mirrors / 3-104**  
**Instrument cluster / 3-109**  
**Gauges / 3-110**  
**Trip computer / 3-113**  
**Warnings and indicators / 3-119**

**Interior lights / 3-125**  
**Lighting / 3-128**  
**Wipers and washers / 3-132**  
**Horn / 3-135**  
**Defroster / 3-136**

**3**

## **Features of your vehicle**

**Hazard warning flasher / 3-137**  
**Manual climate control system / 3-138**  
**Automatic climate control system / 3-149**  
**Windshield defrosting and defogging / 3-162**  
**Luggage net holder / 3-165**  
**Roof rack / 3-166**  
**Homelink® wireless control system / 3-167**  
**Storage compartments / 3-171**  
**Interior features / 3-175**  
**Antenna / 3-180**  
**Audio remote control / 3-181**  
**Audio system / 3-182**  
**Rear seat entertainment system / DVD player / 3-212**

## KEYS



The key code number is stamped on the plate attached to the key set. Should you lose your keys, this number will enable an authorized Hyundai Dealer to duplicate the keys easily. Remove the plate and store it in a safe place. Also, record the code number and keep it in a safe and handy place, but not in the vehicle.

### Key operations

#### *Master key*

Used to start the engine, lock and unlock the doors, lock and unlock the glove box and center console storage (if equipped).

#### **⚠ WARNING**

- **NEVER** leave the ignition key in the vehicle.
- **NEVER** leave any child unattended in the vehicle. Even very young children may inadvertently cause the vehicle to move, entangle themselves in the windows, or otherwise injure themselves or others.

#### **⚠ WARNING**

Use only Hyundai original parts for the ignition key in your vehicle. If an aftermarket key is used, the ignition switch may not return to ON after START. If this happens, the starter will continue to operate causing damage to the starter motor and possible fire due to excessive current in the wiring.

## REMOTE KEYLESS ENTRY (IF EQUIPPED)

Type A



1VQA2002B

Type B



1VQA2002A

Type C



1VQA2002

### (1) Lock ( )

All doors are locked if the lock button is pressed.

If all doors and engine hood are closed, the hazard warning lights blink once to indicate that all doors are locked. However, if any door or engine hood remains open, the hazard warning lights are not operated. After this, if all door and engine hood are closed, the hazard warning lights blink.

### (2) Unlock ( )

Driver's door is unlocked if the unlock button is pressed once.

The hazard warning lights will blink twice to indicate that the driver's door is unlocked.

All doors are unlocked if the unlock button is pressed twice within 3 seconds.

The hazard warning lights will blink twice again to indicate that all doors are unlocked.

After depressing this button, the doors will be locked automatically unless you open any door within 30 seconds.

### (3) Power tailgate opening or closing

(  , if equipped)

The tailgate is opened or closed automatically if the button is pressed.

The hazard warning lights will blink and the chime will sound 3 times to indicate that the tailgate will swing upward or downward.

### (4) Left power sliding door opening or closing ( , if equipped)

The left sliding door is opened or closed automatically if the button is pressed.

### (5) Right power sliding door opening or closing ( , if equipped)

The right sliding door is opened or closed automatically if the button is pressed.

**\* NOTICE**

The power sliding door and power tailgate are not opened by pressing the corresponding button on the transmitter directly when all power sliding doors and power tailgate are locked and closed. To open the power sliding door or power tailgate from outside vehicle, press the unlock button first and press corresponding power sliding door or power tailgate opening button.

**CAUTION**

*The power doors can be operated when the engine is not running. However, the power doors consume large amounts of vehicle electric power. To prevent the battery from being discharged, do not operate them consecutively (more than approximately 10 times).*

**(6) Alarm (  )**

The horn sounds and hazard warning lights flash for about 27 seconds if this button is pressed. To stop the horn and lights, press any button on the transmitter.

**\* NOTICE**

The transmitter will not work if any of following occur:

- The ignition key is in ignition switch.
  - You exceed the operating distance limit (about 90 feet [30 m]).
  - The battery in the transmitter is weak.
  - Other vehicles or objects may be blocking the signal.
  - The weather is extremely cold.
  - The transmitter is close to a radio transmitter such as a radio station or an airport which can interfere with normal operation of the transmitter.
- When the transmitter does not work correctly, open and close the door with the ignition key. If you have a problem with the transmitter, contact an authorized Hyundai Dealer.

**CAUTION**

*Keep the transmitter away from water or any liquid. If the keyless entry system is inoperative due to exposure to water or liquids, it will not be covered by your manufacturer vehicle warranty.*

Operational distance may vary depending upon the area the transmitter is used in. For example, if the vehicle is parked near police stations, government and public offices, broadcasting stations, military installations, airports, or transmitting towers, etc.

**This device complies with Part 15 of the FCC rules.** Operation is subject to the following two conditions:

1. This device may not cause harmful interference, and
2. This device must accept any interference received, including interference that may cause undesired operation.

### **CAUTION**

*Changes or modifications not expressly approved by the party responsible for compliance could void the user's authority to operate the equipment.*

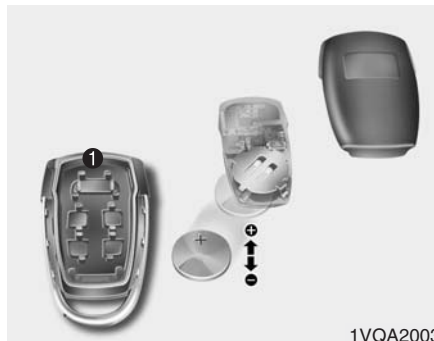

### **Battery replacement**

Transmitter uses a 3 volt lithium battery which will normally last for several years. When replacement is necessary, use the following procedure.

1. Insert a slim tool into the slot and gently pry open the transmitter center cover (1).
2. Replace the battery with new one. When replacing the battery, make sure the battery positive "+" symbol faces up as indicated in the illustration.
3. Install the battery in the reverse order of removal.

For replacement transmitters, see an Authorized Hyundai Dealer for reprogramming.

### **CAUTION**

*The keyless entry system transmitter is designed to give you years of trouble-free use, however it can malfunction if exposed to moisture or static electricity. If you are unsure how to use your transmitter or replace the battery, contact an authorized Hyundai dealer.*

### **CAUTION**

- *Using the wrong battery can cause the transmitter to malfunction. Be sure to use the correct battery.*
- *To avoid damaging the transmitter, don't drop it, get it wet, or expose it to heat or sunlight.*

## THEFT-ALARM SYSTEM (IF EQUIPPED)

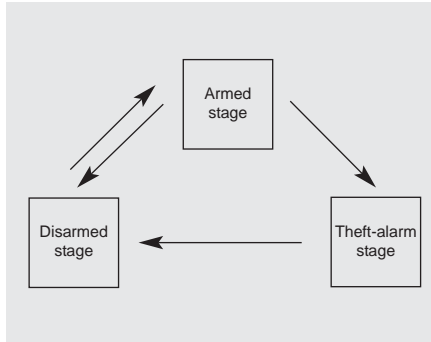

This system is designed to provide protection from unauthorized entry into the car. This system is operated in three stages: the first is the "Armed" stage, the second is the "Theft-alarm" stage, and the third is the "Disarmed" stage. If triggered, the system provides an audible alarm with blinking of the hazard warning lights.

### Armed stage

Park the car and stop the engine. Arm the system as described below.

1. Remove the ignition key from the ignition switch.
2. Make sure that all doors, the engine hood and tailgate are closed and latched.
3. Lock the doors using the transmitter of the keyless entry system.

After completion of the steps above, the hazard warning lights will blink once to indicate that the system is armed.

If any door, tailgate or engine hood remains open, the hazard warning lights won't operate and theft-alarm will not arm. After this, if all doors, tailgate and engine hood are closed, the hazard warning lights blink once.

The system can be armed by locking the doors with the key from the front doors or tailgate. However, the hazard warning lights are not operated.

- If any door, tailgate or engine hood remains open, the system will not be armed. If this happens, re-arm the system as described previously.
- Do not arm the system until all passengers have left the vehicle. If the system is armed while a passenger(s) remains in the vehicle, the alarm may be activated when the remaining passenger(s) leaves the vehicle. If any door, tailgate or engine hood is opened within 30 seconds after entering the armed stage, the system is disarmed.

### **Theft-alarm stage**

The alarm will be activated if any of the following occurs while the system is armed.

- A front or rear door is opened without using the ignition key or transmitter.
- The tailgate is opened without using the ignition key or transmitter.
- The engine hood is opened.

The siren will sound and the hazard warning lights will blink continuously for 27 seconds, and repeat the alarm 3 times unless the system is disarmed. To turn off the system, unlock the doors with the ignition key or transmitter.

### **\* NOTICE**

**Avoid trying to start the engine while the alarm is activated. The vehicle starting motor is disabled during the theft-alarm stage.**

### **Disarmed stage**

The system will be disarmed when the doors are unlocked by depressing the unlock button on the transmitter or unlocked with the ignition key.

After depressing unlock button, the hazard warning lights will blink twice to indicate that the system is disarmed.

After depressing unlock button, if any door is not opened within 30 seconds, the system will be rearmed.

If the system is not disarmed with the ignition key or transmitter, insert the key in the ignition switch, turn the key to the ON position and wait for 30 seconds. Then the system will be disarmed.



## IMMOBILIZER SYSTEM (IF EQUIPPED)

Your vehicle is equipped with an electronic engine immobilizer system to reduce the risk of unauthorized vehicle use.

Your immobilizer system is comprised of a small transponder in the ignition key, and antenna coil in the key cylinder and Immobilizer Control Unit (or Smartra Unit).

With this system, whenever you insert your ignition key into the ignition switch and turn it to ON, the antenna coil in the ignition switch receives a signal from the transponder in the ignition key and then sends the signal to the ECU (Engine Control Unit).

The ECU checks the signal whether the ignition key is valid.

If the key is determined to be valid, the engine will start.

If the key is determined to be invalid, the engine will not start.

### To deactivate the immobilizer system:

Insert the ignition key into the key cylinder and turn it to the ON position.

### To activate the immobilizer system:

Turn the ignition key to the OFF position. The immobilizer system activates automatically. Without a valid ignition key for your vehicle, the engine will not start.

### \* NOTICE

**When starting the engine, do not use the key with other immobilizer keys in close proximity to your vehicle's ignition switch, otherwise the engine may not start or may stop soon after it starts.**

### \* NOTICE

**If you need additional keys or lose your keys, consult your authorized Hyundai dealer.**

### Limp home (override) procedure

When you turn the ignition key to the ON position, if the immobilizer indicator () goes off after blinking 5 times, your transponder equipped in the ignition key is out of order. You cannot start the engine without the limp home procedure. To start the engine, you have to input your password by using the ignition switch.

The following procedure is how to input your password of "2345" as an example.

1. Turn the ignition key to the ON position. The immobilizer indicator () will blink 5 times and go off indicating the beginning of the limp home procedure.
2. Turn the ignition key to the ACC position.
3. To enter the first digit (in this example "2"), turn the ignition key to the ON and ACC position twice. Perform the same procedure for the next digits between 3 seconds and 10 seconds (for example, for "3", turn the ignition ON and ACC 3 times).

4. If all of the digits have been input successfully, you have to start the engine within 30 seconds. If you attempt to start the engine after 30 seconds, the engine will not start and you will have to input your password again.

After performing the limp home procedure, you have to see an authorized Hyundai dealer immediately to inspect and repair your ignition key or immobilizer system.

### **⚡ CAUTION**

*The transponder in your ignition key is an important part of the immobilizer system. It is designed to give years of trouble-free service, however you should avoid exposure to moisture, static electricity and rough handling.*

### **⚡ CAUTION**

*Do not change, alter or adjust the immobilizer system because it could cause the immobilizer system to malfunction. The system should only be serviced by an authorized Hyundai dealer.*

*Malfunctions caused by improper alterations, adjustments or modifications to the immobilizer system are not covered by your vehicle manufacturer warranty.*

**This device complies with Part 15 of the FCC rules.** Operation is subject to the following two conditions:

1. This device may not cause harmful interference, and
2. This device must accept any interference received, including interference that may cause undesired operation.

### **⚡ CAUTION**

*Changes or modifications not expressly approved by the party responsible for compliance could void the user's authority to operate the equipment.*

## DOOR LOCKS

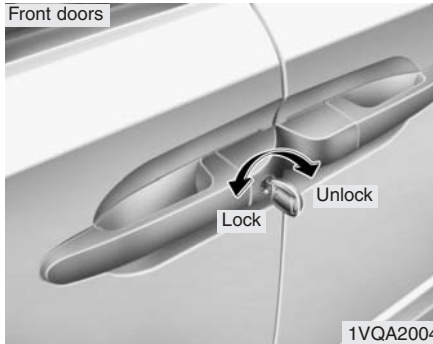

### Operating door locks from outside the vehicle

- Turn the key toward rear of vehicle to unlock and toward front of vehicle to lock.
- Turn the key toward front of vehicle to lock all doors.
- From the driver's door, turn the key to the right once to unlock the driver's door and to the right twice within 3 seconds to unlock all doors.
- From the passenger's door, turn the key to the left once to unlock the passenger's door and to the left twice within 3 seconds to unlock all doors.

- Doors can also be locked and unlocked with the transmitter key (if equipped).
- Once the doors are unlocked, they may be opened by pulling the door handle.
- To close the door, push the door by hand. Make sure that doors are closed securely.

### **⚠ WARNING**

**In cold and wet climates, door lock and door mechanisms may not work properly due to freezing conditions. Be sure that all the doors are securely closed before driving the vehicle.**

### **⚠ WARNING**

**Doors should be kept locked and the keys should be kept out of the reach of children. Never let children play in or around an unattended vehicle. Even very young children may inadvertently cause the vehicle to move or entangle themselves in the windows. Parents must teach their children about the dangers of playing in unattended vehicles.**

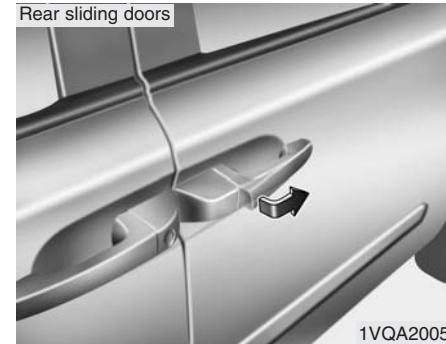

- Once the rear doors are unlocked, they may be opened by pulling the door handle and sliding the door towards the rear of the vehicle.
- When the rear door is fully open, the door will lock into an open position. To close the door, pull out the door handle and slide the door towards the front of vehicle.
- If the window on the rear sliding door is open (more than 3 in./80 mm), the rear sliding door will not open fully, but will open to the 3/4 position.

**⚠ WARNING**

When the rear sliding door is not fully open, it is not latched and may move unintentionally. This could result in a serious injury.

**⚠ CAUTION**

*The left sliding door cannot be opened when the fuel filler lid is open. However, if the fuel filler lid is opened after the door is opened slightly, the left sliding door can be slide rearward. Close the left sliding door to prevent possible damage to the door or the fuel filler lid.*

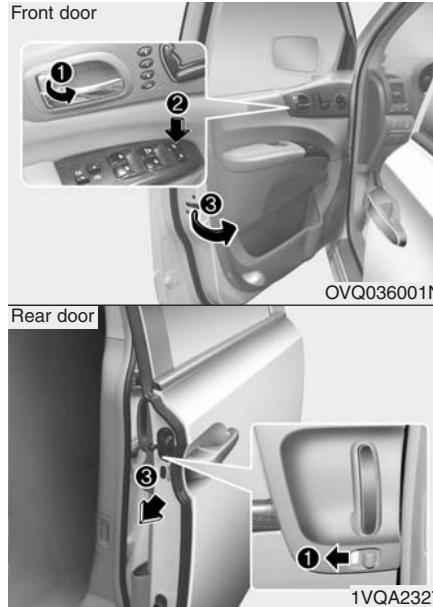

To lock a door without the key, push the inside door lock button (1) or door lock switch (2) to the “Lock” position and close the door (3).

**⚠ WARNING**

Always remove the ignition key, engage the parking brake, close all windows and lock all doors when leaving your vehicle unattended.

**\* NOTICE**

If the door is locked/unlocked multiple times in rapid succession with either the vehicle key or door lock switch, the system may stop operating temporarily in order to protect the circuit and prevent damage to system components.

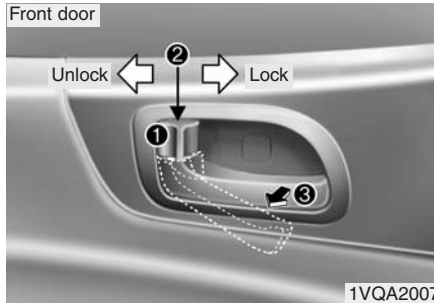

### Operating door locks from inside the vehicle

#### With the door lock button

- To unlock a door, pull the door lock button (1) to the “Unlock” position. If the door is unlocked, the red part (2) of the button becomes visible.

- To lock a door, push the door lock button (1) to the “Lock” position. If the door is locked, red part (2) of the button is not visible.
- To open a door, pull the door handle (3).
- If the inner door handle of the front door is pulled when the door lock button is in lock position, the button is unlocked and door opens. (if equipped)
- Front doors cannot be locked if the ignition key is in the ignition switch and door is open.

### **⚠ WARNING - Door lock malfunction**

**If a power door lock ever fails to function while you are in the vehicle, try one or more of the following techniques to exit:**

- **Operate the door unlock feature repeatedly (both electronic and manual) while simultaneously pulling on the door handle.**
- **Operate the other door locks and handles, front and rear.**
- **Lower a front window and use the key to unlock the door from outside.**

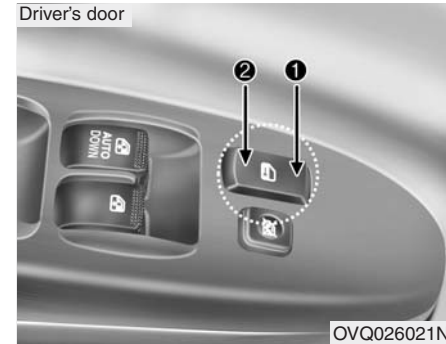

#### With central door lock switch

The central door locking switch is located on the front door arm rest. It is operated by depressing the door lock switch. If any door is open when the switch is depressed (1), the door will remain locked when closed.

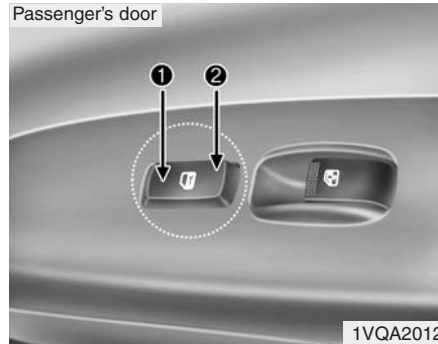

- When pushing down on the front portion (1) of the switch, all vehicle doors will lock.
- When pushing down on the rear portion (2) of the switch, all vehicle doors will unlock.
- However, if the key is in the ignition switch and any front door is open, the doors will not lock when the front portion of central door lock switch is pressed.

### **⚠ WARNING - Doors**

- The doors should always be fully closed and locked while the vehicle is in motion to prevent accidental opening of the door.
- Be careful when opening doors and watch for vehicles, motorcycles, bicycles or pedestrians approaching the vehicle in the path of the door. Opening a door when something is approaching can cause damage or injury.

### **⚠ WARNING - Unlocked vehicles**

Always remove the ignition key, engage the parking brake, close all windows and lock all doors when leaving your vehicle unattended.

### **⚠ WARNING - Unattended children**

- **NEVER** leave any child or animal unattended in the vehicle. Even very young children may inadvertently cause the vehicle to move, entangle themselves in the windows, or otherwise injure themselves or others.
- An enclosed vehicle can become extremely hot, causing death or severe injury to unattended children or animals who cannot escape the vehicle.



### Child-protector rear door lock

The child safety lock is provided to help prevent children from accidentally opening the rear doors from inside the vehicle. The rear door safety locks should be used whenever children are in the vehicle.

1. Open the rear door.
2. Push the child safety lock located on the front edge of the door to the "Lock" position. When the child safety lock is in the "Lock (🔒)" position, the rear door will not open when the inner door handle is pulled inside the vehicle or the sub control button of the power sliding door is pressed.

### 3. Close the rear door.

To open the rear door, pull the outside door handle or push the main control button of the power sliding door.

Even though the doors may be unlocked, the rear door will not open by pulling the inner door handle or pushing the sub control button until rear door child safety lock is unlocked (🔓).

### **⚠️ WARNING - Rear door locks**

**If children accidentally open the rear doors while the vehicle is in motion, they could fall out and be severely injured or killed. To prevent children from opening the rear doors from the inside, the rear door seat locks should be used whenever children are in the vehicle.**

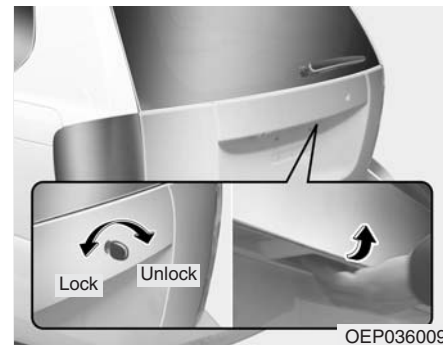

### Tailgate

#### *Opening the tailgate*

- Tailgate is locked or unlocked with a key.
  - If you lock the tailgate with a key, all doors will lock automatically.
  - If you unlock the tailgate with a key, only the tailgate will unlock.
  - To open the tailgate, insert the key into the lock, turn it to the unlock position and pull up the tailgate by pressing the handle.
- You can also lock/unlock the latch (but not release it) with the central door lock system.
- If unlocked, the tailgate can be opened by pressing the handle and pulling it up.



1VQA2010

### ***Closing the tailgate***

To close the tailgate, lower and push down the tailgate firmly. Make sure that the tailgate is securely latched.

### **⚠ WARNING**

In cold and wet climates, door lock and door mechanisms may not work properly due to freezing conditions. Be sure that all the doors are securely closed before driving the vehicle.

### **⚠ WARNING - Tailgate**

The tailgate swings upward. Make sure no objects or people are near the rear of the vehicle when opening the tailgate.

### **⚠ CAUTION**

*Make certain that you close the tailgate before driving your vehicle. Possible damage may occur to the tailgate lift cylinders and attaching hardware if the tailgate is not closed prior to driving.*

### **⚠ WARNING - Exhaust fumes**

The tailgate should always be kept completely closed while the vehicle is in motion. If it is left open or ajar, poisonous exhaust gases may enter the car resulting in serious illness or death to the occupants. See additional warnings concerning exhaust gases on page 4-2.

### **⚠ WARNING - Rear cargo area**

Occupants should never ride in the rear cargo area where no restraints are available. To avoid injury in the event of an accident or sudden stops, occupants should always be properly restrained.



## POWER SLIDING DOOR AND POWER TAILGATE (IF EQUIPPED)

On the overhead console



1VQA2014

On the center pillar trim

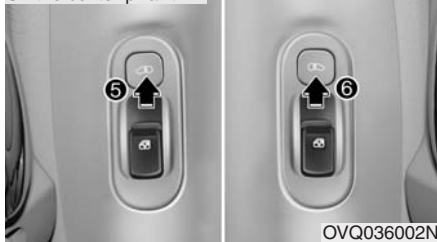

OVQ036002N

On the tailgate



1VQA2016

- (1) Left power sliding door main control button
- (2) Right power sliding door main control button
- (3) Power tailgate main control button\*
- (4) Power ON/OFF button
- (5) Left power sliding door sub control button
- (6) Right power sliding door sub control button
- (7) Power tailgate sub control button\*

\*: if equipped

The power sliding doors and power tailgate can be opened and closed automatically with the transmitter key, the main control buttons on the overhead console or the sub control buttons on the center pillar trim.

When the power ON/OFF button (PWR) is OFF (not depressed), the power sliding door and power tailgate can be opened and closed manually by pulling the door handles from inside or outside vehicle.

### **⚠ WARNING**

**Never leave children or animals unattended in your vehicle. Children or animals might operate the power sliding door or power tailgate that could result in injury to themselves or others or damage to the vehicle.**

### \* NOTICE

If the power sliding door or power tailgate is open approximately 6 hours, the ECU will enter a “sleep” (energy conserving) mode to conserve battery power. The door or tailgate will not close automatically in this mode. Close the door or tailgate manually and then operate the door or tailgate with the power operating system.

### \* NOTICE

In cold and wet climates, power sliding doors and tailgate may not work properly due to freezing conditions.

### \* NOTICE

When the sliding doors are opened manually (power OFF), more effort will be required to open and close the doors than on models not equipped with power sliding doors.

### \* NOTICE

- The power sliding door and power tailgate can be operated when the engine is not running. However the power operation consumes large amounts of vehicle electric power. To prevent the battery from being discharged, do not operate them excessively e.g.: more than approximately 10 times repeatedly.
- To prevent the battery from being discharged, do not leave the power sliding door and power tailgate in the open position for a long time.
- Do not apply excessive force while operating the power sliding door or power tailgate. This could cause damage to the power sliding door or power tailgate.
- Do not modify or repair any part of the power sliding door or power tailgate by yourself. This must be done by an authorized Hyundai dealer.
- When jacking up the vehicle to change a tire or repair the vehicle, do not operate the power sliding door or power tailgate. This could damage the power sliding door or power tailgate.

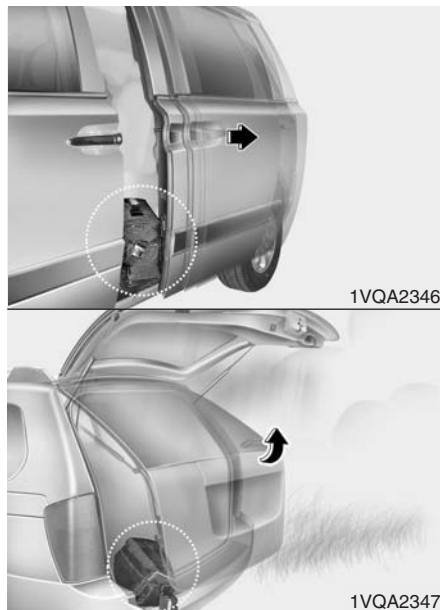

### *Automatic stop and reversal*

If the path of the power sliding door or tailgate is blocked during operation, the power sliding door and power tailgate will detect the resistance, a chime will sound 3 times, and the door or tailgate will stop or move to the full open position to allow the path to be cleared.

However, if the resistance is weak (such as an object that is thin or soft) or the door is in a near latched position, the automatic stop and reversal feature may not detect the resistance and the closing operation will continue. Also, if the power sliding door or power tailgate is forced by a strong impact, the automatic stop and reversal feature may operate.

If the automatic stop and reversal feature operates continuously more than twice during one opening or closing operation, the power sliding door or power tailgate may stop at that position. At this time, close the doors manually and operate the door automatically again.

**⚠ WARNING**

- Never intentionally place any object or part of your body in the path of the power sliding door or power tailgate.
- Make sure rear passengers are seated and there are no people or objects near the door before operating the power sliding door.
- Make sure all faces, arms, hands, body parts and any other obstructions are safely out of the way before operating the power sliding doors or power tailgate.
- Never place any object or part of your body in the path of the power sliding door or power tailgate. This could result in serious injury or cause damage to the vehicle.
- Make sure there are no people or objects around the door before operating the power sliding door or power tailgate. Have rear passengers get in or out of the vehicle after the door is opened completely and door motion has stopped.

On the driver's side fuse panel

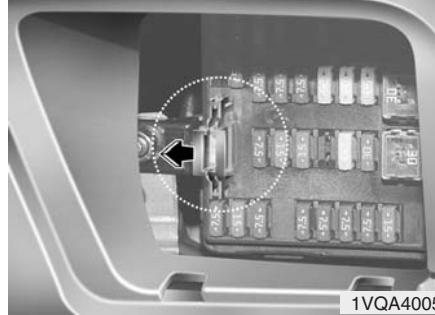
***How to reset the power sliding door and power tailgate***

If the battery has been discharged or disconnected, the related fuse has been replaced or disconnected, and the power sliding door or power tailgate doesn't work properly, the power sliding door and power tailgate must be reset as follows:

1. Put the shift lever in the P (Park) for automatic transaxle.
2. Close the sliding door's windows and fuel filler lid.

3. Pull the SHUNT connector on the driver's side fuse panel and reinstall it after 1 minute.
4. Close the sliding door or tailgate manually.
5. Open the sliding door or tailgate completely using the transmitter or main control button on the overhead console.
6. Close the sliding door or tailgate completely using the transmitter or main control button on the overhead console.

For the left/right power sliding doors and power tailgate, follow above steps to reset.

If the power sliding door or power tailgate doesn't work properly after above procedure, have the system checked by an authorized Hyundai dealer.

**\* NOTICE**

If the shunt connector is pulled up from the fuse panel, the warning chime, audio, clock and interior lamps, etc., will not operate. Some items must be reset after replacement. (Refer to "Items to be reset..." on page 6-36)



### **Power ON/OFF button**

- When the power ON/OFF button (PWR) is ON (depressed), the power sliding door and power tailgate can be controlled with the sub control buttons on the center pillar trim or tailgate. Also, the doors can be opened and closed automatically by pulling the inside or outside door handles.

- When the power ON/OFF button (PWR) is OFF (not depressed), the power sliding door and power tailgate can not be controlled with the sub control buttons or door handles. However, the doors can be controlled with the transmitter or the main control buttons on the overhead console even though the power ON/OFF button (PWR) is OFF (not depressed).

Also, the doors can be opened and closed manually by pulling the inside or outside door handles.

### **⚠ WARNING**

- Keep the power ON/OFF button (PWR) in the OFF (not depressed) position when not in use.
- Do not allow children to play with the power sliding door or power tailgate. Keep the power ON/OFF button (PWR) in the OFF (not depressed) position when not in use. Serious injury or death can result from unintentional power operation by child.

### **\* NOTICE**

Close the sliding door and tailgate, and keep the power ON/OFF button (PWR) in the OFF (not depressed) position before washing the vehicle in an automatic car wash.

### **\* NOTICE**

When the sliding doors are opened manually (power OFF), more effort will be required to open and close the doors than on models not equipped with power sliding doors.

On the overhead console



### ***Power sliding door operation***

- Push the corresponding main control button on the overhead console to open or close the power sliding door. The power sliding door will not open with the transmitter or the main control button when all power sliding doors and power tailgate are locked and closed.

On the center pillar trim



- When the power ON/OFF button (PWR) is ON (depressed), do as follows to open or close the power sliding doors:
  - Push the corresponding sub control button on the center pillar trim.
  - Pull the door handle from inside or outside vehicle.
  - If the sub control button is pushed while the door is locked or child safety lock is engaged, the chime sounds once, and the power sliding door will not open.
- If the door handle is pulled from inside or outside while the door is locked or child safety lock is engaged, the power sliding door will not open. However, the power sliding door can be opened by pulling the outside door handle while the door is unlocked and child safety lock is engaged.
- When the power ON/OFF button (PWR) is OFF (not depressed), the power sliding door can not be controlled with the sub control buttons or door handles, and if the sub control button is pushed, chime sounds once. However, the doors can be opened and closed manually by pulling the door handles from inside or outside vehicle.
- On a steep grade, the power sliding door will slide faster when closing. And chime may sound and the drive unit motor may operate additionally for a moment after the door is closed. This is a normal operation to ensure door closing, not a malfunction.



OEP036004

### **⚠ WARNING**

If your vehicle is facing downward on a steep grade (15 percent or more), the door may not stay open and could slam shut, possibly injuring someone. To make sure the door does not slam shut, turn on the power sliding door feature. Then when the door closes, it will close under the control of the power door system.

### **⚠ WARNING**

If children accidentally open the sliding doors while the vehicle is in motion, they could fall out and be severely injured or killed. To prevent children from opening the sliding doors from the inside, the child seat locks should be used whenever children are in the vehicle.

### **⚠ WARNING**

When the rear passenger operates the power sliding door, make sure there are no people or objects around the door, and have all occupants get in or out of the vehicle after the door is opened completely and door motion has stopped.

### **⚠ WARNING**

- Rear passengers should get in or out of the vehicle only after the door is completely opened. Sudden closing could cause a serious injury.
- Close the door by pulling the door handle after the door is completely opened. Do not pull the door handle while rear passengers are getting in or out. The door could suddenly close by itself and cause a serious injury.
- Sudden starting or accelerating the vehicle while the door is closing could cause it to open resulting in a serious injury or damage to cargo.

- If the window on the power sliding door is open (more than 3 in./80 mm), the power sliding door will not power open fully but will open to the 3/4 position and the chime will sound 3 times. To close the door, use the transmitter or main control button with the power ON/OFF button in OFF position (not depressed), or sub control button or door handle with the power ON/OFF button in ON position (depressed).

 **WARNING**

**Do not leave the power sliding door in a partially opened position. Close the window and then open the door fully. A partially opened door is held and then released after 10 minutes. The chime sounds 3 times to indicate the door is released. If the vehicle is stopped on a downward slope, it may move and cause an injury.**

- The left power sliding door cannot be opened while the fuel filler lid is open fully. If the main or sub control button is pushed, the chime sounds once. Also, if the fuel filler lid open button is pushed while the left power sliding door is opening, the chime sounds once.

**\* NOTICE**

**If the fuel filler lid is opened when the left sliding door is not closed completely, the door may be opened. Close the left sliding door before refueling to prevent possible damage to the door or the fuel filler lid.**

- If the power sliding door is not closed and latched completely after power closing operation, the chime sounds 3 times. Open and close the door again.
  - If the power sliding door is operated while the door is in partially opened position (less than 12 in./300 mm), the door is automatically opened fully.
  - If the power sliding door is operated while the door is in half-opened position (more than 12 in./300 mm), the door is automatically closed completely.
- If the power sliding door is operated again while the door is closing, the door is automatically opened fully.
  - If the power sliding door is operated again while the door is opening, the door is automatically closed completely. However, if the power sliding door is operated again when the door is in partially opened position (less than 12 in./300 mm), the door is opened continuously.
  - The half-opened power sliding door is automatically opened or closed fully by pushing the door forward or backward without pulling the door handle while the power ON/OFF button is in ON (depressed). However, when the door is in a partially opened position (less than 12 in./300 mm), the door will not close automatically.

### Power sliding door non-opening conditions

When the ignition switch is in the ON position, the power sliding door will only automatically close under the following conditions:

1. Vehicle is moving above 3 mph (5 km/h).
2. The gearshift lever is not in P (Park) for automatic transaxle.

Under these conditions, if the main or sub control buttons are pushed when the power sliding door is closed, the chime will sound.

### **⚠ WARNING**

**Do not open the sliding doors while the vehicle is in motion. Passengers or cargo may be ejected from the vehicle, possibly resulting in property damage, severe injury, or death.**



### **Power tailgate operation (if equipped)**

- Push the power tailgate main control button on the overhead console to open or close the power tailgate. The power tailgate will not open with the transmitter or the main control button when all power sliding doors and power tailgate are locked and closed.
- When the power tailgate is operated with the main or sub control button or transmitter, the chime sounds and hazard warning lights flash 3 times.



- When the power ON/OFF button (PWR) is ON (depressed), do as follows to open or close the power tailgate:
  - Push the sub control button on the bottom of the tailgate to close the power tailgate automatically.
  - Press and pull up the tailgate handle slightly to open the power tailgate automatically when the tailgate is unlocked.



- When the power ON/OFF button (PWR) is OFF (not depressed), the power tailgate cannot be controlled with the sub control buttons or tailgate handle, and if the sub control button is pushed, the chime sounds once.

The tailgate may be opened manually by pulling the exterior handle and lifting the tailgate upward. The tailgate may be manually closed by pushing the tailgate downward.

### WARNING

Even though the power ON/OFF button (PWR) is in the OFF (not depressed) position, the tailgate will still be propelled upward by mechanical force if the tailgate is manually opened more than 20 degrees beyond the fully closed position. In addition, if the tailgate is manually closed to the secondary latched position, the tailgate will be electrically moved to the fully latched position. Make sure that face, arms, hands, and other obstructions are safely out of the way before operating the tailgate.

### WARNING

**Make sure there are no people or objects around the tailgate before operating the power tailgate. Wait until the tailgate is open fully and stopped before loading or unloading cargo or passengers from the vehicle.**

### WARNING

**Make sure the tailgate is closed firmly before driving. If the tailgate is open, you will draw dangerous exhaust fumes into your vehicle which can cause serious injury or death to vehicle occupants.**

- If the power tailgate is not closed and latched completely after power closing operation, the chime sounds 3 times.
- If the power tailgate is operated while the tailgate is in partially opened position (less than 20 degrees), the tailgate is automatically opened fully. If the power tailgate is operated while the tailgate is in half-opened position (more than 20 degrees), the tailgate is automatically closed completely.

- If the power tailgate is operated again while the tailgate is closing, the tailgate is automatically opened fully.
- If the power tailgate is operated again while the tailgate is opening, the tailgate is automatically closed completely. However, if the power tailgate button is pressed again when the tailgate is open less than 20 degrees, the tailgate will continue to open.

### *Power tailgate non-opening conditions*

When the ignition switch is in the ON position, the power tailgate will only automatically close under the following conditions:

1. Vehicle is moving above 3 mph (5 km/h).
2. The gearshift lever is not in P (Park) for automatic transaxle.

Under these conditions, if the main or sub control buttons are pushed when the power tailgate is closed, the chime will sound.

## WINDOWS

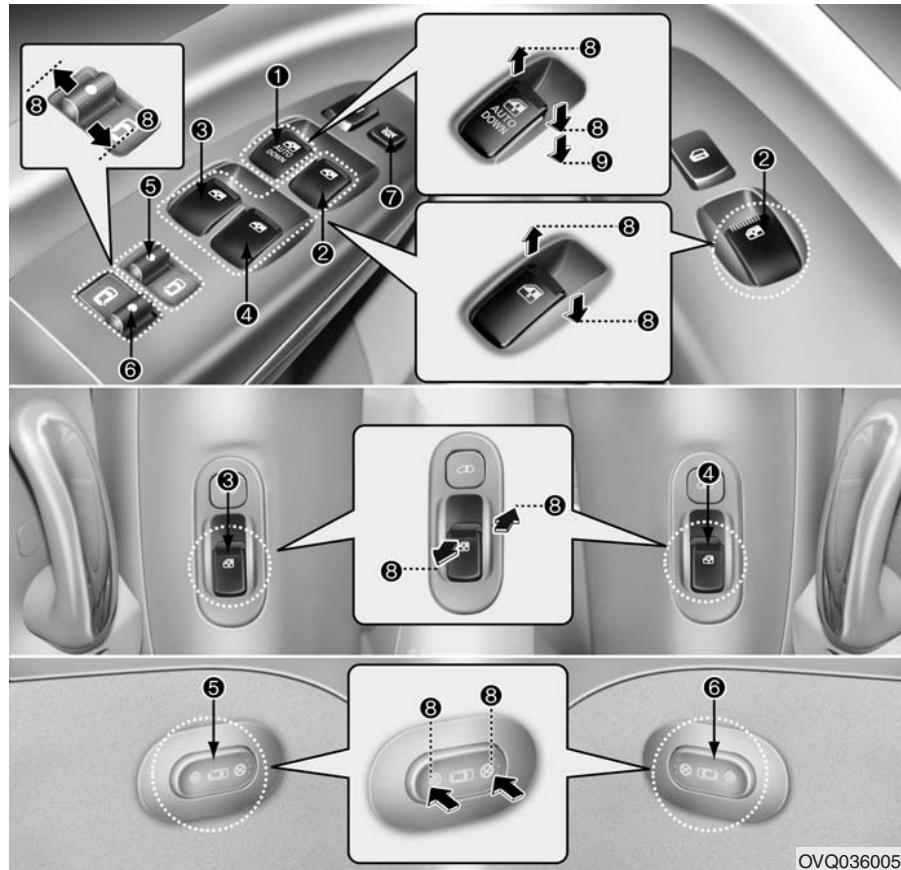

### Power windows

- (1) Driver's door power window switch
- (2) Front passenger's door power window switch
- (3) Rear door (left) power window switch
- (4) Rear door (right) power window switch
- (5) Power rear quarter window (left) switch\*
- (6) Power rear quarter window (right) switch\*
- (7) Power window lock switch
- (8) Window opening and closing
- (9) Automatic power window down (Driver's window)

\*: if equipped

### \* NOTICE

In cold and wet climates, power windows may not work properly due to freezing conditions.

OVQ036005N

The ignition switch must be in the ON position for power windows to operate. Each door has a power window switch that controls that door's window. The driver has a power window lock switch which can block the operation of passenger windows.

The power windows can be operated for approximately 30 seconds after the ignition key is removed or turned to the ACC or LOCK position. However, if the front doors are opened, the power windows cannot be operated within the 30 seconds after the ignition key removal.

While driving, if you notice wind buffeting or pulsation (wind shock) with either side window open, you should open the opposite window slightly to reduce the condition.

### CAUTION

- *To prevent the power window system from the possibility of damage, do not open or close two windows at the same time. This will also ensure the longevity of the fuse.*

*(Continued)*

### *(Continued)*

- *Never try to operate the main switch on the driver's door and the individual door window switch in opposing directions at the same time. If this is done, the window will stop and cannot be opened or closed.*

### WARNING - Windows

- **Passengers can be injured if their head, hands or other body parts are trapped by a closing window. Always check for obstructions before raising any window.**
- **NEVER leave the ignition key in the vehicle.**
- **NEVER leave any child unattended in the vehicle. Even very young children may inadvertently cause the vehicle to move, entangle themselves in the windows, or otherwise injure themselves or others.**

*(Continued)*

### *(Continued)*

- **Do not attempt to operate the main switch on the driver's door and a switch on another door in opposing directions at the same time. If this is done, the window will stop and cannot be opened or closed.**
- **Do not allow children to play with the power windows. Keep the driver's door power window lock switch in the LOCK position (depressed). Serious injury can result from unintentional window operation by the child.**
- **Do not extend head, hands or arms outside through the window opening while driving.**

### *Window opening and closing*

The driver's door has a master power window switch that controls all the windows in the vehicle.

- To open or close a window, press down (8) or pull up (8) the front portion of the corresponding switch.
- To open or close a rear quarter window, push (8) the corresponding switch.

### Automatic power window down (driver's window)

Depressing the power window switch momentarily to the second detent position (9) completely lowers the driver's window even when the switch is released. To stop the window at the desired position while the window is in operation, pull up the switch momentarily to the opposite direction of the window movement.

If the power window is not operating correctly, the automatic power window system can be reset as follows:

1. Turn the ignition key to ON position.
2. Close driver's window and continue pulling up on driver's power window switch for at least 1 second after the window is completely closed.

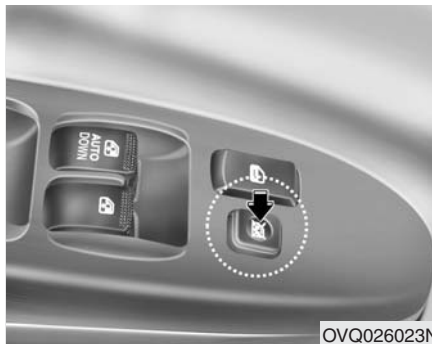

### Power window lock switch

- The driver can disable the power window switches on a passenger door or rear quarter trim by depressing the power window lock switch located on the driver's door to LOCK (pressed).
- **When the power window lock switch is ON, the driver's master control cannot operate the passenger door power windows or rear quarter windows either.**

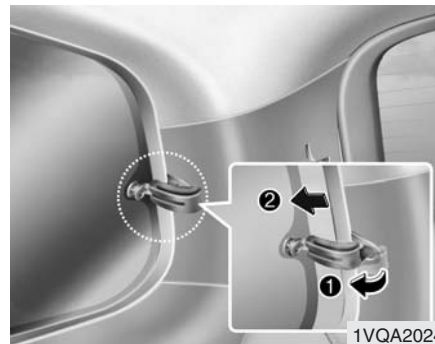

### Manual flip - open (rear quarter windows, if equipped)

To open the quarter windows, pull the rear portion of the latch out. Swing the latch forward and out, then lock it into the open position by pushing outward until you hear a click. To close the windows, pull the handle inward. Then push the handle rearward until you hear a click.

### \* NOTICE

In cold and wet climates, rear quarter panel windows may not work properly due to freezing conditions.

## HOOD

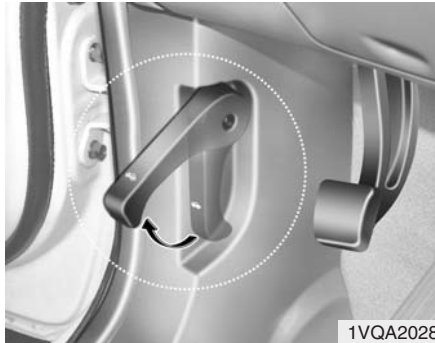

### Opening the hood

1. Pull the release lever to unlatch the hood. The hood should pop open slightly.

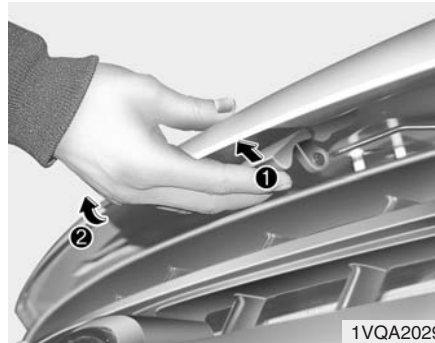

2. Go to the front of the vehicle, raise the hood slightly, pull the secondary latch release lever (1) inside of the hood center and lift (2) the hood.
3. Raise the hood. It will raise completely by itself after it has been raised about halfway.

### Closing the hood

1. Before closing the hood, check the following:
  - All filler caps in engine compartment must be correctly installed.
  - Gloves, rags or any other combustible material must be removed from the engine compartment.
2. Lower the hood halfway and push down to securely lock in place.

#### **⚠ WARNING**

**Make sure the hood is properly locked before driving.**

#### **⚠ WARNING - Hood**

- Before closing the hood, ensure that all obstructions are removed from the hood opening. Closing the hood with an obstruction present in the hood opening may result in property damage or severe personal injury.
- Do not leave gloves, rags or any other combustible material in the engine compartment. Doing so may cause a heat-induced fire.

## FUEL FILLER LID

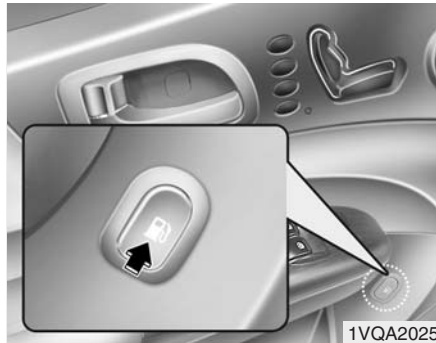

1. Stop the engine.
2. To open the fuel filler lid, push the release button located on the driver's lower door.

### **⚠ WARNING**

To avoid injury from sharp edges, it is recommended that protective gloves be worn if there is a need to open the fuel filler door manually.



3. Pull the fuel filler lid out to open.
4. To remove the cap, turn the fuel tank cap counterclockwise.
5. Refuel as needed.
6. To install the cap, turn it clockwise until it "clicks". This indicates that the cap is securely tightened.
7. Close the fuel filler lid and push it lightly and make sure that it is securely closed.

### **⚠ WARNING - Refueling**

- Always remove the fuel cap carefully and slowly. If the cap is venting fuel or if you hear a hissing sound, wait until the condition stops before completely removing the cap.
- Do not "top off" after the nozzle automatically shuts off when refueling.
- Tighten the cap until it clicks, otherwise the "CHECK" light will illuminate.
- Always check that the fuel cap is installed securely to prevent fuel spillage in the event of an accident.

**⚠ WARNING - Refueling dangers**

Automotive fuels are flammable materials. When refueling, please note the following guidelines carefully. Failure to follow these guidelines may result in severe personal injury, severe burns or death by fire or explosion.

- Before refueling note the location of the Emergency Gasoline Shut-Off, if available, at the gas station facility.
- Before touching the fuel nozzle, you should eliminate potentially dangerous static electricity discharge by touching another metal part of the vehicle, a safe distance away from the fuel filler neck, nozzle, or other gas source.

(Continued)

(Continued)

- Do not get back into a vehicle once you have begun refueling since you can generate static electricity by touching, rubbing or sliding against any item or fabric (polyester, satin, nylon, etc.) capable of producing static electricity. Static electricity discharge can ignite fuel vapors resulting in rapid burning. If you must re-enter the vehicle, you should once again eliminate potentially dangerous static electricity discharge by touching a metal part of the vehicle, away from the fuel filler neck, nozzle or other gasoline source.
- When using an approved portable fuel container be sure to place the container on the ground prior to refueling. Static electricity discharge from the container can ignite fuel vapors causing a fire. Once refueling has begun, contact with the vehicle should be maintained until the filling is complete.

(Continued)

(Continued)

Use only approved portable plastic fuel containers designed to carry and store gasoline.

- Do not use cellular phones while refueling. Electric current and/or electronic interference from cellular phones can potentially ignite fuel vapors causing a fire.
- When refueling, always shut the engine off. Sparks produced by electrical components related to the engine can ignite fuel vapors causing a fire. Once refueling is complete, check to make sure the filler cap and filler door are securely closed, before starting the engine.
- DO NOT use matches or a lighter and DO NOT SMOKE or leave a lit cigarette in your vehicle while at a gas station especially during refueling. Automotive fuel is highly flammable and can, when ignited, result in fire.

(Continued)

### (Continued)

- If a fire breaks out during refueling, leave the vicinity of the vehicle, and immediately contact the manager of the gas station and then contact the local fire department or 911. Follow any seat instructions they provide.

### **CAUTION**

- *Make sure to refuel with unleaded fuel only.*
- *Check to make sure the fuel filler cap is securely closed after refueling. A loose fuel filler cap may cause the "Check Engine" (Malfunction Indicator) light in the instrument panel to illuminate unnecessarily.*
- *If the fuel filler cap requires replacement, use only a genuine Hyundai cap or the equivalent specified for your vehicle. An incorrect fuel filler cap can result in a malfunction of the fuel system or emission control system.*
- *Do not spill fuel on the exterior surfaces of the vehicle. Any type of fuel spilled on painted surfaces may damage the paint.*
- *If the fuel filler lid will not open in cold weather because the area around it is frozen, push or lightly tap the lid.*



### **When fuel filler lid does not open with the release button**

If the fuel filler lid does not open using the remote fuel filler lid release, you can open it manually. Unsnap and remove the panel in the cargo area. Pull the handle outward.



## SUNROOF (IF EQUIPPED)



- (1) Slide button
- (2) Tilt button
- (3) Close button

If your vehicle is equipped with this feature, you can slide or tilt your sunroof with the sunroof control buttons located on the overhead console.

### \* NOTICE

In cold and wet climates, the sunroof may not work properly due to freezing conditions.

The sunroof can only be opened, closed, or tilted when the ignition switch is in the ON position.

The sunroof can be operated for approximately 30 seconds after the ignition key is removed or turned to the ACC or LOCK position. However, if the front door is opened, the sunroof cannot be operated even within the 30 seconds after the ignition key is removed or turned to the ACC or LOCK position.

### **CAUTION**

*Do not continue to press the sunroof control button(s) after the sunroof is in the fully open, closed, or tilt position(s). Damage to the motor or system components could occur.*

### \* NOTICE

The sunroof cannot slide when it is in the tilt position nor can it be tilted while in an open or sliding position.



**Sliding the sunroof**

### *Open*

#### **Autoslide**

To use the autoslide feature, momentarily (less than 0.4 second) press the slide button on the overhead console.

The sunroof will slide all the way open. To stop the sunroof sliding at any point, press any sunroof control button.

#### **Manual slide**

Press the slide button on the overhead console and hold it until the sunroof is opened to the desired position.

### *Close*

To close the sunroof, press the close button on the overhead console and hold it until the sunroof is closed.



**Tilting the sunroof**

### *Open*

#### **Autotilt**

To use the autotilt feature, momentarily (less than 0.4 second) press the tilt button on the overhead console. The sunroof will tilt all the way open. To stop the sunroof tilting at any point, press any sunroof control button.

#### **Manual tilt**

Press the tilt button on the overhead console and hold it until the sunroof is opened to the desired position.

### *Close*

To close the sunroof, press the close button on the overhead console and hold it until the sunroof is closed.



### Sunshade

The sunshade will automatically open with the glass panel when the glass panel slides open. You will have to close it manually if you want it closed.

### **⚠ WARNING - Sunroof**

- Do not extend anyone's face, neck, arms or body outside through the sunroof opening while driving.
- Make sure everyone's hand and face are safely out of the way before closing a sunroof.

### **⚡ CAUTION**

- Do not press any sunroof control button longer than necessary. Damage to the motor or system components could occur.
- Periodically remove any dirt that may accumulate on the guide rail.
- If you try to open the sunroof when the temperature is below freezing or when the sunroof is covered with snow or ice, the glass or the motor could be damaged.
- The sunroof is made to slide together with the sunshade. Do not leave the sunshade closed while the sunroof is open.



### In case of an emergency

- If the sunroof does not open electrically:
1. Open the conversation mirror cover.



2. Remove the two (2) screws, and then remove the overhead console.
3. Insert the emergency handle (provided with the vehicle) and turn the handle clockwise to open or counterclockwise to close the sunroof.

### Resetting the sunroof

Whenever the vehicle battery is disconnected or discharged, or you use the emergency handle to operate the sunroof, you have to reset your sunroof system as follows:

1. Turn the ignition key to the ON position.
2. According to the position of the sunroof, do as follows.
  - 1) in case that the sunroof has closed completely or been tilted :  
Press the tilt button until the sunroof has tilted upward completely.
  - 2) in case that the sunroof has slide-opened:  
Press and hold the close button (for more than 5 seconds) until the sunroof has closed completely.  
Press the tilt button until the sunroof has tilted upward completely.
3. Release the tilt button.

4. Press and hold the tilt button (for more than 10 seconds) until the sunroof has returned to the original position of tilt after it is raised a little higher than the maximum tilt position. Then, release the button.
5. Press and hold the tilt button (for more than 5 seconds) until the sunroof is operated as follows;

TILT DOWN → SLIDE OPEN → SLIDE CLOSE

Then, release the button.

When this has been completed, the sunroof system will be reset.

## SEAT

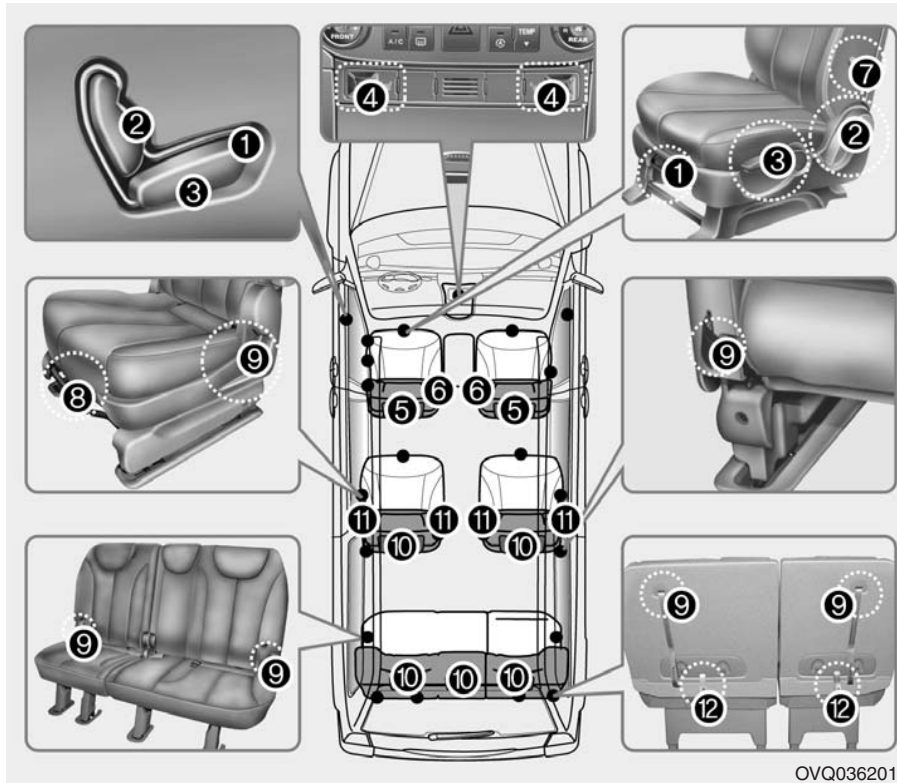

OVQ036201N

**Front seat**

- (1) Forward and backward
- (2) Seatback angle
- (3) Seat cushion height
- (4) Seat warmer\*
- (5) Headrest
- (6) Armrest
- (7) Lumbar support

**Rear seats**

- (8) Forward and backward
- (9) Seatback angle
- (10) Headrest
- (11) Armrest
- (12) Stowing\*

\* if equipped

**⚠ WARNING - Loose objects**  
 Loose objects in the driver's foot area could interfere with the operation of the foot pedals, possibly causing an accident. Do not place anything under the front seats.

**⚠ WARNING - Uprighting seat**

When you return the seatback to its upright position, hold the seatback and return it slowly and be sure there are no other occupants around the seat. If the seatback is returned without being held and controlled, the back of the seat could spring forward resulting in accidental injury to a person struck by the seatback.

**⚠ WARNING - Driver's seat**

- Never adjust the driver's seat while the vehicle is moving. Any sudden or unexpected movement of the seat could cause you to lose control of the vehicle resulting in an accident. Only adjust the driver's seat when the vehicle is stationary.

(Continued)

(Continued)

- Do not allow anything to interfere with the normal position of the seatback. Storing items against a seatback or in any other way interfering with proper locking of a seatback could result in serious or fatal injury in a sudden stop or collision.
- Always drive and ride with your seatback upright and the lap portion of the seat belt snug and low across the hips. This is the best position to protect you in case of an accident.
- Do not sit or lean unnecessarily close to the air bag. Position the seat so that you can sit as far back as possible from the air bag and still comfortably reach all controls. The U.S. government recommends that your chest be at least 10 inches (250 mm) away from the steering wheel.
- After adjusting the seat, always check that it is securely locked into place by attempting to move the seat forward or reverse without using the lock release lever. Sudden or unexpected movement of the driver's seat could cause you to lose control of the vehicle resulting in an accident.

**⚠ WARNING - Rear Seatback**

- The rear seatback must be securely latched. If not, passengers and objects could be thrown forward resulting in serious injury or death in the event of a sudden stop or collision.
- Luggage and other cargo should be laid flat in the cargo area. If objects are large, heavy, or must be piled, they must be secured. Under no circumstances should cargo be piled higher than the seatbacks. Failure to follow these warnings could result in serious injury or death in the event of a sudden stop, collision or rollover.
- No passenger should ride in the cargo area or sit or lie on folded seatbacks while the vehicle is moving. All passengers must be in seats and restrained properly while riding.
- When resetting the seatback to the upright position, make sure it is securely latched by pushing it forward and backwards.
- To avoid the possibility of burns, do not remove the carpet in the cargo area. Emission controls beneath this floor generate high exhaust temperatures.

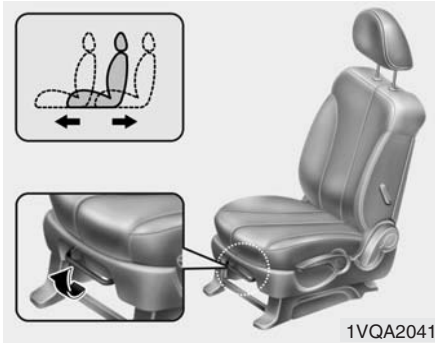

### Front seat adjustment - manual

#### *Forward and backward*

To move the seat forward or backward:

1. Pull the seat slide adjustment lever under the front edge of the seat cushion up and hold it.
2. Slide the seat to the position you desire.
3. Release the lever and make sure the seat is locked in place.

Adjust the seat before driving, and make sure the seat is locked securely by trying to move forward and backward without using the lever. If the seat moves, it is not locked properly.

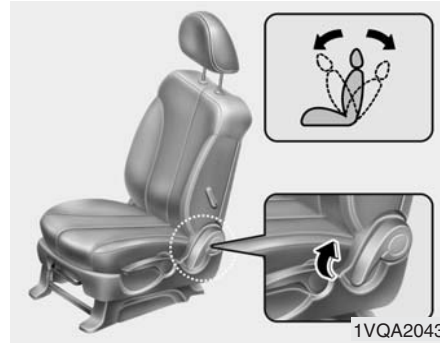

### *Seatback angle*

To recline the seatback:

1. Lean forward slightly and lift up on the seatback recline lever located on the outside of the seat, at the rear.
2. Carefully lean back on the seat and adjust the seatback of the seat to the position you desire.
3. Release the lever and make sure the seatback is locked in place. (The lever **MUST** return to its original position for the seatback to lock.)

### **⚠ WARNING - Driver responsibility for front seat passenger**

Riding with a reclined seatback increases your chance of serious or fatal injuries in the event of a collision or sudden stop. The protection of your restraint system (seat belts and air bags) is greatly reduced by reclining your seat. Seat belts must be snug against your hips and chest to work properly. The more the seatback is reclined, the greater the chance that an occupant's hips will slide under the lap belt causing serious internal injuries or the occupant's neck could strike the shoulder belt. Drivers and passengers should always sit well back in their seats, properly belted, and with the seatbacks upright.

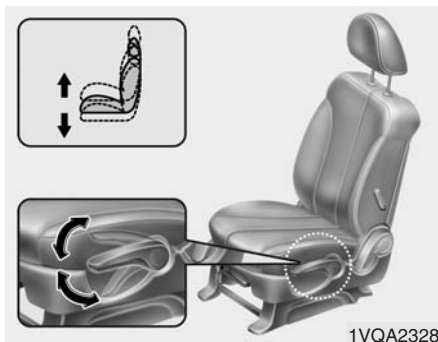

### Seat cushion height (for driver's seat)

To change the height of the seat cushion, push the lever located on the outside of the seat cushion up or down.

- To lower the seat cushion, push down the lever several times.
- To raise the seat cushion, pull up the lever several times.

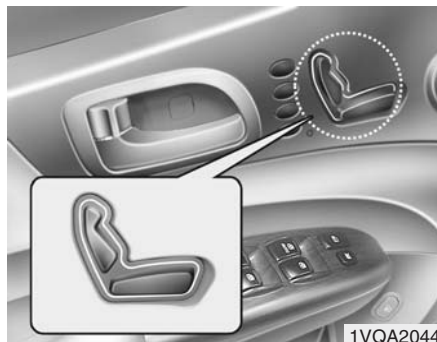

### Front seat adjustment - power

The front seat can be adjusted by using the control knob on the front door. Before driving, adjust the seat to the proper position so as to easily control the steering wheel, pedals and switches on the instrument panel.

### **CAUTION**

- *Power seats are driven by an electric motor. Stop operating once the adjustment is completed. Excessive operation may damage the electrical equipment.*
- *When in operation, the power seats consume large amounts of electrical power. To prevent unnecessary charging system drain, don't adjust the power seats longer than necessary while the engine is not running.*
- *Do not operate two or more power seat control buttons at the same time. Doing so may result in power seat motor or electrical component malfunction.*

### **WARNING**

The power seats are operable with the ignition OFF.

Therefore, children should never be left unattended in the car.



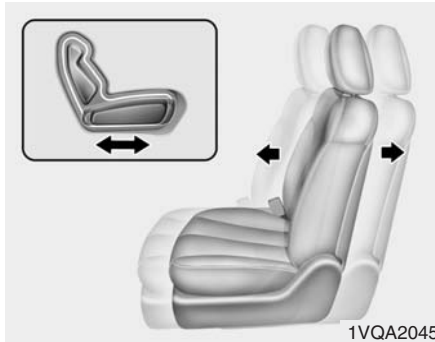

#### **Forward and backward**

Push the control knob forward or backward to move the seat to the desired position. Release the knob once the seat reaches to the desired position.

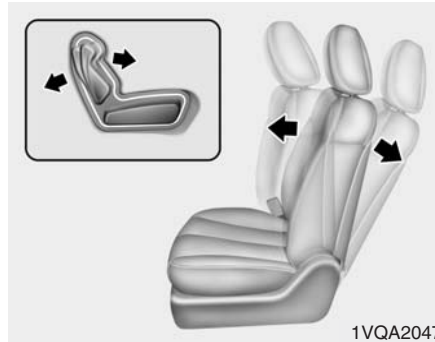

#### **Seatback angle**

Push the control knob forward or backward to move the seatback to the desired angle. Release the knob once the seat reaches to the desired position.

#### **⚠ WARNING - Driver responsibility for front seat passenger**

Riding with a reclined seatback increases your chance of serious or fatal injuries in the event of a collision or sudden stop. The protection of your restraint system (seat belts and air bags) is greatly reduced by reclining your seat.

(Continued)

(Continued)

Seat belts must be snug against your hips and chest to work properly. The more the seatback is reclined, the greater the chance that an occupant's hips will slide under the lap belt causing serious internal injuries or the occupant's neck could strike the shoulder belt. Drivers and passengers should always sit well back in their seats, properly belted, and with the seatbacks upright.

#### **⚠ WARNING**

- Never adjust a driver's seat while the vehicle is moving. Any sudden or unexpected movement of the seat could cause you to lose control of the vehicle resulting in an accident. Only adjust the driver's seat when the vehicle is stationary.
- Do not sit or lean unnecessarily close to the air bag. Position the seat so that you can sit as far back as possible from the air bag and still comfortably reach all controls.

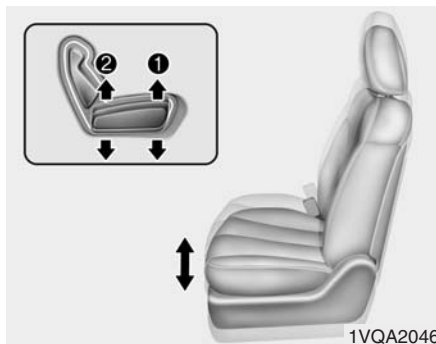

### **Seat cushion height (for driver's seat)**

Push the front portion (1) of the control knob up to raise or down to lower the front part of the seat cushion. Push the rear portion (2) of the control knob up to raise or down to lower the rear part of the seat cushion. Release the knob once the seat reaches to the desired position.

### **Headrest (front)**

The headrest not only provides comfort for the driver and passenger, but also helps to protect the head and neck in the event of a collision.

For best protection, adjust the headrest so its center is as high as your ears. Also adjust the headrest so that it properly supports the head and neck.



### **Active headrest (if equipped)**

The active headrest is designed to move forward and upward during a rear impact. This helps to prevent the driver's and front passenger's head from moving backward and thus helps prevent neck injuries.

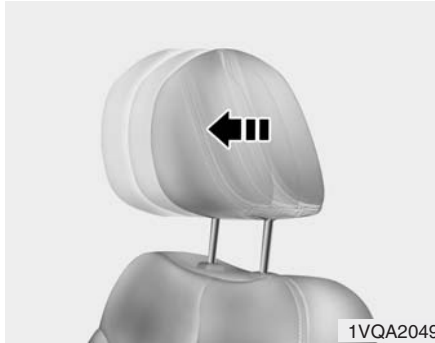

#### Forward and backward adjustment

The headrest may be adjusted forward to three different positions by pulling the headrest forward. To adjust the headrest backward, pull it fully forward to the farthest position and release it. Adjust the headrest so that it properly supports the head and neck.

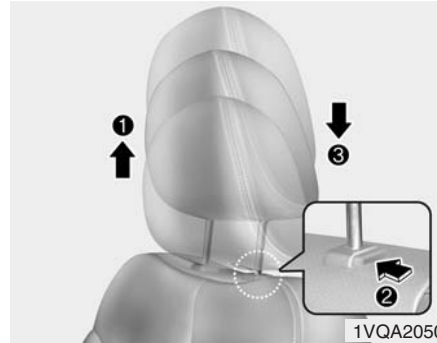

#### Adjusting the height up and down

To raise the headrest, pull it up to the desired position (1). To lower the headrest, push and hold the release button (2) on the headrest support and lower the headrest to the desired position (3). To remove the headrest, raise it as far as it can go then press the release button while pulling upward. This should only be done when the seat is not occupied.

#### **⚠ WARNING - Headrest positioning**

To reduce the risk of head and neck injuries, each occupant headrest must be properly adjusted. Do not drive the vehicle with the headrest removed or improperly positioned. Do not adjust the driver's headrest while driving, or else loss of control and an accident is possible.

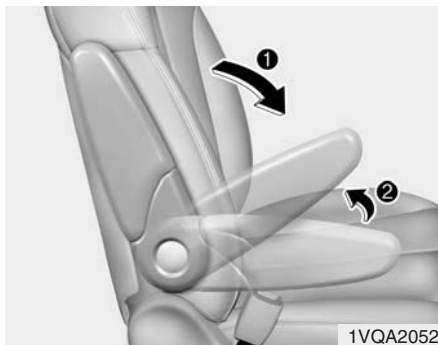

1VQA2052

### **Armrest**

The front seat armrest are located on the side of the seatback.

#### **Type A**

To use the armrest, swing down the armrest to the lowest position.

#### **Type B**

To use the armrest, swing down the armrest to the lowest position then pull it up to the desired position.



1VQA2053

### **Seatback pocket**

A seatback pocket is provided on the back of the front passenger and drivers seatbacks.

### **⚠ WARNING**

For proper operation of the occupant classification system:

- Do not place any items cumulatively weighing over 2.2 lbs (1 kg) in the seatback pocket or on the seat.
- Do not hang onto the front passenger seat.

### **⚠ WARNING - Seatback pockets**

**Do not put heavy or sharp objects in the seatback pockets. In an accident they could come loose from the pocket and injure vehicle occupants.**



\* The location of the seat warmer switch may be different depending on your model.

### Seat warmer (if equipped)

The front seats can be electrically heated individually when the ignition switch is ON. When the switch is ON, a number ranging from 1 to 5 is displayed on the switch (5 = warmest setting).

To turn off the seat warmer, set the switch to 0.

The seat warmer turns off automatically when the seat temperature reaches the selected range and will turn on again if the temperature drops below the selected range.

### CAUTION

- When cleaning the seats, do not use an organic solvent such as thinner, benzene, alcohol and gasoline. Doing so may damage the surface of the heater or seats.
- To prevent overheating the seat warmer, do not place blankets, cushions or seat covers on the seats while the seat warmer is in operation.
- Do not place heavy or sharp objects on seats equipped with seat warmers. Damage to the seat warming components could occur.

### WARNING - Seat heater burns

Passengers should use extreme caution when using seat warmers due to the possibility of excess heating or burns. The seat warmers should not be turned on when children, the elderly, ill people, and sleeping people occupy the seat.

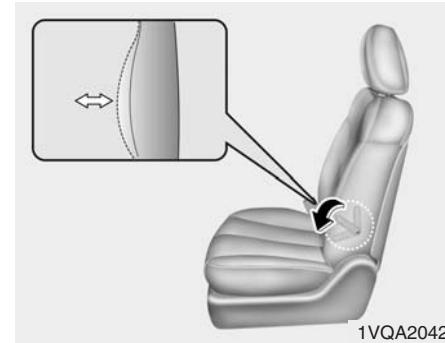

### Lumbar support (driver's seat only)

You can adjust the lumbar support by moving the lever on the outside of the driver's seatback. Pivoting the lever increases or decreases the lumbar support.

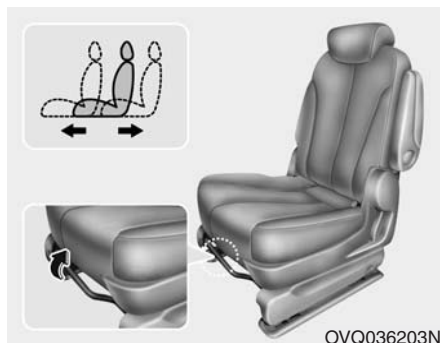

## Rear seat adjustment

### Adjusting the seat forward and backward (2nd row)

#### To move the seat forward or backward:

1. Pull the seat slide adjustment lever under the front edge of the seat cushion up and hold it.
2. Slide the seat to the position you desire.
3. Release the lever and make sure the seat is locked in place.

Adjust the seat before driving, and make sure the seat is locked securely by trying to move forward and backward without using the lever. If the seat moves, it is not locked properly.

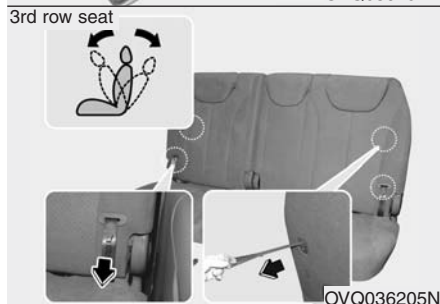

## Seatback angle

### To recline the seatback:

1. Lean forward slightly and lift up on the seatback recline lever located on the outside of the seat, at the rear.

2. Carefully lean back on the seat and adjust the seatback of the seat to the position you desire.
3. Release the lever and make sure the seatback is locked in place. (The lever **MUST** return to its original position for the seatback to lock.)



### Armrest

The 2nd row seats have the armrest located on the side of seatback. To use the armrest, swing down the armrest to the lowest position.

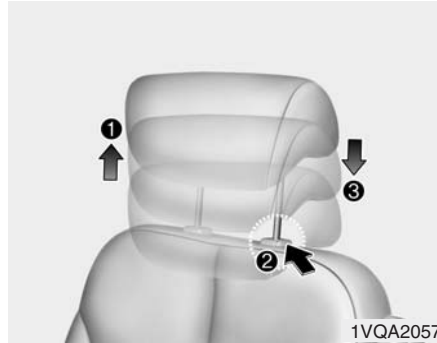

### Headrest (rear)

The headrest not only provides comfort for passengers, but also helps to protect the head and neck in the event of a collision. For best protection, adjust the headrest so its center is as high as your ears.

#### Adjusting the height up and down

To raise the headrest, pull it up to the desired position (1). To lower the headrest, push and hold the release button (2) on the headrest support and lower the headrest to the desired position (3).

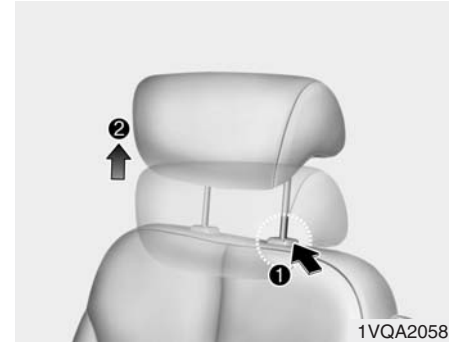

### Removal

To remove the headrest, raise it as far as it can go then press the release button (1) while pulling upward (2).

### **⚠ WARNING**

**To reduce the risk of head and neck injuries, do not ride with the headrest removed or improperly positioned.**

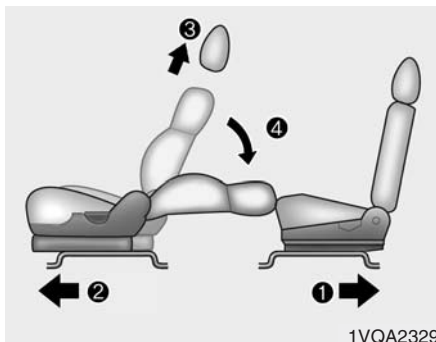

### **Full flat seat**

When the vehicle is parked, you can place the front seat in a reclined position, nearly flat.

1. Move the rear seat to the farthest rearward position.
2. Move the front seat to the farthest forward position.
3. Remove the headrest.
4. Recline the seatback as far as it can go to allow the rear seat passenger to support their legs in the reclined position.

### **⚠ WARNING - Uprighting seat**

When you return the seatback to its upright position, hold the seatback and return it slowly. If the seatback is returned without holding it, the back of the seat could spring forward resulting in accidental injury from being struck by the seatback.

### **⚠ WARNING - Full flat seat**

Never allow a passenger to use the full flat seat feature while the vehicle is in motion because severe injury or death could occur in an accident.

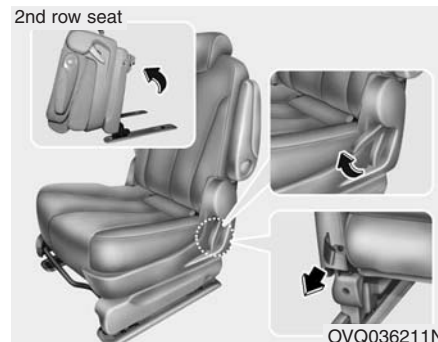

### **Folding the rear seatback**

The rear seatbacks fold forward to provide additional cargo space and to provide access to the cargo area.

**To fold the rear seat:**

#### **2nd row seat**

1. Lower the headrest to the lowest position.





2. Pull the seatback recliner and double-fold the seat forward.
3. Push down the seat backward firmly to lock the catches into the rear anchors until an audible "click" is heard.

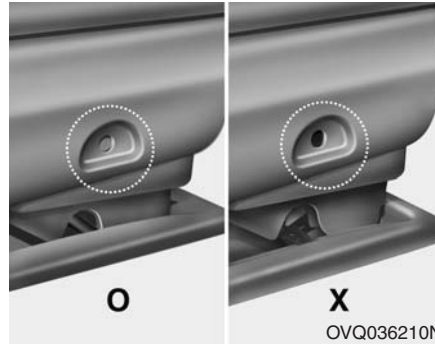

4. Make sure the green mark on the rear seat cushion frame is visible and the catches are locked in position by moving the seat forward and backward or lifting the front portion of the seat. If the green mark is not visible and the seat moves, it is not locked properly.



### 3rd row seat

1. Lower the headrest to the lowest position.
2. Hold the seatback and pull out the folding strap.
3. Fold the seatback forward and down firmly until it clicks into place.

### \* NOTICE

Before folding the rear seats, disconnect the rear center belt. See page 3-65.

### To unfold the rear seat:

1. Pull up the seatback recline lever (or folding strap).
2. Lift and push the seatback backward firmly until it clicks into place.  
Make sure the seatback is locked in place.
3. Return the rear seat belt to the proper position.



### *Double-folding the rear seat (2nd row)*

#### To fold the rear seat:

1. Lower the headrest to the lowest position.
2. Move the seat to rear-most position.
3. Double-fold the rear seat forward by pull up the seatback recline lever.

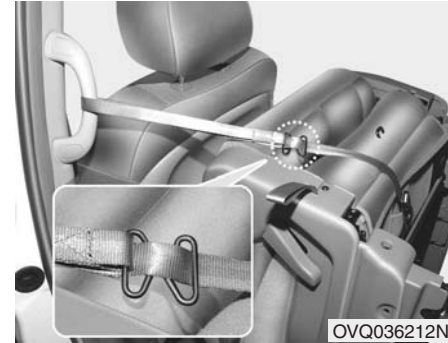

4. Pull the folding strap out of the pocket located under the seat cushion.
5. Lift the entire folded seat forward and tie the folded seat to the assist handle using the strap.



**To unfold the rear seat**

1. Untie the strap from the assist handle.
2. Insert the strap into the pocket.
3. Push down the seat backward firmly to lock the catches into the rear anchors until an audible “click” is heard.

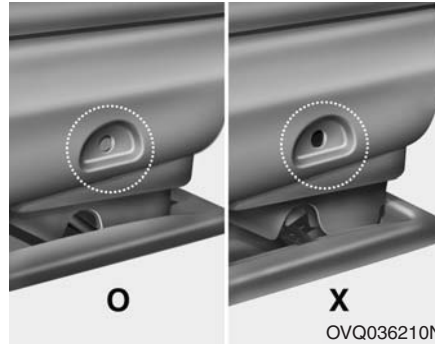

4. Make sure the green mark on the rear seat cushion frame is visible and the catches are locked in position by moving the seat forward and backward or lifting the front portion of the seat. If the green mark is not visible and the seat moves, it is not locked properly.
5. Push the seatbacks to an upright and locked position.

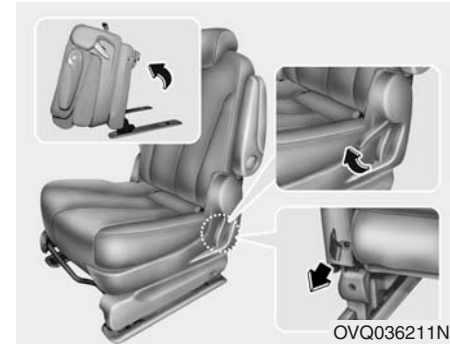

**Removing the rear seat (2nd row)**

**To remove a rear seat:**

1. Double-fold the rear seat by pull up the seatback recline lever.



2. Pull up the catch release lever under the front of the seat cushion while reclining the folded seat rearward slightly to release the front catches from the anchors.
3. Remove the entire seat from the floor.

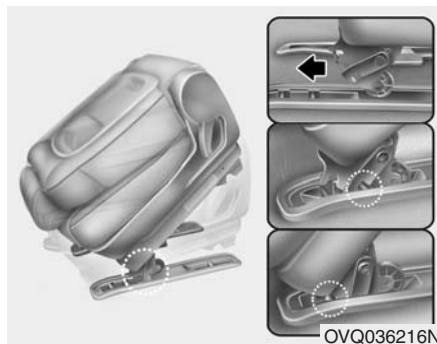

### To install the rear seat:

1. Put the front anchor strikers along the front anchors on the floor.
2. Insert two front anchor strikers into the front anchors.



3. Lift the rear portion of the seat cushion then push down firmly to lock the catches into the rear anchors until an audible "click" is heard.

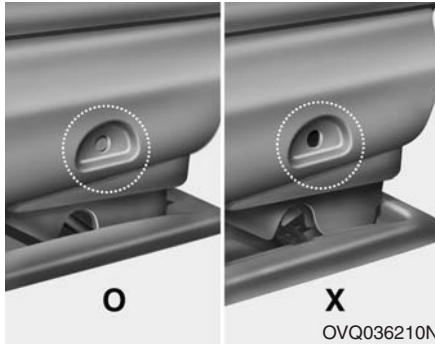

4. Make sure the green mark on the rear seat cushion frame is visible and the catches are locked in position by moving the seat forward and backward or lifting the front portion of the seat. If the green mark is not visible and the seat moves, it is not locked properly.
5. Push the seatbacks to an upright and locked position.

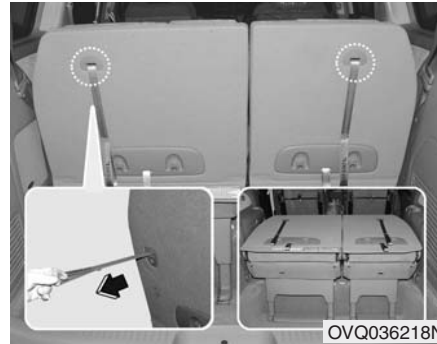

**Stowing the rear seat (3rd row)**

The rear seat can be folded and stowed in the luggage compartment to provide additional cargo space.

**To stow the rear seat:**

1. Lower the headrest to the lowest position.
2. Fold the seatback by pulling out the folding strap.



3. Pull the seat by using the stowing strap.



4. Stow the seat by pushing down firmly.



**To use the rear seat:**

1. Lift the seat by pulling out the stowing strap.

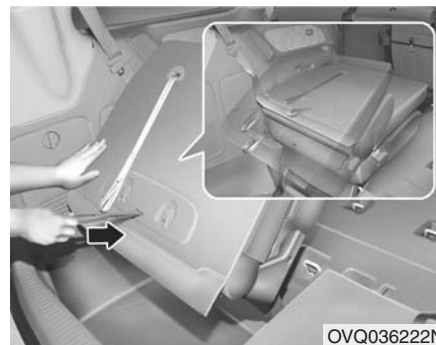

2. Release the strap and push the seat forward firmly until it clicks into place to insert the catches into the anchors.

## **⚠ WARNING**

- Make sure there are no persons or objects around the seat and be careful not to injure your hands or body under the seat or in the moving seat parts when stowing or reinstalling the seat.
- Do not sit on the seat when it is stowed with the seatback upright in the luggage compartment. Sitting on the unstable and unlocked seat could cause serious injuries or death in an accident.

## **\* NOTICE**

Do not push down the upper part of the seatback when pushing the seat forward. Doing so can prevent the catches from being locked in position.



OVQ036223N

3. Make sure the catches are locked in position by moving the seat forward and backward or lifting the front portion of the seat. If the seat moves, it is not locked properly.
4. Push the seatbacks to an upright and locked position.

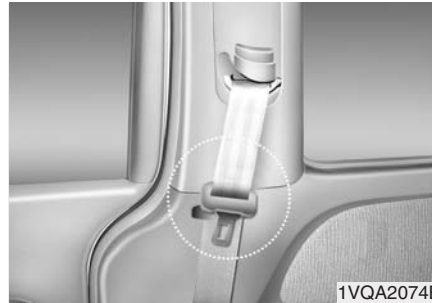

1VQA2074B

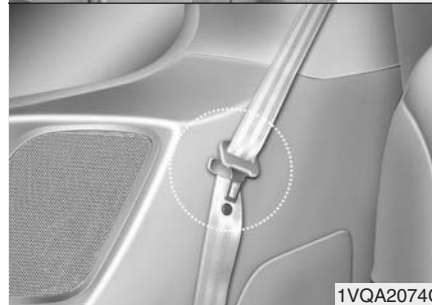

1VQA2074C

**CAUTION - Avoid damaging rear seat belt buckles**

*When you fold the rear seatback or put luggage on the rear seat cushion, insert the buckle in the pocket between the rear seatback and cushion. Doing so can prevent the buckle from being damaged by the rear seatback or luggage.*

**CAUTION - Rear seat belts**

*When returning the rear seatbacks to the upright position, remember to return the rear shoulder belts to their proper position. Routing the seat belt webbing through the rear seat belt guides will help keep the belts from being trapped behind or under the seats.*

## DRIVER POSITION MEMORY SYSTEM (IF EQUIPPED)

### **⚠ WARNING - Cargo**

Cargo should always be secured to prevent it from being thrown about the vehicle in a collision and causing serious injury to the vehicle occupants. Special care should be taken of objects placed in the rear seats, since those may strike the front seat occupants in a frontal collision.

### **⚠ WARNING - Cargo loading**

Make sure the engine is off, the transaxle is in P and the parking brake is applied whenever loading or unloading cargo. Failure to take these steps may allow the vehicle to move if the shift lever is inadvertently moved to another position.

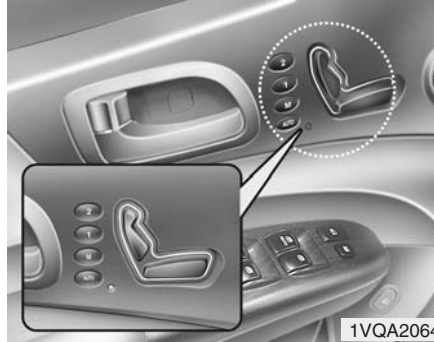

A driver position memory system is provided to store and recall the driver seat, outside rearview mirror and adjustable pedal positions with a simple button operation. By saving the desired positions into the system memory, different drivers can reposition the driver seat, outside rearview mirror and adjustable pedals based upon their driving preference.

If the battery is disconnected, the position memory will be lost and the driving positions must be restored in the system.

### **⚠ WARNING**

Never attempt to operate the driver position memory system while the vehicle is moving.

This could result in loss of control, and an accident causing death, serious injury, or property damage.

### **Storing positions into memory using the buttons on the door**

#### *Storing driver's seat positions*

1. Shift the transaxle lever into P while the ignition switch is ON.
2. Adjust the driver seat, outside rearview mirror and adjustable pedal to positions comfortable for the driver.
3. Press the M button on the control panel. The system will beep once.
4. Press one of the memory buttons (1 or 2) within 5 seconds after pressing the M button. The system will beep twice when memory has been successfully stored.



**Recalling positions from memory**

1. Shift the transaxle lever into P while the ignition switch is ON.
2. To recall the position in memory, press the desired memory button (1 or 2). The system will beep once, then the driver seat, outside rearview mirror and adjustable pedals will automatically adjust to the stored positions.

Adjusting one of the control knobs for the driver seat, outside rearview mirror and adjustable pedals while the system is recalling the stored positions will cause the movement for that component to stop and move in the direction that the control knob is moved. Other components will continue position recalling.

**⚠ WARNING**

**Use caution when recalling adjustment memory while sitting in the vehicle. Push the seat position control knob to the desired position immediately if the seat moves too far in any direction.**

**Storing and recalling with transmitter****Storing with the transmitter**

Remove the key from the ignition switch and lock all the doors using the transmitter. The driver seat, outside rearview mirror and adjustable pedal positions will be stored in the system memory.

**Driver's position recalling with transmitter**

Unlock the door with the transmitter, positions stored in the system memory will be recalled automatically.

**\* NOTICE**

**The buzzer sounds 10 times if there is a malfunction of the memory system. Have the driver position memory system checked by an authorized Hyundai dealer.**

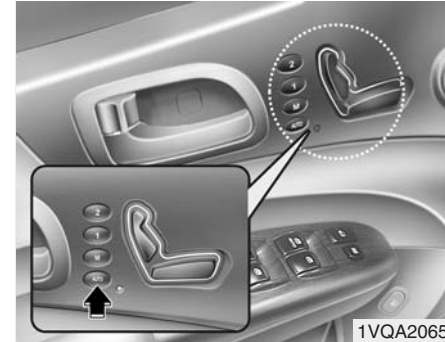
**Easy access function**

When the AUTO button is ON (the indicator light illuminates) with the shift lever in P position, the system will move the driver's seat forward or rearward automatically so you can comfortably enter and exit the vehicle.

- It will move the driver's seat rearward when the ignition key is removed.
- It will move the driver's seat forward when the ignition key is inserted.

## POWER ADJUSTABLE PEDALS (IF EQUIPPED)

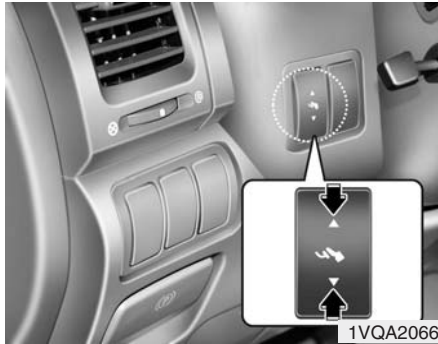

1VQA2066

To adjust the position of the accelerator and brake pedals, push the switch with the shift lever in the P position.

If you push the ▲ portion of the switch, the pedals move toward the driver.

If you push the ▼ portion of the switch, the pedals move away from the driver.

### Setting the adjustable pedal position

1. Be sure the parking brake is engaged.
2. Move the accelerator and brake pedals to the front most position by pushing the ▼ portion of the switch.
3. Adjust the seat position and the steering wheel angle properly.
4. Move the pedals toward you until you can fully depress the brake pedal by pushing the ▲ portion of the switch.
5. Depress the pedals a few times to get used to the feel after adjusting.

### **⚠ WARNING**

- Adjust the pedals after parking the vehicle on level ground. Never attempt to adjust the pedals while the vehicle is moving.
- Never adjust the pedals with your foot on the accelerator pedal as this may result in increasing the engine speed and acceleration.
- Make sure that you can fully depress the brake pedal before driving. Otherwise, you may not be able to hold down the brake pedal firmly in an emergency stop.

## SEAT BELTS

### Seat belt precautions

#### **WARNING**

All occupants of the vehicle must wear their seat belts at all times. Seat belts and child restraints reduce the risk of serious or fatal injuries for all occupants in the event of a collision or sudden stop. Without a seat belt, occupants could be shifted too close to a deploying air bag, strike the interior structure or be thrown from the vehicle. Properly worn seat belts greatly reduce these hazards. Even with advanced air bags, unbelted occupants can be severely injured by a deploying air bag. Always follow the precautions about seat belts, air bags and occupant seat contained in this manual.

#### *Infant or small child*

All 50 states have child restraint laws. You should be aware of the specific requirements in your state. Child and/or infant safety seats must be properly placed and installed in the rear seat. Information about the use of these restraints begins on page 3-71.

#### **WARNING**

Every person in your vehicle needs to be properly restrained at all times, including infants and children. Never hold a child in your arms or lap when riding in a vehicle. The violent forces created during a crash will tear the child from your arms and throw the child against the interior. Always use a child restraint appropriate for your child's height and weight, see page 3-71.

#### **\* NOTICE**

Small children are best protected from injury in an accident when properly restrained in the rear seat by a child restraint system that meets the requirements of the Federal Motor Vehicle Safety Standards. Before buying any child restraint system, make sure that it has a label certifying that it meets Federal Motor Vehicle Safety Standard 213. The restraint must be appropriate for your child's height and weight. Check the label on the child restraint for this information. See page 3-71.

### ***Larger children***

Children who are too large for child restraint systems should always occupy the rear seat and use the available lap/shoulder belts. The lap portion should be fastened snug on the hips and as low as possible. Check belt fit periodically. A child's squirming could put the belt out of position. Children are afforded the most safety in the event of an accident when they are restrained by a proper restraint system in the rear seat. If a larger child (over age 13) must be seated in the front seat, the child should be securely restrained by the available lap/shoulder belt and the seat should be placed in the rearmost position. Children under the age of 13 should be restrained securely in the rear seat. NEVER place a child under the age of 13 in the front seat. NEVER place a rear facing child seat in the front seat of a vehicle.

If the shoulder belt portion slightly touches the child's neck or face, try placing the child closer to the center of the vehicle. If the shoulder belt still touches their face or neck they need to be returned to a child restraint system. In addition, aftermarket devices are available from independent manufacturers which help pull the shoulder belt down and away from the child's face or neck.

-  **WARNING - Shoulder belts on small children**
- **Never allow a shoulder belt to be in contact with a child's neck or face while the vehicle is in motion.**
  - **If safety belts are not properly worn and adjusted on children, there is a risk of death or serious injury.**

### ***Pregnant women***

The use of a seat belt is recommended for pregnant women to lessen the chance of injury in an accident. When a seat belt is used, the lap belt portion should be placed as low and snugly as possible on the hips, not across the abdomen. For specific recommendations, consult a physician.

### ***Injured person***

A seat belt should be used when an injured person is being transported. When this is necessary, you should consult a physician for recommendations.

### ***One person per belt***

Two people (including children) should never attempt to use a single seat belt. This could increase the severity of injuries in case of an accident.

### ***Do not lie down***

To reduce the chance of injuries in the event of an accident and to achieve maximum effectiveness of the restraint system, all passengers should be sitting up and the front seats should be in an upright position when the car is moving. A seat belt cannot provide proper protection if the person is lying down in the rear seat or if the front seat is in a reclined position.

#### **WARNING**

Riding with a reclined seatback increases your chance of serious or fatal injuries in the event of a collision or sudden stop. The protection of your restraint system (seat belts and air bags) is greatly reduced by reclining your seat. Seat belts must be snug against your hips and chest to work properly. The more the seatback is reclined, the greater the chance that an occupant's hips will slide under the lap belt causing serious internal injuries or the occupant's neck could strike the shoulder belt. Drivers and passengers should always sit well back in their seats, properly belted, and with the seatbacks upright.

### **Care of seat belts**

Seat belt systems should never be disassembled or modified. In addition, care should be taken to assure that seat belts and belt hardware are not damaged by seat hinges, doors or other abuse.

#### **WARNING**

**When you return the rear seatback to its upright position after the rear seatback was folded down, be careful not to damage the seat belt webbing or buckle. Be sure that the webbing or buckle does not get caught or pinched in the rear seat. A seat belt with damaged webbing or buckle will not be as strong and could possibly fail during a collision or sudden stop, resulting in serious injury.**

### ***Periodic inspection***

It is recommended that all seat belts be inspected periodically for wear or damage of any kind. Parts of the system that are damaged should be replaced as soon as possible.

### ***Keep belts clean and dry***

Seat belts should be kept clean and dry. If belts become dirty, they can be cleaned by using a mild soap solution and warm water. Bleach, dye, strong detergents or abrasives should not be used because they may damage and weaken the fabric.

### ***When to replace seat belts***

Entire in-use seat belt assembly or assemblies should be replaced if the vehicle has been involved in an accident. This should be done even if no damage is visible. Additional questions concerning seat belt operation should be directed to your Hyundai Dealer.



### Height adjustable shoulder belt (if equipped)

You can adjust the height of the shoulder belt anchor to one of 5 positions for maximum comfort and safety.

If the height of the adjusting seat belt is too near your neck, you will not be getting the most effective protection. The shoulder portion should be adjusted so that it lies across your chest and midway over your shoulder nearest the door and not your neck.

To adjust the height of the seat belt anchor, lower or raise the height adjuster (A) into an appropriate position.

To raise the height adjuster, pull it up (1). To lower it, push it down (3) while pressing the height adjuster button (2).

Release the button to lock the anchor into position. Try sliding the height adjuster to make sure that it has locked into position.

### **⚠ WARNING**

- **Verify the shoulder belt anchor is locked into position at the appropriate height. Never position the shoulder belt across your neck or face. Improperly positioned seat belts can cause serious injuries in an accident.**
- **Failure to replace seat belts after an accident could leave you with damaged seat belts that will not provide protection in the event of another collision leading to personal injury or death. Replace your seat belts after being in an accident as soon as possible.**

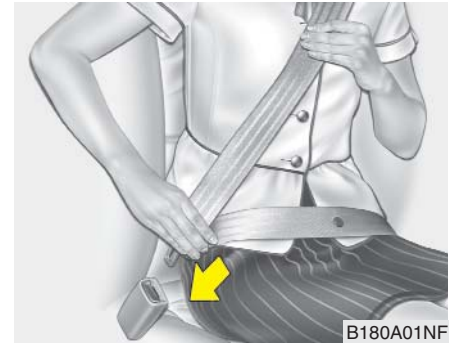

### Seat belt - Driver's 3-point system with emergency locking retractor

#### *To fasten your belt*

To fasten your seat belt, pull it out of the retractor and insert the metal tab into the buckle. There will be an audible "click" when the tab locks into the buckle.

The seat belt automatically adjusts to the proper length only after the lap belt portion is adjusted manually so that it fits snugly around your hips. If you lean forward in a slow, easy motion, the belt will extend and let you move around. If there is a sudden stop or impact, however, the belt will lock into position. It will also lock if you try to lean forward too quickly.

**\* NOTICE**

If the driver's safety belt is not fastened when the key is turned ON or if it is disconnected after the key is turned ON, the safety belt warning light will blink until the belt is fastened.

If the driver's safety belt is not fastened when the key is turned ON or if it is unfastened after the key is ON, the safety belt warning chime will sound for approximately 6 seconds.

**Seat belts - Front passenger and rear seat 3-point system with combination locking retractor*****To fasten your belt***

Combination retractor type seat belts are installed in the rear seat positions to help accommodate the installation of child restraint systems. Although a combination retractor is also installed in the front passenger seat position, Hyundai strongly recommends that children always be seated in the rear seat. NEVER place any infant restraint system in the front seat of the vehicle.

This type of seat belt combines the features of both an emergency locking retractor seat belt and an automatic locking retractor seat belt. To fasten your seat belt, pull it out of the retractor and insert the metal tab into the buckle. There will be an audible "click" when the tab locks into the buckle. When not securing a child restraint, the seat belt operates in the same way as the driver's seat belt (Emergency Locking Retractor Type). It automatically adjusts to the proper length only after the lap belt portion of the seat belt is adjusted manually so that it fits snugly around your hips.

When the seat belt is fully extended from the retractor to allow the installation of a child restraint system, the seat belt operation changes to allow the belt to retract, but not to extend (Automatic Locking Retractor Type). See page 3-72.

**\* NOTICE**

Although the combination retractor provides the same level of protection for seated passengers in either emergency or automatic locking modes, it is recommended that seated passengers use the emergency locking feature for improved convenience. The automatic locking function is intended to facilitate child restraint installation. To convert from the automatic locking feature to the emergency locking operation mode, allow the unbuckled seat belt to fully retract.

** WARNING**

- For maximum restraint system protection, the seat belts must always be used whenever the car is moving.
- Seat belts are most effective when seatbacks are in the upright position.

(Continued)

(Continued)

- Children age 12 and younger must always be properly restrained in the rear seat. Never allow children to ride in the front passenger seat. If a child over 13 must be seated in the front seat, he/she must be properly belted and the seat should be moved as far back as possible.
- Never wear the shoulder belt under your arm or behind your back. An improperly positioned shoulder belt can cause serious injuries in a crash. The shoulder belt should be positioned midway over your shoulder across your collarbone.
- Avoid wearing twisted seat belts. A twisted belt can't do its job as well. In a collision, it could even cut into you. Be sure the belt webbing is straight and not twisted.
- Be careful not to damage the belt webbing or hardware. If the belt webbing or hardware is damaged, replace it.

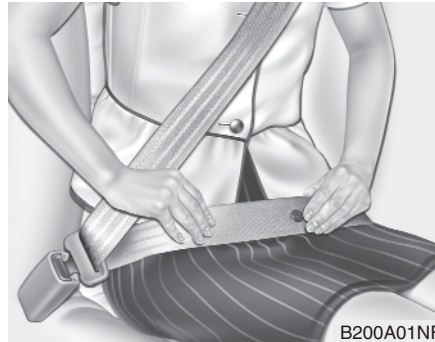

*Adjusting your seat belt*

### **⚠ WARNING**

You should place the lap belt portion as low as possible and snugly across your hips, not on your waist. If the lap belt is located too high on your waist, it may increase the chance of injury in the event of a collision. Both arms should not be under or over the belt. Rather, one should be over and the other under, as shown in the illustration.

Never wear the seat belt under the arm nearest the door.

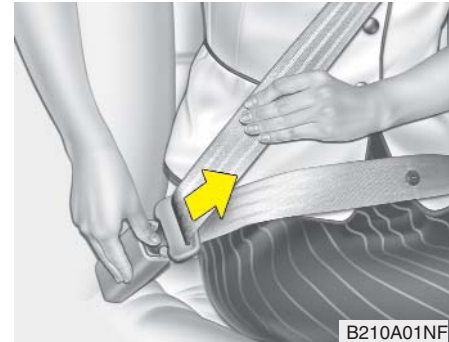

*To release the seat belt*

The seat belt is released by pressing the release button in the locking buckle. When it is released, the belt should automatically draw back into the retractor.

If this does not happen, check the belt to be sure it is not twisted, then try again.



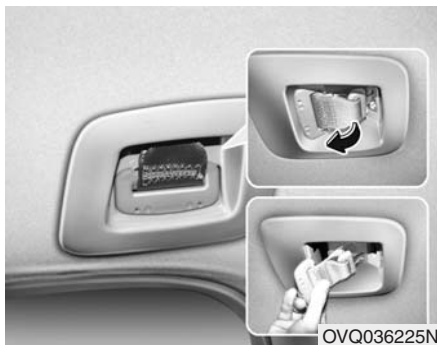

### 3-Point rear center seat belt

#### To fasten the rear center belt

1. Extract the tongue plate from the hole on the belt assembly cover and slowly pull the tongue plates out from the retractor.

#### **CAUTION - Cargo**

*Be sure that cargo is securely loaded in the rear cargo area. Failing to do so may cause damage to the rear center seat belt in sudden stops or collisions.*

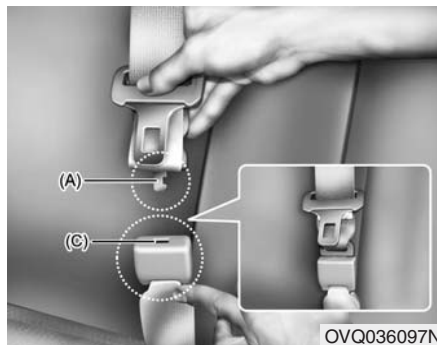

2. Insert the tongue plate (A) into the open end of the buckle (C) until an audible “click” is heard, indicating the latch is locked. Make sure the belt is not twisted.

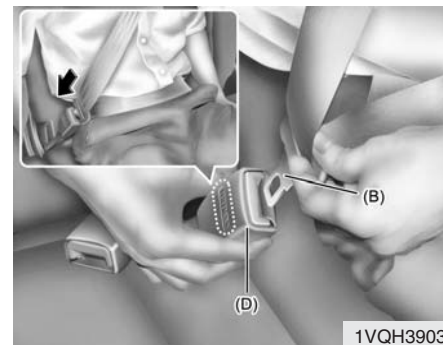

3. Pull the tongue plate (B) and insert the tongue plate (B) into the open end of the buckle (D) until an audible “click” is heard, indicating the latch is locked. Make sure the belt is not twisted.

#### **WARNING**

Never let anyone ride in the rear center seat without fastening all metal tabs and buckles as described in this section. This seat belt is designed to function as a typical 3-point restraint (lap/shoulder belt). Using only the shoulder portion or lap portion of the belt can result in serious or fatal injuries in the event of a collision or sudden stop.

There will be an audible “click” when the tab locks in the buckle. The seat belt automatically adjusts to the proper length only after the lap belt is adjusted manually so that it fits snugly around your hips. If you lean forward in a slow, easy motion, the belt will extend and let you move around. If there is a sudden stop or impact, the belt will lock into position. It will also lock if you try to lean forward too quickly.

### **⚠ WARNING**

**When using the rear seat center belt, you must lock all tongue plates and buckles. If any tongue plate or buckle is not locked, it will increase the chance of injury in the event of collision.**

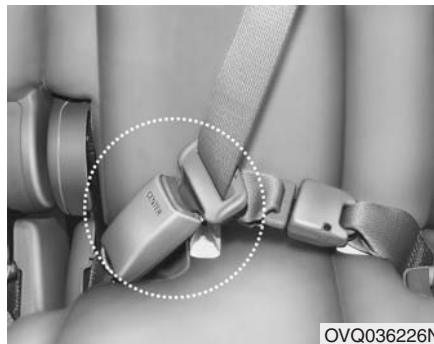

When using the rear center seat belt, the buckle with the “CENTER” mark must be used.

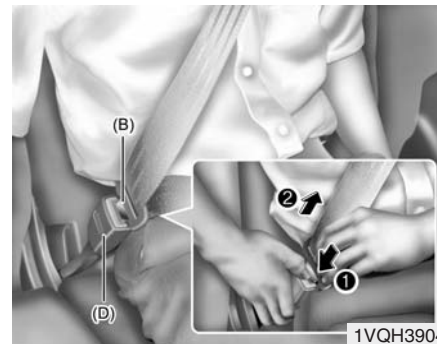

### ***To unfasten the rear center seat belt***

1. Press the release button on the buckle (D) and remove the tongue plate (B) from the buckle (D).
2. Retract the rear center seat belt.

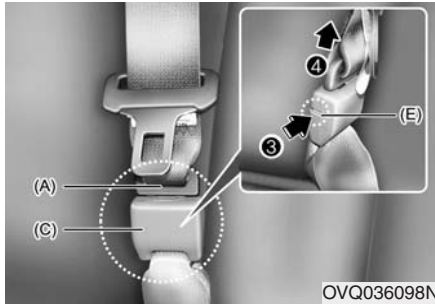

3. Insert a key or similar small rigid device into the web release button (E) on the anchor connector. Pull up on the seat belt web (A) and allow the webbing to retract automatically.
4. Insert the tongue plate (A) into the hole on the belt assembly cover.

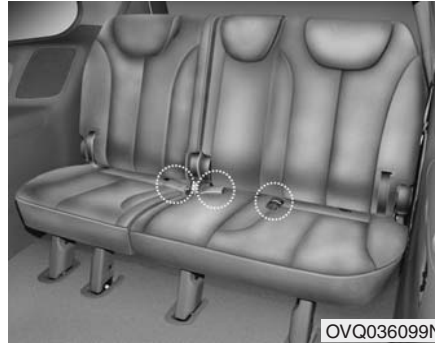

#### ***Stowing the rear seat belt***

The rear seat belt can be stowed in the pocket between the rear seatback and cushion when not in use.

#### **Proper use and care of the seat belt system**

To ensure that the seat belts provide the maximum protection, please follow these instructions:

- Use the seat belts at all times - even on short trips.
- If the seat belt is twisted, straighten it prior to use.
- Keep sharp edges and damaging objects away from the seat belts.
- After wearing a seat belt, make sure it fully retracts to the stowed position. Do not allow the belt to get caught in the door when you close it.



### Pre-tensioner seat belt

Your Hyundai vehicle is equipped with driver's and front passenger's pre-tensioner seat belts. The purpose of the pre-tensioner is to make sure that the seat belts fit tightly against the occupant's body in certain frontal collisions. The pre-tensioner seat belts can be activated alone or, where the frontal collision is severe enough, together with the air bags.

When the vehicle stops suddenly, or if the occupant tries to lean forward too quickly, the seat belt retractor will lock into position. In certain frontal collisions, the pre-tensioner will activate and pull the seat belt into tighter contact against the occupant's body.

If the system senses excessive seat belt tension on the driver or passenger's seat belt when the pre-tensioner activates, the load limiter inside the pre-tensioner will release some of the pressure on the affected seat belt.

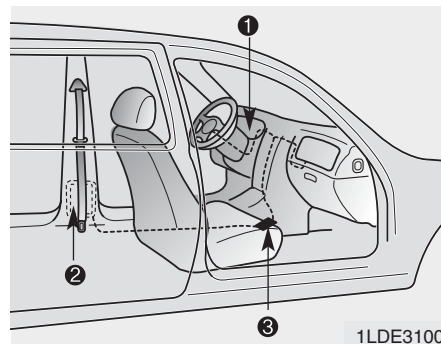

The seat belt pre-tensioner system consists mainly of the following components. Their locations are shown in the illustration:

1. SRS air bag warning light
2. Retractor pre-tensioner assembly
3. SRS control module

**⚠ WARNING**

To obtain maximum benefit from a pre-tensioner seat belt:

1. The seatbelt must be work correctly and adjusted to the proper position (see pages 3-61). Please read and follow all of the important information and precautions about your vehicle's occupant safety features – including seat belts and advanced air bags – that are provided in this manual.
2. Be sure you and your passengers always wear seat belts and wear them properly.

**\* NOTICE**

- Both the driver's and front passenger's pre-tensioner seat belts will be activated in certain frontal collisions. The pre-tensioner seat belts can be activated alone or, where the frontal collision is severe enough, together with the air bags. The pre-tensioners will not be activated if the seat belts are not being worn at the time of the collision.
- When the pre-tensioner seat belts are activated, a loud noise may be heard and fine dust, which may appear to be smoke, may be visible in the passenger compartment. These are normal operating conditions and are not hazardous.
- Although it is harmless, the fine dust may cause skin irritation and should not be breathed for prolonged periods. Wash all exposed skin areas thoroughly after an accident in which the pre-tensioner seat belts were activated.

**⚠ CAUTION**

- *Because the sensor that activates the SRS air bag is connected with the pre-tensioner seat belt, the SRS air bag warning light  on the instrument panel will illuminate for approximately 6 seconds after the ignition key has been turned to the "ON" position, and then it should turn off.*
- *If the pre-tensioner seat belt is not working properly, this warning light will illuminate even if there is no malfunction of the SRS air bag. If the SRS air bag warning light does not illuminate when the ignition key is turned to "ON", or if it blinks for a second and remains illuminated after illuminating for approximately 6 seconds, or if it illuminates while the vehicle is being driven, please have an authorized Hyundai dealer inspect the pre-tensioner seat belt or SRS air bag system as soon as possible.*

### **WARNING**

- Pre-tensioners are designed to operate only one time. After activation, pre-tensioner seat belts must be replaced. All seat belts, of any type, should always be replaced after they have been worn during a collision.
- The pre-tensioner seat belt assembly mechanisms become hot during activation. Do not touch the pre-tensioner seat belt assemblies for several minutes after they have been activated.
- Do not attempt to inspect or replace the pre-tensioner seat belts yourself. This must be done by an authorized Hyundai dealer.
- Do not strike the pre-tensioner seat belt assemblies.
- Do not attempt to service or repair the pre-tensioner seat belt system in any manner.

(Continued)

### (Continued)

- Improper handling of the pre-tensioner seat belt assemblies, and failure to heed the warnings not to strike, modify, inspect, replace, service or repair the pre-tensioner seat belt assemblies may lead to improper operation or inadvertent activation and serious injury.
- Always wear the seat belts when driving or riding in a motor vehicle.

## CHILD RESTRAINT SYSTEM

Children riding in the car should sit in the rear seat and must always be properly restrained to minimize the risk of injury in an accident, sudden stop or sudden maneuver. According to accident statistics provided by the National Highway Traffic Safety Administration (NHTSA), children are safer when properly restrained in the rear seats than in the front seat. Larger children not in a child restraint should use one of the seat belts provided.

All 50 states have child restraint laws. You should be aware of the specific requirements in your state. Child and/or infant safety seats must be properly placed and installed in the rear seat. You must use a commercially available child restraint system that meets the requirements of the Federal Motor Vehicle Safety Standards (FMVSS).

Children could be injured or killed in a crash if their restraints are not properly secured. For small children and babies, a child seat or infant seat must be used. Before buying a particular child restraint system, make sure it fits your car seat and seat belts, and fits your child. Follow all the instructions provided by the manufacturer when installing the child restraint system.

### WARNING

- **A child restraint system must be placed in the rear seat. Never install a child or infant seat on the front passenger's seat. Should an accident occur and cause the passenger side air bag to deploy, it could severely injure or kill an infant or child seated in an infant or child seat. Thus only use a child restraint in the rear seat of your vehicle.**
- **A safety belt or child restraint system can become very hot if it is left in a closed vehicle on a sunny day, even if the outside temperature does not feel hot. Be sure to check the seat cover and buckles before placing a child there.**
- **When the child restraint system is not in use, store it in the trunk or fasten it with a safety belt so that it will not be thrown forward in the case of a sudden stop or an accident.**
- **Children may be seriously injured or killed by an inflating air bag. All children, even those too large for child restraints, must ride in the rear seat.**

### WARNING

**To reduce the chance or serious or fatal injuries:**

- **Children of all ages are safer when restrained in the rear seat. A child riding in the front passenger seat can be forcefully struck by an inflating air bag resulting in serious or fatal injuries.**
- **Always follow the instructions for installation and use of the child restraint maker.**
- **Always make sure the child seat is secured properly in the car and your child is securely restrained in the child seat.**
- **Never hold a child in your arms or lap when riding in a vehicle. The violent forces created during a crash will tear the child from your arms and throw the child against the car's interior.**
- **Never put a seat belt over yourself and a child. During a crash, the belt could press deep into the child causing serious internal injuries.**

(Continued)

### (Continued)

- **Never leave children unattended in a vehicle – not even for a short time. The car can heat up very quickly, resulting in serious injuries to children inside. Even very young children may inadvertently cause the vehicle to move, entangle themselves in the windows, or lock themselves or others inside the vehicle.**
- **Never allow two children, or any two persons, to use the same seat belt.**
- **Children often squirm and reposition themselves improperly. Never let a child ride with the shoulder belt under their arm or behind their back. Always properly position and secure children in rear seat.**
- **Never allow a child to stand-up or kneel on the seat or floorboard of a moving vehicle. During a collision or sudden stop, the child can be violently thrown against the vehicles interior, resulting in serious injury.**

(Continued)

### (Continued)

- **Never use an infant carrier or a child safety seat that "hooks" over a seatback, it may not provide adequate security in an accident.**
- **Seat belts can become very hot, especially when the car is parked in direct sunlight. Always check seat belt buckles before fastening them over a child.**
- **Always store or secure a child seat, even when it is not in use. During a collision or sudden stop, the child seat could be thrown inside the vehicle.**

### Using a child restraint system

For small children and babies, the use of a child seat or infant seat is required. This child seat or infant seat should be of appropriate size for the child and should be installed in accordance with the manufacturer's instructions. It is further required that the seat be placed in the vehicle's rear seat. Your vehicle is provided with three child restraint hook holders for installing the child seat or infant seat.





## Securing a child restraint seat

### *Tether anchor system*

Child restraint hook holders are located on the back of the rear seat cushions.



1. Route the child restraint seat strap over the seatback.

For vehicles with adjustable headrest, route the tether strap under the headrest and between the headrest posts, otherwise route the tether strap over the top of the seatback.

2. Connect the tether strap hook to the appropriate child restraint hook holder and tighten to secure the seat.

### **⚠ WARNING - Tether strap**

- A child can be seriously injured or killed in a collision if the child restraint is not properly anchored. Always follow the child seat manufacturer's instructions for installation and use.
- Never mount more than one child restraint to a single tether or to a single lower anchorage point. The increased load caused by multiple seats may cause the tethers or anchorage points to break, causing serious injury or death.

### **⚠ WARNING - Child restraint check**

Check that the child restraint system is secure by pushing and pulling it in different directions. Incorrectly fitted child restraints may swing, twist, tip or separate causing death or serious injury.

### **⚠ WARNING**

#### **- Child restraint anchorage**

- Child restraint anchorages are designed to withstand only those loads imposed by correctly fitted child restraints. Under no circumstances are they to be used for adult seat belts or harnesses or for attaching other items or equipment to the vehicle.
- The tether strap may not work properly if attached somewhere other than the correct tether anchor.

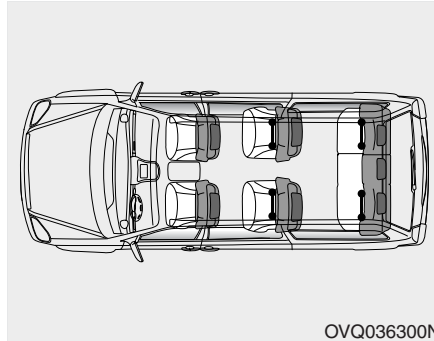

#### ***Child seat lower anchors***

Some child seat manufacturers make child restraint seats that are labeled as International Standards Organization Fixed (ISOFIX) or ISOFIX-compatible child restraint seats. These seats include two rigid or webbing mounted attachments that connect to two ISOFIX anchors at specific seating positions in your vehicle. This type of child restraint seat eliminates the need to use seat belts to attach the child seat for forward-facing child restraint seats in the rear seats.

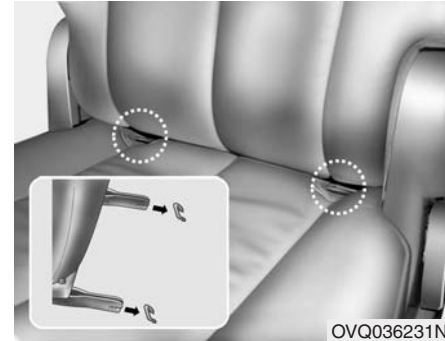

ISOFIX anchors have been provided in your vehicle. The ISOFIX anchors are located in the left and right outboard rear seating positions. Their locations are shown in the illustration. There is no ISOFIX anchor provided for the center rear seating position.

The ISOFIX anchors are located between the seatback and the seat cushion of the rear seat left and right outboard seating positions.

Follow the child seat manufacturer's instructions to properly install child restraint seats with ISOFIX or ISOFIX-compatible attachments.

Once you have installed the ISOFIX child restraint, assure that the seat is properly attached to the ISOFIX and tether anchors. Also, test the child restraint seat before you place the child in it. Tilt the seat from side to side. Also try to tug the seat forward. Check to see if the anchors hold the seat in place.

### **WARNING**

**When using the vehicle's "ISOFIX" system to install a child restraint system in the rear seat, all unused vehicle rear seat belt metal latch plates or tabs must be latched securely in their seat belt buckles and the seat belt webbing must be retracted behind the child restraint to prevent the child from reaching and taking hold of unretracted seat belts. Unlatched metal latch plates or tabs may allow the child to reach the unretracted seat belts which may result in strangulation and a serious injury or death to the child in the child restraint.**

### **WARNING - ISOFIX Anchors**

- **A child can be seriously injured or killed in a collision if the child restraint is not properly anchored. Always follow the child seat manufacturer's instructions for installation and use.**
- **Never install a child restraint using the ISOFIX anchors at the center position of the rear seat. In a crash, the ISOFIX anchors may break if a car seat is improperly placed in the center position resulting in serious or fatal injuries. Only place a ISOFIX or ISOFIX-compatible child seat in the left or right out-board rear seating positions (as shown) to the appropriate ISOFIX anchors provided.**
- **Never mount more than one child restraint to a single tether or to a single lower anchorage point. The increased load caused by multiple seats may cause the tethers or anchorage points to break, causing serious injury or death.**

### **WARNING**

**Install the child restraint seat fully rearward against the seatback with the seatback in a vertical position, not reclined.**

### **Placing a passenger seat belt into the auto lock mode**

The use of the auto lock mode will ensure that the normal movement of the child in the vehicle does not cause the seat belt to be pulled out and loosen the firmness of its hold on the child restraint system. To secure a child restraint system, use the following procedure.

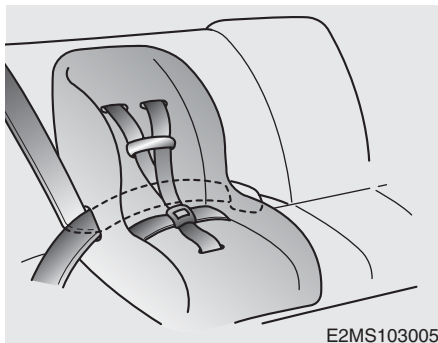

### ***Installing a child restraint system by lap/shoulder belt***

To install a child restraint system on the outboard or center rear seats, do the following:

1. Place the child restraint system in the seat and route the lap/shoulder belt around or through the restraint, following the restraint manufacturer's instructions. Be sure the seat belt webbing is not twisted.

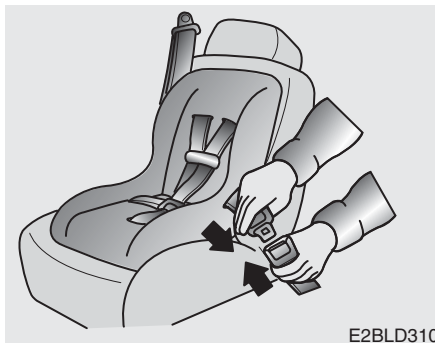

2. Fasten the lap/shoulder belt latch into the buckle. Listen for the distinct "click" sound.  
*Position the release button so that it is easy to access in case of an emergency.*

### **⚠ WARNING**

**A child can be seriously injured or killed in a collision if the child restraint is not properly anchored to the car and the child is not properly restrained in the child restraint. Always follow the child seat manufacturer's instructions for installation and use.**



3. Pull the shoulder portion of the seat belt all the way out. When the shoulder portion of the seat belt is fully extended, it will shift the retractor to the "Auto Lock" (child restraint) mode.



MMSA3029



MMSA3030

4. Slowly allow the shoulder portion of the seat belt to retract and listen for an audible “clicking” or “ratcheting” sound. This indicates that the retractor is in the “Auto Lock” mode. If no distinct sound is heard, repeat steps 3 and 4.

5. Remove as much slack from the belt as possible by pushing down on the child restraint system while feeding the shoulder belt back into the retractor.
6. Push and pull on the child restraint system to confirm that the seat belt is holding it firmly in place. If it is not, release the seat belt and repeat steps 2 through 6.
7. Double check that the retractor is in the “Auto Lock” mode by attempting to pull more of the seat belt out of the retractor. If you cannot, the retractor is in the “Auto Lock” mode.

To remove the child restraint, press the release button on the buckle and then pull the lap/shoulder belt out of the restraint and allow the seat belt to retract fully.

### **⚠ WARNING - Auto lock mode**

The lap/shoulder belt automatically returns to the “emergency lock mode” whenever the belt is allowed to retract fully. Therefore, the preceding seven steps must be followed each time a child restraint is installed.

If the retractor is not in the Automatic Locking mode, the child restraint can move when your vehicle turns or stops suddenly. A child can be seriously injured or killed if the child restraint is not properly anchored to the car, including setting the retractor to the Automatic Locking mode.

**When the seat belt is allowed to retract to its fully stowed position, the retractor will automatically switch from the “Auto Lock” mode to the emergency lock mode for normal adult usage.**

## AIR BAG - ADVANCED SUPPLEMENTAL RESTRAINT SYSTEM

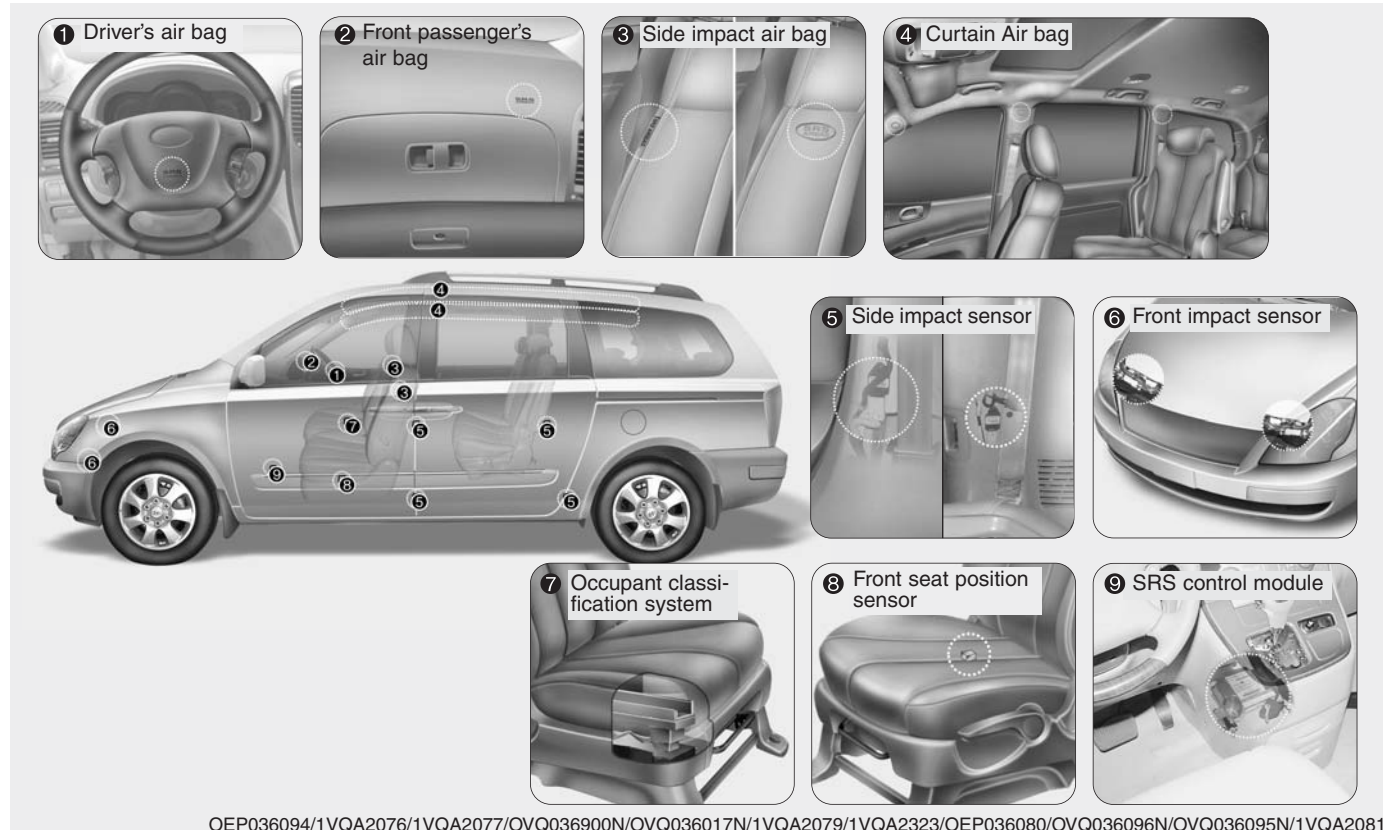

OEP036094/1VQA2076/1VQA2077/OVQ036900N/OVQ036017N/1VQA2079/1VQA2323/OEP036080/OVQ036096N/OVQ036095N/1VQA2081

Driver's front air bag



### Driver's and passenger's front air bag

Your Hyundai is equipped with an advanced Supplemental Restraint (Air bag) System. The indications of the system's presence are the letters "SRS AIR BAG" embossed on the air bag pad cover in the steering wheel and the passenger's side front panel pad above the glove box.

The Hyundai SRS consists of air bags installed under the pad covers in the center of the steering wheel and the passenger's side front panel above the glove box.

The purpose of the SRS is to provide the vehicle's driver and/or the front passenger with additional protection than that offered by the seat belt system alone in case of a frontal impact of sufficient severity. The SRS uses sensors to gather information about the driver's seat position, the driver's and front passenger's seat belt usage and impact severity.

The driver's seat track position sensors, which are installed on the seat track, determine if the seat is fore or aft of a reference position. The seat belt buckle sensors determine if the driver and front passenger's seat belts are fastened. These sensors provide the ability to control the SRS deployment based on how close the driver's seat is to the steering wheel, whether or not the seat belts are fastened, and how severe the impact is.

The advanced SRS offers the ability to control the air bag inflation with two levels. A first stage level is provided for moderate-severity impacts. A second stage level is provided for more severe impacts.

According to the impact severity, seating position and seat belt usage, the SRSCM (SRS Control Module) controls the air bag inflation. Failure to properly wear seat belts can increase the risk or severity of injury in an accident.

Additionally, your Hyundai is equipped with an occupant classification system in the front passenger's seat. The occupant classification system detects the presence of a passenger in the front passenger's seat and will turn off the front passenger's air bag under certain conditions. For more detail, see "Occupant Classification System" later in this section.

### CAUTION

*If a seat track position sensor or an occupant classification system is not working properly, the SRS air bag warning light  on the instrument panel will illuminate because the SRS air bag warning light is connected with the seat track position sensor and the occupant classification system. If the SRS air bag warning light does not illuminate when the ignition key is turned to the "ON" position, remains illuminated after approximately 6 seconds when the ignition key is turned to the "ON" position, or if it illuminates while the vehicle is being driven, have an authorized Hyundai dealer inspect the advanced SRS air bag system as soon as possible.*

### WARNING

- Modification to the seat structure can adversely affect the seat track position sensor and cause the air bag to deploy at a different level than should be provided.
- Do not place any objects underneath the front seats as they could damage the seat track position sensor or interfere with the occupant classification system.
- Do not place any objects that may cause magnetic fields near the front seat. These may cause a malfunction of the seat track position sensor.

### \* NOTICE

- Be sure to read information about the SRS on the labels provided on the sun visor and in the glove box.
- Advanced air bags are combined with pre-tensioner seat belts to help provide enhanced occupant protection in frontal crashes. Front air bags are not intended to deploy in collisions in which sufficient protection can be provided by the pre-tensioner seat belt.
- If you are considering modification of your vehicle due to a disability, please contact the Hyundai Customer Assistance Center at 1-800-633-5151.



**⚠ WARNING**

Always use seat belts and child restraints – every trip, every time, everyone! Air bags inflate with considerable force and in the blink of an eye. Seat belts help keep occupants in proper position to obtain maximum benefit from the air bag. Even with advanced air bags, improperly and unbelted occupants can be severely injured when the air bag inflates. Always follow the precautions about seat belts, air bags and occupant safety contained in this manual.

To reduce the chance of serious or fatal injuries and receive the maximum safety benefit from your restraint system:

- Never place a child in any child or booster seat in the front seat (see child restraints 3-71).
- ABC – Always Buckle Children in the back seat. It is the safest place for children of any age to ride.
- Front and side impact air bags can injure occupants improperly positioned in the front seats.

(Continued)

(Continued)

- Move your seat as far back as practical from the front air bags, while still maintaining control of the vehicle.
- Never sit or lean unnecessarily close to the front or side air bags
- Never lean against the door or center console – always sit in an upright position.
- Do not allow a passenger to ride in the front seat when the “PASSENGER AIR BAG OFF” indicator is illuminated, because the air bag will not deploy in the event of a moderate or severe frontal crash.
- Never place objects over or near any air bag module (front or side impact air bags), because these objects can injure passengers in a crash.
- Never place covers, blankets or aftermarket seat warmers on the passenger seat as these may interfere with the occupant classification system.

(Continued)

(Continued)

- Do not tamper or disconnect SRS wiring or other components. Injuries could result from inadvertent deployment or failure of the air bag to deploy in a crash.
- If the SRS air bag warning light (see page 3-119) remains illuminated while the vehicle is being driven, have an authorized Hyundai dealer inspect the air bag system as soon as possible.
- Air bags can only be used once – have an authorized Hyundai dealer replace the air bag immediately after deployment.
- The SRS is designed to deploy the front air bags only when an impact is sufficiently severe and when the impact angle is less than 30° from the forward longitudinal axis of the vehicle. The front air bags will not deploy in side, rear or rollover impacts. Additionally, the air bags will only deploy once. Seat belts must be worn at all times.

(Continued)

### (Continued)

- Front air bags are not intended to deploy in side-impact, rear-impact or rollover crashes. In addition, front air bags will not deploy in frontal crashes below the deployment threshold.

#### Rear impact



OEP036096N

#### Side impact



OVP036018N

#### Rollover



OEP036091

(Continued)

### (Continued)

- Move your seat as far back as practical from the front air bags, while still maintaining control of the vehicle. You and your passengers should never sit or lean unnecessarily close to the air bags. Improperly positioned drivers and passengers can be severely injured by inflating air bags.
- No objects should be placed over or near the air bag modules on the steering wheel, instrument panel, and the front passenger's panel above the glove box, because any such object could cause harm if the vehicle is in a crash severe enough to cause the air bags to deploy.
- If the air bags deploy, they must be replaced by an authorized Hyundai dealer. Deployed air bags WILL NOT inflate again and will provide no protection in subsequent collisions.

(Continued)

### (Continued)

- Do not tamper with or disconnect SRS wiring or other components of the SRS system. Doing so could result in injury, due to accidental deployment of the air bags or by rendering the SRS inoperative.
- Even though your vehicle is equipped with the occupant classification system, do not install a child restraint system in the front passenger seat position. A child restraint system must never be placed in the front seat. The infant or child could be severely injured or killed by an air bag deployment in case of an accident.
- Children younger than 13 years must always be properly restrained in the rear seat. Never allow children to ride in the front passenger seat. If a child over 13 must be seated in the front seat, he or she must be properly belted and the seat should be moved as far back as possible.

(Continued)

(Continued)

- For maximum safety protection in all types of crashes, all occupants including the driver should always wear their seat belts whether or not an air bag is also provided at their seating position to minimize the risk of severe injury or death in the event of a crash. Do not sit or lean unnecessarily close to the air bag while the vehicle is in motion.
- Sitting improperly or out of position can result in serious or fatal injury in a crash. All occupants should sit upright with the seat back in an upright position, centered on the seat cushion with their seat belt on, legs comfortably extended and their feet on the floor until the vehicle is parked and the ignition key is removed.
- The SRS air bag system must deploy very rapidly to provide protection in a crash. If an occupant is out of position because of not wearing a seat belt, the air bag may forcefully contact the occupant causing serious or fatal injuries.

### SRS components and functions

The SRS consists of the following components:

1. Front Impact Sensors
2. "PASSENGER AIR BAG OFF" Indicator (Front passenger's seat only)
3. SRS "AIR BAG" warning light
4. Knee Bolster
5. Passenger's Air bag Module
6. Driver's Air bag Module
7. SRS Control Module (SRSCM)
8. Occupant Classification System (Front passenger's seat only)
9. Driver's Seat Track Position Sensor
10. Driver's and Front Passenger's Seat Belt Buckle Sensors
11. Side Impact Sensors
12. Retractor Pre-tensioner Assemblies
13. Side Impact Air bag Modules
14. Curtain Air bag Modules

The SRSCM continually monitors all elements while the ignition is "ON" to determine if a frontal or near-frontal impact is severe enough to require air bag deployment or pre-tensioner seat belt deployment.

The SRS "AIR BAG" warning light on the instrument panel will illuminate for about 6 seconds after the ignition key is turned to the "ON" position or after the engine is started, after which the "AIR BAG" warning light should go out.

Driver's front air bag



The air bag modules are located both in the center of the steering wheel and in the front passenger's panel above the glove box. When the SRSCM detects a sufficiently severe impact to the front of the vehicle, it will automatically deploy the front air bags.

Driver's front air bag



Upon deployment, tear seams molded directly into the pad covers will separate under pressure from the expansion of the air bags. Further opening of the covers then allows full inflation of the air bags.

Driver's front air bag



A fully inflated air bag, in combination with a properly worn seat belt, slows the driver's or the passenger's forward motion, reducing the risk of head and chest injury.

After complete inflation, the air bag immediately starts deflating, enabling the driver to maintain forward visibility and the ability to steer or operate other controls.

Passenger's front air bag

**(Continued)**

*If there is any leakage from the air freshener onto these areas (instrument cluster, instrument panel or air ventilator), it may damage these parts. If the liquid from the air freshener does leak onto these areas, wash them with water immediately.*

Passenger's front air bag

**CAUTION**

- Do not install or place any accessories (drink holder, cassette holder, sticker, etc.) on the front passenger's panel above the glove box in a vehicle with a passenger's air bag. Such objects may become dangerous projectiles and cause injury if the passenger's air bag inflates.
- When installing a container of liquid air freshener inside the vehicle, do not place it near the instrument cluster nor on the instrument panel surface.

**(Continued)****WARNING**

- If an air bag deploys, there may be a loud noise followed by a fine dust released in the vehicle. These conditions are normal and are not hazardous - the air bags are packed in this fine powder. The dust generated during air bag deployment may cause skin or eye irritation as well as aggravate asthma for some persons. Always wash all exposed skin areas thoroughly with lukewarm water and a mild soap after an accident in which the air bags were deployed.

**(Continued)**

(Continued)

- The SRS can function only when the ignition key is in the "ON" position. If the SRS "AIR BAG" warning light does not illuminate, or continuously remains on after illuminating for about 6 seconds when the ignition key is turned to the "ON" position, or after the engine is started, comes on while driving, the SRS is not working properly. If this occurs, have your vehicle immediately inspected by your Hyundai dealer.
- Before you replace a fuse or disconnect a battery terminal, turn the ignition key to the "LOCK" position and remove the ignition key. Never remove or replace the air bag related fuse(s) when the ignition key is in the "ON" position. Failure to heed this warning will cause the SRS "AIR BAG" warning light to illuminate.



### Occupant classification system

Your vehicle is equipped with an occupant classification system in the front passenger's seat.

The occupant classification system is designed to detect the presence of a properly-seated front passenger and determine if the passenger's front air bag should be enabled (may inflate) or not. The driver's front air bag is not affected or controlled by the occupant classification system.

If the front passenger seat is occupied by a person that the system determines to be of adult size, and he/she sits properly (sitting upright with the seatback in an upright position, centered on the seat cushion with their seat belt on, legs comfortably extended and their feet on the floor), the "PASSENGER AIR BAG OFF" indicator will be turned off and the front passenger's air bag will be able to inflate, if necessary, in frontal crashes.

You will find the "PASSENGER AIR BAG OFF" indicator on the center facia panel. This system detects the conditions 1~4 in the following table and activates or deactivates front passenger air bags based on these conditions.

**Condition and operation in the front passenger occupant classification system**

Condition detected by the occupant classification system	Indicator/Warning light		Devices
	"PASSENGER AIR BAG OFF" indicator light	SRS warning light	Front passenger air bag
1. Adult *1	Off	Off	Activated
2. Child*2 or child restraint system*3	On	Off	Deactivated
3. Unoccupied	On	Off	Deactivated
4. There is a malfunction in the system	Off	On	Activated

- \*1) The system judges a person of adult size as an adult. When a smaller adult sits in the front passenger seat, the system may recognize him/her as a child depending on his/her physique and posture.
- \*2) Do not allow children to ride in the front passenger seat. When a larger child who has outgrown a child restraint system sits in the front passenger seat, the system may recognize him/her as an adult depending on his/her physique or posture.
- \*3) Never install a child restraint system on the front passenger seat.

**⚠ WARNING**

**Riding in an improper position or placing weight on the front passenger's seat when it is unoccupied by a passenger adversely affects the occupant classification system (OCS).**

**(Continued)**

(Continued)



- Never put a heavy load in the front passenger seat or seatback pocket.



- Never sit with hips shifted towards the front of the seat.



- Never place feet on the dashboard.



- Never place feet on the front passenger seatback.



- Never excessively recline the front passenger seatback.



- Never lean on the center console.  
- Never sit on one side of the front passenger seat.



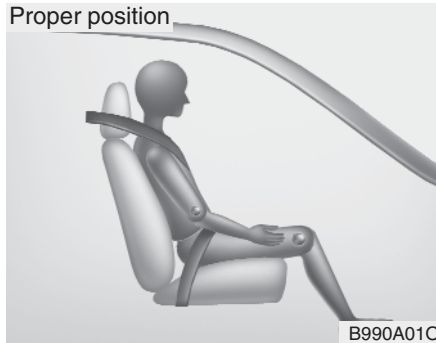

When an adult is seated in the front passenger seat, if the "PASSENGER AIR BAG OFF" indicator is on, turn the ignition key to "LOCK" and ask the passenger to sit properly (sitting upright with the seat back in an upright position, centered on the seat cushion with their seat belt on, legs comfortably extended and their feet on the floor). Restart the engine and have the person remain in that position for about 30 seconds. This will allow the system to detect the person and to enable the passenger air bag. If the "PASSENGER AIR BAG OFF" indicator is still on, turn the ignition key to "LOCK" and ask the passenger to sit properly and restart the engine again.

If the "PASSENGER AIR BAG OFF" indicator is still on, ask the passenger to move to the rear seat.

### **⚠ WARNING**

Do not allow a passenger to ride in the front seat when the "PASSENGER AIR BAG OFF" indicator is illuminated, because the air bag will not deploy in the event of a crash. If the "PASSENGER AIR BAG OFF" indicator remains illuminated after the passenger repositions themselves properly and the car is restarted, Hyundai recommends that passenger move to the rear seat because the passenger's front air bag will not deploy.

The "PASSENGER AIR BAG OFF" indicator will not change according to the occupants posture after the vehicle has been running for 30 seconds. Front seat passengers must stay properly seated to avoid serious injury from a deploying air bag. For more information see page 3-86.

### **\* NOTICE**

The "PASSENGER AIR BAG OFF" indicator illuminates for about 4 seconds after the ignition key is turned to the "ON" position or after the engine is started. If the front passenger seat is occupied, the occupant classification sensor will then classify the front passenger within approximately 10 seconds after the ignition is turned on.

### **⚠ WARNING**

Do not put a heavy load in the front passenger seatback pocket or on the front passenger seat. Do not hang onto the front passenger seat. Do not hang any items such as seatback table on the front passenger seatback. Do not place feet on the front passenger seatback. Do not place any items under the front passenger seat. Any of these could interfere with proper sensor operation.

**CAUTION**

*If the occupant classification system is not working properly, the SRS air bag warning light  on the instrument panel will illuminate because the passenger's front air bags are connected with the occupant classification system. If there is a malfunction of the occupant classification system, the "PASSENGER AIR BAG OFF" indicator will not illuminate and the passenger's front air bags will inflate in frontal impact crashes even if there is no occupant in the front passenger's seat. If the SRS air bag warning light does not illuminate when the ignition key is turned to the "ON" position, remains illuminated after approximately 6 seconds when the ignition key is turned to the "ON" position, or if it illuminates while the vehicle is being driven, have an authorized Hyundai dealer inspect the occupant classification system and the SRS air bag system as soon as possible.*

**WARNING**

- Even though your vehicle is equipped with the occupation classification system, never install a child restraint system in the front passenger's seat. A deploying air bag can forcefully strike a child resulting in serious injuries or death. Any child under 13 years of age should ride in the rear seat. Children too large for child restraints should use the available lap/shoulder belts. No matter what type of crash, children of all ages are safer when restrained in the rear seat.
- If the "PASSENGER AIR BAG OFF" indicator is illuminated when the front passenger's seat is occupied by an adult and he/she sits properly (sitting upright with the seatback in an upright position, centered on the seat cushion with their seat belt on, legs comfortably extended and their feet on the floor), have that person sit in the rear seat.

(Continued)

(Continued)

- If you change the weight on the front passenger seat just after sit-in or restart of the engine, the "PASSENGER AIR BAG OFF" indicator may be turned on or off for a few seconds, disabling or enabling the passenger air bags. After the initial stage of about 30 seconds, the "PASSENGER AIR BAG OFF" indicator will not toggle.
- Do not modify or replace the front passenger seat. Don't place anything on or attach anything such as a blanket or after market seat heater to the front passenger seat. This can adversely affect the occupant classification system.
- Do not sit on sharp objects such as tools when occupying the front passenger seat. This can adversely affect the occupant classification system.
- Do not use accessory seat covers on the front seats.

(Continued)

(Continued)

- Accident statistics show that children are safer if they are restrained in the rear, as opposed to the front seat. It is recommended that child restraints be secured in a rear seat, including an infant riding in a rear-facing infant seat, a child riding in a forward-facing child seat and an older child riding in a booster seat.
- Air bags can only be used once – have an authorized Hyundai dealer replace the air bag immediately after deployment.
- A smaller-stature adult who is not seated correctly (for example: seat excessively reclined, leaning on the center console, or hips shifted forward in the seat) can cause a condition where the advanced frontal air bag system senses less weight than if the occupant were seated properly (sitting upright with the seatback in an upright position, centered on the seat cushion with their seat belt on, legs comfortably extended and their feet on the floor).

(Continued)

(Continued)

This condition can result in an adult potentially being misclassified and illumination of the "PASSENGER AIR BAG OFF" indicator.

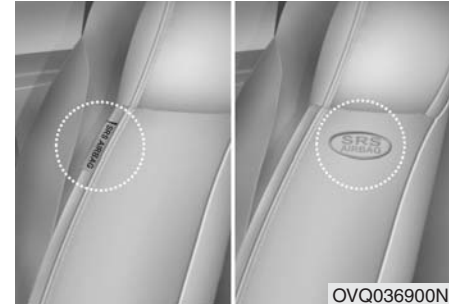

OVQ036900N

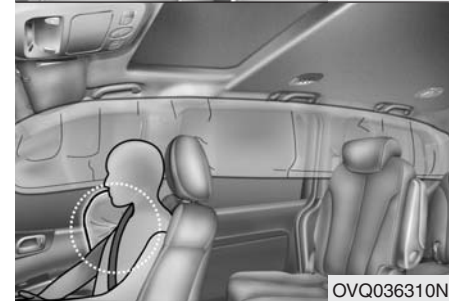

OVQ036310N

### Side impact air bag (if equipped)

Your Hyundai is equipped with a side impact air bag in each front seat. The purpose of the air bag is to provide the vehicle's driver and/or the front passenger with additional protection than that offered by the seat belt alone.

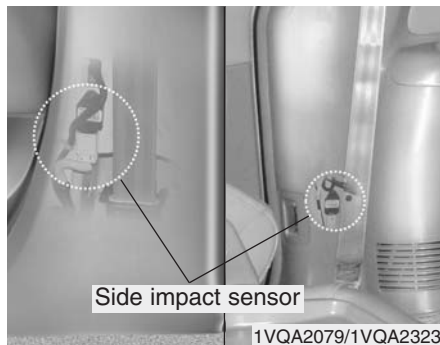

The side impact air bags are designed to deploy only during certain side-impact collisions, depending on the crash severity, angle, speed and point of impact. The side impact air bags are not designed to deploy in all side impact situations.

### **⚠ WARNING**

- The side impact air bag is supplemental to the driver's and the passenger's seat belt systems and is not a substitute for them. Therefore your seat belts must be worn at all times while the vehicle is in motion. The air bags deploy only in certain side impact conditions severe enough to cause significant injury to the vehicle occupants.
- For best protection from the side impact air bag system and to avoid being injured by the deploying side impact air bag, both front seat occupants should sit in an upright position with the seat belt properly fastened. The driver's hands should be placed on the steering wheel at the 9:00 and 3:00 positions. The passenger's arms and hands should be placed on their laps.
- Do not use any accessory seat covers.
- Use of seat covers could reduce or prevent the effectiveness of the system.

(Continued)

(Continued)

- Do not install any accessories on the side or near the side impact air bag.
- Do not place any objects over the air bag or between the air bag and yourself.
- Do not place any objects (an umbrella, bag, etc.) between the front door and the front seat. Such objects may become dangerous projectiles and cause injury if the supplemental side impact air bag inflates.
- To prevent unexpected deployment of the side impact air bag that may result in personal injury, avoid impact to the side impact sensor when the ignition key is on.

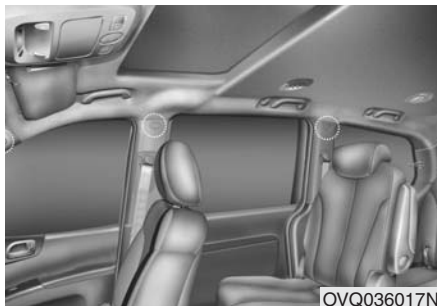

OVQ036017N

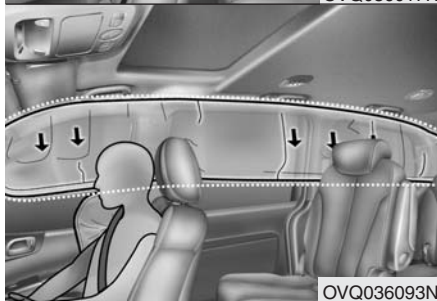

OVQ036093N

### Curtain air bag (if equipped)

Curtain air bags are located along both sides of the roof rails above the front and rear doors.

They are designed to help protect the heads of the front seat occupants and the rear outboard seat occupants in certain side impact collisions.

The curtain air bags are designed to deploy only during certain side impact collisions, depending on the crash severity, angle, speed and impact. The curtain air bags are not designed to deploy in all side impact situations, collisions from the front or rear of the vehicle or in most rollover situations.

### **⚠ WARNING**

- In order for side air bags (side and curtain air bags) to provide its best protection, both front seat occupants and both outboard rear occupants should sit in an upright position with the seat belts properly fastened. Importantly, children should sit in a proper child restraint system in the rear seat.

(Continued)

### (Continued)

- When children are seated in the rear outboard seats, they must be seated in the proper child restraint system. Make sure to put the child restraint system as far away from the door side as possible, and secure the child restraint system in a locked position.
- Do not allow the passengers to lean their heads or bodies onto doors, put their arms on the doors, stretch their arms out of the window, or place objects between the doors and passengers when they are seated on seats equipped with side air bags.
- Never try to open or repair any components of the side curtain air bag system. This should only be done by an authorized Kia dealer.

Failure to follow the above mentioned instructions can result in injury or death to the vehicle occupants in an accident.



### SRS Care

The SRS is virtually maintenance-free and so there are no parts you can safely service by yourself. If the SRS "AIR BAG" warning light does not illuminate, or continuously remains on, have your vehicle immediately inspected by your Hyundai dealer.

Any work on the SRS system, such as removing, installing, repairing, or any work on the steering wheel must be performed by a qualified Hyundai technician. Improper handling of the SRS system may result in serious personal injury.

### **⚠ WARNING**

- Do not install a child restraint system in the front passenger seat position. A child restraint system must never be placed in the front seat. The infant or child could be severely injured by an air bag deployment in case of an accident.
- Modification to SRS components or wiring, including the addition of any kind of badges to the pad covers or modifications to the body structure, can adversely affect SRS performance and lead to possible injury.
- For cleaning the air bag pad covers, use only a soft, dry cloth or one which has been moistened with plain water. Solvents or cleaners could adversely affect the air bag covers and proper deployment of the system.
- No objects should be placed over or near the air bag modules on the steering wheel, instrument panel, and the front passenger's panel above the glove box, because any such object could cause harm if the vehicle is in a crash severe enough to cause the air bags to inflate.

(Continued)

(Continued)

- If the air bags inflate, they must be replaced by an authorized Hyundai dealer.
- Do not tamper with or disconnect SRS wiring, or other components of the SRS system. Doing so could result in injury, due to accidental inflation of the air bags or by rendering the SRS inoperative.
- If components of the air bag system must be discarded, or if the vehicle must be scrapped, certain safety precautions must be observed. Your Hyundai dealer knows these precautions and can give you the necessary information. Failure to follow these precautions and procedures could increase the risk of personal injury.
- If your car was flooded and has soaked carpeting or water on flooring, you shouldn't try to start the engine; have the car towed to an authorized Hyundai dealer.

### Additional safety precautions

- **Never let passengers ride in the cargo area or on top of a folded-down back seat.** All occupants should sit upright, fully back in their seats with their seat belts on and their feet on the floor.
- **Passengers should not move out of or change seats while the vehicle is moving.** A passenger who is not wearing a seat belt during a crash or emergency stop can be thrown against the inside of the vehicle, against other occupants, or out of the vehicle.
- **Each seat belt is designed to restrain one occupant.** If more than one person uses the same seat belt, they could be seriously injured or killed in a collision.
- **Do not use any accessories on seat belts.** Devices claiming to improve occupant comfort or reposition the seat belt can reduce the protection provided by the seat belt and increase the chance of serious injury in a crash.
- **Passengers should not place hard or sharp objects between themselves and the air bags.** Carrying hard or sharp objects on your lap or in your mouth can result in injuries if an air bag inflates.
- **Keep occupants away from the air bag covers.** All occupants should sit upright, fully back in their seats with their seat belts on and their feet on the floor. If occupants are too close to the air bag covers, they could be injured if the air bags inflate.
- **Do not attach or place objects on or near the air bag covers.** Any object attached to or placed on the front or side impact air bag covers could interfere with the proper operation of the air bags.
- **Do not modify the front seats.** Modification of the front seats could interfere with the operation of the supplemental restraint system sensing components or side impact air bags.
- **Do not place items under the front seats.** Placing items under the front seats could interfere with the operation of the supplemental restraint system sensing components and wiring harnesses.
- **Never hold an infant or child on your lap.** The infant or child could be seriously injured or killed in the event of a crash. All infants and children should be properly restrained in appropriate child safety seats or seat belts in the rear seat.

### WARNING

- **Sitting improperly or out of position can cause occupants to be shifted too close to a deploying air bag, strike the interior structure or be thrown from the vehicle resulting in serious injury or death.**
- **Always sit upright with the seat-back in an upright position, centered on the seat cushion with your seat belt on, legs comfortably extended and your feet on the floor.**

### Adding equipment to or modifying your air bag-equipped vehicle.

If you modify your vehicle by changing your vehicle's frame, bumper system, front end or side sheet metal or ride height, this may affect the operation of your vehicle's air bag system.

## Why didn't my air bag go off in a collision?

*(Inflation and non-inflation conditions of the air bag)*

There are many types of accidents in which the air bag would not be expected to provide additional protection.

These include rear impacts, second or third collisions in multiple impact accidents, as well as low speed impacts. In other words, just because your vehicle is damaged and even if it is totally unusable, don't be surprised that the air bags did not inflate.

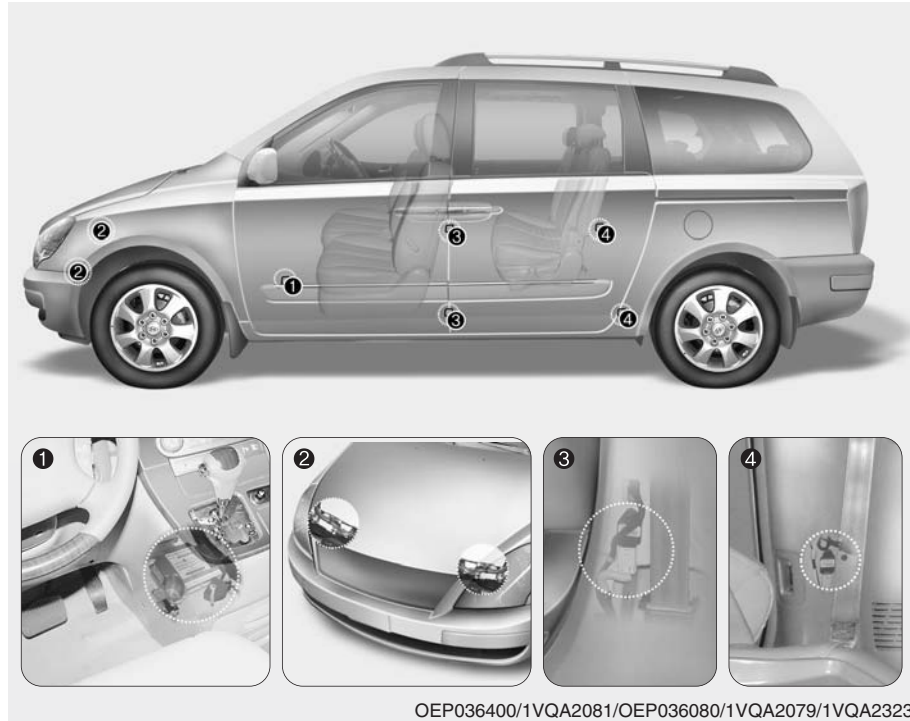

OEP036400/1VQA2081/OEP036080/1VQA2079/1VQA2323

### ***Air bag collision sensors***

- (1) SRS control module
- (2) Front impact sensor

- (3) Side impact sensor (if equipped)
- (4) Side impact sensor (if equipped)



**⚠ WARNING**

- Do not hit or allow any objects to impact the locations where air bag or sensors are installed.

This may cause unexpected air bag deployment, which could result in serious personal injury or death.

- If the installation location or angle of the sensors is altered in any way, the air bags may deploy when they should not or they may not deploy when they should, causing severe injury or death.

Therefore, do not try to perform maintenance on or around the air bag sensors. Have the vehicle checked and repaired by an authorized Hyundai dealer.

(Continued)

**(Continued)**

- Problems may arise if the sensor installation angles are changed due to the deformation of the front bumper, body or B/C pillar where side collision sensors are installed. Have the vehicle checked and repaired by an authorized Hyundai dealer.
- Your vehicle has been designed to absorb impact and deploy the air bag(s) in certain collisions. Installing aftermarket bumper guards or replacing a bumper with non-genuine parts may adversely affect your vehicles collision and air bag deployment performance.

***Air bag inflation conditions*****Front air bag**

Front air bags are designed to inflate in a frontal collision depending on the intensity, speed or angles of impact of the front collision - generally from an area a little to the left to a little to the right of straight ahead.

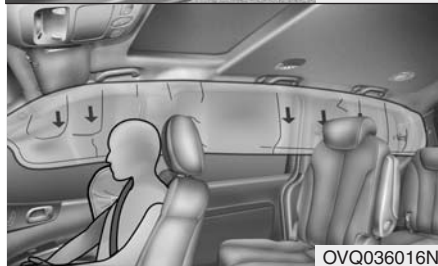

### Side impact air bags (if equipped)

Side impact air bags (side and/or curtain air bags) are designed to inflate when an impact is detected by side collision sensors depending on the strength, speed or angles of impact resulting from a side impact collision or rollover.

Although the front air bags (driver's and front passenger's air bags) are designed to inflate only in frontal collisions, they also may inflate in other types of collisions if the front impact sensors detect a sufficient impact. Side impact air bags (side and/or curtain air bags) are designed to inflate only in side impact collisions, but they may inflate in other collisions if the side impact sensors detect a sufficient impact.

If the vehicle chassis is impacted by bumps or objects on unimproved roads or sidewalks, air bags may deploy. Drive carefully on unimproved roads or on surfaces not designed for vehicle traffic to prevent unintended air bag deployment.

To protect occupants, front air bags or pre-tensioner seat belts may deploy in certain side impact collisions.



### Air bag non-inflation conditions

- In certain low-speed collisions the air bags may not deploy. The air bags are designed not to deploy in such cases because they may not provide benefits beyond the protection of the seat belts in such collisions.

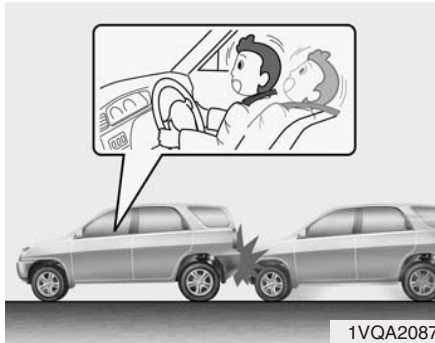

- Frontal air bags are not designed to inflate in rear collisions, because occupants are moved backward by the force of the impact. In this case, inflated air bags would not be able to provide any additional benefit.



- Front air bags may not inflate in side impact collisions, because occupants move to the direction of the collision, and thus in side impacts, frontal air bag deployment would not provide additional occupant protection.  
However, side or curtain air bags may inflate depending on the intensity, vehicle speed and angles of impact.

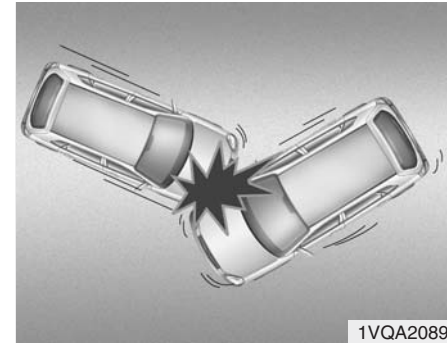

- In a slant or angled collision, the force of impact may direct the occupants in a direction where the air bags would not be able to provide any additional benefit, and thus the sensors may not deploy any air bags.

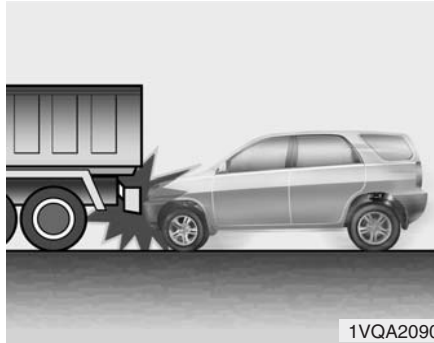

- Just before impact, drivers often brake heavily. Such heavy braking lowers the front portion of the vehicle causing it to “ride” under a vehicle with a higher ground clearance. Air bags may not inflate in this “under-ride” situation because deceleration forces that are detected by sensors may be significantly replaced by such “under-ride” collisions.

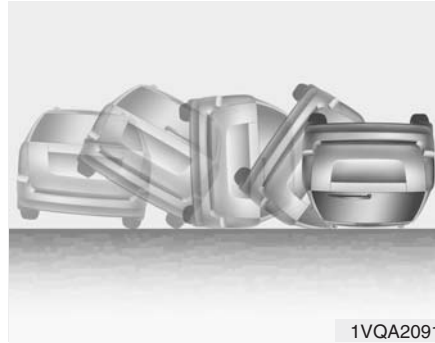

- Air bags may not inflate in rollover accidents because air bag deployment would not provide protection to the occupants. However, side air bags may inflate when the vehicle is rolled over by a side impact collision, if the vehicle is equipped with side impact air bags and curtain air bags.

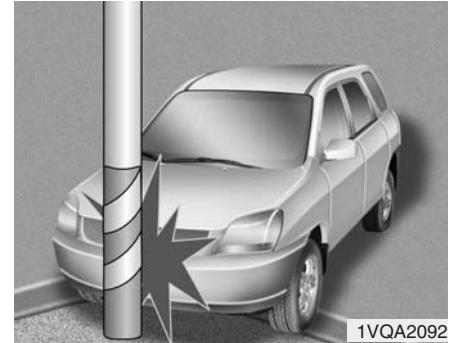

- Air bags may not inflate if the vehicle collides with objects such as utility poles or trees, where the point of impact is concentrated to one area and the full force of the impact is not delivered to the sensors.

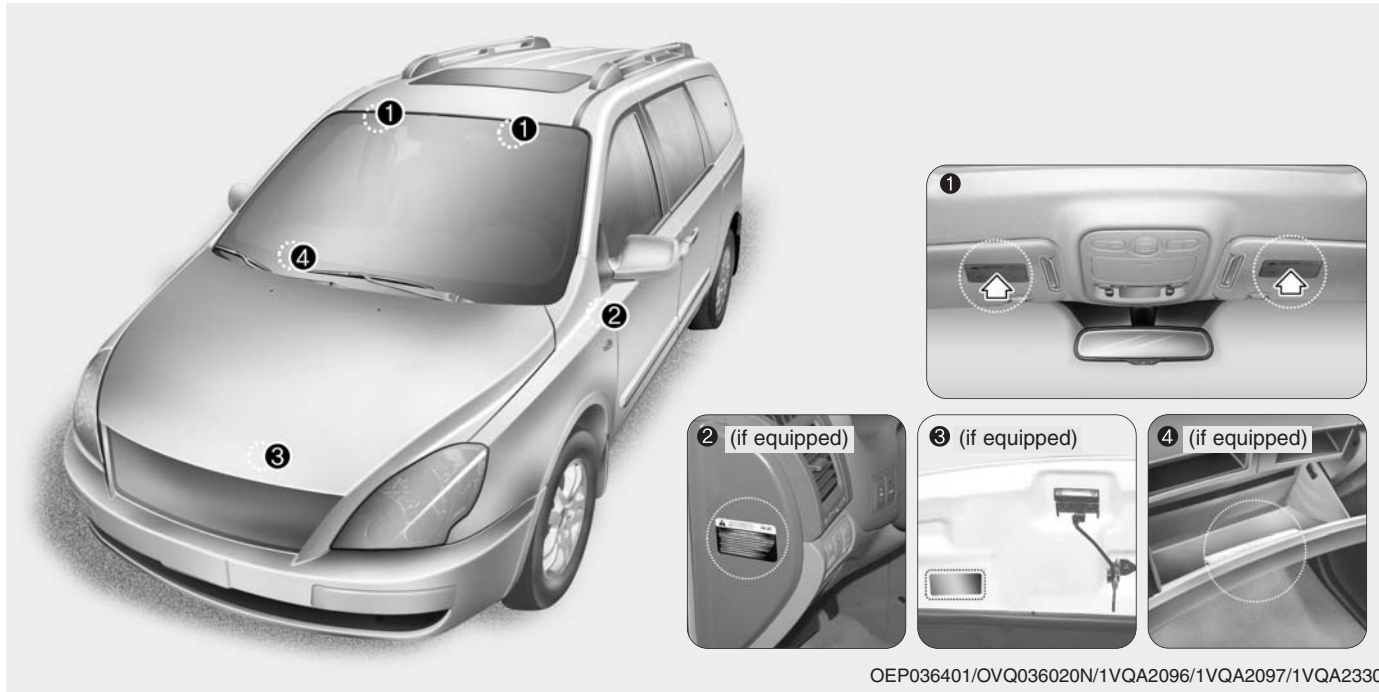

OEP036401/OVQ036020N/1VQA2096/1VQA2097/1VQA2330

**Air bag warning label**

Air bag warning labels required by the U.S. National Highway Traffic Seat Administration (NHTSA) are attached to alert driver and passengers of potential risks of the air bag system.

## STEERING WHEEL

### Power steering

Power steering uses energy from the engine to assist you in steering the vehicle. If the engine is off or if the power steering system becomes inoperative, the vehicle may still be steered, but it will require increased steering effort.

Should you notice any change in the effort required to steer during normal vehicle operation, have the power steering checked by an Authorized Hyundai Dealer.

### CAUTION

- ***Never hold the steering wheel against a stop (extreme right or left turn) for more than 5 seconds with the engine running. Holding the steering wheel for more than 5 seconds in either position may cause damage to the power steering pump.***
- ***If the power steering drive belt breaks or if the power steering pump malfunctions, the steering effort will greatly increase.***

### \* NOTICE

If the vehicle is parked for extended periods outside in cold weather (below 14°F/-10°C), the power steering may require increased effort when the engine is first started. This is caused by increased fluid viscosity due to the cold weather and does not indicate a malfunction.

When this happens, increase the engine RPM by depressing accelerator until the RPM reaches 1,500 rpm then release or let the engine idle for two or three minutes to warm up the fluid.

### Tilt steering

A tilt steering wheel allows you to adjust the steering wheel before you drive. You can also raise it to the highest level to give your legs more room when you exit and enter the vehicle.

The steering wheel should be positioned so that it is comfortable for you to drive, while permitting you to see the instrument panel warning lights and gauges.

#### **⚠ WARNING**

- **Never adjust the angle of the steering wheel while driving. You may lose your steering control and cause an accident that may result in serious injury or death.**
- **After adjusting, push the steering wheel both up and down to be certain it is locked in position.**

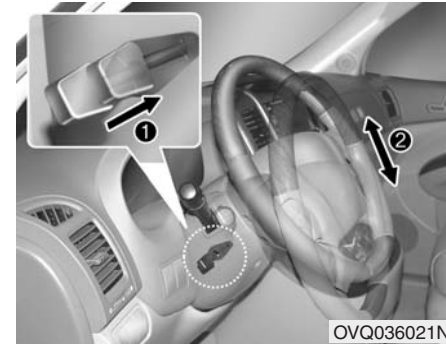

To change the steering wheel angle, pull up the lock release lever (1), adjust the steering wheel to the desired angle (2), then release the lock-release lever to lock the steering wheel in place. Be sure to adjust the steering wheel to the desired position before driving.

## MIRRORS

### Outside rearview mirror

Be sure to adjust mirror angles before driving.

Your vehicle is equipped with both left-hand and right-hand outside rearview mirrors. The mirrors can be adjusted remotely with the remote switch. The mirror heads can be folded back to prevent damage during an automatic car wash or when passing in a narrow street.

### **⚠ WARNING - Rearview mirrors**

- **The right outside rearview mirror is convex. Objects seen in the mirror are closer than they appear.**
- **Use your interior rearview mirror or direct observation to determine the actual distance of following vehicles when changing lanes.**

### **⚡ CAUTION**

***Do not scrape ice off the mirror face; this may damage the surface of the glass. If ice should restrict movement of the mirror, do not force the mirror for adjustment. To remove ice, use a deicer spray, or a sponge or soft cloth with very warm water.***

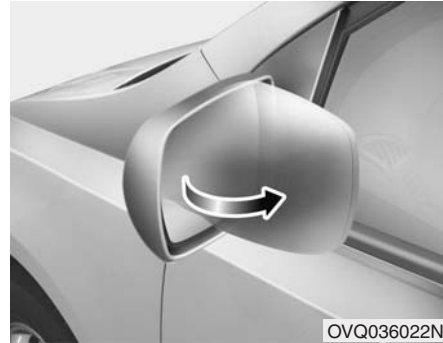

OVQ036022N

### ***Folding the outside rearview mirror***

To fold an outside rearview mirror, grasp the housing of the mirror and then fold it toward the rear of the vehicle.



### ***Outside rearview mirror heater (if equipped)***

The outside rearview mirror heater is actuated in connection with the rear window defroster. To heat the outside rearview mirror glass, push the button for the rear window defroster.

The rearview mirror heater (and rear window defroster) will not operate unless the engine is running.

The outside rearview mirror glass will be heated for defrosting or defogging and will give you improved rear vision in inclement weather conditions. Push the button again to turn the heater off. The outside rearview mirror heater automatically turns off after 20 minutes.

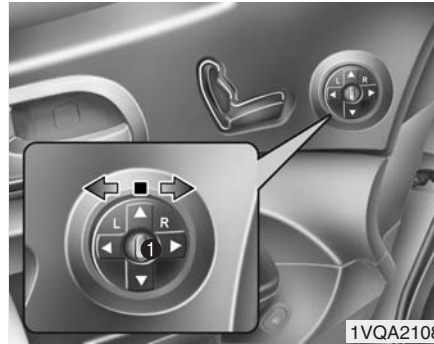

### ***Electric remote control***

The electric remote control mirror switch allows you to adjust the position of the left and right outside rearview mirrors. To adjust the position of either mirror, move the selection switch lever (1) to R or L to select the right side mirror or the left side mirror, then press a corresponding point (▲) on the mirror adjustment control to position the selected mirror up, down, left or right.

After adjustment, put the selection switch lever into neutral position to prevent the inadvertent adjustment.

### ***CAUTION***

- *The mirrors stop moving when they reach the maximum adjusting angles, but the motor continues to operate while the switch is depressed. Do not depress the switch longer than necessary, the motor may be damaged.*
- *Do not attempt to adjust the outside rearview mirror by hand. Doing so may damage the mirror.*

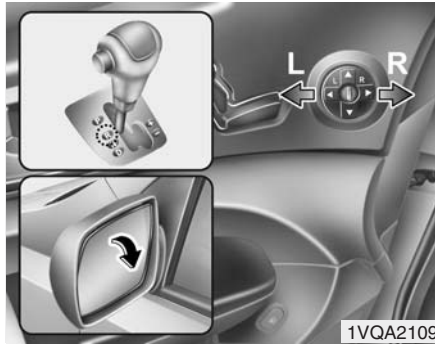

### **Automatic mirror adjustment in reverse maneuvers (if equipped)**

When the transaxle gear is shifted into reverse (R), the outside rearview mirror(s) will automatically be turned downward about 5 degrees to improve driver visibility. They will stay in that position until the transaxle shift lever is shifted out of reverse (R).

Use the mirror selection switch lever to control automatic mirror adjustment as follows:

- L** : Both the left and right outside rearview mirrors will be turned downward about 5 degrees.
- R** : Only the right outside rearview mirror will be turned downward about 5 degrees.
- Center** : Automatic mirror adjustment function is disabled. No mirror will be turned downward.

The outside rearview mirror(s) will return to its previous position automatically if the outside rearview mirror selection switch is changed to another position, or transaxle shift lever is shifted out of reverse (R).

### **(Examples)**

If the shift lever is shifted into reverse (R) when the outside rearview mirror selection switch is in L, both the right and left outside rearview mirrors will automatically be turned down about 5 degrees.

If the outside rearview mirror selection switch is set to R while shift lever is in reverse (R), the left outside rearview mirror will return to its previous position. The right outside rearview mirror will not return to its previous position.

If the shift lever is shifted into any other range OR the outside rearview mirror selection switch is set to center, the right outside rearview mirror will automatically return to its original position.

### Day/night rearview mirror

Adjust the rearview mirror to center on the view through the rear window. Make this adjustment before you start driving.

**⚠ WARNING - Rear visibility**  
Do not place objects in the rear seat or cargo area which would interfere with your vision out the rear window.

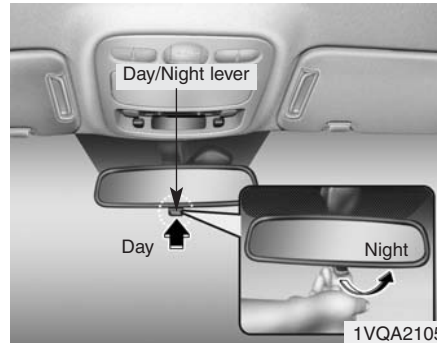

#### Manual type

Make this adjustment before you start driving and while the day/night lever is in the day position.

Pull the day/night lever toward you to reduce glare from the headlights of vehicles behind you during night driving.

*Remember that you lose some rearview clarity in the night position.*

#### Electric type

The electric rearview mirror automatically controls the glare from the headlights of the car behind you in nighttime or low light driving conditions. The sensor mounted in the mirror senses the light level around the vehicle, and through a chemical reaction, automatically controls the headlight glare from vehicles behind you.

When the engine is running, the glare is automatically controlled by the sensor mounted in the rearview mirror.

Whenever the shift lever is shifted into reverse (R), the mirror will automatically change to the brightest setting in order to improve the driver's view behind the vehicle.

#### **CAUTION**

**When cleaning the mirror, use a paper towel or similar material dampened with glass cleaner. Do not spray glass cleaner directly on the mirror as that may cause the liquid cleaner to enter the mirror housing and cause damage to the mirror components.**

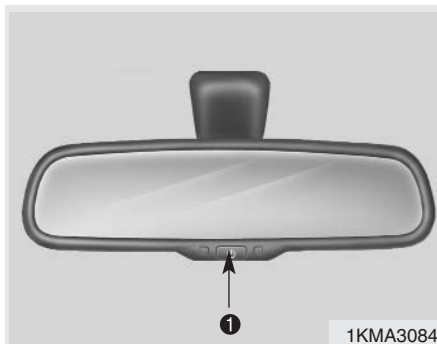

## Type A

### To operate the electric rearview mirror

Press the ON/OFF button (1) to turn the automatic- dimming function on. The mirror indicator light will illuminate.

Press the ON/OFF button to turn the automatic- dimming function off. The mirror indicator light will turn off.



## Type B (with homelink wireless control system)

### To operate the electric rearview mirror

Press the I button (1) to turn the automatic- dimming function on. The mirror indicator light will illuminate.

Press the O button (2) to turn the automatic- dimming function off. The mirror indicator light will turn off.



## Conversation mirror

The mirror is a convenient feature to help the front passenger talk with rear passengers without turning the head or body rearward. To use the mirror, push the cover and open it.

Adjust mirror angle to the desired position.

Close the cover after use.

## **⚠ WARNING**

**Do not adjust the mirror angle or talk with rear passengers while driving. You may lose your steering control and cause an accident that may result in severe personal injury or death.**

## INSTRUMENT CLUSTER

## ■ Type A



1. Tachometer
2. Turn signal indicators
3. Speedometer
4. Engine temperature gauge
5. Warning and indicator lights
6. Shift position indicator  
(Automatic transaxle only)
7. Odometer/Trip odometer
8. Fuel gauge

## ■ Type B



OVQ036026N/OVQ036027N

## GAUGES



### Speedometer

The speedometer indicates the forward speed of the vehicle.



### Odometer/Trip odometer

You can choose the odometer, trip odometer A and trip odometer B by pressing the tripmeter mode button.



### Odometer

The odometer indicates the total distance the vehicle has been driven.



OVQ036036N

### **Trip odometer**

TRIP A: Trip odometer A

TRIP B: Trip odometer B

The trip odometer indicates the distance of individual trips selected by the driver. Trip odometer A and B can be reset to 0 by pressing the reset button for 1 second or more, and then releasing.



OVQ036030N

### **Tachometer**

The tachometer indicates the approximate number of engine revolutions per minute (rpm).

Use the tachometer to select the correct shift points and to prevent lugging and/or over-revving the engine.

The tachometer pointer may move slightly when the ignition switch is in ACC or ON position with the engine OFF. This movement is normal and will not affect the accuracy of the tachometer once the engine is running.

#### **CAUTION**

**Do not operate the engine within the tachometer's RED ZONE.**

**This may cause severe engine damage.**



OVQ036031N

### **Engine temperature gauge**

This gauge shows the temperature of the engine coolant when the ignition switch is ON.

Do not continue driving with an overheated engine. If your vehicle overheats, refer to "Overheating" in the Index.

#### **CAUTION**

**If the gauge pointer moves beyond the normal range area toward the "H" position, it indicates overheating that may damage the engine.**



### Fuel gauge

The fuel gauge indicates the approximate amount of fuel remaining in the fuel tank.

Fuel tank capacity : 21 US gallons (80 liters)

The fuel gauge is supplemented by a low fuel warning light, which will illuminate when the fuel tank is nearly empty.

**⚠ WARNING - Fuel gauge**  
Running out of fuel can expose vehicle occupants to danger. You must stop and obtain additional fuel as soon as possible after the warning light comes on or when the gauge indicator comes close to the E level.

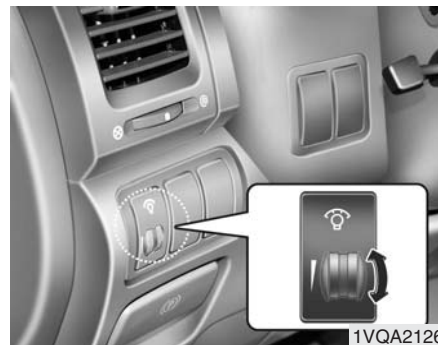

### Instrument panel illumination

When the vehicle's parking lights or headlights are on, rotate the illumination control knob to adjust the instrument panel illumination intensity.

The instrument cluster (Type B) illumination intensity can be adjusted by rotating the control knob with the headlight switch in any position when the ignition switch is in ON position.



## TRIP COMPUTER (IF EQUIPPED)



The trip computer is a microcomputer-controlled driver information system that displays information related to driving, including compass, distance to empty, driving time, average fuel consumption and outside temperature on the display when the ignition switch is in the ON position. All stored driving information is reset if the battery is disconnected.

### Mode selection

The compass is always displayed until the display is turned off.

Push the MODE button to select distance to empty, driving time, average fuel consumption and outside temperature functions.

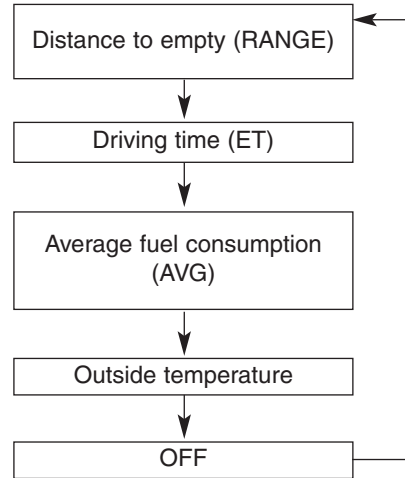

### Compass

The vehicle compass displays the direction the vehicle is heading.

Heading display

- E : East
- W : West
- S : South
- N : North
- ex) NE : North East

### \* NOTICE

Perform the calibration procedure for a new vehicle as follows.

#### *Calibration procedure*

The compass may not indicate the correct compass direction when you are driving in certain areas (tunnels, parking garages, underground parking lots, near transformer substations, etc.), and the following may occur:

- The compass headings become inaccurate.
- The compass heading doesn't change when the vehicle changes direction.
- Some compass headings are not displayed.
- The compass headings are inaccurate in long distance driving.

If the vehicle's compass headings become inaccurate continuously, the compass should be manually calibrated as follows:



1. Move the vehicle away from any large steel structures or power generating cables or equipment and into a safe open location, such as an abandoned parking lot.
2. Check the terrestrial deviation angle value by pressing and holding the MODE button for 4.5 seconds until the current terrestrial deviation angle value appears in the display.
3. If the terrestrial deviation angle value is different for your country, set the correct angle referring to "Setting the compass zone" and perform the "Calibration procedure" again.
4. Make sure the vehicle windshield wipers are turned off.

5. Press and hold the MODE button again for 2~4.5 seconds until the "turn" appears and "DIR" blinks in the display and release the button.
6. Drive your vehicle in at least 1 complete (either clockwise or counter-clockwise) circle at less than 3 mph (5 km/h) within 10 minutes until the compass heading appears.
7. If the vehicle's compass headings become inaccurate again, repeat steps 1 through 6 above.

### \* NOTICE

If you press the MODE button before the calibration is completed or the vehicle is not rotated within 10 minutes after "turn" appears and "DIR" blinks, the correction will be cancelled.



1VQA2317

### Setting the compass zone

This compass must be set to compensate for the variation between true north and magnetic north. To set the variation:

1. Find your current location and terrestrial deviation angle value on the zone map.
2. Press and hold the MODE button for 4.5 seconds. The current terrestrial deviation angle value will appear in the display.

3. Release the MODE button and press the RESET button repeatedly until the correct terrestrial deviation angle value for your location appears in the display.
4. Press and hold the MODE button for more than 1 second, and then the display will show a compass direction.

### \* NOTICE

If you press the MODE button for less than 1 second before a new compass zone is set, the correction is cancelled. Also, if the correction is not completed within 30 seconds, the current terrestrial deviation angle value will blink for 2 seconds and the correction will be cancelled.

### \* NOTICE

1. Do not install a ski rack, antenna, etc. that is attached to the vehicle using a magnet, as anything attached to the roof of the vehicle with a magnet will effect compass operation.
2. If the compass deviates from the correct indication after repeated adjustment, have the compass checked at an authorized dealer.
3. The compass may not indicate the correct compass point in tunnels or while driving up or down a steep hill. (The compass returns to the correct compass point when the vehicle moves to an area where the geomagnetism is stabilized.)

Compass zone map

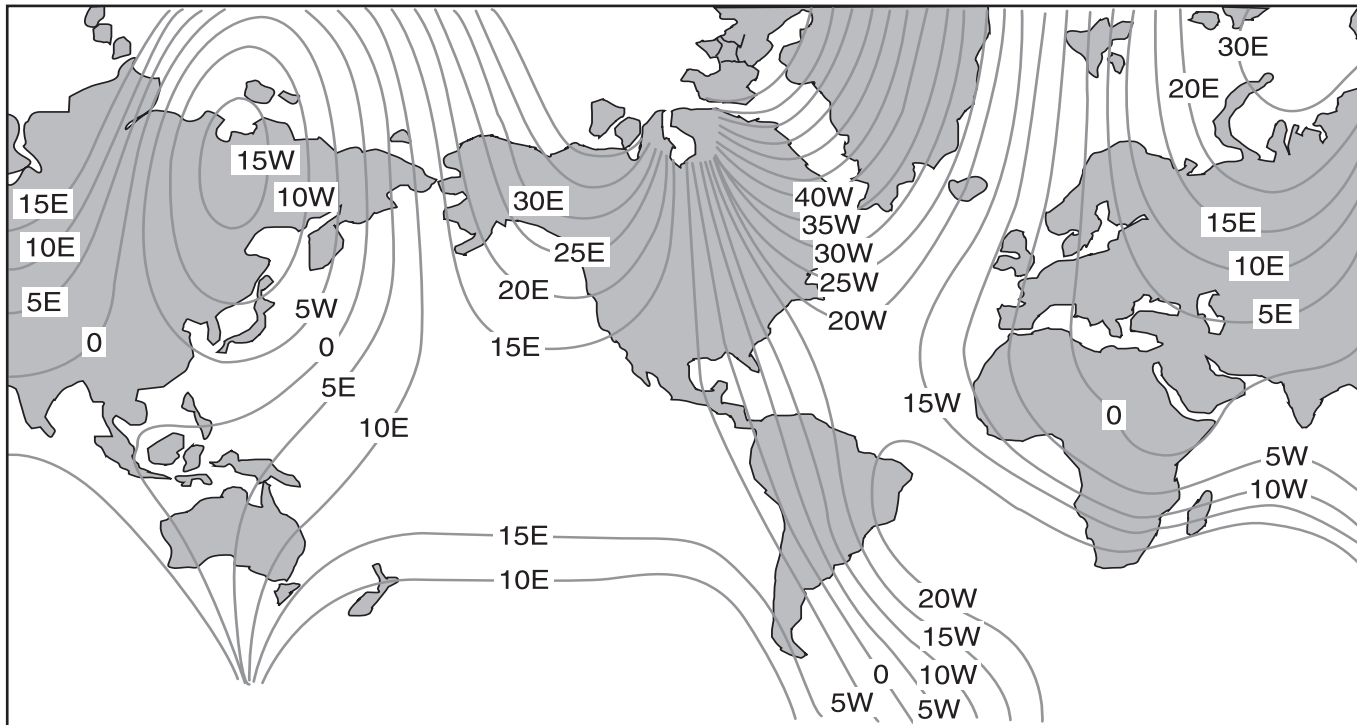



### Distance to empty (“RANGE” shown on display)

This mode indicates the estimated distance to empty based on the current fuel in the fuel tank and the amount of fuel delivered to the engine. When the remaining distance is below 30 miles (50 km), a blinking “----” symbol will be displayed.

The meter’s working range is from 30 to 1500 miles (50 to 1500 km).

### \* NOTICE

- If the vehicle is not on level ground or the battery power has been interrupted, the “Distance to empty” function may not operate correctly. The trip computer may not register additional fuel if less than 1.6 gallons (6 liters) of fuel are added to the vehicle.
- The fuel consumption and distance to empty values may vary significantly based on driving conditions, driving habits, and condition of the vehicle.
- The distance to empty value is an estimate of the available driving distance. This value may differ from the actual driving distance available.



### Driving time (“ET” shown on display)

This mode indicates the total time traveled since the last driving time reset. Even if the vehicle is not in motion, the driving time keeps going while the engine is running.

The meter’s working range is from 0:00~99:59.

Pressing the RESET button for less than 4 seconds, when the driving time is being displayed, clears the driving time to zero.



### Average fuel consumption (“AVG” shown on display)

This mode calculates the average fuel consumption from the total fuel used and the distance since the last average consumption reset. The total fuel used is calculated from the fuel consumption input. For an accurate calculation, drive more than 0.3 miles (500 m).

The meter's working range is from 0.0 to 99.9 miles per gallon (0.0 to 99.9 l/100 km).

Pressing the RESET button for less than 4 seconds, when the average fuel consumption is being displayed, clears the average fuel consumption to “-” until the vehicle is moved to 0.3 miles (500 m).



### Outside temperature

This mode indicates the outside temperature around the vehicle. The meter's working range is from -40°F~140°F (-40°C to 60°C).

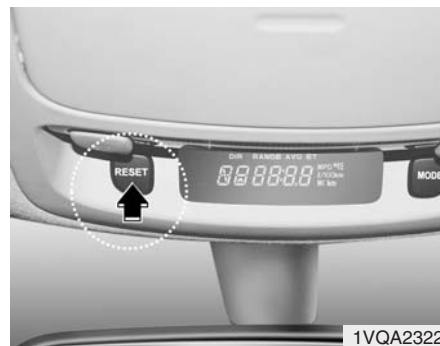

### Unit conversion

The unit on each mode can be changed by pushing the RESET button for more than 4 seconds as follows:

- Distance to empty: km ↔ MI
- Average fuel consumption: l/100km ↔ MPG
- Outside temperature: °C ↔ °F

The units on the mode of distance to empty and average fuel consumption are changed together. However, the outside temperature mode display units are changed separately.

## WARNINGS AND INDICATORS

### Checking operation

All warning lights are checked by turning the ignition switch ON (do not start the engine). Any light that does not illuminate should be checked by an Authorized Hyundai Dealer.

After starting the engine, check to make sure that all warning lights are off. If any are still on, this indicates a situation that needs attention. When releasing the parking brake, the brake system warning light should go off. The fuel warning light will stay on if the fuel level is low.

### Air bag warning light



This warning light will illuminate for approximately 6 seconds each time you turn the ignition switch to the ON position.

If this indicator does not go out, or if it illuminates while the vehicle is being driven, see an authorized Hyundai Dealer for immediate service.

### Anti-lock brake system (ABS) warning light



This light illuminates if the key is turned to ON and goes off in approximately 3 seconds if the system is operating normally.

If the light stays on, you may have a problem with your ABS system. Contact an authorized Hyundai dealer as soon as possible.

### Electronic brake force distribution (EBD) system warning light



If two warning lights illuminate at the same time while driving, your vehicle has a problem with the ABS and EBD system.

In this case, your ABS system and regular brake system may not work normally. Have the vehicle checked by an Authorized Hyundai Dealer as soon as possible.



### WARNING

**If both ABS and Brake warning lights are ON and stay ON, your vehicle's brake system will not work normally. So you may experience an unexpected and dangerous situation during sudden braking. In this case, avoid high speed driving and abrupt braking. Have your vehicle checked by Authorized Hyundai Dealer as soon as possible.**

## Seat belt warning light



If the driver's seat belt is not fastened when the key is turned ON or if it is unfastened after the key is turned ON, the seat belt warning light blinks until the belt is fastened.

## Seat belt warning chime (if equipped)

If the driver's seat belt is not fastened when the ignition key is turned ON or if it is unfastened after the key is turned ON, the seat belt warning chime will sound for approximately 6 seconds. At this time, if the seat belt is fastened, the chime will stop at once.

## High beam indicator

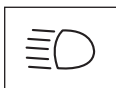

This indicator illuminates when the headlights are on and in the high beam position or when the turn signal lever is pulled into the Flash-to-Pass position.

## Engine oil pressure warning



This warning light indicates the engine oil pressure is low.

If the warning light illuminates while driving:

1. Drive safely to the side of the road and stop.
2. With the engine off, check the engine oil level. If the level is low, add oil as required.

If the warning light remains on after adding oil or if oil is not available, call an Authorized Hyundai Dealer.

### CAUTION

*If the engine is not stopped immediately after the engine oil pressure warning light is illuminated, severe damage could result.*

## Parking brake & brake fluid warning



### *Parking brake warning*

This light is illuminated when the parking brake is applied with the ignition switch in the START or ON position. The warning light should go off when the parking brake is released.

### *Low brake fluid level warning*

If the warning light remains on, it may indicate that the brake fluid level in the reservoir is low.

If the warning light remains on:

1. Drive carefully to the nearest safe location and stop your vehicle.
2. With the engine stopped, check the brake fluid level immediately and add fluid as required. Then check all brake components for fluid leaks.
3. Do not drive the vehicle if leaks are found, the warning light remains on or the brakes do not operate properly. Have it towed to any Authorized Hyundai Dealer for a brake system inspection and necessary repairs.



To check bulb operation, check whether the parking brake and brake fluid warning light illuminates when the ignition switch is in the ON position.

### **⚠ WARNING**

**Driving the vehicle with a warning light on is dangerous. If the brake warning light remains on, have the brakes checked and repaired immediately by an authorized Hyundai Dealer.**

### **Parking brake warning chime**

If you drive over 6 mph (10 km/h) with the parking brake applied, the parking brake warning chime will sound.

### **Front fog light indicator (if equipped)**

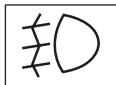

This light comes on when the front fog lights are ON.

### **Shift pattern indicators (if equipped)**



The individual indicators illuminate to show the automatic transaxle shift lever selection.

### **Charging system warning**

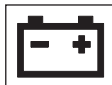

This warning light indicates a malfunction of either the generator or electrical charging system.

If the warning light comes on while the vehicle is in motion:

1. Drive to the nearest safe location.
2. With the engine off, check the generator drive belt for looseness or breakage.
3. If the belt is adjusted properly, a problem exists somewhere in the electrical charging system. Have an Authorized Hyundai Dealer correct the problem as soon as possible.

### **Tailgate open warning light**



This warning light comes on when the tailgate is not closed securely.

### **Door ajar warning light**



This warning light illuminates when a door is not closed securely with the ignition in any position.

### **Door ajar warning chime**

If a door or tailgate is opened while driving the vehicle over 6 mph (10km/h), the warning chime will sound.

### Immobilizer indicator (if equipped)



This light illuminates when the immobilizer key is inserted and turned to the ON position to start the engine.

At this time, you can start the engine. The light goes out after the engine is running. If this light blinks when the ignition switch is in the ON position before starting the engine, have the system checked by an authorized Hyundai Dealer.

### Low fuel level warning



This warning light indicates the fuel tank is nearly empty. When it comes on, you should add fuel as soon as possible. Driving with the fuel level warning light on or with the fuel level below “E” can cause the engine to misfire and damage the catalytic converter.

### Malfunction indicator lamp (MIL) (check engine light)





This indicator light is part of the Engine Control System which monitors various emission control system components. If this light illuminates while driving, it indicates that a potential problem has been detected somewhere in the emission control system.

Generally, your vehicle will continue to be drivable, but have the system checked by an authorized Hyundai Dealer promptly.

### \* NOTICE

A loose fuel filler cap may cause the On Board Diagnostic System Malfunction Indicator Light (  ) in the instrument panel to illuminate unnecessarily. Always make sure that the fuel filler cap is tight.

### CAUTION

- Prolonged driving with the Emission Control System Malfunction Indicator Light (  ) illuminated may cause damage to the emission control systems which could effect drivability and/or fuel economy.
- If the Emission Control System Malfunction Indicator Light (  ) illuminates, potential catalytic converter damage is possible which could result in loss of engine power. Have the Engine Control System inspected as soon as possible by an authorized Hyundai Dealer.

### Low washer fluid level warning indicator



This warning light indicates the washer fluid reservoir is near empty. Refill the washer fluid as soon as possible.

**ESC indicator  
(Electronic Stability  
Control) (if equipped)**A square icon with a black border containing the letters "ESC" in a bold, sans-serif font.

The ESC indicator will illuminate when the ignition switch is turned ON, but should go off after approximately 3 seconds. When the ESC is on, it monitors the driving conditions and under normal driving conditions, the ESC light will remain off. When a slippery or low traction condition is encountered, the ESC will operate, and the ESC indicator will blink to indicate the ESC is operating.

**ESC OFF indicator  
(if equipped)**A square icon with a black border containing the letters "ESC OFF" in a bold, sans-serif font.

The ESC OFF indicator will illuminate when the ignition switch is turned ON, but should go off after approximately 3 seconds. To switch to ESC OFF mode, press the ESC OFF button. The ESC OFF indicator will illuminate indicating the ESC is deactivated. If this indicator stays on in the ESC ON mode, the ESC may have a malfunction. Take your car to the authorized Hyundai dealer and have the system checked.

**Cruise indicator (if equipped)****CRUISE indicator**A square icon with a black border containing the word "CRUISE" in a bold, sans-serif font.

The indicator light illuminates when the cruise control system is enabled.

**Cruise SET indicator**A square icon with a black border containing the word "SET" in a bold, sans-serif font.

The indicator light illuminates when the cruise function switch (COAST/SET or RES/ACCEL) is ON.

**Lights on warning chime**

The lights on warning chime will sound if the headlight switch is left in the 1st or 2nd position and the driver's door is opened.

**Key reminder warning chime**

If the driver's door is opened while the ignition key is left in the ignition switch (ACC or LOCK position), the key reminder warning chime will sound. This is to prevent you from locking your keys in the vehicle.

### Low tire pressure indicator



### Low tire pressure position indicator

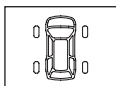

The low tire pressure and position indicators illuminate for 3 seconds after the ignition key is turned to the "ON" position.

If the warning lights do not come on, or continuously remain on after the 3-second bulb check when you turned the ignition key to the "ON" position, the Tire Pressure Monitoring System is not working properly. If this occurs, have your vehicle checked by an authorized Hyundai dealer as soon as possible.

This warning lights will also illuminate if one or more of your tires is significantly under-inflated. The low tire pressure position indicator light will indicate which tire is significantly under-inflated by illuminating the corresponding position light.

You should stop and check your tires as soon as possible. If the warning lights illuminate while driving, reduce vehicle speed immediately and stop the vehicle. Avoid hard braking and overcorrecting at the steering wheel. Inflate the tires to the proper pressure as indicated on the vehicle's tire information placard.

#### **WARNING**

**Significantly low tire pressure makes the vehicle unstable and can contribute to loss of vehicle control and increased braking distances.**

**Continued driving on low pressure tires will cause the tires to overheat and fail.**

### TPMS (Tire pressure monitoring system) malfunction indicator

TPMS

TPMS malfunction indicator illuminates for 3 seconds after the ignition key is turned to the "ON" position.

If the warning light does not come on, or continuously remains on after the 3-second bulb check when you turned the ignition key to the "ON" position, the Tire Pressure Monitoring System is not working properly. If this occurs, have your vehicle checked by an authorized Hyundai dealer as soon as possible.

The warning light also comes on and stays on when there is a problem with the Tire Pressure Monitoring System.

If this happens, the system may not monitor the tire pressure. Have the system checked by an authorized Hyundai dealer as soon as possible.

#### **WARNING**

- **The TPMS cannot alert you to severe and sudden tire damage caused by external factors.**
- **If you feel any vehicle instability, immediately take your foot off the accelerator and slowly move to a safe position off the road.**

## INTERIOR LIGHTS



### Map light

The lights are turned ON or OFF based on the status of the doors, main control switch and corresponding light switch.

#### Map lights operating logic

Main control switch status	Door open/close status	Map light switch	
		ON (depressed)	DOOR (not depressed)
OFF	Any	ON	OFF
DOOR	Open or Close → Open	ON	Lamp turns ON, then turns OFF after about 20 minutes* <sup>1)</sup>
	Close	ON	OFF* <sup>2)</sup>
	Open → Close	ON	Lamp dims gradually over a 5-second period* <sup>3)</sup>
ON	Any	ON	

<sup>1)</sup> If other door is opened while the light stays off after about 20 minutes, the light stays on again for about 20 minutes.

<sup>2)</sup> When a door is unlocked by the transmitter, the light stays on for about 30 seconds as long as any door is not opened.

When the ignition switch is turned to the ACC or LOCK position, the light stays on for about 15 seconds.

<sup>3)</sup> If the ignition switch is turned to the ON position, the light turns off immediately.

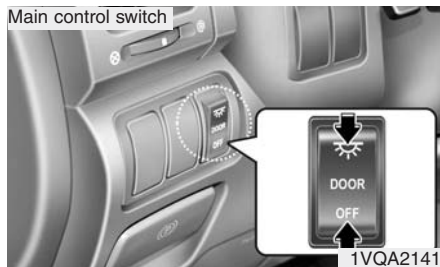

## Dome light

The lights are turned ON or OFF based on the status of the doors, main control switch and corresponding light switch.

### Dome lights operating logic

Main control switch status	Door open/ close status	Dome light switch		
		ON	DOOR	OFF
OFF	Any	OFF		
DOOR	Open or Close → Open	ON	Lamp turns ON, then turns OFF after about 20 minutes* <sup>1)</sup>	OFF
	Close	ON	OFF* <sup>2)</sup>	OFF
	Open → Close	ON	Lamp dims gradually over a 5-second period* <sup>3)</sup>	OFF
ON	Any	ON		

<sup>1)</sup> If other door is opened while the light stays off after about 20 minutes, the light stays on again for about 20 minutes.

<sup>2)</sup> When a door is unlocked by the transmitter, the light stays on for about 30 seconds as long as any door is not opened.

When the ignition switch is turned to the ACC or LOCK position, the light stays on for about 15 seconds.

<sup>3)</sup> If the ignition switch is turned to the ON position, the light turns off immediately.

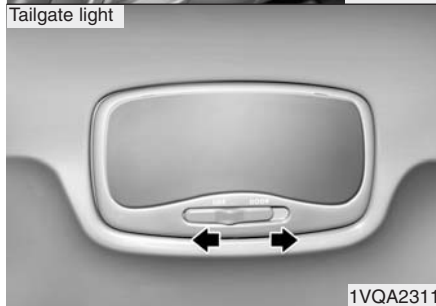
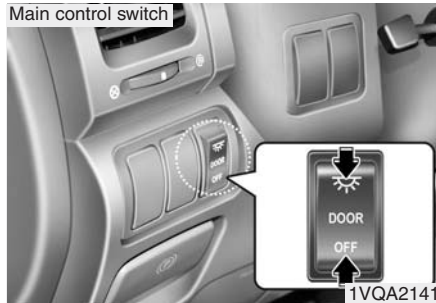

### Tailgate light

The lights are turned ON or OFF based on the status of the tailgate, main control switch and corresponding light switch.

#### Tailgate light operating logic

Main control switch status	Tailgate open/ close status	Tailgate light switch	
		DOOR	OFF
OFF	Open	ON	OFF
	Close	OFF	
DOOR	Open or Close → Open	Lamp turns ON, then turns OFF after about 20 minutes	OFF
	Close or Open → Close	OFF	
ON	Any	ON	

Front



OVQ036041N

Rear

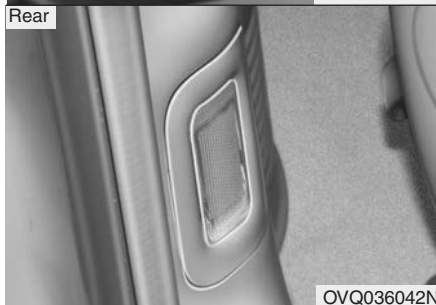

OVQ036042N

### Door courtesy lamp (if equipped)

The door courtesy lamp comes ON when the door is opened to assist entering or exiting the vehicle. It also serves as a warning to passing vehicles that the vehicle door is open.



OVQ036043N

### Glove box lamp

The glove box lamp comes ON when the glove box is opened. The parking lights or headlights must be ON for the glove box lamp to function.

## LIGHTING

### Battery saver function

- The purpose of this feature is to prevent the battery from being discharged. The system automatically turns off the small light when the driver removes the ignition key and opens the driver-side door.
- With this feature, the parking lights will be turned off automatically if the driver parks on the side of road at night. If necessary, to keep the lights on when the ignition key is removed, perform the following :
  - 1) Open the driver-side door.
  - 2) Turn the parking lights OFF and ON again using the light switch on the steering column.



### Rescue mode function

If your vehicle has any problem on the vehicle network system, the headlights (low beam) and parking lights turn on automatically with the ignition switch in the ON position even though the headlight switch is not turned on. At this time, the emergency lighting is not turned off when the headlight switch is turned off.

#### **CAUTION**

*If the rescue mode occurs, have your vehicle checked by an authorized Hyundai dealer as soon as possible.*



1VQA2129

### Lighting control

The light switch has a Headlight and a Parking light position.

To operate the lights, turn the knob at the end of the control lever to one of the following positions:

- (1) OFF position
- (2) Parking light position
- (3) Headlight position
- (4) Auto light position (if equipped)



1VQA2130

### *Parking light position ( )*

When the light switch is in the parking light position (1st position), the tail, position, license and instrument panel lights are ON.



### Headlight position (D/D)

When the light switch is in the headlight position (2nd position) the head, tail, position, license and instrument panel lights are ON.

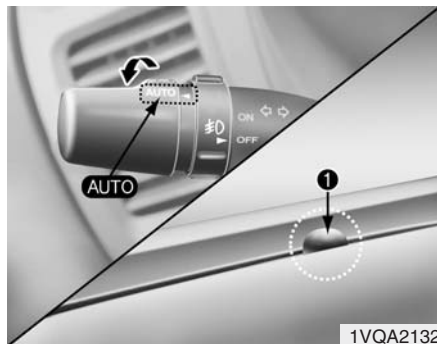

### Auto light position (if equipped)

When the light switch is in the AUTO light position, the taillights and headlights will be turned ON or OFF automatically depending on the amount of light outside the vehicle.

### CAUTION

- **Never place anything over sensor (1) located on the instrument panel, this will ensure better auto-light system control.**
- **Don't clean the sensor using a window cleaner, the cleanser may leave a light film which could interfere with sensor operation.**
- **If your vehicle has window tint or other types of coating on the front windshield, the Auto light system may not work properly.**



1VQA2134

### High - beam operation

To turn on the high beam headlights, push the lever away from you. Pull it back for low beams.

The high-beam indicator will light when the headlight high beams are switched on.

To prevent the battery from being discharged, do not leave the lights on for a prolonged time while the engine is not running.



1VQA2133

### Flashing headlights

To flash the headlights, pull the lever towards you. It will return to the normal (low-beam) position when released. The headlight switch does not need to be on to use this flashing feature.

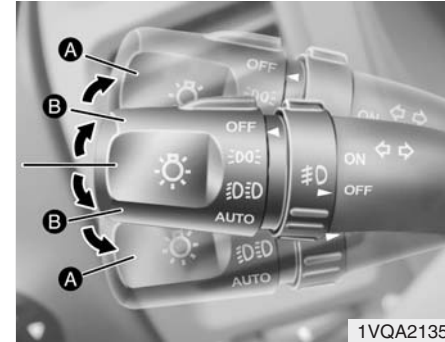

1VQA2135

### Turn signals (A)

The ignition switch must be on for the turn signals to function. To turn on the turn signals, move the lever up or down. Green arrow indicators on the instrument panel indicate which turn signal is operating. They will self-cancel after a turn is completed. If the indicator continues to flash after a turn, manually return the lever to the OFF position.

### Lane change signals (B)

To signal a lane change, move the turn signal lever slightly and hold it in position. The lever will return to the OFF position when released.

If an indicator stays on and does not flash or if it flashes abnormally, one of the turn signal bulbs may be burned out and will require replacement.

### \* NOTICE

If an indicator flash is abnormally quick or slow, a bulb may be burned out or there may be a poor electrical connection in the circuit.



### Front fog light (if equipped)

Fog lights are used to provide improved visibility and avoid accidents when visibility is poor due to fog, rain or snow etc. The fog lights will turn on when the fog light switch (1) is turned to ON after the headlights are turned on.

To turn off the fog lights, turn the switch to OFF.

### **CAUTION**

*When in operation, the fog lights consume large amounts of vehicle electrical power. Only use the fog lights when visibility is poor or unnecessary battery and generator drain could occur.*

## WIPERS AND WASHERS

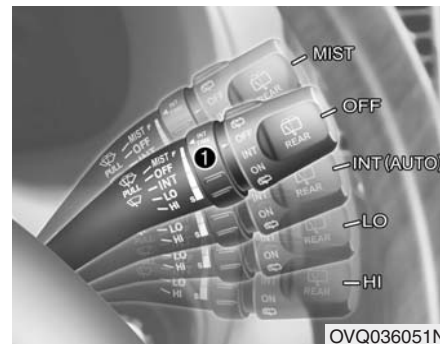

### Windshield wipers

Operates as follows when the ignition switch is turned ON.

OFF : Wiper is not in operation

INT : Wiper operates intermittently at the same wiping intervals. Use this mode in a light rain or mist. To vary the speed setting, turn the speed control knob(1). (S : slow operation, F: fast operation)

LO : Normal wiper speed

HI : Fast wiper speed

MIST: For a single wiping cycle, push the lever upward and release it with the lever in the OFF position. The wipers will operate continuously if the lever is pushed upward and held.

### \* NOTICE

If there is heavy accumulation of snow or ice on the windshield, defrost the windshield for about 10 minutes, or until the snow and/or ice is removed before using the windshield wipers to ensure proper operation.



OVQ036052N

#### Auto control (if equipped)

The rain sensor located on the upper end of windshield glass senses the amount of rainfall and controls the wiping cycle for the proper intervals. The more it rains, the faster the wiper operates. When the rain stops, the wiper stops. To vary the speed setting, turn the speed control knob (1). (S : slow operation, F: fast operation.)

If the wiper switch is set in AUTO mode when the ignition switch is ON, or the speed control knob is turned toward the F position when the wiper switch is in AUTO mode, wiper will operate once to perform a self-check of the system. Set the wiper to OFF position when the wiper is not in use.

### CAUTION

- When washing the vehicle, set the wiper switch in the OFF position to stop the auto wiper operation.
- The windshield wipers may operate and be damaged if the switch is set in AUTO mode while washing vehicle.
- Do not remove the sensor cover located on the upper end of the passenger side windshield glass. Damage to system parts could occur and may not be covered by your vehicle warranty.
- When the starting the vehicle in winter, set the wiper switch in the OFF position. Otherwise, wipers may operate and ice may damage the windshield wiper blades. Always remove all snow and ice and defrost the windshield properly prior to operating the windshield wipers.

### **CAUTION**

*When the ignition switch is ON and the windshield wiper switch is placed in the AUTO mode, use caution in the following situations to avoid any injury to the hands or other parts of the body:*

- *Do not touch the upper end of the windshield glass facing the rain sensor.*
- *Do not wipe the upper end of the windshield glass with a damp or wet cloth.*
- *Do not put pressure on the windshield glass.*

### **Variable intermittent wipers**

Set the lever to the INT/AUTO position and choose the desired wiper interval by turning the ring.

### **One - touch wiper**

For a single wiping cycle, push the lever upward and release it with the lever in the OFF position.

The wipers will operate continuously if the lever is pushed upward and held.

### **CAUTION**

- *To prevent possible damage to the wipers or windshield, do not operate the wipers when the windshield is dry.*
- *To prevent damage to the wiper blades, do not use gasoline, kerosene, paint thinner, or other solvents on or near them.*
- *To prevent damage to the wiper arms and other components, do not attempt to move the wipers manually.*



OVQ036053N

### **Windshield washers**

In the OFF position, pull the lever gently toward you to spray washer fluid on the windshield and to run the wipers 1-3 cycles.

Use this function when the windshield is dirty.

The spray and wiper operation will continue until you release the lever.

If the washer does not work, check the washer fluid level. If the fluid level is not sufficient, you will need to add appropriate non-abrasive windshield washer fluid to the washer reservoir.

The reservoir filler neck is located in the front of the engine compartment on the passenger side (see page 6-20).

**CAUTION**

To prevent possible damage to the washer pump, do not operate the washer when the fluid reservoir is empty.

**WARNING**

Do not use the washer in freezing temperatures without first warming the windshield with the defroster; the washer solution could freeze on contact with the windshield and obscure your vision.

**Rear window wiper and washer switch (if equipped)**

The rear window wiper and washer switch is located at the end of the wiper and washer switch lever. Turn the switch to desired position to operate the rear wiper and washer.

-  - Spraying washer fluid and wiping
- OFF - Wiper is not in operation
- INT - Intermittent wiper operation
- ON - Normal wiper operation

**HORN**

To sound the horn, press the area indicated by the horn symbol on your steering wheel (see illustration). The horn will operate only when this area is pressed. Check the horn regularly to be sure it operates properly.

**CAUTION**

- Do not strike the horn severely to operate it, or hit it with your fist.
- Do not press on the horn with a sharp-pointed object.

## DEFROSTER



The defroster heats the window to remove frost, fog and thin ice from the interior and exterior of the rear window while engine is running.

### **CAUTION**

- *To prevent damage to the conductors bonded to the inside surface of the rear window, never use sharp instruments or window cleaners containing abrasives to clean the window.*
- *If you want to defrost and defog on the front windshield, refer to “Windshield Defrosting and Defogging” in this section.*

To activate the rear window defroster, press the rear window defroster button located in the center console switch panel. The indicator on the rear window defroster button illuminates when the defroster is ON.

If there is heavy accumulation of snow on the rear window, brush it off before operating the rear defroster.

The rear window defroster automatically turns off after approximately 20 minutes or when the ignition switch is turned off. To turn off the defroster, press the rear window defroster button again.

### **Outside mirror defroster (if equipped)**

If your vehicle is equipped with an outside mirror defroster, it will operate at the same time as the rear window defroster.





OVQ036058N

\* The location of the front windshield deicer button may be different depending on your model.

### Front windshield deicer (if equipped)

The engine must be running to enable this feature. To activate the front windshield deicer, press the front windshield deicer button. The indicator on the button illuminates when the deicer is ON. The front windshield deicer automatically turns off after approximately 20 minutes or when the ignition switch is turned off. To turn off the deicer, press the front windshield deicer button again.

## HAZARD WARNING FLASHER



OVQ036059N

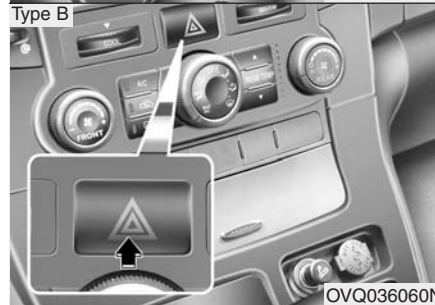

OVQ036060N

To activate the flasher, depress the hazard warning flasher switch. This switch operates in any ignition switch position. To turn the flashers off, depress the switch again.

The hazard warning flasher causes the front and rear turn signal lights to flash on and off, which serves as a warning to other drivers to exercise caution when approaching or passing your vehicle.

## MANUAL CLIMATE CONTROL SYSTEM (IF EQUIPPED)



1. Driver's temperature control knob
2. Passenger's temperature control knob
3. Front fan speed control knob
4. Air conditioning button (if equipped)
5. Air intake control button

6. Rear window defroster button
7. Mode selection knob
8. Rear temperature control button
9. Rear fan speed control knob

OVQ036061N



OVQ036062N

### Heating and ventilation (front)

#### *Fan speed control knob*

The ignition switch must be in the ON position for fan operation.

The fan speed control knob allows you to control the fan speed of the air flowing from the ventilation system. To change the fan speed, turn the knob to the right for higher speed or left for lower speed.

Setting the mode selection knob to the OFF position turns off the fan.



OVQ036063N

### *Air intake control button*

This is used to select outside (fresh) air position or recirculated air position.

To change the air intake control position, push the control button.

### Recirculated air position

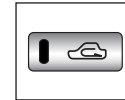

The indicator light on the button is illuminated when the recirculated air position is selected.

With the recirculated air position selected, air from passenger compartment will be drawn through the ventilation system and heated or cooled according to the function selected.

### Outside (fresh) air position

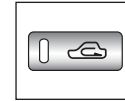

The indicator light on the button is not illuminated when the outside (fresh) air position is selected.

With the outside (fresh) air position selected, air enters the vehicle from outside and is heated or cooled according to the function selected.

### \* NOTICE

It should be noted that prolonged operation of the heating in recirculated air position will cause fogging of the windshield and side windows and the air within the passenger compartment will become stale.

In addition, prolonged use of the air conditioning with the “recirculated air position” selected, will result in excessively dry air in the passenger compartment.

### ⚠ WARNING

- Continued climate control system operation in the recirculated air position may allow humidity to increase inside vehicle which may fog the glass and obscure visibility.
- Do not sleep in a vehicle with air conditioning or heating system on. It may cause serious harm or death due to a drop in the oxygen level and/or body temperature.
- Continued climate control system operation in the recirculated air position can cause drowsiness or sleepiness, and loss of vehicle control. Set the air intake control to the outside (fresh) air position as much as possible while driving.



### *Temperature control knob*

The temperature control knob allows you to control the temperature of the air flowing from the ventilation system. To change the air temperature in the passenger compartment, turn the knob to the WARM position for warm and hot air or COOL position for cooler air.

- Turn the left knob to control the driver side air temperature.
- Turn the right knob to control the passenger side air temperature.



OVQ036065N

### Mode selection knob

The mode selection knob controls the direction of the air flow through the ventilation system.

The steps (•) between the air flow positions adjust the direction of the air flow to the middle position.

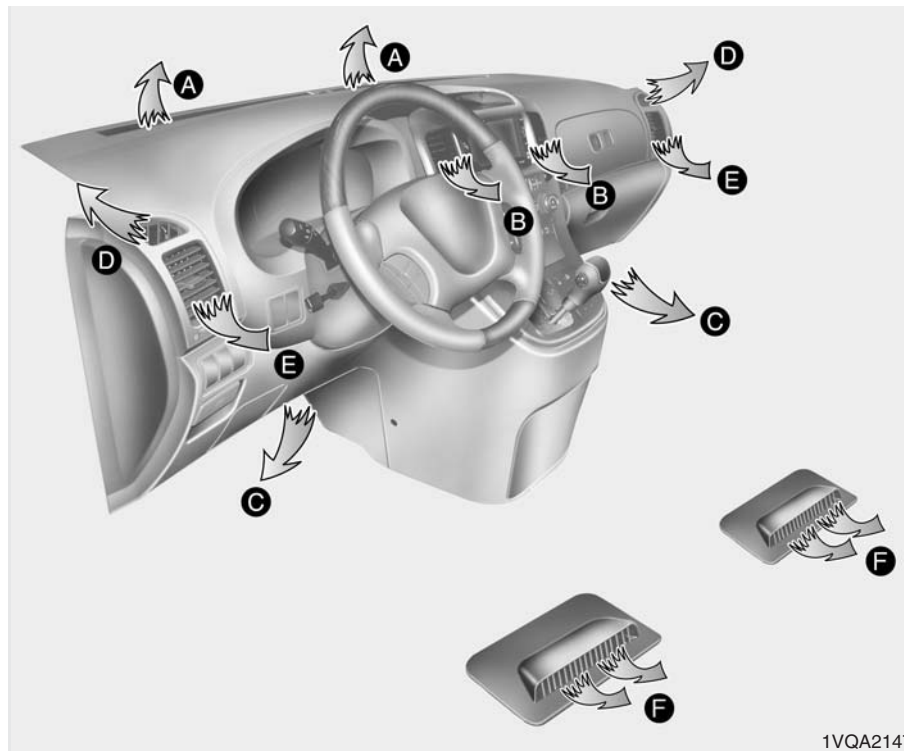

1VQA2147

Outlet port locations

## MAX/A/C position

### MAX A/C

When you select the MAX A/C mode while the fan speed is on, the following system settings will be made automatically;

- the air conditioning system will be turned on.
- the recirculated air position will be selected.
- the face mode will be selected.

If you select MAX A/C mode, you will not be able to cancel the A/C system operation, or change the recirculated air mode position.

Set the fan speed control knob to the desired speed and rotate the temperature control knob to the COOL position for maximum cooling. (outlet port : B, E)

## Face position



Air flow is directed toward the upper body and face. Additionally, each outlet can be controlled to direct the air discharged from the outlet. (outlet port: B, E)

## Face - floor position



Air flow is directed towards the face and the floor. (outlet port: B, C, E, F)

## OFF position



The fan is turned off.

## Floor position



Most of the air flow is directed to the floor, with a small amount of the air being directed to the windshield and side window defroster. (outlet port: A, C, D, E, F)

## Floor - defrost position



Most of the air flow is directed to the floor and the windshield with a small amount directed to the side window defrosters. (outlet port: A, C, D, E, F)

## Defrost position



Most of the air flow is directed to the windshield with a small amount of air directed to the side window defrosters. (outlet port: A, D, E)

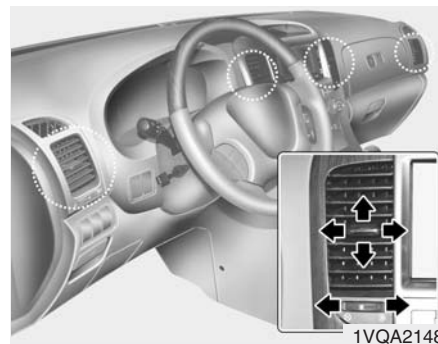

1VQA2148

## Instrument panel vents

If air flow control is not satisfactory, check the instrument panel vents. The outlet port (B, E) can be opened or closed separately using the horizontal thumbwheel. To close the vent, rotate it left to the maximum position. To open the vent, rotate it right to the desired position.

Also, you can adjust the direction of air delivery from these vents using the vent control lever as shown.



### Air conditioning button (if equipped)

Push the A/C button to turn the air conditioning system on (indicator light will illuminate). Push the button again to turn the air conditioning system off.

#### ■ Front



1. Rear fan speed control knob (from front seat)
2. Rear temperature control button (from front seat)
3. Rear fan speed control knob (from rear seat)
4. Rear mode selection button (from rear seat)
5. Rear temperature control button (from rear seat)

#### ■ Rear



1VQA2335/1VQA2168

### Ventilation (rear)

Temperature, fan speed and mode of the rear climate control system can be controlled independently regardless of the front climate control system operation.

However, the front climate control system should be operated together for rear air conditioning as follows;

1. Set the front fan speed to the desired position.
2. Push the air conditioning button.
3. Set the rear temperature, fan speed and mode to the desired position.



#### **Rear fan speed control**

##### **From front seat**

Set the rear fan speed control (REAR) knob in the front climate control panel to the desired position (except R and 0 positions).

To change the rear fan speed, turn the knob to the right for higher speed or left for lower speed.

Setting the knob to the OFF(0) position turns off the rear fan.



##### **From rear seat**

Set the rear fan speed control (REAR) knob in the front climate control panel to the R position and set the rear fan speed control knob on the rear control panel to the desired position.

To change the rear fan speed, turn the knob to the right for higher speed or left for lower speed.

Setting the knob to the OFF(0) position turns off the rear fan.





### Rear temperature control

#### From front seat

Set the rear fan speed control (REAR) knob in the front climate control panel to the desired position (except R and 0 positions), and set the rear temperature control in the front climate control panel to the desired position.

To change the rear air temperature, push the upper part ▲ of the button for warmer air or push the lower part ▼ of the button for cooler air.

The lights located to the right of the rear temperature control will illuminate to indicate the selected outlet temperature range.



#### From rear seat





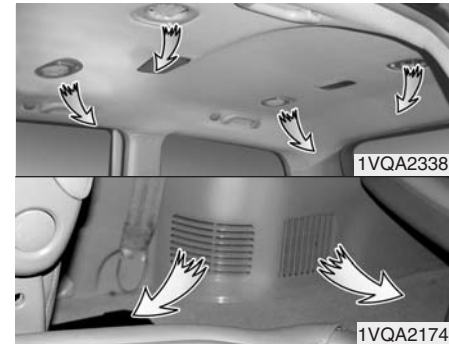



Set the rear fan speed control (REAR) knob in the front climate control panel to the R position and turn the rear temperature control knob on the rear control panel to the desired position.

To change the rear air temperature, turn the knob to the right for warmer air or left for cooler air.





### Rear mode selection

When the rear fan speed control (REAR) knob in the front climate control panel is in the any position (except R and 0 positions), the rear mode is selected automatically depending on the mode of the front climate control as follows:

- Front climate control is MAX A/C,  or  :  
Rear air blows from the upper vents on the rear ceiling.
- Front climate control is  or  :  
Rear air blows from the upper vents on the rear ceiling and the lower vents on the right rear trim together.
- Front climate control is OFF, , , , ,  :  
Rear air blows from the lower vents on the right rear trim.



When the rear fan speed control (REAR) knob in the front climate control panel is in the R position, the rear mode is selected by pushing the rear mode selection button on the rear control panel as follows:

-  : Rear air blows from the upper vents on the rear ceiling.
-  : Rear air blows from the upper vents on the rear ceiling and the lower vents on the right rear trim together.
-  : Rear air blows from the lower vents on the right rear trim.

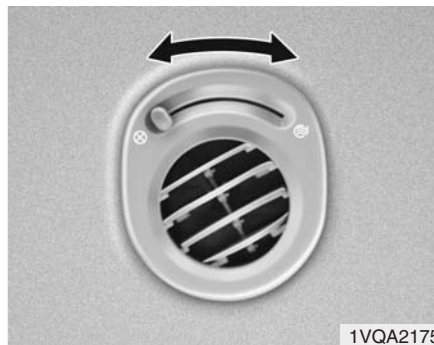

### Rear vents

If air flow control is not satisfactory, check the rear vents on the rear ceiling.

The vent can be opened or closed separately using the control lever. To close the vent, move it to the close position (⊗). To open the vent, move it to the open position (⊕).



Also, you can adjust the direction of air delivery from these vents by moving the blade.

## System operation

### Ventilation

1. Set the mode to the  position.
2. Set the air intake control to the outside (fresh) air position.
3. Set the temperature control to the desired position.
4. Set the fan speed control to the desired speed.

**Heating**

1. Set the mode to the  position.
2. Set the air intake control to the outside (fresh) air position.
3. Set the temperature control to the desired position.
4. Set the fan speed control to the desired speed.
5. If dehumidified heating is desired, turn the air conditioning system (if equipped) on.
  - If the windshield fogs up, set the mode to the  or  position.

**Air conditioning (if equipped)**

All Hyundai Air Conditioning Systems use R-134a refrigerant which is not damaging to the ozone layer.

1. Start the engine. Push the air conditioning button.
2. Set the mode to the  position.
3. Set the air intake control to the outside air or recirculated air position.
4. Set the temperature control to the desired position.
5. Set the fan speed control to the desired speed.
6. Adjust the fan speed control and temperature control to maintain maximum comfort.
  - When maximum cooling is desired, set the temperature control to the COOL position, set the air intake control to the recirculated air position, then set the fan speed control to the highest speed.

**CAUTION**

- **When using the air conditioning system, monitor the temperature gauge closely while driving up hills or in heavy traffic when outside temperatures are high. Air conditioning system operation may cause engine overheating. Continue to use the blower fan by turning the air conditioning system off if the engine temperature gauge indicates engine overheating.**
- **When opening the windows in humid weather, the air conditioning system may cause condensation inside the vehicle. Since excessive condensation (water) may cause damage to electrical equipment, the air conditioning should only be run with the windows closed.**

### Air conditioning system operation tips

- If the vehicle has been parked in direct sunlight during hot weather, open the windows for a short time to let the hot air inside the vehicle escape.
- To help reduce moisture inside of windows on rainy humid days, decrease the humidity inside the vehicle by operating the air conditioning system.
- During air conditioning system operation, you may occasionally notice a slight change in engine speed as the air conditioning compressor cycles on. This is a normal system operation characteristics.
- Use the air conditioning system every month for a few minutes to ensure maximum system performance.
- When using the air conditioning system, you may notice water dripping (or puddling) on the ground under the passenger side of the vehicle. This is a normal system operation characteristic.
- Operating the air conditioning system in the recirculated air position does provide maximum cooling, however, continual operation in this mode may cause the air inside the vehicle to become stale.

### Checking the amount of air conditioner refrigerant and compressor lubricant

When the amount of refrigerant is low, the performance of the air conditioning is reduced. Overfilling also has negative result on the air conditioning system.

Therefore, if abnormal operation is found, have the system inspected by an authorized Hyundai dealer.

### WARNING

**The air conditioning system should be serviced by an authorized Hyundai dealer. Improper service may cause serious injury.**

### CAUTION

***When the performance of the air conditioning system is reduced it is important that the correct type and amount of oil and refrigerant is used. Otherwise, damage to the compressor and abnormal system operation may occur.***

## AUTOMATIC CLIMATE CONTROL SYSTEM (IF EQUIPPED)



- |  |                                     |                                 |
|--|-------------------------------------|---------------------------------|
| 1. AUTO (automatic control) button           | 6. Front fan speed control knob     | 11. Rear fan speed control knob |
| 2. Driver's temperature control button       | 7. Mode selection button            | 12. System OFF button           |
| 3. A/C display                               | 8. Front windshield defrost button  | 13. Air conditioning button     |
| 4. Passenger's temperature control button    | 9. Recirculated air position button | 14. Rear window defrost button  |
| 5. Dual temperature control selection button | 10. Rear temperature control button | 15. Outside air position button |

OVQ036069N



### Automatic operation

The automatic climate control system is controlled by simply setting the desired temperature.

The Full Automatic Temperature Control (FATC) system automatically controls the heating and cooling system as follows;

1. Push the AUTO button. It is indicated by AUTO on the display. The modes, fan speeds, air intake and air-conditioning will be controlled automatically by the temperature setting.

2. Push the TEMP button to set the desired temperature.

If the temperature is set to the lowest setting LO (62°F/17°C), the air conditioning system will operate continuously.

3. To turn the automatic operation off, press any button except the temperature control button. If you press the mode selection button, air-conditioning button, defrost button, air intake control button or fan speed knob, the selected function will be controlled manually while other functions operate automatically.

Regardless of the temperature setting, when using automatic operation, the air conditioning system can automatically turn on to decrease the humidity inside the vehicle, even if the temperature is set to warm.

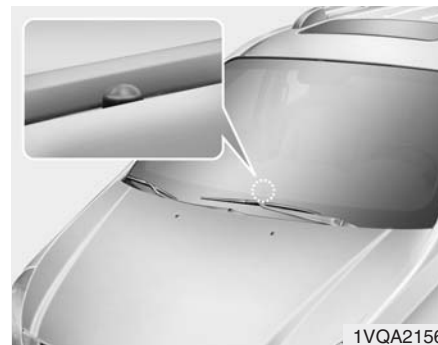

### **CAUTION**

***Never place anything over the sensor located on the instrument panel to ensure better control of the heating and cooling system.***

## Manual operation

The heating and cooling system can be controlled manually as well by pushing buttons other than the AUTO button. In this case, the system works sequentially according to the order of buttons selected.

When pressing any button except the AUTO button during automatic operation, the functions of the buttons not selected will be controlled automatically.

Press the AUTO button in order to convert to full automatic control of the system.

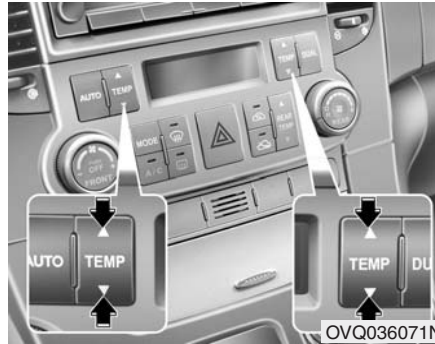

### Temperature control button

The temperature will increase to the maximum 90°F/32°C (HI) by pushing the up button. Each push of the button will cause the temperature to increase by 1°F/0.5°C. The temperature will decrease to the minimum 62°F/17°C (LO) by pushing the down button. Each push of the down button will cause the temperature to decrease by 1°F/0.5°C. When set to the lowest temperature setting, the air conditioning system will operate continuously.



### Dual temperature control selection button

#### Adjusting the driver and passenger side temperature individually

1. Press the DUAL button to operate the driver and passenger side temperature individually. Pressing the right temperature control button will automatically switch to the DUAL mode as well.
2. Press the left temperature control to adjust the driver side temperature. Press the right temperature control to adjust the passenger side temperature.

### Adjusting the driver and passenger side temperature equally

1. Press the DUAL button again to deactivate DUAL mode. The passenger side temperature will be set to the same as the driver side temperature.
2. Press the left temperature control button. The driver and passenger side temperature will be adjusted equally.

### Temperature conversion

If the battery has been discharged or disconnected, the temperature mode display will reset to Fahrenheit.

This is normal condition. You can switch the temperature mode between Fahrenheit to Centigrade as follows;

While depressing the AUTO button, depress the OFF button for 3 seconds or more. The display will change from Fahrenheit to Centigrade, or from Centigrade to Fahrenheit.



OVQ036073N

### Fan speed control knob

The fan speed can be set to the desired speed by turning the fan speed control knob.

The higher the fan speed is, the more air is delivered.

Pressing the OFF button turns off the fan.



OVQ036074N

### Air intake control button

These are used to select outside (fresh) air position or recirculated air position.

To change the air intake control position, push the desired control button.



**Recirculated air position**

The indicator light on the button is illuminated when the recirculated air position is selected.

With the recirculated air position selected, air from passenger compartment will be drawn through the ventilation system and heated or cooled according to the function selected.

**Outside (fresh) air position**

The indicator light on the button is illuminated when the outside (fresh) air position is selected.

With the outside (fresh) air position selected, air enters the vehicle from outside and is heated or cooled according to the function selected.

**\* NOTICE**

It should be noted that prolonged operation of the heating in recirculated air position will cause fogging of the windshield and side windows and the air within the passenger compartment will become stale.

In addition, prolonged use of the air conditioning with the “recirculated air position” selected, will result in excessively dry air in the passenger compartment.



OVQ036075N

**Defrost button**

Most of the air flow is directed to the windshield with a small amount of air directed to the side window defrosters. (outlet port: A, D, E)

**⚠ WARNING**

- **Continued climate control system operation in the recirculated air position may allow humidity to increase inside vehicle which may fog the glass and obscure visibility.**
- **Do not sleep in a vehicle with air conditioning or heating system on. It may cause serious harm or death due to a drop in the oxygen level and/or body temperature.**
- **Continued climate control system operation in the recirculated air position can cause drowsiness or sleepiness, and loss of vehicle control. Set the air intake control to the outside (fresh) air position as much as possible while driving.**



## Mode selection button

The mode selection button controls the direction of the air flow through the ventilation system.

The air flow outlet port is converted as follows:

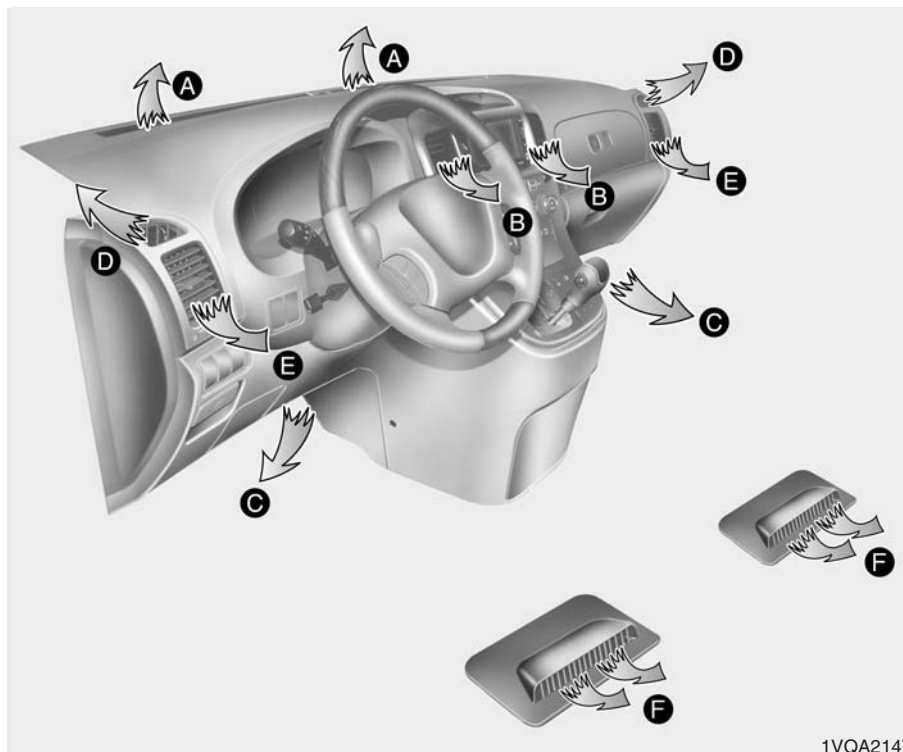

*Outlet port locations*

1VQA2147

**Face position**



Air flow is directed toward the upper body and face. Additionally, each outlet can be controlled to direct the air discharged from the outlet. (outlet port: B, E)

**Face - floor position**



Air flow is directed towards the face and the floor. (outlet port: B, C, E, F)

**Floor position**



Most of the air flow is directed to the floor, with a small amount of the air being directed to the windshield and side window defroster. (outlet port: A, C, D, E, F)

**Floor - defrost position**



Most of the air flow is directed to the floor and the windshield with a small amount directed to the side window defrosters. (outlet port: A, C, D, E, F)

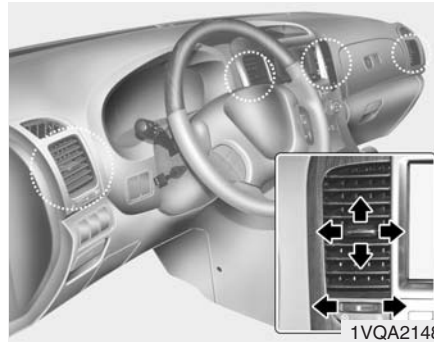

**Instrument panel vents**

If air flow control is not satisfactory, check the instrument panel vents. The outlet port (B, E) can be opened or closed separately using the horizontal thumbwheel. To close the vent, rotate it left to the maximum position. To open the vent, rotate it right to the desired position.

Also, you can adjust the direction of air delivery from these vents using the vent control lever as shown.



**Air conditioning button**

Push the A/C button to turn the air conditioning system on (indicator light will illuminate).

Push the button again to turn the air conditioning system off.



## OFF button

Push the OFF button to turn off the air climate control system. You can still operate the mode and air intake buttons as long as the ignition switch is ON.

## ■ Front



1. Rear fan speed control knob (from front seat)
2. Rear temperature control button (from front seat)
3. Rear fan speed control knob (from rear seat)
4. Rear mode selection button (from rear seat)
5. Rear temperature control button (from rear seat)

## ■ Rear



1VQH2167N/1VQA2168

## Ventilation (rear)

Temperature, fan speed and mode of the rear climate control system can be controlled independently regardless of the front climate control system operation.

However, the front climate control system should be operated together for rear air conditioning as follows;

1. Set the front fan speed to the desired position.
2. Push the air conditioning button.
3. Set the rear temperature, fan speed and mode to the desired position.



### *Rear fan speed control*

#### **From front seat**

Set the rear fan speed control (REAR) knob in the front climate control panel to the desired position (except R and 0 positions).

To change the rear fan speed, turn the knob to the right for higher speed or left for lower speed.

Setting the knob to the OFF(0) position turns off the rear fan.



#### **From rear seat**

Set the rear fan speed control (REAR) knob in the front climate control panel to the R position and set the rear fan speed control knob on the rear control panel to the desired position.

To change the rear fan speed, turn the knob to the right for higher speed or left for lower speed.

Setting the knob to the OFF(0) position turns off the rear fan.



## Rear temperature control

### From front seat

Set the rear fan speed control (REAR) knob in the front climate control panel to the desired position (except R and 0 positions), and set the rear temperature control in the front climate control panel to the desired position.

To change the rear air temperature, push the upper part ▲ of the button for warmer air or push the lower part ▼ of the button for cooler air.



### From rear seat



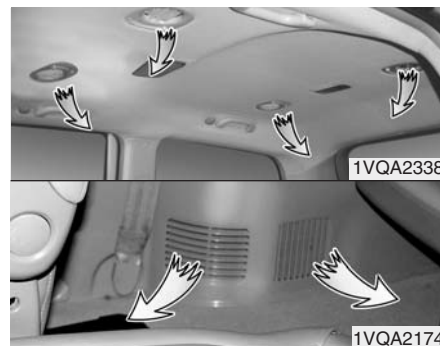

Set the rear fan speed control (REAR) knob in the front climate control panel to the R position and turn the rear temperature control knob on the rear control panel to the desired position.

To change the rear air temperature, turn the knob to the right for warmer air or left for cooler air.





## Rear mode selection

When the rear fan speed control (REAR) knob in the front climate control panel is in the any position (except R and 0 positions), the rear mode is selected automatically depending on the mode of the front climate control as follows:

- Front climate control is  : Rear air blows from the upper vents on the rear ceiling.
- Front climate control is  : Rear air blows from the upper vents on the rear ceiling and the lower vents on the right rear trim together.
- Front climate control is , ,  : Rear air blows from the lower vents on the right rear trim together.



When the rear fan speed control (REAR) knob in the front climate control panel is in the R position, the rear mode is selected by pushing the rear mode selection button on the rear control panel as follows:

-  : Rear air blows from the upper vents on the rear ceiling.
-  : Rear air blows from the upper vents on the rear ceiling and the lower vents on the right rear trim together.
-  : Rear air blows from the lower vents on the right rear trim together.

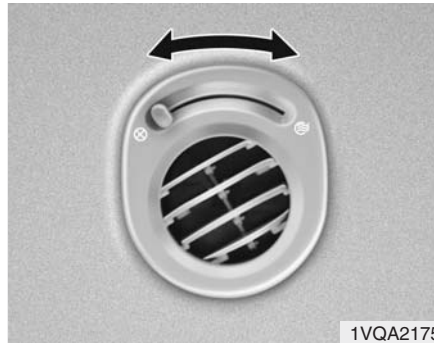

### Rear vents

If air flow control is not satisfactory, check the rear vents on the rear ceiling.

The vent can be opened or closed separately using the control lever. To close the vent, move it to the close position (⊗). To open the vent, move it to the open position (⊕).



Also, you can adjust the direction of air delivery from these vents by moving the blade.

## System operation

### Ventilation

1. Set the mode to the  position.
2. Set the air intake control to the outside (fresh) air position.
3. Set the temperature control to the desired position.
4. Set the fan speed control to the desired speed.

### Heating

1. Set the mode to the  position.
  2. Set the air intake control to the outside (fresh) air position.
  3. Set the temperature control to the desired position.
  4. Set the fan speed control to the desired speed.
  5. If dehumidified heating is desired, turn the air conditioning system on.
- If the windshield fogs up, set the mode to the  or  position.

### ***Air conditioning (Automatic system)***

All Hyundai Air Conditioning Systems use R-134a refrigerant which is not damaging to the ozone layer.

1. Start the engine. Push the AUTO button.
2. Set the temperature control to the desired position.

### ***CAUTION***

- ***When using the air conditioning system, monitor the temperature gauge closely while driving up hills or in heavy traffic when outside temperatures are high. Air conditioning system operation may cause engine overheating. Continue to use the blower fan by turning the air conditioning system off if the engine temperature gauge indicates engine overheating.***
- ***When opening the windows in humid weather, the air conditioning system may cause condensation inside the vehicle. Since excessive condensation (water) may cause damage to electrical equipment, the air conditioning should only be run with the windows closed.***

### **Air conditioning system operation tips**

- If the vehicle has been parked in direct sunlight during hot weather, open the windows for a short time to let the hot air inside the vehicle escape.
- To help reduce moisture inside of windows on rainy humid days, decrease the humidity inside the vehicle by operating the air conditioning system.
- During air conditioning system operation, you may occasionally notice a slight change in engine speed as the air conditioning compressor cycles on. This is a normal system operation characteristics.
- Use the air conditioning system every month for a few minutes to ensure maximum system performance.
- When using the air conditioning system, you may notice water dripping (or puddling) on the ground under the passenger side of the vehicle. This is a normal system operation characteristic.
- Operating the air conditioning system in the recirculated air position does provide maximum cooling, however, continual operation in this mode may cause the air inside the vehicle to become stale.



### Checking the amount of air conditioner refrigerant and compressor lubricant

When the amount of refrigerant is low, the performance of the air conditioning is reduced. Overfilling also has negative result on the air conditioning system.

Therefore, if abnormal operation is found, have the system inspected by an authorized Hyundai dealer.

#### **WARNING**

**The air conditioning system should be serviced by an authorized Hyundai dealer. Improper service may cause serious injury.**

#### **CAUTION**

*When the performance of the air conditioning system is reduced it is important that the correct type and amount of oil and refrigerant is used. Otherwise, damage to the compressor and abnormal system operation may occur.*

## WINDSHIELD DEFROSTING AND DEFOGGING

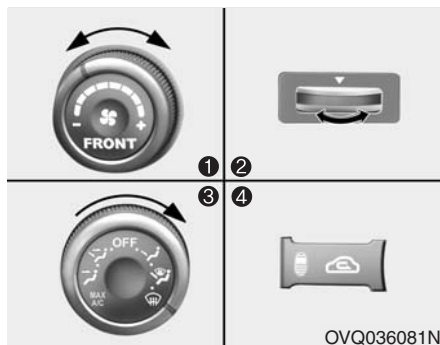

### Manual climate control system

#### To defog inside windshield

1. Select any fan speed.
2. Select desired temperature.
3. Select the or position.
4. The outside (fresh) air will be selected automatically.

If the outside (fresh) air position are not selected automatically, press the corresponding button manually.

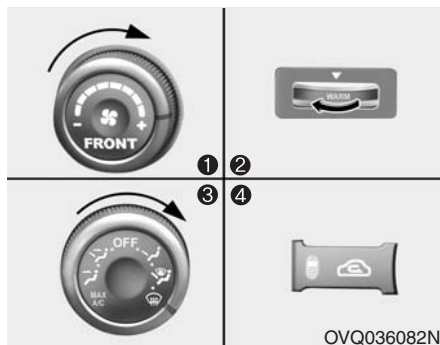

#### To defrost outside windshield

1. Set the fan speed to the highest (extreme right) position.
2. Set the temperature to the extreme hot position.
3. Select the position.
4. The outside (fresh) air will be selected automatically.

### WARNING

Do not use the or position during cooling operation in extremely humid weather. The difference between the temperature of the outside air and that of the windshield could cause the outer surface of the windshield to fog up, causing loss of visibility. In this case, set the mode selection knob to the position and fan speed control knob to the lower speed.

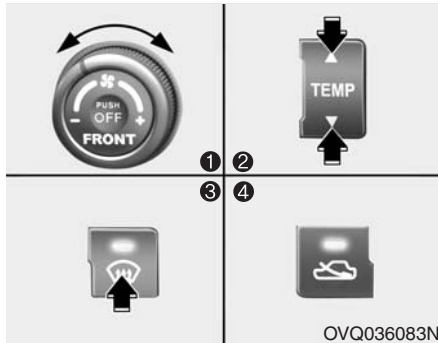

### Automatic climate control system

#### To defog inside windshield

1. Select desired fan speed.
2. Select desired temperature.
3. Press the defrost button (  ).
4. The outside (fresh) air position will be selected automatically.

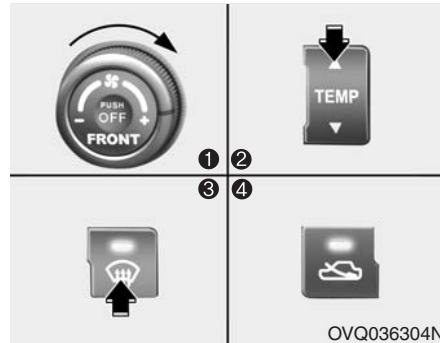

If the outside (fresh) air position are not selected automatically, adjust the corresponding button manually.



#### To defrost outside windshield

1. Set fan speed to the highest (extreme right) position.
2. Set temperature to the extreme hot (HI) position.
3. Press the defrost button (  ).
4. The outside (fresh) air position will be selected automatically.

### WARNING







Do not use the  or  position during cooling operation in extremely humid weather. The difference between the temperature of the outside air and that of the windshield could cause the outer surface of the windshield to fog up, causing loss of visibility. In this case, set the mode selection knob to the  position and fan speed control knob to the lower speed.

- For maximum defrosting, set the temperature control to the extreme highest temperature setting and the fan speed control to the highest speed.
- If warm air to the floor is desired while defrosting or defogging, set the mode to the floor-defrost position.
- Before driving, clear all snow and ice from the windshield, rear window, outside rear view mirrors, and all side windows.
- Clear all snow and ice from the hood and air inlet in the cowl grill to improve heater and defroster efficiency and to reduce the probability of fogging up inside of the windshield.

## Defogging logic

### Manual climate control system



To reduce the probability of fogging up the inside of the windshield, the air intake control is set to the outside (fresh) air position automatically if any of following occur.

- The mode is selected to the ,  or  while the system is activated.
- The ignition switch is turned on while the mode is selected to the ,  or .
- The ignition switch is turned off.
- The fan is off.
- The fan begins to be operated.

Press the air intake control button to select the recirculated air position while the ignition switch is on.



### How to cancel or return defogging logic of manual climate control system





1. Turn the ignition switch to the "ON" position.
2. Turn the mode selection knob to the defrost position () .
3. Push the air intake control button () at least 5 times within 3 seconds.

The indicator light in the air intake control button () will blink 3 times with 0.5 second of interval. It indicates that the defogging logic is canceled or returned to the programmed status.

If the battery has been discharged or disconnected, it is reset as the defog logic status.

### Automatic climate control system

To reduce the probability of fogging up inside of the windshield, the air intake control is set to outside (fresh) air position automatically if any of following occur.

- The ignition switch is turned on while the mode is selected to the , .
- The OFF button is pushed.
- The mode is selected to the  or  position.

Press the air intake control button to select the recirculated air position while the ignition switch is on.

## LUGGAGE NET HOLDER (IF EQUIPPED)

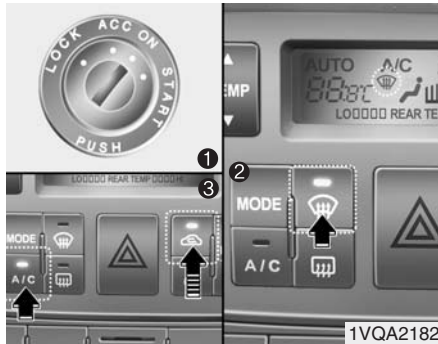
**How to cancel or return defogging logic of automatic climate control system**

1. Turn the ignition switch to the “ON” position.
2. Select the defrost position pressing defrost button (❄️).
3. While holding the air conditioning button (A/C) pressed, press the air intake control button (🌀) at least 5 times within 3 seconds.

The display panel blinks 3 times with 0.5 second of interval. It indicates that the defogging logic is canceled or returned to the programmed status.

If the battery has been discharged or disconnected, it is reset as the defog logic status.



To keep items from shifting in the cargo area, you can use the four holders located in the cargo area to attach the luggage net.

Contact your authorized Hyundai dealer to obtain a luggage net.

## ROOF RACK (IF EQUIPPED)



1VQA2206

If the vehicle has a roof rack, you can load cargo on top of your vehicle.

Crossbars and fixing components needed to install the roof rack on your vehicle may be obtained from an authorized Hyundai dealer.

### **CAUTION**

- *The crossbars should be placed in the proper load carrying positions prior to placing items onto the roof rack.*
- *If the vehicle is equipped with a sunroof, be sure not to position cargo onto the roof rack in such a way that it could interfere with sunroof operation.*

(Continued)

(Continued)

- *When carrying cargo on the roof rack, take the necessary precautions to make sure the cargo does not damage the roof of the vehicle.*
- *When carrying large objects on the roof rack, make sure they do not exceed the overall roof length or width.*

### **WARNING**

- **The following specification is the maximum weight that can be loaded onto the roof rack. Distribute the load as evenly as possible across the crossbars and roof rack and secure the load firmly.**

ROOF RACK	165 lbs. (75 kg) EVENLY DISTRIBUTED
-----------	--

- **The vehicle center of gravity will be higher when items are loaded onto the roof rack. Avoid sudden starts, braking, sharp turns, abrupt maneuvers or high speeds that may result in loss of vehicle control or rollover causing an accident.**

(Continued)

(Continued)

- **Always drive slowly and turn corners carefully when carrying items on the roof rack. Severe wind updrafts, caused by passing vehicles or natural causes, can cause sudden upward pressure on items loaded on the roof rack. This is especially true when carrying large, flat items.**
- **To prevent damage or loss of cargo while driving, check frequently to make sure the items on the roof rack are securely fastened.**

### **CAUTION**

- *If the vehicle has a sunroof, do not position the roof rack loads so that they could interfere with the sunroof.*
- *Loading cargo or luggage above specification on the roof rack may damage your vehicle.*

## HOMELINK® WIRELESS CONTROL SYSTEM (IF EQUIPPED)

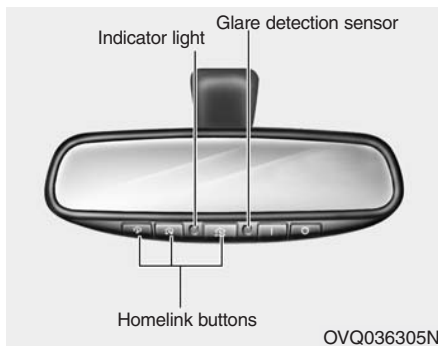

Your new mirror comes with an integrated HomeLink Universal Transceiver, which allows you to program the mirror to activate your garage door(s), estate gate, home lighting, etc. The mirror actually learns the codes from your various existing transmitters.

### **⚠ WARNING**

- When programming the HomeLink® Wireless Control System, you may be operating a garage door or gate operator. Make sure that people and objects are out of the way of the moving door or gate to prevent potential harm or damage.

(Continued)

### (Continued)

- Do not use HomeLink with any garage door opener that lacks the safety stop and reverse feature as required by federal safety standards. (This includes any garage door opener model manufactured before April 1, 1982.) A garage door opener which cannot detect an object, signaling the door to stop and reverse, does not meet current federal safety standards. Using a garage door opener without these features increases risk of serious injury or death. For more information, call 1-800-355-3515 or on the internet at [www.homelink.com](http://www.homelink.com).



Retain the original transmitter for future programming procedures (i.e., new vehicle purchase). It is also suggested that upon the sale of the vehicle, the programmed HomeLink buttons be erased for security purposes (follow step 1 in the "Programming" portion of this text).

### Programming

Your vehicle may require the ignition switch to be turned to the ACC position for programming and/or operation of HomeLink. It is also recommended that a new battery be replaced in the hand-held transmitter of the device being programmed to HomeLink for quicker training and accurate transmission of the radio-frequency.

Follow these steps to train your HomeLink mirror:



1. When programming the buttons for the first time, press and hold the left and center buttons (  ,  ) simultaneously until the indicator light begins to flash after approximately 20 seconds. (This procedure erases the factory-set default codes. Do not perform this step to program additional hand-held transmitters.)

### \* NOTICE

For non rolling code garage door openers, follow steps 2 - 3.

For rolling code garage door openers, follow steps 2 - 6.

For Canadian Programming, please follow the Canadian Programming section. For help with determining whether your garage is non-rolling code or rolling code, please refer to the garage door openers owner's manual or contact HomeLink customer service at 1-800-355-3515.



2. Press and hold the button on the HomeLink system you wish to train and the button on the transmitter while the transmitter is approximately 1 to 3 inches away from the mirror. Do not release the buttons until step 3 has been completed.
3. The HomeLink indicator light will flash, first slowly and then rapidly. When the indicator light flashes rapidly, both buttons may be released. (The rapid flashing light indicates successful programming of the new frequency signal.)

### \* NOTICE

Some gate operators and garage door openers may require you to replace step #3 with the “cycling” procedure noted in the “Canadian Programming” section of this document.



## Rolling code programming

To train a garage door opener (or other rolling code equipped devices) with the rolling code feature, follow these instructions after completing the “Programming” portion of this text. (A second person may make the following training procedures quicker & easier.)

4. Locate the “learn” or “smart” button on the device’s motor head unit. Exact location and color of the button may vary by product brand. If there is difficulty locating the “learn” or “smart” button, reference the device’s owner’s manual or contact HomeLink at 1-800-355-3515 or on the internet at [www.homelink.com](http://www.homelink.com).
5. Press and release the “learn” or “smart” button on the device’s motor head unit. You have 30 seconds to complete step number 6.
6. Return to the vehicle and firmly press and release the programmed HomeLink button up to three times. The rolling code equipped device should now recognize the HomeLink signal and activate when the HomeLink button is pressed. The remaining two buttons may now be programmed if this has not previously been done. Refer to the “Programming” portion of this text.

## Operating HomeLink

To operate, simply press the programmed HomeLink button. Activation will now occur for the trained product (garage door, security system, entry door lock, estate gate, or home or office lighting). For convenience, the hand-held transmitter of the device may also be used at any time. The HomeLink Wireless Controls System (once programmed) or the original hand-held transmitter may be used to activate the device (e.g. garage door, entry door lock, etc.). In the event that there are still programming difficulties, contact HomeLink at 1-800-355-3515 or on the internet at [www.homelink.com](http://www.homelink.com).



## Erasing programmed HomeLink buttons

To erase the three programmed buttons (individual buttons cannot be erased):

- Press and hold the left and center buttons simultaneously, until the indicator light begins to flash (approximately 20 seconds). Release both buttons. Do not hold for longer than 30 seconds.

HomeLink is now in the train (or learning) mode and can be programmed at any time.

### Reprogramming a single HomeLink button

To program a device to HomeLink using a HomeLink button previously trained, follow these steps:

1. Press and hold the desired HomeLink button. Do NOT release until step 4 has been completed.
2. When the indicator light begins to flash slowly (after 20 seconds), position the hand-held transmitter 1 to 3 inches away from the HomeLink surface.
3. Press and hold the hand-held transmitter button (or press and “cycle” - as described in “Canadian Programming” above).
4. The HomeLink indicator light will flash, first slowly and then rapidly. When the indicator light begins to flash rapidly, release both buttons.

The previous device has now been erased and the new device can be activated by pushing the HomeLink button that has just been programmed. This procedure will not affect any other programmed HomeLink buttons.

### Gate operator programming & canadian programming

During programming, your hand-held transmitter may automatically stop transmitting. Continue to press and hold the HomeLink button (note steps 2 through 4 in the “Programming” portion of this text) while you press and re-press (“cycle”) your handheld transmitter every two seconds until the frequency signal has been learned. The indicator light will flash slowly and then rapidly after several seconds upon successful training.

#### CAUTION

*If programming a garage door opener or gate, it is advised to unplug the device during the “cycling” process to prevent possible motor burn-up.*

### Accessories

If you would like additional information on the HomeLink Wireless Control System, HomeLink compatible products, or to purchase other accessories such as the HomeLink® Lighting Package, please contact HomeLink at 1-800-355-3515 or on the internet at [www.homelink.com](http://www.homelink.com).

**This device complies with Part 15 of the FCC rules.** Operation is subject to the following two conditions:

1. This device may not cause harmful interference, and
2. This device must accept any interference received, including interference that may cause undesired operation.

#### WARNING

**The HomeLink transmitter has been tested and complies with FCC and DOC/MDC rules. Changes or modifications not expressly approved by the party responsible for compliance could void the user’s authority to operate the equipment.**

**IC: 4112104541A Gentex  
MODEL/FCC ID: NZLSTDHL3**

## STORAGE COMPARTMENTS

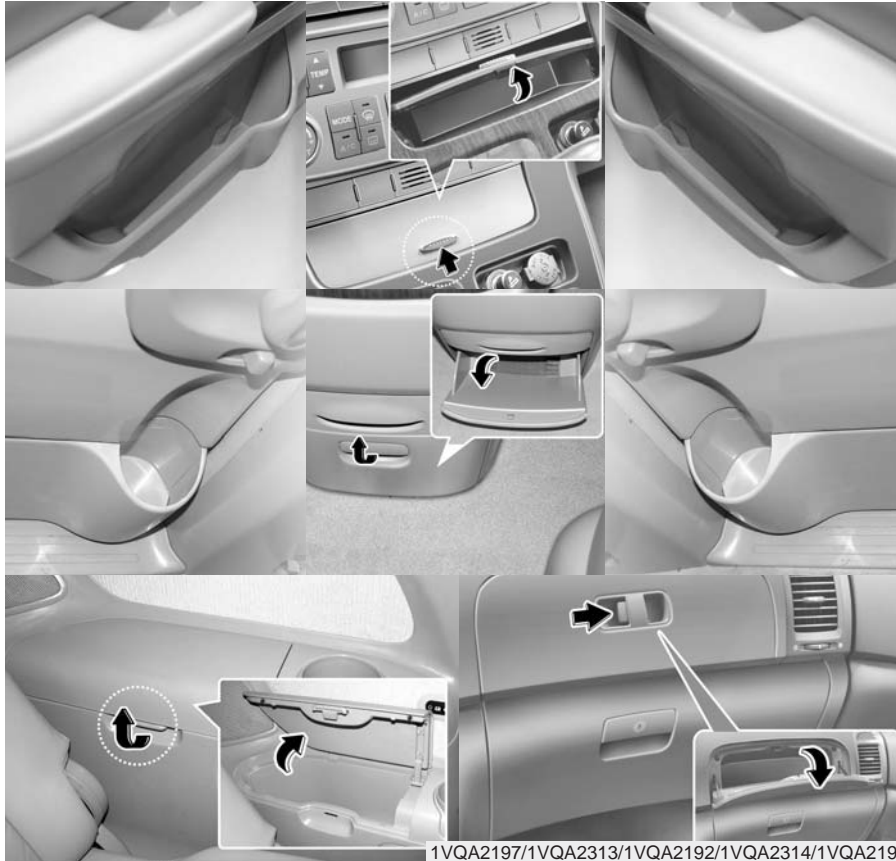

1VQA2197/1VQA2313/1VQA2192/1VQA2314/1VQA2193

These compartments can be used to store small items required by the driver or passengers.

**CAUTION**

- To avoid possible theft, do not leave valuables in the storage compartment.
- Always keep the storage compartment covers closed while driving. Do not attempt to place so many items in the storage compartment that the storage compartment cover can not close securely.

**WARNING - Flammable materials**

Do not store cigarette lighters, propane cylinders, or other flammable/explosive materials in the vehicle. These items may catch fire and/or explode if the vehicle is exposed to hot temperatures for extended periods.



### **Center console storage (if equipped)**

These compartments can be used to store small items required by the driver or front passenger.

#### **Front**

Cups or small beverage cans may be placed in the cup holders.

#### **Center**

The center compartment can be locked and unlocked with a master key.

To open the center compartment, make sure it is unlocked, then pull the lever and raise the cover.

To remove the bucket, lift it upward.

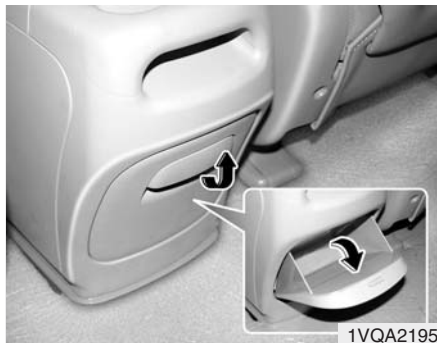

#### **Rear**

To open the rear compartment, pull the lever and the compartment will automatically open. Close the compartment after use.

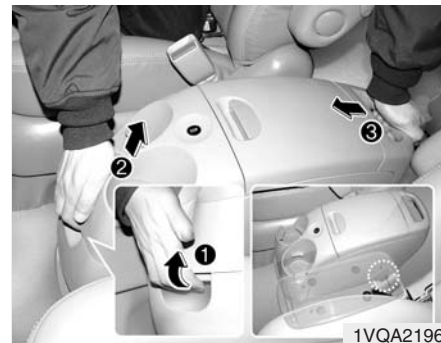

The center console storage can be removed and reinstalled.

To remove the storage, pull up the front portion slightly while pressing the release lever and move it forward.

To reinstall the storage, insert the rear tap on the bottom of the storage into the rear hole on the floor, put the front portion slightly on the floor while pressing the release lever and release the lever. Make sure the compartment is locked in place.

**⚠ WARNING**

Never leave the removed center storage console in the vehicle unsecured. The storage console can be thrown about in the vehicle in a sudden stop or an accident causing serious injuries or death to the vehicle occupants. Always make sure the storage console is locked in place.

**⚠ CAUTION**

*Since key is not fully inserted into the center console storage key set, do not apply excessive force. Doing so may damage the parts.*

**⚠ WARNING**

To reduce the risk of injury in an accident or sudden stop, always keep the center console storage cover closed while driving.

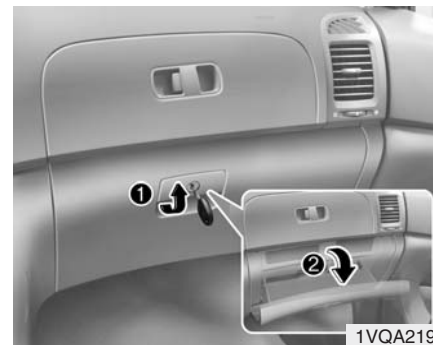
**Glove box**

The glove box can be locked and unlocked with a master key.

To open the glove box, make sure it is unlocked, then pull the handle (1) and the glove box will automatically open (2). Close the glove box after use.

**CAUTION**

Since key is not fully inserted into the glove box key set, do not apply excessive force. Doing so may damage the parts.

**WARNING**

To reduce the risk of injury in an accident or sudden stop, always keep the glove box door closed while driving.

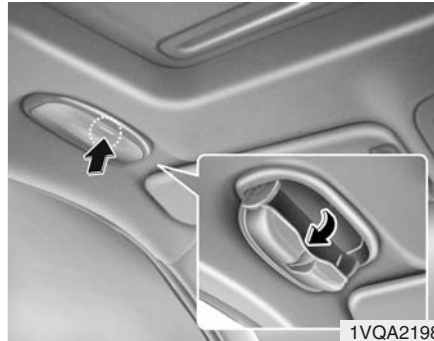

**Sunglass holder**

To open the sunglasses holder, press the cover and the holder will slowly open. Place your sunglasses in the compartment door with the lenses facing out. Push to close.

**CAUTION**

Make sure the sunglasses holder is closed while driving.

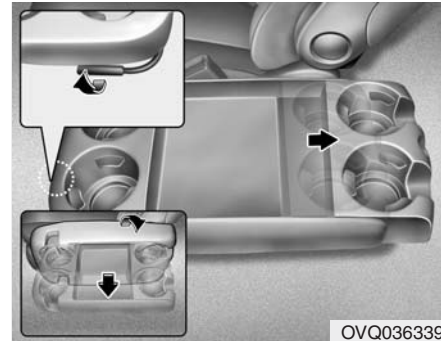

**Side table (if equipped)**

The side table is located on the inner portion of the passenger's seat.

To use the table, pull the table all the way up until it locks into place. Verify the table is locked by trying to push it down. If the table moves down, it is not locked properly.

You can extend it by pulling the rear portion backward.

To fold down the table, pull up the release lever and press down the edge of the table.

## INTERIOR FEATURES



### Cigarette lighter (if equipped)

To operate the cigarette lighter, press it in and release it. When it is heated, it automatically pops out ready for use.

If the engine is not running, the ignition switch must be in the ACC or ON position for the lighter to operate.

### **CAUTION**

- *Do not hold the lighter in after it is already heated because it will overheat.*
- *Only a genuine Hyundai lighter should be used in the cigarette lighter socket. The use of plug-in accessories (shavers, hand-held vacuums, and coffee pots, for example) may damage the socket or cause electrical failure.*
- *If the lighter does not pop out within 30 seconds, remove it to prevent overheating.*

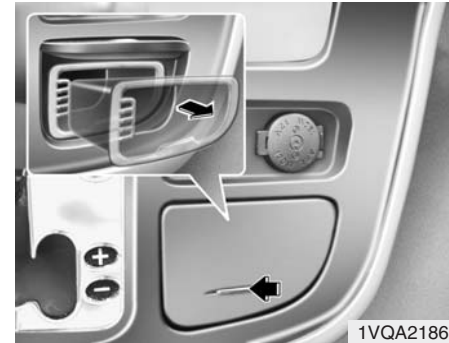

### Ashtray (if equipped)

To use the ashtray, press the cover and release it.

To remove the ashtray to empty or clean it, lift it upward and pull it out.

### **WARNING - Ashtray use**

- **Do not use the vehicle's ashtrays as waste receptacles.**
- **Putting lit cigarettes or matches in an ashtray with other combustible materials may cause a fire.**

## Cup holder

### **⚠ WARNING - Hot liquids**

- Do not place uncovered cups of hot liquid in the cup holder while the vehicle is in motion. If the hot liquid spills, you could be burned. Such a burn to the driver could cause a loss of control of the vehicle.
- To reduce the risk of personal injury in the event of sudden stop or collision, do not place uncovered or unsecured bottles, glasses, cans, etc., in the cup holder while the vehicle is in motion.



### **Front**

To use the cup holders, pull the cup holder cover out. Push the cover to close after use.

### **⚠ CAUTION**

***Do not place heavy cups or cans in cup holders. Cup holders could be damaged.***



### **Center (if equipped)**

Cups or small beverage cans may be placed in the cup holders. The storage can be removed and reinstalled.

To remove the storage, pull up the rear portion slightly after moving the locking tab to the unlock position and move it rearward.

To reinstall the storage, insert the front tab on the bottom of the storage into the front hole on the floor, put the rear portion on the floor and move the locking tab to the lock position. Make sure the compartment is locked in place.





OVQ036090N

**Rear**

Cups or small beverage cans may be placed in the cup holders.

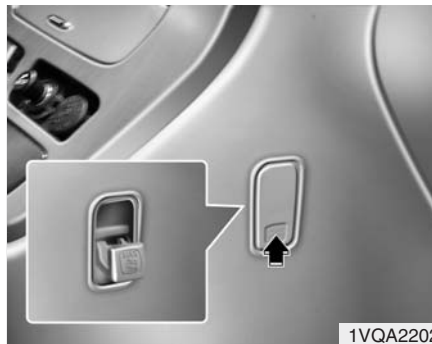

1VQA2202

**Shopping bag holder**

**Front**

To use the holder, push the lower portion.

**CAUTION**

*Do not hang a bag weighing more than 7 lbs. (3 kg). It may cause damage to the shopping bag holder.*



OVQ036308N

**Rear**

**\* NOTICE**

Do not hang heavy bags as they may damage the holder.

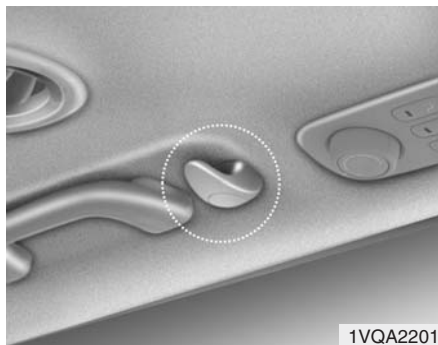

1VQA2201

### Clothes hanger

#### **CAUTION**

*To avoid damage to the hook, do not hang heavy clothing on the clothes hanger.*

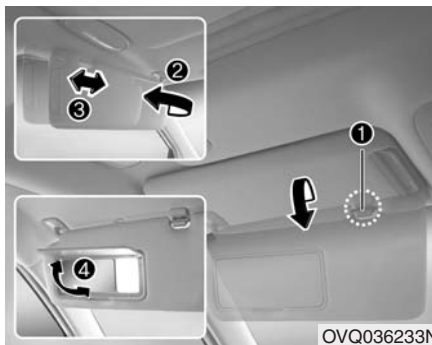

OVQ036233N

### Sunvisor

Use the sunvisor to shield direct light through the front or side windows.

To use the sunvisor, pull it downward.

To use the sunvisor for a side window, pull it downward, unsnap it from the bracket (1) and swing it to the side (2).

Adjust the sunvisor extension forward or backward (3).

To use the vanity mirror, pull down the visor and pull up the mirror cover (4).

#### **CAUTION - Vanity mirror (if equipped)**

*Close the vanity mirror cover securely and return the sunvisor to its original position after use. If the vanity mirror is not closed securely, the lamp will stay on and could result in battery discharge and possible sunvisor damage.*

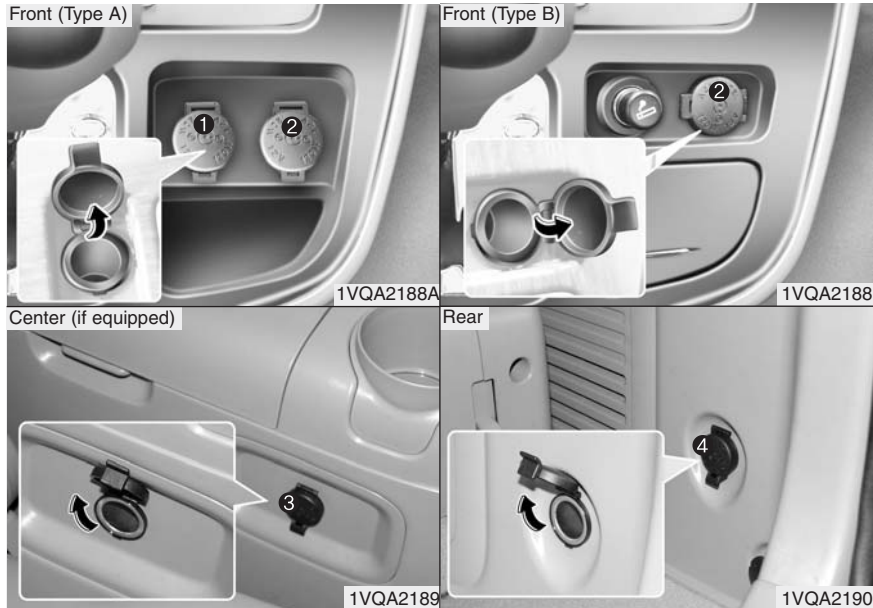

(1) : Can be used when the ignition switch is in ACC or ON position.

(2), (3), (4) : Can be used regardless of the ignition switch position.

### Power outlet

The power outlets are designed to provide power for mobile telephones or other devices designed to operate with vehicle electrical systems. The devices should draw less than 10 amps with the engine running.

### **CAUTION**

- *Use power outlet only when the engine is running and remove the accessory plug after use. Using the accessory plug for prolonged periods of time with the engine off could cause the battery to discharge.*
- *Only use 12V electric accessories which are less than 10A in electric capacity.*
- *Adjust the air-conditioner or heater to the lowest operating level when using the power outlet.*
- *Close the cover when not in use.*
- *Some electronic devices can cause electronic interference when plugged into a vehicle's power outlet. These devices may cause excessive audio static and malfunctions in other electronic systems or devices used in your vehicle.*



### Digital clock

Whenever the battery terminals or related fuses are disconnected, you must reset the time.

When the ignition switch is in the ACC or ON position, the clock buttons operate as follows:

- **HOUR:**

Pressing the “H” button with your finger, a pencil or similar object will advance the time displayed by one hour.

- **MINUTE:**

Pressing the “M” button with your finger, a pencil or similar object will advance the time displayed by one minute.

- **RESET:**

To clear the minutes display, press the “R” button with your finger, a pencil or similar object. Then the clock will be set precisely on the hour.

For example, if the “R” button is pressed while the time is between 9:01 and 9:29, the display will be reset to 9:00.

9:01 ~ 9:29 display changed to 9:00

9:30 ~ 9:59 display changed to 10:00

To change the 12 hour format to the 24 hour format, press the “R” button for more than 5 seconds.

For example, if the “R” button is pressed for more than 5 seconds while the time is 10:15 p.m., the display will be changed to 22:15.

## ANTENNA

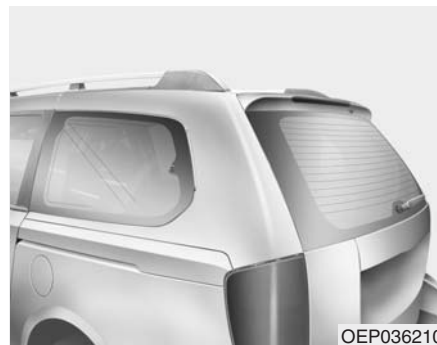

### Glass antenna

When the radio power switch is turned on while the ignition key is in either the ON or ACC position, your car will receive both AM and FM broadcast signals through the antenna in the rear window glass or quarter glass.

### **CAUTION**

- ***Do not clean the inside of the rear window glass or quarter glass with a cleaner or use a scraper to remove any foreign deposits as this may cause damage to the antenna elements.***
- ***Avoid adding metallic coating such as Ni, Cd, and so on. These can interfere with AM/FM reception.***

## AUDIO REMOTE CONTROL (IF EQUIPPED)

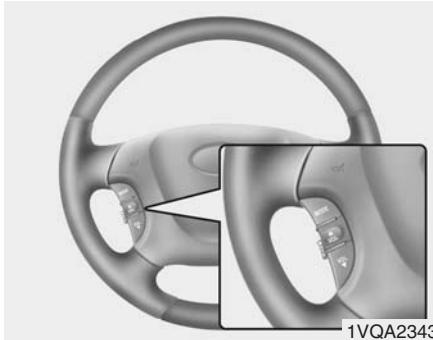

Remote audio control buttons are provided on the steering wheel.

### \* NOTICE

Do not operate audio remote control buttons simultaneously.

### MODE

Press the MODE button to select Radio, Tape (if equipped) or CD (compact disc).

### MUTE

- Pull the MUTE button to deactivate the sound.
- Once again pull the MUTE button to reactivate the sound.

### VOL (▲/▼)

- Press the VOL (▲) button to increase volume.
- Press the VOL (▼) button to decrease volume.

## AUDIO SYSTEM

### FM reception

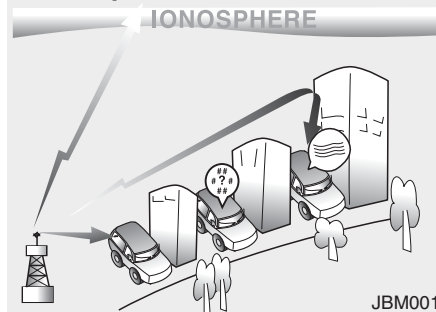

### How car audio works

AM and FM radio signals are broadcast from transmitter towers located around your city. They are intercepted by the radio antenna on your car. This signal is then received by the radio and sent to your car speakers. When a strong radio signal has reached your vehicle, the precise engineering of your audio system ensures the best possible quality reproduction. However, in some cases the signal coming to your vehicle may not be strong and clear. This can be due to factors such as the distance from the radio station, closeness of other strong radio stations or the presence of buildings, bridges or other large obstructions in the area.

### AM reception

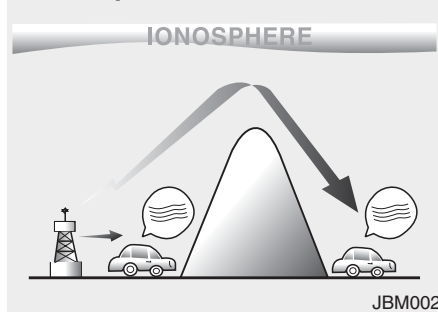

AM broadcasts can be received at greater distances than FM broadcasts. This is because AM radio waves are transmitted at low frequencies. These long, low frequency radio waves can follow the curvature of the earth rather than travelling straight out into the atmosphere. In addition, they curve around obstructions so that they can provide better signal coverage.

### FM radio station

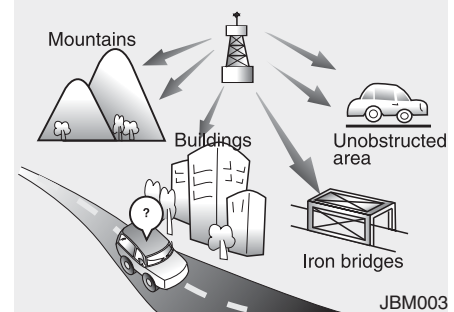

FM broadcasts are transmitted at high frequencies and do not bend to follow the earth's surface. Because of this, FM broadcasts generally begin to fade at short distances from the station. Also, FM signals are easily affected by buildings, mountains, or other obstructions. These can result in certain listening conditions which might lead you to believe a problem exists with your radio. The following conditions are normal and do not indicate radio trouble:

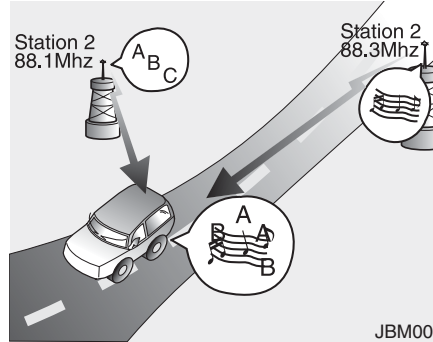
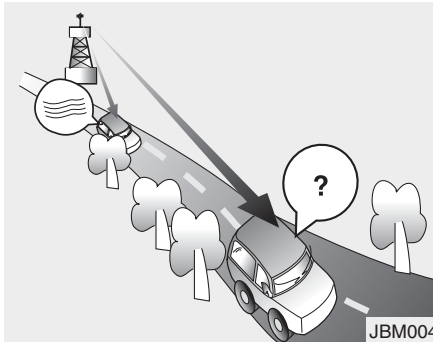

- Fading - As your car moves away from the radio station, the signal will weaken and sound will begin to fade. When this occurs, select another stronger station.
- Flutter/Static - Weak FM signals or large obstructions between the transmitter and your radio can disturb the signal causing static or fluttering noises to occur. Reducing the treble level may lessen this effect until the disturbance clears.

- Station Swapping - As a FM signal weakens, another more powerful signal near the same frequency may begin to play. This is because your radio is designed to lock onto the clearest signal. If this occurs, select another station with a stronger signal.
- Multi-Path Cancellation - Radio signals being received from several directions can cause distortion or fluttering. This can be caused by a direct and reflected signal from the same station, or by signals from two stations with close frequencies. If this occurs, select another station until the condition has passed.

### Using a cellular phone or a two-way radio

When a cellular phone is used inside the vehicle, noise may be produced from the audio equipment. This does not mean that something is wrong with the audio equipment. In such a case, use the cellular phone at a place as far as possible from the audio equipment.

#### **⚠ WARNING**

**Hyundai recommends that you never use a cell phone while driving. This could result in loss of control, and an accident that may cause death, serious injury, or property damage. You must stop at a safe place to use a cellular phone.**

#### **\* NOTICE**

Some states and cities have regulations prohibiting the use of cell phones while driving. You should be aware of the specific requirements in your area.

### Care of cassette tapes (if equipped)

- Because the thickness of a cassette tape with the total playback time of over 60 minutes (C-60) are too thin, we suggest that you do not use any of them to avoid having tapes being tangled.
- To achieve better sound quality, periodically clean the tape head using a cotton stick with colorless alcohol (once per month).
- If a tape is too loose, fasten it to reel by winding with objects like a pencil.
- Because dust or foreign objects on a cassette tape may damage the playback head, always store tapes in their cases when not in use.
- Make sure cassette tapes are kept away from magnetic devices (TV, stereo system, etc) in order to achieve better sound quality.
- Be certain that no objects or substances other than cassette tapes are inserted into the cassette tape player.
- Because tape media can be distorted when exposed to direct sunlight, Do not leave cassette tapes on the seats, dashboard or near the back windshield.

### Care of disc (if equipped)

- If the temperature inside the car is too high, open the car windows for ventilation before using your car audio.
- It is illegal to copy and use MP3/WMA/AAC/WAVE files without permission (If equipped with M465, use only MP3/WMA, If equipped with M445, use only CD-DA). Use CDs that are created only by lawful means.
- Do not apply volatile agents such as benzene and thinner, normal cleaners and magnetic sprays made for analogue disc onto CDs.
- To prevent the disc surface from getting damaged. Hold and carry CDs by the edges or the edges of the center hole only.
- Clean the disc surface with a piece of soft cloth before playback (wipe it from the center to the outside edge).
- Do not damage the disc surface or attach pieces of sticky tape or paper onto it.
- Make sure nothing other than CDs are inserted into the CD player (Do not insert more than one CD at a time).
- Keep CDs in their cases after use to protect them from scratches or dirt.

- Depending on the type of CD-R/CD-RW CDs, certain CDs may not operate normally according to manufacturing companies or making and recording methods. In such circumstances, if you still continue to use those CDs, they may cause a malfunction of your audio system.

### \* NOTICE - Playing an Incompatible Copy-Protected Audio CD

Some copy-protected CDs, which do not comply with international audio CD standards, may not play on your car audio. Please note that if you try to play copy protected CDs and the CD player of your car audio is not performing to your expectation, this may be caused by those CDs and not a defect in the device itself.



## STEREO RADIO OPERATION (M445) (IF EQUIPPED)

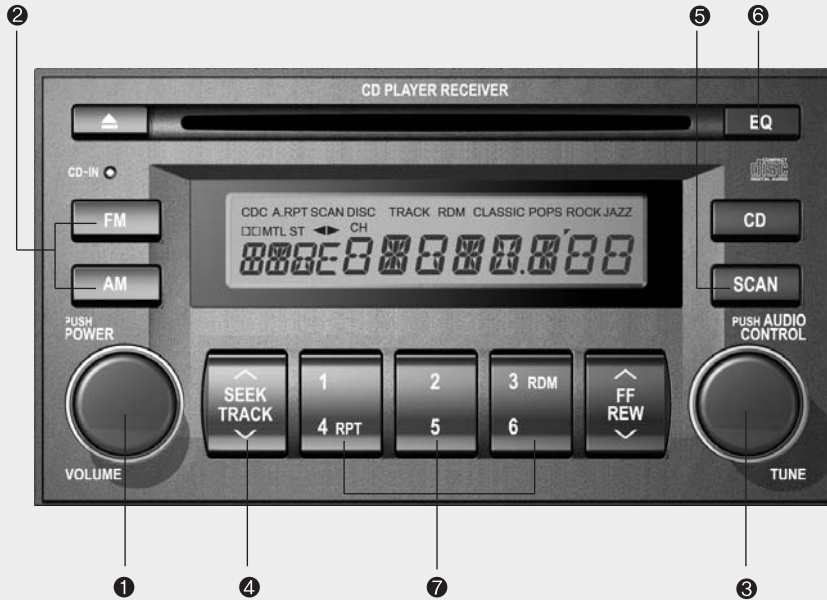

1. POWER ON-OFF, VOLUME Control Knob
2. BAND (AM/FM) Select Buttons
3. TUNE Select/AUDIO Control Knob
4. AUTO SEEK Select Button
5. SCAN Button
6. EQUILIZER (EQ) Button
7. PRESET STATION Select Buttons

JBM445UR

### 1. POWER ON-OFF Control Knob

- The radio unit may be operated when the ignition key is in the “ACC” or “ON” position. Press the knob to switch the power on. The LCD shows the radio frequency in radio mode, and displays the CD track in CD mode. To switch the power off, press the knob again.
- Push the FM/AM or CD to turn on that function without pushing the Power ON-OFF control knob.

#### *VOLUME Control*

Rotate the knob clockwise to increase the volume and turn the knob counterclockwise to reduce the volume.

### 2. BAND Selector

#### *FM Selection Button*

Pressing the  button changes between the FM1 and FM2 bands.

#### *AM(MW, LW) Selection Button*

Pressing the  button selects the AM band. AM mode is displayed on the LCD.

### 3. TUNE Select/AUDIO Control Knob

Rotate the knob clockwise to increase the frequency and turn the knob counterclockwise to reduce the frequency.

#### *Mode Select Knob*

Pressing the TUNE knob changes the BASS, MID-RANGE, TREBLE, FADER and BALANCE mode.

The mode selected is shown on the display.

After selecting each mode, rotate the mode select knob clockwise or counterclockwise.

#### *BASS Control*

To increase the BASS, rotate the knob clockwise, while to decrease the BASS, rotate the knob counterclockwise.

#### *MID-RANGE Control*

To increase the MID-RANGE, rotate the knob clockwise, while to decrease the MID-RANGE, rotate the knob counterclockwise.

#### *TREBLE Control*

To increase the TREBLE, rotate the knob clockwise, while to decrease the TREBLE, rotate the knob counterclockwise.



#### *FADER Control*

Rotate the control knob clockwise to emphasize rear speaker sound (front speaker sound will be attenuated). When the control knob is turned counterclockwise, front speaker sound will be emphasized (rear speaker sound will be attenuated).

#### *BALANCE Control*

Rotate the knob clockwise to emphasize right speaker sound (left speaker sound will be attenuated). When the control knob is turned counterclockwise, left speaker sound will be emphasized (right speaker sound will be attenuated).

### 4. AUTO SEEK Select Button (Automatic Channel Selection)

Press the AUTO SEEK select button. When the  side is pressed, the unit will automatically tune to the next higher frequency and when the  side is pressed, it will automatically tune to the next lower frequency.

## 5. SCAN Button

When you Press the button, frequency is changed and the next channel is received automatically.

To stay on a station, press the SCAN button again.

## 6. EQUALIZER (EQ) Button

Press the EQ button to select the CLASSIC, POPS, ROCK, JAZZ and OFF MODE for the desired tone quality. Each press of the button changes the display as follows;

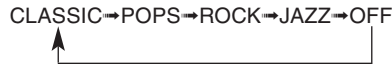

## 7. PRESET STATION Select Buttons

Six stations for AM, FM1 and FM2 respectively can be preset in the electronic memory circuit.

### HOW TO PRESET STATIONS

Six AM and twelve FM stations may be programmed into the memory of the radio. Then, by simply pressing the AM/FM band select buttons and/or one of the six station select buttons, you may recall any of these stations instantly.

To program the stations, follow these steps:

- Press AM/FM selector to set the band for AM, FM1 and FM2.
- Select the desired station to be stored by seek or manual tuning.
- Determine the preset station select button you wish to use to access that station.
- Press and hold the station select button for more than 1 second. A select button indicator will show in the display indicating which select button you have depressed. The frequency display will flash after it has been stored into the memory. You should then release the button, and proceed to program the next desired station. A total of 18 stations can be programmed by selecting one AM and two FM stations per button.
- When completed, any preset station may be recalled by selecting AM, FM1 or FM2 band and the appropriate station button.

### **CAUTION**

- *Do not place beverages close to the audio system. The audio system mechanism may be damaged if you spill them.*
- *Do not strike or allow anything to impact the audio system; damage to the system mechanisms could occur.*

### COMPACT DISC PLAYER OPERATION (M445) (IF EQUIPPED)



1. CD Select Button
2. TRACK UP/DOWN Button
3. FF/REW Button
4. REPEAT (RPT) Button
5. SCAN (BSM) Button
6. CD EJECT Button
7. RANDOM (RDM) Button

JBM445NA

## 1. CD Select Button

- Insert the CD with the label facing upward.
- Insert the CD to start CD playback, during radio operation.
- When a disc is in the CD deck, if you press the CD button the CD player will begin playing even if the radio player is being used.
- The CD player can be used when the ignition switch is in either the "ON" or "ACC" position.
- Push the CD button to turn on that function without pushing the Power ON-OFF control knob.

### \* NOTICE

- Do not stick paper or tape etc., on the label side or the recording side of any discs, as it may cause a malfunction.
- The unit cannot play a CD-R(Recordable CD) and CD-RW(Rewritable CD) that is not finalized.  
Please refer to the manual of CD-R/CD-RW recoder or CD-R/CD-RW software for more information on finalization process.
- Depending on the recording status, some CD-Rs/CD-RWs may not be played on this unit.

## 2. TRACK UP/DOWN Button

- The desired track on the disc currently being played can be selected using the track number.
- Press  $\wedge$  button once to skip forward to the beginning of the next track.  
Press  $\vee$  within a second after playback begins to quickly move backward through a CD.  
If you press  $\vee$  after more than a second, it will take you to the beginning of the track you are now listening to.

## 3. FF/REW Button

If you want to fast forward or reverse through the compact disc track, push and hold the FF or REW button.

When you release the button, the compact disc player will resume playing.

## 4. REPEAT (RPT) Button

- To repeat the track you are currently listening to, press the RPT button. To cancel, press it again.
- If you do not release RPT operation when the track ends, it will automatically be replayed.  
This process will be continued until you push the button again or turn the Power OFF then ON.

## 5. SCAN Button

- To playback the first 10 seconds of each track, press the SCAN button.
- Press the SCAN button again within 10 sec. when you have reached the desired track.

## 6. CD EJECT Button

When the  button is pressed with a CD loaded, the CD will eject.

Forcing to eject : To force to eject a CD, press this button for more than 3 seconds.

(Do this only when a CD is jammed and you can not eject it in the normal way - e.g.) in case that you have inserted 2 CDs by mistake)

## 7. RANDOM (RDM) Button

With the random function, you can listen to the tracks in random, rather than sequential order.

To use the random function, do the following:

Press the RDM button to listen to recorded tracks in random sequence. Press RDM again to cancel or turn the power OFF then ON. The unit defaults to playing tracks in sequential order.

### \* NOTICE

- To assure proper operation of the unit, keep the vehicle interior temperature within a normal range by using the vehicle's air conditioning or heating system.
- When replacing the audio unit fuse, replace it with a fuse having the correct capacity.
- All stored stations are all erased when the car battery is disconnected or power to the vehicle is lost. If this occurs, the bookmarks station presets will have to be reset.
- This equipment is designed to be used only in a 12 volt DC battery system with negative ground.
- This unit is made of precision parts. Do not attempt to disassemble or adjust any parts.
- When driving your vehicle, be sure to keep the volume of the unit set low enough to allow you to hear sounds coming from the outside.
- Do not expose this equipment (including the speakers and CD) to water or excessive moisture.

### CAUTION

- *Do not insert warped or poor quality discs into the CD player as damage to the unit may occur.*
- *Do not insert anything like coins into the player slot as damage to the unit may occur.*
- *Do not place beverages close to the audio system. The playback mechanism may be damaged if you spill them.*
- *Do not strike or allow anything to impact the audio system, damage to the system mechanisms could occur.*
- *Off-road or rough surface driving may cause the compact disc to skip. Do not use the compact disc when driving in such conditions as damage to the compact disc face could occur.*

*(Continued)*

*(Continued)*

- *Do not attempt to grab or pull the compact disc out while the disc is being pulled into the audio unit by the self-loading mechanism. Damage to the audio unit and compact disc could occur.*
- *Avoid using home-recorded compact discs in your audio unit. Original compact discs are recommended for best results.*

**STEREO RADIO OPERATION (M455) (IF EQUIPPED)**



1. POWER ON-OFF, VOLUME Control Knob
2. AUDIO Select Button
3. BAND Select Button
4. SCAN Button
5. EQUILIZER (EQ) Button
6. AUTO SEEK Select Button
7. TUNE Select/AUDIO Control knob
8. PRESET STATION Select Buttons

JBM455UR

### 1. POWER ON-OFF Control Knob

- The radio unit may be operated when the ignition key is in the "ACC" or "ON" position. Press the button to switch the power on. The LCD shows the radio frequency in the radio mode, the tape direction indicator in the tape mode or CD/MP3 track in the CD/MP3 mode. To switch the power off, press the button again.
- Push the FM/AM, TAPE or CD/MP3 to turn on that function without pushing the Power ON-OFF control knob.

#### *VOLUME Control*

Rotate the knob clockwise to increase the volume and turn the knob counterclockwise to reduce the volume.

### 2. AUDIO Select Button

Pressing the AUDIO button changes the BASS, MID-RANGE, TREBLE, FADER and BALANCE mode.

The mode selected is shown on the display.

After selecting each mode, rotate the Audio control knob clockwise or counterclockwise.

#### *BASS Control*

To increase the BASS, rotate the knob clockwise, while to decrease the BASS, rotate the knob counterclockwise.

#### *MID-RANGE Control*

To increase the MID-RANGE, rotate the knob clockwise, while to decrease the MID-RANGE, rotate the knob counterclockwise.

#### *TREBLE Control*

To increase the TREBLE, rotate the knob clockwise, while to decrease the TREBLE, rotate the knob counterclockwise.

#### *FADER Control*

Turn the control knob clockwise to emphasize rear speaker sound (front speaker sound will be attenuated). When the control knob is turned counterclockwise, front speaker sound will be emphasized (rear speaker sound will be attenuated).

#### *BALANCE Control*

Rotate the knob clockwise to emphasize right speaker sound (left speaker sound will be attenuated). When the control knob is turned counterclockwise, left speaker sound will be emphasized (right speaker sound will be attenuated).

### 3. BAND Select Button

Pressing the FM/AM button changes the AM, FM1 and FM2 bands. The mode selected is shown on the display.

### 4. SCAN Button

When you press the button, frequency is changed and the next channel is received automatically.

To stay on a station, press the SCAN button again.

### 5. EQUALIZER (EQ) Button

Press the EQ button to select the CLASSIC, POPS, ROCK, JAZZ and OFF MODE for the desired tone quality. Each press of the button changes the display as follows:

CLASSIC → POPS → ROCK → JAZZ → OFF



### 6. AUTO SEEK Select Button (Automatic Channel Selection)

Press the AUTO SEEK select button. When the  $\wedge$  side is pressed, the unit will automatically tune to the next higher frequency and when the  $\vee$  side is pressed, it will automatically tune to the next lower frequency.



## 7. TUNE Select/Audio Control Knob

Rotate the knob clockwise to increase the frequency and turn the knob counter-clockwise to reduce the frequency.

## 8. PRESET STATION Select Buttons

Six stations for AM, FM1 and FM2 respectively can be preset in the electronic memory circuit.

### HOW TO PRESET STATIONS

Six AM and twelve FM stations may be programmed into the memory of the radio. Then, by simply pressing the AM/FM band select button and/or one of the six station select buttons, you may recall any of these stations instantly. To program the stations, follow these steps:

- Press AM/FM selector to set the band for AM, FM1 and FM2.
- Select the desired station to be stored by seek or manual tuning.
- Determine the preset station select button you wish to use to access that station.

- Press and hold the station select button for more than 0.8 seconds. A select button indicator will show in the display indicating which select button you have depressed. The frequency display will flash after it has been stored in to the memory. You should then release the button, and proceed to program the next desired station. A total of 18 stations can be programmed by selecting one AM and two FM stations per button.
- When completed, any preset station may be recalled by selecting AM, FM1 or FM2 band and the appropriate station button.

### CAUTION

- *Do not place beverages close to the audio system. The playback mechanism may be damaged if you spill them.*
- *Do not strike or allow anything to impact the audio system, damage to the system mechanisms could occur.*

### CASSETTE TAPE PLAYER OPERATION (M455) (IF EQUIPPED)





1. TAPE PROGRAM Button
2. TAPE EJECT Button
3. AUTO MUSIC SEARCH (AMS) Button
4. FF/REW Button
5. REPEAT (RPT) Button
6. DOLBY Button
7. EQUILIZER (EQ) Button

JBM455UR

### 1. TAPE PROGRAM Button



- This allows you to play the reverse side of the tape by merely depressing the program button. An arrow will appear in the display to show tape direction.
- Push the TAPE button while the tape is in the tape deck to turn on that function without pushing the Power ON-OFF control knob.

### 2. TAPE EJECT Button

- When the  button is pressed with a cassette loaded, the cassette will eject.
- When the  button is pressed during FF/REW mode, the cassette will eject.

### 3. AUTO MUSIC SEARCH (AMS) Button

Press the button to find the starting point of each song in a prerecorded music tape. The quiet space between songs (must have at least 4 sec. gap) can be identified by the AUTO MUSIC SEARCH button.

- Pressing the  button will play the beginning of the next music segment.
- Pressing the  button will start replay at the beginning of the music just listened to.

- To stop FF or REW action, press the button again.

### 4. FF/REW Button

- Forward tape winding starts when the FF button is pressed during PLAY or REW mode.
- Tape PLAY starts when the FF button is pressed again during FF mode.
- Tape rewinding starts when the REW button is pressed during PLAY or FF mode.
- Tape PLAY starts when the REW button pressed again during REW mode.

### 5. REPEAT (RPT) Button

- To repeat the track you are currently listening to, press the RPT button. To cancel, press again.
- If you do not release RPT operation when the track ends, it will automatically be replayed. This process will be continued until you push the button again or turn the power OFF then ON.

### 6. DOLBY Button

If you get background noise during tape play, you can reduce this considerably by merely pressing the DOLBY button. If you want to cancel the DOLBY feature, press the button again.

### 7. EQUALIZER (EQ) Button

Press the EQ button to select the CLASSIC, POPS, ROCK, JAZZ and OFF MODE for the desired tone quality. Each press of the button changes the display as follows;

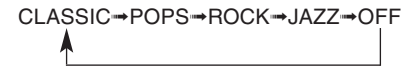

### \* NOTICE

- To assure proper operation of the unit, keep the vehicle interior temperature within a normal range by using the vehicle's air conditioning or heating system.
- When replacing the audio unit fuse, replace it with a fuse having the correct capacity.
- The preset station frequencies are all erased when the car battery is disconnected. Therefore, all data will have to be set again if this should occur.
- Do not add any oil to the rotating parts. Keep magnets, screwdrivers and other metallic objects away from the tape mechanism and head.
- This equipment is designed to be used only in a 12 volt DC battery system with negative ground.
- This unit is made of precision parts. Do not attempt to disassemble or adjust any parts.

(Continued)

(Continued)

- When driving your vehicle, be sure to keep the volume of the unit set low enough to allow you to hear sounds coming from the outside.
- Do not expose this equipment (including the speakers and tape) to water or excessive moisture.

### CAUTION

- *Do not insert anything like coins into the player slot as damage to the unit may occur.*
- *Do not place beverages close to the audio system. The playback mechanism may be damaged if you spill them.*
- *Do not strike or allow anything to impact the audio system, damage to the system mechanisms could occur.*

**COMPACT DISC PLAYER (M455) (IF EQUIPPED) - Compatible with mp3/wma/aac/wave**



1. AUDIO/MP3 CD Select Button
2. TRACK UP/DOWN Button
3. FF/REW Button
4. REPEAT (RPT) Button
5. RANDOM (RDM) Button
6. BOOKMARK (MARK) Button
7. SCROLL Button
8. EQUILIZER (EQ) Button
9. CD EJECT Button
10. SCAN Button
11. FILE SEARCH Knob  
(TUNE Select Knob)
12. DIRECTORY SEARCH (DIR) Button

JBM455UR

### 1. AUDIO/MP3 CD Select Button

- Insert the CD with the label facing upward.
- Insert the CD to start CD playback, during radio operation or cassette tape playback.
- If you press the CD button while a disc is in the CD deck, the CD player will begin playing even if the radio or cassette player is being used.
- The CD player can be used when the ignition switch is in either the "ON" or "ACC" position.
- Push the CD button to turn on that function without pushing the Power ON-OFF control knob.

### \* NOTICE

- Do not stick paper or tape etc., on the label side or the recording side of any discs, as it may cause a malfunction.
- The unit can play a multi-session CD-R (recordable CD) and CD-RW (rewritable CD) that consists of more than two sessions.  
Please refer to the manual of CD-R/CD-RW recoder or CD-R/CD-RW software for more information on finalization process.
- Depending on the recording status, some CD-Rs/CD-RWs may not be played on this unit.

### \* NOTICE

Playback of MP3, AAC and WMA file formats are supported. Load to play time for these formats may be longer due to the compressed nature of these discs.

### 2. TRACK UP/DOWN Button

- The desired track on the disc currently being played can be selected using the track number.
- Press  $\blacktriangle$  button once to skip forward to the beginning of the next track.  
Press  $\blacktriangledown$  within a second after playback begins to quickly move backward through a CD.  
If you press  $\blacktriangledown$  after more than a second, it will take you to the beginning of the file you are now listening to.

### 3. FF/REW Button

If you want to fast forward or reverse through the compact disc track, push and hold the FF or REW button.

When you release the button, the compact disc player will resume playing.

### 4. REPEAT (RPT) Button

- To repeat the track you are currently listening to, press the RPT button. To cancel, press it again.
- To repeat the music within selected folder, press the RPT button for more than 1 second. To cancel, press it again. (MP3 CD only)
- If you do not release RPT operation when the track ends, it will automatically be replayed.  
This process will be continued until you push the button again or turn the power OFF then ON.

### 5. RANDOM (RDM) Button

With random, you can listen to the tracks in random, rather than sequential order.

To use random, do the following:

- Press the RDM button to listen to recorded tracks in random sequence. Press RDM again to cancel or turn the power OFF then ON. The unit defaults to playing tracks in sequential order.
- To listen to the music within the selected folder in random order, press the RDM button within a second. To cancel, press it again or turn the power OFF then ON. (MP3 CD only)

## 6. BOOKMARK (MARK) Button

When the CD player unit is operating, the desired track on the disc can be bookmarked by using the MARK button.(MP3 CD only)

- Press the MARK button for more than 1 second to bookmark the desired track.

“M” will be displayed on the LCD and “MEMORY(1~50)” will display for approximately five seconds with beep sound.

To play a bookmarked track, press the MARK button within 1 second and select the bookmarked track to play.

- To erase a bookmarked track, press the MARK button for more than 1 second. The unit will beep once when the bookmark is erased.

### \* NOTICE

Tracks stored on Mark Memory will be automatically erased after you eject CDs that contain those tracks.

## 7. SCROLL Button

Press the button, and you can check the file names with more than 16 characters on MP3 CD(max 34 characters.).

The button doesn't work on file names less than 16 characters.

## 8. EQUILIZER (EQ) Button

Press the EQ button to select the CLASSIC, POPS, ROCK, JAZZ and OFF MODE for the desired tone quality. Each press of the button changes the display as follows;

CLASSIC → POPS → ROCK → JAZZ → OFF

## 9. CD EJECT Button

When the  button is pressed with a CD loaded, the CD will eject.

Forcing to eject : To force to eject a CD, press this button for more than 3 seconds.

(Do this only when a CD is jammed and you can not eject it in the normal way - e.g.) in case that you have inserted 2 CDs by mistake)

## 10. CD SCAN Button

- To playback the first 10 seconds of each track, press the SCAN button more than 1 second.
- To playback the first 10 seconds of each track in the selected folder, press the SCAN button within 1 second. (MP3 CD only)

- Press the SCAN button again within 10 sec. when you have reached the desired track.



## 11. FILE SEARCH Knob (TUNE Select Knob)

- You can skip the track (file) by turning the FILE SEARCH knob clockwise or counterclockwise.

After selecting the desired track (file), press the FILE SEARCH knob to playback the track (file).

If you do not press the FILE SEARCH knob within five seconds, the search will stop.

## 12. DIRECTORY SEARCH (DIR) Button

- You can move through the folder by pushing the DIR button to up () and down()
- After moving the desired folder, press the FILE SEARCH knob to play back in the selected folder. If you do not press the FILE SEARCH knob within 5 seconds, the folder searching function will be released. It can not be operated in a single folder.

### \* NOTICE

- To assure proper operation of the unit, keep the vehicle interior temperature within a normal range by using the vehicle's air conditioning or heating system.
- When replacing the audio unit fuse, replace it with a fuse having the correct capacity.
- All stored CD bookmarks are all erased when the car battery is disconnected or power to the vehicle is lost. If this occurs, the bookmarks will have to be reset.
- This equipment is designed to be used only in a 12 volt DC battery system with negative ground.
- This unit is made of precision parts. Do not attempt to disassemble or adjust any parts.
- When driving your vehicle, be sure to keep the volume of the unit set low enough to allow you to hear sounds coming from the outside.
- Do not expose this equipment (including the speakers and tape) to water or excessive moisture.

### CAUTION

- *Do not insert warped or poor quality discs into the CD player as damage to the unit may occur.*
- *Do not insert anything like coins into the player slot as damage to the unit may occur.*
- *Do not place beverages close to the audio system. The playback mechanism may be damaged if you spill them.*
- *Do not strike or allow anything to impact the audio system, damage to the system mechanisms could occur.*
- *Off-road or rough surface driving may cause the compact disc to skip. Do not use the compact disc when driving in such conditions as damage to the compact disc face could occur.*

*(Continued)*

*(Continued)*

- *Do not attempt to grab or pull the compact disc out while the disc is being pulled into the audio unit by the self-loading mechanism. Damage to the audio unit and compact disc could occur.*
- *Avoid using recorded compact discs in your audio unit. Original compact discs are recommended for best results.*



### STEREO RADIO OPERATION (M465) (IF EQUIPPED)



1. POWER ON-OFF, VOLUME Control Knob
2. BAND Select Button
3. AUDIO Select Button
4. TUNE Select/AUDIO Control Knob
5. AUTO SEEK Select Button
6. SCAN Button
7. EQUALIZER (EQ) Button or AUX Button
8. PRESET Station Select Buttons

JBM465UR

### 1. POWER ON-OFF Control Knob

- The radio unit may be operated when the ignition key is in the "ACC" or "ON" position. Press the knob to switch the power on. The LCD shows the radio frequency in the radio mode, the tape direction indicator in the tape mode or CD/MP3 track in the CD/MP3 mode or CD AUTO CHANGER mode. To switch the power off, press the knob again.
- Push the FM/AM, TAPE or CD/MP3 to turn on that function without pushing the Power ON-OFF control knob.

#### *VOLUME Control*

Rotate the knob clockwise to increase the volume and turn the knob counterclockwise to reduce the volume.

### 2. BAND Select Button

Pressing the FM/AM button changes the AM, FM1 and FM2 bands. The mode selected is shown on the display.

### 3. AUDIO Select Button

Pressing the AUDIO button changes the BASS, MID-RANGE, TREBLE, FADER, BALANCE and SURROUND ON/OFF mode. The mode selected is shown on the display.

After selecting the each mode, rotate the Audio control knob clockwise or counterclockwise.

#### *BASS Control*

To increase the BASS, rotate the knob clockwise, while to decrease the BASS, rotate the knob counterclockwise.

#### *MID-RANGE Control*

To increase the MID-RANGE, rotate the knob clockwise, while to decrease the MID-RANGE, rotate the knob counterclockwise.

#### *TREBLE Control*

To increase the TREBLE, rotate the knob clockwise, while to decrease the TREBLE, rotate the knob counterclockwise.

#### *FADER Control*

Rotate the control knob clockwise to emphasize rear speaker sound (front speaker sound will be attenuated). When the control knob is turned counterclockwise, front speaker sound will be emphasized (rear speaker sound will be attenuated).

#### *BALANCE Control*

Rotate the knob clockwise to emphasize right speaker sound (left speaker sound will be attenuated). When the control knob is turned counterclockwise, left speaker sound will be emphasized (right speaker sound will be attenuated).

### 4. TUNE Select/AUDIO Control Knob

Rotate the knob clockwise to increase the frequency and turn the knob counterclockwise to reduce the frequency.

### 5. AUTO SEEK Select Button (Automatic Channel Selection)

Press the AUTO SEEK select button. When the  $\wedge$  side is pressed, the unit will automatically tune to the next higher frequency and when the  $\vee$  side is pressed, it will automatically tune to the next lower frequency.

### 6. SCAN Button

When you press the button, frequency is changed and the next channel is received automatically.

To stay on a station, press the SCAN button again.

## 7. EQUALIZER (EQ) Button or AUXILIARY (AUX) Button

Press the EQ button to select the CLASSIC, POPS, ROCK, JAZZ and OFF MODE for the desired tone quality. Each press of the button changes the display as follows;

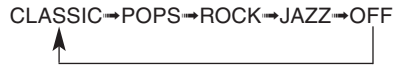

- If the button is labeled AUX, it will change to AUX mode when you press the button, and the button has no EQ function.
- The AUX button is functional only if Rear Seat Entertainment (RSE) unit is on.
- You can enjoy the RSE audio through the speakers in AUX mode.
- The speaker volume level is adjustable by VOLUME(+,-) key, on RSE unit or wireless remote control.
- \* Refer to the “RSE” in this section for details RSE operation.
- \* RSE : Rear Seat Entertainment System(A/V).

## 8. PRESET STATION Select Buttons

Six stations for AM, FM1 and FM2 respectively can be preset in the electronic memory circuit.

### HOW TO PRESET STATIONS

Six AM and twelve FM stations may be programmed into the memory of the radio. Then, by simply pressing the AM/FM band select button and/or one of the six station select buttons, you may recall any of these stations instantly. To program the stations, follow these steps:

- Press AM/FM selector to set the band for AM, FM1 and FM2.
- Select the desired station to be stored by seek or manual tuning.
- Determine the preset station select button you wish to use to access that station.

- Press and hold the station select button for more than 1 second. A select button indicator will show in the display indicating which select button you have depressed. The frequency display will flash after it has been stored into the memory. You should then release the button, and proceed to program the next desired station. A total of 18 stations can be programmed by selecting one AM and two FM stations per button.
- When completed, any preset station may be recalled by selecting AM, FM1 or FM2 band and the appropriate station button.

### **CAUTION**

- **Do not place beverages close to the audio system. The audio system mechanism may be damaged if you spill them.**
- **Do not strike or allow anything to impact the audio system, damage to the system mechanisms could occur.**

### CASSETTE TAPE PLAYER OPERATION (M465) (IF EQUIPPED)





1. TAPE PROGRAM Button
2. TAPE EJECT Button
3. AUTO MUSIC SEARCH (AMS) Button
4. FF/REW Button
5. REPEAT (RPT) Button
6. DOLBY Button
7. EQUALIZER (EQ) Button or AUXILIARY (AUX) Button

JBM465UR

### 1. TAPE PROGRAM Button



- This allows you to play the reverse side of the tape by merely depressing the program button. An arrow will appear in the display to show tape direction.
- Push the TAPE button while the tape is in the tape deck, to turn on that function without pushing the Power ON-OFF control knob.

### 2. TAPE EJECT Button

- When the  button is pressed with a cassette loaded, the cassette will eject.
- When the  button is pressed during FF/REW mode, the cassette will eject.

### 3. AUTO MUSIC SEARCH (AMS) Button

Press the button to find the starting point of each song in a prerecorded music tape. The quiet space between songs (must have at least 4 sec. gap) can be identified by the AUTO MUSIC SEARCH button.

- Pressing the  button will play the beginning of the next music segment.
- Pressing the  button will start replay at the beginning of the music just listened to.
- To stop FF or REW action, press the button again.

### 4. FF/REW Button

- Forward tape winding starts when the FF button is pressed during PLAY or REW mode.
- Tape PLAY starts when the FF button is pressed again during FF mode.
- Tape rewinding starts when the REW button is pressed during PLAY or FF mode.
- Tape PLAY starts when the REW button pressed again during REW mode.

### 5. REPEAT (RPT) Button

- To repeat the track you are currently listening to, press the RPT button. To cancel, press again.
- If you do not release RPT operation when the track ends, it will automatically be replayed. This process will be continued until you push the button again or turn the power OFF then ON.

### 6. DOLBY Button

If you get background noise during tape PLAY, you can reduce this considerably by merely pressing the DOLBY button. If you want to cancel the DOLBY feature, press the button again.

### 7. EQUALIZER (EQ) Button or AUXILIARY (AUX) Button

Press the EQ button to select the CLASSIC, POPS, ROCK, JAZZ and OFF MODE for the desired tone quality. Each press of the button changes the display as follows;

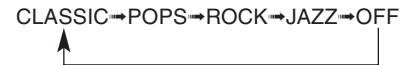

- If the button is labeled AUX, it will change to AUX mode when you press the button, and the button has no EQ function.
- The AUX button is functional only if RSE unit is on.
- You can enjoy the RSE audio through the speakers in AUX mode.
- The speaker volume level is adjustable by VOLUME(+,-) key, on RSE unit or wireless remote control.
- \* Refer to the “RSE” in this section for details RSE operation.
- \* RSE : Rear Seat Entertainment System(A/V).

### \* NOTICE

- To assure proper operation of the unit, keep the vehicle interior temperature within a normal range by using the vehicle's air conditioning or heating system.
- When replacing the audio unit fuse, replace it with a fuse having the correct capacity.
- The preset station frequencies are all erased when the car battery is disconnected. Therefore, all data will have to be set again if this should occur.
- Do not add any oil to the rotating parts. Keep magnets, screwdrivers and other metallic objects away from the tape mechanism and head.
- This equipment is designed to be used only in a 12 volt DC battery system with negative ground.
- This unit is made of precision parts. Do not attempt to disassemble or adjust any parts.

(Continued)

(Continued)

- When driving your vehicle, be sure to keep the volume of the unit set low enough to allow you to hear sounds coming from the outside.
- Do not expose this equipment (including the speakers and tape) to water or excessive moisture.

### CAUTION

- *Do not insert anything like coins into the player slot as damage to the unit may occur.*
- *Do not place beverages close to the audio system. The playback mechanism may be damaged if you spill them.*
- *Do not strike or allow anything to impact the audio system, damage to the system mechanisms could occur.*

## COMPACT DISC PLAYER/CD AUTO CHANGER OPERATION (M465) (IF EQUIPPED)

- Compatible with MP3/WMA



1. LOAD Button
2. Playing CD Button
3. CD EJECT Button
4. TRACK UP/DOWN Button
5. SCROLL Button
6. FF/REW Button
7. EQUALIZER (EQ) Button or AUX Button
8. SCAN Button
9. BOOKMARK (MARK) Button
10. REPEAT (RPT) Button
11. RANDOM (RDM) Button
12. DISC UP/DOWN Button
13. FILE SEARCH Knob  
(TUNE Select Knob)
14. DIRECTORY SEARCH (DIR) Button

JBM465UR

### 1. LOAD Button

This compact disc player will accommodate up to six compact discs.

To insert multiple discs into the player, perform the following:

1. Press and release the LOAD Button.
2. Green light on the slot will be illuminated and the lowest number of empty slot will blink on the display.  
After "WAIT" is displayed on the LCD, the slot will open with "INSERT" displayed on the LCD.
3. Insert a disc partway into the slot, label side up. The player will pull the disc in.

When the disc is inserted, the disc will begin to play automatically.

#### \* NOTICE

- **The disc can be only inserted while the green light is blinking on the slot.**
- **This CD player is suitable only for 12 centimeter discs, do not use irregular shaped CDs.**

To insert multiple discs do the followings:

1. Press and hold the LOAD button for one second or more.  
You will then hear a beep sound and the green light on the slot will be illuminated, and the numbers of empty disc will blink on the display.

2. After "WAIT" is displayed on the LCD with the lowest number of empty slot blinking, the slot will open with "INSERT" displayed on the LCD.

3. Insert a disc partway into the slot, label side up. The player will pull the disc in. Once the disc is loaded, the numbers of the empty disc will blink on the display continuously.  
If the next "DISC NO." is displayed when the slot is illuminated, you can then load another disc.

4. Load the remaining disc by following the same procedures 1 and 2. When you finished loading 6 discs, the CD player will begin to play the last CD loaded.

5. To load more than one disc but less than six, complete Steps 1 and 2.

When you have finished loading discs, press LOAD button to cancel the loading function or wait for 10 seconds. The CD player will begin to play the last CD loaded. As each CD starts to play, the DISC number will appear on the display.

#### \* NOTICE

**The disc player takes up to six discs. Do not try to load more than six.**

### 2. Playing CD Button

- Press the CD Button to start CD playback, during radio operation or cassette tape playback.
- When discs are in the CD deck, if you press the CD button, the CD player will begin playing even if the radio or cassette player is being used.
- The CD player can be used when the ignition switch is in either the "ON" or "ACC" position.
- Push the CD button to turn on that function without pushing the Power ON-OFF control knob.

#### \* NOTICE

- **Do not stick paper or tape etc., on the label side or the recording side of any discs, as it may cause a malfunction.**
- **The unit can play a multi-session CD-R (recordable CD) and CD-RW (rewritable CD) that consists of more than two sessions.**  
Please refer to the manual of CD-R/CD-RW recorder or CD-R/CD-RW software for more information on finalization process.
- **Depending on the recording status, some CD-Rs/CD-RWs may not play on this unit.**





**\* NOTICE**

Playback of MP3 and WMA file formats are supported. Load to play time for these formats may be longer due to the compressed nature of these discs.

**3. CD EJECT Button**

- When the  button is pressed with a CD loaded, the CD will eject.
- To eject all of the discs, press this button for one second or more.

**4. TRACK UP/DOWN Button**

- The desired track on the disc currently being played can be selected using the track number.
- Press  once to skip forward to the beginning of the next track.
- Press  once to skip back to the beginning of the track.
- Press  before playback begins to quickly move backward through a CD.

**5. SCROLL Button**

Press the button, and you can check the file names with more than 16 characters on MP3 CD(max 34 characters).

The button doesn't work on file names less than 16 characters.

**6. FF/REW Button**

If you want to fast forward or reverse through the compact disc track, push and hold the FF or REW button.

When you release the button, the compact disc player will resume playing.

**7. EQUALIZER (EQ) Button or AUXILIARY (AUX) Button**

Press the EQ button to select the CLASSIC, POPS, ROCK, JAZZ and OFF MODE for the desired tone quality. Each press of the button changes the display as follows;

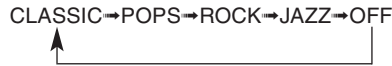

- If the button is labeled AUX, it will change to AUX mode when you press the button, and the button has no EQ function.
- The AUX button is functional only if RSE unit is on.
- You can enjoy the RSE audio through the speakers in AUX mode.
- The speaker volume level is adjustable by VOLUME(+,-) key, on RSE unit or wireless remote control.
- \* Refer to the "RSE" in this section for details RSE operation.
- \* RSE : Rear Seat Entertainment System(A/V).

**8. SCAN Button**

- To playback the first 10 seconds of each track, press the SCAN button more than 1 second.
- To playback the first 10 seconds of each track in the selected folder, press the SCAN button within 1 second. (MP3 CD only)
- Press the SCAN button again within 10 sec. when you have reached the desired track.

### 9. BOOKMARK (MARK) Button

When the CD player unit is operating, the desired track on the disc can be bookmarked by using the MARK button.

- Press the MARK button for more than 1 second to bookmark the desired track.  
"M" will be displayed on the LCD and "MEMORY(1~50)" will display for approximately five seconds with beep sound.  
To play the bookmarked tracks, press the MARK button within 1 second and select the bookmarked track to play.
- To erase a bookmarked track, press the MARK button for more than 1 second. The unit will beep once when the bookmark is erased.

If you want to delete all tracks stored on Mark Memory, press FILE SEARCH Knob in the Mark Play mode for more than 0.8 seconds. You will hear a beep sound and all tracks will be deleted from Mark Memory with "MARK DELETE ALL" displayed on the LCD.

### \* NOTICE

**Tracks stored on Mark Memory will be automatically erased after you eject CDs that contain those tracks.**

### 10. REPEAT (RPT) Button

- To repeat the track you are currently listening to, press the RPT button.  
To cancel, press it again.
- To repeat the music within selected CD, press the RPT button for more than 1 second.  
To cancel, press it again for more than 1 second.
- To repeat the music within currently played folder, press the RPT button for more than 1 second.  
To cancel, press it again(MP3 CD only).
- If you do not release RPT operation after all the tracks are played back, the unit will play back again from the first track.  
This process will be continued until you push the button again or turn the power OFF then ON.

### 11. RANDOM (RDM) Button

With random, you can listen to the tracks in random, rather than sequential order on one disc.

To use random, do the following:

- Press the RDM button to listen to recorded tracks in random sequence. Press RDM again to cancel or turn the power OFF then ON. The unit defaults to playing tracks in sequential order.
- To listen to the music within the selected folder in random order, press the RDM button within a second. To cancel, press it again or turn the power OFF then ON. (MP3 CD only)

### 12. DISC UP/DOWN Button

- By pressing "DISC  $\wedge$ "/"DISC  $\vee$ " while CD changer is playing you can move backward or forward to the next disc and playback automatically begins.
- If any of the slots do not contain a CD, your car audio will skip the empty slot and play only those that contain a CD. When switching CD's, the LCD displays the selected CD's number.

### 13. FILE SEARCH Knob (TUNE Select Knob)

- You can skip the track (file) by turning the FILE SEARCH knob clockwise or counterclockwise.

After selecting the desired track (file), press the FILE SEARCH knob to play-back the track (file).

If you do not press the FILE SEARCH knob within five seconds, the search will stop.

### 14. DIRECTORY SEARCH (DIR) Button

- You can move through the folder by pushing the DIR button to up (^) and down(∨).
- After moving the desired folder, press the FILE SEARCH knob to play back in the selected folder. If you do not press the FILE SEARCH knob within 5 seconds, the folder searching function will be released. It can not be operated in a single folder.

### \* NOTICE

- To assure proper operation of the unit, keep the vehicle interior temperature within a normal range by using the vehicle's air conditioning or heating system.
- When replacing the audio unit fuse, replace it with a fuse having the correct capacity.
- Stored CD bookmarks are all erased when the car battery is disconnected or power to the vehicle is lost. If this occurs, the bookmarks will have to be reset.
- This equipment is designed to be used only in a 12 volt DC battery system with negative ground.
- This unit is made of precision parts. Do not attempt to disassemble or adjust any parts.
- When driving your vehicle, be sure to keep the volume of the unit set low enough to allow you to hear sounds coming from the outside.
- Do not expose this equipment (including the speakers and tape) to water or excessive moisture.

### CAUTION

- *Do not insert warped or poor quality discs into the CD player as damage to the unit may occur.*
- *Do not insert anything like coins into the player slot as damage to the unit may occur.*
- *Do not place beverages close to the audio system. The playback mechanism may be damaged if you spill them.*
- *Do not strike or allow anything to impact the audio system, damage to the system mechanisms could occur.*
- *Off-road or rough surface driving may cause the compact disc to skip. Do not use the compact disc when driving in such conditions as damage to the compact disc face could occur.*
- *Do not attempt to grab or pull the compact disc out while the disc is being pulled into the audio unit by the self-loading mechanism. Damage to the audio unit and compact disc could occur.*
- *Avoid using home-recorded compact discs in your audio unit. Original compact discs are recommended for best results.*

### REAR SEAT ENTERTAINMENT SYSTEM / DVD PLAYER (IF EQUIPPED)

The Rear Seat Entertainment (RSE) System is a compact, built-in, easy-to-use entertainment system designed to provide family fun while you are on the road. Enjoy great quality sound from the 11 speakers, or have a private, quiet viewing with the wireless headphones.

The display unit is mounted to the ceiling in the rear passenger area of the vehicle, allowing rear-seat passengers to play DVD movies, video CDs or music CDs. Users may also plug in a game platform or VHS player. Headphones, game cartridges and other accessories can be kept neatly out of the way in the 3rd-row armrest compartment.

#### System Overview

The RSE System includes a mounted color monitor with a built-in audio/video control panel and a DVD player. It also includes a remote control and two (2) sets of battery-operated wireless headphones.

#### Connections / Setup

The RSE system is designed to make your time on the road more enjoyable. Please follow these instructions carefully to get the most out of your RSE.

#### CAUTION

- **Refrain from using food or drinks near the RSE, the wireless headphones or the remote control.**
- **Direct sunlight may interfere with the headphone's operation and performance.**
- **Normal RSE operation cannot be guaranteed with duplicated discs.**
- **In order to prevent inadvertent battery discharge, the RSE will remain in standby mode when ignition switch is turned to ignition ON or accessory mode.**
- **Use of rear seat entertainment system without the engine running will reduce battery power.**

#### CAUTION

**Disclaimer: The RSE system is programmed to the regional display formats for your region (NTSC or PAL). Please note that your RSE will not read DVDs from a different region.**

#### \* NOTICE

RSE operation is prevented during the first 2 seconds after the ignition switch is turned to ignition on or accessory mode.

Close



RES\_CLOSED\_8111

Open



RES\_OPEN\_8111

### **Viewing/Adjusting the Monitor**

To view the monitor, locate the latch on the bottom center of the mounted unit and pull it forward. This will release the monitor from its locked, stow-away position. Use your hands to adjust the monitor into optimal viewing position. Do not touch the LCD panel itself to avoid damage or smudging.

To close the monitor, pull the bottom edge forward and push it up until it clicks into the stow-away position.

Folded



HEADPHONE8111

Spread



HEADPHONE8112

### **Headphones**

The RSE comes with two (2) sets of wireless headphones and four (4) AAA 1.5V batteries. Install the batteries by opening the compartment on the right side of the headphones. Each set of headphones requires two (2) AAA 1.5V batteries.



HEADPHONE8112

To turn the headphones on, push the button (1) once. Push the button again to turn the headphones off. The red LED indicator on the headphone identifies the On/Off status. The power status indicator is located on the left headphone.

The sound level of the headphones is controlled by the volume up[down] knob (2) located on the side of the headphones.

The headphones can be stored by folding the headphones.

### \* NOTICE

- **Conserve the energy of your batteries by turning the headphones off when they are not in use. The on/off button is located on the left side of the headphones.**
- **The headphone has an automatic shutoff feature if an IR signal from the RSE units is not received after 20 seconds. This feature is used to prevent inadvertent battery discharging of the headphones.**
- **The life cycle of headphone's battery is approximately 48 hours.**
- **In case of poor reception performance, check the battery condition.**
- **The headphones are best used within 2-6 feet (0.6-1.8 m) of the RSE unit. Getting too close or too far away will cause poor audio reception.**
- **Audio from the vehicle's CD/radio cannot be heard through the headphones.**



ICDX\_VQ-465\_1

### *Audio Via Vehicle Speakers*

To hear the audio from the RSE through the vehicle's speakers, the RSE must be selected by the Head Unit in the front of the vehicle. To select the RSE, press AUX button. To end the RSE audio through the vehicle's speakers, press AUX button again. When RSE is deselected by the Head Unit, the headphones can still be used to hear audio.

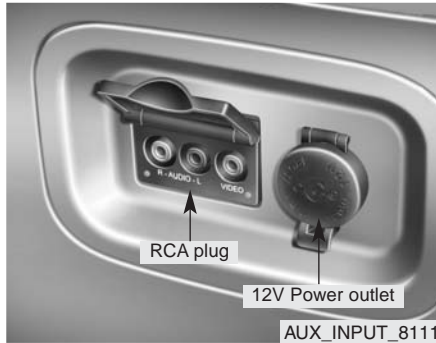

### Connecting Other Devices to the RSE

Electronic devices such as video game systems, VHS players, Camcorder or etc, can be played through the RSE. These external devices can be connected to the unit via RCA plugs available throughout the vehicle. DC power for additional electronic equipment is provided by one of the 12-volt power outlets located in the dash, third row and cargo areas. Additional information can be found in the vehicle manual.

Press the SOURCE (SRC) Button to switch to the externally connected device. (AUX mode)

The RSE unit has an automatic video detection feature that will automatic switch to external device when the device is plugged into the auxiliary jacks in the vehicle.

Once the RSE has switched to the external device, you can make your selections by using the buttons on the external device. The RSE controls will not work for external devices. For example, to select a video game after the RSE has recognized the source, you must use the game controls, not the RSE controls, to choose a selection.

The RSE unit will automatically switch to the RSE mode when the external device is unplugged from the auxiliary jacks.

The display mode can be changed by DISP (DISP) button.

### CAUTION

**Connect only appropriate input sources to the RSE jacks. Connecting an incorrect input may cause damage to the player and/or the external electronic device.**

### \* NOTICE

**Only external devices that have an active video source - such as video game systems or VHS players - can be read by the RSE. The RSE will not play an external device that only has an audio source, such as a cassette player or other CD player.**

### Cleaning of Display

If the LCD display becomes dusty or dirty, clean it by wiping gently with a soft, dry, clean cloth.

### Using the DVD player

#### *Disc compatibility*

Your RSE player accepts and plays all DVDs in 4:3 (normal) and 16:9 (wide screen) video formats. With DVDs that offer multiple formats, the default format is 16:9 and will stay that way unless the user changes the format. (See “Display” to learn how to adjust the format.)

#### **\* NOTICE**

- The DVD player has the capability to play DVD-Video, DVD-R, DVD-RW, CD-DA, CD-R, CD-RW and Video-CD.
- The DVD player has the capability to play CD-DA, DVD, VCD, PCM, Dolby Digital and DTS formats.
- Please refer to the appendix for the error messages.

#### *Loading a Disc*

Insert the disc part way into the load slot. The player will automatically grip the disc and pull it in the rest of the way. The player will display “reading” on the screen and show the “Hyundai Motors” logo before beginning the DVD.

The player is only capable of reading the bottom side of a disc. When inserting a single-sided disc, the label side should be up. When inserting a two-sided disc, the desired play side should be down.

#### **\* NOTICE**

- Because there is no universal standard for DVD programming, your disc may behave differently than below. Some DVDs may present warning messages about unauthorized duplication, some will go directly to a menu and others may start playing the movie immediately.
- When the vehicle's ignition is active, the loading of any playable disc will cause the player to initialize and automatically play the disc. If a disc was playing prior to the ignition being turned off, it will not automatically replay once the ignition is turned on again. Instead, it will go into standby mode. Press the SRC or PLAY/PAUSE(▶/||) button to “wake up” the unit and resume disc play.

#### *Disc Protection*

The player has an Auto-Reload Disc Protection feature to protect discs from accidental damage. If an ejected disc is not removed within 25 seconds after being ejected, it will be pulled back into the player. The disc will not begin playing. Disc can be played by the SRC or PLAY/PAUSE(▶/||) buttons.

#### **DVD Controls**

You can control your DVD by using the buttons on the unit's control panel or by using the remote control. Instructions for the controls listed below are the same whether you are using the control panel or the remote control. However, there are functions that are only available from the remote control. These buttons and their functionality are discussed in the “REMOTE CONTROL” section beginning.



## VIDEO MODE OPERATION (IF EQUIPPED)



1. STOP/EJECT
2. SPEAKER VOLUME CONTROL
3. PLAY/PAUSE
4. DISPLAY
5. FORWARD
6. REVERSE
7. NEXT CHAPTER
8. PREVIOUS CHAPTER
9. ENTER
10. MENU
11. SOURCE

RES\_OPEN\_8111

### \* NOTICE

The RSE will enter standby mode when the vehicle ignition is turned off and back on. Press the SRC or PLAY/PAUSE() button to “wake up” the unit and resume disc play.

#### 1. Stop/Eject

While the disc is playing, press the STOP/EJECT () button to stop disc play. When the disc has stopped, press the button again to eject the disc.

### \* NOTICE

The player has an Auto-Reload Disc Protection feature to protect discs from accidental damage. If an ejected disc is not removed within 25 seconds after being ejected, it will be pulled back into the player. This is to protect the disc from accidental damage.



#### 2. Speaker Volume Control

You can adjust the volume one of two ways. First, if you are adjusting the volume for audio through the vehicle speakers, you can use the VOLUME button on the control panel or the remote control. This button is reserved for sending a signal to the vehicle speakers only, and will not adjust the headphone volume. Press “+” to increase the volume and “-” to decrease the volume.

Second, the volume on the wireless headphones can be adjusted by turning the VOL knob located on the left side of the headphones.

#### 3. Play/Pause

You do not need to press the play button after first loading a DVD or VCD; it will start automatically by playing the first track or bringing up the disc menu.

If the disc does not automatically load, press PLAY/PAUSE() to play the DVD. While playing a DVD, press PLAY/PAUSE() to pause the DVD. Press the button again to resume play.

#### 4. Display

When the player is in DVD mode, press the DISP button to view the DVD title, chapter number and elapsed time and other information about the DVD currently playing.

It will also display brightness. There are “Day Time” brightness with brightest level and “Night Time” brightness which has 70% level of “Day Time” brightness. Adjust the level of brightness by pressing the REV(dimmer) or FWD(brighter) buttons.

The next time the player is turned on, it will return to the brightness level it was adjusted to when last used.

The RSE unit has two presets of display brightness. When the headlamp is turned on, the display brightness level will be dimmed as the preset. However, when the headlamp is turned off, the display brightness will return to the daytime brightness.

Press DISP to adjust the image format. The image format, also known as the aspect ratio, is a ratio of the height to width of the image on the screen. For example, a 4:3 ratio would mean an image that is 4 units by 3 units.

You have two options: 4:3 (normal) and 16:9 (widescreen). Press the display button to select the preferred aspect ratio.

When the RSE unit receives video signals from the AUX, the aspect ratio can be changed to 16:9 or 4:3 by the DISP button.

The aspect ratio information will automatically disappear if no button is pressed for three seconds.

### 5. Forward

There are three DVD and VCD fast forward speeds. Press and hold the FWD button for up to 2 seconds and the player will fast forward at 4 times the normal speed (8 times for VCDs). Hold the button for more than 2 seconds but less than 4 seconds and the player will fast forward at about 8 times the normal speed (20 times for VCDs). Hold the button for more than 4 seconds and the fast forward will increase to about 32 times the normal speed for both DVDs and VCDs. Press the FWD button again to stop fast forwarding and return to normal speed play.

### 6. Reverse

There are three DVD and VCD fast reverse speeds. Press and hold the REV button for up to 2 seconds and the player will reverse through the DVD at 4 times the normal speed (8 times for VCDs). Hold the button for more than 2 seconds but less than 4 seconds and the player will reverse at about 8 times the normal speed (20 times for VCDs). Hold the button for more than 4 seconds and the reverse will increase to 32 times the normal speed for both DVDs and VCDs.

Press the REV button again to stop reversing and return to normal speed play.

### 7. Next Chapter

While a DVD is playing, press the NEXT button to skip to the next chapter. The current chapter number is shown on the screen. Press and hold the NEXT button to move quickly through the chapters.

### \* NOTICE

Depending on the DVD, if NEXT is pressed during the last chapter on a DVD, a red circle with a “Invalid icon[⊙]” may be displayed, indicating an invalid button press.

### 8. Previous Chapter

Press the PREV button to skip to the beginning of the previous chapter. Press and hold the PREV button to move quickly through the chapters.

Depending on your DVD, if the PREV button is pressed during the first 8 seconds of the first chapter, the player will skip to the beginning of the last chapter of the DVD.

### 9. Enter

A momentary press shall initiate a select or enter function of a selected menu item.

### 10. Menu

DVDs may contain special programming or features that are accessed by using the menu. To use the menu with a DVD that is playing, press the MENU button once to display the DVD disc menu. Press the button a second time to exit the menu and return to the DVD program.

The menu is not available during disc initialization, the beginning credits or any copyright warnings.

When viewing a menu, pressing the MENU button again will automatically return to the movie at the point it was being viewed. You can also select "play" or any other option by using the NEXT, PREV, FWD and REV buttons.

Press the NEXT button to move the cursor up and the PREV button to move the cursor down the menu.

Press the FWD button to move the cursor to the right, and the REV button to move the cursor to the left.

### **\* NOTICE**

**You must repeatedly push any button to move through several items. Pressing and holding any button will not advance the cursor beyond the position just moved.**

Press ENTER to select the desired menu choice.

### **11. Source**

Press the SOURCE button to switch from the RSE's internal DVD player to an external device such as a VCR or video game. The sound and images from the external source will be presented through the RSE.

Pressing the SRC button will switch between the following RSE states:

Playback state - will play DVDs, VCDs, and CDs

Auxiliary (AUX) state - will play video games and other external devices

When an external source is selected, the RSE's internal DVD player turns off. Press the SRC button to switch back from the external source to the internal DVD player.

If a disc is present in the DVD player, the disc will begin to play. If another source has been detected, such as a VCR or video game, the RSE will enter the AUX mode automatically and shall remain so until a disc is inserted or until the PLAY/SRC button is pressed on the RSE's front panel or on the remote control. If the vehicle ignition is on but the player isn't being used, the display will power off. The DVD mechanism will be in sleep mode, but the main RSE's controller will stay up to accept commands from the front panel controls or the remote control.

### **\* NOTICE**

**The external device must be correctly connected to the RSE in order to play properly.**

### **Using the CD Player**

The RSE will play audio CDs in both the standard (12 cm) and mini-disc (8 cm) format.

### **\* NOTICE**

**While the player will accept DVD ROMs and CD ROMs discs, the RSE cannot play discs in these formats and will eject them.**

With power applied to your unit, insert the disc part way into the load slot. The player will automatically grip the CD disc, pull it the rest of the way in and begin playing.

### **CD Controls**

The following functions are available when playing audio CDs.

### AUDIO MODE OPERATION (IF EQUIPPED)



1. STOP/EJECT
2. VOLUME CONTROL
3. PLAY/PAUSE
4. DISPLAY
5. FORWARD
6. REVERSE
7. NEXT TRACK
8. PREVIOUS TRACK

RES\_CLOSED\_8111

### 1. Stop/Eject

While the disc is playing, press the STOP/EJECT () button to stop disc play.

While the disc is stopped, press the STOP/EJECT () button again to eject the disc.

### 2. Volume Control



You can adjust the volume one of two ways. First, if you are adjusting the volume for audio through the vehicle speakers, you can use the VOLUME () button on the control panel or the remote control. Press “+” to increase the volume and “-” to decrease the volume. The volume level will be displayed on the head-unit, when the RSE unit volume level is adjusted from its control panel or remote control. This button does not affect headphone volume.

Second, you can adjust the volume on the wireless headphones by locating the VOL control wheel on the left side of the headphones. Roll the control wheel to adjust the volume.

### 3. Play/Pause

When an audio CD is inserted, the RSE will display the HYUNDAI logo, then automatically begin playing the first track. The track number and time elapsed for the current track is displayed.

If a CD is loaded and playing, press the PLAY/PAUSE () button to pause the CD. Press the button again to resume play.

If a CD is already loaded, stopping and playing the CD by pressing PLAY/PAUSE () button on the remote control; cycling the ignition and pressing play; or changing the source will cause the CD to begin playing at the point where it was stopped during the previous play. The player will automatically play this previous play position unless the STOP/EJECT () button is pressed.

At the end of the CD, the player will automatically return to the first track and continue playing.

### 4. Display

When the player is in DVD mode, press the DISP button to view the DVD title, chapter number and elapsed time and other information about the DVD currently playing.

The next time the player is turned on, it will return to the brightness level it was adjusted to when last used.

The RSE unit has two presets of display brightness. When the headlamp is turned on, the display brightness level will be dimmed as the preset. However, when the headlamp is turned off, the display brightness will return to the daytime brightness.

Press DISP to adjust the image format. The image format, also known as the aspect ratio, is a ratio of the height to width of the image on the screen. For example, a 4:3 ratio would mean an image that is 4 units by 3 units. You have two options: 4:3 (normal) and 16:9 (widescreen). Press the display button to select the preferred aspect ratio.

When the RSE unit receives video signals from the AUX, the aspect ratio can be changed to 16:9 or 4:3 by the DISP button.

The aspect ratio information will automatically disappear if no button is pressed for three seconds.

### **5. Forward**

There are two CD fast forward speeds. Press and hold the FWD button for up to 2 seconds and the player will fast forward at 3 times the normal speed. Hold the button for more than 2 seconds and the player will fast forward at about 10 times the normal speed. When the holding button is released, the RSE unit will automatically return to a play mode.

### **6. Reverse**

There are two fast reverse speeds. The RSE unit will fast reverse at 3 times the normal speed, if the REV button is pressed. Hold the button for more than 2 seconds and the RSE unit will fast reverse at about 10 times the normal speed. When the button is released, the RSE unit will automatically return to a play mode.

### **7. Next Track**

Press the NEXT button to skip to the beginning of the next track. The next track number is displayed on the screen. Press and hold the NEXT button for 2 seconds or more to move quickly through the tracks.

### **8. Previous Track**

Press the PREV button to skip to the beginning of the current track. Press the PREV button during the first 8 seconds of the current track to skip to the beginning of the previous track. Press the PREV button during the first 8 seconds of the first track to skip to the beginning of the last track on the CD. Press and hold the PREV button for 2 seconds or more to move quickly through the tracks.

## REMOTE CONTROL

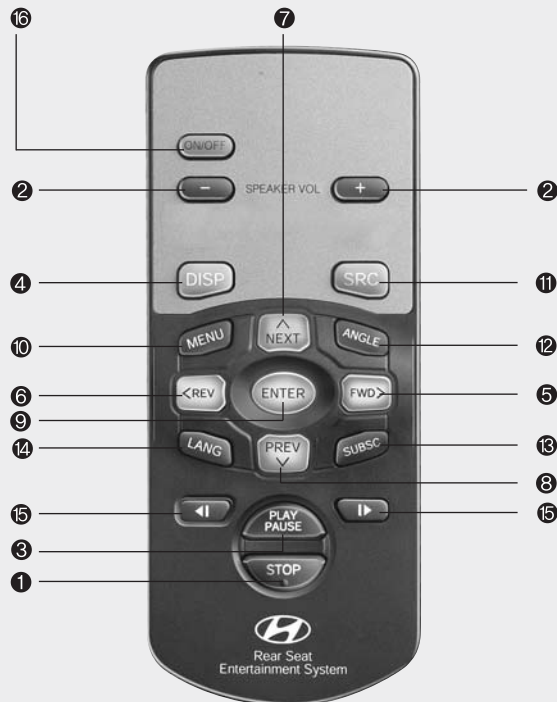

1. STOP
2. SPEAKER VOL (+, -)
3. PLAY/PAUSE
4. DISPLAY
5. FORWARD
6. REVERSE
7. NEXT
8. PREVIOUS
9. ENTER
10. MENU
11. SOURCE
12. ANGLE
13. SUBSCRIPT
14. LANGUAGE
15. SLOW PLAY
16. ON/OFF

REMOTE\_CONTROL\_EP\_8111



## Using the Remote Control

In addition to having all the buttons and functionality listed in the DVD and CD Controls section, the remote control has several other buttons that offer additional functions. It is an infrared remote control, and must be pointed at the face of the RSE at a 45° angle for best results. It requires a CR2025 battery (included). The remote control has the following additional buttons:

### \* NOTICE

The RSE system is always “awake” when the vehicle’s ignition is turned on or when the vehicle is in “accessory” power mode.

#### 1. Stop

Pressing this button once will stop DVD or CD play. To eject a disc, you must use the eject button on the control panel.

#### 2. Speaker Volume “+” and “-”

These buttons control the volume of the audio of a DVD or CD through the vehicle speakers, not the volume from headphones. Press “+” to turn the volume up and “-” to turn the volume down.

### 3. Play/Pause

When an audio CD(VCD/DVD) is inserted, the RSE will display the HYUNDAI logo, then automatically begin playing the first track. The track number and time elapsed for the current track is displayed.

If a CD(VCD/DVD) is loaded and playing, press the PLAY/PAUSE(▶/⏸) button to pause the CD(VCD/DVD). Press the button again to resume play.

If a CD(VCD/DVD) is already loaded, stopping and playing the CD(VCD/ DVD) by pressing PLAY/PAUSE(▶/⏸) button on the remote control; cycling the ignition and pressing play; or changing the source will cause the CD(VCD/DVD) to begin playing at the point where it was stopped during the previous play. The player will automatically play this previous play position unless the STOP/EJECT(⏹) button is pressed.

At the end of the CD(VCD/DVD), the player will automatically return to the first track and continue playing.

### 4. Display

When the player is in DVD mode, press the DISP button to view the DVD title, chapter number and elapsed time and other information about the DVD currently playing.

It will also display brightness. There are “Day Time” brightness with brightest level and “Night Time” brightness which has 70% level of “Day Time” brightness. Adjust the level of brightness by pressing the REV(dimmer) or FWD(brighter) buttons.

The next time the player is turned on, it will return to the brightness level it was adjusted to when last used.

The RSE unit has two presets of display brightness. When the headlamp is turned on, the display brightness level will be dimmed as the preset. However, when the headlamp is turned off, the display brightness will return to the daytime brightness.

Press DISP to adjust the image format. The image format, also known as the aspect ratio, is a ratio of the height to width of the image on the screen. For example, a 4:3 ratio would mean an image that is 4 units by 3 units. You have two options: 4:3 (normal) and 16:9 (widescreen). Press the display button to select the preferred aspect ratio.

When the RSE unit receives video signals from the AUX, the aspect ratio can be changed to 16:9 or 4:3 by the DISP button.

The aspect ratio information will automatically disappear if no button is pressed for three seconds.

### **5. Forward**

There are three DVD and VCD fast forward speeds. Press and hold the FWD button for up to 2 seconds and the player will fast forward at 4 times the normal speed (8 times for VCDs). Hold the button for more than 2 seconds but less than 4 seconds and the player will fast forward at about 8 times the normal speed (20 times for VCDs). Hold the button for more than 4 seconds and the fast forward will increase to about 32 times the normal speed for both DVDs and VCDs. Press the FWD button again to stop fast forwarding and return to normal speed play.

### **6. Reverse**

There are three DVD and VCD fast reverse speeds. Press and hold the REV button for up to 2 seconds and the player will reverse through the DVD at 4 times the normal speed (8 times for VCDs). Hold the button for more than 2 seconds but less than 4 seconds and the player will reverse at about 8 times the normal speed (20 times for VCDs). Hold the button for more than 4 seconds and the reverse will increase to 32 times the normal speed for both DVDs and VCDs.

Press the REV button again to stop reversing and return to normal speed play.

### **7. Next**

While a DVD is playing, press the NEXT button to skip to the next chapter. The current chapter number is shown on the screen. Press and hold the NEXT button to move quickly through the chapters.

### **\* NOTICE**

**Depending on the DVD, if NEXT is pressed during the last chapter on a DVD, a red circle with a “Invalid icon[⊗]” may be displayed, indicating an invalid button press.**

### **8. Previous**

Press the PREV button to skip to the beginning of the previous chapter. Press and hold the PREV button to move quickly through the chapters.

Depending on your DVD, if the PREV button is pressed during the first 8 seconds of the first chapter, the player will skip to the beginning of the last chapter of the DVD.

### **9. Enter**

A momentary press shall initiate a select or enter function of a selected menu item.

### **10. Menu**

DVDs may contain special programming or features that are accessed by using the menu. To use the menu with a DVD that is playing, press the MENU button once to display the DVD disc menu. Press the button a second time to exit the menu and return to the DVD program.

The menu is not available during disc initialization, the beginning credits or any copyright warnings.

When viewing a menu, pressing the MENU button again will automatically return to the movie at the point it was being viewed. You can also select “play” or any other option by using the NEXT, PREV, FWD and REV buttons.

Press the NEXT button to move the cursor up and the PREV button to move the cursor down the menu.

Press the FWD button to move the cursor to the right, and the REV button to move the cursor to the left.

**\* NOTICE**

You must repeatedly push any button to move through several items. Pressing and holding any button will not advance the cursor beyond the position just moved.

Press ENTER to select the desired menu choice.

**11. Source**

Press the SOURCE button to switch from the RSE's internal DVD player to an external device such as a VCR or video game. The sound and images from the external source will be presented through the RSE.

Pressing the SRC button will switch between the following RSE states:

Playback state - will play DVDs, VCDs, and CDs

Auxiliary (AUX) state - will play video games and other external devices

When an external source is selected, the RSE's internal DVD player turns off. Press the SRC button to switch back from the external source to the internal DVD player.

If a disc is present in the DVD player, the disc will begin to play. If another source has been detected, such as a VCR or video game, the RSE will enter the AUX mode automatically and shall remain so until a disc is inserted or until the PLAY/SRC button is pressed on the RSE's front panel or on the remote control. If the vehicle ignition is on but the player isn't being used, the display will power off. The DVD mechanism will be in sleep mode, but the main RSE's controller will stay up to accept commands from the front panel controls or the remote control.

**\* NOTICE**

The external device must be correctly connected to the RSE in order to play properly.

**12. Angle**

Some DVDs offer different scene angles. If available on the DVD, the ANGLE button will show you the other available scene angles. If angle scenes are not available, then "Invalid icon[⊗]" will be displayed. Pressing the ANGLE button during CD play will do nothing.



**13. Subscript**



The SUBSC button allows you to display or remove language subtitles. If no language subtitles are available, the display will show an invalid icon[⊗]. Pressing the SUBSC button during CD play will do nothing.

**14. Language**



Pressing the LANG button will allow you to select your preferred language, if available. Select the language and then press enter. If no other languages are available, the display will show an invalid icon[⊗]. Pressing the LANG button during CD play will do nothing.

### **15. Slow Play**

There are 3 slow forward and 3 slow reverse speeds available when viewing DVDs. To review a DVD in slow motion, first press the PLAY/PAUSE (  ) button to pause the DVD, then press either REV or FWD ( (  ) or (  ) on the remote control) to select slow playback in either reverse or forward.

Pressing either the REV or FWD ( (  ) or (  ) on the remote control) button once changes the player to 1/8 of normal speed. Press the button again to return to pause mode.

Press and hold either button for more than 2 seconds but less than 4 seconds and the player will switch to 1/4 of the normal speed. Hold either button for more than 4 seconds and the player will switch to 1/2 of the normal speed.

From the remote control for DVD, you can immediately switch to 1/8 forward or backward speed with the (  ,  ) buttons. Press either button again to return to normal play.

While using the Slow Play feature, the current play speed is displayed on the screen.

Press PLAY again to resume normal play.

### **16. On/Off**

This button will only turn off the DVD or CD and display, not the system itself. The system will remain on standby.

**Appendix****Messages**

<b>NON PLAYABLE MEDIA</b>	An incompatible format disc is inserted, or the disc is not playable.
⊗[INVALID ICON]	Invalid button press: The PREV button was pressed during the first chapter of a DVD, or the NEXT button was pressed during the last chapter of a DVD.
<b>NO DISC</b>	Displayed with the PLAY button is pressed but no disc is in the player.
<b>READING</b>	The player is searching the disc to determine its format and check for any special programming.
<b>STOP</b>	A disc is inserted in the RSE but not playing.
<b>DISC ERROR</b>	The inserted disc is either scratched or otherwise damaged, and cannot be played.
<b>REGION ERROR</b>	The region code of the disc is different from the RSE DVD region setting. The RSE unit can only play disc from the intent region. (ie, Korean Region, US region, European region, etc...)

**Technical Specifications**

<b>Input power requirements</b>	12 volts nominal (10.5 to 15.5 volts) @ 5 amps nominal (10amps peak max)
<b>A/V inputs</b>	- Audio Input : 1 volts nominal (0.8 to 1.2 V) - Video Input : 1 volts nominal (0.7 to 1.4 V)

*Troubleshooting*

<b>Problem</b>	<b>Possible causes / solutions</b>
<b>The disc becomes stuck or blocked.</b>	Press the STOP/EJECT button to release the disc. The player will attempt to eject the disc up to three times before performing the Auto-Reload function. Once the Auto-Reload function is complete, press the STOP/EJECT button again to release the disc from the player. If a disc is still stuck or blocked in the RSE unit, turn the ignition off and then on again to reset the RSE unit.
<b>There is no audio in the headphones.</b>	Verify that the headphone is equipped with batteries, and that the batteries are charged. Insert or replace 2 AAA batteries to resume headphone function.
<b>The RSE does not work.</b>	If the display does not show “NO DISC”, then there is no power. Check the vehicle fuse. If the RSE still does not work, contact your authorized Hyundai dealer.
<b>The remote control does not work.</b>	Make sure you are pointing the remote control at the face of the RSE at a 45° angle. Change the battery. [Device requires one (1) CR2025 battery.] Use the control buttons on the RSE display panel. If the remote control still does not work, contact your authorized Hyundai dealer.
<b>Continue receiving an invalid icon[☹] when a button is pressed</b>	Invalid button press. The function you are trying to perform is not available.

**Engine exhaust can be dangerous! / 4-2**  
**Before driving / 4-3**  
**Key positions / 4-5**  
**Starting the engine / 4-6**  
**Automatic transaxle / 4-7**  
**Cruise control system / 4-14**  
**Brake system / 4-17**  
**Electronic stability control (ESC) / 4-22**

## Driving your vehicle

4

**Back warning system / 4-25**  
**Good braking practices / 4-28**  
**Economical operation / 4-29**  
**Special driving conditions / 4-30**  
**Winter driving / 4-32**  
**Trailer towing / 4-34**  
**Vehicle load limit / 4-41**  
**Weight of the vehicle / 4-46**

### **WARNING - ENGINE EXHAUST CAN BE DANGEROUS!**

Engine exhaust fumes can be extremely dangerous. If, at any time, you smell exhaust fumes inside the vehicle, open the windows immediately.

- **Do not inhale exhaust fumes.**

Exhaust fumes contain carbon monoxide, a colorless, odorless gas that can cause unconsciousness and death by asphyxiation.

- **Be sure the exhaust system does not leak.**

The exhaust system should be checked whenever the vehicle is raised to change the oil or for any other purpose. If you hear a change in the sound of the exhaust or if you drive over something that strikes the underneath side of the car, have the exhaust system checked as soon as possible by your Hyundai dealer.

- **Do not run the engine in an enclosed area.**

Letting the engine idle in your garage, even with the garage door open, is a hazardous practice. Never run the engine in your garage any longer than it takes to start the engine and back the car out.

- **Avoid idling the engine for prolonged periods with people inside the car.**

If it is necessary to idle the engine for a prolonged period with people inside the car, be sure to do so only in an open area with the air intake set at "Fresh" and fan operating at one of the higher speeds so fresh air is drawn into the interior.

If you must drive with the trunk lid open because you are carrying objects that make this necessary:

1. Close all windows.
2. Open side vents.
3. Set the air intake control at "Fresh", the air flow control at "Floor" or "Face" and the fan at one of the higher speeds.

To assure proper operation of the ventilation system, be sure the ventilation air intakes located just in front of the windshield are kept clear of snow, ice, leaves or other obstructions.





### **PROPOSITION 65 WARNING**

**Engine exhaust and a wide variety of automobile components and parts, including components found in the interior furnishings in a vehicle, contain or emit chemicals known to the State of California to cause cancer and birth defects and reproductive harm. In addition, certain fluids contained in vehicles and certain products of component wear contain or emit chemicals known to the State of California to cause cancer and birth defects or other reproductive harm.**

## **BEFORE DRIVING**

### **Before entering vehicle:**

- Be sure that all windows, outside mirror(s), and outside lights are clean.
- Check the condition of the tires.
- Check under the vehicle for any sign of leaks.
- Be sure there are no obstacles behind you if you intend to back up.

### **Necessary inspections**

Fluid levels, such as engine oil, engine coolant, brake fluid, and washer fluid should be checked on a regular basis, with the exact interval depending on the fluid. Further details are provided in Section 6, Maintenance.

### **Before starting**

- Close and lock all doors.
  - Position the seat so that all controls are easily reached.
  - Adjust the inside and outside rearview mirrors.
  - Be sure that all lights work.
  - Check all gauges.
  - Check the operation of warning lights when the ignition switch is turned to the ON position.
  - Release the parking brake and make sure the brake warning light goes out.
- For safe operation, be sure you are familiar with your vehicle and its equipment.

**⚠ WARNING**

All passengers must be properly belted whenever the vehicle is moving. Refer to pages: 3-59 through 3-67 for more information on their proper use.

**⚠ WARNING**

Always check the surrounding areas near your vehicle for people, especially children, before putting a car into “Drive” or “Reverse”.

**⚠ WARNING - Driving under the influence of alcohol or drugs**

Drinking and driving is dangerous. Drunk driving is the number one contributor to the highway death toll each year. Even a small amount of alcohol will affect your reflexes, perceptions and judgement. Driving while under the influence of drugs is as dangerous or more dangerous than driving drunk.

You are much more likely to have a serious accident if you drink or take drugs and drive.

If you are drinking or taking drugs, don't drive. Do not ride with a driver who has been drinking or taking drugs. Choose a designated driver or call a cab.

## KEY POSITIONS



1VQA3017

### Illuminated ignition switch

Whenever a front door is opened, the ignition switch will be illuminated for your convenience, provided the ignition switch is not in the ON position. The light will go off approximately 10 seconds after closing the door or when the ignition switch is turned on.



1VQA3018

### Ignition switch and anti-theft steering column lock

#### Ignition switch position

#### LOCK

The steering wheel locks to protect against theft. The ignition key can be removed only in the LOCK position. When turning the ignition switch to the LOCK position, push the key inward at the ACC position and turn the key toward the LOCK position.

#### ACC (Accessory)

The steering wheel is unlocked and electrical accessories are operative.

#### ON

The warning lights can be checked before the engine is started. This is the normal running position after the engine is started.

*Do not leave the ignition switch ON if the engine is not running to prevent battery discharge.*

#### START

Turn the ignition key to the START position to start the engine. The engine will crank until you release the key; then it returns to the ON position. The brake warning lamp can be checked in this position.

*If difficulty is experienced in turning the ignition key to the START position, turn the steering wheel right and left to release the tension and then turn the key.*

## STARTING THE ENGINE

### **WARNING** - Ignition key

- Never turn the ignition switch to LOCK or ACC while the vehicle is moving. This would result in loss of directional control and braking function, which could cause an accident.
- The anti-theft steering column lock is not a substitute for the parking brake. Before leaving the driver's seat, always make sure the shift lever is engaged in P (Park) for the automatic transaxle and set the parking brake fully and shut the engine off. Unexpected and sudden vehicle movement may occur if these precautions are not taken.
- Never reach for the ignition switch, or any other controls through the steering wheel while the vehicle is in motion. The presence of your hand or arm in this area could cause a loss of vehicle control, an accident and serious bodily injury or death.
- Do not place any movable objects around the driver's seat as they may move while driving, interfere with the driver and lead to an accident.

### **WARNING**

Always wear appropriate shoes when operating your vehicle. Unsuitable shoes (high heels, ski boots, etc.) may interfere with your ability to use the brake and accelerator pedal, and the clutch (if equipped).

1. Make sure the parking brake is applied.
2. Place the transaxle shift lever in P (Park). Depress the brake pedal fully. *You can also start the engine when the shift lever is in the N (Neutral) position.*
3. Turn the ignition switch to START and hold it there until the engine starts (a maximum of 10 seconds), then release the key.
4. In extremely cold weather (below 0°F / -18°C) or after the vehicle has not been operated for several days, let the engine warm up without depressing the accelerator.

*Whether the engine is cold or warm, it should be started **without depressing the accelerator.***

### **CAUTION**

*If the engine stalls while you are in motion, do not attempt to move the shift lever to the P (Park) position. If traffic and road conditions permit, you may put the shift lever in the N (Neutral) position while the vehicle is still moving and turn the ignition switch to the START position in an attempt to restart the engine.*

### **CAUTION**

*Do not engage the starter for more than 10 seconds. If the engine stalls or fails to start, wait 5 to 10 seconds before re-engaging the starter. Improper use of the starter may damage it.*

## AUTOMATIC TRANSAXLE

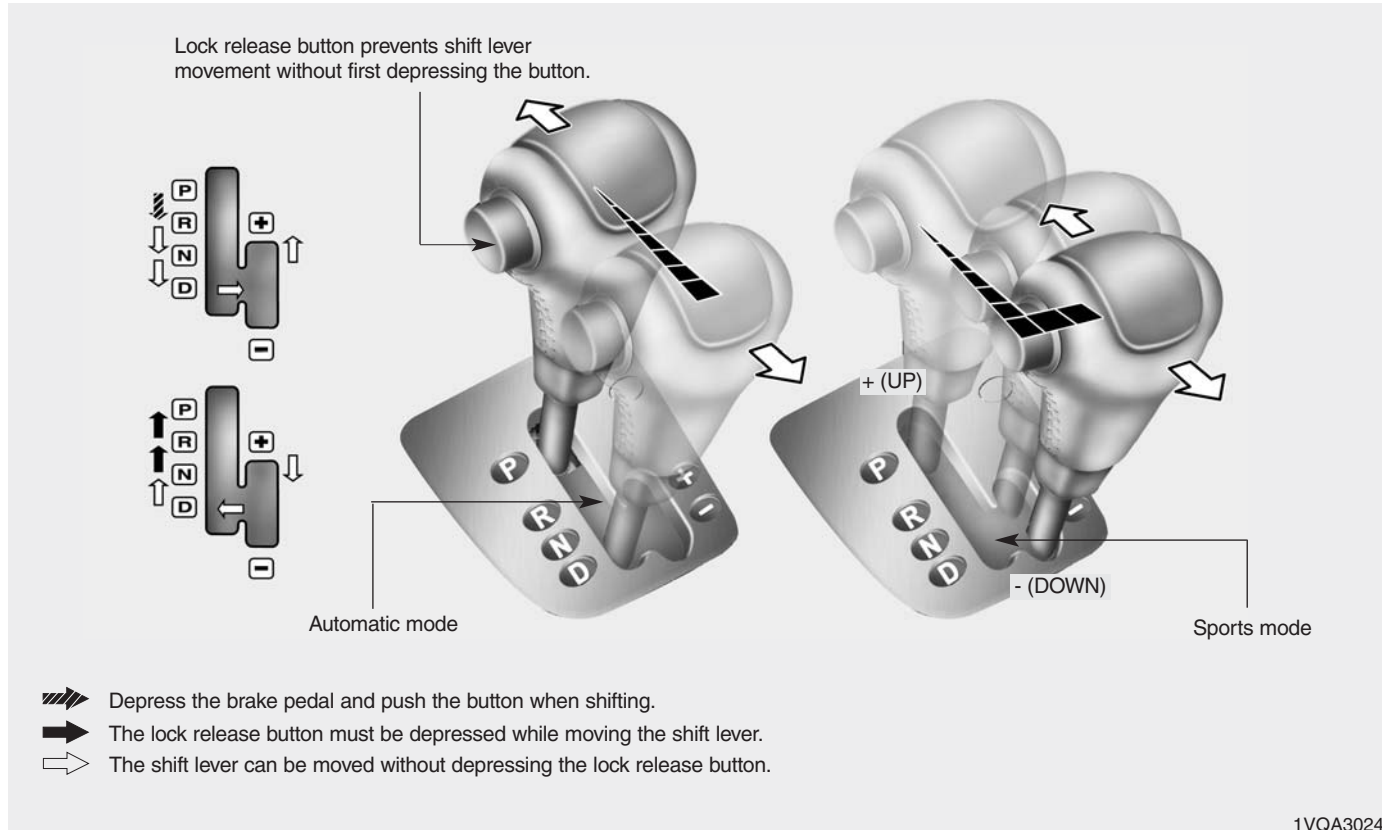

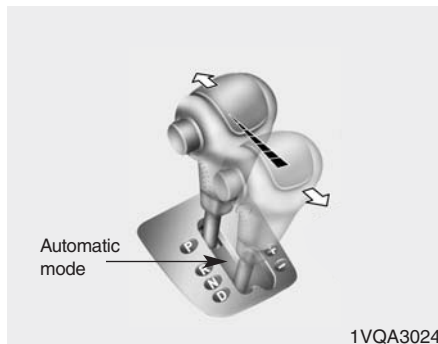

### Automatic transaxle operation

All normal forward driving is done with the shift lever in the D (Drive) position. To move the shift lever from the P (Park) position, the brake pedal must be depressed and the lock release button must be depressed.

### \* NOTICE

The first few shifts on a new vehicle, or if the battery has been disconnected, may be somewhat abrupt. This is a normal condition, and the shifting sequence will adjust after shifts are cycled a few times by the T.C.M (Transaxle Control Module).

For smooth operation, depress the brake pedal when shifting from N (Neutral) to a forward or reverse gear.

### **⚠ WARNING - Automatic transaxle**

- Always check the surrounding areas near your vehicle for people, especially children, before putting a car into “Drive” or “Reverse”.
- Before leaving the driver’s seat, always make sure the shift lever is in the P (PARK) position; then set the parking brake fully and shut the engine off. Unexpected and sudden vehicle movement can occur if these precautions are not followed in the order identified.

### **⚡ CAUTION**

- To avoid damage to your transaxle, do not accelerate the engine in R (Reverse) or any forward gear position with the brakes on.
- When stopped on an upgrade, do not hold the vehicle stationary with engine power. Use the service brake or the parking brake.
- Do not shift from N (Neutral) or P (Park) into D (Drive), or R (Reverse) when the engine is above idle speed.

## Transaxle ranges

### *P (park)*

Always come to a complete stop before shifting into P (Park). This position locks the transaxle and prevents the front wheels from rotating.

#### **WARNING**

- Shifting into P (Park) while the vehicle is in motion will cause the drive wheels to lock which will cause you to lose control of the vehicle.
- Do not use the P (Park) position in place of the parking brake. Always make sure the shift lever is latched in the P (Park) position so that it cannot be moved unless the lock release button is pushed in, AND set the parking brake fully.

(Continued)

#### (Continued)

- Before leaving the driver's seat, always make sure the shift lever is in the P (PARK) position. Set the parking brake fully, shut the engine off and take the key with you. Unexpected and sudden vehicle movement can occur if you do not follow these precautions in the order specified.
- Never leave a child unattended in a vehicle.

#### **CAUTION**

*The transaxle may be damaged if you shift into P (Park) while the vehicle is in motion.*

### *R (reverse)*

Use this position to drive the vehicle backward.

#### **CAUTION**

*Always come to a complete stop before shifting into or out of R (Reverse); you may damage the transaxle if you shift into R while the vehicle is in motion, except as explained in "Rocking the Vehicle", in this manual.*

### *N (neutral)*

The wheels and transaxle are not locked. The vehicle will roll freely even on the slightest incline unless the parking brake or service brakes are applied.

### *D (drive)*

This is the normal forward driving position. The transaxle will automatically shift through a 5-gear sequence, providing the best fuel economy and power.

For extra power when passing another vehicle or climbing grades, depress the accelerator fully, at which time the transaxle will automatically downshift to the next lower gear.

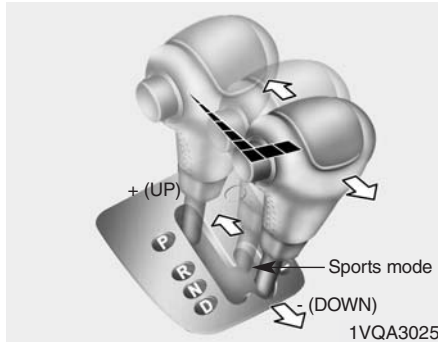

### Sports mode

Whether the vehicle is stationary or in motion, sports mode is selected by pushing the shift lever from the “D” position into the manual gate. To return to “D” range operation, push the shift lever back into the main gate.

In sports mode, moving the shift lever backwards and forwards will allow you to make gearshifts rapidly. In contrast to a manual transaxle, the sports mode allows gearshifts with the accelerator pedal depressed.

Up (+) : Push the lever forward once to shift up one gear.

Down (-) : Pull the lever backwards once to shift down one gear.

### \* NOTICE

- In sports mode, the driver must execute upshifts in accordance with road conditions, taking care to keep the engine speed below the red zone.
- In sports mode, only the five forward gears can be selected. To reverse or park the vehicle, move the shift lever to the “R” or “P” position as required.
- In sports mode, downshifts are made automatically when the vehicle slows down. When the vehicle stops, 1st gear is automatically selected.

(Continued)

(Continued)

- In sports mode, when the engine rpm approaches the red zone, shift points are varied to upshift automatically.
- To maintain the required levels of vehicle performance and safety, the system may not execute certain gearshifts when the shift lever is operated.
- When driving on a slippery road, push the shift lever forward into the +(up) position. This causes the transaxle to shift into the 2nd gear which is better for smooth driving on a slippery road. Push the shift lever to the -(down) side to shift back to the 1st gear.



### Moving up a steep grade from a standing start

To move up a steep grade from a standing start, depress the brake pedal, shift the shift lever to D (Drive). Select the appropriate gear depending on load weight and steepness of the grade, and release the parking brake. Depress the accelerator gradually while releasing the service brakes.

**When accelerating from a stop on a steep hill, the vehicle may have a tendency to roll backwards. Shifting the shift lever into 2 (Second Gear) while in Sports mode will help prevent the vehicle from rolling backwards.**

### Good driving practices

- Never move the gear selector lever from "P" or "N" to any other position with the accelerator pedal depressed.
- Never move the gear selector lever into "P" when the vehicle is in motion.
- Be sure the car is completely stopped before you attempt to shift into "R".
- Never take the car out of gear and coast down a hill. This may be extremely hazardous. Always leave the car in gear when moving.
- Do not "ride" the brakes. This can cause them to overheat and malfunction. Instead, when you are driving down a long hill, slow down and shift to a lower gear. When you do this, engine braking will help slow the car.
- Slow down before shifting to a lower gear. Otherwise, the lower gear may not be engaged.
- Always use the parking brake. Do not depend on placing the transaxle in "P" to keep the car from moving.
- Exercise extreme caution when driving on a slippery surface. Be especially careful when braking, accelerating or shifting gears. On a slippery surface, an abrupt change in vehicle speed can cause the drive wheels to lose traction and the vehicle to go out of control.

- Optimum vehicle performance and economy is obtained by smoothly depressing and releasing the accelerator pedal.

### WARNING

- **Always buckle-up! In a collision, an unbelted occupant is significantly more likely to be seriously injured or killed than a properly belted occupant.**
- **Avoid high speeds when cornering or turning.**
- **Do not make quick steering wheel movements, such as sharp lane changes or fast, sharp turns.**
- **The risk of rollover is greatly increased if you lose control of your vehicle at highway speeds.**
- **Loss of control often occurs if two or more wheels drop off the roadway and the driver oversteers to reenter the roadway.**
- **In the event your vehicle leaves the roadway, do not steer sharply. Instead, slow down before pulling back into the travel lanes.**
- **Never exceed posted speed limits.**

### **CAUTION**

*If your vehicle becomes stuck in snow, mud, sand, etc., then you may attempt to rock the vehicle free by moving it forward and backward. Do not attempt this procedure if people or objects are anywhere near the vehicle. During the rocking operation the vehicle may suddenly move forward or backward as it becomes unstuck, causing injury or damage to nearby people or objects.*

### **Shift lock system**

For your safety, the automatic transaxle has a shift lock system which prevents shifting the transaxle out of P (Park) unless the brake pedal is depressed.

To shift the transaxle out of P (Park):

1. Depress and hold the brake pedal.
2. Start the engine or turn the ignition to the ON position.
3. Depress the lock release button and move the shift lever.

If the brake pedal is repeatedly depressed and released with the shift lever in the P (Park) position, a chattering noise near the shift lever may be heard. This is a normal condition.

### **WARNING**

**Always fully depress the brake pedal before and while shifting out of the "P" Park position into another position to avoid inadvertent motion of the vehicle which could injure persons in or around the car.**



### **Shift-lock override**

If the shift lever cannot be moved from the P (Park) position with the brake pedal depressed, continue depressing the brake, then do the following:

1. Carefully remove the cap covering the shift-lock override access hole which is located on the right side of the shift lever.



2. Insert a screwdriver into the access hole and press down on the screwdriver.

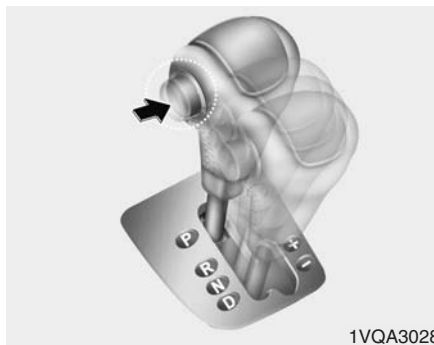

3. Depress the lock release button and move the shift lever.
4. Have your vehicle inspected by an authorized Hyundai dealership immediately.

### Ignition key interlock system

The ignition key cannot be removed unless the shift lever is in the P (Park) position. If the ignition switch is in any other position, the key cannot be removed.

## CRUISE CONTROL SYSTEM (IF EQUIPPED)

The cruise control system allows you to program the vehicle to maintain a constant speed without resting your foot on the accelerator pedal.

With cruise control, you can set and automatically maintain any speed of between 24 mph (40 km/h) and 96 mph (160 km/h).

### **⚠ WARNING - Cruise control**

**Do not use the cruise control feature under the following conditions:**

- Heavy or unsteady traffic
- Slippery or winding roads
- Situations that involve varying speeds



### **To set cruise control speed:**

1. Pull the CRUISE ON-OFF button on the steering wheel to turn the system on. The CRUISE indicator light in the instrument cluster will illuminate.
2. Accelerate to the desired speed, which must be more than 24 mph (40 km/h) and less than 96 mph (160 km/h).

### **⚠ WARNING**

**If the cruise control is left on, (CRUISE indicator light in the instrument cluster illuminated) the cruise control can be switched on accidentally. Keep the cruise control system off (CRUISE indicator light OFF) when the cruise control is not in use, to avoid inadvertently setting a speed.**



3. Push the COAST/SET switch, and release it at the desired speed. The SET indicator light in the instrument cluster will illuminate. Release the accelerator at the same time. The desired speed will automatically be maintained.

*The SET function cannot be activated until approximately 2 seconds after the CRUISE ON-OFF button has been engaged.*

*On a steep grade, the vehicle may momentarily slow down while going downhill.*



**To cancel cruise control, do one of the following:**

- Press the brake pedal.
- Shift into N (Neutral) with an automatic transaxle.
- Press the CANCEL switch located on the steering wheel.
- Press the COAST/SET and RES/ACCEL switches at the same time.

*Each of these actions will cancel cruise control operation (the SET indicator light in the instrument cluster will go OFF), but it will not turn the system off. If you wish to resume cruise control operation, push the RES/ACCEL switch located on your steering wheel. You will return to your previously preset speed.*

**To turn cruise control off, do one of the following:**

- Pull the CRUISE ON-OFF button (the CRUISE indicator light in the instrument cluster will go OFF).
- Turn the ignition off.

*Both of these actions cancel cruise control operation. If you want to resume cruise control operation, repeat the steps provided in "To Set Cruise Control Speed" on the previous page.*



**To increase cruise control set speed:**

Follow either of these procedures:

- Push the RES/ACCEL switch and hold it. Your vehicle will accelerate. Release the switch at the speed you want.
- Push the RES/ACCEL switch and release it immediately. The cruising speed will increase by 1 mph (1.6 km/h) each time the RES/ACCEL switch is operated in this manner.

**To temporarily accelerate with the cruise control on:**

If you want to speed up temporarily when the cruise control is on, depress the accelerator pedal. Increased speed will not interfere with cruise control operation or change the set speed.

To return to the set speed, take your foot off the accelerator.

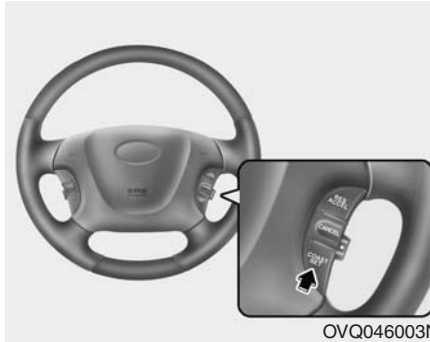

**To decrease the cruising speed:**

Follow either of these procedures:

- Push the COAST/SET switch and hold it. Your vehicle will gradually slow down. Release the switch at the speed you want to maintain.
- Push the COAST/SET switch and release it immediately. The cruising speed will decrease by 1 mph (1.6 km/h) each time the COAST/SET switch is operated in this manner.



**To resume cruising speed at more than 24 mph (40 km/h):**

If any method other than the CRUISE ON-OFF switch was used to cancel cruising speed and the system is still activated, the most recent set speed will automatically resume when the RES/ACCEL switch is pushed.

It will not resume, however, if the vehicle speed has dropped below 24 mph (40 km/h).

## BRAKE SYSTEM

### Power brakes

Your vehicle has power-assisted brakes that adjust automatically through normal usage.

In the event that the power-assisted brakes lose power because of a stalled engine or some other reason, you can still stop your vehicle by applying greater force to the brake pedal than you normally would. The stopping distance, however, will be longer.

When the engine is not running, the reserve brake power is partially depleted each time the brake pedal is applied. Do not pump the brake pedal when the power assist has been interrupted.

Pump the brake pedal only when necessary to maintain steering control on slippery surfaces.

### In the event of brake failure

If service brakes fail to operate while the vehicle is in motion, you can make an emergency stop with the parking brake. The stopping distance, however, will be much greater than normal.

**⚠ WARNING - Parking brake**  
Applying the parking brake while the vehicle is moving at normal speeds can cause a sudden loss of control of the vehicle. If you must use the parking brake to stop the vehicle, use great caution in applying the brake.

**⚠ WARNING - Brakes**

- Do not drive with your foot resting on the brake pedal. This will create abnormal high brake temperatures, excessive brake lining and pad wear, and increased stopping distances.

(Continued)

(Continued)

- When descending a long or steep hill, shift to a lower gear and avoid continuous application of the brakes. Continuous brake application will cause the brakes to overheat and could result in a temporary loss of braking performance.
- Wet brakes may result in the vehicle not slowing down at the usual rate and pulling to one side when the brakes are applied. Applying the brakes lightly will indicate whether they have been affected in this way. Always test your brakes in this fashion after driving through deep water. To dry the brakes, apply them lightly while maintaining a safe forward speed until brake performance returns to normal.

### Disc brakes wear indicator

Your vehicle has disc brakes.

When your brake pads are worn and new pads are required, you will hear a high-pitched warning sound from your front brakes or rear brakes (if equipped). You may hear this sound come and go or it may occur whenever you depress the brake pedal.

Please remember that some driving conditions or climates may cause a brake squeal when you first apply (or lightly apply) the brakes. This is normal and does not indicate a problem with your brakes.

#### CAUTION

*To avoid costly brake repairs, do not continue to drive with worn brake pads.*

#### CAUTION

*Always replace brake pads as complete front or rear axle sets.*

#### WARNING - Brake wear

**This brake wear warning sound means your vehicle needs service. If you ignore this audible warning, you will eventually lose braking performance, which could lead to a serious accident.**

### Parking on curbed streets

- When parking your vehicle on an uphill grade, park as close to the curb as possible and turn the front wheels away from the curb so that the front wheels will contact the curb if the vehicle moves backward.
- When parking your vehicle on a downhill grade, park as close to the curb as possible and turn the front wheels toward the curb so that the front wheels will contact the curb if the vehicle moves forward.



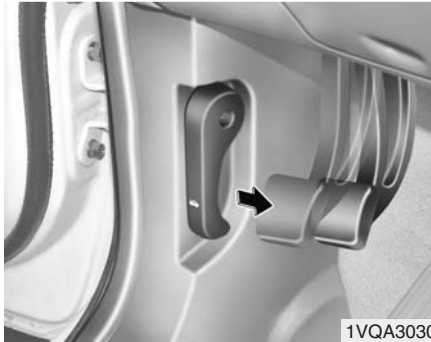

### Parking brake

To apply the parking brake, depress the parking brake pedal fully and firmly downward while applying the service brake.

#### **CAUTION**

*Driving with the parking brake applied will cause excessive brake pad and brake rotor wear.*

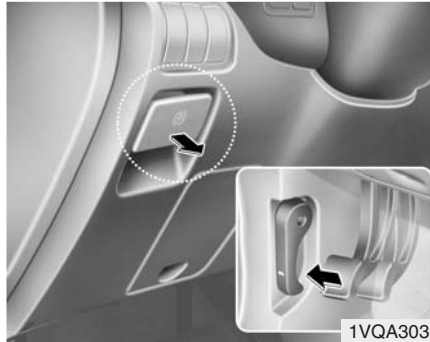

To release the parking brake, pull the parking brake release lever while applying the service brake. The pedal will automatically extend to the fully released position. If the parking brake pedal does not release or does not release all the way, have the system checked by an authorized Hyundai dealer.

#### **WARNING - Parking brake**

- To prevent unintentional movement when stopped and leaving the vehicle, do not use the gearshift lever in place of the parking brake. Set the parking brake AND make sure the gearshift lever is securely positioned in P (Park) for automatic transaxle equipped vehicles.
- Never allow a person who is unfamiliar with the vehicle or children to touch the parking brake. If the parking brake is released unintentionally, serious injury may occur.

#### **WARNING**

Whenever leaving vehicle or parking always set the parking brake as far as possible and fully engage the vehicle's transaxle into the park position. Vehicles not fully engaged in park with the parking brake set are at risk for moving inadvertently and injuring yourself or others.



Check the brake warning light by turning the ignition switch ON (do not start the engine). This light will be illuminated when the parking brake is applied with the ignition switch in the START or ON position.

Before driving, be sure the parking brake is fully released and the brake warning light is off.

If the brake warning light remains on after the parking brake is released, there may be a malfunction in the brake system. Immediate attention is necessary.

If at all possible, cease driving the vehicle immediately. If that is not possible, use extreme caution while operating the vehicle and only continue to drive the vehicle until you can reach a safe location or repair shop.

## Anti-lock brake system (ABS)

### **⚠ WARNING - ABS**

ABS (ESC) will not prevent accidents due to improper or dangerous driving maneuvers. Even though vehicle control is improved during emergency braking, always maintain a safe distance between you and objects ahead. **Vehicle speeds should always be reduced during extreme road conditions.**

**The braking distance for cars equipped with an anti-lock braking system (Electronic Stability Control System) may be longer than for those without it in the following road conditions.**

**During these conditions the vehicle should be driven at reduced speeds:**

- **Rough, gravel or snow-covered roads.**
- **With tire chains installed.**
- **On roads where the road surface is pitted or has different surface height.**

**(Continued)**

**(Continued)**

**The safety features of an ABS (ESC) equipped vehicle should not be tested by high speed driving or cornering. This could endanger the safety of yourself or others.**

The ABS continuously senses the speed of the wheels. If the wheels are going to lock, the ABS system repeatedly modulates the hydraulic brake pressure to the wheels.

When you apply your brakes under conditions which may lock the wheels, you may hear a “tik-tik” sound from the brakes, or feel a corresponding sensation in the brake pedal. This is normal and it means your ABS is active.

In order to obtain the maximum benefit from your ABS in an emergency situation, do not attempt to modulate your brake pressure and do not try to pump your brakes. Press your brake pedal as hard as possible or as hard as the situation warrants and allow the ABS to control the force being delivered to the brakes.

**\* NOTICE**

A click sound may be heard in the engine compartment when the vehicle begins to move after the engine is started. These conditions are normal and indicate that the anti-lock brake system is functioning properly.

- Even with the anti-lock brake system, your vehicle still requires sufficient stopping distance. Always maintain a safe distance from the vehicle in front of you.
- Always slow down when cornering. The anti-lock brake system cannot prevent accidents resulting from excessive speeds.
- On loose or uneven road surfaces, operation of the anti-lock brake system may result in a longer stopping distance than for vehicles equipped with a conventional brake system.

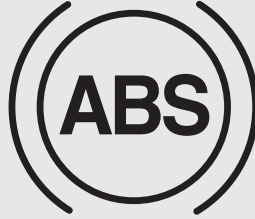

W-78

**CAUTION**

- *If the ABS warning light is on and stays on, you may have a problem with the ABS. In this case, however, your regular brakes will work normally.*
- *The ABS warning light will stay on for approximately 3 seconds after the ignition switch is ON. During that time, the ABS will go through self-diagnosis and the light will go off if everything is normal. If the light stays on, you may have a problem with your ABS. Contact an authorized Hyundai dealer as soon as possible.*

**CAUTION**

- *When you drive on a road having poor traction, such as an icy road, and operate your brakes continuously, the ABS will be active continuously and the ABS warning light may illuminate. Pull your car over to a safe place and stop the engine.*
- *Restart the engine. If the ABS warning light is off, then your ABS system is normal. Otherwise, you may have a problem with the ABS. Contact an authorized Hyundai dealer as soon as possible.*

**\* NOTICE**

When you jump start your vehicle because of a drained battery, the engine may not run as smoothly and the ABS warning light may turn on at the same time. This happens because of the low battery voltage. It does not mean your ABS is malfunctioning.

- Do not pump your brakes!
- Have the battery recharged before driving the vehicle.

**ELECTRONIC STABILITY CONTROL (ESC) (IF EQUIPPED)**

\* The location of the ESC OFF button may be different depending on your model.

**⚠ WARNING**

**Never drive too fast for the road conditions or too quickly when cornering. Electronic stability control (ESC) will not prevent accidents. Excessive speed in turns, abrupt maneuvers and hydroplaning on wet surfaces can still result in serious accidents. Only a safe and attentive driver can prevent accidents by avoiding maneuvers that cause the vehicle to lose traction. Even with ESC installed, always follow all the normal precautions for driving - including driving at safe speeds for the conditions.**

The Electronic Stability Control (ESC) system is designed to stabilize the vehicle during cornering maneuvers. ESC checks where you are steering and where the vehicle is actually going. ESC applies the brakes at individual wheels and intervenes in the engine management system to stabilize the vehicle.

The Electronic Stability Control (ESC) system is an electronic system designed to help the driver maintain vehicle control under adverse conditions. It is not a substitute for safe driving practices. Factors including speed, road conditions and driver steering input can all affect whether ESC will be effective in preventing a loss of control. It is still your responsibility to drive and corner at reasonable speeds and to leave a sufficient margin of safety.

**ESC operation****ESC ON condition**

- When the ignition is turned ON, ESC and ESC OFF indicator lights illuminate for approximately 3 seconds, then ESC is turned on.
- Press the ESC OFF button for at least half a second after turning the ignition ON to turn ESC off. (ESC OFF indicator will illuminate). To turn the ESC on, press the ESC OFF button (ESC OFF indicator light will go off).
- When starting the engine, you may hear a slight ticking sound. This is the ESC performing an automatic system self-check and does not indicate a problem.

**When operating****ESC**

When the ESC is in operation, ESC indicator light blinks.

- When the Electronic Stability Control is operating properly, you can feel a slight pulsation in the vehicle. This is only the effect of brake control and indicates nothing unusual.
- When moving out of the mud or slippery road, pressing the accelerator pedal may not cause the engine rpm (revolutions per minute) to increase.

**ESC operation off****ESC OFF state****ESC OFF**

- To cancel ESC operation, press the ESC OFF button (ESC OFF indicator light illuminates).
- If the ignition switch is turned to LOCK position when ESC is off, ESC remains off. Upon restarting the engine, the ESC will automatically turn on again.

- ESC indicator light (blinks)

**ESC**

- ESC OFF indicator light (comes on)

**ESC OFF****Indicator light**

When ignition switch is turned to ON, the indicator light illuminates, then goes off if ESC system is operating normally.

The ESC indicator light blinks whenever ESC is operating.

ESC OFF indicator light comes on when either the ESC is turned off with the button, or ESC fails to operate when turned on.

**CAUTION**

*Driving with varying tire or wheel sizes may cause the ESC system to malfunction. When replacing tires, make sure they are the same size as your original tires.*

**WARNING**

The Electronic Stability Control system is only a driving aid; use precautions for safe driving by slowing down on curved, snowy, or icy roads. Drive slowly and don't attempt to accelerate whenever the ESC indicator light is blinking, or when the road surface is slippery.

**ESC OFF usage**

*When driving*

- It's a good idea to keep the ESC turned on for daily driving whenever possible.
- To turn ESC off while driving, press the ESC OFF button while driving on a flat road surface.

Never press ESC OFF button while ESC is operating (ESC indicator light blinks). If ESC is turned off while ESC is operating, the vehicle may slip out of control.

**\* NOTICE**

A click sound may be heard in the engine compartment when the vehicle begins to move after the engine is started. These conditions are normal and indicate that the Electronic Stability Control System is functioning properly.

**\* NOTICE**

- When operating the vehicle on a dynamometer, ensure that the ESC is turned off (ESC OFF light illuminated). If the ESC is left on, it may prevent the vehicle speed from increasing, and result in false diagnosis.
- Turning the ESC off does not affect ABS or brake system operation.

**WARNING**

Never press the ESC OFF button while ESC is operating.

If the ESC is turned off while ESC is operating, the vehicle may go out of control.

To turn ESC off while driving, press the ESC OFF button while driving on a flat road surface.

## BACK WARNING SYSTEM (IF EQUIPPED)



OEP036098

The back warning system assists the driver during backward movement of the vehicle by chiming if any object is sensed within a distance of 47 in. (120 cm) behind the vehicle. This system is a supplemental system and it is not intended to nor does it replace the need for extreme care and attention of the driver. The sensing range and objects detectable by the back sensors are limited. Whenever backing-up, pay as much attention to what is behind you as you would in a vehicle without a back warning system.

### **⚠ WARNING**

**The Back Warning System is a supplementary function only. The operation of the Back Warning System can be affected by several factors (including environmental conditions). It is the responsibility of the driver to always check the area behind the vehicle before backing up.**

## Operation of the back warning system

### *Operating condition*

- This system will activate when backing up with the ignition key ON. If the vehicle is moving at a speed over 3 mph (5 km/h), the system may not be activated correctly.
- The sensing distance while the Back Warning System is in operation is approximately 47 in. (120 cm).
- When more than two objects are sensed at the same time, the closest one will be recognized first.

### *Types of warning sound*

- When an object is 47 in. to 32 in. (120 cm to 81 cm) from the rear bumper : Buzzer beeps intermittently
- When an object is 31 in. to 16 in. (80 cm to 41 cm) from the rear bumper : Buzzer beeps more frequently
- When an object is within 15 in. (40 cm) of the rear bumper : Buzzer sounds continuously.

### **Non-operational conditions of back warning system**

***The back warning system may not operate properly when:***

1. Moisture is frozen to the sensor. (It will operate normally when the moisture has been cleared.)
2. The sensor is covered with foreign matter, such as snow or water, or the sensor cover is blocked. (It will operate normally when the material is removed or the sensor is no longer blocked.)
3. Driving on uneven road surfaces (unpaved roads, gravel, bumps, gradient).
4. Objects generating excessive noise (vehicle horns, loud motorcycle engines, or truck air brakes) are within range of the sensor.
5. Heavy rain or water spray exists.
6. Wireless transmitters or mobile phones are within range of the sensor.
7. The sensor is covered with snow.
8. Trailer towing

***The detecting range may decrease when:***

1. The sensor is stained with foreign matter such as snow or water. (The sensing range will return to normal when removed.)
2. Outside air temperature is extremely hot or cold.

***The following objects may not be recognized by the sensor:***

1. Sharp or slim objects such as ropes, chains or small poles.
2. Objects which tend to absorb the sensor frequency such as clothes, spongy material or snow.
3. Undetectable objects smaller than 40 in. (1 m) and narrower than 6 in. (14 cm) in diameter.

### **CAUTION**

1. ***The back warning may not sound sequentially depending on the speed and shapes of the objects detected.***
2. ***The back warning system may malfunction if the vehicle bumper height or sensor installation has been modified or damaged. Any non-factory installed equipment or accessories may also interfere with the sensor performance.***
3. ***The sensor may not recognize objects less than 15 in. (40 cm) from the sensor, or it may sense an incorrect distance. Use caution.***
4. ***When the sensor is frozen or stained with snow, dirt, or water, the sensor may be inoperative until the stains are removed using a soft cloth.***
5. ***Do not push, scratch or strike the sensor. Sensor damage could occur.***



**⚠ CAUTION**

*This system can only sense objects within the range and location of the sensors; It can not detect objects in other areas where sensors are not installed. Also, small or slim objects, such as poles or objects located between sensors may not be detected by the sensors.*

*Always visually check behind the vehicle when backing up.*

*Be sure to inform any drivers of the vehicle that may be unfamiliar with the system regarding the systems capabilities and limitations.*

*Your new vehicle warranty does not cover any accidents or damage to the vehicle or its occupants due to a back warning system malfunction. Always drive safely and cautiously.*

**⚠ WARNING**

Pay close attention when the vehicle is driven close to objects on the road, particularly pedestrians, and especially children. Be aware that some objects may not be detected by the sensors, due to the object's distance, size or material, all of which can limit the effectiveness of the sensor. Always perform a visual inspection to make sure the vehicle is clear of all obstructions before moving the vehicle in any direction.

**\* NOTICE**

If you don't hear an audible warning sound or if the buzzer sounds intermittently when shifting the gear to "R" position, this may indicate a malfunction in the back warning system. If this occurs, have your vehicle checked by an authorized Hyundai dealer as soon as possible.

## GOOD BRAKING PRACTICES

### WARNING

**Whenever leaving vehicle or parking, always set the parking brake as far as possible and fully engage the vehicle's transaxle into the park position. Vehicles not fully engaged in park with the parking brake set are at risk for moving inadvertently and injuring yourself or others.**

### WARNING

**All vehicles should always have the parking brake fully engaged when parking to avoid inadvertent movement of the car which can injure occupants or pedestrians.**

- After being parked, check to be sure the parking brake is not engaged and that the parking brake indicator light is out before driving away.
- Driving through water may get the brakes wet. They can also get wet when the car is washed. Wet brakes can be dangerous! Your car will not stop as quickly if the brakes are wet. Wet brakes may cause the car to pull to one side.

To dry the brakes, apply the brakes lightly until the braking action returns to normal, taking care to keep the car under control at all times. If the braking action does not return to normal, stop as soon as it is safe to do so and call your Hyundai dealer for assistance.

- Don't coast down hills with the car out of gear. This is extremely hazardous. Keep the car in gear at all times, use the brakes to slow down, then shift to a lower gear so that engine braking will help you maintain a safe speed.
- Don't "ride" the brake pedal. Resting your foot on the brake pedal while driving can be dangerous because it can result in the brakes overheating and losing their effectiveness. It also increases the wear of the brake components.
- If a tire goes flat while you are driving, apply the brakes gently and keep the car pointed straight ahead while you slow down. When you are moving slowly enough for it to be safe to do so, pull off the road and stop in a safe place.
- If your car is equipped with an automatic transaxle, don't let your car creep forward. To avoid creeping forward, keep your foot firmly on the brake pedal when the car is stopped.
- Use caution when parking on a hill. Firmly engage the parking brake and place the gear selector lever in "P" (automatic transaxle) or in first or reverse gear (manual transaxle). If your car is facing downhill, turn the front wheels into the curb to help keep the car from rolling. If your car is facing uphill, turn the front wheels away from the curb to help keep the car from rolling. If there is no curb or if it is required by other conditions to keep the car from rolling, block the wheels.
- Under some conditions your parking brake can freeze in the engaged position. This is most likely to happen when there is an accumulation of snow or ice around or near the rear brakes or if the brakes are wet. If there is a risk that the parking brake may freeze, apply it only temporarily while you put the gear selector lever in "P" (automatic) or in first or reverse gear (manual transaxle) and block the rear wheels so the car cannot roll. Then release the parking brake.
- Do not hold the vehicle on the upgrade with the accelerator pedal. This can cause the transaxle to overheat. Always use the brake pedal or parking brake.

## ECONOMICAL OPERATION

Your vehicle's fuel economy depends mainly on your style of driving, where you drive and when you drive.

Each of these factors affects how many miles (kilometers) you can get from a gallon (liter) of fuel. To operate your vehicle as economically as possible, use the following driving suggestions to help save money in both fuel and repairs:

- Avoid lengthy warm-up idling. Once the engine is running smoothly, begin driving. Remember, engine warm-up may take a little longer on cold days.
- Save fuel by accelerating slowly after stopping.
- Keep the engine in tune and follow the recommended periodic maintenance schedule. This will increase the life of all parts and lower your operating costs.
- Do not use the air conditioner unnecessarily.
- Slow down when driving on rough roads.
- For longer tire life and better fuel economy, always keep the tires inflated to the recommended pressures.
- Maintain a safe distance from other vehicles to avoid sudden stops. This will reduce wear on brake linings and pads. Driving in such a way will also save fuel because extra fuel is required to accelerate back to driving speed.
- Do not carry unnecessary weight in the vehicle.
- Do not rest your foot on the brake pedal while driving. This can cause needless wear, possible damage to the brakes, and poor fuel economy.
- Improper wheel alignment results in faster tire wear and lower fuel economy.
- Open windows at high speeds can reduce fuel economy.
- Fuel economy is less in crosswinds and headwinds. To help offset some of this loss, slow down when driving in these conditions.

Keeping a vehicle in good operating condition is important both for economy and safety. Therefore, have an authorized Hyundai dealer perform scheduled inspections and maintenance.

### **WARNING - Engine off during motion**

**Never turn the engine off to coast down hills or anytime the vehicle is in motion. The power steering and power brakes will not function properly without the engine running. Instead, keep the engine on and downshift to an appropriate gear for engine braking effect. In addition, turning off the ignition while driving could engage the steering wheel lock resulting in loss of vehicle steering which could cause serious injury or death.**

## SPECIAL DRIVING CONDITIONS

### Hazardous driving conditions

When hazardous driving conditions are encountered such as water, snow, ice, mud, sand, or similar hazards, follow these suggestions:

- Drive cautiously and allow extra distance for braking.
- Avoid sudden movements in braking or steering.
- When braking with non-ABS brakes pump the brake pedal with a light up-and-down motion until the vehicle is stopped.

#### **WARNING - ABS**

**Do not pump the brake pedal on a vehicle equipped with ABS.**

- If stalled in snow, mud, or sand, use second gear. Accelerate slowly to avoid spinning the drive wheels.
- Use sand, rock salt, tire chains, or other non-slip material under the drive wheels to provide traction when stalled in ice, snow, or mud.

 **WARNING - Downshifting**  
**Downshifting with an automatic transaxle, while driving on slippery surfaces can cause an accident. The sudden change in tire speed could cause the tires to skid. Be careful when downshifting on slippery surfaces.**

### Rocking the vehicle

If it is necessary to rock the vehicle to free it from snow, sand, or mud, first turn the steering wheel right and left to clear the area around your front wheels. Then, shift back and forth between R (Reverse) and any forward gear in vehicles equipped with an automatic transaxle. Do not race the engine, and spin the wheels as little as possible. If you are still stuck after a few tries, have the vehicle pulled out by a tow vehicle to avoid engine overheating and possible damage to the transaxle.

#### **CAUTION**

*Prolonged rocking may cause engine over-heating, transaxle damage or failure, and tire damage.*

#### **WARNING - Spinning tires**

**Do not spin the wheels, especially at speeds more than 35 mph (56 km/h). Spinning the wheels at high speeds when the vehicle is stationary could cause a tire to overheat, explode and injure bystanders.**

#### **CAUTION**

*The ESC system (if equipped) should be turned OFF prior to rocking the vehicle.*

### Driving at night

Because night driving presents more hazards than driving in the daylight, here are some important tips to remember:

- Slow down and keep more distance between you and other vehicles, as it may be more difficult to see at night, especially in areas where there may not be any street lights.
- Adjust your mirrors to reduce the glare from other driver's headlights.
- Keep your headlights clean and properly aimed on vehicles not equipped with the automatic headlight aiming feature. Dirty or improperly aimed headlights will make it much more difficult to see at night.
- Avoid staring directly at the headlights of oncoming vehicles. You could be temporarily blinded, and it will take several seconds for your eyes to readjust to the darkness.

### Driving in the rain

Rain and wet roads can make driving dangerous, especially if you're not prepared for the slick pavement. Here are a few things to consider when driving in the rain:

- A heavy rainfall will make it harder to see and will increase the distance needed to stop your vehicle, so slow down.
- Keep your windshield wiping equipment in good shape. Replace your windshield wiper blades when they show signs of streaking or missing areas on the windshield.
- If your tires are not in good condition, making a quick stop on wet pavement can cause a skid and possibly lead to an accident. Be sure your tires are in good shape.
- Turn on your headlights to make it easier for others to see you.
- Driving too fast through large puddles can affect your brakes. If you must go through puddles, try to drive through them slowly.
- If you believe you may have gotten your brakes wet, apply them lightly while driving until normal braking operation returns.

### Driving in flooded areas

Avoid driving through flooded areas unless you are sure the water is no higher than the bottom of the wheel hub. Drive through any water slowly. Allow adequate stopping distance because brake performance may be affected.

After driving through water, dry the brakes by gently applying them several times while the vehicle is moving slowly.

## WINTER DRIVING

- We recommend that you carry emergency equipment, including tire chains, a window scraper, windshield de-icer, a bag of sand or salt, flares, a small shovel and jumper cables.
- Make sure you have sufficient ethylene-glycol coolant in the radiator.
- Check the battery condition and cables. Cold temperatures reduce the capacity of any battery, so it must be in excellent condition to provide enough winter starting power.
- Make sure the engine oil viscosity is suitable for cold weather.
- Check the ignition system for loose connections and damage.
- Use antifreeze-formulated windshield washer fluid. (Do not use engine coolant antifreeze.)
- Do not use the parking brake if it might freeze. When parking, shift to P (Park) with an automatic transaxle and block the rear wheels.

### Snow tires

If you mount snow tires on your Hyundai, make sure they are radial tires of the same size and load range as the original tires. Mount snow tires on all four wheels to balance your vehicle's handling in all weather conditions. Keep in mind that the traction provided by snow tires on dry roads may not be as high as your vehicle's original equipment tires. You should drive cautiously even when the roads are clear. Check with the tire dealer for maximum speed recommendations.

**⚠ WARNING - Snow tire size**  
**Snow tires should be equivalent in size and type to the vehicle's standard tires. Otherwise, the safety and handling of your vehicle may be adversely affected.**

*Do not install studded tires without first checking local, state and municipal regulations for possible restrictions against their use.*



### Tire chains

Since the sidewalls of radial tires are thinner, they can be damaged by mounting some types of snow chains on them. Therefore, the use of snow tires is recommended instead of snow chains. Do not mount tire chains on vehicles equipped with aluminum wheels; snow chains may cause damage to the wheels. If snow chains must be used, use wire-type chains with a thickness of less than 0.59 in (15 mm). Damage to your vehicle caused by improper snow chain use is not covered by your vehicle manufacturer's warranty.

Install tire chains only on the front tires.

**CAUTION**

- *Make sure the snow chains are the correct size and type for your tires. Incorrect snow chains can cause damage to the vehicle body and suspension and may not be covered by your vehicle manufacturer warranty. Also, the snow chain connecting hooks may be damaged from contacting vehicle components causing the snow chains to come loose from the tire. Make sure the snow chains are SAE class "S" certified.*
- *Always check chain installation for proper mounting after driving approximately 0.3 to 0.6 miles (0.5 to 1 km) to ensure safe mounting. Retighten or remount the chains if they are loose.*

**Chain installation**

When installing chains, follow the manufacturer's instructions and mount them as tightly as you can. Drive slowly with chains installed. If you hear the chains contacting the body or chassis, stop and tighten them. If they still make contact, slow down until it stops. Remove the chains as soon as you begin driving on cleared roads.

**WARNING****- Mounting chains**

When mounting snow chains, park the vehicle on level ground away from traffic. Turn on the vehicle Hazard Warning flashers and place a triangular emergency warning device behind the vehicle if available. Always place the vehicle in park (P), apply the parking brake and turn off the engine before installing snow chains.

**WARNING - Tire chains**

- **The use of chains may adversely affect vehicle handling.**
- **Do not exceed 20 mph (30 km/h) or the chain manufacturer's recommended speed limit, whichever is lower.**
- **Drive carefully and avoid bumps, holes, sharp turns, and other road hazards, which may cause the vehicle to bounce.**
- **Avoid sharp turns or locked-wheel braking.**
- **Chains that are the wrong size or improperly installed can damage your vehicle's brake lines, suspension, body and wheels.**
- **Stop driving and retighten the chains any time you hear them hitting the vehicle.**

## TRAILER TOWING

### **WARNING - Towing a trailer**

If you don't use the correct equipment and drive improperly, you can lose control when you pull a trailer. For example, if the trailer is too heavy, the brakes may not work well - or even at all. You and your passengers could be seriously or fatally injured. Pull a trailer only if you have followed all the steps in this section.

### **WARNING - Weight limits**

Before towing, make sure the total trailer weight, gross combination weight, gross vehicle weight, gross axle weight and trailer tongue load are all within the limits.

### **CAUTION**

*Pulling a trailer improperly can damage your vehicle and result in costly repairs not covered by your warranty. To pull a trailer correctly, follow the advice in this section.*

Your vehicle can tow a trailer. To identify what the vehicle trailering capacity is for your vehicle, you should read the information in "Weight of the Trailer" that appears later in this section.

Remember that trailering is different than just driving your vehicle by itself. Trailering means changes in handling, durability, and fuel economy. Successful, safe trailering requires correct equipment, and it has to be used properly.

This section contains many time-tested, important trailering tips and safety rules. Many of these are important for your safety and that of your passengers. Please read this section carefully before you pull a trailer.

Load-pulling components such as the engine, transaxle, wheel assemblies, and tires are forced to work harder against the load of the added weight. The engine is required to operate at relatively higher speeds and under greater loads. This additional burden generates extra heat. The trailer also adds considerably to wind resistance, increasing the pulling requirements.



### **Hitches**

It's important to have the correct hitch equipment. Crosswinds, large trucks going by, and rough roads are a few reasons why you'll need the right hitch. Here are some rules to follow:

- Will you have to make any holes in the body of your vehicle when you install a trailer hitch? If you do, then be sure to seal the holes later when you remove the hitch.  
If you don't seal them, deadly carbon monoxide (CO) from your exhaust can get into your vehicle, as well as dirt and water.
- The bumpers on your vehicle are not intended for hitches. Do not attach rental hitches or other bumper-type hitches to them. Use only a frame-mounted hitch that does not attach to the bumper.

### **Safety chains**

You should always attach chains between your vehicle and your trailer. Cross the safety chains under the tongue of the trailer so that the tongue will not drop to the road if it becomes separated from the hitch.

Instructions about safety chains may be provided by the hitch manufacturer or by the trailer manufacturer. Follow the manufacturer's recommendation for attaching safety chains. Always leave just enough slack so you can turn with your trailer. And, never allow safety chains to drag on the ground.

### **Trailer brakes**

If your trailer weighs more than the maximum trailer weight without trailer brakes loaded, then it needs its own brakes and they must be adequate. Be sure to read and follow the instructions for the trailer brakes so you'll be able to install, adjust and maintain them properly.

- Don't tap into your vehicle's brake system.



#### **WARNING - Trailer brakes**

**Do not use a trailer with its own brakes unless you are absolutely certain that you have properly set up the brake system. This is not a task for amateurs. Use an experienced, competent trailer shop for this work.**

### ***Driving with a trailer***

Towing a trailer requires a certain amount of experience. Before setting out for the open road, you must get to know your trailer. Acquaint yourself with the feel of handling and braking with the added weight of the trailer. And always keep in mind that the vehicle you are driving is now a good deal longer and not nearly so responsive as your vehicle is by itself.

Before you start, check the trailer hitch and platform, safety chains, electrical connector(s), lights, tires and mirror adjustment. If the trailer has electric brakes, start your vehicle and trailer moving and then apply the trailer brake controller by hand to be sure the brakes are working. This lets you check your electrical connection at the same time.

During your trip, check occasionally to be sure that the load is secure, and that the lights and any trailer brakes are still working.

### ***Following distance***

Stay at least twice as far behind the vehicle ahead as you would when driving your vehicle without a trailer. This can help you avoid situations that require heavy braking and sudden turns.

### ***Passing***

You'll need more passing distance up ahead when you're towing a trailer. And, because of the increased vehicle length, you'll need to go much farther beyond the passed vehicle before you can return to your lane.

### ***Backing up***

Hold the bottom of the steering wheel with one hand. Then, to move the trailer to the left, just move your hand to the left. To move the trailer to the right, move your hand to the right. Always back up slowly and, if possible, have someone guide you.

### ***Making turns***

When you're turning with a trailer, make wider turns than normal. Do this so your trailer won't strike soft shoulders, curbs, road signs, trees, or other objects. Avoid jerky or sudden maneuvers. Signal well in advance.

### ***Turn signals when towing a trailer***

When you tow a trailer, your vehicle has to have a different turn signal flasher and extra wiring. The green arrows on your instrument panel will flash whenever you signal a turn or lane change. Properly connected, the trailer lights will also flash to alert other drivers you're about to turn, change lanes, or stop.

When towing a trailer, the green arrows on your instrument panel will flash for turns even if the bulbs on the trailer are burned out. Thus, you may think drivers behind you are seeing your signals when, in fact, they are not. It's important to check occasionally to be sure the trailer bulbs are still working. You must also check the lights every time you disconnect and then reconnect the wires.

Do not connect a trailer lighting system directly to your vehicle's lighting system. Use only an approved trailer wiring harness.

Your Authorized Hyundai Dealer can assist you in installing the wiring harness.

### **WARNING**

**Failure to use an approved trailer wiring harness could result in damage to the vehicle electrical system and/or personal injury.**

***Driving on grades***

Reduce speed and shift to a lower gear before you start down a long or steep downgrade. If you don't shift down, you might have to use your brakes so much that they would get hot and no longer operate efficiently.

On a long uphill grade, shift down and reduce your speed to around 45 mph (70 km/h) to reduce the possibility of engine and transaxle overheating.

If your trailer weighs more than the maximum trailer weight without trailer brakes and you have an automatic transaxle, you should drive in D (Drive) when towing a trailer.

Operating your vehicle in D (Drive) when towing a trailer will minimize heat build up and extend the life of your transaxle.

***CAUTION***

- ***When towing a trailer on steep grades (in excess of 6%) pay close attention to the engine coolant temperature gauge to ensure the engine does not overheat. If the needle of the coolant temperature gauge moves across the dial towards "H" (HOT), pull over and stop as soon as it is safe to do so, and allow the engine to idle until it cools down. You may proceed once the engine has cooled sufficiently.***
- ***You must decide driving speed depending on trailer weight and uphill grade to reduce the possibility of engine and transaxle overheating.***

***Parking on hills***

Generally, you should not park your vehicle, with a trailer attached, on a hill. People can be seriously or fatally injured, and both your vehicle and the trailer can be damaged if they begin a downhill trajectory.

**WARNING - Parking on a hill**

**Parking your vehicle on a hill with a trailer attached could cause serious injury or death, should the trailer break lose.**

However, if you ever have to park your trailer on a hill, here's how to do it:

1. Apply your brakes, but don't shift into gear.
2. Have someone place chocks under the trailer wheels.
3. When the wheel chocks are in place, release the brakes until the chocks absorb the load.
4. Reapply the brakes. Apply your parking brake, and then shift to P (Park) for an automatic transaxle.
5. Release the brakes.

**⚠ WARNING - Parking brake**

**It can be dangerous to get out of your vehicle if the parking brake is not firmly set.**

**If you have left the engine running, the vehicle can move suddenly. You or others could be seriously or fatally injured.**

***When you are ready to leave after parking on a hill***

1. With the automatic transaxle in P (Park), apply your brakes and hold the brake pedal down while you:
  - Start your engine;
  - Shift into gear; and
  - Release the parking brake.
2. Slowly remove your foot from the brake pedal.
3. Drive slowly until the trailer is clear of the chocks.
4. Stop and have someone pick up and store the chocks.

**Maintenance when trailer towing**

Your vehicle will need service more often when you regularly pull a trailer. Important items to pay particular attention to include engine oil, automatic transaxle fluid, axle lubricant and cooling system fluid. Brake condition is another important item to frequently check. Each item is covered in this manual, and the Index will help you find them quickly. If you're trailering, it's a good idea to review these sections before you start your trip.

Don't forget to also maintain your trailer and hitch. Follow the maintenance schedule that accompanied your trailer and check it periodically. Preferably, conduct the check at the start of each day's driving. Most importantly, all hitch nuts and bolts should be tight.

**⚡ CAUTION**

- ***Due to higher load during trailer usage, overheating might occur in hot days or during uphill driving. If the coolant gauge indicates over-heating, switch off the A/C and stop the vehicle in a safe area to cool down the engine.***
- ***When towing check transaxle fluid more frequently.***
- ***If your vehicle is not equipped with the air conditioner, you should install a condenser fan to improve engine performance when towing a trailer.***

### If you do decide to pull a trailer

Here are some important points if you decide to pull a trailer:

- Consider using a sway control. You can ask a hitch dealer about sway control.
- Do not do any towing with your car during its first 1,200 miles (2,000 km) in order to allow the engine to properly break in. Failure to heed this caution may result in serious engine or transaxle damage.
- When towing a trailer, be sure to consult your Hyundai dealer for further information on additional requirements such as a towing kit, etc.
- Always drive your vehicle at a moderate speed (less than 60 mph (100 km/h)).
- On a long uphill grade, do not exceed 45 mph (70 km/h) or the posted towing speed limit, whichever is lower.
- The important considerations have to do with weight:

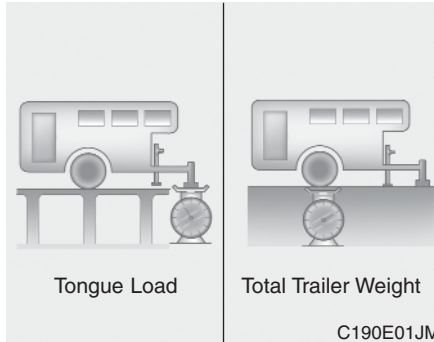

#### Weight of the trailer

How heavy can a trailer safely be? It should never weigh more than the maximum trailer weight with trailer brakes. But even that can be too heavy.

It depends on how you plan to use your trailer. For example, speed, altitude, road grades, outside temperature and how often your vehicle is used to pull a trailer are all important. The ideal trailer weight can also depend on any special equipment that you have on your vehicle.

	lbs. (kg)	
	Maximum Towable Weight Trailer	Tongue
With brake	3500 (1587)	350 (158)
Without brake	1000 (453)	

#### Weight of the trailer tongue

The tongue load of any trailer is an important weight to measure because it affects the total gross vehicle weight (GVW) of your vehicle. This weight includes the curb weight of the vehicle, any cargo you may carry in it, and the people who will be riding in the vehicle. And if you will tow a trailer, you must add the tongue load to the GVW because your vehicle will also be carrying that weight.

The trailer tongue should weigh a maximum of 10% of the total loaded trailer weight. After you've loaded your trailer, weigh the trailer and then the tongue, separately, to see if the weights are proper. If they aren't, you may be able to correct them simply by moving some items around in the trailer.

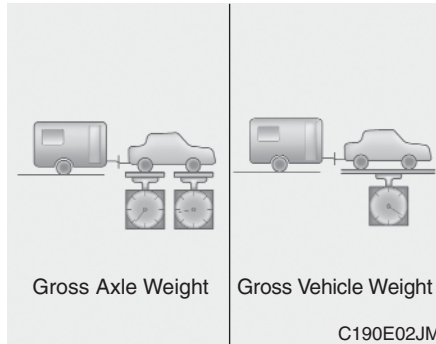

**(Continued)**

- Never exceed the maximum weight limits of the trailer or trailer towing equipment. Improper loading can result in damage to your vehicle and/or personal injury. Check weights and loading at a commercial scale or highway patrol office equipped with scales.
- An improperly loaded trailer can cause loss of vehicle control.

**⚠ WARNING - Trailer**

- Never load a trailer with more weight in the rear than in the front. The front should be loaded with approximately 60% of the total trailer load; the rear should be loaded with approximately 40% of the total trailer load.

**(Continued)**

## VEHICLE LOAD LIMIT

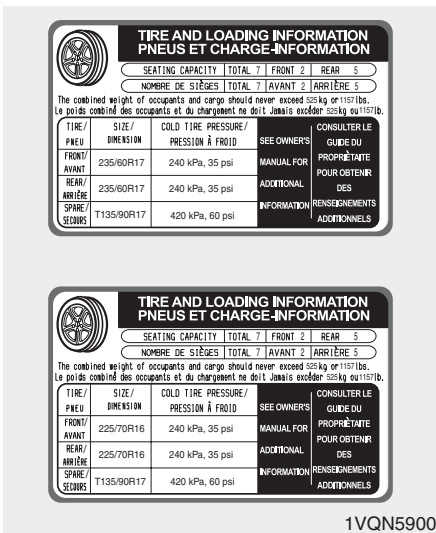

### Tire and loading information label

The label located on the driver's door sill gives the original tire size, cold tire pressures recommended for your vehicle, the number of people that can be in your vehicle and vehicle capacity weight.

### Vehicle capacity weight:

1157 lbs (525 kg)

Vehicle capacity weight is the maximum combined weight of occupants and cargo. If your vehicle is equipped with a trailer, the combined weight includes the tongue load.

### Seating capacity:

Total : 7 persons

(Front seat : 2 persons,  
Rear seat : 5 persons)

Seating capacity is the maximum number of occupants including a driver, your vehicle may carry. However the seating capacity may be reduced based upon the weight of all of the occupants, and the weight of the cargo being carried or towed.

Do not overload the vehicle as there is a limit to the total weight, or load limit including occupants and cargo, the vehicle can carry.

### Towing capacity:

Without trailer brakes:

1000 lbs (453 kg)

With trailer brakes:

3500 lbs (1587 kg)

Towing capacity is the maximum trailer weight including its cargo weight, your vehicle can tow.

### Cargo capacity:

The cargo capacity of your vehicle will increase or decrease depending on the weight and the number of occupants and the tongue load, if your vehicle is equipped with a trailer.

### Steps for determining correct load limit

1. Locate the statement "The combined weight of occupants and cargo should never exceed XXX kg or XXX lbs." on your vehicle's placard.
2. Determine the combined weight of the driver and passengers that will be riding in your vehicle.
3. Subtract the combined weight of the driver and passengers from XXX kg or XXX lbs.
4. The resulting figure equals the available amount of cargo and luggage load capacity. For example, if the "XXX" amount equals 1400 lbs. (635 kg), and there will be five 150 lbs. (68 kg) passengers in your vehicle, the amount of available cargo and luggage load capacity is 650 lbs. (295 kg).  
 $(1400 - 750 (5 \times 150)) = 650$  lbs. or  
 $635 - 340 (5 \times 68) = 295$  kg
5. Determine the combined weight of luggage and cargo being loaded on the vehicle. That weight may not safely exceed the available cargo and luggage load capacity calculated in Step 4.
6. If your vehicle will be towing a trailer, load from your trailer will be transferred to your vehicle. Consult this manual to determine how this reduces the available cargo and luggage load capacity of your vehicle.

#### Example 1

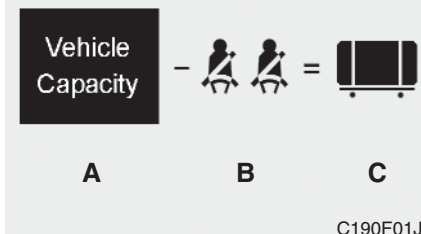

C190F01JM

Item	Description	Total
A	Vehicle Capacity Weight	1400 lbs (635 kg)
B	Subtract Occupant Weight 150 lbs (68 kg) × 2	300 lbs (136 kg)
C	Available Cargo and Luggage weight	1100 lbs (499 kg)



## Example 2

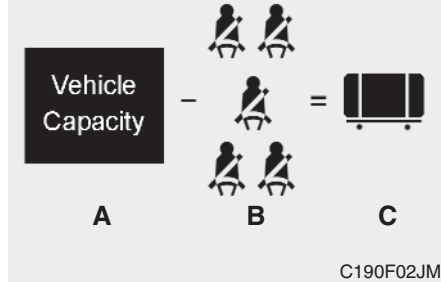

Item	Description	Total
A	Vehicle Capacity Weight	1400 lbs (635 kg)
B	Subtract Occupant Weight 150 lbs (68 kg) × 5	750 lbs (340 kg)
C	Available Cargo and Luggage weight	650 lbs (295 kg)

Refer to your vehicle's tire and loading information label for specific information about your vehicle's capacity weight and seating positions. The combined weight of the driver, passengers and cargo should never exceed your vehicle's capacity weight.

## Example 3

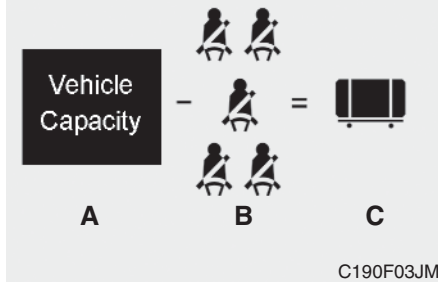

Item	Description	Total
A	Vehicle Capacity Weight	1400 lbs (635 kg)
B	Subtract Occupant Weight 172 lbs (78 kg) × 5	860 lbs (390 kg)
C	Available Cargo and Luggage weight	540 lbs (245 kg)



## Compliance label

The compliance label is located on the driver's door sill.

This label shows the maximum allowable weight of the fully loaded vehicle. This is called the GVWR (Gross Vehicle Weight Rating). The GVWR includes the weight of the vehicle, all occupants, fuel and cargo.

This label also tells you the maximum weight that can be supported by the front and rear axles, called Gross Axle Weight Rating (GAWR).

To find out the actual loads on your front and rear axles, you need to go to a weigh station and weigh your vehicle. Your dealer can help you with this. Be sure to spread out your load equally on both sides of the centerline.

### **WARNING - Over loading**

- Never exceed the GVWR for your vehicle, the GAWR for either the front or rear axle and vehicle capacity weight. Exceeding these ratings can cause an accident or vehicle damage. You can calculate the weight of your load by weighing the items (or people) before putting them in the vehicle. Be careful not to overload your vehicle.

(Continued)

### (Continued)

- Do not load your vehicle any heavier than the GVWR, either the maximum front or rear GAWR and vehicle capacity weight. If you do, parts, including tires on your vehicle can break, and it can change the way your vehicle handles and braking ability. This could cause you to lose control and crash. Also, overloading can shorten the life of your vehicle.

The label will help you decide how much cargo and installed equipment your vehicle can carry.

If you carry items inside your vehicle - like suitcases, tools, packages, or anything else - they are moving as fast as the vehicle. If you have to stop or turn quickly, or if there is a crash, the items will keep going and can cause an injury if they strike the driver or a passenger.

### **WARNING**

- Overloading your vehicle can cause heat buildup in your vehicle's tires and possible tire failure that could lead to a crash.
- Overloading your vehicle can cause increased stopping distances that could lead to a crash.
- A crash resulting from poor handling vehicle damage, tire failure, or increased stopping distances could result in serious injury or death.

**⚠ CAUTION**

- *Overloading your vehicle may cause damage. Repairs would not be covered by your warranty. Do not overload your vehicle.*
- *Using heavier suspension components to get added durability might not change your weight ratings. Ask your dealer to help you load your vehicle the right way.*

**⚠ WARNING - Loose cargo**

Items you carry inside your vehicle can strike and injure occupants in a sudden stop or turn, or in a crash.

- Put items in the cargo area of your vehicle. Try to spread the weight evenly.
- Never stack items, like suitcases, inside the vehicle above the tops of the seats.
- Do not leave an unsecured child restraint in your vehicle.
- When you carry something inside the vehicle, secure it.
- Do not drive with a seat folded down unless necessary.

## WEIGHT OF THE VEHICLE

This section will guide you in the proper loading of your vehicle and/or trailer, to keep your loaded vehicle weight within its design rating capability, with or without a trailer. Properly loading your vehicle will provide maximum return of the vehicle design performance. Before loading your vehicle, familiarize yourself with the following terms for determining your vehicle's weight ratings, with or without a trailer, from the vehicle's specifications and the compliance label:

### **Base curb weight**

This is the weight of the vehicle including a full tank of fuel and all standard equipment. It does not include passengers, cargo, or optional equipment.

### **Vehicle curb weight**

This is the weight of your new vehicle when you picked it up from your dealer plus any aftermarket equipment.

### **Cargo weight**

This figure includes all weight added to the Base Curb Weight, including cargo and optional equipment.

### **GAW (Gross axle weight)**

This is the total weight placed on each axle (front and rear) - including vehicle curb weight and all payload.

### **GAWR (Gross axle weight rating)**

This is the maximum allowable weight that can be carried by a single axle (front or rear). These numbers are shown on the compliance label. The total load on each axle must never exceed its GAWR.

### **GVW (Gross vehicle weight)**

This is the Base Curb Weight plus actual Cargo Weight plus passengers.

### **GVWR (Gross vehicle weight rating)**

This is the maximum allowable weight of the fully loaded vehicle (including all options, equipment, passengers and cargo). The GVWR is shown on the compliance label located on the driver's door sill.

**Road warning / 5-2**

**If the engine will not start / 5-2**

**Emergency starting / 5-3**

**If the engine overheats / 5-5**

**Tire pressure monitoring system (TPMS) / 5-6**

**If you have a flat tire / 5-10**

**Towing / 5-19**

**What to do in an emergency**

**5**

## ROAD WARNING

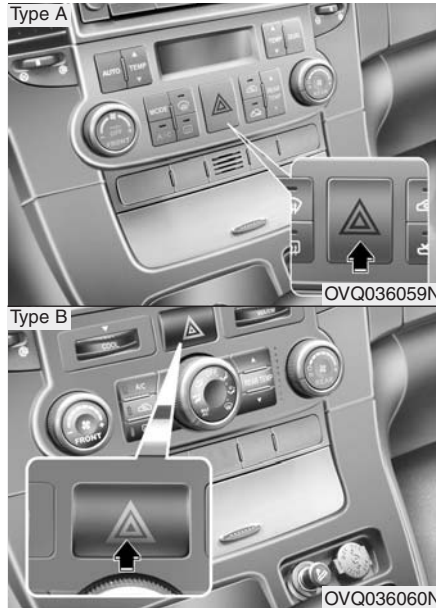

### Hazard warning flasher

The hazard warning flasher serves as a warning to other drivers to exercise extreme caution when approaching, overtaking, or passing your vehicle.

It should be used whenever emergency repairs are being made or when the vehicle is stopped near the edge of a roadway.

Depress the flasher switch with the ignition switch in any position. The flasher switch is located in the center console switch panel. All turn signal lights will flash simultaneously.

- The hazard warning flasher operates whether your vehicle is running or not.
- The turn signals do not work when the hazard flasher is on.
- Care must be taken when using the hazard warning flasher while the vehicle is being towed.

## IF THE ENGINE WILL NOT START

### **⚠ WARNING**

**If the engine will not start, do not push or pull the car to start it. This could result in a collision or cause other damage. In addition, push or pull starting may cause the catalytic converter to be overloaded and create a fire hazard.**

### **If engine doesn't turn over or turns over slowly**

1. If your car has an automatic transaxle, be sure the gear selector lever is in "N" or "P" and the emergency brake is set.
2. Check the battery connections to be sure they are clean and tight.
3. Turn on the interior light. If the light dims or goes out when you operate the starter, the battery is discharged.
4. Check the starter connections to be sure they are securely tightened.
5. Do not push or pull the vehicle to start it. See instructions for "Jump Starting".

**If engine turns over normally but does not start**

1. Check fuel level.
2. With the key in the "OFF" position, check all connectors at ignition, coil and spark plugs. Reconnect any that may be disconnected or loose.
3. Check the fuel line in the engine compartment.
4. If the engine still does not start, call a Hyundai dealer or seek other qualified assistance.

**If engine stalls while driving**

1. Reduce your speed gradually, keeping a straight line. Move cautiously off the road to a safe place.
2. Turn on your emergency flashers.
3. Try to start the engine again. If your vehicle will not start, contact a Hyundai dealer or seek other qualified assistance.

**EMERGENCY STARTING****Jump starting**

Jump starting can be dangerous if done incorrectly. Therefore, to avoid harm to yourself or damage to your vehicle or battery, follow the jump starting procedures. If in doubt, we strongly recommend that you have a competent technician or towing service jump start your vehicle.

** CAUTION**

*Use only a 12-volt jumper system. You can damage a 12-volt starting motor, ignition system, and other electrical parts beyond repair by use of a 24-volt power supply (either two 12-volt batteries in series or a 24-volt motor generator set).*

** WARNING - Battery**

**Never attempt to check the electrolyte level of the battery as this may cause the battery to rupture or explode causing serious injury.**

** WARNING - Battery**

- Keep all flames or sparks away from the battery. The battery produces hydrogen gas which may explode if exposed to flame or sparks.
- Do not attempt to jump start the vehicle if the discharged battery is frozen or if the electrolyte level is low; the battery may rupture or explode.

## Connecting jumper cables

Connect cables in numerical order and disconnect in reverse order.

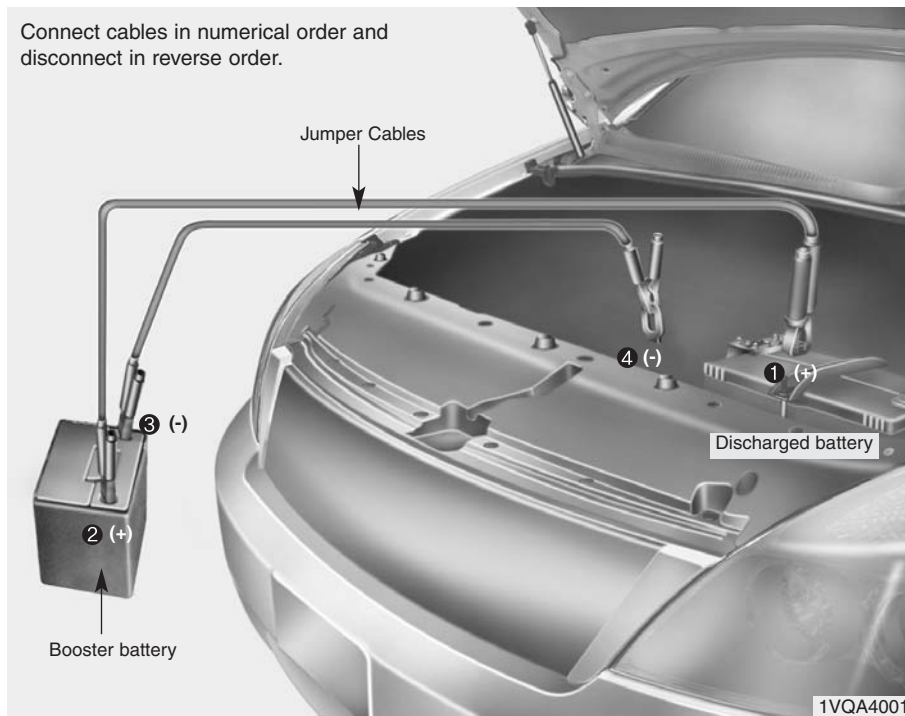

## Jump starting procedure

1. Make sure the booster battery is 12-volt and that its negative terminal is grounded.
2. If the booster battery is in another vehicle, do not allow the vehicles to touch.
3. Turn off all unnecessary electrical loads.
4. Connect the jumper cables in the exact sequence shown in the illustration. First connect one end of a jumper cable to the positive terminal of the discharged battery (1), then connect the other end to the positive terminal on the booster battery (2). Proceed to connect one end of the other jumper cable to the negative terminal of the booster battery (3), then the other end to a solid, stationary, metallic point (for example, the engine lifting bracket) away from the battery (4). Do not connect it to or near any part that moves when the engine is cranked.

Do not allow the jumper cables to contact anything except the correct battery terminals or the correct ground. Do not lean over the battery when making connections.



**⚠ CAUTION - Battery cables**  
*Do not connect the jumper cable from the negative terminal of the booster battery to the negative terminal of the discharged battery. This can cause the discharged battery to overheat and crack, releasing battery acid.*

5. Start the engine of the vehicle with the booster battery and let it run at 2,000 rpm, then start the engine of the vehicle with the discharged battery.

*If the cause of your battery discharging is not apparent, you should have your vehicle checked by an Authorized Hyundai Dealer.*

### Push-starting

Vehicles equipped with automatic transaxle cannot be push-started. Follow the directions in this section for jump-starting.

**⚠ CAUTION**  
*Never tow a vehicle to start it because the sudden surge forward when the engine starts could cause a collision with the tow vehicle.*

## IF THE ENGINE OVERHEATS

If your temperature gauge indicates overheating, if you experience a loss of power, or if you hear a loud knocking or pinging noise, the engine has probably overheated. Should any of these symptoms occur, use the following procedure:

1. Turn on the hazard warning flasher, then drive to the nearest safe location and stop your vehicle; set the automatic transaxle in P (Park) and apply the parking brake.
2. Make sure the air conditioner is off.
3. If coolant or steam is boiling out of the radiator, stop the engine and call an Authorized Hyundai Dealer for assistance.

If coolant is not boiling out, allow the engine to idle and open the hood to permit the engine to cool gradually.

If the temperature does not go down with the engine idling, stop the engine and allow sufficient time for it to cool.

4. The coolant level should then be checked. If the level in the reservoir is low, look for leaks at the radiator hoses and connections, heater hoses and connections, radiator, and water pump. If you find a major leak or another problem that may have caused the engine to overheat, do not operate the engine until it has been corrected. Call an Authorized Hyundai Dealer for assistance. If you do not find a leak or other problem, carefully add coolant to the reservoir.

*If the engine frequently overheats, have the cooling system checked and repaired by an Authorized Hyundai Dealer.*

**⚠ WARNING - Removing radiator cap**

**Do not remove the radiator cap when the engine and radiator are hot. Scalding hot coolant and steam may blow out under pressure. This could cause serious injury.**

## TIRE PRESSURE MONITORING SYSTEM (TPMS)

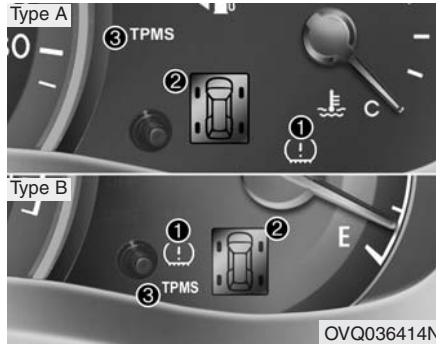

- (1) Low Tire Pressure Indicator
- (2) Low Tire Pressure Position Indicator
- (3) TPMS Malfunction Indicator

Each tire, including the spare, should be checked monthly when cold and inflated to the inflation pressure recommended by the vehicle manufacturer on the vehicle placard or tire inflation pressure label. (If your vehicle has tires of a different size than the size indicated on the vehicle placard or tire inflation pressure label, you should determine the proper tire inflation pressure for those tires.)

As an added safety feature, your vehicle has been equipped with a Tire Pressure Monitoring System (TPMS) that illuminates a low tire pressure indicator and a low tire pressure position indicator when one or more of your tires is significantly under-inflated. Accordingly, when the low tire pressure indicator and a low tire pressure position indicator illuminate, you should stop and check your tires as soon as possible, and inflate them to the proper pressure. Driving on a significantly under-inflated tire causes the tire to overheat and can lead to tire failure. Under-inflation also reduces fuel efficiency and tire tread life, and may affect the vehicle's handling and stopping ability.

Please note that the TPMS is not a substitute for proper tire maintenance, and it is the driver's responsibility to maintain correct tire pressure, even if under-inflation has not reached the level to trigger illumination of the TPMS low tire pressure and position indicators.

Your vehicle has also been equipped with a TPMS malfunction indicator to indicate when the system is not operating properly. The TPMS malfunction indicator is provided by a separate indicator, which displays the symbol "TPMS" when illuminated. When the malfunction indicator is illuminated, the system may not be able to detect or signal low tire pressure as intended. TPMS malfunctions may occur for a variety of reasons, including the installation of replacement or alternative tires or wheels on the vehicle that prevent the TPMS from functioning properly. Always check the TPMS malfunction indicator after replacing one or more tires or wheels on your vehicle to ensure that the replacement or alternative tires and wheels allow the TPMS to continue to function properly.

### Low tire pressure indicator



### Low tire pressure position indicator

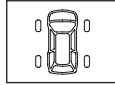

When the tire pressure monitoring system warning indicators are illuminated, one or more of your tires is significantly under-inflated. And the low tire pressure position indicator light will indicate which tire is significantly under-inflated by illuminating the corresponding position light.

Immediately reduce your speed, avoid hard cornering and anticipate increased stopping distances. You should stop and check your tires as soon as possible. Inflate the tires to the proper pressure as indicated on the vehicle's placard or tire inflation pressure label located on the driver's side center pillar outer panel. If you cannot reach a service station or if the tire cannot hold the newly added air, replace the low pressure tire with the compact spare tire.

The Low Tire Pressure and Position indicators will remain on when the low pressure tire is in the vehicle before you have the low pressure tire repaired and replaced on the vehicle. However, if the low pressure tire is not in the vehicle, the Low Tire Pressure and Position indicators will go off and the TPMS malfunction indicator will go on after a few minutes because the compact spare tire is not equipped with a tire pressure sensor.

### **CAUTION**

*In winter or cold weather, the low tire pressure indicator may be illuminated if the tire pressure was adjusted to the recommended tire inflation pressure in warm weather. It does not mean your TPMS is malfunctioning because the decreased temperature leads to a proportional lowering of tire pressure.*

*When you drive your vehicle from a warm area to a cold area or from a cold area to a warm area, or the outside temperature significantly increases or decreases, you should check the tire inflation pressure and adjust the tires to the recommended tire inflation pressure.*

**⚠ WARNING - Low tire pressure**

Significantly low tire pressure makes the vehicle unstable and can contribute to loss of vehicle control and increased braking distances.

Continued driving on low pressure tires will cause the tires to overheat and fail.

**TPMS (Tire pressure monitoring system) malfunction indicator**

**TPMS**

The TPMS malfunction indicator comes on and stays on when there is a problem with the Tire Pressure Monitoring System. If Front Left sensor fails, the TPMS malfunction indicator comes on, but if the Front Right, Rear Left, or Rear Right tire is under-inflated, the low tire pressure and position indicators may come on together with the TPMS malfunction indicator.

Have the system checked by an authorized Hyundai dealer as soon as possible to determine the cause of the problem.

**\* NOTICE**

- The TPMS malfunction indicator may be illuminated if the vehicle is moving around electric power supply cables or radio transmitters such as may be located at police stations, government and public offices, broadcasting stations, military installations, airports, or transmitting towers, etc. This can interfere with normal operation of the Tire Pressure Monitoring System (TPMS).
- The TPMS malfunction indicator may be illuminated if some electronic devices, such as notebook computers, are used in the vehicle. This can interfere with normal operation of the Tire Pressure Monitoring System (TPMS).

**Changing a tire with TPMS**

If you have a flat tire, the Low Tire Pressure and Position indicators will come on. Have the flat tire repaired by an authorized Hyundai dealer as soon as possible or replace the flat tire with the compact spare tire. NEVER use a puncture-repairing agent to repair and/or inflate a low pressure tire. If used, you will have to replace the tire pressure sensor.

Each wheel is equipped with a tire pressure sensor mounted inside the tire behind the valve stem. You must use TPMS specific wheels. It is recommended that you always have your tires serviced by an authorized Hyundai dealer as soon as possible.

Even if you replace the low pressure tire with the compact tire, the Low Tire Pressure and Position indicators will remain on when the low pressure tire is in the vehicle. However, if the low pressure tire is not in the vehicle, the Low Tire Pressure and Position indicators will go off and the TPMS malfunction indicator will go on after a few minutes because the compact spare tire does not have a sensor.

Once the low pressure tire is re-inflated to the recommended pressure and installed on the vehicle, the TPMS malfunction indicator and the low tire pressure and position indicators will extinguish within a few minutes.

If the indicators are not extinguished after a few minutes, please visit an authorized Hyundai dealer.

You may not be able identify a low pressure tire by simply looking at it. Always use a good quality tire pressure gauge to measure the tire's inflation pressure. Please note that a tire that is hot (from being driven) will have a higher pressure measurement than a tire that is cold (from sitting stationary for at least 3 hours and driven less than 1 mile (1.6km) during that 3 hour period). Allow the tire to cool before measuring the inflation pressure.

Always be sure the tire is cold before inflating to the recommended pressure.

A cold tire means the vehicle has been sitting for 3 hours and driven for less than 1 mile (1.6km) in that 3 hour period.

### \* NOTICE

Do not use any tire sealant if your vehicle is equipped with a Tire Pressure Monitoring System. The liquid sealant can damage the tire pressure sensors.

### WARNING - TPMS

- The TPMS cannot alert you to severe and sudden tire damage caused by external factors.
- If you feel any vehicle instability, immediately take your foot off the accelerator and slowly move to a safe position off the road.

### WARNING

Tampering with, modifying, or disabling the Tire Pressure Monitoring System (TPMS) components may interfere with the system's ability to warn the driver of low tire pressure conditions and/or TPMS malfunctions. Tampering with, modifying, or disabling the Tire Pressure Monitoring System (TPMS) components may void the warranty for that portion of the vehicle.

**This device complies with Part 15 of the FCC rules.** Operation is subject to the following two conditions:

1. This device may not cause harmful interference, and
2. This device must accept any interference received, including interference that may cause undesired operation.

### CAUTION

*Changes or modifications not expressly approved by the party responsible for compliance could void the user's authority to operate the equipment.*

## IF YOU HAVE A FLAT TIRE



The jack, jack handle, wheel lug nut wrench are stored in the luggage compartment. Remove the panel indicated in the illustration.



### Removing the spare tire

Your spare tire is stored underneath your vehicle, directly below the right sliding door.

1. Open the right sliding door and find the plastic hex bolt cover on the floor.
2. Remove the cover.

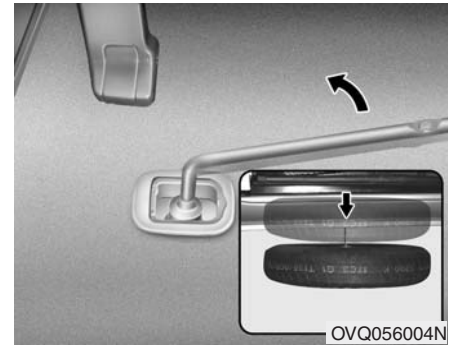

3. Use the wheel lug nut wrench to loosen the bolt enough to lower the spare tire.



4. Turn the wrench counterclockwise until the spare tire reaches the ground. After the spare tire reaches the ground, continue to turn the wrench counterclockwise, and draw the spare tire outside. Never rotate the wrench excessively, otherwise the spare tire carrier may be damaged.
5. Remove the retainer from the center of the spare tire.



### Storing the spare tire

1. Lay the tire on the ground with the valve stem facing down.
2. Place the wheel under the vehicle and install the retainer through the wheel center.
3. Turn the wrench clockwise until it clicks.

### **⚠ WARNING**

Ensure the spare tire retainer is properly aligned with the center of the spare tire to prevent the spare tire “rattling”. Otherwise, it may cause the spare tire to fall off the carrier and lead to an accident.

## Important - use of compact spare tire

Your vehicle is equipped with a compact spare tire. This compact spare tire takes up less space than a regular-size tire. This tire is smaller than a conventional tire and is designed for temporary use only.

### **CAUTION**

- *You should drive carefully when the compact spare is in use. The compact spare should be replaced by the proper conventional tire and rim at the first opportunity.*
- *The operation of this vehicle is not recommended with more than one compact spare tire in use at the same time.*

### **WARNING**

**This spare tire should be used only for VERY short distances. Compact spares should NEVER be used for long drives or extended distances.**

The compact spare should be inflated to 60 psi (420 kPa).

### **\* NOTICE**

Check the inflation pressure after installing the spare tire. Adjust it to the specified pressure, as necessary.

When using a compact spare tire, observe the following precautions:

- Under no circumstances should you exceed 50 mph (80 km/h); a higher speed could damage the tire.
- Ensure that you drive slowly enough for the road conditions to avoid all hazards. Any road hazard, such as a pothole or debris, could seriously damage the compact spare.
- Any continuous road use of this tire could result in tire failure, loss of vehicle control, and possible personal injury.
- Do not exceed the vehicle's maximum load rating or the load-carrying capacity shown on the sidewall of the compact spare tire.
- Avoid driving over obstacles. The compact spare tire diameter is smaller than the diameter of a conventional tire and reduces the ground clearance approximately 1 inch (25 mm), which could result in damage to the vehicle.



- Do not take this vehicle through an automatic car wash while the compact spare tire is installed.
- Do not use tire chains on the compact spare tire. Because of the smaller size, a tire chain will not fit properly. This could damage the vehicle and result in loss of the chain.
- The compact spare tire should not be installed on the front axle if the vehicle must be driven in snow or on ice.
- Do not use the compact spare tire on any other vehicle because this tire has been designed especially for your vehicle.
- The compact spare tire's tread life is shorter than a regular tire. Inspect your compact spare tire regularly and replace worn compact spare tires with the same size and design, mounted on the same wheel.



## Changing tires

### *Jacking instructions*

The jack is provided for emergency tire changing only.

To prevent the jack from “rattling” while the vehicle is in motion, lower the jack to the lowest position, place the jack in the luggage side trim and turn the wing bolt (1) clockwise firmly.

Make sure the jack is secured firmly by trying to move the jack forward and backward.

Follow jacking instructions to reduce the possibility of personal injury.

### **⚠ WARNING - Changing tires**

- **Never attempt vehicle repairs in the traffic lanes of a public road or highway.**
- **Always move the vehicle completely off the road and onto the shoulder before trying to change a tire. The jack should be used on level firm ground. If you cannot find a firm, level place off the road, call a towing service company for assistance.**
- **Be sure to use the correct front and rear jacking positions on the vehicle; never use the bumpers or any other part of the vehicle for jack support.**

**(Continued)**

(Continued)

- The vehicle can easily roll off the jack causing serious injury or death. No person should place any portion of their body under a vehicle that is supported only by a jack; use vehicle support stands.
- Do not start or run the engine while the vehicle is on the jack.
- Do not allow anyone to remain in the vehicle while it is on the jack.
- Make sure any children present are in a secure place away from the road and from the vehicle to be raised with the jack.

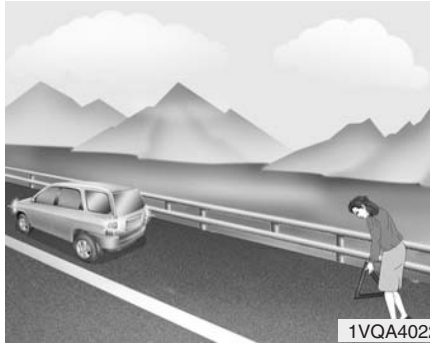

**Tire replacement**

1. Park on a level surface and apply the parking brake firmly.
2. Shift the automatic transaxle shift lever into P (Park).
3. Activate the hazard warning flasher.



4. Remove the wheel lug nut wrench, jack, jack handle, and spare tire from the vehicle.
5. Block both the front and rear of the wheel that is diagonally opposite the jack position.

**⚠ WARNING - Changing a tire**

- To prevent vehicle movement while changing a tire, always set the parking brake fully, and always block the wheel diagonally opposite the wheel being changed.
- We recommend that the wheels of the vehicle be chocked, and that no person remain in a vehicle that is being jacked.



OEP056027

6. Loosen the wheel lug nuts counterclockwise one turn each, but do not remove any nut until the tire has been raised off the ground.

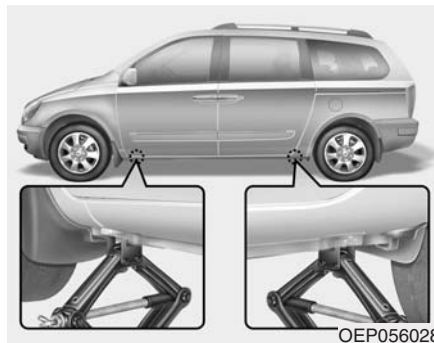

OEP056028

7. Place the jack at the front or rear jacking position closest to the tire you are changing. Place the jack at the designated locations under the frame. The jacking positions are plates welded to the frame with two tabs and a raised dot to index with the jack.

**⚠ WARNING - Jack location**

To reduce the possibility of injury, be sure to use only the jack provided with the vehicle and in the correct jack position; never use any other part of the vehicle for jack support.



8. Insert the jack handle into the jack and turn it clockwise, raising the vehicle until the tire just clears the ground. This measurement is approximately 1.2 in (30 mm). Before removing the wheel lug nuts, make sure the vehicle is stable and that there is no chance for movement or slippage.
9. Remove the wheel lug nuts by turning them counterclockwise, then remove the wheel.
10. Mount the spare tire into position and install the wheel lug nuts with the beveled edge inward.



11. Once the wheel lug nuts have been tightened, lower the vehicle fully to the ground and continue to tighten the lug nuts until they are fully secured. Tighten the wheel lug nuts firmly in a “ $\times$ ” pattern.  
If you are unsure of the tightness of the wheel lug nuts, have them checked at the nearest service station. The specified tightening torque is 65-79 lb•ft (9~11 kg•m, 88-107 N•m). Improperly tightened wheel lug nuts could cause brake pedal vibration while braking.

## **CAUTION**

*Your vehicle has metric threads on the wheel studs and nuts. Make certain during wheel removal that the same nuts removed are reinstalled - or, if replaced, that nuts with metric threads and the same chamfer configuration are used. Installation of a non-metric thread nut on a metric stud or vice-versa will not secure the wheel to the hub properly and will damage the stud so that it must be replaced.*

*Note that most lug nuts do not have metric threads. Be sure to use extreme care in checking for thread style before installing aftermarket lug nuts or wheels. If in doubt, consult an Authorized Hyundai Dealer.*

**⚠️ WARNING - Wheel studs**

If the studs are damaged, they may lose their ability to retain the wheel. This could lead to the loss of the wheel and a collision resulting in serious injuries.

To prevent the jack, jack handle, wheel lug nut wrench and spare tire from rattling while the vehicle is in motion, store them properly.

**⚠️ WARNING - Inadequate spare tire pressure**

Check the inflation pressures as soon as possible after installing the spare tire. Adjust it to the specified pressure, if necessary. Refer to Section 8, Specifications.

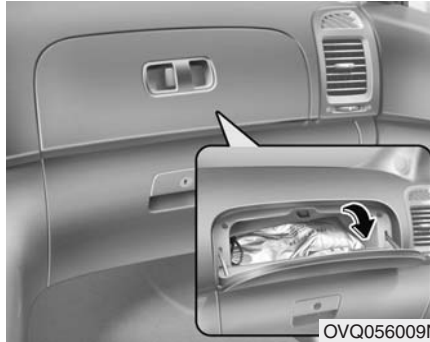

**Carrying a flat tire**

Do not store the flat tire on the compact spare tire carrier underneath your vehicle. The full size flat tire should be stored and fixed in the vehicle until you reach a service station.



***To place a flat tire in the vehicle:***

1. Put the flat tire into the cover with the valve stem facing up.

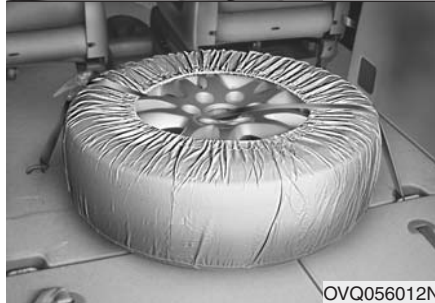

2. Place the flat tire in the cargo area when the 3rd row seat is upright position or on the floor when the 3rd row seat is stowed in the cargo area.

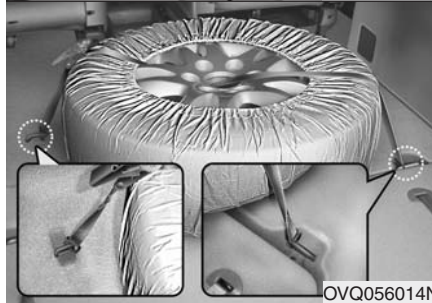
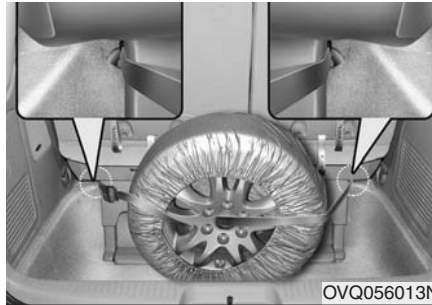

3. Pass one end of the strap through the wheel center and connect both strap hooks to each striker of the 3rd row seat on the floor.

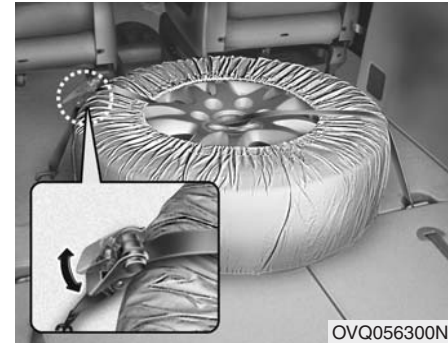

4. Tighten the strap firmly using the ratchet.
5. Make sure the flat tire is properly secured by trying to move it.

### **⚠ WARNING - Flat tire**

**Never leave the flat tire unsecured in the vehicle to prevent the tire “rattling”. Otherwise, the unsecured flat tire may be thrown about inside the vehicle which can cause damage to the vehicle and serious injury or death to the vehicle occupants in case of a sharp turn, a sudden stop or an accident.**

## TOWING

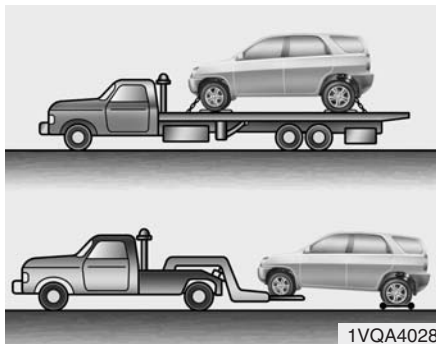

1VQA4028

If emergency towing is necessary, we recommend having it done by an authorized Hyundai dealer or a commercial tow-truck service. Proper lifting and towing procedures are necessary to prevent damage to the vehicle. The use of wheel dollies or flatbed is recommended.

*For trailer towing guidelines information, refer to section 4 "Driving your vehicle".*

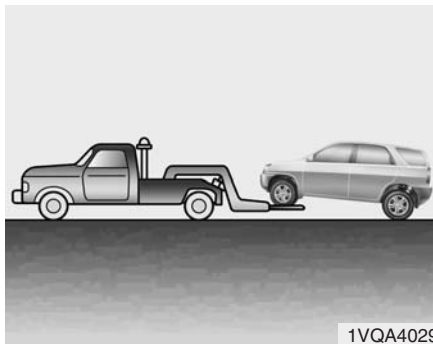

1VQA4029

It is acceptable to tow the vehicle with the rear wheels on the ground (without dollies) and the front wheels off the ground. When being towed by a commercial tow truck and wheel dollies are not used, the front of the vehicle should always be lifted, not the rear.



1VQA4030

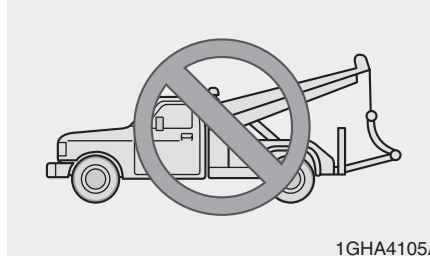

1GHA4105A

### **CAUTION**

- **Do not tow the vehicle backwards with the front wheels on the ground as this may cause damage to the vehicle.**
- **Do not tow with sling-type equipment. Use wheel lift or flatbed equipment.**

When towing your vehicle in an emergency without wheel dollies :

1. Set the ignition switch in the ACC position.
2. Place the transaxle shift lever in N (Neutral).
3. Release the parking brake.

### **CAUTION**

*Failure to place the transaxle shift lever in N (Neutral) may cause internal damage to the transaxle.*



### **If your car must be towed**

*Towing with a vehicle other than a tow truck*

**If towing is necessary, we recommend you to have it done by an Authorized Hyundai dealer or a commercial tow truck service.**

If towing service is not available in an emergency, your vehicle may be temporarily towed using a cable or chain secured to the emergency towing hook under the rear of the vehicle. Use extreme caution when towing the vehicle. A driver must be in the vehicle to steer it and operate the brakes.

Towing in this manner may be done only on hard-surfaced roads for a short distance and at low speeds. Also, the wheels, axles, power train, steering and brakes must all be in good condition.

- Do not use the tow hooks to pull a vehicle out of mud, sand or other conditions from which the vehicle cannot be driven out under its own power.
- Avoid towing a vehicle heavier than the vehicle doing the towing.
- The drivers of both vehicles should communicate with each other frequently.



**⚡ CAUTION**

- *Attach a towing strap to the tow hook.*
- *Using a portion of the vehicle other than the tow hooks for towing may damage the body of your vehicle.*
- *Use only a cable or chain specifically intended for use in towing vehicles. Securely fasten the cable or chain to the towing hook provided.*

- Before emergency towing, check that the hook is not broken or damaged.
- Fasten the towing cable or chain securely to the hook.
- Do not jerk the hook. Apply steady and even force.
- To avoid damaging the hook, do not pull from the side or at a vertical angle. Always pull straight ahead.

**⚠ WARNING**

Use extreme caution when towing the vehicle.

- Avoid sudden starts or erratic driving maneuvers which would place excessive stress on the emergency towing hook and towing cable or chain. The hook and towing cable or chain may break and cause serious injury or damage.
- If the disabled vehicle is unable to be moved, do not forcibly continue the towing. Contact an Authorized Hyundai dealer or a commercial tow truck service for assistance.
- Tow the vehicle as straight ahead as possible.
- Keep away from the vehicle during towing.

**⚡ CAUTION**

*To prevent internal damage to the transaxle, never tow your vehicle from the rear (backwards) with all four tires in contact with the surface.*

### Tips for towing a stuck vehicle

The following methods are effective when your vehicle is stuck in mud, sand or similar substances that prevent the vehicle from being driven out under its own power.

- Remove the soil and sand, etc. from the front and the back of the tires.
- Place a stone or wood under the tires.

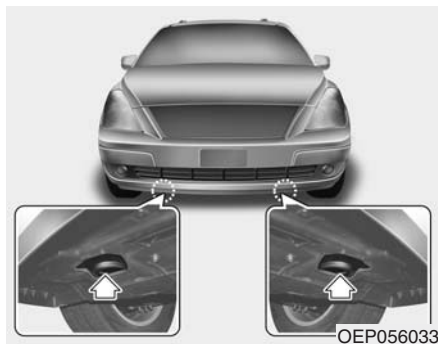

### Tie-down hook (for flatbed towing)

#### **⚠ WARNING**

Do not use the hooks under the front of the vehicle for towing purposes. These hooks are designed **ONLY** for transport tie-down. If the tie-down hooks are used for towing, the tie-down hooks or front bumper will be damaged and this could lead to serious injury.

**Maintenance services / 6-2**  
**Scheduled maintenance service / 6-2**  
**Explanation of scheduled maintenance items / 6-7**  
**Owner maintenance / 6-9**  
**Engine compartment / 6-11**  
**Engine oil / 6-12**  
**Engine coolant / 6-13**  
**Air cleaner / 6-15**  
**Automatic transaxle / 6-17**  
**Brakes / 6-19**  
**Lubricants and fluids / 6-20**  
**Power steering / 6-21**  
**Climate control air filter / 6-22**  
**Wiper blades / 6-24**  
**Fuses / 6-26**

## Maintenance

6

**Battery / 6-35**  
**Tires and wheels / 6-37**  
**Light bulbs replacement / 6-51**  
**Lubricant / 6-59**  
**Corrosion protection / 6-61**  
**Appearance care / 6-63**  
**Emission control system / 6-66**

## MAINTENANCE SERVICES

You should exercise the utmost care to prevent damage to your vehicle and injury to yourself whenever performing any maintenance or inspection procedures.

Should you have any doubts concerning the inspection or servicing of your vehicle, we strongly recommend that you have an Authorized Hyundai Dealer perform this work.

An Authorized Hyundai Dealer has factory-trained technicians and genuine Hyundai parts to service your vehicle properly. For expert advice and quality service, see an Authorized Hyundai Dealer.

Inadequate, incomplete or insufficient servicing may result in operational problems with your vehicle that could lead to vehicle damage, an accident, or personal injury.

### Owner's responsibility

#### **Maintenance Service and Record Retention are the owner's responsibility.**

You should retain documents that show proper maintenance has been performed on your vehicle in accordance with the scheduled maintenance service charts shown on the following pages. You need this information to establish your compliance with the servicing and maintenance requirements of your Hyundai warranties. Detailed warranty information is provided in your Owner's Handbook & Warranty Information booklet.

Repairs and adjustments required as a result of improper maintenance or a lack of required maintenance are not covered. We recommend you have your vehicle maintained and repaired by an authorized Hyundai dealer.

An authorized Hyundai dealer meets Hyundai's high service quality standards and receives technical support from Hyundai in order to provide you with a high level of service satisfaction.

## SCHEDULED MAINTENANCE SERVICE

If none of the following conditions are applicable, then use Schedule 1 – Normal Maintenance.

- Repeated short distance driving.
- Driving in dusty conditions or sandy areas.
- Extensive use of brakes.
- Driving in areas where salt or other corrosive materials are being used.
- Driving on rough or muddy roads.
- Driving in mountainous areas.
- Extended periods of idling or low speed operation.
- Driving for a prolonged period in cold temperatures and/or extremely humid climates.
- More than 50% driving in heavy city traffic during hot weather above 90°F (32°C).

However, if any of the preceding conditions apply, follow Schedule 2 – Severe Maintenance.

*After 120 months or 150,000 miles (240,000 km) continue to follow the prescribed maintenance intervals.*

## NORMAL MAINTENANCE SCHEDULE

The following maintenance services must be performed to ensure good emission control and performance. Keep receipts for all vehicle emission services to protect your warranty. Where both mileage and time are shown, the frequency of service is determined by whichever occurs first.

R : Replace

I : Inspect and, after Inspection, clean, adjust, repair or replace if necessary.

No.	DESCRIPTION	MILES X 1000	7.5	15	22.5	30	37.5	45	52.5	60	67.5	75	82.5	90	97.5	105	112.5	120	127.5	135	142.5	150
		KILOMETERS X 1000	12	24	36	48	60	72	84	96	108	120	132	144	156	168	180	192	204	216	228	240
		MONTHS	6	12	18	24	30	36	42	48	54	60	66	72	78	84	90	96	102	108	114	120
EMISSION CONTROL ITEMS																						
1	ENGINE OIL AND FILTER	R	R	R	R	R	R	R	R	R	R	R	R	R	R	R	R	R	R	R	R	R
2	FUEL FILTER					R						R					R					R
3	FUEL LINES, FUEL HOSES AND CONNECTIONS	I	I	I	I	I	I	I	I	I	I	I	I	I	I	I	I	I	I	I	I	I
4	VACUUM HOSE	I	I	I	I	I	I	I	I	I	I	I	I	I	I	I	I	I	I	I	I	I
5	CRANKCASE VENTILATION HOSE				I					I				I				I				I
6	VAPOR HOSE AND FUEL FILLER CAP	I	I	I	I	I	I	I	I	I	I	I	I	I	I	I	I	I	I	I	I	I
7	AIR CLEANER FILTER		I		R		I		R		I		R		I		R		I		R	
8	SPARK PLUGS (IRIDIUM COATED)														R							
9	VALVE CLEARANCE									I								I				
10	FUEL TANK AIR FILTER		I		R		I		R		I		R		I		R		I		R	
11	ELECTRONIC THROTTLE CONTROL		I		I		I		I		I		I		I		I		I		I	

R : Replace

I : Inspect and, after inspection, clean, adjust, repair or replace if necessary

No.	DESCRIPTION	MILES X 1000	7.5	15	22.5	30	37.5	45	52.5	60	67.5	75	82.5	90	97.5	105	112.5	120	127.5	135	142.5	150
		KILOMETERS X 1000	12	24	36	48	60	72	84	96	108	120	132	144	156	168	180	192	204	216	228	240
		MONTHS	6	12	18	24	30	36	42	48	54	60	66	72	78	84	90	96	102	108	114	120
GENERAL ITEMS																						
1	DRIVE BELT (AUTO-TENSIONER, ALT, P/STR'G, A/CON, W/PUMP)				I					I				I				I				I
2	COOLANT	See Note *1																				
3	AUTOMATIC TRANSAXLE FLUID		I		I		I		I		I		I		R		I		I		I	
4	BRAKE FLUID				I				I				I				I					I
5	BRAKE HOSES AND LINES		I		I		I		I		I		I		I		I		I		I	
6	REAR DISC BRAKE/LININGS, PARKING BRAKE				I				I				I				I					I
7	BRAKE PADS, CALIPERS AND ROTORS		I		I		I		I		I		I		I		I		I		I	

Note:

- \*1. FOR THE FIRST TIME, REPLACE THE COOLANT AT 60,000 MILES (96,000 KM) OR 60 MONTHS.  
AFTER THAT, REPLACE IT EVERY 30,000 MILES (48,000 KM) OR 24 MONTHS.

R : Replace

I : Inspect and, after inspection, clean, adjust, repair or replace if necessary

No.	DESCRIPTION	MILES X 1000	7.5	15	22.5	30	37.5	45	52.5	60	67.5	75	82.5	90	97.5	105	112.5	120	127.5	135	142.5	150	
		KILOMETERS X 1000	12	24	36	48	60	72	84	96	108	120	132	144	156	168	180	192	204	216	228	240	
		MONTHS	6	12	18	24	30	36	42	48	54	60	66	72	78	84	90	96	102	108	114	120	
GENERAL ITEMS																							
8	EXHAUST PIPE AND MUFFLER		I		I		I		I		I		I		I		I		I		I		I
9	SUSPENSION MOUNTING BOLTS		I	I	I	I	I	I	I	I	I	I	I	I	I	I	I	I	I	I	I	I	I
10	STEERING GEAR BOX, LINKAGE & BOOTS /LOWER ARM BALL JOINT, UPPER ARM BALL JOINT		I	I	I	I	I	I	I	I	I	I	I	I	I	I	I	I	I	I	I	I	I
11	POWER STEERING PUMP, BELT AND HOSES		I		I		I		I		I		I		I		I		I		I		I
12	DRIVE SHAFTS AND BOOTS		I		I		I		I		I		I		I		I		I		I		I
13	AIR CONDITIONING REFRIGERANT		I		I		I		I		I		I		I		I		I		I		I
14	CLIMATE CONTROL AIR FILTER (FOR EVAPORATOR AND BLOWER UNIT)	See Note *2																					

Note:

\*2. FOR EVERY 12 MONTHS OR 10,000 MILES (15,000 KM), WHICHEVER OCCURS FIRST : "R"

## MAINTENANCE UNDER SEVERE USAGE CONDITIONS

The following items must be serviced more frequently on cars normally used under severe driving conditions. Refer to the chart below for the appropriate maintenance intervals.

R : Replace

I : Inspect and, after inspection, clean, adjust, repair or replace if necessary

MAINTENANCE ITEM	MAINTENANCE OPERATION	MAINTENANCE INTERVALS	DRIVING CONDITION
ENGINE OIL AND FILTER	R	EVERY 3,000 MILES (4,800 KM) OR 3 MONTHS	A, B, C, D, E, F, G, H, I, K
AIR CLEANER FILTER	I	MORE FREQUENTLY	C, E
SPARK PLUGS	I	MORE FREQUENTLY	B, H
BRAKE PADS, CALIPERS AND ROTORS	I	MORE FREQUENTLY	C, D, G, H
REAR DISC BRAKE/LININGS, PARKING BRAKE	I	MORE FREQUENTLY	C, D, G, H
STEERING GEAR BOX, LINKAGE & BOOTS/ LOWER ARM BALL JOINT, UPPER ARM BALL JOINT	I	MORE FREQUENTLY	C, D, E, F, G, H, I
DRIVE SHAFTS AND BOOTS	I	EVERY 7,500 MILES (12,000 KM) OR 6 MONTHS	C, D, E, F, H
AUTOMATIC TRANSAXLE FLUID	R	EVERY 30,000 MILES (48,000 KM)	A, C, E, F, G, H, I
CLIMATE CONTROL AIR FILTER (FOR EVAPORATOR AND BLOWER UNIT)	R	MORE FREQUENTLY	C, E

### SEVERE DRIVING CONDITIONS

- A - Repeatedly driving short distance of less than 5miles (8km) in normal temperature or less than 10miles (16km) in freezing temperature
- B - Extensive engine idling or low speed driving for long distances
- C - Driving on rough, dusty, muddy, unpaved, graveled or salt- spread roads
- D - Driving in areas using salt or other corrosive materials or in very cold weather

- E - Driving in sandy areas
- F - Driving in heavy traffic area over 90°F (32°C)
- G - Driving on uphill, downhill, or mountain road
- H - Towing a Trailer, or using a camper, or roof rack
- I - Driving as a patrol car, taxi, other commercial use or vehicle towing
- J - Driving over 100 MPH (170 Km/h)
- K - Frequently driving in stop-and-go conditions



## EXPLANATION OF SCHEDULED MAINTENANCE ITEMS

### Engine oil and filter

The engine oil and filter should be changed at the intervals specified in the maintenance schedule. If the car is being driven in severe conditions, more frequent oil and filter changes are required.

### Fuel filter

A clogged filter can limit the speed at which the vehicle may be driven, damage the emission system and cause hard starting. If an excessive amount of foreign matter accumulates in the fuel tank, the filter may require replacement more frequently.

After installing a new filter, run the engine for several minutes, and check for leaks at the connections. Fuel filters should be installed by trained technicians.

### Drive belts

Inspect all drive belts for evidence of cuts, cracks, excessive wear or oil saturation and replace if necessary. Drive belts should be checked periodically for proper tension.

### Fuel lines, fuel hoses and connections

Check the fuel lines, fuel hoses and connections for leakage and damage. Have a trained technician replace any damaged or leaking parts immediately.

### Vacuum, crankcase ventilation hoses

Inspect the surface of hoses for evidence of heat and/or mechanical damage. Hard and brittle rubber, cracking, tears, cuts, abrasions, and excessive swelling indicate deterioration. Particular attention should be paid to examine those hose surfaces nearest to high heat sources, such as the exhaust manifold.

Inspect the hose routing to assure that the hoses do not come in contact with any heat source, sharp edges or moving component which might cause heat damage or mechanical wear. Inspect all hose connections, such as clamps and couplings, to make sure they are secure, and that no leaks are present. Hoses should be replaced immediately if there is any evidence of deterioration or damage.

### Vapor hose and fuel filler cap

The vapor hose and fuel filler cap should be inspected at those intervals specified in the maintenance schedule. Make sure that a new vapor hose or fuel filler cap is correctly replaced.

### Air cleaner filter

A Genuine Hyundai air cleaner filter is recommended when the filter is replaced.

### Spark plugs

Make sure to install new spark plugs of the correct heat range.

### Valve clearance

Inspect excessive valve noise and/or engine vibration and adjust if necessary. A qualified technician should perform the operation.

### Coolant

The coolant should be changed at the intervals specified in the maintenance schedule.

### **Automatic transaxle fluid**

The fluid level should be in the "HOT" range of the dipstick, after the engine and transaxle are at normal operating temperature. Check the automatic transaxle fluid level with the engine running and the transaxle in neutral, with the parking brake properly applied. Use HYUNDAI GENUINE ATF SP-III, DIAMOND ATF SP-III, SK ATF SP-III or other brands meeting the SP III specification approved by Hyundai Motor Co. when adding or changing fluid. Using the wrong ATF may result in damage to the ATM.

### **Brake hoses and lines**

Visually check for proper installation, chafing, cracks, deterioration and any leakage. Replace any deteriorated or damaged parts immediately.

### **Brake fluid**

Check brake fluid level in the brake fluid reservoir. The level should be between "MIN" and "MAX" marks on the side of the reservoir. Use only hydraulic brake fluid conforming to DOT 3 or DOT 4.

### **Rear disc brake / linings, parking brake**

Check the rear disc brake and linings for scoring, burning, leaking fluid, broken parts, and excessive wear. Inspect the parking brake system including the parking brake pedal and cables. For detailed service procedures, refer to the Shop Manual.

### **Brake pads, calipers and rotors**

Check the pads for excessive wear, discs for run out and wear, and calipers for fluid leakage.

### **Exhaust pipe and muffler**

Visually inspect the exhaust pipes, muffler and hangers for cracks, deterioration, or damage. Start the engine and listen carefully for any exhaust gas leakage. Tighten connections or replace parts as necessary.

### **Suspension mounting bolts**

Check the suspension connections for looseness or damage. Retighten to the specified torque.

### **Steering gear box, linkage & boots/lower arm ball joint, upper arm ball joint**

With the vehicle stopped and engine off, check for excessive free-play in the steering wheel. Check the linkage for bends or damage. Check the dust boots and ball joints for deterioration, cracks, or damage. Replace any damaged parts.

### **Power steering pump, belt and hoses**

Check the power steering pump and hoses for leakage and damage. Replace any damaged or leaking parts immediately. Inspect the power steering belt (or drive belt) for evidence of cuts, cracks, excessive wear, oiliness and proper tension. Replace or adjust it if necessary.

### **Drive shafts and boots**

Check the drive shafts, boots and clamps for cracks, deterioration, or damage. Replace any damaged parts and, if necessary, repack the grease.

### **Air conditioning refrigerant**

Check the air conditioning lines and connections for leakage and damage. Check air conditioning performance according to the relevant shop manual if necessary.

## OWNER MAINTENANCE

### Owner maintenance schedule

The following lists are vehicle checks and inspections that should be performed by the owner or an Authorized Hyundai Dealer at the frequencies indicated to help ensure safe, dependable operation of your vehicle.

Any adverse conditions should be brought to the attention of your dealer as soon as possible.

These Owner Maintenance Checks are generally not covered by warranties and you may be charged for labor, parts and lubricants used.

#### *When you stop for fuel:*

- Check the engine oil level.
- Check coolant level in coolant reservoir.

#### **WARNING**

**Be careful when checking your engine coolant level when the engine is hot. Scalding hot coolant and steam may blow out under pressure. This could cause burns or other serious injury.**

- Check the windshield washer fluid level.
- Look for low or under-inflated tires.

#### *While operating your vehicle:*

- Note any changes in the sound of the exhaust or any smell of exhaust fumes in the vehicle.
- Check for vibrations in the steering wheel. Notice any increased steering effort or looseness in the steering wheel, or change in its straight-ahead position.
- Notice if your vehicle constantly turns slightly or “pulls” to one side when traveling on smooth, level roads.
- When stopping, listen and check for unusual sounds, pulling to one side, increased brake pedal travel or “hard-to-push” brake pedal.
- If any slipping or changes in the operation of your transaxle occurs, check the transaxle fluid level.
- Check automatic transaxle P (Park) function.
- Check parking brake.
- Check for fluid leaks under your vehicle (water dripping from the air conditioning system during or after use is normal).

#### *At least monthly:*

- Check coolant level in the coolant recovery reservoir.
- Check the operation of all exterior lights, including the stoplights, turn signals and hazard warning flashers.
- Check the inflation pressures of all tires including the spare.

#### *At least twice a year (i.e., every Spring and Fall):*

- Check radiator, heater and air conditioning hoses for leaks or damage.
- Check windshield washer spray and wiper operation. Clean wiper blades with clean cloth dampened with washer fluid.
- Check headlight alignment.
- Check muffler, exhaust pipes, shields and clamps.
- Check the lap/shoulder belts for wear and function.
- Check for worn tires and loose wheel lug nuts.

### ***At least once a year:***

- Clean body and door drain holes.
- Lubricate door hinges and checks, and hood hinges.
- Lubricate door and hood locks and latches.
- Lubricate door rubber weatherstrips.
- Check the air conditioning system before the warm weather season.
- Check the power steering fluid level.
- Inspect and lubricate automatic transaxle linkage and controls.
- Clean battery and terminals.
- Check the brake fluid level.

### **Owner maintenance precautions**

Improper or incomplete service may result in problems. This section gives instructions only for the maintenance items that are easy to perform.

As explained earlier in this section, several procedures can be done only by an Authorized Hyundai Dealer with special tools.

**Improper owner maintenance during the warranty period may affect warranty coverage. For details, read the separate Hyundai Owner's Handbook & Warranty Information booklet provided with the vehicle. If you're unsure about any servicing or maintenance procedure, have it done by an Authorized Hyundai Dealer.**

### **WARNING - Maintenance work**

- **Performing maintenance work on a vehicle can be dangerous. You can be seriously injured while performing some maintenance procedures. If you lack sufficient knowledge and experience or the proper tools and equipment to do the work, have it done by an Authorized Hyundai Dealer.**
- **Working under the hood with the engine running is dangerous. It becomes even more dangerous when you wear jewelry or loose clothing. These can become entangled in moving parts and result in injury. Always remove all loose or hanging clothing and all jewelry before working on the engine.**

## ENGINE COMPARTMENT

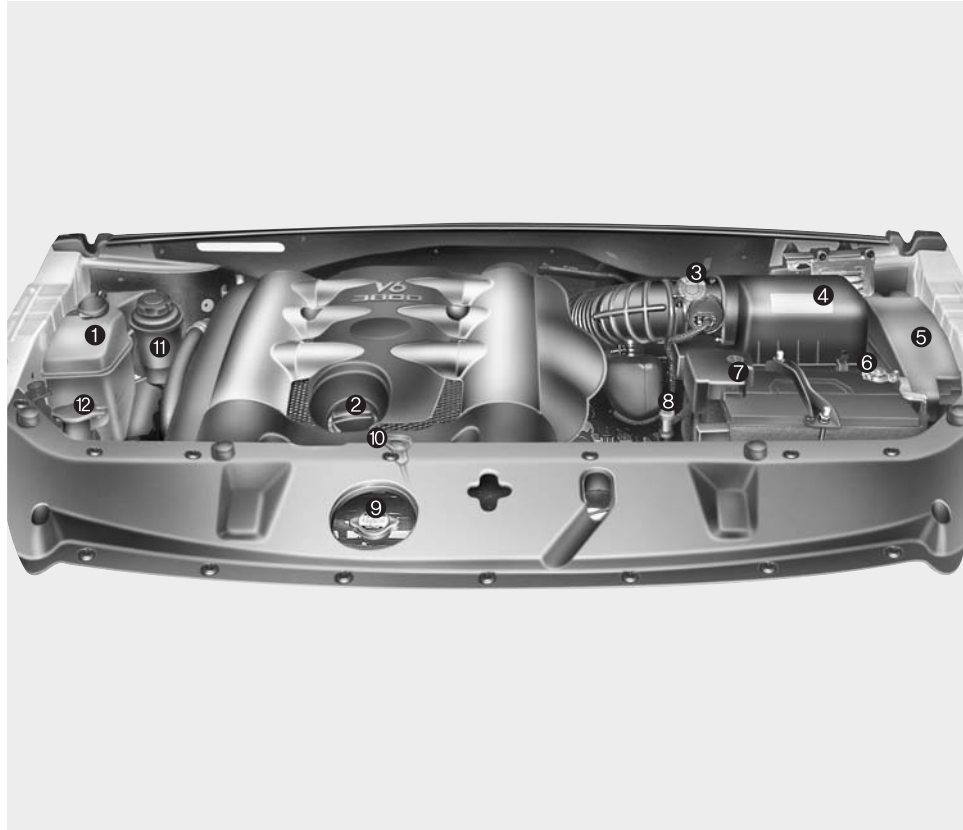

1. Engine coolant reservoir
2. Engine oil filler cap
3. Brake fluid reservoir
4. Air cleaner
5. Fuse box
6. Negative battery terminal
7. Positive battery terminal
8. Auto transaxle oil dipstick
9. Radiator cap
10. Engine oil dipstick
11. Power steering fluid reservoir
12. Windshield washer fluid reservoir

OVQ066001N

## ENGINE OIL



OVQ066002N

**Checking the engine oil level**

1. Be sure the vehicle is on level ground.
2. Start the engine and allow it to reach normal operating temperature.
3. Turn the engine off and wait for a few minutes (about 5 minutes) for the oil to return to the oil pan.
4. Pull the dipstick out, wipe it clean, and re-insert it fully.

**⚠ WARNING - Radiator hose**  
Be very careful not to touch the radiator hose when checking or adding the engine oil as it may be hot enough to burn you.

5. Pull the dipstick out again and check the level. The level should be between F and L.

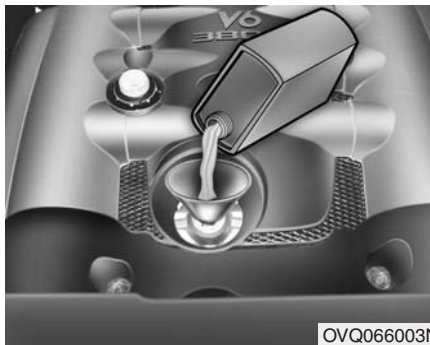

OVQ066003N

If it is near or at L, add enough oil to bring the level to F. **Do not overfill.**

**Use a funnel to refill the new oil comfortably.**

*Use only the specified engine oil. (Refer to "Recommended Lubricants" later in this section.)*

Have engine oil and filter changed by an Authorized Hyundai Dealer according to the Maintenance Schedule at the beginning of this section.



**⚠ PROPOSITION 65 WARNING**

Used engine oil may cause irritation or cancer of the skin if left in contact with the skin for prolonged periods of time. Used engine oil contains chemicals that have caused cancer in laboratory animals. Always protect your skin by washing your hands thoroughly with soap and warm water as soon as possible after handling used oil.

## ENGINE COOLANT

The high-pressure cooling system has a reservoir filled with year-round antifreeze coolant. The reservoir is filled at the factory.

Check the antifreeze protection and coolant level at least once a year, at the beginning of the winter season, and before traveling to a colder climate.

### Checking the coolant level

#### **⚠ WARNING - Removing radiator cap**

- Never attempt to remove the radiator cap while the engine is operating or hot. Doing so might lead to cooling system and engine damage and could result in serious personal injury from escaping hot coolant or steam.

(Continued)

#### (Continued)

- Turn the engine off and wait until it cools down. Use extreme care when removing the radiator cap. Wrap a thick towel around it, and turn it counterclockwise slowly to the first stop. Step back while the pressure is released from the cooling system. When you are sure all the pressure has been released, press down on the cap, using a thick towel, and continue turning counterclockwise to remove it.
- Even if the engine is not operating, do not remove the radiator cap or the drain plug while the engine and radiator are hot. Hot coolant and steam may still blow out under pressure, causing serious injury.

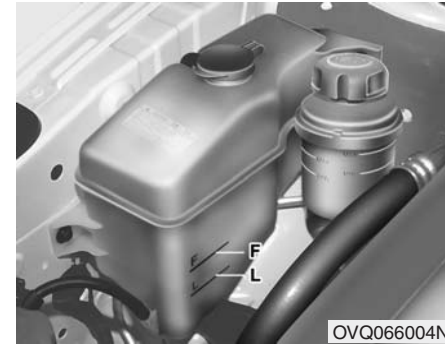

Check the condition and connections of all cooling system hoses and heater hoses. Replace any swollen or deteriorated hoses.



The coolant level should be filled between F and L marks on the side of the coolant reservoir when the engine is cool.

If the coolant level is low, add enough specified coolant to provide protection against freezing and corrosion. Bring the level to F, but do not overfill. If frequent additions are required, see an Authorized Hyundai Dealer for a cooling system inspection.

## **CAUTION**

*Engine coolant can damage the finish of your car. If you spill engine coolant on the car, wash it off thoroughly with clean water.*

Have coolant changed by an Authorized Hyundai Dealer according to the Maintenance Schedule at the beginning of this section.

- Use only soft (de-mineralized) water in the coolant mixture.
- The engine in your vehicle has aluminum engine parts and must be protected by an ethylene-glycol-based coolant to prevent corrosion and freezing.
- DO NOT USE alcohol or methanol coolant or mix them with the specified coolant.
- Do not use a solution that contains more than 60% antifreeze or less than 35% antifreeze, which would reduce the effectiveness of the solution.

For mixture percentage, refer to the following table.

Ambient Temperature	Mixture Percentage (volume)	
	Coolant Solution	Water
5°F (-15°C)	35	65
-13°F (-25°C)	40	60
-31°F (-35°C)	50	50
-49°F (-45°C)	60	40

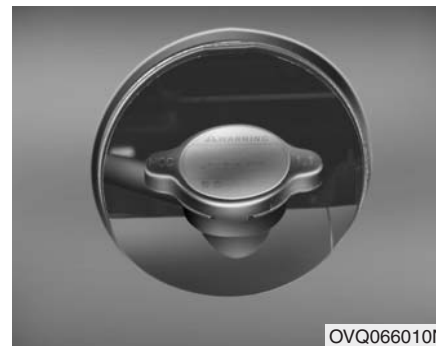

**⚠ WARNING - Radiator cap**  
**Do not remove the radiator cap when the engine and radiator are hot. Scalding hot coolant and steam may blow out under pressure causing serious injury.**



## AIR CLEANER

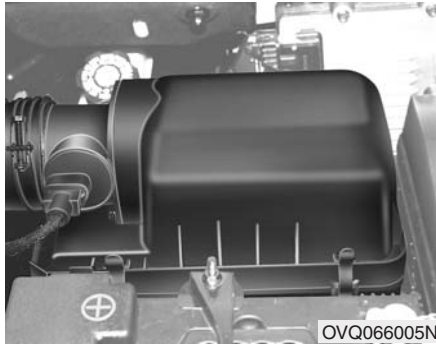

### Element replacement

A viscous paper air cleaner filter is used. It must be replaced when necessary, and should not be cleaned and reused.

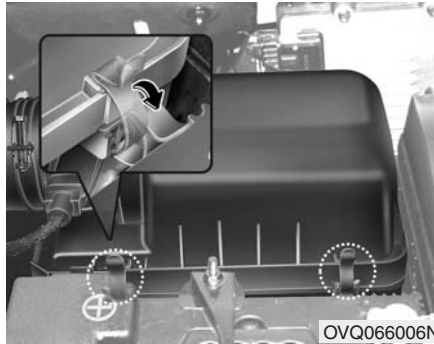

1. Loosen the air cleaner cover attaching clips and open the cover.

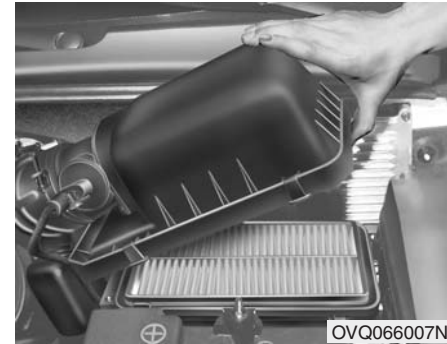

2. Wipe the inside of the air cleaner housing with a clean, damp cloth.



3. Replace the air cleaner element. We recommend that the air cleaner element be replaced with genuine Hyundai parts.
4. Lock the cover with the cover attaching clips.

Replace the element according to the Scheduled Maintenance Section.

*If the vehicle is operated in extremely dusty or sandy areas, replace the element more often than the usual recommended intervals. (Refer to Schedule 2 - Severe Maintenance in this section.)*

**⚠ WARNING - Engine**  
Driving without an air cleaner encourages backfiring, which could cause a fire in the engine compartment.

### **⚠ CAUTION - Engine**

- ***Do not drive with the air cleaner removed; this will result in excessive engine wear.***
- ***When removing the air cleaner element, be careful that dust or dirt does not enter the air intake, or damage may result.***

## AUTOMATIC TRANSAXLE



### Checking the automatic transaxle fluid level

The automatic transaxle fluid level should be checked regularly.

The volume of the transaxle fluid changes with temperature. Although it is best to check the level after having driven the vehicle for at least 30 minutes, the level can be checked after warming the fluid using the following procedure.

1. Park the vehicle on level ground and firmly apply the parking brake.
2. Allow the engine to idle for about 2 minutes.
3. Depress the brake pedal and move the shift lever slowly through all ranges then set it in P (Park) or N (Neutral).
4. With the engine still idling, pull out the dipstick, wipe it clean and reinsert it fully.
5. Pull out the dipstick again and check the fluid level.

**⚠ WARNING - Transaxle fluid**  
The transaxle fluid level should be checked when the engine is at normal operating temperature. This means that the engine, radiator, radiator hose and exhaust system etc., are very hot. Exercise great care not to burn yourself during this procedure.

### ⚡ CAUTION

- *Low fluid level causes transaxle slippage. Overfilling can cause foaming, loss of fluid and transaxle malfunction.*
- *The use of a non-specified fluid could result in transaxle malfunction and failure.*

### ⚠ WARNING - Parking brake

To avoid sudden movement of the vehicle, apply parking brake and depress the brake pedal before moving the shift lever.



1VQA5008

If the fluid has been warmed to normal operating temperature of approximately 158~176°F (70~80°C), the fluid level should be within “HOT” range.

**“COLD” scale is for reference only and should NOT be used to determine transaxle fluid level.**

**New automatic transaxle fluid should be red. The red dye is added so the assembly plant can identify it as automatic transaxle fluid and distinguish it from engine oil or antifreeze. The red dye, which is not an indicator of fluid quality, is not permanent. As the vehicle is driven, the automatic transaxle fluid will begin to look darker. The color may eventually appear light brown.**

### **\* NOTICE**

**Have an Authorized Hyundai dealer change the automatic transaxle fluid according to the Scheduled Maintenance at the beginning of this section.**

Use only the specified automatic transaxle fluid. (Refer to "Recommended Lubricants" later in this section.)

## BRAKES



### Checking brake fluid level

Check the fluid level in the reservoir periodically. The fluid level should be between MAX and MIN marks on the side of the reservoir.

Before removing the reservoir cap and adding brake fluid, clean the area around the reservoir cap thoroughly to prevent brake fluid contamination.

If the level is low, add fluid to the MAX level. The level will fall with accumulated mileage. This is a normal condition associated with the wear of the brake linings. If the fluid level is excessively low, have the brake system checked by an Authorized Hyundai Dealer.

*Use only the specified brake fluid. (Refer to “Recommended Lubricants” later in this section.)*

*Never mix different types of fluid.*

### **⚠ WARNING - Loss of brake fluid**

**In the event the brake system requires frequent additions of fluid, the vehicle should be inspected by an Authorized Hyundai Dealer.**

### **⚠ WARNING - Brake fluid**

**When changing and adding brake fluid, handle it carefully. Do not let it come in contact with your eyes. If brake fluid should come in contact with your eyes, immediately flush them with a large quantity of fresh tap water. Have your eyes examined by a doctor as soon as possible.**

### **⚠ CAUTION**

***Do not allow brake fluid to contact the vehicle's body paint, as paint damage will result. Brake fluid, which has been exposed to open air for an extended time should never be used as its quality cannot be guaranteed. It should be thrown out. Don't put in the wrong kind of fluid. A few drops of mineral-based oil, such as engine oil, in your brake system can damage brake system parts.***

## LUBRICANTS AND FLUIDS

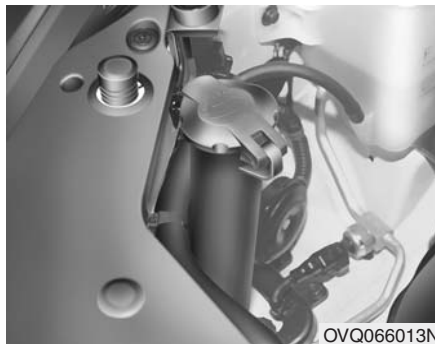

### Checking the washer fluid level

The reservoir is translucent so that you can check the level with a quick visual inspection.

Check the fluid level in the washer fluid reservoir and add fluid if necessary. Plain water may be used if washer fluid is not available. However, use washer solvent with antifreeze characteristics in cold climates to prevent freezing.



This warning light indicates the washer fluid reservoir is near empty. Refill the washer fluid as soon as possible.

### **⚠ WARNING - Coolant**

- Do not use radiator coolant or antifreeze in the washer fluid reservoir.
- Radiator coolant can severely obscure visibility when sprayed on the windshield and may cause loss of vehicle control or damage to paint and body trim.
- Windshield washer fluid agents contain some amounts of alcohol and can be flammable under certain circumstances. Do not allow sparks or flame to contact the washer fluid or the washer fluid reservoir. Damage to the vehicle or it's occupants could occur.
- Windshield washer fluid is poisonous to humans and animals. Do not drink and avoid contacting windshield washer fluid. Serious injury or death could occur.

### Body lubrication

All moving points of the body, such as door hinges, hood hinges, and locks, should be lubricated each time the engine oil is changed. Use a non-freezing lubricant on locks during cold weather.

Make sure the engine hood secondary latch keeps the hood from opening when the primary latch is released.

## POWER STEERING



### Checking the power steering fluid level

With the vehicle on level ground, check the fluid level in the power steering reservoir periodically. The fluid should be between MAX and MIN marks on the side of the reservoir at the normal temperature.

Before adding power steering fluid, thoroughly clean the area around the reservoir cap to prevent power steering fluid contamination.

If the level is low, add fluid to the MAX level.

In the event the power steering system requires frequent addition of fluid, the vehicle should be inspected by an Authorized Hyundai Dealer.

### **CAUTION**

- *To avoid damage to the power steering pump, do not operate the vehicle for prolonged periods with a low power steering fluid level.*
- *Never start the engine when the reservoir tank is empty.*
- *When adding fluid, be careful that dirt does not get into the tank.*
- *Too little fluid can result in increased steering effort and/or noise from the power steering system.*
- *The use of the non-specified fluid could reduce the effectiveness of the power steering system and cause damage to it.*

*Use only the specified power steering fluid. (Refer to "Recommended Lubricants" later in this section.)*

### Power steering hoses

Check the connections for oil leaks, severe damage and twists in the power steering hose before driving.

## CLIMATE CONTROL AIR FILTER

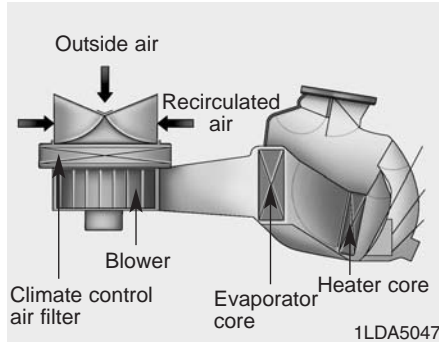

The climate control air filter installed behind the glove box filters the dust or other pollutants that come into the vehicle from the outside through the heating and air conditioning system. If dust or other pollutants accumulate in the filter over a period of time, the air flow from the air vents may decrease, resulting in moisture accumulation on the inside of the windshield even when the outside (fresh) air position is selected. If this happens, have the climate control air filter replaced by an Authorized Hyundai Dealer.

The climate control air filter should be replaced every 10,000 miles (15,000 km). If the vehicle is operated in severely air-polluted cities or on dusty rough roads for a long period, it should be inspected more frequently and replaced earlier. When you try to replace the climate control air filter, perform the following procedure, and be careful to avoid damaging other components.



### Filter replacement

1. Open the glove box and remove the support rod.



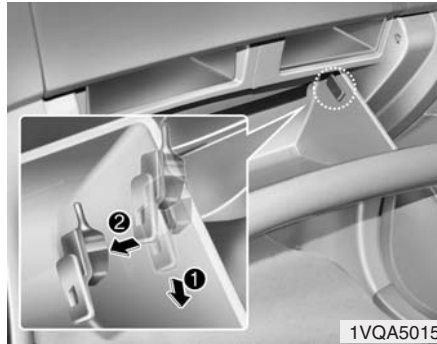

1VQA5015

2. With the glove box open, remove the stoppers on both sides to allow the glove box hang freely on the hinges.

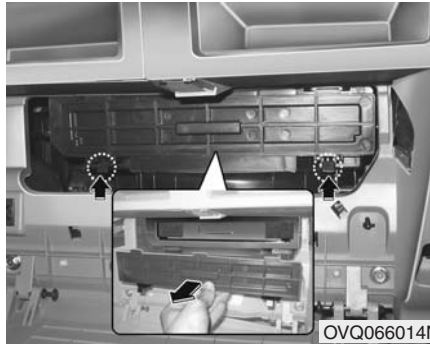

OVQ066014N

3. Remove the climate control air filter cover pulling up both taps of the cover.

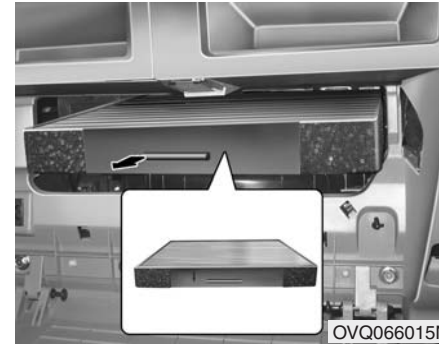

OVQ066015N

4. Replace the climate control air filter.  
5. Reassemble in the reverse order of disassembly.

#### \* NOTICE

When replacing the climate control air filter install it according to the “↓” identification marks. Otherwise, the system may produce noise and the effectiveness of the filter may be reduced.

## WIPER BLADES



1VQA5022

### Maintenance

Commercial hot waxes applied by automatic car washes have been known to make the windshield difficult to clean.

Contamination of either the windshield or the wiper blades with foreign matter can reduce the effectiveness of the windshield wipers. Common sources of contamination are insects, tree sap, and hot wax treatments used by some commercial car washes. If the blades are not wiping properly, clean both the window and the blades with a good cleaner or mild detergent, and rinse thoroughly with clean water.

### **CAUTION**

*To prevent damage to the wiper blades, do not use gasoline, kerosene, paint thinner, or other solvents on or near them.*

### Replacement

When the wipers no longer clean adequately, the blades may be worn or cracked, and require replacement.

### **CAUTION**

*To prevent damage to the wiper arms or other components, do not attempt to move the wipers manually.*

### **CAUTION**

*The use of a non-specified wiper blade could result in wiper malfunction and failure.*



1LDA5023

### **Front windshield wiper blade**

1. Raise the wiper arm and turn the wiper blade assembly to expose the plastic locking clip.

### **CAUTION**

*Do not allow the wiper arm to fall against the windshield, since it may chip or crack the windshield.*

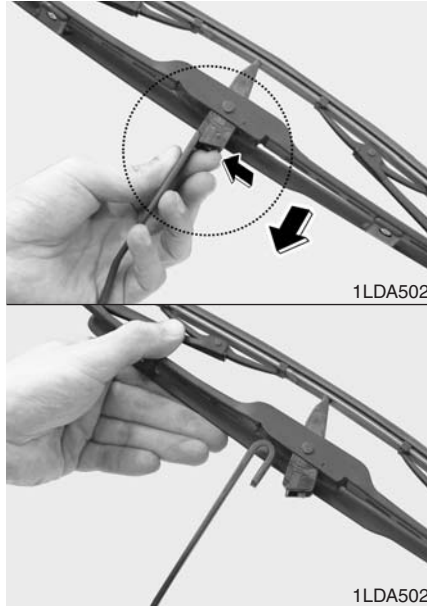

1LDA5024

1LDA5025

2. Compress the clip and slide the blade assembly downward.
3. Lift it off the arm.
4. Install the blade assembly in the reverse order of removal.

### **Rear window wiper blade**

To prevent damage to the wiper arms or other components, have an authorized Hyundai dealer replace the wiper blade.

## FUSES

Blade type



Normal

Blown

Cartridge type



Normal

Blown

Fusible link



Normal

Blown

1VQA4037

A vehicle's electrical system is protected from electrical overload damage by fuses.

This vehicle has three fuse panels, one located in the driver's side panel bolster, another in the cargo area, the other in the engine compartment near the battery.

If any of your vehicle's lights, accessories, or controls do not work, check the appropriate circuit fuse. If a fuse has blown, the element inside the fuse will be melted.

If the electrical system does not work, first check the driver's side fuse panel.

Always replace a blown fuse with one of the same rating.

If the replacement fuse blows, this indicates an electrical problem. Avoid using the system involved and immediately consult an Authorized Hyundai Dealer.

*Three kinds of fuses are used: blade type for lower amperage rating and cartridge type, fusible link for higher amperage ratings.*

### Fuse replacement

#### **⚠ WARNING - Fuse replacement**

- **Never replace a fuse with anything but another fuse of the same rating.**
- **A higher capacity fuse could cause damage and possibly a fire.**
- **Never install a wire instead of the proper fuse - even as a temporary repair. It may cause extensive wiring damage and possibly a fire.**

#### **⚠ CAUTION**

**Do not use a screwdriver or any other metal object to remove fuses because it may cause a short circuit and damage the system.**



### **Engine compartment**

1. Turn the ignition switch and all other switches off.
2. Remove the fuse box cover by pressing the tap and pulling up.
3. Check the removed fuse; replace it if it is blown. To remove or insert the fuse, use the fuse puller in the main fuse box in the engine compartment.
4. Push in a new fuse of the same rating, and make sure it fits tightly in the clips. If it fits loosely, consult an Authorized Hyundai Dealer.

### **CAUTION**

*After checking the fuse box in the engine compartment, securely install the fuse box cover. If not, electrical failures may occur from water leaking in.*

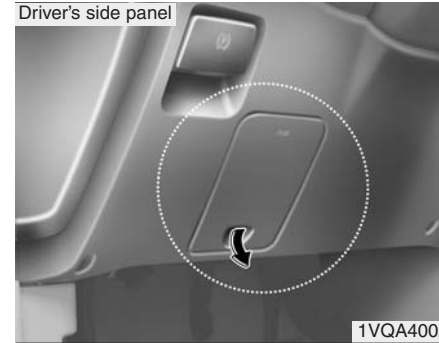

### **Inner panel**

1. Turn the ignition switch and all other switches off.
2. Open the fuse panel cover.



If the headlights or other electrical components do not work and the fuses are OK, check the fuse block in the engine compartment. If a fuse is blown, it must be replaced.

3. Pull the suspected fuse straight out. Use the removal tool provided on the main fuse box in the engine compartment.

4. Check the removed fuse; replace it if it is blown.

*Spare fuses are provided in the main fuse box in the engine compartment.*

5. Push in a new fuse of the same rating, and make sure it fits tightly in the clips.

If it fits loosely, consult an Authorized Hyundai Dealer.

*If you do not have a spare, use a fuse of the same rating from a circuit you may not need for operating the vehicle, such as the cigar lighter fuse.*

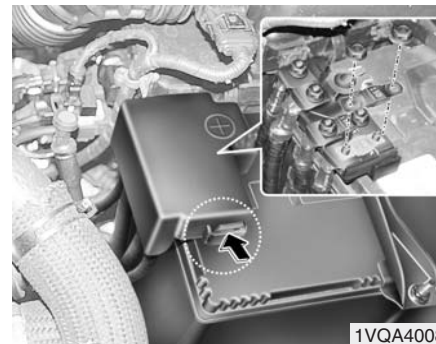

### **Main fuse**

If the main fuse is blown, it must be removed as follows:

1. Disconnect the negative battery cable.
2. Remove the nuts shown in the picture above.
3. Replace the fuse with a new one of the same rating.
4. Reinstall in the reverse order of removal.

### **\* NOTICE**

**If the main fuse is blown, consult an Authorized Hyundai Dealer.**

### Fuse/Relay panel description

Inside the fuse/relay box covers, you can find the fuse/relay label describing fuse/relay name and capacity.

Driver's side panel



Rear cargo area panel

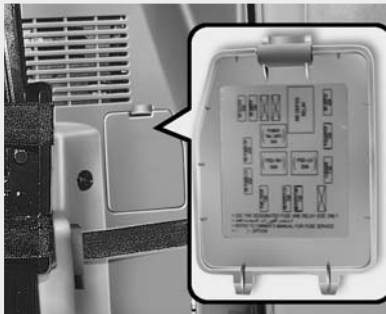

Engine compartment

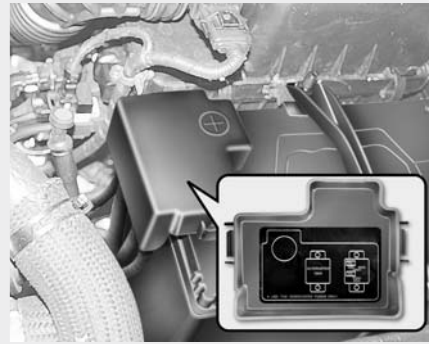

1VQA4009/OVQ066017N/1VQA4013/OVQ046010N

### \* NOTICE

Not all fuse panel descriptions in this manual may be applicable to your vehicle. It is accurate at the time of printing. When you inspect the fuse box on your vehicle, refer to the fuse box label.

## Driver's side fuse panel

Description	Fuse rating	Protected component
AUDIO	15A	Audio, Step lamp
MEMORY	7.5A	Climate control module, Clock, Cluster, Trip computer, Front area module, Power sliding door module, Power tailgate module, Driver's door module, Front passenger door module, Driver's power seat module, Driver position memory system unit
IG2-1	7.5A	Air conditioner control module, Multi function switch, Inside relay box, ECM mirror, Rain sensor, Seat Warmer
IG2-2	7.5A	Rear climate control button, Front area module, Power sliding door module, Power tailgate module, Driver's door module, Front passenger door module, Driver's power seat module, Driver position memory system unit
OBD-II	7.5A	OBD-II, Diagonosis connector
ROOM	7.5A	Vanity mirror, Map lamp, Overhead console, Room lamp switch, Climate control module, Homelink
K/LOCK	7.5A	Key interlock solenoid
ILLUMI	7.5A	Instrument panel illumination
AMP	25A	Amplifier
SEAT WARMER	20A	Inside relay box(Seat warmer)
SUNROOF	25A	Sunroof module
DDM	30A	Driver's door module
TPMS	7.5A	Tire pressure monitoring system
PEDAL	15A	Power adjustable pedal relay(Non-driver position memory system only)
P/OUTLET 1	15A	Power outlet(Front)
ASS P/SEAT	20A	Front passenger's power seat module
DRV P/SEAT	30A	Driver's power seat module
ADM	30A	Front passenger door module
ACC	7.5A	Audio, Clock, Outside rearview mirror control and folding switch
P/OUTLET 2	15A	Cigar lighter, Power outlet
START	7.5A	Start relay
AIRBAG IND	7.5A	Cluster



Description	Fuse rating	Protected component
ENG	7.5A	Automatic shift lever switch, Vehicle speed sensor, Inhibitor switch, Transaxle control module, Input speed sensor, Output speed sensor, Back-up lamp switch, Fuel filter
IG1	7.5A	Trip computer, Buzzer(Back warning system), Cluster, ESC switch, Ambient temperature sensor, Generator
ABS	7.5A	ABS control module, ESC control module, Yaw rate sensor, Steering angle sensor
AIRBAG	15A	Air bag control module
ALTERNATOR	-	Generator relay
SHUNT	-	Shunt connector

#### Rear cargo area panel

Description	Fuse rating	Protected component
RR D/LOCK	20A	Sliding door lock relay, Sliding door unlock relay, Sliding door lock actuator, Tailgate lock actuator
RR WIPER	15A	Rear wiper relay, Rear wiper motor
RR DEFOG	25A	Rear window defroster relay, Rear window defroster
POWER TAIL GATE	30A	Power tailgate module
P/QUARTER	10A	Power rear quarter glass open relay, Power rear quarter glass close relay, Power rear quarter glass motor
RR P/WIN-RH	25A	Sliding door power window relay(Right), Sliding door power window motor(Right)
RR P/WIN-LH	25A	Sliding door power window relay(Left), Sliding door power window motor(Left)
PSD-RH	30A	Power sliding door module(Right)
PSD-LH	30A	Power sliding door module(Left)
LUGGAGE	7.5A	Step lamp, Power tailgate ON/OFF switch, Tailgate lamp
FUEL DOOR	15A	Fuel filler lid relay, Fuel filler lid actuator
RR P/OTLT-LH	15A	Rear power outlet(Left)
RR P/OTLT-RH	15A	Rear power outlet(Right)
RR DEFOG RELAY	-	Rear window defroster relay

## Engine compartment

Description	Fuse rating	Protected component
FRT/RR WASHER	10A	Front washer motor relay, Rear washer motor relay
IG 2	7.5A	Fuel filter
STOP LAMP	20A	Stop lamp, High mounted stop lamp
KEY SW 1	25A	Instrument panel module
STOP SIGNAL	7.5A	TCU, PCU/ECU, ABS/ESC Unit
A/C COMP	7.5A	Air conditioner compressor relay
ATM	15A	ATM solenoid
FRT DEICER	15A	Front deicer
HORN	15A	Horn relay
ECU 1	10A	PCU/ECU, A/C comp relay, Mass air flow sensor, Immobilizer unit
O2 DN	10A	O2 sensor(RL, RR)
ECU 2	15A	PCU/ECU, Oil control valve 1/2, Variable intake manifold valve 1/2, Canister purge solenoid valve, Canister close valve, Pulse width modulation relay
O2 UP	10A	O2 sensor(FL, FR)
IGN COIL	20A	Ignition coil 1/2/3/4/5/6, Condensor
INJECTOR	15A	PCU/ECU, Injector 1/2/3/4/5/6, Intake manifold valve, EGR Solenoid valve, Cooling fan relay, Air flow sensor, Intake throttle valve

Description	Fuse rating	Protected component
P/TRAIN	7.5A	Theft alarm relay, Main relay, TCM, Generator, ECM, Injector 15A, ECU 2 15A, ECU 1 10A, Air conditioner compressor relay, Inlet metering valve, EGR sole- noid valve, Air flow sensor, Immobilizer module
FUEL PUMP	15A	Fuel pump motor
SP	7.5A	Spare fuse
SP	10A	Spare fuse
SP	15A	Spare fuse
SP	20A	Spare fuse
SP	25A	Spare fuse
ABS 1	40A	ABS control module, ESC control module
ABS 2	20A	ABS control module, ESC control module
FRT WIPER	30A	Front wiper ON relay
KEY SW 2	30A	Start relay, IG2 Load(ECM mirror, Rain sensor, Seat warmer)
RAM 1	50A	Rear area module
RAM 2	50A	Rear area module
RAM 3	50A	Rear area module

Description	Fuse rating	Protected component
IPM 1	50A	Instrument panel module
IPM 2	50A	Instrument panel module
IPM 3	50A	Instrument panel module
FRT BLOWER	40A	Inside relay box(Front blower relay)
RR BLOWER	30A	Inside relay box(Rear blower relay)
IG 2 RELAY	-	Ignition relay
A/C COMP RELAY	-	Air conditioner compressor relay
MAIN RELAY	-	Main relay
START RELAY	-	Start relay
FUEL PUMP RELAY	-	Fuel pump relay

#### Engine compartment (main fuse)

Description	Fuse rating	Protected component
ALT	150A	Generator
C/FAN	60A	Cooling fan

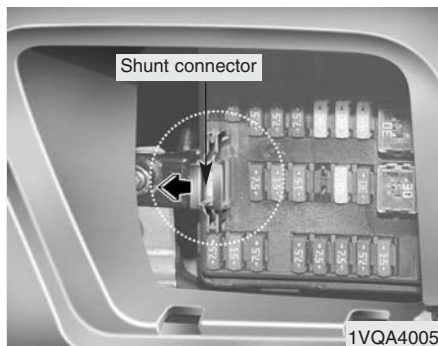

### Shunt connector

Your vehicle is equipped with a shunt connector to prevent battery discharge if your vehicle is parked without being operated for prolonged periods. Use the following procedures before parking the vehicle for prolonged periods.

1. Turn off the engine.
2. Turn off the headlights and tail lights.
3. Open the driver's side panel cover and pull up the shunt connector.

### \* NOTICE

- If the shunt connector is pulled up from the fuse panel, the warning chime, audio, clock and interior lamps, etc., will not operate. Some items must be reset after replacement. (Refer to “Items to be reset...” on page 6-36)
- Even though the shunt connector is pulled up, the battery can still be discharged by operation of the headlights or other electrical devices.

## BATTERY

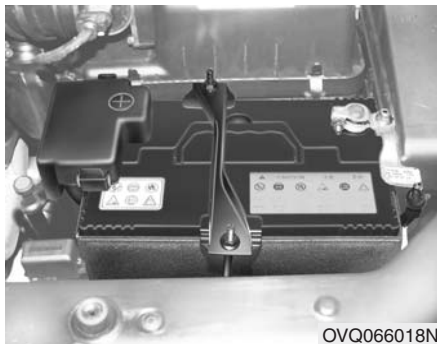

OVQ066018N

### ⚠️ WARNING - Battery dangers



Always read the following instructions carefully when handling a battery.



Keep lighted cigarettes and all other flames and sparks away from the battery.



Hydrogen, a highly combustible gas, is always present in battery cells and may explode if ignited.

(Continued)

(Continued)



Keep batteries out of the reach of children because batteries contain highly corrosive SULFURIC ACID. Do not allow battery acid to contact your skin, eyes, clothing or paint finish.



If any electrolyte gets into your eyes, flush your eyes with clean water for at least 15 minutes and get immediate medical attention. If possible, continue to apply water with a sponge or cloth until medical attention is received. If electrolyte gets on your skin, thoroughly wash the contacted area. If you feel a pain or a burning sensation, get medical attention immediately.



Wear eye protection when charging or working near a battery. Always provide ventilation when working in an enclosed space.

(Continued)

(Continued)

- When lifting a plastic-cased battery, excessive pressure on the case may cause battery acid to leak, resulting in personal injury. Lift with a battery carrier or with your hands on opposite corners.
- Never attempt to recharge the battery when the battery cables are connected.
- The electrical ignition system works with high voltage. Never touch these components with the engine running or the ignition switched on.

Failure to follow the above warnings can result in serious bodily injury or death.

### ⚠️ PROPOSITION 65 WARNING

Battery posts, terminals, and related accessories contain lead and lead compounds, chemicals known to the State of California to cause cancer and reproductive harm. Batteries also contain other chemicals known to the State of California to cause cancer. Wash hands after handling.

## For best battery service:

- Keep the battery securely mounted.
- Keep the battery top clean and dry.
- Keep the terminals and connections clean, tight, and coated with petroleum jelly or terminal grease.
- Rinse any spilled electrolyte from the battery immediately with a solution of water and baking soda.
- If the vehicle is not going to be used for an extended time, disconnect the battery cables.

## Battery recharging

Your vehicle has a maintenance-free, calcium-based battery.

- If the battery becomes discharged in a short time (because, for example, the headlights or interior lights were left on while the vehicle was not in use), recharge it by slow charging (trickle) for 10 hours.
- If the battery gradually discharges because of high electric load while the vehicle is being used, recharge it at 20-30A for two hours.

## Items to be reset after the battery has been discharged or the battery has been disconnected.

- Clock (See Chapter 3)
- Sunroof (See Chapter 3)
- Trip computer (See Chapter 3)
- Climate control system (See Chapter 3)
- Audio (See Chapter 3)
- Power sliding door and power tailgate (See Chapter 3)

### **WARNING - Recharging battery**

When recharging the battery, observe the following precautions:

- The battery must be removed from the vehicle and placed in an area with good ventilation.
- Do not allow cigarettes, sparks, or flame near the battery.
- Watch the battery during charging, and stop or reduce the charging rate if the battery cells begin gassing (boiling) violently or if the temperature of the electrolyte of any cell exceeds 120°F (49°C).

(Continued)

(Continued)

- Wear eye protection when checking the battery during charging.
- Disconnect the battery charger in the following order.
  1. Turn off the battery charger main switch.
  2. Unhook the negative clamp from the negative battery terminal.
  3. Unhook the positive clamp from the positive battery terminal.

### **CAUTION**

- Before performing maintenance or recharging the battery, turn off all accessories and stop the engine.
- The negative battery cable must be removed first and installed last when the battery is disconnected.

## TIRES AND WHEELS

### Tire care

For proper maintenance, safety, and maximum fuel economy, you must always maintain recommended tire inflation pressures and stay within the load limits and weight distribution recommended for your vehicle.

### Recommended cold tire inflation pressures

All tire pressures (including the spare) should be checked every day when the tires are cold. "Cold Tires" means the vehicle has not been driven for at least three hours or driven less than one mile (1.6 km).

Recommended pressures must be maintained for the best ride, top vehicle handling, and minimum tire wear.

### **⚠ WARNING**

- **Underinflated or overinflated tires can cause poor handling, loss of vehicle control, and sudden tire failure leading to accidents, injuries, and even death. Always check tires are properly inflated before driving.**
- **Driving on tires with no or insufficient tread is dangerous. Worn-out tires can result in loss of vehicle control, collisions, and injury and even death. Worn-out tires should be replaced as soon as possible and should never be used for driving. Always check tire tread before driving your car.**



OVQ066022N

All specifications (sizes and pressures) can be found on a label attached to the vehicle.

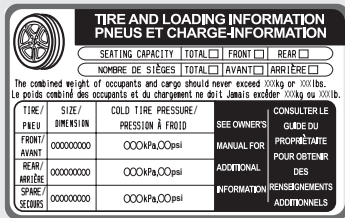

1KMN5039

### **⚠ WARNING - Tire underinflation**

Severe underinflation (10 psi (70 kPa) or more) can lead to severe heat build-up, causing blowouts, tread separation and other tire failures that can result in the loss of vehicle control leading to severe injury or death. This risk is much higher on hot days and when driving for protracted periods at high speeds.

### **⚠ CAUTION**

- *Underinflation also results in excessive wear, poor handling and reduced fuel economy. Wheel deformation also is possible. Keep your tire pressures at the proper levels. If a tire frequently needs refilling, have it checked by an Authorized Hyundai Dealer.*
- *Overinflation produces a harsh ride, excessive wear at the center of the tire tread, and a greater possibility of damage from road hazards.*

### **⚠ CAUTION**

- *Warm tires normally exceed recommended cold tire pressures by 4 to 6 psi (28 to 41 kPa). Do not release air from warm tires to adjust the pressure or the tires will be under-inflated.*
- *Be sure to reinstall the tire inflation valve caps. Without the valve cap, dirt or moisture could get into the valve core and cause air leakage. If a valve cap is missing, install a new one as soon as possible.*

### **⚠ WARNING - Tire Inflation**

Overinflation or underinflation can reduce tire life, adversely affect vehicle handling, and lead to sudden tire failure. This could result in loss of vehicle control and potential injury.



**⚠ CAUTION - Tire pressure**  
***Always observe the following:***

- ***Check tire pressure when the tires are cold. (After vehicle has been parked for at least three hours or hasn't been driven more than one mile (1.6 km) since startup.)***
- ***Check the pressure of your spare tire each time you check the pressure of other tires.***
- ***Never overload your vehicle. Be careful not to overload a vehicle luggage rack if your vehicle is equipped with one.***
- ***Worn, old tires can cause accidents. If your tread is badly worn, or if your tires have been damaged, replace them.***

### **Checking tire inflation pressure**

Check your tires once a month or more.

Also, check the tire pressure of the spare tire.

#### ***How to check***

Use a good quality gage to check tire pressure. You can not tell if your tires are properly inflated simply by looking at them. Radial tires may look properly inflated even when they're underinflated.

Check the tire's inflation pressure when the tires are cold. - "Cold" means your vehicle has been sitting for at least three hours or driven no more than 1 mile (1.6 km).

Remove the valve cap from the tire valve stem. Press the tire gage firmly onto the valve to get a pressure measurement. If the cold tire inflation pressure matches the recommended pressure on the tire and loading information label, no further adjustment is necessary. If the pressure is low, add air until you reach the recommended amount.

If you overfill the tire, release air by pushing on the metal stem in the center of the tire valve. Recheck the tire pressure with the tire gage. Be sure to put the valve caps back on the valve stems. They help prevent leaks by keeping out dirt and moisture.

## ⚠ WARNING

- **Inspect your tires frequently for proper inflation as well as wear and damage. Always use a tire pressure gauge.**
- **Tires with too much or too little pressure wear unevenly causing poor handling, loss of vehicle control, and sudden tire failure leading to accidents, injuries, and even death. The recommended cold tire pressure for your vehicle can be found in this manual and on the tire label located on the driver's side of the center pillar.**
- **Worn tires can cause accidents. Replace tires that are worn, show uneven wear, or are damaged.**
- **Remember to check the pressure of your spare tire. Hyundai recommends that you check the spare every time you check the pressure of the other tires on your vehicle.**

## Tire rotation

To equalize tread wear, it is recommended that the tires be rotated every 7,500 miles (12,000 km) or sooner if irregular wear develops.

During rotation, check the tires for correct balance.

When rotating tires, check for uneven wear and damage. Abnormal wear is usually caused by incorrect tire pressure, improper wheel alignment, out-of-balance wheels, severe braking or severe cornering. Look for bumps or bulges in the tread or side of tire. Replace the tire if you find either of these conditions. Replace the tire if fabric or cord is visible. After rotation, be sure to bring the front and rear tire pressures to specification and check lug nut tightness.

Refer to Section 8, Specifications.

With a full-size spare tire (if equipped)

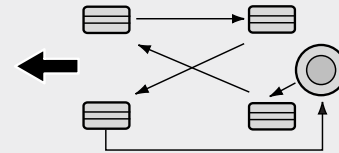

S2BLA790

Without a spare tire

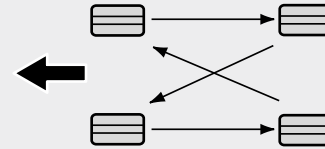

S2BLA790A

Directional tires (if equipped)



CBGQ0707A

*Disc brake pads should be inspected for wear whenever tires are rotated.*

Rotate radial tires that have an asymmetric tread pattern only from front to rear and not from right to left.

### **⚠ WARNING**

- Do not use the compact spare tire for tire rotation
- Do not mix bias ply and radial ply tires under any circumstances. This may cause unusual handling characteristics that could result in death, severe injury, or property damage.



### **Tire replacement**

If the tire is worn evenly, a tread wear indicator will appear as a solid band across the tread. This shows there is less than 1/16 inch (1.6 mm) of tread left on the tire. Replace the tire when this happens.

Do not wait for the band to appear across the entire tread before replacing the tire.

### **⚠ WARNING**

Driving on tires with no or insufficient tread is dangerous. Worn-out tires can result in loss of vehicle control, collisions, injury, and even death. Worn-out tires should be replaced as soon as possible and should never be used for driving. Always check tire tread before driving your car. Refer to 8-3 for further information and tread limits.

### Compact spare tire replacement

A compact spare tire has a shorter tread life than a regular size tire. Replace it when you can see the tread wear indicator bars on the tire. The replacement compact spare tire should be the same size and design tire as the one provided with your new Hyundai and should be mounted on the same compact spare tire wheel. The compact spare tire is not designed to be mounted on a regular size wheel, and the compact spare tire wheel is not designed for mounting a regular size tire.

### Wheel replacement

When replacing the metal wheels for any reason, make sure the new wheels are equivalent to the original factory units in diameter, rim width and offset.

#### **WARNING**

**A wheel that is not the correct size may adversely affect wheel and bearing life, braking and stopping abilities, handling characteristics, ground clearance, body-to-tire clearance, snow chain clearance, speedometer calibration, headlight aim and bumper height.**

### Wheel alignment and tire balance

The wheels on your vehicle were aligned and balanced carefully at the factory to give you the longest tire life and best overall performance.

In most cases, you will not need to have your wheels aligned again. However, if you notice unusual tire wear or your vehicle pulling one way or the other, the alignment may need to be reset.

If you notice your vehicle vibrating when driving on a smooth road, your wheels may need to be rebalanced.

**⚠ CAUTION**

*Improper wheel weights can damage your vehicle's aluminum wheels. Use only approved wheel weights.*

**⚠ WARNING - Replacing tires**

To reduce the chance of serious or fatal injuries from an accident caused by tire failure or loss of vehicle control:

- Replace tires that are worn, show uneven wear, or are damaged. Worn tires can cause loss of braking effectiveness, steering control, and traction.
- Do not drive your vehicle with too little or too much pressure in your tires. This can lead to uneven wear and tire failure.
- When replacing tires, never mix radial and bias-ply tires on the same car. You must replace all tires (including the spare) if moving from radial to bias-ply tires.

(Continued)

(Continued)

- Using tires and wheel other than the recommended sizes could cause unusual handling characteristics and poor vehicle control, resulting in a serious accident.
- Wheels that do not meet Hyundai's specifications may fit poorly and result in damage to the vehicle or unusual handling and poor vehicle control.

## Tire traction

Tire traction can be reduced if you drive on worn tires, tires that are improperly inflated or on slippery road surfaces. Tires should be replaced when tread wear indicators appear. To reduce the possibility of losing control, slow down whenever there is rain, snow or ice on the road.

## Tire maintenance

In addition to proper inflation, correct wheel alignment helps to decrease tire wear. If you find a tire is worn unevenly, have your dealer check the wheel alignment.

When you have new tires installed, make sure they are balanced. This will increase vehicle ride comfort and tire life. Additionally, a tire should always be rebalanced if it is removed from the wheel.

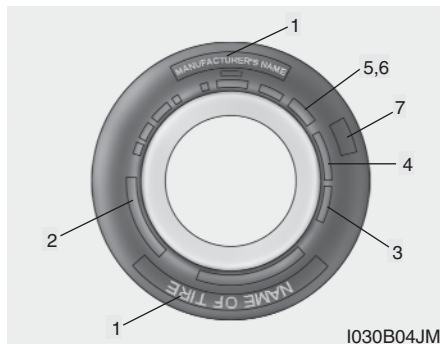

## Tire sidewall labeling

Federal law requires tire manufacturers to place standardized information on the sidewall of all tires. This information identifies and describes the fundamental characteristics of the tire and also provides the tire identification number (TIN) for safety standard certification. The TIN can be used to identify the tire in case of a recall.

### 1. *Manufacturer or brand name*

Manufacturer or Brand name is shown.

## 2. *Tire size designation*

A tire's sidewall is marked with a tire size designation. You will need this information when selecting replacement tires for your car. The following explains what the letters and numbers in the tire size designation mean.

Example tire size designation:

(These numbers are provided as an example only; your tire size designator could vary depending on your vehicle.)

### **P185/65R14 86H**

P - Applicable vehicle type (tires marked with the prefix "P" are intended for use on passenger cars or light trucks; however, not all tires have this marking).

185 - Tire width in millimeters.

65 - Aspect ratio. The tire's section height as a percentage of its width.

R - Tire construction code (Radial).

14 - Rim diameter in inches.

86 - Load Index, a numerical code associated with the maximum load the tire can carry.

H - Speed Rating Symbol. See the speed rating chart in this section for additional information.

### Wheel size designation

Wheels are also marked with important information that you need if you ever have to replace one. The following explains what the letters and numbers in the wheel size designation mean.

Example wheel size designation:

**5.5JX14**

5.5 - Rim width in inches.

J - Rim contour designation.

14 - Rim diameter in inches.

### Tire speed ratings

The chart below lists many of the different speed ratings currently being used for passenger cars. The speed rating is part of the tire size designation on the sidewall of the tire. This symbol corresponds to that tire's designed maximum safe operating speed.

Speed Rating Symbol	Maximum Speed
S	112 mph (180 km/h)
T	118 mph (190 km/h)
H	130 mph (210 km/h)
V	149 mph (240 km/h)
Z	Above 149 mph (240 km/h)

### 3. Checking tire life (TIN : Tire Identification Number)

Any tires that are over 6 years, based on the manufacturing date, tire strength and performance, decline with age naturally (even unused spare tires). Therefore, the tires (including the spare tire) should be replaced by new ones. You can find the manufacturing date on the tire sidewall (possibly on the inside of the wheel), displaying the DOT Code. The DOT Code is a series of numbers on a tire consisting of numbers and English letters. The manufacturing date is designated by the last four digits (characters) of the DOT code.

#### DOT : XXXX XXXX OOOO

The front part of the DOT means a plant code number, tire size and tread pattern and the last four numbers indicate week and year manufactured.

For example:

DOT XXXX XXXX 1605 represents that the tire was produced in the 16th week of 2005.

**⚠ WARNING - Tire age**

**A tire more than 6 years old may sustain separation of cord layers inside the tire. Tire failure to separation of cord, can cause accidents resulting in severe injuries or death.**

**Make sure to check the manufacturing date of the tire and replace it within 6 years of that date.**

**4. Tire ply composition and material**

The number of layers or plies of rubber-coated fabric are in the tire. Tire manufacturers also must indicate the materials in the tire, which include steel, nylon, polyester, and others. The letter "R" means radial ply construction; the letter "D" means diagonal or bias ply construction; and the letter "B" means belted-bias ply construction.

**5. Maximum permissible inflation pressure**

This number is the greatest amount of air pressure that should be put in the tire. Do not exceed the maximum permissible inflation pressure. Refer to the Tire and Loading Information label for recommended inflation pressure.

**6. Maximum load rating**

This number indicates the maximum load in kilograms and pounds that can be carried by the tire. When replacing the tires on the vehicle, always use a tire that has the same load rating as the factory installed tire.

**7. Uniform tire quality grading**

The following information relates to the tire grading system developed by the National Highway Traffic Safety Administration (NHTSA) for grading tires by tread wear, traction and temperature performance.

**Tread wear**

The tread wear grade is a comparative rating based on the wear rate of the tire when tested under controlled conditions on a specified government test course. For example, a tire graded 150 would wear one-and-a-half times as well on the government course as a tire graded 100.

The relative performance of tires depends upon the actual conditions of their use. However, performance may differ from the norm because of variations in driving habits, service practices and differences in road characteristics and climate.

These grades are molded on the side-walls of passenger vehicle tires. The tires available as standard or optional equipment on Hyundai vehicles may vary with respect to grade.



### Traction - AA, A, B & C

The traction grades, from highest to lowest, are AA, A, B and C. The grades represent the tires ability to stop on wet pavement as measured under controlled conditions on specified government test surfaces of asphalt and concrete. A tire marked C may have poor traction performance.

### Temperature -A, B & C

The temperature grades are A (the highest), B and C. The grades represent the tire's resistance to the generation of heat and its ability to dissipate heat when tested under controlled conditions on a specified indoor laboratory test wheel.

Sustained high temperature can cause the material of the tire to degenerate and reduce tire life, and excessive temperature can lead to sudden tire failure. Grade C corresponds to a level of performance which all passenger vehicle tires must meet under the Federal Motor Vehicle Safety Standard No. 109. Grades A and B represent higher levels of performance on the laboratory test wheel than the minimum required by the law.

### **WARNING - Tire temperature**

**The temperature grade for this tire is established for a tire that is properly inflated and not overloaded. Excessive speed, underinflation, or excessive loading, either separately or in combination, can cause heat build-up and possible sudden tire failure. This can cause loss of vehicle control and serious injury or death.**

### Tire terminology and definitions

**Air Pressure:** The amount of air inside the tire pressing outward on the tire. Air pressure is expressed in pounds per square inch (psi) or kilopascal (kPa).

**Accessory Weight:** This means the combined weight of optional accessories. Some examples of optional accessories are, automatic transmission, power seats, and air conditioning.

**Aspect Ratio:** The relationship of a tire's height to its width.

**Belt:** A rubber coated layer of cords that is located between the plies and the tread. Cords may be made from steel or other reinforcing materials.

**Bead:** The tire bead contains steel wires wrapped by steel cords that hold the tire onto the rim.

**Bias Ply Tire:** A pneumatic tire in which the plies are laid at alternate angles less than 90 degrees to the centerline of the tread.

**Cold Tire Pressure:** The amount of air pressure in a tire, measured in pounds per square inch (psi) or kilopascals (kPa) before a tire has built up heat from driving.

**Curb Weight:** This means the weight of a motor vehicle with standard and optional equipment including the maximum capacity of fuel, oil and coolant, but without passengers and cargo.

**DOT Markings:** A code molded into the sidewall of a tire signifying that the tire is in compliance with the U.S. Department of Transportation motor vehicle safety standards. The DOT code includes the Tire Identification Number (TIN), an alphanumeric designator which can also identify the tire manufacturer, production plant, brand and date of production.

**GVWR:** Gross Vehicle Weight Rating

**GAWR FRT:** Gross Axle Weight Rating for the front Axle.

**GAWR RR:** Gross Axle Weight Rating for the rear axle.

**Intended Outboard Sidewall:** The side of an asymmetrical tire, that must always face outward when mounted on a vehicle.

**Kilopascal (kPa):** The metric unit for air pressure.

**Load Index:** An assigned number ranging from 1 to 279 that corresponds to the load carrying capacity of a tire.

**Maximum Inflation Pressure:** The maximum air pressure to which a cold tire may be inflated. The maximum air pressure is molded onto the sidewall.

**Maximum Load Rating:** The load rating for a tire at the maximum permissible inflation pressure for that tire.

**Maximum Loaded Vehicle Weight:** The sum of curb weight; accessory weight; vehicle capacity weight; and production options weight.

**Normal Occupant Weight:** The number of occupants a vehicle is designed to seat multiplied by 150 pounds (68 kg).

**Occupant Distribution:** Designated seating positions.

**Outward Facing Sidewall:** The side of a asymmetrical tire that has a particular side that faces outward when mounted on a vehicle. The outward facing sidewall bears white lettering or bears manufacturer, brand, and/or model name molding that is higher or deeper than the same moldings on the inner facing sidewall.

**Passenger (P-Metric) Tire:** A tire used on passenger cars and some light duty trucks and multipurpose vehicles.

**Recommended Inflation Pressure:** Vehicle manufacturer's recommended tire inflation pressure and shown on the tire placard.

**Radial Ply Tire:** A pneumatic tire in which the ply cords that extend to the beads are laid at 90 degrees to the centerline of the tread.

**Rim:** A metal support for a tire and upon which the tire beads are seated.

**Sidewall:** The portion of a tire between the tread and the bead.

**Speed Rating:** An alphanumeric code assigned to a tire indicating the maximum speed at which a tire can operate.

**Traction:** The friction between the tire and the road surface. The amount of grip provided.

**Tread:** The portion of a tire that comes into contact with the road.

**Treadwear Indicators:** Narrow bands, sometimes called "wear bars," that show across the tread of a tire when only 2/32 inch of tread remains.

**UTQGS:** Uniform Tire Quality Grading Standards, a tire information system that provides consumers with ratings for a tire's traction, temperature and treadwear. Ratings are determined by tire manufacturers using government testing procedures. The ratings are molded into the sidewall of the tire.

**Vehicle Capacity Weight:** The number of designated seating positions multiplied by 150 lbs. (68 kg) plus the rated cargo and luggage load.

**Vehicle Maximum Load on the Tire:** Load on an individual tire due to curb and accessory weight plus maximum occupant and cargo weight.

**Vehicle Normal Load on the Tire:** Load on an individual tire that is determined by distributing to each axle its share of the curb weight, accessory weight, and normal occupant weight and driving by 2.

**Vehicle Placard:** A label permanently attached to a vehicle showing the original equipment tire size and recommended inflation pressure.

## All season tires

Hyundai specifies all season tires on some models to provide good performance for use all year round, including snowy and icy road conditions. All season tires are identified by ALL SEASON and/or M+S (Mud and Snow) on the tire sidewall. Snow tires have better snow traction than all season tires and may be more appropriate in some areas.

## Summer tires

Hyundai specifies summer tires on some models to provide superior performance on dry roads. Summer tire performance is substantially reduced in snow and ice. Summer tires do not have the tire traction rating M+S (Mud and Snow) on the tire side wall. If you plan to operate your vehicle in snowy or icy conditions, Hyundai recommends the use of snow tires or all season tires on all four wheels.

## Snow tires

If you equip your car with snow tires, they should be the same size and have the same load capacity as the original tires. Snow tires should be installed on all four wheels; otherwise, poor handling may result.

Snow tires should carry 4 psi (28 kPa) more air pressure than the pressure recommended for the standard tires on the tire label on the driver's side of the center pillar, or up to the maximum pressure shown on the tire sidewall, whichever is less.

Do not drive faster than 75 mph (120 km/h) when your car is equipped with snow tires.

## Tire chains

Tire chains, if necessary, should be installed on the drive wheels (front wheel).

Be sure that the chains are installed in accordance with the manufacturer's instructions.

To minimize tire and chain wear, do not continue to use tire chains when they are no longer needed.

### **WARNING - Snow or ice**

- When driving on roads covered with snow or ice, drive at less than 20 mph (30 km/h).
- Use the SAE "S" class or wire chains.
- If you have noise caused by chains contacting the body, retighten the chain to avoid contact with the vehicle body.
- To prevent body damage, retighten the chains after driving 0.3~0.6 miles.
- Do not use tire chains on vehicles equipped with aluminum wheels. In unavoidable circumstance, use a wire type chain.
- Use wire chains less than 15mm to prevent damage to the chain's connection.

### **CAUTION**

- If you hear noise caused by chains contacting the body, retighten the chain to avoid contact with the vehicle body.
- To prevent body damage, retighten the chains after driving 0.3 ~ 0.6 miles (0.5 ~ 1.0 km).

## LIGHT BULBS REPLACEMENT

### **⚠ WARNING - Working on the lights**

Prior to working on the light, firmly apply the parking brake, ensure that the ignition switch is turned to the "LOCK" position and turn off the lights to avoid sudden movement of the vehicle and burning your fingers or receiving an electric shock.

Use only the bulbs of the specified wattage.

### **⚠ CAUTION**

Be sure to replace the burned-out bulb with one of the same wattage rating. Otherwise, it may cause damage to the fuse or electric wiring system.

### **⚠ CAUTION**

If you don't have necessary tools, the correct bulbs and the expertise, consult an Authorized Hyundai Dealer. In many cases, it is difficult to replace vehicle light bulbs because other parts of the vehicle must be removed before you can get to the bulb. This is especially true if you have to remove the headlight assembly to get to the bulb(s). Removing/installing the headlight assembly can result in damage to the vehicle.

### **\* NOTICE**

After driving in heavy rain or washing, headlight and taillight lenses could appear frosty. This condition is caused by the temperature difference between the lamp inside and outside. This is similar to the condensation on your windows inside your vehicle during the rain and doesn't indicate a problem with your vehicle. If the water leaks into the lamp bulb circuitry, have the vehicle checked by an Authorized Hyundai Dealer.



OVQ036901N

### **Headlight aiming adjustment**

To performing aiming adjustment, open the engine hood and find the access hole in grille guard assembly for vertical headlight adjustment.



## Headlight bulb

- (1) Headlight (High)
- (2) Headlight (Low)
- (3) Position light/Front turn signal light
- (4) Front side mark light
- (5) Front fog light (if equipped)



## **⚠ WARNING - Halogen bulbs**

- Halogen bulbs contain pressurized gas that will produce flying pieces of glass if broken.
- Always handle them carefully, and avoid scratches and abrasions. If the bulbs are lit, avoid contact with liquids. Never touch the glass with bare hands. Residual oil may cause the bulb to overheat and burst when lit. A bulb should be operated only when installed in a headlight.
- If a bulb becomes damaged or cracked, replace it immediately and carefully dispose of it.
- Wear eye protection when changing a bulb. Allow the bulb to cool down before handling it.

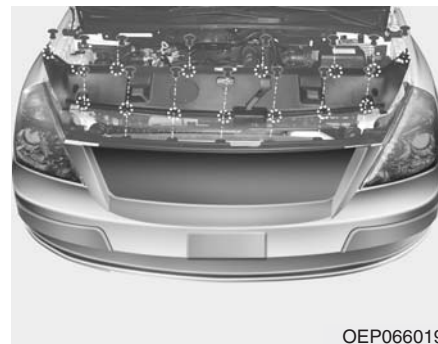

1. Open the hood and loosen the fastener on the radiator grill cover.



1VQA5034

2. Loosen the retaining bolts and remove the headlight assembly from the body of the vehicle.
3. Remove the headlight bulb cover by turning it counterclockwise.
4. Disconnect the headlight bulb socket-connector.
5. Unsnap the headlight bulb retaining wire by depressing the end and pushing it upward.
6. Remove the bulb from the headlight assembly.

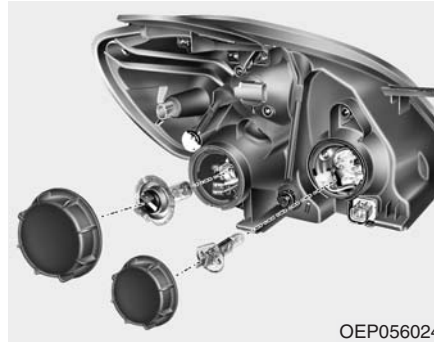

OEP056024

7. Install a new headlight bulb and snap the headlight bulb retaining wire into position by aligning the wire with the groove on the bulb.
8. Connect the headlight bulb socket-connector.
9. Install the headlight bulb cover by turning it clockwise.
10. Reinstall the headlight assembly to the body of the vehicle.

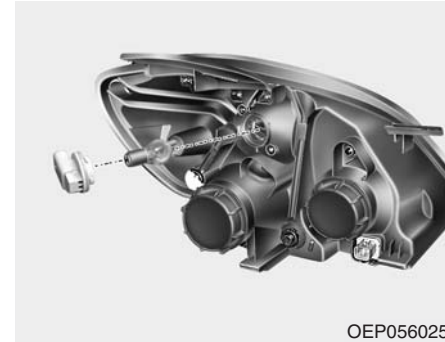

OEP056025

### Position/Turn signal light bulb

1. Open the hood.
2. Loosen the retaining bolts and remove the headlight assembly from the body of the vehicle.
3. Remove the socket from the assembly by turning the socket counterclockwise until the tabs on the socket align with the slots on the assembly.

4. Remove the bulb from the socket by pressing it in and rotating it until the tabs on the bulb align with the slots in the socket. Pull the bulb out of the socket.
5. Insert a new bulb by inserting it into the socket and rotating it until it locks into place.
6. Install the socket in the assembly by aligning the tabs on the socket with the slots in the assembly. Insert the socket into the assembly and turn the socket clockwise.
7. Reinstall the headlight assembly to the body of the vehicle.

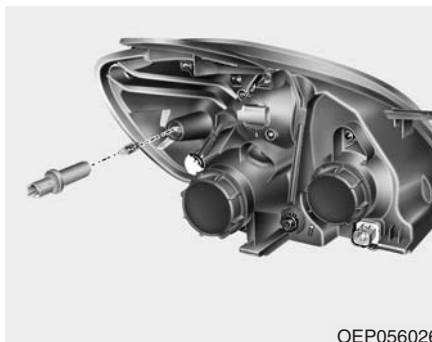

OEP056026

### Front side mark light bulb

1. Open the hood.
2. Loosen the retaining bolts and remove the headlight assembly from the body of the vehicle.
3. Remove the socket from the assembly by turning the socket counterclockwise until the tabs on the socket align with the slots on the assembly.
4. Remove the bulb by pulling it straight out.
5. Install a new bulb in the socket.
6. Install the socket in the assembly by aligning the tabs on the socket with the slots in the assembly. Insert the socket into the assembly and turn the socket clockwise.
7. Reinstall the headlight assembly to the body of the vehicle.

### Front fog light bulb

If the light bulb is not operating, have the vehicle checked by an authorized Hyundai Dealer.



Front map lamp



1VQA5043

Tailgate lamp

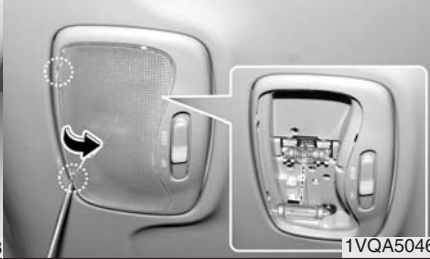

1VQA5046

Center/rear dome lamp



1VQA5044

Glove box lamp



OVQ066020N

Center dome lamp (if equipped)

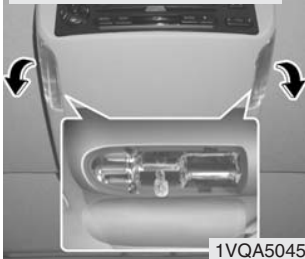

1VQA5045

Door courtesy lamp

• Front

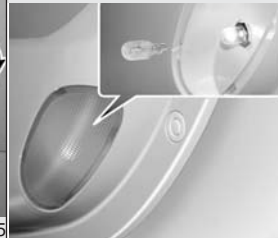

• Rear



1VQA5050

## Interior lights bulb replacement

1. Using a flat-blade screwdriver, gently pry the lens from the interior light housing.

### **⚠ WARNING**

**Prior to working on the Interior Lights, ensure that the "OFF" button is depressed to avoid burning your fingers or receiving an electric shock.**

2. Remove the bulb by pulling it straight out.
3. Install a new bulb in the socket.
4. Align the lens tabs with the interior light housing notches and snap the lens into place.

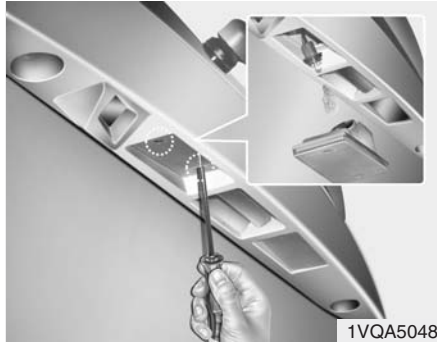

## License plate lights bulb

1. Loosen the lens retaining screws with a cross-tip screwdriver.
2. Remove the lens.
3. Remove the bulb by pulling it straight out.
4. Install a new bulb.
5. Reinstall the lens securely with the lens retaining screws.



## Rear combination light bulb

- (1) Stop and tail light
- (2) Back-up light
- (3) Rear turn signal light

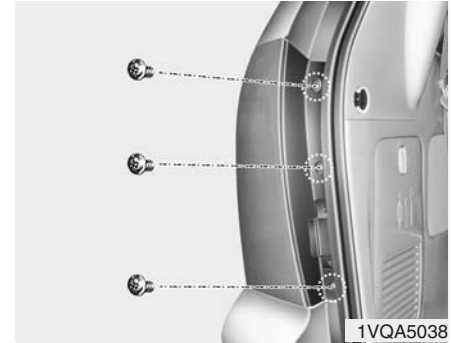

1. Open the tailgate.
2. Loosen the light assembly retaining screws with a cross-tip screwdriver.



3. Remove the rear combination light assembly from the body of the vehicle.

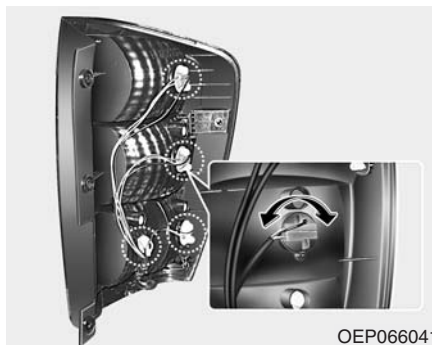

4. Remove the socket from the assembly by turning the socket counterclockwise until the tabs on the socket align with the slots on the assembly.

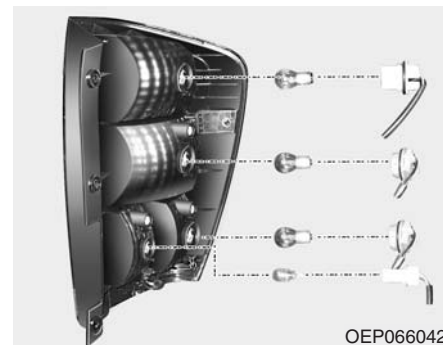

5. Remove the bulb from the socket by pressing it in and rotating it until the tabs on the bulb align with the slots in the socket. Pull the bulb out of the socket.
6. Insert a new bulb by inserting it into the socket and rotating it until it locks into place.
7. Install the socket in the assembly by aligning the tabs on the socket with the slots in the assembly. Push the socket into the assembly and turn the socket clockwise.
8. Replace the service cover and tighten the screws.



### **High mounted stop light bulb replacement**

If the light bulb is not operating, have the vehicle checked by an authorized Hyundai Dealer.

## LUBRICANT

### Recommended lubricants

To help achieve proper engine and powertrain performance and durability, use only lubricants of the proper quality. The correct lubricants also help promote engine efficiency that results in improved fuel economy.

Engine oils labeled Energy Conserving Oil are now available. Along with other additional benefits, they contribute to fuel economy by reducing the amount of fuel necessary to overcome engine friction. Often, these improvements are difficult to measure in everyday driving, but in a year's time, they can offer significant cost and energy savings.

#### PROPOSITION 65 WARNING

This product contains a chemical known to the State of California to cause cancer. Used engine oil may cause irritation or cancer of the skin if left in contact with the skin for prolonged periods of time. Used engine oil contains chemicals that have caused cancer in laboratory animals. Always protect your skin by washing your hands thoroughly with soap and warm water as soon as possible after handling used oil.

These lubricants and fluids are recommended for use in your vehicle.

Lubricant	Classification
Engine oil *1  <Recommends>	API Service SJ, SL or above, ILSAC GF-3 or above (SAE 5W-20, 5W-30)
Automatic transaxle fluid	HYUNDAI GEUINE ATF SP-III, DIAMOND ATF SP-III, SK ATF SP-III or other brands meeting the SP-III specification approved by Hyundai Motors Corp.
Power steering fluid	PSF-3
Brake fluid	FMVSS116 DOT-3, DOT-4 or Equivalent

\*1 Refer to the recommended SAE viscosity numbers on the next page.

## Recommended SAE viscosity number

### CAUTION

*Always be sure to clean the area around any filler plug, drain plug, or dipstick before checking or draining any lubricant. This is especially important in dusty or sandy areas and when the vehicle is used on unpaved roads. Cleaning the plug and dipstick areas will prevent dirt and grit from entering the engine and other mechanisms that could be damaged.*

Engine oil viscosity (thickness) has an effect on fuel economy and cold weather operating (starting and oil flow). Lower viscosity engine oils can provide better fuel economy and cold weather performance, however, higher viscosity engine oils are required for satisfactory lubrication in hot weather. Using oils of any viscosity other than those recommended could result in engine damage.

When choosing an oil, consider the range of temperature your vehicle will be operated in before the next oil change. Proceed to select the recommended oil viscosity from the chart.

Temperature Range for SAE Viscosity Numbers										
Temperature	°C	-30	-20	-10	0	10	20	30	40	50
	(°F)	-10	0	20	40	60	80	100	120	
Gasoline Engine Oil *1		<b>10W-30</b>								
		<b>5W-20, 5W-30</b>								

- For better fuel economy, it is recommended to use the engine oil of a viscosity grade SAE 5W-20, 5W-30 (API SJ, SL / ILSAC GF-3). However, if the engine oil is not available in your country, select the proper engine oil using the engine oil viscosity chart.

## CORROSION PROTECTION

### Protecting your Hyundai from corrosion

By using the most advanced design and construction practices to combat corrosion, Hyundai produces cars of the highest quality. However, this is only part of the job. To achieve the long-term corrosion resistance your Hyundai can deliver, the owner's cooperation and assistance is also required.

### Common causes of corrosion

The most common causes of corrosion on your car are:

- Road salt, dirt and moisture that is allowed to accumulate underneath the car.
- Removal of paint or protective coatings by stones, gravel, abrasion or minor scrapes and dents which leave unprotected metal exposed to corrosion.

### High-corrosion areas

If you live in an area where your car is regularly exposed to corrosive materials, corrosion protection is particularly important. Some of the common causes of accelerated corrosion are road salts, dust control chemicals, ocean air and industrial pollution.

### Moisture breeds corrosion

Moisture creates the conditions in which corrosion is most likely to occur. For example, corrosion is accelerated by high humidity, particularly when temperatures are just above freezing. In such conditions, the corrosive material is kept in contact with the car surfaces by moisture that is slow to evaporate.

Mud is particularly corrosive because it is slow to dry and holds moisture in contact with the vehicle. Although the mud appears to be dry, it can still retain the moisture and promote corrosion.

High temperatures can also accelerate corrosion of parts that are not properly ventilated so the moisture can be dispersed. For all these reasons, it is particularly important to keep your car clean and free of mud or accumulations of other materials. This applies not only to the visible surfaces but particularly to the underside of the car.

### To help prevent corrosion

You can help prevent corrosion from getting started by observing the following:

#### *Keep your car clean*

The best way to prevent corrosion is to keep your car clean and free of corrosive materials. Attention to the underside of the car is particularly important.

- If you live in a high-corrosion area — where road salts are used, near the ocean, areas with industrial pollution, acid rain, etc.—, you should take extra care to prevent corrosion. In winter, hose off the underside of your car at least once a month and be sure to clean the underside thoroughly when winter is over.

- When cleaning underneath the car, give particular attention to the components under the fenders and other areas that are hidden from view. Do a thorough job; just dampening the accumulated mud rather than washing it away will accelerate corrosion rather than prevent it. Water under high pressure and steam are particularly effective in removing accumulated mud and corrosive materials.
- When cleaning lower door panels, rocker panels and frame members, be sure that drain holes are kept open so that moisture can escape and not be trapped inside to accelerate corrosion.

#### *Keep your garage dry*

Don't park your car in a damp, poorly ventilated garage. This creates a favorable environment for corrosion. This is particularly true if you wash your car in the garage or drive it into the garage when it is still wet or covered with snow, ice or mud. Even a heated garage can contribute to corrosion unless it is well ventilated so moisture is dispersed.

#### *Keep paint and trim in good condition*

Scratches or chips in the finish should be covered with "touch-up" paint as soon as possible to reduce the possibility of corrosion. If bare metal is showing through, the attention of a qualified body and paint shop is recommended.

**Bird droppings :** Bird droppings are highly corrosive and may damage painted surfaces in just a few hours. Always remove bird droppings as soon as possible.

#### *Don't neglect the interior*

Moisture can collect under the floor mats and carpeting to cause corrosion. Check under the mats periodically to be sure the carpeting is dry. Use particular care if you carry fertilizers, cleaning materials or chemicals in the car.

These should be carried only in proper containers and any spills or leaks should be cleaned up, flushed with clean water and thoroughly dried.



## APPEARANCE CARE

### Exterior care

#### *Exterior general caution*

It is very important to follow the label directions when using any chemical cleaner or polish. Read all warning and caution statements that appear on the label.

#### *Finish maintenance*

##### **Washing**

To help protect your vehicle's finish from rust and deterioration, wash it thoroughly and frequently at least once a month with lukewarm or cold water.

If you use your vehicle for off-road driving, you should wash it after each off-road trip. Pay special attention to the removal of any accumulation of salt, dirt, mud, and other foreign materials. Make sure the drain holes in the lower edges of the doors and rocker panels are kept clear and clean.

Insects, tar, tree sap, bird droppings, industrial pollution and similar deposits can damage your vehicle's finish if not removed immediately.

Even prompt washing with plain water may not completely remove all these deposits. A mild soap, safe for use on painted surfaces, may be used.

After washing, rinse the vehicle thoroughly with lukewarm or cold water. Do not allow soap to dry on the finish.

#### **CAUTION**

***Do not use strong soap, chemical detergents or hot water, and do not wash the vehicle in direct sunlight or when the body of the vehicle is warm.***

#### **WARNING - Wet brakes**

**After washing the vehicle, test the brakes while driving slowly to see if they have been affected by water. If braking performance is impaired, dry the brakes by applying them lightly while maintaining a slow forward speed.**

#### **CAUTION**

- ***Water washing in the engine compartment may cause the failure of electrical circuits located in the engine compartment.***
- ***Never allow water or other liquids to come in contact with electrical/electronic components inside the vehicle as this may damage them.***

## Waxing

Wax the vehicle when water will no longer bead on the paint.

Always wash and dry the vehicle before waxing. Use a good quality liquid or paste wax, and follow the manufacturer's instructions. Wax all metal trim to protect it and to maintain its luster.

Removing oil, tar, and similar materials with a spot remover will usually strip the wax from the finish. Be sure to re-wax these areas even if the rest of the vehicle does not yet need waxing.

### CAUTION

- ***Wiping dust or dirt off the body with a dry cloth will scratch the finish.***
- ***Do not use steel wool, abrasive cleaners, or strong detergents containing highly alkaline or caustic agents on chrome-plated or anodized aluminum parts. This may result in damage to the protective coating and cause discoloration or paint deterioration.***

## Finish damage repair

Deep scratches or stone chips in the painted surface must be repaired promptly. Exposed metal will quickly rust and may develop into a major repair expense.

### \* NOTICE

**If your vehicle is damaged and requires any metal repair or replacement, be sure the body shop applies anti-corrosion materials to the parts repaired or replaced.**

## Bright-metal maintenance

- To remove road tar and insects, use a tar remover, not a scraper or other sharp object.
- To protect the surfaces of bright-metal parts from corrosion, apply a coating of wax or chrome preservative and rub to a high luster.
- During winter weather or in coastal areas, cover the bright metal parts with a heavier coating of wax or preservative. If necessary, coat the parts with non-corrosive petroleum jelly or other protective compound.

## Underbody maintenance

Corrosive materials used for ice and snow removal and dust control may collect on the underbody. If these materials are not removed, accelerated rusting can occur on underbody parts such as the fuel lines, frame, floor pan and exhaust system, even though they have been treated with rust protection.

Thoroughly flush the vehicle underbody and wheel openings with lukewarm or cold water once a month at the end of each winter. Pay special attention to these areas because it is difficult to see all the mud and dirt. It will do more harm than good to wet down the road grime without removing it. The lower edges of doors, rocker panels, and frame members have drain holes that should not be allowed to clog with dirt; trapped water in these areas can cause rusting.

### WARNING

**After washing the vehicle, test the brakes while driving slowly to see if they have been affected by water. If braking performance is impaired, dry the brakes by applying them lightly while maintaining a slow forward speed.**

### **Aluminum wheel maintenance**

The aluminum wheels are coated with a clear protective finish.

- Do not use any abrasive cleaner, polishing compound, solvent, or wire brushes on aluminum wheels. They may scratch or damage the finish.
- Use only a mild soap or neutral detergent, and rinse thoroughly with water. Also, be sure to clean the wheels after driving on salted roads. This helps prevent corrosion.
- Avoid washing the wheels with high-speed car wash brushes.
- Do not use any acid detergent. It may damage and corrode the aluminum wheels coated with a clear protective finish.

### **Interior care**

#### ***Interior general precautions***

Prevent caustic solutions such as perfume and cosmetic oil from contacting the dashboard because they may cause damage or discoloration. If they do contact the dashboard, wipe them off immediately. See the instructions that follow for the proper way to clean vinyl.

#### ***CAUTION***

***Never allow water or other liquids to come in contact with electrical/electronic components inside the vehicle as this may damage them.***

#### ***Cleaning the upholstery and interior trim***

##### **Vinyl**

Remove dust and loose dirt from vinyl with a whisk broom or vacuum cleaner. Clean vinyl surfaces with a vinyl cleaner.

##### **Fabric**

Remove dust and loose dirt from fabric with a whisk broom or vacuum cleaner. Clean with a mild soap solution recommended for upholstery or carpets. Remove fresh spots immediately with a fabric spot cleaner. If fresh spots do not receive immediate attention, the fabric can be stained and its color can be affected. Also, its fire-resistant properties can be reduced if the material is not properly maintained.

#### ***CAUTION***

***Using anything but recommended cleaners and procedures may affect the fabric's appearance and fire-resistant properties.***

## ***Cleaning the lap/shoulder belt webbing***

Clean the belt webbing with any mild soap solution recommended for cleaning upholstery or carpet. Follow the instructions provided with the soap. Do not bleach or re-dye the webbing because this may weaken it.

## ***Cleaning the interior window glass***

If the interior glass surfaces of the vehicle become fogged (that is, covered with an oily, greasy or waxy film), they should be cleaned with glass cleaner. Follow the directions on the glass cleaner container.

### ***CAUTION***

***Do not scrape or scratch the inside of the rear window. This may result in damage to the rear window defroster grid.***

## **EMISSION CONTROL SYSTEM**

The emission control system of your vehicle is covered by a written limited warranty. Please see the warranty information contained in the Owner's Handbook & Warranty Information booklet in your vehicle.

Your Hyundai is equipped with an emission control system to meet all emission regulations.

There are three emission control systems which are as follows.

- (1) Crankcase emission control system
- (2) Evaporative emission control system
- (3) Exhaust emission control system

In order to assure the proper function of the emission control systems, it is recommended that you have your car inspected and maintained by an authorized Hyundai dealer in accordance with the maintenance schedule in this manual.

## **Caution for the Inspection and Maintenance Test (With Electronic Stability Control (ESC) system)**

- **To prevent the vehicle from misfiring during dynamometer testing, turn the Electronic Stability Control (ESC) system off by pressing the ESC switch.**
- **After dynamometer testing is completed, turn the ESC system back on by pressing the ESC switch again.**

## **1. Crankcase emission control system**

The positive crankcase ventilation system is employed to prevent air pollution caused by blow-by gases being emitted from the crankcase. This system supplies fresh filtered air to the crankcase through the air intake hose. Inside the crankcase, the fresh air mixes with blow-by gases, which then pass through the PCV valve into the induction system.

## 2. Evaporative emission control (including ORVR: Onboard Refueling Vapor Recovery) System

The Evaporative Emission Control System is designed to prevent fuel vapors from escaping into the atmosphere.

(The ORVR system is designed to allow the vapors from the fuel tank to be loaded into a canister while refueling at the gas station, preventing the escape of fuel vapors into the atmosphere.)

### *Canister*

Fuel vapors generated inside the fuel tank are absorbed and stored in the onboard canister. When the engine is running, the fuel vapors absorbed in the canister are drawn into the surge tank through the purge control solenoid valve.

### *Purge Control Solenoid Valve (PCSV)*

The purge control solenoid valve is controlled by the Engine Control Module (ECM); when the engine coolant temperature is low during idling, the PCSV closes so that evaporated fuel is not taken into the engine. After the engine warms-up during ordinary driving, the PCSV opens to introduce evaporated fuel to the engine.

## 3. Exhaust emission control system

The Exhaust Emission Control System is a highly effective system which controls exhaust emissions while maintaining good vehicle performance.

### *Vehicle modifications*

This vehicle should not be modified. Modification of your Hyundai could affect its performance, safety or durability and may even violate governmental safety and emissions regulations.

In addition, damage or performance problems resulting from any modification may not be covered under warranty.

### *Engine exhaust gas precautions (carbon monoxide)*

- Carbon monoxide can be present with other exhaust fumes. Therefore, if you smell exhaust fumes of any kind inside your vehicle, have it inspected and repaired immediately. If you ever suspect exhaust fumes are coming into your vehicle, drive it only with all the windows fully open. Have your vehicle checked and repaired immediately.

### **WARNING - Exhaust**

Engine exhaust gases contain carbon monoxide (CO). Though colorless and odorless, it is dangerous and could be lethal if inhaled. Follow the instructions following to avoid CO poisoning.

### **PROPOSITION 65 WARNING**

Engine exhaust and a wide variety of automobile components and parts, including components found in the interior furnishings in a vehicle, contain or emit chemicals known to the State of California to cause cancer and birth defects and reproductive harm. In addition, certain fluids contained in vehicles and certain products of component wear contain or emit chemicals known to the State of California to cause cancer and birth defects or other reproductive harm.

- Do not operate the engine in confined or closed areas (such as garages) any more than what is necessary to move the vehicle in or out of the area.
- When the vehicle is stopped in an open area for more than a short time with the engine running, adjust the ventilation system (as needed) to draw outside air into the vehicle.
- Never sit in a parked or stopped vehicle for any extended time with the engine running.
- When the engine stalls or fails to start, excessive attempts to re-start the engine may cause damage to the emission control system.

### Operating precautions for catalytic converters

#### **WARNING - Fire**

**A hot exhaust system can ignite flammable items under your vehicle. Do not park the vehicle over or near flammable objects, such as grass, vegetation, paper, leaves, etc.**

Your vehicle is equipped with a catalytic converter emission control device.

Therefore, the following precautions must be observed:

- Use only UNLEADED FUEL for gasoline engine.
- Do not operate the vehicle when there are signs of engine malfunction, such as misfire or a noticeable loss of performance.
- Do not misuse or abuse the engine. Examples of misuse are coasting with the ignition off and descending steep grades in gear with the ignition off.

- Do not operate the engine at high idle speed for extended periods (5 minutes or more).
- Do not modify or tamper with any part of the engine or emission control system. All inspections and adjustments must be made by an authorized Hyundai dealer.
- Avoid driving with a very low fuel level. If you run out of gasoline, it could cause the engine to misfire and result in excessive loading of the catalytic converter.

Failure to observe these precautions could result in damage to the catalytic converter and to your vehicle. Additionally, such actions could void your warranties.

---

**Label information / 7-2**

**Warranties for your Hyundai vehicle / 7-3**

**Consumer information / 7-4**

**Reporting safety defects / 7-5**

**Binding arbitration (U.S.A only) / 7-5**

**Consumer information**

**7**

---

## LABEL INFORMATION

There are several important labels and identification numbers located on your vehicle. The label locations are identified in the illustrations shown.

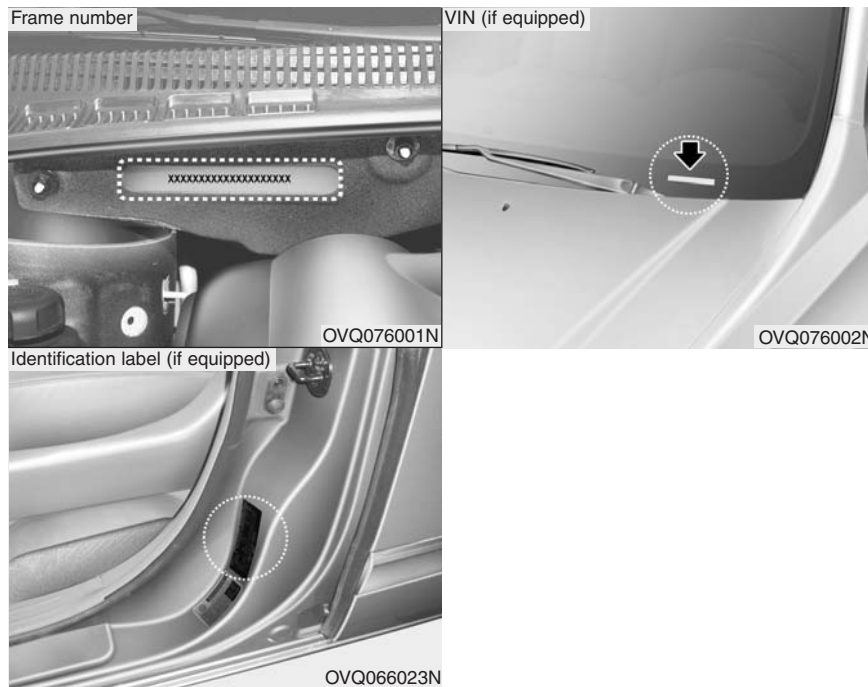

### Vehicle identification number (VIN)

The vehicle identification number (VIN) is the number used in registering your car and in all legal matters pertaining to its ownership, etc.



**Tire specification / pressure label**

Tire label located on the driver's side of the center pillar outer panel gives the cold tire pressures recommended for your vehicle with the original tire size, the number of people that can be in your vehicle and vehicle capacity weight.

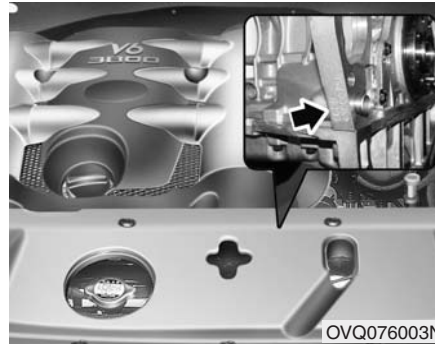
**Engine number**

The engine number is stamped on the engine block as shown in the drawing.

**WARRANTIES FOR YOUR HYUNDAI VEHICLE**

Please consult your Owner's Handbook & Warranty Information booklet for your vehicle's specific warranty coverage.

## CONSUMER INFORMATION

This consumer information has been prepared in accordance with regulations issued by the National Highway Traffic Safety Administration of the U.S. Department of Transportation. It provides the purchasers and/or prospective purchasers of Hyundai automobiles with information on uniform tire quality grading. Your Hyundai dealer will help answer any questions you may have as you read this information.

Hyundai motor vehicles are designed and manufactured to meet or exceed all applicable safety standards.

For your safety, however, we strongly urge you to read and follow all directions in this Owner's Manual, particularly the information under the headings "NOTICE", "CAUTION" and "WARNING".

If, after reading this manual, you have any questions regarding the operation of your vehicle, please contact your nearest Hyundai Motor America Regional Office as listed following:

**Eastern Region:** Connecticut, Delaware, Maine, Maryland, Massachusetts, New Hampshire, New Jersey, New York, Pennsylvania, Rhode Island, Vermont, Virginia, West Virginia.

Eastern Region  
1100 Cranbury South River Road  
Jamesburg, NJ 08831  
(800) 633-5151

**Southern Region:** Florida, Georgia, North Carolina, South Carolina.

Southern Region  
270 Riverside Parkway, Suite A  
Austell, GA 30168  
(800) 633-5151

**South Central Region:** Alabama, Arkansas, Colorado, Kansas, Louisiana, Mississippi, Missouri, New Mexico, Oklahoma, Tennessee, Texas, Wyoming.

South Central Region  
1421 South Beltline Road, Suite 400  
Coppell, TX 75019  
(800) 633-5151

**Central Region:** Illinois, Indiana, Iowa, Kentucky, Michigan, Minnesota, Nebraska, North Dakota, South Dakota, Ohio, Wisconsin.

Central Region  
1705 Sequoia Drive  
Aurora, Illinois 60506  
(800) 633-5151

**Western Region:** Alaska, Hawaii, Arizona, California, Idaho, Montana, Nevada, Oregon, Texas, Utah, Washington.

Western Region  
10550 Talbert Avenue  
P.O.Box 20850  
Fountain Valley, California 92728-0850  
(800) 633-5151

**REPORTING SAFETY DEFECTS**

If you believe that your vehicle has a defect which could cause a crash or could cause injury or death, you should immediately inform the National Highway Traffic Safety Administration (NHTSA) in addition to notifying HYUNDAI MOTOR AMERICA. If NHTSA receives similar complaints, it may open an investigation, and if it finds that a safety defect exists in a group of vehicles, it may order a recall and remedy campaign. However, NHTSA cannot become involved in individual problems between you, your dealer, or HYUNDAI MOTOR AMERICA.

To contact NHTSA, you may call the Vehicle Safety Hotline toll-free at 1-888-327-4236 (TTY: 1-800-424-9153); go to <http://www.safercar.gov>; or write to: Administrator, NHTSA, 400 Seventh Street, SW., Washington, DC 20590. You can also obtain other information about motor vehicle safety from <http://www.safercar.gov>.

**BINDING ARBITRATION (U.S.A ONLY)**

Any claim or dispute you may have related to your vehicle's warranty or the duties contemplated under the warranty, including claims related to the refund or partial refund of your vehicle's purchase price (excluding personal injury or product liability claims), shall be resolved by binding arbitration. Binding arbitration shall be administered by and through the National Arbitration Forum (NAF) or the American Arbitration Association (AAA), under the Code of Procedure of the entity you select.

You will not be responsible for paying filing and hearing fees above \$275.00. All other arbitration costs shall be borne by Hyundai Motor America. You are not responsible to pay any of the costs Hyundai incurs.

This Binding Arbitration Agreement shall not deprive you of any remedies available to you under applicable law. The parties are waiving their right to seek remedies in court, including the right to a jury trial.

This Binding Arbitration Agreement shall be governed by and interpreted under the Federal Arbitration Act, 9 U.S.C. sections 1-16. Judgment upon any award may be entered in any court having jurisdiction.

You may revoke this Arbitration Agreement by (1) written notice or (2) electronic notice. Written notice must be delivered (via certified mail) to Hyundai Motor America, Attn: Consumer Affairs, 10550 Talbert Avenue, P.O. Box 20849, Fountain Valley, CA 92728-0849.

Electronic notice must be submitted at the following website address: <http://warranty-arbitration.hyundaiUSA.com>. Notice must be received within 90 days after you purchase your vehicle.

---

**Dimensions / 8-2**  
**Bulb wattage / 8-2**  
**Tires / 8-3**  
**Capacities / 8-3**

**Specifications**

## DIMENSIONS

Item	in (mm)
Overall length	202.0 (5130)
Overall width	78.1 (1985) <sup>1</sup> / 76.4 (1940)
Overall height	71.5 (1815) <sup>2</sup> / 69.3 (1760)
Front tread	66.3 (1685)
Rear tread	66.3 (1685)
Wheelbase	118.9 (3020)

<sup>1</sup> With door handle

<sup>2</sup> With roof rack

## BULB WATTAGE

Light Bulb	Wattage
Headlights (Low)	55
Headlights (High)	55
Front turn signal/Position lights	28/8 (Amber)
Side mark lights	5
Front fog lights	51
Stop and tail lights	27/8
Rear turn signal lights	27 (Amber)
Back-up lights	16
High mounted stop light	LED <sup>1</sup>
License plate lights	5
Front map lamps	10
Center dome lamps	10
Tailgate lamp	10
Door courtesy lamps	5
Glove box lamp	5
Vanity mirror lamps	3

<sup>1</sup> LED : Light-emitting diode

**TIRES**

Item	Tire size	Wheel size	Inflation pressure psi (kPa)		Wheel lug nut torque lb•ft (kg•m, N•m)
			Front	Rear	
Full size tire	225/70R16 102T	6.5J×16	35	35	65~79 (9~11 , 88~107)
	235/60R17 102T	6.5J×17	(240)	(240)	
Compact spare tire	T135/90R17 104M	4.0T×17	60 (420)	60 (420)	

**CAPACITIES**

Lubricant	Volume	Classification
Engine oil <sup>*1</sup> (with filter change)  <Recommends>	5.91 US qt. (5.6 l)	API Service SJ, SL or above, ILSAC GF-3 or above (SAE 5W-20, 5W-30)
Automatic transaxle fluid	11.52 US qt. (10.9 l)	HYUNDAI GENUINE ATF SP-III, DIAMOND ATF SP-III, SK ATF SP-III or other brands meeting the SP-III specification approved by Hyundai Motors Corp.
Power steering	1.06 US qt. (1.0 l)	PSF-3
Coolant	9.09 US qt. (8.6 l)	Ethylene glycol base for aluminum radiator
Brake fluid	0.7~0.8 US qt. (0.7~0.8 l)	FMVSS116 DOT-3, DOT-4 or Equivalent
Fuel	21.1 US gal. (80 l)	-

\*1 Refer to the recommended SAE viscosity numbers on the page 6-59.



**A**

Air bag - advanced supplemental restraint system .....	3-78
Driver's and passenger's front air bag .....	3-79
SRS components and functions .....	3-83
Occupant classification system .....	3-86
Side impact air bag .....	3-91
Curtain air bag .....	3-93
SRS care .....	3-94
Air bag warning label .....	3-101
Air cleaner .....	6-15
Antenna .....	3-180
Appearance care .....	6-63
Audio remote control .....	3-181
Audio system .....	3-182
M445 .....	3-185
M455 .....	3-191
M465 .....	3-201
Automatic climate control system .....	3-149
Air conditioning button .....	3-155
Heating and ventilation (front) .....	3-150
Heating and ventilation (rear) .....	3-157
Automatic transaxle .....	4-7
Ignition key interlock system .....	4-13
Automatic transaxle operation .....	4-8
Transaxle ranges .....	4-9
Sports mode .....	4-10
Shift lock system .....	4-12
Automatic transaxle .....	6-17

**B**

Back warning system .....	4-25
Battery .....	6-35
Before driving .....	4-3
Bidding arbitration (U.S.A only) .....	7-5
Brake system .....	4-17
Anti-lock brake system (ABS) .....	4-20
Parking brake .....	4-19
Power brakes .....	4-17
Brakes .....	6-19
Bulb wattage .....	8-2

**C**

Capacities .....	8-3
Child restraint system .....	3-71
Tether anchor system .....	3-73
Child seat lower anchors .....	3-74
Placing a passenger seat belt into the auto lock mode .....	3-75
Climate control air filter .....	6-22
Consumer assistance .....	7-4
Corrosion protection .....	6-61
Cruise control system .....	4-14

**D**

Defroster .....	3-136
Dimensions .....	8-2
Door locks .....	3-11



Central door lock switch .....	3-13
Child-protector rear door lock .....	3-15
Tailgate .....	3-15
Driver position memory system .....	3-56

**E**

Economical operation .....	4-29
Electronic stability control (ESC) .....	4-22
Emergency starting .....	5-3
Emission control system .....	6-66
Engine compartment .....	6-11
Engine coolant .....	6-13
Engine exhaust can be dangerous! .....	4-2
Engine oil .....	6-12
Explanation of scheduled maintenance items .....	6-7

**F**

Fuel filler lid .....	3-30
Fuel requirements .....	1-2
Fuses .....	6-26

**G**

Gauges .....	3-110
Engine temperature gauge .....	3-109
Fuel gauge .....	3-112
Instrument panel illumination .....	3-112
Odometer/Trip odometer .....	3-110
Speedometer .....	3-110

Tachometer .....	3-111
Good braking practices .....	4-28

**H**

Hazard warning flasher .....	3-137
Homelink® wireless control system .....	3-167
Hood .....	3-29
Horn .....	3-135
How to use this manual .....	1-2

**I**

If the engine overheats .....	5-5
If the engine will not start .....	5-2
If you have a flat tire .....	5-10
Carrying a flat tire .....	5-17
Changing tires .....	5-13
Removing the spare tire .....	5-10
Storing the spare tire .....	5-11
Important - use of compact spare tire .....	5-12
Immobilizer system .....	3-9
Instrument cluster .....	3-109
Instrument panel overview .....	2-3
Interior features .....	3-175
Ashtray .....	3-175
Cigarette lighter .....	3-175
Clothes hanger .....	3-178
Cup holder .....	3-176
Digital clock .....	3-180
Power outlet .....	3-179

Shopping bag holder .....	3-177
Sunvisor .....	3-178
Interior lights .....	3-125
Interior overview .....	2-2

**K**

Key positions .....	4-5
Illuminated ignition switch .....	4-5
Keys .....	3-3

**L**

Label information .....	7-2
Light bulbs replacement .....	6-51
Lighting .....	3-128
Lubricant .....	6-59
Lubricants and fluids .....	6-20
Luggage net holder .....	3-165

**M**

Maintenance services .....	6-2
Manual climate control system .....	3-138
Air conditioning button .....	3-143
Heating and ventilation (front) .....	3-139
Heating and ventilation (rear) .....	3-144
Mirrors .....	3-104

**O**

Owner maintenance .....	6-9
-------------------------	-----

**P**

Power adjustable pedals .....	3-58
Power sliding door and power tailgate .....	3-17
Power ON/OFF button .....	3-20
Power sliding door operation .....	3-21
Power tailgate operation .....	3-24
Power steering .....	6-21

**R**

Rear seat entertainment system / DVD player .....	3-212
Headphones .....	3-213
Audio via vehicle speakers .....	3-214
Connecting other devices to the RSE .....	3-215
Using the DVD player .....	3-216
Using the CD player .....	3-220
Using the remote control .....	3-225
Remote keyless entry .....	3-4
Reporting safety defects .....	7-5
Road warning .....	5-2
Roof rack .....	3-166

**S**

Scheduled maintenance service .....	6-2
Seat .....	3-37

Armrest .....	3-44
Headrest .....	3-42
Front seat adjustment - manual .....	3-39
Front seat adjustment - power .....	3-40
Lumbar support .....	3-45
Rear seat adjustment .....	3-46
Seatback pocket .....	3-44
Seat warmer .....	3-45
Seat belts .....	3-59
Seat belt precautions .....	3-59
Care of seat belts .....	3-61
Height adjustable shoulder belts .....	3-62
Driver's 3-point system .....	3-62
Passenger's 3-point system .....	3-63
3-point rear center belt .....	3-65
Proper use and care of the seat belt system .....	3-67
Pre-tensioner safety belt .....	3-68
Special driving conditions .....	4-30
Starting the engine .....	4-6
Steering wheel .....	3-102
Storage compartments .....	3-171
Center console storage .....	3-172
Glove box .....	3-173
Side table .....	3-174
Sunglass holder .....	3-174
Sunroof .....	3-33

**T**

Theft-alarm system .....	3-7
Tire pressure monitoring system (TPMS) .....	5-6

Tires .....	8-3
Tires and wheels .....	6-37
Towing .....	5-19
Tie-down hook .....	5-22
Trailer towing .....	4-34
Hitches .....	4-35
Safety chains .....	4-35
Trailer brakes .....	4-35
Weight of the trailer (tongue) .....	4-39
Trip computer .....	3-113

**V**

Vehicle break-in process .....	1-3
Vehicle data collection and event data recorders .....	1-4
Vehicle load limit .....	4-41
Compliance label .....	4-43
Tire and loading information label .....	4-41
Vehicle capacity weight .....	4-41
Seating capacity .....	4-41
Towing capacity .....	4-41
Cargo capacity .....	4-41

**W**

Warnings and indicators .....	3-119
Warranties for your Hyundai vehicle .....	7-3
Weight of the vehicle .....	4-40
Window .....	3-26
Rear quarter window (manual flip - open) .....	3-28
Power window lock switch .....	3-28

Windshield defrosting and defogging .....	3-162
Automatic climate control system .....	3-163
Defogging logic .....	3-164
Manual climate control system .....	3-162
Winter driving .....	4-32
Snow tires .....	4-32
Tire chains .....	4-32
Wiper blades .....	6-24
Wipers and washers .....	3-132

This Owner's Manual should be considered a part of the car and remain with it when it is sold for the use of the next owner.

OWNER'S INFORMATION

ORIGINAL OWNER \_\_\_\_\_

ADDRESS \_\_\_\_\_

CITY \_\_\_\_\_ STATE \_\_\_\_\_ ZIP CODE \_\_\_\_\_

DELIVERY DATE \_\_\_\_\_

(Date Sold to Original Retail Purchaser)

DEALER NAME \_\_\_\_\_ DEALER NO. \_\_\_\_\_

ADDRESS \_\_\_\_\_

CITY \_\_\_\_\_ STATE \_\_\_\_\_ ZIP CODE \_\_\_\_\_

**SERVICE STATION INFORMATION FUEL:**

UNLEADED gasoline only  
Pump Octane Rating of 87 (Research Octane Number 91) or higher.

**FUEL TANK CAPACITY**

Original, US.gal (Imp.gal., liter) 21.1 (17.6, 80)

**TIRE PRESSURE:**

See the label on the driver's side of the center pillar outer panel.

**OTHER TIRE INFORMATION:**

See page 8-3.

**HOOD RELEASE:**

Pull handle under left side of dash.

**ENGINE OIL:**

API grade SJ, SL or ABOVE / ILSAC grade GF-3 or ABOVE and fuel efficient oil. Use SAE 5W-20, 5W-30 or 10W-30 if normal temperatures are above 0°F(-18°C). For other viscosity recommendations, see page 6-60 or 8-3.

**AUTOMATIC TRANSAXLE:**

Apply the parking brake, with the engine running, shift the selector lever through all ranges and return to "N" (Neutral) position. Then check the level of fluid on the dipstick. Use only HYUNDAI GENUINE ATF SP III, DIAMOND ATF SP III, SK ATF SP III or other brands meeting the SP III specification approved by Hyundai Motor Co..

**QUICK INDEX**

- o Car will not start . . . . . 5-2
- o Flat tire . . . . . 5-10
- o Warning light/chime comes on . . . . . 3-119~3-124
- o Engine overheats . . . . . 5-5
- o Towing of your vehicle . . . . . 5-19
- o Starting the engine . . . . . 4-6
- o Driving tips for first 1,200 miles (2,000 km) . . . . . 1-3
- o Scheduled maintenance . . . . . 6-2
- o Reporting safety defects . . . . . 7-5