

Jeep[®]

2013

OWNER'S MANUAL

Wrangler

Includes Wrangler Unlimited

VEHICLES SOLD IN CANADA

With respect to any Vehicles Sold in Canada, the name Chrysler Group LLC shall be deemed to be deleted and the name Chrysler Canada Inc. used in substitution therefore.

DRIVING AND ALCOHOL

Drunken driving is one of the most frequent causes of accidents.

Your driving ability can be seriously impaired with blood alcohol levels far below the legal minimum. If you are drinking, don't drive. Ride with a designated non-drinking driver, call a cab, a friend, or use public transportation.

WARNING!

Driving after drinking can lead to an accident. Your perceptions are less sharp, your reflexes are slower, and your judgment is impaired when you have been drinking. Never drink and then drive.

This manual illustrates and describes the operation of features and equipment that are either standard or optional on this vehicle. This manual may also include a description of features and equipment that are no longer available or were not ordered on this vehicle. Please disregard any features and equipment described in this manual that are not on this vehicle.

Chrysler Group LLC reserves the right to make changes in design and specifications, and/or make additions to or improvements to its products without imposing any obligation upon itself to install them on products previously manufactured.

Jeep[®]

Jeep is a registered trademark of Chrysler Group LLC

Copyright © 2012 Chrysler Group LLC



TABLE OF CONTENTS

SECTION		PAGE
1	INTRODUCTION	3
2	THINGS TO KNOW BEFORE STARTING YOUR VEHICLE	11
3	UNDERSTANDING THE FEATURES OF YOUR VEHICLE	105
4	UNDERSTANDING YOUR INSTRUMENT PANEL	295
5	STARTING AND OPERATING	405
6	WHAT TO DO IN EMERGENCIES	537
7	MAINTAINING YOUR VEHICLE	559
8	MAINTENANCE SCHEDULES	613
9	IF YOU NEED CONSUMER ASSISTANCE	623
10	INDEX	633

INTRODUCTION

CONTENTS

■ INTRODUCTION	4	■ WARNINGS AND CAUTIONS	8
■ ROLLOVER WARNING	5	■ VEHICLE IDENTIFICATION NUMBER	8
■ HOW TO USE THIS MANUAL	6	■ VEHICLE MODIFICATIONS/ALTERATIONS	9

INTRODUCTION

Congratulations on selecting your new Chrysler Group LLC vehicle. Be assured that it represents precision workmanship, distinctive styling, and high quality - all essentials that are traditional to our vehicles.

This is a specialized utility vehicle. It can go places and perform tasks that conventional passenger cars are not intended. It handles and maneuvers differently from many passenger cars both on-road and off-road, so take time to become familiar with your vehicle.

The two-wheel drive version of this vehicle was designed for on-road use only. It is not intended for off-road driving or use in other severe conditions suited for a four-wheel drive vehicle.

Before you start to drive this vehicle, read the Owner's Manual. Be sure you are familiar with all vehicle controls, particularly those used for braking, steering, transmission, and transfer case shifting. Learn how your vehicle handles on different road surfaces. Your driving skills will improve with experience. When driving off-road or working the vehicle, don't overload the vehicle or expect the vehicle to overcome the natural laws of physics. Always observe federal, state, provincial and local laws wherever you drive.

As with other vehicles of this type, failure to operate this vehicle correctly may result in loss of control or a collision. Refer to "On-Road/Off-Road Driving Tips" in "Starting And Operating" for further information.

This Owner's Manual has been prepared with the assistance of service and engineering specialists to acquaint you with the operation and maintenance of your vehicle. It is supplemented by Warranty Information, and various customer-oriented documents. Please take the time to read these publications carefully. Following the instructions and recommendations in this manual will help assure safe and enjoyable operation of your vehicle.

NOTE: After reviewing the owner information, it should be stored in the vehicle for convenient referencing and remain with the vehicle when sold.

When it comes to service, remember that your authorized dealer knows your vehicle best, has factory-trained technicians and genuine MOPAR® parts, and cares about your satisfaction.

ROLLOVER WARNING

Utility vehicles have a significantly higher rollover rate than other types of vehicles. This vehicle has a higher ground clearance and a higher center of gravity than many passenger cars. It is capable of performing better in a wide variety of off-road applications. Driven in an unsafe manner, all vehicles can go out of control. Because of the higher center of gravity and the narrower track, if this vehicle is out of control it may roll over when some other vehicles may not.

6 INTRODUCTION

Do not attempt sharp turns, abrupt maneuvers, or other unsafe driving actions that can cause loss of vehicle control. Failure to operate this vehicle safely may result in a collision, rollover of the vehicle, and severe or fatal injury. Drive carefully.

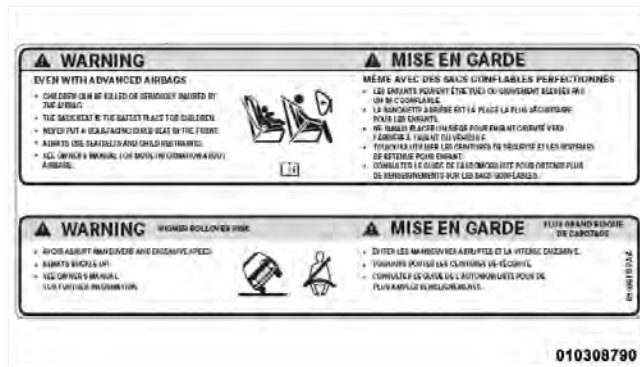

Rollover Warning Label

Failure to use the driver and passenger seat belts provided is a major cause of severe or fatal injury. In a rollover crash, an unbelted person is significantly more likely to die than a person wearing a seat belt. Always buckle up.

HOW TO USE THIS MANUAL

Consult the Table of Contents to determine which section contains the information you desire.

Since the specification of your vehicle depends on the items of equipment ordered, certain descriptions and illustrations may differ from your vehicle's equipment.

The detailed index at the back of this Owner's Manual contains a complete listing of all subjects.

Consult the following table for a description of the symbols that may be used on your vehicle or throughout this Owner's Manual:

											
WATER IN FUEL	REAR WINDOW WIPER	WINDSHIELD WIPER INTERMITTENT	EXTERIOR BULB FAILURE	HIGH BEAM	TURN SIGNALS	UPPER AIR OUTLET	HEATED SEAT LOW	DOOR LOCK	ADJUSTABLE PEDALS	ELECTRONIC SPEED CONTROL	ELECTRONIC STABILITY PROGRAM / BRAKE ASSIST SYSTEM
											
FUEL	REAR WINDOW INTERMITTENT WIPER	WINDSHIELD WASHER	MASTER LIGHTING SWITCH	LOW BEAM	KEY ACTIVATE (POWER OUTLET)	UPPER AND LOWER AIR OUTLET	HEATED SEAT HIGH	WINDOW LIFT	TIRE PRESSURE MONITOR	HILL DESCENT CONTROL	BRAKE ASSIST SYSTEM
											
FUEL FILL SIDE	REAR WINDOW WASHER	WINDSHIELD WASHER FLUID LEVEL	DOME LIGHT	FRONT FOG LIGHT	HOOD RELEASE	LOWER AIR OUTLET	RECIRCULATION	CONVERTIBLE 4 WINDOW DOWN	ELECTRONIC STABILITY CONTROL	AWD!	FAILURE OF ANTI-LOCK BRAKING SYSTEM
											
ENGINE OIL	REAR WINDOW DEFROST	WINDSHIELD, ELECTRICALLY HEATED	PARK LIGHTS	REAR FOG LAMP	LIFTGATE RELEASE AND LIFTGATE OPEN	DEFROST AND LOWER AIR OUTLET	VENTILATING FAN	WINDOW LOCK	ELECTRONIC THROTTLE CONTROL	4WD!	BRAKE ASSIST SYSTEM WARNING PARKING BRAKE
											
BATTERY CHARGING	HEATED MIRROR	WINDSHIELD DEFROST	INSTRUMENT PANEL ILLUMINATION	SEAT BELT	SLIDING DOOR	TRUNK / DECK RELEASE	AIR CONDITIONING	CHILD SEAT TETHER ANCHOR	VOICE RECOGNITION BUTTON	WARNING	TOW / HAUL
											
GLOW PLUG	POWER STEERING FLUID	WINDSHIELD WIPER AND WASHER	SIDE AIRBAG	AIRBAG	SLIDING DOOR	EMERGENCY RELEASE HANDLE	LIGHTER	LOWER ANCHORS AND TETHER FOR CHILDREN (LATCH)	UCONNECT™ BUTTON	HAZARD	4 LOW
											
MALFUNCTION INDICATOR LIGHT	TRANS OIL TEMP	ENGINE COOLANT TEMPERATURE	SUPPLEMENTAL RESTRAINT SYSTEM	PASSENGER AIRBAG OFF	DOOR AJAR	CONVERTIBLE TOP DOWN	CONVERTIBLE TOP UP	HORN	SEE OWNER'S MANUAL ISO	A/C PUSH	ELECTRONIC STABILITY CONTROL OFF

WARNINGS AND CAUTIONS

This Owners Manual contains **WARNINGS** against operating procedures that could result in a collision or bodily injury. It also contains **CAUTIONS** against procedures that could result in damage to your vehicle. If you do not read this entire Owners Manual, you may miss important information. Observe all Warnings and Cautions.

VEHICLE IDENTIFICATION NUMBER

The Vehicle Identification Number (VIN) is found on the left front corner of the instrument panel pad, visible from outside of the vehicle through the windshield. This number also appears underbody, on the right side of the frame rail near the center of the vehicle, as well as on the Automobile Information Disclosure Label affixed to a window on your vehicle. Save this label for a convenient record of your vehicle identification number and optional equipment.



Vehicle Identification Number

NOTE: It is illegal to remove or alter the VIN plate.

VEHICLE MODIFICATIONS/ALTERATIONS

WARNING!

Any modifications or alterations to this vehicle could seriously affect its roadworthiness and safety and may lead to a collision resulting in serious injury or death.

THINGS TO KNOW BEFORE STARTING YOUR VEHICLE

CONTENTS

2

■ A WORD ABOUT YOUR KEYS	14	□ To Disarm The System	20
□ Ignition Key Removal	14	■ ILLUMINATED ENTRY — IF EQUIPPED	21
□ Key-In-Ignition Reminder	16	■ REMOTE KEYLESS ENTRY (RKE) — IF EQUIPPED	22
■ SENTRY KEY®	16	□ To Unlock The Doors And Swing Gate	22
□ Replacement Keys	17	□ Remote Key Unlock On First Press	22
□ Customer Key Programming	18	□ To Lock The Doors And Swing Gate	23
□ General Information	19	□ Sound Horn On Lock	24
■ VEHICLE SECURITY ALARM — IF EQUIPPED .19		□ Using The Panic Alarm	24
□ Rearming The System	20	□ To Turn Off Flash Lights With Lock	25
□ To Arm The System	20		

12 THINGS TO KNOW BEFORE STARTING YOUR VEHICLE

- Programming Additional Transmitters 26
- General Information 26
- Transmitter Battery Replacement 27
- REMOTE STARTING SYSTEM —
IF EQUIPPED 28
- How To Use Remote Start 28
- DOORS 31
- Upper Half Door Window Removal — If
Equipped 31
- Upper Half Door Window Installation — If
Equipped 31
- Front Door Removal 32
- Rear Door Removal (Four-Door Models) 34
- DOOR LOCKS 36
- Manual Door Locks 36
- Power Door Locks — If Equipped 38
- Child-Protection Door Lock System — Rear
Doors. 40
- WINDOWS 41
- Power Windows — If Equipped 41
- Wind Buffeting 43
- REAR SWING GATE 44
- OCCUPANT RESTRAINTS 45
- Lap/Shoulder Belts 48
- Rear Center Lap/Shoulder Belt Retractor
Lockout — Four-Door Models Only 54
- Lap/Shoulder Belt Untwisting Procedure 55

□ Adjustable Upper Shoulder Belt Anchorage55
□ Seat Belts In Passenger Seating Positions56
□ Automatic Locking Retractor Mode (ALR) — If Equipped57
□ Energy Management Feature58
□ Seat Belt Pretensioners59
□ Enhanced Seat Belt Use Reminder System (BeltAlert®)59
□ Seat Belts And Pregnant Women61
□ Seat Belt Extender61
□ Supplemental Restraint System (SRS) — Air Bags62

THINGS TO KNOW BEFORE STARTING YOUR VEHICLE 13

□ Air Bag Deployment Sensors And Controls67
□ Event Data Recorder (EDR)75
□ Child Restraints76
■ ENGINE BREAK-IN RECOMMENDATIONS98
■ SAFETY TIPS99
□ Transporting Passengers.99
□ Exhaust Gas100
□ Safety Checks You Should Make Inside The Vehicle101
□ Periodic Safety Checks You Should Make Outside The Vehicle103

A WORD ABOUT YOUR KEYS

The keys for your new vehicle are enclosed in a plastic bag with the key code number on it. If you received your keys without the bag, ask your authorized dealer to give you the number. The key code can also be obtained by your authorized dealer from your vehicle invoice.

Ignition Key Removal

1. Place the shift lever in PARK (if equipped with an automatic transmission).
2. Turn the ignition switch to the ACC (ACCESSORY) position.

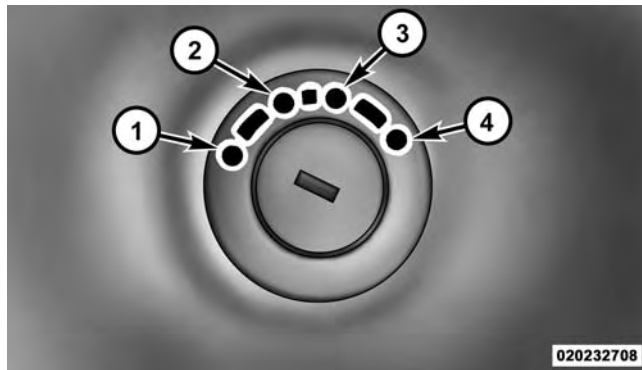

Ignition Switch Positions

- | | |
|---------------------|------------|
| 1 — LOCK | 3 — ON/RUN |
| 2 — ACC (ACCESSORY) | 4 — START |
-

3. Push the ignition key inward.
4. Turn the ignition key to the LOCK position, and remove the key.

WARNING!

- Before exiting a vehicle, always apply the parking brake, shift the transmission into PARK, and remove the Key Fob from the ignition. When leaving the vehicle, always lock your vehicle.
- Never leave children alone in a vehicle, or with access to an unlocked vehicle.
- Allowing children to be in a vehicle unattended is dangerous for a number of reasons. A child or others could be seriously or fatally injured. Children should be warned not to touch the parking brake, brake pedal or the shift lever.

(Continued)

WARNING! (Continued)

- Do not leave the Key Fob in or near the vehicle, and do not leave the ignition in the ACC or ON/RUN position. A child could operate power windows, other controls, or move the vehicle.
- Do not leave children or animals inside parked vehicles in hot weather. Interior heat build-up may cause serious injury or death.

CAUTION!

An unlocked car is an invitation to thieves. Always remove key from the ignition and lock all doors when leaving the vehicle unattended.

Key-In-Ignition Reminder

Opening the driver's door when the key is in the ignition sounds a signal to remind you to remove the key.

NOTE: The Key-In-Ignition reminder only sounds when the ignition key is placed in the LOCK or ACC position.

SENTRY KEY®

The Sentry Key® Immobilizer System prevents unauthorized vehicle operation by disabling the engine. The system does not need to be armed or activated. Operation is automatic, regardless of whether the vehicle is locked or unlocked.

The system uses ignition keys that have an embedded electronic chip (transponder) to prevent unauthorized vehicle operation. Therefore, only keys that are programmed to the vehicle can be used to start and operate the vehicle. The system will shut the engine off in two seconds if someone uses an invalid key to try to start the engine.

NOTE: A key that has not been programmed is also considered an invalid key, even if it is cut to fit the ignition switch lock cylinder for that vehicle.

During normal operation, after turning on the ignition switch, the Vehicle Security Light will turn on for three seconds for a bulb check. If the light remains on after the bulb check, it indicates that there is a problem with the electronics. In addition, if the Vehicle Security Light begins to flash after the bulb check, it indicates that someone used an invalid key to try to start the engine. Either of these conditions will result in the engine being shut off after two seconds.

If the Vehicle Security Light turns on during normal vehicle operation (vehicle running for longer than 10 seconds), it indicates that there is a fault in the electronics. Should this occur, have the vehicle serviced as soon as possible by an authorized dealer.

CAUTION!

The Sentry Key® Immobilizer system is not compatible with some after-market remote starting systems. Use of these systems may result in vehicle starting problems and loss of security protection.

All of the keys provided with your new vehicle have been programmed to the vehicle electronics.

Replacement Keys

NOTE: Only keys that are programmed to the vehicle electronics can be used to start and operate the vehicle. Once a Sentry Key® is programmed to a vehicle, it cannot be programmed to any other vehicle.

CAUTION!

Always remove the Sentry Keys® from the vehicle and lock all doors when leaving the vehicle unattended.

At the time of purchase, the original owner is provided with a four-digit Personal Identification Number (PIN). Keep the PIN in a secure location. This number is required for authorized dealer replacement of keys. Duplication of keys may be performed at an authorized dealer or by following the customer key programming procedure. This procedure consists of programming a blank key to the vehicle electronics. A blank key is one that has never been programmed.

NOTE: When having the Sentry Key® Immobilizer System serviced, bring all vehicle keys with you to an authorized dealer.

Customer Key Programming

If you have two valid Sentry Keys®, you can program new Sentry Keys® to the system by performing the following procedure:

1. Cut the additional Sentry Key® Transponder blank(s) to match the ignition switch lock cylinder key code.
2. Insert the first valid key into the ignition switch. Turn the ignition switch to the ON/RUN position for at least three seconds, but no longer than 15 seconds. Then, turn the ignition switch to the LOCK position and remove the first key.
3. Insert the second valid key into the ignition switch. Turn the ignition switch to the ON/RUN position within 15 seconds. After 10 seconds, a chime will sound. In addition, the Vehicle Security Light will begin to flash. Turn the ignition switch to the LOCK position and remove the second key.

4. Insert a blank Sentry Key® into the ignition switch. Turn the ignition switch to the ON/RUN position within 60 seconds. After 10 seconds, a single chime will sound. In addition, the Vehicle Security Light will stop flashing. To indicate that programming is complete, the Vehicle Security Light will turn on again for three seconds and then turn off.

The new Sentry Key® is programmed. **The Remote Keyless Entry (RKE) transmitter will also be programmed during this procedure.**

Repeat this procedure to program up to eight keys. If you do not have a programmed Sentry Key®, contact your authorized dealer for details.

NOTE: If a programmed key is lost, see your authorized dealer to have all remaining keys erased from the system's memory. This will prevent the lost key from starting your vehicle. The remaining keys must then be reprogrammed. All vehicle keys must be taken to an authorized dealer at the time of service to be reprogrammed.

General Information

The Sentry Key® system complies with FCC rules Part 15 and with RSS-210 of Industry Canada. Operation is subject to the following conditions:

- This device may not cause harmful interference.
- This device must accept any interference that may be received, including interference that may cause undesired operation.

VEHICLE SECURITY ALARM — IF EQUIPPED

The Vehicle Security Alarm monitors the vehicle doors, swing gate, and ignition for unauthorized operation. While the Vehicle Security Alarm is armed, interior switches for door locks are disabled. The Vehicle Security Alarm provides both audible and visible signals when alarming. The horn will sound, the headlights will turn on, the park lamps and/or turn signals will flash repeatedly for three minutes. If the disturbance is still present (driver's door, passenger door, other doors, ignition) after three minutes, the headlights, park lamps and/or turn signals will flash for an additional 15 minutes.

NOTE: The Panic Alarm and the Vehicle Security Alarm are quite different. Please take a moment to activate the Panic Alarm and the Vehicle Security Alarm to hear the differences in the horn. In case one should go off in the future, you will need to know which mode has been activated in order to deactivate it.

Rearming The System

If something triggers the alarm, and no action is taken to disarm it, the Vehicle Security Alarm will turn off the horn after three minutes, turn off all of the visual signals after 15 minutes, and then the Vehicle Security Alarm will rearm itself.

To Arm The System

The Vehicle Security Alarm will set when you use the Remote Keyless Entry (RKE) transmitter to lock the doors and swing gate, or when you use the power door lock switch while the door is open. After all the doors are locked and closed, the Vehicle Security Light (located on the instrument cluster) will flash rapidly for about 16 seconds to signal that the Vehicle Security Alarm is arming. During this 16-second arming period, opening any door or the swing gate will cancel the arming. If the

Vehicle Security Alarm is successfully set, the Vehicle Security Light will flash at a slower rate to indicate the Vehicle Security Alarm is armed.

To Disarm The System

To disarm the Vehicle Security Alarm, you will need to press the UNLOCK button on the RKE transmitter, or turn the ignition switch to the ON/RUN position. If something has triggered the Vehicle Security Alarm in your absence, the horn will sound three times and the exterior lights blink three times when you unlock the doors. Check the vehicle for tampering.

The Vehicle Security Alarm is designed to protect your vehicle; however, you can create conditions where the Vehicle Security Alarm will arm unexpectedly. If you remain in the vehicle and lock the doors with the RKE transmitter, once the Vehicle Security Alarm is armed (after 16 seconds), when you pull the door handle to exit,

the alarm will sound. If this occurs, press the UNLOCK button on the RKE transmitter to disarm the Vehicle Security Alarm. You may also accidentally disarm the Vehicle Security Alarm by unlocking the driver's door with the key and then locking it. The door will be locked but the Vehicle Security Alarm will not arm.

NOTE:

- Unlocking the doors with the manual door lock plungers or the driver's door lock cylinder will not disarm the Vehicle Security Alarm.
- When the Vehicle Security Alarm is armed, the interior power door lock switches will not unlock the doors.

ILLUMINATED ENTRY — IF EQUIPPED

The courtesy lights will turn on when you use the Remote Keyless Entry (RKE) transmitter to unlock the doors or open any door.

This feature also turns on the approach lighting in the outside mirrors (if equipped). Refer to "Mirrors" in "Understanding The Features Of Your Vehicle" for further information.

The lights will fade to off after approximately 30 seconds or they will immediately fade to off once the ignition switch is turned to ON/RUN from the OFF position.

NOTE:

- The front courtesy overhead console and door courtesy lights will turn on if the dimmer control is in the "Dome ON" position (extreme top position).
- The Illuminated Entry system will not operate if the dimmer control is in the "Dome defeat" position (extreme bottom position).

REMOTE KEYLESS ENTRY (RKE) — IF EQUIPPED

This system allows you to lock or unlock the doors, swing gate, and activate the Panic Alarm from a maximum distance of 66 ft (20 m) using a Remote Keyless Entry (RKE) transmitter. The RKE transmitter does not need to be pointed at the vehicle to activate the system.



021340825

Three Button RKE Transmitter

NOTE: The line of transmission must not be blocked with metal objects.

To Unlock The Doors And Swing Gate

Press and release the RKE transmitter UNLOCK button once to unlock the driver's door only, or twice to unlock all the doors and swing gate. When the RKE transmitter UNLOCK button is pressed, the Illuminated Entry will initiate and the parking lights will flash twice.

Remote Key Unlock On First Press

This feature lets you program the system to unlock either the driver's side, or all doors and swing gate on the first press of the UNLOCK button on the RKE transmitter.

- For vehicles equipped with an Electronic Vehicle Information Center (EVIC), refer to "Electronic Vehicle Information Center (EVIC)/Personal Settings (Customer-Programmable Features)" in "Understanding Your Instrument Panel" for further information.

- For vehicles not equipped with the EVIC, the Remote Unlock feature can be enabled or disabled by performing the following steps:

1. Press and hold the LOCK button on a programmed RKE transmitter.
2. Continue to hold the RKE transmitter LOCK button for at least four seconds, but not longer than 10 seconds, then press and hold the RKE transmitter UNLOCK button.
3. Release both buttons at the same time.
4. Test this feature while outside of the vehicle by pressing the LOCK/UNLOCK button on the RKE transmitter.

NOTE: Pressing the RKE transmitter LOCK button while you are inside of the vehicle will activate the Vehicle Security Alarm. Opening a door with the Vehicle

Security Alarm activated will cause the alarm to sound. Press the RKE transmitter UNLOCK button to deactivate the Vehicle Security Alarm.

5. If the desired programming was not achieved or to reactivate this feature, repeat the above steps.

NOTE: Pressing the LOCK button on the RKE transmitter while you are inside the vehicle will activate the Vehicle Security Alarm. Opening a door with the Vehicle Security Alarm activated will cause the alarm to sound. Press the UNLOCK button to deactivate the Vehicle Security Alarm.

To Lock The Doors And Swing Gate

Press and release the LOCK button on the RKE transmitter to lock all doors. The turn signals will flash and the horn will chirp once to acknowledge the lock signal.

Sound Horn On Lock

This feature will cause the horn to chirp when the doors are locked with the RKE transmitter. This feature can be turned on or turned off. To change the current setting, proceed as follows:

- For vehicles equipped with the EVIC, refer to “Electronic Vehicle Information Center (EVIC)/Personal Settings (Customer-Programmable Features)” in “Understanding Your Instrument Panel” for further information.
- For vehicles not equipped with the EVIC, perform the following steps:
 1. Press the RKE transmitter LOCK button for 4 to 10 seconds.
 2. While the LOCK button is pressed (after four seconds), press the RKE transmitter PANIC button. Release both buttons.

The “Sound Horn On Lock” feature can be reactivated by repeating this procedure.

Using The Panic Alarm

To turn the Panic Alarm feature on or off, press and hold the PANIC button on the RKE transmitter for at least one second and release. When the Panic Alarm is activated, the headlights will turn on, the park lights will flash, the horn will pulse on and off and the interior lights will turn on.

The Panic Alarm will stay on for three minutes unless you turn it off by pressing the PANIC button a second time, or if the vehicle speed is 5 mph (8 km/h) or greater.

NOTE: When you turn off the Panic Alarm by pressing the PANIC button a second time, you may have to move closer to the vehicle due to the radio frequency noises of the system.

To Turn Off Flash Lights With Lock

This feature will cause the turn signal lights to flash when the doors are locked or unlocked with the RKE transmitter. This feature can be turned on or turned off. To change the current setting, proceed as follows:

- For vehicles equipped with the EVIC, refer to “Electronic Vehicle Information Center (EVIC)/Personal Settings (Customer-Programmable Features)” in “Understanding Your Instrument Panel” for further information.
- For vehicles not equipped with the EVIC, perform the following steps:
 1. Press the RKE transmitter UNLOCK button for 4 to 10 seconds.
 2. While the UNLOCK button is pressed, (after four seconds) press the RKE transmitter LOCK button. Release both buttons.

3. Test the “Flash Lights With Lock” feature outside of the vehicle by pressing the RKE transmitter LOCK button with the ignition in the LOCK position and the key removed.

NOTE: Pressing the RKE transmitter LOCK button while you are in the vehicle will activate the Vehicle Security Alarm. Opening a door with the Vehicle Security Alarm activated will cause the alarm to sound. Press the RKE transmitter UNLOCK button to deactivate the Vehicle Security Alarm.

The “Flash Lights With Lock” feature can be reactivated by repeating this procedure.

Programming Additional Transmitters

Refer to Sentry Key® “Customer Key Programming.”

If you do not have a programmed RKE transmitter, contact your authorized dealer for details.

General Information

This device complies with part 15 of FCC rules and with RS-210 of Industry Canada. Operation is subject to the following conditions:

1. This device may not cause harmful interference.
2. This device must accept any interference that may be received including interference that may cause undesired operation.

NOTE: Changes or modifications not expressly approved by the party responsible for compliance could void the user’s authority to operate the equipment.

If your RKE transmitter fails to operate from a normal distance, check for these two conditions:

1. Weak battery in the RKE transmitter. The expected life of a battery is five years.
2. Closeness to a radio transmitter such as a radio station tower, airport transmitter, military base, and some mobile or CB radios.

Transmitter Battery Replacement

The recommended replacement battery is CR2032.

NOTE: Perchlorate Material – special handling may apply. See www.dtsc.ca.gov/hazardouswaste/perchlorate

1. With the RKE transmitter buttons facing down, use a flat blade screwdriver to pry the two halves of the RKE transmitter apart. Use **extreme care** not to damage the seal or internal components.

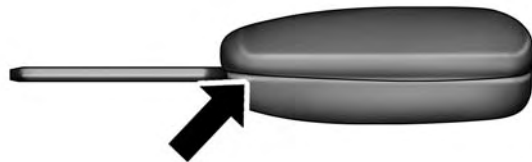

2

021432709

Separating RKE Transmitter Halves

2. Remove and replace the battery. Avoid touching the new battery with your fingers. Skin oils may cause battery deterioration. If you touch a battery, clean it with rubbing alcohol.
3. To reassemble the RKE transmitter case, snap the two halves together.

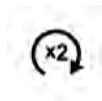
REMOTE STARTING SYSTEM — IF EQUIPPED

This system uses the Remote Keyless Entry (RKE) transmitter to start the engine conveniently from outside the vehicle while still maintaining security. The system has a range of approximately 300 ft (91 m).

NOTE:

- The vehicle must be equipped with an automatic transmission to be equipped with Remote Start.
- Obstructions between the vehicle and RKE transmitter may reduce this range.

How To Use Remote Start

All of the following conditions must be met before the engine will remote start:

- Shift lever in PARK
- Doors closed

- Hood closed
- Hazard switch off
- Brake switch inactive (brake pedal not pressed)
- Ignition key removed from ignition switch
- Battery at an acceptable charge level
- RKE PANIC button not pressed
- System not disabled from previous remote start event
- Vehicle theft alarm not active

WARNING!

- **Do not start or run an engine in a closed garage or confined area. Exhaust gas contains Carbon Monoxide (CO) which is odorless and colorless. Carbon Monoxide is poisonous and can cause serious injury or death when inhaled.**

(Continued)

WARNING! (Continued)

- **Keep Remote Keyless Entry (RKE) transmitters away from children. Operation of the Remote Start System, windows, door locks or other controls could cause serious injury or death.**

Remote Start Abort Message On Electronic Vehicle Information Center (EVIC) — If Equipped

The following messages will display in the EVIC if the vehicle fails to remote start or exits remote start prematurely:

- Remote Start Aborted — Door Ajar
- Remote Start Aborted — Hood Ajar
- Remote Start Aborted — Fuel Low
- Remote Start Aborted — L/Gate Ajar
- Remote Start Aborted — System Fault

The EVIC message stays active until the ignition is turned to the ON/RUN position.

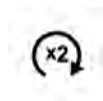
To Enter Remote Start

Press and release the REMOTE START button on the RKE transmitter twice within five seconds. The vehicle doors will lock, the parking lights will flash and the horn will chirp twice (if programmed). Then, the engine will start and the vehicle will remain in the Remote Start mode for a 15-minute cycle.

NOTE:

- The park lamps will turn on and remain on during Remote Start mode.
- For security, power window operation is disabled when the vehicle is in the Remote Start mode.

30 THINGS TO KNOW BEFORE STARTING YOUR VEHICLE

- The engine can be started two consecutive times (two 15-minute cycles) with the RKE transmitter. However, the ignition switch must be cycled to the ON/RUN position before you can repeat the start sequence for a third cycle.

Remote start will also cancel if any of the following occur:

- The engine stalls or RPM exceeds 2500
- Any engine warning lamps come on
- The hood is opened
- The hazard switch is pressed
- The transmission is moved out of PARK
- The brake pedal is pressed

To Exit Remote Start Mode Without Driving The Vehicle

Press and release the REMOTE START button one time or allow the engine to run for the entire 15-minute cycle.

NOTE: To avoid unintentional shut downs, the system will disable the one time press of the REMOTE START button for two seconds after receiving a valid Remote Start request.

To Exit Remote Start Mode And Drive The Vehicle

Before the end of the 15-minute cycle, press and release the UNLOCK button on the RKE transmitter to unlock the doors and disarm the Vehicle Security Alarm (if equipped). Then, insert the key into the ignition switch and turn the switch to the ON/RUN position.

NOTE: The ignition switch must be in the ON/RUN position in order to drive the vehicle.

DOORS

CAUTION!

Careless handling and storage of the removable door panels may damage the seals, causing water to leak into the vehicle's interior.

Upper Half Door Window Removal — If Equipped

Grasp the half door window and pull upward.



Upper Half Door Window

Upper Half Door Window Installation — If Equipped

1. Grasp the half door window and line up the pins with the pockets in the lower door.
2. Push down to ensure the half door window is fully seated.

Front Door Removal

WARNING!

Do not drive your vehicle on public roads with the doors removed as you will lose the protection that they can provide. This procedure is furnished for use during off-road operation only.

1. Roll down the glass window to prevent any damage.
2. Remove the hinge pin screws from the upper and lower outside hinges (using a #T50 Torx® head driver).

NOTE: The hinge pin screws and nuts can be stowed in the rear cargo tray located under the rear loadfloor.

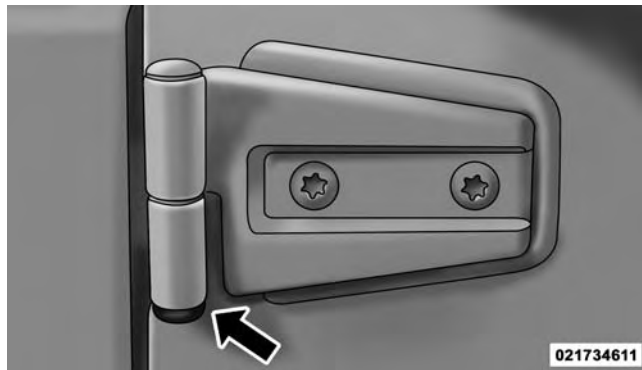

Hinge Pin Screw

3. Unplug the wiring harness connector under the instrument panel by pressing the tab at the top of the connector and pulling to disconnect.

NOTE: If the red latch on the connector is locked, push the red latch down until you can only see the latch on one end (top) of the connector. This will unlock the connector

tab, allowing the tab to be pressed down and enabling the harness to be disconnected.

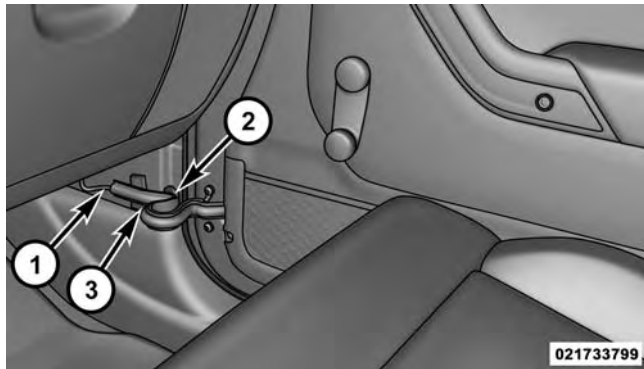

Door Strap/Harness Location

- 1 — Harness Connector
- 2 — Body Hook
- 3 — Door/Harness Strap

4. Unhook the door strap from the body hook. Be careful not to allow the door to swing fully open as the mirror may damage the paint.
5. With the door open, lift the door to clear the hinge pins from their hinges and remove the door.

NOTE: Doors are heavy; use caution when removing them.

To reinstall the door(s), perform the previous steps in the opposite order.

Rear Door Removal (Four-Door Models)

WARNING!

Do not drive your vehicle on public roads with the doors removed as you will lose the protection that they can provide. This procedure is furnished for use during off-road operation only.

1. Roll down the glass window to prevent any damage.
2. Remove the hinge pin screws from the upper and lower outside hinges (using a #T50 Torx® head driver).

NOTE: The hinge pin screws and nuts can be stowed in the rear cargo tray located under the rear loadfloor.

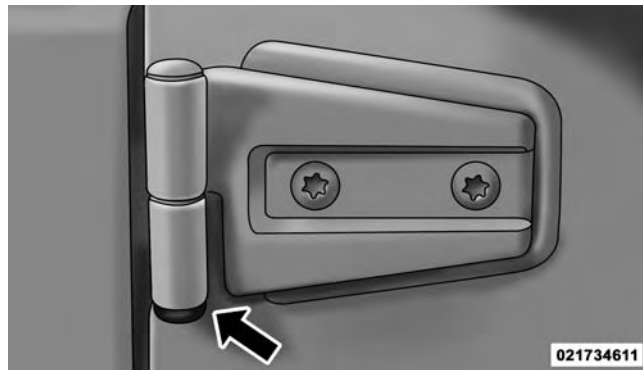

Hinge Pin Screw

3. Slide the front seat(s) fully forward.
4. Remove the trim access door from the bottom of the B-pillar.

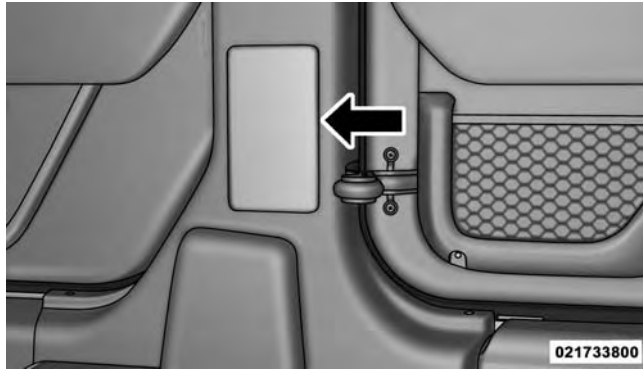

Trim Access Door

5. Unplug the wiring harness connector.

NOTE: If the red latch on the connector is locked, push the red latch to the right until you can only see the latch on one end (right) of the connector. This will unlock the connector tab, allowing the tab to be pressed down and enabling the harness to be disconnected.

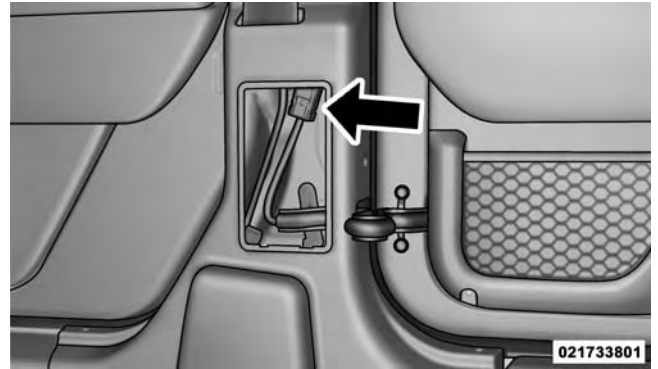

Red Connector Latch

6. Unhook the door strap from the body hook.

7. With the door open, lift the door to clear the hinge pins from their hinges and remove the door.

NOTE: Doors are heavy; use caution when removing them.

To reinstall the door(s), perform the previous steps in the opposite order.

DOOR LOCKS

Manual Door Locks

All doors are equipped with an interior rocker-type door lock lever. To lock a door when leaving your vehicle, press the rocker lever forward to the LOCK position and close the door. To UNLOCK the door press the rocker lever rearward.

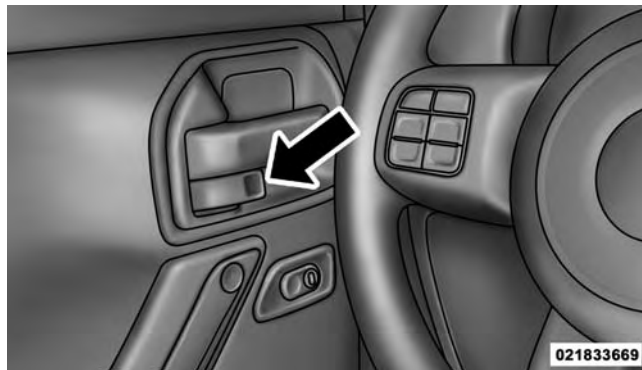

Manual Door Lock (Full Frame Doors)



021868194

Manual Door Lock (Half Doors)

NOTE: The ignition key that is used to start the vehicle is used to lock or unlock the doors, swing gate, glove compartment, and console storage.

WARNING!

- For personal security reasons and safety in a collision, lock the vehicle doors when you drive, as well as when you park and leave the vehicle.
- When leaving the vehicle, always remove the Key Fob from the ignition and lock your vehicle.
- Never leave children alone in a vehicle, or with access to an unlocked vehicle.
- Allowing children to be in a vehicle unattended is dangerous for a number of reasons. A child or others could be seriously or fatally injured. Children should be warned not to touch the parking brake, brake pedal or the shift lever.
- Do not leave the key in or near the vehicle. A child could operate power windows, other controls, or move the vehicle.

Power Door Locks — If Equipped

The power door lock switch is located on each front door panel. Press the switch forward to lock the doors, and rearward to unlock the doors.

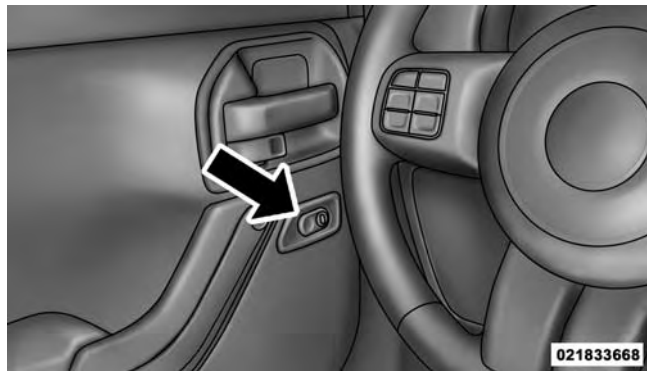

Power Door Lock Switch

WARNING!

- For personal security reasons and safety in a collision, lock the vehicle doors when you drive, as well as when you park and leave the vehicle.
- When leaving the vehicle, always remove the Key Fob from the ignition and lock your vehicle.
- Never leave children alone in a vehicle, or with access to an unlocked vehicle.
- Allowing children to be in a vehicle unattended is dangerous for a number of reasons. A child or others could be seriously or fatally injured. Children should be warned not to touch the parking brake, brake pedal or the shift lever.
- Do not leave the key in or near the vehicle. A child could operate power windows, other controls, or move the vehicle.

Automatic Door Locks — If Equipped

When enabled, the door locks will lock automatically when the vehicle's speed exceeds 15 mph (24 km/h). The auto door lock feature can be enabled or disabled by your authorized dealer . Please see your authorized dealer for service.

Automatic Unlock Doors On Exit

The doors will unlock automatically on vehicles with power door locks if:

1. The “Automatic Unlock Doors On Exit” feature is enabled.
2. The vehicle speed returned to 0 mph (0 km/h) and the transmission shift lever is in NEUTRAL or PARK.
3. The driver door is opened.
4. The doors were not previously unlocked.

Automatic Unlock Doors On Exit Programming

The “Automatic Unlock Doors On Exit” feature can be enabled or disabled as follows:

1. Close all doors and place the key in the ignition.
2. Cycle the ignition switch between LOCK and ON/RUN and then back to LOCK four times ending up in the LOCK position.
3. Press the power door unlock switch to unlock the doors.
4. A single chime will indicate the completion of the programming.
5. Repeat these steps if you want to return this feature to its previous setting.

NOTE: Use the “Automatic Unlock Doors On Exit” feature in accordance with local laws.

Child-Protection Door Lock System — Rear Doors

To provide a safer environment for small children riding in the rear seats, the rear doors are equipped with Child-Protection Door Lock system.

To Engage Or Disengage The Child-Protection Door Lock System

1. Open the rear door.
2. Insert the tip of the ignition key into the lock and rotate to the LOCK or UNLOCK position.
3. Repeat steps 1 and 2 for the opposite rear door.



Child-Protection Door Lock Function

WARNING!

Avoid trapping anyone in a vehicle in a collision. Remember that the rear doors can only be opened from the outside when the Child-Protection locks are engaged.

NOTE: For emergency exit with the system engaged, move the rocker lever rearward (unlocked position), roll down the window and open the door with the outside door handle.

WINDOWS

Power Windows — If Equipped

The power window switches are located on the instrument panel below the radio. Press the switch downward to open the window and upward to close the window.



2

Power Window Switches

The top left switch controls the left front window and the top right switch controls the right front window.

NOTE: The switches will continue to function for up to 10 minutes after the ignition key has been turned to the LOCK position, or until a front door is opened.

Four-Door Models

The lower left switch controls the left rear passenger window, and the lower right switch controls the right rear passenger window.

Auto-Down

Both the driver and front passenger window switches have an “Auto-Down” feature. Press the window switch past the first detent, release, and the window will go down automatically. To cancel the Auto-Down movement, operate the switch in either the up or down direction and release the switch.

To stop the window from going all the way down during the Auto-Down operation, pull up on the switch briefly.

To partially open the window, press halfway to the first detent and release it when you want the window to stop.

Window Lockout Switch — Four-Door Models

The window lockout switch (located between the front window switches) allows you to disable the rear window switches that are located on the back of the center floor console. To disable the window controls, press the window lockout button downward. To enable the window controls, press the window lockout button upward.



Window Lockout Switch

Rear Power Windows — Four-Door Models

The rear passenger window switches are located on the back of the center floor console. Press the switch downward to open the window and upward to close the window.

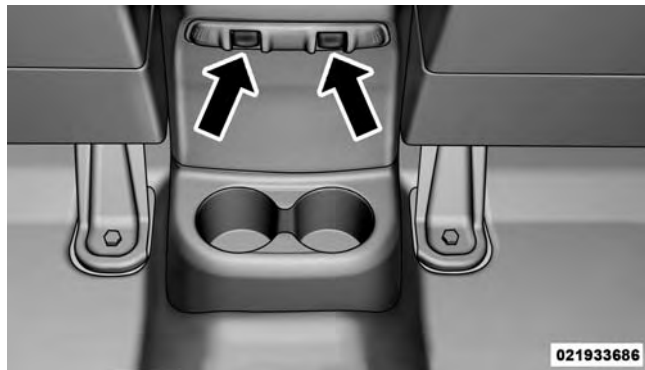

Rear Power Window Switches (Four-Door Models)

Wind Buffeting

Wind buffeting can be described as the perception of pressure on the ears or a helicopter-type sound in the ears. Your vehicle may exhibit wind buffeting with the windows down in certain open or partially open positions. This is a normal occurrence and can be minimized by adjusting the window opening.

REAR SWING GATE

The rear swing gate can be unlocked by using the key, Remote Keyless Entry (RKE) transmitter, or by activating the power door lock switches located on the front doors.

To open the swing gate, press the button on the gate handle.

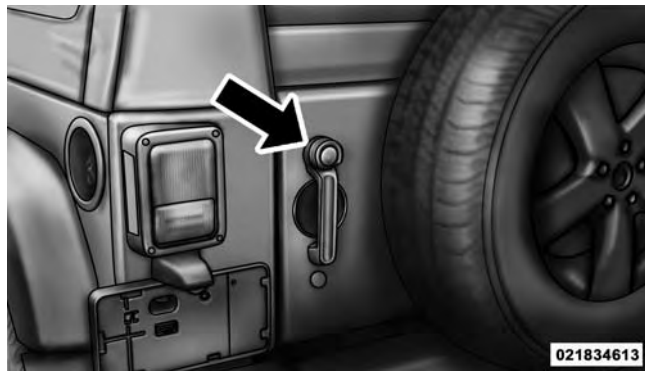

Gate Handle

NOTE: Close the rear flip-up window before attempting to close the swing gate (hard top models only).

CAUTION!

Do not press on rear wiper blade when closing the rear flip-up window, as damage to the blade will result.

WARNING!

Driving with the flip-up window open can allow poisonous exhaust gases into your vehicle. You and your passengers could be injured by these fumes. Keep the flip-up window closed when you are operating the vehicle.

OCCUPANT RESTRAINTS

Some of the most important safety features in your vehicle are the restraint systems:

- Three-point lap and shoulder belts for the driver and all passengers
- Advanced Front Air Bags for driver and front passenger
- Supplemental Seat-Mounted Side Air Bags (SAB) — if equipped
- An energy-absorbing steering column and steering wheel
- Knee bolsters/blockers for front seat occupants
- Front seat belts incorporate pretensioners that may enhance occupant protection by managing occupant energy during an impact event

- All seat belt systems (except the driver's) include Automatic Locking Retractors (ALRs), which lock the seat belt webbing into position by extending the belt all the way out and then adjusting the belt to the desired length to restrain a child seat or secure a large item in a seat — if equipped

Please pay close attention to the information in this section. It tells you how to use your restraint system properly, to keep you and your passengers as safe as possible.

If you will be carrying children too small for adult-sized seat belts, the seat belts or the Lower Anchors and Tether for CHildren (LATCH) feature also can be used to hold infant and child restraint systems. For more information on LATCH, refer to Lower Anchors and Tether for CHildren (LATCH).

NOTE: The Advanced Front Air Bags have a multistage inflator design. This allows the air bag to have different rates of inflation based on several factors, including the severity and type of collision.

Here are some simple steps you can take to minimize the risk of harm from a deploying air bag:

1. **Children 12 years old and under should always ride buckled up in a rear seat.**

WARNING!

Infants in rear facing child restraints should never ride in the front seat of a vehicle with a passenger Advanced Front Air Bag. An air bag deployment can cause severe injury or death to infants in that position.

Children that are not big enough to wear the vehicle seat belt properly (see section on Child Restraints) should be secured in the rear seat in child restraints or belt-positioning booster seats. Older children who do not use child restraints or belt-positioning booster seats should ride properly buckled up in the rear seat. Never allow children to slide the shoulder belt behind them or under their arm.

If a child from 1 to 12 years old (not in a rear facing child seat) must ride in the front passenger seat, move the seat as far back as possible and use the proper child restraint. (Refer to “Child Restraints”)

You should read the instructions provided with your child restraint to make sure that you are using it properly.

2. All occupants should always wear their lap and shoulder belts properly.
3. The driver and front passenger seats should be moved back as far as practical to allow the Advanced Front Air Bags room to inflate.
4. Do not lean against the door or window. If your vehicle has side air bags, and deployment occurs, the side air bags will inflate forcefully into the space between you and the door.
5. If the air bag system in this vehicle needs to be modified to accommodate a disabled person, contact the Customer Center. Phone numbers are provided under "If You Need Assistance".

WARNING!

- Relying on the air bags alone could lead to more severe injuries in a collision. The air bags work with your seat belt to restrain you properly. In some collisions, the air bags won't deploy at all. Always wear your seat belts even though you have air bags.
- Being too close to the steering wheel or instrument panel during Advanced Front Air Bag deployment could cause serious injury, including death. Air Bags need room to inflate. Sit back, comfortably extending your arms to reach the steering wheel or instrument panel.
- Seat-Mounted Side Air Bags (SAB) need room to inflate. Do not lean against the door or window. Sit upright in the center of the seat.

(Continued)

WARNING! (Continued)

- **In a collision, you and your passengers can suffer much greater injuries if you are not properly buckled up. You can strike the interior of your vehicle or other passengers, or you can be thrown out of the vehicle. Always be sure you and others in your vehicle are buckled up properly.**

Buckle up even though you are an excellent driver, even on short trips. Someone on the road may be a poor driver and cause a collision that includes you. This can happen far away from home or on your own street.

Research has shown that seat belts save lives, and they can reduce the seriousness of injuries in a collision. Some of the worst injuries happen when people are thrown

from the vehicle. Seat belts reduce the possibility of ejection and the risk of injury caused by striking the inside of the vehicle. Everyone in a motor vehicle should be belted at all times.

Lap/Shoulder Belts

All seating positions in your vehicle are equipped with lap/shoulder belts. The belt webbing retractor is designed to lock during very sudden stops or collisions. This feature allows the shoulder part of the belt to move freely with you under normal conditions. However, in a collision the belt will lock and reduce the risk of you striking the inside of the vehicle or being thrown out.

WARNING!

- It is dangerous to ride in a cargo area, inside or outside of a vehicle. In a collision, people riding in these areas are more likely to be seriously injured or killed.
- Do not allow people to ride in any area of your vehicle that is not equipped with seats and seat belts.
- Be sure everyone in your vehicle is in a seat and using a seat belt properly.
- Wearing a seat belt incorrectly is dangerous. Seat belts are designed to go around the large bones of your body. These are the strongest parts of your body and can take the forces of a collision the best.

(Continued)

WARNING! (Continued)

- Wearing your belt in the wrong place could make your injuries in a collision much worse. You might suffer internal injuries, or you could even slide out of part of the belt. Follow these instructions to wear your seat belt safely and to keep your passengers safe, too.
- Two people should never be belted into a single seat belt. People belted together can crash into one another in a collision, hurting one another badly. Never use a lap/shoulder belt or lap belt for more than one person, no matter what their size.

Lap/Shoulder Belt Operating Instructions

1. Enter the vehicle and close the door. Sit back and adjust the seat.
2. The seat belt latch plate is above the back of the front seat and next to your arm in the rear seat. Grasp the latch plate and pull out the belt. Slide the latch plate up the webbing as far as necessary to allow the belt to go around your lap.

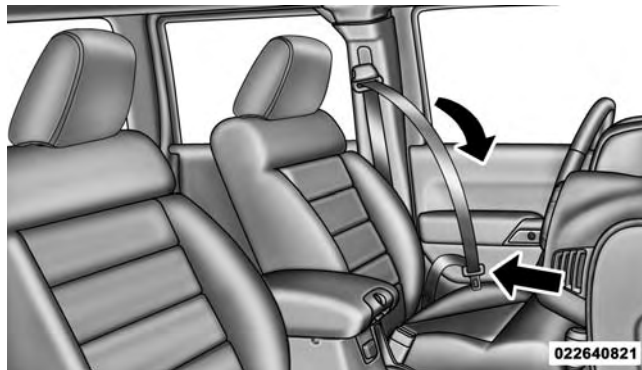

Gate Handle

3. When the belt is long enough to fit, insert the latch plate into the buckle until you hear a “click.”



Inserting Latch Plate Into Buckle

WARNING!

- A belt that is buckled into the wrong buckle will not protect you properly. The lap portion could ride too high on your body, possibly causing internal injuries. Always buckle your belt into the buckle nearest you.
- A belt that is too loose will not protect you properly. In a sudden stop you could move too far forward, increasing the possibility of injury. Wear your seat belt snugly.
- A belt that is worn under your arm is dangerous. Your body could strike the inside surfaces of the vehicle in a collision, increasing head and neck injury. A belt worn under the arm can cause internal injuries. Ribs aren't as strong as shoulder bones. Wear the belt over your shoulder so that your strongest bones will take the force in a collision.

(Continued)

WARNING! (Continued)

- A shoulder belt placed behind you will not protect you from injury during a collision. You are more likely to hit your head in a collision if you do not wear your shoulder belt. The lap and shoulder belt are meant to be used together.

4. Position the lap belt across your thighs, below your abdomen. To remove slack in the lap belt portion, pull up on the shoulder belt. To loosen the lap belt if it is too tight, tilt the latch plate and pull on the lap belt. A snug belt reduces the risk of sliding under the belt in a collision.

NOTE: The Seat Belt Reminder Light will remain on until the driver and front passenger (if equipped with front passenger BeltAlert®) seat belt is buckled. For further information, refer to “Enhanced Seat Belt Use Reminder System (BeltAlert®)”.



Removing Slack From Belt

WARNING!

- A lap belt worn too high can increase the risk of injury in a collision. The belt forces won't be at the strong hip and pelvic bones, but across your abdomen. Always wear the lap part of your seat belt as low as possible and keep it snug.
 - A twisted belt may not protect you properly. In a collision, it could even cut into you. Be sure the belt is straight. If you can't straighten a belt in your vehicle, take it to your authorized dealer immediately and have it fixed.
5. Position the shoulder belt on your chest so that it is comfortable and not resting on your neck. The retractor will withdraw any slack in the belt.

6. To release the belt, push the red button on the buckle. The belt will automatically retract to its stowed position. If necessary, slide the latch plate down the webbing to allow the belt to retract fully.

WARNING!

A frayed or torn belt could rip apart in a collision and leave you with no protection. Inspect the belt system periodically, checking for cuts, frays, or loose parts. Damaged parts must be replaced immediately. Do not disassemble or modify the system. Seat belt assemblies must be replaced after a collision if they have been damaged (i.e., bent retractor, torn webbing, etc.).

Rear Center Lap/Shoulder Belt Retractor Lockout — Four-Door Models Only

This feature is designed to lock the retractor whenever the 60% rear seatback is not fully latched. This prevents someone from wearing the rear center lap/shoulder belt when the rear seatback is not fully latched.

NOTE:

- If the rear center lap/shoulder belt cannot be pulled out, check that the rear seatback is fully latched.
- If the rear seatback is properly latched and the rear center lap/shoulder belt still cannot be pulled out, the Automatic-Locking Retractor (ALR) system may be activated. To reset this feature you must let all of the belt webbing return into the retractor. You will not be able to pull out more webbing until all of the webbing has been returned back into the retractor.

WARNING!

The rear center lap/shoulder belt is equipped with a lock-out feature to ensure that the rear seatback is in the fully upright and locked position when occupied. If the rear seatback is not fully upright and locked and the rear center lap/shoulder belt can be pulled out of the retractor, the vehicle should immediately be taken to your authorized dealer for service. Failure to follow this warning could result in serious or fatal injury.

Lap/Shoulder Belt Untwisting Procedure

Use the following procedure to untwist a twisted lap/shoulder belt.

1. Position the latch plate as close as possible to the anchor point.
2. At about 6 to 12 in (15 to 30 cm) above the latch plate, grasp and twist the belt webbing 180 degrees to create a fold that begins immediately above the latch plate.
3. Slide the latch plate upward over the folded webbing. The folded webbing must enter the slot at the top of the latch plate.
4. Continue to slide the latch plate up until it clears the folded webbing.

Adjustable Upper Shoulder Belt Anchorage

In the front seat positions, the shoulder belt anchorage can be adjusted upward or downward to position the belt away from your neck. Push in on the anchorage near your outside shoulder and slide it up or down to reach the position that serves you best.

2

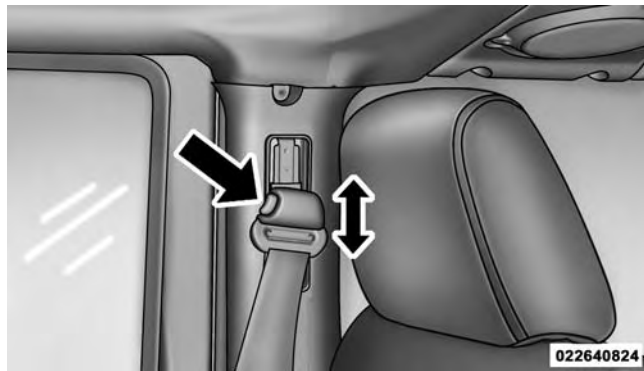

Adjusting Upper Shoulder Belt

WARNING!

Position the shoulder belt height adjusters so that the belt rests across the middle of your shoulder. Failure to adjust the safety belt properly could reduce the effectiveness of the seat belt and increase the risk of injury in a collision.

As a guide, if you are shorter than average, you will prefer a lower position, and if you are taller than average, you will prefer a higher position. When you release the anchorage, try to move it up or down to make sure that it is locked in position.

Seat Belts In Passenger Seating Positions

The seat belts in the passenger seating positions are equipped with Automatic Locking Retractors (ALR) which are used to secure a child restraint system. For additional information, refer to “Installing Child Restraints Using The Vehicle Seat Belt” under the “Child Restraints” section. The chart below defines the type of feature for each seating position.

	Driver	Center	Passenger
First Row	N/A	N/A	ALR
Second Row	ALR	ALR	ALR

- N/A — Not Applicable
- ALR — Automatic Locking Retractor

If the passenger seating position is equipped with an ALR and is being used for normal usage:

Only pull the belt webbing out far enough to comfortably wrap around the occupant's mid-section so as to not activate the ALR. If the ALR is activated, you will hear a ratcheting sound as the belt retracts. Allow the webbing to retract completely in this case and then carefully pull out only the amount of webbing necessary to comfortably wrap around the occupant's mid-section. Slide the latch plate into the buckle until you hear a "click."

Automatic Locking Retractor Mode (ALR) — If Equipped

In this mode, the shoulder belt is automatically pre-locked. The belt will still retract to remove any slack in the shoulder belt. The Automatic Locking Mode is available

on all passenger-seating positions with a combination lap/shoulder belt. Use the Automatic Locking Mode anytime a child safety seat is installed in a seating position that has a belt with this feature. Children 12 years old and under should always be properly restrained in the rear seat.

How To Engage The Automatic Locking Mode

1. Buckle the combination lap and shoulder belt.
2. Grasp the shoulder portion and pull downward until the entire belt is extracted.
3. Allow the belt to retract. As the belt retracts, you will hear a clicking sound. This indicates the safety belt is now in the Automatic Locking Mode.

How To Disengage The Automatic Locking Mode

Unbuckle the combination lap/shoulder belt and allow it to retract completely to disengage the Automatic Locking Mode and activate the vehicle sensitive (emergency) locking mode.

WARNING!

- The belt and retractor assembly must be replaced if the seat belt assembly Automatic Locking Retractor (ALR) feature or any other seat belt function is not working properly when checked according to the procedures in the Service Manual.
- Failure to replace the belt and retractor assembly could increase the risk of injury in collisions.

Energy Management Feature

This vehicle has a safety belt system with an Energy Management feature in the front seating positions to help further reduce the risk of injury in the event of a head-on collision.

This safety belt system has a retractor assembly that is designed to release webbing in a controlled manner. This feature is designed to help reduce the belt force acting on the occupant's chest.

WARNING!

- The belt and retractor assembly must be replaced if the seat belt assembly Automatic Locking Retractor (ALR) feature or any other seat belt function is not working properly when checked according to the procedures in the Service Manual.

(Continued)

WARNING! (Continued)

- Failure to replace the belt and retractor assembly could increase the risk of injury in collisions.

Seat Belt Pretensioners

The seat belts for both front seating positions are equipped with pretensioning devices that are designed to remove slack from the seat belt in the event of a collision. These devices may improve the performance of the seat belt by assuring that the belt is tight about the occupant early in a collision. Pretensioners work for all size occupants, including those in child restraints.

NOTE: These devices are not a substitute for proper seat belt placement by the occupant. The seat belt still must be worn snugly and positioned properly.

The pretensioners are triggered by the Occupant Restraint Controller (ORC). Like the air bags, the pretensioners are single use items. A deployed pretensioner or a deployed air bag must be replaced immediately.

Enhanced Seat Belt Use Reminder System (BeltAlert®)

BeltAlert® is a feature intended to remind the driver and front passenger (if equipped with front passenger BeltAlert®) to fasten their seat belts. The feature is active whenever the ignition is on. If the driver or front seat passenger is unbelted, the Seat Belt Reminder Light will turn on and remain on until both front seat belts are fastened.

The BeltAlert® warning sequence begins after the vehicle speed is over 5 mph (8 km/h), by blinking the Seat Belt Reminder Light and sounding an intermittent chime. Once the sequence starts, it will continue for the entire duration or until the respective seatbelts are fastened. After the sequence completes, the Seat Belt Reminder Light remains illuminated until the respective seat belts are fastened. The driver should instruct all other occupants to fasten their seat belts. If a front seat belt is unbuckled while traveling at speeds greater than 5 mph (8 km/h), BeltAlert® will provide both audio and visual notification.

The front passenger seat BeltAlert® is not active when the front passenger seat is unoccupied. BeltAlert® may be triggered when an animal or heavy object is on the front passenger seat or when the seat is folded flat (if equipped). It is recommended that pets be restrained in the rear seat in pet harnesses or pet carriers that are secured by seat belts, and cargo is properly stowed.

BeltAlert® can be enabled or disabled by your authorized dealer. Chrysler Group LLC does not recommend deactivating BeltAlert®.

NOTE: Although BeltAlert® has been deactivated, the Seat Belt Reminder Light will continue to illuminate while the driver's or front passenger (if equipped with BeltAlert®) seat belt remains unfastened.

Seat Belts And Pregnant Women

We recommend that pregnant women use seat belts throughout their pregnancy. Keeping the mother safe is the best way to keep the baby safe.

Pregnant women should wear the lap part of the belt across the thighs and as snug across the hips as possible. Keep the belt low so that it does not come across the abdomen. That way the strong bones of the hips will take the force if there is a collision.

Seat Belt Extender

If a seat belt is too short, even when fully extended and when the adjustable upper shoulder belt anchorage (if equipped) is in its lowest position, your authorized

dealer can provide you with a seat belt extender. This extender should be used only if the existing belt is not long enough. When it is not required, remove the extender and store it.

WARNING!

Using a seat belt extender when not needed can increase the risk of injury in a collision. Only use when the seat belt is not long enough when it is worn low and snug, and in the recommended seating positions. Remove and store the extender when not needed.

Supplemental Restraint System (SRS) — Air Bags

This vehicle has Advanced Front Air Bags for both the driver and right front passenger as a supplement to the seat belt restraint systems. The driver's Advanced Front Air Bag is mounted in the steering wheel. The Advanced Front Passenger Air Bag is mounted in the instrument panel, above the glove compartment. The letters SRS are embossed on the air bag covers.

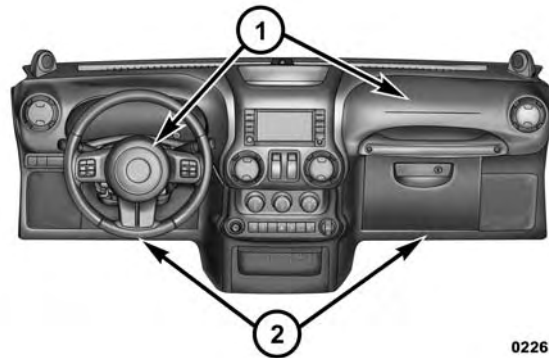

022633796

Supplemental Restraint System (SRS) — Air Bags

- 1 — Driver And Passenger Advanced Front Air Bags
 - 2 — Knee Bolster
-

NOTE: The Driver and Passenger Advanced Front Air Bags are certified to new Federal regulations.

The Advanced Front Air Bags have a multistage inflator design. This allows the air bag to have different rates of inflation that are based on several factors, including the severity and type of collision.

This vehicle may be equipped with driver and/or front passenger seat track position sensors that may adjust the inflation rate of the Advanced Front Air Bags based upon seat position.

This vehicle may be equipped with a driver and/or front passenger seat belt buckle switch that detects whether the driver or front passenger seat belt is fastened. The seat belt buckle switch may adjust the inflation rate of the Advanced Front Air Bags.

This vehicle may be equipped with Supplemental Seat-Mounted Side Air Bags (SAB). The SABs are marked with an air bag label sewn into the outboard side of the front seats.

NOTE:

- Air Bag covers may not be obvious in the interior trim, but they will open during air bag deployment.
- After any collision, the vehicle should be taken to an authorized dealer immediately.

Air Bag System Components

Your vehicle may be equipped with the following air bag system components:

- Occupant Restraint Controller (ORC)
- Air Bag Warning Light
- Steering Wheel and Column
- Instrument Panel
- Knee Impact Bolster
- Driver Advanced Front Air Bag
- Passenger Advanced Front Air Bag
- Supplemental Seat-Mounted Side Air Bags (SAB)
- Front and Side Impact Sensors
- Front Seat Belt Pretensioners, Seat Belt Buckle Switch, and Seat Track Position Sensors

Advanced Front Air Bag Features

The Advanced Front Air Bag system has multistage driver and front passenger air bags. This system provides output appropriate to the severity and type of collision as determined by the Occupant Restraint Controller (ORC), which may receive information from the front impact sensors.

The first stage inflator is triggered immediately during an impact that requires air bag deployment. This low output is used in less severe collisions. A higher energy output is used for more severe collisions.

WARNING!

- **No objects should be placed over or near the air bag on the instrument panel, because any such objects could cause harm if the vehicle is in a collision severe enough to cause the air bag to inflate.**

(Continued)

WARNING! (Continued)

- Do not put anything on or around the air bag covers or attempt to open them manually. You may damage the air bags and you could be injured because the air bags may no longer be functional. The protective covers for the air bag cushions are designed to open only when the air bags are inflating.
- If your vehicle is equipped with Supplemental Seat-Mounted Side Air Bags (SAB), do not use accessory seat covers or place objects between you and the SAB; the performance could be adversely affected and/or objects could be pushed into you, causing serious injury.

(Continued)

WARNING! (Continued)

- If your vehicle is equipped with SAB, do not attach cupholders or any other objects on or around the door. The inflating SAB could drive the objects into occupants, causing serious injury.
- Do not cover or place items on the air bag covers. These items may cause serious injury during inflation.
- Do not drill, cut or tamper with the knee bolster in any way.
- Do not mount any accessories to the knee bolster such as alarm lights, stereos, citizen band radios, etc.

Supplemental Seat-Mounted Side Air Bags (SAB) — If Equipped

Supplemental Seat-Mounted Side Air Bags (SAB) may provide enhanced protection to help protect an occupant during a side impact. The SAB is marked with an air bag label sewn into the outboard side of the front seats.

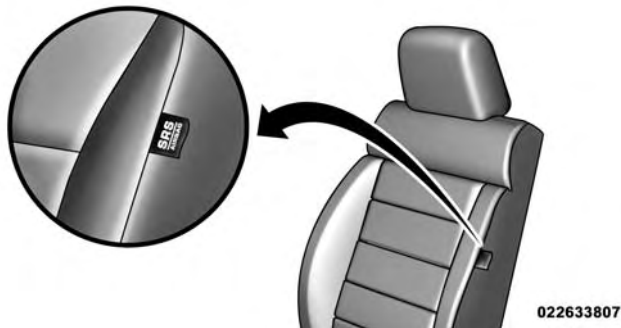

Supplemental Seat-Mounted Side Air Bag Location

When the air bag deploys, it opens the seam between the front and side of the seat's trim cover. Each air bag deploys independently; a left side impact deploys the left air bag only and a right-side impact deploys the right air bag only.

NOTE:

- Air Bag covers may not be obvious in the interior trim, but they will open during air bag deployment.
- Being too close to the SAB during deployment could cause you to be severely injured or killed.

Knee Impact Bolsters

The Knee Impact Bolster helps protect the knees of the front passenger, and position the front occupant for the best interaction with the Advanced Front Air Bag.

Along with seat belts and pretensioners, Advanced Front Air Bags work with the Supplemental Driver Side Knee Air Bag and the passenger side knee bolster to provide improved protection for the driver and front passenger. Side air bags also work with seat belts to improve occupant protection.

Air Bag Deployment Sensors And Controls

Occupant Restraint Controller (ORC)

The ORC is part of a Federally regulated safety system required for this vehicle.

The ORC determines if deployment of the front and/or side air bags is required in a frontal or side collision. Based on the impact sensor's signals, a central electronic ORC deploys the Advanced Front Air Bags, Supplemental Seat-Mounted Side Air Bags (SAB) — if equipped, and front seat belt pretensioners, as required, depending on the severity and type of impact.

Advanced Front Air Bags are designed to provide additional protection by supplementing the seat belts in certain frontal collisions depending on the severity and type of collision. Advanced Front Air Bags are not expected to reduce the risk of injury in rear, side, or rollover collisions.

The Advanced Front Air Bags will not deploy in all frontal collisions, including some that may produce substantial vehicle damage — for example, some pole collisions, truck underrides, and angle offset collisions. On the other hand, depending on the type and location of impact, Advanced Front Air Bags may deploy in crashes with little vehicle front-end damage but that produce a severe initial deceleration.

The side air bags will not deploy in all side collisions. Side air bag deployment will depend on the severity and type of collision.

Because air bag sensors measure vehicle deceleration over time, vehicle speed and damage by themselves are not good indicators of whether or not an air bag should have deployed.

Seat belts are necessary for your protection in all crashes, and also are needed to help keep you in position, away from an inflating air bag.

The ORC also monitors the readiness of the electronic parts of the air bag system whenever the ignition switch is in the START or ON/RUN positions. If the key is in the LOCK position, in the ACC position, or not in the ignition, the air bag system is not on and the air bags will not inflate.

The ORC contains a backup power supply system that may deploy the air bags even if the battery loses power or it becomes disconnected prior to deployment.



Also, the ORC turns on the Air Bag Warning Light for four to eight seconds for a self-check when the ignition is first turned on. After the self-check, the Air Bag Warning Light will turn off. If the ORC detects a malfunction in any part of the system, it turns on the Air Bag Warning Light either momentarily or continuously. A single chime will sound if the light comes on again after initial startup.

It also includes diagnostics that will illuminate the instrument cluster Air Bag Warning Light if a malfunction is noted that could affect the air bag system. The diagnostics also record the nature of the malfunction.

WARNING!

Ignoring the Air Bag Warning Light in your instrument panel could mean you won't have the air bags to protect you in a collision. If the light does not come on as a bulb check when the ignition is first turned on, stays on after you start the vehicle, or if it comes on as you drive, have an authorized dealer service the air bag system immediately.

Driver And Passenger Advanced Front Air Bag Inflator Units

The Driver and Passenger Advanced Front Air Bag Inflator Units are located in the center of the steering wheel and on the right side of the instrument panel.

When the ORC detects a collision requiring the Advanced Front Air Bags, it signals the inflator units. A large quantity of non-toxic gas is generated to inflate the Advanced Front Air Bags. Different air bag inflation rates are possible, based on several factors, including the collision type and severity. The steering wheel hub trim cover and the upper right side of the instrument panel separate and fold out of the way as the air bags inflate to their full size. The air bags fully inflate in about 50 to 70 milliseconds. This is about half of the time it takes to blink your eyes. The air bags then quickly deflate while helping to restrain the driver and front passenger.

The Advanced Front Air Bag gas is vented through the vent holes in the sides of the air bag. In this way, the air bags do not interfere with your control of the vehicle.

Supplemental Seat-Mounted Side Air Bags (SAB) Inflator Units — If Equipped

The Supplemental Seat-Mounted Side Air Bags Inflator Units (if equipped) are designed to activate only in certain side collisions.

The ORC determines if a side collision requires the side air bags to inflate, based on several factors, including the severity and type of collision.

Based on several factors, including the severity and type of collision, the side air bag inflator on the crash side of the vehicle is triggered releasing a quantity of non-toxic gas. The inflating SAB exits through the seat seam into the space between the occupant and the door. The SAB fully inflates in about 10 milliseconds. The side air bag moves at a very high speed and with such a high force that it could injure you if you are not seated properly, or if items are positioned in the area where the side air bag inflates. This especially applies to children.

Front And Side Impact Sensors

In front and side impacts, impact sensors can aid the ORC in determining appropriate response to impact events.

Enhanced Accident Response System

In the event of an impact causing air bag deployment, if the communication network remains intact, and the power remains intact, depending on the nature of the event the ORC will determine whether to have the Enhanced Accident Response System perform the following functions:

- Cut off fuel to the engine.
- Flash hazard lights as long as the battery has power or until the ignition key is turned off.

- Turn on the interior lights, which remain on as long as the battery has power or until the ignition key is removed.
- Unlock the doors automatically.

In order to reset the Enhanced Accident Response System functions after an event, the ignition switch must be changed from IGN ON to IGN OFF.

If A Deployment Occurs

The Advanced Front Air Bags are designed to deflate immediately after deployment.

NOTE: Front and/or side air bags will not deploy in all collisions. This does not mean something is wrong with the air bag system.

If you do have a collision which deploys the air bags, any or all of the following may occur:

- The nylon air bag material may sometimes cause abrasions and/or skin reddening to the driver and front passenger as the air bags deploy and unfold. The abrasions are similar to friction rope burns or those you might get sliding along a carpet or gymnasium floor. They are not caused by contact with chemicals. They are not permanent and normally heal quickly. However, if you haven't healed significantly within a few days, or if you have any blistering, see your doctor immediately.

72 THINGS TO KNOW BEFORE STARTING YOUR VEHICLE

- As the air bags deflate you may see some smoke-like particles. The particles are a normal by-product of the process that generates the non-toxic gas used for air bag inflation. These airborne particles may irritate the skin, eyes, nose, or throat. If you have skin or eye irritation, rinse the area with cool water. For nose or throat irritation, move to fresh air. If the irritation continues, see your doctor. If these particles settle on your clothing, follow the garment manufacturer's instructions for cleaning.
- Do not drive your vehicle after the air bags have deployed. If you are involved in another collision, the air bags will not be in place to protect you.

WARNING!

- **Deployed air bags and seat belt pretensioners cannot protect you in another collision. Have the air bags, seat belt pretensioner, and seat belt retractor assembly replaced by an authorized dealer immediately. Also, have the Occupant Restraint Controller (ORC) system serviced as well.**

(Continued)

WARNING! (Continued)

- Do not attempt to modify any part of your air bag system. The air bag may inflate accidentally or may not function properly if modifications are made. Take your vehicle to an authorized dealer for any air bag system service. If your seat, including your trim cover and cushion, needs to be serviced in any way (including removal or loosening/tightening of seat attachment bolts), take the vehicle to your authorized dealer. Only manufacturer approved seat accessories may be used. If it is necessary to modify the air bag system for persons with disabilities, contact your authorized dealer.

Maintaining Your Air Bag System**WARNING!**

- Modifications to any part of the air bag system could cause it to fail when you need it. You could be injured if the air bag system is not there to protect you. Do not modify the components or wiring, including adding any kind of badges or stickers to the steering wheel hub trim cover or the upper right side of the instrument panel. Do not modify the front bumper or vehicle body structure, or add aftermarket side steps or running boards.
- You need proper knee impact protection in a collision. Do not mount or locate any aftermarket equipment on or behind the knee bolsters.

(Continued)

WARNING! (Continued)

- It is dangerous to try to repair any part of the air bag system yourself. Be sure to tell anyone who works on your vehicle that it has an air bag system.

Air Bag Warning Light

You will want to have the air bags ready to inflate for your protection in a collision. The Air Bag Warning Light monitors the internal circuits and interconnecting wiring associated with air bag system electrical components. While the air bag system is designed to be maintenance free. If any of the following occurs, have an authorized dealer service the air bag system immediately.

- The Air Bag Warning Light does not come on during the four to eight seconds when the ignition switch is first turned to the ON/RUN position.

- The Air Bag Warning Light remains on after the four to eight-second interval.
- The Air Bag Warning Light comes on intermittently or remains on while driving.

NOTE: If the speedometer, tachometer, or any engine related gauges are not working, the Occupant Restraint Controller (ORC) may also be disabled. The air bags may not be ready to inflate for your protection. Promptly check the fuse block for blown fuses. Refer to the label located on the inside of the fuse block cover for the proper air bag fuses. See your authorized dealer if the fuse is good.

Event Data Recorder (EDR)

This vehicle is equipped with an event data recorder (EDR). The main purpose of an EDR is to record, in certain crash or near crash-like situations, such as an air bag deployment or hitting a road obstacle, data that will assist in understanding how a vehicle's systems performed. The EDR is designed to record data related to vehicle dynamics and safety systems for a short period of time, typically 30 seconds or less. The EDR in this vehicle is designed to record such data as:

- How various systems in your vehicle were operating;
- Whether or not the driver and passenger safety belts were buckled/fastened;
- How far (if at all) the driver was depressing the accelerator and/or brake pedal; and,
- How fast the vehicle was traveling.

These data can help provide a better understanding of the circumstances in which crashes and injuries occur.

NOTE: EDR data are recorded by your vehicle only if a non-trivial crash situation occurs; no data are recorded by the EDR under normal driving conditions and no personal data (e.g., name, gender, age, and crash location) are recorded. However, other parties, such as law enforcement, could combine the EDR data with the type of personally identifying data routinely acquired during a crash investigation.

To read data recorded by an EDR, special equipment is required, and access to the vehicle or the EDR is needed. In addition to the vehicle manufacturer, other parties, such as law enforcement, that have the special equipment, can read the information if they have access to the vehicle or the EDR.

Child Restraints

Everyone in your vehicle needs to be buckled up at all times, including babies and children. Every state in the United States, and every Canadian province, requires that small children ride in proper restraint systems. This is the law, and you can be prosecuted for ignoring it.

Children 12 years or younger should ride properly buckled up in a rear seat, if available. According to crash statistics, children are safer when properly restrained in the rear seats rather than in the front.

There are different sizes and types of restraints for children from newborn size to the child almost large enough for an adult safety belt. Always check the child seat Owner's Manual to make sure you have the correct seat for your child.

Before buying any restraint system, make sure that it has a label certifying that it meets all applicable Safety Standards. You should also make sure that you can install it in the vehicle where you will use it.

NOTE: For additional information, refer to www.seatcheck.org or call 1-866-SEATCHECK. Canadian residents should refer to Transport Canada's website for additional information: <http://www.tc.gc.ca/eng/roadsafety/safedrivers-childsafety-index-53.htm>

WARNING!

In a collision, an unrestrained child can become a projectile inside the vehicle. The force required to hold even an infant on your lap could become so great that you could not hold the child, no matter how strong you are. The child and others could be badly injured. Any child riding in your vehicle should be in a proper restraint for the child's size.

Summary Of Recommendations For Restraining Children In Vehicles

	Child Size, Height, Weight or Age	Recommended Type of Child Restraint
Infants and Toddlers	Children who are two years old or younger and who have not reached the height or weight limits of their child restraint	Either an Infant Carrier or a Convertible Child Restraint, facing rearward in the rear seat of the vehicle
Small Children	Children who are at least two years old or who have out-grown the height or weight limit of their rear-facing child restraint	Forward-Facing Child Restraint with a five-point Harness, facing forward in the rear seat of the vehicle
Larger Children	Children who have out-grown their forward-facing child restraint, but are too small to properly fit the vehicle's seat belt	Belt Positioning Booster Seat and the vehicle seat belt, seated in the rear seat of the vehicle
Children Too Large for Child Restraints	Children 12 years old or younger, who have out-grown the height or weight limit of their booster seat	Vehicle Seat Belt, seated in the rear seat of the vehicle

Infants And Child Restraints

Safety experts recommend that children ride rearward-facing in the vehicle until they are two years old or until they reach either the height or weight limit of their rear-facing child safety seat. Two types of child restraints can be used rearward-facing: infant carriers and convertible child seats.

The infant carrier is only used rearward-facing in the vehicle. It is recommended for children from birth until they reach the weight or height limit of the infant carrier. Convertible child seats can be used either rearward-facing or forward-facing in the vehicle. Convertible child seats often have a higher weight limit in the rearward-facing direction than infant carriers do, so they can be used rearward-facing by children who have outgrown

their infant carrier but are still less than at least two years old. Children should remain rearward-facing until they reach the highest weight or height allowed by their convertible child seat.

WARNING!

- **Never place a rear facing infant seat in front of an air bag. A deploying passenger Advanced Front Air Bag can cause death or serious injury to a child 12 years or younger, including a child in a rearward facing infant seat.**
- **Only use a rearward-facing child restraint in a rear seat.**

Older Children And Child Restraints

Children who are two years old or who have outgrown their rear-facing convertible child seat can ride forward-facing in the vehicle. Forward-facing child seats and convertible child seats used in the forward-facing direction are for children who are over two years old or who have outgrown the rear-facing weight or height limit of their rear-facing convertible child seat. Children should remain in a forward-facing child seat with a harness for as long as possible, up to the highest weight or height allowed by the child seat.

All children whose weight or height is above the forward-facing limit for the child seat should use a belt-positioning booster seat until the vehicle's seat belts fit properly. If the child cannot sit with knees bent over the vehicle's seat cushion while the child's back is against the seatback, they should use a belt-positioning booster

seat. The child and belt-positioning booster seat are held in the vehicle by the seat belt.

WARNING!

- **Improper installation can lead to failure of an infant or child restraint. It could come loose in a collision. The child could be badly injured or killed. Follow the child restraint manufacturer's directions exactly when installing an infant or child restraint.**
- **When your child restraint is not in use, secure it in the vehicle with the seat belt or LATCH anchorages, or remove it from the vehicle. Do not leave it loose in the vehicle. In a sudden stop or accident, it could strike the occupants or seatbacks and cause serious personal injury.**

Children Too Large For Booster Seats

Children who are large enough to wear the shoulder belt comfortably, and whose legs are long enough to bend over the front of the seat when their back is against the seatback, should use the seat belt in a rear seat. Use this simple 5-step test to decide whether the child can use the vehicle's seat belt alone:

1. Can the child sit all the way back against the back of the vehicle seat?
2. Do the child's knees bend comfortably over the front of the vehicle seat – while they are still sitting all the way back?
3. Does the shoulder belt cross the child's shoulder between their neck and arm?
4. Is the lap part of the belt as low as possible, touching the child's thighs and not their stomach?
5. Can the child stay seated like this for the whole trip?

If the answer to any of these questions was “no,” then the child still needs to use a booster seat in this vehicle. If the child is using the lap/shoulder belt, check belt fit periodically. A child's squirming or slouching can move the belt out of position. If the shoulder belt contacts the face or neck, move the child closer to the center of the vehicle. Never allow a child to put the shoulder belt under an arm or behind their back.

Recommendations For Attaching Child Restraints

Restraint Type	Combined Weight of the Child + Child Restraint	Use any attachment method shown with an "X" Below			
		LATCH – Lower Anchors Only	Seat Belt Only	LATCH – Lower Anchors + Top Tether Anchor	Seat Belt + Top Tether Anchor
Rear-Facing Child Restraint	Up to 65 lbs (29.5 kg)	X	X		
Rear-Facing Child Restraint	More than 65 lbs (29.5 kg)		X		
Forward-Facing Child Restraint	Up to 65 lbs (29.5 kg)			X	X
Forward-Facing Child Restraint	More than 65 lbs (29.5 kg)				X

Lower Anchors and Tethers for Children (LATCH) Restraint System



Your vehicle is equipped with the child restraint anchorage system called LATCH, which stands for Lower Anchors and Tethers for Children. The LATCH system has three vehicle anchor points for installing LATCH-equipped child seats. There are two lower anchorages located at the back of the seat cushion where it meets the seatback and one top tether anchorage located behind the seating position. These anchorages are used to install LATCH-equipped child seats without using the vehicle's seat belts. Some seating positions may have a top tether anchorage but no lower anchorages. In these seating positions, the seat belt must be used with the top tether anchorage to install the child restraint. Please see the following table for more information.

LATCH Positions For Installing Child Restraints In This Vehicle

2

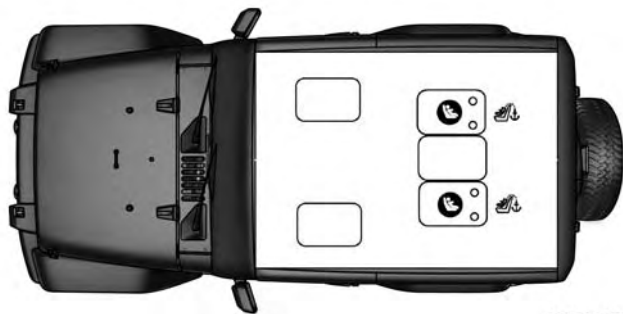

022669336

LATCH Positions (Two-Door Models)

 Lower Anchorage Symbol 2 anchorages per seating position

 Top Tether Anchorage Symbol



022669338

LATCH Positions (Four-Door Models)

 Lower Anchorage Symbol 2 anchorages per seating position

 Top Tether Anchorage Symbol

What is the weight limit (child's weight + weight of the child restraint) for using the LATCH anchorage system to attach the child restraint?	65 lbs (29.5 kg)	Use the LATCH anchorage system until the combined weight of the child and the child restraint is 65 lbs (29.5 kg). Use the seat belt and tether anchor instead of the LATCH system once the combined weight is more than 65 lbs (29.5 kg).
Can the LATCH anchorages and the seat belt be used together to attach a rear-facing or forward-facing child restraint?	No	Do not use the seat belt when you use the LATCH anchorage system to attach a rear-facing or forward-facing child restraint.
Can a child seat be installed in the center position using the inner LATCH lower anchorages?	No	Use the seat belt and tether anchor to install a child seat in the center seating position.

Can two child restraints be attached using a common lower LATCH anchorage?	No	Never “share” a LATCH anchorage with two or more child restraints. If the center position does not have dedicated LATCH lower anchorages, use the seat belt to install a child seat in the center position next to a child seat using the LATCH anchorages in an outboard position.
Can the rear-facing child restraint touch the back of the front passenger seat?	Yes	The child seat may touch the back of the front passenger seat if the child restraint manufacturer also allows contact. See your child restraint owner’s manual for more information.
Can the head restraints be removed?	Yes, center position only.	

Locating The LATCH Anchorages



The lower anchorages are round bars that are found at the rear of the seat cushion where it meets the seatback, below the anchorage symbols on the seatback. They are just visible when you lean into the rear seat to install the child restraint. You will easily feel them if you run your finger along gap between the seatback and seat cushion.



Latch Anchorages (Two-Door Models)

Locating The LATCH Anchorages



In addition, there are tether strap anchors located behind each rear seatback, near to the floor.

2



Latch Anchorages (Four-Door Models)

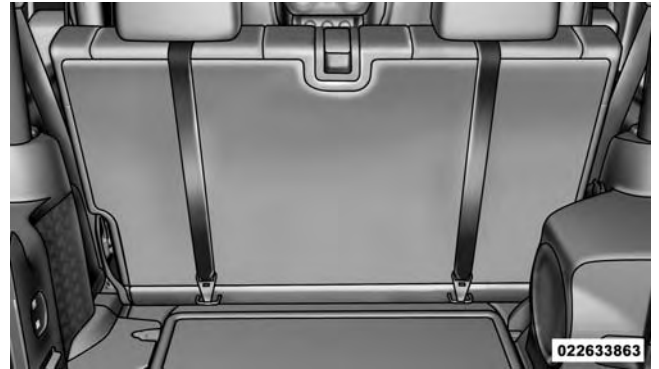

Tether Strap Mounting (Two-Door Models)

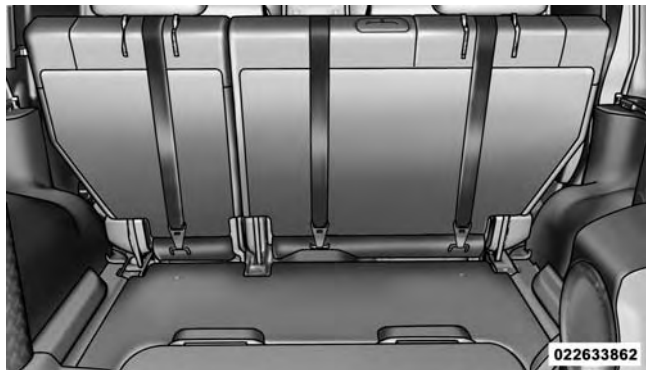

Tether Strap Mounting (Four-Door Models)

LATCH-compatible child restraint systems will be equipped with a rigid bar or a flexible strap on each side. Each will have a hook or connector to attach to the lower anchorage and a way to tighten the connection to the

anchorage. Forward-facing child restraints and some rear-facing infant restraints will also be equipped with a tether strap. The tether strap will have a hook at the end to attach to the top tether anchorage and a way to tighten the strap after it is attached to the anchorage.

Center Seat LATCH

WARNING!

This vehicle does not have a center seating position. Do not use the center lower LATCH anchorages to install a child seat in the center of the back seat.

Always follow the directions of the child restraint manufacturer when installing your child restraint. Not all child restraint systems will be installed as described here.

To Install A LATCH-compatible Child Restraint

1. If the selected seating position has a Switchable Automatic Locking Retractor (ALR) seat belt, stow the seat belt, following the instructions below. See the section “Installing Child Restraints Using the Vehicle Seat Belt” to check what type of seat belt each seating position has.
2. Loosen the adjusters on the lower straps and on the tether strap of the child seat so that you can more easily attach the hooks or connectors to the vehicle anchorages.
3. Place the child seat between the lower anchorages for that seating position. For some second row seats, you may need to recline the seat and / or raise the head restraint to get a better fit.
4. Attach the lower hooks or connectors of the child restraint to the lower anchorages in the selected seating position.
5. If the child restraint has a tether strap, connect it to the top tether anchorage. See the section “Installing Child Restraints Using the Top Tether Anchorage” for directions to attach a tether anchor.
6. Tighten all of the straps as you push the child restraint rearward and downward into the seat. Remove slack in the straps according to the child restraint manufacturer’s instructions.
7. Test that the child restraint is installed tightly by pulling back and forth on the child seat at the belt path. It should not move more than 1 inch (25.4 mm) in any direction.

How To Stow An Unused ALR Seatbelt

When using the LATCH attaching system to install a child restraint, stow all ALR seat belts that are not being used by other occupants or being used to secure child restraints. An unused belt could injure a child if they play with it and accidentally lock the seatbelt retractor. Before installing a child restraint using the LATCH system, buckle the seat belt behind the child restraint and out of the child's reach. If the buckled seat belt interferes with the child restraint installation, instead of buckling it behind the child restraint, route the seat belt through the child restraint belt path and then buckle it. Do not lock the seatbelt. Remind all children in the vehicle that the seat belts are not toys and that they should not play with them.

WARNING!

Improper installation of a child restraint to the LATCH anchorages can lead to failure of the restraint. The child could be badly injured or killed. Follow the child restraint manufacturer's directions exactly when installing an infant or child restraint.

Installing Child Restraints Using The Vehicle Seat Belt

The seat belts in the passenger seating positions are equipped with either a Switchable Automatic Locking Retractor (ALR) or a cinching latch plate or both. Both types of seat belts are designed to keep the lap portion of the seat belt tight around the child restraint so that it is not necessary to use a locking clip. The ALR retractor can be “switched” into a locked mode by pulling all of the webbing out of the retractor and then letting the webbing retract back into the retractor. If it is locked, the ALR will make a clicking noise while the webbing is pulled back into the retractor. For additional information on ALR,

refer to the “Automatic Locking Mode” description under “Occupant Restraints.” The cinching latch plate is designed to hold the lap portion of the seatbelt tight when webbing is pulled tight and straight through a child restraint’s belt path. Please see the table below and the following sections for more information about both types of seat belts.

Lap/Shoulder Belt Systems for Installing Child Restraints in this Vehicle

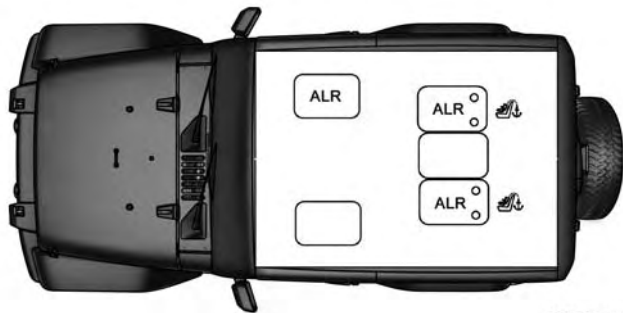

022669337

Two-Door Models



022669339

Four-Door Models

<p>What is the weight limit (child's weight + weight of the child restraint) for using the Tether Anchor with the seat belt to attach a forward facing child restraint?</p>	<p>Weight limit of the Child Restraint</p>	<p>Always use the tether anchor when using the seat belt to install a forward facing child restraint, up to the recommended weight limit of the child restraint.</p>
<p>Can the rear-facing child restraint touch the back of the front passenger seat?</p>	<p>Yes</p>	<p>Contact between the front passenger seat and the child restraint is allowed, if the child restraint manufacturer also allows contact.</p>
<p>Can the head restraints be removed?</p>	<p>Yes, center position only.</p>	
<p>Can the buckle stalk be twisted to tighten the seat belt against the belt path of the child restraint?</p>	<p>Yes</p>	<p>In positions with cinching latch plates (CINCH), the buckle stalk may be twisted up to 3 full turns. Do not twist the buckle stalk in a seating position with an ALR retractor.</p>

Installing A Child Restraint with a Switchable Automatic Locking Retractor (ALR)

1. Place the child seat in the center of the seating position. For some second row seats, you may need to recline the seat and/or raise the head restraint to get a better fit.
2. Pull enough of the seat belt webbing from the retractor to pass it through the belt path of the child restraint. Do not twist the belt webbing in the belt path.
3. Slide the latch plate into the buckle until you hear a "click."
4. Pull on the webbing to make the lap portion tight against the child seat.
5. To lock the seat belt, pull down on the shoulder part of the belt until you have pulled all the seat belt webbing out of the retractor. Then, allow the webbing to retract back into the retractor. As the webbing retracts, you will hear a clicking sound. This means the seat belt is now in the Automatic Locking mode.
6. Try to pull the webbing out of the retractor. If it is locked, you should not be able to pull out any webbing. If the retractor is not locked, repeat step 5.
7. Finally, pull up on any excess webbing to tighten the lap portion around the child restraint while you push the child restraint rearward and downward into the vehicle seat.
8. If the child restraint has a top tether strap and the seating position has a top tether anchorage, connect the tether strap to the anchorage and tighten the tether strap. Refer to "Lower Anchors and Tethers for Children (LATCH) Restraint System" for directions to attach a tether anchor.

9. Test that the child restraint is installed tightly by pulling back and forth on the child seat at the belt path. It should not move more than 1 inch (25.4 mm) in any direction.

Any seat belt system will loosen with time, so check the belt occasionally, and pull it tight if necessary.

Installing A Child Restraint With A Cinching Latch Plate (CINCH) — If Equipped

1. Place the child seat in the center of the seating position. For some second row seats, you may need to recline the seat and / or raise the head restraint to get a better fit.
2. Next, pull enough of the seat belt webbing from the retractor to pass it through the belt path of the child restraint. Do not twist the belt webbing in the belt path.

3. Slide the latch plate into the buckle until you hear a “click.”
4. Finally, pull up on any excess webbing to tighten the lap portion around the child restraint while you push the child restraint rearward and downward into the vehicle seat.
5. If the child restraint has a top tether strap and the seating position has a top tether anchorage, connect the tether strap to the anchorage and tighten the tether strap. Refer to “Lower Anchors and Tethers for Children (LATCH) Restraint System” for directions to attach a tether anchor.
6. Test that the child restraint is installed tightly by pulling back and forth on the child seat at the belt path. It should not move more than 1 inch (25.4 mm) in any direction.

Any seat belt system will loosen with time, so check the belt occasionally, and pull it tight if necessary.

If the buckle or the cinching latch plate is too close to the belt path opening of the child restraint, you may have trouble tightening the seat belt. If this happens, disconnect the latch plate from the buckle and twist the short buckle-end belt up to three full turns to shorten it. Insert the latch plate into the buckle with the release button facing out, away from the child restraint. Repeat steps 4 to 6, above, to complete the installation of the child restraint.

If the belt still cannot be tightened after you shorten the buckle, disconnect the latch plate from the buckle, turn the buckle around one half turn, and insert the latch plate into the buckle again. If you still cannot make the child restraint installation tight, try a different seating position.

Installing Child Restraints Using The Top Tether Anchorage — Second Row Captains Chairs

1. Look behind the seating position where you plan to install the child restraint to find the tether anchorage. You may need to move the seat forward to provide better access to the tether anchorage. If there is no top tether anchorage for that seating position (see the charts above), move the child restraint to another position in the vehicle if one is available.
2. Route the tether strap to provide the most direct path for the strap between the anchor and the child seat. If your vehicle is equipped with adjustable rear head restraints, raise the head restraint, and where possible, route the tether strap under the head restraint and between the two posts. If not possible, lower the head restraint and pass the tether strap around the outboard side of the head restraint.

3. Attach the tether strap hook of the child restraint to the top tether anchorage as shown in the diagram.

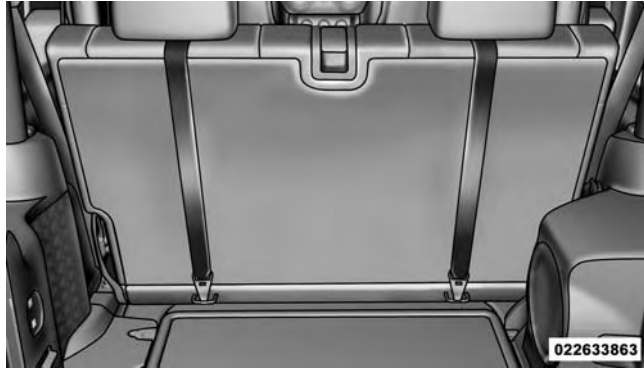

Tether Strap Mounting (Two-Door Models)

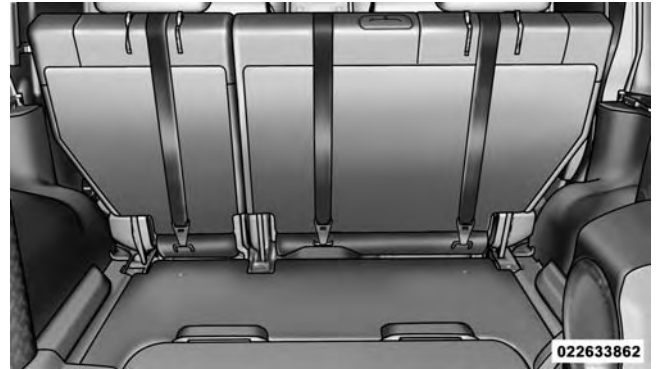

Tether Strap Mounting (Four-Door Models)

4. Remove slack in the tether strap according to the child restraint manufacturer's instructions.

WARNING!

- An incorrectly anchored tether strap could lead to increased head motion and possible injury to the child. Use only the anchorage position directly behind the child seat to secure a child restraint top tether strap.
- If your vehicle is equipped with a split rear seat, make sure the tether strap does not slip into the opening between the seatbacks as you remove slack in the strap.

Transporting Pets

Air Bags deploying in the front seat could harm your pet. An unrestrained pet will be thrown about and possibly injured, or injure a passenger during panic braking or in a collision.

Pets should be restrained in the rear seat in pet harnesses or pet carriers that are secured by seat belts.

ENGINE BREAK-IN RECOMMENDATIONS

A long break-in period is not required for the engine and drivetrain (transmission and axle) in your vehicle.

Drive moderately during the first 500 miles (800 km). After the initial 60 miles (100 km), speeds up to 50 or 55 mph (80 or 90 km/h) are desirable.

While cruising, brief full-throttle acceleration within the limits of local traffic laws contributes to a good break-in. Wide-open throttle acceleration in low gear can be detrimental and should be avoided. Trailer tow is not recommended during break in period.

The engine oil installed in the engine at the factory is a high-quality energy conserving type lubricant. Oil changes should be consistent with anticipated climate conditions under which vehicle operations will occur.

For the recommended viscosity and quality grades, refer to “Maintenance Procedures” in “Maintaining Your Vehicle”. NON-DETERGENT OR STRAIGHT MINERAL OILS MUST NEVER BE USED.

A new engine may consume some oil during its first few thousand miles (kilometers) of operation. This should be considered a normal part of the break-in and not interpreted as an indication of difficulty.

SAFETY TIPS

Transporting Passengers

NEVER TRANSPORT PASSENGERS IN THE CARGO AREA.

WARNING!

- Do not leave children or animals inside parked vehicles in hot weather. Interior heat build-up may cause serious injury or death.
- It is extremely dangerous to ride in a cargo area, inside or outside of a vehicle. In a collision, people riding in these areas are more likely to be seriously injured or killed.
- Do not allow people to ride in any area of your vehicle that is not equipped with seats and seat belts.
- Be sure everyone in your vehicle is in a seat and using a seat belt properly.

Exhaust Gas

WARNING!

Exhaust gases can injure or kill. They contain carbon monoxide (CO), which is colorless and odorless. Breathing it can make you unconscious and can eventually poison you. To avoid breathing (CO), follow these safety tips:

- Do not run the engine in a closed garage or in confined areas any longer than needed to move your vehicle in or out of the area.
- If you are required to drive with the trunk/liftgate open, make sure that all windows are closed and the climate control BLOWER switch is set at high speed. DO NOT use the recirculation mode.

(Continued)

WARNING! *(Continued)*

- If it is necessary to sit in a parked vehicle with the engine running, adjust your heating or cooling controls to force outside air into the vehicle. Set the blower at high speed.

The best protection against carbon monoxide entry into the vehicle body is a properly maintained engine exhaust system.

Whenever a change is noticed in the sound of the exhaust system, when exhaust fumes can be detected inside the vehicle, or when the underside or rear of the vehicle is damaged, have a competent mechanic inspect the complete exhaust system and adjacent body areas for broken, damaged, deteriorated, or mispositioned parts. Open seams or loose connections could permit exhaust fumes

to seep into the passenger compartment. In addition, inspect the exhaust system each time the vehicle is raised for lubrication or oil change. Replace as required.

Safety Checks You Should Make Inside The Vehicle

Seat Belts

Inspect the belt system periodically, checking for cuts, frays, and loose parts. Damaged parts must be replaced immediately. Do not disassemble or modify the system.

Front seat belt assemblies must be replaced after a collision. Rear seat belt assemblies must be replaced after a collision if they have been damaged (i.e., bent retractor, torn webbing, etc.). If there is any question regarding belt or retractor condition, replace the belt.

Air Bag Warning Light



The light should come on and remain on for four to eight seconds as a bulb check when the ignition switch is first turned ON. If the light is not lit during starting, see your authorized dealer. If the light stays on, flickers, or comes on while driving, have the system checked by an authorized dealer.

Defroster

Check operation by selecting the defrost mode and place the blower control on high speed. You should be able to feel the air directed against the windshield. See your authorized dealer for service if your defroster is inoperable.

Floor Mat Safety Information

Always use floor mats designed to fit the footwell of your vehicle. Use only floor mats that leave the pedal area unobstructed and that are firmly secured so that they cannot slip out of position and interfere with the pedals or impair safe operation of your vehicle in other ways.

WARNING!

Pedals that cannot move freely can cause loss of vehicle control and increase the risk of serious personal injury.

- Always make sure that floor mats are properly attached to the floor mat fasteners.
- Never place or install floor mats or other floor coverings in the vehicle that cannot be properly secured to prevent them from moving and interfering with the pedals or the ability to control the vehicle.

(Continued)

WARNING! (Continued)

- Never put floor mats or other floor coverings on top of already installed floor mats. Additional floor mats and other coverings will reduce the size of the pedal area and interfere with the pedals.
- Check mounting of mats on a regular basis. Always properly reinstall and secure floor mats that have been removed for cleaning.
- Always make sure that objects cannot fall into the driver footwell while the vehicle is moving. Objects can become trapped under the brake pedal and accelerator pedal causing a loss of vehicle control.
- If required, mounting posts must be properly installed, if not equipped from the factory.

Failure to properly follow floor mat installation or mounting can cause interference with the brake pedal and accelerator pedal operation causing loss of control of the vehicle.

Periodic Safety Checks You Should Make Outside The Vehicle

Tires

Examine tires for excessive tread wear and uneven wear patterns. Check for stones, nails, glass, or other objects lodged in the tread or sidewall. Inspect the tread for cuts and cracks. Inspect sidewalls for cuts, cracks and bulges. Check the wheel nuts for tightness. Check the tires (including spare) for proper cold inflation pressure.

Lights

Have someone observe the operation of brake lights and exterior lights while you work the controls. Check turn signal and high beam indicator lights on the instrument panel.

Door Latches

Check for positive closing, latching, and locking.

Fluid Leaks

Check area under vehicle after overnight parking for fuel, engine coolant, oil, or other fluid leaks. Also, if gasoline fumes are detected or if fuel, power steering fluid, or brake fluid leaks are suspected, the cause should be located and corrected immediately.

UNDERSTANDING THE FEATURES OF YOUR VEHICLE

CONTENTS

■ MIRRORS111	□ Pair (Link) Uconnect™ Phone to a Mobile Phone118
□ Inside Day/Night Mirror111	□ Dial by Saying a Number119
□ Outside Mirrors112	□ Call by Saying a Name.120
□ Power Mirrors — If Equipped113	□ Add Names to Your Uconnect™ Phonebook. . .	.120
□ Heated Mirrors — If Equipped113	□ Phonebook Download – Automatic Phonebook Transfer From Mobile Phone.121
□ Vanity Mirrors114	□ Phonebook Download — Single Entry122
■ Uconnect™ Phone — IF EQUIPPED114	□ Edit Uconnect™ Phonebook Entries.123
□ Operation117	□ Delete Uconnect™ Phonebook Entry123
□ Help Command.118		
□ Cancel Command118		

106 UNDERSTANDING THE FEATURES OF YOUR VEHICLE

- Delete/Erase “All” Uconnect™ Phonebook Entries124
- List All Names in the Uconnect™ Phonebook. .125
- Phone Call Features125
- Uconnect™ Phone Features128
- Advanced Phone Connectivity134
- Things You Should Know About Your Uconnect™ Phone135
- General Information146
- VOICE COMMAND — IF EQUIPPED146
 - Voice Command System Operation146
 - Commands148
 - Voice Training151
- SEATS152
 - Front Seat Adjustment152
 - Manual Seat Height Adjustment — If Equipped154
 - Front Seatback Recline154
 - Front Passenger Easy Entry Seat — Two-Door Models155
 - Tip n’ Slide Seats — Two-Door Models157
 - Heated Seats — If Equipped159
 - Head Restraints160
 - Fold And Tumble Rear Seat — Two-Door Models161
 - Removing The Rear Seat — Two-Door Models163

□ Replacing The Rear Seat — Two-Door Models164
□ 60/40 Split Folding Rear Seat — Four-Door Models164
■ TO OPEN AND CLOSE THE HOOD166
■ LIGHTS167
□ Multifunction Lever167
□ Headlights And Parking Lights167
□ Automatic Headlights — If Equipped168
□ Turn Signals169
□ Lane Change Assist169
□ Lights-On Reminder170
□ High/Low Beam Switch170
□ Flash-To-Pass170

UNDERSTANDING THE FEATURES OF YOUR VEHICLE	107
□ Front Fog Lights170
□ Instrument Panel Dimmer170
□ Daytime Running Lights — If Equipped171
□ Interior Lights171
■ WINDSHIELD WIPERS AND WASHERS173
□ Windshield Wiper Operation174
□ Intermittent Wiper System174
□ Windshield Washers175
□ Mist Feature176
■ TILT STEERING COLUMN177
■ ELECTRONIC SPEED CONTROL — IF EQUIPPED178
□ To Activate179

108 UNDERSTANDING THE FEATURES OF YOUR VEHICLE

- To Set A Desired Speed179
- To Deactivate180
- To Resume Speed180
- To Vary The Speed Setting180
- To Accelerate For Passing181
- ELECTRICAL POWER OUTLET182
- POWER INVERTER — IF EQUIPPED186
- CUPHOLDERS188
 - Front Cupholders188
 - Rear Cupholders188
- STORAGE189
 - Glovebox Storage.189
 - Console Storage Compartment189
 - Rear Storage Compartment190
- DUAL TOP — TWO-DOOR MODELS — IF EQUIPPED191
 - Removing The Soft Top — Two-Door Models . .191
 - Installing The Soft Top — Two-Door Models . .193
- DUAL TOP — FOUR-DOOR MODELS — IF EQUIPPED196
 - Removing The Soft Top — Four-Door Models .197
 - Installing The Soft Top — Four-Door Models .199
- FREEDOM TOP™ THREE-PIECE MODULAR HARD TOP — IF EQUIPPED202
 - Front Panel(s) Removal203
 - Freedom Top™ Storage Bag205
 - Front Panel(s) Installation209

FRONT PANEL(S) INSTALLATION WITH REAR HARD TOP REMOVED		UNDERSTANDING THE FEATURES OF YOUR VEHICLE	109
□ Front Panel(s) Installation With Rear Hard Top Removed210	□ Raising The Soft Top240
□ Rear Hard Top Removal210	■ SOFT TOP — FOUR-DOOR MODELS249
□ Rear Hard Top Installation213	□ Quick Steps For Lowering The Soft Top252
■ DOOR FRAME214	□ Quick Steps For Raising The Soft Top256
□ Door Frame Removal215	□ Folding Down The Soft Top261
□ Door Frame Installation — Two-Door Models217	□ Putting Up The Soft Top271
□ Door Frame Installation — Four-Door Models218	■ SUNRIDER® (TWO-DOOR MODELS) — IF EQUIPPED280
■ SOFT TOP — TWO-DOOR MODELS221	□ Opening The Sunrider®281
□ Quick Steps To Lowering The Soft Top223	□ Closing The Sunrider®283
□ Quick Steps To Raising The Soft Top227	■ SUNRIDER® (FOUR-DOOR MODELS) — IF EQUIPPED283
□ Lowering The Soft Top231	□ Opening The Sunrider®284
		□ Closing The Sunrider®286

■ FOLDING WINDSHIELD286	■ REAR WINDOW FEATURES	
□ Lowering The Windshield And Removing Side Bars288	— HARD TOP ONLY293
□ Raising The Windshield And Replacing Side Bars291	□ Rear Window Wiper/Washer — If Equipped .	.293
		□ Rear Window Defroster — If Equipped294

MIRRORS

Inside Day/Night Mirror

A two-point pivot system allows for horizontal and vertical adjustment of the mirror. Adjust the mirror to center on the view through the rear window.

Headlight glare can be reduced by moving the small control lever under the mirror to the night position (lever flipped toward the rear of vehicle). The mirror should be adjusted while set in the day position (toward the windshield).



030407085

Adjusting Rearview Mirror

Outside Mirrors

To receive maximum benefit, adjust the outside mirror(s) to center on the adjacent lane of traffic with a slight overlap of the view obtained on the inside mirror.



Outside Rearview Mirror

WARNING!

Vehicles and other objects seen in the passenger side convex mirror will look smaller and farther away than they really are. Relying too much on your passenger side mirror could cause you to collide with another vehicle or other object. Use your inside mirror when judging the size or distance of a vehicle seen in the passenger side mirror.

Power Mirrors — If Equipped

The power mirror switch is located on the center of the instrument panel, below the climate controls. A rotary knob selects the left mirror, right mirror or off position.



Power Mirror Switch

After selecting a mirror, move the knob in the same direction you want the mirror to move. Use the center off position to guard against accidentally moving a mirror position.

Heated Mirrors — If Equipped



These mirrors are heated to melt frost or ice. This feature is activated whenever you turn on the rear window defroster. Refer to “Rear Window Features” in “Understanding The Features Of Your Vehicle” for further information.

Vanity Mirrors

Vanity mirrors are located on the sun visors. To use the mirrors, rotate the sun visor down and swing the mirror cover upward.



Vanity Mirror

Uconnect™ Phone — IF EQUIPPED

Uconnect™ Phone is a voice-activated, hands-free, in-vehicle communications system. Uconnect™ Phone allows you to dial a phone number with your mobile phone using simple voice commands (e.g., “Call” ... “Mike” ... “Work” or “Dial” ... “248-555-1212”). Your mobile phone’s audio is transmitted through your vehicle’s audio system; the system will automatically mute your radio when using the Uconnect™ Phone.

NOTE: The Uconnect™ Phone requires a mobile phone equipped with the Bluetooth® “Hands-Free Profile”, Version 0.96 or higher. See the Uconnect™ website for supported phones.

For Uconnect™ customer support, visit the following websites:

- www.chrysler.com/uconnect
- www.dodge.com/uconnect
- www.jeep.com/uconnect
- or call 1-877-855-8400

Uconnect™ Phone allows you to transfer calls between the system and your mobile phone as you enter or exit your vehicle and enables you to mute the system's microphone for private conversation.

The Uconnect™ Phone is driven through your Bluetooth® "Hands-Free Profile" mobile phone. Uconnect™ features Bluetooth® technology - the global standard that enables different electronic devices to connect to each other without wires or a docking station, so Uconnect™ Phone works no matter where you stow your mobile phone (be it your



purse, pocket, or briefcase), as long as your phone is turned on and has been paired to the vehicle's Uconnect™ Phone. The Uconnect™ Phone allows up to seven mobile phones to be linked to the system. Only one linked (or paired) mobile phone can be used with the system at a time. The system is available in English, Spanish, or French languages.

WARNING!

Any voice commanded system should be used only in safe driving conditions following all applicable laws, including laws regarding phone use. All attention should be kept on the roadway ahead. Failure to do so may result in a collision causing serious injury or death.

Uconnect™ Phone Button



The radio or steering wheel controls (if equipped) will contain the two control buttons (Uconnect™ Phone  button and Voice Command  button) that will enable you to access the system. When you press the button you will hear the word Uconnect™ followed by a BEEP. The beep is your signal to give a command.

NOTE: The driver side upper windshield trim contains the microphone for the Uconnect™ Phone.

Voice Command Button

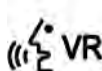

Actual button location may vary with the radio. The individual buttons are described in the “Operation” section.

The Uconnect™ Phone can be used with any Hands-Free Profile certified Bluetooth® mobile phone. See the Uconnect™ website for supported phones. Refer to your mobile service provider or the phone manufacturer for details.

The Uconnect™ Phone is fully integrated with the vehicle’s audio system. The volume of the Uconnect™ Phone can be adjusted either from the radio volume control knob or from the steering wheel radio control (right switch), if so equipped.

The radio display will be used for visual prompts from the Uconnect™ Phone such as “CELL” or caller ID on certain radios.

Operation

Voice commands can be used to operate the Uconnect™ Phone and to navigate through the Uconnect™ Phone menu structure. Voice commands are required after most Uconnect™ Phone prompts. You will be prompted for a specific command and then guided through the available options.

- Prior to giving a voice command, one must wait for the beep, which follows the “Ready” prompt or another prompt.
- For certain operations, compound commands can be used. For example, instead of saying “Setup” and then “Phone Pairing”, the following compound command can be said: “Setup Phone Pairing”.



- For each feature explanation in this section, only the compound form of the voice command is given. You can also break the commands into parts and say each part of the command when you are asked for it. For example, you can use the compound form voice command “Phonebook New Entry”, or you can break the compound form command into two voice commands: “Phonebook” and “New Entry”. Please remember, the Uconnect™ Phone works best when you talk in a normal conversational tone, as if speaking to someone sitting a few feet/meters away from you.

Voice Command Tree

Refer to “Voice Tree” in this section.

Help Command

If you need assistance at any prompt, or if you want to know your options at any prompt, say “Help” following the beep. The Uconnect™ Phone will play all the options at any prompt if you ask for help.

To activate the Uconnect™ Phone from idle, simply press the  button and follow the audible prompts for directions. All Uconnect™ Phone sessions begin with a press of the  button on the radio control head.

Cancel Command

At any prompt, after the beep, you can say “Cancel” and you will be returned to the main menu. However, in a few instances the system will take you back to the previous menu.

Pair (Link) Uconnect™ Phone to a Mobile Phone

To begin using your Uconnect™ Phone, you must pair your compatible Bluetooth® enabled mobile phone.

To complete the pairing process, you will need to reference your mobile phone Owner’s Manual. The Uconnect™ website may also provide detailed instructions for pairing.

The following are general phone to Uconnect™ Phone pairing instructions:

- Press the  button to begin.
- After the “Ready” prompt and the following beep, say “Setup Phone Pairing”.
- When prompted, after the beep, say “Pair a Phone” and follow the audible prompts.

- You will be asked to say a four-digit Personal Identification Number (PIN), which you will later need to enter into your mobile phone. You can enter any four-digit PIN. You will not need to remember this PIN after the initial pairing process.
- For identification purposes, you will be prompted to give the Uconnect™ Phone a name for your mobile phone. Each mobile phone that is paired should be given a unique phone name.
- You will then be asked to give your mobile phone a priority level between one and seven, with one being the highest priority. You can pair up to seven mobile phones to your Uconnect™ Phone. However, at any given time, only one mobile phone can be in use, connected to your Uconnect™ System. The priority allows the Uconnect™ Phone to know which mobile phone to use if multiple mobile phones are in the vehicle at the same time. For example, if priority three

and priority five phones are present in the vehicle, the Uconnect™ Phone will use the priority three mobile phone when you make a call. You can select to use a lower priority mobile phone at any time (refer to “Advanced Phone Connectivity” in this section).

Dial by Saying a Number

- Press the  button to begin.
- After the “Ready” prompt and the following beep, say “Dial”.
- The system will prompt you to say the number you want to call.
- For example, you can say “234-567-8901”.
- The Uconnect™ Phone will confirm the phone number and then dial. The number will appear in the display of certain radios.

Call by Saying a Name

- Press the  button to begin.
- After the “Ready” prompt and the following beep, say “Call”.
- The system will prompt you to say the name of the person you want to call.
- After the “Ready” prompt and the following beep, say the name of the person you want to call. For example, you can say “John Doe”, where John Doe is a previously stored name entry in the Uconnect™ phonebook or downloaded phonebook. To learn how to store a name in the phonebook, refer to “Add Names to Your Uconnect™ Phonebook”, in the phonebook.
- The Uconnect™ system will confirm the name and then dial the corresponding phone number, which may appear in the display of certain radios.

Add Names to Your Uconnect™ Phonebook

NOTE: Adding names to the Uconnect™ Phonebook is recommended when the vehicle is not in motion.

- Press the  button to begin.
- After the “Ready” prompt and the following beep, say “Phonebook New Entry”.
- When prompted, say the name of the new entry. Use of long names helps the Voice Command and it is recommended. For example, say “Robert Smith” or “Robert” instead of “Bob”.
- When prompted, enter the number designation (e.g., “Home”, “Work”, “Mobile”, or “Other”). This will allow you to store multiple numbers for each phonebook entry, if desired.
- When prompted, recite the phone number for the phonebook entry that you are adding.

After you are finished adding an entry into the phonebook, you will be given the opportunity to add more phone numbers to the current entry or to return to the main menu.

The Uconnect™ Phone will allow you to enter up to 32 names in the phonebook with each name having up to four associated phone numbers and designations. Each language has a separate 32-name phonebook accessible only in that language. In addition, if equipped and supported by your phone, Uconnect™ Phone automatically downloads your mobile phone's phonebook.

Phonebook Download – Automatic Phonebook Transfer From Mobile Phone

If equipped and specifically supported by your phone, Uconnect™ Phone automatically downloads names (text names) and number entries from your mobile phone's phonebook. Specific Bluetooth® Phones with Phone Book

Access Profile may support this feature. See Uconnect™ website for supported phones.

- To call a name from downloaded (or Uconnect™) Phonebook, follow the procedure in “Call by Saying a Name” section.
- Automatic download and update, if supported, begins as soon as the Bluetooth® wireless phone connection is made to the Uconnect™ Phone, for example, after you start the vehicle.
- A maximum of 1000 entries per phone will be downloaded and updated every time a phone is connected to the Uconnect™ Phone.
- Depending on the maximum number of entries downloaded, there may be a short delay before the latest downloaded names can be used. Until then, if available, the previous downloaded phonebook is available for use.

- Only the phonebook of the currently connected mobile phone is accessible.
- Only the mobile phone's phonebook is downloaded. SIM card phonebook is not part of the Mobile phonebook.
- This downloaded phonebook cannot be edited or deleted on the Uconnect™ Phone. These can only be edited on the mobile phone. The changes are transferred and updated to Uconnect™ Phone on the next phone connection.

Phonebook Download — Single Entry

If equipped and supported by your phone, Uconnect™ Phone also allows the user to download entries one at a time from their phone via Bluetooth®. To use this feature, press the  button and say "Phonebook Download". The system prompts, "Ready to accept "V" card entry via Bluetooth®..." The system is now ready to accept a single

phonebook entry from your phone using the Bluetooth® Object Exchange Profile (OBEX). Please see your phone Owner's Manual for specific instructions on how to send these entries from your phone.

NOTE:

- The phone handset must support Bluetooth® OBEX transfers of phonebook entries to use this feature.
- Some phones cannot send phonebook entries if they are already connected to any system via Bluetooth®, and you may see a message on the phone display that the Bluetooth® link is busy. In this case, the user must first disconnect or drop the Bluetooth® connection to the Uconnect™ phone, and then send the address book entry via Bluetooth®. Please see your phone Owner's Manual for specific instructions on how to drop the Bluetooth® connection.
- If the phonebook entry is longer than 24 characters, it will only use the first 24 characters.

Edit Uconnect™ Phonebook Entries

NOTE:

- Editing names in the phonebook is recommended when the vehicle is not in motion.
- Automatic downloaded phonebook entries cannot be deleted or edited.
- Press the  button to begin.
- After the “Ready” prompt and the following beep, say “Phonebook Edit”.
- You will then be asked for the name of the phonebook entry that you wish to edit.
- Next, choose the number designation (home, work, mobile, or other) that you wish to edit.
- When prompted, recite the new phone number for the phonebook entry that you are editing.

After you are finished editing an entry in the phonebook, you will be given the opportunity to edit another entry in the phonebook, call the number you just edited, or return to the main menu.

“Phonebook Edit” can be used to add another phone number to a name entry that already exists in the phonebook. For example, the entry John Doe may have a mobile and a home number, but you can add “John Doe’s” work number later using the “Phonebook Edit” feature.

Delete Uconnect™ Phonebook Entry

NOTE: Editing phonebook entries is recommended when the vehicle is not in motion.



- Press the  button to begin.
- After the “Ready” prompt and the following beep, say “Phonebook Delete”.

- After you enter the Phonebook Delete menu, you will then be asked for the name of the entry that you wish to delete. You can either say the name of a phonebook entry that you wish to delete or you can say “List Names” to hear a list of the entries in the phonebook from which you choose. To select one of the entries from the list, press the  button while the Uconnect™ Phone is playing the desired entry and say “Delete”.
- After you enter the name, the Uconnect™ Phone will ask you which designation you wish to delete: home, work, mobile, other, or all. Say the designation you wish to delete.
- Note that only the phonebook entry in the current language is deleted.
- Automatic downloaded phonebook entries cannot be deleted or edited.

Delete/Erase “All” Uconnect™ Phonebook Entries

- Press the  button to begin.
- After the “Ready” prompt and the following beep, say “Phonebook Erase All”.
- The Uconnect™ Phone will ask you to verify that you wish to delete all the entries from the phonebook.
- After confirmation, the phonebook entries will be deleted.
- Note that only the phonebook in the current language is deleted.
- Automatic downloaded phonebook entries cannot be deleted or edited.

List All Names in the Uconnect™ Phonebook

- Press the  button to begin.
- After the “Ready” prompt and the following beep, say “Phonebook List Names”.
- The Uconnect™ Phone will play the names of all the phonebook entries, including the downloaded phonebook entries, if available.
- To call one of the names in the list, press the  button during the playing of the desired name, and say “Call”.



NOTE: The user can also exercise “Edit” or “Delete” operations at this point.

- The Uconnect™ Phone will then prompt you as to the number designation you wish to call.
- The selected number will be dialed.

Phone Call Features

The following features can be accessed through the Uconnect™ Phone if the feature(s) are available on your mobile service plan. For example, if your mobile service plan provides three-way calling, this feature can be accessed through the Uconnect™ Phone. Check with your mobile service provider for the features that you have.

Answer or Reject an Incoming Call - No Call Currently in Progress

When you receive a call on your mobile phone, the Uconnect™ Phone will interrupt the vehicle audio system, if on, and will ask if you would like to answer the call. Press the  button to accept the call. To reject the call, press and hold the  button until you hear a single beep, indicating that the incoming call was rejected.

Answer or Reject an Incoming Call - Call Currently in Progress

If a call is currently in progress and you have another incoming call, you will hear the same network tones for call waiting that you normally hear when using your mobile phone. Press the  button to place the current call on hold and answer the incoming call.



NOTE: The Uconnect™ Phone compatible phones in the market today do not support rejecting an incoming call when another call is in progress. Therefore, the user can only answer an incoming call or ignore it.

Making a Second Call While Current Call is in Progress

To make a second call while you are currently on a call, press the  button and say “Dial” or “Call” followed by the phone number or phonebook entry you wish to

call. The first call will be on hold while the second call is in progress. To go back to the first call, refer to “Toggling Between Calls” in this section. To combine two calls, refer to “Conference Call” in this section.

Place/Retrieve a Call From Hold

To put a call on hold, press the  button until you hear a single beep. This indicates that the call is on hold. To bring the call back from hold, press and hold the  button until you hear a single beep.



Toggling Between Calls

If two calls are in progress (one active and one on hold), press the  button until you hear a single beep, indicating that the active and hold status of the two calls have switched. Only one call can be placed on hold at a time.

Conference Call

When two calls are in progress (one active and one on hold), press and hold the  button until you hear a double beep indicating that the two calls have been joined into one conference call.

Three-Way Calling

To initiate three-way calling, press the  button while a call is in progress, and make a second phone call, as described under “Making a Second Call While Current Call is in Progress”. After the second call has established, press and hold the  button until you hear a double beep, indicating that the two calls have been joined into one conference call.

Call Termination

To end a call in progress, momentarily press the  button. Only the active call(s) will be terminated and if there

is a call on hold, it will become the new active call. If the active call is terminated by the phone far end, a call on hold may not become active automatically. This is cell phone-dependent. To bring the call back from hold, press and hold the  button until you hear a single beep.

Redial

- Press the  button to begin.
- After the “Ready” prompt and the following beep, say “Redial”.
- The Uconnect™ Phone will call the last number that was dialed from your mobile phone.

NOTE: This may not be the last number dialed from the Uconnect™ Phone.

Call Continuation

Call continuation is the progression of a phone call on the Uconnect™ Phone after the vehicle ignition key has been switched to OFF. Call continuation functionality available on the vehicle can be any one of three types:

- After the ignition key is switched to OFF, a call can continue on the Uconnect™ Phone either until the call ends, or until the vehicle battery condition dictates cessation of the call on the Uconnect™ Phone and transfer of the call to the mobile phone.
- After the ignition key is switched to OFF, a call can continue on the Uconnect™ Phone for a certain duration, after which the call is automatically transferred from the Uconnect™ Phone to the mobile phone.
- An active call is automatically transferred to the mobile phone after the ignition key is switched to OFF.

Uconnect™ Phone Features

Language Selection

To change the language that the Uconnect™ Phone is using:

- Press the  button to begin.
- After the “Ready” prompt and the following beep, say the name of the language you wish to switch to English, Espanol, or Francais.
- Continue to follow the system prompts to complete the language selection.

After selecting one of the languages, all prompts and voice commands will be in that language.

NOTE: After every Uconnect™ Phone language change operation, only the language-specific 32-name phone-book is usable. The paired phone name is not language-specific and usable across all languages.

Emergency Assistance

If you are in an emergency and the mobile phone is reachable:

- Pick up the phone and manually dial the emergency number for your area.

If the phone is not reachable and the Uconnect™ Phone is operational, you may reach the emergency number as follows:

- Press the  button to begin.
- After the “Ready” prompt and the following beep, say “Emergency” and the Uconnect™ Phone will instruct the paired mobile phone to call the emergency number. This feature is supported in the U.S., Canada, and Mexico.

NOTE:

- The emergency number dialed is based on the country where the vehicle is purchased (911 for the U.S. and Canada and 060 for Mexico). The number dialed may not be applicable with the available mobile service and area.
- If supported, this number may be programmable on some systems. To do this, press the  button and say “Setup”, followed by “Emergency”.
- The Uconnect™ Phone does slightly lower your chances of successfully making a phone call as to that for the mobile phone directly.

WARNING!

To use your Uconnect™ Phone System in an emergency, your mobile phone must be:

- turned on,
- paired to the Uconnect™ System,
- and have network coverage.

Towing Assistance

If you need towing assistance:

- Press the  button to begin.
- After the “Ready” prompt and the following beep, say “Towing Assistance”.

NOTE:

- The towing assistance number dialed is based on the country where the vehicle is purchased (1-800-528-2069 for the U.S., 1-877-213-4525 for Canada, 55-14-3454 for Mexico City and 1-800-712-3040 for outside Mexico City in Mexico). Please refer to the 24-Hour Towing Assistance coverage details on the DVD in the Warranty Information Booklet and the 24-Hour Towing Assistance references.
- If supported, this number may be programmable on some systems. To do this, press the  button and say “Setup”, followed by “Towing Assistance”.

Paging

To learn how to page, refer to “Working with Automated Systems”. Paging works properly except for pagers of certain companies, which time out a little too soon to work properly with the Uconnect™ Phone.

Voice Mail Calling



To learn how to access your voice mail, refer to “Working with Automated Systems”.

Working with Automated Systems

This method is used in instances where one generally has to press numbers on the mobile phone keypad while navigating through an automated telephone system.

You can use your Uconnect™ Phone to access a voice mail system or an automated service, such as a paging service or automated customer service line. Some services require immediate response selection. In some instances, that may be too quick for use of the Uconnect™ Phone.

When calling a number with your Uconnect™ Phone that normally requires you to enter in a touch-tone sequence on your mobile phone keypad, you can press the

 button and say the sequence you wish to enter, followed by the word “Send”. For example, if required to enter your PIN followed with a pound, (3 7 4 6 #), you can press the  button and say, “3 7 4 6 # Send”. Saying a number, or sequence of numbers, followed by “Send”, is also to be used for navigating through an automated customer service center menu structure, and to leave a number on a pager.

You can also send stored Uconnect™ Phonebook entries as tones for fast and easy access to voice mail and pager entries. To use this feature, dial the number you wish to call and then press the  button and say, “Send”. The system will prompt you to enter the name or number and say the name of the phonebook entry you wish to send. The Uconnect™ Phone will then send the corresponding phone number associated with the phonebook entry, as tones over the phone.

NOTE:

- You may not hear all of the tones due to mobile phone network configurations. This is normal.
- Some paging and voice mail systems have system time out settings that are too short and may not allow the use of this feature.

Barge In - Overriding Prompts

The “Voice Command” button can be used when you wish to skip part of a prompt and issue your voice command immediately. For example, if a prompt is asking “Would you like to pair a phone, clear a...,” you could press the  button and say, “Pair a Phone” to select that option without having to listen to the rest of the voice prompt.

Turning Confirmation Prompts On/Off

Turning confirmation prompts off will stop the system from confirming your choices (e.g., the Uconnect™ Phone will not repeat a phone number before you dial it).

- Press the  button to begin.
- After the “Ready” prompt and the following beep, say:
 - “Setup Confirmations Prompts On”
 - “Setup Confirmations Prompts Off”

Phone and Network Status Indicators

If available on the radio and/or on a premium display such as the instrument panel cluster, and supported by your mobile phone, the Uconnect™ Phone will provide notification to inform you of your phone and network status when you are attempting to make a phone call using Uconnect™ Phone. The status is given for roaming, network signal strength, phone battery strength, etc.

Dialing Using the Mobile Phone Keypad

You can dial a phone number with your mobile phone keypad and still use the Uconnect™ Phone (while dialing via the mobile phone keypad, the user must exercise caution and take precautionary safety measures). By dialing a number with your paired Bluetooth® mobile phone, the audio will be played through your vehicle's audio system. The Uconnect™ Phone will work the same as if you dial the number using Voice Command.

NOTE: Certain brands of mobile phones do not send the dial ring to the Uconnect™ Phone to play it on the vehicle audio system, so you will not hear it. Under this situation, after successfully dialing a number the user may feel that the call did not go through even though the call is in progress. Once your call is answered, you will hear the audio.

Mute/Un-Mute (Mute ON/OFF)

When you mute the Uconnect™ Phone, you will still be able to hear the conversation coming from the other party, but the other party will not be able to hear you. In order to mute the Uconnect™ Phone:

- Press the  button.
- Following the beep, say "Mute".

In order to un-mute the Uconnect™ Phone:

- Press the  button.
- Following the beep, say "Mute off".

Advanced Phone Connectivity

Transfer Call to and from Mobile Phone



The Uconnect™ Phone allows ongoing calls to be transferred from your mobile phone to the Uconnect™ Phone without terminating the call. To transfer an ongoing call from your Uconnect™ Phone paired mobile phone to the Uconnect™ Phone or vice versa, press the  button and say “Transfer Call”.

Connect or Disconnect Link Between the Uconnect™ Phone and Mobile Phone

Your mobile phone can be paired with many different electronic devices, but can only be actively “connected” with one electronic device at a time.

If you would like to connect or disconnect the Bluetooth® connection between a Uconnect™ Phone paired mobile phone and the Uconnect™ Phone, follow the instructions described in your mobile phone User’s Manual.

List Paired Mobile Phone Names

- Press the  button to begin.
- After the “Ready” prompt and the following beep, say “Setup Phone Pairing”.
- When prompted, say “List Phones”.
- The Uconnect™ Phone will play the phone names of all paired mobile phones in order from the highest to the lowest priority. To “Select” or “Delete” a paired phone being announced, press the  button and say “Select” or “Delete”. Also, see the next two sections for an alternate way to “Select” or “Delete” a paired phone.



Select Another Mobile Phone

This feature allows you to select and start using another phone paired with the Uconnect™ Phone.

- Press the  button to begin.
- After the “Ready” prompt and the following beep, say “Setup Select Phone” and follow the prompts.

- You can also press the  button at any time while the list is being played, and then choose the phone that you wish to select.
- The selected phone will be used for the next phone call. If the selected phone is not available, the Uconnect™ Phone will return to using the highest priority phone present in or near (approximately within 30 ft (9 m)) the vehicle.

Delete Uconnect™ Phone Paired Mobile Phones

- Press the  button to begin.
- After the “Ready” prompt and the following beep, say “Setup Phone Pairing”.
- At the next prompt, say “Delete” and follow the prompts.
- You can also press the  button at any time while the list is being played, and then choose the phone you wish to delete.

Things You Should Know About Your Uconnect™ Phone



Uconnect™ Phone Tutorial

To hear a brief tutorial of the system features, press the  button and say “Uconnect™ Tutorial”.

Voice Training

For users experiencing difficulty with the system recognizing their voice commands or numbers, the Uconnect™ Phone Voice Training feature may be used. To enter this training mode, follow one of the two following procedures:

From outside the Uconnect™ Phone mode (e.g., from radio mode):

- Press and hold the  button for five seconds until the session begins, or,
- Press the  button and say the “Voice Training”, “System Training”, or “Start Voice Training” command.

You can either press the Uconnect™ Phone button to restore the factory setting or repeat the words and phrases when prompted by the Uconnect™ Phone. For best results, the Voice Training session should be completed when the vehicle is parked with the engine running, all windows closed, and the blower fan switched off.

This procedure may be repeated with a new user. The system will adapt to the last trained voice only.

Reset

- press the  button.
- After the “Ready” prompt, and the following beep, say “Setup”, then “Reset”.

This will delete all phone pairing, phone book entries, and other settings in all language modes. The System will prompt you before resetting to factory settings.

Voice Command

- For best performance, adjust the rearview mirror to provide at least ½ in (1 cm) gap between the overhead console (if equipped) and the mirror.
- Always wait for the beep before speaking.
- Speak normally, without pausing, just as you would speak to a person sitting a few feet/meters away from you.
- Make sure that no one other than you is speaking during a Voice Command period.
- Performance is maximized under:
 - low-to-medium blower setting,
 - low-to-medium vehicle speed,
 - low road noise,
 - smooth road surface,
 - fully closed windows,
 - dry weather condition.

- Even though the system is designed for users speaking in North American English, French, and Spanish accents, the system may not always work for some.
- When navigating through an automated system such as voice mail, or when sending a page, at the end of speaking the digit string, make sure to say “Send”.
- Storing names in the phonebook when the vehicle is not in motion is recommended.
- It is not recommended to store similar sounding names in the Uconnect™ Phonebook.
- Phonebook (Downloaded and Uconnect™ Phone Local) name recognition rate is optimized when the entries are not similar.
- Numbers must be spoken in single digits. “800” must be spoken “eight-zero-zero” not “eight hundred”.
- You can say “O” (letter “O”) for “0” (zero).
- Even though international dialing for most number combinations is supported, some shortcut dialing number combinations may not be supported.
- In a convertible vehicle, system performance may be compromised with the convertible top down.

Far End Audio Performance

- Audio quality is maximized under:
 - low-to-medium blower setting,
 - low-to-medium vehicle speed,
 - low road noise,
 - smooth road surface,
 - fully closed windows,
 - dry weather conditions, and
 - operation from the driver’s seat.

- Performance, such as audio clarity, echo, and loudness to a large degree rely on the phone and network, and not the Uconnect™ Phone.
- Echo at the phone far end can sometimes be reduced by lowering the in-vehicle audio volume.
- In a convertible vehicle, system performance may be compromised with the convertible top down.

Recent Calls

If your phone supports “Automatic Phonebook Download”, Uconnect™ Phone can list your Outgoing, Incoming and Missed Calls.

SMS

Uconnect™ Phone can read or send new messages on your phone.

Read Messages:

If you receive a new text message while your phone is connected to Uconnect™ Phone, an announcement will be made to notify you that you have a new text message. If you wish to hear the new message:

- Press the  button.
- After the “Ready” prompt and the following beep, say “SMS Read” or “Read Messages”.
- Uconnect™ Phone will play the new text message for you.

After reading a message, you can “Reply” or “Forward” the message using Uconnect™ Phone.

Send Messages:

You can send messages using Uconnect™ Phone. To send a new message:

- Press the  button.
- After the “Ready” prompt and the following beep, say “SMS Send” or “Send Messages”.
- You can either say the message you wish to send or say “List Messages”. There are 20 preset messages.

To send a message, press the  button while the system is listing the message and say “Send”.

Uconnect™ Phone will prompt you to say the name or number of the person you wish to send the message to.

List of Preset Messages:

1. Yes
2. No

3. Where are you?
4. I need more direction.
5. L O L
6. Why
7. I love you
8. Call me
9. Call me later
10. Thanks
11. See You in 15 minutes
12. I am on my way
13. I'll be late
14. Are you there yet?
15. Where are we meeting?

16. Can this wait?
17. Bye for now
18. When can we meet
19. Send number to call
20. Start without me

Turn SMS Incoming Announcement ON/OFF

Turning the SMS Incoming Announcement OFF will stop the system from announcing the new incoming messages.

- Press the  button.
- After the “Ready” prompt and the following beep, say “Setup, Incoming Message Announcement,” you will then be given a choice to change it.

Bluetooth® Communication Link

Mobile phones have been found to lose connection to the Uconnect™ Phone. When this happens, the connection can generally be reestablished by switching the phone off/on. Your mobile phone is recommended to remain in Bluetooth® ON mode.

Power-Up

After switching the ignition key from OFF to either the ON or ACC position, or after a language change, you must wait at least five seconds prior to using the system.

Voice Tree

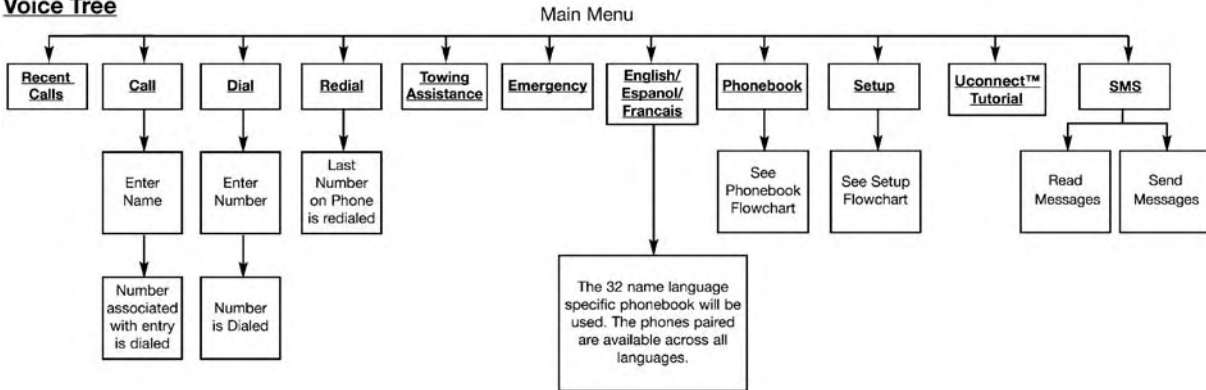

Note: Available Voice commands are shown in bold face and are underlined.

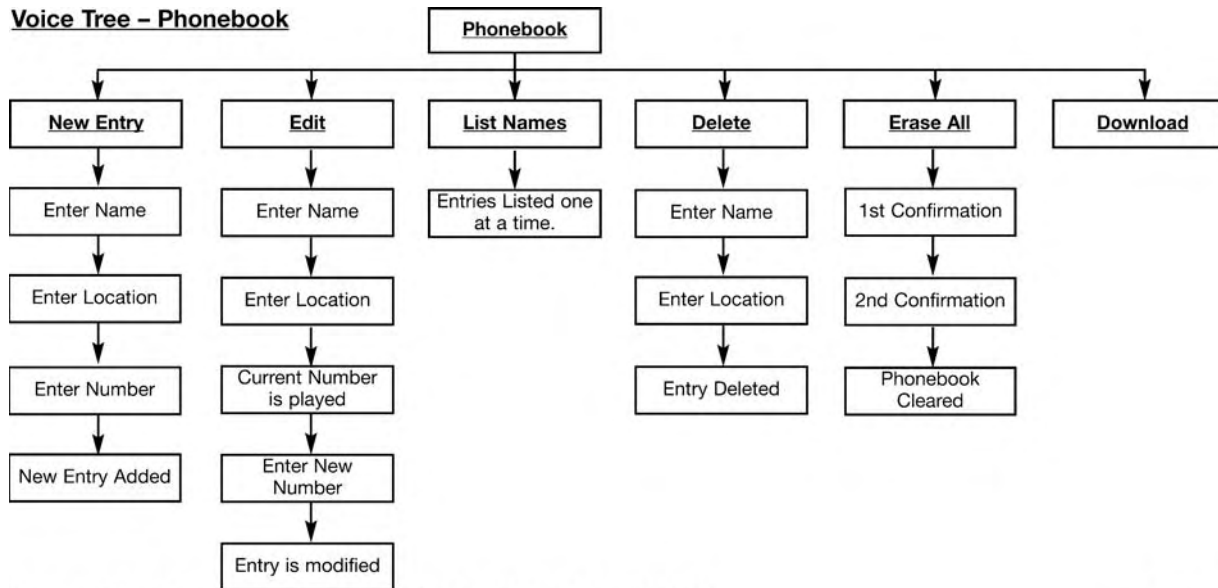
Voice Tree – Phonebook

Note: Available Voice commands are shown in bold face and are underlined.

Voice Tree – Setup

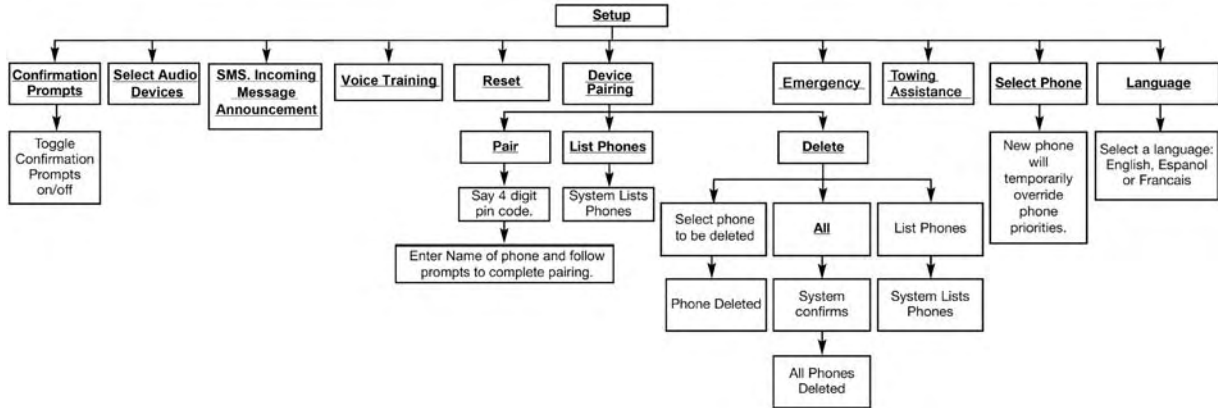

Note: Available Voice commands are shown in bold face and are underlined.

030605540

Voice Commands	
Primary	Alternate (s)
zero	
one	
two	
three	
four	
five	
six	
seven	
eight	
nine	
star (*)	
plus (+)	
pound (#)	
add location	
all	

Voice Commands	
Primary	Alternate (s)
call	
cancel	
confirmation prompts	
continue	
delete	
dial	
download	
edit	
emergency	
English	
erase all	
Espanol	
Francais	
help	
home	

Voice Commands	
Primary	Alternate (s)
language	
list names	
list phones	
mobile	
mute	
mute off	
new entry	
no	
other	
pair a phone	
phone pairing	pairing
phonebook	phone book
previous	
record again	
redial	

Voice Commands	
Primary	Alternate (s)
return to main menu	return or main menu
select phone	select
send	
set up	phone settings or phone set up
towing assistance	
transfer call	
Uconnect™ Tutorial	
try again	
voice training	
work	
yes	

General Information

This device complies with Part 15 of the FCC rules and RSS 210 of Industry Canada. Operation is subject to the following conditions:

- Changes or modifications not expressly approved by the party responsible for compliance could void the user's authority to operate the equipment.
- This device may not cause harmful interference.
- This device must accept any interference received, including interference that may cause undesired operation.

VOICE COMMAND — IF EQUIPPED

Voice Command System Operation

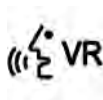

This Voice Command system allows you to control your AM, FM radio, satellite radio, disc player, and a memo recorder.

NOTE: Take care to speak into the Voice Interface System as calmly and normally as possible. The ability of the Voice Interface System to recognize user voice commands may be negatively affected by rapid speaking or a raised voice level.

WARNING!

Any voice commanded system should be used only in safe driving conditions following all applicable laws. All attention should be kept on the roadway ahead. Failure to do so may result in a collision causing serious injury or death.

When you press the Voice Command  button, you will hear a beep. The beep is your signal to give a command.

NOTE: If you do not say a command within a few seconds, the system will present you with a list of options.

If you ever wish to interrupt the system while it lists options, press the Voice Command  button, listen for the beep, and say your command.

Pressing the Voice Command  button while the system is speaking is known as “barging in.” The system will be interrupted, and after the beep, you can add or change commands. This will become helpful once you start to learn the options.

NOTE: At any time, you can say the words “Cancel”, “Help” or “Main Menu”.

These commands are universal and can be used from any menu. All other commands can be used depending upon the active application.

When using this system, you should speak clearly and at a normal speaking volume.

The system will best recognize your speech if the windows are closed, and the heater/air conditioning fan is set to low.

At any point, if the system does not recognize one of your commands, you will be prompted to repeat it.

To hear the first available Menu, press the Voice Command  button and say “Help” or “Main Menu”.

Commands

The Voice Command system understands two types of commands. Universal commands are available at all times. Local commands are available if the supported radio mode is active.

Changing the Volume

1. Start a dialogue by pressing the Voice Command  button.
2. Say a command (e.g., “Help”).
3. Use the ON/OFF VOLUME rotary knob to adjust the volume to a comfortable level while the Voice Command system is speaking. Please note the volume setting for Voice Command is different than the audio system.

Main Menu

Start a dialogue by pressing the Voice Command  button. You may say “Main Menu” to switch to the main menu.

In this mode, you can say the following commands:

- “Radio” (to switch to the radio mode)
- “Disc” (to switch to the disc mode)
- “Memo” (to switch to the memo recorder)
- “Setup” (to switch to system setup)

Radio AM

To switch to the AM band, say “AM” or “Radio AM”. In this mode, you may say the following commands:

- “Frequency #” (to change the frequency)
- “Next Station” (to select the next station)

- “Previous Station” (to select the previous station)
- “Radio Menu” (to switch to the radio menu)
- “Main Menu” (to switch to the main menu)

Radio FM

To switch to the FM band, say “FM” or “Radio FM”. In this mode, you may say the following commands:

- “Frequency #” (to change the frequency)
- “Next Station” (to select the next station)
- “Previous Station” (to select the previous station)
- “Menu Radio” (to switch to the radio menu)
- “Main Menu” (to switch to the main menu)

Satellite Radio

To switch to satellite radio mode, say “Sat” or “Satellite Radio”. In this mode, you may say the following commands:

- “Channel Number” (to change the channel by its spoken number)
- “Next Channel” (to select the next channel)
- “Previous Channel” (to select the previous channel)
- “List Channel” (to hear a list of available channels)
- “Select Name” (to say the name of a channel)
- “Menu Radio” (to switch to the radio menu)
- “Main Menu” (to switch to the main menu)

Disc

To switch to the disc mode, say “Disc”. In this mode, you may say the following commands:

- “Track” (#) (to change the track)
- “Next Track” (to play the next track)
- “Previous Track” (to play the previous track)
- “Main Menu” (to switch to the main menu)

Memo

To switch to the voice recorder mode, say “Memo”. In this mode, you may say the following commands:

- “New Memo” (to record a new memo) — During the recording, you may press the Voice Command  button to stop recording. You proceed by saying one of the following commands:
 - “Save” (to save the memo)

- “Continue” (to continue recording)
- “Delete” (to delete the recording)
- “Play Memos” (to play previously recorded memos) — During the playback you may press the Voice Command  button to stop playing memos. You proceed by saying one of the following commands:
 - “Repeat” (to repeat a memo)
 - “Next” (to play the next memo)
 - “Previous” (to play the previous memo)
 - “Delete” (to delete a memo)
- “Delete All” (to delete all memos)

Setup

To switch to system setup, you may say one of the following:

- “Change to setup”
- “Switch to system setup”

- “Change to setup”
- “Main menu setup” or
- “Switch to setup”

In this mode, you may say the following commands:

- “Language English”
- “Language French”
- “Language Spanish”
- “Tutorial”
- “Voice Training”

NOTE: Keep in mind that you have to press the Voice Command  button first and wait for the beep before speaking the “Barge In” commands.

Voice Training

For users experiencing difficulty with the system recognizing their voice commands or numbers the Uconnect™ Voice “Voice Training” feature may be used.

1. Press the Voice Command  button, say “System Setup” and once you are in that menu then say “Voice Training.” This will train your own voice to the system and will improve recognition.
2. Repeat the words and phrases when prompted by Uconnect™ Voice. For best results, the “Voice Training” session should be completed when the vehicle is parked, engine running, all windows closed, and the blower fan switched off. This procedure may be repeated with a new user. The system will adapt to the last trained voice only.

SEATS

Seats are part of the Occupant Restraint System of the vehicle.

WARNING!

- It is dangerous to ride in a cargo area, inside or outside of a vehicle. In a collision, people riding in these areas are more likely to be seriously injured or killed.
- Do not allow people to ride in any area of your vehicle that is not equipped with seats and seat belts. In a collision, people riding in these areas are more likely to be seriously injured or killed.
- Be sure everyone in your vehicle is in a seat and using a seat belt properly.

Front Seat Adjustment

The seat can be adjusted forward or rearward by using a bar located by the front of the seat cushion, near the floor. While sitting in the seat, lift up on the bar located under the seat cushion and move the seat forward or rearward. Release the bar once you have reached the desired position. Then, using body pressure, move forward and rearward on the seat to be sure that the seat adjusters have latched.

WARNING!

- Adjusting a seat while driving may be dangerous. Moving a seat while driving could result in loss of control which could cause a collision and serious injury or death.
- Seats should be adjusted before fastening the seat belts and while the vehicle is parked. Serious injury or death could result from a poorly adjusted seat belt.

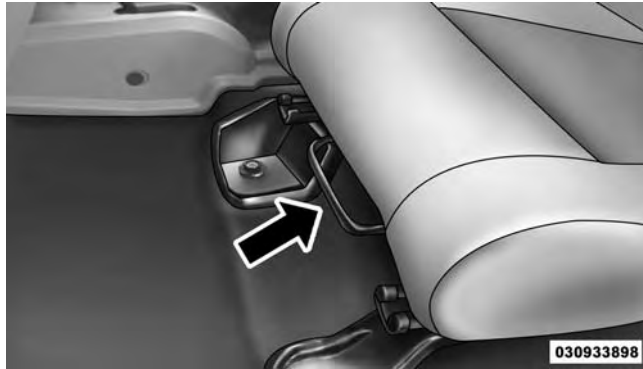

Manual Seat Adjustment

Manual Seat Height Adjustment — If Equipped

The driver's seat height can be raised or lowered by using the ratcheting handle, located on the outboard side of the seat. Pull upward on the handle to raise the seat; push downward on the handle to lower the seat.

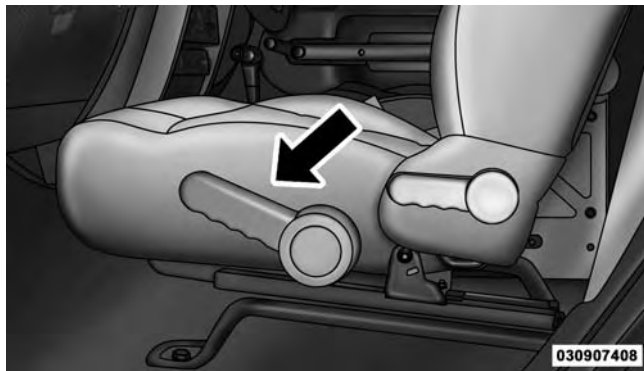

Seat Height Adjustment

Front Seatback Recline

Lean forward before lifting the handle, then lean back to the desired position and release the handle. Lift the handle to return the seatback to an upright position.

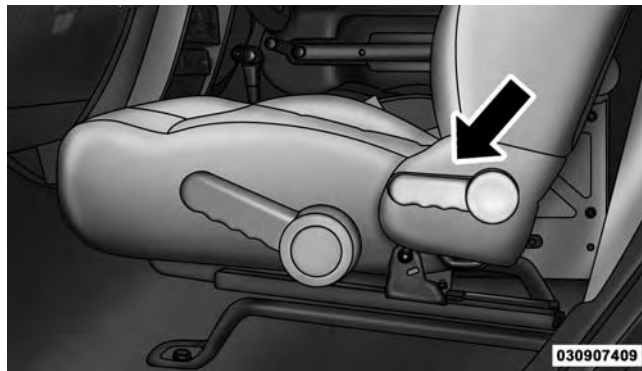

Recline Lever

WARNING!

Do not ride with the seatback reclined so that the shoulder belt is no longer resting against your chest. In a collision you could slide under the seat belt, which could result in serious injury or death.

Front Passenger Easy Entry Seat — Two-Door Models

Pull upward on the recline lever (toward the rear of the vehicle) and slide the entire seat forward.

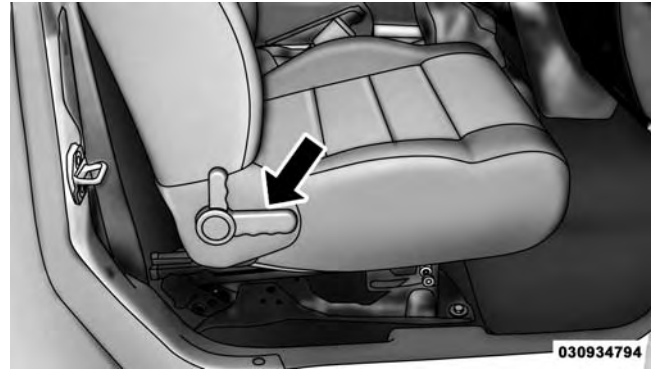
**3**

Easy Entry Lever

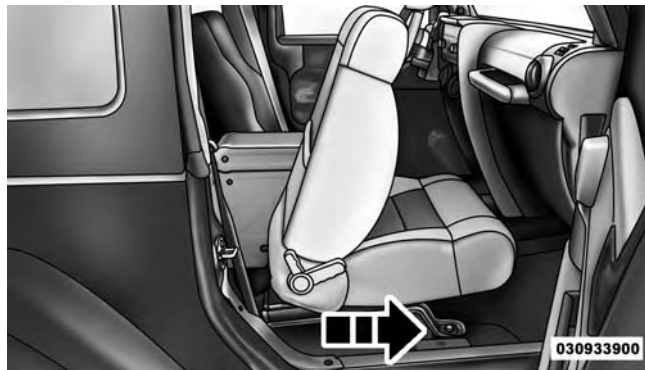

Easy Entry Seat

To return the seat to a sitting position, rotate the seatback upright until it locks and push the seat rearward until the track locks.

NOTE:

- The front passenger seats have a track memory, which returns the seat to just past the halfway point of the track regardless of its original position.
- The recliner and easy entry levers should not be used during the automatic returning of the seat to its sitting position.

Tip n' Slide Seats — Two-Door Models

This feature allows the front seats to be rotated toward the instrument panel to allow easier entry into the rear seats.

Driver's Seat

Pull upward on the recline lever and bring the seatback to its full forward position.

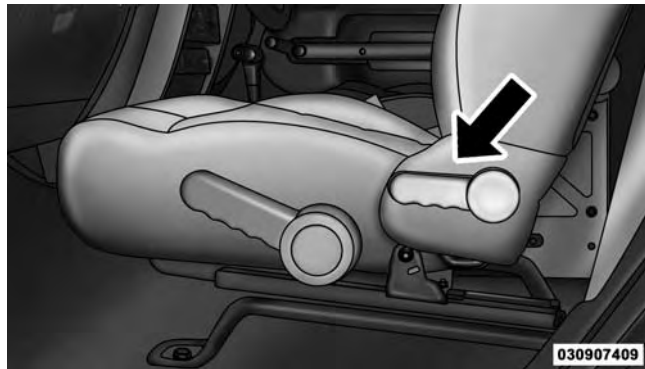

Recline Lever

Rotate the entire seat assembly toward the instrument panel.



Tip n' Slide

Passenger Seat

In addition to Easy Entry, the front passenger seat is also equipped with Tip n' Slide. This feature allows for easier entry for rear passengers.

Pull upward on the recline lever and slide the entire seat forward (Easy Entry).

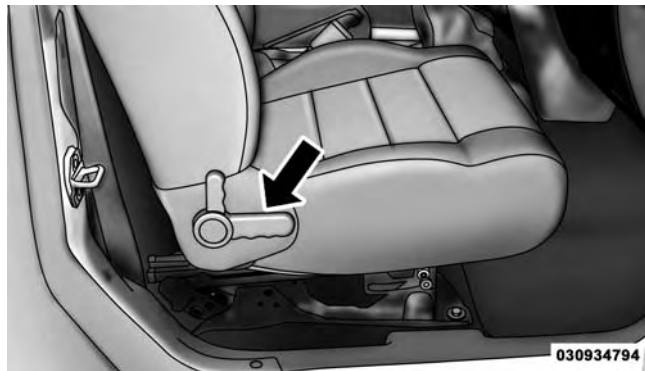

Easy Entry Lever

With the seat forward, pull the entire seat assembly toward the instrument panel.

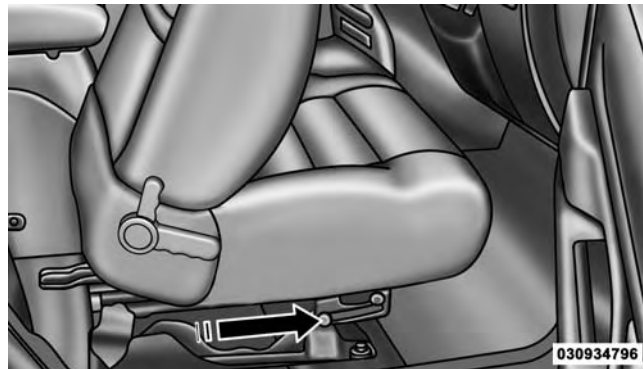

Tip n' Slide

Heated Seats — If Equipped

On some models, the front driver and passenger seats may be equipped with heaters in both the seat cushions and seatbacks.

There are two heated seat switches that allow the driver and passenger to operate the seats independently. The controls for each seat are located on a switch bank near the bottom center of the instrument panel.

You can choose from HIGH, LOW or OFF heat settings. Amber indicator lights in each switch indicate the level of heat in use. Two indicator lights will illuminate for HIGH, one for LOW and none for OFF.



Press the switch once to select HIGH-level heating. Press the switch a second time to select LOW-level heating. Press the switch a third time to shut the heating elements OFF.

When the HIGH-level setting is selected, the heater will provide a boosted heat level during the first four minutes of operation. Then, the heat output will drop to the normal HIGH-level. If the HIGH-level setting is selected, the system will automatically switch to LOW-level after approximately 30 minutes of continuous operation. At that time, the number of illuminated LEDs changes from two to one, indicating the change. The LOW-level setting will turn OFF automatically after approximately 30 minutes.

NOTE: When a heat setting is selected, heat will be felt within two to five minutes.

WARNING!

- Persons who are unable to feel pain to the skin because of advanced age, chronic illness, diabetes, spinal cord injury, medication, alcohol use, exhaustion or other physical condition must exercise care when using the seat heater. It may cause burns even at low temperatures, especially if used for long periods of time.
- Do not place anything on the seat or seatback that insulates against heat, such as a blanket or cushion. This may cause the seat heater to overheat. Sitting in a seat that has been overheated could cause serious burns due to the increased surface temperature of the seat.

Head Restraints

Head restraints are designed to reduce the risk of injury by restricting head movement in the event of a rear impact. Head restraints should be adjusted so that the top of the head restraint is located above the top of your ear.

WARNING!

The head restraints for all occupants must be properly adjusted prior to operating the vehicle or occupying a seat. Head restraints should never be adjusted while the vehicle is in motion. Driving a vehicle with the head restraints improperly adjusted or removed could cause serious injury or death in the event of a collision.

Front Head Restraints

To raise the head restraint, pull upward on the head restraint. To lower the head restraint, press the adjustment button, located on the base of the head restraint, and push downward on the head restraint.

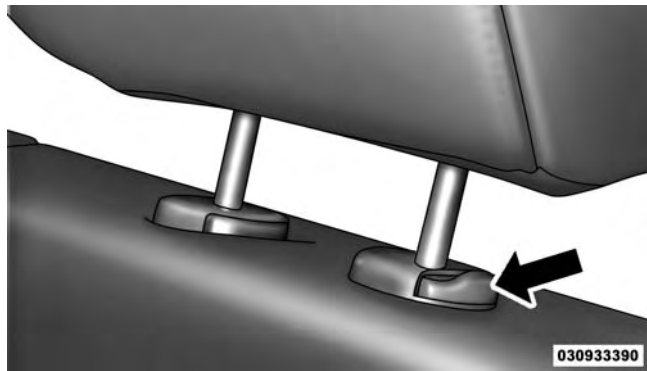

Adjustment Button

Rear Head Restraints

The rear seat is equipped with nonadjustable head restraints. Refer to “Occupant Restraints” in “Things to Know Before Starting Your Vehicle” for information on child seat tether routing.

Fold And Tumble Rear Seat — Two-Door Models

NOTE:

- Prior to folding the rear seat, it may be necessary to reposition the front seats.
- Be sure that the front seats are fully upright and positioned forward. This will allow the rear seat to fold down easily.

162 UNDERSTANDING THE FEATURES OF YOUR VEHICLE

1. Lift the seatback release lever and fold the seatback forward.

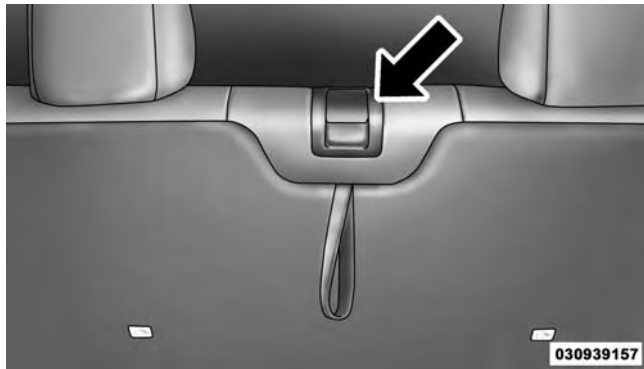

Rear Seat Release

2. Slowly flip the entire seat forward.

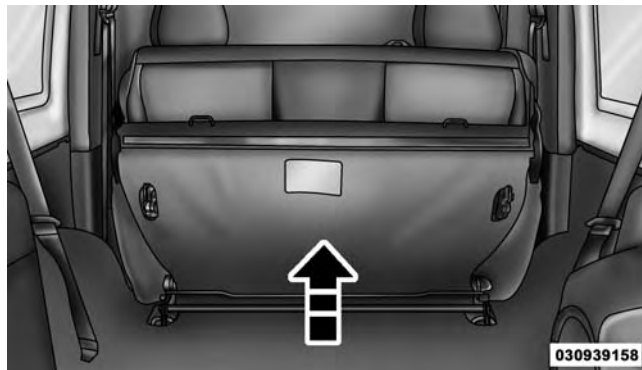

Folding Rear Seat

3. Return the seat to the normal position.
4. Raise the rear seatback using the assist strap and firmly lock the seat into position.

Removing The Rear Seat — Two-Door Models

WARNING!

- It is extremely dangerous to ride in a cargo area, inside or outside of a vehicle. In a collision, people riding in these areas are more likely to be seriously injured or killed.
- Do not allow people to ride in any area of your vehicle that is not equipped with seats and seat belts.
- Be sure everyone in your vehicle is in a seat and using a seat belt properly.
- In a collision, you or others in your vehicle could be injured if seats are not properly latched to their floor attachments. Always be sure that the seats are fully latched.

1. Fold the rear seat forward following steps 1 and 2 under “Fold And Tumble Rear Seat” in this section.
2. Press down on the release bar on each side, and pull the seat out and away from the lower bracket.
3. Remove the seat from the vehicle.

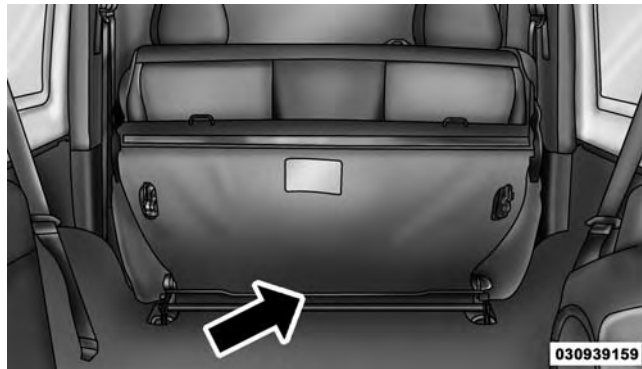

Release Bar Location

Replacing The Rear Seat — Two-Door Models

Reverse the steps for removing the seat.

WARNING!

- To help protect against personal injury, passengers should not be seated in the rear cargo area with the rear seat folded down or removed from the vehicle.
- The rear cargo space is intended for load carrying purposes only, not for passengers who should sit in seats and use seat belts.

60/40 Split Folding Rear Seat — Four-Door Models

To provide additional storage area, each rear seat can be folded flat to allow for extended cargo space and still maintain some rear seating room.

NOTE:

- Prior to folding the rear seat, it may be necessary to reposition the front seat to its mid-track position.
- Be sure that the front seats are fully upright and positioned forward. This will allow the rear seat to fold down easily.

WARNING!

- It is extremely dangerous to ride in a cargo area, inside or outside of a vehicle. In a collision, people riding in these areas are more likely to be seriously injured or killed.
- Do not allow people to ride in any area of your vehicle that is not equipped with seats and seat belts.
- Be sure everyone in your vehicle is in a seat and using a seat belt properly.

To Fold Down The Rear Seat

Locate the pull strap (lower outboard side of seat), and pull it toward you until the seatback releases.

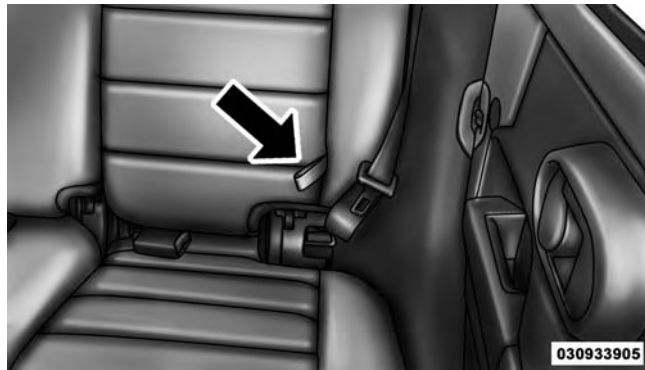

Pull Strap

To Raise The Rear Seat

Raise the seatback and lock it into place. If interference from the cargo area prevents the seatback from fully locking, you will have difficulty returning the seat to its proper position.

NOTE: If the rear seatback is not fully latched, the center shoulder belt will not be able to be extended for use. If you cannot extend the center shoulder belt, make sure your seatback is fully latched.

WARNING!

Be certain that the seatback is securely locked into position. If the seatback is not securely locked into position the seat will not provide the proper stability for child seats and/or passengers. An improperly latched seat could cause serious injury.

TO OPEN AND CLOSE THE HOOD

Release both the hood latches.



031333906

Hood Latch

Raise the hood and locate the safety latch, located in the middle of the hood opening. Push the latch to the left side of the vehicle, to open the hood. You may have to push

down slightly on the hood before pushing the safety latch. Insert the support rod into the slot on the hood.

To close the hood, remove the support rod from the hood panel and place it in the retaining clip. Lower the hood slowly. Secure both of the hood latches.

WARNING!

Be sure the hood is fully latched before driving your vehicle. If the hood is not fully latched, it could open when the vehicle is in motion and block your vision. Failure to follow this warning could result in serious injury or death.

LIGHTS

Multifunction Lever

The multifunction lever controls the operation of the parking lights, headlights, headlight beam selection, passing light, fog lights, instrument panel light dimming and turn signals. The multifunction lever is located on the left side of the steering column.



031407547

Multifunction Lever

Headlights And Parking Lights

Turn the end of the multifunction lever to the first detent for parking light operation. Turn to the second detent for headlight operation.



031407548

Headlight Switch

Automatic Headlights — If Equipped

This system automatically turns the headlights on or off according to ambient light levels. To turn the system on, turn the end of the multifunction lever to the AUTO position (third detent). When the system is on, the Headlight Time Delay feature is also on. This means the headlights will stay on for up to 90 seconds after you turn the ignition switch to the LOCK position. To turn the Automatic System off, turn the end of the multifunction lever out of the AUTO position.



031407553

Headlight Switch

NOTE: The engine must be running before the headlights will turn on in the Automatic mode.

Turn Signals

Move the multifunction lever up or down and the arrows on each side of the instrument cluster flash to show proper operation of the front and rear turn signal lights.

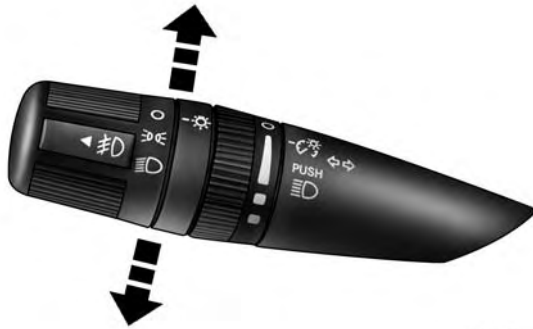

031407551

Turn Signal Operation

NOTE:

- If either light remains on and does not flash, or there is a very fast flash rate, check for a defective outside light bulb. If an indicator fails to light when the lever is moved, it would suggest that the indicator bulb is defective.
- A tone will chime if the turn signals are left on for more than 1 mile (2 km).

Lane Change Assist

Tap the lever up or down once, without moving beyond the detent, and the turn signal (right or left) will flash three times then automatically turn off.

Lights-On Reminder

If the headlights or parking lights are left on after the ignition is turned OFF, a chime will sound to alert the driver when the driver's door is opened.

High/Low Beam Switch

Push the multifunction lever away from you to switch the headlights to high beam. Pull the lever toward you, to switch the headlights back to low beam.

Flash-To-Pass

You can signal another vehicle with your headlights by lightly pulling the multifunction lever toward you. This will turn on the high beams headlights until the lever is released.

Front Fog Lights



The front fog light switch is located on the multifunction lever. To activate the front fog lights, turn on the parking or low beam headlights and pull out the end of the lever.

NOTE: The fog lights will only operate with the parking lights or the headlights on low beam. Selecting high beam headlights will turn off the fog lights.

Instrument Panel Dimmer

Rotate the center portion of the lever to the extreme bottom position to fully dim the instrument panel lights and prevent the interior lights from illuminating when a door is opened.

Rotate the center portion of the lever up to increase the brightness of the instrument panel lights when the parking lights or headlights are on.

Rotate the center portion of the lever upward to the next detent position to brighten the odometer and radio when the parking lights or headlights are on.

Rotate the center portion of the lever upward to the last detent to turn on the interior lighting.



031407549

Dimmer Control

Daytime Running Lights — If Equipped

The headlights come on at a low intensity level when shifted into any position other than PARK (auto transmission) or when the vehicle begins to move (manual transmission).

NOTE: The Daytime Running Light on the same side of the vehicle as the active turn signal will turn off automatically when a turn signal is in operation and turn on again when the turn signal is not operating.

Interior Lights

The overhead light will turn on when a door is opened. It may also be turned on by rotating the control for the dimmer switch on the multifunction lever fully upward.

The overhead light will automatically turn off in approximately 10 minutes if a door is left open or the dimmer control is left in the dome light position. Turn the ignition switch ON to restore the overhead light operation.

Cargo Lamp

The courtesy and dome lights will turn on when the front doors are opened, by rotating the control for the dimmer switch on the multifunction lever fully upward, or if equipped, when the UNLOCK button is pressed on the Remote Keyless Entry (RKE) transmitter.

The sports bar reading lights (available on four-door models) can be turned on by pressing the switches, located on either side of the lens. Press a switch a second time to turn the light off.

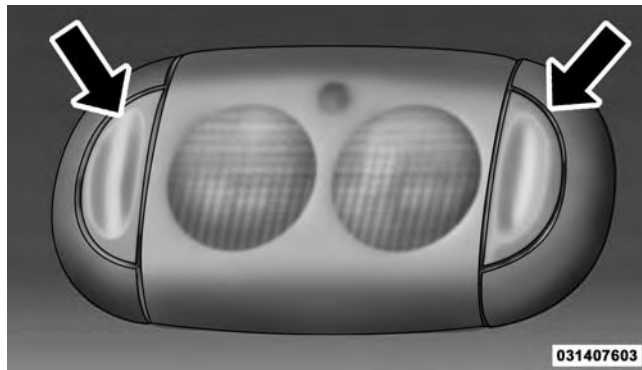

Sports Bar Reading Light

The rear cargo light may be turned on by pressing the lens. Press the lens a second time to turn the light off.

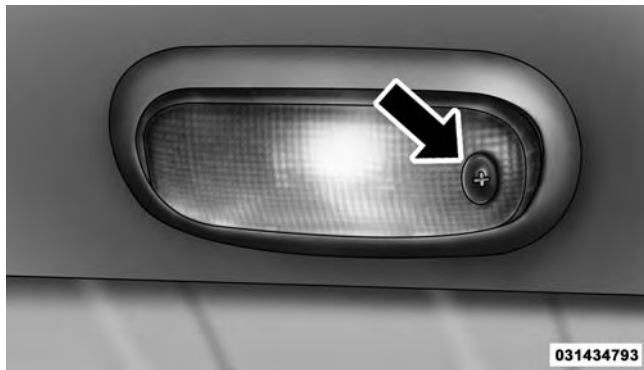

Rear Cargo Light

When a door is open and the interior lights are on, rotating the dimmer control to the extreme bottom position will cause all the interior lights to turn off. This is also known as the “Party” mode because it allows the doors to stay open for extended periods of time without discharging the vehicle’s battery.

WINDSHIELD WIPERS AND WASHERS

The windshield wiper/washer control lever is located on the right side of the steering column. The front wipers are operated by rotating a switch, located at the end of the lever. For information on using the rear window wiper/washer, refer to “Rear Window Features” in “Understanding The Features Of Your Vehicle”.

3



036407502

Windshield Wiper/Washer Lever

Windshield Wiper Operation

Rotate the end of the lever upward to the second detent past the intermittent settings for low-speed wiper operation. Rotate the end of the lever upward to the third detent past the intermittent settings for high-speed wiper operation.



031507503

Front Wiper Control

CAUTION!

In cold weather, always turn off the wiper switch and allow the wipers to return to the park position before turning off the engine. If the wiper switch is left on and the wipers freeze to the windshield, damage to the wiper motor may occur when the vehicle is restarted.

Intermittent Wiper System

Use the intermittent wiper when weather conditions make a single wiping cycle, with a variable pause between cycles, desirable. Rotate the end of the lever to the first detent position for one of five intermittent settings. The delay cycle can be set anywhere between 1 to 18 seconds.



031507503

Front Wiper Control

NOTE: The wiper delay times depend on vehicle speed. If the vehicle is moving less than 10 mph (16 km/h), delay times will be doubled.

Windshield Washers

To use the washer, pull the lever toward you and hold while spray is desired. If the lever is pulled while in the delay range, the wiper will start and continue to operate for two or three wipe cycles after the lever is released, and then resume the intermittent interval previously selected.

If the lever is pulled while in the off position, the wipers will operate for two or three wipe cycles and then turn off.

WARNING!

Sudden loss of visibility through the windshield could lead to a collision. You might not see other vehicles or other obstacles. To avoid sudden icing of the windshield during freezing weather, warm the windshield with defroster before and during windshield washer use.

Mist Feature

Push down on the wiper lever to activate a single wipe to clear off road mist or spray from a passing vehicle. As long as the lever is held down, the wipers will continue to operate.

NOTE: The mist feature does not activate the washer pump; therefore, no washer fluid will be sprayed on the windshield. The wash function must be used in order to spray the windshield with washer fluid.



031507504

Mist Control

TILT STEERING COLUMN

This feature allows you to tilt the steering column upward or downward. The tilt lever is located on the steering column, below the turn signal lever.

Push down on the lever to unlock the steering column. With one hand firmly on the steering wheel, move the steering column up or down, as desired. Pull upwards on the lever to lock the column firmly in place.

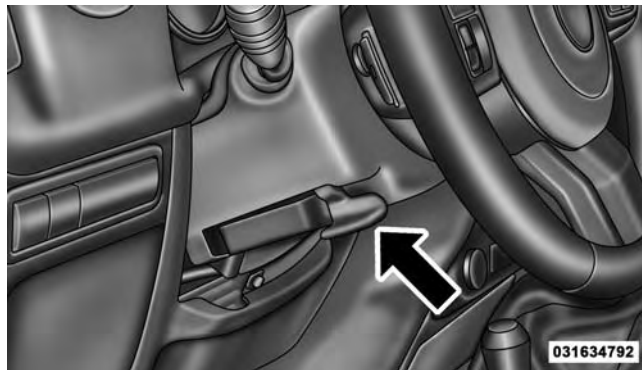

Tilt Steering Column Lever

WARNING!

Do not adjust the steering column while driving. Adjusting the steering column while driving or driving with the steering column unlocked, could cause

(Continued)

WARNING! (Continued)

the driver to lose control of the vehicle. Be sure the steering column is locked before driving your vehicle. Failure to follow this warning may result in serious injury or death.

ELECTRONIC SPEED CONTROL — IF EQUIPPED

When engaged, the Electronic Speed Control takes over accelerator operations at speeds greater than 25 mph (40 km/h).

The Electronic Speed Control buttons are located on the right side of the steering wheel.

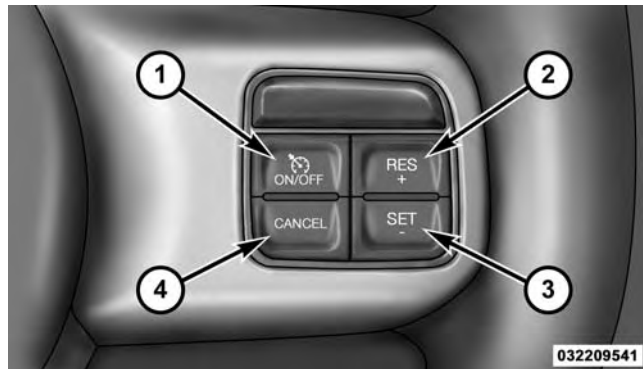

Electronic Speed Control Buttons

- | | |
|------------|-----------|
| 1 — ON/OFF | 2 — RES + |
| 4 — CANCEL | 3 — SET - |

NOTE: In order to ensure proper operation, the Electronic Speed Control System has been designed to shut down if multiple Speed Control functions are operated at the same time. If this occurs, the Electronic Speed Control System can be reactivated by pushing the Electronic Speed Control ON/OFF button and resetting the desired vehicle set speed.

To Activate

Push the ON/OFF button. The Cruise Indicator Light in the instrument cluster will illuminate. To turn the system off, push the ON/OFF button a second time. The Cruise Indicator Light will turn off. The system should be turned off when not in use.

WARNING!

Leaving the Electronic Speed Control system on when not in use is dangerous. You could accidentally set the system or cause it to go faster than you want. You could lose control and have an accident. Always leave the system OFF when you are not using it.

To Set A Desired Speed

Turn the Electronic Speed Control ON. When the vehicle has reached the desired speed, press the SET (-) button and release. Release the accelerator and the vehicle will operate at the selected speed.

NOTE: The vehicle should be traveling at a steady speed and on level ground before pressing the SET button.

To Deactivate

A soft tap on the brake pedal, pushing the CANCEL button, or normal brake pressure while slowing the vehicle will deactivate Electronic Speed Control without erasing the set speed memory. Pressing the ON/OFF button or turning the ignition switch OFF erases the set speed memory.

To Resume Speed

To resume a previously set speed, push the RES (+) button and release. Resume can be used at any speed above 20 mph (32 km/h).

To Vary The Speed Setting

When the Electronic Speed Control is set, you can increase speed by pushing the RES (+) button. If the button is continually pressed, the set speed will continue to increase until the button is released, then the new set speed will be established.

Pressing the RES (+) button once will result in a 1 mph (1.6 km/h) increase in set speed. Each subsequent tap of the button results in an increase of 1 mph (1.6 km/h).

To decrease speed while the Electronic Speed Control is set, push the SET (-) button. If the button is continually held in the SET (-) position, the set speed will continue to decrease until the button is released. Release the button when the desired speed is reached, and the new set speed will be established.

Pressing the SET (-) button once will result in a 1 mph (1.6 km/h) decrease in set speed. Each subsequent tap of the button results in a decrease of 1 mph (1.6 km/h).

To Accelerate For Passing

Press the accelerator as you would normally. When the pedal is released, the vehicle will return to the set speed.

Using Electronic Speed Control On Hills

The transmission may downshift on hills to maintain the vehicle set speed.

NOTE: The Electronic Speed Control system maintains speed up and down hills. A slight speed change on moderate hills is normal.

On steep hills, a greater speed loss or gain may occur so it may be preferable to drive without Electronic Speed Control.

WARNING!

Electronic Speed Control can be dangerous where the system cannot maintain a constant speed. Your vehicle could go too fast for the conditions, and you could lose control and have an accident. Do not use Electronic Speed Control in heavy traffic or on roads that are winding, icy, snow-covered or slippery.

ELECTRICAL POWER OUTLET

There are two 12 Volt (13 Amp) auxiliary power outlets that can provide power for accessories designed for use with the standard power outlet adapters.

The front power outlet is powered from the ignition switch. Power is available when the ignition switch is in the ON or ACC position.



Front Power Outlet

When the optional cigar lighter heating element is used in the power outlet, it heats when pushed in and pops out automatically when ready for use. **To preserve the heating element, do not hold the lighter in the heating position.**

A second power outlet is located inside the center console and is powered directly from the vehicle battery.

CAUTION!

- Do not exceed the maximum power of 160 Watts (13 Amps) at 12 Volts. If the 160 Watt (13 Amp) power rating is exceeded the fuse protecting the system will need to be replaced.
- Power outlets are designed for accessory plugs only. Do not insert any other object in the power outlets as this will damage the outlet and blow the fuse. Improper use of the power outlet can cause damage not covered by your New Vehicle Limited Warranty.

On vehicles equipped with a rear subwoofer, there is a third power outlet located in the right rear cargo area.

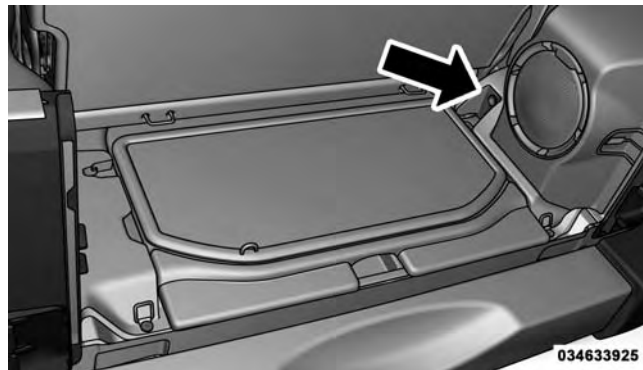

Rear Power Outlet — If Equipped

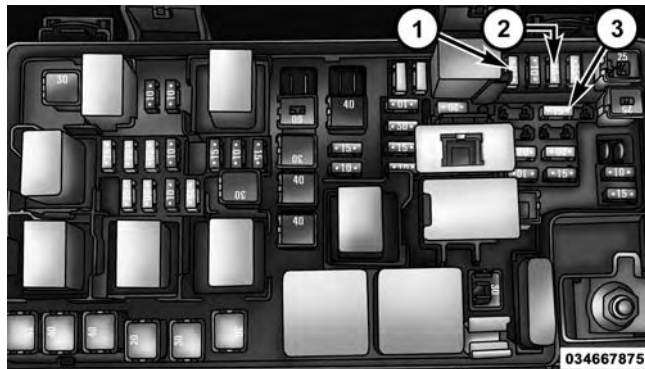

Power Outlet Fuse Locations

- 1 — M36 Fuse 20 A Yellow Power Outlet Console Bin
- 2 — M6 Fuse 20 A Yellow Cigar Lighter Instrument Panel
- 3 — M7 Fuse 20 A Yellow Power Outlet Rear with Sub Woofer (Opt.)

WARNING!

To avoid serious injury or death:

- Only devices designed for use in this type of outlet should be inserted into any 12 Volt outlet.
- Do not touch with wet hands.
- Close the lid when not in use and while driving the vehicle.
- If this outlet is mishandled, it may cause an electric shock and failure.

CAUTION!

- Many accessories that can be plugged in draw power from the vehicle's battery, even when not in use (i.e., mobile phones, etc.). Eventually, if plugged in long enough, the vehicle's battery will discharge sufficiently to degrade battery life and/or prevent the engine from starting.
- Accessories that draw higher power (i.e., coolers, vacuum cleaners, lights, etc.), will degrade the battery even more quickly. Only use these intermittently and with greater caution.

(Continued)

CAUTION! (Continued)

- After the use of high-power draw accessories, or long periods of the vehicle not being started (with accessories still plugged in), the vehicle must be driven a sufficient length of time to allow the alternator to recharge the vehicle's battery.
- Power outlets are designed for accessory plugs only. Do not hang any type of accessory or accessory bracket from the plug.

POWER INVERTER — IF EQUIPPED

There is a 115 Volt, 150 Watt inverter outlet located on the front of the center console to convert DC current to AC current. This outlet can power cellular phones, electronics and other low power devices requiring power up to 150 Watts. Certain high-end video games, such as PlayStation3 and XBox360 will exceed this power limit, as will most power tools.

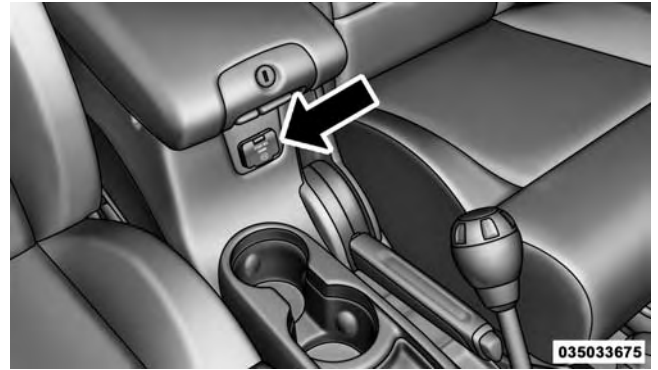

Power Inverter

The power inverter is designed with built-in overload protection. If the power rating of 150 Watts is exceeded, the power inverter will automatically shut down. Once the electrical device has been removed from the outlet the

inverter should automatically reset. If the power rating exceeds approximately 170 Watts, the power inverter may have to be reset manually. To reset the inverter manually press the power inverter button OFF and ON. To avoid overloading the circuit, check the power ratings on electrical devices prior to using the inverter.



035005840

The power inverter switch is located on the instrument panel below the climate controls. To turn on the power outlet, press the switch once. The indicator light will illuminate. Press the switch a second time to turn the power inverter outlet off.

NOTE: When the power inverter switch is pressed, there will be a delay of approximately one second before the inverter indicator light turns ON.

WARNING!

To avoid serious injury or death:

- Do not use a three-prong adaptor.
- Do not insert any objects into the receptacles.
- Do not touch with wet hands.
- Close the lid when not in use.
- If this outlet is mishandled it may cause an electric shock and failure.

CUPHOLDERS

Front Cupholders

The front cupholders are located in the center console.

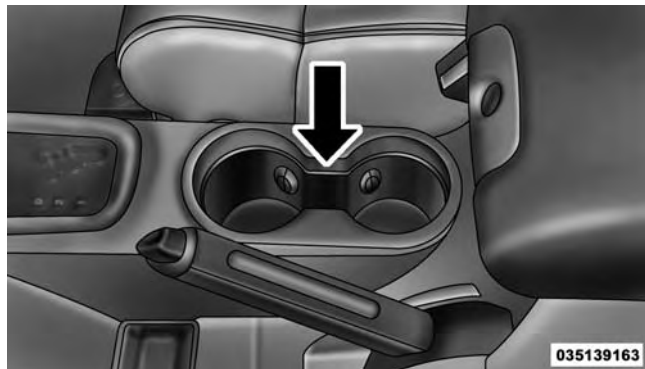

Front Cupholders

Rear Cupholders

The rear cupholders are located on the back of the center console.

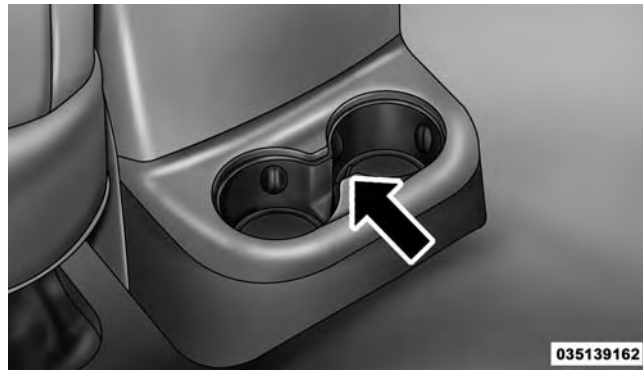

Rear Cupholders

STORAGE

Glovebox Storage

The lockable glovebox storage compartment is located on the passenger side of the lower instrument panel. Pull outward on the handle/latch to open the compartment.

Console Storage Compartment

To lock or unlock the storage compartment, insert the ignition key and turn. To open the storage compartment, press the latch and lift the cover.

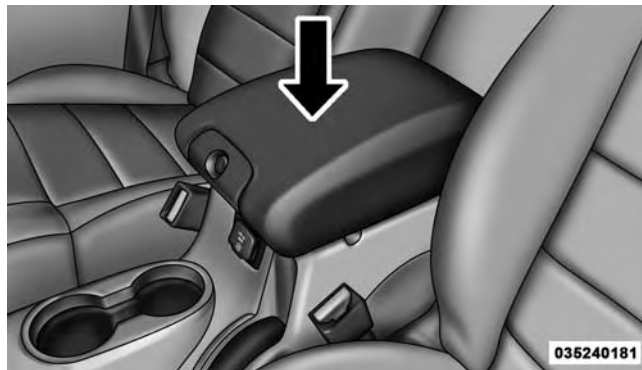

Center Console

Rear Storage Compartment

The rear cargo area storage compartment cover is held by a spring-loaded latch. In order to remove the rear storage compartment cover, use the following procedure:

NOTE: The rear storage compartment latch should not be used as cargo tie-down.

1. Flip up the pull loop so it is perpendicular (straight up) to the top surface of the tray.
2. Pull up on the loop and twist it 90 degrees, so it is parallel to the slotted hole in the tray.
3. Open the rear compartment cover.

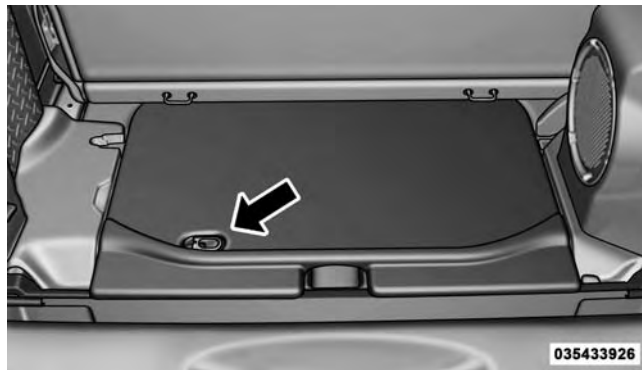

Rear Storage Cover

DUAL TOP — TWO-DOOR MODELS — IF EQUIPPED

If your vehicle is equipped with a Dual Top, **you must remove one of the tops from the vehicle. If the soft top is removed, the pivot brackets must also be removed from the sport bar.** The soft top was installed at the factory for shipping purposes only. **The soft top and the hard top are to be used independently.** Removal is mandatory to prevent any possible wear and tear on the soft top. Your vehicle warranty will not cover damage resulting from both tops remaining on the vehicle at the same time for extended periods of time.

Removing The Soft Top — Two-Door Models

1. Locate and remove the two boxes that contain the following items:
 - Right and left door frames
 - Four door frame attachment knobs
 - Right and left quarter windows
 - Rear window
 - Two rear window roll up straps
 - Two Sunrider® secure straps (if equipped)
 - Two rear swing gate brackets
2. Remove the hard top. Refer to “Freedom Top Three-Piece Modular Hard Top — Front/Rear Panel Removal” in this section.

3. Remove the soft top bow assembly pivot bracket screws (two per side) using a #T30 Torx® head driver.

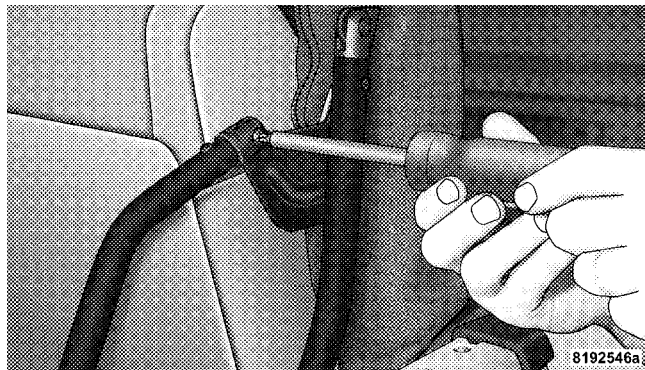

4. Disconnect the knuckles from the left and right metal pivot brackets. Remove the soft top from the vehicle and store in a clean, dry location.

NOTE: To aid in disconnecting the knuckles, you may carefully tap on the knuckles using a rubber mallet.

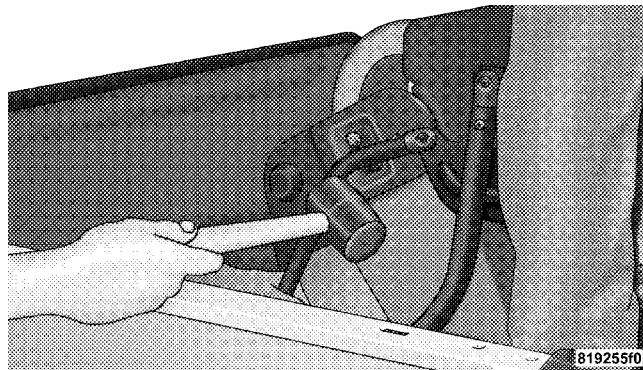

5. Unzip the zipper on the sport bar cover to expose the pivot brackets. Remove the brackets using a #T30 Torx® head driver. Recover and re-zip the sports bar cover. Store the pivot brackets and screws in a safe place.

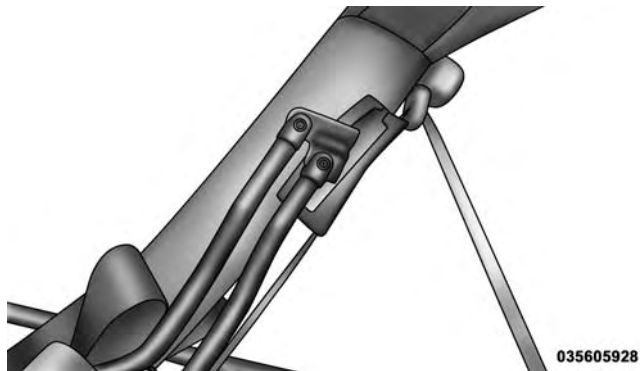

6. Reinstall the hard top. Refer to “Freedom Top Three-Piece Modular Hard Top — Front/Rear Panel Installation” in this section.

Installing The Soft Top — Two-Door Models

NOTE: The following procedures are for first time set up only. For future soft top procedures, refer to “Soft Top” in this section.

1. Locate and remove the following items prior to hard top removal:
 - Right and left door frames
 - Door frame attachment knobs (four for two-door models, six for four-door models)
 - Right and left quarter windows
 - Rear window
2. Remove the hard top. Refer to “Freedom Top Three-Piece Modular Hard Top — Front/Rear Panel Removal” in this section.

3. Install the door frames. Refer to “Door Frame” in this section.
4. If the soft top has been removed, follow these steps to reinstall the soft top. If the soft top is on the vehicle, proceed to step #5.
1. If the pivot brackets have been removed, unzip the sport bar covers and attach the pivot brackets to the sports bar with the four screws that were removed using a #T30 Torx® head driver. Re-cover and re-zip the sport bar covers.

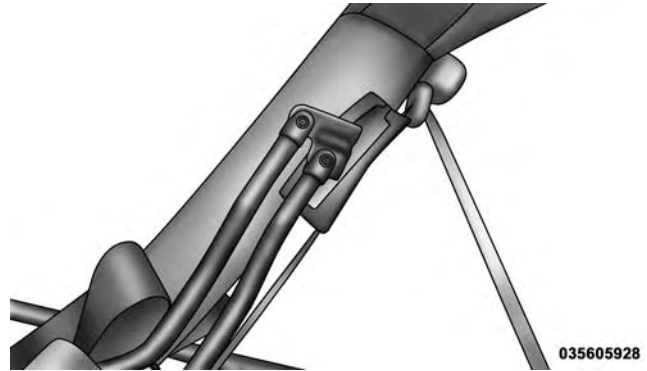

2. Lay the soft top into the rear of the vehicle with the bows pointing forward and the curved portion of the bows facing upward.
3. Reattach the knuckles onto the metal pivot brackets.

NOTE: To aid in reattaching the knuckles, you may carefully tap on the knuckles using a rubber mallet.

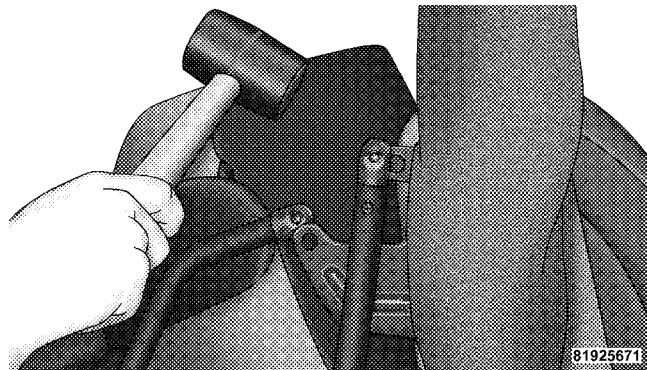

4. Screw the pivot screws back into place using a #T30 Torx® head driver. Secure them until they are snug, being careful not to cross-thread the screws or overtighten.

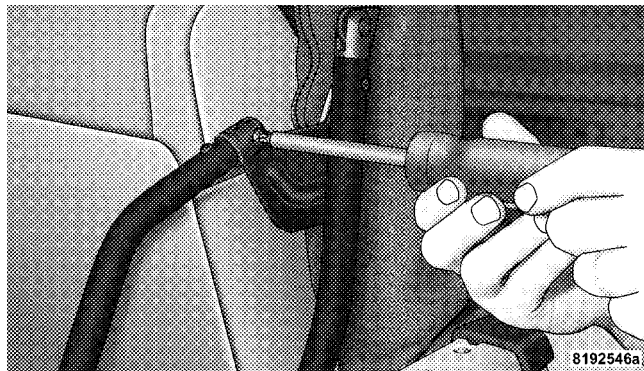

CAUTION!

Do not overtighten the screws. You can strip the screws if they are overtightened.

1. Remove the swing gate bar (black metal bar for bottom of rear window) and set aside.

NOTE: Be sure the wire harness in the left rear corner is not tangled in the soft top bows before you lift the top.

2. Unsnap and remove the black boot cover. This cover should be discarded. It was intended as a protective cover for shipping only.

NOTE: A visual instruction sheet is enclosed in the dual top wrap.

3. Put up the soft top. Refer to “Soft Top — Putting Up The Soft Top” in this section.

DUAL TOP — FOUR-DOOR MODELS — IF EQUIPPED

If your vehicle is equipped with a Dual Top, **you must remove one of the tops from the vehicle. If the soft top is removed, the pivot brackets must also be removed from the sport bar.** The soft top was installed at the factory for shipping purposes only. **The soft top and the hard top are to be used independently.** Removal is mandatory to prevent any possible wear and tear on the soft top. Your vehicle warranty will not cover damage resulting from both tops remaining on the vehicle at the same time for extended periods of time.

Removing The Soft Top — Four-Door Models

1. Locate and remove the two boxes that contain the following items:
 - Right and left door frames
 - Six door frame attachment knobs
 - Right and left quarter windows
 - Rear window
 - Two rear window roll up straps
 - Two Sunrider® secure straps (if equipped)
 - Two rear swing gate brackets
2. Remove the hard top. Refer to “Freedom Top Three-Piece Modular Hard Top — Front/Rear Panel Removal” in this section.

3. Unbutton the side bow tether strap (both sides).

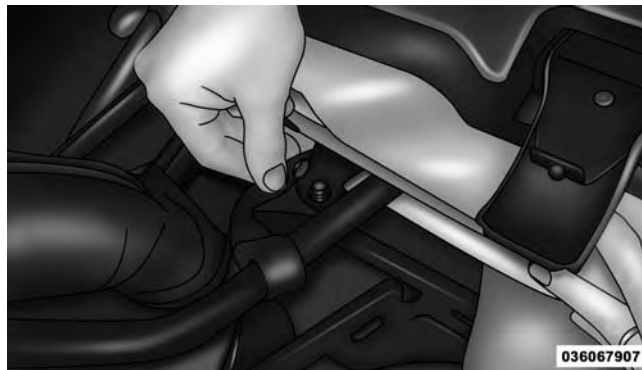

198 UNDERSTANDING THE FEATURES OF YOUR VEHICLE

- Slide the tether strap up the side bow and attach to pivot bracket to secure side bows before removing soft top (both sides).

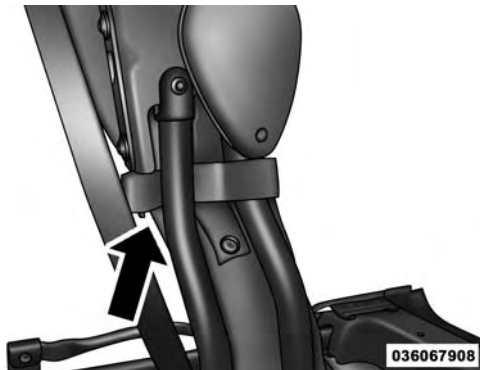

- Remove the soft top bow assembly pivot bracket screws (two per side) from the sport bar using a #T30 Torx® head driver.

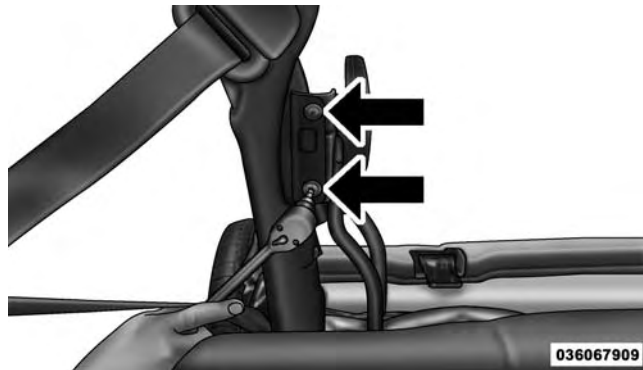

- Lift the soft top in an upward motion to release the pivot bracket from the sport bar bracket mounting tab.

Remove the soft top from the vehicle and store in a clean, dry location (another person may be needed to help with this operation).

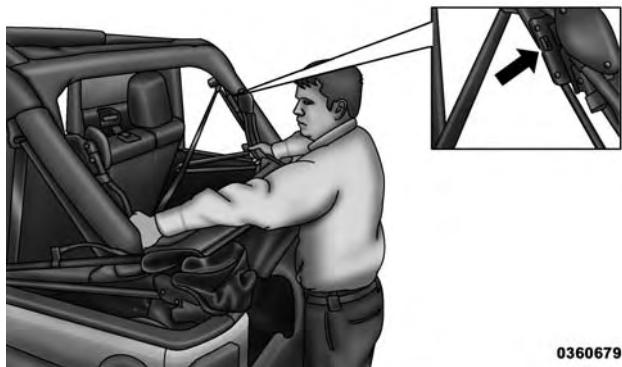

036067910

7. Reinstall the hard top. Refer to “Freedom Top Three-Piece Modular Hard Top — Front/Rear Panel Installation” in this section.

Installing The Soft Top — Four-Door Models

NOTE: The following procedures are for first time set up only. For future soft top procedures, refer to “Soft Top” in this section.

1. Locate and remove the following items prior to hard top removal:
 - Right and left door frames
 - Six door frame attachment knobs
 - Right and left quarter windows
 - Rear window
2. Remove the hard top. Refer to “Freedom Top Three-Piece Modular Hard Top — Front/Rear Panel Removal” in this section.
3. Install the door frames. Refer to “Door Frame” in this section.

200 UNDERSTANDING THE FEATURES OF YOUR VEHICLE

4. Install the soft top with the pivot bracket above the sport bar bracket, lower the pivot bracket onto the sport bar bracket mounting tab in a downward motion to lock into tab (another person may be needed to help with this operation).

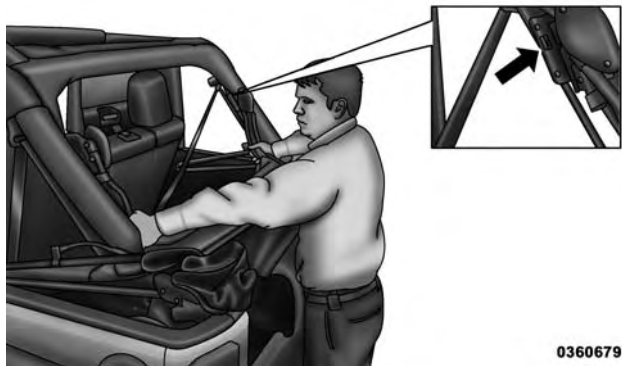

036067910

5. Screw the pivot screws back into place using a #T30 Torx® head driver. Secure them until they are snug, being careful not to cross-thread the screws or over-tighten.

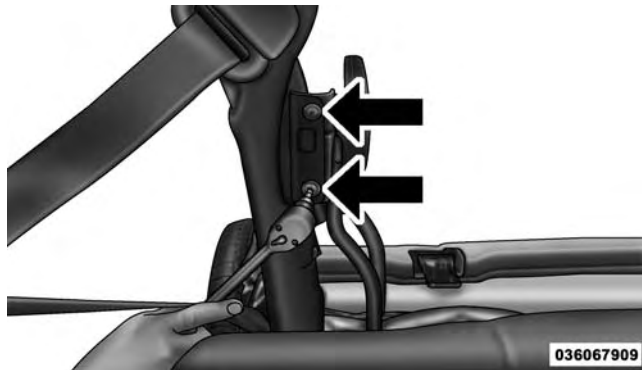

036067909

CAUTION!

Do not overtighten the screws. You can strip the screws if they are overtightened.

6. Remove the tether strap from the pivot bracket and slide down the side bow (both sides).

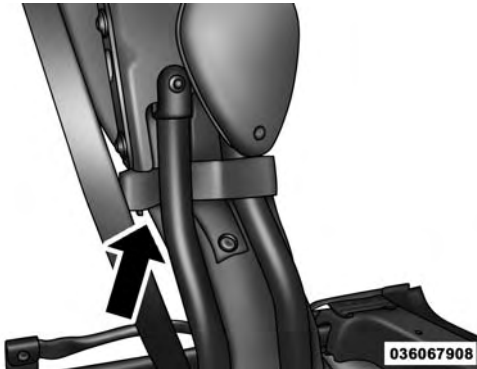

7. Button the side bow tether strap (both sides).

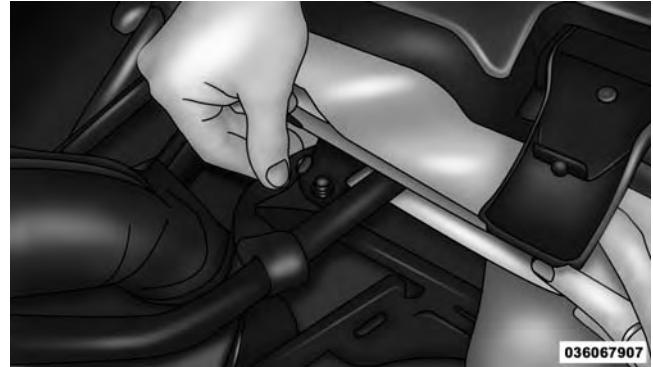

8. Remove the swing gate bar (black metal bar for bottom of rear window) and set aside.

NOTE: Be sure the wire harness in the left rear corner is not tangled in the soft top bows before you lift the top.

9. Unsnap and remove the black boot cover. This cover should be discarded. It was intended as a protective cover for shipping only.

NOTE: A visual instruction sheet is enclosed in the dual top wrap.

10. Put up the soft top. Refer to “Soft Top — Putting Up The Soft Top” in this section.

FREEDOM TOP™ THREE-PIECE MODULAR HARD TOP — IF EQUIPPED

CAUTION!

- The hard top is not designed to carry any additional loads such as roof racks, spare tires, building, hunting, or camping supplies, and/or luggage,

(Continued)

CAUTION! (Continued)

etc. Also, it was not designed as a structural member of the vehicle, and thus cannot properly carry any additional loads other than environmental (rain, snow, etc.).

- Do not move your vehicle until the top has been either fully attached to the windshield frame and bodyside, or fully removed.

CAUTION!

Failure to follow these cautions may cause interior water damage, stains or mildew:

- It is recommended that the top be free of water prior to panel removal. Removing the top, opening a door or lowering a window while the top is wet may allow water to drip into the vehicles interior.

(Continued)

CAUTION! *(Continued)*

- The hard top assembly must be positioned properly to ensure sealing. Improper installation can cause water to leak into the vehicles interior.
- Careless handling and storage of the removable roof panels may damage the seals, causing water to leak into the vehicles interior.
- The front panel(s) must be positioned properly to ensure sealing. Improper installation can cause water to leak into the vehicles interior.

Front Panel(s) Removal

NOTE: Left panel must be removed before removing right panel.

1. Fold down the sun visor, and move it to the side.

2. Turn the rear fasteners (knobs) (located on the overhead speaker bar assembly) counterclockwise until they can be removed.

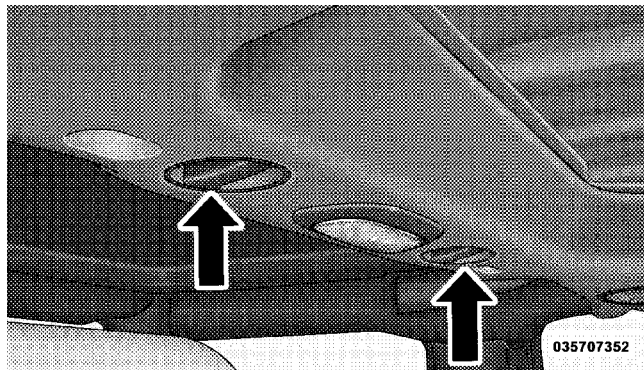

204 UNDERSTANDING THE FEATURES OF YOUR VEHICLE

3. Turn the center L-shaped locks (two) from the center of the roof panel.



4. Turn the rear L-shaped lock (located above the shoulder belt anchorage).

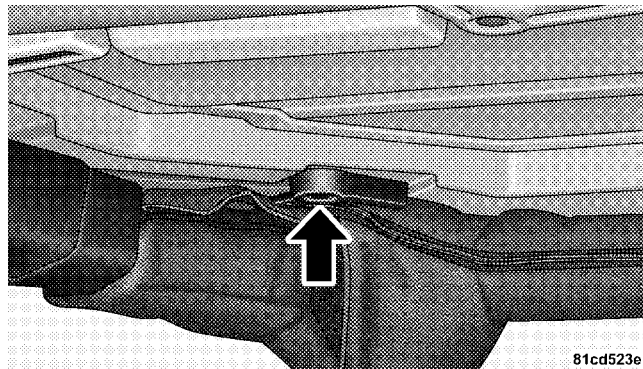

5. Unlatch the header panel latch located at the top of the windshield.



6. Remove the left-hand panel.

To remove the right panel, follow the steps above except for Step 3.

Freedom Top™ Storage Bag

Vehicles equipped with a Freedom Top™ Modular Hard Top, come with a Freedom Top™ storage bag that allows you to store your Freedom Top™ panels. The storage bag contains two compartments and fits behind the rear seat.

Lay the Freedom bag down so the loops and hooks are facing downward. Unzip the bag and fold back the outer flap. Release the Velcro on the black panel divider and fold it back.

NOTE: Ensure the front Freedom Top™ panel latch is closed prior to inserting the panel into the Freedom bag.

206 UNDERSTANDING THE FEATURES OF YOUR VEHICLE

Insert the right side Freedom panel into the bag with the latches facing downward.

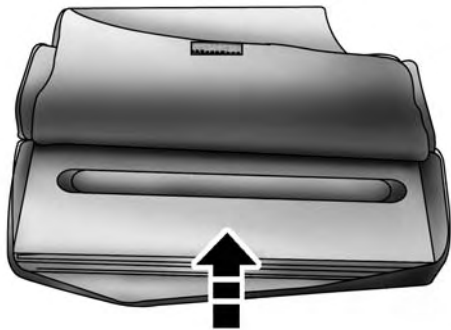

035707990

Unfold the black panel divider (ensure the divider is laying flat). Secure the Velcro, located at the center of the divider.

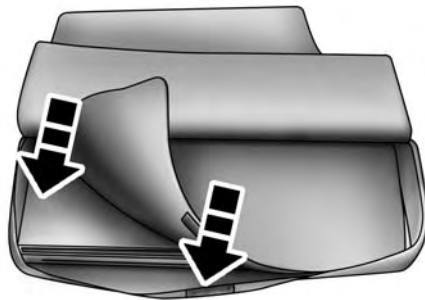

035707991

Insert the left-side Freedom panel into the bag with the latches facing upward.

NOTE: Ensure the front Freedom panel latch is closed prior to inserting the panel into the bag.

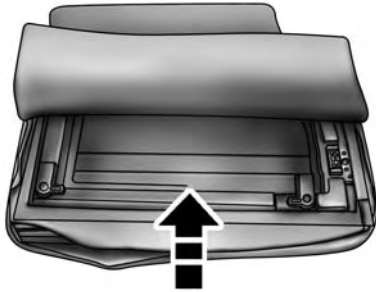

035707992

Unfold the outer flap and zip the Freedom bag closed.



035707993

208 UNDERSTANDING THE FEATURES OF YOUR VEHICLE

Install the seat attachment strap (at the top of the bag) through the loops.

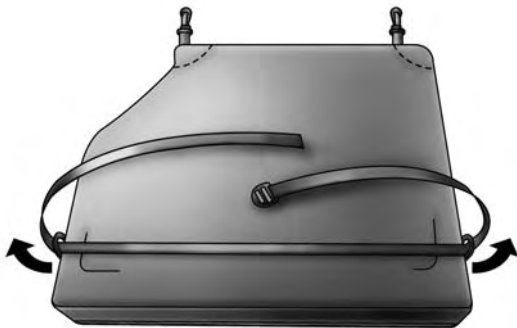

035707994

Lift the Freedom bag into the vehicle with the hooks and straps facing the back of the rear seat. Attach the clips at the bottom of the bag to the child restraint anchorages, located at the base of the rear seat.



035707995

Wrap the upper strap around the rear head restraints and loop the strap through the buckle. Pull on the strap to tighten the Freedom bag securely against the rear seat.

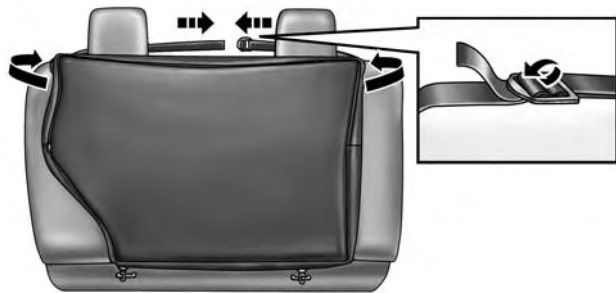

035707996

Front Panel(s) Installation

NOTE: Set the panels on the windshield frame so that there is no overhang. Also, make sure that the panels are sitting flush with the body.

1. Install the right panel first, then the left panel.
2. Reinstall the panel(s) using the same steps for removal in reverse order.

Front Panel(s) Installation With Rear Hard Top Removed

1. Turn the left and right panels over and move the spacer block (located on the rear of the panel) upward 90 degrees.



035707391

NOTE: The front panel(s) must be positioned properly to ensure sealing. Set the panels on the windshield frame so that there is no overhang. Also, make sure that the panels are sitting flush with the body.

2. Install the right panel first, then the left panel.
3. Reinstall the panel(s) using the same steps for removal in reverse order.

Rear Hard Top Removal

1. Remove both front panels. Refer to “Front Panel(s) Removal” in this section.
2. Open both doors.
3. Remove the two Torx® head screws that secure the hard top at the B-pillar (near the top of the door) using a #40 Torx® head driver (Four-Door Only).

4. Remove the six Torx® head screws that secure the hard top to the vehicle (along the interior bodyside) using a #40 Torx® head driver.
5. Open the swing gate all the way to ensure clearance of the rear window glass. Lift the rear window glass.
6. Locate the wire harness on the left rear inside corner of the vehicle.

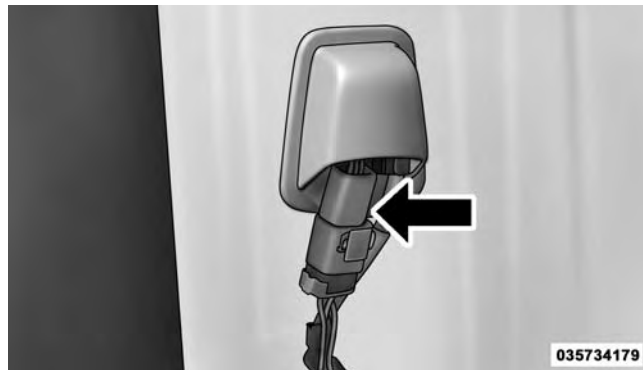
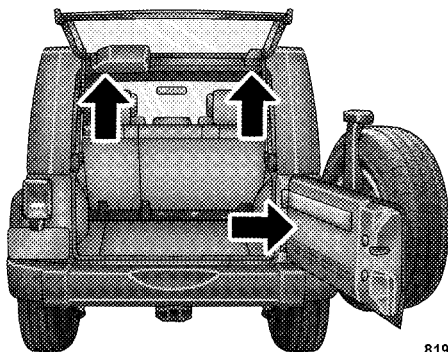

Wire Harness Connector

7. Release the red locking tab by pulling outward to the right.

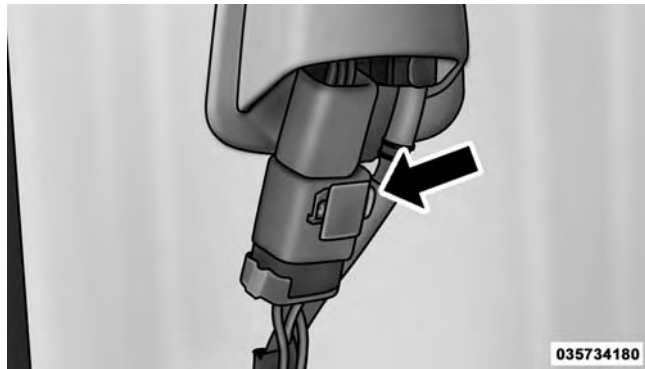

Red Locking Tab

8. To remove the wiring harness press the tab and pull downward to disconnect.

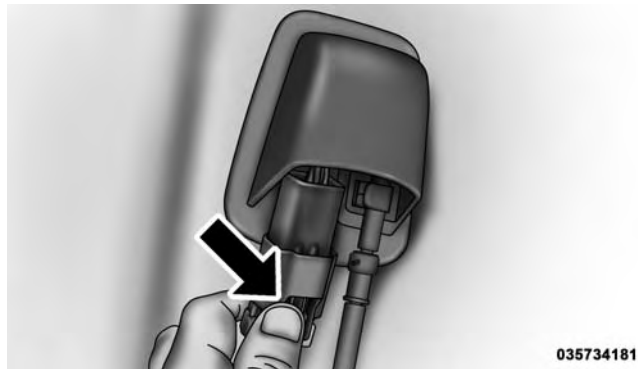

Press Tab To Disconnect

- To remove the washer hose, pinch the grips on hose connector and pull downward.

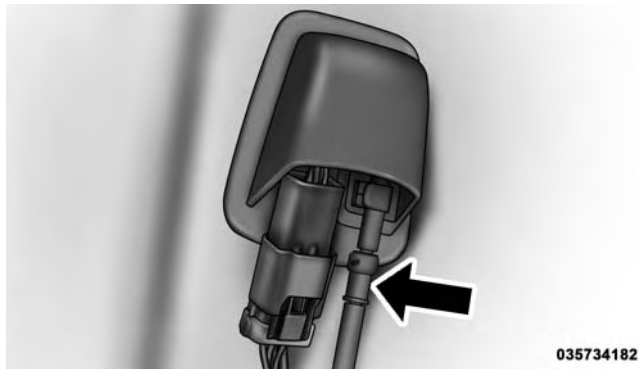

Pinch Grip On Hose

- Close the swing gate.
- Remove the hard top from the vehicle. Place the hard top on a soft surface to prevent damage.

CAUTION!

The removal of the Freedom Top requires four adults located on each corner. Failure to follow this caution could damage the Freedom Top.

Rear Hard Top Installation

NOTE: If the door frames are installed from soft top usage, they must be removed prior to installation of the hard top.

- Inspect the hard top seals for damage and replace if necessary.
- Install the hard top using the same steps for removal in reverse order.

Make sure that the hard top is sitting flush with the body at the sides and check to ensure that there is a uniform gap between the lift glass and hard top.

NOTE:

- The Torx fasteners that attach the hard top to the body should be torqued to 66 in lb +/- 22 in lb (7.5 N·m +/- 2.5 N·m)
- It is not necessary to pinch connection when reinstalling washer hose. Push on until click is heard.

DOOR FRAME**WARNING!**

Do not drive your vehicle on pavement with the door frame(s) removed as you will lose the protection that they can provide. This procedure is furnished for use during off-road operation only.

CAUTION!

Failure to follow these cautions may cause interior water damage, stains or mildew:

- **Opening a door or lowering a window while the top is wet may allow water to drip into the vehicle's interior.**

(Continued)

CAUTION! *(Continued)*

- Careless handling and storage of the removable door frame(s) may damage the seals, causing water to leak into the vehicle's interior.
- The door frame(s) must be positioned properly to ensure sealing. Improper installation can cause water to leak into the vehicle's interior.

Door Frame Removal

1. Unscrew and remove the door frame attachment knobs (two per door).

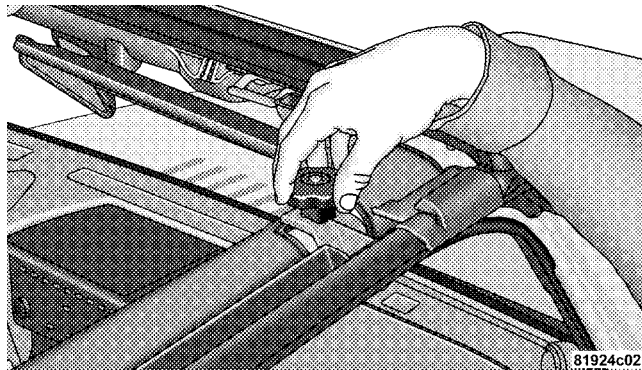
**WARNING!**

Use both hands to remove the door frames. The door frames will fold and could cause injury if both hands are not used.

216 UNDERSTANDING THE FEATURES OF YOUR VEHICLE

2. Place one hand on the upper rear and one hand on the front of the door frame.
3. Pull the frame toward you with your rearward hand to remove the frame from the vehicle.

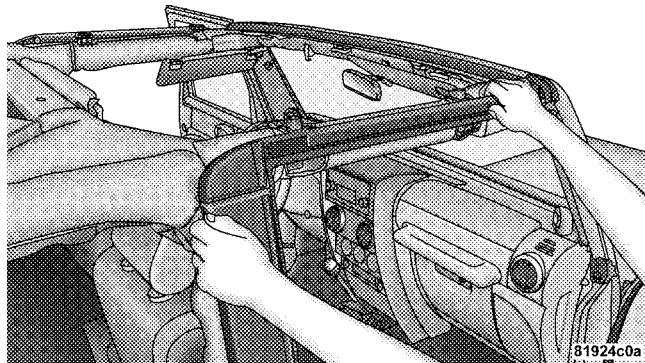

4. Screw the knobs back into the door frame and fold for storage. Store in a secure location.

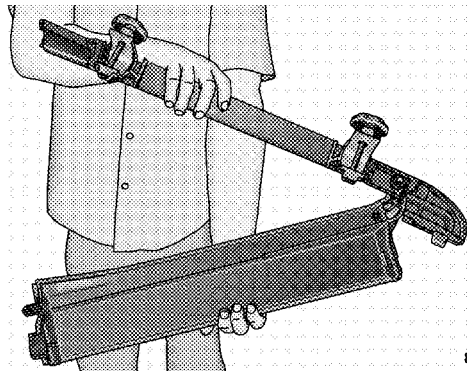

WARNING!

Never store the door frames in your vehicle. In an event of an accident, a loose door frame may cause personal injury. If removed, always store the door frames outside of the vehicle.

Door Frame Installation — Two-Door Models

1. Unfold door frame and unscrew thumbscrews.
2. Set the door frame pin into the hole on top of the body side, behind the door opening.

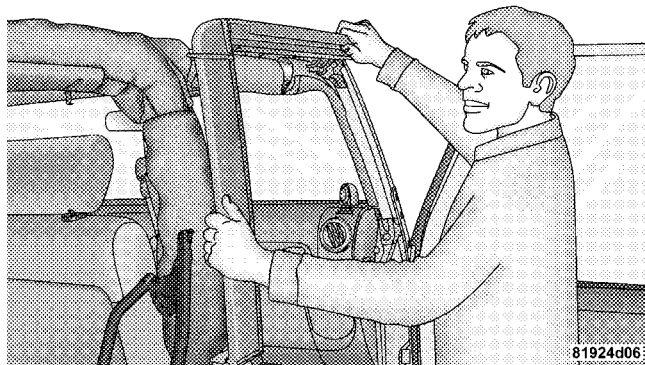

3. After the door frame pin has been set into the body side hole, carefully set the front of the door frame into the rubber seal at the top of the windshield.
4. Starting with the front of the door frame, clip it over the metal side bar and then clip the rear, making sure that the material for the side bar covers is not pinched by the door frame.

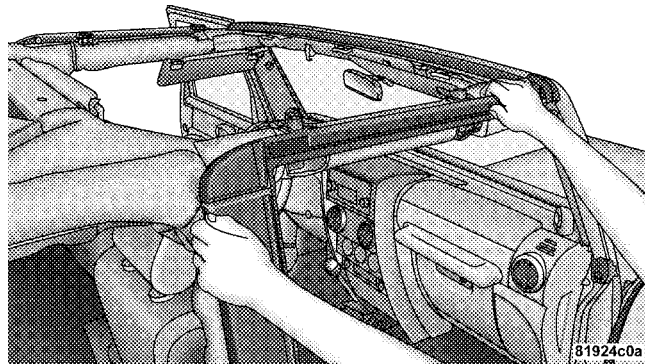

5. Starting with the front knob, screw in and tighten both knobs. Repeat on the other side.

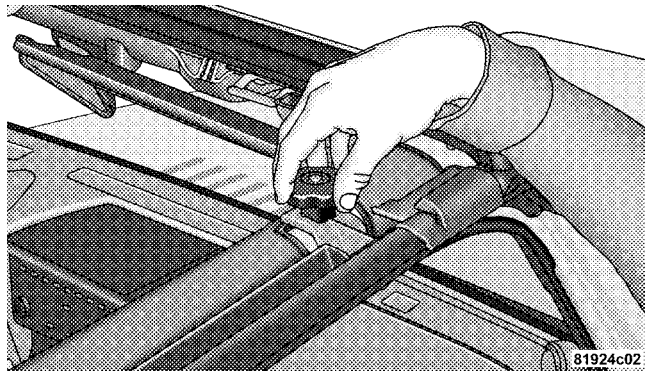

Door Frame Installation — Four-Door Models

1. Install the rear door frame first.
2. Set the door frame pin into the hole on top of the body side, just behind the rear door opening.

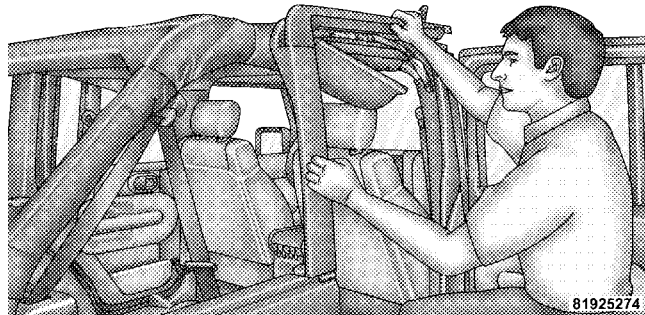

3. Position the top of the door frame against the metal sport bar and press onto the side bar making sure not to pinch the material of the sports bar covers and to ensure it is properly positioned on the seal above the front of the rear door.

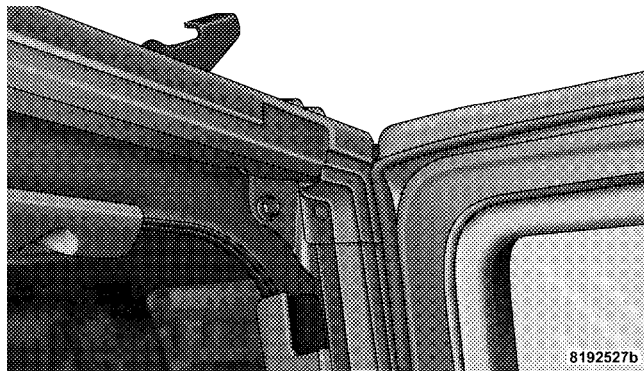

4. Loosely install the rear knob (long knob) to hold the door rail in position.
5. Carefully set the front of the front door frame in the rubber seal at the top of the windshield.

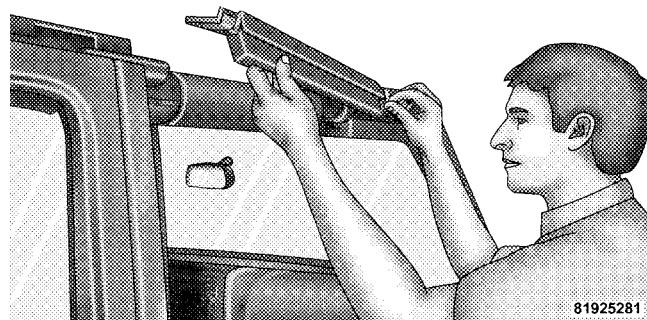

220 UNDERSTANDING THE FEATURES OF YOUR VEHICLE

- Clip the front of the door rail over the side bar making sure that the material for the side bar cover is not pinched by the door frame.
- Position the rear of the front door frame to lay on top of the front of the rear door frame. Ensure the seals are installed correctly to avoid water leaks.

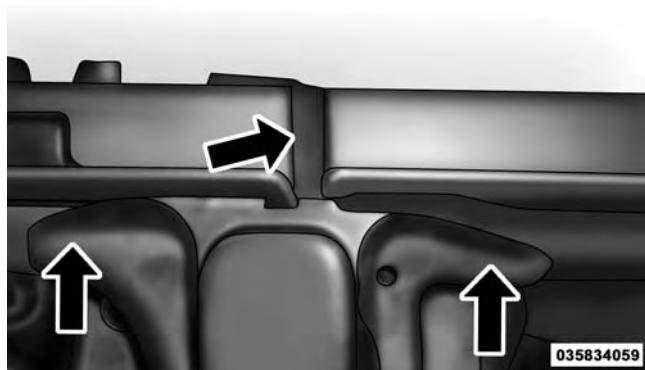

- Loosely install both knobs beginning with the front knob (long knob). Then, install the middle knob (short knob) through the front and rear door frames and screw into the top of the B-pillar.
- Tighten the front knob, then the rear most knob, and then the middle knob. Repeat this procedure for the other side.

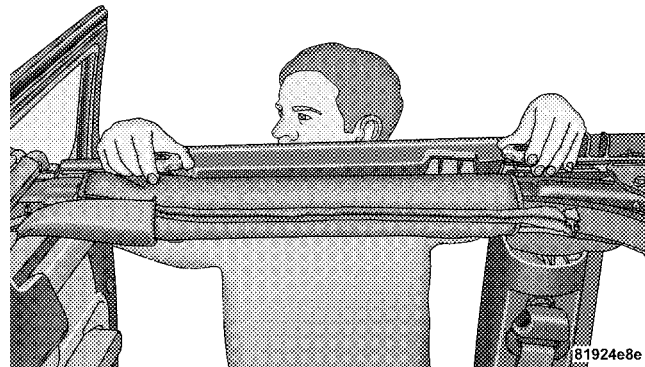

SOFT TOP — TWO-DOOR MODELS

Please visit the owners section of Jeep.com for instructional videos.

CAUTION!

The soft top is not designed to carry any additional loads such as roof racks, spare tires, building, hunting, or camping supplies, and/or luggage, etc. Also, it was not designed as a structural member of the vehicle and, thus, cannot properly carry any additional loads other than environmental (rain, snow, etc.).

If the temperature is below 72°F (24°C) and/or the top has been folded down for a period of time, the top will appear to have shrunk when you raise it, making it difficult to put up. This is caused by a natural contraction of the vinyl coating on the fabric top.

Place the vehicle in a warm area. Pull steadily on the top fabric. The vinyl will stretch back to its original size and the top can then be installed. **If the temperature is 41°F (5°C) or below, do not attempt to put the top down or roll the rear or side curtains.**

CAUTION!

- Do not run a fabric top through an automatic car wash. Window scratches and wax build up may result.
- Do not lower the top when the temperature is below 41°F (5°C). Damage to the top may result.
- Do not move your vehicle until the top has been either fully attached to the windshield frame, or fully lowered.
- Do not lower the top with the windows installed. Window and top damage may occur.

(Continued)

CAUTION! *(Continued)*

- Refer to “Appearance Care For Fabric Top Models” in “Maintaining Your Vehicle” for further information. It contains important information on cleaning and caring for your vehicle’s fabric top.
- Do not use any tools (screwdrivers, etc.) to pry or force any of the clamps, clips, or retainers securing the soft top. Do not force or pry the soft top framework when opening or closing. Damage to the top may result.

WARNING!

- Do not drive the vehicle with the rear window curtain up unless the side curtains are also removed. Dangerous exhaust gases could enter the vehicle causing harm to the driver and passengers.
- The fabric upper doors and fabric top are designed only for protection against the elements. Do not rely on them to contain occupants within the vehicle or to protect against injury during an accident. Remember, always wear seat belts.

CAUTION!

Failure to follow these cautions may cause interior water damage, stains or mildew on the top material:

- It is recommended that the top be free of water prior to opening it. Operating the top, opening a door or lowering a window while the top is wet may allow water to drip into the vehicle's interior.
- Careless handling and storage of the soft top may damage the seals, causing water to leak into the vehicle's interior.
- The soft top must be positioned properly to ensure sealing. Improper installation can cause water to leak into the vehicle's interior.

Quick Steps To Lowering The Soft Top

Refer to "Lowering The Soft Top" in this section for further information.

1. Remove the side windows.

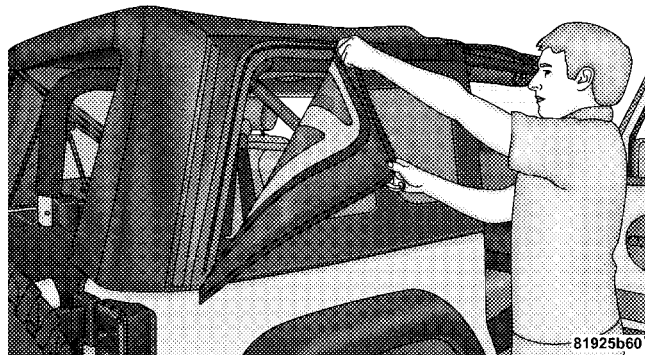

2. Remove the back window.



3. Release header latches from the windshield frame.

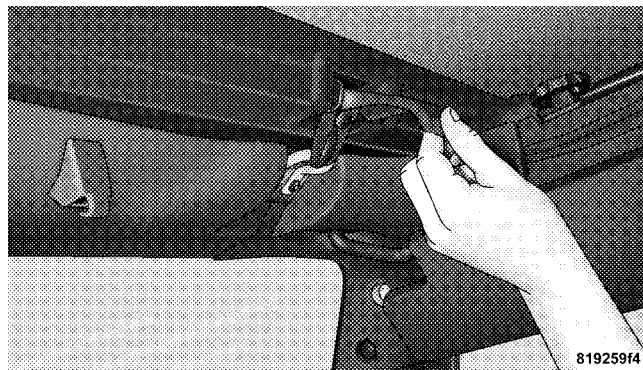

4. Release the sail panel retainers from the body side channel at the rear corners of the vehicle.
5. As you begin to lower the top, fold the sail panels so that they rest on top of the soft top.

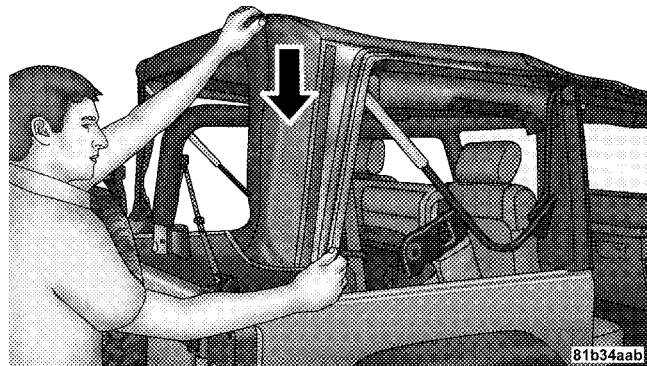

NOTE: When releasing the sail panel retainers, it is helpful to pull down on the rear roof bow.

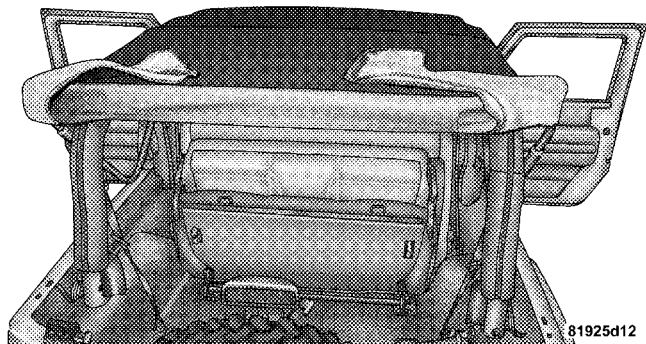

6. Release the Sunrider® latch (both sides).

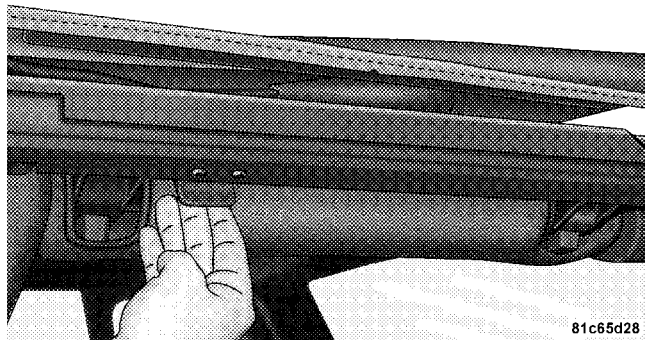

7. Open the swing gate and lower the top.

NOTE: Ensure fabric does not overhang the sides of the vehicle.

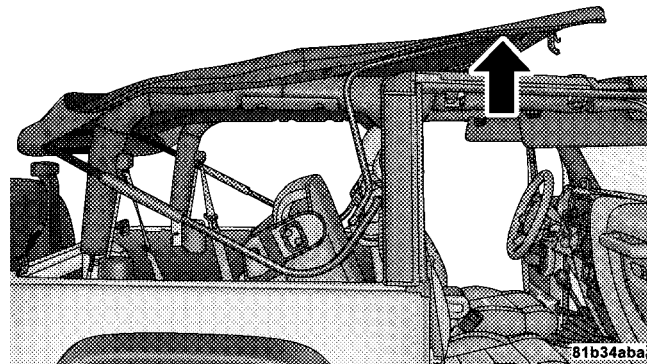

Quick Steps To Raising The Soft Top

Refer to “Raising The Soft Top” in this section for further information.

1. Open the swing gate and raise the top, engaging the Sunrider® latches (another person may be needed to help with this operation).

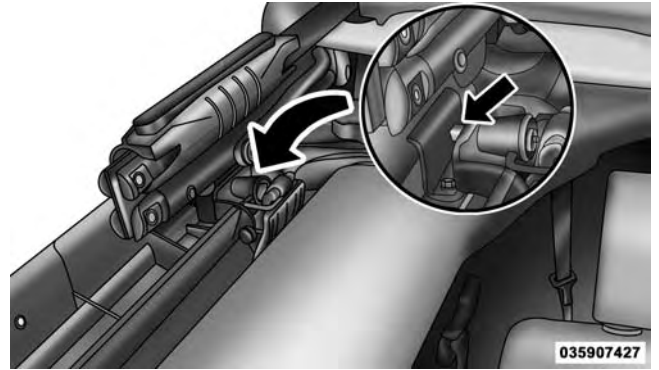
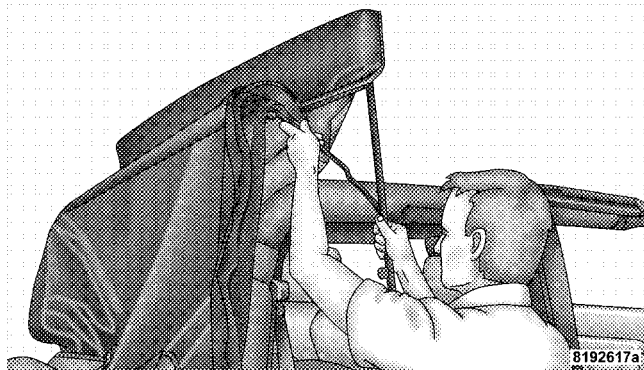

2. Engage header latches.

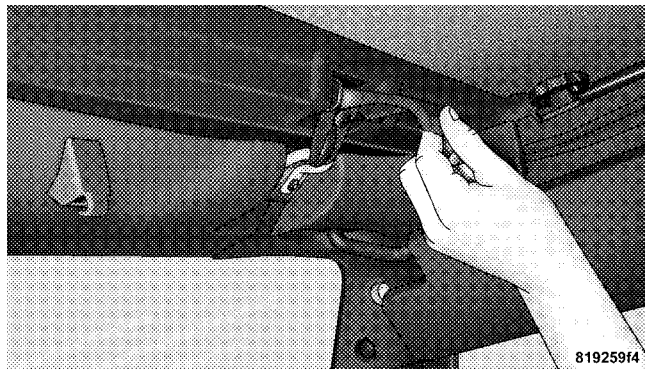

3. Install rear corner panels.

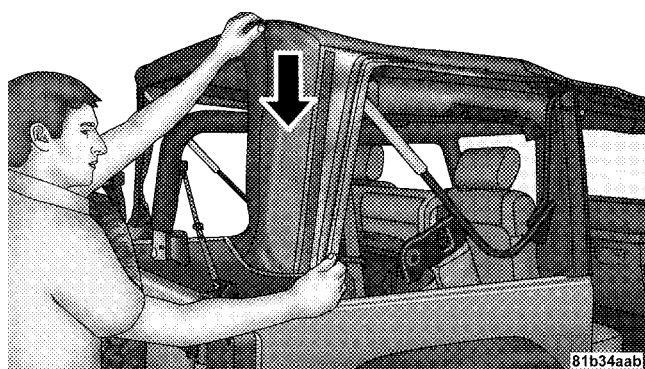

4. Install the back window.



5. Install the side windows.



230 UNDERSTANDING THE FEATURES OF YOUR VEHICLE

6. Insert the front retainer of the window into the door channel, making sure the retainer is fully seated and properly positioned on the door frame. Failure to do so can result in wind and water leaks or damage to the window.

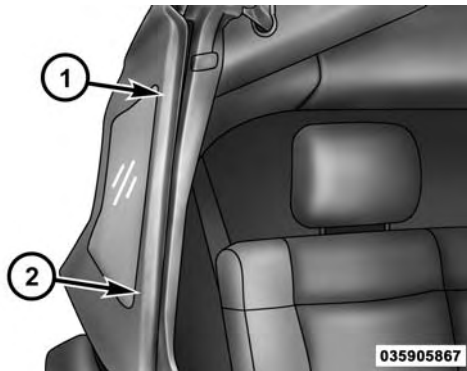

- 1 — Incorrect Insertion
2 — Correct Insertion

7. Insert the retainer along the bottom edge of the window into the bottom side channel, beginning at the front and working to the rear of the vehicle. Finish by closing the zipper completely and attaching the Velcro® along the top and rear of the window. Repeat this step for the opposite side.

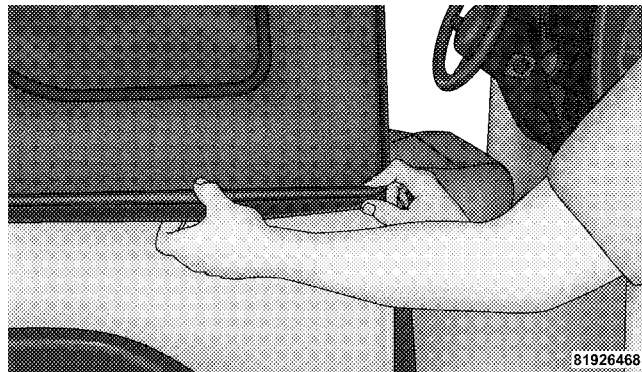

Lowering The Soft Top

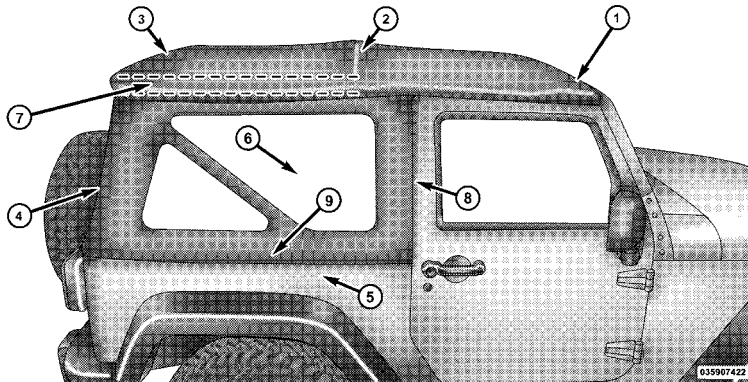

- 1 — Header Bow
- 2 — 2-Bow
- 3 — 3-Bow
- 4 — Sail Panel
- 5 — Body Side Retainer

- 6 — Quarter Window
- 7 — Check Strap
- 8 — Front Retainer — Quarter Window
- 9 — Bottom Retainer — Quarter Window

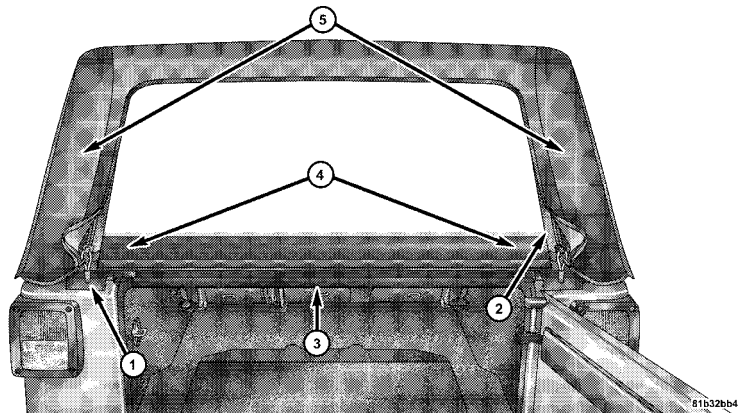

- 1 — Zipper Start
 - 2 — Zipper Finish
 - 3 — Swing Gate Bar
 - 4 — Swing Gate Brackets
 - 5 — Sail Panels
-

NOTE: Clean side and rear windows before removal to assist in preventing scratching during removal of the soft top. If zippers are difficult to operate due to road dust, etc., clean them with a mild soap solution and a small brush. Cleaning products are available through your authorized dealer.

1. If your vehicle has half doors, remove each half-door window by opening the door and lifting the half-door window out.

NOTE: Stow the half-door windows carefully outside of the vehicle, never inside, to avoid scratches.

2. Unclip and move the sun visors to the side.

3. Release the header latches and leave the hooks in the loops on the windshield.

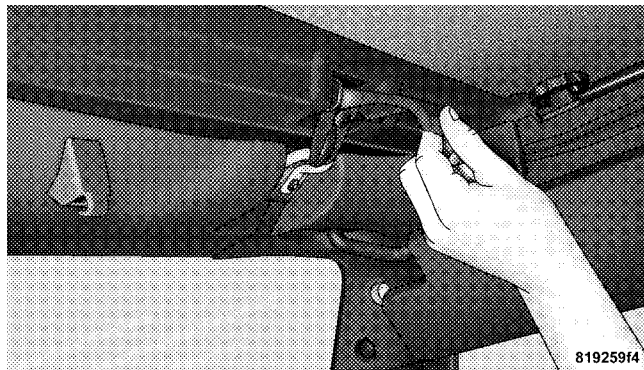

4. Open the swing gate.

234 UNDERSTANDING THE FEATURES OF YOUR VEHICLE

5. Before unzipping the rear window, release the first 3 in (7.6 cm) of both sail panels from the channel. Remove the swing gate bar by pulling it straight rearward out of the swing gate brackets.

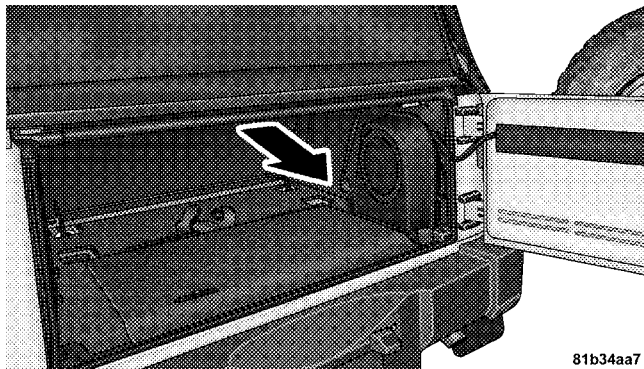

- Unzip the rear window starting at the right lower corner of the window. Pull the zipper up, across the top and down to the left lower corner. **Zipper pulls will stay on the rear window.** Pull down on the rear window to disengage it from the zipper on the top cover.



6. Remove the rear window retainer from the swing gate bracket on both the left and right sides.

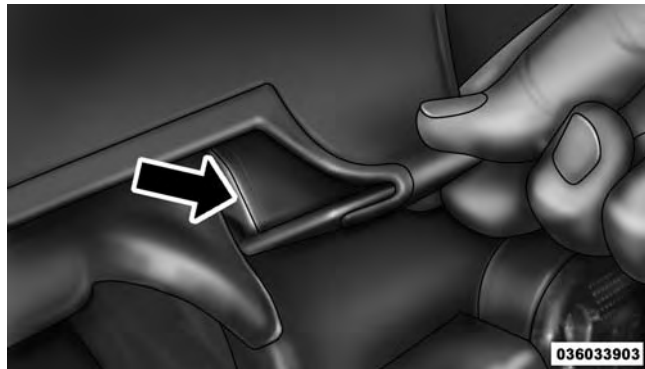

7. Stow the windows carefully to avoid scratching.
8. Undo the Velcro® that runs along the top and rear edge of the side window.

9. Beginning from the rear lower corner, completely unzip the window.

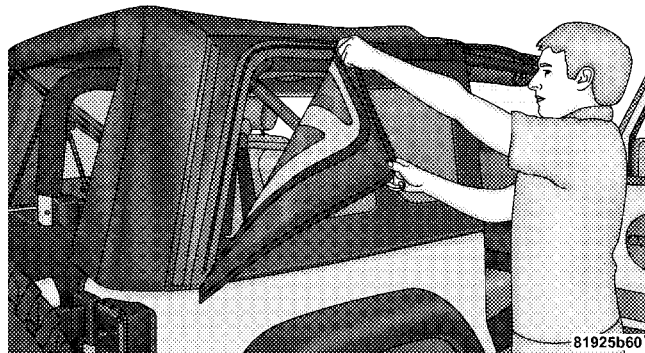

10. Once unzipped, remove the side window retainers from the door channel and body side channel. Repeat this step on the opposite side.

236 UNDERSTANDING THE FEATURES OF YOUR VEHICLE

11. Finish releasing the sail panel retainers from the body side channel at the rear corners of the vehicle.

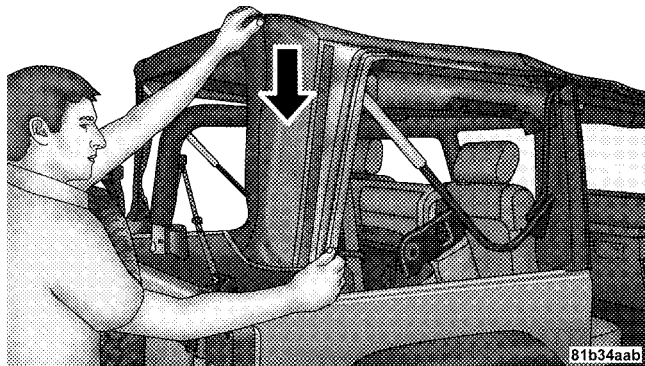

NOTE: When releasing the sail panel retainers, it is helpful to pull down on the rear roof bow.

12. As you begin to lower the top, fold the sail panels so that they rest on top of the soft top.

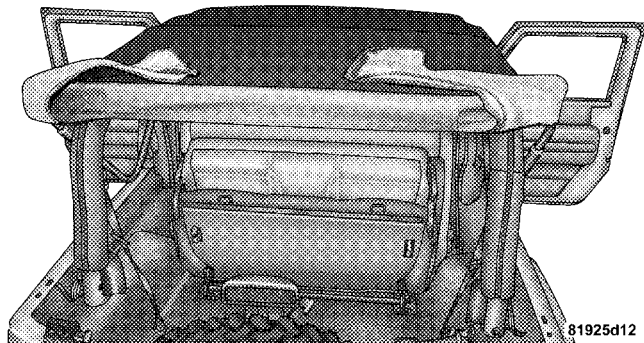

13. The swing gate brackets do not need to be removed unless the hard top is being installed. To remove the swing gate brackets, pull the front of the bracket forward while rolling the entire bracket back in toward the vehicle to disengage.

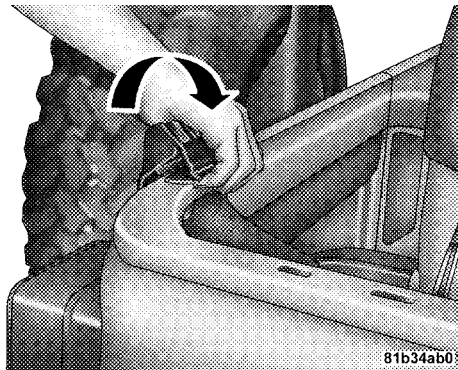

14. Completely release the latches from the loops on the windshield frame. **If your vehicle is not equipped with the Sunrider® package, proceed to Step 15.**

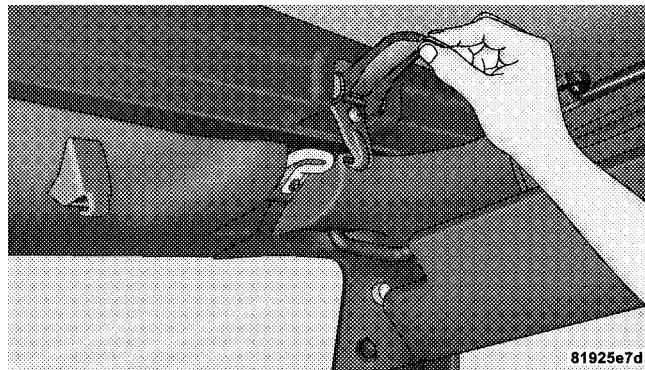

238 UNDERSTANDING THE FEATURES OF YOUR VEHICLE

15. Make sure the plastic sleeves are slid rearward over the Sunrider® link (Sunrider® Models only).

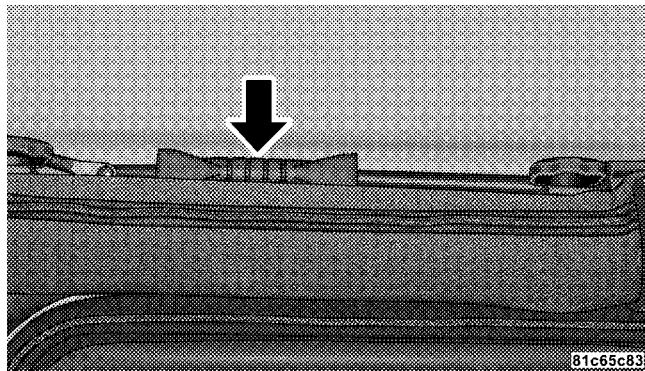

16. Unlatch the side bows from both door rails (Sunrider® Models only).

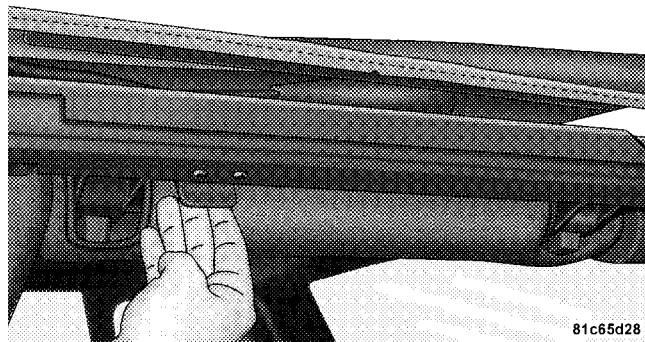

17. Before lowering the top, open the swing gate to prevent possible damage to the rear center high-mounted brake light. Move to the front of the vehicle. Grasp the side bow behind the header and lift the top, folding it toward the rear of the vehicle.

NOTE: Help from another person will ease this operation.

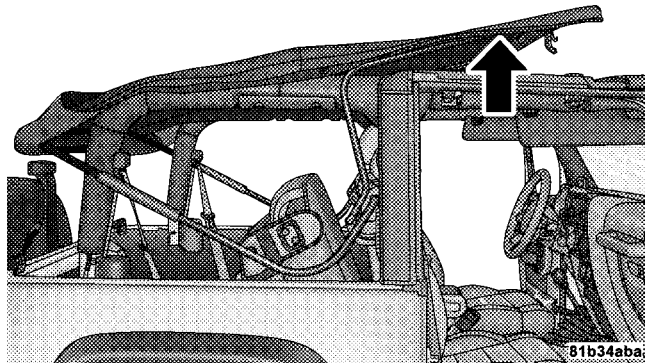

18. Tuck the fabric and the check straps between the bows and as far inward as possible. This will keep any portion of the top from flapping outside of the vehicle.

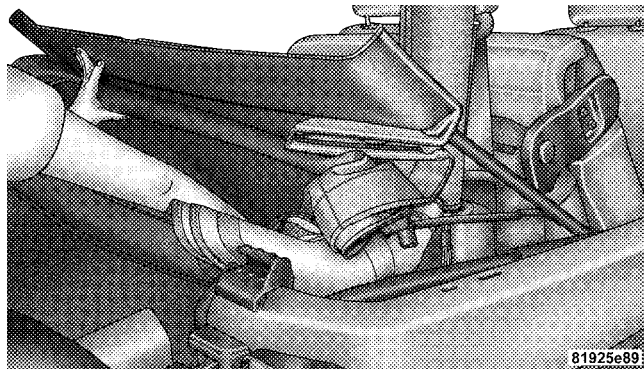

3

19. Close the front header latches.
20. Remove the door frames, if desired. Refer to "Door Frame" in this section for further information.

Raising The Soft Top

1. Unclip and move the sun visors to the side.
2. Install door frames, if removed. Refer to “Door Frame” in this section for further information.
3. Make sure the plastic sleeve is slid over Sunrider® link (Sunrider® Models only).

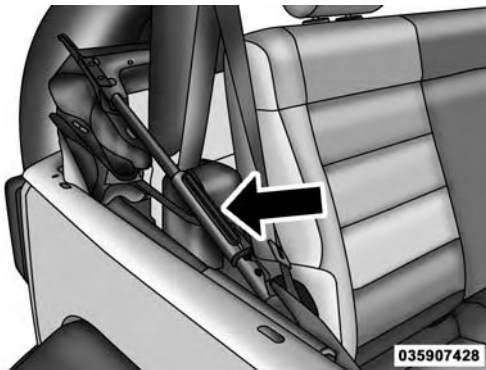

4. Standing on the side of the vehicle, lift the top by the side bow and the 2-bow (middle bow) up and over the sports bar until the header rests on the top of the windshield frame.

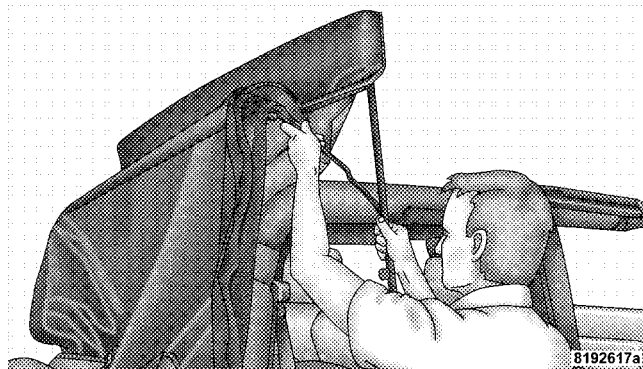

5. Make sure the Sunrider® bracket on the side bows latches to the door rails (Sunrider® Models only).
6. Open the header latches and engage the hook on each side onto the windshield loops (do not close the latches).

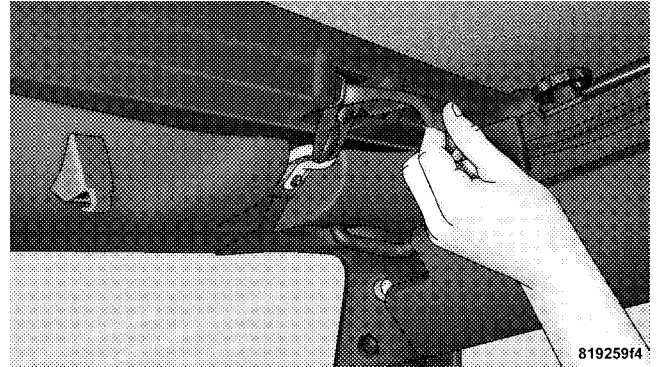
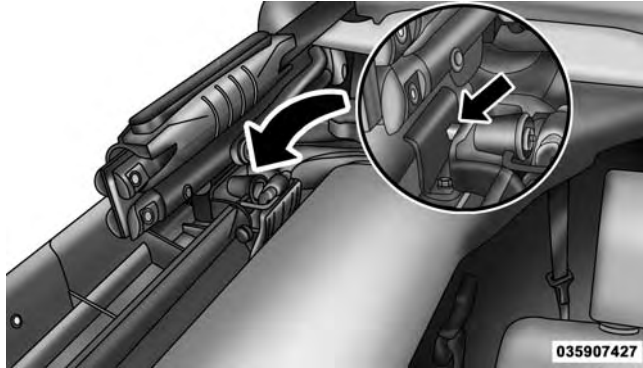

242 UNDERSTANDING THE FEATURES OF YOUR VEHICLE

7. If the swing gate brackets were removed, install them by hooking the rear edge of the bracket on the interior side of the body channel. Then, rotate it rearward and over the channel until it snaps onto the exterior part of the rail. To be properly located, the bracket must only be clipped to the shortened rail edge.

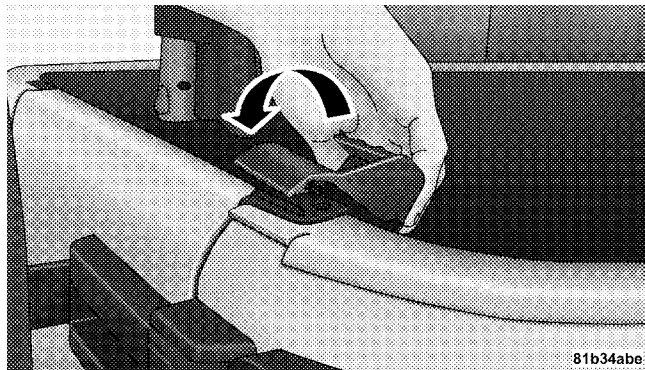

8. Move to the rear of the vehicle and gently pull the sail panels over the rear roof bow.

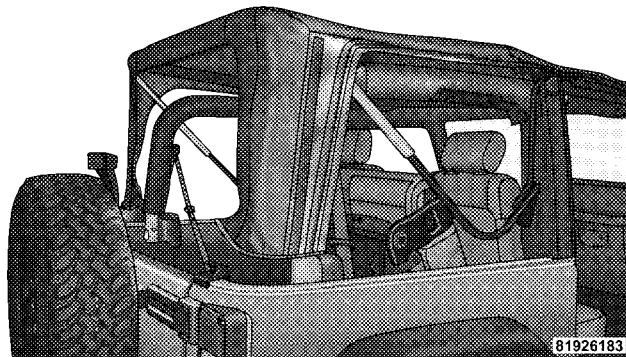

9. Partially install the sail panel retainers into the body side channel, leaving the last 3 in (7.6 cm) toward the rear window loose (on both sides). Pulling down on the rear roof bow (3-bow) will aid to reach the channel with the retainers.

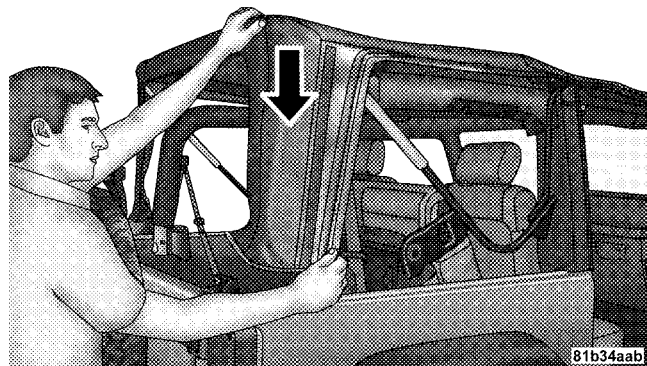

10. To install the side windows, affix the window temporarily by attaching to the Velcro® in the rear corner. Start the zipper but close only about 1 in (2.5 cm).

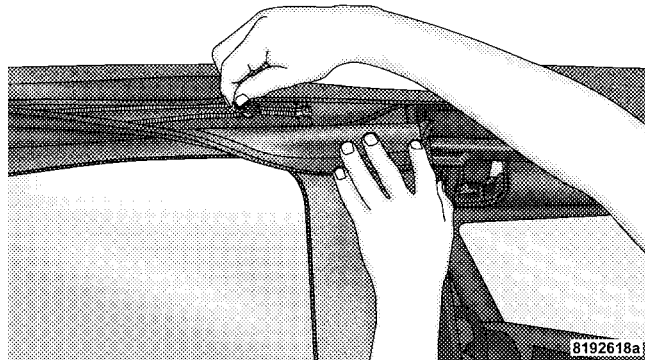

244 UNDERSTANDING THE FEATURES OF YOUR VEHICLE

11. Insert the front retainer of the window into the door channel, making sure the retainer is fully seated and properly positioned on the door frame. Failure to do so can result in wind and water leaks or damage to the window.

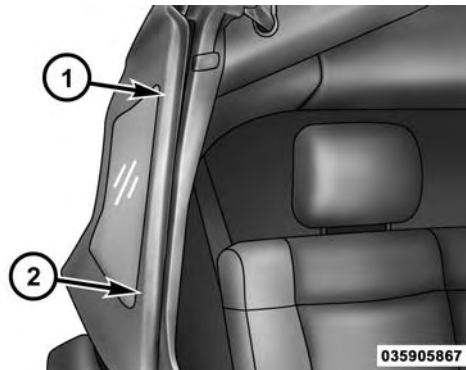
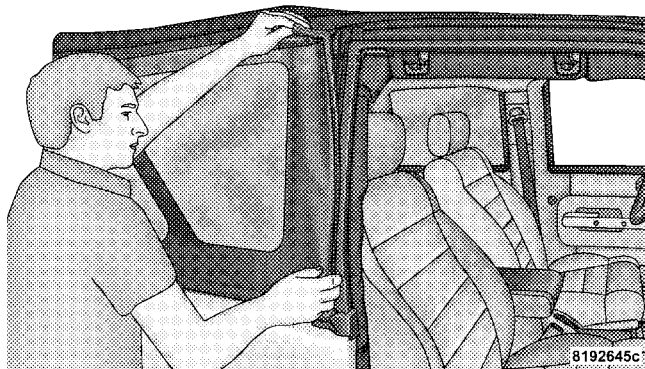

- 1 — Incorrect Insertion
- 2 — Correct Insertion

12. Insert the retainer along the bottom edge of the window into the bottom side channel, beginning at the front and working to the rear of the vehicle. Finish by closing the zipper completely and attaching the Velcro® along the top and rear of the window. Repeat this step for the opposite side.

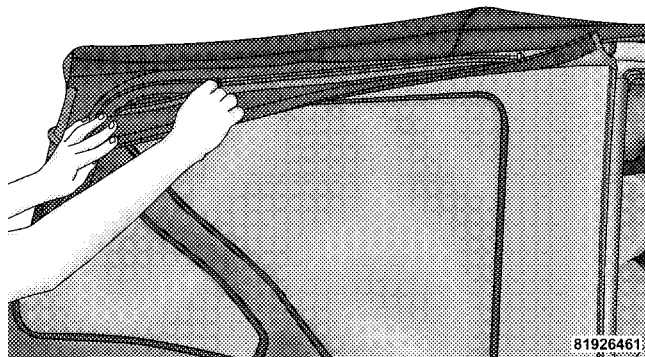
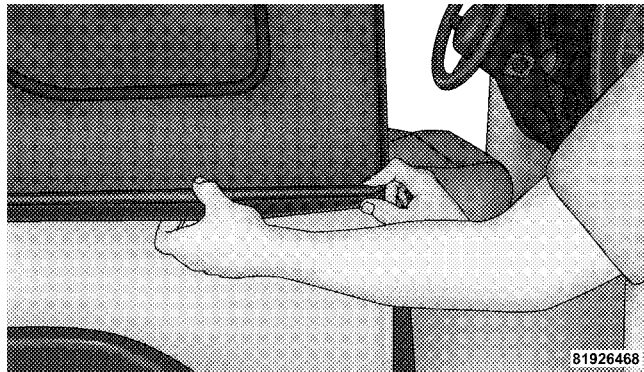

246 UNDERSTANDING THE FEATURES OF YOUR VEHICLE

13. Locate the black swing gate bar. Slide the swing gate bar over the receiver at the bottom inside of the rear window. The spongy part of the seal should be down and pointed outward to seal with the swing gate when closed.

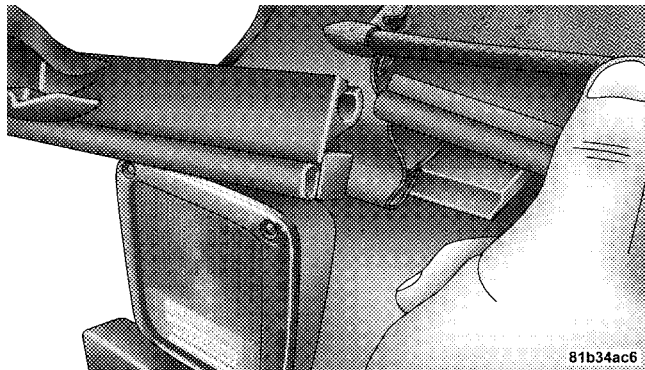

14. Install the rear window by starting both zipper ends at the lower left corner of the rear window opening. Ensure that the zippers are properly started and aligned before zipping to prevent damage.

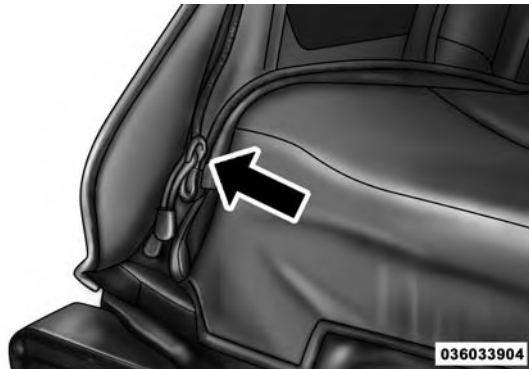

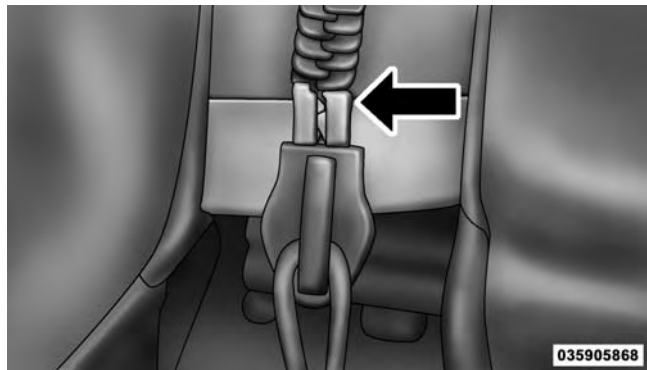

15. Run the zipper fully around to the right side of the window.

16. Grasp the swing gate bar and position it into the swing gate brackets.

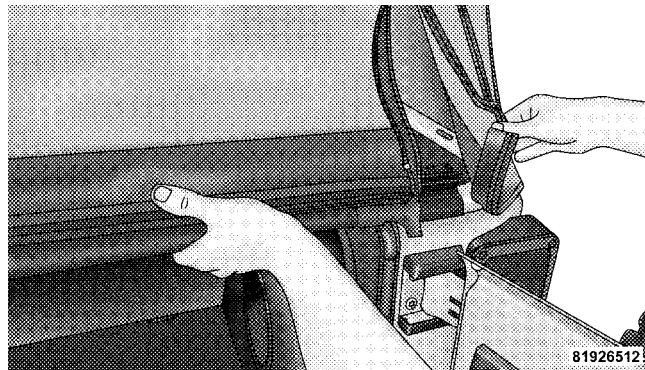

17. Insert the rear window retainer into the swing gate bracket on both the left and right sides.

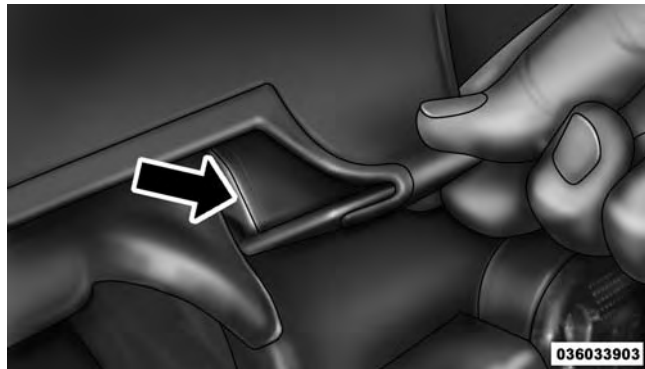

18. Apply downward pressure on the top corner of the rear soft top bow (3-bow), then complete attaching the sail panel retainers into the body side channel.

19. Close the header latches and return the sun visors to their secured position.

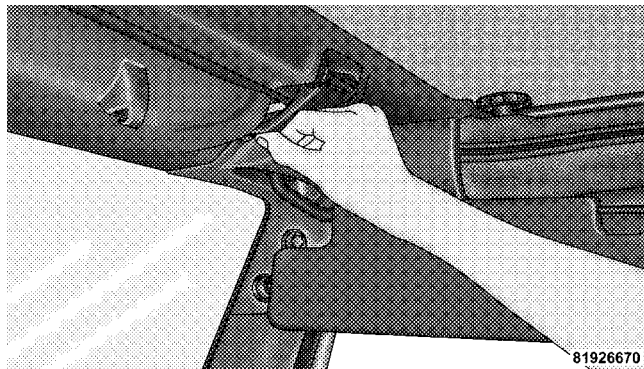

SOFT TOP — FOUR-DOOR MODELS

Please visit the owner's section of Jeep.com for instructional videos.

CAUTION!

The soft top is not designed to carry any additional loads such as roof racks, spare tires, building, hunting, or camping supplies, and/or luggage, etc. Also, it was not designed as a structural member of the vehicle, and thus cannot properly carry any additional loads other than environmental (rain, snow, etc.).

If the temperature is below 72°F (24°C) and/or the top has been folded down for a period of time, the top will appear to have shrunk when you raise it, making it difficult to put up. This is caused by a natural contraction of the vinyl coating on the fabric top.

Place the vehicle in a warm area. Pull steadily on the top fabric. The vinyl will stretch back to its original size and the top can then be snapped into place. **If the temperature is 41°F (5°C) or below, do not attempt to put the top down or roll the rear or side curtains.**

CAUTION!

- Do not run a fabric top through an automatic car wash. Window scratches and wax buildup may result.
- Do not lower the top when the temperature is below 41°F (5°C). Damage to the top may result.
- Do not lower the top when the windows are dirty. Grit may scratch the window.
- Do not move your vehicle until the top has been either fully attached to the windshield frame, or fully lowered.

(Continued)

CAUTION! *(Continued)*

- Do not lower the top with the windows installed. Window and top damage may occur.
- Refer to “Appearance Care for Fabric Top Models” in “Maintaining Your Vehicle” for further information. It contains important information on cleaning and caring for your vehicle’s fabric top.
- Do not use any tools (screwdrivers, etc.) to pry or force any of the clamps, clips, or retainers securing the soft top. Do not force or pry the soft top framework when opening or closing. Damage to the top may result.

WARNING!

- Do not drive the vehicle with the rear window curtain up unless the side curtains are also open. Dangerous exhaust gases which can kill could enter the vehicle.
- The fabric upper doors and fabric top are designed only for protection against the elements. Do not rely on them to contain occupants within the vehicle or to protect against injury during an accident. Remember, always wear seat belts.

CAUTION!

Failure to follow these cautions may cause interior water damage, stains or mildew on the top material:

- It is recommended that the top be free of water prior to opening it. Operating the top, opening a door or lowering a window while the top is wet may allow water to drip into the vehicle's interior.
- Careless handling and storage of the soft top may damage the seals, causing water to leak into the vehicle's interior.
- The soft top must be positioned properly to ensure sealing. Improper installation can cause water to leak into the vehicle's interior.

NOTE: Do not remove any of the three attachment knobs unless you are planning on installing the hard top.

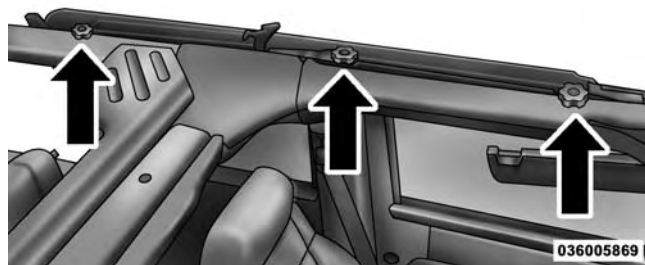

Quick Steps For Lowering The Soft Top

1. Remove the side windows.



2. Remove the back window.

NOTE: Start zipper from the right side to remove back window.



3. Release header latches from the windshield frame.

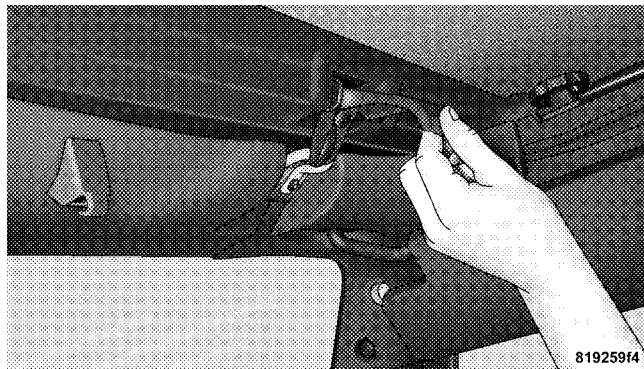

4. Release the sail panel retainers from the body side channel at the rear corners of the vehicle.

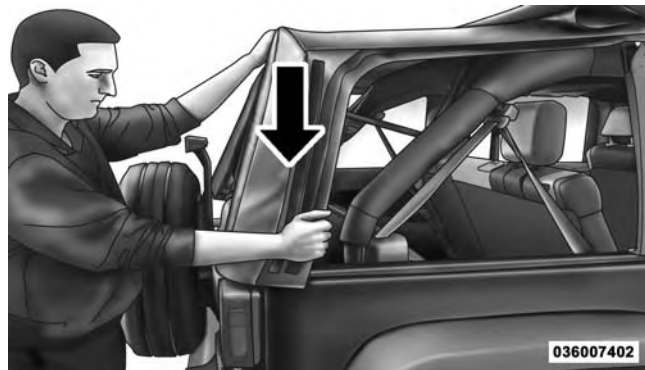

3

NOTE: When releasing the sail panel retainers, it is helpful to pull down on the rear roof bow.

254 UNDERSTANDING THE FEATURES OF YOUR VEHICLE

5. Fold the sail panels so that they rest on top of the soft top.



6. Fold header rearward, pulling the fabric to the rear.

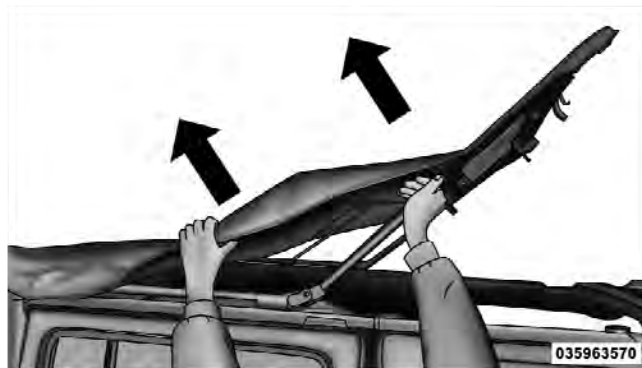

7. Release Sunrider® latch (both sides).



8. Open the swing gate and lower the top.



NOTE: Ensure the fabric does not overhang the sides of the vehicle.

Quick Steps For Raising The Soft Top

1. Open the swing gate and raise the top, engaging the Sunrider® latches (another person may be needed to help with this operation).



2. Install rear corner panels.

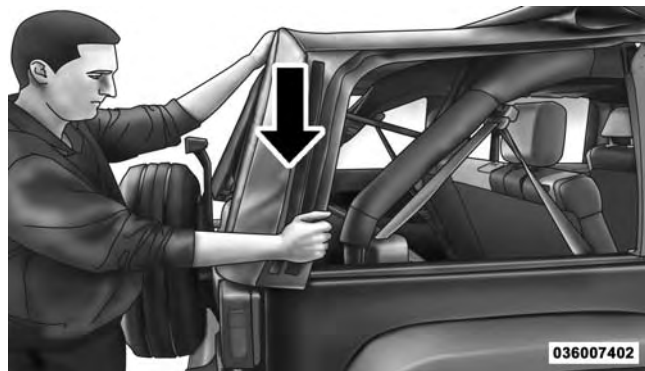
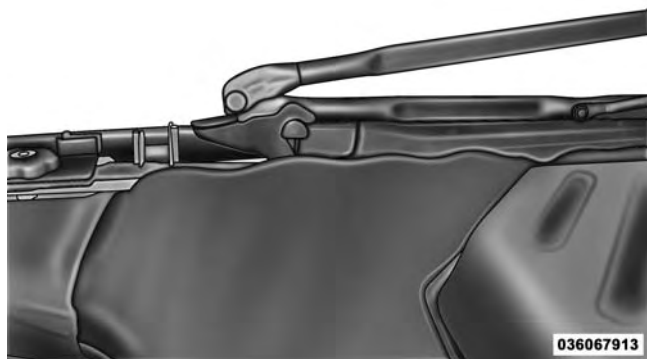

3. Rotate the header forward.



4. Engage the header latches.

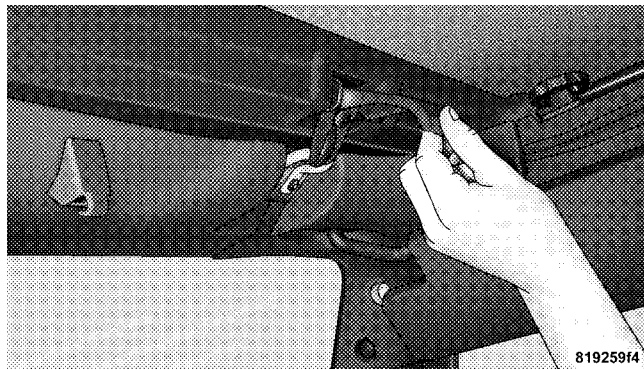

5. Install the back window.



6. Install the side windows.



7. Insert the front retainer of the window into the door channel, making sure the retainer is fully seated and properly positioned on the door frame. Failure to do so can result in wind and water leaks or damage to the window.

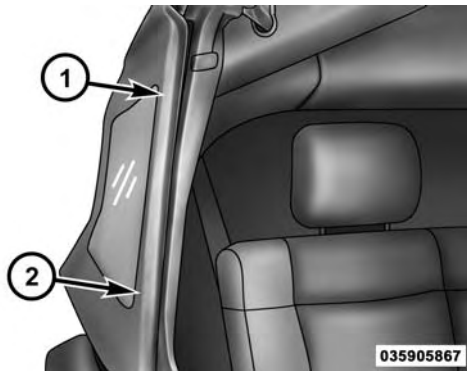

- 1 — Incorrect Insertion
2 — Correct Insertion

8. Insert the retainer along the bottom edge of the window into the bottom side channel, beginning at the front and working to the rear of the vehicle. Finish by closing the zipper completely and attaching the Velcro® along the top and rear of the window. Repeat this step for the opposite side.

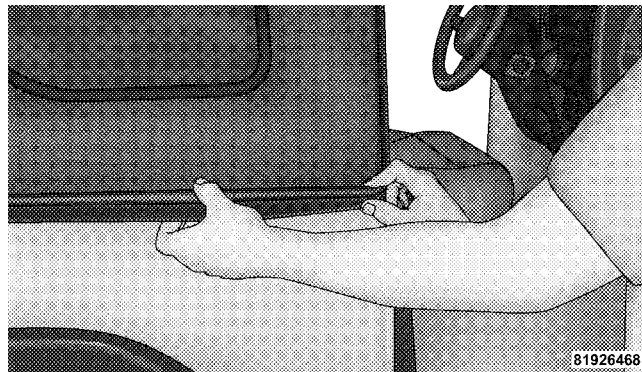

Folding Down The Soft Top

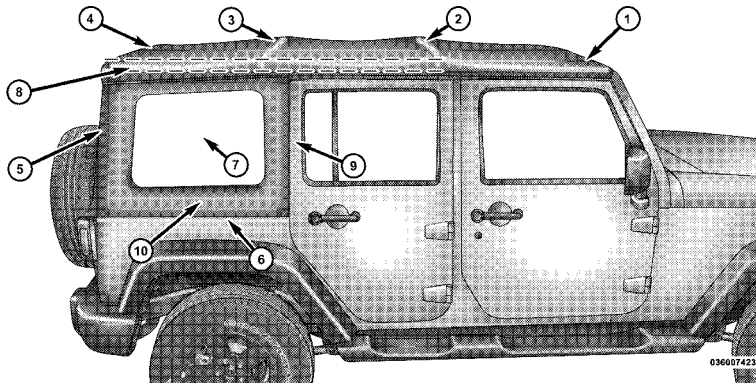

- 1 — Header Bow
- 2 — 2-Bow
- 3 — 3-Bow
- 4 — 4-Bow
- 5 — Sail Panel

- 6 — Body Side Retainer
- 7 — Quarter Window
- 8 — Check Strap
- 9 — Front Retainer — Quarter Window
- 10 — Bottom Retainer — Quarter Window

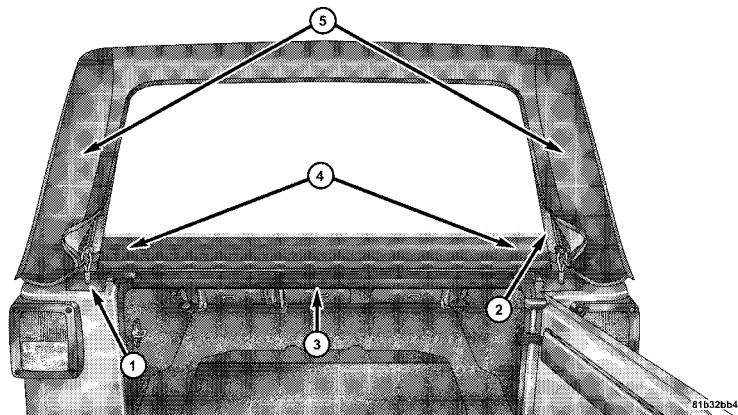

- 1 — Zipper Start
 - 2 — Zipper Finish
 - 3 — Swing Gate Bar
 - 4 — Swing Gate Brackets
 - 5 — Sail Panels
-

NOTE: Clean side and rear windows before removal to assist in preventing scratching during removal of the soft top. If zippers are difficult to operate due to road dust, etc., clean them with a mild soap solution and a small brush. Cleaning products are available through your authorized dealer.

1. If your vehicle has half-doors, remove each half-door window by opening the door and lifting the half-door window out.

NOTE: Stow half-door windows carefully outside of the vehicle, never inside, to avoid scratches.

2. Unclip and move the sun visors to the side.

3. Release the header latches and hooks from the loops on the windshield frame.

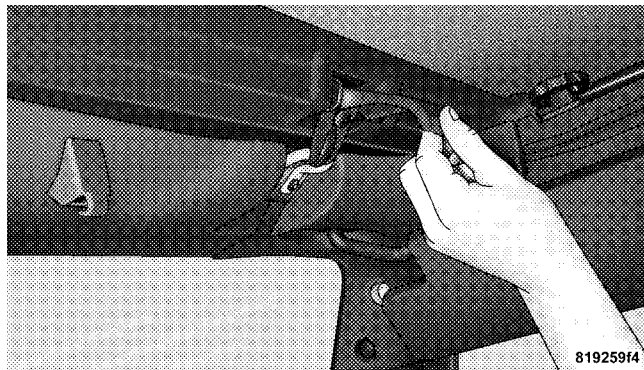

4. Open the swing gate.
5. Before unzipping the rear window, release the first 3 in (7.6 cm) of both sail panels from the channel. Remove the swing gate bar by pulling it straight rearward out of the swing gate brackets.

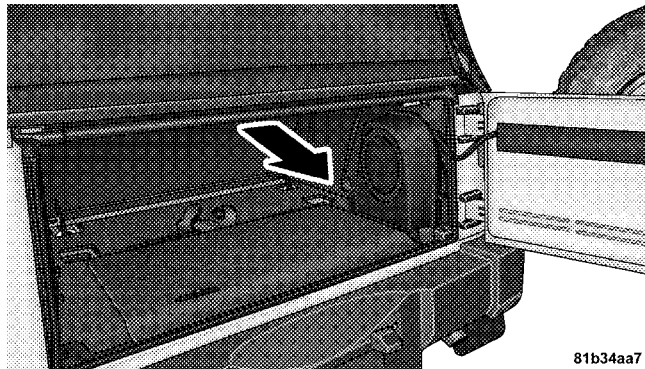

- Unzip the rear window starting at the right lower corner of the window. Pull the zipper up, across the top and down to the left lower corner. **Zipper pulls will stay on the rear window.** Pull down on the rear window to disengage it from the zipper on the top cover.



- Remove the rear window retainer from the swing gate bracket on both the left and right sides.

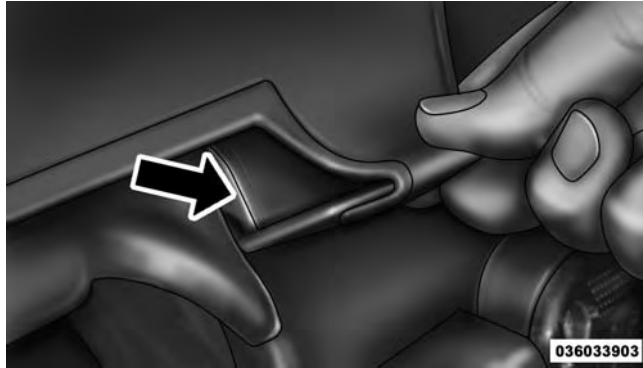

- Stow the windows carefully to avoid scratching.
- Undo the Velcro® that runs along the top and rear edge of the side window.

- Beginning from the rear lower corner, completely unzip the window.



- Once unzipped, remove the side window retainers from the door channel and body side channel. Repeat this step on the opposite side.

266 UNDERSTANDING THE FEATURES OF YOUR VEHICLE

11. Finish releasing the sail panel retainers from the body side channel at the rear corners of the vehicle.

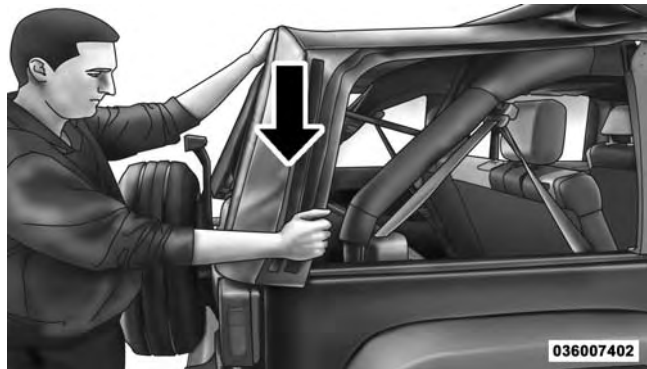

NOTE: When releasing the sail panel retainers, it is helpful to pull down on the rear roof bow.

12. Fold the sail panels so that they rest on top of the soft top.



13. The swing gate brackets do not need to be removed unless the hard top is being installed. To remove the swing gate brackets, pull the front of the bracket forward while rolling the entire bracket back in toward the vehicle to disengage.

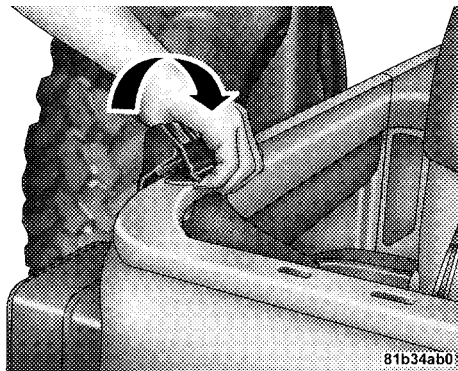

14. Grasp the front side bow behind the header, and lift the top.

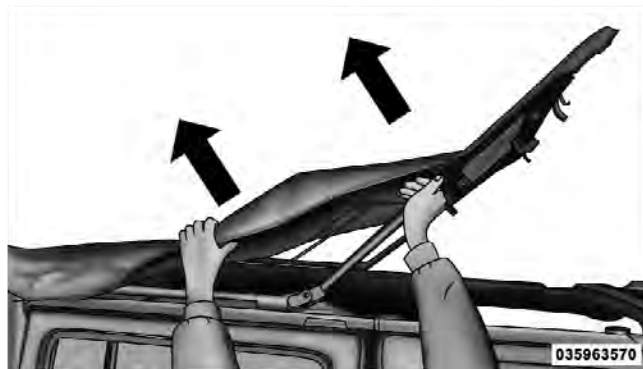

15. Fold back the front section of the top, pulling the fabric rearward. Gently rest the header on top of the rear portion of the deck.



16. Fold the top so that the material forms a "W" as shown. Enter the vehicle and move the material into two folds.



17. Release the side bows by pressing down on the latch above the front of the rear door. Push the top rearward to disengage. Repeat this step on the other side.



18. Before lowering the top, open the swing gate to prevent possible damage to the rear center high-mounted brake light. Grasp the folded side bows and slide the top along the door frame track to the rear door frame.



270 UNDERSTANDING THE FEATURES OF YOUR VEHICLE

19. Gently slide the side bows off the door frame track and lower the top down into the vehicle.

NOTE: Help from another person will ease this operation.



20. Tuck the fabric and the check straps between the bows as far inside as possible. This will keep any portion of the top from flapping outside of the vehicle.

21. Once the top is fully down, use the Velcro® straps provided to secure the top to the vehicle by wrapping the strap around the side bows and through the slot on the body.

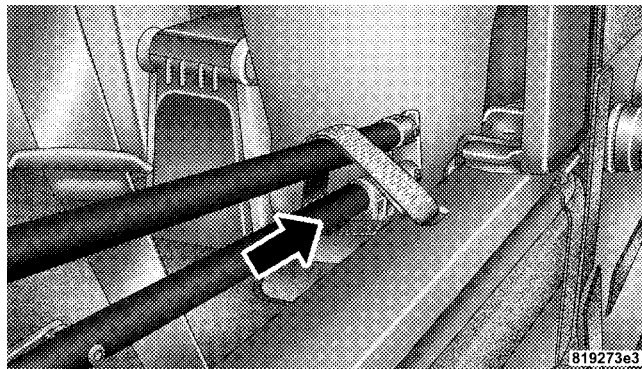

22. Close the front header latches.
23. Remove the door frames, if desired. Refer to "Door Frame" in this section for further information.

Putting Up The Soft Top

NOTE: Be extremely careful when putting up the soft top to prevent the doors from getting scratched. It may be helpful to open the rear doors.

1. Install the door frames, if removed. Refer to “Door Frame” in this section for further information.
2. Undo the straps used to secure the top in the down position and store in secure location.
3. Open the swing gate.

4. Grasp the folded side bows and lift to the top of the rear door frames.

NOTE: Help from another person will ease this operation.



272 UNDERSTANDING THE FEATURES OF YOUR VEHICLE

5. Insert the slider feature of the knuckles into the door frame tracks and slide the top forward.
6. Ensure that the top locks into the Sunrider® locking mechanisms that are located above the front of the rear doors.

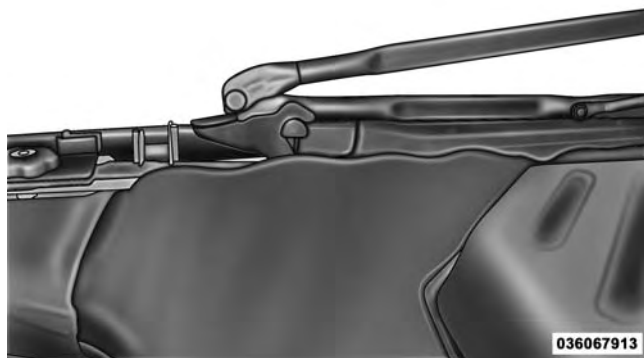

7. Unclip and move the sun visors to the side.
8. Standing on the side of the vehicle, lift the top by the side bow until it rests on the windshield frame.



9. Open the header latches and engage the hook on each side onto the windshield loops (do not close the latches).

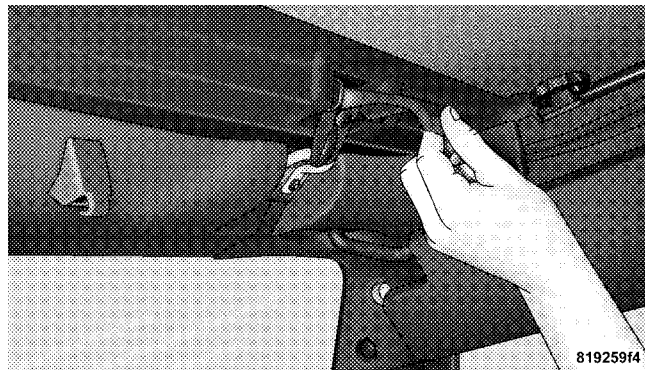

274 UNDERSTANDING THE FEATURES OF YOUR VEHICLE

10. If the swing gate brackets were removed, install them by hooking the rear edge of the bracket on the interior side of the body channel. Then, rotate it rearward and over the channel until it snaps onto the exterior part of the rail. To be properly located, the bracket must only be clipped to the shortened rail edge.

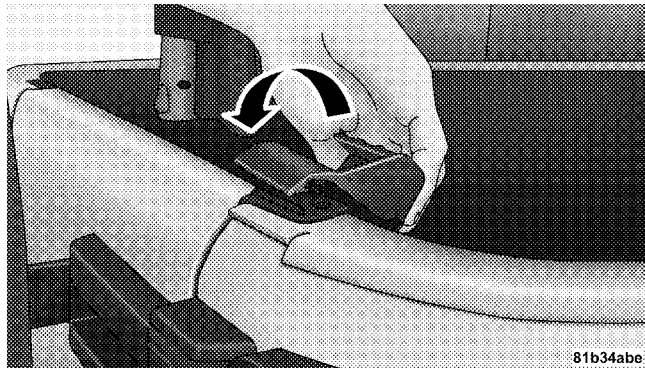

11. Ensure that the straps are positioned correctly before pulling the sail panels over the rear roof bow (4-bow).

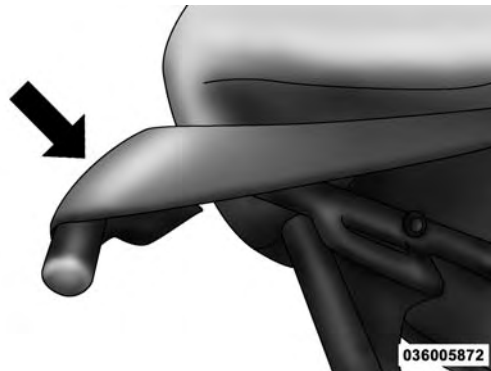

Partially install the sail panel retainers into the body side channel, leaving the last 3 in (7.6 cm) toward the rear window loose (on both sides). Pulling down on the rear roof bow (4-bow) will aid in reaching the channel with the retainers.

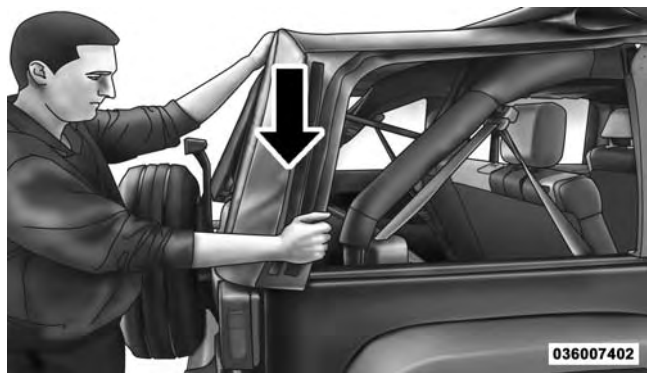

12. To install the side windows, affix the window temporarily by attaching it to the Velcro® in the upper rear corner. Start the zipper but close only about 1 in (2.5 cm).

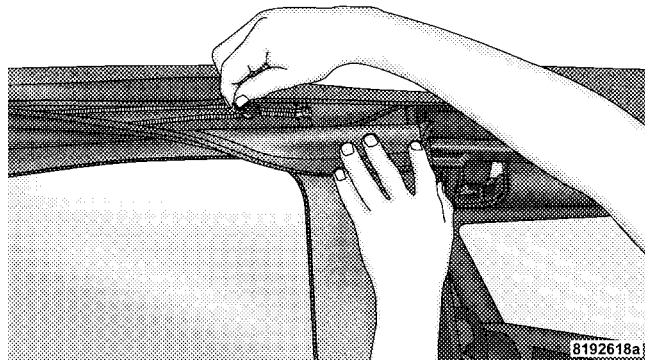

276 UNDERSTANDING THE FEATURES OF YOUR VEHICLE

13. Insert the front retainer of the window into the door channel, making sure the retainer is fully seated and properly positioned on the door frame. Failure to do so can result in wind and water leaks or damage to the window.

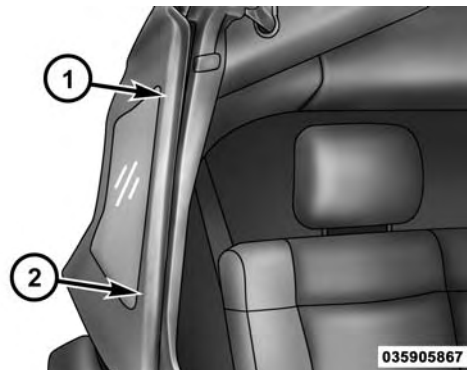

- 1 — Incorrect Insertion
- 2 — Correct Insertion

14. Insert the retainer along the bottom edge of the window into the bottom side channel, beginning at the front and working to the rear of the vehicle. Finish by closing the zipper completely and attaching the Velcro® along the top and rear of the window. Repeat this step for the opposite side.

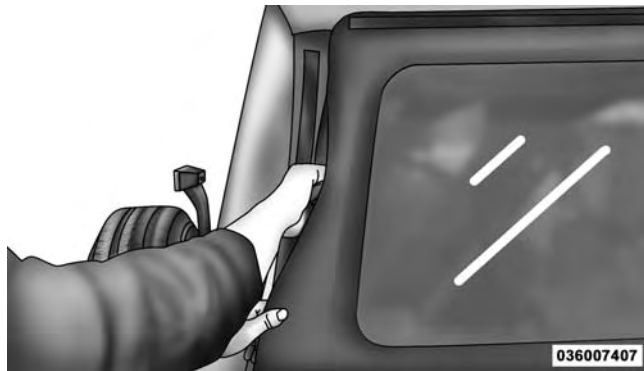
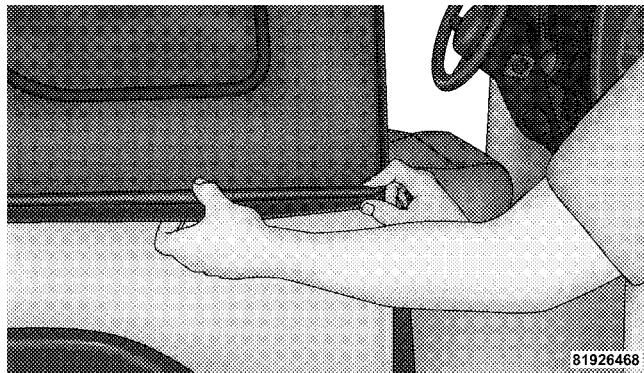

278 UNDERSTANDING THE FEATURES OF YOUR VEHICLE

15. Locate the black swing gate bar. Slide the swing gate bar over the receiver at the bottom inside of the rear window. The spongy part of the seal should be down and pointed outward to seal with the swing gate when closed.

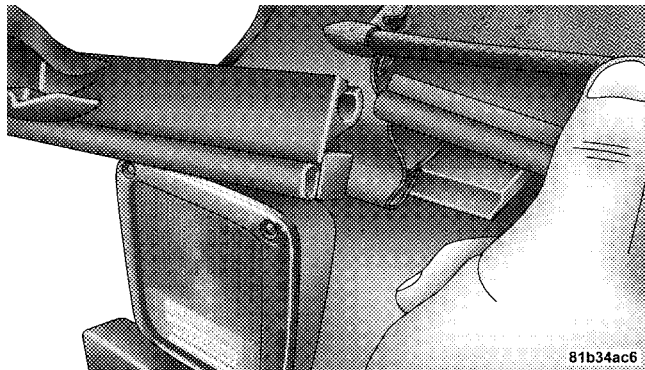

16. Install the rear window by starting both zipper ends at the lower left corner of the rear window opening. Ensure that the zippers are properly started and aligned before zipping to prevent damage.

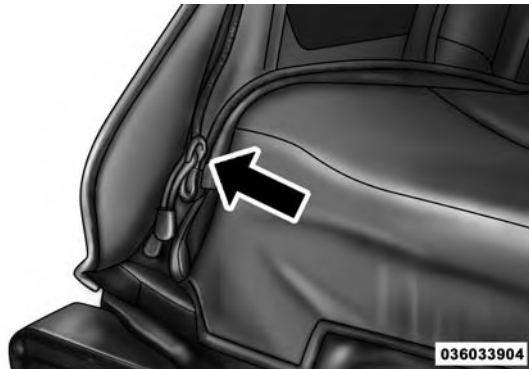

17. Run the first zipper fully around to the right side of the window.
18. Grasp the swing gate bar and position it into the swing gate brackets.
19. Insert the rear window retainer into the swing gate bracket on both the left and right sides.

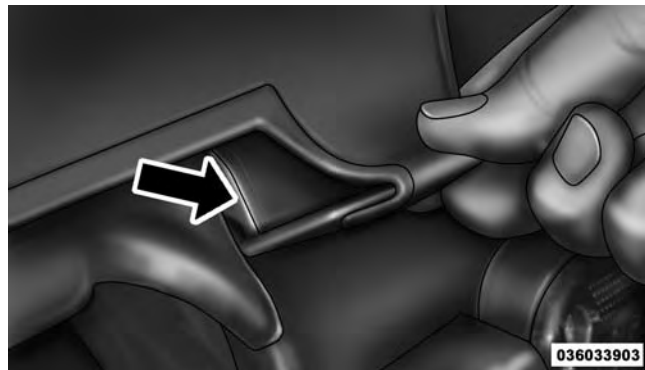
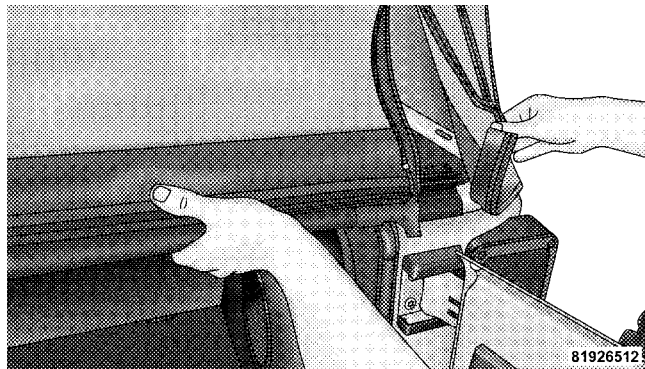

20. Complete the installation of the sail panel by inserting the rest of the retainer into the body channel.
21. Close the header latches and return the sun visors to their secured position.

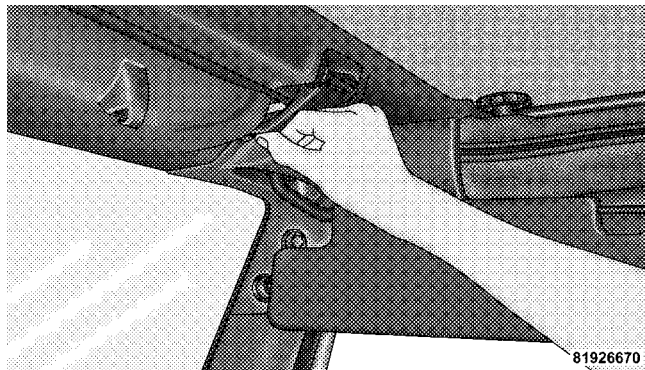

**SUNRIDER® (TWO-DOOR MODELS) —
IF EQUIPPED**

CAUTION!

Operating the top, opening a door or lowering a window while the top is wet may allow water to drip into the vehicle's interior.

NOTE: If you are going to be driving faster than 40 mph (64 km/h) with the Sunrider® feature open, it is recommended that you remove the rear window of the vehicle.

Opening The Sunrider®

1. Unclip and move the sun visors to the side.
2. Release the header latches from the loops on the windshield frame.

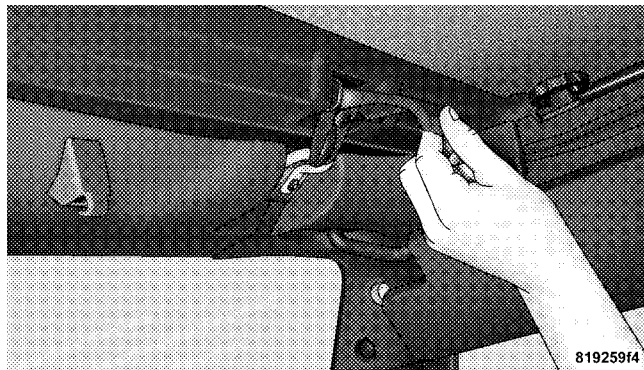

3. Slide the plastic sleeve forward.

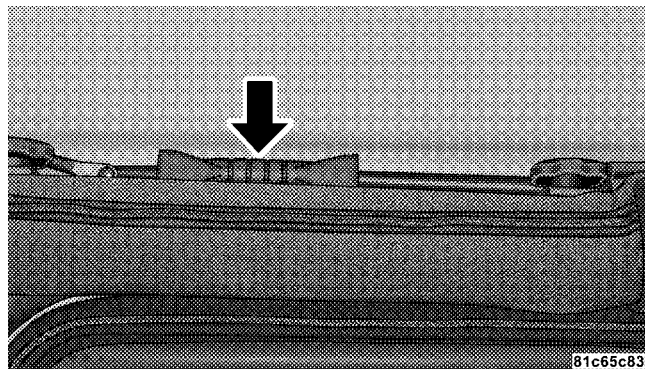

282 UNDERSTANDING THE FEATURES OF YOUR VEHICLE

4. Grasp the header and lift the top back. Make sure the material is folded back as shown.

NOTE: The Sunrider® latch on the door rail should not be activated for Sunrider® use. If activated, the soft top must be reinstalled starting from the sail panels.



5. Locate the straps to secure the side bows. Wrap the straps around the bows as shown. Repeat on the other side.

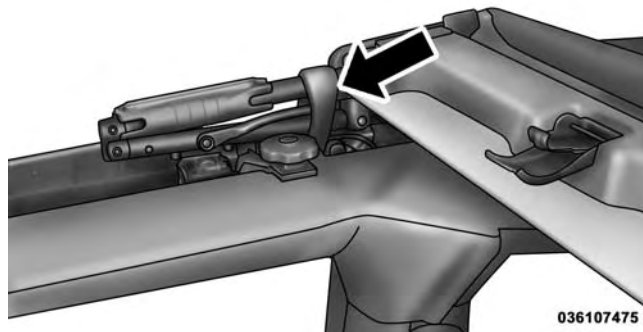

6. Reposition the sun visors.

Closing The Sunrider®

1. Remove the straps from the side bows.
2. Unclip and move the sun visors to the side.
3. Grasp the front header and pull it to the front of the vehicle.
4. Hook the header latches to the loops on the windshield frame, close latches, and return the sun visors to their original positions.
5. Slide the plastic sleeve rearward over the Sunrider® link.

SUNRIDER® (FOUR-DOOR MODELS) — IF EQUIPPED

CAUTION!

Operating the top, opening a door or lowering a window while the top is wet may allow water to drip into the vehicle's interior.

NOTE: If you are going to be driving faster than 40 mph (64 km/h) with the Sunrider® feature open, it is recommended that you remove the rear window of the vehicle.

Opening The Sunrider®

1. Unclip and move the sun visors to the side.
2. Release the header latches from the loops on the windshield frame.

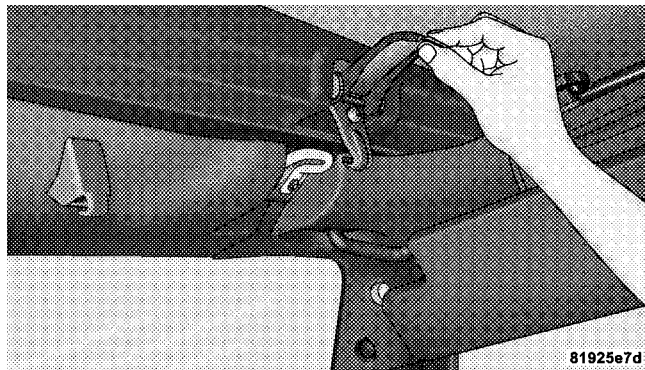

3. Grasp the front side bow behind the header, and lift the top.

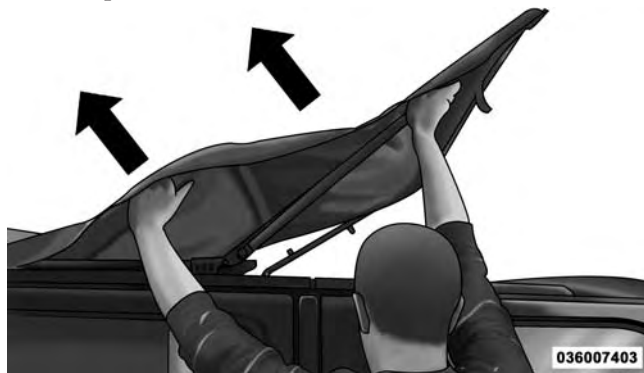

4. Fold back the front section of the top and gently rest the header on top of the rear portion of the deck.
5. Fold the top so that the material forms a "W" as shown. Enter the vehicle and move the material into two folds.

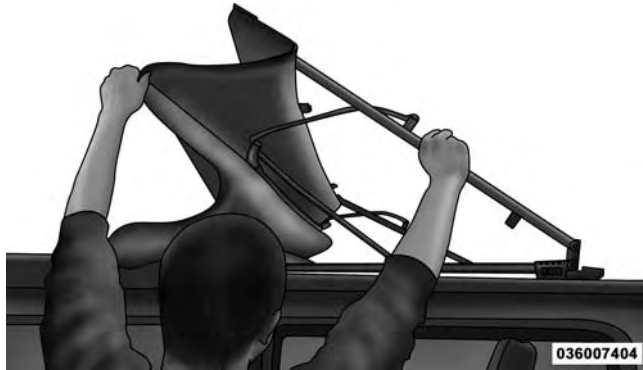

- Secure the top by using the two provided straps. Each strap will wrap around the side bow and Velcro® to itself; use one strap on each side of the vehicle.

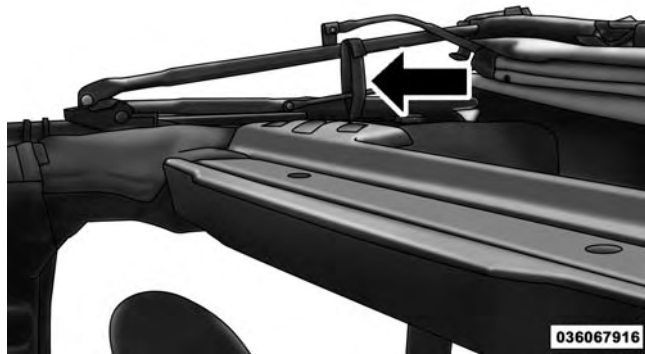

Closing The Sunrider®

Perform the above steps in the opposite order.

NOTE: Failure to fold the fabric rearward will allow the material to sag and may block the rearview mirror.

FOLDING WINDSHIELD

The fold-down windshield and removable side bars on your vehicle are structural elements that can provide some protection in some accidents. The windshield also provides some protection against weather, road debris and intrusion of small branches and other objects.

Do not drive your vehicle on-road with the windshield down and the side bars removed as you lose the protection these structural elements can provide.

If required for certain off-road uses, the side bars can be removed and the windshield folded down. However, the protection afforded by these features is then lost. If you remove the side bars and fold down the windshield, drive slowly and cautiously. It is recommended that the speed of the vehicle be limited to 10 mph (16 km/h), with low range operation preferred if you are driving off-road with the windshield folded down.

Raise the windshield and reinstall the side bars as soon as the task that required their removal is completed and before you return to on-road driving. Both you and your passenger should wear seat belts at all times, on-road and off-road, regardless of whether the windshield is raised or folded down.

Outside rearview mirrors are mounted on the doors. If you choose to remove the doors, see your authorized dealer for a replacement cowl-mounted outside mirror. Federal law requires outside mirrors on vehicles for on-road use.

WARNING!

Carefully follow these warnings to help protect against personal injury:

- Do not drive your vehicle on-road with the windshield down.

(Continued)

WARNING! (Continued)

- Do not drive your vehicle unless the windshield is securely fastened, either up or down.
- Eye protection, such as goggles, should be worn at all times when the windshield is down.
- Be sure that you carefully follow the instructions for raising the windshield. Make sure that the folding windshield, windshield wipers, side bars, and all associated hardware and fasteners are correctly and tightly assembled before driving your vehicle. Failure to follow these instructions may prevent your vehicle from providing you and your passengers protection in some accidents.
- If you remove the doors, store them outside the vehicle. In the event of an accident, a loose door may cause personal injury.

Lowering The Windshield And Removing Side Bars

1. Lower the fabric top or remove the hard top following the instructions in this manual.

NOTE: To assist in properly reinstalling side bars, mark the original locations prior to removing.

2. Remove the two top hex bolts (13 mm), and the one side hex bolt (13 mm) visible through the trim (Do not remove plastic corner trim, sun visor bolts, or sport bar covering).

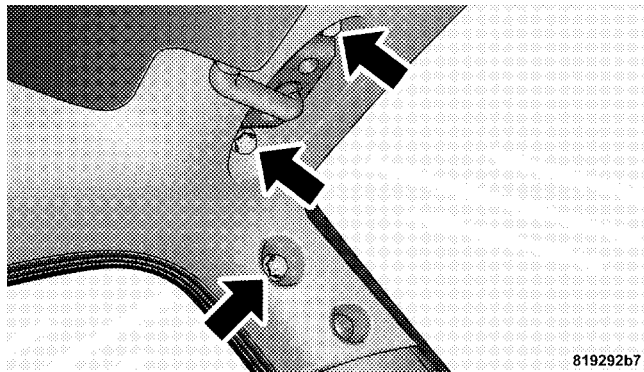

819292b7

3. Remove the sun visor.
4. Remove the A-pillar cap.
5. Disconnect microphone (if equipped with Uconnect™ phone).
6. Open the sport bar Velcro covering.

- Remove the one hex bolt (13 mm) visible through the plastic trim on the bottom side of the side bar, one hex bolt (13 mm) on the side of the side bar, and one hex bolt (13 mm) on top of the side bar.

NOTE: Pull side bar out horizontally when removing.

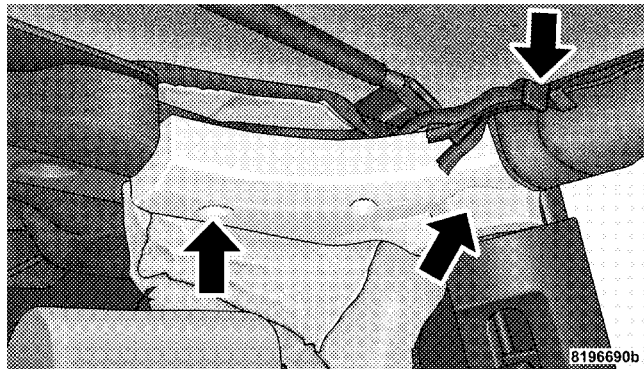

CAUTION!

Do not remove the head impact foam from the side bars, as damage to the foam may result.

NOTE: Store all of the mounting bolts in their original threaded holes and tighten for safekeeping.

- Remove the side bar assembly, and reattach the sport bar Velcro® covering.
- To safely store the side bars in your vehicle, use four cinch straps (available from your authorized dealer). Attach the straps through the slots located on the floor behind the folded rear seat at the front of the storage bin cover.

WARNING!

You or others could be injured if you carry the side bars loose in your vehicle. Remove the side bars from the vehicle or securely store them as described or they may cause personal injury if an accident occurs. See your authorized dealer for the cinch straps.

10. Remove the windshield wiper arms by first pulling the wiper away from the windshield and out to the “lock” position. Unsnap the wiper arm nut caps, and remove the retaining nuts. Lift the wiper arms off and store them in the center console or securely behind the rear seat.

NOTE: It may be necessary to use a battery terminal puller tool in order to separate the wiper arms from the shaft after the nuts have been removed.

11. Remove the lower windshield plates by removing the six black round-headed Torx® head screws (using a #40 Torx® head driver) on each side of the base of the windshield.

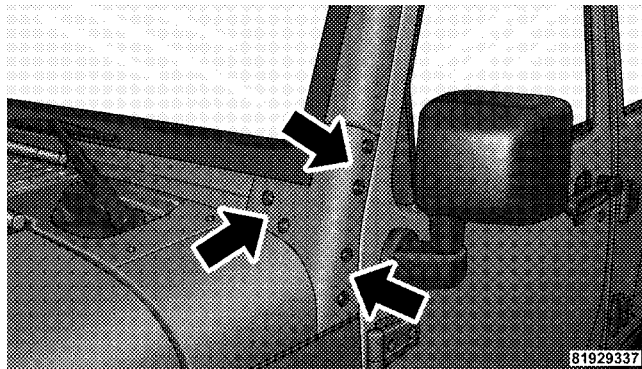

12. Lower the windshield gently until it contacts the rubber hood bumpers.
13. Secure the windshield by passing a cinch strap through the footman hoop on the center of the hood and on the center of the windshield frame. Tighten the strap to secure the windshield in place.

Raising The Windshield And Replacing Side Bars

1. Raise the windshield.
2. Loosely attach the rear of the side bar to the sport bar. Refer to Step 4 of “Lowering Windshield And Removing Side Bars” earlier in this section.

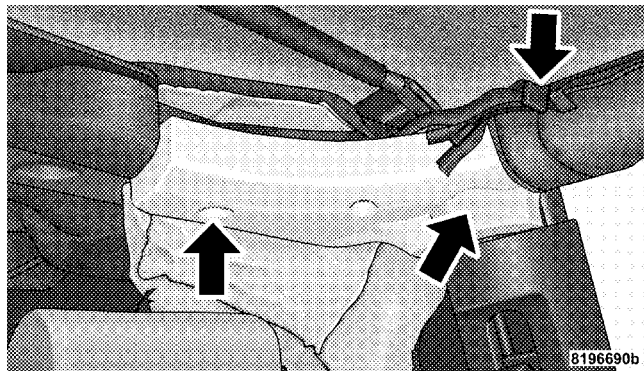

- Reattach the sport bar Velcro® covering.

3. Attach the front of the side bar to the windshield frame.
 - Install the top two hex bolts (13 mm) first, then the lower side hex bolt (13 mm). The lower side bolt will not align until the top two bolts are installed.

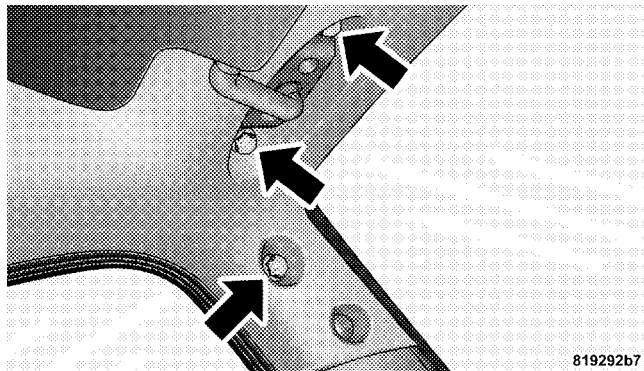

4. Tighten all side bar attachment bolts.

5. Install the lower windshield plates with the six black round-headed Torx® head screws (using a #40 Torx® head driver) on each side of the base of the windshield.

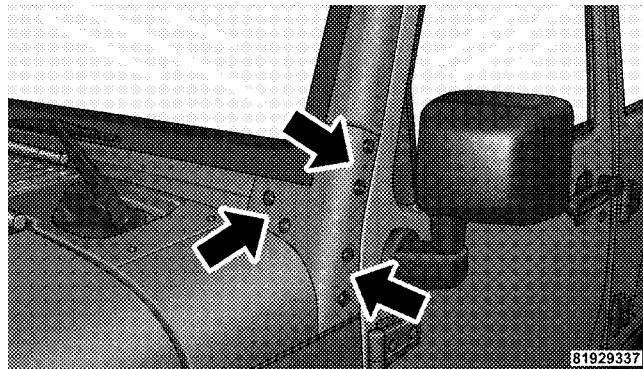

6. Reinstall the wiper arms.

REAR WINDOW FEATURES — HARD TOP ONLY**Rear Window Wiper/Washer — If Equipped**

A rotary switch on the center portion of the control lever (located on the right side of the steering column) controls the operation of the rear wiper/washer function.



031507505

Rear Wiper/Washer Control



Rotate the switch upward to the first detent position for rear wiper operation.



Rotate the switch upward past the first detent to activate the rear washer. The washer pump and the wiper will continue to operate as long as the switch is held. Upon release, the wiper will cycle two to three times before returning to the set position.

If the rear wiper is operating when the ignition is turned to the LOCK position, the wiper will automatically return to the “Park” position. When the vehicle is restarted, the wiper will resume function at whichever position the switch is set at.

Rear Window Defroster — If Equipped



The rear window defroster button is located on the bottom right-side of the blower control knob. Press this button to turn on the rear window defroster. An indicator in the button will illuminate when the rear window defroster is on. The rear window defroster automatically turns off after approximately 10 minutes. For an additional five minutes of operation, press the button a second time.

NOTE: To prevent excessive battery drain, use the rear window defroster only when the engine is operating.

CAUTION!

Failure to follow these cautions can cause damage to the heating elements:

- Use care when washing the inside of the rear window. Do not use abrasive window cleaners on the interior surface of the window. Use a soft cloth and a mild washing solution, wiping parallel to the heating elements. Labels can be peeled off after soaking with warm water.
- Do not use scrapers, sharp instruments, or abrasive window cleaners on the interior surface of the window.
- Keep all objects a safe distance from the window.

UNDERSTANDING YOUR INSTRUMENT PANEL

CONTENTS

■ INSTRUMENT PANEL FEATURES298	□ Electronic Vehicle Information Center (EVIC) Displays324
■ INSTRUMENT CLUSTER299	□ Oil Change Required325
■ INSTRUMENT CLUSTER DESCRIPTIONS300	□ EVIC Main Menu326
■ COMPASS AND TRIP COMPUTER — IF EQUIPPED315	□ Compass Display / ECO (Fuel Saver Mode) — If Equipped326
□ Control Buttons316	□ Average Fuel Economy329
□ Compass/Temperature Display317	□ Distance To Empty (DTE)330
□ Trip Conditions320	□ Elapsed Time330
■ ELECTRONIC VEHICLE INFORMATION CENTER (EVIC) — IF EQUIPPED321	□ EVIC Units Selection (UNITS IN Display)330

- System Status 331
- Personal Settings (Customer-Programmable Features) 331
- MEDIA CENTER 230 (REQ) — AM/FM STEREO RADIO AND 6-DISC CD/DVD CHANGER (MP3/WMA AUX JACK) 335
 - Operating Instructions - Radio Mode. 335
 - Operation Instructions - (DISC MODE for CD and MP3/WMA Audio Play, DVD-VIDEO) . . . 344
 - Notes On Playing MP3/WMA Files. 346
 - LIST Button (DISC Mode for MP3/WMA Play) . . 348
 - INFO Button (DISC Mode for MP3/WMA Play). . 349
 - Uconnect™ Multimedia (Satellite Radio) — If Equipped 377
- MEDIA CENTER 730N/430/430N (RHR/RER/RBZ/RHB) CD/DVD/HDD/NAV — IF EQUIPPED 355
 - Operating Instructions (Voice Command System) — If Equipped 355
 - Operating Instructions (Uconnect™ Phone) — If Equipped 355
- MEDIA CENTER 130 (SALES CODE RES) 356
 - Operating Instructions — Radio Mode. 356
 - Operation Instructions — CD MODE For CD And MP3 Audio Play 359
 - Notes on Playing MP3 Files 362
 - Operation Instructions - Auxiliary Mode 364
- MEDIA CENTER 130 WITH SATELLITE RADIO (SALES CODE RES+RSC) 365

- Operating Instructions — Radio Mode 365
- Operation Instructions — CD MODE for CD and MP3 Audio Play 371
- Notes On Playing MP3 Files 374
- LIST Button (CD Mode for MP3 Play) 376
- INFO Button (CD Mode for MP3 Play) 376
- Uconnect™ Multimedia (Satellite Radio) — If Equipped 377
- iPod®/USB/MP3 CONTROL — IF EQUIPPED . 382
 - Connecting The iPod® Or External USB Device 382
 - Using This Feature. 383
 - Controlling The iPod® Or External USB Device Using Radio Buttons 384
- Play Mode 384
- List Or Browse Mode 386
- Bluetooth Streaming Audio (BTSA) 388
- STEERING WHEEL AUDIO CONTROLS 389
 - Radio Operation 390
 - CD Player 390
- CD/DVD DISC MAINTENANCE 390
- RADIO OPERATION AND MOBILE PHONES . 391
- CLIMATE CONTROLS 391
 - Manual Heating And Air Conditioning 392
 - Automatic Temperature Control (ATC) — If Equipped 396
 - Operating Tips 401

INSTRUMENT PANEL FEATURES

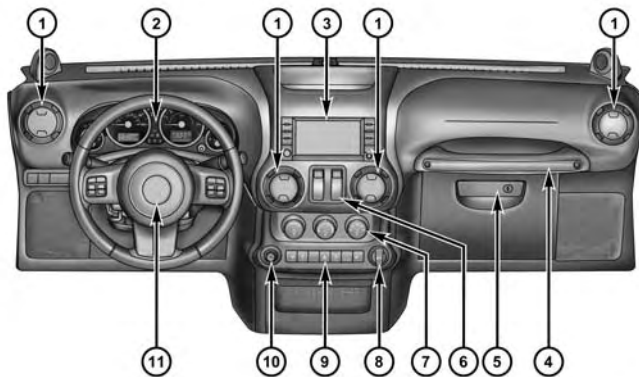

040133797

- 1 — Air Outlet
- 2 — Instrument Cluster
- 3 — Radio
- 4 — Assist Handle
- 5 — Glove Compartment
- 6 — Power Window Switches

- 7 — Climate Controls
- 8 — Power Outlet
- 9 — Lower Switch Bank
- 10 — Power Mirror Switch — If Equipped
- 11 — Horn

INSTRUMENT CLUSTER

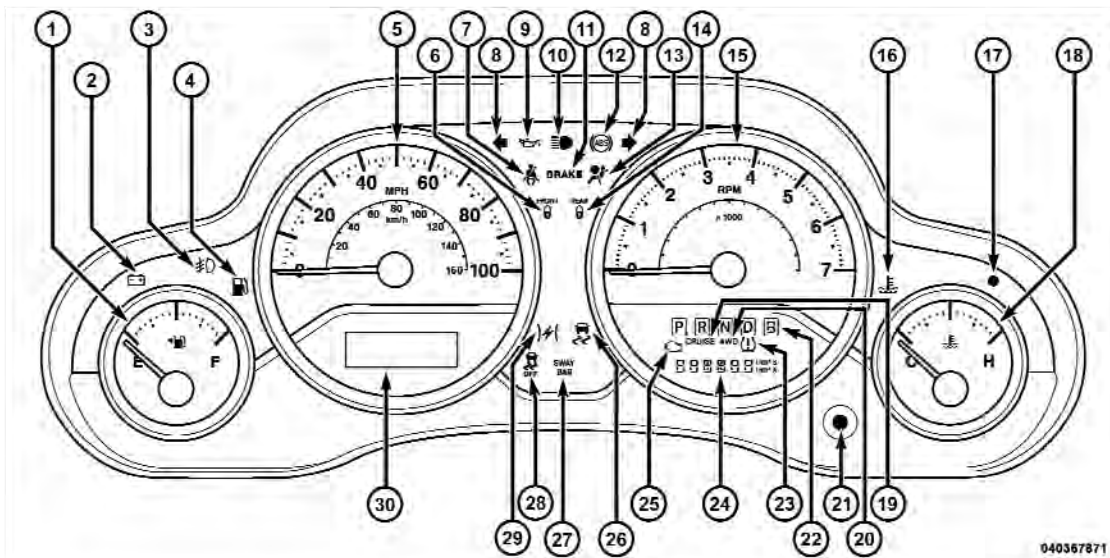

INSTRUMENT CLUSTER DESCRIPTIONS

1. Fuel Gauge

The pointer shows the level of fuel in the fuel tank when the ignition switch is in the ON/RUN position.

2. Charging System Light

 This light shows the status of the electrical charging system. The light should come on when the ignition switch is first turned to ON/RUN, and remain on briefly as a bulb check. If the light stays on or comes on while driving, turn off some of the vehicle's non-essential electrical devices or increase engine speed (if at idle). If the charging system light remains on, it means that the vehicle is experiencing a problem with the charging system. Obtain SERVICE IMMEDIATELY. See an authorized dealer.

If jump starting is required, refer to "Jump Starting Procedures" in "What To Do In Emergencies".

3. Front Fog Light Indicator — If Equipped

 This indicator will illuminate when the front fog lights are on.

4. Low Fuel Warning Light

 When the fuel level reaches approximately 2.8 gal (10.6L) this light will turn on and a single chime will sound.

5. Speedometer

Indicates vehicle speed.

6. Front Axle Lock Indicator — If Equipped

 Indicates when the front axle lock has been activated.

7. Seat Belt Reminder Light



When the ignition switch is first turned to ON/RUN, this light will turn on for four to eight seconds as a bulb check. During the bulb check, if the driver's seat belt is unbuckled, a chime will sound. After the bulb check or when driving, if the driver seat belt remains unbuckled, the Seat Belt Reminder Light will flash or remain on continuously. Refer to "Occupant Restraints" in "Things To Know Before Starting Your Vehicle" for further information.

8. Turn Signal Indicators



The left or right arrow will flash with the corresponding exterior turn signal lights when the turn signal lever is operated. A chime will sound if the vehicle is driven more than 1 mile (1.6 km) with either turn signal on.

NOTE: If either indicator flashes at a rapid rate, check for a defective outside light bulb.

9. Oil Pressure Warning Light



This light indicates low engine oil pressure. The light should turn on momentarily when the engine is started; if the bulb does not come on, have the system checked by an authorized dealer. If the light turns on while driving, stop the vehicle and shut off the engine as soon as possible. A chime will sound when this light turns on.

Do not operate the vehicle until the cause is corrected. This light does not indicate how much oil is in the engine. The engine oil level must be checked under the hood.

10. High Beam Indicator



This indicator shows that the high beam headlights are on. Push the multifunction control lever away from you to switch the headlights to high beam. Pull the lever toward you to switch the headlights back to low beam. If the driver's door is open, and the headlights or park lights are left on, the high beam indicator light will remain illuminated and a chime will sound.

11. Brake Warning Light

BRAKE

This light monitors various brake functions, including brake fluid level and parking brake application. If the brake light turns on it may indicate that the parking brake is applied, that the brake fluid level is low, or that there is a problem with the anti-lock brake system reservoir.

If the light remains on when the parking brake has been disengaged, and the fluid level is at the full mark on the master cylinder reservoir, it indicates a possible brake hydraulic system malfunction or that a problem with the Brake Booster has been detected by the Anti-Lock Brake System (ABS) / Electronic Stability Control (ESC) system. In this case, the light will remain on until the condition has been corrected. If the problem is related to the brake booster, the ABS pump will run when applying the brake and a brake pedal pulsation may be felt during each stop.

The dual brake system provides a reserve braking capacity in the event of a failure to a portion of the hydraulic system. A leak in either half of the dual brake system is indicated by the Brake Warning Light, which will turn on when the brake fluid level in the master cylinder has dropped below a specified level.

The light will remain on until the cause is corrected.

NOTE: The light may flash momentarily during sharp cornering maneuvers, which change fluid level conditions. The vehicle should have service performed, and the brake fluid level checked.

If brake failure is indicated, immediate repair is necessary.

WARNING!

Driving a vehicle with the red brake light on is dangerous. Part of the brake system may have failed.

(Continued)

WARNING! (Continued)

It will take longer to stop the vehicle. You could have a collision. Have the vehicle checked immediately.

Vehicles equipped with the Anti-Lock Brake System (ABS), are also equipped with Electronic Brake Force Distribution (EBD). In the event of an EBD failure, the Brake Warning Light will turn on along with the ABS Light. Immediate repair to the ABS system is required.

Operation of the Brake Warning Light can be checked by turning the ignition switch from the OFF position to the ON/RUN position. The light should illuminate for approximately two seconds. The light should then turn off unless the parking brake is applied or a brake fault is detected. If the light does not illuminate, have the light inspected by an authorized dealer.

The light also will turn on when the parking brake is applied with the ignition switch in the ON/RUN position.

NOTE: This light shows only that the parking brake is applied. It does not show the degree of brake application.

12. *Anti-Lock Brake (ABS) Light*

 After the ignition is turned on, the Anti-Lock Brake System (ABS) light illuminates to indicate function check at vehicle start-up. If the light remains on after start-up or comes on and stays on at road speeds, it may indicate that the ABS has detected a malfunction or has become inoperative. The system reverts to standard non-anti-lock brakes.

If both the Brake Warning Light and the ABS Warning Light are on, see an authorized dealer immediately. Refer to "Anti-Lock Brake System" in "Starting And Operating".

13. Air Bag Warning Light



This light will turn on for four to eight seconds as a bulb check when the ignition switch is first turned to ON/RUN. If the light is either not on during starting, stays on, or turns on while driving, have the system inspected at an authorized dealer as soon as possible. Refer to “Occupant Restraints” in “Things To Know Before Starting Your Vehicle” for further information.

14. Rear Axle Lock Indicator — If Equipped



This light indicates when the rear axle lock has been activated.

15. Tachometer

Indicates the engine speed in revolutions per minute (RPM x 1000).

CAUTION!

Do not operate the engine with the tachometer pointer in the red area. Engine damage will occur.

16. Coolant Temperature Warning Light



This light warns of an overheated engine condition. If the light turns on while driving, safely pull over and stop the vehicle. If the A/C system is on, turn it off. Also, shift the transmission into NEUTRAL and idle the vehicle. If the temperature reading does not return to normal, turn the engine off immediately and call for service.

NOTE: As the coolant temperature gauge approaches “H,” this indicator will illuminate and a single chime will sound. Further overheating will cause the temperature

gauge to pass "H." In this case, a continuous chime will sound, until the engine is allowed to cool or the 4 minutes duration is expired, whichever come first.

17. *Vehicle Security Light — If Equipped*

- This light will flash at a fast rate for approximately 15 seconds, when the vehicle security alarm is arming, and then will flash slowly until the vehicle is disarmed.

18. *Temperature Gauge*

The temperature gauge shows engine coolant temperature. Any reading within the normal range indicates that the engine cooling system is operating satisfactorily.

The gauge pointer will likely indicate a higher temperature when driving in hot weather, up mountain grades, or when towing a trailer. It should not be allowed to exceed the upper limits of the normal operating range.

CAUTION!

Driving with a hot engine cooling system could damage your vehicle. If the temperature gauge reads "H" pull over and stop the vehicle. Idle the vehicle with the air conditioner turned off until the pointer drops back into the normal range. If the pointer remains on the "H" and you hear continuous chimes, turn the engine off immediately and call an authorized dealer for service.

WARNING!

A hot engine cooling system is dangerous. You or others could be badly burned by steam or boiling coolant. You may want to call an authorized dealer for service if your vehicle overheats. If you decide to

(Continued)

WARNING! (Continued)

look under the hood yourself, see “Maintaining Your Vehicle”. Follow the warnings under the Cooling System Pressure Cap paragraph.

19. Cruise Indicator

CRUISE This indicator shows when the electronic speed control system is turned on.

20. 4WD Indicator Light — If Equipped

4WD This light alerts the driver that the vehicle is in the four-wheel drive mode, and the front and rear driveshafts are mechanically locked together forcing the front and rear wheels to rotate at the same speed.

21. Odometer/Trip Odometer/ECO (Fuel Saver Indicator) Button

Press this button to change the display from odometer to either of the two trip odometer settings or the “ECO” display. Trip A or Trip B will appear when in the trip odometer mode. Press and hold the button for two seconds to reset the trip odometer to 0 miles or kilometers. The odometer must be in trip mode to reset.

22. Shift Lever Indicator

The Shift Lever Indicator is self-contained within the instrument cluster. It displays the gear position of the automatic transmission.

23. Tire Pressure Monitoring Telltale Light

Each tire, including the spare (if provided), should be checked monthly when cold and inflated to the inflation pressure recommended by

the vehicle manufacturer on the vehicle placard or tire inflation pressure label. (If your vehicle has tires of a different size than the size indicated on the vehicle placard or tire inflation pressure label, you should determine the proper tire inflation pressure for those tires.)

As an added safety feature, your vehicle has been equipped with a Tire Pressure Monitoring System (TPMS) that illuminates a low tire pressure telltale when one or more of your tires is significantly under-inflated. Accordingly, when the low tire pressure telltale illuminates, you should stop and check your tires as soon as possible, and inflate them to the proper pressure. Driving on a significantly under-inflated tire causes the tire to overheat and can lead to tire failure. Under-inflation also reduces fuel efficiency and tire tread life, and may affect the vehicle's handling and stopping ability.

Please note that the TPMS is not a substitute for proper tire maintenance, and it is the driver's responsibility to maintain correct tire pressure, even if under-inflation has not reached the level to trigger illumination of the TPMS low tire pressure telltale.

Your vehicle has also been equipped with a TPMS malfunction indicator to indicate when the system is not operating properly. The TPMS malfunction indicator is combined with the low tire pressure telltale. When the system detects a malfunction, the telltale will flash for approximately one minute and then remain continuously illuminated. This sequence will continue upon subsequent vehicle start-ups as long as the malfunction exists. When the malfunction indicator is illuminated, the system may not be able to detect or signal low tire pressure as intended. TPMS malfunctions may occur for a variety of reasons, including the installation of replacement or alternate tires or wheels on the vehicle that prevent the

TPMS from functioning properly. Always check the TPMS malfunction telltale after replacing one or more tires or wheels on your vehicle, to ensure that the replacement or alternate tires and wheels allow the TPMS to continue to function properly.

CAUTION!

The TPMS has been optimized for the original equipment tires and wheels. TPMS pressures and warning have been established for the tire size equipped on your vehicle. Undesirable system operation or sensor damage may result when using replacement equipment that is not of the same size, type, and/or style. Aftermarket wheels can cause sensor damage. Do not use tire sealant from a can or balance beads if your vehicle is equipped with a TPMS, as damage to the sensors may result.

24. Odometer / Trip Odometer Display Area

The odometer display shows the total distance the vehicle has been driven. The trip odometer shows individual trip mileage. Refer to “Odometer/Trip Odometer/ECO (Fuel Saver Indicator) Button” for additional information.

U.S. Federal regulations require that upon transfer of vehicle ownership, the seller certify to the purchaser the correct mileage that the vehicle has been driven. If your odometer needs to be repaired or serviced, the repair technician should leave the odometer reading the same as it was before the repair or service. If s/he cannot do so, then the odometer must be set at zero, and a sticker must be placed in the door jamb stating what the mileage was before the repair or service. It is a good idea for you to make a record of the odometer reading before the repair/service, so that you can be sure that it is properly reset, or that the door jamb sticker is accurate if the odometer must be reset at zero.

Vehicle Odometer Messages

When the appropriate conditions exist, the following odometer messages will display:

ECO	Fuel Saver Indicator
door	Door Ajar
gATE	Swing Gate Ajar
LoW tirE	Low Tire Pressure
HOTOIL	Transmission Oil Temperature Above Normal Limits
gASCAP	Fuel Cap Fault
noFUSE	Fuse Fault
CHAngE OIL	Oil Change Required

ECO (Fuel Saver Indicator) — If Equipped

The ECO indicator will illuminate when you are driving in a fuel efficient manner and can be used to modify driving habits in order to increase fuel economy.

LoW tirE

When the appropriate condition exists, the odometer display will toggle between LoW and tirE for three cycles.

“HOTOIL” Transmission Temperature Warning Message

The “HOTOIL” cluster message will appear in the odometer accompanied with a chime to indicate that there is excessive transmission fluid temperature that might occur with severe usage such as trailer towing. It may also occur when operating the vehicle in a high torque converter slip condition, such as 4-wheel drive operation

(e.g., snow plowing, off-road operation). If this “HOTOIL” message turns on, stop the vehicle and run the engine at idle or faster with the transmission in NEUTRAL until the message turns off.

CAUTION!

Continuous driving with the Transmission Temperature “HOTOIL” Warning message illuminated will eventually cause severe transmission damage or transmission failure.

WARNING!

If the Transmission Temperature “HOTOIL” Warning message is illuminated and you continue operating the vehicle, in some circumstances you could cause the fluid to boil over, come in contact with hot engine or exhaust components and cause a fire.

gASCAP

If the vehicle diagnostic system determines that the fuel filler cap is loose, improperly installed, or damaged, a “gASCAP” message will display in the odometer display area. Tighten the fuel filler cap properly and press the TRIP ODOMETER button to turn off the message. If the problem continues, the message will appear the next time the vehicle is started.

noFUSE

If the vehicle diagnostic system determines that the Ignition Off Draw (IOD) fuse is improperly installed, or damaged, a “noFUSE” message will display in the odometer display area. For further information on fuses and fuse locations refer to “Fuses” in “Maintaining Your Vehicle”.

CHAngE OIL Message

Your vehicle is equipped with an engine oil change indicator system. The “CHAngE OIL” message will flash in the instrument cluster odometer for approximately 12 seconds after a single chime has sounded to indicate the next scheduled oil change interval. The engine oil change indicator system is duty-cycle based, which means the engine oil change interval may fluctuate dependent upon your personal driving style.

Unless reset, this message will continue to display each time you turn the ignition switch to the ON/RUN position. To turn off the message temporarily, press and release the Trip Odometer button on the instrument cluster. To reset the oil change indicator system (after performing the scheduled maintenance), refer to the following procedure:

Turn the ignition switch to the ON/RUN position (do not start the engine).

Fully depress the accelerator pedal slowly three times within 10 seconds.

Turn the ignition switch to the OFF/LOCK position.

NOTE: If the indicator message illuminates when you start the vehicle, the oil change indicator system did not reset. If necessary, repeat this procedure.

25. *Malfunction Indicator Light (MIL)*



The Malfunction Indicator Light (MIL) is a part of an Onboard Diagnostic System called OBD II that monitors engine and automatic transmission control systems. The light will illuminate when the ignition is in the ON position before engine start. If the bulb does not come on when turning the key from OFF to ON/RUN, have the condition checked promptly.

Certain conditions, such as a loose or missing gas cap, poor quality fuel, etc., may illuminate the light after engine start. The vehicle should be serviced if the light stays on through several typical driving styles. In most situations, the vehicle will drive normally and will not require towing.

When the engine is running, the MIL may flash to alert serious conditions that could lead to immediate loss of power or severe catalytic converter damage. The vehicle should be serviced as soon as possible if this occurs.

CAUTION!

Prolonged driving with the MIL on could cause damage to the engine control system. It also could affect fuel economy and drivability. If the MIL is flashing, severe catalytic converter damage and power loss will soon occur. Immediate service is required.

WARNING!

A malfunctioning catalytic converter, as referenced above, can reach higher temperatures than in normal operating conditions. This can cause a fire if you drive slowly or park over flammable substances such as dry plants, wood, cardboard, etc. This could result in death or serious injury to the driver, occupants or others.

26. Electronic Stability Control (ESC) Activation/ Malfunction Indicator Light — If Equipped



The “ESC Activation/Malfunction Indicator Light” in the instrument cluster will come on when the ignition switch is turned to the ON/RUN position. It should go out with the

engine running. If the “ESC Activation/Malfunction Indicator Light” comes on continuously with the engine running, a malfunction has been detected in the ESC system. If this light remains on after several ignition cycles, and the vehicle has been driven several miles (kilometers) at speeds greater than 30 mph (48 km/h), see your authorized dealer as soon as possible to have the problem diagnosed and corrected.

NOTE:

The “ESC Off Indicator Light” and the “ESC Activation/Malfunction Indicator Light” come on momentarily each time the ignition switch is turned to ON/RUN.

Each time the ignition is turned to ON/RUN, the ESC system will be ON, even if it was turned off previously.

The ESC system will make buzzing or clicking sounds when it is active. This is normal; the sounds will stop when ESC becomes inactive following the maneuver that caused the ESC activation.

WARNING!

The Electronic Stability Control (ESC) cannot prevent the natural laws of physics from acting on the vehicle, nor can it increase the traction afforded by prevailing road conditions. ESC cannot prevent accidents, including those resulting from excessive speed in turns, driving on very slippery surfaces, or hydroplaning. The capabilities of an ESC-equipped vehicle must never be exploited in a reckless or dangerous manner which could jeopardize the user’s safety or the safety of others.

27. Sway Bar Indicator Light — If Equipped



This indicator will illuminate when the front sway bar is disconnected.

28. Electronic Stability Control (ESC) OFF Indicator Light — If Equipped



This light indicates the Electronic Stability Control (ESC) is off.

29. Electronic Throttle Control (ETC) Light



This light informs you of a problem with the Electronic Throttle Control (ETC) system. If a problem is detected while the engine is running, the light will either stay on or flash depending on

the nature of the problem. Cycle the ignition key when the vehicle is safely and completely stopped and the shift lever is placed in the PARK position. The light should turn off. If the light remains on with the engine running, your vehicle will usually be drivable; however, see an authorized dealer for service as soon as possible.

If the light continues to flash when the engine is running, immediate service is required and you may experience reduced performance, an elevated/rough idle, or engine stall and your vehicle may require towing. The light will come on when the ignition is first turned to ON/RUN and remain on briefly as a bulb check. If the light does not come on during starting, have the system checked by an authorized dealer.

30. *Electronic Vehicle Information Center (EVIC) Display/ Compass Mini-Trip Computer Display — If Equipped*

When the appropriate conditions exist, this display shows the Electronic Vehicle Information Center (EVIC) messages. For further information, refer to “Electronic Vehicle Information Center”.

When the appropriate conditions exist, this display shows the Mini-Trip Computer messages. Refer to “Mini-Trip Computer” for further information.

COMPASS AND TRIP COMPUTER — IF EQUIPPED

The Compass/Trip Computer features a driver-interactive display (displays information on outside temperature, compass direction, and trip information). It is located on the lower left part of the cluster below the speedometer.

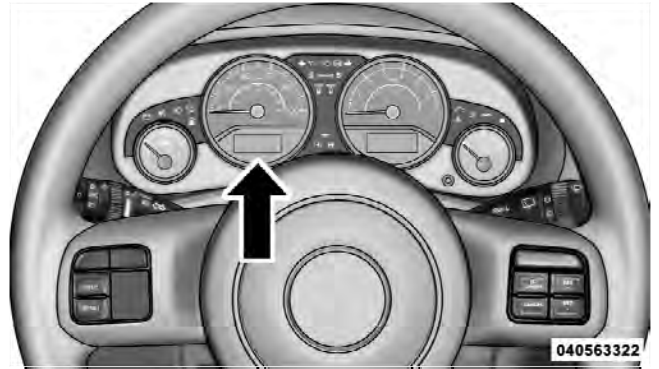

Compass Display

Control Buttons

The Compass/Temperature control buttons are located on the left spoke of the steering wheel.



040541179

Mini-Trip Control Buttons

Press and release the STEP button on the steering wheel to access the options in the Compass display.

NOTE: The system will display the last known outside temperature when starting the vehicle and may need to be driven several minutes before the updated temperature is displayed. Engine temperature can also affect the displayed temperature; therefore, temperature readings are not updated when the vehicle is not moving.

The following displays can be reset or changed:

- Compass/Temperature
- AVG ECO (changes to present fuel economy)
- ET (will reset display)
- DTE (distance to empty)

These messages can be cycled through by pressing the STEP button on the steering wheel. To reset the AVG ECO or ET, press and hold the STEP button for approximately three seconds.

Compass/Temperature Display

NOTE: If the vehicle is equipped with a Chrysler Uconnect™ gps (Navigation Radio), the NAV system will provide the compass direction, and the variance and calibration menus will be unavailable. The compass will perform accurately, based on GPS signals instead of the Earth's magnetic field.

Compass Variance

Compass Variance is the difference between Magnetic North and Geographic North. To compensate for the differences, the variance should be set for the zone where the vehicle is driven, per the zone map. Once properly set, the compass will automatically compensate for the differences and provide the most accurate compass heading.

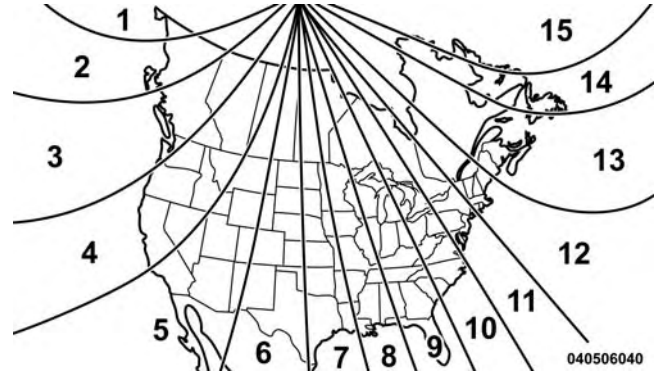

Compass Variance Map

To Set The Variance

Start the engine and leave the transmission gear selector lever in the PARK position. Press and hold the RESET button on the steering wheel (for approximately ten seconds) until the current variance zone number is displayed.

To change the zone, press and release the STEP button to increase the variance one step. Repeat as necessary until the desired variance is achieved.

NOTE: The factory default zone is 8. During programming, the zone value will wrap around from zone 15 to zone 1.

Manual Compass Calibration

If the compass appears erratic, inaccurate or abnormal, you may wish to calibrate the compass. Prior to calibrating the compass, make sure the proper zone is selected.

1. Start the engine and leave the transmission in the PARK position.
2. Press and hold the RESET button (for approximately 10 seconds) until the current variance zone number is displayed.
3. Release the RESET button, then press and hold again for approximately 10 seconds, until the direction is displayed, with the CAL indicator on continuously in the display.
4. To complete the compass calibration, drive the vehicle in one or more complete 360-degree circles, under 5 mph (8 km/h) in an area free from power lines and large metallic objects, until the CAL indicator turns off. The compass will now function normally.

NOTE:

- A good calibration requires a level surface and an environment free from large metallic objects such as buildings, bridges, underground cables, railroad tracks, etc.
- Magnetic materials should be kept away from the top of the center of the instrument panel. This is where the compass sensor is located.

**Average Fuel Economy/Distance To Empty (DTE)/
Elapsed Time**

- *Average Fuel Economy*

Shows the average fuel economy since the last reset. When the fuel economy is reset, the digits will go blank while the history information is erased. The averaging will restart when enough new distance and fuel data is accumulated.

- *Distance To Empty (DTE)*

Shows the estimated distance that can be traveled with the fuel remaining in the tank. This estimated distance is determined by a weighted average of the instantaneous and average fuel economy, according to the current fuel tank level. DTE cannot be reset.

- *Elapsed Time*

Shows the total elapsed time of travel since the last reset. Elapsed time will increment when the ignition switch is in the RUN or START positions. The elapsed timer displays minutes:seconds. After 59minutes:59seconds, it displays hours:minutes:seconds.

Trip Conditions

Trip Odometer (ODO) / ECO (Fuel Saver Indicator) — If Equipped

This display shows the distance traveled since the last reset. Press and release the right button (on the instrument cluster) to switch from odometer to Trip A or Trip B or to ECO. Press and hold the right button while the odometer/trip odometer is displayed to reset.

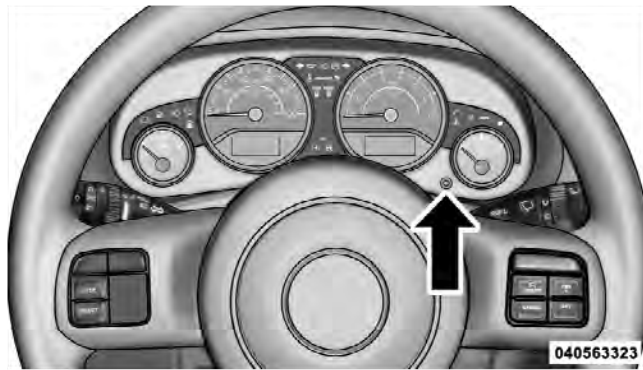

Trip Display Button

Trip A

Shows the total distance traveled for trip A since the last reset.

Trip B

Shows the total distance traveled for trip B since the last reset.

ECO (Fuel Saver Indicator) — If Equipped

The ECO indicator will illuminate when you are driving in a fuel efficient manner and can be used to modify driving habits in order to increase fuel economy.

ELECTRONIC VEHICLE INFORMATION CENTER (EVIC) — IF EQUIPPED

The Electronic Vehicle Information Center (EVIC) features a driver-interactive display that is located in the instrument cluster.

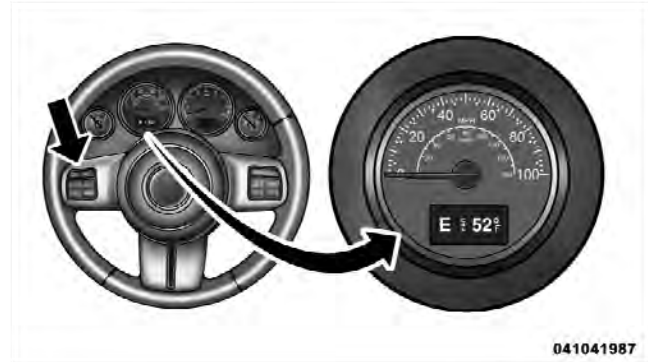

Electronic Vehicle Information Center (EVIC)

322 UNDERSTANDING YOUR INSTRUMENT PANEL

This system conveniently allows the driver to select a variety of useful information by pressing the switches mounted on the steering wheel. The EVIC consists of the following:

- Compass Heading (N, S, E, W, NE, NW, SE, SW)
- Outside Temperature (°F or °C)
- ECO Display
- Fuel Economy
- Miles/kilometers To Empty
- Timer
- Display Units Selection
- System Warnings (Door Ajar, etc.)
- Personal Settings (Customer-Programmable Features)

The system allows the driver to select information by pressing the following buttons mounted on the steering wheel:



041035449

EVIC Steering Wheel Buttons

MENU Button

Press and release the MENU button to advance the display to each of the EVIC Main Menu features or to return to the Main Menu from a sub-menu. Upon reaching the last item in the Main Menu the EVIC will advance to the first item in the Main Menu with the next MENU button press and release.

COMPASS Button

Press and release the COMPASS button to return to the Compass/Outside Temperature/Audio Information/ECO screen whenever the current display is not the Compass/Outside Temperature/Audio Information/ECO screen.

SELECT Button

Press and release the SELECT button when prompted by the EVIC to Reset Main Menu features with a reset capability or to change Personal Settings.

DOWN Button

Press and release the DOWN button when prompted by the EVIC to step through stored system warning messages or Personal Settings features.

Electronic Vehicle Information Center (EVIC) Displays

When the appropriate conditions exist, the EVIC displays the following messages:

- Low Tire Pressure
- Service TPM System (refer to "Tire Pressure Monitoring System" in "Starting and Operating")
- Premium TPM System Graphic Display
- Damaged Key
- Key in Ignition
- Turn Signal On (with a continuous warning chime)
- Left Front Turn Signal Lamp Out (with a single chime)
- Left Rear Turn Signal Lamp Out (with a single chime)
- Right Front Turn Signal Lamp Out (with a single chime)
- Right Rear Turn Signal Lamp Out (with a single chime)
- Key Fob Battery Low (with a single chime)
- Personal Settings Not Avail. – Vehicle Not in Park — automatic transmission
- Personal Settings Not Avail. – Vehicle in Motion — manual transmission
- Door Ajar (with vehicle graphic showing which door is open. A single chime sounds if the vehicle is in motion).
- Gate Ajar (with vehicle graphic showing the Liftgate/back door open and A single chime)

- Check Gascap (refer to “Adding Fuel” in “Starting And Operating” for more details)
- Oil Change Required (with a single chime)
- ECO (Fuel Saver Indicator) — if equipped

Oil Change Required

Your vehicle is equipped with an engine oil change indicator system. The “Oil Change Required” message will flash in the EVIC display for approximately 10 seconds after a single chime has sounded to indicate the next scheduled oil change interval. The engine oil change indicator system is duty cycle based, which means the engine oil change interval may fluctuate dependent upon your personal driving style.

Unless reset, this message will continue to display each time you turn the ignition switch to the ON position. To turn off the message temporarily, press and release the MENU button. To reset the oil change indicator system (after performing the scheduled maintenance), perform the following procedure:

1. Turn the ignition switch to the ON position. **Do not start the engine.**
2. Fully depress the accelerator pedal slowly three times within 10 seconds.
3. Turn the ignition switch to the LOCK position.

NOTE: If the indicator message illuminates when you start the vehicle, the oil change indicator system did not reset. If necessary, repeat this procedure.

EVIC Main Menu

To step to each main menu feature press and release the MENU button once for each step. A step from the last item in the list will cause the first item in the feature list to be displayed. The following features are in the Main menu:

- Compass, Outside Temperature, and ECO display
- Average Fuel Economy
- Distance to Empty
- Elapsed Time
- EVIC Units Selection
- System Status
- Personal Settings
- Tire PSI

NOTE: For features in the EVIC that can be reset (Average Fuel Economy and Elapsed Time), the EVIC prompts a reset with a SELECT button graphic and the word RESET next to it.

When the SELECT button is pressed, the selected feature will reset and RESET ALL will display next to the SELECT button graphic. Pressing SELECT a second time will reset both Average Fuel Economy and Elapsed Time. After three seconds without pressing SELECT, RESET ALL will return to RESET and only the selected feature will have been reset.

Compass Display / ECO (Fuel Saver Mode) — If Equipped

The compass readings indicate the direction the vehicle is facing. Press and release the COMPASS button to display one of eight compass headings, the outside temperature/ECO if the EVIC display is not already displaying this screen.

NOTE: The system will display the last known outside temperature when starting the vehicle and may need to be driven several minutes before the updated temperature is displayed. Engine temperature can also affect the displayed temperature; therefore, temperature readings are not updated when the vehicle is not moving.

ECO (Fuel Saver Mode) — If Equipped

The ECO message will display below the outside temperature in the EVIC display (if the audio system is on the ECO indicator will override the audio information display line if the "Display Fuel Saver" personal setting is ON — see "Personal Settings" section). This message will appear whenever you are driving in a fuel efficient manner.

This feature allows you to monitor when you are driving in a fuel efficient manner, and it can be used to modify driving habits in order to increase fuel economy.

Automatic Compass Calibration

This compass is self-calibrating, which eliminates the need to set the compass manually. When the vehicle is new, the compass may appear erratic and the EVIC will display "CAL" until the compass is calibrated. You may also calibrate the compass by completing one or more 360-degree turns (in an area free from large metal or metallic objects) until the "CAL" message displayed in the EVIC turns off. The compass will now function normally.

NOTE: A good calibration requires a level surface and an environment free from large metallic objects such as buildings, bridges, underground cables, railroad tracks, etc.

Manual Compass Calibration

If the compass appears erratic and the “CAL” indicator does not appear in the EVIC display, you must put the compass into the Calibration Mode manually as follows:

1. Start the engine. Leave the shift lever in PARK in order to enter the EVIC Programming Menus.
2. Press the MENU button until Personal Settings (Customer-Programmable Features) displays in the EVIC.
3. Press the DOWN button until “Calibrate Compass” displays in the EVIC.
4. Press and release the SELECT button to start the calibration. The “CAL” indicator will display in the EVIC.

5. Complete one or more 360-degree turns (in an area free from large metal or metallic objects) until the “CAL” indicator turns off. The compass will now function normally.

Compass Variance

Compass Variance is the difference between Magnetic North and Geographic North. To compensate for the differences, the variance should be set for the zone where the vehicle is driven, per the zone map. Once properly set, the compass will automatically compensate for the differences and provide the most accurate compass heading.

NOTE: Magnetic materials should be kept away from the top of the instrument panel; this is where the compass sensor is located.

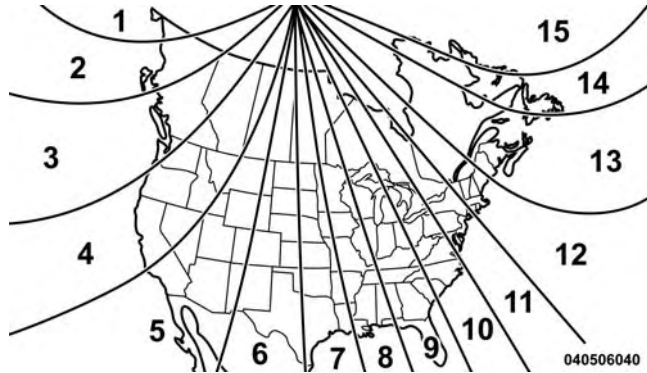

Compass Variance Map

To Change The Compass Variance:

1. Turn the ignition switch RUN (it is not necessary to start the engine).
2. Press the MENU button until Personal Settings (Customer-Programmable Features) displays in the EVIC.

3. Press the DOWN button until "Compass Variance" message and the last variance zone number displays in the EVIC.
4. Press and release the SELECT button until the proper variance zone is selected according to the map.
5. Press and release the COMPASS button to exit.

Average Fuel Economy

Shows the average fuel economy since the last reset. Average Fuel Economy can be reset by pressing and holding the SELECT button (as prompted in the EVIC display). Upon reset, the history information will be erased, and the averaging will continue from the last fuel average reading before the reset.

Distance To Empty (DTE)

Shows the estimated distance that can be traveled with the fuel remaining in the tank. This estimated distance is determined by a weighted average of the instantaneous and average fuel economy, according to the current fuel tank level. DTE cannot be reset.

NOTE: Significant changes in driving style or vehicle loading will greatly affect the actual drivable distance of the vehicle, regardless of the DTE display value.

When the DTE value is less than 30 miles (48 km) estimated driving distance, the DTE display will change to a text display of "LOW FUEL". This display will continue until the vehicle runs out of fuel. Adding a significant amount of fuel to the vehicle will turn off the LOW FUEL text and a new DTE value will display.

Elapsed Time

Shows the total elapsed time of travel since the last reset. Elapsed time will increment when the ignition switch is in the RUN or START position.

Elapsed time is displayed as follows:

hours:minutes:seconds

Elapsed time can be reset by pressing and holding the SELECT button (as prompted in the EVIC display). Upon reset all digits will change to zeros and time will start incrementing again if the ignition switch is in RUN or START.

EVIC Units Selection (UNITS IN Display)

Displays the units used for the Outside Temperature, Average Fuel Economy and Distance to Empty features. Press and Release the SELECT button to toggle units between "U.S." and "METRIC".

System Status

Displays SYSTEM OK if there are no active Warning Messages stored. Pressing and releasing the DOWN button when SYSTEM OK is displayed will do nothing. Displays SYSTEM WARNINGS PRESENT if there are active Warning Messages stored. Pressing and releasing the DOWN button when SYSTEM WARNINGS PRESENT is displayed will display each stored warning for each button press. Press and Release the MENU button to return to the Main Menu.

Personal Settings (Customer-Programmable Features)

Personal Settings allows the driver to set and recall features when the vehicle speed is at 0 mph (0 km/h) (manual transmission) or when the shift lever is in PARK (auto transmission).

Press and release the MENU button until Personal Settings displays in the EVIC.

Use the DOWN button to display one of the following choices:

Language

When in this display you may select one of five languages for all display nomenclature, including the trip functions and the navigation system (if equipped). Press the SELECT button while in this display to select English, Espanol or Francais. Then, as you continue, the information will display in the selected language.

Auto Lock Doors

When this feature is selected, all doors will lock automatically when the vehicle reaches a speed of 15 mph (24 km/h). The auto door lock feature can be enabled or disabled, to make your selection, press and release the SELECT button until a check-mark appears next to the feature showing the system has been activated or the check-mark is removed showing the system has been deactivated.

Auto Unlk On Exit

When ON is selected, all doors will unlock when the vehicle is stopped and the transmission is in the PARK or NEUTRAL position and the driver's door is opened. To make your selection, press and release the SELECT button until "On" or "Off" appears.

RKE Unlock

When **Driver Door 1st Press** is selected, only the driver's door will unlock on the first press of the Remote Keyless Entry (RKE) transmitter UNLOCK button. When Driver Door 1st Press is selected, you must press the RKE transmitter UNLOCK button twice to unlock the passenger's doors. When **All Doors 1st Press** is selected, all of the doors will unlock on the first press of the RKE transmitter UNLOCK button. To make your selection, press and release the SELECT button until "Driver Door 1st Press" or "All Doors 1st Press" appears.

Sound Horn With Lock

When on is selected, a short horn sound will occur when the RKE transmitter LOCK button is pressed. This feature may be selected with or without the Flash Lamp with Lock feature. To make your selection, press and release the SELECT button until "On" or "Off" appears.

Flash Lamp with Lock

When on is selected, the front and rear turn signals will flash when the doors are locked or unlocked with the RKE transmitter. This feature may be selected with or without the Sound Horn with Lock feature selected. To make your selection, press and release the SELECT button until "On" or "Off" appears.

Headlamp Off Delay

When this feature is selected, the driver can choose to have the headlights remain on for 0, 30, 60, or 90 seconds

when exiting the vehicle. To make your selection, press and release the SELECT button until “0,” “30,” “60,” or “90” appears.

Headlamps with Wipers (Available with Auto Headlights Only)

When on is selected, and the headlight switch is in the AUTO position, the headlights will turn on approximately 10 seconds after the wipers are turned on. If the headlights were turned on by this feature they will also turn off when the wipers are turned off. To make your selection, press and release the SELECT button until “ON” or “OFF” appears.

NOTE: Turning the headlights on during the daytime causes the instrument panel lights to dim. To increase the brightness, refer to “Lights” in “Understanding The Features Of Your Vehicle”.

Key Off Power Delay

When this feature is selected, the power window switches, radio, hands-free system (if equipped), DVD video system (if equipped), power sunroof (if equipped), and power outlets will remain active for up to 10 minutes after the ignition switch is turned to the LOCK position. Opening either front vehicle door will cancel this feature. To make your selection, press and release the SELECT button until “Off,” “45 sec.,” “5 min.,” or “10 min.” appears.

Illumin. Approach

When this feature is selected, the headlights will activate and remain on for up to 90 seconds when the doors are unlocked with the RKE transmitter. To make your selection, press and hold the SELECT button until “Off,” “30 sec,” “60 sec,” or “90 sec” appears.

Hill Start Assist (HSA) — If Equipped

When on is selected, the HSA system is active. Refer to “Electronic Brake Control System” in “Starting And Operating” for system function and operating information. To make your selection, press and release the SELECT button until “On” or “Off” appears.

Display Units In

The EVIC can be changed between English and Metric units of measure. The units apply to the Outside Temperature, Average Fuel Economy, and Distance to Empty. To make your selection, press and release the SELECT button until “U.S.” or “METRIC” appears.

Nav-Turn By Turn — If Equipped

When on enables display of Navigation System street name, turn direction, and distance to turn information in the EVIC. To make your selection, press and release the SELECT button until “On” or “Off” appears.

Display Fuel Saver — If Equipped

The “ECO” message is located in the compass / outside temperature / audio information / ECO display. If Display Fuel Saver is selected as ON, only the ECO message will display in the audio information / ECO line of the display. If Display Fuel Saver is selected as OFF, only the audio information will display in the audio information / ECO line of the display when the audio system is on. To make your selection, press and release the SELECT button until “ON” or “OFF” appears.

Compass Variance

Refer to “Compass Display” for more information.

Calibrate Compass

Refer to “Compass Display” for more information.

MEDIA CENTER 230 (REQ) — AM/FM STEREO RADIO AND 6-DISC CD/DVD CHANGER (MP3/WMA AUX JACK)

NOTE: The radio sales code is located on the lower right side of the radio faceplate.

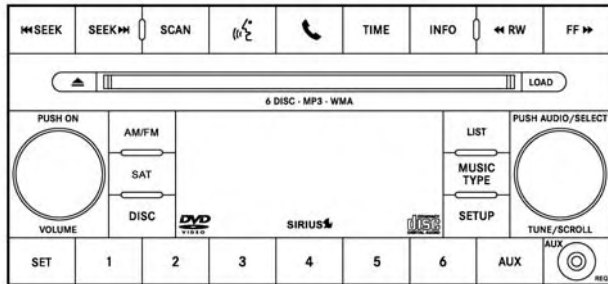

042040029

Media Center 230 (REQ)

Operating Instructions - Radio Mode

NOTE: The ignition switch must be in the ON or ACC position to operate the radio.

Power Switch/Volume Control (Rotary)

Push the ON/VOLUME control knob to turn on the radio. Press the ON/VOLUME control knob a second time to turn off the radio.

Electronic Volume Control

The electronic volume control turns continuously (360 degrees) in either direction without stopping. Turning the ON/VOLUME control knob to the right increases the volume and to the left decreases it.

When the audio system is turned ON, the sound will be set at the same volume level as last played.

SEEK Buttons

Press and release the SEEK buttons to search for the next listenable station in AM/FM mode. Press the right switch to seek up and the left switch to seek down. The radio will remain tuned to the new station until you make another selection. Holding either button will bypass stations without stopping, until you release it.

SCAN Button

Pressing the SCAN button causes the tuner to search for the next listenable station in AM, FM or Satellite (if equipped) frequencies, pausing for five seconds at each listenable station before continuing to the next. To stop the search, press the SCAN button a second time.

Voice Command Button Uconnect™ Phone — If Equipped

Press this button to operate the Uconnect™ Phone feature (if equipped). Refer to “Voice Command” for further details.

If your vehicle is not equipped with or this feature is not available on your vehicle, a “Not Equipped With Uconnect Phone” message will display on the radio screen.

Phone Button Uconnect™ Phone — If Equipped

Press this button to operate the Uconnect™ Phone feature (if equipped). Refer to “Uconnect™ Phone” for further details.

If your vehicle is not equipped with or this feature is not available on your vehicle, a “Not Equipped With Uconnect Phone” message will display on the radio screen.

TIME Button

Press the TIME button to alternate locations of the time and frequency display.

Clock Setting Procedure

1. Press and hold the TIME button until the hours blink.
2. Adjust the hours by turning the right side TUNE/SCROLL control knob.
3. After adjusting the hours, press the right side TUNE/SCROLL control knob to set the minutes. The minutes will begin to blink.
4. Adjust the minutes using the right side TUNE/SCROLL control knob. Press the TUNE/SCROLL control knob to save the time change.
5. To exit, press any button/knob or wait five seconds.

The clock can also be set by pressing the SETUP button and selecting the "SET HOME CLOCK" entry. Once in this display follow the above procedure, starting at step 2.

INFO Button

Press the INFO button for an RDS station (one with call letters displayed). The radio will return a Radio Text message broadcast from an FM station (FM mode only).

RW/FF

Pressing the RW (Rewind) or FF (Fast Forward) buttons causes the tuner to search for the next frequency in the direction of the arrows. This feature operates in AM, FM or Satellite (if equipped) frequencies.

TUNE Control

Turn the rotary TUNE/SCROLL control knob clockwise to increase or counterclockwise to decrease the frequency.

Setting the Tone, Balance, and Fade

Push the rotary TUNE/SCROLL control knob and BASS will display. Turn the TUNE/SCROLL control knob to the right or left to increase or decrease the bass tones.

Push the rotary TUNE/SCROLL control knob a second time and MID will display. Turn the TUNE/SCROLL control knob to the right or left to increase or decrease the mid-range tones.

Push the rotary TUNE/SCROLL control knob a third time and TREBLE will display. Turn the TUNE/SCROLL control knob to the right or left to increase or decrease the treble tones.

Push the rotary TUNE/SCROLL control knob a fourth time and BALANCE will display. Turn the TUNE/SCROLL control knob to the right or left to adjust the sound level from the right or left side speakers.

Push the rotary TUNE/SCROLL control knob a fifth time and FADE will display. Turn the TUNE/SCROLL control knob to the left or right to adjust the sound level between the front and rear speakers.

Push the rotary TUNE/SCROLL control knob again to exit setting tone, balance, and fade.

MUSIC TYPE Button

Pressing this button once will turn on the Music Type mode for five seconds. Pressing the MUSIC TYPE button or turning the TUNE/SCROLL control knob within five seconds will allow the program format type to be selected. Many radio stations do not currently broadcast Music Type information.

Toggle the MUSIC TYPE button to select the following format types:

Program Type	16-Digit Character Display
No program type or undefined	None
Adult Hits	Adlt Hit
Classical	Classicl
Classic Rock	Cls Rock
College	College
Country	Country
Foreign Language	Language
Information	Inform
Jazz	Jazz
News	News
Nostalgia	Nostalgia

Program Type	16-Digit Character Display
Oldies	Oldies
Personality	Persnlty
Public	Public
Rhythm and Blues	R & B
Religious Music	Rel Musc
Religious Talk	Rel Talk
Rock	Rock
Soft	Soft
Soft Rock	Soft Rck
Soft Rhythm and Blues	Soft R & B
Sports	Sports
Talk	Talk
Top 40	Top 40
Weather	Weather

By pressing the SEEK button when the Music Type icon is displayed, the radio will be tuned to the next frequency station with the same selected Music Type name. The Music Type function only operates when in the FM mode.

If a preset button is activated while in the Music Type (Program Type) mode, the Music Type mode will be exited and the radio will tune to the preset station.

SETUP Button

Pressing the SETUP button allows you to select between the following items:

NOTE: Turn the TUNE/SCROLL control knob to scroll through the entries. Push the AUDIO/SELECT button to select an entry and make changes.

- **DVD Enter** - When the disc is in DVD Menu mode, selecting DVD Enter will allow you to play the current highlighted selection. Use the remote control to scroll up and down the menu (if equipped).

- **DISC Play/Pause** -



You can toggle between playing the DVD and pausing the DVD by pushing the SELECT button (if equipped).

- **DVD Play Options** - Selecting the DVD Play Options will display the following:
 - **Subtitle** – Repeatedly pressing SELECT will switch subtitles to different subtitle languages that are available on the disc (if equipped).
 - **Audio Stream** – Repeatedly pressing SELECT will switch to different audio languages (if supported on the disc) (if equipped).
 - **Angle** – Repeatedly pressing SELECT will change the viewing angle if supported by the DVD disc (if equipped).

NOTE:

- The available selections for each of the above entries varies depending upon the disc.
- These selections can only be made while playing a DVD.
- **VES™ Power** - Allows you to turn VES™ ON and OFF (if equipped).
- **VES™ Lock** - Locks out rear VES™ remote controls (if equipped).
- **VES™ CH1/CH2** -Allows the user to change the mode of either the IR1 or IR2 wireless headphones by pressing the AUDIO/SELECT button (if equipped).
- **Set Home Clock** -Pressing the SELECT button allows you to set the clock. Turn the TUNE/SCROLL control knob to adjust the hours and then press and turn the

TUNE/SCROLL control knob to adjust the minutes. Press the TUNE/SCROLL control knob again to save changes.

- **Player Defaults** -Selecting this item will allow the user to scroll through the following items and set defaults according to customer preference.

Menu Language — If Equipped

Selecting this item will allow the user to choose the default startup DVD menu language (effective only if language supported by disc). If you want to select a language not listed, then scroll down and select "other." Enter the four-digit country code using the TUNE/SCROLL control knob to scroll up and down to select the number and then push to select.

Audio Language — If Equipped

Selecting this item allows you to choose a default audio language (effective only if the language is supported by the disc). You can select a language not listed by scrolling down and selecting "other." Enter the country code using the TUNE/SCROLL control knob to scroll up and down to select the number and then push to select.

Subtitle Language — If Equipped

Selecting this item allows you to choose a default subtitle language (effective only if the language is supported by the disc). You can select a language not listed by scrolling down and selecting "other." Enter the country code using the TUNE/SCROLL control knob to scroll up and down to select the number and then push to select.

Subtitles — If Equipped

Selecting this item allows you to choose between subtitle Off or On.

Audio DRC — If Equipped

Selecting this item allows you to limit maximum audio dynamic range. The default is set to "High," and under this setting, dialogues will play at 11 db higher than if the setting is "Normal."

Aspect Ratio — If Equipped

Selecting this item allows you to choose between wide screen, pan scan, and letter box.

AutoPlay — If Equipped

When this is set to On and a DVD video is inserted, it will bypass the DVD menu screen and automatically play the movie. In some rare cases, the DVD player may not auto-play the main title. In such cases, use the MENU button on the remote control to select desired title to play.

NOTE: The user will have to set these defaults before loading a disc. If changes are made to these settings after

a disc is loaded, changes will not be effective. Also, the defaults are effective only if the disc supports the customer-preferred settings.

AM and FM Buttons

Press the buttons to select AM or FM mode.

SET Button — To Set the Pushbutton Memory

When you are receiving a station that you wish to commit to pushbutton memory, press the SET button. The symbol SET 1 will now show in the display window. Select the button (1-6) you wish to lock onto this station and press and release that button. If a button is not selected within five seconds after pressing the SET button, the station will continue to play but will not be stored into pushbutton memory.

You may add a second station to each pushbutton by repeating the above procedure with this exception: Press the SET button twice and SET 2 will show in the display

window. Each button can be set for SET 1 and SET 2 in both AM and FM. This allows a total of 12 AM, 12 FM, and 12 Satellite (if equipped) stations to be stored into pushbutton memory. The stations stored in SET 2 memory can be selected by pressing the pushbutton twice.

Every time a preset button is used, a corresponding button number will display.

Buttons 1 - 6

These buttons tune the radio to the stations that you commit to pushbutton memory {12 AM, 12 FM, and 12 Satellite (if equipped) stations}.

DISC Button

Pressing the DISC button will allow you to switch from AM/FM modes to Disc modes.

Operation Instructions - (DISC MODE for CD and MP3/WMA Audio Play, DVD-VIDEO)

The radio DVD player and many DVD discs are coded by geographic region. These region codes must match in order for the disc to play. If the region code for the DVD disc does not match the region code for the radio DVD player, it will not play the disc. Customers may take their vehicle to an authorized dealer to change the region code of the player a maximum of five times.

CAUTION!

The radio may shut down during extremely hot conditions. When this occurs, the radio will indicate "Disc Hot" and shut off until a safe temperature is reached. This shutdown is necessary to protect the optics of the DVD player and other radio internal components.

NOTE: The ignition switch must be in the ON or ACC position to operate the radio.

LOAD Button — Loading Compact Disc(s)

Press the LOAD button and the pushbutton with the corresponding number (1-6) where the CD is being loaded. The radio will display PLEASE WAIT and prompt when to INSERT DISC. After the radio displays "INSERT DISC," insert the CD into the player.

Radio display will show "LOADING DISC" when the disc is loading and "READING DISC" when the radio is reading the disc.

CAUTION!

This CD player will accept 4-3/4 in (12 cm) discs only. The use of other sized discs may damage the CD player mechanism.

Eject Button — Ejecting Compact Disc(s)

Press the EJECT button and the pushbutton with the corresponding number (1-6) where the CD was loaded and the disc will unload and move to the entrance for easy removal. Radio display will show "EJECTING DISC" when the disc is being ejected and prompt the user to remove the disc.

Press and hold the EJECT button for five seconds and all CDs will be ejected from the radio.

The disc can be ejected with the radio and ignition OFF.

SEEK Button (CD MODE)

Press the right SEEK button for the next selection on the CD. Press the left SEEK button to return to the beginning of the current selection, or return to the beginning of the previous selection if the CD is within the first second of the current selection. Pressing and holding the SEEK button will allow you to scroll through the tracks faster in CD and MP3/MWA modes.

SCAN Button (CD MODE)

Press the SCAN button to scan through each track on the CD currently playing.

TIME Button (CD MODE)

Press this button to change the display from a large CD playing time display to a small CD playing time display.

RW/FF (CD MODE)

Press and hold FF (Fast Forward) and the CD player will begin to fast forward until FF is released, or RW or another CD button is pressed. The RW (Rewind) button works in a similar manner.

AM or FM Button (CD MODE)

Switches the radio into the AM or FM radio mode.

Notes On Playing MP3/WMA Files

The radio can play MP3/WMA files; however, acceptable MP3/WMA file recording media and formats are limited. When writing MP3/WMA files, pay attention to the following restrictions.

Supported Media (Disc Types)

The MP3/WMA file recording media supported by the radio are CDDA, CD-R, CD-RW, MP3, WMA, DVD Video, DVD-R, DVD-RW, DVD+R, DVD+RW, and CDDA+MP3.

Supported Medium Formats (File Systems)

The medium formats supported by the radio are ISO 9660 Level 1 and Level 2 and includes the Joliet extension. When reading discs recorded using formats other than ISO 9660 Level 1 and Level 2, the radio may fail to read files properly and may be unable to play the file normally. UDF and Apple HFS formats are not supported.

The radio uses the following limits for file systems:

- Maximum number of directory levels: 8
- Maximum number of files: 255
- Maximum number of folders: 100
- Maximum number of characters in file/folder names:
 - Level 1: 12 (including a separator "." and a three-character extension)
 - Level 2: 31 (including a separator "." and a three-character extension)

Multisession disc formats are supported by the radio. Multisession discs may contain combinations of normal CD audio tracks and computer files (including MP3/WMA files). Discs created with an option such as "keep disc open after writing" are most likely multisession discs. The use of multisession for CD audio or MP3/WMA playback may result in longer disc loading times.

If a disc contains multi-formats, such as CD audio and MP3/WMA tracks, the radio will only play the MP3/WMA tracks on that disc.

Supported MP3/WMA File Formats

The radio will recognize only files with the *.MP3/WMA extension as MP3/WMA files. Non-MP3/WMA files named with the *.MP3/WMA extension may cause playback problems. The radio is designed to recognize the file as an invalid MP3/WMA and will not play the file.

When using the MP3/WMA encoder to compress audio data to an MP3/WMA file, the bit rate and sampling frequencies in the following table are supported. In addition, variable bit rates (VBR) are also supported. The majority of MP3/WMA files use a 44.1 kHz sampling rate and a 192, 160, 128, 96 or VBR bit rates.

MPEG Specification	Sampling Frequency (kHz)	Bit Rate (kbps)
MPEG-1 Audio Layer 3	48, 44.1, 32	320, 256, 224, 192, 160, 128, 112, 96, 80, 64, 56, 48
MPEG-2 Audio Layer 3	24, 22.05, 16	160, 128, 144, 112, 96, 80, 64, 56, 48

WMA Specification	Sampling Frequency (kHz)	Bit Rate (kbps)
WMA	44.1 and 48	48, 64, 96, 128, 160, 192 VBR

ID3 Tag information for artist, song title, and album title are supported for ID3 version 1 tags. ID3 version 2 is not supported by the radios.

Playlist files are not supported. MP3 Pro files are not supported.

Playback of MP3/WMA Files

When a medium containing MP3/WMA data is loaded, the radio checks all files on the medium. If the medium contains a lot of folders or files, the radio will take more time to start playing the MP3/WMA files.

Loading times for playback of MP3/WMA files may be affected by the following:

- Media - CD-RW media may take longer to load than CD-R media
- Medium formats - Multisession discs may take longer to load than non-multisession discs

- Number of files and folders - Loading times will increase with more files and folders

To increase the speed of disc loading, it is recommended to use CD-R media and single-session discs. To create a single-session disc, enable the “Disc at Once” option before writing to the disc.

LIST Button (DISC Mode for MP3/WMA Play)

Pressing the LIST button will bring up a list of all folders on the disc. Scrolling up or down the list is done by turning the TUNE/SCROLL control knob. Selecting a folder by pressing the TUNE/SCROLL control knob will begin playing the files contained in that folder (or the next folder in sequence if the selection does not contain playable files).

The folder list will time out after five seconds.

INFO Button (DISC Mode for MP3/WMA Play)

Pressing the INFO button repeatedly will scroll through the following TAG information: Song Title, Artist, File Name, and Folder Name (if available).

Press the INFO button once more to return to "elapsed time" priority mode.

Press and hold the INFO button for three seconds or more and radio will display song titles for each file.

Press and hold the INFO button again for three seconds to return to "elapsed time" display.

Operation Instructions - Auxiliary Mode

The auxiliary (AUX) jack is an audio input jack which allows the user to plug in a portable device such as an MP3/WMA player, cassette player, or microphone and utilize the vehicle's audio system to amplify the source and play through the vehicle speakers.

Pressing the AUX button will change the mode to auxiliary device if the AUX jack is connected.

NOTE: The AUX device must be turned on and the device's volume set to the proper level. If the AUX audio is not loud enough, turn the device's volume up. If the AUX audio sounds distorted, turn the device's volume down.

SEEK Button (Auxiliary Mode)

No function.

SCAN Button (Auxiliary Mode)

No function.

EJECT Button (Auxiliary Mode)

No function.

TIME Button (Auxiliary Mode)

Press the TIME button to change the display from elapsed playing time to time of day. The time of day will display for five seconds.

RW/FF (Auxiliary Mode)

No function.

SET Button (Auxiliary Mode)

No function.

Operating Instructions — Voice Command System (If Equipped)

Refer to “Voice Command” for further details.

Operating Instructions - Uconnect™ Phone (If Equipped)

Refer to “Uconnect™ Phone” for further details.

Operating Instructions - Video Entertainment System (VES)™ (If Equipped)

Refer to “Video Entertainment System (VES)™” for further details.

Dolby®

Manufactured under license from Dolby® Laboratories. Dolby® and the double-D symbol are trademarks of Dolby® Laboratories.

Macrovision

This product incorporates copyright protection technology that is protected by U.S. patents and other intellectual property rights. Use of this copyright protection technology must be authorized by Macrovision, and is intended for home and other limited viewing uses only, unless otherwise authorized by Macrovision. Reverse engineering or disassembly is prohibited.

DTS™

“DTS™ and “DTS™ 2.0” are trademarks of Digital Theater Systems, Inc.

Uconnect™ Multimedia (Satellite Radio) — If Equipped

Satellite radio uses direct satellite-to-receiver broadcasting technology to provide clear digital sound, coast to coast. The subscription service provider is Sirius Satellite Radio. This service offers over 130 channels of music, sports, news, entertainment, and programming for children, directly from its satellites and broadcasting studios.

NOTE: Sirius service is not available in Hawaii and has limited coverage in Alaska.

System Activation

Sirius Satellite Radio service is pre-activated, and you may begin listening immediately to the one year of audio service

that is included with the factory-installed satellite radio system in your vehicle. Sirius will supply a welcome kit that contains general information, including how to setup your on-line listening account. For further information, call the toll-free number 888-539-7474, or visit the Sirius web site at www.sirius.com, or at www.siriuscanada.ca for Canadian residents.

Electronic Serial Number/Sirius Identification Number (ESN/SID)

Please have the following information available when calling:

1. The Electronic Serial Number/Sirius Identification Number (ESN/SID).
2. Your Vehicle Identification Number.

To access the ESN/SID, refer to the following steps:

ESN/SID Access

With the ignition switch in the ON/RUN or ACC position and the radio on, press the SETUP button and scroll using the TUNE/SCROLL control knob until Sirius ID is selected. Press the TUNE/SCROLL control knob and the Sirius ID number will display. The Sirius ID number display will time out in two minutes. Press any button on the radio to exit this screen.

Selecting Uconnect™ Multimedia (Satellite) Mode

Press the SAT button until "SAT" appears in the display. A CD may remain in the radio while in the Satellite radio mode.

Satellite Antenna

To ensure optimum reception, do not place items on the roof around the rooftop antenna location. Metal objects placed within the line of sight of the antenna will cause

decreased performance. Larger luggage items such as bikes should be placed as far rearward as possible, within the loading design of the rack. Do not place items directly on or above the antenna.

Reception Quality

Satellite reception may be interrupted due to one of the following reasons:

- The vehicle is parked in an underground parking structure or under a physical obstacle.
- Dense tree coverage may interrupt reception in the form of short audio mutes.
- Driving under wide bridges or along tall buildings can cause intermittent reception.
- Placing objects over or too close to the antenna can cause signal blockage.

Operating Instructions - Uconnect™ Multimedia (Satellite) Mode

NOTE: The ignition switch must be in the ON/RUN or ACC position to operate the radio.

SEEK Buttons

Press and release the SEEK buttons to search for the next channel in Satellite mode. Press the right switch to seek up and the left switch to seek down. The radio will remain tuned to the new channel until you make another selection. Holding either button will bypass channels without stopping until you release it.

SCAN Button

Pressing the SCAN button causes the tuner to search for the next channel, pausing for eight seconds before continuing to the next. To stop the search, press the SCAN button a second time.

INFO Button

Pressing the INFO button will cycle the display information between Artist, Song Title, and Composer (if available). Also, pressing and holding the INFO button for an additional three seconds will make the radio display the Song Title all of the time (press and hold again to return to normal display).

RW/FF

Pressing the RW (Rewind) or FF (Fast Forward) buttons causes the tuner to search for the next channel in the direction of the arrows.

TUNE Control (Rotary)

Turn the rotary TUNE/SCROLL control knob clockwise to increase or counterclockwise to decrease the channel.

MUSIC TYPE Button

Pressing this button once will turn on the Music Type mode for five seconds. Pressing the MUSIC TYPE button or turning the TUNE/SCROLL control knob within five seconds will allow the program format type to be selected.

Toggle the MUSIC TYPE button again to select the music type.

By pressing the SEEK button when the Music Type function is active, the radio will be tuned to the next channel with the same selected Music Type name.

If a preset button is activated while in the Music Type (Program Type) mode, the Music Type mode will be exited and the radio will tune to the preset channel.

SETUP Button

Pressing the SETUP button allows you to select the following items:

- Display Sirius ID number — Press the AUDIO/SELECT button to display the Sirius ID number. This number is used to activate, deactivate, or change the Sirius subscription.

SET Button – To Set the Pushbutton Memory

When you are receiving a channel that you wish to commit to pushbutton memory, press the SET button. The symbol SET 1 will now show in the display window. Select the button (1-6) you wish to lock onto this channel and press and release that button. If a button is not selected within five seconds after pressing the SET button, the channel will continue to play but will not be stored into pushbutton memory.

You may add a second channel to each pushbutton by repeating the above procedure with this exception: Press the SET button twice and SET 2 will show in the display window. Each button can be set for SET 1 and SET 2. This allows a total of 12 Satellite channels to be stored into pushbutton memory. The channels stored in SET 2 memory can be selected by pressing the pushbutton twice.

Every time a preset button is used, a corresponding button number will display.

Buttons 1 - 6

These buttons tune the radio to the channels that you commit to pushbutton memory (12 Satellite stations).

MEDIA CENTER 730N/430/430N (RHR/RER/RBZ/RHB) CD/DVD/HDD/NAV — IF EQUIPPED

NOTE: The sales code is located on the lower right side of the unit's faceplate.

Refer to your Uconnect™ Multimedia RHR, RER, RBZ or RHB user's manual for detailed operating instructions.

Operating Instructions (Voice Command System) — If Equipped

Refer to "Voice Command" for further details.

Operating Instructions (Uconnect™ Phone) — If Equipped

Refer to "Uconnect™ Phone" for further details.

MEDIA CENTER 130 (SALES CODE RES)

NOTE: The radio sales code is located on the lower right side of the radio faceplate.

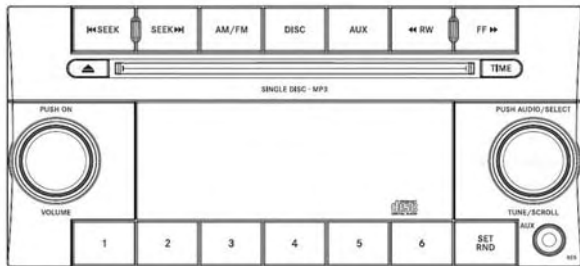

042305232

Media Center 130 (RES)

Operating Instructions — Radio Mode

NOTE: The ignition switch must be in the ON/RUN or ACC position to operate the radio.

Power Switch/Volume Control (Rotary)

Push the ON/VOLUME control knob to turn on the radio. Push the ON/VOLUME control knob a second time to turn off the radio.

Electronic Volume Control

The electronic volume control turns continuously (360 degrees) in either direction, without stopping. Turning the ON/VOLUME control knob to the right increases the volume, and to the left decreases it.

When the audio system is turned on, the sound will be set at the same volume level as last played.

SEEK Buttons

Press and release the SEEK buttons to search for the next listenable station in AM/FM mode. Press the right switch to seek up and the left switch to seek down. The radio will remain tuned to the new station until you make another selection. Holding either button will bypass stations without stopping, until you release it.

TIME Button

Press the TIME button to alternate display of the time and radio frequency.

Clock Setting Procedure

1. Press and hold the TIME button until the hours blink.
2. Adjust the hours by turning the right side TUNE/SCROLL control knob.

3. After adjusting the hours, press the right side TUNE/SCROLL control knob to set the minutes. The minutes will begin to blink.
4. Adjust the minutes using the right side TUNE/SCROLL control knob. Press the TUNE/SCROLL control knob to save time change.
5. To exit, press any button/knob, or wait five seconds.

RW/FF

Pressing the RW (Rewind) or FF (Fast Forward) buttons causes the tuner to search for the next frequency in the direction of the arrows. This feature operates in either AM or FM frequencies.

TUNE Control

Turn the rotary TUNE/SCROLL control knob clockwise to increase or counterclockwise to decrease the frequency.

Setting the Tone, Balance, and Fade

Push the rotary TUNE/SCROLL control knob and BASS will display. Turn the TUNE/SCROLL control knob to the right or left to increase or decrease the bass tones.

Push the rotary TUNE/SCROLL control knob a second time and MID will display. Turn the TUNE/SCROLL control knob to the right or left to increase or decrease the mid-range tones.

Push the rotary TUNE/SCROLL control knob a third time and TREBLE will display. Turn the TUNE/SCROLL control knob to the right or left to increase or decrease the treble tones.

Push the rotary TUNE/SCROLL control knob a fourth time and BALANCE will display. Turn the TUNE/SCROLL control knob to the right or left to adjust the sound level from the right or left side speakers.

Push the rotary TUNE/SCROLL control knob a fifth time and FADE will display. Turn the TUNE/SCROLL control knob to the left or right to adjust the sound level between the front and rear speakers.

Push the rotary TUNE/SCROLL control knob again to exit setting tone, balance, and fade.

AM/FM Button

Press the buttons to select either AM or FM mode.

SET/RND Button — To Set the Pushbutton Memory

When you are receiving a station that you wish to commit to pushbutton memory, press the SET/RND button. The symbol SET 1 will now show in the display window. Select the button (1 to 6) you wish to lock onto this station and press and release that button. If a button is not selected within five seconds after pressing the SET/RND button, the station will continue to play but will not be stored into pushbutton memory.

You may add a second station to each pushbutton by repeating the above procedure with this exception: Press the SET/RND button twice and SET 2 will show in the display window. Each button can be set for SET 1 and SET 2 in both AM and FM. This allows a total of 12 AM and 12 FM stations to be stored into pushbutton memory. The stations stored in SET 2 memory can be selected by pressing the pushbutton twice.

Every time a preset button is used, a corresponding button number will display.

Buttons 1 - 6

These buttons tune the radio to the stations that you commit to pushbutton memory (12 AM and 12 FM stations).

DISC Button

Pressing the DISC button will allow you to switch from AM/FM modes to Disc modes.

Operation Instructions — CD MODE For CD And MP3 Audio Play

NOTE:

- The ignition switch must be in the ON/RUN or ACC position to operate the radio.
- This radio is capable of playing compact discs (CD), recordable compact discs (CD-R), rewritable compact discs (CD-RW), compact discs with MP3 tracks and multisession compact discs with CD and MP3 tracks.

Inserting Compact Disc(s)

Gently insert one CD into the CD player with the CD label facing up. The CD will automatically be pulled into the CD player and the CD icon will illuminate on the radio display. If a CD does not go into the slot more than 1.0 in (2.5 cm), a disc may already be loaded and must be ejected before a new disc can be loaded.

If you insert a disc with the ignition ON/RUN and the radio ON, the unit will switch from radio to CD mode and begin to play when you insert the disc. The display will show the track number, and index time in minutes and seconds. Play will begin at the start of track 1.

CAUTION!

- This CD player will accept 4-3/4 in (12 cm) discs only. The use of other sized discs may damage the CD player mechanism.
- Do not use adhesive labels. These labels can peel away and jam the player mechanism.
- The RES Media Center is a single CD player. Do not attempt to insert a second CD if one is already loaded.

EJECT Button - Ejecting a CD



Press the EJECT button to eject the CD.

If you have ejected a disc and have not removed it within 10 seconds, it will be reloaded. If the CD is not removed, the radio will reinsert the CD but will not play it.

A disc can be ejected with the radio and ignition OFF.

NOTE: Ejecting with the ignition OFF is not allowed on convertible or soft-top models (if equipped).

SEEK Button

Press the right SEEK button for the next selection on the CD. Press the left SEEK button to return to the beginning of the current selection, or return to the beginning of the previous selection if the CD is within the first second of

the current selection. Pressing and holding the SEEK button will allow faster scrolling through the tracks in CD and MP3 modes.

TIME Button

Press this button to change the display from a large CD playing time display to a small CD playing time display.

RW/FF

Press and hold the FF (Fast Forward) button and the CD player will begin to fast forward until FF is released, or RW or another CD button is pressed. The RW (Reverse) button works in a similar manner.

AM/FM Button

Press the button to select either AM or FM mode.

SET/RND Button (Random Play Button)

Press this button while the CD is playing to activate Random Play. This feature plays the selections on the compact disc in random order to provide an interesting change of pace.

Press the right SEEK button to move to the next randomly selected track.

Press the RND button a second time to stop Random Play.

Notes on Playing MP3 Files

The radio can play MP3 files; however, acceptable MP3 file recording media and formats are limited. When writing MP3 files, pay attention to the following restrictions.

Supported Media (Disc Types)

The MP3 file recording media supported by the radio are CDDA, CD-R, CD-RW, MP3, and CDDA+MP3.

Supported Medium Formats (File Systems)

The medium formats supported by the radio are ISO 9660 Level 1 and Level 2 and includes the Joliet extension. When reading discs recorded using formats other than ISO 9660 Level 1 and Level 2, the radio may fail to read files properly and may be unable to play the file normally. UDF and Apple HFS formats are not supported.

The radio uses the following limits for file systems:

- Maximum number of folder levels: 8
- Maximum number of files: 255
- Maximum number of folders. (The radio display of file names and folder names is limited. For large numbers of files and/or folders, the radio may be unable to display the file name and folder name, and will assign a number instead. With a maximum number of files, exceeding 20 folders will result in this display. With 200 files, exceeding 50 folders will result in this display.)
- Maximum number of characters in file/folder names:
 - Level 1: 12 (including a separator "." and a three-character extension)
 - Level 2: 31 (including a separator "." and a three-character extension)

Multisession disc formats are supported by the radio. Multisession discs may contain combinations of normal CD audio tracks and computer files (including MP3 files). Discs created with an option such as "keep disc open after writing" are most likely multisession discs. The use of multisession for CD audio or MP3 playback may result in longer disc loading times.

Supported MP3 File Formats

The radio will recognize only files with the *.MP3 extension as MP3 files. Non-MP3 files named with the *.MP3 extension may cause playback problems. The radio is designed to recognize the file as an invalid MP3 and will not play the file.

When using the MP3 encoder to compress audio data to an MP3 file, the bit rate and sampling frequencies in the following table are supported. In addition, variable bit rates (VBR) are also supported. The majority of MP3 files use a 44.1 kHz sampling rate and a 192, 160, 128, 96 or VBR bit rate.

MPEG Specification	Sampling Frequency (kHz)	Bit Rate (kbps)
MPEG-1 Audio Layer 3	48, 44.1, 32	320, 256, 224, 192, 160, 128, 112, 96, 80, 64, 56, 48, 40, 32
MPEG-2 Audio Layer 3	24, 22.05, 16	160, 128, 144, 112, 96, 80, 64, 56, 48, 40, 32, 24, 16, 8

ID3 Tag information for artist, song title, and album title are supported for version 1 ID3 tags. ID3 version 2 is not supported by the radios.

Playlist files are not supported. MP3 Pro files are not supported.

Playback of MP3 Files

When a medium containing MP3 data is loaded, the radio checks all files on the medium. If the medium contains a lot of folders or files, the radio will take more time to start playing the MP3 files.

Loading times for playback of MP3 files may be affected by the following:

- Media - CD-RW media may take longer to load than CD-R media
- Medium formats - Multisession discs may take longer to load than non-multisession discs
- Number of files and folders - Loading times will increase with more files and folders

To increase the speed of disc loading, it is recommended to use CD-R media and single-session discs. To create a single-session disc, enable the “Disc at Once” option before writing to the disc.

Operation Instructions - Auxiliary Mode

The auxiliary (AUX) jack is an audio input jack, which allows the user to plug in a portable device, such as an MP3 player, or cassette player, and utilize the vehicle’s audio system to amplify the source and play through the vehicle speakers.

Pressing the DISC/AUX button will change the mode to auxiliary device if the AUX jack is connected.

NOTE: The AUX device must be turned on and the device’s volume set to proper level. If the AUX audio is not loud enough, turn the device’s volume up. If the AUX audio sounds distorted, turn the device’s volume down.

TIME Button (Auxiliary Mode)

Press this button to change the display to time of day. The time of day will display for five seconds (when ignition is OFF).

MEDIA CENTER 130 WITH SATELLITE RADIO (SALES CODE RES+RSC)

NOTE: The radio sales code is located on the lower right side of the radio faceplate.

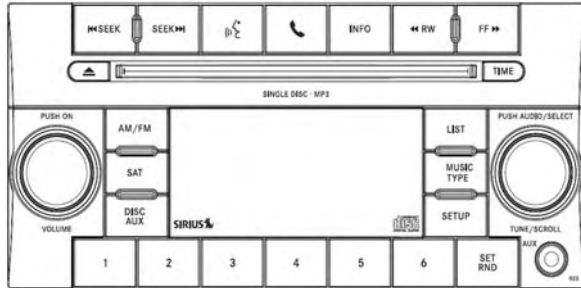

042340030

Media Center 130 (RES/RSC)

Operating Instructions — Radio Mode

NOTE: The ignition switch must be in the ON or ACC position to operate the radio.

Power Switch/Volume Control (Rotary)

Push the ON/VOLUME control knob to turn on the radio. Push the ON/VOLUME control knob a second time to turn off the radio.

Electronic Volume Control

The electronic volume control turns continuously (360 degrees) in either direction, without stopping. Turning the ON/VOLUME control knob to the right increases the volume, and to the left decreases it.

When the audio system is turned on, the sound will be set at the same volume level as last played.

SEEK Buttons

Press and release the SEEK buttons to search for the next listenable station in AM/FM mode. Press the right switch to seek up and the left switch to seek down. The radio will remain tuned to the new station until you make another selection. Holding either button will bypass stations without stopping, until you release it.

Voice Command System (Radio) — If Equipped

Refer to “Voice Command” in “Understanding The Features If Your Vehicle”.

Voice Command Button Uconnect™ Phone — If Equipped

Press this button to operate the Uconnect™ Phone feature (if equipped). Refer to “Uconnect™ Phone” in “Understanding The Features If Your Vehicle”.

If your vehicle is not equipped with or this feature is not available on your vehicle, a “Not Equipped With Uconnect Phone” message will display on the radio screen.

Phone Button Uconnect™ Phone — If Equipped

Press this button to operate the Uconnect™ Phone feature (if equipped). Refer to “Uconnect™ Phone” in “Understanding The Features If Your Vehicle”.

If your vehicle is not equipped with or this feature is not available on your vehicle, a “Not Equipped With Uconnect Phone” message will display on the radio screen.

TIME Button

Press the TIME button to alternate display of the time and radio frequency.

Clock Setting Procedure

1. Press and hold the TIME button until the hours blink.
2. Adjust the hours by turning the right side TUNE/SCROLL control knob.
3. After adjusting the hours, press the right side TUNE/SCROLL control knob to set the minutes. The minutes will begin to blink.
4. Adjust the minutes using the right side TUNE/SCROLL control knob. Press the TUNE/SCROLL control knob to save time change.
5. To exit, press any button/knob or wait five seconds.

The clock can also be set by pressing the SETUP button. For vehicles equipped with satellite radio, press the SETUP button, use the TUNE/SCROLL control to select SET CLOCK, and then follow the above procedure,

starting at Step 2. For vehicles not equipped with satellite radio, press the SETUP button and then follow the above procedure, starting at Step 2.

INFO Button

Press the INFO button for an RDS station (one with call letters displayed). The radio will return a Radio Text message broadcast from an FM station (FM mode only).

RW/FF

Pressing the RW (Rewind) or FF (Fast Forward) buttons causes the tuner to search for the next frequency in the direction of the arrows. This feature operates in either AM or FM frequencies.

TUNE Control

Turn the rotary TUNE/SCROLL control knob clockwise to increase or counterclockwise to decrease the frequency.

Setting the Tone, Balance, and Fade

Push the rotary TUNE/SCROLL control knob and BASS will display. Turn the TUNE/SCROLL control knob to the right or left to increase or decrease the bass tones.

Push the rotary TUNE/SCROLL control knob a second time and MID will display. Turn the TUNE/SCROLL control knob to the right or left to increase or decrease the mid-range tones.

Push the rotary TUNE/SCROLL control knob a third time and TREBLE will display. Turn the TUNE/SCROLL control knob to the right or left to increase or decrease the treble tones.

Push the rotary TUNE/SCROLL control knob a fourth time and BALANCE will display. Turn the TUNE/SCROLL control knob to the right or left to adjust the sound level from the right or left side speakers.

Push the rotary TUNE/SCROLL control knob a fifth time and FADE will display. Turn the TUNE/SCROLL control knob to the left or right to adjust the sound level between the front and rear speakers.

Push the rotary TUNE/SCROLL control knob again to exit setting tone, balance, and fade.

MUSIC TYPE Button

Pressing this button once will turn on the Music Type mode for five seconds. Pressing the MUSIC TYPE button or turning the TUNE/SCROLL control knob within five seconds will allow the program format type to be selected. Many radio stations do not currently broadcast Music Type information.

Toggle the MUSIC TYPE button to select the following format types:

Program Type	16-Digit Character Display
No program type or undefined	None
Adult Hits	Adlt Hit
Classical	Classicl
Classic Rock	Cls Rock
College	College
Country	Country
Foreign Language	Language
Information	Inform
Jazz	Jazz
News	News
Nostalgia	Nostalgia

Program Type	16-Digit Character Display
Oldies	Oldies
Personality	Persnlty
Public	Public
Rhythm and Blues	R & B
Religious Music	Rel Musc
Religious Talk	Rel Talk
Rock	Rock
Soft	Soft
Soft Rock	Soft Rck
Soft Rhythm and Blues	Soft R&B
Sports	Sports
Talk	Talk
Top 40	Top 40
Weather	Weather

By pressing the SEEK button when the Music Type icon is displayed, the radio will be tuned to the next frequency station with the same selected Music Type name. The Music Type function only operates when in the FM mode.

If a preset button is activated while in the Music Type (Program Type) mode, the Music Type mode will be exited and the radio will tune to the preset station.

SETUP Button

Pressing the SETUP button allows you to select between the following items:

- **Set Clock** — Pressing the SELECT button will allow you to set the clock. Adjust the hours by turning the TUNE/SCROLL control knob. After adjusting the hours, press the TUNE/SCROLL control knob to set the minutes. The minutes will begin to blink. Adjust

the minutes using the right side TUNE/SCROLL control knob. Press the TUNE/SCROLL control knob to save time change.

AM/FM Button

Press the button to select either AM or FM mode.

SET/RND Button — To Set the Pushbutton Memory

When you are receiving a station that you wish to commit to pushbutton memory, press the SET/RND button. The symbol SET 1 will now show in the display window. Select the button (1–6) you wish to lock onto this station and press and release that button. If a button is not selected within five seconds after pressing the SET/RND button, the station will continue to play but will not be stored into pushbutton memory.

You may add a second station to each pushbutton by repeating the above procedure with this exception: Press the SET/RND button twice and SET 2 will show in the display window. Each button can be set for SET 1 and SET 2 in both AM and FM. This allows a total of 12 AM and 12 FM stations to be stored into pushbutton memory. The stations stored in SET 2 memory can be selected by pressing the pushbutton twice.

Every time a preset button is used, a corresponding button number will display.

Buttons 1 - 6

These buttons tune the radio to the stations that you commit to pushbutton memory (12 AM and 12 FM stations).

DISC/AUX Button

Pressing the DISC/AUX button will allow you to switch from AM/FM modes to DISC/AUX mode.

Operation Instructions — CD MODE for CD and MP3 Audio Play

NOTE:

- The ignition switch must be in the ON or ACC position to operate the radio.
- This radio is capable of playing compact discs (CD), recordable compact discs (CD-R), rewritable compact discs (CD-RW), compact discs with MP3 tracks and multisession compact discs with CD and MP3 tracks.

Inserting Compact Disc(s)

Gently insert one CD into the CD player with the CD label facing up. The CD will automatically be pulled into the CD player and the CD icon will illuminate on the radio display. If a CD does not go into the slot more than 1.0 in (2.5 cm), a disc may already be loaded and must be ejected before a new disc can be loaded.

If you insert a disc with the ignition ON and the radio ON, the unit will switch from radio to CD mode and begin to play when you insert the disc. The display will show the track number, and index time in minutes and seconds. Play will begin at the start of track 1.

CAUTION!

- This CD player will accept 4-3/4 in (12 cm) discs only. The use of other sized discs may damage the CD player mechanism.
- Do not use adhesive labels. These labels can peel away and jam the player mechanism.
- The RES Media Center is a single CD player. Do not attempt to insert a second CD if one is already loaded.

EJECT Button - Ejecting a CD

Press the EJECT button to eject the CD.



If you have ejected a disc and have not removed it within 10 seconds, it will be reloaded. If the CD is not removed, the radio will reinsert the CD but will not play it.

A disc can be ejected with the radio and ignition OFF.

NOTE: Ejecting with the ignition OFF is not allowed on convertible or soft-top models (if equipped).

SEEK Button

Press the right SEEK button for the next selection on the CD. Press the left SEEK button to return to the beginning of the current selection, or return to the beginning of the

previous selection if the CD is within the first second of the current selection. Pressing and holding the SEEK button will allow faster scrolling through the tracks in CD and MP3 modes.

TIME Button

Press this button to change the display from a large CD playing time display to a small CD playing time display.

RW/FF

Press and hold FF (Fast Forward) and the CD player will begin to fast forward until FF is released or RW or another CD button is pressed. The RW (Reverse) button works in a similar manner.

AM/FM Button

Press the button to select either AM or FM mode.

SET/RND Button (Random Play Button)

Press this button while the CD is playing to activate Random Play. This feature plays the selections on the compact disc in random order to provide an interesting change of pace.

Press the right SEEK button to move to the next randomly selected track.

Press the SET/RND button a second time to stop Random Play.

Notes On Playing MP3 Files

The radio can play MP3 files; however, acceptable MP3 file recording media and formats are limited. When writing MP3 files, pay attention to the following restrictions.

Supported Media (Disc Types)

The MP3 file recording media supported by the radio are CDDA, CD-R, CD-RW, MP3, and CDDA+MP3.

Supported Medium Formats (File Systems)

The medium formats supported by the radio are ISO 9660 Level 1 and Level 2 and includes the Joliet extension. When reading discs recorded using formats other than ISO 9660 Level 1 and Level 2, the radio may fail to read files properly and may be unable to play the file normally. UDF and Apple HFS formats are not supported.

The radio uses the following limits for file systems:

- Maximum number of folder levels: 8
- Maximum number of files: 255
- Maximum number of folders. (The radio display of file names and folder names is limited. For large numbers of files and/or folders, the radio may be unable to display the file name and folder name, and will assign a number instead. With a maximum number of files, exceeding 20 folders will result in this display. With 200 files, exceeding 50 folders will result in this display.)
- Maximum number of characters in file/folder names:
 - Level 1: 12 (including a separator "." and a three-character extension)
 - Level 2: 31 (including a separator "." and a three-character extension)

Multisession disc formats are supported by the radio. Multisession discs may contain combinations of normal CD audio tracks and computer files (including MP3 files). Discs created with an option such as "keep disc open after writing" are most likely multisession discs. The use of multisession for CD audio or MP3 playback may result in longer disc loading times.

Supported MP3 File Formats

The radio will recognize only files with the *.MP3 extension as MP3 files. Non-MP3 files named with the *.MP3 extension may cause playback problems. The radio is designed to recognize the file as an invalid MP3 and will not play the file.

When using the MP3 encoder to compress audio data to an MP3 file, the bit rate and sampling frequencies in the following table are supported. In addition, variable bit rates (VBR) are also supported. The majority of MP3 files use a 44.1 kHz sampling rate and a 192, 160, 128, 96 or VBR bit rates.

MPEG Specification	Sampling Frequency (kHz)	Bit Rate (kbps)
MPEG-1 Audio Layer 3	48, 44.1, 32	320, 256, 224, 192, 160, 128, 112, 96, 80, 64, 56, 48, 40, 32
MPEG-2 Audio Layer 3	24, 22.05, 16	160, 128, 144, 112, 96, 80, 64, 56, 48, 40, 32, 24, 16, 8

ID3 Tag information for artist, song title, and album title are supported for version 1 ID3 tags. ID3 version 2 is not supported by the radios.

Playlist files are not supported. MP3 Pro files are not supported.

Playback of MP3 Files

When a medium containing MP3 data is loaded, the radio checks all files on the medium. If the medium contains a lot of folders or files, the radio will take more time to start playing the MP3 files.

Loading times for playback of MP3 files may be affected by the following:

- Media - CD-RW media may take longer to load than CD-R media
- Medium formats - Multisession discs may take longer to load than non-multisession discs
- Number of files and folders - Loading times will increase with more files and folders

To increase the speed of disc loading, it is recommended to use CD-R media and single-session discs. To create a single-session disc, enable the "Disc at Once" option before writing to the disc.

LIST Button (CD Mode for MP3 Play)

Pressing the LIST button will bring up a list of all folders on the disc. Scrolling up or down the list is done by turning the TUNE/SCROLL control knob. Selecting a folder by pressing the TUNE/SCROLL control knob will begin playing the files contained in that folder (or the next folder in sequence if the selection does not contain playable files).

The folder list will time out after five seconds.

INFO Button (CD Mode for MP3 Play)

Pressing the INFO button repeatedly will scroll through the following TAG information: Song Title, Artist, File Name, and Folder Name (if available).

Press the INFO button once more to return to "elapsed time" priority mode.

Press and hold the INFO button for three seconds or more and the radio will display song titles for each file.

Press and hold the INFO button again for three seconds to return to "elapsed time" display.

Operation Instructions - Auxiliary Mode

The auxiliary (AUX) jack is an audio input jack which allows the user to plug in a portable device such as an MP3 player or cassette player and utilize the vehicle's audio system to amplify the source and play through the vehicle speakers.

Pressing the AUX button will change the mode to auxiliary device if the AUX jack is connected.

NOTE: The AUX device must be turned on and the device's volume set to the proper level. If the AUX audio is not loud enough, turn the device's volume up. If the AUX audio sounds distorted, turn the device's volume down.

TIME Button (Auxiliary Mode)

Press this button to change the display to time of day. The time of day will display for five seconds (when the ignition is OFF).

Uconnect™ Multimedia (Satellite Radio) — If Equipped

Satellite radio uses direct satellite-to-receiver broadcasting technology to provide clear digital sound, coast to coast. The subscription service provider is Sirius Satellite Radio. This service offers over 130 channels of music, sports, news, entertainment, and programming for children, directly from its satellites and broadcasting studios.

NOTE: Sirius service is not available in Hawaii and has limited coverage in Alaska.

System Activation

Sirius Satellite Radio service is pre-activated, and you may begin listening immediately to the one year of audio service that is included with the factory-installed satellite radio system in your vehicle. Sirius will supply a welcome kit that contains general information, including

how to setup your on-line listening account. For further information, call the toll-free number 888-539-7474, or visit the Sirius web site at www.sirius.com, or at www.siriuscanada.ca for Canadian residents.

Electronic Serial Number/Sirius Identification Number (ESN/SID)

Please have the following information available when calling:

1. The Electronic Serial Number/Sirius Identification Number (ESN/SID).
2. Your Vehicle Identification Number.

To access the ESN/SID, refer to the following steps:

ESN/SID Access

With the ignition switch in the ON/RUN or ACC position and the radio on, press the SETUP button and scroll using the TUNE/SCROLL control knob until Sirius ID is

selected. Press the TUNE/SCROLL control knob and the Sirius ID number will display. The Sirius ID number display will time out in two minutes. Press any button on the radio to exit this screen.

Selecting Uconnect™ Multimedia (Satellite) Mode

Press the SAT button until "SAT" appears in the display. A CD may remain in the radio while in the Satellite radio mode.

Satellite Antenna

To ensure optimum reception, do not place items on the roof around the rooftop antenna location. Metal objects placed within the line of sight of the antenna will cause decreased performance. Larger luggage items such as bikes should be placed as far rearward as possible, within the loading design of the rack. Do not place items directly on or above the antenna.

Reception Quality

Satellite reception may be interrupted due to one of the following reasons:

- The vehicle is parked in an underground parking structure or under a physical obstacle.
- Dense tree coverage may interrupt reception in the form of short audio mutes.
- Driving under wide bridges or along tall buildings can cause intermittent reception.
- Placing objects over or too close to the antenna can cause signal blockage.

Operating Instructions - Uconnect™ Multimedia (Satellite) Mode

NOTE: The ignition switch must be in the ON/RUN or ACC position to operate the radio.

SEEK Buttons

Press and release the SEEK buttons to search for the next channel in Satellite mode. Press the right switch to seek up and the left switch to seek down. The radio will remain tuned to the new channel until you make another selection. Holding either button will bypass channels without stopping until you release it.

SCAN Button

Pressing the SCAN button causes the tuner to search for the next channel, pausing for eight seconds before continuing to the next. To stop the search, press the SCAN button a second time.

INFO Button

Pressing the INFO button will cycle the display information between Artist, Song Title, and Composer (if available). Also, pressing and holding the INFO button for an

additional three seconds will make the radio display the Song Title all of the time (press and hold again to return to normal display).

RW/FF

Pressing the RW (Rewind) or FF (Fast Forward) buttons causes the tuner to search for the next channel in the direction of the arrows.

TUNE Control (Rotary)

Turn the rotary TUNE/SCROLL control knob clockwise to increase or counterclockwise to decrease the channel.

MUSIC TYPE Button

Pressing this button once will turn on the Music Type mode for five seconds. Pressing the MUSIC TYPE button or turning the TUNE/SCROLL control knob within five seconds will allow the program format type to be selected.

Toggle the MUSIC TYPE button again to select the music type.

By pressing the SEEK button when the Music Type function is active, the radio will be tuned to the next channel with the same selected Music Type name.

If a preset button is activated while in the Music Type (Program Type) mode, the Music Type mode will be exited and the radio will tune to the preset channel.

SETUP Button

Pressing the SETUP button allows you to select the following items:

- Display Sirius ID number — Press the AUDIO/SELECT button to display the Sirius ID number. This number is used to activate, deactivate, or change the Sirius subscription.

SET Button – To Set the Pushbutton Memory

When you are receiving a channel that you wish to commit to pushbutton memory, press the SET button. The symbol SET 1 will now show in the display window. Select the button (1-6) you wish to lock onto this channel and press and release that button. If a button is not selected within five seconds after pressing the SET button, the channel will continue to play but will not be stored into pushbutton memory.

You may add a second channel to each pushbutton by repeating the above procedure with this exception: Press the SET button twice and SET 2 will show in the display window. Each button can be set for SET 1 and SET 2. This allows a total of 12 Satellite channels to be stored into pushbutton memory. The channels stored in SET 2 memory can be selected by pressing the pushbutton twice.

Every time a preset button is used, a corresponding button number will display.

Buttons 1 - 6

These buttons tune the radio to the channels that you commit to pushbutton memory (12 Satellite stations).

Operating Instructions - Uconnect™ Phone (If Equipped)

Refer to “Uconnect™ Phone” in “Understanding The Features Of Your Vehicle”.

iPod®/USB/MP3 CONTROL — IF EQUIPPED

NOTE: This section is for sales code RES and REQ/REL/RET radios only with Uconnect™. For sales code RBZ/RHB, RHR, RHP, RHW or RB2 touch-screen radio iPod®/USB/MP3 control feature, refer to the separate RBZ/RHB, RHR, RHP, RHW or RB2 User's Manual. iPod®/USB/MP3 control is available only if equipped as an option with these radios.

This feature allows an iPod® or external USB device to be plugged into the USB port, located in the center console.

iPod® control supports Mini, 4G, Photo, Nano, 5G iPod® and iPhone® devices. Some iPod® software versions may not fully support the iPod® control features. Please visit Apple's website for software updates.

NOTE:

- If the radio has a USB port, refer to the appropriate Uconnect™ Multimedia radio User's Manual for iPod® or external USB device support capability.
- Connecting an iPod® or consumer electronic audio device to the AUX port located in the radio faceplate, plays media, but does not use the iPod® /MP3 control feature to control the connected device.

Connecting The iPod® Or External USB Device

Use the connection cable to connect an iPod® or external USB device to the vehicle's USB/AUX connector port which is located in the center console.

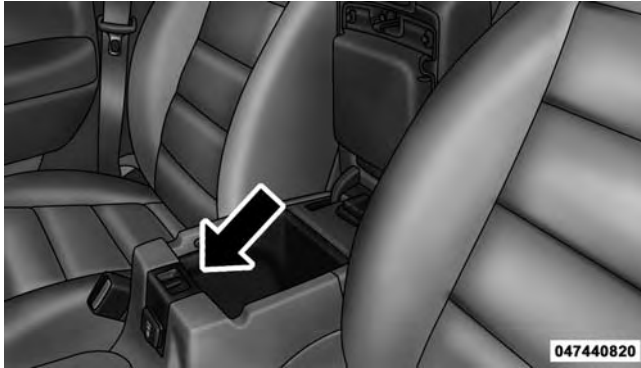

Center Console USB/AUX Connector Port

Once the audio device is connected and synchronized to the vehicle's iPod®/USB/MP3 control system (iPod® or external USB device may take a few minutes to connect), the audio device starts charging and is ready for use by pressing radio switches, as described below.

NOTE: If the audio device battery is completely discharged, it may not communicate with the iPod®/USB/MP3 control system until a minimum charge is attained. Leaving the audio device connected to the iPod®/USB/MP3 control system may charge it to the required level.

Using This Feature

By using iPod cable or external USB device to connect to USB port:

- The audio device can be played on the vehicle's sound system, providing metadata (artist, track title, album, etc.) information on the radio display.
- The audio device can be controlled using the radio buttons to Play, Browse, and List the iPod® contents.
- The audio device battery charges when plugged into the USB/AUX connector (if supported by the specific audio device)

Controlling The iPod® Or External USB Device Using Radio Buttons

To get into the iPod®/USB/MP3 control mode and access a connected audio device, either press the “AUX” button on the radio faceplate or press the VR button and say “USB” or “Switch to USB”. Once in the iPod®/USB/MP3 control mode, audio tracks (if available from audio device) start playing over the vehicle’s audio system.

Play Mode

When switched to iPod®/USB/MP3 control mode, the iPod® or external USB device automatically starts Play mode. In Play mode, the following buttons on the radio faceplate may be used to control the iPod® or external USB device and display data:

- Use the TUNE control knob to select the next or previous track.
- Turning it clockwise (forward) by one click, while playing a track, skips to the next track or press the VR button and say “Next Track”.
- Turning it counterclockwise (backward) by one click, will jump to the previous track in the list or press the VR button and say “Previous Track”
- Jump backward in the current track by pressing and holding the << **RW** button. Holding the << **RW** button long enough will jump to the beginning of the current track.
- Jump forward in the current track by pressing and holding the **FF**>> button.
- A single press backward << **RW** or forward **FF**>> will jump backward or forward respectively, for five seconds.

- Use the << **SEEK** and **SEEK**>> buttons to jump to the previous or next track. Pressing the **SEEK**>> button during play mode will jump to the next track in the list, or press the VR button and say "Next or Previous Track".
- While a track is playing, press the **INFO** button to see the associated metadata (artist, track title, album, etc.) for that track. Pressing the **INFO** button again jumps to the next screen of data for that track. Once all screens have been viewed, the last **INFO** button press will go back to the play mode screen on the radio.
- Pressing the **REPEAT** button will change the audio device mode to repeat the current playing track or press the VR button and say "Repeat ON" or "Repeat Off".
- Press the **SCAN** button to use iPod®/USB/MP3 device scan mode, which will play the first 10 seconds of each track in the current list and then forward to the next song. To stop SCAN mode and start playing the desired track, when it is playing the track, press the **SCAN** button again. During Scan mode, pressing the << **SEEK** and **SEEK**>> buttons will select the previous and next tracks.
- **RND** button (available on sales code RES radio only): Pressing this button toggles between Shuffle ON and Shuffle OFF modes for the iPod® or external USB device, or press the VR button and say "Shuffle ON" or "Shuffle Off". If the **RND** icon is showing on the radio display, then the shuffle mode is ON.

List Or Browse Mode

During Play mode, pressing any of the buttons described below, will bring up List mode. List mode enables scrolling through the list of menus and tracks on the audio device.

- **TUNE** control knob: The **TUNE** control knob functions in a similar manner as the scroll wheel on the audio device or external USB device.
 - Turning it clockwise (forward) and counterclockwise (backward) scrolls through the lists, displaying the track detail on the radio display. Once the track to be played is highlighted on the radio display, press the **TUNE** control knob to select and start playing the track. Turning the **TUNE** control knob fast will scroll through the list faster. During fast scroll, a slight delay in updating the information on the radio display may be noticeable.
- During all List modes, the iPod® displays all lists in “wrap-around” mode. So if the track is at the bottom of the list, just turn the wheel backward (counterclockwise) to get to the track faster.
- In List mode, the radio **PRESET** buttons are used as shortcuts to the following lists on the iPod® or external USB device.
 - Preset 1 – Playlists
 - Preset 2 – Artists
 - Preset 3 – Albums
 - Preset 4 – Genres
 - Preset 5 – Audiobooks
 - Preset 6 – Podcasts
- Pressing a **PRESET** button will display the current list on the top line and the first item in that list on the second line.

- To exit List mode without selecting a track, press the same **PRESET** button again to go back to **Play mode**.
- **LIST** button: The **LIST** button will display the top level menu of the iPod® or external USB device. Turn the **TUNE** control knob to list the top-menu item to be selected and press the **TUNE** control knob. This will display the next sub-menu list item on the audio device, then follow the same steps to go to the desired track in that list. Not all iPod® or external USB device sub-menu levels are available on this system.
- **MUSIC TYPE** button: The **MUSIC TYPE** button is another shortcut button to the genre listing on your audio device.

CAUTION!

- Leaving the iPod® or external USB device (or any supported device) anywhere in the vehicle in extreme heat or cold can alter the operation or damage the device. Follow the device manufacturer's guidelines.
- Placing items on the iPod® or external USB device, or connections to the iPod® or external USB device in the vehicle, can cause damage to the device and/or to the connectors.

WARNING!

Do not plug in or remove the iPod® or external USB device while driving. Failure to follow this warning could result in an accident.

Bluetooth Streaming Audio (BTSA)

Music can be streamed from your cellular phone to the Uconnect™ phone system.

Controlling BTSA Using Radio Buttons

To get into the BTSA mode, press either “AUX” button on the radio or press the VR button and say “Bluetooth Streaming Audio”.

Play Mode

When switched to BTSA mode, some audio devices can start playing music over the vehicle’s audio system, but some devices require the music to be initiated on the device first, then it will get streamed to the Uconnect™ phone system. Seven devices can be paired to the Uconnect™ phone system, but just one can be selected and played.

Selecting Different Audio Device

1. Press PHONE button to begin.
2. After the “Ready” prompt and the following beep, say “Setup”, then “Select Audio Devices”.
3. Say the name of the audio device or ask the Uconnect™ phone system to list audio devices.

Next Track

Use the SEEK UP button, or press the VR button on the radio and say “Next Track” to jump to the next track music on your cellular phone.

Previous Track

Use the SEEK DOWN button, or press the VR button on the radio and say “Previous Track” to jump to the previous track music on your cellular phone.

Browse

Browsing is not available on a BTSA device. Only the current song that is playing will display info.

STEERING WHEEL AUDIO CONTROLS

The remote sound system controls are located on the rear surface of the steering wheel. Reach behind the wheel to access the switches.



045033001

Remote Sound System Controls (Back View Of Steering Wheel)

The right-hand control is a rocker-type switch with a pushbutton in the center and controls the volume and mode of the sound system. Pressing the top of the rocker switch will increase the volume, and pressing the bottom of the rocker switch will decrease the volume.

Pressing the center button will make the radio switch between the various modes available (AM/FM/SAT/CD/HDD/AUX/VES, etc.).

The left-hand control is a rocker-type switch with a pushbutton in the center. The function of the left-hand control is different depending on which mode you are in.

The following describes the left-hand control operation in each mode.

Radio Operation

Pressing the top of the switch will “Seek” up for the next listenable station and pressing the bottom of the switch will “Seek” down for the next listenable station.

The button located in the center of the left-hand control will tune to the next preset station that you have programmed in the radio preset pushbutton.

CD Player

Pressing the top of the switch once will go to the next track on the CD. Pressing the bottom of the switch once will go to the beginning of the current track, or to the beginning of the previous track if it is within one second after the current track begins to play.

If you press the switch up or down twice, it plays the second track; three times, it will play the third, etc.

The center button on the left side rocker switch has no function for a single-disc CD player. However, when a multiple-disc CD player is equipped on the vehicle, the center button will select the next available CD in the player.

CD/DVD DISC MAINTENANCE

To keep a CD/DVD in good condition, take the following precautions:

1. Handle the disc by its edge; avoid touching the surface.
2. If the disc is stained, clean the surface with a soft cloth, wiping from center to edge.
3. Do not apply paper or tape to the disc; avoid scratching the disc.

4. Do not use solvents such as benzene, thinner, cleaners, or anti-static sprays.
5. Store the disc in its case after playing.
6. Do not expose the disc to direct sunlight.
7. Do not store the disc where temperatures may become too high.

NOTE: If you experience difficulty in playing a particular disc, it may be damaged (i.e., scratched, reflective coating removed, a hair, moisture or dew on the disc) oversized, or have protection encoding. Try a known good disc before considering disc player service.

RADIO OPERATION AND MOBILE PHONES

Under certain conditions, the mobile phone being on in your vehicle can cause erratic or noisy performance from your radio. This condition may be lessened or eliminated by relocating the mobile phone antenna. This condition is not harmful to the radio. If your radio performance does not satisfactorily “clear” by the repositioning of the antenna, it is recommended that the radio volume be turned down or off during mobile phone operation when not using Uconnect™ (if equipped).

CLIMATE CONTROLS

The air conditioning and heating system is designed to make you comfortable in all types of weather.

Manual Heating And Air Conditioning



045607535

Manual Temperature Control

The Manual Temperature Controls consist of a series of outer rotary dials and inner push knobs.

Blower Control



045607539

Rotate this control to regulate the amount of air forced through the ventilation system in any mode. The blower speed increases as you move the control to the right from the “O” (OFF) position. There are seven blower speeds.

NOTE: For vehicles equipped with Remote Start, the climate controls will not function during Remote Start operation if the blower control is left in the “O” (Off) position.

Temperature Control



045607540

Rotate this control to regulate the temperature of the air inside the passenger compartment. Rotating the dial left into the blue area of the scale indicates cooler temperatures, while rotating right into the red area indicates warmer temperatures.

NOTE: If your air conditioning performance seems lower than expected, check the front of the A/C condenser located in front of the radiator for an accumulation of dirt or insects. Clean with a gentle water spray from behind the radiator and through the condenser. Fabric front fascia protectors may reduce airflow to the condenser, reducing air conditioning performance.

Mode Control (Air Direction)



045607541

Rotate this control to choose from several patterns of air distribution. You can select either a primary mode as identified by the symbols on the control, or a blend of two of these modes. The closer the setting is to a particular symbol, the more air distribution you

receive from that mode.

Panel



Air is directed through the outlets in the instrument panel. These outlets can be adjusted to direct airflow.

NOTE: The center instrument panel outlets can be aimed so that they are directed toward the rear seat passengers for maximum airflow to the rear.

Bi-Level

Air is directed through the panel and floor outlets.

NOTE: For all settings, except full cold or full hot, there is a difference in temperature between the upper and lower outlets. The warmer air flows to the floor outlets. This feature gives improved comfort during sunny but cool conditions.

Floor

Air is directed through the floor outlets with a small amount flowing through the defrost and side window demist outlets.

Mix

Air is directed through the floor, defrost, and side window demist outlets. This setting works best in cold or snowy conditions that require extra heat to the windshield. This setting is good for maintaining comfort while reducing moisture on the windshield.

Defrost

Air is directed through the windshield and side window demist outlets. Use this mode with maximum blower and temperature settings for best windshield and side window defrosting.

NOTE: The air conditioning compressor operates in Mix, Defrost, or a blend of these modes, even if the Air Conditioning (A/C) button is not pressed. This dehumidifies the air to help dry the windshield. To improve fuel economy, use these modes only when necessary.

Recirculation Control

Pressing the Recirculation Control button will put the system in recirculation mode. This can be used when outside conditions such as smoke, odors, dust, or high humidity are present. Activating recirculation will cause the LED in the control button to illuminate.

NOTE:

- Continuous use of the Recirculation mode may make the inside air stuffy and window fogging may occur. Extended use of this mode is not recommended.
- The use of the Recirculation mode in cold or damp weather will cause windows to fog on the inside, because of moisture buildup inside the vehicle. Select the outside air position for maximum defogging.
- The A/C will engage automatically to prevent fogging when the recirculation button is pressed and the mode control is set to panel or Bi-Level.
- The A/C can be deselected manually without disturbing the mode control selection.
- When the ignition switch is turned to the LOCK position, the recirculation feature will be cancelled.

Air Conditioning Control

Press this button to engage the Air Conditioning. A light will illuminate when the Air Conditioning system is engaged. Rotating the dial left into the blue area of the scale indicates cooler temperatures, while rotating right into the red area indicates warmer temperatures.

NOTE: The air conditioning compressor will not engage until the engine has been running for about 10 seconds.

- **MAX A/C**

For maximum cooling, turn on the A/C and recirculation buttons at the same time.

- **ECONOMY MODE**

If economy mode is desired, press the A/C button to turn OFF the indicator light and the A/C compressor. Then, move the temperature control to the desired temperature.

Automatic Temperature Control (ATC) — If Equipped



045640031

Automatic Temperature Control Automatic Operation

The Automatic Temperature Control system automatically maintains the climate in the cabin of the vehicle at the comfort levels desired by the driver and passenger.

Operation of the system is quite simple.

1. Turn the Mode Control knob (on the right) and the Blower Control knob (on the left) to AUTO.

NOTE: The AUTO position performs best for front seat occupants only.



045638695

Dial in the temperature you would like the system to maintain by rotating the Temperature Control knob. Once the comfort level is selected, the system will maintain that level automatically using the heating system. Should the desired comfort level require air conditioning, the system will automatically make the adjustment.

You will experience the greatest efficiency by simply allowing the system to function automatically. Selecting the "O" (OFF) position on the blower control stops the system completely and closes the outside air intake.

The recommended setting for maximum comfort is 72°F (22°C) for the average person; however, this may vary.

NOTE:

- The temperature setting can be adjusted at anytime without affecting automatic operation.
- Pressing the Air Conditioning Control button while in AUTO mode will cause the LED in the control button to flash three times and then turn off. This indicates that the system is in AUTO mode and requesting the air conditioning is not necessary.
- If your air conditioning performance seems lower than expected, check the front of the A/C condenser located in front of the radiator for an accumulation of dirt or insects. Clean with a gentle water spray from behind the radiator and through the condenser. Fabric front fascia protectors may reduce airflow to the condenser, reducing air conditioning performance.

Blower Control



045607536

For full automatic operation or for automatic blower operation, turn the knob to the AUTO position. In manual mode, there are seven blower speeds that can be individually selected. In off position, the blower will shut off.

Manual Operation

This system offers a full complement of manual override features, which consist of Blower Preferred Automatic, Mode Preferred Automatic, or Blower and Mode Preferred Automatic. This means the operator can override the blower, the mode, or both. There is a manual blower range for times when the AUTO setting is not desired. The blower can be set to any fixed blower speed by rotating the Blower Control knob (on the left).

NOTE: Please read the Automatic Temperature Control Operation Chart that follows for details.

Automatic Temperature Control Operation		The system will...				
Operation	How	Blower Control	Mode Control	Air Temperature Control	Air Recirculation Control	A/C Operation
Full Automatic Operation	Set blower knob to Auto. Set mode knob to Auto. Set temperature knobs for comfort.	Automatic	Automatic	Automatic	Automatic but can be overridden for 10 minutes at a time.	Automatic
Blower Preferred Automatic	Set blower knob to any desired airflow level other than Auto. Set mode knob to Auto. Set temperature knobs for comfort.	User selectable to any speed.	Automatic	Automatic	Automatic but can be overridden for 10 minutes at a time.	Automatic
Mode Preferred Automatic	Set mode knob to any desired air delivery point other than Auto. Set blower knob to Auto. Set temperature knobs for comfort.	Automatic	User selectable to any air delivery point.	Automatic	User selectable outside or recirculated. Not allowed in Defrost Mode	User selectable A/C on or off.
Blower and Mode Preferred Automatic	Set blower knob to any desired airflow level other than Auto. Set mode knob to any desired air delivery point other than Auto. Set temperature knobs for comfort.	User selectable to any speed.	User selectable to any air delivery point.	Automatic	User selectable outside or recirculated. Not allowed in Defrost Mode	User selectable A/C on or off.

The operator can override the AUTO mode setting to change airflow distribution by rotating the Mode Control knob (on the right) to one of the following positions.

- *Panel*



Air is directed through the outlets in the instrument panel. These outlets can be adjusted to direct airflow.

NOTE: The center instrument panel outlets can be aimed so that they are directed toward the rear seat passengers for maximum airflow to the rear.

- *Bi-Level*



Air is directed through the panel and floor outlets.

NOTE: For all settings, except full cold or full hot, there is a difference in temperature between the upper and lower outlets. The warmer air flows to the floor outlets. This feature gives improved comfort during sunny but cool conditions.

- *Floor*



Air is directed through the floor outlets with a small amount flowing through the defrost and side window demist outlets.

- *Mix*



Air is directed through the floor, defrost, and side window demist outlets. This setting works best in cold or snowy conditions that require extra heat to the windshield. This setting is good for maintaining comfort while reducing moisture on the windshield.

- *Defrost*



Air is directed through the windshield and side window demist outlets. Use this mode with maximum blower and temperature settings for best windshield and side window defrosting.

- *Air Conditioner Control*



045638696

Press this button to turn on the air conditioning during manual operation only. When the air conditioning is turned on, cool dehumidified air will flow through the outlets selected with the Mode control dial. Press this button a second time to turn OFF the air conditioning. An LED in the button illuminates when manual compressor operation is selected.

- *Recirculation Control*



The system will automatically control recirculation. However, pressing the Recirculation Control button will put the system in recirculation mode. This can be used when outside conditions such as smoke, odors, dust, or high humidity are present. Activating recirculation will cause the LED in the control button to illuminate.

NOTE:

- When the ignition switch is turned to the LOCK position, the recirculation feature will be cancelled.
- In cold weather, use of the Recirculation mode may lead to excessive window fogging. The Recirculation mode is not allowed in the defrost mode in order to improve window clearing. Recirculation will be disabled automatically if in defrost mode.
- Extended use of recirculation may cause the windows to fog. If the interior of the windows begins to fog, press the Recirculation button to return to outside air. Some temp/humidity conditions will cause captured interior air to condense on windows and hamper visibility. For this reason, the system will not allow recirculation to be selected while in defrost mode. Attempting to use recirculation while in these modes will cause the LED in the control button to blink and then turn off.

- Most of the time, when in Automatic Operation, you can temporarily put the system into Recirculation mode by pressing the Recirculation button. However, under certain conditions, while in Automatic mode, the system is blowing air out the defrost vents. When these conditions are present, and the Recirculation button is pressed, the indicator will flash and then turn off. This tells you that you are unable to go into Recirculation mode at this time. If you would like the system to go into Recirculation mode, you must first move the Mode knob to Panel, Bi-Level and then press the Recirculation button. This feature reduces the possibility of window fogging.

Operating Tips

NOTE: Refer to the chart at the end of this section for suggested control settings for various weather conditions.

Summer Operation

The engine cooling system in air-conditioned vehicles must be protected with a high-quality antifreeze coolant to provide proper corrosion protection and to protect against engine overheating. A solution of 50% ethylene glycol antifreeze coolant and 50% water is recommended. Refer to “Maintenance Procedures” in “Maintaining Your Vehicle” for proper coolant selection.

Winter Operation

Use of the air Recirculation mode during winter months is not recommended because it may cause window fogging.

Vacation Storage

Anytime you store your vehicle, or keep it out of service (i.e., vacation) for two weeks or more, run the air conditioning system at idle for about five minutes in the fresh air and high blower settings. This will ensure adequate system lubrication to minimize the possibility of compressor damage when the system is started again.

Window Fogging

Interior fogging on the windshield can be quickly removed by turning the mode selector to Defrost. The Defrost/Floor mode can be used to maintain a clear windshield and provide sufficient heating. If side window fogging becomes a problem, increase blower speed. Vehicle windows tend to fog on the inside in mild but rainy or humid weather.

NOTE: Recirculate without A/C should not be used for long periods as fogging may occur.

Side Window Demisters

A side window demister outlet is located at each end of the instrument panel. These non-adjustable outlets direct air toward the side windows when the system is in the Floor, Mix, or Defrost mode. The air is directed at the area of the windows through which you view the outside mirrors.











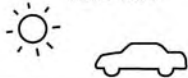





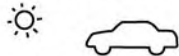

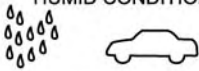

Outside Air Intake

Make sure the air intake, located directly in front of the windshield, is free of obstructions such as leaves. Leaves collected in the air intake may reduce airflow, and if they enter the plenum, they could plug the water drains. In winter months, make sure the air intake is clear of ice, slush, and snow.

A/C Air Filter — If Equipped

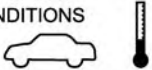
The A/C Filter prevents most dust and pollen from entering the cabin. The filter acts on air coming from outside the vehicle and recirculated air within the passenger compartment. Refer to “Maintenance Procedures” in “Maintaining Your Vehicle” for A/C Air Filter service information or see your authorized dealer for service. Refer to “Maintenance Schedules” for filter service intervals.

Control Setting Suggestions For Various Weather Conditions

WEATHER	CONTROL SETTINGS
<p>HOT WEATHER AND VEHICLE INTERIOR IS VERY HOT</p> 	<p>Open the windows, start the vehicle, press the  button to turn recirculate off. Set the Fan control to the high position (full clockwise). Press the A/C button. Set the Mode control at or between  and . Set the temperature control to full cool. After the hot air is pushed from the vehicle press the  button to turn recirculate on and roll up the windows. Once you are comfortable, press the  button to turn recirculate off and adjust the temperature control for comfort.</p>
<p>WARM WEATHER</p> 	<p>Press the  button to turn recirculate off. If it's sunny, set the Mode control at or near  and turn the air conditioning on. If it's cloudy or dark, set the Mode control at or near .</p>
<p>COOL OR COLD HUMID CONDITIONS</p> 	<p>Press the  button to turn recirculate off. If it's sunny, set the Mode control at or between  and  then turn the air conditioning on. If it's cloudy or dark, set the Mode control at or near  and turn the air conditioning on. If the windows begin to fog, set Mode control at or between  and .</p>
<p>COLD DRY CONDITIONS</p> 	<p>Set the Mode control at or near . If it is sunny, you may want more upper air. In this case, set the Mode control at or between  and . In very cold weather, if you need extra heat at the windshield, set the Mode control at or near the .</p>

045606725

STARTING AND OPERATING

CONTENTS

■ STARTING PROCEDURES410	■ MANUAL TRANSMISSION — IF EQUIPPED . .	.414
□ Manual Transmission – If Equipped410	□ Shifting.415
□ Automatic Transmission – If Equipped410	□ Downshifting416
□ Normal Starting.411	□ Reverse Shifting417
□ Extreme Cold Weather (Below –20°F Or –29°C)411	■ AUTOMATIC TRANSMISSION — IF EQUIPPED418
□ If Engine Fails To Start411	□ Key Ignition Park Interlock.419
□ After Starting413	□ Brake/Transmission Shift Interlock System . .	.419
■ ENGINE BLOCK HEATER — IF EQUIPPED . .	.413	□ Five-Speed Automatic Transmission420
		□ Gear Ranges421

- FOUR-WHEEL DRIVE OPERATION (COMMAND-TRAC I® OR ROCK-TRAC®)428
 - Operating Instructions/Precautions428
 - Shift Positions430
 - Shifting Procedure431
- TRAC-LOK® REAR AXLE — IF EQUIPPED432
- AXLE LOCK (TRU-LOK®) — RUBICON MODELS433
- ELECTRONIC SWAY BAR DISCONNECT — IF EQUIPPED434
- ON-ROAD DRIVING TIPS436
- OFF-ROAD DRIVING TIPS437
 - Side Step Removal – If Equipped437
 - The Basics Of Off-Road Driving438
 - When To Use 4L (Low) Range.438
 - Simultaneous Brake And Throttle Operation. . .439
 - Driving In Snow, Mud And Sand439
 - Crossing Obstacles (Rocks And Other High Points)441
 - Hill Climbing443
 - Driving Through Water446
 - After Driving Off-Road449
- POWER STEERING450
 - Power Steering Fluid Check451
- PARKING BRAKE452
- ANTI-LOCK BRAKE SYSTEM455
- ELECTRONIC BRAKE CONTROL SYSTEM456

- Traction Control System (TCS) 457
- Brake Assist System (BAS) 457
- Hill Start Assist (HSA) 458
- Electronic Roll Mitigation (ERM) 462
- Electronic Stability Control (ESC) 463
- ESC Activation/Malfunction Indicator Light
And ESC OFF Indicator Light 468
- Trailer Sway Control (TSC) 469
- Hill Descent Control (HDC) – If Equipped . . 470
- **TIRE SAFETY INFORMATION 471**
- Tire Markings 471
- Tire Identification Number (TIN). 475
- Tire Terminology And Definitions 476

- Tire Loading And Tire Pressure 477
- **TIRES — GENERAL INFORMATION. 482**
- Tire Pressure 482
- Tire Inflation Pressures 483
- Tire Pressures For High Speed Operation . . . 485
- Radial Ply Tires 485
- All Season Tires – If Equipped 485
- Summer Or Three Season Tires – If Equipped. 486
- Snow Tires 486
- Spare Tire Matching Original Equipped Tire
And Wheel – If Equipped. 487
- Compact Spare Tire – If Equipped 487
- Full Size Spare – If Equipped 488

408 STARTING AND OPERATING

- Limited-Use Spare – If Equipped 488
- Tire Spinning 489
- Tread Wear Indicators 490
- Life Of Tire 490
- Replacement Tires 491
- TIRE CHAINS (TRACTION DEVICES) 492
- TIRE ROTATION RECOMMENDATIONS 494
- TIRE PRESSURE MONITOR SYSTEM (TPMS) . . 495
 - Premium and Base TPM System 498
 - Premium System – If Equipped. 501
 - General Information 506
- FUEL REQUIREMENTS 506
 - 3.6L Engine. 506
 - Reformulated Gasoline 507
 - Gasoline/Oxygenate Blends 507
 - E-85 Usage In Non-Flex Fuel Vehicles 508
 - MMT In Gasoline 508
 - Materials Added To Fuel 509
 - Fuel System Cautions. 509
 - Carbon Monoxide Warnings 510
- ADDING FUEL 510
 - Fuel Filler Cap (Gas Cap) 510
 - Loose Fuel Filler Cap Message 512
- VEHICLE LOADING 513
 - Certification Label 513

<ul style="list-style-type: none"> ■ TRAILER TOWING515 <ul style="list-style-type: none"> □ Common Towing Definitions515 □ Trailer Hitch Classification518 □ Trailer Towing Weights (Maximum Trailer Weight Ratings)519 □ Trailer And Tongue Weight524 □ Towing Requirements525 □ Towing Tips530 	<ul style="list-style-type: none"> ■ RECREATIONAL TOWING (BEHIND MOTORHOME, ETC.)532 <ul style="list-style-type: none"> □ Towing This Vehicle Behind Another Vehicle . .532 □ Recreational Towing – Four-Wheel Drive Models533
------------------------------------------------------------------------------------------------------------------------------------------------------------------------------------------------------------------------------------------------------------------------------------------------------------------------------------------------------------------------------------------------------------------------------------------------------------------------	----------------------------------------------------------------------------------------------------------------------------------------------------------------------------------------------------------------------------------------------------------------------------------------------------------------

STARTING PROCEDURES

Before starting your vehicle, adjust your seat, adjust both inside and outside mirrors, and fasten your seat belts.

WARNING!

- When leaving the vehicle, always remove the key fob from the ignition and lock your vehicle.
- Never leave children alone in a vehicle, or with access to an unlocked vehicle. Allowing children to be in a vehicle unattended is dangerous for a number of reasons. A child or others could be seriously or fatally injured. Children should be warned not to touch the parking brake, brake pedal or the shift lever.

Manual Transmission – If Equipped

Apply the parking brake, place the shift lever in NEUTRAL, and press the clutch pedal before starting the vehicle. This vehicle is equipped with a clutch interlocking ignition system. It will not start unless the clutch pedal is pressed to the floor.

Four-Wheel Drive Models Only

In 4L mode, this vehicle will start regardless of whether or not the clutch pedal is pressed to the floor. This feature enhances off-road performance by allowing the vehicle to start when in 4L without having to press the clutch pedal. The “4WD Indicator Light” will illuminate when the transfer case has been shifted into this mode.

Automatic Transmission – If Equipped

Start the vehicle with the shift lever in the PARK position (vehicle can also be started in NEUTRAL). Apply the brake before shifting to any driving range.

Normal Starting

NOTE: Normal starting of either a cold or a warm engine is obtained without pumping or pressing the accelerator pedal.

Turn the ignition switch to the START position and release when the engine starts. If the engine fails to start within 10 seconds, turn the ignition switch to the LOCK position, wait 10 to 15 seconds, then repeat the “Normal Starting” procedure.

Tip Start Feature – Automatic Transmission Only

Turn the ignition switch to the START position and release it as soon as the starter engages. The starter motor will continue to run, but will automatically disengage itself when the engine is running. If the engine fails to start, the starter will disengage automatically in 10 seconds. If this occurs, turn the ignition switch to the LOCK position, wait 10 to 15 seconds, then repeat the “Normal Starting” procedure.

Extreme Cold Weather (Below -20°F Or -29°C)

To ensure reliable starting at these temperatures, use of an externally powered electric engine block heater (available from your authorized dealer) is recommended.

If Engine Fails To Start

WARNING!

- Never pour fuel or other flammable liquids into the throttle body air inlet opening in an attempt to start the vehicle. This could result in a flash fire causing serious personal injury.
- Do not attempt to push or tow your vehicle to get it started. Vehicles equipped with an automatic transmission cannot be started this way. Unburned fuel could enter the catalytic converter and, once the engine has started, ignite and damage the converter and vehicle.

(Continued)

WARNING! (Continued)

- If the vehicle has a discharged battery, booster cables may be used to obtain a start from a booster battery or the battery in another vehicle. This type of start can be dangerous if done improperly. Refer to “Jump Starting” in “What To Do In Emergencies” for further information.

Without Tip Start – Manual Transmission Only

If the engine fails to start after you have followed the “Normal Starting” or “Extreme Cold Weather” procedures, it may be flooded. Push the accelerator pedal all the way to the floor and hold it there while cranking the engine. This should clear any excess fuel in case the engine is flooded.

CAUTION!

To prevent damage to the starter, do not crank the engine for more than 15 seconds at a time. Wait 10 to 15 seconds before trying again.

If the engine has been flooded, it may start to run, but not have enough power to continue running when the key is released. If this occurs, continue cranking with the accelerator pedal pushed all the way to the floor. Release the accelerator pedal and the key once the engine is running smoothly.

If the engine shows no sign of starting after two 15-second periods of cranking with the accelerator pedal held to the floor, repeat the “Normal Starting” or “Extreme Cold Weather” procedures.

With Tip Start – Automatic Transmission Only

If the engine fails to start after you have followed the “Normal Starting” or “Extreme Cold Weather” procedures, it may be flooded. To clear any excess fuel, push the accelerator pedal all the way to the floor and hold it. Then, turn the ignition switch to the START position and release it as soon as the starter engages. The starter motor will disengage automatically in 10 seconds. Once this occurs, release the accelerator pedal, turn the ignition switch to the LOCK position, wait 10 to 15 seconds, then repeat the “Normal Starting” procedure.

CAUTION!

To prevent damage to the starter, wait 10 to 15 seconds before trying again.

After Starting

The idle speed is controlled automatically and it will decrease as the engine warms up.

ENGINE BLOCK HEATER — IF EQUIPPED

The engine block heater warms the engine, and permits quicker starts in cold weather. Connect the cord to a standard 110-115 Volt AC electrical outlet with a grounded, three-wire extension cord.

The engine block heater must be plugged in at least one hour to have an adequate warming effect on the engine.

The engine block heater cord is found under the hood bundled in front of the battery tray.

WARNING!

Remember to disconnect the engine block heater cord before driving. Damage to the 110-115 Volt AC electrical cord could cause electrocution.

MANUAL TRANSMISSION — IF EQUIPPED**WARNING!**

You or others could be injured if you leave the vehicle unattended without having the parking brake fully applied. The parking brake should always be applied when the driver is not in the vehicle, especially on an incline.

CAUTION!

Never drive with your foot resting on the clutch pedal, or attempt to hold the vehicle on a hill with the clutch pedal partially engaged, as this will cause abnormal wear on the clutch.

NOTE: During cold weather, you may experience increased effort in shifting until the transmission fluid warms up. This is normal.

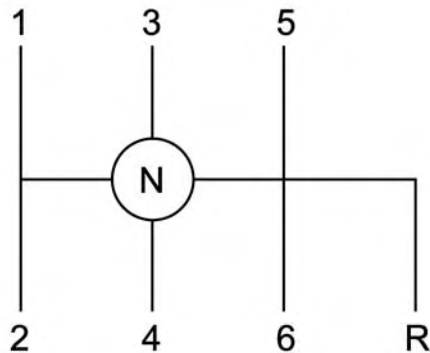

Shift Pattern

81cd6226

Shifting

Fully press the clutch pedal before shifting gears. As you release the clutch pedal, lightly press the accelerator pedal.

You should always use first gear when starting from a standing position.

Recommended Vehicle Shift Speeds

To utilize your manual transmission efficiently for both fuel economy and performance, it should be upshifted as listed in recommended shift speed chart. Shift at the vehicle speeds listed for acceleration. When heavily loaded or pulling a trailer these recommended up-shift speeds may not apply.

Manual Transmission Shift Speeds in MPH (KM/H)						
Engine	Speeds	1 to 2	2 to 3	3 to 4	4 to 5	5 to 6
3.6L	Accel.	15 (24)	24 (39)	34 (55)	47 (76)	56 (90)
	Cruise	10 (16)	19 (31)	27 (43)	37 (60)	41 (66)

NOTE: Vehicle speeds shown in the chart above are for 2H and 4H only, vehicle speeds in 4L would be significantly less.

Downshifting

Moving from a high gear down to a lower gear is recommended to preserve brakes when driving down steep hills. In addition, downshifting at the right time provides better acceleration when you desire to resume speed. Downshift progressively. Do not skip gears to avoid overspeeding the engine and clutch.

WARNING!

Do not downshift for additional engine braking on a slippery surface. The drive wheels could lose their grip, and the vehicle could skid.

CAUTION!

When descending a hill, be very careful to downshift one gear at a time to prevent overspeeding the engine which can cause valve damage, and/or clutch disc damage, even if the clutch pedal is pressed.

Maximum Recommended Downshift Speeds

CAUTION!

Failure to follow the maximum recommended downshifting speeds may cause the engine to overspeed and/or damage the clutch disc, even if the clutch pedal is pressed.

Manual Transmission Downshift Speeds in MPH (KM/H)					
Gear Selection	6 to 5	5 to 4	4 to 3	3 to 2	2 to 1
Maximum Speed	80 (129)	70 (113)	50 (81)	30 (48)	15 (24)

NOTE: Vehicle speeds shown in the chart above are for 2H and 4H only, vehicle speeds in 4L would be significantly less.

Reverse Shifting

To shift into REVERSE, bring the vehicle to a complete stop. Press the clutch and pause briefly to allow the gear train to stop rotating. Beginning from the NEUTRAL position, move the shift lever in one quick, smooth motion straight across and into the REVERSE area (the driver will feel a firm “click” as the shifter passes the “knock-over”). Complete the shift by pulling the shift lever into REVERSE.

The “knock-over” prevents the driver from accidentally entering the REVERSE shift area and warns the driver that they are about to shift the transmission into REVERSE. Due to this feature, a slow shift to REVERSE can be perceived as a high shift effort.

AUTOMATIC TRANSMISSION — IF EQUIPPED**CAUTION!**

Damage to the transmission may occur if the following precautions are not observed:

- Shift into PARK only after the vehicle has come to a complete stop.
- Shift into or out of REVERSE only after the vehicle has come to a complete stop and the engine is at idle speed.
- Do not shift between PARK, REVERSE, NEUTRAL, or DRIVE when the engine is above idle speed.
- Before shifting into any gear, make sure your foot is firmly pressing the brake pedal.

NOTE: You must press and hold the brake pedal while shifting out of PARK.

WARNING!

- Unintended movement of a vehicle could injure those in or near the vehicle. As with all vehicles, you should never exit a vehicle while the engine is running. Before exiting a vehicle, always apply the parking brake, shift the transmission into PARK, and remove the ignition key. Once the ignition key is removed, the shift lever is locked in PARK, securing the vehicle against unwanted movement.
- When leaving the vehicle, always remove the key fob from the ignition key and lock your vehicle. Never leave children alone in a vehicle, or with access to an unlocked vehicle. Allowing children to be in a vehicle unattended is dangerous for a

(Continued)

WARNING! (Continued)

number of reasons. A child or others could be seriously or fatally injured. Children should be warned not to touch the parking brake, brake pedal or the shift lever. Do not leave the ignition key in or near the vehicle. A child could operate power windows, other controls, or move the vehicle.

- It is dangerous to move the shift lever out of PARK or NEUTRAL if the engine speed is higher than idle speed. If your foot is not firmly pressing the brake pedal, the vehicle could accelerate quickly forward or in reverse. You could lose control of the vehicle and hit someone or something. Only shift into gear when the engine is idling normally and your foot is firmly pressing the brake pedal.

Key Ignition Park Interlock

This vehicle is equipped with a Key Ignition Park Interlock which requires the shift lever to be placed in PARK before the ignition switch can be turned to the LOCK/OFF position. The key can only be removed from the ignition when the ignition is in the LOCK/OFF position and once removed the shift lever is locked in PARK.

Brake/Transmission Shift Interlock System

This vehicle is equipped with a Brake Transmission Shift Interlock System (BTSI) that holds the shift lever in PARK unless the brakes are applied. To move the shift lever out of PARK, the ignition switch must be turned to the ON/RUN position (engine running or not) and the brake pedal must be pressed.

Five-Speed Automatic Transmission

The shift lever position display (located in the instrument cluster) indicates the transmission gear range. You must press the brake pedal to move the shift lever out of PARK (refer to “Brake/Transmission Shift Interlock System” in this section). To drive, move the shift lever from PARK or NEUTRAL to the DRIVE position.

The electronically-controlled transmission provides a precise shift schedule. The transmission electronics are self-calibrating; therefore, the first few shifts on a new vehicle may be somewhat abrupt. This is a normal condition, and precision shifts will develop within a few hundred miles (kilometers).

Only shift from DRIVE to PARK or REVERSE when the accelerator pedal is released and the vehicle is stopped. Be sure to keep your foot on the brake pedal when moving the shift lever between these gears.

The transmission shift lever has only PARK, REVERSE, NEUTRAL, and DRIVE shift positions. Manual downshifts can be made using the Electronic Range Select (ERS) shift control (refer to “Electronic Range Select (ERS) Operation” in this section). Moving the shift lever to the left or right (-/+) while in the DRIVE position will select the highest available transmission gear, and will display that gear in the instrument cluster as 4, 3, 2, 1.

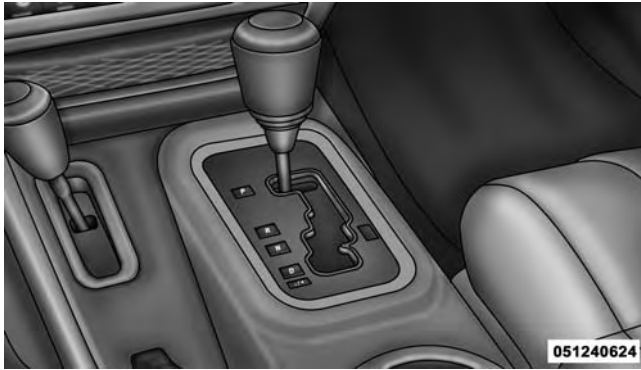

Shift Lever

Gear Ranges

DO NOT race the engine when shifting from PARK or NEUTRAL into another gear range.

NOTE: After selecting any gear range, wait a moment to allow the selected gear to engage before accelerating. This is especially important when the engine is cold.

PARK

This range supplements the parking brake by locking the transmission. The engine can be started in this range. Never attempt to use PARK while the vehicle is in motion. Apply the parking brake when leaving the vehicle in this range.

When parking on a level surface, you may place the shift lever in PARK first, and then apply the parking brake.

When parking on a hill, apply the parking brake before placing the shift lever in PARK, otherwise the load on the transmission locking mechanism may make it difficult to move the shift lever out of PARK. As an added precaution, turn the front wheels toward the curb on a downhill grade and away from the curb on an uphill grade.

WARNING!

- Never use the PARK position as a substitute for the parking brake. Always apply the parking brake fully when parked to guard against vehicle movement and possible injury or damage.
- Your vehicle could move and injure you and others if it is not completely in PARK. Check by trying to move the shift lever rearward (with the brake pedal released), after you have placed it in PARK. Make sure the transmission is in PARK before leaving the vehicle.
- It is dangerous to move the shift lever out of PARK or NEUTRAL if the engine speed is higher than idle speed. If your foot is not firmly pressing the brake pedal, the vehicle could accelerate quickly forward or in reverse. You could lose control of the vehicle and hit someone or something. Only shift

(Continued)

WARNING! (Continued)

- into gear when the engine is idling normally and when your foot is firmly pressing the brake pedal.
- Unintended movement of a vehicle could injure those in or near the vehicle. As with all vehicles, you should never exit a vehicle while the engine is running. Before exiting a vehicle, always apply the parking brake, shift the transmission into PARK, and remove the ignition key. Once the ignition key is removed, the shift lever is locked in the PARK position, securing the vehicle against unwanted movement.
- When leaving the vehicle, always remove the key fob from the ignition and lock your vehicle. Never leave children alone in a vehicle, or with access to an unlocked vehicle. Allowing children to be in a vehicle unattended is dangerous for a number of

(Continued)

WARNING! (Continued)

reasons. A child or others could be seriously or fatally injured. Children should be warned not to touch the parking brake, brake pedal or the shift lever. Do not leave the key in or near the vehicle. A child could operate power windows, other controls, or move the vehicle.

CAUTION!

- Before moving the shift lever out of PARK, you must turn the ignition switch from the LOCK/OFF position to the ON/RUN position, and also press the brake pedal. Otherwise, damage to the shift lever could result.
- DO NOT race the engine when shifting from PARK or NEUTRAL into another gear range, as this can damage the drivetrain.

The following indicators should be used to ensure that you have engaged the shift lever into the PARK position:

- When shifting into PARK, firmly move the shift lever all the way forward and to the left until it stops and is fully seated.
- Look at the shift lever position display and verify that it indicates the PARK position.
- With brake pedal released, verify that the shift lever will not move out of PARK.

REVERSE

This range is for moving the vehicle backward. Shift into REVERSE only after the vehicle has come to a complete stop.

NEUTRAL

Use this range when the vehicle is standing for prolonged periods with the engine running. The engine may be started in this range. Apply the parking brake and shift the transmission into PARK if you must leave the vehicle.

WARNING!

Do not coast in NEUTRAL and never turn off the ignition to coast down a hill. These are unsafe practices that limit your response to changing traffic or road conditions. You might lose control of the vehicle and have a collision.

CAUTION!

Towing the vehicle, coasting, or driving for any other reason with the transmission in NEUTRAL can cause severe transmission damage. Refer to "Recreational Towing" in "Starting And Operating" and "Towing A Disabled Vehicle" in "What To Do In Emergencies" for further information.

DRIVE

This range should be used for most city and highway driving. It provides the smoothest upshifts and downshifts, and the best fuel economy. The transmission automatically upshifts through underdrive first, second, and third gears, direct fourth gear and overdrive fifth gear. The DRIVE position provides optimum driving characteristics under all normal operating conditions.

When frequent transmission shifting occurs (such as when operating the vehicle under heavy loading conditions, in hilly terrain, traveling into strong head winds, or while towing heavy trailers), use the Electronic Range Select (ERS) shift control (refer to “Electronic Range Select (ERS) Operation” in this section) to select a lower gear range. Under these conditions, using a lower gear range will improve performance and extend transmission life by reducing excessive shifting and heat buildup.

Transmission Limp Home Mode

Transmission function is monitored electronically for abnormal conditions. If a condition is detected that could result in transmission damage, Transmission Limp Home Mode is activated. In this mode, the transmission remains in the current gear until the vehicle is brought to a stop.

After the vehicle has stopped, the transmission will remain in second gear regardless of which forward gear is selected. PARK, REVERSE, and NEUTRAL will continue to operate. The Malfunction Indicator Light (MIL) may be illuminated. Limp Home Mode allows the vehicle to be driven to an authorized dealer for service without damaging the transmission.

In the event of a momentary problem, the transmission can be reset to regain all forward gears by performing the following steps:

1. Stop the vehicle.
2. Shift the transmission into PARK.
3. Turn the engine OFF.
4. Wait approximately 10 seconds.

- Restart the engine.
- Shift into the desired gear range. If the problem is no longer detected, the transmission will return to normal operation.

NOTE: Even if the transmission can be reset, we recommend that you visit your authorized dealer at your earliest possible convenience. Your authorized dealer has diagnostic equipment to determine if the problem could recur. If the transmission cannot be reset, authorized dealer service is required.

Electronic Range Select (ERS) Operation

The Electronic Range Select (ERS) shift control allows the driver to limit the highest available gear when the shift lever is in the DRIVE position. For example, if you shift

the transmission into 3 (third gear), the transmission will never shift above third gear, but will shift down into second and first gear normally.

You can switch between DRIVE and ERS mode at any vehicle speed. When the shift lever is in the DRIVE position, the transmission will operate automatically, shifting between all available gears. Tapping the shift lever to the left (-) will downshift the transmission, activate ERS mode, display the current gear in the instrument cluster, and maintain that gear as the top available gear. Once in ERS mode, tapping the shift lever to the left (-) or right (+) will change the top available gear.

To exit ERS mode, simply press and hold the shift lever to the right (+) until "D" is once again displayed in the shift lever position indicator in the instrument cluster.

WARNING!

Do not downshift for additional engine braking on a slippery surface. The drive wheels could lose their grip and the vehicle could skid, causing an accident or personal injury.

Screen Display	1	2	3	4	D
Actual Gear(s) Allowed	1	1-2	1-3	1-4	1-5

NOTE: To select the proper gear position for maximum deceleration (engine braking), tap the shift lever to the left (-) repeatedly as the vehicle slows. The transmission will shift to the range from which the vehicle can best be slowed down.

Overdrive Operation

The automatic transmission includes an electronically controlled Overdrive (fifth gear). The transmission will automatically shift into Overdrive if the following conditions are present:

- the shift lever is in the DRIVE position,
- vehicle speed is sufficiently high, and
- the driver is not heavily pressing the accelerator.

FOUR-WHEEL DRIVE OPERATION (COMMAND-TRAC I® OR ROCK-TRAC®)

WARNING!

Failure to engage a position completely can cause transfer case damage or loss of power and vehicle control. You could have a collision. Do not drive the vehicle unless the transfer case is fully engaged.

Operating Instructions/Precautions

The transfer case provides four mode positions:

- 2H (Two-wheel drive high range)
- 4H (Four-wheel drive high range)
- N (Neutral)
- 4L (Four-wheel drive low range)



Four-Wheel Drive Shift Controls

The transfer case is intended to be driven in the 2H position for normal street and highway conditions such as hard-surfaced roads.

In the event that additional traction is required, the transfer case 4H and 4L positions can be used to lock the front and rear driveshafts together, forcing the front and rear wheels to rotate at the same speed. This is accomplished by simply moving the shift lever to one of these positions. The 4H and 4L positions are intended for loose, slippery road surfaces only and not intended for normal driving. Driving in the 4H and 4L positions on hard-surfaced roads will cause increased tire wear and damage to the driveline components.

The “4WD Indicator Light” (located in the instrument cluster) alerts the driver that the vehicle is in four-wheel drive, and the front and rear driveshafts are locked together. The light will illuminate when the transfer case is shifted into the 4H position.

NOTE: Do not attempt to shift when only the front or rear wheels are spinning. The transfer case is not equipped with a synchronizer, and the front and rear

driveshaft speeds must be equal for a shift to take place. Shifting while only the front or rear wheels are spinning can cause damage to the transfer case.

When operating your vehicle in 4L, the engine speed will be approximately three times (four times for Rubicon models) that of the 2H or 4H positions at a given road speed. Take care not to overspeed the engine.

Proper operation of four-wheel drive vehicles depends on tires of equal size, type, and circumference on each wheel. Any difference will adversely affect shifting and cause damage to the transfer case.

Because four-wheel drive provides improved traction, there is a tendency to exceed safe turning and stopping speeds. Do not go faster than road conditions permit.

WARNING!

You or others could be injured if you leave the vehicle unattended with the transfer case in the N (Neutral) position without first fully engaging the parking brake. The transfer case N (Neutral) position disengages both the front and rear driveshaft from the powertrain, and will allow the vehicle to move regardless of the transmission position. The parking brake should always be applied when the driver is not in the vehicle.

Shift Positions

For additional information on the appropriate use of each transfer case mode position, see the information below:

2H Position

This range is used for normal street and highway driving on hard-surfaced roads.

4H Position

This range locks the front and rear driveshafts together, forcing the front and rear wheels to rotate at the same speed. This range (4H) provides additional traction for loose, slippery road surfaces and should not be used on dry pavement.

The “4WD Indicator Light” (located in the instrument cluster) will illuminate when the transfer case is shifted into the 4H position.

N (Neutral) Position

This range disengages the front and rear driveshafts from the powertrain. It is to be used for flat towing behind another vehicle. Refer to “Recreational Towing” in “Starting and Operating” for further information.

4L Position

This range locks the front and rear driveshafts together, forcing the front and rear wheels to rotate at the same

speed. This range (4L) provides additional traction and maximum pulling power for loose, slippery road surfaces only. Do not exceed 25 mph (40 km/h).

The “4WD Indicator Light” (located in the instrument cluster) will illuminate when the transfer case is shifted into the 4L position.

NOTE: When in 4WD, the “ESC Off Indicator Light” will display in the instrument cluster.

Shifting Procedure

2H to 4H or 4H to 2H

Shifting between 2H and 4H can be made with the vehicle stopped or in motion. With the vehicle in motion, the transfer case will engage/disengage faster if you momentarily release the accelerator pedal after completing the shift. Apply a constant force when shifting the transfer case lever.

4H to 4L or 4L to 4H

With the vehicle rolling at 2 to 3 mph (3 to 5 km/h), shift an automatic transmission into NEUTRAL (N), or press the clutch pedal on a manual transmission. While the vehicle is coasting at 2 to 3 mph (3 to 5 km/h), shift the transfer case lever firmly to the desired position. Do not pause with the transfer case in N (Neutral). Once the shift is completed, place the automatic transmission into DRIVE or release the clutch pedal on a manual transmission.

NOTE: Shifting into or out of 4L is possible with the vehicle completely stopped; however, difficulty may occur due to the mating teeth not being properly aligned. Several attempts may be required for clutch teeth alignment and shift completion to occur. The preferred method is with the vehicle rolling at 2 to 3 mph (3 to 5 km/h). Avoid attempting to engage or disengage 4L with the vehicle moving faster than 2 to 3 mph (3 to 5 km/h).

WARNING!

Failure to engage a position completely can cause transfer case damage or loss of power and vehicle control. You could have a collision. Do not drive the vehicle unless the transfer case is fully engaged.

TRAC-LOK® REAR AXLE — IF EQUIPPED

The Trac-Lok® rear axle provides a constant driving force to both rear wheels and reduces wheel spin caused by the loss of traction at one driving wheel. If traction differs between the two rear wheels, the differential automatically proportions the usable torque by providing more torque to the wheel that has traction.

Trac-Lok® is especially helpful during slippery driving conditions. With both rear wheels on a slippery surface, a slight application of the accelerator will supply maximum traction.

WARNING!

On vehicles equipped with a limited-slip differential, never run the engine with one rear wheel off the ground. The vehicle may drive through the rear wheel remaining on the ground and cause you to lose control of your vehicle.

AXLE LOCK (TRU-LOK®) — RUBICON MODELS

The AXLE LOCK switch is located on the instrument panel (to the left of the steering column).

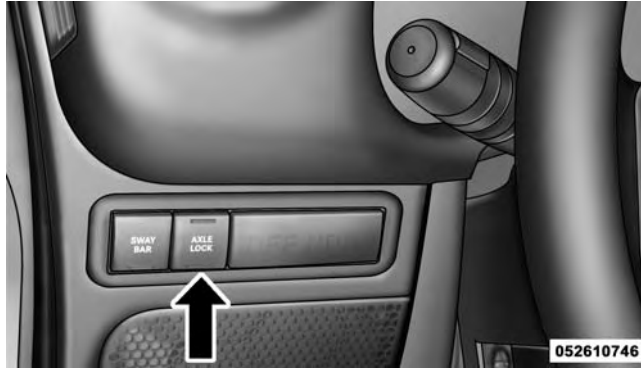

Axle Lock Switch

This feature will only activate when the following conditions are met:

- Key in ignition, vehicle in 4L (Low) range.
- Vehicle speed should be 10 mph (16 km/h) or less.

To activate the system, press the bottom of the AXLE LOCK switch once to lock the rear axle only (the “Rear Axle Lock Indicator Light” will illuminate), press the bottom of the switch again to lock the front axle (the “Front Axle Lock Indicator Light” will illuminate). When the rear axle is locked, pressing the switch again will lock or unlock the front axle.

NOTE: The indicator lights will flash until the axles are fully locked or unlocked.

To unlock the axles, press the top of the AXLE LOCK switch.

Axle lock will disengage if the vehicle is taken out of 4L (Low) range, or the ignition switch is turned to the OFF position.

ELECTRONIC SWAY BAR DISCONNECT — IF EQUIPPED

Your vehicle may be equipped with an electronic disconnecting stabilizer/sway bar. This system allows greater front suspension travel in off-road situations.

This system is controlled by the SWAY BAR switch located on the instrument panel (to the left of the steering column).

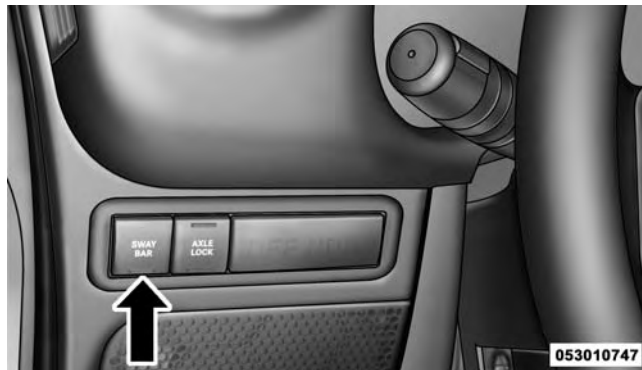

Sway Bar Switch

Press the SWAY BAR switch to activate the system. Press the switch again to deactivate the system. The “Sway Bar Indicator Light” (located in the instrument cluster) will illuminate when the bar is disconnected. The “Sway Bar Indicator Light” will flash during activation transition, or when activation conditions are not met. The stabilizer/

sway bar should remain in on-road mode during normal driving conditions.

WARNING!

Do not disconnect the stabilizer bar and drive on hard-surfaced roads or at speeds above 18 mph (29 km/h); you may lose control of the vehicle, which could result in serious injury. The front stabilizer bar enhances vehicle stability and is necessary for maintaining control of the vehicle. The system monitors vehicle speed and will attempt to reconnect the stabilizer bar at speeds over 18 mph (29 km/h). This is indicated by a flashing or solid "Sway Bar Indicator Light." Once vehicle speed is reduced below 14 mph (22 km/h), the system will once again attempt to return to off-road mode.

To disconnect the stabilizer/sway bar, shift to either 4H or 4L and press the SWAY BAR switch to obtain the off-road position. Refer to "Four-Wheel Drive Operation" in "Starting and Operating" for further information. The "Sway Bar Indicator Light" will flash until the stabilizer/sway bar has been fully disconnected.

NOTE: The stabilizer/sway bar may be torque locked due to left and right suspension height differences. This condition is due to driving surface differences or vehicle loading. In order for the stabilizer/sway bar to disconnect/reconnect, the right and left halves of the bar must be aligned. This alignment may require that the vehicle be driven onto level ground or rocked from side to side.

To return to on-road mode, press the SWAY BAR switch again.

WARNING!

If the stabilizer/sway bar will not return to on-road mode, vehicle stability is greatly reduced. Do not attempt to drive the vehicle over 18 mph (29 km/h). Driving faster than 18 mph (29 km/h) may cause loss of control of the vehicle, which could result in serious injury. Contact your local authorized dealer for assistance.

ON-ROAD DRIVING TIPS

Utility vehicles have higher ground clearance and a narrower track to make them capable of performing in a wide variety of off-road applications. Specific design characteristics give them a higher center of gravity than ordinary cars.

An advantage of the higher ground clearance is a better view of the road, allowing you to anticipate problems. They are not designed for cornering at the same speeds as conventional two-wheel drive vehicles any more than low-slung sports cars are designed to perform satisfactorily in off-road conditions. If at all possible, avoid sharp turns or abrupt maneuvers. As with other vehicles of this type, failure to operate this vehicle correctly may result in loss of control or vehicle rollover.

OFF-ROAD DRIVING TIPS

Side Step Removal – If Equipped

NOTE: Prior to off-road usage, the side steps should be removed to prevent damage.

1. Remove the two nuts from the bodyside.

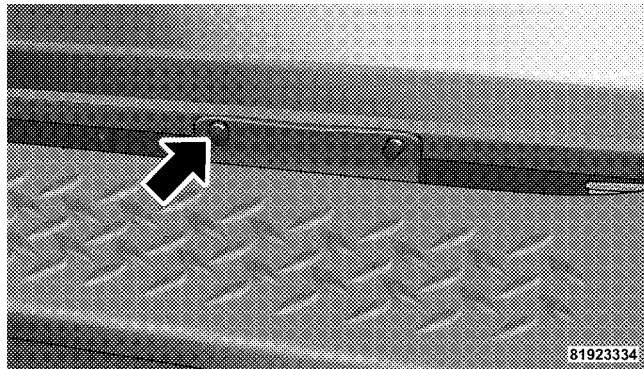

2. Remove one bolt from the underside of the vehicle.

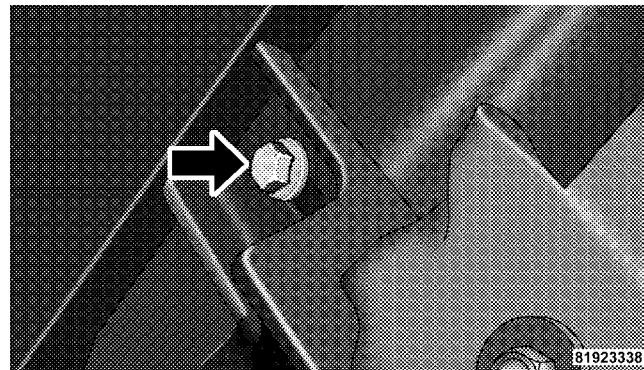

3. Remove the side step assembly.

The Basics Of Off-Road Driving

You will encounter many types of terrain driving off-road. You should be familiar with the terrain and area before proceeding. There are many types of surface conditions: hard-packed dirt, gravel, rocks, grass, sand, mud, snow and ice. Every surface has a different effect on your vehicle's steering, handling and traction. Controlling your vehicle is one of the keys to successful off-road driving, so always keep a firm grip on the steering wheel and maintain a good driving posture. Avoid sudden accelerations, turns or braking. In most cases, there are no road signs, posted speed limits or signal lights. Therefore, you will need to use your own good judgment on what is safe and what is not. When on a trail, you should always be looking ahead for surface obstacles and changes in terrain. The key is to plan your future driving route while remembering what you are currently driving over.

CAUTION!

Never park your vehicle over dry grass or other combustible materials. The heat from your vehicle exhaust system could cause a fire.

WARNING!

Always wear your seat belt and firmly tie down cargo. Unsecured cargo can become projectiles in an off-road situation.

When To Use 4L (Low) Range

When off-road driving, shift into 4L (Low) for additional traction and control on slippery or difficult terrain, ascending or descending steep hills, and to increase low speed pulling power. This range should be limited to

extreme situations such as deep snow, mud, steep inclines, or sand where additional low speed pulling power is needed. Vehicle speeds in excess of 25 mph (40 km/h) should be avoided when in 4L (Low) range.

CAUTION!

Do not use 4L (Low) range when operating the vehicle on dry pavement. Driveline hardware damage can result.

Simultaneous Brake And Throttle Operation

Many off-road driving conditions require the simultaneous use of the brake and throttle (two-footed driving). When climbing rocks, logs, or other stepped objects, using light brake pressure with light throttle will keep the vehicle from jerking or lurching. This technique is also used when you need to stop and restart a vehicle on a steep incline.

Driving In Snow, Mud And Sand

Snow

In heavy snow or for additional control and traction at slower speeds, shift the transmission into a low gear and the transfer case into 4L (Low) if necessary. Do not shift to a lower gear than necessary to maintain headway. Over-revving the engine can spin the wheels and traction will be lost. If you start to slow to a stop, try turning your steering wheel no more than a 1/4 turn quickly back and forth, while still applying throttle. This will allow the tires to get a fresh "bite" and help maintain your momentum.

CAUTION!

On icy or slippery roads, do not downshift at high engine RPM or vehicle speeds, because engine braking may cause skidding and loss of control.

Mud

Deep mud creates a great deal of suction around the tires and is very difficult to get through. You should use second gear (manual transmission), or DRIVE (automatic transmission), with the transfer case in the 4L (Low) position to maintain your momentum. If you start to slow to a stop, try turning your steering wheel no more than a 1/4 turn quickly back and forth for additional traction. Mud holes pose an increased threat of vehicle damage and getting stuck. They are normally full of debris from previous vehicles getting stuck. As a good practice before entering any mud hole, get out and determine how deep it is, if there are any hidden obstacles and if the vehicle can be safely recovered if stuck.

Sand

Soft sand is very difficult to travel through with full tire pressure. When crossing soft, sandy spots in a trail, maintain your vehicle's momentum and do not stop. The key to

driving in soft sand is using the appropriate tire pressure, accelerating slowly, avoiding abrupt maneuvers and maintaining the vehicle's momentum. If you are going to be driving on large soft sandy areas or dunes, reduce your tire pressure to a minimum of 15 psi (103 kPa) to allow for a greater tire surface area. Reduced tire pressure will drastically improve your traction and handling while driving on the soft sand, but you must return the tires to normal air pressure before driving on pavement or other hard surfaces. Be sure you have a way to reinflate the tires prior to reducing the pressure.

CAUTION!

Reduced tire pressures may cause tire unseating and total loss of air pressure. To reduce the risk of tire unseating, while at a reduced tire pressure, reduce your speed and avoid sharp turns or abrupt maneuvers.

Crossing Obstacles (Rocks And Other High Points)

While driving off-road, you will encounter many types of terrain. These varying types of terrain bring different types of obstacles. Before proceeding, review the path ahead to determine the correct approach and your ability to safely recover the vehicle if something goes wrong. Keeping a firm grip on the steering wheel, bring the vehicle to a complete stop and then inch the vehicle forward until it makes contact with the object. Apply the throttle lightly while holding a light brake pressure and ease the vehicle up and over the object.

WARNING!

Crossing obstacles can cause abrupt steering system loading which could cause you to loose control of your vehicle.

Using A Spotter

There are many times where it is hard to see the obstacle or determine the correct path. Determining the correct path can be extremely difficult when you are confronting many obstacles. In these cases have someone guide you over, through, or around the obstacle. Have the person stand a safe distance in front of you where they can see the obstacle, watch your tires and undercarriage, and guide you through.

Crossing Large Rocks

When approaching large rocks, choose a path which ensures you drive over the largest of them with your tires. This will lift your undercarriage over the obstacle. The tread of the tire is tougher and thicker than the side wall and is designed to take the abuse. Always look ahead and make every effort to cross the large rocks with your tires.

CAUTION!

- Never attempt to straddle a rock that is large enough to strike your axles or undercarriage.
- Never attempt to drive over a rock which is large enough to contact the door sills.

Crossing A Ravine, Gully, Ditch, Washout Or Rut

When crossing a ravine, gully, ditch, washout or a large rut, the angled approach is the key to maintaining your vehicle's mobility. Approach these obstacles at a 45-degree angle and let each tire go through the obstacle independently. You need to use caution when crossing large obstacles with steep sides. Do not attempt to cross any large obstacle with steep sides at an angle great enough to put the vehicle at risk of a rollover. If you get caught in a rut, dig a small trench to the right or left at a 45-degree angle ahead of the front tires. Use the removed dirt to fill the rut ahead of the

turnout you just created. You should now be able to drive out following the trench you just created at a 45-degree angle.

WARNING!

There is an increased risk of rollover when crossing an obstacle, at any angle, with steep sides.

Crossing Logs

To cross a log, approach it at a slight angle (approximately 10 to 15 degrees). This allows one front tire to be on top of the log while the other just starts to climb the log. While climbing the log, modulate your brake and accelerator to avoid spinning the log out from under your tires. Then ease the vehicle off the log using your brakes.

CAUTION!

Do not attempt to cross a log with a greater diameter than the running ground clearance or the vehicle will become high-centered.

Getting High-Centered

If you get hung up or high-centered on an object, get out of the vehicle and try to determine what the vehicle is hung up on, where it is contacting the underbody and what is the best direction to recover the vehicle. Depending on what you are in contact with, jack the vehicle up and place a few rocks under the tires so the weight is off of the high point when you let the vehicle down. You can also try rocking the vehicle or winching the vehicle off the object.

CAUTION!

Winching or rocking the vehicle off hard objects increases the risk of underbody damage.

Hill Climbing

Hill climbing requires good judgment and a good understanding of your abilities and your vehicle's limitations. Hills can cause serious problems. Some are just too steep to climb and should not be attempted. You should always feel confident with the vehicle and your abilities. You should always climb hills straight up and down. Never attempt to climb a hill on an angle.

Before Climbing A Steep Hill

As you approach a hill, consider its grade or steepness. Determine if it is too steep. Look to see what the traction is on the hill side trail. Is the trail straight up and down? What is on top and the other side? Are there ruts, rocks, branches or other obstacles on the path? Can you safely recover the vehicle if something goes wrong? If everything looks good and you feel confident, shift the transmission into a lower gear with 4L (Low) engaged, and proceed with caution, maintaining your momentum as you climb the hill.

Driving Up Hill

Once you have determined your ability to proceed and have shifted into the appropriate gear, line your vehicle up for the straightest possible run. Accelerate with an easy constant throttle and apply more power as you start up the hill. Do not race forward into a steep grade; the abrupt change of grade could cause you to lose control.

If the front end begins to bounce, ease off the throttle slightly to bring all four tires back on the ground. As you approach the crest of the hill, ease off the throttle and slowly proceed over the top. If the wheels start to slip as you approach the crest of a hill, ease off the accelerator and maintain headway by turning the steering wheel no more than a 1/4 turn quickly back and forth. This will provide a fresh "bite" into the surface and will usually provide enough traction to complete the climb. If you do not make it to the top, place the vehicle in REVERSE and back straight down the grade using engine resistance along with the vehicle brakes.

WARNING!

Never attempt to climb a hill at an angle or turn around on a steep grade. Driving across an incline increases the risk of a rollover, which may result in severe injury.

Driving Downhill

Before driving down a steep hill, you need to determine if it is too steep for a safe descent. What is the surface traction? Is the grade too steep to maintain a slow, controlled descent? Are there obstacles? Is it a straight descent? Is there plenty of distance at the base of the hill to regain control if the vehicle descends too fast? If you feel confident in your ability to proceed, then make sure you are in 4L (Low) and proceed with caution. Allow engine braking to control the descent and apply your brakes, if necessary, but do not allow the tires to lock.

WARNING!

Do not descend a steep grade in NEUTRAL. Use vehicle brakes in conjunction with engine braking. Descending a grade too fast could cause you to lose control and be seriously injured.

Driving Across An Incline

If at all possible, avoid driving across an incline. If it is necessary, know your vehicle's abilities. Driving across an incline places more weight on the downhill wheels, which increases the possibilities of a downhill slide or rollover. Make sure the surface has good traction with firm and stable soils. If possible, transverse the incline at an angle heading slightly up or down.

WARNING!

Driving across an incline increases the risk of a rollover, which may result in severe injury.

If You Stall Or Begin To Lose Headway

If you stall or begin to lose headway while climbing a steep hill, allow your vehicle to come to a stop and immediately apply the brake. Restart the engine and shift into REVERSE. Back slowly down the hill allowing engine braking to control the descent and apply your brakes, if necessary, but do not allow the tires to lock.

WARNING!

If the engine stalls or you lose headway or cannot make it to the top of a steep hill or grade, never attempt to turn around. To do so may result in tipping and rolling the vehicle, which may result in severe injury. Always back carefully straight down a hill in REVERSE. Never back down a hill in NEUTRAL using only the vehicle brakes. Never drive diagonally across a hill, always drive straight up or down.

Driving Through Water

Extreme care should be taken crossing any type of water. Water crossings should be avoided, if possible, and only be attempted when necessary in a safe, responsible manner. You should only drive through areas which are designated and approved. You should tread lightly and avoid damage to the environment. You should know your vehicle's abilities and be able to recover if something goes wrong. You should never stop or shut a vehicle off when crossing deep water unless you ingested water into the engine air intake. If the engine stalls, do not attempt to restart it. Determine if it has ingested water first. The key to any crossing is low and slow. Shift into first gear (manual transmission), or DRIVE (automatic transmission), with the transfer case in the 4L (Low) position and proceed very slowly with a constant slow speed {3 to 5 mph (5 to 8 km/h) maximum} and light throttle. Keep the vehicle moving; do not try to

accelerate through the crossing. After crossing any water higher than the bottom of the axle differentials, you should inspect all of the vehicle fluids for signs of water ingestion.

CAUTION!

- **Water ingestion into the axles, transmission, transfer case, engine or vehicle interior can occur if you drive too fast or through too deep of water. Water can cause permanent damage to engine, driveline or other vehicle components, and your brakes will be less effective once wet and/or muddy.**
- **This vehicle is capable of crossing through water at a depth of 30 inches (76 cm) at speeds no greater than 5 mph (8 km/h). Water ingestion can occur causing damage to your vehicle.**

Before You Cross Any Type Of Water

As you approach any type of water, you need to determine if you can cross it safely and responsibly. If necessary, get out and walk through the water or probe it with a stick. You need to be sure of its depth, approach angle, current and bottom condition. Be careful of murky or muddy waters; check for hidden obstacles. Make sure you will not be intruding on any wildlife, and you can recover the vehicle if necessary. The key to a safe crossing is the water depth, current and bottom conditions. On soft bottoms, the vehicle will sink in, effectively increasing the water level on the vehicle. Be sure to consider this when determining the depth and the ability to safely cross.

Crossing Puddles, Pools, Flooded Areas Or Other Standing Water

Puddles, pools, flooded or other standing water areas normally contain murky or muddy waters. These water types normally contain hidden obstacles and make it difficult to determine an accurate water depth, approach angle, and bottom condition. Murky or muddy water holes are where you want to hook up tow straps prior to entering. This makes for a faster, cleaner and easier vehicle recovery. If you are able to determine you can safely cross, than proceed using the low and slow method.

CAUTION!

Muddy waters can reduce the cooling system effectiveness by depositing debris onto the radiator.

Crossing Ditches, Streams, Shallow Rivers Or Other Flowing Water

Flowing water can be extremely dangerous. Never attempt to cross a fast running stream or river even in shallow water. Fast moving water can easily push your vehicle downstream, sweeping it out of control. Even in very shallow water, a high current can still wash the dirt out from around your tires putting you and your vehicle in jeopardy. There is still a high risk of personal injury and vehicle damage with slower water currents in depths greater than the vehicle's running ground clearance. You should never attempt to cross flowing water which is deeper than the vehicle's running ground clearance. Even the slowest current can push the heaviest vehicle downstream and out of control if the water is deep enough to push on the large surface area of the vehicle's body. Before you proceed, determine the speed of the current, the water's depth, approach angle, bottom condition and if there are any obstacles. Then cross at an angle heading slightly upstream using the low and slow technique.

WARNING!

Never drive through fast moving deep water. It can push your vehicle downstream, sweeping it out of control. This could put you and your passengers at risk of injury or drowning.

After Driving Off-Road

Off-road operation puts more stress on your vehicle than does most on-road driving. After going off-road, it is always a good idea to check for damage. That way you can get any problems taken care of right away and have your vehicle ready when you need it.

- Completely inspect the underbody of your vehicle. Check tires, body structure, steering, suspension, and exhaust system for damage.
- Inspect the radiator for mud and debris and clean as required.
- Check threaded fasteners for looseness, particularly on the chassis, drivetrain components, steering, and suspension. Retighten them, if required, and torque to the values specified in the Service Manual.
- Check for accumulations of plants or brush. These things could be a fire hazard. They might hide damage to fuel lines, brake hoses, axle pinion seals, and propeller shafts.
- After extended operation in mud, sand, water, or similar dirty conditions, have the radiator, fan, brake rotors, wheels, brake linings, and axle yokes inspected and cleaned as soon as possible.

WARNING!

Abrasive material in any part of the brakes may cause excessive wear or unpredictable braking. You might not have full braking power when you need it to prevent a collision. If you have been operating your vehicle in dirty conditions, get your brakes checked and cleaned as necessary.

- If you experience unusual vibration after driving in mud, slush or similar conditions, check the wheels for impacted material. Impacted material can cause a wheel imbalance and freeing the wheels of it will correct the situation.

POWER STEERING

The standard power steering system will give you good vehicle response and increased ease of maneuverability in tight spaces. The system will provide mechanical steering capability if power assist is lost.

If for some reason the power assist is interrupted, it will still be possible to steer your vehicle. Under these conditions, you will observe a substantial increase in steering effort, especially at very low vehicle speeds and during parking maneuvers.

NOTE:

- Increased noise levels at the end of the steering wheel travel are considered normal and do not indicate that there is a problem with the power steering system.

- Upon initial start-up in cold weather, the power steering pump may make noise for a short amount of time. This is due to the cold, thick fluid in the steering system. This noise should be considered normal, and it does not in any way damage the steering system.

WARNING!

Continued operation with reduced power steering assist could pose a safety risk to yourself and others. Service should be obtained as soon as possible.

CAUTION!

Prolonged operation of the steering system at the end of the steering wheel travel will increase the steering fluid temperature and it should be avoided when possible. Damage to the power steering pump may occur.

Power Steering Fluid Check

Checking the power steering fluid level at a defined service interval is not required. The fluid should only be checked if a leak is suspected, abnormal noises are apparent, and/or the system is not functioning as anticipated. Coordinate inspection efforts through an authorized dealer.

CAUTION!

Do not use chemical flushes in your power steering system as the chemicals can damage your power steering components. Such damage is not covered by the New Vehicle Limited Warranty.

WARNING!

Fluid level should be checked on a level surface and with the engine off to prevent injury from moving parts and to ensure accurate fluid level reading. Do not overfill. Use only manufacturer's recommended power steering fluid.

If necessary, add fluid to restore to the proper indicated level. With a clean cloth, wipe any spilled fluid from all surfaces. Refer to "Fluids, Lubricants, and Genuine Parts" in "Maintaining Your Vehicle" for further information.

PARKING BRAKE

Before leaving the vehicle, make sure that the parking brake is fully applied. Also, be certain to leave an automatic transmission in PARK, or manual transmission in REVERSE or first gear.

The parking brake lever is located in the center console. To apply the parking brake, pull the lever up as firmly as possible. To release the parking brake, pull the lever up slightly, press the center button, then lower the lever completely.

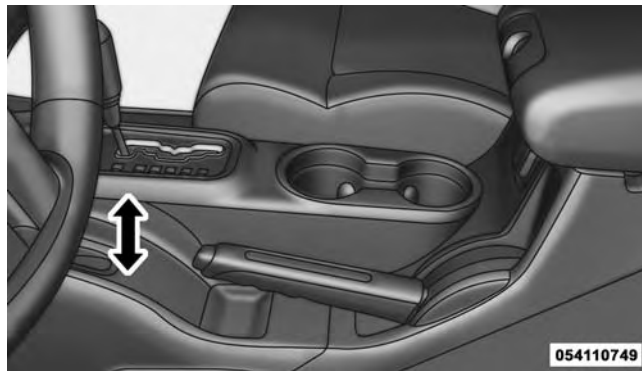

Parking Brake

When the parking brake is applied with the ignition switch ON, the “Brake Warning Light” in the instrument cluster will illuminate.

NOTE:

- When the parking brake is applied and the automatic transmission is placed in gear, the “Brake Warning Light” will flash. If vehicle speed is detected, a chime will sound to alert the driver. Fully release the parking brake before attempting to move the vehicle.
- This light only shows that the parking brake is applied. It does not show the degree of brake application.

When parking on a hill, it is important to turn the front wheels toward the curb on a downhill grade and away from the curb on an uphill grade. For vehicles equipped with an automatic transmission, apply the parking brake

before placing the shift lever in PARK, otherwise the load on the transmission locking mechanism may make it difficult to move the shift lever out of PARK. The parking brake should always be applied whenever the driver is not in the vehicle.

WARNING!

- **Never use the PARK position on an automatic transmission as a substitute for the parking brake. Always apply the parking brake fully when parked to guard against vehicle movement and possible injury or damage.**
- **When leaving the vehicle, always remove the key fob from the ignition and lock your vehicle.**

(Continued)

WARNING! (Continued)

- Never leave children alone in a vehicle, or with access to an unlocked vehicle. Allowing children to be in a vehicle unattended is dangerous for a number of reasons. A child or others could be seriously or fatally injured. Children should be warned not to touch the parking brake, brake pedal or the shift lever.
- Do not leave the key in or near the vehicle. A child could operate power windows, other controls, or move the vehicle.
- Be sure the parking brake is fully disengaged before driving; failure to do so can lead to brake failure and a collision.

(Continued)

WARNING! (Continued)

- Always fully apply the parking brake when leaving your vehicle or it may roll and cause damage or injury. Also, be certain to leave an automatic transmission in PARK, a manual transmission in REVERSE or first gear. Failure to do so may cause the vehicle to roll and cause damage or injury.

CAUTION!

If the "Brake Warning Light" remains on with the parking brake released, a brake system malfunction is indicated. Have the brake system serviced by an authorized dealer immediately.

ANTI-LOCK BRAKE SYSTEM

The Anti-Lock Brake System (ABS) is designed to aid the driver in maintaining vehicle control under adverse braking conditions. The system operates with a separate computer to modulate hydraulic pressure to prevent wheel lock-up and help avoid skidding on slippery surfaces.

All vehicle wheels and tires must be the same size and type, and tires must be properly inflated to produce accurate signals for the computer.

WARNING!

Significant over or under-inflation of tires, or mixing sizes of tires or wheels on the vehicle can lead to loss of braking effectiveness.

The Anti-Lock Brake System conducts a low speed self-test at about 12 mph (20 km/h). If for any reason your foot is on the brake when the vehicle reaches 12 mph (20 km/h), this check will be delayed until 25 mph (40 km/h).

The Anti-Lock Brake System pump motor runs during the self-test, and during an ABS stop, to provide the regulated hydraulic pressure. The motor pump makes a low humming noise during operation; this is normal.

WARNING!

- Pumping of the Anti-Lock Brakes will diminish their effectiveness and may lead to a collision. Pumping makes the stopping distance longer. Just press firmly on your brake pedal when you need to slow down or stop.

(Continued)

WARNING! *(Continued)*

- The Anti-Lock Brake System (ABS) cannot prevent the natural laws of physics from acting on the vehicle, nor can they increase braking or steering efficiency beyond that afforded by the condition of the vehicle brakes and tires or the traction afforded.
- The ABS cannot prevent collisions, including those resulting from excessive speed in turns, following another vehicle too closely, or hydroplaning.
- The capabilities of an ABS-equipped vehicle must never be exploited in a reckless or dangerous manner which could jeopardize the user's safety or the safety of others.

CAUTION!

The Anti-Lock Brake System is subject to possible detrimental effects of electronic interference caused by improperly installed aftermarket radios or telephones.

NOTE: During severe braking conditions, a pulsing sensation may occur and a clicking noise will be heard. This is normal, indicating that the Anti-Lock Brake System is functioning.

ELECTRONIC BRAKE CONTROL SYSTEM

Your vehicle is equipped with an advanced electronic brake control system that includes Anti-Lock Brake System (ABS), Traction Control System (TCS), Brake Assist System (BAS), Hill Start Assist (HSA), Electronic Roll Mitigation (ERM), Electronic Stability Control (ESC), Trailer Sway Control (TSC), and Hill Descent Control (HDC). All of these systems work together to enhance vehicle stability and control in various driving conditions, and are commonly referred to as ESC.

WARNING!

The Anti-Lock Brake System (ABS) cannot prevent the natural laws of physics from acting on the vehicle, nor can they increase the traction afforded by prevailing road conditions. The ABS cannot prevent collisions, including those resulting from excessive speed in turns, driving on very slippery surfaces, or hydroplaning. The capabilities of an ABS-equipped vehicle must never be exploited in a reckless or dangerous manner which could jeopardize the user's safety or the safety of others.

Traction Control System (TCS)

This system monitors the amount of wheel spin of each of the driven wheels. If wheel spin is detected, brake pressure is applied to the slipping wheel(s) to provide enhanced acceleration and stability. A feature of the TCS

system functions similar to a limited slip differential and controls the wheel spin across a driven axle. If one wheel on a driven axle is spinning faster than the other, the system will apply the brake of the spinning wheel. This will allow more engine torque to be applied to the wheel that is not spinning. This feature remains active even if TCS and ESC are in either the "Partial Off" or "Full Off" modes. Refer to "Electronic Stability Control (ESC)" in this section for further information.

Brake Assist System (BAS)

The BAS is designed to optimize the vehicle's braking capability during emergency braking maneuvers. The system detects an emergency braking situation by sensing the rate and amount of brake application and then applies optimum pressure to the brakes. This can help reduce braking distances. The BAS complements the anti-lock brake system (ABS). Applying the brakes very quickly results in the best BAS assistance. To receive the

benefit of the system, you must apply continuous braking pressure during the stopping sequence. Do not reduce brake pedal pressure unless braking is no longer desired. Once the brake pedal is released, the BAS is deactivated.

WARNING!

The Brake Assist System (BAS) cannot prevent the natural laws of physics from acting on the vehicle, nor can it increase the traction afforded by prevailing road conditions. The BAS cannot prevent collisions, including those resulting from excessive speed in turns, driving on very slippery surfaces, or hydroplaning. The capabilities of a BAS-equipped vehicle must never be exploited in a reckless or dangerous manner which could jeopardize the user's safety or the safety of others.

Hill Start Assist (HSA)

The HSA system is designed to assist the driver when starting a vehicle from a stop on a hill. HSA will maintain the level of brake pressure the driver applied for a short period of time after the driver takes their foot off of the brake pedal. If the driver does not apply the throttle during this short period of time, the system will release brake pressure and the vehicle will roll down the hill. The system will release brake pressure in proportion to amount of throttle applied as the vehicle starts to move in the intended direction of travel.

WARNING!

If the clutch pedal (manual transmission only) remains pressed during the application of the throttle, the HSA will disengage allowing the vehicle to roll down the incline. This could cause a collision with

(Continued)

WARNING! (Continued)

another vehicle or object. To avoid this, do not apply throttle while pressing the clutch pedal until you are ready to release the clutch. Always remember the driver is responsible for braking the vehicle.

HSA Activation Criteria

The following criteria must be met in order for HSA to activate:

- Vehicle must be stopped
- Vehicle must be on an 8% or greater incline (3% for manual transmission equipped vehicles)
- Gear selection matches vehicle uphill direction (i.e., vehicle facing uphill is in forward gear; vehicle backing uphill is in REVERSE gear).

WARNING!

There may be situations on minor hills (i.e., less than 8%), with a loaded vehicle, or while pulling a trailer where the system will not activate and slight rolling may occur, which could cause a collision with another vehicle or object. Always remember the driver is responsible for braking the vehicle.

The system will only work if the intended direction of the vehicle and vehicle gear match. For example, if the intended direction is forward up a hill and the vehicle is in DRIVE (automatic transmission equipped vehicle), and the activation criteria are met, HSA will activate.

HSA On Automatic Transmission Vehicles

The system will work in REVERSE, and all forward gears on vehicles equipped with an automatic transmission. The system will not activate if the vehicle is placed in NEUTRAL.

HSA On Manual Transmission Vehicles

The system will work in REVERSE, forward gears, and NEUTRAL on manual transmission equipped vehicles. The system does not recognize NEUTRAL on manual vehicles, thus it will hold the vehicle on an incline for a short period while in NEUTRAL, regardless of clutch position. To prevent this, do not attempt to roll down a hill simply by putting the transmission in NEUTRAL and letting gravity act on the vehicle, as the HSA will prevent the vehicle from rolling. Instead, use the appropriate gear for moving in the desired direction.

Towing With HSA

HSA will provide assistance when starting on a grade when pulling a trailer.

WARNING!

- If you use a trailer brake controller with your trailer, your trailer brakes may be activated and deactivated with the brake switch. If so, when the brake pedal is released, there may not be enough brake pressure to hold the vehicle and trailer on a hill and this could cause a collision with another vehicle or object behind you. In order to avoid rolling down the hill while resuming acceleration, manually activate the trailer brake prior to releasing the brake pedal. Always remember the driver is responsible for braking the vehicle.

(Continued)

WARNING! (Continued)

- **HSA is not a parking brake. Always apply the parking brake fully when leaving your vehicle. Also, be certain to leave the transmission in PARK. Failure to follow these warnings may cause the vehicle to roll down the incline and could collide with another vehicle, object or person, and cause serious or fatal injury. Always remember to use the parking brake while parking on a hill and that the driver is responsible for braking the vehicle.**

NOTE: The HSA system may also be turned on and off if the vehicle is equipped with the Electronic Vehicle Information Center (EVIC). Refer to “Electronic Vehicle Information Center (EVIC)” in “Understanding Your Instrument Panel” for further information.

HSA Off

If you wish to turn off the HSA system, follow this procedure:

1. Start with the engine off and vehicle in PARK (automatic transmission) or NEUTRAL with clutch out (manual transmission) with wheels straight. Apply parking brake on manual transmission vehicle.
2. Start the engine.
3. With the engine running, the brake applied, and the clutch out, rotate the steering wheel 180° counterclockwise from center.
4. Press the ESC OFF switch four times within twenty seconds.
5. Rotate the steering wheel 360° clockwise (180° clockwise from center).

6. Cycle ignition switch OFF then ON.
7. If the sequence was completed properly, the “ESC Activation/Malfunction Indicator Light” will blink several times to confirm HSA is off.

Steps 1-7 must be completed within 90 seconds to turn off HSA. Repeat steps 1-7 to re-enable HSA functionality.

Electronic Roll Mitigation (ERM)

This system anticipates the potential for wheel lift by monitoring the driver’s steering wheel input and the speed of the vehicle. When ERM determines that the rate of change of the steering wheel angle and vehicle’s speed are sufficient to potentially cause wheel lift, it applies the appropriate brake and may reduce engine power to lessen the chance that wheel lift will occur. ERM will only intervene during very severe or evasive driving maneuvers.

Electronic Roll Mitigation (ERM) can only reduce the chance of wheel lift occurring during severe or evasive driving maneuvers. It cannot prevent wheel lift due to other factors such as road conditions, leaving the roadway or striking objects or other vehicles.

NOTE: Anytime the ESC system is in the “Full Off” mode, ERM is disabled. Refer to Electronic Stability Control (ESC) for a complete explanation of the available ESC modes.

WARNING!

Many factors, such as vehicle loading, road conditions and driving conditions, influence the chance that wheel lift or rollover may occur. Electronic Roll Mitigation (ERM) cannot prevent all wheel lift or rollovers, especially those that involve leaving the roadway or striking objects or other vehicles. The

(Continued)

WARNING! (Continued)

capabilities of an ERM-equipped vehicle must never be exploited in a reckless or dangerous manner which could jeopardize the user's safety or the safety of others.

Electronic Stability Control (ESC)

This system enhances directional control and stability of the vehicle under various driving conditions. The ESC corrects for over/under steering of the vehicle by applying the brake of the appropriate wheel to assist in counteracting the over/under steer condition. Engine power may also be reduced to help the vehicle maintain the desired path.

ESC uses sensors in the vehicle to determine the vehicle path intended by the driver and compares it to the actual path of the vehicle. When the actual path does not match

the intended path, ESC applies the brake of the appropriate wheel to assist in counteracting the oversteer or understeer condition.

- Oversteer - when the vehicle is turning more than appropriate for the steering wheel position.
- Understeer - when the vehicle is turning less than appropriate for the steering wheel position.

The "ESC Activation/Malfunction Indicator Light" (located in the instrument cluster), starts to flash as soon as the tires lose traction and the ESC system becomes active. The "ESC Activation/Malfunction Indicator Light" also flashes when TCS is active. If the "ESC Activation/Malfunction Indicator Light" begins to flash during acceleration, ease up on the accelerator and apply as little throttle as possible. Be sure to adapt your speed and driving to the prevailing road conditions.

WARNING!

Electronic Stability Control (ESC) cannot prevent the natural laws of physics from acting on the vehicle, nor can it increase the traction afforded by prevailing road conditions. ESC cannot prevent accidents, including those resulting from excessive speed in turns, driving on very slippery surfaces, or hydroplaning. ESC also cannot prevent accidents resulting from loss of vehicle control due to inappropriate driver input for the conditions. Only a safe, attentive, and skillful driver can prevent accidents. The capabilities of an ESC equipped vehicle must never be exploited in a reckless or dangerous manner which could jeopardize the user's safety or the safety of others.

The ESC system has three available operating modes in 4H range. The system has one operating mode in 4L range. Two-wheel drive vehicles and four-wheel drive vehicles in 2H range have two operating modes.

4H Range (4WD Models)**On**

This is the normal operating mode for ESC in 4H range.

Partial Off

This mode is entered by momentarily pressing the ESC OFF switch.

ESC Off

This mode is entered by pressing and holding momentarily pressing the ESC OFF switch for 5 seconds.

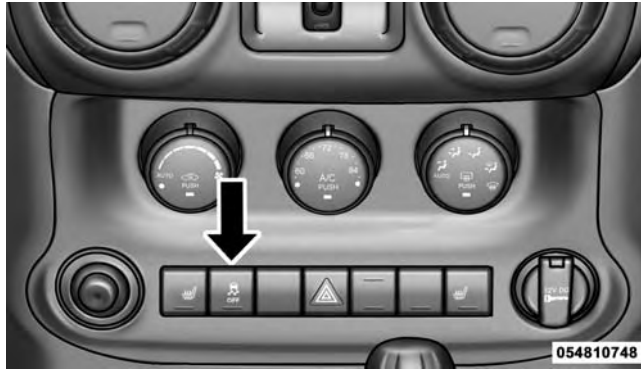

ESC OFF Switch

When in "Partial Off" mode, the TCS portion of ESC has been disabled and the "ESC Activation/Malfunction Indicator Light" will be illuminated.

All other stability features of ESC function normally. This mode is intended to be used if the vehicle is in deep snow, sand, or gravel conditions and more wheel spin than ESC would normally allow is required to gain traction. To turn ESC on again, momentarily press the ESC OFF switch. This will restore the normal "ESC On" mode of operation.

NOTE: To improve the vehicle's traction when driving with snow chains, or starting off in deep snow, sand, or gravel, it may be desirable to switch to the "Partial Off" mode by pressing the ESC OFF switch. Once the situation requiring ESC to be switched to the "Partial Off" mode is overcome, turn ESC back on by momentarily pressing the ESC OFF switch. This may be done while the vehicle is in motion.

When in ESC Off mode, ESC and TCS, except for the "limited slip" feature described in the TCS section, are turned off. To turn ESC on again, momentarily press the

ESC OFF switch. This will restore normal “ESC On” mode of operation.

WARNING!

With the ESC switched off, the enhanced vehicle stability offered by ESC and ERM are unavailable. In an emergency evasive maneuver, the ESC and ERM systems will not engage to assist in maintaining stability. The “Full Off” ESC mode is intended for off-road use only.

4L Range (4WD Models)

ESC Off

This is the normal operating mode for ESC in 4L range. Whenever the vehicle is started in 4L range, or the transfer case (if equipped) is shifted from 4H range or NEUTRAL to 4L range, the ESC system will be in this mode. In 4L range, ESC and TCS, except for the “limited

slip” feature described in the TCS section, are turned off until the vehicle reaches a speed of 40 mph (64 km/h). At 40 mph (64 km/h), the normal ESC stability function returns but TCS remains off. When the vehicle speed drops below 35 mph (56 km/h), the ESC system shuts off. The ESC is off at low vehicle speeds in 4L range so that it will not interfere with off-road driving, but the ESC function returns to provide the stability feature at speeds above 40 mph (64 km/h). The “ESC Activation/Malfunction Indicator Light” will always be illuminated in 4L range when ESC is off.

NOTE: The “ESC OFF” message will display and the audible chime will sound when the shift lever is placed in the PARK position from any position other than PARK, and then moved out of the PARK position. This will occur even if the message was previously cleared.

WARNING!

With the ESC switched off, the enhanced vehicle stability offered by ESC and ERM are unavailable. In an emergency evasive maneuver, the ESC and ERM systems will not engage to assist in maintaining stability. The “Full Off” mode is intended for off-road use only.

2H Range (4WD Models) Or 2WD Models**On**

This is the normal operating mode for ESC in 2H range and on 2WD vehicles.

Partial Off

When in “Partial Off” mode, the TCS portion of ESC has been disabled and the “ESC Activation/Malfunction Indicator Light” will be illuminated.

All other stability features of ESC function normally. This mode is intended to be used if the vehicle is in deep snow, sand, or gravel conditions and more wheel spin than ESC would normally allow is required to gain traction. To turn ESC on again, momentarily press the ESC OFF switch. This will restore the normal “ESC On” mode of operation.

NOTE: To improve the vehicle’s traction when driving with snow chains, or starting off in deep snow, sand, or gravel, it may be desirable to switch to the “Partial Off” mode by pressing the ESC OFF switch. Once the situation requiring ESC to be switched to the “Partial Off” mode is overcome, turn ESC back on by momentarily pressing the ESC OFF switch. This may be done while the vehicle is in motion.

ESC Activation/Malfunction Indicator Light And ESC OFF Indicator Light



The “ESC Activation/Malfunction Indicator Light” in the instrument cluster will come on when the ignition switch is turned to the ON position. It should go out with the engine running. If the “ESC Activation/Malfunction Indicator Light” comes on continuously with the engine running, a malfunction has been detected in the ESC system. If this light remains on after several ignition cycles, and the vehicle has been driven several miles (kilometers) at speeds greater than 30 mph (48 km/h), see your authorized dealer as soon as possible to have the problem diagnosed and corrected.

The “ESC Activation/Malfunction Indicator Light” (located in the instrument cluster) starts to flash as soon as the tires lose traction and the ESC system becomes active.

The “ESC Activation/Malfunction Indicator Light” also flashes when TCS is active. If the “ESC Activation/Malfunction Indicator Light” begins to flash during acceleration, ease up on the accelerator and apply as little throttle as possible. Be sure to adapt your speed and driving to the prevailing road conditions.

NOTE:

- The “ESC Activation/Malfunction Indicator Light” and the “ESC OFF Indicator Light” come on momentarily each time the ignition switch is turned ON.
- Each time the ignition is turned ON, the ESC system will be ON even if it was turned off previously.
- The ESC system will make buzzing or clicking sounds when it is active. This is normal; the sounds will stop when ESC becomes inactive following the maneuver that caused the ESC activation.



The “ESC OFF Indicator Light” indicates the Electronic Stability Control (ESC) is off.

Trailer Sway Control (TSC)

TSC uses sensors in the vehicle to recognize an excessively swaying trailer and will take the appropriate actions to attempt to stop the sway. The system may reduce engine power and apply the brake of the appropriate wheel(s) to counteract the sway of the trailer. TSC will become active automatically once an excessively swaying trailer is recognized. No driver action is required. Note that TSC cannot stop all trailers from swaying. Always use caution when towing a trailer and follow the tongue weight recommendations. Refer to

“Trailer Towing” in “Starting and Operating” for further information. When TSC is functioning, the “ESC Activation/Malfunction Indicator Light” will flash, the engine power may be reduced and you may feel the brakes being applied to individual wheels to attempt to stop the trailer from swaying. TSC is disabled when the ESP system is in the “Partial Off” or “Full Off” modes.

WARNING!

If TSC activates while driving, slow the vehicle down, stop at the nearest safe location, and adjust the trailer load to eliminate trailer sway.

Hill Descent Control (HDC) – If Equipped

HDC is only intended for low speed off-road driving. HDC maintains vehicle speed while descending hills in off-road driving conditions by applying the brakes when necessary.



The symbol indicates the status of the Hill Descent Control (HDC) feature. The lamp will be on solid when HDC is armed. HDC can only be armed when the transfer case is in the “4WD LOW” position and the vehicle speed is less than 30 mph (48 km/h). If these conditions are not met while attempting to use the HDC feature, the HDC indicator light will flash on/off.

When enabled, HDC senses the terrain and activates when the vehicle is descending a hill. HDC speed may be adjusted by the driver to suit the driving conditions. The speed corresponds to the transmission gear selected.

Gear	Approximate HDC Set Speed
1st	1 mph (1.5 km/h)
2nd	2.5 mph (4 km/h)
3rd	4 mph (6.5 km/h)
4th	5.5 mph (9 km/h)
DRIVE	7.5 mph (12 km/h)
REVERSE	1 mph (1.5 km/h)

However, the driver can override HDC operation by applying the brake to slow the vehicle down below the HDC control speed. If more speed is desired during HDC control, the accelerator pedal will increase vehicle speed in the usual manner. When either the brake or the accelerator is released, HDC will control the vehicle at the original set speed.

Enabling HDC

1. Shift the transfer case into 4WD LOW range. Refer to “Four-Wheel Drive Operation” in “Starting and Operating” for further information.
2. Press the “Hill Descent” button. The “Hill Descent Control Indicator Light” in the instrument cluster will turn on solid.

NOTE: If the transfer case is not in 4WD LOW range, the “Hill Descent Control Indicator Light” will flash for five seconds and HDC will not be enabled.

Disabling HDC

Press the “Hill Descent” button or shift the transfer case out of 4WD LOW range. The “Hill Descent Control Indicator” light in the instrument cluster will turn off.

TIRE SAFETY INFORMATION

Tire Markings

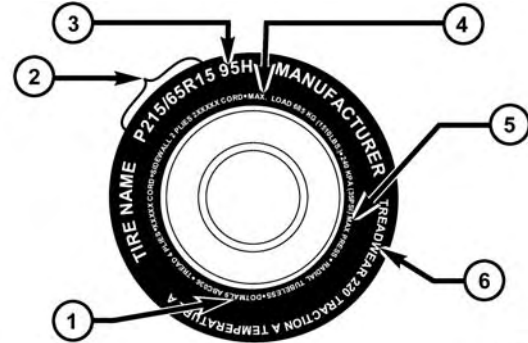

054903773

- | | |
|------------------------------------------|------------------------------------------------|
| 1 — U.S. DOT Safety Standards Code (TIN) | 4 — Maximum Load |
| 2 — Size Designation | 5 — Maximum Pressure |
| 3 — Service Description | 6 — Treadwear, Traction and Temperature Grades |

NOTE:

- P (Passenger) - Metric tire sizing is based on U.S. design standards. P-Metric tires have the letter "P" molded into the sidewall preceding the size designation. Example: P215/65R15 95H.
- European-Metric tire sizing is based on European design standards. Tires designed to this standard have the tire size molded into the sidewall beginning with the section width. The letter "P" is absent from this tire size designation. Example: 215/65R15 96H.
- LT (Light Truck) - Metric tire sizing is based on U.S. design standards. The size designation for LT-Metric tires is the same as for P-Metric tires except for the letters "LT" that are molded into the sidewall preceding the size designation. Example: LT235/85R16.
- Temporary spare tires are spares designed for temporary emergency use only. Temporary high pressure compact spare tires have the letter "T" or "S" molded into the sidewall preceding the size designation. Example: T145/80D18 103M.
- High flotation tire sizing is based on U.S. design standards and it begins with the tire diameter molded into the sidewall. Example: 31x10.5 R15 LT.

Tire Sizing Chart

EXAMPLE:	
Size Designation:	
P	= Passenger car tire size based on U.S. design standards
"...blank..."	= Passenger car tire based on European design standards
LT	= Light truck tire based on U.S. design standards
T or S	= Temporary spare tire
31	= Overall diameter in inches (in)
215	= Section width in millimeters (mm)
65	= Aspect ratio in percent (%) — Ratio of section height to section width of tire
10.5	= Section width in inches (in)
R	= Construction code — "R" means radial construction — "D" means diagonal or bias construction
15	= Rim diameter in inches (in)

EXAMPLE:**Service Description:**

95 = Load Index

— A numerical code associated with the maximum load a tire can carry

H = Speed Symbol

— A symbol indicating the range of speeds at which a tire can carry a load corresponding to its load index under certain operating conditions

— The maximum speed corresponding to the speed symbol should only be achieved under specified operating conditions (i.e., tire pressure, vehicle loading, road conditions, and posted speed limits)

Load Identification:

"...blank..." = Absence of any text on the sidewall of the tire indicates a Standard Load (SL) tire

Extra Load (XL) = Extra load (or reinforced) tire

Light Load (LL) = Light load tire

C, D, E, F, G = Load range associated with the maximum load a tire can carry at a specified pressure

Maximum Load— Maximum load indicates the maximum load this tire is designed to carry

Maximum Pressure— Maximum pressure indicates the maximum permissible cold tire inflation pressure for this tire

Tire Identification Number (TIN)

The TIN may be found on one or both sides of the tire, however, the date code may only be on one side. Tires with white sidewalls will have the full TIN, including the date code, located on the white sidewall side of the tire.

Look for the TIN on the outboard side of black sidewall tires as mounted on the vehicle. If the TIN is not found on the outboard side, then you will find it on the inboard side of the tire.

EXAMPLE:	
DOT MA L9 ABCD 0301	
DOT = Department of Transportation	— This symbol certifies that the tire is in compliance with the U.S. Department of Transportation tire safety standards and is approved for highway use
MA = Code representing the tire manufacturing location (two digits)	
L9 = Code representing the tire size (two digits)	
ABCD = Code used by the tire manufacturer (one to four digits)	
03 = Number representing the week in which the tire was manufactured (two digits)	—03 means the 3rd week.
01 = Number representing the year in which the tire was manufactured (two digits)	—01 means the year 2001 — Prior to July 2000, tire manufacturers were only required to have one number to represent the year in which the tire was manufactured. Example: 031 could represent the 3rd week of 1981 or 1991

Tire Terminology And Definitions

Term	Definition
B-Pillar	The vehicle B-Pillar is the structural member of the body located behind the front door.
Cold Tire Inflation Pressure	Cold tire inflation pressure is defined as the tire pressure after the vehicle has not been driven for at least 3 hours, or driven less than 1 mile (1.6 km) after sitting for a three hour period. Inflation pressure is measured in units of PSI (pounds per square inch) or kPa (kilopascals).
Maximum Inflation Pressure	The maximum inflation pressure is the maximum permissible cold tire inflation pressure for this tire. The maximum inflation pressure is molded into the sidewall.
Recommended Cold Tire Inflation Pressure	Vehicle manufacturer's recommended cold tire inflation pressure as shown on the tire placard.
Tire Placard	A paper label permanently attached to the vehicle describing the vehicle's loading capacity, the original equipment tire sizes and the recommended cold tire inflation pressures.

Tire Loading And Tire Pressure

Tire Placard Location

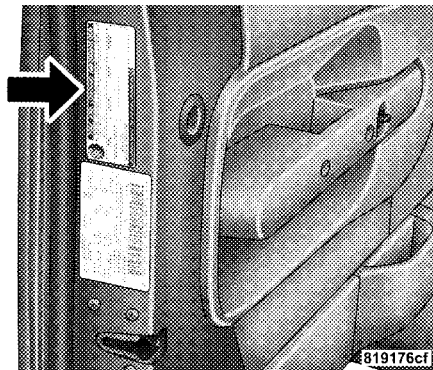

Tire Placard Location (Two-Door Model)

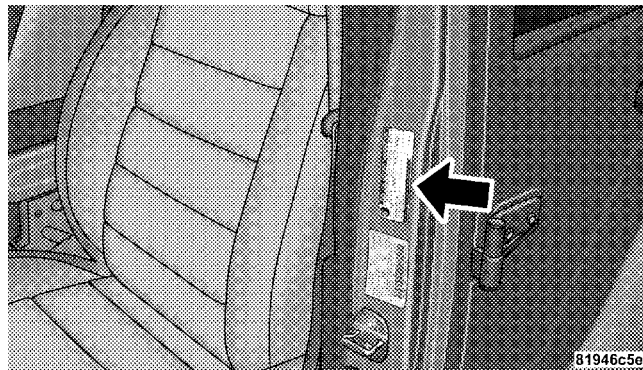

Tire Placard Location (Four-Door Model)

Tire And Loading Information Placard

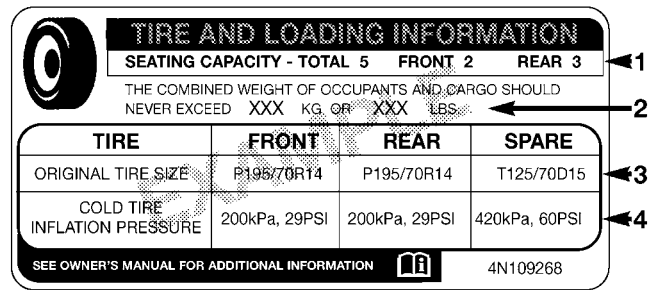

TIRE AND LOADING INFORMATION

SEATING CAPACITY - TOTAL 5 FRONT 2 REAR 3

THE COMBINED WEIGHT OF OCCUPANTS AND CARGO SHOULD NEVER EXCEED XXX KG OR XXX LBS.

TIRE	FRONT	REAR	SPARE
ORIGINAL TIRE SIZE	P195/70R14	P195/70R14	T125/70D15
COLD TIRE INFLATION PRESSURE	200kPa, 29PSI	200kPa, 29PSI	420kPa, 60PSI

SEE OWNER'S MANUAL FOR ADDITIONAL INFORMATION  4N109268

811b5a9a

Tire and Loading Information Placard

This placard tells you important information about the:

- 1) number of people that can be carried in the vehicle
- 2) total weight your vehicle can carry

- 3) tire size designed for your vehicle
- 4) cold tire inflation pressures for the front, rear, and spare tires.

Loading

The vehicle maximum load on the tire must not exceed the load carrying capacity of the tire on your vehicle. You will not exceed the tire's load carrying capacity if you adhere to the loading conditions, tire size, and cold tire inflation pressures specified on the Tire and Loading Information placard and in the "Vehicle Loading" section of this manual.

NOTE: Under a maximum loaded vehicle condition, gross axle weight ratings (GAWRs) for the front and rear axles must not be exceeded. For further information on GAWRs, vehicle loading, and trailer towing, refer to "Vehicle Loading" in this section.

To determine the maximum loading conditions of your vehicle, locate the statement “The combined weight of occupants and cargo should never exceed XXX lbs or XXX kg” on the Tire and Loading Information placard. The combined weight of occupants, cargo/luggage and trailer tongue weight (if applicable) should never exceed the weight referenced here.

Steps For Determining Correct Load Limit

1. Locate the statement “The combined weight of occupants and cargo should never exceed XXX lbs or XXX kg” on your vehicle’s placard.
2. Determine the combined weight of the driver and passengers that will be riding in your vehicle.
3. Subtract the combined weight of the driver and passengers from XXX lbs or XXX kg.
4. The resulting figure equals the available amount of cargo and luggage load capacity. For example, if “XXX” amount equals 1,400 lbs (635 kg) and there will be five 150 lb (68 kg) passengers in your vehicle, the amount of available cargo and luggage load capacity is 650 lbs (295 kg) (since $5 \times 150 = 750$, and $1400 - 750 = 650$ lbs [295 kg]).
5. Determine the combined weight of luggage and cargo being loaded on the vehicle. That weight may not safely exceed the available cargo and luggage load capacity calculated in Step 4.
6. If your vehicle will be towing a trailer, load from your trailer will be transferred to your vehicle. Consult this manual to determine how this reduces the available cargo and luggage load capacity of your vehicle.

NOTE:

- The following table shows examples on how to calculate total load, cargo/luggage, and towing capacities of your vehicle with varying seating configurations and number and size of occupants. This table is for illustration purposes only and may not be accurate for the seating and load carry capacity of your vehicle.
- For the following example, the combined weight of occupants and cargo should never exceed 865 lbs (392 kg).

Occupants			Combined weight of occupants and cargo from Tire Placard	MINUS	Combined Occupant's weight	=	AVAILABLE Cargo/Luggage and Trailer Tongue Weight
TOTAL	FRONT	REAR					
<u>EXAMPLE 1</u>			865 lbs	minus	670 lbs	=	195 lbs
5	2	3					
<u>EXAMPLE 2</u>			865 lbs	minus	540 lbs	=	325 lbs
3	2	1					
<u>EXAMPLE 3</u>			865 lbs	minus	400 lbs	=	465 lbs
2	2	0					

EXAMPLE

WARNING!

Overloading of your tires is dangerous. Overloading can cause tire failure, affect vehicle handling, and increase your stopping distance. Use tires of the recommended load capacity for your vehicle. Never overload them.

TIRES — GENERAL INFORMATION**Tire Pressure**

Proper tire inflation pressure is essential to the safe and satisfactory operation of your vehicle. Three primary areas are affected by improper tire pressure:

Safety**WARNING!**

- Improperly inflated tires are dangerous and can cause collisions.
- Under-inflation increases tire flexing and can result in over-heating and tire failure.
- Over-inflation reduces a tire's ability to cushion shock. Objects on the road and chuckholes can cause damage that result in tire failure.
- Over-inflated or under-inflated tires can affect vehicle handling and can fail suddenly, resulting in loss of vehicle control.
- Unequal tire pressures can cause steering problems. You could lose control of your vehicle.

(Continued)

WARNING! (Continued)

- Unequal tire pressures from one side of the vehicle to the other can cause the vehicle to drift to the right or left.
- Always drive with each tire inflated to the recommended cold tire inflation pressure.

Economy

Improper inflation pressures can cause uneven wear patterns to develop across the tire tread. These abnormal wear patterns will reduce tread life resulting in a need for earlier tire replacement. Under-inflation also increases tire rolling resistance resulting in higher fuel consumption.

Ride Comfort And Vehicle Stability

Proper tire inflation contributes to a comfortable ride. Over-inflation produces a jarring and uncomfortable ride. Both under-inflation and over-inflation affect the

stability of the vehicle and can produce a feeling of sluggish response or over responsiveness in the steering.

Unequal tire pressures can cause erratic and unpredictable steering response.

Unequal tire pressure from side to side may cause the vehicle to drift left or right.

Tire Inflation Pressures

Tire pressure should be checked and adjusted as well as inspected for signs of tire wear or visible damage, at least once a month. Use a good quality pocket-type gauge to check tire pressure. Do not make a visual judgement when determining proper inflation. Radial tires may look properly inflated even when they are under-inflated.

CAUTION!

After inspecting or adjusting the tire pressure, always reinstall the valve stem cap. This will prevent moisture and dirt from entering the valve stem, which could damage the Tire Pressure Monitoring Sensor.

Inflation pressures specified on the placard are always “cold tire inflation pressure.” Cold tire inflation pressure is defined as the tire pressure after the vehicle has not been driven for at least three hours, or driven less than 1 mile (1.6 km) after a three-hour period. The cold tire inflation pressure must not exceed the maximum inflation pressure molded into the tire side wall.

Check tire pressures more often if subject to a wide range of outdoor temperatures, as tire pressures vary with temperature changes.

Tire pressures change by approximately 1 psi (7 kPa) per 12° F (7° C) of air temperature change. Keep this in mind when checking tire pressure inside a garage, especially in the Winter.

Example: If garage temperature = 68° F (20° C) and the outside temperature = 32° F (0° C) then the cold tire inflation pressure should be increased by 3 psi (21 kPa), which equals 1 psi (7 kPa) for every 12° F (7° C) for this outside temperature condition.

Tire pressure may increase from 2 to 6 psi (13 to 40 kPa) during operation. DO NOT reduce this normal pressure buildup or your tire pressure will be too low.

Tire Pressures For High Speed Operation

The manufacturer advocates driving at safe speeds within posted speed limits. Where speed limits or conditions are such that the vehicle can be driven at high speeds, maintaining correct tire inflation pressure is very important. Increased tire pressure and reduced vehicle loading may be required for high-speed vehicle operation. Refer to original equipment or an authorized tire dealer for recommended safe operating speeds, loading and cold tire inflation pressures.

WARNING!

High speed driving with your vehicle under maximum load is dangerous. The added strain on your tires could cause them to fail. You could have a serious collision. Do not drive a vehicle loaded to the maximum capacity at continuous speeds above 75 mph (120 km/h).

Radial Ply Tires

WARNING!

Combining radial ply tires with other types of tires on your vehicle will cause your vehicle to handle poorly. The instability could cause a collision. Always use radial ply tires in sets of four. Never combine them with other types of tires.

Cuts and punctures in radial tires are repairable only in the tread area because of sidewall flexing. Consult your authorized tire dealer for radial tire repairs.

All Season Tires – If Equipped

All Season tires provide traction for all seasons (spring, summer, fall and winter). Traction levels may vary between different all season tires. All season tires can be identified by the M+S, M&S, M/S or MS designation on

the tire sidewall. Use all season tires only in sets of four; failure to do so may adversely affect the safety and handling of your vehicle.

Summer Or Three Season Tires – If Equipped

Summer tires provide traction in both wet and dry conditions, and are not intended to be driven in snow or on ice. Summer tires will not contain the all season designation or mountain/snowflake symbol on the tire sidewall. Use summer tires only in sets of four; failure to do so may adversely affect the safety and handling of your vehicle.

Snow Tires

Some areas of the country require the use of snow tires during the winter. Snow tires can be identified by a mountain/snowflake symbol on the tire sidewall.

If you need snow tires, select tires equivalent in size and type to the original equipment tires. Use snow tires only in sets of four; failure to do so may adversely affect the safety and handling of your vehicle.

Snow tires generally have lower speed ratings than what was originally equipped with your vehicle and should not be operated at sustained speeds over 75 mph (120 km/h). For speeds above 75 mph (120 km/h) refer to original equipment or an authorized tire dealer for recommended safe operating speeds, loading and cold tire inflation pressures.

While studded tires improve performance on ice, skid and traction capability on wet or dry surfaces may be poorer than that of non-studded tires. Some states prohibit studded tires; therefore, local laws should be checked before using these tire types.

Spare Tire Matching Original Equipped Tire And Wheel – If Equipped

Your vehicle may be equipped with a spare tire and wheel equivalent in look and function to the original equipment tire and wheel found on the front or rear axle of your vehicle. This spare tire may be used in the tire rotation for your vehicle. If your vehicle has this option refer to an authorized tire dealer for the recommended tire rotation pattern.

If your vehicle is not equipped with an original equipment tire and wheel as a spare, a non-matching temporary emergency use spare may be equipped with your vehicle. Temporary use spares are engineered to be used only with your vehicle. Your vehicle may be equipped with one of the following types of non-matching temporary use spares; compact, full size, or limited-use. Do not install more than one non-matching temporary use spare tire/wheel on the vehicle at any given time.

CAUTION!

Because of the reduced ground clearance, do not take your vehicle through an automatic car wash with a compact, full size or limited-use temporary spare installed. Damage to the vehicle may result.

Compact Spare Tire – If Equipped

The compact spare is for temporary emergency use only. You can identify if your vehicle is equipped with a compact spare by looking at the spare tire description on the Tire and Loading Information Placard located on the driver's side door opening or on the sidewall of the tire. Compact spare tire descriptions begin with the letter "T" or "S" preceding the size designation. Example: T145/80D18 103M.

T, S = Temporary Spare Tire

Since this tire has limited tread life the original equipment tire should be repaired (or replaced) and reinstalled on your vehicle at the first opportunity.

Do not install a wheel cover or attempt to mount a conventional tire on the compact spare wheel, since the wheel is designed specifically for the compact spare tire. Do not install more than one compact spare tire and wheel on the vehicle at any given time.

WARNING!

Compact spares are for temporary emergency use only. With these spares, do not drive more than 50 mph (80 km/h). Temporary use spares have limited tread life. When the tread is worn to the tread wear indicators, the temporary use spare tire needs to be replaced. Be sure to follow the warnings, which apply to your spare. Failure to do so could result in spare tire failure and loss of vehicle control.

Full Size Spare – If Equipped

The full size spare is for temporary emergency use only. This tire may look like the original equipped tire on the front or rear axle of your vehicle, but it is not. This spare tire may have limited tread life. When the tread is worn to the tread wear indicators, the temporary use full size spare tire needs to be replaced. Since it is not the same as your original equipment tire, replace (or repair) the original equipment tire and reinstall on the vehicle at the first opportunity.

Limited-Use Spare – If Equipped

The limited-use spare tire is for temporary emergency use only. This tire is identified by a label located on the limited-use spare wheel. This label contains the driving limitations for this spare. This tire may look like the original equipped tire on the front or rear axle of your vehicle, but it is not. Installation of this limited-use spare tire affects vehicle handling. Since it is not the same as

your original equipment tire, replace (or repair) the original equipment tire and reinstall on the vehicle at the first opportunity.

WARNING!

Limited-use spares are for emergency use only. Installation of this limited-use spare tire affects vehicle handling. With this tire, do not drive more than the speed listed on the limit-use spare wheel. Keep inflated to the cold tire inflation pressure listed on your Tire and Loading Information Placard located on the driver's side door opening. Replace (or repair) the original equipment tire at the first opportunity and reinstall it on your vehicle. Failure to do so could result in loss of vehicle control.

Tire Spinning

When stuck in mud, sand, snow, or ice conditions, do not spin your vehicle's wheels above 30 mph (48 km/h) or for longer than 30 seconds continuously without stopping when you are stuck.

Refer to "Freeing A Stuck Vehicle" in "What To Do In Emergencies" for further information.

WARNING!

Fast spinning tires can be dangerous. Forces generated by excessive wheel speeds may cause tire damage or failure. A tire could explode and injure someone. Do not spin your vehicle's wheels faster than 30 mph (48 km/h) for more than 30 seconds continuously when you are stuck, and do not let anyone near a spinning wheel, no matter what the speed.

Tread Wear Indicators

Tread wear indicators are in the original equipment tires to help you in determining when your tires should be replaced.



055007576

- 1 — Worn Tire
2 — New Tire

These indicators are molded into the bottom of the tread grooves. They will appear as bands when the tread depth becomes 1/16 in (2 mm). When the tread is worn to the tread wear indicators, the tire should be replaced.

Life Of Tire

The service life of a tire is dependent upon varying factors including, but not limited to:

- Driving style
- Tire pressure
- Distance driven
- Performance tires, tires with a speed rating of V or higher, and summer tires, typically have a reduced tread life. Rotation of these tires per the vehicle maintenance schedule is highly recommended.

WARNING!

Tires and the spare tire should be replaced after six years, regardless of the remaining tread. Failure to follow this warning can result in sudden tire failure. You could lose control and have a collision resulting in serious injury or death.

Keep dismounted tires in a cool, dry place with as little exposure to light as possible. Protect tires from contact with oil, grease, and gasoline.

Replacement Tires

The tires on your new vehicle provide a balance of many characteristics. They should be inspected regularly for wear and correct cold tire inflation pressure. The manufacturer strongly recommends that you use tires equivalent to the originals in size, quality and performance when replacement is needed. (Refer to the paragraph on

“Tread Wear Indicators”). Refer to the “Tire and Loading Information” placard for the size designation of your tire. The Load Index and Speed Symbol for your tire will be found on the original equipment tire sidewall. See the Tire Sizing Chart example found in the Tire Safety Information section of this manual for more information relating to the Load Index and Speed Symbol of a tire.

It is recommended to replace the two front tires or two rear tires as a pair. Replacing just one tire can seriously affect your vehicle’s handling. If you ever replace a wheel, make sure that the wheel’s specifications match those of the original wheels.

It is recommended you contact your original equipment or an authorized tire dealer with any questions you may have on tire specifications or capability. Failure to use equivalent replacement tires may adversely affect the safety, handling, and ride of your vehicle.

WARNING!

- Do not use a tire, wheel size or rating other than that specified for your vehicle. Some combinations of unapproved tires and wheels may change suspension dimensions and performance characteristics, resulting in changes to steering, handling, and braking of your vehicle. This can cause unpredictable handling and stress to steering and suspension components. You could lose control and have a collision resulting in serious injury or death. Use only the tire and wheel sizes with load ratings approved for your vehicle.
- Never use a tire with a smaller load index or capacity, other than what was originally equipped on your vehicle. Using a tire with a smaller load index could result in tire overloading and failure. You could lose control and have a collision.

(Continued)

WARNING! (Continued)

- Failure to equip your vehicle with tires having adequate speed capability can result in sudden tire failure and loss of vehicle control.

CAUTION!

Replacing original tires with tires of a different size may result in false speedometer and odometer readings.

TIRE CHAINS (TRACTION DEVICES)

Use of traction devices require sufficient tire-to-body clearance. Follow these recommendations to guard against damage.

- Traction device must be of proper size for the tire, as recommended by the traction device manufacturer.
- Install on Rear Tires Only.

- P225/75R16 or a P235/65R17 tire with the use of a traction device that meets the SAE type “Class S” specification is recommended.

WARNING!

Using tires of different size and type (M+S, Snow) between front and rear axles can cause unpredictable handling. You could lose control and have a collision.

CAUTION!

To avoid damage to your vehicle or tires, observe the following precautions:

- Because of restricted traction device clearance between tires and other suspension components, it is important that only traction devices in good condition are used. Broken devices can cause serious damage. Stop the vehicle immediately if noise occurs

(Continued)

CAUTION! *(Continued)*

- that could indicate device breakage. Remove the damaged parts of the device before further use.
- Install device as tightly as possible and then re-tighten after driving about ½ mile (0.8 km).
- Do not exceed 30 mph (48 km/h).
- Drive cautiously and avoid severe turns and large bumps, especially with a loaded vehicle.
- Do not drive for prolonged period on dry pavement.
- Observe the traction device manufacturer’s instructions on the method of installation, operating speed, and conditions for use. Always use the suggested operating speed of the device manufacturer’s if it is less than 30 mph (48 km/h).
- Do not use traction devices on a compact spare tire.

TIRE ROTATION RECOMMENDATIONS

The tires on the front and rear of your vehicle operate at different loads and perform different steering, handling, and braking functions. For these reasons, they wear at unequal rates.

These effects can be reduced by timely rotation of tires. The benefits of rotation are especially worthwhile with aggressive tread designs such as those on On/Off Road type tires. Rotation will increase tread life, help to maintain mud, snow, and wet traction levels, and contribute to a smooth, quiet ride.

Refer to the “Maintenance Schedule” for the proper maintenance intervals. The reasons for any rapid or unusual wear should be corrected prior to rotation being performed.

The suggested rotation method is the “forward-cross” shown in the following diagram.

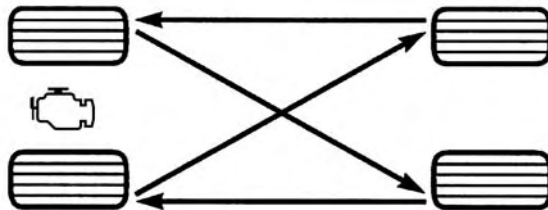

Tire Rotation

055703771

CAUTION!

Proper operation of four-wheel drive vehicles depends on tires of equal size, type and circumference on each wheel. Any difference in tire size can cause damage to the transfer case. Tire rotation schedule should be followed to balance tire wear.

TIRE PRESSURE MONITOR SYSTEM (TPMS)

The Tire Pressure Monitoring System (TPMS) will warn the driver of a low tire pressure based on the vehicle recommended cold placard pressure.

The tire pressure will vary with temperature by about 1 psi (6.9 kPa) for every 12°F (6.5°C). This means that when the outside temperature decreases, the tire pressure will decrease. Tire pressure should always be set based on cold inflation tire pressure. This is defined as the tire

pressure after a vehicle has not been driven for more than three hours, or driven less than 1 mile (1.6 km) after a three-hour period. Refer to “Tires – General Information” in “Starting and Operating” for information on how to properly inflate the vehicle’s tires. The tire pressure will also increase as the vehicle is driven; this is normal and there should be no adjustment for this increased pressure.

The TPMS will warn the driver of a low tire pressure if the tire pressure falls below the low pressure warning threshold for any reason, including low temperature effects, or natural pressure loss through the tire.

The TPMS will continue to warn the driver of low tire pressure as long as the condition exists, and will not turn off until the tire pressure is at or above recommended cold placard pressure. Once the “Tire Pressure Monitoring Telltale Light” has been illuminated, the tire pressure

must be increased to the recommended cold placard pressure in order for the “Tire Pressure Monitoring Telltale Light” to be turned OFF. The system will automatically update and the “Tire Pressure Monitoring Telltale Light” will extinguish once the updated tire pressures have been received. The vehicle may need to be driven for up to 20 minutes above 15 mph (24 km/h) to receive this information.

For example, your vehicle may have a recommended cold (parked for more than three hours) air pressure of 35 psi (241 kPa). If the ambient temperature is 68°F (20°C) and the measured tire pressure is 30 psi (207 kPa), a temperature drop to 20°F (-7°C) will decrease the tire pressure to approximately 26 psi (179 kPa). This tire pressure is sufficiently low enough to turn ON the “Tire Pressure Monitoring Telltale Light.” Driving the vehicle may cause the tire pressure to rise to approximately 30 psi (207 kPa), but the “Tire Pressure Monitoring Telltale Light” will still be ON. In this situation, the “Tire

Pressure Monitoring Telltale Light” will turn OFF only after the tires have been inflated to the vehicle’s recommended cold placard pressure value.

CAUTION!

- **The TPMS has been optimized for the original equipment tires and wheels. The TPMS pressures have been established for the tire size equipped on your vehicle. Undesirable system operation or sensor damage may result when using replacement equipment that is not of the same size, type, and/or style. Aftermarket wheels can cause sensor damage. Do not use aftermarket tire sealants or balance beads if your vehicle is equipped with a TPMS, as damage to the sensors may result.**

(Continued)

CAUTION! *(Continued)*

- After inspecting or adjusting the tire pressure, always reinstall the valve stem cap. This will prevent moisture and dirt from entering the valve stem, which could damage the Tire Pressure Monitoring Sensor.

NOTE:

- The TPMS is not intended to replace normal tire care and maintenance, nor to provide warning of a tire failure or condition.
- The TPMS should not be used as a tire pressure gauge while adjusting your tire pressure.
- Driving on a significantly under-inflated tire causes the tire to overheat and can lead to tire failure. Under-inflation also reduces fuel efficiency and tire tread life, and may affect the vehicle's handling and stopping ability.
- The TPMS is not a substitute for proper tire maintenance, and it is the driver's responsibility to maintain correct tire pressure, even if under-inflation has not reached the level to trigger illumination of the "Tire Pressure Monitoring Telltale Light."
- Seasonal temperature changes will affect tire pressure, and the TPMS will monitor the actual tire pressure in the tire.

Premium and Base TPM System

The Tire Pressure Monitor System (TPMS) uses wireless technology with wheel rim-mounted electronic sensors to monitor tire pressure levels. Sensors, mounted to each wheel as part of the valve stem, transmit tire pressure readings to the Receiver Module.

NOTE: It is particularly important for you to check the tire pressure in all of your tires regularly and to maintain the proper pressure.

The Tire Pressure Monitor System (TPMS) consists of the following components:

- Receiver Module
- Four Tire Pressure Monitoring Sensors
- Tire Pressure Monitoring Telltale Light

A tire pressure monitoring sensor is located in the spare wheel if the vehicle is equipped with a matching full size spare wheel and tire assembly. The matching full size spare tire can be used in place of any of the four road tires. A low spare tire will not cause the “Tire Pressure Monitoring Telltale Light” to illuminate or the chime to sound.



The “Tire Pressure Monitoring Telltale Light” will illuminate in the instrument cluster, , a “LOW TIRE PRESSURE” message will display in the EVIC, and an audible chime will be activated when one or more of the four active road tire pressures are low. Should this occur, you should stop as soon as possible, check the inflation pressure of each tire on your vehicle, and inflate each tire to the vehicle’s recommended cold placard pressure value. The system will automatically update and the “Tire Pressure Monitoring Telltale Light” will extinguish once the updated tire pressures have been

received. The vehicle may need to be driven for up to 20 minutes above 15 mph (24 km/h) to receive this information.

The “Tire Pressure Monitoring Telltale Light” will flash on and off for 75 seconds, and will remain on solid when a system fault is detected. The system fault will also sound a chime. If the ignition key is cycled, this sequence will repeat, providing the system fault still exists. A system fault can occur by any of the following scenarios:

Base Tire Pressure Monitoring

Vehicles not equipped with EVIC will inform the driver which tire(s) are low but not provide actual tire pressure. The low tire ISO telltale will illuminate along with “LoTIRE” message displayed in the ODO and then it will scroll to which tire location is lower than the Placard Value.

Tire location will be displayed as follows:

LF = Left Front

rF = right Front

Lr = Left rear

rr = right rear

Premium Tire Pressure Monitoring

Vehicles equipped with a EVIC will display specific tire pressure information. When tire pressure is low the low tire ISO telltale will illuminate and the EVIC will display actual individual tire pressure when the tire pressure is lower than the Placard Value.

1. Jamming due to electronic devices or driving next to facilities emitting the same Radio Frequencies as the TPM sensors.
2. Installing some form of aftermarket window tinting that affects radio wave signals.

3. Lots of snow or ice around the wheels or wheel housings.
4. Using tire chains on the vehicle.
5. Using wheels/tires not equipped with TPM sensors.

NOTE:

- If your vehicle is equipped with a matching full-size spare wheel and tire assembly, it has a tire pressure monitoring sensor, and can be monitored by the Tire Pressure Monitoring System (TPMS). In the event that the matching full-size spare tire is swapped with a low pressure road tire, the next ignition key cycle will still show the “Tire Pressure Monitoring Telltale Light” to be ON, and a chime to sound. Driving the vehicle for up to 20 minutes above 15 mph (24 km/h) will turn OFF the “Tire Pressure Monitoring Telltale Light” as long as none of the road tires are below the low pressure warning threshold.
- If your vehicle is not equipped with a matching full-size spare wheel and tire assembly, it does not have a tire pressure monitoring sensor in the spare tire. The TPMS will not be able to monitor the tire pressure. If you install the spare tire in place of a road tire that has a pressure below the low-pressure warning limit, upon the next ignition key cycle, a chime will sound and the “Tire Pressure Monitoring Telltale Light” will turn ON. After driving the vehicle for up to 20 minutes above 15 mph (24 km/h), the “Tire Pressure Monitoring Telltale Light” will flash on and off for 75 seconds and then remain on solid. For each subsequent ignition key cycle, a chime will sound and the “Tire Pressure Monitoring Telltale Light” will flash on and off for 75 seconds and then remain on solid. Once you repair or replace the original road tire, and reinstall it on the vehicle in place of the spare tire, the TPMS will update automatically and the “Tire Pressure Monitoring Telltale Light” will turn OFF, as long as no tire pressure is

below the low-pressure warning limit in any of the four active road tires. The vehicle may need to be driven for up to 20 minutes above 15 mph (24 km/h) in order for the TPMS to receive this information.

Premium System – If Equipped

The Tire Pressure Monitor System (TPMS) uses wireless technology with wheel rim-mounted electronic sensors to monitor tire pressure levels. Sensors, mounted to each wheel as part of the valve stem, transmit tire pressure readings to the Receiver Module.

NOTE: It is particularly important, for you to regularly check the tire pressure in all of your tires and to maintain the proper pressure.

The Tire Pressure Monitor System (TPMS) consists of the following components:

- Receiver Module
- Four Tire Pressure Monitoring Sensors
- Various Tire Pressure Monitoring System Messages, which display in the Electronic Vehicle Information Center (EVIC), and a graphic displaying tire pressures
- Tire Pressure Monitoring Telltale Light

A tire pressure monitoring sensor is located in the spare wheel, if the vehicle is equipped with a matching full-size spare wheel and tire assembly. The matching full-size spare tire can be used in place of any of the four road tires.

Tire Pressure Monitoring Low Pressure Warnings

 The Tire Pressure Monitoring Telltale Light will illuminate in the instrument cluster, and an audible chime will be activated, when one or more of the four active road tire pressures are low. In addition, the EVIC will display a “LOW TIRE PRESSURE” message for a minimum of five seconds, and a graphic display of the pressure value(s) with the low tire(s) “flashing.” Refer to “Electronic Vehicle Information Center (EVIC)” in “Understanding Your Instrument Panel” for further information.

NOTE: Your system can be set to display pressure units in PSI, kPa, or BAR.

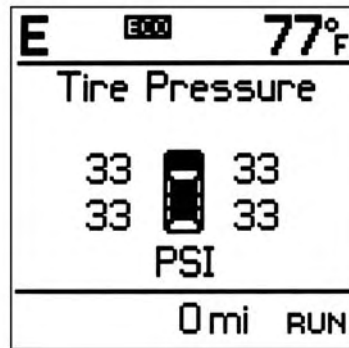

055838588

Should a low tire condition occur on any of the four active road tire(s), you should stop as soon as possible, and inflate the low tire(s) that is “flashing” on the graphic display to the vehicle’s recommended cold tire pressure.

The system will automatically update, the graphic display of the pressure value(s) will stop “flashing,” and the Tire Pressure Monitoring Telltale Light will extinguish once the updated tire pressure(s) have been received. The vehicle may need to be driven for up to 20 minutes above 15 mph (24 km/h) to receive this information.

SERVICE TPM SYSTEM Warning

The “Tire Pressure Monitoring Telltale Light” will flash on and off for 75 seconds, and remain on solid when a system fault is detected. The system fault will also sound a chime. The EVIC will display a “SERVICE TPM SYSTEM” message for a minimum of five seconds. This message is then followed by a graphic display, with “- -” in place of the pressure value(s), indicating which Tire Pressure Monitoring Sensor(s) is not being received.

NOTE: Your system can be set to display pressure units in PSI, kPa, or BAR.

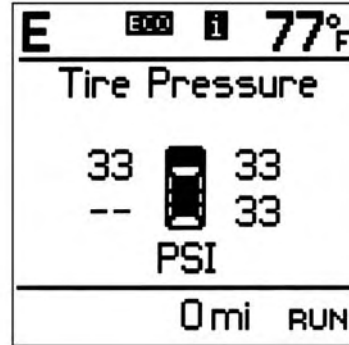

055838856

If the ignition switch is cycled, this sequence will repeat, providing the system fault still exists. If the system fault no longer exists, the "Tire Pressure Monitoring Telltale Light" will no longer flash, the "SERVICE TPM SYSTEM" message will not be present, and a pressure value will be displayed instead of dashes. A system fault can occur by any of the following:

1. Jamming due to electronic devices or driving next to facilities emitting the same Radio Frequencies as the TPM sensors.
2. Installing some form of aftermarket window tinting that affects radio wave signals.
3. Lots of snow or ice around the wheels or wheel housings.
4. Using tire chains on the vehicle.
5. Using wheels/tires not equipped with TPM sensors.

The EVIC will also display a "SERVICE TPM SYSTEM" message for a minimum of five seconds when a system fault is detected possibly related to an incorrect sensor location fault. In this case, the "SERVICE TPM SYSTEM" message is then followed by a graphic display, with pressure values still shown. This indicates the pressure values are still being received from the TPM Sensors but they may not be located in the correct vehicle position. However, the system still needs to be serviced as long as the "SERVICE TPM SYSTEM" message exists.

NOTE:

- If your vehicle is equipped with a matching full-size spare wheel and tire assembly, it has a tire pressure monitoring sensor, and can be monitored by the Tire Pressure Monitoring System (TPMS). In the event that the matching full-size spare tire is swapped with a low pressure road tire, the next ignition switch cycle will still show the "Tire Pressure Monitoring Telltale Light" to be ON, a chime to sound, a "LOW TIRE PRESSURE"

message to appear in the EVIC, and the graphic display will still show the low tire pressure value “flashing.” Driving the vehicle for up to 20 minutes above 15 mph (24 km/h) will turn OFF the “Tire Pressure Monitoring Telltale Light” as long as none of road tires are below the low pressure warning threshold.

- If your vehicle is not equipped with a matching full-size spare wheel and tire assembly, it does not have a tire pressure monitoring sensor in the spare tire. The TPMS will not be able to monitor the tire pressure. If you install the spare tire in place of a road tire that has a pressure below the low-pressure warning limit, upon the next ignition switch cycle, the “Tire Pressure Monitoring Telltale Light” will remain ON, a chime will sound, and the EVIC will still display a “flashing” pressure value in the graphic display. After driving the vehicle for up to 20 minutes above 15 mph (24 km/h), the “Tire Pressure Monitoring Telltale Light” will flash on and off for 75 seconds and then remain on solid.

In addition, the EVIC will display a “SERVICE TPM SYSTEM” message for a minimum of five seconds and then display dashes (- -) in place of the pressure value. For each subsequent ignition switch cycle, a chime will sound, the “Tire Pressure Monitoring Telltale Light” will flash on and off for 75 seconds and then remain on solid, and the EVIC will display a “SERVICE TPM SYSTEM” message for a minimum of five seconds and then display dashes (- -) in place of the pressure value. Once you repair or replace the original road tire, and reinstall it on the vehicle in place of the spare tire, the TPMS will update automatically.

In addition, the “Tire Pressure Monitoring Telltale Light” will turn OFF and the graphic in the EVIC will display a new pressure value instead of dashes (- -), as long as no tire pressure is below the low-pressure warning limit in any of the four active road tires. The vehicle may need to be driven for up to 20 minutes above 15 mph (24 km/h) in order for the TPMS to receive this information.

General Information

This device complies with part 15 of the FCC rules and RSS 210 of Industry Canada. Operation is subject to the following conditions:

- This device may not cause harmful interference.
- This device must accept any interference received, including interference that may cause undesired operation.

The tire pressure sensors are covered under one of the following licenses:

United States	MRXC4W4MA4
Canada	2546A-C4W4MA4

FUEL REQUIREMENTS

3.6L Engine



This engine is designed to meet all emissions regulations and provide excellent fuel economy and performance when using high-quality unleaded “regular” gasoline having an octane rating of 87. The use of premium gasoline is not recommended, as it will not provide any benefit over regular gasoline in these engines.

Light spark knock at low engine speeds is not harmful to your engine. However, continued heavy spark knock at high speeds can cause damage and immediate service is required. Poor quality gasoline can cause problems such as hard starting, stalling, and hesitations. If you experience these symptoms, try another brand of gasoline before considering service for the vehicle.

Over 40 auto manufacturers worldwide have issued and endorsed consistent gasoline specifications (the Worldwide Fuel Charter, WWFC) which define fuel properties necessary to deliver enhanced emissions, performance, and durability for your vehicle. The manufacturer recommends the use of gasolines that meet the WWFC specifications if they are available.

Reformulated Gasoline

Many areas of the country require the use of cleaner burning gasoline referred to as “Reformulated Gasoline.” Reformulated gasolines contain oxygenates and are specifically blended to reduce vehicle emissions and improve air quality.

The manufacturer supports the use of reformulated gasolines. Properly blended reformulated gasolines will provide excellent performance and durability of engine and fuel system components.

Gasoline/Oxygenate Blends

Some fuel suppliers blend unleaded gasoline with oxygenates such as Ethanol. Fuels blended with oxygenates may be used in your vehicle.

CAUTION!

DO NOT use gasoline containing Methanol or gasoline containing more than 10% Ethanol. Use of these blends may result in starting and driveability problems, damage critical fuel system components, cause emissions to exceed the applicable standard, and/or cause the “Malfunction Indicator Light” to illuminate. Pump labels should clearly communicate if a fuel contains greater than 10% Ethanol.

Problems that result from using gasoline containing Methanol or gasoline containing more than 10% Ethanol are not the responsibility of the manufacturer and may not be covered under warranty.

E-85 Usage In Non-Flex Fuel Vehicles

Non-FFV vehicles are compatible with gasoline containing 10% ethanol (E10). Gasoline with higher ethanol content may void the vehicle's warranty.

If a Non-FFV vehicle is inadvertently fueled with E-85 fuel, the engine will have some or all of these symptoms:

- operate in a lean mode
- OBD II "Malfunction Indicator Light" on
- poor engine performance
- poor cold start and cold drivability
- increased risk for fuel system component corrosion

To fix a Non-FFV vehicle inadvertently fueled once with E-85 perform the following:

- drain the fuel tank (see your authorized dealer)

- change the engine oil and oil filter
- disconnect and reconnect the battery to reset the engine controller memory

More extensive repairs will be required for prolonged exposure to E-85 fuel.

MMT In Gasoline

MMT is a manganese-containing metallic additive that is blended into some gasoline to increase octane. Gasoline blended with MMT provides no performance advantage beyond gasoline of the same octane number without MMT. Gasoline blended with MMT reduces spark plug life and reduces emissions system performance in some vehicles. The manufacturer recommends that gasoline without MMT be used in your vehicle. The MMT content of gasoline may not be indicated on the gasoline pump, therefore, you should ask your gasoline retailer whether the gasoline contains MMT. It is even more important to look for gasoline without MMT in Canada, because MMT

can be used at levels higher than those allowed in the United States. MMT is prohibited in Federal and California reformulated gasoline.

Materials Added To Fuel

All gasoline sold in the United States is required to contain effective detergent additives. Use of additional detergents or other additives is not needed under normal conditions and they would result in additional cost. Therefore, you should not have to add anything to the fuel.

Fuel System Cautions

CAUTION!

Follow these guidelines to maintain your vehicle's performance:

- The use of leaded gas is prohibited by Federal law. Using leaded gasoline can impair engine performance and damage the emissions control system.

(Continued)

CAUTION! *(Continued)*

- An out-of-tune engine or certain fuel or ignition malfunctions can cause the catalytic converter to overheat. If you notice a pungent burning odor or some light smoke, your engine may be out of tune or malfunctioning and may require immediate service. Contact your authorized dealer for service assistance.
- The use of fuel additives, which are now being sold as octane enhancers, is not recommended. Most of these products contain high concentrations of methanol. Fuel system damage or vehicle performance problems resulting from the use of such fuels or additives is not the responsibility of the manufacturer.

NOTE: Intentional tampering with the emissions control system can result in civil penalties being assessed against you.

Carbon Monoxide Warnings

WARNING!

Carbon monoxide (CO) in exhaust gases is deadly. Follow the precautions below to prevent carbon monoxide poisoning:

- Do not inhale exhaust gases. They contain carbon monoxide, a colorless and odorless gas, which can kill. Never run the engine in a closed area, such as a garage, and never sit in a parked vehicle with the engine running for an extended period. If the vehicle is stopped in an open area with the engine running for more than a short period, adjust the ventilation system to force fresh, outside air into the vehicle.

(Continued)

WARNING! *(Continued)*

- Guard against carbon monoxide with proper maintenance. Have the exhaust system inspected every time the vehicle is raised. Have any abnormal conditions repaired promptly. Until repaired, drive with all side windows fully open.

ADDING FUEL

Fuel Filler Cap (Gas Cap)

The gas cap is located on the driver's side of the vehicle. If the gas cap is lost or damaged, be sure the replacement cap is the correct one for this vehicle.

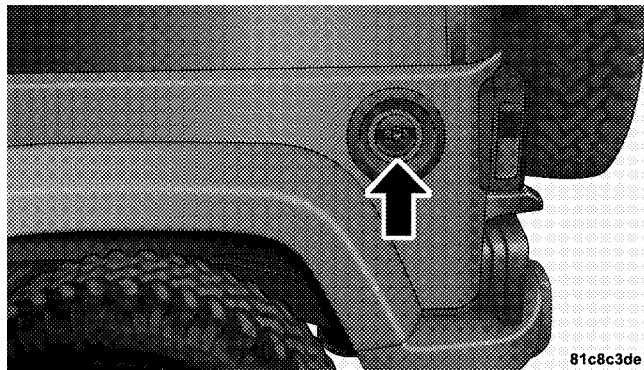

81c8c3de

Fuel Filler Cap

CAUTION!

- Damage to the fuel system or emission control system could result from using an improper fuel

*(Continued)***CAUTION!** *(Continued)*

cap (gas cap). A poorly fitting cap could let impurities into the fuel system. Also, a poorly fitting aftermarket cap can cause the "Malfunction Indicator Light (MIL)" to illuminate, due to fuel vapors escaping from the system.

- To avoid fuel spillage and overfilling, do not "top off" the fuel tank after filling.

WARNING!

- Never have any smoking materials lit in or near the vehicle when the gas cap is removed or the tank is being filled.
- Never add fuel when the engine is running. This is in violation of most state and federal fire regulations and may cause the MIL to turn on.

(Continued)

WARNING! (Continued)

- A fire may result if gasoline is pumped into a portable container that is inside of a vehicle. You could be burned. Always place gas containers on the ground while filling.

NOTE:

- When the fuel nozzle “clicks” or shuts off, the fuel tank is full.
- Tighten the gas cap about 1/4 turn until you hear one click. This is an indication that the cap is properly tightened.
- If the gas cap is not tightened properly, the MIL will come on. Be sure the gas cap is tightened every time the vehicle is refueled.

Loose Fuel Filler Cap Message

After fuel has been added, the vehicle diagnostic system can determine if the fuel filler cap is possibly loose, improperly installed, or damaged. If the system detects a malfunction, the “gASCAP” message will display in the odometer display. Tighten the gas cap until a “clicking” sound is heard. This is an indication that the gas cap is properly tightened. Press the odometer reset button to turn the message off. If the problem persists, the message will appear the next time the vehicle is started. This might indicate a damaged cap. If the problem is detected twice in a row, the system will turn on the MIL. Resolving the problem will turn the MIL off.

VEHICLE LOADING

Certification Label

As required by National Highway Traffic Safety Administration regulations, your vehicle has a certification label affixed to the driver's side door or pillar.

This label contains the month and year of manufacture, Gross Vehicle Weight Rating (GVWR), Gross Axle Weight Rating (GAWR) front and rear, and Vehicle Identification Number (VIN). A Month-Day-Hour (MDH) number is included on this label and indicates the Month, Day and Hour of manufacture. The bar code that appears on the bottom of the label is your VIN.

Gross Vehicle Weight Rating (GVWR)

The GVWR is the total permissible weight of your vehicle including driver, passengers, vehicle, options and cargo. The label also specifies maximum capacities of front and

rear axle systems (GAWR). Total load must be limited so GVWR and front and rear GAWR are not exceeded.

Payload

The payload of a vehicle is defined as the allowable load weight a truck can carry, including the weight of the driver, all passengers, options and cargo.

Gross Axle Weight Rating (GAWR)

The GAWR is the maximum permissible load on the front and rear axles. The load must be distributed in the cargo area so that the GAWR of each axle is not exceeded.

Each axle GAWR is determined by the components in the system with the lowest load carrying capacity (axle, springs, tires or wheels). Heavier axles or suspension components sometimes specified by purchasers for increased durability does not necessarily increase the vehicle's GVWR.

Tire Size

The tire size on the Vehicle Certification Label represents the actual tire size on your vehicle. Replacement tires must be equal to the load capacity of this tire size.

Rim Size

This is the rim size that is appropriate for the tire size listed.

Inflation Pressure

This is the cold tire inflation pressure for your vehicle for all loading conditions up to full GAWR.

Curb Weight

The curb weight of a vehicle is defined as the total weight of the vehicle with all fluids, including vehicle fuel, at full capacity conditions, and with no occupants or cargo loaded into the vehicle. The front and rear curb weight

values are determined by weighing your vehicle on a commercial scale before any occupants or cargo are added.

Loading

The actual total weight and the weight of the front and rear of your vehicle at the ground can best be determined by weighing it when it is loaded and ready for operation.

The entire vehicle should first be weighed on a commercial scale to insure that the GVWR has not been exceeded. The weight on the front and rear of the vehicle should then be determined separately to be sure that the load is properly distributed over the front and rear axle. Weighing the vehicle may show that the GAWR of either the front or rear axles has been exceeded but the total load is within the specified GVWR. If so, weight must be shifted from front to rear or rear to front as appropriate until the specified weight limitations are met. Store the heavier

items down low and be sure that the weight is distributed equally. Stow all loose items securely before driving.

Improper weight distributions can have an adverse effect on the way your vehicle steers and handles and the way the brakes operate.

CAUTION!

Do not load your vehicle any heavier than the GVWR or the maximum front and rear GAWR. If you do, parts on your vehicle can break, or it can change the way your vehicle handles. This could cause you to lose control. Also overloading can shorten the life of your vehicle.

TRAILER TOWING

In this section you will find safety tips and information on limits to the type of towing you can reasonably do with your vehicle. Before towing a trailer, carefully review this information to tow your load as efficiently and safely as possible.

To maintain warranty coverage, follow the requirements and recommendations in this manual concerning vehicles used for trailer towing.

Common Towing Definitions

The following trailer towing related definitions will assist you in understanding the following information:

Gross Vehicle Weight Rating (GVWR)

The GVWR is the total allowable weight of your vehicle. This includes driver, passengers, cargo and tongue weight. The total load must be limited so that you do not

exceed the GVWR. Refer to “Vehicle Loading/Vehicle Certification Label” in “Starting and Operating” for further information.

Gross Trailer Weight (GTW)

The GTW is the weight of the trailer plus the weight of all cargo, consumables and equipment (permanent or temporary) loaded in or on the trailer in its “loaded and ready for operation” condition. The recommended way to measure GTW is to put your fully loaded trailer on a vehicle scale. The entire weight of the trailer must be supported by the scale.

Gross Combination Weight Rating (GCWR)

The GCWR is the total permissible weight of your vehicle and trailer when weighed in combination.

NOTE: The GCWR rating includes a 150 lbs (68 kg) allowance for the presence of a driver.

Gross Axle Weight Rating (GAWR)

The GAWR is the maximum capacity of the front and rear axles. Distribute the load over the front and rear axles evenly. Make sure that you do not exceed either front or rear GAWR. Refer to “Vehicle Loading/Vehicle Certification Label” in “Starting and Operating” for further information.

WARNING!

It is important that you do not exceed the maximum front or rear GAWR. A dangerous driving condition can result if either rating is exceeded. You could lose control of the vehicle and have a collision.

Tongue Weight (TW)

The tongue weight is the downward force exerted on the hitch ball by the trailer. In most cases it should not be less than 10% or more than 15% of the trailer load. You must consider this as part of the load on your vehicle.

Frontal Area

The frontal area is the maximum height multiplied by the maximum width of the front of a trailer.

Trailer Sway Control – If Equipped

The trailer sway control is a telescoping link that can be installed between the hitch receiver and the trailer tongue. It typically provides adjustable friction associated with the telescoping motion to dampen any unwanted trailer swaying motions while traveling.

Weight-Carrying Hitch

A weight-carrying hitch supports the trailer tongue weight, just as if it were luggage located at a hitch ball or some other connecting point of the vehicle. These kinds of hitches are the most popular on the market today and they are commonly used to tow small- and medium-sized trailers.

Weight-Distributing Hitch

A weight-distributing system works by applying leverage through spring (load) bars. They are typically used for heavier loads to distribute trailer tongue weight to the tow vehicle's front axle and the trailer axle(s). When used in accordance with the manufacturer's directions, it provides for a more level ride, offering more consistent steering and brake control thereby enhancing towing safety. The addition of a friction / hydraulic sway control also dampens sway caused by traffic and crosswinds and contributes positively to tow vehicle and trailer stability. Trailer sway control and a weight distributing (load equalizing) hitch are recommended for heavier Tongue Weights (TW) and may be required depending on vehicle and trailer configuration / loading to comply with Gross Axle Weight Rating (GAWR) requirements.

WARNING!

- An improperly adjusted Weight Distributing Hitch system may reduce handling, stability, braking performance, and could result in a collision.
- Weight Distributing Systems may not be compatible with Surge Brake Couplers. Consult with your hitch and trailer manufacturer or a reputable Recreational Vehicle dealer for additional information.

Trailer Hitch Classification

The following chart provides the industry standard for the maximum trailer weight a given trailer hitch class can tow and should be used to assist you in selecting the correct trailer hitch for your intended towing condition.

Trailer Hitch Classification Definitions

Class	Max. Trailer Hitch Industry Standards
Class I - Light Duty	2,000 lbs (907 kg)
Class II - Medium Duty	3,500 lbs (1 587 kg)
Class III - Heavy Duty	5,000 lbs (2 268 kg)
Class IV - Extra Heavy Duty	10,000 lbs (4 540 kg)
Refer to the "Trailer Towing Weights (Maximum Trailer Weight Ratings)" chart for the Maximum Gross Trailer Weight (GTW) towable for your given drivetrain.	
All trailer hitches should be professionally installed on your vehicle.	

Trailer Towing Weights (Maximum Trailer Weight Ratings)

The following chart provides the maximum trailer weight ratings towable for your given drivetrain.

Engine/ Transmission	Axle	Model	GCWR (Gross Combined Wt. Rating)	Frontal Area	Max. GTW (Gross Trailer Wt.)	Max. Trailer Tongue Wt. (See Note)
3.6L/Manual	3.21	Two-Door Sport Model (4WD)	5,329 lbs (2 417 kg)	25 sq ft (2.32 sq m)	1,000 lbs (453 kg)	100 lbs (45 kg)
3.6L/Manual	3.73	Two-Door Sport Model (4WD)	6,329 lbs (2 871 kg)	25 sq ft (2.32 sq m)	2,000 lbs (907 kg)	200 lbs (91 kg)
3.6L/ Automatic	3.73	Two-Door Sport Model (4WD)	6,353 lbs (2 881 kg)	25 sq ft (2.32 sq m)	2,000 lbs (907 kg)	200 lbs (91 kg)

Engine/ Transmission	Axle	Model	GCWR (Gross Combined Wt. Rating)	Frontal Area	Max. GTW (Gross Trailer Wt.)	Max. Trailer Tongue Wt. (See Note)
3.6L/Manual	3.21	Two-Door Sahara Model (4WD)	5,430 lbs (2 463 kg)	25 sq ft (2.32 sq m)	1,000 lbs (453 kg)	100 lbs (45 kg)
3.6L/Manual	3.73	Two-Door Sahara Model (4WD)	6,430 lbs (2 916 kg)	25 sq ft (2.32 sq m)	2,000 lbs (907 kg)	200 lbs (91 kg)
3.6L/ Automatic	3.73	Two-Door Sahara Model (4WD)	6,454 lbs (2 927 kg)	25 sq ft (2.32 sq m)	2,000 lbs (907 kg)	200 lbs (91 kg)
3.6L/Manual	4.10	2-Door Rubicon Model (4WD)	6,507 lbs (2 951 kg)	25 sq ft (2.32 sq m)	2,000 lbs (907 kg)	200 lbs (91 kg)

Engine/ Transmission	Axle	Model	GCWR (Gross Combined Wt. Rating)	Frontal Area	Max. GTW (Gross Trailer Wt.)	Max. Trailer Tongue Wt. (See Note)
3.6L/ Automatic	4.10	Two-Door Rubicon Model (4WD)	6,533 lbs (2 963 kg)	25 sq ft (2.32 sq m)	2,000 lbs (907 kg)	200 lbs (91 kg)
3.6L/Manual	3.21	Four-Door Sport Model (4WD)	5,742 lbs (2 604 kg)	32 sq ft (2.97 sq m)	1,000 lbs (453 kg)	100 lbs (45 kg)
3.6L/Manual	3.73	Four-Door Sport Model (4WD)	8,242 lbs (3 738 kg)	32 sq ft (2.97 sq m)	3,500 lbs (1 587 kg)	350 lbs (159 kg)
3.6L/ Automatic	3.73	Four-Door Sport Model (4WD)	8,257 lbs (3 745 kg)	32 sq ft (2.97 sq m)	3,500 lbs (1 587 kg)	350 lbs (159 kg)

Engine/ Transmission	Axle	Model	GCWR (Gross Combined Wt. Rating)	Frontal Area	Max. GTW (Gross Trailer Wt.)	Max. Trailer Tongue Wt. (See Note)
3.6L/Manual	3.21	Four-Door Sahara Model (4WD)	5,782 lbs (2 623 kg)	32 sq ft (2.97 sq m)	1,000 lbs (453 kg)	100 lbs (45 kg)
3.6L/Manual	3.73	Four-Door Sahara Model (4WD)	8,282 lbs (3 757 kg)	32 sq ft (2.97 sq m)	3,500 lbs (1 587 kg)	350 lbs (159 kg)
3.6L/ Automatic	3.73	Four-Door Sahara Model (4WD)	8,297 lbs (3 763 kg)	32 sq ft (2.97 sq m)	3,500 lbs (1 587 kg)	350 lbs (159 kg)
3.6L/Manual	4.10	Four-Door Rubicon Model (4WD)	8,406 lbs (3 813 kg)	32 sq ft (2.97 sq m)	3,500 lbs (1 587 kg)	350 lbs (159 kg)

Engine/ Transmission	Axle	Model	GCWR (Gross Combined Wt. Rating)	Frontal Area	Max. GTW (Gross Trailer Wt.)	Max. Trailer Tongue Wt. (See Note)
3.6L/ Automatic	4.10	Four-Door Rubicon Model (4WD)	8,431 lbs (3 824 kg)	32 sq ft (2.97 sq m)	3,500 lbs (1 587 kg)	350 lbs (159 kg)
Refer to local laws for maximum trailer towing speeds.						

NOTE: The trailer tongue weight must be considered as part of the combined weight of occupants and cargo (ie. the GVWR), and the GVWR should never exceed the weight referenced on the Tire and Loading Information placard. Refer to “Tire Safety Information” in “Starting and Operating” for further information.

Trailer And Tongue Weight

Always load a trailer with 60% to 65% of the weight in the front of the trailer. This places 10% to 15% of the Gross Trailer Weight (GTW) on the tow hitch of your vehicle. Loads balanced over the wheels or heavier in the rear can cause the trailer to sway **severely** side to side which will cause loss of control of the vehicle and trailer. Failure to load trailers heavier in front is the cause of many trailer collisions.

Never exceed the maximum tongue weight stamped on your bumper or trailer hitch.

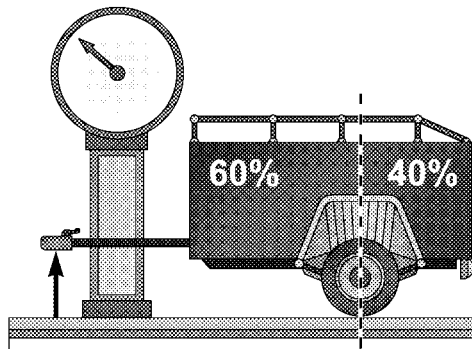

057003767

Consider the following items when computing the weight on the rear axle of the vehicle:

- The tongue weight of the trailer.
- The weight of any other type of cargo or equipment put in or on your vehicle.
- The weight of the driver and all passengers.

NOTE: Remember that everything put into or on the trailer adds to the load on your vehicle. Also, additional factory-installed options or dealer-installed options must be considered as part of the total load on your vehicle. Refer to the “Tire and Loading Information” placard for the maximum combined weight of occupants and cargo for your vehicle.

Towing Requirements

To promote proper break-in of your new vehicle drivetrain components, the following guidelines are recommended:

NOTE: Trailer towing requires special rear axle lubricant. Refer to “Fluids, Lubricants, and Genuine Parts” in “Maintaining Your Vehicle” for the correct fluid type.

CAUTION!

- **Do not tow a trailer at all during the first 500 miles (805 km) the new vehicle is driven. The engine, axle or other parts could be damaged.**
- **Then, during the first 500 miles (805 km) that a trailer is towed, do not drive over 50 mph (80 km/h) and do not make starts at full throttle. This helps the engine and other parts of the vehicle wear in at the heavier loads.**

WARNING!

Improper towing can lead to a collision. Follow these guidelines to make your trailer towing as safe as possible:

- Make certain that the load is secured in the trailer and will not shift during travel. When trailering cargo that is not fully secured, dynamic load shifts can occur that may be difficult for the driver to control. You could lose control of your vehicle and have a collision.
- When hauling cargo or towing a trailer, do not overload your vehicle or trailer. Overloading can cause a loss of control, poor performance or damage to the brakes, axle, engine, transmission, steering, suspension, chassis structure or tires.

(Continued)

WARNING! (Continued)

- Safety chains must always be used between your vehicle and trailer. Always connect the chains to the frame or hook retainers of the vehicle hitch. Cross the chains under the trailer tongue and allow enough slack for turning corners.
- Vehicles with trailers should not be parked on a grade. When parking, apply the parking brake on the tow vehicle. Put the tow vehicle automatic transmission in PARK. With a manual transmission, shift the transmission into first gear. And with four-wheel-drive vehicles, make sure the transfer case is not in N (Neutral). Always, block or "chock" the trailer wheels.
- GCWR must not be exceeded.

(Continued)

WARNING! (Continued)

- **Total weight must be distributed between the tow vehicle and the trailer such that the following four ratings are not exceeded:**
 1. GVWR
 2. GTW
 3. GAWR
 4. **Tongue weight rating for the trailer hitch utilized (This requirement may limit the ability to always achieve the 10% to 15% range of tongue weight as a percentage of total trailer weight).**

Towing Requirements – Tires

- Proper tire inflation pressures are essential to the safe and satisfactory operation of your vehicle. Refer to “Tires – General Information” in “Starting and Operating” for proper tire inflation procedures.
- Check the trailer tires for proper tire inflation pressures before trailer usage.
- Check for signs of tire wear or visible tire damage before towing a trailer. Refer to “Tires – General Information” in “Starting and Operating” for proper inspection procedure.
- When replacing tires, refer to “Tires – General Information” in “Starting and Operating” for proper tire replacement procedures. Replacing tires with a higher load carrying capacity will not increase the vehicle’s GVWR and GAWR limits.

Towing Requirements – Trailer Brakes

- Do **not** interconnect the hydraulic brake system or vacuum system of your vehicle with that of the trailer. This could cause inadequate braking and possible personal injury.
- An electronically actuated trailer brake controller is required when towing a trailer with electronically actuated brakes. When towing a trailer equipped with a hydraulic surge actuated brake system, an electronic brake controller is not required.
- Trailer brakes are recommended for trailers over 1,000 lbs (454 kg) and required for trailers in excess of 2,000 lbs (907 kg).

CAUTION!

If the trailer weighs more than 1,000 lbs (454 kg) loaded, it should have its own brakes and they should be of adequate capacity. Failure to do this could lead to accelerated brake lining wear, higher brake pedal effort, and longer stopping distances.

WARNING!

- Do not connect trailer brakes to your vehicle's hydraulic brake lines. It can overload your brake system and cause it to fail. You might not have brakes when you need them and could have a collision.
- Towing any trailer will increase your stopping distance. When towing you should allow for additional space between your vehicle and the vehicle in front of you. Failure to do so could result in a collision.

Towing Requirements – Trailer Lights And Wiring

Whenever you pull a trailer, regardless of the trailer size, stop lights and turn signals on the trailer are required for motoring safety.

The Trailer Tow Package will include a four-pin wiring harness. Use a factory-approved trailer harness and connector.

NOTE: Do not cut or splice wiring into the vehicles wiring harness.

The electrical connections are all complete to the vehicle but you must mate the harness to a trailer connector. Refer to the following illustration.

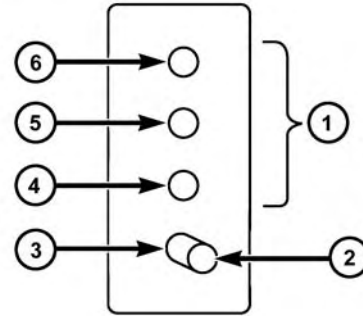

Four-Pin Connector

- 1 — Female Pins
- 2 — Male Pin
- 3 — Ground

- 4 — Park
- 5 — Left Stop/Turn
- 6 — Right Stop/Turn

057003766

Towing Tips

Before setting out on a trip, practice turning, stopping and backing the trailer in an area away from heavy traffic.

If using a manual transmission vehicle for trailer towing, all starts must be in first gear to avoid excessive clutch slippage.

Automatic Transmission – If Equipped

The DRIVE range can be selected when towing. However, if frequent shifting occurs while in this range, use the Electronic Range Select (ERS) shift control to select a lower gear range.

NOTE: Using a lower gear range while operating the vehicle under heavy loading conditions will improve performance and extend transmission life by reducing excessive shifting and heat buildup. This action will also provide better engine braking.

If you REGULARLY tow a trailer for more than 45 minutes of continuous operation, then change the transmission fluid and filter as specified for "police, taxi, fleet, or frequent trailer towing." Refer to the "Maintenance Schedule" for the proper maintenance intervals.

NOTE: Check the automatic transmission fluid level before towing.

Electronic Speed Control – If Equipped

- Do not use in hilly terrain or with heavy loads.
- When using the speed control, if you experience speed drops greater than 10 mph (16 km/h), disengage until you can get back to cruising speed.
- Use speed control in flat terrain and with light loads to maximize fuel efficiency.

Cooling System

To reduce potential for engine and transmission overheating, take the following actions:

City Driving

When stopped for short periods of time, shift the transmission into NEUTRAL and increase engine idle speed.

Highway Driving

Reduce speed.

Air Conditioning

Turn off temporarily.

RECREATIONAL TOWING (BEHIND MOTORHOME, ETC.)**Towing This Vehicle Behind Another Vehicle**

Towing Condition	Wheels OFF the Ground	Four-Wheel Drive Models
Flat Tow	NONE	See Instructions <ul style="list-style-type: none">• Automatic transmission in PARK• Manual transmission in gear (NOT in N NEUTRAL)• Transfer case in NEUTRAL (N)• Tow in forward direction
Dolly Tow	Front	NOT ALLOWED
	Rear	NOT ALLOWED
On Trailer	ALL	OK

Recreational Towing – Four-Wheel Drive Models

NOTE: The transfer case must be shifted into **NEUTRAL (N)**, automatic transmission must be shifted into **PARK**, and manual transmission must be placed in gear (**NOT** in **NEUTRAL**) for recreational towing.

CAUTION!

- Front or rear wheel lifts should not be used. Internal damage to the transmission or transfer case will occur if a front or rear wheel lift is used when recreational towing.
- Tow only in the forward direction. Towing this vehicle backwards can cause severe damage to the transfer case.
- Automatic transmissions must be placed in the **PARK** position for recreational towing.

(Continued)

CAUTION! *(Continued)*

- Manual transmissions must be placed in gear (not in Neutral) for recreational towing.
- Before recreational towing, perform the procedure outlined under “Shifting Into **NEUTRAL (N)**” to be certain that the transfer case is fully in **NEUTRAL (N)**. Otherwise, internal damage will result.
- Towing this vehicle in violation of the above requirements can cause severe transmission and/or transfer case damage. Damage from improper towing is not covered under the New Vehicle Limited Warranty.
- Do not use a bumper-mounted clamp-on tow bar on your vehicle. The bumper face bar will be damaged.

Shifting Into NEUTRAL (N)

Use the following procedure to prepare your vehicle for recreational towing.

WARNING!

You or others could be injured if you leave the vehicle unattended with the transfer case in the NEUTRAL (N) position without first fully engaging the parking brake. The transfer case NEUTRAL (N) position disengages both the front and rear drive-shafts from the powertrain and will allow the vehicle to move, even if the transmission is in PARK. The parking brake should always be applied when the driver is not in the vehicle.

CAUTION!

It is necessary to follow these steps to be certain that the transfer case is fully in NEUTRAL (N) before recreational towing to prevent damage to internal parts.

1. Bring the vehicle to a complete stop.
2. Turn OFF the engine.
3. Press and hold the brake pedal.
4. Shift the automatic transmission into NEUTRAL or depress the clutch pedal on a manual transmission.
5. Shift the transfer case lever into NEUTRAL (N).
6. Start the engine.

7. Shift the transmission into REVERSE.
8. Release the brake pedal (and clutch pedal on manual transmissions) for five seconds and ensure that there is no vehicle movement.
9. Repeat Steps 7 and 8 with automatic transmission in DRIVE or manual transmission in first gear.
10. Turn OFF the engine.
11. Firmly apply the parking brake.
12. Shift the transmission into PARK or place manual transmission in gear (NOT in Neutral).

CAUTION!

Damage to the transmission may occur if the transmission is shifted into PARK with the transfer case in NEUTRAL (N) and the engine running. With the transfer case in NEUTRAL (N) ensure that the engine is OFF before shifting the transmission into PARK.

13. Attach the vehicle to the tow vehicle using a suitable tow bar.
14. Release the parking brake.

Shifting Out of NEUTRAL (N)

Use the following procedure to prepare your vehicle for normal usage.

1. Bring the vehicle to a complete stop, leaving it connected to the tow vehicle.
 2. Firmly apply the parking brake.
 3. Turn the ignition switch to the LOCK/OFF position.
 4. Turn the ignition switch to the ON/RUN position, but do not start the engine.
 5. Press and hold the brake pedal.
 6. Shift the transmission into NEUTRAL.
 7. Shift the transfer case lever to the desired position.
- NOTE:** When shifting out of transfer case NEUTRAL (N), turning the engine OFF may be required to avoid gear clash.
8. Shift the automatic transmission into PARK, or place manual transmission in Neutral.
 9. Release the brake pedal.
 10. Disconnect vehicle from the tow vehicle.
 11. Start the engine.
 12. Press and hold the brake pedal.
 13. Release the parking brake.
 14. Shift the transmission into gear, release the brake pedal (and clutch pedal on manual transmissions), and check that the vehicle operates normally.

WHAT TO DO IN EMERGENCIES

CONTENTS

- HAZARD WARNING FLASHERS 538
- IF YOUR ENGINE OVERHEATS 538
- JACKING AND TIRE CHANGING 540
 - Jack Location 541
 - Spare Tire Stowage 542
 - Preparations For Jacking 542
 - Jacking Instructions 543
 - Road Tire Installation. 547
- JUMP-STARTING PROCEDURES. 548
 - Preparations For Jump-Start 549
 - Jump-Starting Procedure 550
- FREEING A STUCK VEHICLE. 552
- EMERGENCY TOW HOOKS — IF EQUIPPED . 554
- SHIFT LEVER OVERRIDE 554
- TOWING A DISABLED VEHICLE 556
 - Without The Ignition Key. 557
 - Four-Wheel Drive Models 558

HAZARD WARNING FLASHERS

The Hazard Warning flasher switch is located on the instrument panel below the climate controls.



Press the switch to turn on the Hazard Warning flasher. When the switch is activated, all directional turn signals will flash on and off to warn oncoming traffic of an emergency. Press the switch a second time to turn off the Hazard Warning flashers.

This is an emergency warning system and it should not be used when the vehicle is in motion. Use it when your vehicle is disabled and it is creating a safety hazard for other motorists.

When you must leave the vehicle to seek assistance, the Hazard Warning flashers will continue to operate even though the ignition is placed in the OFF position.

NOTE: With extended use the Hazard Warning flashers may wear down your battery.

IF YOUR ENGINE OVERHEATS

In any of the following situations, you can reduce the potential for overheating by taking the appropriate action.

- On the highways — slow down.
- In city traffic — while stopped, shift transmission into NEUTRAL, but do not increase engine idle speed.

CAUTION!

Driving with a hot cooling system could damage your vehicle. If the temperature gauge reads **HOT (H)**, pull over and stop the vehicle. Idle the vehicle with the air conditioner turned off until the pointer drops back into the normal range. If the pointer remains on **HOT (H)**, and you hear continuous chimes, turn the engine off immediately, and call for service.

NOTE: There are steps that you can take to slow down an impending overheat condition:

- If your air conditioner (A/C) is on, turn it off. The A/C system adds heat to the engine cooling system and turning the A/C off can help remove this heat.

- You can also turn the temperature control to maximum heat, the mode control to floor and the blower control to high. This allows the heater core to act as a supplement to the radiator and aids in removing heat from the engine cooling system.

WARNING!

You or others can be badly burned by hot engine coolant (antifreeze) or steam from your radiator. If you see or hear steam coming from under the hood, do not open the hood until the radiator has had time to cool. Never try to open a cooling system pressure cap when the radiator or coolant bottle is hot.

JACKING AND TIRE CHANGING**WARNING!**

- Do not attempt to change a tire on the side of the vehicle close to moving traffic. Pull far enough off the road to avoid the danger of being hit when operating the jack or changing the wheel.
- Being under a jacked-up vehicle is dangerous. The vehicle could slip off the jack and fall on you. You could be crushed. Never put any part of your body under a vehicle that is on a jack. If you need to get under a raised vehicle, take it to a service center where it can be raised on a lift.

(Continued)

WARNING! (Continued)

- Never start or run the engine while the vehicle is on a jack.
- The jack is designed to be used as a tool for changing tires only. The jack should not be used to lift the vehicle for service purposes. The vehicle should be jacked on a firm level surface only. Avoid ice or slippery areas.

Jack Location

The jack and lug wrench are located in the rear storage compartment.



060633923

Jack Storage

NOTE: Turn the black plastic wing nut counter clockwise to loosen the jack from the storage bin.



060567480

Jack Wing Nut

Spare Tire Stowage

To remove the spare tire from the carrier, remove the tire cover, if equipped, and remove the lug nuts with the lug wrench turning them counterclockwise.

NOTE: If you have added aftermarket accessories to the spare tire mounted carrier, it cannot exceed a gross weight of 50 lbs (23 kg) including the weight of the spare tire.

Preparations For Jacking

1. Park on a firm, level surface. Avoid ice or slippery areas.

WARNING!

Do not attempt to change a tire on the side of the vehicle close to moving traffic, pull far enough off the road to avoid being hit when operating the jack or changing the wheel.

2. Turn on the Hazard Warning flasher.
3. Set the parking brake.
4. Shift the automatic transmission into PARK, or a manual transmission into REVERSE.
5. Turn the ignition to LOCK.



Block both the front and rear of the wheel diagonally opposite of the jacking position. For example, if changing the right front tire, block the left rear wheel.

NOTE: Passengers should not remain in the vehicle when the vehicle is being jacked.

Jacking Instructions

WARNING!

Carefully follow these tire changing warnings to help prevent personal injury or damage to your vehicle:

- Always park on a firm, level surface as far from the edge of the roadway as possible before raising the vehicle.
- Turn on the Hazard Warning flasher.
- Block the wheel diagonally opposite the wheel to be raised.
- Set the parking brake firmly and set an automatic transmission in PARK; a manual transmission in REVERSE.
- Never start or run the engine with the vehicle on a jack.

(Continued)

WARNING! *(Continued)*

- Do not let anyone sit in the vehicle when it is on a jack.
- Do not get under the vehicle when it is on a jack. If you need to get under a raised vehicle, take it to a service center where it can be raised on a lift.
- Only use the jack in the positions indicated and for lifting this vehicle during a tire change.
- If working on or near a roadway, be extremely careful of motor traffic.
- To assure that spare tires, flat or inflated, are securely stowed, spares must be stowed with the valve stem facing the ground.



Jack Warning Label

CAUTION!

Do not attempt to raise the vehicle by jacking on locations other than those indicated in the Jacking Instructions for this vehicle.

1. Remove the spare tire, jack and tools from the stored location.
2. Loosen (but do not remove) the wheel lug nuts by turning them to the left one turn while the wheel is still on the ground.

3. Assemble the jack and jacking tools. Connect the jack handle driver to the extension, then to the lug wrench.
4. Operate the jack from the front or the rear of the vehicle. Place the jack under the axle tube, as shown. **Do not raise the vehicle until you are sure the jack is fully engaged.**

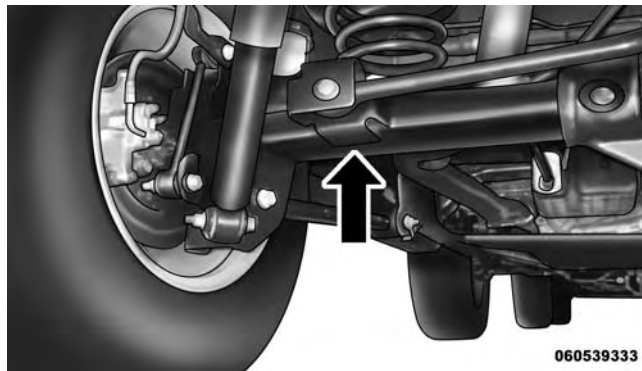

060539333

Rear Jacking Location

WARNING!

Raising the vehicle higher than necessary can make the vehicle less stable and cause a collision. It could slip off the jack and hurt someone near it. Raise the vehicle only enough to remove the tire.

6. Remove the lug nuts and wheel.

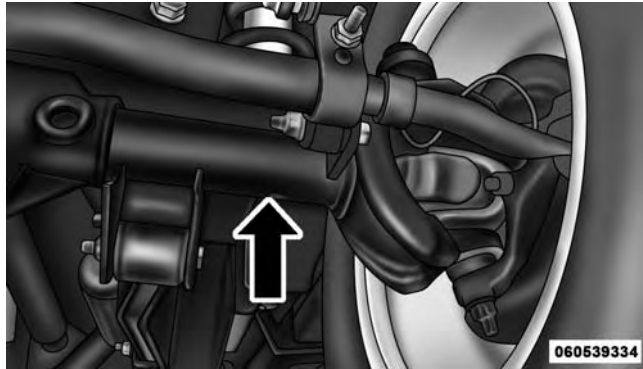
**Front Jacking Location**

5. Raise the vehicle by turning the jack screw to the right. Raise the vehicle till the tire is raised from the surface of the road. Minimum tire lift provides maximum stability.

7. Position the spare wheel/tire on the vehicle and install the lug nuts with the cone-shaped end toward the wheel. Lightly tighten the lug nuts clockwise.

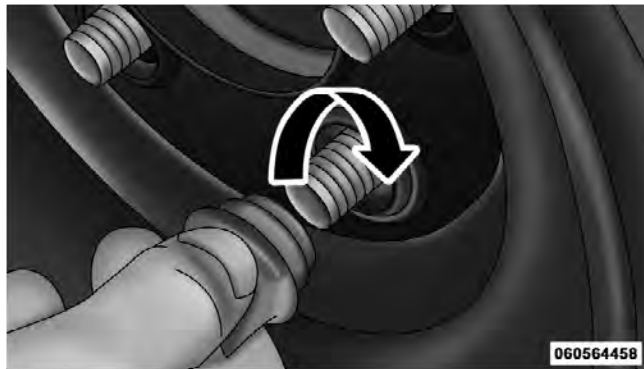

Lug Nut Installation

WARNING!

To avoid the risk of forcing the vehicle off the jack, do not tighten the lug nuts fully until the vehicle has been lowered. Failure to follow this warning may result in personal injury.

8. Lower the vehicle by turning the jack screw to the left, and remove the jack.
9. Finish tightening the lug nuts. Push down on the wrench while tightening for increased leverage. Alternate nuts until each nut has been tightened twice. The correct wheel nut tightness is 95 ft lbs (130 N·m). If in doubt about the correct tightness, have them checked with a torque wrench by your authorized dealer or at a service station.

10. Remove the jack assembly and wheel blocks.
11. Secure the tire, jack, and tools in their proper locations.
12. Remove blocks from wheels.

WARNING!

A loose tire or jack thrown forward in a collision or hard stop, could endanger the occupants of the vehicle. Always stow the jack parts and the spare tire in the places provided.

Road Tire Installation

1. Mount the road tire on the axle.
2. Install the remaining lug nuts with the cone shaped end of the nut toward the wheel. Lightly tighten the lug nuts.

WARNING!

To avoid the risk of forcing the vehicle off the jack, do not tighten the lug nuts fully until the vehicle has been lowered. Failure to follow this warning may result in personal injury.

3. Lower the vehicle to the ground by turning the jack handle counterclockwise.
4. Finish tightening the lug nuts. Push down on the wrench while at the end of the handle for increased leverage. Tighten the lug nuts in a star pattern until each nut has been tightened twice. The correct tightness of each lug nut is 95 ft/lbs (130 N·m). If in doubt about the correct tightness, have them checked with a torque wrench by your authorized dealer or service station.
5. After 25 miles (40 km) check the lug nut torque with a torque wrench to ensure that all lug nuts are properly seated against the wheel.

JUMP-STARTING PROCEDURES

If your vehicle has a discharged battery it can be jump-started using a set of jumper cables and a battery in another vehicle or by using a portable battery booster pack. Jump-starting can be dangerous if done improperly so please follow the procedures in this section carefully.

NOTE: When using a portable battery booster pack follow the manufacturer's operating instructions and precautions.

CAUTION!

Do not use a portable battery booster pack or any other booster source with a system voltage greater than 12 Volts or damage to the battery, starter motor, alternator or electrical system may occur.

WARNING!

Do not attempt jump-starting if the battery is frozen. It could rupture or explode and cause personal injury.

Preparations For Jump-Start

The battery in your vehicle is located in the right rear of the engine compartment, behind the Power Distribution Center.

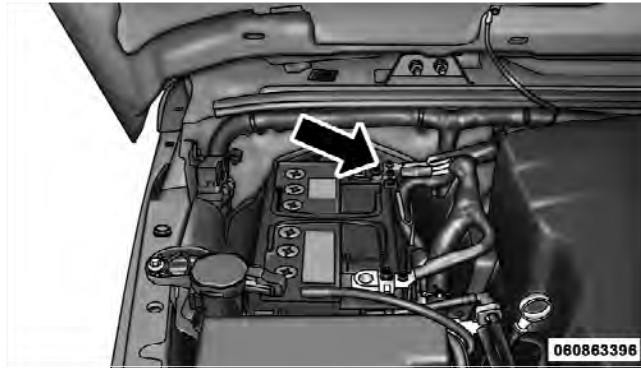

Positive Battery Post

WARNING!

- Take care to avoid the radiator cooling fan whenever the hood is raised. It can start anytime the ignition switch is ON. You can be injured by moving fan blades.
- Remove any metal jewelry such as watch bands or bracelets that might make an inadvertent electrical contact. You could be seriously injured.
- Batteries contain sulfuric acid that can burn your skin or eyes and generate hydrogen gas which is flammable and explosive. Keep open flames or sparks away from the battery.

1. Set the parking brake, shift the automatic transmission into PARK (manual transmission in NEUTRAL) and turn the ignition to LOCK.
2. Turn off the heater, radio, and all unnecessary electrical accessories.
3. If using another vehicle to jump-start the battery, park the vehicle within the jumper cables reach, set the parking brake and make sure the ignition is OFF.

WARNING!

Do not allow vehicles to touch each other as this could establish a ground connection and personal injury could result.

Jump-Starting Procedure**WARNING!**

Failure to follow this procedure could result in personal injury or property damage due to battery explosion.

CAUTION!

Failure to follow these procedures could result in damage to the charging system of the booster vehicle or the discharged vehicle.

1. Connect the positive (+) end of the jumper cable to the positive (+) post of the discharged vehicle.
2. Connect the opposite end of the positive (+) jumper cable to the positive (+) post of the booster battery.

3. Connect the negative end (-) of the jumper cable to the negative (-) post of the booster battery.
4. Connect the opposite end of the negative (-) jumper cable to a good engine ground (exposed metal part of the discharged vehicle's engine) away from the battery and the fuel injection system.

WARNING!

Do not connect the cable to the negative post (-) of the discharged battery. The resulting electrical spark could cause the battery to explode and could result in personal injury.

5. Start the engine in the vehicle that has the booster battery, let the engine idle a few minutes, and then start the engine in the vehicle with the discharged battery.

Once the engine is started, remove the jumper cables in the reverse sequence:

6. Disconnect the negative (-) jumper cable from the engine ground of the vehicle with the discharged battery.
7. Disconnect the negative end (-) of the jumper cable from the negative (-) post of the booster battery.
8. Disconnect the opposite end of the positive (+) jumper cable from the positive (+) post of the booster battery.
9. Disconnect the positive (+) end of the jumper cable from the positive (+) post of the discharged vehicle.

If frequent jump-starting is required to start your vehicle you should have the battery and charging system inspected at your authorized dealer.

CAUTION!

Accessories that can be plugged into the vehicle power outlets draw power from the vehicle's battery, even when not in use (i.e., cellular phones, etc.). Eventually, if plugged in long enough, the vehicle's battery will discharge sufficiently to degrade battery life and/or prevent the engine from starting.

FREEING A STUCK VEHICLE

If your vehicle becomes stuck in mud, sand or snow, it can often be moved using a rocking motion. Turn the steering wheel right and left to clear the area around the front wheels. Then shift back and forth between DRIVE and REVERSE (with automatic transmission) or 2nd gear and REVERSE (with manual transmission), while gently

pressing the accelerator. Use the least amount of accelerator pedal pressure that will maintain the rocking motion, without spinning the wheels, or racing the engine.

CAUTION!

Racing the engine or spinning the wheels may lead to transmission overheating and failure. Allow the engine to idle with the shift lever in NEUTRAL for at least one minute after every five rocking-motion cycles. This will minimize overheating and reduce the risk of transmission failure during prolonged efforts to free a stuck vehicle.

NOTE: Press the "ESC Off" switch, to place the Electronic Stability Control (ESC) system in "Partial Off" mode, before rocking the vehicle. Refer to "Electronic Brake

Control" in "Starting And Operating" for further information. Once the vehicle has been freed, press the "ESC Off" switch again to restore "ESC On" mode.

CAUTION!

- When "rocking" a stuck vehicle by shifting between DRIVE/2nd gear and REVERSE, do not spin the wheels faster than 15 mph (24 km/h), or drivetrain damage may result.
- Revving the engine or spinning the wheels too fast may lead to transmission overheating and failure. It can also damage the tires. Do not spin the wheels above 30 mph (48 km/h) while in gear (no transmission shifting occurring).

WARNING!

Fast spinning tires can be dangerous. Forces generated by excessive wheel speeds may cause damage, or even failure, of the axle and tires. A tire could explode and injure someone. Do not spin your vehicle's wheels faster than 30 mph (48 km/h) or for longer than 30 seconds continuously without stopping when you are stuck and do not let anyone near a spinning wheel, no matter what the speed.

EMERGENCY TOW HOOKS — IF EQUIPPED

If your vehicle is equipped with tow hooks, they are mounted in the front and the rear.

NOTE: For off-road recovery, it is recommended to use both of the front tow hooks to minimize the risk of damage to the vehicle. Always use an appropriately rated tow strap.

WARNING!

- **Do not use a chain for freeing a stuck vehicle. Chains may break, causing serious injury or death.**
- **Stand clear of vehicles when pulling with tow hooks. Tow straps may become disengaged, causing serious injury.**

CAUTION!

Tow hooks are for emergency use only, to rescue a vehicle stranded off road. Do not use tow hooks for tow truck hookup or highway towing. You could damage your vehicle. Tow straps are recommended when towing the vehicle, chains may cause vehicle damage.

SHIFT LEVER OVERRIDE

If a malfunction occurs and the shift lever cannot be moved out of the PARK position, you can use the following procedure to temporarily move the shift lever:

1. Turn the engine OFF.
2. Firmly apply the parking brake.

- Using a small screwdriver or similar tool, remove the shift lever override access cover (located to the right of the shift lever).
- Turn the ignition to the ACC or ON/RUN position, but do not start the engine.
- Press and maintain firm pressure on the brake pedal.
- Insert the screwdriver or similar tool into the access port, and push and hold the override release lever down.
- Move the shift lever to the NEUTRAL position.
- The vehicle may then be started in NEUTRAL.
- Reinstall the shift lever override access cover.

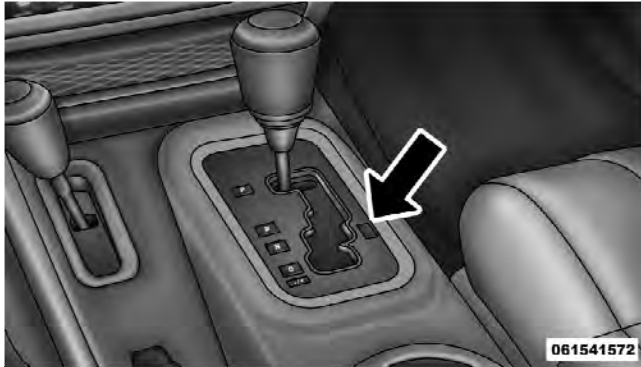

Shift Lever Override Access Cover

TOWING A DISABLED VEHICLE

This section describes procedures for towing a disabled vehicle using a commercial wrecker service. If the transmission and drivetrain are operable, disabled vehicles may also be towed as described under “Recreational Towing” in the “Starting And Operating” section.

Towing Condition	Wheels OFF the Ground	4WD MODELS
Flat Tow	NONE	See instructions under “Recreational Towing” <ul style="list-style-type: none"> • Automatic Transmission in PARK • Manual Transmission in gear (NOT in Neutral) • Transfer Case in NEUTRAL • Tow in forward direction
Wheel Lift or Dolly Tow	Front	NOT ALLOWED
	Rear	NOT ALLOWED
Flatbed	ALL	BEST METHOD

Proper towing or lifting equipment is required to prevent damage to your vehicle. Use only tow bars and other equipment designed for this purpose, following equipment manufacturer's instructions. Use of safety chains is mandatory. Attach a tow bar or other towing device to main structural members of the vehicle, not to bumpers or associated brackets. State and local laws regarding vehicles under tow must be observed.

If you must use the accessories (wipers, defrosters, etc.) while being towed, the ignition must be in the ON/RUN position, not the ACC position.

If the vehicle's battery is discharged, refer to "Shift Lever Override" in "What To Do In Emergencies" for instructions on shifting the automatic transmission out of PARK for towing.

CAUTION!

Do not use sling type equipment when towing. When securing the vehicle to a flatbed truck, do not attach to front or rear suspension components. Damage to your vehicle may result from improper towing.

Without The Ignition Key

Special care must be taken when the vehicle is towed with the ignition in the OFF position. The only approved method of towing without the key fob is with a flatbed truck. Proper towing equipment is necessary to prevent damage to the vehicle.

Four-Wheel Drive Models

The manufacturer recommends towing with all wheels **OFF** the ground. Acceptable methods are to tow the vehicle on a flatbed or with one end of the vehicle raised and the opposite end on a towing dolly.

If flatbed equipment is not available and the transfer case is operable, the vehicle may be towed (in the forward direction, with **ALL** wheels on the ground), **IF** the transfer case is in **NEUTRAL** (N) and the transmission is in **PARK** (for automatic transmissions) or in gear (**NOT** in **NEUTRAL**, for manual transmissions). Refer to “Recreational Towing” in “Starting And Operating” for detailed instructions.

CAUTION!

- **Front or rear wheel lifts should not be used. Internal transmission damage or transfer case will occur if a front or rear wheel lift is used when towing.**
- **Failure to follow these towing methods can cause severe transmission damage and/or transfer case. Such damage is not covered by the New Vehicle Limited Warranty.**

MAINTAINING YOUR VEHICLE

CONTENTS

- ENGINE COMPARTMENT — 3.6L561
- ONBOARD DIAGNOSTIC SYSTEM — OBD II .562
 - Loose Fuel Filler Cap Message562
- EMISSIONS INSPECTION AND MAINTENANCE PROGRAMS563
- REPLACEMENT PARTS564
- DEALER SERVICE564
- MAINTENANCE PROCEDURES565
 - Engine Oil566
 - Engine Oil Filter569
 - Engine Air Cleaner Filter569
 - Maintenance-Free Battery570
 - Air Conditioner Maintenance571
 - Body Lubrication572
 - Windshield Wiper Blades573
 - Adding Washer Fluid574
 - Exhaust System574
 - Cooling System577
 - Brake System583
 - Automatic Transmission – If Equipped585

560 MAINTAINING YOUR VEHICLE

- Clutch Hydraulic System (Manual Transmission) – If Equipped588
- Manual Transmission – If Equipped588
- Transfer Case589
- Front/Rear Axle Fluid590
- Appearance Care And Protection From Corrosion591
- FUSES598
 - Totally Integrated Power Module598
- VEHICLE STORAGE605
- REPLACEMENT BULBS606
- BULB REPLACEMENT607
 - Headlamp607
 - Front Park/Turn Signal608
 - Front Side Marker608
 - Front Fog Lamp608
 - Rear Tail, Stop, Turn Signal, And Backup Lamp609
 - Center High-Mounted Stop Lamp (CHMSL) . .609
- FLUID CAPACITIES610
- FLUIDS, LUBRICANTS AND GENUINE PARTS611
 - Engine611
 - Chassis612

ENGINE COMPARTMENT — 3.6L

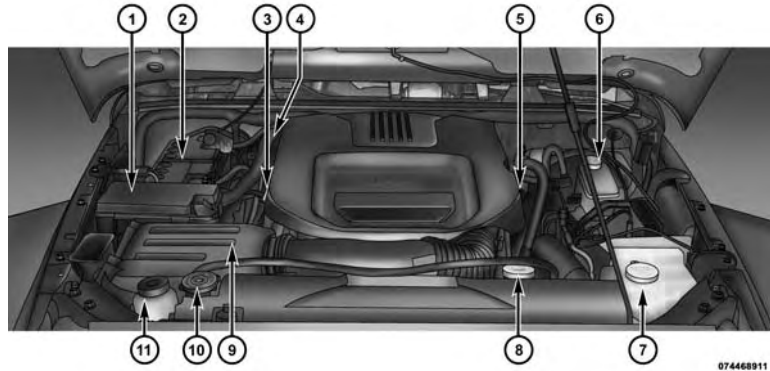

- 1 — Integrated Power Module (Fuses)
- 2 — Battery
- 3 — Engine Oil Dipstick
- 4 — Automatic Transmission Dipstick (Under Engine Cover)
- 5 — Engine Oil Fill
- 6 — Brake Fluid Reservoir

- 7 — Washer Fluid Reservoir
- 8 — Engine Coolant Reservoir
- 9 — Air Cleaner Filter
- 10 — Coolant Pressure Cap
- 11 — Power Steering Fluid Reservoir

ONBOARD DIAGNOSTIC SYSTEM — OBD II

Your vehicle is equipped with a sophisticated onboard diagnostic system called OBD II. This system monitors the performance of the emissions, engine, and automatic transmission control systems. When these systems are operating properly, your vehicle will provide excellent performance and fuel economy, as well as engine emissions well within current government regulations.

If any of these systems require service, the OBD II system will turn on the “Malfunction Indicator Light” (MIL). It will also store diagnostic codes and other information to assist your service technician in making repairs. Although your vehicle will usually be drivable and not need towing, see your authorized dealer for service as soon as possible.

CAUTION!

- **Prolonged driving with the MIL on could cause further damage to the emission control system. It could also affect fuel economy and drivability. The vehicle must be serviced before any emissions tests can be performed.**
- **If the MIL is flashing while the engine is running, severe catalytic converter damage and power loss will soon occur. Immediate service is required.**

Loose Fuel Filler Cap Message

After fuel is added, the vehicle diagnostic system can determine if the fuel filler cap is possibly loose, improperly installed, or damaged. A “gASCAP” message will be displayed in the odometer. Tighten the gas cap until a “clicking” sound is heard. This is an indication that the

gas cap is properly tightened. Press the odometer reset button to turn the message off. If the problem persists, the message will appear the next time the vehicle is started. This might indicate a damaged cap. If the problem is detected twice in a row, the system will turn on the MIL. Resolving the problem will turn the MIL off.

EMISSIONS INSPECTION AND MAINTENANCE PROGRAMS

In some localities, it may be a legal requirement to pass an inspection of your vehicle's emissions control system. Failure to pass could prevent vehicle registration.



For states that require an Inspection and Maintenance (I/M), this check verifies the "Malfunction Indicator Light (MIL)" is functioning and is not on when the engine is running, and that the OBD II system is ready for testing.

Normally, the OBD II system will be ready. The OBD II system may **not** be ready if your vehicle was recently serviced, recently had a dead battery or a battery replacement. If the OBD II system should be determined not ready for the I/M test, your vehicle may fail the test.

Your vehicle has a simple ignition key-actuated test, which you can use prior to going to the test station. To check if your vehicle's OBD II system is ready, you must do the following:

1. Turn the ignition switch to the ON position, but do not crank or start the engine.
2. If you crank or start the engine, you will have to start this test over.
3. As soon as you turn the ignition switch to the ON position, you will see the MIL symbol come on as part of a normal bulb check.

4. Approximately 15 seconds later, one of two things will happen:

- The MIL will flash for about 10 seconds and then return to being fully illuminated until you turn OFF the ignition or start the engine. This means that your vehicle's OBD II system is **not ready** and you should **not** proceed to the I/M station.
- The MIL will not flash at all and will remain fully illuminated until you turn OFF the ignition or start the engine. This means that your vehicle's OBD II system is **ready** and you can proceed to the I/M station.

If your OBD II system is **not ready**, you should see your authorized dealer or repair facility. If your vehicle was recently serviced or had a battery failure or replacement, you may need to do nothing more than drive your vehicle as you normally would in order for your OBD II system to update. A recheck with the above test routine may then indicate that the system is now ready.

Regardless of whether your vehicle's OBD II system is ready or not, if the MIL is illuminated during normal vehicle operation you should have your vehicle serviced before going to the I/M station. The I/M station can fail your vehicle because the MIL is on with the engine running.

REPLACEMENT PARTS

Use of genuine MOPAR® parts for normal/scheduled maintenance and repairs is highly recommended to ensure the designed performance. Damage or failures caused by the use of non-MOPAR® parts for maintenance and repairs will not be covered by the manufacturer's warranty.

DEALER SERVICE

Your authorized dealer has the qualified service personnel, special tools, and equipment to perform all service operations in an expert manner. Service Manuals are

available which include detailed service information for your vehicle. Refer to these Service Manuals before attempting any procedure yourself.

NOTE: Intentional tampering with emissions control systems may void your warranty and could result in civil penalties being assessed against you.

WARNING!

You can be badly injured working on or around a motor vehicle. Only do service work for which you have the knowledge and the proper equipment. If you have any doubt about your ability to perform a service job, take your vehicle to a competent mechanic.

MAINTENANCE PROCEDURES

The pages that follow contain the **required** maintenance services determined by the engineers who designed your vehicle.

Besides those maintenance items specified in the fixed maintenance schedule, there are other components which may require servicing or replacement in the future.

CAUTION!

- Failure to properly maintain your vehicle or perform repairs and service when necessary could result in more costly repairs, damage to other components or negatively impact vehicle performance. Immediately have potential malfunctions examined by an authorized dealer or qualified repair center.

(Continued)

CAUTION! *(Continued)*

- Your vehicle has been built with improved fluids that protect the performance and durability of your vehicle and also allow extended maintenance intervals. Do not use chemical flushes in these components as the chemicals can damage your engine, transmission, power steering or air conditioning. Such damage is not covered by the New Vehicle Limited Warranty. If a flush is needed because of component malfunction, use only the specified fluid for the flushing procedure.

Engine Oil**Checking Oil Level**

To assure proper lubrication of your vehicle's engine, the engine oil must be maintained at the correct level. The engine oil level should be checked five minutes after a warmed up engine has been shut off.

Checking the oil while the vehicle is on level ground will improve the accuracy of the oil level readings. Always maintain the oil level within the SAFE zone on the dipstick. Adding 1 U.S. Quart (0.95L) of oil when the reading is at the bottom of the SAFE zone will result in a reading at the top of the safe zone on these engines.

CAUTION!

Overfilling or underfilling the crankcase will cause aeration or loss of oil pressure. This could damage your engine.

Change Engine Oil

The oil change indicator system will remind you that it is time to take your vehicle in for scheduled maintenance. Refer to the “Maintenance Schedule” for further information.

NOTE: Under no circumstances should oil change intervals exceed 10,000 miles (16,000 km) or twelve months, whichever occurs first.

Engine Oil Selection

For best performance and maximum protection under all types of operating conditions, the manufacturer only recommends engine oils that are API Certified and meet the requirements of Chrysler Material Standard MS-6395.

American Petroleum Institute (API) Engine Oil Identification Symbol

This symbol means that the oil has been certified by the American Petroleum Institute (API). The manufacturer only recommends API Certified engine oils.

CAUTION!

Do not use chemical flushes in your engine oil as the chemicals can damage your engine. Such damage is not covered by the New Vehicle Limited Warranty.

Engine Oil Viscosity – 3.6L Engine

SAE 5W-20 engine oil is recommended for all operating temperatures. This engine oil improves low temperature starting and vehicle fuel economy.

The engine oil filler cap also shows the recommended engine oil viscosity for your vehicle. For information on engine oil filler cap location, refer to “Engine Compartment” in “Maintaining Your Vehicle” for further information.

Lubricants, which do not have both the engine oil certification mark and the correct SAE viscosity grade number, should not be used.

Synthetic Engine Oils

You may use synthetic engine oils provided the recommended oil quality requirements are met, and the recommended maintenance intervals for oil and filter changes are followed.

Materials Added To Engine Oil

The manufacturer strongly recommends against the addition of any additives (other than leak detection dyes) to the engine oil. Engine oil is an engineered product and its performance may be impaired by supplemental additives.

Disposing Of Used Engine Oil And Oil Filters

Care should be taken in disposing of used engine oil and oil filters from your vehicle. Used oil and oil filters, indiscriminately discarded, can present a problem to the environment. Contact your authorized dealer, service

station or governmental agency for advice on how and where used oil and oil filters can be safely discarded in your area.

Engine Oil Filter

The engine oil filter should be replaced with a new filter at every engine oil change.

Engine Oil Filter Selection

This manufacturer's engines have a full-flow type oil filter. Use a filter of this type for replacement. The quality of replacement filters varies considerably. Only high quality filters should be used to assure most efficient service. MOPAR® engine oil filters are a high quality oil filter and are recommended.

Engine Air Cleaner Filter

Refer to the "Maintenance Schedule" for the proper maintenance intervals.

WARNING!

The air induction system (air cleaner, hoses, etc.) can provide a measure of protection in the case of engine backfire. Do not remove the air induction system (air cleaner, hoses, etc.) unless such removal is necessary for repair or maintenance. Make sure that no one is near the engine compartment before starting the vehicle with the air induction system (air cleaner, hoses, etc.) removed. Failure to do so can result in serious personal injury.

Engine Air Cleaner Filter Selection

The quality of replacement engine air cleaner filters varies considerably. Only high quality filters should be used to assure most efficient service. MOPAR® engine air cleaner filters are a high quality filter and are recommended.

Maintenance-Free Battery

Your vehicle is equipped with a maintenance-free battery. You will never have to add water, nor is periodic maintenance required.

WARNING!

- **Battery fluid is a corrosive acid solution and can burn or even blind you. Do not allow battery fluid to contact your eyes, skin, or clothing. Do not lean over a battery when attaching clamps. If acid splashes in eyes or on skin, flush the area immediately with large amounts of water. Refer to "Jump-Starting Procedures" in "What To Do In Emergencies" for further information.**
- **Battery gas is flammable and explosive. Keep flame or sparks away from the battery. Do not use a booster battery or any other booster source with an output greater than 12 Volts. Do not allow cable clamps to touch each other.**
- **Battery posts, terminals, and related accessories contain lead and lead compounds. Wash hands after handling.**

CAUTION!

- It is essential when replacing the cables on the battery that the positive cable is attached to the positive post and the negative cable is attached to the negative post. Battery posts are marked positive (+) and negative (-) and are identified on the battery case. Cable clamps should be tight on the terminal posts and free of corrosion.
- If a “fast charger” is used while the battery is in the vehicle, disconnect both vehicle battery cables before connecting the charger to the battery. Do not use a “fast charger” to provide starting voltage.

Air Conditioner Maintenance

For best possible performance, your air conditioner should be checked and serviced by an authorized dealer at the start of each warm season. This service should include cleaning of the condenser fins and a performance test. Drive belt tension should also be checked at this time.

CAUTION!

Do not use chemical flushes in your air conditioning system as the chemicals can damage your air conditioning components. Such damage is not covered by the New Vehicle Limited Warranty.

WARNING!

- Use only refrigerants and compressor lubricants approved by the manufacturer for your air conditioning system. Some unapproved refrigerants are flammable and can explode, injuring you. Other unapproved refrigerants or lubricants can cause the system to fail, requiring costly repairs. Refer to Warranty Information Book, located on the DVD, for further warranty information.
- The air conditioning system contains refrigerant under high pressure. To avoid risk of personal injury or damage to the system, adding refrigerant or any repair requiring lines to be disconnected should be done by an experienced technician.

Refrigerant Recovery And Recycling

R-134a Air Conditioning Refrigerant is a hydrofluorocarbon (HFC) that is endorsed by the Environmental Protection Agency and is an ozone-saving product. However, the manufacturer recommends that air conditioning service be performed by authorized dealer or other service facilities using recovery and recycling equipment.

NOTE: Use only manufacturer approved A/C system sealers, stop leak products, seal conditioners, compressor oil, and refrigerants.

Body Lubrication

Locks and all body pivot points, including such items as seat tracks, door hinge pivot points and rollers, liftgate, tailgate, sliding doors and hood hinges, should be lubricated periodically with a lithium based grease, such as

MOPAR® Spray White Lube or equivalent to assure quiet, easy operation and to protect against rust and wear. Prior to the application of any lubricant, the parts concerned should be wiped clean to remove dust and grit; after lubricating excess oil and grease should be removed. Particular attention should also be given to hood latching components to ensure proper function. When performing other underhood services, the hood latch, release mechanism and safety catch should be cleaned and lubricated.

The external lock cylinders should be lubricated twice a year, preferably in the Fall and Spring. Apply a small amount of a high quality lubricant, such as MOPAR® Lock Cylinder Lubricant or equivalent directly into the lock cylinder.

Windshield Wiper Blades

Clean the rubber edges of the wiper blades and the windshield periodically with a sponge or soft cloth and a mild nonabrasive cleaner. This will remove accumulations of salt or road film.

Operation of the wipers on dry glass for long periods may cause deterioration of the wiper blades. Always use washer fluid when using the wipers to remove salt or dirt from a dry windshield.

Avoid using the wiper blades to remove frost or ice from the windshield. Keep the blade rubber out of contact with petroleum products such as engine oil, gasoline, etc.

NOTE: Life expectancy of wiper blades varies depending on geographical area and frequency of use. Poor performance of blades may be present with chattering, marks, water lines or wet spots. If any of these conditions are present, clean the wiper blades or replace as necessary.

Adding Washer Fluid

The fluid reservoir for the windshield washers and the rear window washer (if equipped) is shared. The fluid reservoir is located in the engine compartment. Be sure to check the fluid level at regular intervals. Fill the reservoir with windshield washer solvent only (not radiator anti-freeze). When refilling the washer fluid reservoir, take some washer fluid and apply it to a cloth or towel and wipe clean the wiper blades; this will help blade performance.

To prevent freeze-up of your windshield washer system in cold weather, select a solution or mixture that meets or exceeds the temperature range of your climate. This rating information can be found on most washer fluid containers.

WARNING!

Commercial windshield washer solvents are flammable. They could ignite and burn you. Care must be exercised when filling or working around the washer solution.

Exhaust System

The best protection against carbon monoxide entry into the vehicle body is a properly maintained engine exhaust system.

If you notice a change in the sound of the exhaust system; or if the exhaust fumes can be detected inside the vehicle; or when the underside or rear of the vehicle is damaged; have an authorized technician inspect the complete exhaust system and adjacent body areas for broken, damaged, deteriorated, or mispositioned parts. Open seams or loose connections could permit exhaust fumes to seep

into the passenger compartment. In addition, have the exhaust system inspected each time the vehicle is raised for lubrication or oil change. Replace as required.

WARNING!

- Exhaust gases can injure or kill. They contain carbon monoxide (CO), which is colorless and odorless. Breathing it can make you unconscious and can eventually poison you. To avoid breathing CO, refer to "Safety Tips/Exhaust Gas" in "Things To Know Before Starting Your Vehicle" for further information.
- A hot exhaust system can start a fire if you park over materials that can burn. Such materials might be grass or leaves coming into contact with your exhaust system. Do not park or operate your vehicle in areas where your exhaust system can contact anything that can burn.

CAUTION!

- The catalytic converter requires the use of unleaded fuel only. Leaded gasoline will destroy the effectiveness of the catalyst as an emissions control device and may seriously reduce engine performance and cause serious damage to the engine.
- Damage to the catalytic converter can result if your vehicle is not kept in proper operating condition. In the event of engine malfunction, particularly involving engine misfire or other apparent loss of performance, have your vehicle serviced promptly. Continued operation of your vehicle with a severe malfunction could cause the converter to overheat, resulting in possible damage to the converter and vehicle.

Under normal operating conditions, the catalytic converter will not require maintenance. However, it is important to keep the engine properly tuned to assure proper catalyst operation and prevent possible catalyst damage.

NOTE: Intentional tampering with emissions control systems can result in civil penalties being assessed against you.

In unusual situations involving grossly malfunctioning engine operation, a scorching odor may suggest severe and abnormal catalyst overheating. If this occurs, stop the vehicle, turn off the engine and allow it to cool. Service, including a tune-up to manufacturer's specifications, should be obtained immediately.

To minimize the possibility of catalytic converter damage:

- Do not shut off the engine or interrupt the ignition, when the transmission is in gear and the vehicle is in motion.
- Do not try to start the engine by pushing or towing the vehicle.
- Do not idle the engine with any spark plug wires disconnected or removed, such as when diagnostic testing, or for prolonged periods during very rough idle or malfunctioning operating conditions.

Cooling System

WARNING!

You or others can be badly burned by hot engine coolant (antifreeze) or steam from your radiator. If you see or hear steam coming from under the hood, do not open the hood until the radiator has had time to cool. Never try to open a cooling system pressure cap when the radiator or coolant bottle is hot.

Engine Coolant Checks

Check the engine coolant (antifreeze) protection every 12 months (before the onset of freezing weather, where applicable). If the engine coolant (antifreeze) is dirty or rusty in appearance, the system should be drained, flushed and refilled with fresh engine coolant (antifreeze).

Check the front of the A/C condenser (if equipped) or radiator for any accumulation of bugs, leaves, etc. If dirty, clean by gently spraying water from a garden hose vertically down the face of the A/C condenser (if equipped) or the back of the radiator core.

Check the engine cooling system hoses for brittle rubber, cracking, tears, cuts, and tightness of the connection at the coolant recovery bottle and radiator. Inspect the entire system for leaks.

With the engine at normal operating temperature (but not running), check the cooling system pressure cap for proper vacuum sealing by draining a small amount of engine coolant (antifreeze) from the radiator drain cock. If the cap is sealing properly, the engine coolant (antifreeze) will begin to drain from the coolant recovery bottle. **DO NOT REMOVE THE COOLANT PRESSURE CAP WHEN THE COOLING SYSTEM IS HOT.**

Cooling System – Drain, Flush, And Refill

If the engine coolant (antifreeze) is dirty or contains a considerable amount of sediment, clean and flush with a reliable cooling system cleaner. Follow with a thorough rinsing to remove all deposits and chemicals. Properly dispose of the old engine coolant (antifreeze) solution.

Refer to the “Maintenance Schedule” for the proper maintenance intervals.

Selection Of Coolant

Refer to “Fluids, Lubricants, and Genuine Parts” in “Maintaining Your Vehicle” for further information.

CAUTION!

- **Mixing of engine coolant (antifreeze) other than specified Organic Additive Technology (OAT) engine coolant (antifreeze), may result in engine damage and may decrease corrosion protection. Organic Additive Technology (OAT) engine coolant is different and should not be mixed with Hybrid Organic Additive Technology (HOAT) engine coolant (antifreeze). If a non-OAT engine coolant (antifreeze) is introduced into the cooling system in an emergency, it should be replaced with the specified engine coolant (antifreeze) as soon as possible.**

(Continued)

CAUTION! *(Continued)*

- Do not use water alone or alcohol-based engine coolant (antifreeze) products. Do not use additional rust inhibitors or antirust products, as they may not be compatible with the radiator engine coolant and may plug the radiator.
- This vehicle has not been designed for use with propylene glycol-based engine coolant (antifreeze). Use of propylene glycol-based engine coolant (antifreeze) is not recommended.

Adding Coolant

Your vehicle has been built with an improved engine coolant (antifreeze) that allows extended maintenance intervals. This engine coolant (antifreeze) can be used up to ten years or 150,000 miles (240,000 km) before replacement. To prevent reducing this extended maintenance

period, it is important that you use the same engine coolant (antifreeze) throughout the life of your vehicle.

Please review these recommendations for using Organic Additive Technology (OAT) engine coolant (antifreeze). When adding engine coolant (antifreeze):

- The manufacturer recommends using MOPAR® Antifreeze/Coolant 10 Year/150,000 Mile Formula OAT (Organic Additive Technology) or equivalent.
- Mix a minimum solution of 50% OAT engine coolant and distilled water. Use higher concentrations (not to exceed 70%) if temperatures below -34°F (-37°C) are anticipated.
- Use only high purity water such as distilled or deionized water when mixing the water/engine coolant (antifreeze) solution. The use of lower quality water will reduce the amount of corrosion protection in the engine cooling system.

Please note that it is the owner's responsibility to maintain the proper level of protection against freezing according to the temperatures occurring in the area where the vehicle is operated.

NOTE: Mixing engine coolant (antifreeze) types is not recommended and can result in cooling system damage. Drain, flush, and refill as soon as possible to avoid damage if coolant types are mixed in an emergency.

Cooling System Pressure Cap

The cap must be fully tightened to prevent loss of engine coolant (antifreeze), and to ensure that engine coolant (antifreeze) will return to the radiator from the coolant recovery tank.

The cap should be inspected and cleaned if there is any accumulation of foreign material on the sealing surfaces.

WARNING!

- **The warning words "DO NOT OPEN HOT" on the cooling system pressure cap are a safety precaution. Never add engine coolant (antifreeze) when the engine is overheated. Do not loosen or remove the cap to cool an overheated engine. Heat causes pressure to build up in the cooling system. To prevent scalding or injury, do not remove the pressure cap while the system is hot or under pressure.**
- **Do not use a pressure cap other than the one specified for your vehicle. Personal injury or engine damage may result.**

Disposal Of Used Engine Coolant

Used ethylene glycol-based engine coolant (antifreeze) is a regulated substance requiring proper disposal. Check with your local authorities to determine the disposal rules for your community. To prevent ingestion by animals or children, do not store ethylene glycol-based engine coolant in open containers or allow it to remain in puddles on the ground. If ingested by a child or pet, seek emergency assistance immediately. Clean up any ground spills immediately.

Engine Coolant Level

The coolant bottle provides a quick visual method for determining that the coolant level is adequate. With the engine idling, and warm to normal operating temperature, the level of the engine coolant (antifreeze) in the bottle should be between the ranges indicated on the bottle.

The radiator normally remains completely full, so there is no need to remove the radiator cap unless checking for engine coolant (antifreeze) freeze point or replacing engine coolant (antifreeze). Advise your service attendant of this. As long as the engine operating temperature is satisfactory, the coolant bottle need only be checked once a month.

When additional engine coolant (antifreeze) is needed to maintain the proper level, it should be added to the coolant bottle. Do not overfill.

Points To Remember

NOTE: When the vehicle is stopped after a few miles/kilometers of operation, you may observe vapor coming from the front of the engine compartment. This is normally a result of moisture from rain, snow, or high humidity accumulating on the radiator and being vaporized when the thermostat opens, allowing hot engine coolant (antifreeze) to enter the radiator.

If an examination of your engine compartment shows no evidence of radiator or hose leaks, the vehicle may be safely driven. The vapor will soon dissipate.

- Do not overfill the coolant expansion bottle.
- Check the coolant freeze point in the radiator and in the coolant expansion bottle. If engine coolant (antifreeze) needs to be added, the contents of the coolant expansion bottle must also be protected against freezing.
- If frequent engine coolant (antifreeze) additions are required, the cooling system should be pressure tested for leaks.
- Maintain engine coolant (antifreeze) concentration at 50% OAT engine coolant (antifreeze) (minimum) and distilled water for proper corrosion protection of your engine which contains aluminum components.
- Make sure that the coolant expansion bottle overflow hoses are not kinked or obstructed.
- Keep the front of the radiator clean. If your vehicle is equipped with air conditioning, keep the front of the condenser clean.
- Do not change the thermostat for Summer or Winter operation. If replacement is ever necessary, install **ONLY** the correct type thermostat. Other designs may result in unsatisfactory engine coolant (antifreeze) performance, poor gas mileage, and increased emissions.

Brake System

In order to assure brake system performance, all brake system components should be inspected periodically. Refer to the “Maintenance Schedule” for the proper maintenance intervals.

WARNING!

Riding the brakes can lead to brake failure and possibly a collision. Driving with your foot resting or riding on the brake pedal can result in abnormally high brake temperatures, excessive lining wear, and possible brake damage. You would not have your full braking capacity in an emergency.

Power Disc Brakes

Disc brakes do not require adjustment; however, several hard stops during the break-in period are recommended to seat the linings and wear off any foreign material.

Brake Master Cylinder

The fluid level in the master cylinders should be checked whenever the vehicle is serviced. If necessary, add fluid to bring level to the full level mark on the side of the reservoir of the brake master cylinder. With disc brakes, fluid level can be expected to fall as the brake pads wear. If the brake fluid level is abnormally low, check system for leaks.

Refer to “Fluids, Lubricants, and Genuine Parts” in “Maintaining Your Vehicle” for further information.

WARNING!

- Use only manufacturer's recommended brake fluid. Refer to "Fluids, Lubricants, and Genuine Parts" in "Maintaining Your Vehicle" for further information. Using the wrong type of brake fluid can severely damage your brake system and/or impair its performance. The proper type of brake fluid for your vehicle is also identified on the original factory installed hydraulic master cylinder reservoir.
- To avoid contamination from foreign matter or moisture, use only new brake fluid or fluid that has been in a tightly closed container. Keep the master cylinder reservoir cap secured at all times. Brake fluid in an open container absorbs moisture from the air resulting in a lower boiling point. This may

WARNING! (Continued)

- cause it to boil unexpectedly during hard or prolonged braking, resulting in sudden brake failure. This could result in a collision.
- Overfilling the brake fluid reservoir can result in spilling brake fluid on hot engine parts, causing the brake fluid to catch fire. Brake fluid can also damage painted and vinyl surfaces, care should be taken to avoid its contact with these surfaces.
- Do not allow petroleum based fluid to contaminate the brake fluid. Brake seal components could be damaged, causing partial or complete brake failure. This could result in a collision.

(Continued)

Automatic Transmission – If Equipped

Selection Of Lubricant

It is important to use the proper transmission fluid to ensure optimum transmission performance and life. Use only the manufacturer's recommended transmission fluid. Refer to "Fluids, Lubricants, and Genuine Parts" in "Maintaining Your Vehicle" for further fluid specifications. It is important to maintain the transmission fluid at the correct level using the recommended fluid.

NOTE: No chemical flushes should be used in any transmission; only the approved lubricant should be used.

CAUTION!

Using a transmission fluid other than the manufacturer's recommended fluid may cause deterioration in transmission shift quality and/or torque converter

(Continued)

CAUTION! *(Continued)*

shudder. Using a transmission fluid other than the manufacturer's recommended fluid will require more frequent fluid and filter changes. Refer to "Fluids, Lubricants, and Genuine Parts" in "Maintaining Your Vehicle" for further information.

Special Additives

Automatic Transmission Fluid (ATF) is an engineered product and its performance may be impaired by supplemental additives. Therefore, do not add any fluid additives to the transmission. The only exception to this policy is the use of special dyes for diagnosing fluid leaks. Avoid using transmission sealers as they may adversely affect seals.

CAUTION!

- Using a transmission fluid other than the manufacturer's recommended fluid may cause deterioration in transmission shift quality and/or torque converter shudder. Using a transmission fluid other than that recommended by the manufacturer, and will require more frequent fluid and filter changes. Refer to "Fluids, Lubricants, and Genuine Parts" in "Maintaining Your Vehicle" for further fluid specification.
- If a transmission fluid leak occurs, visit your authorized dealer immediately. Severe transmission damage may occur. Your authorized dealer has the proper tools to adjust the fluid level accurately.

Fluid Level Check

It is best to check the fluid level when the transmission is at normal operating temperature (approximately 180° F (82° C)). This occurs after at least 15 miles (25 km) of driving. At normal operating temperature, the fluid cannot be held comfortably between the fingertips.

Use the following procedure to check the transmission fluid level properly:

1. Park the vehicle on level ground.
2. Run the engine at idle speed and normal operating temperature.
3. Fully apply the parking brake, and press the brake pedal.

4. Place the shift lever momentarily into each gear position (allowing time for the transmission to fully engage in each position), ending with the shift lever in PARK.
5. Remove the dipstick, wipe it clean and reinsert it until seated.
6. Remove the dipstick again and note the fluid level on both sides. The fluid level reading is only valid if there is a solid coating of oil on both sides of the dipstick. The fluid level should be between the HOT (upper) reference holes on the dipstick at normal operating temperature. If the fluid level is low, add fluid through the dipstick tube to bring it to the proper level. **Do not overfill.** After adding any quantity of oil through the dipstick tube, wait a minimum of two minutes for the oil to fully drain into the transmission before rechecking the fluid level.

NOTE:

- The holes in the dipstick will be full of fluid if the actual level is at or above the hole.
- If it is necessary to check the transmission below the operating temperature, the fluid level should be between the two COLD (lower) holes on the dipstick with the fluid at approximately 80° F (27° C). If the fluid level is correctly established at 80° F (27° C), it should be between the HOT (upper) reference holes when the transmission reaches 180° F (82° C). Remember it is best to check the level at the normal operating temperature.

CAUTION!

Be aware that if the fluid temperature is below 50° F (10° C), it may not register on the dipstick. Do not add fluid until the temperature is elevated enough to produce an accurate reading.

7. Check for leaks. Release the parking brake.

NOTE: To prevent dirt and water from entering the transmission after checking or replenishing fluid, make sure that the dipstick cap is properly reseated. It is normal for the dipstick cap to spring back slightly from its fully seated position, as long as its seal remains engaged in the dipstick tube.

Fluid And Filter Changes

Refer to the “Maintenance Schedule” for the proper maintenance intervals.

In addition, change the fluid and filter(s) if the transmission is disassembled for any reason.

Clutch Hydraulic System (Manual Transmission) – If Equipped

The clutch hydraulic system is fed by a segregated volume of fluid within the brake system master cylinder reservoir. In the event of leakage or wear, use only the manufacturer’s recommended brake fluid. Refer to “Fluids, Lubricants, and Genuine Parts” in “Maintaining Your Vehicle” for further information.

Manual Transmission – If Equipped

Selection Of Lubricant

Use only manufacturer’s recommended manual transmission fluid. Refer to “Fluids, Lubricants, and Genuine Parts” in “Maintaining Your Vehicle” for further information.

Fluid Level Check

Check the fluid level by removing the fill plug. The fluid level should be between the bottom of the fill hole and a point not more than 3/16 in (4.76 mm) below the bottom of the hole.

Add fluid, if necessary, to maintain the proper level.

Frequency Of Fluid Change

Under normal operating conditions, the fluid installed at the factory will give satisfactory lubrication for the life of the vehicle. If the fluid becomes contaminated with water, it should be changed immediately. Otherwise, change the fluid as recommended in the Maintenance Schedule. Refer to the "Maintenance Schedule" for the proper maintenance intervals.

Transfer Case

Fluid Level Check

The fluid level should be to the bottom edge of the fill hole (A) when the vehicle is in a level position.

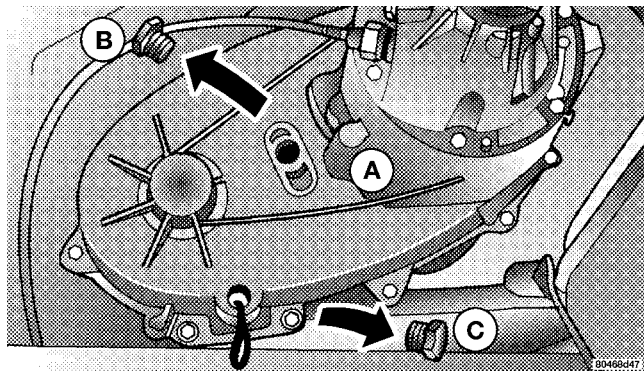

Adding Fluid

Fluid should be added only at filler hole until fluid begins to run out of the hole.

Drain

First remove the fill plug (B), then the drain plug (C). The recommended tightening torque for the drain and fill plugs is 15 to 25 ft lbs (20 to 34 N·m).

CAUTION!

When replacing the plugs, do not overtighten them. You could damage them and cause them to leak.

Selection Of Lubricant

Use only manufacturer's recommended fluid. Refer to "Fluids, Lubricants, and Genuine Parts" in "Maintaining Your Vehicle" for further information.

Front/Rear Axle Fluid

For normal service, periodic fluid level checks are not required. When the vehicle is serviced for other reasons the exterior surfaces of the axle assembly should be inspected. If gear oil leakage is suspected inspect the fluid level. Refer to "Fluids, Lubricants, and Genuine Parts" in "Maintaining Your Vehicle" for further information.

Fluid Level Check

Lubricant should be at the bottom edge of the oil fill hole.

Adding Fluid

Add lubricant only at the fill hole and only to the level specified above.

Selection Of Lubricant

Use only manufacturer's recommended fluid. Refer to "Fluids, Lubricants, and Genuine Parts" in "Maintaining Your Vehicle" for further information.

Appearance Care And Protection From Corrosion

Protection Of Body And Paint From Corrosion

Vehicle body care requirements vary according to geographic locations and usage. Chemicals that make roads passable in snow and ice and those that are sprayed on trees and road surfaces during other seasons are highly corrosive to the metal in your vehicle. Outside parking, which exposes your vehicle to airborne contaminants, road surfaces on which the vehicle is operated, extreme hot or cold weather and other extreme conditions will have an adverse effect on paint, metal trim, and underbody protection.

The following maintenance recommendations will enable you to obtain maximum benefit from the corrosion resistance built into your vehicle.

What Causes Corrosion?

Corrosion is the result of deterioration or removal of paint and protective coatings from your vehicle.

The most common causes are:

- Road salt, dirt and moisture accumulation.
- Stone and gravel impact.
- Insects, tree sap and tar.
- Salt in the air near seacoast localities.
- Atmospheric fallout/industrial pollutants.

Washing

- Wash your vehicle regularly. Always wash your vehicle in the shade using MOPAR® Car Wash or equivalent, or a mild car wash soap, and rinse the panels completely with clear water.
- If insects, tar, or other similar deposits have accumulated on your vehicle, use MOPAR® Super Kleen Bug and Tar Remover or equivalent to remove.
- Use a high quality cleaner wax, such as MOPAR® Cleaner Wax or equivalent, to remove road film, stains and to protect your paint finish. Take care never to scratch the paint.
- Avoid using abrasive compounds and power buffing that may diminish the gloss or thin out the paint finish.

CAUTION!

- **Do not use abrasive or strong cleaning materials such as steel wool or scouring powder that will scratch metal and painted surfaces.**
- **Use of power washers exceeding 1,200 psi (8 274 kPa) can result in damage or removal of paint and decals.**

Special Care

- If you drive on salted or dusty roads or if you drive near the ocean, hose off the undercarriage at least once a month.
- It is important that the drain holes in the lower edges of the doors, rocker panels, and trunk be kept clear and open.

- If you detect any stone chips or scratches in the paint, touch them up immediately. The cost of such repairs is considered the responsibility of the owner.
- If your vehicle is damaged due to a collision or similar cause that destroys the paint and protective coating, have your vehicle repaired as soon as possible. The cost of such repairs is considered the responsibility of the owner.
- If you carry special cargo such as chemicals, fertilizers, de-icer salt, etc., be sure that such materials are well packaged and sealed.
- If a lot of driving is done on gravel roads, consider mud or stone shields behind each wheel.
- Use MOPAR® Touch Up Paint or equivalent on scratches as soon as possible. Your authorized dealer has touch up paint to match the color of your vehicle.

Wheel And Wheel Trim Care

- All wheels and wheel trim, especially aluminum and chrome plated wheels, should be cleaned regularly with a mild soap and water to prevent corrosion.
- To remove heavy soil and/or excessive brake dust, use MOPAR® Wheel Cleaner or equivalent or select a non-abrasive, non-acidic cleaner.

CAUTION!

Do not use scouring pads, steel wool, a bristle brush, or metal polishes. Do not use oven cleaner. These products may damage the wheel's protective finish. Avoid automatic car washes that use acidic solutions or harsh brushes that may damage the wheel's protective finish. Only MOPAR® Wheel Cleaner or equivalent is recommended.

Interior Care

Use MOPAR® Total Clean or equivalent to clean fabric upholstery and carpeting.

Interior Trim should be cleaned starting with a damp cloth, a damp cloth with MOPAR® Total Clean or equivalent, then MOPAR® Spot & Stain Remover or equivalent if absolutely necessary. Do not use harsh cleaners or Armor All®. Use MOPAR® Total Clean or equivalent to clean vinyl upholstery.

WARNING!

Do not use volatile solvents for cleaning purposes. Many are potentially flammable and, if used in closed areas, they may cause respiratory harm.

CAUTION!

When installing hanging air fresheners in your vehicle, read the installation instructions carefully. Some air fresheners will damage the finish of painted or decorated parts if allowed to directly contact any surface.

Glass Surfaces

All glass surfaces should be cleaned on a regular basis with MOPAR® Glass Cleaner or equivalent, or any commercial household-type glass cleaner. Never use an abrasive type cleaner. Use caution when cleaning the inside rear window equipped with electric defrosters or the right rear quarter window equipped with the radio antenna. Do not use scrapers or other sharp instrument that may scratch the elements.

When cleaning the rear view mirror, spray cleaner on the towel or rag that you are using. Do not spray cleaner directly on the mirror.

Cleaning Plastic Instrument Cluster Lenses

The lenses in front of the instruments in this vehicle are molded in clear plastic. When cleaning the lenses, care must be taken to avoid scratching the plastic.

1. Clean with a wet soft rag. A mild soap solution may be used, but do not use high alcohol content or abrasive cleaners. If soap is used, wipe clean with a clean damp rag.
2. Dry with a soft cloth.

Seat Belt Maintenance

Do not bleach, dye, or clean the belts with chemical solvents or abrasive cleaners. This will weaken the fabric. Sun damage can also weaken the fabric.

If the belts need cleaning, use MOPAR® Total Clean or equivalent, a mild soap solution, or lukewarm water. Do not remove the belts from the vehicle to wash them. Dry with a soft cloth.

Replace the belts if they appear frayed or worn or if the buckles do not work properly.

Appearance Care For Fabric Top Models

CAUTION!

To maintain the appearance of your vehicle's interior trim and top, follow these precautions:

- Avoid leaving your vehicle unattended with the top down, as exposure to sun or rain may damage interior trim.
- Do not use harsh cleaners or bleaching agents on top material, as damage may result.

- Do not allow any vinyl cleaner to run down and dry on the paint, leaving a streak.
- After cleaning your vehicle's fabric top, always make sure it is completely dry before lowering.
- Be especially careful when washing the windows by following the directions for "Care of Fabric Top Windows."

WASHING — Use MOPAR® Car Wash or equivalent, or mild soap suds, lukewarm water, and a brush with soft bristles. If extra cleaning is required, use MOPAR® Convertible Cloth Top Cleaner or equivalent, or a mild foaming cleaner on the entire top, but support the top from underneath.

RINSING — Be sure to remove all traces of cleaner by rinsing the top thoroughly with clean water. Remember to allow the top to dry before lowering it.

CAUTION!

Failure to follow these cautions may cause interior water damage, stains or mildew on the top material:

- Avoid high-pressure car washes, as they can damage the top material. Also, increased water pressure may force past the weather strips.
- It is recommended that the top be free of water prior to opening it. Operating the top, opening a door or lowering a window while the top is wet may allow water to drip into the vehicle's interior.
- Use care when washing the vehicle, water pressure directed at the weather strip seals may cause water to leak into the vehicle's interior.
- Careless handling and storage of the removable roof panels may damage the seals, causing water to leak into the vehicle's interior.

(Continued)

CAUTION! (Continued)

- The front panel(s) must be positioned properly to ensure sealing. Improper installation can cause water to leak into the vehicle's interior.

Care Of Fabric Top Windows**CAUTION!**

Your vehicle's fabric top has pliable plastic windows which can be scratched unless special care is taken by following these directions:

1. Never use a dry cloth to remove dust. Instead, use a **microfiber towel or soft cotton cloth moistened with cold or warm, clean water, and wipe across the window, not up and down.** MOPAR® Jeep Soft Glass Window Cleaner or equivalent will safely clean all plastic windows without scratching. It removes fine scratches to improve visibility and provides UV protection to help prevent yellowing.
2. When washing, **never use hot water** or anything stronger than a mild soap. Never use solvents such as alcohol or harsh cleaning agents.
3. Always rinse thoroughly with cold water, then wipe with a soft and slightly moist, clean cloth.
4. When removing frost, snow or ice, **never use a scraper or de-icing chemicals.** Use warm water only if you must clean the window quickly.
5. Debris (sand, mud/dirt, dust, or salt) from off-road driving will have a major impact on zipper operation. Even normal on-road driving and vehicle washing will eventually impact window zipper operation. To maintain ease of use of the window zippers, each window zipper should be cleaned and lubricated

regularly. Use MOPAR® Soft Top Zipper Cleaner and Lubricant or equivalent to ease zipper operation. Before applying, make sure the zipper teeth are clear of sand, mud, and other materials. Clean both sides of the zipper, not just one side. Rinse both zipper halves with fresh water and allow to dry. Aggressively work the MOPAR® Soft Top Zipper Cleaner and Lubricant or equivalent into the zipper teeth. If a stuck zipper slide is experienced, work the MOPAR® Soft Top Zipper Cleaner and Lubricant or equivalent into the zipper slide. Several applications may be required before the zipper comes free.

6. Never paste stickers, gummed labels or any tape to the windows. Adhesives are hard to remove and may damage the windows.

FUSES

Totally Integrated Power Module

The Totally Integrated Power Module is located in the engine compartment near the battery. This center contains cartridge fuses, mini fuses and relays. A label that identifies each component is printed on the inside of the cover.

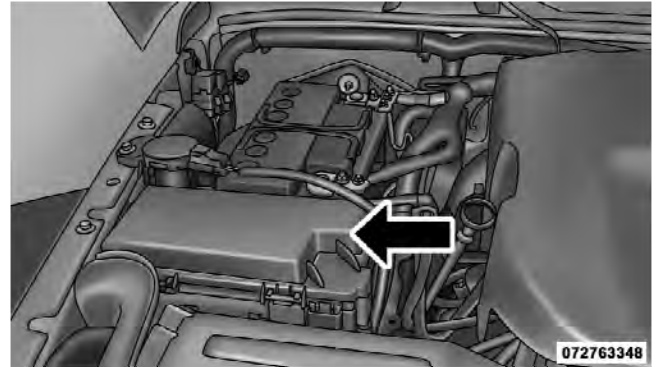

Totally Integrated Power Module

Cavity	Cartridge Fuse	Mini Fuse	Description
J1	—		—
J2	30 Amp Pink		Transfer Case Module
J3	—		—
J4	25 Amp Natural		Driver Door Node
J5	25 Amp Natural		Passenger Door Node
J6	40 Amp Green		Anti-Lock Brake System (ABS) Pump/Stability Control System

Cavity	Cartridge Fuse	Mini Fuse	Description
J7	30 Amp Pink		Anti-Lock Brake System (ABS) Valve/Stability Control System
J8	—		—
J9	40 Amp Green		PZEV Sec Motor/Flex Fuel
J10	30 Amp Pink		Headlamp Wash Relay/Manifold Tuning Valve
J11	30 Amp Pink		Sway Bar
J12	30 Amp Pink		Rear Blower Motor/Radiator Fan

Cavity	Cartridge Fuse	Mini Fuse	Description
J13	60 Amp Yellow		Ignition Off Draw (IOD) – Main
J14	40 Amp Green		Rear Defroster
J15	40 Amp Green		Front Blower
J17	40 Amp Green		Starter Solenoid
J18	20 Amp Blue		Powertrain Control Module (PCM) Trans Range
J19	60 Amp Yellow		Radiator Fan

Cavity	Cartridge Fuse	Mini Fuse	Description
J20	30 Amp Pink		Front Wiper LO/HI
J21	20 Amp Blue		Front/Rear Washer
J22	—		Spare
M1		15 Amp Blue	Center High-Mounted Stop Light (CHMSL)/Switch Stop Lamp Feed
M2		20 Amp Yellow	Relay Trailer Lighting (Stoplamp)
M3		20 Amp Yellow	Frt/Rear Axle Locker Relay

Cavity	Cartridge Fuse	Mini Fuse	Description
M4		—	—
M5		25 Amp Natural	Power Inverter – If Equipped
M6		20 Amp Yellow	Power Outlet #1/ Rain Sensor
M7		20 Amp Yellow	Power Outlet #2 (BATT/ACC SELECT)
M8		20 Amp Yellow	Front Heated Seat
M9		20 Amp Yellow	Rear Heated Seat – If Equipped

Cavity	Cartridge Fuse	Mini Fuse	Description
M10		15 Amp Blue	Ignition Off Draw – Vehicle Entertainment System, Satellite Digital Audio Receiver (SDARS), DVD, Hands-Free Module, RADIO, Antenna, Universal Garage Door Opener, Vanity Lamp
M11		10 Amp Red	(Ignition Off Draw) Climate Control System, Underhood Lamp

Cavity	Cartridge Fuse	Mini Fuse	Description
M12		30 Amp Green	Amplifier
M13		20 Amp Yellow	Ignition Off Draw – Cabin Compartment Node, Wireless Control Module, SIREN, Multifunction Control Switch
M14		20 Amp Yellow	Trailer Tow (Export Only)

Cavity	Cartridge Fuse	Mini Fuse	Description
M15		20 Amp Yellow	Climate Control System, Rear View Mirror, Cabin Compartment Node, Transfer Case Switch, Multifunction Control Switch, Tire Pressure Monitor, Glow Plug Module – Export Diesel Only
M16		10 Amp Red	Airbag Module
M17		15 Amp Blue	Left Tail/License/ Park Lamp

Cavity	Cartridge Fuse	Mini Fuse	Description
M18		15 Amp Blue	Right Tail/Park/ Run Lamp
M19		25 Amp Natural	Auto Shut Down (ASD #1 and #2)
M20		15 Amp Blue	Cabin Compartment Node Interior Light, Switch Bank
M21		20 Amp Yellow	Auto Shut Down (ASD #3)
M22		10 Amp Red	Right Horn (HI/LOW)
M23		10 Amp Red	Left Horn (HI/LOW)

Cavity	Cartridge Fuse	Mini Fuse	Description
M24		25 Amp Natural	Rear Wiper
M25		20 Amp Yellow	Fuel Pump, Diesel Lift Pump – Export Only
M26		10 Amp Red	Power Window Switch, Driver Window Switch
M27		10 Amp Red	Ignition Switch Feed, Wireless Module
M28		10 Amp Red	Powertrain Control Module

Cavity	Cartridge Fuse	Mini Fuse	Description
M29		10 Amp Red	Powertrain
M30		15 Amp Blue	Wiper Motor Frt, J1962 Diagnostic Feed
M31		20 Amp Yellow	Backup Lamps
M32		10 Amp Red	Airbag Controller, TT EUROPE
M33		10 Amp Red	Powertrain Controller
M34		10 Amp Red	Park Assist, Climate Control System, Headlamp Wash, Compass

Cavity	Cartridge Fuse	Mini Fuse	Description
M35		10 Amp Red	Heated Mirrors
M36		20 Amp Yellow	Power Outlet
M37		10 Amp Red	Anti-Lock Brake System, Electronic Stability Control, Stop Lamp Switch, Fuel Pump Relay
M38		25 Amp Natural	Lock/Unlock Motors

CAUTION!

- When installing the Integrated Power Module cover, it is important to ensure the cover is properly positioned and fully latched. Failure to do so may allow water to get into the Integrated Power Module, and possibly result in an electrical system failure.
- When replacing a blown fuse, it is important to use only a fuse having the correct amperage rating. The use of a fuse with a rating other than indicated may result in a dangerous electrical system overload. If a properly rated fuse continues to blow, it indicates a problem in the circuit that must be corrected.

VEHICLE STORAGE

If you are leaving your vehicle dormant for more than 21 days, you may want to take steps to protect your battery. You may:

- Remove Cartridge fuse #J13 in the Power Distribution Center (PDC) labeled Ignition-Off Draw (IOD) and store it in a safe location within the PDC.
- Or, disconnect the negative cable from the battery.
- Anytime you store your vehicle, or keep it out of service (i.e., vacation) for two weeks or more, run the air conditioning system at idle for about five minutes in the fresh air and high blower setting. This will ensure adequate system lubrication to minimize the possibility of compressor damage when the system is started again.

REPLACEMENT BULBS**Interior Bulbs**

	Bulb Number
Automatic Transmission Indicator Lamp	658
Heater Control Lamps (2)	194
Rocker Switch Indicator Lamp (Rear Window Defogger, and Rear Wash/Wipe)	**
Soundbar Dome Lamp	912
** Bulbs only available from authorized dealer.	

Exterior Bulbs

	Bulb Number
Headlamps (2)	H13
Front Park/Turn Signal Lamps (2)	3157

	Bulb Number
Front Side Marker Lamps (2)	168
Fog Lamps	PSX24W
Rear Stop/Tail/Turn Lamps (2)	3157
Center High-Mounted Stop Lamp	L.E.D.
Backup Lamps (2)	3157
License Lamp	194

NOTE:

Numbers refer to commercial bulb types that can be purchased from your local authorized dealer. If a bulb needs to be replaced, visit your authorized dealer or refer to the applicable Service Manual.

BULB REPLACEMENT

NOTE: Lens fogging can occur under certain atmospheric conditions. This will usually clear as atmospheric conditions change to allow the condensation to change back into a vapor. Turning the lamps on will usually accelerate the clearing process.

Headlamp

1. Open hood and support using prop rod.
2. Remove the front grille. Turn the retainers along the top 1/4 turn counterclockwise and remove.
3. Pull the bottom of the grille away starting at one side and working toward the other.
4. Turn both park and turn signal socket assemblies 1/4 turn counterclockwise and remove.
5. Remove the four screws holding the metal retaining ring.
6. Remove the lamp from the collar.
7. Grasp the bulb and turn 1/4 turn counterclockwise.
8. Pull the bulb from the housing.
9. Push connector locking tab to the unlock position.
10. Remove connector from bulb.
11. Push connector onto new bulb base, and push the connector locking tab to the lock position.
12. Reinstall bulb housing. Rotate the bulb 1/4 turn clockwise.

CAUTION!

Do not touch the new bulb with your fingers. Oil contamination will severely shorten bulb life. If the bulb comes in contact with any oily surface, clean the bulb with rubbing alcohol.

Front Park/Turn Signal

1. Remove the front grille. Turn the retainers along the top 1/4 turn counterclockwise and remove.
2. Pull the bottom of the grille away starting at one side and working toward the other.
3. Turn the socket assembly 1/4 turn counterclockwise and remove from housing. Pull the bulb straight from the socket to replace.

Front Side Marker

1. Reach under the front fender flare and locate the front side marker socket.
2. Turn the socket assembly counterclockwise 1/3 turn and remove it from the housing. Pull the bulb straight from the socket to replace.

Front Fog Lamp

1. Reach under the vehicle to access the back of the front fog lamp.
2. Disconnect the wire harness connector from the front fog lamp connector receptacle.
3. Firmly grasp the bulb by the two latch features and squeeze them together to unlock the bulb from the back of the front fog lamp housing.
4. Pull the bulb straight out from the keyed opening in the housing and then connect the replacement bulb.

CAUTION!

Do not touch the new bulb with your fingers. Oil contamination will severely shorten bulb life. If the bulb comes in contact with any oily surface, clean the bulb with rubbing alcohol.

Rear Tail, Stop, Turn Signal, And Backup Lamp

1. Remove the two inboard screws attaching the tail light housing to the body. **DO NOT REMOVE THE OUTER SCREWS AT ANY TIME.**

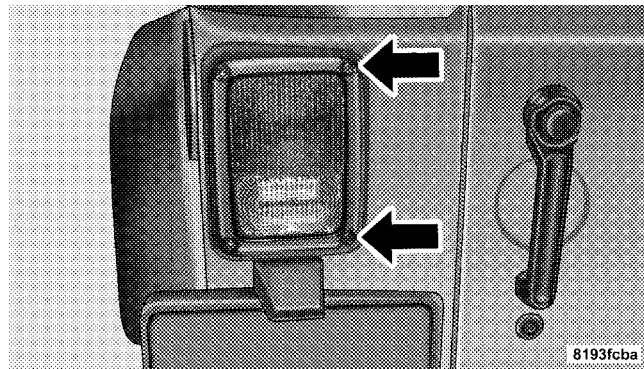

2. Separate the housing from the body by pushing the lamp inboard while pulling the lamp away from the body.

3. Rotate the appropriate socket 1/4 turn counterclockwise, then remove it from the housing.
4. Pull the bulb straight from the socket to replace.

Center High-Mounted Stop Lamp (CHMSL)

The stop lamp is mounted on a bracket that extends upward from the tailgate behind the spare tire. If service is needed, obtain the LED/Cover Assembly from your local authorized dealer.

1. Remove the spare tire.
2. Remove the four screws holding the lens/cover in place on the spare tire carrier.
3. Disconnect the wire harness from the back of the LED cover.

FLUID CAPACITIES

	U.S.	Metric
Fuel (Approximate) — Two Door Models	18.6 Gallons	70 Liters
Fuel (Approximate) — Four Door Models	22.5 Gallons	85 Liters
Engine Oil with Filter		
3.6L Engine	6 Quarts	5.6 Liters
Cooling System *		
3.6L Engine (MOPAR® Antifreeze/Engine Coolant 10 Year/152,000 Mile Formula or equivalent)	10.5 Quarts	9.9 Liters
* Includes coolant recovery bottle filled to MAX level.		

FLUIDS, LUBRICANTS AND GENUINE PARTS

Engine

Component	Fluid, Lubricant, or Genuine Part
Engine Coolant	MOPAR® Antifreeze/Coolant 10 Year/150,000 Mile Formula OAT (Organic Additive Technology) or equivalent meeting the requirements of Chrysler Material Standard MS-12106.
Engine Oil	Use API Certified SAE 5W-20 Engine Oil, meeting the requirements of Chrysler Material Standard MS-6395. Refer to your engine oil filler cap for correct SAE grade.
Engine Oil Filter	MOPAR® Engine Oil Filter or equivalent.
Spark Plugs	RER8ZWYCB4 (Gap 0.043 in [1.1 mm])
Fuel Selection	87 Octane

Chassis

Component	Fluid, Lubricant, or Genuine Part
Automatic Transmission – If Equipped	MOPAR® ATF+4® Automatic Transmission Fluid or equivalent licensed ATF+4® product.
Manual Transmission – If Equipped	MOPAR® Manual Transmission Lubricant or equivalent (meeting the requirements of Chrysler Material Standard MS-9224).
Transfer Case	MOPAR® ATF+4® Automatic Transmission Fluid or equivalent licensed ATF+4® product.
Axle Differential (Front)	MOPAR® Gear & Axle Lubricant (SAE 80W-90) (API GL-5) or equivalent.
Axle Differential (Rear)	226 RBI (Model 44) – MOPAR® Gear & Axle Lubricant (SAE 80W-90) (API GL-5) or equivalent. For trailer towing, use MOPAR® Synthetic Gear & Axle Lubricant (SAE 75W-140) or equivalent. Models equipped with Trac-Lok™ require an additive.
Brake Master Cylinder	MOPAR® DOT 3 Brake Fluid, SAE J1703 should be used. If DOT 3, SAE J1703 brake fluid is not available, then DOT 4 is acceptable. Use only recommended brake fluids.
Power Steering Reservoir	MOPAR® Power Steering Fluid +4, MOPAR® ATF+4® Automatic Transmission Fluid or equivalent licensed ATF+4® product.

MAINTENANCE SCHEDULES

CONTENTS

- MAINTENANCE SCHEDULE614
 - Maintenance Chart.616

MAINTENANCE SCHEDULE

Your vehicle is equipped with an automatic oil change indicator system. The oil change indicator system will remind you that it is time to take your vehicle in for scheduled maintenance.

Based on engine operation conditions, the oil change indicator message will illuminate. This means that service is required for your vehicle. Operating conditions such as frequent short-trips, trailer tow, extremely hot or cold ambient temperatures, and E85 fuel usage will influence when the “Change Oil” or “Oil Change Required” message is displayed. Severe Operating Conditions can cause the change oil message to illuminate as early as 3,500 miles (5,600 km) since last reset. Have your vehicle serviced as soon as possible, within the next 500 miles (805 km).

On Electronic Vehicle Information Center (EVIC) equipped vehicles, “Oil Change Required” will be displayed in the EVIC and a single chime will sound, indicating that an oil change is necessary.

On Non-EVIC equipped vehicles, “Change Oil” will flash in the instrument cluster odometer and a single chime will sound, indicating that an oil change is necessary.

Your authorized dealer will reset the oil change indicator message after completing the scheduled oil change. If a scheduled oil change is performed by someone other than your authorized dealer, the message can be reset by referring to the steps described under “Electronic Vehicle Information Center (EVIC)/Oil Change Required” in “Understanding Your Instrument Panel” or under “Instrument Cluster Description/Odometer/Trip Odometer” in “Understanding Your Instrument Panel” for further information.

NOTE: Under no circumstances should oil change intervals exceed 10,000 miles (16,000 km) or twelve months, whichever comes first.

Once A Month Or Before A Long Trip:

- Check engine oil level
- Check windshield washer fluid level
- Check the tire inflation pressures and look for unusual wear or damage
- Check the fluid levels of the coolant reservoir, brake master cylinder, power steering and transmission as needed
- Check function of all interior and exterior lights

Required Maintenance Intervals.

Refer to the maintenance schedules on the following page for the required maintenance intervals.

<p>At Every Oil Change Interval As Indicated By Oil Change Indicator System:</p>
<ul style="list-style-type: none"> • Change oil and filter
<ul style="list-style-type: none"> • Rotate the tires. Rotate at the first sign of irregular wear, even if it occurs before the oil indicator system turns on.
<ul style="list-style-type: none"> • Inspect battery and clean and tighten terminals as required
<ul style="list-style-type: none"> • Inspect automatic transmission fluid if equipped with dipstick
<ul style="list-style-type: none"> • Inspect brake pads, shoes, rotors, drums, hoses and park brake
<ul style="list-style-type: none"> • Inspect engine cooling system protection and hoses
<ul style="list-style-type: none"> • Inspect exhaust system
<ul style="list-style-type: none"> • Inspect engine air cleaner if using in dusty or off-road conditions

Maintenance Chart

Refer to the Maintenance Schedules on the following pages for the required maintenance intervals.

Mileage or time passed (whichever comes first)	20,000	30,000	40,000	50,000	60,000	70,000	80,000	90,000	100,000	110,000	120,000	130,000	140,000	150,000
Or Years:	2	3	4	5	6	7	8	9	10	11	12	13	14	15
Or Kilometers:	32,000	48,000	64,000	80,000	96,000	112,000	128,000	144,000	160,000	176,000	192,000	208,000	224,000	240,000
Additional Inspections														
Inspect all door latches for presence of grease, reapply if necessary.	X	X	X	X	X	X	X	X	X	X	X	X	X	X
Inspect the CV joints.	X		X		X		X		X		X		X	
Inspect front suspension, tie rod ends, and replace if necessary.	X		X		X		X		X		X		X	
Inspect the front and rear axle fluid.	X				X				X				X	

Mileage or time passed (whichever comes first)	20,000	30,000	40,000	50,000	60,000	70,000	80,000	90,000	100,000	110,000	120,000	130,000	140,000	150,000
Or Years:	2	3	4	5	6	7	8	9	10	11	12	13	14	15
Or Kilometers:	32,000	48,000	64,000	80,000	96,000	112,000	128,000	144,000	160,000	176,000	192,000	208,000	224,000	240,000
Inspect the brake linings, parking brake function.	X		X		X		X		X		X		X	
Inspect transfer case fluid.		X						X						X
Additional Maintenance														
Replace engine air cleaner filter.		X			X			X			X			X
Replace spark plugs **									X					
Replace the ignition cables.									X					
Flush and replace the engine coolant at 10 years or 150,000 miles (240,000 km) whichever comes first.									X					X

618 MAINTENANCE SCHEDULES

Mileage or time passed (whichever comes first)	20,000	30,000	40,000	50,000	60,000	70,000	80,000	90,000	100,000	110,000	120,000	130,000	140,000	150,000
Or Years:	2	3	4	5	6	7	8	9	10	11	12	13	14	15
Or Kilometers:	32,000	48,000	64,000	80,000	96,000	112,000	128,000	144,000	160,000	176,000	192,000	208,000	224,000	240,000
Change automatic transmission fluid and filter if using your vehicle for any of the following: trailer towing, snow plowing, heavy loading, taxi, police, delivery service (commercial service), off-road, desert operation or more than 50% of your driving is at sustained high speeds during hot weather, above 90°F (32°C).					X									
Change the automatic transmission fluid and filter(s).										X				

Mileage or time passed (whichever comes first)	20,000	30,000	40,000	50,000	60,000	70,000	80,000	90,000	100,000	110,000	120,000	130,000	140,000	150,000
Or Years:	2	3	4	5	6	7	8	9	10	11	12	13	14	15
Or Kilometers:	32,000	48,000	64,000	80,000	96,000	112,000	128,000	144,000	160,000	176,000	192,000	208,000	224,000	240,000
Change the manual transmission fluid if using your vehicle for any of the following: trailer towing, snow plowing, heavy loading, taxi, police, delivery service (commercial service), off-road, desert operation or more than 50% of your driving is at sustained high speeds during hot weather, above 90°F (32°C).		X			X			X			X			X
Change transfer case fluid if using your vehicle for any of the following: police, taxi, fleet, or frequent trailer towing.					X						X			

620 MAINTENANCE SCHEDULES

Mileage or time passed (whichever comes first)	20,000	30,000	40,000	50,000	60,000	70,000	80,000	90,000	100,000	110,000	120,000	130,000	140,000	150,000
Or Years:	2	3	4	5	6	7	8	9	10	11	12	13	14	15
Or Kilometers:	32,000	48,000	64,000	80,000	96,000	112,000	128,000	144,000	160,000	176,000	192,000	208,000	224,000	240,000
Inspect and replace PCV valve if necessary.									X					
Change front and rear axle fluid if using your vehicle for police, taxi, fleet, off-road or frequent trailer towing.			X				X				X			

** The spark plug change interval is mileage based only, yearly intervals do not apply.

WARNING!

- You can be badly injured working on or around a motor vehicle. Do only service work for which you have the knowledge and the right equipment. If you have any doubt about your ability to perform a service job, take your vehicle to a competent mechanic.
- Failure to properly inspect and maintain your vehicle could result in a component malfunction and effect vehicle handling and performance. This could cause an accident.

IF YOU NEED CONSUMER ASSISTANCE

CONTENTS

■ SUGGESTIONS FOR OBTAINING SERVICE FOR YOUR VEHICLE625	□ Customer Assistance For The Hearing Or Speech Impaired (TDD/TTY)627
□ Prepare For The Appointment.625	□ Service Contract627
□ Prepare A List625	■ WARRANTY INFORMATION628
□ Be Reasonable With Requests625	■ MOPAR® PARTS629
■ IF YOU NEED ASSISTANCE625	■ REPORTING SAFETY DEFECTS629
□ Chrysler Group LLC Customer Center.626	□ In The 50 United States And Washington, D.C.629
□ Chrysler Canada Inc. Customer Center626	□ In Canada.629
□ In Mexico contact:627		

624 IF YOU NEED CONSUMER ASSISTANCE

■ PUBLICATION ORDER FORMS630	□ Traction Grades632
■ DEPARTMENT OF TRANSPORTATION		□ Temperature Grades632
UNIFORM TIRE QUALITY GRADES631		
□ Treadwear631		

SUGGESTIONS FOR OBTAINING SERVICE FOR YOUR VEHICLE

Prepare For The Appointment

If you are having warranty work done, be sure to have the right papers with you. Take your warranty folder. All work to be performed may not be covered by the warranty. Discuss additional charges with the service manager. Keep a maintenance log of your vehicle's service history. This can often provide a clue to the current problem.

Prepare A List

Make a written list of your vehicle's problems or the specific work you want done. If you've had an accident or work done that is not on your maintenance log, let the service advisor know.

Be Reasonable With Requests

If you list a number of items and you must have your vehicle by the end of the day, discuss the situation with the service advisor and list the items in order of priority. At many authorized dealer, you may obtain a rental vehicle at a minimal daily charge. If you need a rental, it is advisable to make these arrangements when you call for an appointment.

IF YOU NEED ASSISTANCE

The manufacturer and its authorized dealer are vitally interested in your satisfaction. We want you to be happy with our products and services.

Warranty service must be done by an authorized dealer. We strongly recommend that you take the vehicle to an authorized dealer. They know your vehicle the best, and are most concerned that you get prompt and high quality

service. The manufacturer's authorized dealer have the facilities, factory-trained technicians, special tools, and the latest information to ensure the vehicle is fixed correctly and in a timely manner.

This is why you should always talk to an authorized dealer service manager first. Most matters can be resolved with this process.

- If for some reason you are still not satisfied, talk to the general manager or owner of the authorized dealer. They want to know if you need assistance.
- If an authorized dealer is unable to resolve the concern, you may contact the manufacturer's customer center.

Any communication to the manufacturer's customer center should include the following information:

- Owner's name and address
- Owner's telephone number (home and office)

- Authorized dealer name
- Vehicle Identification Number (VIN)
- Vehicle delivery date and mileage

Chrysler Group LLC Customer Center

P.O. Box 21-8004

Auburn Hills, MI 48321-8004

Phone: (877) 426-5337

Chrysler Canada Inc. Customer Center

P.O. Box 1621

Windsor, Ontario N9A 4H6

Phone: (800) 465-2001 English / (800) 387-9983 French

In Mexico contact:

Av. Prolongacion Paseo de la Reforma, 1240

Sante Fe C.P. 05109

Mexico, D. F.

In Mexico City: 5081-7568

Outside Mexico City: 1-800-505-1300

Customer Assistance For The Hearing Or Speech Impaired (TDD/TTY)

To assist customers who have hearing difficulties, the manufacturer has installed special TDD (Telecommunication Devices for the Deaf) equipment at its customer center. Any hearing or speech impaired customer, who has access to a TDD or a conventional teletypewriter (TTY) in the United States, can communicate with the manufacturer by dialing 1-800-380-CHRY.

Canadian residents with hearing difficulties that require assistance can use the special needs relay service offered by Bell Canada. For TTY teletypewriter users, dial 711 and for Voice callers, dial 1 800 855-0511 to connect with a Bell Relay Service operator.

Service Contract

You may have purchased a service contract for a vehicle to help protect you from the high cost of unexpected repairs after the manufacturer's New Vehicle Limited Warranty expires. The manufacturer stands behind only the manufacturer's service contracts. If you purchased a manufacturer's service contract, you will receive Plan Provisions and an Owner Identification Card in the mail within three weeks of the vehicle delivery date. If you have any questions about the service contract, call the manufacturer's Service Contract National Customer Hotline at 1-800-521-9922 (Canadian residents, call (800) 465-2001 English / (800) 387-9983 French).

The manufacturer will not stand behind any service contract that is not the manufacturer's service contract. It is not responsible for any service contract other than the manufacturer's service contract. If you purchased a service contract that is not a manufacturer's service contract, and you require service after the manufacturer's New Vehicle Limited Warranty expires, please refer to the contract documents, and contact the person listed in those documents.

We appreciate that you have made a major investment when you purchased the vehicle. An authorized dealer has also made a major investment in facilities, tools, and training to assure that you are absolutely delighted with the ownership experience. You will be pleased with their sincere efforts to resolve any warranty issues or related concerns.

WARNING!

Engine exhaust, some of its constituents, and certain vehicle components contain, or emit, chemicals known to the State of California to cause cancer and birth defects, or other reproductive harm. In addition, certain fluids contained in vehicles and certain products of component wear contain, or emit, chemicals known to the State of California to cause cancer and birth defects, or other reproductive harm.

WARRANTY INFORMATION

See the Warranty Information Booklet, located on the DVD, for the terms and provisions of Chrysler Group LLC warranties applicable to this vehicle and market.

MOPAR® PARTS

MOPAR® fluids, lubricants, parts, and accessories are available from an authorized dealer. They are recommended for your vehicle in order to help keep the vehicle operating at its best.

REPORTING SAFETY DEFECTS

In The 50 United States And Washington, D.C.

If you believe that your vehicle has a defect that could cause a crash or cause injury or death, you should immediately inform the National Highway Traffic Safety Administration (NHTSA) in addition to notifying the manufacturer.

If NHTSA receives similar complaints, it may open an investigation, and if it finds that a safety defect exists in a group of vehicles, it may order a recall and remedy

campaign. However, NHTSA cannot become involved in individual problems between you, your authorized dealer, and the manufacturer.

To contact NHTSA, you may either call the Auto Safety Hotline toll free at 1-888-327-4236 (TTY: 1-800-424-9153), or go to <http://www.safercar.gov>; or write to: Administrator, NHTSA, 1200 New Jersey Avenue, SE., West Building, Washington, D.C. 20590. You can also obtain other information about motor vehicle safety from <http://www.safercar.gov>.

In Canada

If you believe that your vehicle has a safety defect, you should contact the Customer Service Department immediately. Canadian customers who wish to report a safety defect to the Canadian government should contact Transport Canada, Motor Vehicle Defect Investigations and Recalls at 1-800-333-0510 or go to <http://www.tc.gc.ca/roadsafety/>

PUBLICATION ORDER FORMS

To order the following manuals, you may use either the website or the phone numbers listed below. Visa, MasterCard, American Express, and Discover orders are accepted. If you prefer mailing your payment, please call for an order form.

NOTE: A street address is required when ordering manuals (no P.O. Boxes).

Service Manuals

These comprehensive Service Manuals provide the information that students and professional technicians need in diagnosing/troubleshooting, problem solving, maintaining, servicing, and repairing Chrysler Group LLC vehicles. A complete working knowledge of the vehicle, system, and/or components is written in straightforward language with illustrations, diagrams, and charts.

Diagnostic Procedure Manuals

Diagnostic Procedure Manuals are filled with diagrams, charts and detailed illustrations. These practical manuals make it easy for students and technicians to find and fix problems on computer-controlled vehicle systems and features. They show exactly how to find and correct problems the first time, using step-by-step troubleshooting and drivability procedures, proven diagnostic tests and a complete list of all tools and equipment.

Owner's Manuals

These Owner's Manuals have been prepared with the assistance of service and engineering specialists to acquaint you with specific Chrysler Group LLC vehicles. Included are starting, operating, emergency and maintenance procedures as well as specifications, capabilities and safety tips.

Call toll free at:

- 1-800-890-4038 (U.S.)
- 1-800-387-1143 (Canada)

Or

Visit us on the Worldwide Web at:

- www.techauthority.com

DEPARTMENT OF TRANSPORTATION UNIFORM TIRE QUALITY GRADES

The following tire grading categories were established by the National Highway Traffic Safety Administration. The specific grade rating assigned by the tire's manufacturer in each category is shown on the sidewall of the tires on your vehicle.

All passenger car tires must conform to Federal safety requirements in addition to these grades.

Treadwear

The Treadwear grade is a comparative rating, based on the wear rate of the tire when tested under controlled conditions on a specified government test course. For example, a tire graded 150 would wear one and one-half times as well on the government course as a tire graded 100. The relative performance of tires depends upon the actual conditions of their use, however, and may depart significantly from the norm due to variations in driving habits, service practices, and differences in road characteristics and climate.

Traction Grades

The Traction grades, from highest to lowest, are AA, A, B, and C. These grades represent the tire's ability to stop on wet pavement, as measured under controlled conditions on specified government test surfaces of asphalt and concrete. A tire marked C may have poor traction performance.

WARNING!

The traction grade assigned to this tire is based on straight-ahead braking traction tests, and does not include acceleration, cornering, hydroplaning, or peak traction characteristics.

Temperature Grades

The temperature grades are A (the highest), B, and C, representing the tire's resistance to the generation of heat and its ability to dissipate heat, when tested under

controlled conditions on a specified indoor laboratory test wheel. Sustained high temperature can cause the material of the tire to degenerate and reduce tire life, and excessive temperature can lead to sudden tire failure. The grade C corresponds to a level of performance, which all passenger car tires must meet under the Federal Motor Vehicle Safety Standard No. 109. Grades B and A represent higher levels of performance on the laboratory test wheel, than the minimum required by law.

WARNING!

The temperature grade for this tire is established for a tire that is properly inflated and not overloaded. Excessive speed, under-inflation, or excessive loading, either separately or in combination, can cause heat buildup and possible tire failure.

INDEX

ABS (Anti-Lock Brake System)303	Alarm (Security Alarm)19
Adding Engine Coolant (Antifreeze)579	Alterations/Modifications, Vehicle9
Adding Fuel510	Antenna, Satellite Radio352
Additives, Fuel509	Antifreeze (Engine Coolant)578
Airbag62	Disposal581
Airbag Deployment71	Anti-Lock Brake System (ABS)455
Airbag Light74	Anti-Lock Warning Light303
Airbag Maintenance73	Appearance Care591
Airbag, Side70	Arming Theft System (Security Alarm)20
Air Cleaner, Engine (Engine Air Cleaner Filter)569	Assistance Towing130
Air Conditioner Maintenance571	Auto Down Power Windows42
Air Conditioning392	Automatic Door Locks39
Air Conditioning Controls392	Automatic Headlights168
Air Conditioning Filter402	Automatic Oil Change Indicator325
Air Conditioning, Operating Tips403	Automatic Temperature Control (ATC)396
Air Conditioning Refrigerant571	Automatic Transmission420
Air Conditioning System392	Adding Fluid588
Air Pressure, Tires483	Fluid and Filter Changes588
Alarm Light305	Fluid Change588

Fluid Level Check586	Brake/Transmission Interlock419
Fluid Type585	Break-In Recommendations, New Vehicle98
Special Additives585	Bulb Replacement606
Autostick426	Bulbs, Light103
Auxiliary Electrical Outlet (Power Outlet)182	Calibration, Compass318
Auxiliary Power Outlet182	Capacities, Fluid610
Axle Lock433	Caps, Filler	
Battery570	Fuel510
Keyless Transmitter Replacement (RKE)27	Power Steering451
Belts, Seat48	Radiator (Coolant Pressure)580
Body Mechanism Lubrication572	Carbon Monoxide Warning100
Brake Assist System457	Cargo Light172
Brake Control System, Electronic456	Car Washes592
Brake System583	Cellular Phone114
Anti-Lock (ABS)455	Center High Mounted Stop Light609
Master Cylinder583	Certification Label513
Parking452	Chains, Tire492
Warning Light302	Changing A Flat Tire540

- Chart, Tire Sizing473
- Check Engine Light
 (Malfunction Indicator Light)311
- Checking Your Vehicle For Safety99
- Checks, Safety99
- Child Restraint76
- Child Safety Locks40
- Clean Air Gasoline507
- Cleaning
 Wheels593
- Climate Control391
- Clock337
- Cold Weather Operation411
- Compact Disc (CD) Maintenance390
- Compact Spare Tire487
- Compass315
- Compass Calibration318
- Compass Variance317
- Computer, Trip/Travel315
- Connector
 UCI382
 Universal Consumer Interface (UCI)382
- Console189
- Console, Floor189
- Contract, Service627
- Coolant Pressure Cap (Radiator Cap)580
- Cooling System577
 Adding Coolant (Antifreeze)579
 Coolant Capacity610
 Coolant Level581
 Disposal of Used Coolant581
 Drain, Flush, and Refill578
 Inspection577
 Points to Remember581
 Pressure Cap580
 Radiator Cap580
 Selection of Coolant (Antifreeze)578
- Corrosion Protection591

Cruise Light306	Door Locks36
Cupholders188	Door Locks, Automatic39
Customer Assistance625	Doors31
		Driver's Seat Back Tilt154
Data Recorder, Event75	Driving436
Daytime Running Lights171	Dual Top191
Dealer Service.564		
Defroster, Rear Window.294	Electrical Outlet, Auxiliary (Power Outlet).182
Defroster, Windshield101	Electrical Power Outlets.182
Delay (Intermittent) Wipers174	Electric Remote Mirrors113
Diagnostic System, Onboard562	Electronic Brake Control System.456
Dimmer Switch, Headlight.170	Brake Assist System457
Dipsticks		Electronic Roll Mitigation462
Oil (Engine)566	Traction Control System457
Power Steering451	Electronic Roll Mitigation (ERM)462
Disabled Vehicle Towing556	Electronic Speed Control (Cruise Control)178
Disarming, Theft System20	Electronic Stability Control (ESC)463
Disposal		Electronic Throttle Control Warning Light314
Antifreeze (Engine Coolant)581	Electronic Vehicle Information Center (EVIC).315

Emergency Brake452	Oil Change Interval325
Emergency, In Case of		Oil Selection567
Jacking540	Oil Synthetic568
Jump Starting548	Overheating538
Tow Hooks554	Starting410
Emission Control System Maintenance563	Temperature Gauge305
Engine		Engine Oil Viscosity568
Air Cleaner569	Engine Oil Viscosity Chart568
Block Heater413	Enhanced Accident Response Feature70
Break-In Recommendations98	Entry System, Illuminated21
Compartment561	Ethanol507
Compartment Identification561	Event Data Recorder75
Cooling577	Exhaust Gas Caution100
Exhaust Gas Caution100	Exhaust System100
Fails to Start411	Extender, Seat Belt61
Flooded, Starting411	Exterior Lights103
Fuel Requirements506	Fabric Care594
Jump Starting548	Fabric Top595
Oil566		

Filters		Fold and Tumble Rear Seat161
Air Cleaner569	Folding Rear Seat164
Air Conditioning402	Folding Windshield286
Engine Oil569	Four-Way Hazard Flasher538
Engine Oil Disposal568	Four Wheel Drive428
Flashers		Four Wheel Drive Operation428
Hazard Warning538	Freeing A Stuck Vehicle552
Turn Signal103	Front Axle (Differential)590
Flash-To-Pass170	Fuel506
Flooded Engine Starting411	Adding510
Fluid Capacities610	Additives509
Fluid Leaks103	Clean Air507
Fluid Level Checks590	Ethanol507
Engine Oil566	Filler Cap (Gas Cap)510
Manual Transmission589	Gasoline506
Power Steering451	Gauge300
Fluids, Lubricants and Genuine Parts611	Materials Added509
Fog Lights170	Methanol507
Fog Light Service608	Octane Rating506

Requirements506	Gross Axle Weight Rating516
Tank Capacity610	Gross Vehicle Weight Rating.515
Fueling510	GVWR.513
Fuses598		
		Hands-Free Phone (Uconnect™)114
Gas Cap (Fuel Filler Cap)510	Hard Top202
Gasoline, Clean Air507	Hard Top, Modular202
Gasoline (Fuel)506	Hard Top Removal210
Gasoline, Reformulated507	Hazard Warning Flasher538
Gauges		Headlights	
Coolant Temperature305	Automatic168
Fuel300	Bulb Replacement607
Odometer308	High Beam170
Speedometer300	High Beam/Low Beam Select Switch170
Tachometer304	Passing170
Gear Ranges.415	Replacing607
Gear Select Lever Override554	Switch167
General Information19	Head Restraints160
Glass Cleaning594	Heated Mirrors113

Heated Seats159	Inside Rearview Mirror111
Heater392	Instrument Cluster299
Heater, Engine Block413	Instrument Panel and Controls298
High Beam Indicator301	Instrument Panel Lens Cleaning595
Hill Descent Control470	Integrated Power Module (Fuses)598
Hill Descent Control Indicator470	Interior Appearance Care594
Hill Start Assist458	Interior Lights171
Hitches		Intermittent Wipers (Delay Wipers)174
Trailer Towing518	Introduction4
Hood Release166	Inverter, Power186
Ignition14	Jacking Instructions543
Key14	Jack Location541
Ignition Key Removal14	Jack Operation540
Illuminated Entry21	Jump Starting548
Immobilizer (Sentry Key)16	Key-In Reminder16
Infant Restraint76	Keyless Entry System22
Inflation Pressure Tires483	Key, Programming18
Information Center, Vehicle321		

Key, Replacement17	Back-Up609
Keys14	Brake Assist Warning468
Key, Sentry (Immobilizer)16	Brake Warning302
 		Bulb Replacement607
Lane Change and Turn Signals301	Cargo172
Lane Change Assist169	Center Mounted Stop609
Lap Belts48	Check Engine (Malfunction Indicator)311
Lap/Shoulder Belts48	Cruise306
Latches103	Daytime Running171
Lead Free Gasoline506	Electronic Stability Program (ESP) Indicator468
Leaks, Fluid103	Electronic Throttle Control Warning314
Life of Tires490	Exterior103
Light Bulbs103	Fog170
Lights103	Hazard Warning Flasher538
Airbag74	Headlights167
Alarm305	Headlight Switch167
Anti-Lock303	High Beam301
Anti-Lock Warning303	High Beam Indicator301
Automatic Headlights168	Hill Descent Control Indicator470

Illuminated Entry21	Loading Vehicle513
Instrument Cluster167	Tires477
Interior171	Locking Axle433
Lights On Reminder170	Locks36
Low Fuel300	Automatic Door39
Oil Pressure301	Child Protection40
Passing170	Door36
Rear Servicing609	Power Door38
Rear Tail609	Lubrication, Body572
Seat Belt Reminder301	Maintenance Free Battery570
Security Alarm (Theft Alarm)305	Maintenance Procedures565
Service607	Maintenance Schedule614
Side Marker609	Malfunction Indicator Light (Check Engine).311
Theft Alarm (Security Alarm)305	Manual, Service630
Tire Pressure Monitoring (TPMS)306	Manual Transmission414
Traction Control468	Fluid Level Check589
Turn Signal103	Lubricant Selection588
Voltage300	Shift Speeds415
Warning (Instrument Cluster Description)300		

Master Cylinder (Brakes)583	Octane Rating, Gasoline (Fuel)506
Methanol507	Odometer308
Mini-Trip Computer315	Trip306
Mirrors111	Oil Change Indicator311
Electric Powered113	Oil Change Indicator, Reset311
Electric Remote113	Oil, Engine566
Heated113	Capacity610
Outside112	Change Interval325
Rearview111	Dipstick566
Vanity114	Disposal568
Modifications/Alterations, Vehicle9	Filter569
Modular Hard Top202	Filter Disposal568
Monitor, Tire Pressure System495	Identification Logo567
Mopar Parts564	Materials Added to568
MTBE/ETBE507	Pressure Warning Light301
		Recommendation567
New Vehicle Break-In Period98	Synthetic568
		Viscosity568
Occupant Restraints45	Oil Filter, Selection569

Oil Pressure Light301	Placard, Tire and Loading Information478
Onboard Diagnostic System562	Power	
Operating Precautions562	Door Locks38
Operator Manual (Owner's Manual)6	Inverter186
Outside Rearview Mirrors112	Mirrors113
Overdrive427	Steering450
Overdrive OFF Switch427	Windows41
Overheating, Engine305	Pregnant Women and Seat Belts61
Owner's Manual (Operator Manual)6	Preparation for Jacking542
		Pretensioners	
Paint Care591	Seat Belts59
Panic Alarm24	Programmable Electronic Features331
Parking Brake452		
Passing Light170	Radial Ply Tires485
Personal Settings331	Radiator Cap (Coolant Pressure Cap)580
Pets98	Radio Operation391
Pets, Transporting98	Rear Axle (Differential)590
Phone, Cellular114	Rear Swing Gate44
Phone, Hands-Free (Uconnect™)114	Rear Window Defroster294

Rear Window Features293	Replacement Tires491
Rear Wiper/Washer.293	Reporting Safety Defects629
Recorder, Event Data75	Resetting Oil Change Indicator.325
Recreational Towing532	Restraint, Head.160
Shifting into Transfer Case Neutral (N)534	Restraints, Child.76
Shifting out of Transfer Case Neutral (N)536	Restraints, Occupant.45
Reformulated Gasoline507	Rotation, Tires494
Refrigerant572	Safety Checks Inside Vehicle101
Release, Hood.166	Safety Checks Outside Vehicle103
Reminder, Seat Belt.59	Safety Defects, Reporting.629
Remote Control		Safety, Exhaust Gas100
Door Locks22	Safety Information, Tire471
Starting System28	Safety Tips.99
Remote Keyless Entry (RKE)22	Satellite Radio Antenna352
Remote Sound System (Radio) Controls389	Schedule, Maintenance614
Remote Starting System.28	Seat Belt Maintenance595
Replacement Bulbs606	Seat Belt Reminder59
Replacement Keys17	Seat Belts.48
Replacement Parts.564		

Adjustable Upper Shoulder Anchorage55	Security Against Theft.19
And Pregnant Women61	Security Alarm (Theft Alarm).19
Child Restraint76	Sentry Key (Immobilizer)16
Extender61	Sentry Key Programming18
Front Seat48	Sentry Key Replacement17
Inspection101	Service Assistance625
Pretensioners59	Service Contract627
Reminder301	Service Manuals630
Untwisting Procedure55	Settings, Personal331
Seats152	Setting the Clock.337
Adjustment152	Shifting418
Easy Entry155	Automatic Transmission418
Fold and Tumble Rear161	Manual Transmission414
Heated159	Transfer Case, Shifting into Transfer Case	
Height Adjustment154	Neutral (N)534
Rear Folding164	Transfer Case, Shifting out of Transfer Case	
Removal163	Neutral (N)536
Seatback Release154	Shift Lever Override554
Tilting154	Shoulder Belts48

Shoulder Belt Upper Anchorage55	Tilt Column177
Side Airbag70	Wheel, Tilt177
Side Window Demisters (Defrosters)402	Steering Wheel Audio Controls389
Signals, Turn103	Steering Wheel Mounted Sound System Controls389
Snow Chains (Tire Chains)492	Storage605
Snow Tires486	Storage, Behind the Seat190
Soft Top221	Storage, Vehicle401
Spare Tire487	Storing Your Vehicle605
Speed Control (Cruise Control)178	Stuck, Freeing552
Speedometer300	Sunrider280
Starting28	Supplemental Restraint System - Airbag62
Automatic Transmission410	Sway Bar Disconnect, Electronic434
Cold Weather411	Swing Gate, Rear44
Engine Block Heater413	Synthetic Engine Oil568
Engine Fails to Start411	System, Remote Starting28
Manual Transmission410	Tachometer304
Remote28	Temperature Control, Automatic (ATC)396
Steering		Temperature Gauge, Engine Coolant305
Power450		

Theft System Arming20	Pressure Warning Light306
Theft System Disarming20	Quality Grading631
Tilt Steering Column177	Radial485
Tip Start411	Replacement491
Tire and Loading Information Placard477	Rotation494
Tire Markings471	Safety471
Tires103	Sizes473
Aging (Life of Tires)490	Snow Tires486
Air Pressure482	Spare Tire542
Chains492	Spinning489
Changing540	Tread Wear Indicators490
Compact Spare487	Tire Safety Information471
General Information482	Tongue Weight/Trailer Weight524
High Speed485	To Open Hood166
Inflation Pressures483	Tow Hooks, Emergency554
Jacking540	Towing515
Life of Tires490	24-Hour Towing Assistance130
Load Capacity477	Disabled Vehicle556
Pressure Monitor System (TPMS)495	Guide519

Recreational532	Manual414
Weight519	Range Indicator306
Towing Assistance.130	Shifting418
Trac-Lok Rear Axle432	Transmitter Battery Service (Remote Keyless Entry)27
Traction Control457	Tread Wear Indicators490
Trailer Sway Control (TSC)469	Trip Computer315
Trailer Towing515	Trip Odometer308
Cooling System Tips531	Trip Odometer Reset Button.306
Hitches518	Turn Signals169
Minimum Requirements525	UCI Connector382
Trailer and Tongue Weight524	Uconnect™ (Hands-Free Phone)114
Wiring529	Uniform Tire Quality Grades631
Trailer Towing Guide.519	Universal Consumer Interface (UCI) Connector382
Trailer Weight.519	Unleaded Gasoline506
Transfer Case589	Untwisting Procedure, Seat Belt55
Four-Wheel-Drive Operation428	Upholstery Care594
Maintenance589		
Transmission585		
Automatic420		

Vanity Mirrors114	Wheel and Wheel Trim Care593
Variance, Compass317	Wind Buffeting43
Vehicle Identification Number (VIN)8	Window Fogging402
Vehicle Loading478	Windows41
Vehicle Modifications/Alterations9	Power41
Vehicle Storage401	Windshield Defroster101
Viscosity, Engine Oil568	Windshield, Folding286
Voice Recognition System (VR)146	Windshield Washers173
		Fluid574
Warning Lights (Instrument Cluster Description)300	Windshield Wiper Blades573
Warnings and Cautions8	Windshield Wipers173
Warranty Information628	Wiper Blade Replacement573
Washers, Windshield574	Wiper, Rear293
Washing Vehicle592		
Wheel and Wheel Trim593		

INSTALLATION OF RADIO TRANSMITTING EQUIPMENT

Special design considerations are incorporated into this vehicle's electronic system to provide immunity to radio frequency signals. Mobile two-way radios and telephone equipment must be installed properly by trained personnel. The following must be observed during installation.

The positive power connection should be made directly to the battery and fused as close to the battery as possible. The negative power connection should be made to body sheet metal adjacent to the negative battery connection. This connection should not be fused.

Antennas for two-way radios should be mounted on the roof or the rear area of the vehicle. Care should be used in mounting antennas with magnet bases. Magnets may affect the accuracy or operation of the compass on vehicles so equipped.

The antenna cable should be as short as practical and routed away from the vehicle wiring when possible. Use only fully shielded coaxial cable.

Carefully match the antenna and cable to the radio to ensure a low Standing Wave Ratio (SWR).

Mobile radio equipment with output power greater than normal may require special precautions.

All installations should be checked for possible interference between the communications equipment and the vehicle's electronic systems.



STICK WITH THE SPECIALISTS®

