



### Digital – in the vehicle

Familiarize yourself with the contents of the Operator's Manual directly via the vehicle's multimedia system (menu item "Vehicle"). Start with the quick guide, discover your vehicle's highlights or broaden your knowledge with useful tips.



### Vehicle document wallet

Here you can find comprehensive information about operating your vehicle and about services and warranties in printed form.



### Digital – on the Internet

You can find the Operator's Manual on the Mercedes-Benz homepage.



### Digital – as an App

The Mercedes-Benz Guides App is available free-of-charge in familiar App stores.

S-Class



2225849009

Order no. P222 0157 13 Part no. 222 584 90 09  
Edition C 2018



Apple® iOS



Android™

Mercedes-Benz

## S-Class

Operator's Manual

Mercedes-Benz





## Symbols

In this Operator's Manual, you will find the following symbols:

 **DANGER** Danger due to not observing the warning notices

Warning notices draw your attention to hazards that may endanger your health or life, or the health or life of others.

 Please observe the warning notices in this manual.

 **ENVIRONMENTAL NOTE** Environmental damage due to failure to observe environmental notes

Environmental notes include information on environmentally responsible behavior or environmentally responsible disposal.

 Observe environmental notes.

 **NOTE** Damage to property due to failure to observe notes on material damage

Notes on material damage inform you of risks which may lead to your vehicle being damaged.

 Observe notes on material damage.

 Useful instructions or further information that could be helpful to you.

 Instruction

( → page) Further information on a topic

**Display** Information in the multifunction display/multimedia display

 Highest menu level, which is to be selected in the multimedia system

 Corresponding submenus, which are to be selected in the multimedia system

\* Indicates a cause

## Publication details

### Internet

Further information about Mercedes-Benz vehicles and about Daimler AG can be found on the following websites:

<http://www.mbusa.com> (USA only)

<http://www.mercedes-benz.ca> (Canada only)

### Editorial office

©Daimler AG: Not to be reprinted, translated or otherwise reproduced, in whole or in part, without written permission from Daimler AG.

### Vehicle manufacturer

Daimler AG

Mercedesstrasse 137

70327 Stuttgart

Germany

## Welcome to the world of Mercedes-Benz

Before you first drive off, read this Operator's Manual carefully and familiarize yourself with your vehicle. For your own safety and a longer vehicle life, follow the instructions and warning notices in this Operator's Manual. Disregarding them may lead to damage to the vehicle or personal injury.

Vehicle damage resulting from the disregard of the instructions is not covered by the Mercedes-Benz Limited Warranty.

The equipment or model designation of your vehicle may vary according to:

- Model
- Order
- National version
- Availability

Mercedes-Benz reserves the right to introduce changes in the following areas:

- Design
- Equipment
- Technical features

The equipment in your vehicle may therefore differ from that shown in the descriptions and illustrations.

The following are integral parts of the vehicle:

- Digital Operator's Manual
- Printed Operator's Manual
- Maintenance Booklet
- Equipment-dependent supplements

Keep these documents in the vehicle at all times. If you sell the vehicle, always pass all of the documents on to the new owner.

Mercedes-Benz USA, LLC

Mercedes-Benz Canada, Inc.

A Daimler Company

2225849009



<b>At a glance</b> .....	<b>6</b>	Reporting safety defects .....	25	<b>Seats and stowing</b> .....	<b>88</b>
Cockpit .....	6	Limited Warranty .....	26	Notes on the correct driver's seat position ...	88
Warning and indicator lamps .....	8	QR codes for the rescue card .....	26	Seats .....	89
Overhead control panel .....	10	Vehicle data storage .....	26	Steering wheel .....	110
Door control panel and seat adjustment .....	12	Copyright .....	30	Using the memory function .....	113
Control settings in the rear passenger compartment .....	14			Memory function in the rear passenger compartment .....	114
Emergencies and breakdowns .....	16	<b>Occupant safety</b> .....	<b>31</b>	Stowage areas .....	118
		Restraint system .....	31	Cup holder .....	129
		Seat belts .....	33	Ashtray and cigarette lighter .....	132
		Airbags .....	38	Sockets .....	134
<b>Digital Operator's Manual</b> .....	<b>18</b>	PRE-SAFE® system .....	45	Refrigerator box .....	137
Calling up the Digital Operator's Manual .....	18	Children in the vehicle .....	47	Wireless charging of the mobile phone and connection with the exterior antenna ..	139
		Notes on pets in the vehicle .....	56	Installing or removing the floor mats .....	141
				Installing/removing the pennant holder .....	141
<b>General notes</b> .....	<b>19</b>	<b>Opening and closing</b> .....	<b>58</b>		
Protecting the environment .....	19	SmartKey .....	58	<b>Light and visibility</b> .....	<b>143</b>
Mercedes-Benz GenuineParts .....	19	Doors .....	62	Exterior lighting .....	143
Operator's Manual .....	20	Trunk .....	66	Interior lighting .....	148
Service and vehicle operation .....	21	Roller sun blinds .....	72	Windshield wiper and windshield washer system .....	149
Operating safety .....	22	Side windows .....	73	Mirrors .....	152
Declaration of conformity for wireless vehicle components .....	23	Sliding sunroof .....	77	Operating the sun visors .....	155
Diagnostics connection .....	24	Anti-theft protection .....	86		
Qualified specialist workshop .....	25				
Correct use of the vehicle .....	25				
Problems with your vehicle .....	25				

Function of the infrared reflective wind-  
shield ..... 155

**Climate control ..... 157**

Overview of climate control systems ..... 157  
Operating the climate control system ..... 158

**Driving and parking ..... 165**

Driving ..... 165  
DYNAMIC SELECT switch ..... 172  
Automatic transmission ..... 173  
Refueling ..... 177  
Parking ..... 179  
Driving and driving safety systems ..... 188

**Instrument Display and on-board  
computer ..... 244**

Instrument Display overview ..... 244  
Overview of the buttons on the steering  
wheel ..... 245  
Operating the on-board computer ..... 245  
Overview of displays in the multifunction  
display ..... 247

Adjusting the instrument lighting ..... 247  
Menus and submenus ..... 248  
Head-up Display ..... 254

**Voice Control System ..... 256**

Operating safety ..... 256  
Operation ..... 256  
Using the Voice Control System effec-  
tively ..... 258  
Essential voice commands ..... 259

**Multimedia system ..... 269**

Overview and operation ..... 269  
System settings ..... 277  
ENERGIZING comfort ..... 289  
Navigation ..... 291  
Telephone ..... 315  
Online and Internet functions ..... 330  
Media ..... 337  
Radio ..... 350  
Sound ..... 357  
Rear Seat Entertainment System ..... 360

**Maintenance and care ..... 377**

ASSYST PLUS service interval display ..... 377  
Engine compartment ..... 378  
Cleaning and care ..... 385

**Breakdown assistance ..... 393**

Emergency ..... 393  
Flat tire ..... 393  
Battery (vehicle) ..... 399  
Tow starting or towing away ..... 404  
Electrical fuses ..... 410

**Wheels and tires ..... 413**

Noise or unusual handling characteristics ... 413  
Checking wheels and tires regularly ..... 413  
Notes on snow chains ..... 414  
Tire pressure ..... 414  
Loading the vehicle ..... 420  
Tire labeling ..... 425  
Definition of terms for tires and loading .... 431  
Changing a wheel ..... 433

---

<b>Technical data</b> .....	<b>443</b>
Notes on technical data .....	443
Vehicle electronics .....	443
Vehicle identification plate, VIN and engine number overview .....	445
Operating fluids .....	447
Vehicle data .....	454

---

<b>Display messages and warning/indicator lamps</b> .....	<b>457</b>
Display messages .....	457
Warning and indicator lamps .....	501

---

<b>Index</b> .....	<b>519</b>
--------------------	------------



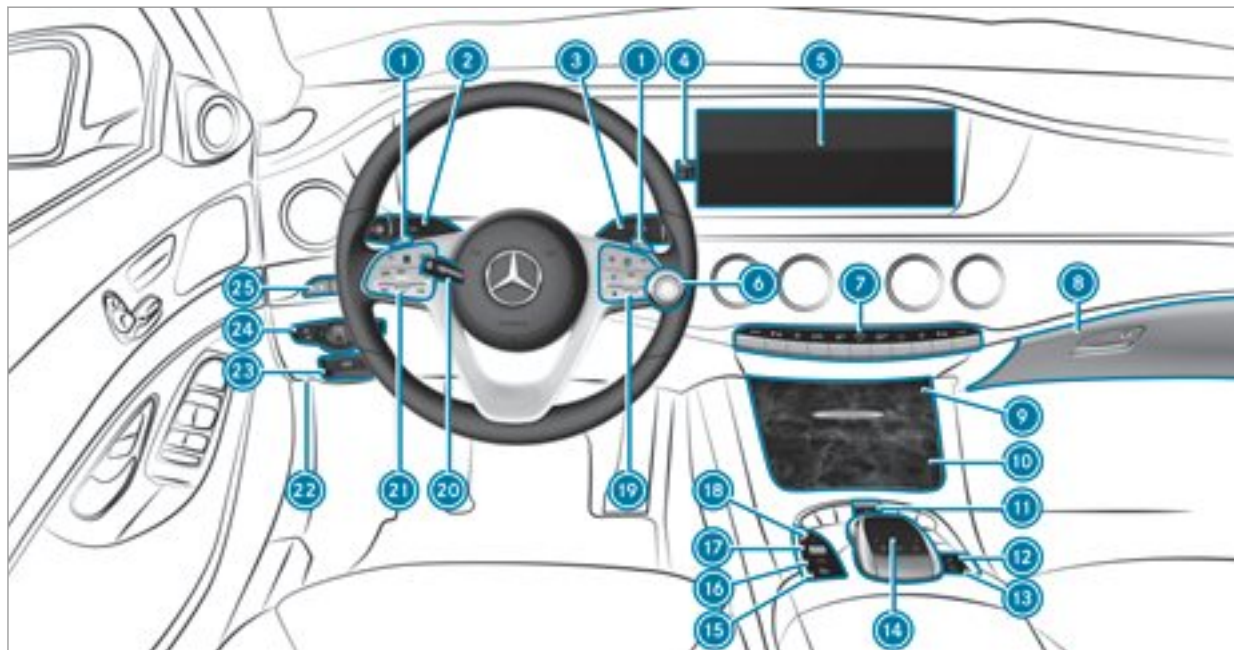





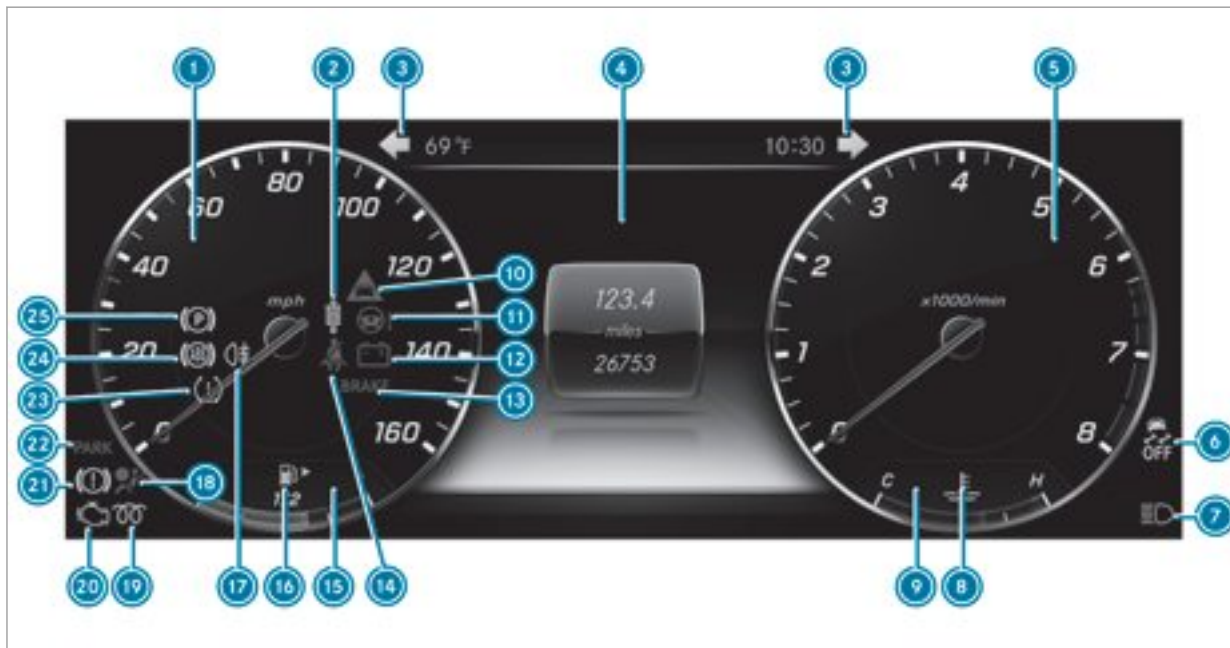





























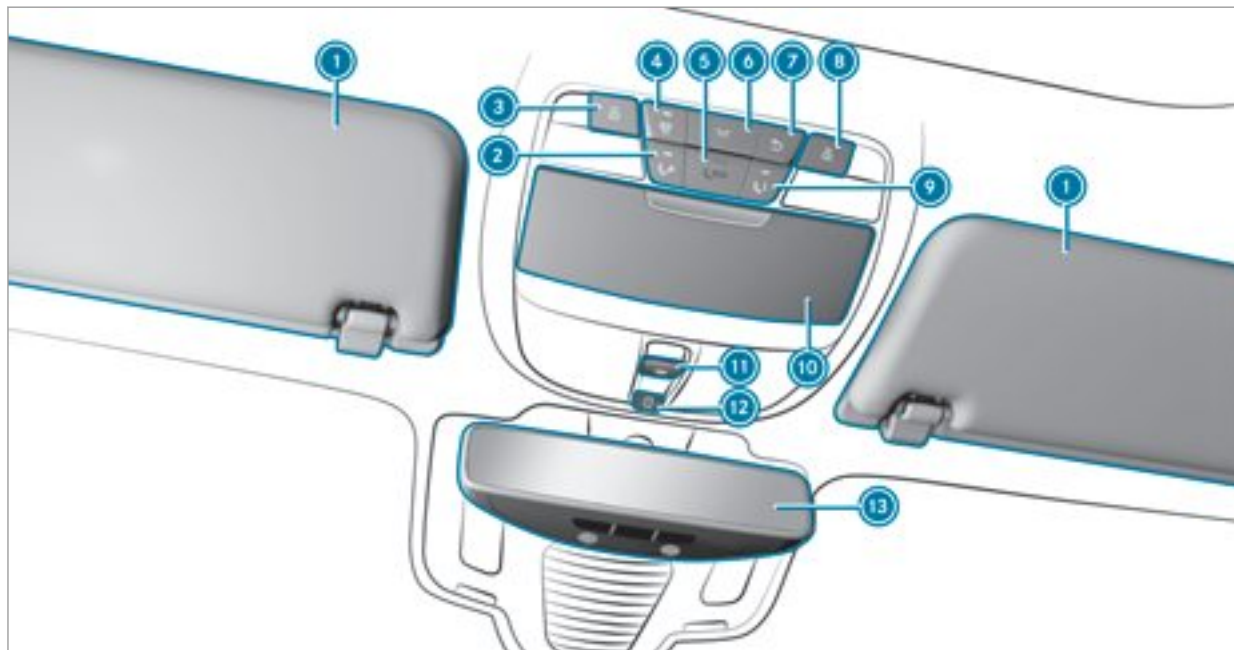





①	Steering wheel gearshift paddle	→	176	⑮	ECO start/stop function	→	171
②	Combination switch	→	144	⑲	Control panel for the multimedia system	→	245
③	DIRECT SELECT lever	→	173	⑳	Adjusts the steering wheel	→	110
④	PASSENGER AIRBAG indicator lamps	→	„ 43	㉑	Control panel for:		
⑤	Display (multimedia system)	→	269		On-board computer	→	245
⑥	Start/Stop button	→	166		Operating cruise control	→	197
⑦	Climate control systems	→	158		Operating Active Distance Assist DISTRONIC	→	200
⑧	Glove box	→	120	㉒	Unlocks the hood	→	378
⑨	Stowage compartment	→	120	㉓	Electric parking brake	→	185
⑩	Cup holder	→	129	㉔	Light switch	→	143
⑪	Hazard warning lights	→	145	㉕	Control panel for:		
⑫	Extends the head restraints of the rear seats	→	102		Active Steering Assist	→	206
⑬	Parking Assist PARKTRONIC	→	220		Active Lane Keeping Assist	→	242
⑭	Control elements for the multimedia system	→	269		Night View Assist	→	236
⑮	Active Parking Assist	→	228		Head-up Display	→	255
⑯	Sets the vehicle level	→	213		Rear window roller sunblind	→	72
⑰	DYNAMIC SELECT switch	→	173				







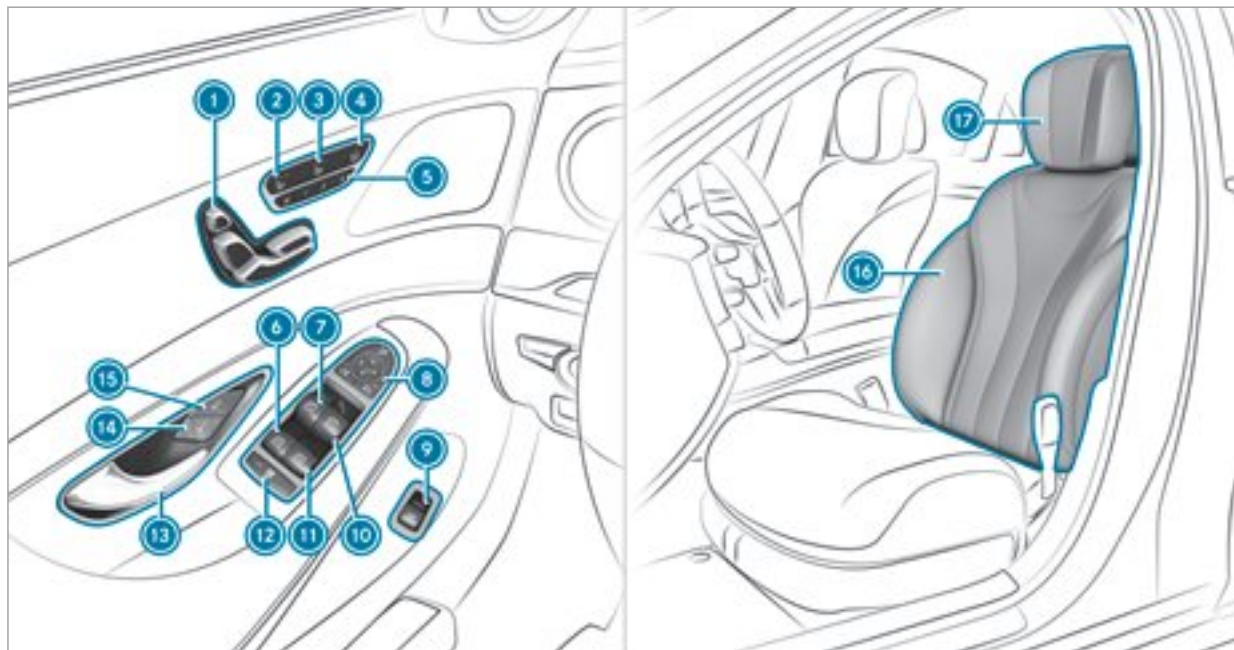

Instrument Display in the Widescreen Cockpit

①	Speedometer	→	244	 BRAKE USA only	
②	AIR BODY CONTROL malfunctioning	→	511	 Canada only	
③	 Turn signal light	→	144	⑭  Seat belt is not fastened	→ 510
④	Multifunction display	→	247	⑮ Fuel level indicator	
⑤	Tachometer	→	244	⑯  Fuel reserve with fuel filler flap location indicator	→ 513
⑥	 ESP® OFF	→	503	⑰  Rear fog light	→ 144
	 ESP®	→	503	⑱  Restraint system	
⑦	 High beam	→	144	⑲  Indicator lamp has no function	
	 Low beam	→	143	⑳  Check Engine	→ 513
	 Parking lights	→	143	㉑  Brakes (yellow)	→ 503
⑧	 Coolant too hot/cold	→	513	㉒ Electric parking brake applied (red)	→ 503
⑨	Coolant temperature gauge	→	244	 PARK USA only	
⑩	 Distance warning	→	511	 Canada only	
⑪	 Steering assistance malfunction	→	512	㉓  Tire pressure monitoring system	→ 517
⑫	 Electrical malfunction	→	513	㉔  ABS malfunction	→ 503
⑬	Brakes (red)	→	503	㉕  Electric parking brake (yellow)	→ 503



①	 Sun visors	→	155	⑧	 Switches the right-hand reading lamp on/off	→	148
②	 Breakdown assistance call button (mbrace®)	→	330	⑨	 MB Info call button (mbrace®)	→	329
③	 Switches the left-hand reading lamp on/off	→	148	⑩	 Eyeglasses compartment	→	121
④	 Switches the automatic lighting control on/off	→	148	⑪	 Opens/closes the panoramic sliding sunroof	→	77
⑤	 SOS button (mbrace®)	→	329		Opens/closes the roller sunblinds	→	77
⑥	 Switches the front interior lighting on/off	→	148	⑫	 Operates MAGIC SKY CONTROL	→	82
⑦	 Switches the rear interior lighting on/off	→	148	⑬	 Rear-view mirror		



①	Adjusts the seats electrically	→	89	⑨	Opens/closes the trunk lid	→	66
②	Switches the seat heater on/off	→	107	⑩	 Opens/closes the right side window	→	73
③	Switches the seat ventilation on/off	→	109	⑪	 Opens/closes the rear right side window	→	73
④	Adjusts the front passenger seat from the driver's seat	→	91	⑫	Child safety lock for the rear side windows	→	56
⑤	Sets the memory function	→	113	⑬	Opens the door	→	62
⑥	 Opens/closes the rear left side window	→	73	⑭	 Locks the vehicle	→	63
⑦	 Opens/closes the left side window	→	73	⑮	 Unlocks the vehicle	→	63
⑧	Adjusts and folds the outside mirrors out/in electrically	→	152	⑯	Seat adjustment using the multimedia system	→	105
				⑰	Adjusts the head restraints	→	100

14 At a glance - Control settings in the rear passenger compartment

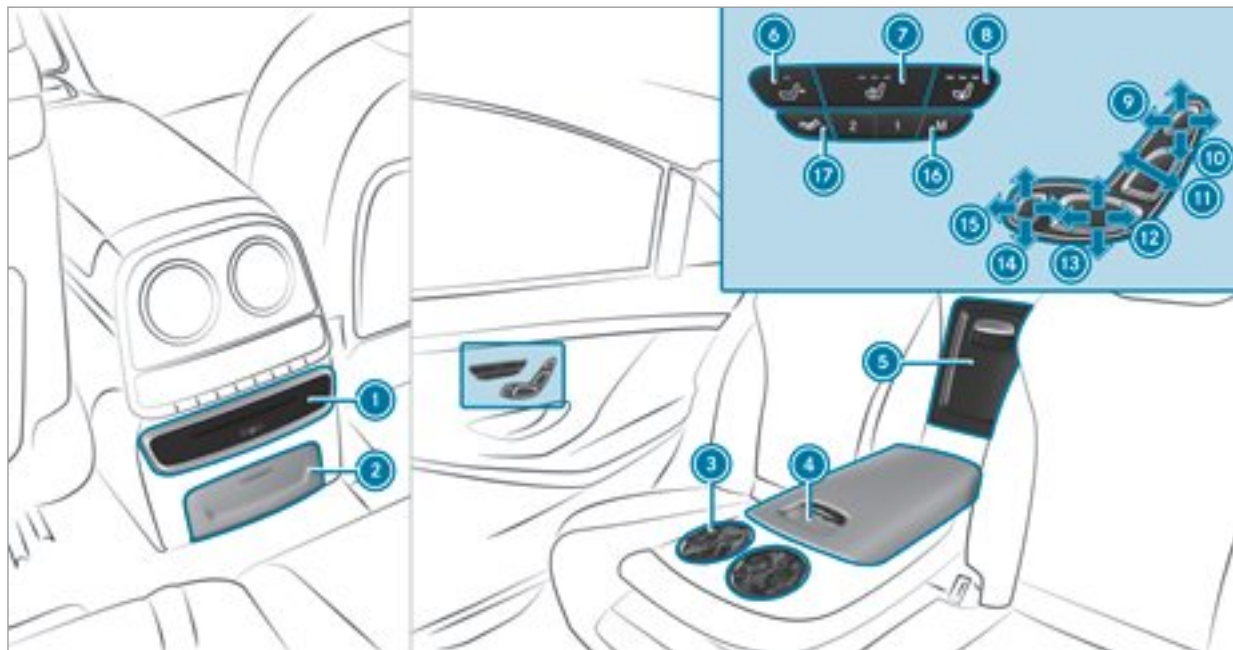

Vehicles with a reclining rear seat



① Blu-ray/DVD drive			
② Cigarette lighter	→	133	
Socket	→	134	
③ Cup holder	→	130	
④ Stowage compartment in the rear armrest	→	121	
⑤ Stowage box in the seat backrest	→	122	
Refrigerator box	→	137	
⑥ Selects the front passenger seat	→	91	
⑦ Switches the rear seat heater on/off	→	107	
⑧ Switches the rear seat ventilation on/off	→	109	
⑨ Sets the fore-and-aft position of the head restraint	→	93	
⑩ Adjusts the height of the head restraint	→	93	
⑪ Seat backrest inclination	→	93	
⑫ Sets the combined seat cushion inclination and length	→	93	
⑬ Sets the combined seat cushion inclination and length	→	93	
⑭ Angle of the leg rest	→	93	
⑮ Fore-and-aft position of the leg rest	→	93	
⑯ Memory function in the rear passenger compartment	→	114	
⑰ Sets the fully reclined position	→	94	

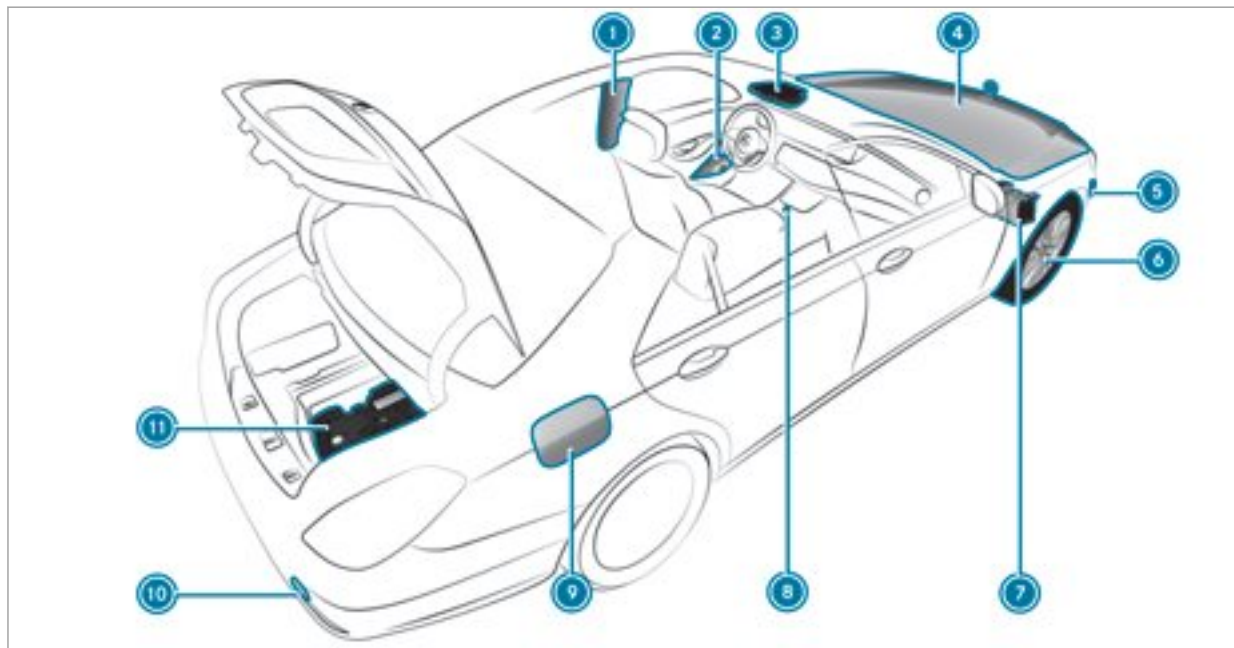

What to do in the event of an accident			
① QR code for accessing the rescue card	→	26	
② Safety vests	→	393	
③ Button for the SOS emergency call system and Roadside Assistance	→	328	
④ Checking and topping up operating fluids	→	447	
⑤ Tow-starting and towing away	→	405	
⑥ Flat tire	→	393	
			⑦ Starting assistance → 401
			⑧ Hazard warning lights → 145
			⑨ Fuel filler flap with instruction labels for tire pressure, fuel type and QR codes for accessing the rescue card → 177
			⑩ Tow-starting and towing away → 405
			⑪ TIREFIT kit → 395

## Calling up the Digital Operator's Manual

Multimedia system:

➔ Vehicle ➔ ⓘ Operator's Manual



▶ Select a menu item.

In addition, you can also call up the Operator's Manual within a main function (e.g. via [Navigation Info](#)).

The Digital Operator's Manual describes the function and operation of:

- the vehicle
- the multimedia system

For safety reasons, the Digital Operator's Manual is deactivated while driving.

The Digital Operator's Manual contains the following menu items:

- **Search:** allows you to search precisely for keywords.
- **Quick start:** provides you with important information so that you can start using your vehicle immediately.
- **Tips:** provides tips on how to use your vehicle in certain situations.
- **Messages:** provides you with further information about the messages in the instrument cluster.
- **Bookmarks:** provides you with a list of all the bookmarks you have stored yourself.

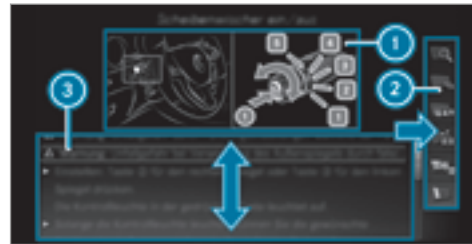

- ① Picture
- ② Menu
- ③ Navigation window

Some sections of the Digital Operator's Manual, such as warning notes, can be made visible by highlighting and pressing them.

- ⓘ The Operator's Manual can also be found in the Mercedes-Benz Guides App in all common App Stores.

## Protecting the environment

**Plug-in hybrid:** observe the notes in the Supplement. Otherwise, you may not recognize dangers.



**ENVIRONMENTAL NOTE** Environmental damage due to operating conditions and personal driving style

The pollutant emission of your vehicle is directly related to the way you operate your vehicle.

You can help to protect the environment by operating your vehicle in an environmentally-responsible manner. Please observe the following recommendations on operating conditions and personal driving style.

### Operating conditions:

- ▶ Make sure that the tire pressure is correct.
- ▶ Do not carry any unnecessary weight (e.g. roof luggage racks once you no longer need them).

- ▶ Adhere to the service intervals. A regularly serviced vehicle will contribute to environmental protection.
- ▶ Always have service work carried out at a qualified specialist workshop.

### Personal driving style:

- ▶ Do not depress the accelerator pedal when starting the engine.
- ▶ Do not warm up the engine while the vehicle is stationary.
- ▶ Drive carefully and maintain a suitable distance from the vehicle in front.
- ▶ Avoid frequent, sudden acceleration and braking.
- ▶ Change gear in good time and use each gear only up to  $\frac{2}{3}$  of its maximum engine speed.
- ▶ Switch off the engine in stationary traffic, e.g. by using the ECO start/stop function.
- ▶ Drive in a fuel-efficient manner.

### Environmental issues and recommendations:

It is recommended that you re-use or recycle materials first instead of just disposing of them.

The relevant environmental regulations and guidelines serve to protect the environment and must be strictly observed.

## Mercedes-Benz GenuineParts



**ENVIRONMENTAL NOTE** Environmental damage caused by not using recycled/reconditioned components

Daimler AG offers recycled/reconditioned components and parts with the same quality as new parts. The same entitlement from the Limited Warranty is valid as for new parts.

- ▶ Use recycled/reconditioned components and parts from Daimler AG.

**!** **NOTE** Impairment of the operating efficiency of the restraint systems from installing accessories or from repairs or welding

Airbags, Emergency Tensioning Devices, as well as control units and sensors for the restraint systems, may be installed in the following areas of your vehicle:

- Doors
  - Door pillars
  - Door sills
  - Seats
  - Cockpit
  - Instrument cluster
  - Center console
- ▶ Do not install accessories such as audio systems in these areas.
- ▶ Do not carry out repairs or welding.
- ▶ Have accessories retrofitted at a qualified specialist workshop.

You could jeopardize the operating safety of your vehicle if you use parts, tires and wheels as well as accessories relevant to safety which have not been approved by Mercedes-Benz. Safety-relevant systems, e.g. the brake system, may malfunction. Only use Mercedes-Benz GenuineParts or parts of equal quality. Only use tires, wheels and accessory parts that have been specifically approved for your vehicle model.

Mercedes-Benz GenuineParts are subject to strict quality control. Each part has been specially developed, manufactured or selected for Mercedes-Benz vehicles and fine-tuned for them. Therefore, only Mercedes-Benz GenuineParts should be used.

More than 300,000 different Mercedes-Benz GenuineParts are available for Mercedes-Benz models.

All authorized Mercedes-Benz Centers maintain a supply of Mercedes-Benz GenuineParts for necessary service and repair work. In addition, strategically located parts-delivery centers provide for quick and reliable parts service.

Always specify the vehicle identification number (VIN) (→ page 445) when ordering Mercedes-Benz GenuineParts.

### Operator's Manual

This Operator's Manual describes all models and all standard and optional equipment available for your vehicle at the time of this Operator's Manual going to press. Country-specific differences are possible. Note that your vehicle may not be equipped with all features described. This also applies to safety-relevant systems and functions. Therefore, the equipment on your vehicle may differ from that in the descriptions and illustrations.

The original purchase contract documentation for your vehicle contains a list of all of the systems in your vehicle.

Should you have any questions concerning equipment and operation, please consult an authorized Mercedes-Benz Center.

The Operator's Manual and Maintenance Booklet are important documents and should be kept in the vehicle.

## Service and vehicle operation

### Vehicle operation outside the USA or Canada

When you are abroad with your vehicle, observe the following points:

- Service points or replacement parts may not be available immediately.
- Unleaded fuel may not be available for vehicles with a catalytic converter. Leaded fuel may cause damage to the catalytic converter.
- The fuel may have an extremely low octane number. Unsuitable fuel can cause engine damage.

Some Mercedes-Benz models are available in Europe through our European Delivery Program. For more information, please consult an authorized Mercedes-Benz service center, or write to one of the following address:

#### **In the USA:**

Mercedes-Benz USA, LLC  
European Delivery Department  
One Mercedes Drive  
Montvale, NJ 07645-0350

#### **In Canada:**

Mercedes-Benz Canada, Inc.  
European Delivery Department  
98 Vanderhoof Avenue  
Toronto, Ontario M4G 4C9

### Maintenance

Your customer advisor confirms the service in the service report.

### Roadside Assistance

The Mercedes-Benz Roadside Assistance Program offers technical help in the case of a breakdown. Your calls to the toll-free Roadside Assistance Hotline are answered by our agents 24 hours a day, 365 days a year.

1-800-FOR-MERCEdes (1-800-367-6372) (USA)  
1-800-387-0100 (Canada)

You can find further information in the Mercedes-Benz Roadside Assistance Program brochure (USA) or the "Roadside Assistance"

section in the maintenance and warranty information booklet (Canada). You will find both in the vehicle document wallet.

### Change of address or change of ownership

In the event of a change of address, please send us the "Notification of address change" in the Service and Guarantee booklet or simply call the Mercedes-Benz Customer Assistance Center (USA) on the hotline number 1-800-FOR-MERCEdes (1-800-367-6372) or Customer Service (Canada) on 1-800-387-0100. We can then reach you in a timely fashion, if necessary.

If you sell your Mercedes, please leave all literature in the vehicle so that it is available to the next owner. If you have purchased a used vehicle, please send us the "Notice of Purchase of Used Car" in the Service and Guarantee booklet or simply call the Mercedes-Benz Customer Assistance Center (USA) at the hotline number 1-800-FOR-MERCEdes (1-800-367-6372) or Customer Service (Canada) at 1-800-387-0100.

### **Important notice for California retail buyers and lessees of Mercedes-Benz automobiles**

Under California law you may be entitled to a replacement of your vehicle or a refund of the purchase price or lease price, if after a reasonable number of repair attempts Mercedes-Benz USA, LLC and/or its authorized repair or service facilities fail to fix one or more substantial defects or malfunctions in the vehicle that are covered by its express warranty.

During a period of 18 months from original delivery of the vehicle or a kilometer/mileage reading of 18,000 miles (29,000 km), whichever occurs first, vehicle repair is presumed for a retail buyer or lessee if one or more of the following occurs:

- (1) the serious defect or damage can result in deadly or serious injury to the vehicle occupants while driving AND this defect has already been repaired at least twice AND Mercedes-Benz, LLC has been informed in writing of the necessity of a repair.
- (2) the defect or damage, though less serious than (1) above, has already been repaired at

least four times AND Mercedes-Benz has been informed in writing of the necessity of a repair.

- (3) the vehicle cannot be used for longer than 30 calendar days because of repair work resulting from this or other serious defects or damage.

Please send your written notice to:

Mercedes-Benz USA, LLC  
Customer Assistance Center  
3 Mercedes Drive  
Montvale, NJ 07645-0350

### **Operating safety**

**Plug-in hybrid:** observe the notes in the Supplement. Otherwise, you may not recognize dangers.

**⚠ WARNING** Risk of accident due to malfunctions or system failures

If you do not have the prescribed service/maintenance work or any required repairs carried out, this could result in malfunctions or system failures.

- ▶ Always have the prescribed service/maintenance work as well any required repairs carried out at a qualified specialist workshop.

**⚠ WARNING** Risk of accident or injury due to incorrect modification of electronic components and parts

Modification to electronic components, their software or wiring could impair their function and/or the function of other networked component parts. In particular, systems relevant to safety could also be affected.

As a result, these may no longer function properly and/or jeopardize the operating safety of the vehicle.



- ▶ Never tamper with the vehicle's wiring, electronic components or software.
- ▶ You should have all work on electrical and electronic components carried out at a qualified specialist workshop.

**⚠ WARNING** Risk of fire due to flammable materials on hot parts of the exhaust system

Flammable material such as leaves, grass or twigs may ignite if they come into contact with hot parts of the exhaust system.

- ▶ When driving on unpaved roads or off-road, regularly check the vehicle underside.
- ▶ Remove trapped plants or other flammable material.
- ▶ If there is damage, consult a qualified specialist workshop immediately.

**! NOTE** Damage to the vehicle

Damage to the vehicle may occur in the following cases:

- The vehicle becomes grounded, e.g. on a high curb or an unpaved road.
- The vehicle is driven too fast over an obstacle, e.g. a curb, speed bump or pothole.
- A heavy object strikes the underbody or parts of the chassis.

In situations such as this, the body, the underbody, chassis parts, wheels or tires could be damaged without the damage being visible. Components damaged in this way can unexpectedly fail or, in the case of an accident, no longer withstand the strain they are designed to.

If the underbody paneling is damaged, flammable materials such as leaves, grass or twigs can gather between the underbody and the underbody paneling. If these materials come into contact with hot parts on the exhaust system, they may catch fire.

- ▶ Have the vehicle checked and repaired immediately at a qualified specialist workshop.

or

- ▶ If driving safety is impaired while continuing your journey, pull over and stop the vehicle immediately, paying attention to road and traffic conditions, and contact a qualified specialist workshop.

**Declaration of conformity for wireless vehicle components**

**USA:** "The wireless devices of this vehicle comply with Part 15 of the FCC Rules. Operation is subject to the following two conditions: 1) These devices may not cause harmful interference, and 2) These devices must accept any interference received, including interference that may cause undesired operation. Changes or modifications not expressly approved by the party responsible for compliance could void the user's authority to operate the equipment."

**Canada:** "The wireless devices of this vehicle comply with Industry Canada license-exempt RSS standard(s). Operation is subject to the following two conditions: (1) These devices may not cause interference, and (2) These devices must accept any interference, including interference that may cause undesired operation of the device."

**USA:** "Wireless charging system for mobile devices (Model: D-WMI2015A): this device complies with Part 18 of the FCC Rules."

The name and address of the responsible party is:

Continental Automotive Systems US Inc.  
2400 Executive Hills Drive  
Auburn Hills, MI 48326-2980  
United States of America

### Diagnosics connection

The diagnostics connection is only intended for the connection of diagnostic devices at a qualified specialist workshop.

**⚠ WARNING** Risk of accident due to connecting devices to the diagnostics connection

If you connect equipment to a diagnostics connection in the vehicle, it may affect the operation of vehicle systems.

As a result, the operating safety of the vehicle could be affected.

- ▶ Only connect equipment to a diagnostics connection in the vehicle which is approved for your vehicle by Mercedes-Benz.

**⚠ WARNING** Risk of accident due to objects in the driver's footwell

Objects in the driver's footwell may impede pedal travel or block a depressed pedal.

This jeopardizes the operating and road safety of the vehicle.

- ▶ Stow all objects in the vehicle securely so that they cannot get into the driver's footwell.

- ▶ Always install the floor mats securely and as prescribed in order to ensure that there is always sufficient room for the pedals.
- ▶ Do not use loose floor mats and do not place floor mats on top of one another.

**! NOTE** Battery discharging from using devices connected to the diagnostics connection

Using devices at the diagnostics connection drains the battery.

- ▶ Check the charge level of the battery.
- ▶ If the charge level is low, charge the battery, e.g. by driving a considerable distance.

Connecting equipment to the diagnostics connection can lead to emissions monitoring information being reset, for example. This may lead to the vehicle failing to meet the requirements of the next emissions inspection during the main inspection.

### Qualified specialist workshop

**Plug-in hybrid:** be sure to observe the notes in the Supplement. Otherwise, you may not recognize dangers.

An authorized Mercedes-Benz Center is a qualified specialist workshop. It has the necessary specialist knowledge, tools and qualifications to correctly carry out the work required on your vehicle. This particularly applies to work relevant to safety.

Always have the following work carried out on your vehicle at a qualified specialist workshop:

- Work relevant to safety
- Service and maintenance work
- Repair work
- Modifications as well as installations and conversions
- Work on electronic component parts

Mercedes-Benz recommends an authorized Mercedes-Benz Center.

### Correct use of the vehicle

If you remove any warning stickers, you or others could fail to recognize certain dangers. Leave warning stickers in position.

When using the vehicle, observe the following information:

- The safety notes in this manual
- The vehicle technical data
- Traffic rules and regulations
- Laws and safety standards pertaining to motor vehicles

### Problems with your vehicle

If you should experience a problem with your vehicle, particularly one that you believe may affect its safe operation, we urge you to contact an authorized Mercedes-Benz service center immediately to have the problem diagnosed and rectified. If the problem is not resolved to your satisfaction, please discuss the problem again with the authorized Mercedes-Benz service cen-

ter or, if necessary, contact us at one of the following addresses.

#### In the USA:

Customer Assistance Center  
Mercedes-Benz USA, LLC  
3 Mercedes Drive  
Montvale, NJ 07645-0350

#### In Canada:

Customer Relations Department  
Mercedes-Benz Canada, Inc.  
98 Vanderhoof Avenue  
Toronto, Ontario M4G 4C9

### Reporting safety defects

#### USA only:

The following text is published as required of manufacturers under Title 49, Code of U.S. Federal Regulations, Part 575 pursuant to the "National Traffic and Motor Vehicle Safety Act of 1966".

If you believe that your vehicle has a defect which could cause a crash or could cause injury or death, you should immediately inform the National Highway Traffic Safety Administration (NHTSA) in addition to notifying Mercedes-Benz USA, LLC.

If NHTSA receives similar complaints, it may open an investigation, and if it finds that a safety defect exists in a group of vehicles, it may order a recall and remedy campaign. However, NHTSA cannot become involved in individual problems between you, your dealer, or Mercedes-Benz USA, LLC.

To contact NHTSA, you may call the Vehicle Safety Hotline toll-free at 1-888-327-4236 (TTY: 1-800-424-9153) (inside the USA); go to <http://www.safercar.gov>; or write to: Administrator, NHTSA, 400 Seventh Street, SW., Washington, DC 20590, USA.

Further information on vehicle safety can be found at: <http://www.safercar.gov>

### Limited Warranty

**!** **NOTE** Damage to the vehicle arising from culpable violation of these operating instructions.

Damage to the vehicle can arise from culpable violation of these operating instructions.

This damage is not covered either by the Mercedes-Benz Limited Warranty or by the New Vehicle or Used Vehicle Warranty.

► Follow the instructions in this manual on proper operation of your vehicle as well as on possible vehicle damage.

### QR codes for the rescue card

The QR code is secured in the fuel filler flap and on the opposite side on the B-pillar. In the event of an accident, rescue services can use the QR code to quickly find the appropriate rescue card for your vehicle. The current rescue card contains the most important information about your vehicle in a compact form, e.g. the routing of the electric lines.

Further information can be obtained at <http://www.mercedes-benz.de/qr-code>.

### Vehicle data storage

#### Information from electronic control units

Your vehicle is equipped with electronic control units. Some of these are necessary for the safe operation of your vehicle, while some assist you when driving (driver assistance systems). In addition, your vehicle provides convenience and entertainment functions, which are also made possible by electronic control units.

Electronic control units contain data memories which can temporarily or permanently store technical information about the vehicle's operating status, component loads, maintenance requirements and technical events or malfunctions.

In general, this information documents the state of a component part, a module, a system or the surroundings, for example:

- operating statuses of system components (e.g. fluid levels, battery status, tire pressure)

- status messages concerning the vehicle and its individual components (e.g. number of wheel revolutions/speed, deceleration, lateral acceleration, display of the fastened seat belts)
- malfunctions or defects in important system components (e.g. lights, brakes)
- information on vehicle damage events
- system reactions in special driving situations (e.g. air bag deployment, intervention of stability control systems)
- ambient conditions (e.g. temperature, rain sensor)

In addition to providing the actual control unit function, this data assists the manufacturer in detecting and rectifying malfunctions and optimizing vehicle functions. The majority of this data is temporary and is only processed in the vehicle itself. Only a small portion of the data is stored in the event or malfunction memory.

When your vehicle is serviced, technical data from the vehicle can be read out by service network employees or third parties. Services include repair services, maintenance processes,

warranty events and quality assurance measures, for example. The read out is performed via the legally prescribed port for OBD ("on-board diagnostics") in the vehicle. The respective service network locations or third parties collect, process and use the data. They document technical statuses of the vehicle, assist in finding malfunctions and improving quality and are transmitted to the manufacturer, if necessary. Furthermore, the manufacturer is subject to product liability. For this, the manufacturer requires technical data from vehicles.

Malfunction memories in the vehicle can be reset by a service outlet as part of repair or maintenance work.

They can enter data into the vehicle's convenience and infotainment functions themselves as part of the selected equipment.

This includes, for example:

- multimedia data such as music, films or photos for playback in an integrated multimedia system

- address book data for use in connection with an integrated hands-free system or an integrated navigation system
- entered navigation destinations
- data about the use of Internet services

This data can be stored locally in the vehicle or is located on a device which you have connected to the vehicle. If this data is stored in the vehicle, you can delete it at any time. This data can only be transmitted to third parties upon your request with particular regard to the scope of use of online services according to your selected settings.

You can store or change convenience settings/individualization in the vehicle at any time.

Depending on the equipment, this includes, for example:

- seat and steering wheel position settings
- suspension and climate control settings
- individualization such as interior lighting

If your vehicle is accordingly equipped, you can connect your smartphone or another mobile end

device to the vehicle. You can control them via the control elements integrated in your vehicle. Images and audio from the smartphone can be output via the multimedia system. Certain information is simultaneously transmitted to your smartphone.

Depending on the respective integration type, this includes, for example:

- general vehicle information
- position data

This enables the use of selected smartphone Apps, e.g. navigation or music playback. There is no further interaction between the smartphone and the vehicle; in particular, vehicle data is not directly accessible. The type of further data processing is determined by the provider of the App used. The respective App and your smartphone's operating system determine whether changes can be made to the settings and which settings can be changed.

## **Service providers**

---

### **Wireless network connection**

If your vehicle has a wireless network connection, it enables data to be exchanged between your vehicle and additional systems. The wireless network connection is enabled via the vehicle's transmission and reception unit or via connected mobile end devices (e.g. smartphones). Online functions can be used via the wireless network connection. This includes online services and applications/Apps provided by the manufacturer or other providers.

### **Manufacturer's services**

The manufacturer describes the respective functions and corresponding legal data protection information when suitable for the manufacturer's online services. Personal data may be used for the provision of online services. Data is exchanged via a secure connection, e.g. to the manufacturer's designated IT systems. Personal data is collected, processed and used via the provision of services exclusively on the basis of legal permissions or with prior consent.

The services and functions (sometimes subject to a fee) can usually be activated or deactivated. In some cases, this also applies to the entire vehicle's data connection. This excludes, in particular, legally prescribed functions and services.

### **Third party services**

If it is possible to use online services from other providers, these services are subject to the data protection and terms of use of the responsible provider. The manufacturer has no influence on the content exchanged.

Please enquire, therefore, about the type, scope and purpose of the collection and use of personal data as part of third party services from their respective provider.

## **COMAND/mbrace**

---

If the vehicle is equipped with COMAND or mbrace, additional data about the vehicle's operation, the use of the vehicle in certain situations, and the location of the vehicle may be compiled through COMAND or the mbrace system.

For additional information please refer to the chapter Multimedia system and/or the mbrace Terms and Conditions.

### Event Data Recorders

This vehicle is equipped with an event data recorder (EDR). The main purpose of an EDR is to record, in certain crash or near crash-like situations, such as an air bag deployment or hitting a road obstacle, data that will assist in understanding how a vehicle's systems performed. The EDR is designed to record data related to vehicle dynamics and safety systems for a short period of time, typically 30 seconds or less.

The EDR in this vehicle is designed to record such data as:

- How various systems in your vehicle were operating
- Whether or not the driver and front passenger seat belts were buckled/fastened
- How far (if at all) the driver was depressing the accelerator and/or brake pedal and
- How fast the vehicle was traveling.

This data can help provide a better understanding of the circumstances in which accidents and injuries occur. NOTE: EDR data is recorded by your vehicle only if a non-trivial crash situation occurs; no data is recorded by the EDR under normal driving conditions and no personal data (e.g. name, gender, age and crash location) is recorded. However, other parties, such as law enforcement, could combine the EDR data with the type of personally identifying data routinely acquired during a crash investigation.

Access to the vehicle and/or the EDR is needed to read data that is recorded by an EDR, and special equipment is required. In addition to the vehicle manufacturer, other parties that have the special equipment, such as law enforcement, can read the information by accessing the vehicle or the EDR.

EDR data may be used in civil and criminal matters as a tool in accident reconstruction, accident claims and vehicle safety. Since the Crash Data Retrieval (CDR) tool that is used to extract data from the EDR is commercially available, Mercedes-Benz USA, LLC ("MBUSA") expressly disclaims any and all liability arising from the

extraction of this information by unauthorized Mercedes-Benz personnel.

MBUSA will not share EDR data with others without the consent of the vehicle owner or, if the vehicle is leased, without the consent of the lessee. Exceptions to this representation include responses to subpoenas by law enforcement; by federal, state or local government; in connection with or arising out of litigation involving MBUSA or its subsidiaries and affiliates; or, as required by law.

Warning: the EDR is a component of the Restraint System Module. Tampering with, altering, modifying or removing the EDR component may result in a malfunction of the Restraint System Module and other systems.

State laws or regulations regarding EDRs that conflict with federal regulation are pre-empted. This means that in the event of such conflict, the federal regulation governs. As of February 2013, 13 states have enacted laws relating to EDRs.

## Copyright

### Free and open source software

---

Information on free and open source software licenses for your vehicle's software can be found on the data storage medium in your vehicle document wallet and on the Internet together with updates:

<http://www.mercedes-benz.com/opensource>

### Registered trademarks

---

- Bluetooth® is a registered trademark of Bluetooth SIG Inc.
- DTS™ is a registered trademark of DTS, Inc.
- Dolby® and MLP™ are registered trademarks of DOLBY Laboratories.
- BabySmart™, ESP® and PRE-SAFE® are registered trademarks of Daimler AG.
- HomeLink® is a registered trademark of Johnson Controls.
- iPod® and iTunes® are registered trademarks of Apple Inc.
- Burmester® is a registered trademark of Burmester Audiosysteme GmbH.
- Microsoft® and Windows Media® are registered trademarks of Microsoft Corporation.
- SIRIUS® is a registered trademark of Sirius XM Radio Inc.
- HD Radio™ is a registered trademark of iBiquity Digital Corporation.
- Gracenote® is a registered trademark of Gracenote, Inc.
- ZAGATSurvey® and related brands are registered trademarks of ZagatSurvey, LLC.



## Restraint system

### Protection by the restraint system

The restraint system includes the following:

- Seat belt system
- Air bags
- Child restraint system
- Child seat securing system

The restraint system can reduce the risk of vehicle occupants coming into contact with parts of the vehicle interior in the event of an accident. In the event of an accident, the restraint system can also reduce the forces to which the vehicle occupants are subjected.

A seat belt can only provide the best level of protection if it is worn correctly. Depending on the detected accident situation, Emergency Tensioning Devices and/or air bags supplement the protection offered by a correctly worn seat belt. Emergency Tensioning Devices and/or air bags are not deployed in every accident.

In order for the restraint system to provide the intended level of protection, each vehicle occupant must observe the following information:

- Fasten seat belts correctly.
- Sit in an almost upright seat position with their back against the seat backrest.
- Sit with their feet resting on the floor, if possible.
- Always secure persons under 5 ft (1.50 m) tall in an additional restraint system suitable for Mercedes-Benz vehicles.

However, no system available today can completely eliminate injuries and fatalities in every accident situation. In particular, the seat belt and air bag generally do not protect against objects penetrating the vehicle from the outside. It is also not possible to completely rule out the risk of injury caused by the air bag deploying.

### Reduced restraint system protection

**⚠ WARNING** Risk of injury or death from modifications to the restraint system

The restraint system can no longer function correctly after alterations have been made.

The restraint system may then not protect the vehicle occupants as intended by failing in an accident or triggering unexpectedly, for example

- ▶ Never alter the parts of the restraint system.
- ▶ Never tamper with the wiring or any electronic component parts or their software.



- If it is necessary to modify the vehicle to accommodate a person with disabilities, contact an authorized Mercedes-Benz Center for details.
- USA only: for details, contact our Customer Assistance Center on 1-800-FOR-MERCEDES (1-800-367-6372).

## Restraint system functionality

When the ignition is switched on, a system self-test is performed, during which the  restraint system warning lamp lights up. It goes out no later than a few seconds after the vehicle is started. The components of the restraint system are then functional.

## Malfunctioning restraint system

A malfunction has occurred in the restraint system if:

- The  restraint system warning lamp does not light up when the ignition is switched on.
- The  restraint system warning lamp lights up continuously or repeatedly during a journey.

**⚠ WARNING** Risk of injury or fatal injury due to a malfunction in the restraint system

If the restraint system is malfunctioning, restraint system components may be triggered unintentionally or might not be triggered at all in the event of an accident. This may affect the Emergency Tensioning Device or airbag, for example.

- ▶ Have the restraint system checked and repaired immediately at a qualified specialist workshop.

## Function of the restraint system in an accident

How the restraint system works is determined by the severity of the impact detected and the type of accident anticipated:

- Frontal impact
- Rear impact
- Side impact
- Rollover

The activation thresholds for the components of the restraint system are determined based on the evaluation of the sensor values measured at various points in the vehicle. This process is preemptive in nature. The triggering/deployment of the components of the restraint system should take place in good time at the start of the collision.

Factors which can only be seen and measured after a collision has occurred cannot play a decisive role in air bag deployment, nor do they provide an indication of air bag deployment.

The vehicle may be deformed significantly without an air bag being deployed. This is the case if only parts which are relatively easily deformed are affected and the rate of vehicle deceleration is not high. Conversely, an air bag may be deployed even though the vehicle suffers only minor deformation. If very rigid vehicle parts such as longitudinal members are hit, for example, the vehicle deceleration may be high enough for this to happen.

**The components of the restraint system can be activated or deployed independently of each other:**

Component	Detected deployment situation
Emergency Tensioning Devices	Frontal impact, rear impact, side impact, rollover
Driver's air bag, front passenger air bag	Frontal impact
Knee air bag	Frontal impact
Side air bag	Side impact
Window air bag	Side impact, rollover, frontal impact
Belt air bag	Frontal impact
Cushionbag	Frontal impact

The front-passenger air bag can be deployed in an accident only if the PASSENGER AIR BAG OFF indicator lamp is off. If the front passenger seat

is occupied, make sure, both before and during the journey, that the status of the front passenger air bag is correct (→ page 43).

**⚠ WARNING** Risk of burns from hot air bag components

The air bag parts are hot after an air bag has been deployed.

- ▶ Do not touch the air bag parts.
- ▶ Have a deployed air bag replaced at a qualified specialist workshop as soon as possible.

Mercedes-Benz recommends that you have the vehicle towed to a qualified specialist workshop after an accident. Take this into account, particularly if an Emergency Tensioning Device is triggered or an air bag is deployed.

If the Emergency Tensioning Devices are triggered or an air bag is deployed, you will hear a bang, and powder may also be released:

- The bang will not generally affect your hearing.

- In general, the powder released is not hazardous to health but may cause short-term breathing difficulties to persons suffering from asthma or other pulmonary conditions. Provided it is safe to do so, leave the vehicle immediately or open the window in order to prevent breathing difficulties.

Air bags and pyrotechnic Emergency Tensioning Devices contain perchlorate material, which may require special handling or environmental protection measures. National guidelines must be observed during disposal. In California, see <http://www.dtsc.ca.gov/HazardousWaste/Perchlorate/index.cfm>.

## Seat belts

### Protection provided by the seat belt

Always fasten your seat belt correctly before starting a journey. A seat belt can only provide the best level of protection if it is worn correctly.

**⚠ WARNING** Risk of injury or death due to incorrectly fastened seat belt

If the seat belt is not worn correctly, it cannot perform its intended protective function.

In addition, an incorrectly fastened seat belt can also cause injuries, for example, in the event of an accident or when braking or changing direction suddenly.

- ▶ Always ensure that all vehicle occupants have their seat belts fastened correctly and are sitting properly.

In order for the correctly worn seat belt to provide the intended level of protection, each vehicle occupant must observe the following information:

- The seat belt must not be twisted and must fit tightly and snugly across the body.
- The seat belt must be routed across the center of the shoulder and as low down across the hips as possible.

- The shoulder section of the seat belt should not touch your neck nor be routed under your arm or behind your back.
- Avoid wearing bulky clothing, e.g. a winter coat.
- Push the lap belt down as far as possible across your hips and pull tight with the shoulder section of the belt. Never route the lap belt across your abdomen.
- Never route the seat belt across sharp, pointed, abrasive or fragile objects.
- Only one person should use each seat belt at any one time. Never allow babies and children to travel sitting on the lap of another vehicle occupant.
- Never secure objects with a seat belt if the seat belt is also being used by one of the vehicle's occupants. Always observe the instructions for loading the vehicle when securing objects, luggage or loads (→ page 118).

Also ensure that no objects are placed between a person and the seat. e.g. a cushion.

The seat belts on the following seats are equipped with a special seatbelt retractor:

- Front passenger seat
- Rear seats

Activate or deactivate the special seatbelt retractor of the seat belt (→ page 50).

If children are traveling in the vehicle, be sure to observe the instructions and safety notes on "Children in the vehicle" (→ page 47).

### Reduced seat belt protection

**⚠ WARNING** Risk of injury or death due to incorrect seat position

The seat belt does not offer the intended level of protection if you have not moved the seat backrest to an almost vertical position.

When braking or in the event of an accident, you could slide underneath the seat belt and sustain abdominal or neck injuries, for example.

- ▶ Adjust the seat properly before beginning your journey.
- ▶ Always ensure that the seat backrest is in an almost vertical position and that the shoulder section of your seat belt is routed across the center of your shoulder.

**⚠ WARNING** Risk of injury or death when additional restraint systems are not used for persons with a smaller build

Persons under 5 ft (1.50 m ) tall cannot wear the seat belt correctly without a suitable additional restraint system.

If the seat belt is not worn correctly, it cannot perform its intended protective function. In addition, an incorrectly fastened seat belt can also cause injuries, for example, in the event of an accident or when braking or changing direction suddenly.

- ▶ Always secure persons under 5 ft (1.50 m) tall in a suitable restraint system.

**⚠ WARNING** Risk of injury or death due to blocked seat belt buckle or seat belt anchorage

Objects next to the front seat that block the seat belt buckle or the moving seat belt anchorage on the front seat impair the function of the Emergency Tensioning Devices.

The Emergency Tensioning Devices can, then, not function as intended and the seat belt can no longer provide the intended protection.

- ▶ Before starting the journey, make sure that there are no objects around the seat belt buckle or between the front seat and door.

**⚠ WARNING** Risk of injury or death due to damaged or modified seat belts

Seat belts cannot provide protection in the following situations:

- If the seat belts are damaged, modified, extremely dirty, bleached or dyed

- If the seat belt buckle is damaged or extremely dirty
- If the Emergency Tensioning Devices, seat belt anchorages or seat belt retractors have been modified

Seat belts may be damaged in an accident, although the damage may not be visible, e.g. due to splinters of glass.

Modified or damaged seat belts may tear or fail, e.g. in an accident.

Modified Emergency Tensioning Devices can accidentally trigger or fail to function as intended.

- ▶ Never modify the seat belts, Emergency Tensioning Devices, seat belt anchorages or seat belt retractors.
- ▶ Make sure that the seat belts are undamaged, not worn and clean.
- ▶ Always have the seat belts checked immediately after an accident at a qualified specialist workshop.

Only use seat belts that have been approved for your vehicle by Mercedes-Benz.

**⚠ WARNING** Risk of injury or death from deployed pyrotechnic Emergency Tensioning Devices

Pyrotechnic Emergency Tensioning Devices that have been deployed are no longer operational and are unable to perform their intended protective function.

- ▶ Therefore, have deployed pyrotechnic Emergency Tensioning Devices immediately replaced at a qualified specialist workshop.

Mercedes-Benz recommends that you have the vehicle towed to a qualified specialist workshop after an accident.

**! NOTE** Damage caused by trapping the seat belt

If an unused seat belt is not fully retracted, it may become trapped in the door or in the seat mechanism.

- ▶ Always ensure that an unused seat belt is fully retracted.

### Information on the belt air bag in the rear seat belt

The BELTBAG identification indicates that a rear seat belt is equipped with a belt air bag.

When activated, the belt air bag increases the protected area of the vehicle occupant's ribcage.

**⚠ WARNING** Risk of injury or death through the use of a non-approved child restraint system

In an accident, the belt air bag may damage a non-approved or non-authorized child restraint system.

As a result, the child restraint system may not be able to provide the intended level of protection.

- ▶ Therefore, always use LATCH or LATCH-type (ISOFIX) to fasten a child seat

equipped with an integrated restraint system.

- ▶ For vehicles equipped with the optional rear seat-belt air bags ("beltbag"), only use a Mercedes-Benz approved booster seat with integrated backrest.
- ▶ Never use an air bag equipped seat belt to fasten a front or rear-facing child seat or a non-approved booster seat.
- ▶ Please contact an authorized Mercedes-Benz Center for information on approved child restraint systems.

### Fastening and adjusting seat belts

If the seat belt is pulled quickly or sharply, the seat belt retractor locks. The belt strap cannot be pulled out any further.



- ▶ Always engage seat belt tongue ② of the seat belt into seat belt buckle ① of the corresponding seat.
- ▶ Press and hold the seat belt outlet release and slide the seat belt outlet into the desired position.
- ▶ Let go of the belt outlet release and ensure that the seat belt outlet locks in position.

**Vehicles with PRE-SAFE®:** If the front seat belt is not pulled tight across your body, the seat belt adjustment may automatically apply a certain tightening force. Do not hold the seat belt tightly while it is adjusting. You can activate and deactivate the seat belt adjustment function using the multimedia system.

**Vehicles with automatic front passenger air bag shutoff:**

! **NOTE** Deployment of the Emergency Tensioning Device and side air bag when the front passenger seat is unoccupied

If the seat belt tongue is engaged in the seat belt buckle of the unoccupied front passenger seat, the Emergency Tensioning Device and the side air bag may also deploy in the event of an accident along with other systems.

- ▶ Only one person should use each seat belt at any one time.

**Vehicles without automatic front passenger air bag shutoff:**

! **NOTE** Deployment of the Emergency Tensioning Device when the front passenger seat is unoccupied

If the seat belt tongue is engaged in the seat belt buckle of the unoccupied front passenger seat, the Emergency Tensioning Device may also deploy in the event of an accident along with other systems.

- ▶ Only one person should use each seat belt at any one time.

**Information on the rear seat belt buckle extender**

The seat belt buckle extender for the outer rear seats makes it easier to fasten the seat belt. Always ensure that the seat belt buckle can be extended and retracted freely.

After the seat belt is fastened, the seat belt buckle returns to its normal position. The seat belt then lies tightly across the lap and thorax areas.

## Releasing seat belts

- ▶ Press the release button in the seat belt buckle and guide the seat belt back with the seat belt tongue.

## Activating or deactivating seat belt adjustment via the multimedia system

Multimedia system:

↳ Vehicle ▶  Vehicle Settings ▶▶ Belt Adjustment

- ▶ Activate  or deactivate  the function.

## Seat belt warning function for the driver and front passenger

The  seat belt warning lamp in the Instrument Display is a reminder that all vehicle occupants must wear their seat belts correctly.

The  seat belt warning lamp lights up for six seconds after every engine start.

In addition, an acoustic warning tone may sound.

When the driver's and front passenger's doors are closed and the driver and front passenger have fastened their seat belts, the seat belt warning goes out.

During a journey, the seat belt warning lights up if:

- The vehicle speed exceeds 15 mph (25 km/h) and the driver's or front passenger seat belt is not fastened.
- The driver or front passenger unfastens their seat belt while the vehicle is in motion.

## Airbags

### Overview of air bags



- ① Knee air bag
- ② Driver's air bag
- ③ Front-passenger front air bag
- ④ Window air bag
- ⑤ Side air bag

The installation location of an air bag is identified by the AIRBAG symbol.



**When activated, an air bag can provide additional protection for the respective vehicle occupant.**

AIR BAG	Potential protection for ...
Knee air bag	Thigh, knee and lower leg
Driver's air bag, front passenger air bag	Head and ribcage
Window air bag	Head
Side air bag	Ribcage, also pelvis for front seat occupants

The front-passenger air bag can be deployed in an accident only if the PASSENGER AIR BAG OFF indicator lamp is off. If the front passenger seat is occupied, make sure, both before and during the journey, that the status of the front passenger air bag is correct (→ page 43).

**!** **NOTE** Important points to remember if the front passenger seat is unoccupied

In an accident, the components of the restraint system may deploy unnecessarily on the front passenger side if:

- There are heavy objects on the front passenger seat.
- The seat belt tongue is engaged in the seat belt buckle of the front passenger seat and the front passenger seat is unoccupied.

- ▶ Stow objects in a suitable place.
- ▶ Only one person should use each seat belt at any one time.

#### **Cushionbag in the reclining rear seat**

If the seat backrest inclination is significant, the cushionbag provides additional occupant protection in the event of a frontal impact. When activated, the cushionbag deploys under the seat cushion. This helps prevent the vehicle occupant from slipping off the seat cushion.

If you install a child restraint system on the reclining rear seat, always observe the additional notes (→ page 47).

#### **Protection potential of air bags**

Depending on the accident situation, an air bag may supplement the protection offered by a correctly fastened seat belt.

**!** **WARNING** Risk of injury or death due to incorrect seat position

If you deviate from the correct seat position, the air bag cannot perform its intended protective function and deployment may even cause further injuries.

To avoid hazardous situations, always make sure that all vehicle occupants:

- Have their seat belt fastened correctly, including pregnant women.
- Are seated properly and that distance to the air bags is as large as possible.
- Observe the following information.

- ▶ Always make sure that there are no objects between the air bag and the vehicle occupant.

To avoid the risks resulting from the deployment of an air bag, each vehicle occupant must observe the following information:

- Before starting your journey, adjust your seat correctly; the driver's seat and front passenger seat should be moved as far back as possible.

When doing so, always observe the information on the correct driver's seat position (→ page 88).

- Only hold the steering wheel by the steering wheel rim. This allows the air bag to be fully deployed.
- Always lean against the seat backrest when the vehicle is in motion. Do not lean forwards or against the door or side window. You may otherwise be in the deployment area of the air bags.
- Always keep your feet on the floor. Do not put your feet on the dashboard, for example.

Your feet may otherwise be in the deployment area of the air bag.

- If children are traveling in the vehicle, observe the additional notes (→ page 47).
- Always stow and secure objects correctly.

Objects in the vehicle interior may prevent an air bag from functioning correctly. Each vehicle occupant must always make sure of the following:

- There are no people, animals or objects between the vehicle occupants and an air bag.
- There are no objects between the seat, door and door pillar (B-pillar).
- There are no hard objects, e.g. coat hangers, hanging on the grab handles or coat hooks.
- There are no accessory parts, such as cup holders, attached to the vehicle within the deployment area of an air bag, e.g. on doors, side windows or side paneling.
- There are no heavy, sharp-edged or fragile objects in the pockets of your clothing. Store such objects in a suitable place.

## Reduced air bag protection

- ⚠ WARNING** Risk of injury from modifications to the airbag cover

If you modify an airbag cover or affix objects such as stickers to it, the airbag can no longer function correctly.

- ▶ Never modify an airbag cover and do not affix objects to it.

The installation location of an air bag is identified by the AIRBAG symbol (→ page 38).

- ⚠ WARNING** Risk of injury or death due to the use of unsuitable seat covers

Unsuitable seat covers can obstruct or prevent the deployment of air bags integrated into the seats.

Consequently, the air bags cannot protect vehicle occupants as they are designed to do. In addition, operation of the automatic front passenger air bag shutoff may be restricted.

- ▶ You should only use seat covers that have been approved for the corresponding seats by Mercedes-Benz.

**⚠ WARNING** Risk of injury due to malfunctions of the sensors in the door paneling

Sensors to control the airbags are located in the doors. Modifications or work not performed correctly to the doors or door paneling, as well as damaged doors, can lead to the function of the sensors being impaired. The airbags might therefore not function properly any more.

Consequently, the airbags cannot protect vehicle occupants as they are designed to do.

- ▶ Never modify the doors or parts of the doors.
- ▶ Always have work on the doors or door paneling carried out at a qualified specialist workshop.

**⚠ WARNING** Risk of injury due to deployed airbag

A deployed airbag no longer has a protective function and cannot protect as intended in the event of an accident.

- ▶ Have the vehicle towed to a qualified specialist workshop in order to have the deployed airbag replaced.

Have deployed air bags replaced immediately.

### Status of the front passenger airbag

#### **Function of the automatic front passenger air bag shutoff**

The automatic front passenger air bag shutoff is able to detect whether the front passenger seat is occupied by a person or a child restraint system. The front passenger air bag is enabled or deactivated accordingly.

When installing a child restraint system on the front passenger seat, always make sure of the following:

- Ensure that the child restraint system is positioned correctly (→ page 47).
- Always observe the child restraint system manufacturer's installation instructions.
- Never place objects under or behind the child restraint system, e.g. cushions.
- Fully retract the seat cushion length adjustment.
- The entire base of the child restraint system must always rest on the seat cushion of the front-passenger seat.
- The backrest of the forward-facing child restraint system must, as far as possible, be resting on the seat backrest of the front passenger seat.
- The child restraint system must not touch the roof or be put under strain by the head restraints. Adjust the seat backrest inclination and the head restraint setting accordingly.

**⚠ WARNING** Risk of injury or death due to objects between the sitting surface and the child restraint system

Objects between the sitting surface and the child restraint system could affect the function of the automatic front passenger airbag shutoff.

This could result in the front passenger airbag not functioning as intended during an accident.

- ▶ Do not place any objects between the sitting surface and the child restraint system.
- ▶ The entire base of the child restraint system must always rest on the sitting surface of the front passenger seat.
- ▶ The backrest of the forward-facing child restraint system must lie as flat as possible against the backrest of the front passenger seat.
- ▶ Always comply with the child restraint system manufacturer's installation instructions.

A person on the front passenger seat must observe the following information:

- Fasten seat belts correctly.
- Sit in an almost upright seat position with their back against the seat backrest.
- Sit with their feet resting on the floor, if possible.

Otherwise, the front passenger air bag may be deactivated by mistake, for example in the following situations:

- The front passenger transfers their weight by supporting themselves on a vehicle armrest.
- The front passenger sits in such a way that their weight is raised from the sitting surface.

**⚠ WARNING** Risk of injury or death due to deactivated front passenger airbag

If the PASSENGER AIR BAG OFF indicator lamp is lit, the front passenger airbag is disabled. It will not be deployed in the event of an accident and cannot perform its intended protective function.

A person in the front passenger seat could then, for example, come into contact with the vehicle interior, especially if the person is sitting too close to the cockpit.

If the front passenger seat is occupied, always ensure that:

- The classification of the person in the front passenger seat is correct and the front passenger airbag is enabled or disabled in accordance with the person in the front passenger seat.
  - The front passenger seat has been moved as far back as possible.
  - The person is seated correctly.
- ▶ Ensure, both before and during the journey, that the status of the front passenger airbag is correct.

## PASSENGER AIR BAG indicator lamp



### System self-test

When the ignition is switched on, a system self-test is performed during which the two PASSENGER AIR BAG ON and OFF indicator lamps light up simultaneously.

The status of the front passenger air bag is displayed after the system self-test:

- PASSENGER AIR BAG ON lights up for 60 seconds, subsequently both PASSENGER AIR BAG ON and OFF indicator lamps are off: the front passenger air bag is able to deploy in the event of an accident.
- PASSENGER AIR BAG OFF lights up continuously: the front passenger air bag is deactivated. It will then not be deployed in the event of an accident.

If the PASSENGER AIR BAG ON indicator lamp is off, only the PASSENGER AIR BAG OFF indicator lamp shows the status of the front passenger air bag. The PASSENGER AIR BAG OFF indicator lamp may be lit continuously or be off.

If the PASSENGER AIR BAG OFF indicator lamp and the  restraint system warning lamp light up simultaneously, the front passenger seat may not be used. Also in this case, do not install a child restraint system on the front passenger seat. Have the automatic front passenger air bag shutoff checked and repaired immediately at a qualified specialist workshop.

### Status display

If the front passenger seat is occupied, ensure, both before and during the journey, that the status of the front passenger air bag is correct for the prevailing situation.

**After installing a rearward-facing child restraint system on the front passenger seat:** PASSENGER AIR BAG OFF must be lit continuously.

**⚠ WARNING** Risk of injury or death from using a rearward-facing child restraint system when the front passenger air bag is enabled

If you secure a child in a rearward-facing child restraint system on the front passenger seat and the PASSENGER AIR BAG OFF indicator lamp is off, the front passenger air bag can deploy in the event of an accident.

The child could be struck by the air bag.

Always ensure that the front passenger air bag is disabled. The PASSENGER AIR BAG OFF indicator lamp must be lit.

NEVER use a rearward facing child restraint on a seat protected by an ACTIVE FRONT AIR BAG in front of it; DEATH or SERIOUS INJURY to the child can occur.

When installing a child restraint system on the front passenger seat, observe the vehicle-specific information in this Operator's Manual.

Depending on the child restraint system and the stature of the child, the PASSENGER AIR BAG OFF indicator lamp may be off. In this case, do not install the rearward-facing child restraint system on the front passenger seat.

Instead, install the rearward-facing child restraint system on a suitable rear seat.

**After installing a forward-facing child restraint system on the front passenger seat:**

depending on the child restraint system and the stature of the child, PASSENGER AIR BAG OFF may be lit continuously or be off. Always observe the following information.

**⚠ WARNING** Risk of injury or death due to incorrect positioning of the forward-facing child restraint system

If you secure a child in a forward-facing child restraint system on the front passenger seat and you position the front passenger seat too close to the cockpit, in the event of an accident, the child could:

- Come into contact with the vehicle interior if the PASSENGER AIR BAG OFF indicator lamp is lit, for example.
- Be struck by the air bag if the PASSENGER AIR BAG OFF indicator lamp is off.

▶ Always move the front passenger seat as far back as possible and fully retract the seat cushion length adjustment. Always make sure that the shoulder belt strap is correctly routed from the seat belt outlet on the vehicle to the shoulder belt guide on the child restraint system. The shoulder belt strap must be routed forwards and downwards from the vehicle belt outlet. If necessary,

adjust the seat belt outlet and the front passenger seat accordingly.

▶ Always observe the child restraint system manufacturer's installation instructions.

When installing a child restraint system on the front passenger seat, observe the vehicle-specific information in this Operator's Manual.

**If a person is sitting in the front passenger seat:** PASSENGER AIR BAG OFF may be lit continuously or be off, depending on the person's stature.

A person on the front passenger seat must always observe the following information:

- If the front passenger seat is occupied with an adult or a person with a stature corresponding to that of an adult, the PASSENGER AIR BAG OFF indicator lamp must be off. This indicates that the front passenger air bag is enabled.

If the PASSENGER AIR BAG OFF indicator lamp is lit continuously, an adult or person with a build corresponding to that of an adult

should not use the front passenger seat. Instead, they should use a rear seat.

- If the front passenger seat is occupied with a person of smaller stature (e.g. a teenager or small adult), the PASSENGER AIR BAG OFF indicator lamp either lights up continuously or remains out, depending on the result of the classification:
  - PASSENGER AIRBAG OFF is off: move the front passenger seat as far back as possible or a person of smaller stature should use a rear seat.
  - If the PASSENGER AIRBAG OFF indicator lamp is lit continuously: a person of smaller stature should not use the front passenger seat.

**⚠ WARNING** Risk of injury or death when the PASSENGER AIR BAG OFF indicator lamp is lit

If the PASSENGER AIR BAG OFF indicator lamp remains lit after the system self-test, the front passenger air bag is deactivated. It will not be deployed in the event of an acci-

dent. In this case, the front passenger air bag cannot perform its intended protective function, e.g. when a person is seated in the front passenger seat.

That person could, for example, come into contact with the vehicle interior, especially if the person is sitting too close to the cockpit.

If the front passenger seat is occupied, always ensure that:

- The classification of the person in the front passenger seat is correct and the front passenger air bag is enabled or deactivated in accordance with the person in the front passenger seat.
- The person is seated properly with a correctly fastened seat belt.
- The front passenger seat has been moved as far back as possible.

#### Further related subjects:

- Child restraint system on the front passenger seat (→ page 53).

## PRE-SAFE® system

### Information on PRE-SAFE® (anticipatory occupant protection)

PRE-SAFE® is able to detect certain critical driving situations and implement pre-emptive measures to protect the vehicle occupants.

PRE-SAFE® can implement the following measures independently of each other:

- Tightening the seat belts on the driver's seat and front passenger seat.
- Closing the side windows.
- **Vehicles with sliding sunroof:** Closing the sliding sunroof.
- **Vehicles with memory function:** Moving the front passenger seat to a more favorable seat position.
- **Vehicles with memory function in the rear passenger compartment:** moving the outer rear seats to a more favorable seat position.

- **Vehicles with multicontour seat:** Increasing the air pressure in the seat side bolsters of the seat backrest.
- **Vehicles with rear seat belt buckle extenders:** tightening seat belts on the outer rear seats.
- **PRE-SAFE® Sound:** Provided that the multimedia system is switched on, generates a brief noise signal to stimulate the innate protective mechanism of a person's hearing.

**!** **NOTE** Damage caused by objects in the footwell or behind the seat

The automatic adjustment of the seat position may result in damage to the seat and/or the object.

▶ Stow objects in a suitable place.

### Reversing the PRE-SAFE® system measures

If an accident did not occur, the pre-emptive measures that were taken are reversed.

You will need to perform certain settings yourself.

- ▶ If the seat belt pre-tensioning is not reduced, move the seat backrest back slightly. The locking mechanism releases.

### Information on PRE-SAFE® PLUS (anticipatory occupant protection plus)

PRE-SAFE® PLUS can detect certain impacts, particularly an imminent rear impact, and take pre-emptive measures to protect the vehicle occupants. These measures cannot necessarily prevent an imminent impact.

PRE-SAFE® PLUS can implement the following measures independently of each other:

- Tightening the seat belts on the driver's seat and front passenger seat.
- **Vehicles with electric rear seats:** tightening seat belts on the outer rear seats.
- Increasing brake pressure when the vehicle is stationary. This brake application is canceled automatically when the vehicle pulls away.

If an accident did not occur, the pre-emptive measures that were taken are reversed.

### **System limitations**

The system will not initiate any action in the following situations:

- when backing up

The system will not initiate any braking application in the following situations:

- whilst driving  
or
- when entering or exiting a parking space while using Active Parking Assist



## Children in the vehicle

### Notes on the safe transportation of children

**⚠ WARNING** Risk of accident and injury due to children left unattended in the vehicle

If you leave children unaccompanied in the vehicle, they may be able to set the vehicle in motion, for example by:

- Releasing the parking brake.
- Shifting the transmission out of park position **P**.
- Starting the engine.

In addition, they may operate vehicle equipment.

- ▶ Never leave children and animals unattended in the vehicle.
- ▶ When leaving the vehicle, always take the SmartKey with you and lock the vehicle.

**⚠ WARNING** Risk of fatal injury due to exposure to extreme heat or cold in the vehicle

If people – particularly children – are exposed to extreme heat or cold over an extended period of time, there is a risk of injury or even fatal injury.

- ▶ Never leave anyone – particularly children – unattended in the vehicle.

**⚠ WARNING** Risk of burns when the child seat is exposed to direct sunlight

If the child restraint system is exposed to direct sunlight or heat, parts could heat up.

Children could suffer burns from these parts, particularly on metallic parts of the child restraint system.

- ▶ Always make sure that the child restraint system is not exposed to direct sunlight.
- ▶ Protect it with a blanket, for example.

- ▶ If the child restraint system has been exposed to direct sunlight, allow it to cool before securing a child into it.
- ▶ Never leave children unattended in the vehicle.

The use of seat belts and child restraint systems is required by law in:

- All 50 states
- The U.S. territories
- The District of Columbia
- All Canadian provinces

All child restraint systems must meet the following standards:

- U.S. Federal Motor Vehicle Safety Standards 213 and 225
- Canadian Motor Vehicle Safety Standards 213 and 210.2

You can obtain further information about the correct child restraint system from any authorized Mercedes-Benz Center.

To improve protection for children younger than 12 years old or under 5 ft (1.50 m) in height, Mercedes-Benz recommends you observe the following information:

- Only secure children using a child restraint system which is suitable and recommended for Mercedes-Benz vehicles, as well as appropriate to the height, age and weight of the child. Be sure to observe the instructions for correct use of the child restraint system.
- Always install a child restraint system on a rear seat if possible.
- Only use the following securing systems for child restraint systems:
  - the seat belt system
  - the LATCH-type (ISOFIX) mounting brackets
  - the Top Tether anchorages
- The manufacturer's installation instructions for the child restraint system.
- The warning labels in the vehicle interior and on the child restraint system.

**⚠ WARNING** Risk of injury or death caused by incorrect installation of the child restraint system

If the child restraint system is incorrectly installed on a suitable seating position, it cannot perform its intended protective function.

The child cannot be restrained in the event of an accident, heavy braking or a sudden change of direction.

- ▶ Always comply with the manufacturer's installation instructions for the child restraint system and its correct use.
- ▶ Make sure that the entire base of the child restraint system always rests on the sitting surface of the seat.
- ▶ Never place objects under or behind the child restraint system, e.g. cushions.
- ▶ Always use child restraint systems with the original cover designed for them.
- ▶ Always replace damaged covers with genuine covers.

**⚠ WARNING** Risk of accident caused by incorrectly installed child restraint systems

If the child restraint system is not correctly installed or secured, it could release in the event of an accident, sudden braking or a sudden change in direction.

The child restraint system could be flung around and hit vehicle occupants. This poses an increased risk of injury or even fatal injury.

- ▶ Always install child restraint systems correctly, even when not in use.
- ▶ Always comply with the child restraint system manufacturer's installation instructions.

**⚠ WARNING** Risk of injury or death caused by the use of damaged child restraint systems

Child restraint systems or their retaining systems that have been subjected to a load in

an accident may then not be able to perform their intended protective function.

The child cannot be restrained in the event of an accident, heavy braking or a sudden change of direction.

- ▶ Always replace child restraint systems immediately that have been damaged or involved in an accident.
- ▶ Have the securing systems for the child restraint systems checked at a qualified specialist workshop before installing a child restraint system again.

A booster seat may be necessary to achieve proper seat belt positioning for children over 40 lbs (18 kg) in weight or until they reach a height where a three-point seat belt can be installed properly without a booster seat.

#### **Vehicles with seat belt buckle extenders:**

When securing a child in a child restraint system on a rear seat, observe the following notes:

- Make sure that the seat belt is fastened on the child restraint system according to the

manufacturer's installation instructions for the child restraint system.

- For child restraint systems with a belt clamp: engage the seat belt tongue into the seat belt buckle before you tighten the seat belt using the belt clamp.

**⚠ WARNING** Risk of injury due to the seat backrest being reclined too far backwards

If a child restraint system is installed and the seat backrest is reclined too far backwards, the cushionbag may deploy by mistake in the event of an accident.

- ▶ When using a child restraint system, always ensure that the seat is correctly adjusted and that the seat backrest is almost vertical.

**Vehicles with a reclining rear seat:** When installing a child restraint system, move the reclining rear seat backrest to an almost upright position. The reclining rear seat backrest must rest against the child restraint system. Observe the notes on the cushionbag (→ page 38).

**Vehicles with a reclining rear seat:** If you install a child restraint system on the reclining rear seat, be sure to observe the child restraint system manufacturer's installation instructions.

The following notes must be observed:

- When installing a child restraint system on the front passenger seat, the information on installing a child restraint system on the front passenger seat (→ page 53).
- Instructions and safety notes on the automatic front passenger air bag shutoff (→ page 41).
- Safety notes on the seat belt (→ page 33).
- Information on the correct use of the seat belt (→ page 38).

## Activating/deactivating the child seat safety feature of the seat belt

**⚠ WARNING** Risk of injury or death if a seat belt is unfastened while the vehicle is in motion

If the seat belt is released while the vehicle is in motion, the child restraint system is no longer correctly secured. The child seat safety feature is deactivated and the seat belt is drawn in a bit by the inertia reel.

It is therefore not possible to engage the seat belt again.

- ▶ Pull over and stop the vehicle safely as soon as possible, paying attention to road and traffic conditions.
- ▶ Activate the child seat safety feature again and correctly secure the child restraint system.

When enabled, the child seat safety feature ensures that the seat belts of the front passenger seat and rear seats do not slacken once the child restraint system is secured.

## Installing a child restraint system:

- ▶ Always comply with the manufacturer's installation instructions when installing and removing the child restraint system.
- ▶ Pull the seat belt smoothly from the seat belt outlet.
- ▶ Engage the seat belt tongue in the seat belt buckle.

## Activating the child seat safety feature:

- ▶ Pull the seat belt out fully and let the inertia reel retract it again. When the child seat safety feature is activated, you should hear a ratcheting sound.
- ▶ Push the child restraint system down until the seat belt sits tightly.

## Deactivating the child seat safety feature:

- ▶ Press the release button of the seat belt buckle.
- ▶ Hold the seat belt tongue and guide it back to the seat belt outlet.

## LATCH-type (ISOFIX) child seat attachment

### Notes on LATCH-type (ISOFIX) child seat securing systems

**⚠ WARNING** Risk of injury or fatal injury if the child secured weighs more than the permissible weight for the LATCH-type (ISOFIX) child restraint system

LATCH-type (ISOFIX) child restraint systems do not offer sufficient protection for children weighing more than 65 lbs (29 kg) together with the child restraint system, who are secured using the seat belt integrated in the child restraint system. For example, the child may not be restrained correctly in the event of an accident.

- ▶ If the child and the child restraint system together weigh more than 65 lbs (29 kg), only use LATCH-type (ISOFIX) child restraint systems with which the child is secured with the vehicle seat belt.
- ▶ Also secure the child restraint system with the Top Tether belt, if available.

When installing a child restraint system, be sure to observe the manufacturer's installation instructions and the instructions for correct use of the child restraint system.

ISOFIX is a standardized securing system for specially designed restraint systems. LATCH-type (ISOFIX) child restraint systems are approved in accordance with ECE R44.

Only child restraint systems that have been approved in accordance with ECE R44 may be attached to LATCH-type (ISOFIX) mounting brackets.



Symbol for installing a LATCH-type (ISOFIX) child restraint system

### Installing LATCH-type (ISOFIX) child seat securing systems

**⚠ WARNING** Risk of injury or fatal injury if the child secured weighs more than the permissible weight for the LATCH-type (ISOFIX) child restraint system

LATCH-type (ISOFIX) child restraint systems do not offer sufficient protection for children weighing more than 65 lbs (29 kg) together with the child restraint system, who are secured using the seat belt integrated in the child restraint system. For example, the child may not be restrained correctly in the event of an accident.

- ▶ If the child and the child restraint system together weigh more than 65 lbs (29 kg), only use LATCH-type (ISOFIX) child restraint systems with which the child is secured with the vehicle seat belt.
- ▶ Also secure the child restraint system with the Top Tether belt, if available.

When installing a child restraint system, be sure to observe the manufacturer's installation instructions and the instructions for correct use of the child restraint system.

Before every trip, make sure that the LATCH-type (ISOFIX) child restraint system is engaged correctly in both LATCH-type (ISOFIX) mounting brackets.

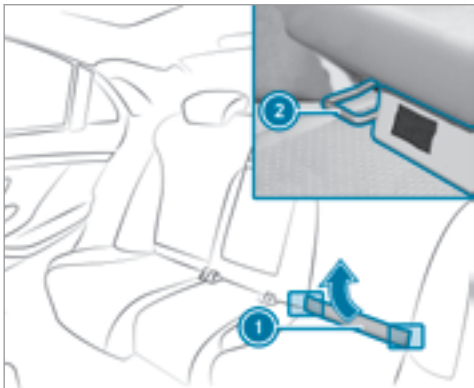

**!** **NOTE** Damage to the seat belt for the center seat

When installing a child restraint system, the seat belt for the center seat could be damaged.

▶ Make sure that the seat belt is not trapped.

- ▶ **Vehicles with a reclining rear seat:** Move the reclining rear seat backrest down slightly before the LATCH-type (ISOFIX) child restraint system is installed.
- ▶ Remove upholstered lining ①.
- ▶ **Vehicles without a reclining rear seat:** Fold upholstered lining ① upwards.
- ▶ Turn the support on the rear side of upholstered lining ① by 90°. Upholstered lining ① remains folded upwards.
- ▶ Attach the LATCH-type (ISOFIX) child restraint system to both LATCH-type (ISOFIX) mounting brackets ②.

- ▶ **Vehicles with a reclining rear seat:** Return the reclining rear seat backrest to an upright position. The reclining rear seat backrest must rest against the child restraint system.

### Securing Top Tether

**!** **WARNING** Risk of injury or death when adjusting the seat after installing a child restraint system

Vehicles with electrically adjustable rear seats:

If you adjust the seat after installing a child restraint system, the following may occur:

- the seat belt may either sit too loose or too tight
- the child restraint system can become loose, incorrectly positioned or damaged

As a result, the child restraint system may not be able to provide the intended level of protection.

- ▶ Never adjust the seat after installing the child restraint system.

The risk of injury can be reduced by Top Tether as Top Tether provides an additional connection between the child restraint system secured with LATCH-type (ISOFIX) and the vehicle.

The child restraint system must be equipped with a Top Tether belt.

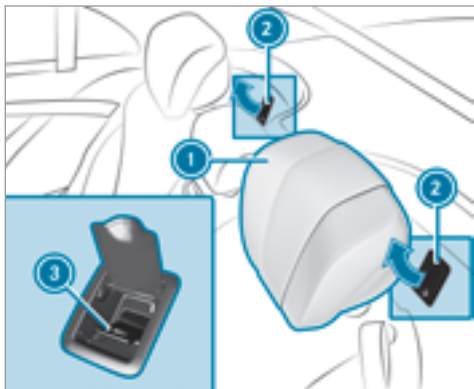

- ▶ If necessary, move head restraint ① upwards (→ page 103).
- ▶ Fold up cover ② of Top Tether anchorage ③.
- ▶ Install the LATCH-type (ISOFIX) child restraint system with Top Tether. Always comply with the child restraint system manufacturer's installation instructions when doing so.



- ▶ Route Top Tether belt ④ under head restraint ① between the two head restraint bars.

- ▶ Hook Top Tether hook ⑤ of Top Tether belt ④ without twisting into Top Tether anchorage ③.
- ▶ Tension Top Tether belt ④. Always comply with the child restraint system manufacturer's installation instructions when doing so.
- ▶ Fold down cover ② of Top Tether anchorage ③.
- ▶ If necessary, slide head restraint ① downwards (→ page 103). Make sure that you do not interfere with the correct routing of Top Tether belt ④.

### Child restraint systems on the front passenger seat

#### Notes on child restraint systems on the front passenger seat

Accident statistics show that children secured in the rear seats are safer than children secured in the front seats. For this reason, Mercedes-Benz strongly advises that you install a child restraint system on a rear seat.

If it is absolutely necessary to install a child restraint system on the front passenger seat, always observe the information on the automatic front passenger air bag shutoff (→ page 41).

By doing this, you can avoid risks caused by:

- A child restraint system that is not detected by the automatic front passenger air bag shutoff.
- An unintentionally deactivated front passenger air bag.
- Incorrect positioning of the child restraint system.

### **Forward-facing and rearward-facing child restraint systems on the front passenger seat**

When using a rearward-facing child restraint system on the front passenger seat, the front passenger air bag must always be deactivated. This is only the case if the PASSENGER AIR BAG OFF indicator lamp is lit continuously (→ page 43).

When using the child restraint system on the front passenger seat, it is essential to observe the following:

- Move the front passenger seat as far back as possible.
- Set the seat backrest to an almost vertical position.
- Retract the seat cushion length as far as possible.
- The entire base of the child restraint system must always rest on the seat cushion of the front-passenger seat.
- The backrest of the forward-facing child restraint system must, as far as possible, be resting on the seat backrest of the front passenger seat. The child restraint system must not touch the roof or be put under strain by the head restraints.
- If necessary, adjust the angle of the seat backrest and the head restraint position accordingly.
- Adjust the seat cushion inclination so that the front edge of the seat cushion is in the

highest position and the rear edge of the seat cushion is in the lowest position.

- Always make sure that the shoulder belt strap is correctly routed from the seat belt outlet of the vehicle to the shoulder belt guide on the child restraint system. The shoulder belt strap must be routed forwards and downwards from the seat belt outlet.
- If necessary, adjust the seat belt outlet and the front passenger seat accordingly.
- Never place objects under or behind the child restraint system, e.g. cushions.

Always comply with the manufacturer's installation and operating instructions for the child restraint system used.



## Child safety locks

### Activating/deactivating the child safety lock for the rear doors

**⚠ WARNING** Risk of accident and injury due to children left unattended in the vehicle

If you leave children unaccompanied in the vehicle, they may be able to set the vehicle in motion, for example by:

- Releasing the parking brake.
- Shifting the transmission out of park position **P**.
- Starting the engine.

In addition, they may operate vehicle equipment.

- ▶ Never leave children and animals unattended in the vehicle.
- ▶ When leaving the vehicle, always take the SmartKey with you and lock the vehicle.

**⚠ WARNING** Risk of fatal injury due to exposure to extreme heat or cold in the vehicle

If people – particularly children – are exposed to extreme heat or cold over an extended period of time, there is a risk of injury or even fatal injury.

- ▶ Never leave anyone – particularly children – unattended in the vehicle.

**⚠ WARNING** There is a risk of accident and injury if you leave children unattended in the vehicle

If children are traveling in the vehicle, they could:

- Open doors, thereby endangering other persons or road users.
- Get out of the vehicle and be hit by oncoming traffic.
- Operate vehicle equipment and become trapped, for example.

- ▶ Always activate the child safety locks available if children are traveling in the vehicle.
- ▶ Never leave children unattended in the vehicle.
- ▶ When leaving the vehicle, always take the SmartKey with you and lock the vehicle.

Child safety locks are available for the rear doors and for the rear side windows.

The child safety lock on the rear doors secures each door separately. The doors can no longer be opened from the inside.

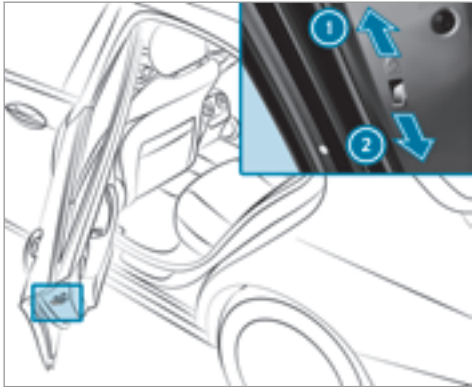

- ▶ Press the lever in direction ① (activate) or ② (deactivate).
- ▶ Make sure that the child safety locks are working properly.

### Activating/deactivating the child safety lock for the rear side windows

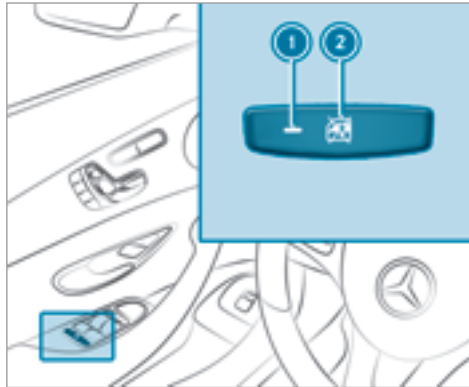

- ▶ **To activate/deactivate:** press button ②. Opening/closing the side window in the rear passenger compartment is possible:
  - With indicator lamp ① lit: via the switch on the driver's door.

- With indicator lamp ① off: via the switch on the corresponding rear door or driver's door.

When the child safety lock is activated, the controls in the rear passenger compartment are deactivated for:

- The rear side windows
- The adjustment of the front passenger seat from the rear passenger compartment
- The roller sunblinds:
  - Of the rear side windows
  - Of the rear window
  - In the roof

### Notes on pets in the vehicle

**⚠ WARNING** Risk of accident and injury due to animals left unsecured or unattended in the vehicle

If you leave animals in the vehicle unattended or unsecured, they could possibly press down buttons or switches.

Thereby an animal may:

- activate vehicle equipment and become trapped, for example
- switch systems on or off and endanger other road users

Unsecured animals may be thrown around in the vehicle in the event of an accident or sudden steering and braking maneuver and injure vehicle occupants in the process.

- ▶ Never leave animals in the vehicle unattended.
- ▶ Always correctly secure animals while driving, for example using a suitable animal carrier.

## SmartKey

### Overview of SmartKey functions

**⚠ WARNING** Risk of accident and injury due to children left unattended in the vehicle

If children are left unattended in the vehicle, they could:

- Open doors, thereby endangering other persons or road users
- Get out of the vehicle and be hit by oncoming traffic
- Operate vehicle equipment

In addition, the children could also set the vehicle in motion, for example, by:

- Releasing the parking brake
- Shifting the transmission out of park position **P**
- Starting the engine.

▶ Never leave children and animals unattended in the vehicle.

- ▶ When leaving the vehicle, always take the SmartKey with you and lock the vehicle.
- ▶ Keep the SmartKey out of the reach of children.

**! NOTE** Damage to the key caused by magnetic fields

- ▶ Keep the key away from strong magnetic fields.



- ① Locks
- ② Battery check lamp

- ③ Unlocks
- ④ Opens/closes the trunk lid
- ⑤ Panic alarm

The SmartKey locks and unlocks the following components:

- Doors
- Trunk lid
- Fuel filler flap

If you do not open the vehicle within approximately 40 seconds after unlocking:

- The vehicle is locked again.
- Anti-theft protection is reactivated.

Do not keep the SmartKey together with electronic devices or metal objects. This can affect the SmartKey's functionality.

Do not keep the SmartKey in the temperature-controlled cup holder. Otherwise, the SmartKey will not be reliably detected.

**i** If battery check lamp ② does not light up after pressing the  or  button, the battery is discharged.

## Activating/deactivating the acoustic locking verification signal

Multimedia system:

→ Vehicle ▶▶  Vehicle Settings ▶▶ Acoustic Lock

▶ Activate  or deactivate  the function.

## Arming/deactivating the panic alarm

**Requirements:**

- The ignition is switched off.





- ▶ **To arm:** press button ① for approximately one second. A visual and audible alarm is triggered.
  - ▶ **To deactivate:** briefly press button ① again.
- or
- ▶ Press the start/stop button on the cockpit (the SmartKey is inside the vehicle).

## Changing the unlocking settings

Possible unlocking functions of the SmartKey:

- Central unlocking
- Unlocking the driver's door and fuel filler flap

- ▶ **To switch between settings:** press the  and  buttons simultaneously for approximately six seconds until the battery check lamp flashes twice.

If the unlocking function for the driver's door and fuel filler flap has been selected:

- Pressing the  button a second time centrally unlocks the vehicle.
- **Vehicles with KEYLESS-GO:** If you touch the inner surface of the door handle on the

driver's door, only the driver's door and fuel filler flap are unlocked.

## Reducing the energy consumption of the SmartKey

**All vehicles:** if you do not use the vehicle or a SmartKey for an extended period of time, you can reduce the energy consumption of the respective SmartKey. To do so, deactivate the SmartKey functions.

- ▶ **To deactivate:** press the  button on the SmartKey twice in rapid succession. The battery check lamp of the SmartKey flashes twice briefly and lights up once.
- ▶ **To activate:** press any button on the SmartKey.

① When the vehicle is started with the SmartKey in the stowage compartment of the center console, the SmartKey functions are automatically activated (→ page 167).

**Vehicles with KEYLESS-GO:** Automatic deactivation of the SmartKey functions occurs after a few minutes if the SmartKey is not moved thus

reducing the power consumption of the SmartKey. When deactivated, the SmartKey cannot be accessed without authorization.

To activate the SmartKey functions:

- Press any button on the SmartKey.
- Move the SmartKey.
- Start the vehicle with the SmartKey in the stowage compartment of the center console (→ page 167).

### Inserting/removing the mechanical key

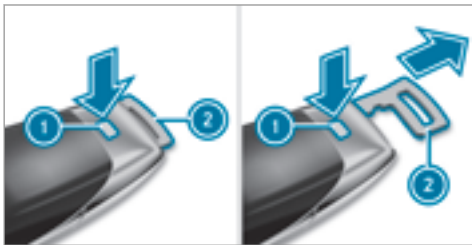

- ▶ **To remove:** press release knob ①. Mechanical key ② is pushed out slightly.

- ▶ Pull out mechanical key ② until it engages in the intermediate position.

① You can use the intermediate position of mechanical key ② to attach the SmartKey to a key ring.

- ▶ Press release knob ① again and fully remove mechanical key ②.

▶ **To insert:** press release knob ①.

- ▶ Insert mechanical key ② to the intermediate position or fully until it engages.

### Replacing the SmartKey battery

**⚠ DANGER** Serious damage to health caused by swallowing batteries

Batteries contain toxic and corrosive substances. Swallowing batteries may cause serious damage to health.

There is a risk of fatal injury.

- ▶ Keep batteries out of the reach of children.

- ▶ If batteries are swallowed, seek medical attention immediately.

**🔥 ENVIRONMENTAL NOTE** Environmental damage caused by improper disposal of batteries



Batteries contain pollutants. It is illegal to dispose of them with the household rubbish.



Dispose of batteries in an environmentally responsible manner. Take discharged batteries to a qualified specialist workshop or to a collection point for used batteries.

### Requirements:

- You require a CR 2032 3 V cell battery.

Mercedes-Benz recommends that you have the battery replaced at a qualified specialist workshop.

- ▶ Remove the mechanical key (→ page 60).



- ▶ Press release button ② down fully and remove cover ①.
- ▶ Remove battery compartment ③ and take out the discharged battery.
- ▶ Insert the new battery into battery compartment ③. Observe the positive pole marking in the battery compartment and on the battery.
- ▶ Push in battery compartment ③.
- ▶ Replace cover ① so that it engages.

## Problems with the SmartKey

Problem	Possible causes/consequences and ▶ Solutions
<p>You can no longer lock or unlock the vehicle.</p>	<p>Possible causes:</p> <ul style="list-style-type: none"> <li>• The SmartKey battery is discharged or nearly discharged.</li> <li>• There is interference from a powerful radio signal source.</li> <li>• The SmartKey is defective.</li> </ul>

Problem	Possible causes/consequences and ► Solutions
	<ul style="list-style-type: none"> <li>► Check the battery using the battery check lamp and replace if necessary .</li> <li>► Use the mechanical key to lock or unlock the vehicle .</li> <li>► Have the SmartKey checked at a qualified specialist workshop.</li> </ul>
You have lost a SmartKey.	<ul style="list-style-type: none"> <li>► Have the SmartKey deactivated at a qualified specialist workshop.</li> <li>► If necessary, have the locks changed as well.</li> </ul>

## Doors

### Unlocking and opening doors from the inside

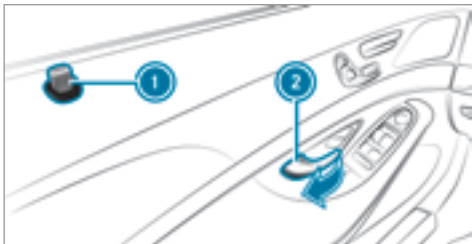

- **To unlock and open a front door:** pull door handle ②. Locking pin ① pops up when the door is unlocked.
- **To unlock a rear door:** pull the rear door handle. The locking pin pops up when the rear door is unlocked.
- **To open a rear door:** pull the rear door handle again.



### Locking/unlocking the vehicle centrally from the inside

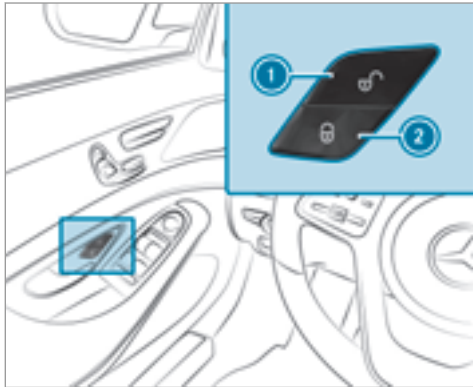

▶ **To unlock:** press button ①.

▶ **To lock:** press button ②.

This does not lock or unlock the fuel filler flap.

The vehicle is not unlocked:

- If you have locked the vehicle using the SmartKey.
- If you have locked the vehicle using KEY-LESS-GO.

### Locking and unlocking the vehicle with KEY-LESS-GO

#### Requirements:

- The SmartKey is outside the vehicle.
- The distance between the SmartKey and the vehicle does not exceed 3 ft (1 m).
- The driver's door and the door at which the door handle is used are closed.

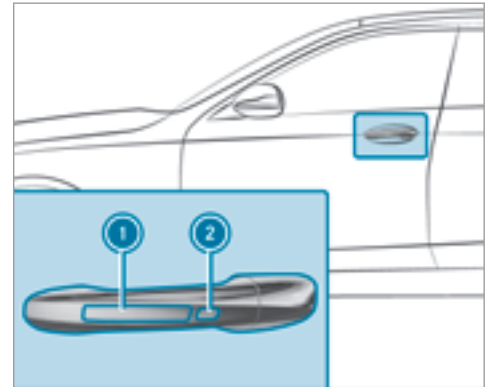

▶ **To unlock the vehicle:** touch the inner surface of the door handle.

▶ **To lock the vehicle:** touch sensor surface ① or ②.

▶ **Convenience closing:** touch recessed sensor surface ② for an extended period.

ⓘ For further information on convenience closing (→ page 75).

If you open the trunk lid from outside, the trunk lid is automatically unlocked.

### Problems with KEYLESS-GO

---

Problem	Possible causes/consequences and ► Solutions
You can no longer lock or unlock the vehicle using KEYLESS-GO.	<p>Possible causes:</p> <ul style="list-style-type: none"><li>• The SmartKey battery is discharged or nearly discharged.</li><li>• There is interference from a powerful radio signal source.</li><li>• The SmartKey is defective.</li></ul> <p>► Check the battery using the battery check lamp and replace if necessary .</p> <p>► Use the mechanical key to lock or unlock the vehicle .</p> <p>► Have the vehicle and SmartKey checked at a qualified specialist workshop.</p>

### Switching the automatic locking feature on/off

---

The vehicle is locked automatically when the ignition is switched on and the wheels are turning faster than walking pace.

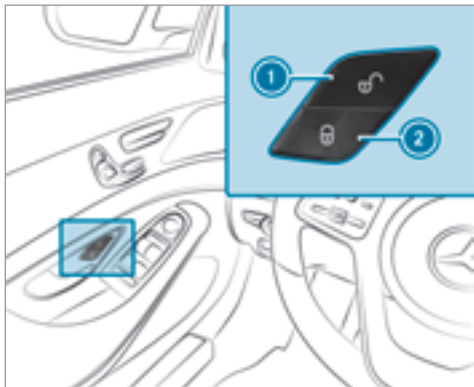

- ▶ **To deactivate:** press and hold button ① for approximately five seconds until an acoustic signal sounds.
- ▶ **To activate:** press and hold button ② for approximately five seconds until an acoustic signal sounds.

In the following situations, there is a danger of being locked out when the function is activated:

- The vehicle is being towed/pushed.

- The vehicle is being tested on a dynamometer.

### Information on the power closing function for the doors

If you push the door into the lock up to the first detent position, the power closing function will automatically pull the door into the lock.

### Unlocking/locking the driver's door using the mechanical key

- ① If you wish to lock the vehicle entirely using the mechanical key, first press the button for locking from the inside while the driver's door is open. Then proceed to lock the driver's door using the mechanical key.

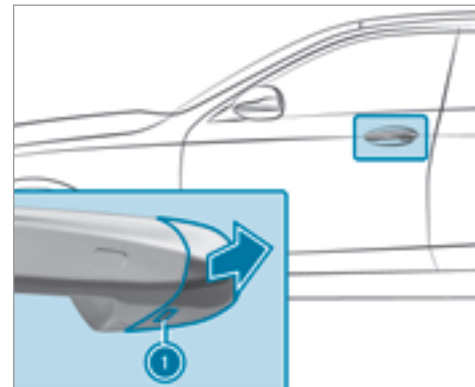

- ▶ Insert the mechanical key as far as it will go into opening ① in the cover.
- ▶ Pull and hold the door handle.
- ▶ Pull the cover on the mechanical key as straight as possible away from the vehicle until it releases.
- ▶ Release the door handle.

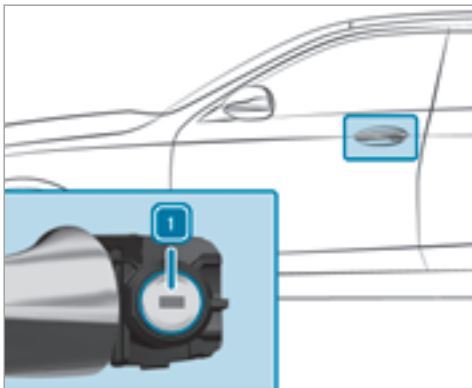

- ▶ **To unlock:** turn the mechanical key counter-clockwise to position 1.
- ▶ **To lock:** turn the mechanical key clockwise to position 1.
- ▶ Carefully press the cover onto the lock cylinder until it engages and is seated firmly.

## Trunk

### Opening the trunk lid

#### ⚠ WARNING Risk of exhaust gas poisoning

Combustion engines emit poisonous exhaust gases such as carbon monoxide. Exhaust gases can enter the vehicle interior if the trunk lid is open when the engine is running, especially if the vehicle is in motion.

- ▶ Always switch off the engine before opening the trunk lid.
- ▶ Never drive with the trunk lid open.

#### ! NOTE Damage to the trunk lid by obstacles above the vehicle

The trunk lid swings upwards when it is opened.

- ▶ Therefore, make sure that there is sufficient clearance above the trunk lid.

You have the following options to open the trunk lid:

- ▶ Pull the trunk lid handle.
- ▶ **Vehicles with trunk lid convenience closing:** With the trunk lid stopped in an intermediate position, pull the trunk lid upwards and release as soon as it begins to open.
- ▶ Press and hold the  button on the SmartKey.

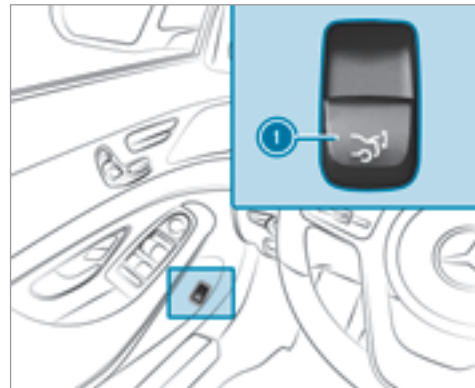

- ▶ Pull trunk lid remote operating switch 1.

- ▶ **Vehicles with HANDS-FREE ACCESS:** move your foot below the bumper (→ page 69).

#### **Vehicles with trunk lid convenience closing:**

If an object restricts the trunk lid during the automatic opening process, the obstacle detection system stops the trunk lid. The obstacle detection function is only an aid and is not a substitute for your attentiveness.

**Plug-in hybrid:** observe the notes in the Supplement. Otherwise, you may not recognize dangers.

### **Closing the trunk lid**

**⚠ WARNING** Risk of injury from unsecured items in the vehicle

If objects, luggage or loads are not secured or not secured sufficiently, they could slip, tip over or be thrown around and thereby hit vehicle occupants.

There is a risk of injury, particularly in the event of sudden braking or a sudden change in direction.

- ▶ Always stow objects in such a way that they cannot be thrown around.
- ▶ Before the journey, secure objects, luggage or loads against slipping or tipping over.

**⚠ WARNING** Risk of becoming trapped during automatic closing of the trunk lid

Parts of the body could become trapped during automatic closing of the trunk lid. Moreover, people, e.g. children, may be standing in the closing area or may enter the closing area during the closing process.

- ▶ Make sure that nobody is in the vicinity of the closing area during the closing process.
- ▶ Use one of the following options to stop the closing process:
  - Press the  button on the SmartKey.
  - Press or pull the remote operating switch on the driver's door.

- Press the closing or locking button on the trunk lid.
- Pull the trunk lid handle.

**Vehicles with HANDS-FREE ACCESS:** It is also possible to stop the closing process by moving your foot in a kicking motion under the rear bumper.

You have the following options to close the trunk lid:

- ▶ Pull the trunk lid down using the handle recess and push it closed.
- ⓘ If you lightly push the trunk lid closed, the power closing function automatically pulls the trunk lid into the lock.
- ▶ **Vehicles with trunk lid convenience closing:** Pull down the trunk lid slightly and release it as soon as it begins to close.
- ▶ **Vehicles with trunk lid convenience closing:** Press and hold the  button on the SmartKey (with the SmartKey in the vicinity of the vehicle).

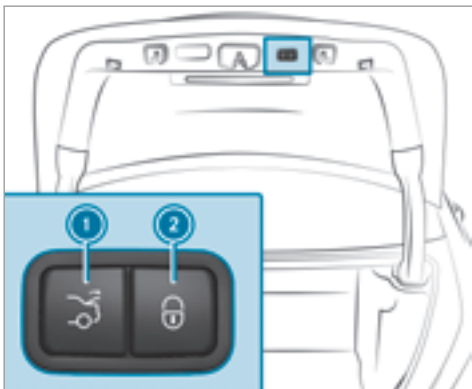

- ▶ **Vehicles with trunk lid convenience closing:** Press closing button ① in the trunk lid.
- ▶ **Vehicles with trunk lid convenience closing and KEYLESS-GO:** Press locking button ② in the trunk lid.  
If a SmartKey is detected outside the vehicle, the trunk lid closes and the vehicle is locked.

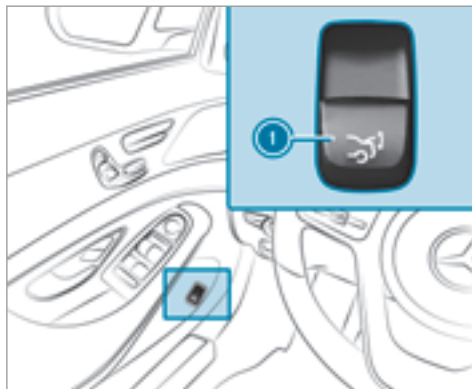

- ▶ **Vehicles with trunk lid convenience closing:** Press trunk lid remote operating switch ①.
- ▶ **Vehicles with HANDS-FREE ACCESS:** move your foot in a kicking motion under the bumper (→ page 69).

#### Automatic reversing function of the trunk lid

If an object restricts the trunk lid during the automatic closing process, the trunk lid opens

again automatically. The automatic reversing function is only an aid and is not a substitute for your attentiveness.

- ▶ When closing, make sure that no body parts are in the closing area.

**⚠ WARNING** Risk of becoming trapped despite the reversing function

The reversing function does not react:

- to soft, light and thin objects, e.g. fingers.
- over the last 1/3 in (8 mm) of the closing path.

In these situations in particular, the reversing function cannot prevent someone being trapped.

- ▶ When closing, make sure that no body parts are in the closing area.
- ▶ If someone is trapped, use one of the following options:
  - Press the  button on the SmartKey.
  - Press the remote operating switch on the driver's door.

- Press the closing or locking button on the trunk lid.
- Pull the trunk lid handle.

### HANDS-FREE ACCESS function

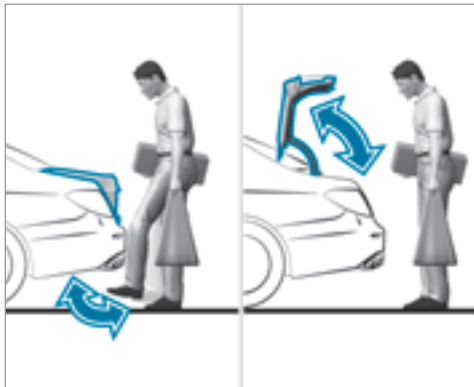

With HANDS-FREE ACCESS you can open, close or interrupt trunk lid movement by performing a kicking movement under the rear bumper.

The kicking movement triggers the opening or closing process alternately.

Observe the notes when opening (→ page 66) and closing (→ page 67) the trunk lid.

**i** A warning tone sounds while the trunk lid is opening or closing.

**⚠ WARNING** Risk of burns caused by a hot exhaust system

The vehicle exhaust system can become very hot. If you use HANDS-FREE ACCESS, you could burn yourself by touching the exhaust system.

▶ Always ensure that you only make a kicking movement within the detection range of the sensors.

**!** **NOTE** Damage to the vehicle caused by unintentionally opening the trunk lid

- When using an automatic car wash
  - When using a high pressure cleaner
- ▶ Deactivate KEYLESS-GO or make sure that the SmartKey located is at least 10 ft (3 m) away from the vehicle in such situations.

When making the kicking movement, make sure that your feet are firmly on the ground, otherwise you could lose your balance, e.g. on ice.

#### Requirements:

- The SmartKey is behind the vehicle.
- Stand at least 12 in (30 cm) away from the vehicle while performing the kicking movement.
- Do not come into contact with the bumper while making the kicking movement.
- Do not carry out the kicking movement too slowly.

- The kicking movement must be towards the vehicle and back.

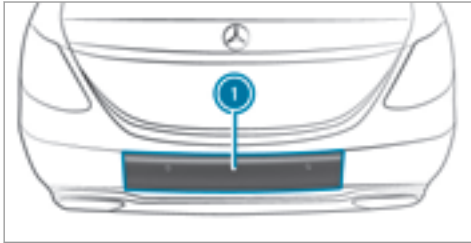

① Sensor detection range

If several consecutive kicking movements are not successful, wait ten seconds.

**System limitations**

The system may be impaired or may not function if:

- Snow or dirt, e.g. from road salt, covers the sensor area.
- The kicking movement is made using a prosthetic leg.

The trunk lid could be opened or closed unintentionally, in the following situations:

- If a person's arms or legs are moving in the sensor detection range, e.g. when polishing the vehicle, sitting on the edge of the trunk, or picking up objects.
- If objects are moved or placed behind the vehicle, e.g. charging cables, tensioning straps or luggage.
- When working on the trailer coupling, trailers or rear bicycle racks.

Deactivate KEYLESS-GO (→ page 59) or do not carry the SmartKey about your person in such situations.

**Switching separate trunk locking on/off**

If you centrally unlock the vehicle while separate locking is activated, the trunk remains locked.

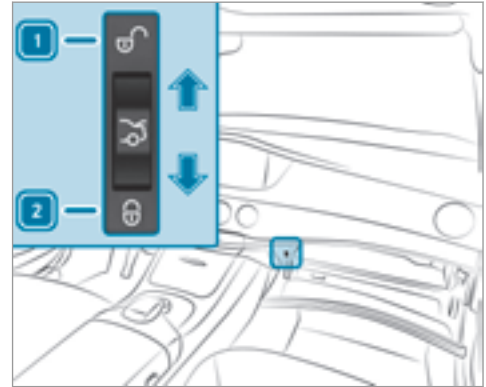

▶ **To switch on:** slide the switch to position ②.

▶ **To switch off:** slide the switch to position ①.

ⓘ If an accident has been detected, the trunk unlocks even if separate locking is switched on.



## Unlocking the trunk with the emergency release from inside

### Requirements:

- the 12 V vehicle battery is connected and charged.

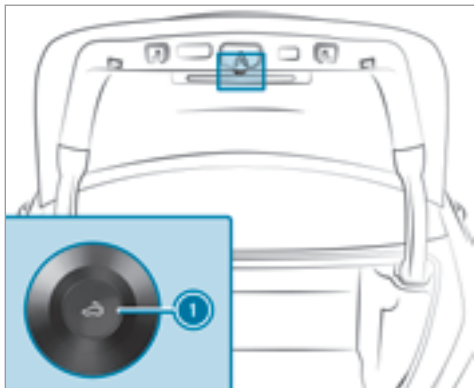

- Press emergency release button ① briefly. The trunk lid unlocks and opens.

## Unlocking the trunk lid using the mechanical key

- Take the mechanical key out of the SmartKey (→ page 60).
- Insert the mechanical key into the trunk lock as far as it will go.

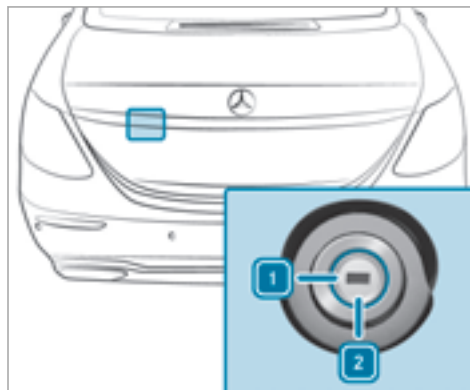

- Turn the mechanical key counter-clockwise from position ① to position ②.
  - Turn the mechanical key back to position ① and remove it.
- ⓘ If you use the mechanical key to unlock and open the trunk lid, the anti-theft alarm system will be triggered.

## Activating/deactivating the trunk lid opening height restriction

Multimedia system:

→ Vehicle »  Vehicle Settings » Trunk Lid Restriction

Activating the function allows you to avoid bumping the trunk lid on a low garage ceiling, for example.

- Activate  or deactivate  the function.

## Roller sun blinds

### Extending or retracting the roller sunblinds on the rear side windows

The roller sunblinds for the rear side windows can be operated with the buttons for the side windows.

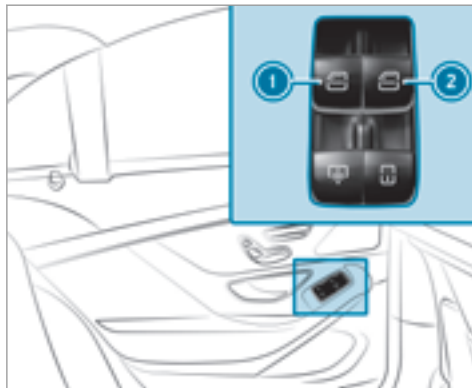

- ① Rear left side window
- ② Rear right side window

- ▶ **To close fully:** pull the corresponding button when the side window is closed.
- ▶ **To open fully:** press the corresponding button.

### Extending/retracting the rear window roller sunblind

**⚠ WARNING** Risk of entrapment when extending or retracting the roller sun blind

Body parts could become entrapped in the sweep of the roller sun blind when it is being extended or retracted.

- ▶ Make sure that no body parts are in the sweep of the roller sun blind when it is being extended or retracted.
- ▶ If someone becomes trapped, briefly press the button again. The opening or closing process is briefly stopped. The roller sun blind then returns to its starting position.

### Extending/retracting from the driver's seat

**! NOTE** Damage caused by objects

- ▶ Make sure that the roller sun blind can move freely.

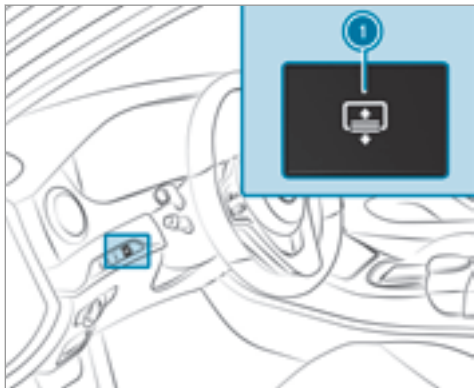

▶ Press button ①.

① Depending on the model, button ① is located in the door control panel on the driver's side.

### Extending/retracting from the rear passenger compartment

! **NOTE** Damage caused by objects

▶ Make sure that the roller sun blind can move freely.

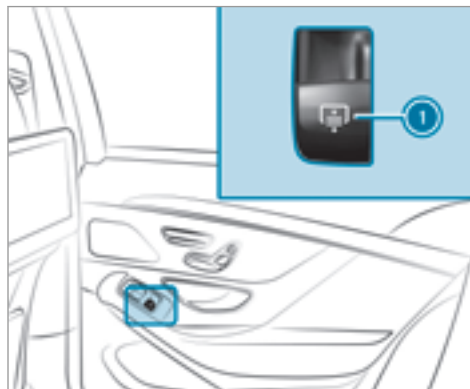

▶ **To extend:** pull switch ①.

▶ **To retract:** push switch ①.

When the override feature for the rear side windows is activated, switch ① cannot be operated.

### Side windows

#### Opening/closing the side windows

! **WARNING** Risk of entrapment when opening a side window

When opening a side window, parts of the body could be drawn in or become trapped between the side window and window frame.

- ▶ When opening, make sure that nobody is touching the side window.
- ▶ If someone is trapped, release the button immediately or pull it in order to close the side window again.

**⚠ WARNING** Risk of becoming trapped when closing a side window

When closing a side window, body parts could be trapped in the closing area in the process.

- ▶ When closing, make sure that no body parts are in the closing area.
- ▶ If someone is trapped, release the button immediately or press the button in order to reopen the side window.

**⚠ WARNING** Risk of becoming trapped when children operate the side windows

Children could become trapped if they operate the side windows, particularly when unattended.

- ▶ Activate the child safety lock for the rear side windows.
- ▶ When leaving the vehicle, always take the SmartKey with you and lock the vehicle.

- ▶ Never leave children unattended in the vehicle.

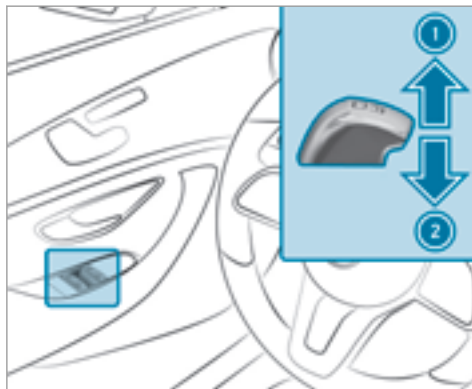

- ① Closes
- ② Opens

The buttons in the driver's door take precedence.

- ▶ **To start automatic operation:** press/pull the  button beyond the pressure point.

- ▶ **To interrupt automatic operation:** press/pull the  button again.

- ⓘ **Vehicles with electric roller sunblinds in the left and right rear doors:** The buttons for the rear side windows also open and close the roller sunblinds (→ page 72).

**Automatic reversing function for the side windows**

If an object blocks a side window during the closing process, the side window opens again automatically. The automatic reversing function is only an aid and is not a substitute for your attentiveness.

- ▶ When closing, make sure that no body parts are in the closing area.

**⚠ WARNING** Risk of becoming trapped despite reversing protection on the side window

The reversing function does not react:

- to soft, light and thin objects, e.g. small fingers.
- over the last 1/6 in (4 mm) of the closing path.
- during resetting.
- when closing the side window again manually immediately after automatic reversing.

This means that the reversing function cannot prevent someone from becoming trapped in these situations.

- ▶ When closing, make sure that no body parts are in the closing area.
- ▶ If someone becomes trapped, press the  button to open the side window again.

### Ventilating the vehicle before starting a journey (convenience opening)

**⚠ WARNING** Risk of entrapment when opening a side window

When opening a side window, parts of the body could be drawn in or become trapped between the side window and window frame.

- ▶ When opening, make sure that nobody is touching the side window.
- ▶ Release the button immediately if somebody becomes trapped.



- ▶ Press and hold the  button on the SmartKey.

The following functions are performed:

- The vehicle is unlocked.
- The side windows are opened.
- The panoramic sliding sunroof is opened.
- The seat ventilation of the driver's seat is switched on.

If the roller sunblinds of the panoramic sliding sunroof are closed, the roller sunblinds are opened first.

If the roller sunblinds of the rear doors are closed, the roller sunblinds are opened first.

- ▶ **To continue the opening procedure:** press the  button again.
- ▶ **To interrupt convenience opening:** release the  button.

### Closing side windows from the outside (convenience closing)

**⚠ WARNING** Risk of entrapment caused by inadvertent convenience closing

When the convenience closing feature is operating, parts of the body could become trapped in the closing area of the side window and the sliding sunroof.

- ▶ Observe the complete closing procedure when using convenience closing.
- ▶ When closing, make sure that no body parts are in the closing area.

▶ Press and hold the  button on the SmartKey.

The following functions are performed:

- The vehicle is locked.

- The side windows are closed.
- The panoramic sliding sunroof is closed.

▶ **To close the roller sunblinds:** press the  button again.

▶ **To interrupt convenience closing:** release the  button.

ⓘ Convenience closing can also be operated with KEYLESS-GO (→ page 63).

## Problems with the side windows

### Problem

A side window cannot be closed and you cannot see the cause.

### Possible causes/consequences and ▶ Solutions

▶ Check to see if any objects are in the window guide.

**⚠ WARNING** Risk of becoming trapped or fatally injured if reversing protection is not activated

If you close a side window again immediately after it has been blocked or reset, the side window closes with increased or maximum force. The reversing feature is then not active.

Parts of the body could become trapped in the closing area in the process.

▶ Make sure that no parts of the body are in the closing area.

▶ To stop the closing process, release the button or press the button again to reopen the side window.

If a side window is obstructed during closing and reopens again slightly:

▶ Immediately after the window blocks, pull the corresponding button again until the side window has closed, and hold the button for an additional second.  
The side window is closed with increased force.

Problem	Possible causes/consequences and ► Solutions
	If a side window is obstructed again during closing and reopens again slightly: ► Repeat the previous step. The side window is closed without the automatic reversing function.
The side windows cannot be opened or closed using the convenience opening feature.	The SmartKey battery is discharged or nearly discharged. ► Check the battery using the battery check lamp and replace if necessary .

## Sliding sunroof

### Opening/closing the sliding sunroof

**⚠ WARNING** Risk of becoming trapped while opening and closing the sliding sunroof

During opening and closing, parts of the body could get caught in the sweep of the sliding sunroof.

- When opening or closing, make sure that no body parts are in the sweep.
- Release the button immediately if somebody becomes trapped.

or

- Press the button in any direction during the automatic opening/closing process. The opening/closing process is stopped.

**⚠ WARNING** Risk of becoming trapped if the sliding sunroof is operated by children

Children operating the sliding sunroof could get caught in the moving parts, particularly if unattended.

- Never leave children unattended in the vehicle.
- When leaving the vehicle, always take the key with you and lock the vehicle.

**⚠ WARNING** Risk of becoming trapped while opening and closing the roller sun blind

When opening or closing, make sure that no body parts become trapped between the roller sun blind and frame or the sliding sunroof.

- ▶ When opening or closing, make sure that no body parts are in the sweep of the roller sun blind.
- ▶ Release the button immediately if somebody becomes trapped.

or

- ▶ Press the button in any direction during the automatic opening/closing process. The opening/closing process is stopped.

**!** **NOTE** Malfunction caused by snow and ice

Snow and ice may lead to a malfunction of the sliding sunroof.

- ▶ Only open the sliding sunroof if it is free of snow and ice.

**!** **NOTE** Damage caused by protruding objects

Objects that protrude from the sliding sunroof may damage the sealing strips.

- ▶ Do not allow anything to protrude from the sliding sunroof.

#### Requirements:

- The sliding sunroof can only be operated when the roller sunblind is open.
  - The roller sunblind can only be operated when the sliding sunroof is closed.
- i** The term "sliding sunroof" refers to the panoramic sliding sunroof.

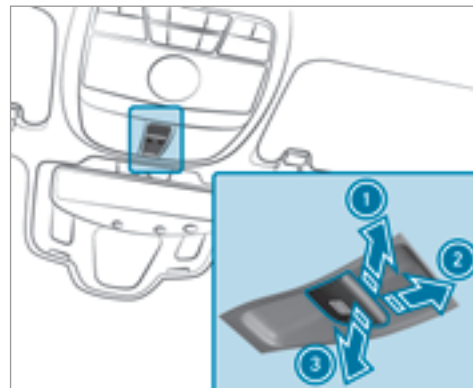

- ① To raise
- ② To open
- ③ To close/lower

Use the  button to operate the sliding sunroof and the front roller sunblind.

- ▶ **To start automatic operation:** press/pull the  button beyond the pressure point.



- ▶ **To interrupt automatic operation:** press/pull the  button again.

Restrictions:

- Automatic operation for raising is only available when the sliding sunroof is closed or raised.
- Do not open the sliding sunroof if a roof rack is installed. The sliding sunroof closes again automatically when it encounters resistance.

### Operating the rear roller sunblind from the front

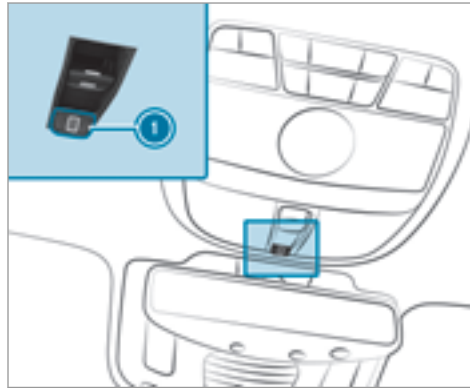

- ▶ **To open or close:** press button ①.
- ▶ **To stop:** press button ① again.

You must first open or close the rear roller sunblind fully before you can move it in the other direction.

### Operating the rear roller sunblind from the rear passenger compartment

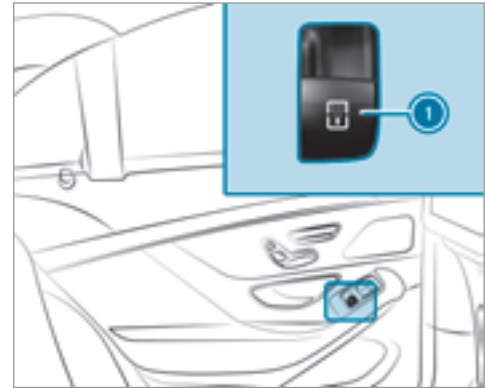

- ▶ **To open/close manually:** press or pull button ① to the point of resistance and hold it until the roller sunblind has reached the desired position.
- ▶ **To open/close fully:** press or pull button ① beyond the point of resistance and release it.

### Automatic reversing function of the sliding sunroof

If there is an object obstructing the sliding sunroof during the closing process, the sliding sunroof opens again automatically. The automatic reversing function is only an aid and is not a substitute for your attentiveness.

- ▶ When closing, make sure that no body parts are in the closing area.

**⚠ WARNING** Risk of becoming trapped despite the reversing function being active

The reversing function does not react:

- to soft, light and thin objects, e.g. small fingers
- during the last 1/6 in (4 mm) of the closing path
- during resetting
- when closing the sliding sunroof again manually immediately after automatic reversing

This means that the reversing function cannot prevent someone being trapped in these situations.

- ▶ When closing, make sure that no body parts are in the closing area.
- ▶ Release the button immediately if somebody becomes trapped.

or

- ▶ Press the button in any direction during the automatic closing process. The closing process is stopped.

### Automatic reversing function of the roller sunblind

If there is an object obstructing the roller sunblind during the closing process, the roller sunblind opens again automatically. The automatic reversing function is only an aid and is not a substitute for your attentiveness.

- ▶ When opening or closing the roller sunblind, make sure that no body parts are in the sweep.

**⚠ WARNING** Risk of becoming trapped despite the reversing function being active

In particular, the reversing function does not react to soft, light and thin objects, for example small fingers.

This means that the reversing function cannot prevent entrapment in these situations.

- ▶ When opening or closing the roller sunblind, make sure that no body parts are in the sweep.
- ▶ Release the button immediately if somebody becomes trapped.

or

- ▶ Press the button in any direction during the automatic closing process. The closing process is stopped.

### Automatic features of the sliding sunroof

- i** The term "sliding sunroof" refers to the panoramic sliding sunroof.

By pushing or pulling the  button, you can interrupt the automatic functions: "Rain closing function when driving" and "Automatic lowering feature".

### Rain closing function when driving

The raised sliding sunroof automatically lowers when driving if it starts to rain.

### Automatic lowering feature

If the sliding sunroof is raised at the rear, it automatically lowers slightly at higher speeds. At low speeds, it is raised again automatically.

**⚠ WARNING** Risk of entrapment by automatic lowering of the sliding sunroof

At high speeds the raised sliding sunroof automatically lowers slightly at the rear.

This could trap you or other persons.

- ▶ Make sure that nobody reaches into the sweep of the sliding sunroof whilst the vehicle is in motion.

- ▶ If somebody becomes trapped, immediately pull back the sliding sunroof button.  
The sliding sunroof lifts during opening.

## MAGIC SKY CONTROL

### MAGIC SKY CONTROL function

MAGIC SKY CONTROL is a function with which you can change the transparency of the panoramic sliding sunroof. You can choose between darkened or transparent states of the front and rear elements of the panoramic sliding sunroof.

**⚠ DANGER** Risk of fatal injury caused by touching electrical component parts of MAGIC SKY CONTROL

MAGIC SKY CONTROL operates using high voltage. If the roof lining is damaged or removed, electric component parts will be exposed.

If you touch these component parts, you could get an electric shock.

- ▶ Never remove the roof lining.
- ▶ If the roof lining is damaged, never touch the electrical component parts behind it.
- ▶ Always have work on MAGIC SKY CONTROL carried out at a qualified specialist workshop.

## Operating MAGIC SKY CONTROL

### Operating the front and rear elements from the front



- ▶ Press button ①.  
If the rear element is in a different state to the front element: the transparency of the front element changes.

If both elements are in the same state: the transparency of both elements changes.

- ① When you switch off the power supply, both elements darken automatically.  
When you switch on the power supply or the ignition, both elements return to the state they were in before the power supply was switched off.

### Operating the rear element from the rear passenger compartment

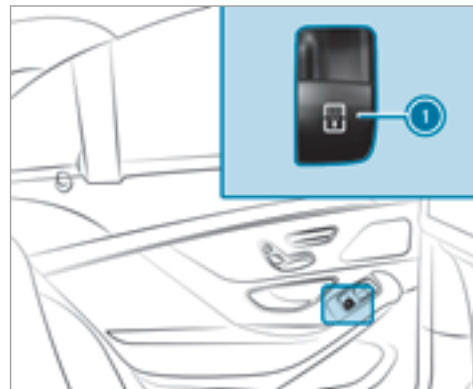

- ▶ If the roller sunblind is fully closed: pull button ①.  
The roller sunblind is opened. The transparency of the rear element then changes.

- ▶ If the roller sunblind is fully opened: press button ①.  
The transparency of the rear element changes.

- ① The rear element darkens automatically if you close the rear roller sunblind.

### Problems with the sliding sunroof

- ① The term "sliding sunroof" refers to the panoramic sliding sunroof.

#### Problem

The sliding sunroof cannot be closed and you cannot see the cause.

#### Possible causes/consequences and ▶ Solutions





**⚠ WARNING** Risk of becoming trapped or fatal injury by closing the sliding sunroof again

If you close the sliding sunroof again immediately after it has been blocked or reset, the sliding sunroof closes with increased or maximum force.

The reversing feature is then not active. Parts of the body could become trapped in the closing area in the process.

- ▶ Make sure that no parts of the body are in the closing area.
  - ▶ Release the button immediately if somebody becomes trapped.
- or
- ▶ Press the button in any direction during the automatic closing process.  
The closing process is stopped.

If the sliding sunroof is obstructed during closing and reopens again slightly:

Problem	Possible causes/consequences and ► Solutions
	<p>► Immediately after automatic reversing, pull and hold the  button down again to the point of resistance until the sliding sunroof is closed. The sliding sunroof is closed with increased force.</p> <p>If the sliding sunroof is obstructed again and reopens again slightly:</p> <p>► Repeat the previous step. The sliding sunroof is closed again with increased force.</p>
The sliding sunroof or the front roller sunblind does not move smoothly.	<p>► Pull the  button down repeatedly to the point of resistance until the sliding sunroof is fully closed.</p> <p>► Pull the  button for another second.</p> <p>► Pull and hold the  button down until the front roller sunblind is fully closed.</p> <p>► Pull the  button for another second.</p> <p>► Use automatic operation to fully open and then close the sliding sunroof.</p>

**Problem**

The rear roller sunblind does not move smoothly.

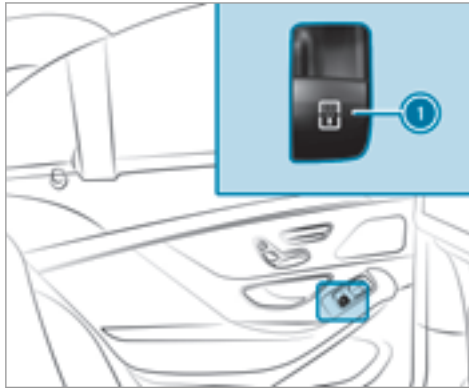
**Possible causes/consequences and ► Solutions**

- Pull and hold button ❶ down repeatedly until the rear roller sunblind is fully closed.
- Pull the ❶ button for another second.
- Use automatic operation to fully open and then close the rear roller sunblind.

## Anti-theft protection

### Function of the immobilizer

The immobilizer prevents your vehicle from being started without the correct SmartKey.

The immobilizer is automatically activated when the ignition is switched off and deactivated when the ignition is switched on.

When leaving the vehicle, always take the SmartKey with you and lock the vehicle. Anyone can start the engine if a valid SmartKey has been left inside the vehicle.

- ❗ If the event that the engine cannot be started (yet the vehicle's battery is charged), the system is not operational. Contact an authorized Mercedes-Benz Center or call 1-800-FOR-MERCEdes (in the USA) or 1-800-387-0100 (in Canada).

## ATA (anti-theft alarm system)

### Function of the ATA system (anti-theft alarm system)

If the ATA system is armed, a visual and audible alarm is triggered in the following situations:

- A door is opened.
- The trunk lid is opened.
- The hood is opened.

The ATA system is armed automatically after approximately 10 seconds:

- After locking the vehicle with the SmartKey.
- After locking the vehicle using KEYLESS-GO.

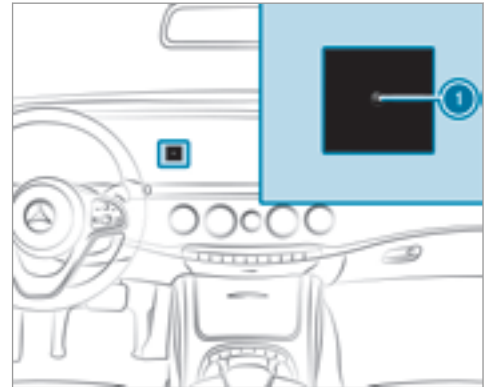

When the ATA system is armed, indicator lamp ❶ flashes.

The ATA system is automatically deactivated:

- After unlocking the vehicle with the SmartKey.
- After pressing the start/stop button with the SmartKey inside the vehicle.



- After unlocking the vehicle using KEYLESS-GO.
- ⓘ When the mbrace service (→ page 329) is active and the alarm stays on for more than 30 seconds, a message is automatically sent to the Customer Assistance Center.

### Deactivating the ATA (anti-theft alarm system) alarm

▶ Press the ,  or  button on the SmartKey.

or

▶ Press the start/stop button (the SmartKey is inside the vehicle).

### Stopping the alarm using KEYLESS-GO

▶ Grasp the outside door handle (with the SmartKey outside the vehicle).

### Notes on the correct driver's seat position

**⚠ WARNING** Risk of injury from adjusting the vehicle settings while the vehicle is in motion

You could lose control of the vehicle in the following situations:

- if you adjust the driver's seat, the head restraint, the steering wheel or the mirror while the vehicle is in motion
- if you fasten your seat belt while the vehicle is in motion

▶ Before starting the engine: adjust the driver's seat, the head restraint, the steering wheel or the mirror and fasten your seat belt.

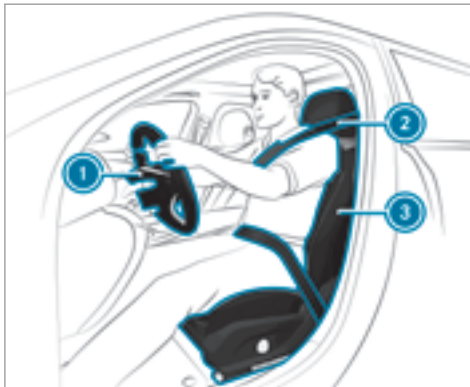

Observe the following when adjusting steering wheel ①, seat belt ② and driver's seat ③:

- you are as far away from the driver's airbag as possible
- you are sitting in a normal upright position
- your thighs are slightly supported by the seat cushion

- your legs are not entirely stretched and you can depress the pedals properly
- the back of your head is supported at eye level by the center of the head restraint
- you can hold the steering wheel with your arms slightly bent
- you can move your legs freely
- you can see all the displays in the instrument cluster clearly
- you should have a good overview of traffic conditions
- the seat belt is pulled snugly against the body and must be routed across the center of your shoulder and across your hips in the pelvic area

## Seats

### Adjusting the front seat electrically

**⚠ WARNING** Risk of becoming trapped if the seats are adjusted by children

Children could become trapped if they adjust the seats, particularly when unattended.

- ▶ When leaving the vehicle, always take the SmartKey with you and lock the vehicle.
- ▶ Never leave children unattended in the vehicle.

The seats can be adjusted when the ignition is switched off.

**⚠ WARNING** Risk of becoming trapped when adjusting the seats

When you adjust a seat, you or other vehicle occupants could become trapped, e.g. on the seat guide rail.

- ▶ Make sure when adjusting a seat that no one has any body parts in the sweep of the seat.

Observe the safety notes on "Air bags" and "Children in the vehicle".

**⚠ WARNING** Risk of injury from adjusting the vehicle settings while the vehicle is in motion

You could lose control of the vehicle in the following situations:

- if you adjust the driver's seat, the head restraint, the steering wheel or the mirror while the vehicle is in motion
  - if you fasten your seat belt while the vehicle is in motion
- ▶ Before starting the engine: adjust the driver's seat, the head restraint, the steering wheel or the mirror and fasten your seat belt.

**⚠ WARNING** Risk of becoming trapped if the seat height is adjusted carelessly

If you adjust the seat height carelessly, you or other vehicle occupants could be trapped and thereby injured.

Children in particular could accidentally press the electrical seat adjustment buttons and become trapped.

- ▶ While moving the seats, make sure that hands or other body parts do not get under the lever assembly of the seat adjustment system.

**⚠ WARNING** Risk of injury due to head restraints which are not installed or are adjusted incorrectly

If head restraints are not installed or are adjusted incorrectly, the head restraints cannot provide protection as intended.

There is an increased risk of injury in the head and neck area, e.g. in the event of an accident or when braking.

- ▶ Always drive with the head restraints installed.
- ▶ Before driving off, make sure for every vehicle occupant that the center of the head restraint supports the back of the head at about eye level.

Do not swap the head restraints of the front and rear seats. Otherwise, you cannot adjust the height and angle of the head restraints correctly.

Adjust the head restraint fore-and-aft position so that it is as close as possible to the back of your head.

**⚠ WARNING** Risk of injury or death due to incorrect seat position

The seat belt does not offer the intended level of protection if you have not moved the seat backrest to an almost vertical position.

When braking or in the event of an accident, you could slide underneath the seat belt and sustain abdominal or neck injuries, for example.

- ▶ Adjust the seat properly before beginning your journey.
- ▶ Always ensure that the seat backrest is in an almost vertical position and that the shoulder section of your seat belt is routed across the center of your shoulder.

**! NOTE** Damage to the seats when moving the seats back

The seats may be damaged by objects when moving the seats back.

- ▶ When moving the seats back, make sure that there are no objects in the footwell or under or behind the seats.

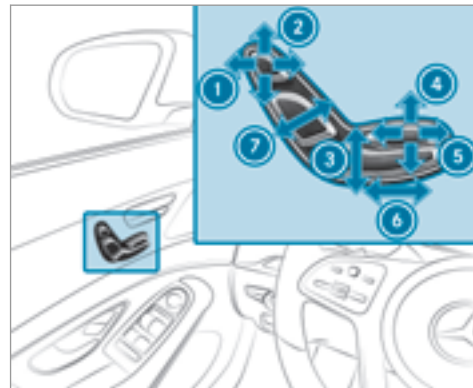

- 1 Height/fore-and-aft position of the head restraint (vehicles with an EASY ADJUST luxury head restraint)
- 2 Head restraint height
- 3 Seat height
- 4 Seat cushion inclination
- 5 Seat cushion length

- ⑥ Seat fore-and-aft adjustment
- ⑦ Backrest angle
- ▶ Save the settings with the memory function (→ page 113).
- ① The head restraint height is adjusted automatically when you adjust the seat height or the seat fore-and-aft position.
- ① **Vehicles with EASY ADJUST luxury head restraints:** the fore-and-aft position of the head restraint is pre-adjusted automatically when you adjust the backrest angle.

### Adjusting the front passenger seat from the driver's seat electrically

#### Requirements:

- To select the front passenger seat: the power supply is switched on



You can call up the following functions for the front passenger seat:

- Seat adjustment
- Seat heater
- Seat ventilation
- Memory function

- ▶ **To select the front passenger seat:** press button ①. When the indicator lamp lights up, the front passenger seat is selected.
- ▶ Adjust the front passenger seat using the buttons in the door control panel on the driver's side.

### Adjusting the front passenger seat electrically from the rear passenger compartment

#### Requirements:

- To select the front passenger seat: the power supply is switched on

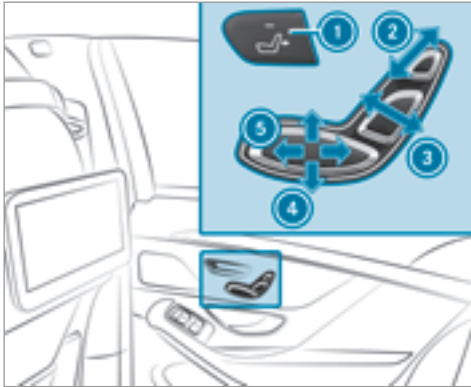

Vehicles with electrically adjustable outer seats

- ① Selects the front passenger seat
- ② Head restraint height
- ③ Seat backrest inclination
- ④ Seat height
- ⑤ Seat fore-and-aft adjustment

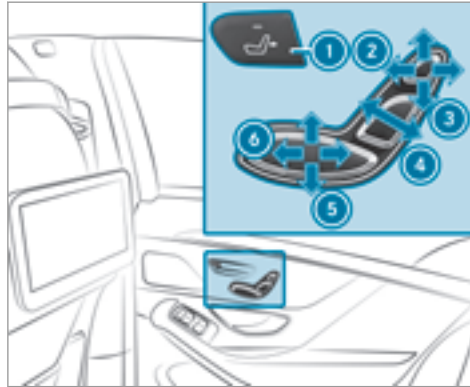

Vehicles with an EASY ADJUST luxury head restraint

- ① Selects the front passenger seat
- ② Head restraint fore-and-aft position
- ③ Head restraint height
- ④ Seat backrest inclination
- ⑤ Seat height
- ⑥ Seat fore-and-aft adjustment

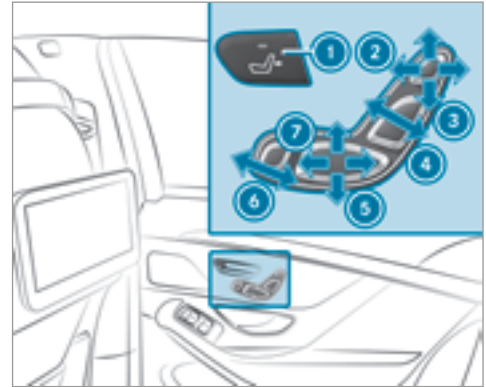

Vehicles with seat for chauffeur mode and long wheelbase

- ① Selects the front passenger seat
- ② Head restraint fore-and-aft position
- ③ Head restraint height
- ④ Seat backrest inclination
- ⑤ Seat height
- ⑥ Footrest
- ⑦ Seat fore-and-aft adjustment

The footrest can only be adjusted when one of the following conditions has been fulfilled:

- The front passenger seat is moved fully forward
- The front passenger seat is in the position for chauffeur mode

▶ Adjust the rear seat (→ page 93).

▶ Adjust the reclining rear seat (→ page 93).

▶ **To select the front passenger seat:** press button ①.

When the indicator lamp lights up, the front passenger seat is selected.

▶ Adjust the front passenger seat using the buttons in the door control panel in the rear passenger compartment.

① **Mercedes-Maybach vehicles:** it is sufficient to adjust the footrest if the front passenger seat is moved into the center setting area.

① You can use the override feature in the rear passenger compartment to disable this function (→ page 56).

### Adjusting the rear seats electrically

You can electrically adjust only the outer seats in the rear passenger compartment.

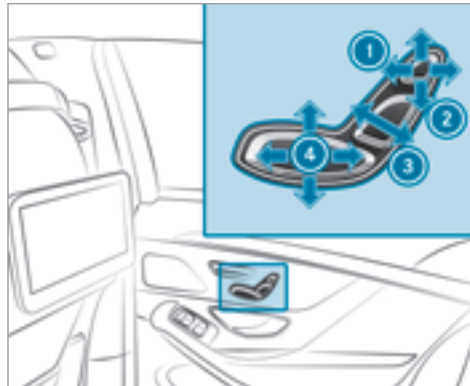

- ① Height/fore-and-aft position of the head restraint (vehicles with active multicontour seat)
- ② Head restraint height

③ Seat backrest inclination

④ Combined seat cushion inclination and length

▶ Saving the settings with the memory function (→ page 114).

### Adjusting a reclining rear seat electrically

The reclining rear seat is available in long wheelbase vehicles equipped with "executive seats". On vehicles without a reclining rear seat, the button for setting the angle and fore-and-aft position of the leg rest has no function.

**Vehicles with a long wheelbase:** the reclining rear seat is on the front passenger side.

**Mercedes-Maybach vehicles:** the reclining rear seats are on the driver's and the front passenger sides.

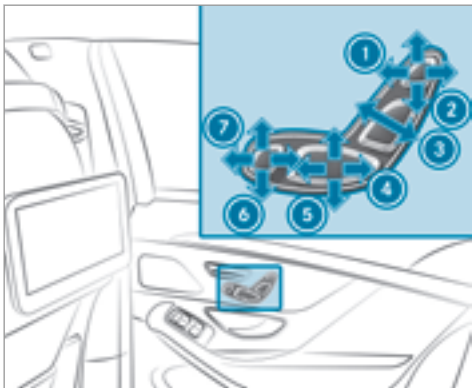

- ① Height/fore-and-aft position of the head restraint (vehicles with active multicontour seat)
- ② Head restraint height
- ③ Seat backrest inclination
- ④ Combined seat cushion inclination and length
- ⑤ Combined seat cushion inclination and length

- ⑥ Angle of the leg rest
- ⑦ Fore-and-aft position of the leg rest

- ▶ Save the settings using the memory function (→ page 114).
- ⓘ The leg rest folds down if overloaded. If this is the case, fold up the leg rest and engage it.
- ⓘ Vehicles with a long wheelbase and a Chauffeur/Rear Seat Memory Package also have a footrest. This is located on the lower part of the front passenger seat backrest (→ page 91).

### Setting the fully reclined position

#### Requirements:

- The power supply is switched on.

This function is available in vehicles with a long wheelbase.

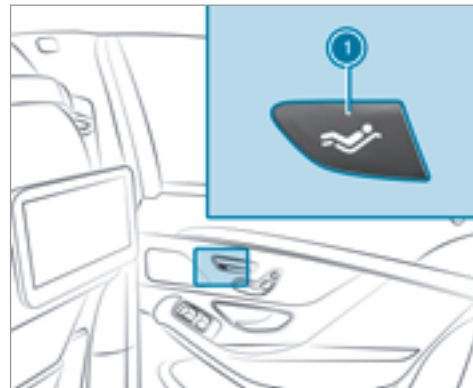

- ▶ **To set the reclined position:** press and hold button ① until the reclined position is reached.
  - The rear seat moves into the reclined position.
  - The front passenger seat moves into the position for chauffeur mode.
  - The footrest moves out from under the front passenger seat.



- if available, the leg rest rises.
- ▶ **To set the seat position:** manually adjust the seat to the desired position.

or

- ▶ Call up the settings with the memory function (→ page 114).
- ⓘ You can use the override feature in the rear passenger compartment to disable this function (→ page 56).
- ⓘ The leg rest folds down if overloaded. If this is the case, fold up the leg rest and engage it.

## Chauffeur mode

### Information on chauffeur mode

**⚠ WARNING** Risk of injury due to head restraints which are not installed or are adjusted incorrectly

If head restraints are not installed or are adjusted incorrectly, the head restraints cannot provide protection as intended.

There is an increased risk of injury in the head and neck area, e.g. in the event of an accident or when braking.

- ▶ Always drive with the head restraints installed.
- ▶ Before driving off, make sure for every vehicle occupant that the center of the head restraint supports the back of the head at about eye level.

Do not swap the head restraints of the front and rear seats. Otherwise, you cannot adjust the height and angle of the head restraints correctly.

Adjust the head restraint fore-and-aft position so that it is as close as possible to the back of your head.

**⚠ WARNING** Risk of accident with the front passenger head restraint folded down

If the front passenger seat is in the chauffeur mode position and the front passenger head restraint is folded down, the view of the passenger's outside mirror can be impaired.

- ▶ To have a free view of the outside mirror, remove the front passenger head restraint before beginning a journey.

**!** **NOTE** Damage to objects in the luggage net of the front passenger footwell when adjusting the front passenger seat to the chauffeur position

Objects in the luggage net in the front passenger footwell can become damaged when the front passenger seat is adjusted to the chauffeur position.

- ▶ Remove the objects from the luggage net.

**!** **NOTE** Damage to the seats when moving the seats back

The seats may be damaged by objects when moving the seats back.

- ▶ When moving the seats back, make sure that there are no objects in the footwell or under or behind the seats.

Observe the following:

- adjust the front passenger seat for chauffeur mode before the journey
- do not remove the front passenger seat head restraint during the journey

For chauffeur mode, the following settings are made for the front passenger seat:

- the seat is moved forwards
- the backrest is tilted forwards
- the head restraint is folded forwards

The front passenger seat automatically moves from the chauffeur position back into the normal position in the following situations:

- the front passenger seat is adjusted using the buttons in the door control panel on the front passenger side
- the front passenger seat belt is fastened
- an occupant is detected on the front passenger seat
- the front passenger head restraint is inserted and the power supply is switched on

- the front passenger backrest is adjusted rearwards
- the front passenger seat is moved in the fore-and-aft direction out of the chauffeur area

### Positioning the front passenger seat for chauffeur mode

#### Requirements:

- The power supply is switched on.
- The front passenger seat is not occupied.
- The front passenger seat belt is not inserted into the seat belt buckle.

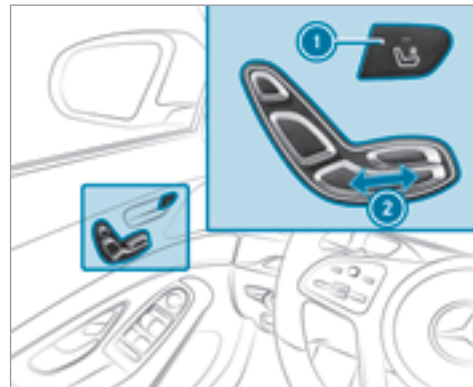

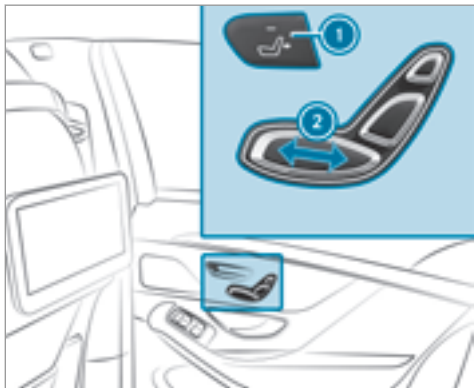

- ▶ **To select the front passenger seat:** press button ①.  
When the indicator lamp lights up, the front passenger seat is selected.

### Setting the chauffeur position

- ▶ Press button ② forwards and hold it in this position.  
The front passenger seat moves forward and stops at the threshold of the area for chauffeur mode.
- ▶ Release button ②.
- ▶ Press forward and hold button ② again until the front passenger seat is in position for chauffeur mode.  
The front passenger head restraint folds forwards. The front passenger seat moves forward.  
The [To view the ext. mirror, adjust front-passenger seat or remove the head restraint](#) display message appears in the multifunction display.
- ① If the front passenger seat is already at the threshold to the area for chauffeur mode, the position for chauffeur mode is set immediately.
- ▶ Saving the settings with the memory function (→ page 114).

- ① You can use the override feature in the rear passenger compartment to disable this function (→ page 56).

### Removing or installing the front passenger head restraints (chauffeur mode)

#### Requirements:

- The front passenger head restraint is folded completely forward

## Removing the head restraint

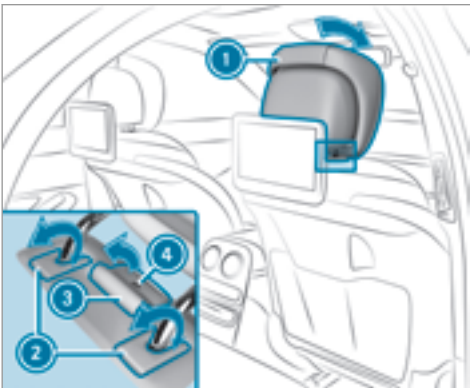

- ▶ Fold head restraint bar covers ② towards the rear.
- ▶ Hold front passenger head restraint ① tightly.
- ▶ Pull adjuster lever ③ towards the rear and hold it in this position.
- ▶ Remove front passenger head restraint ①.

- ▶ Release adjuster lever ③. Red pin ④ protrudes from the adjuster lever.
- ▶ Press down red pin ④.
- ▶ Fold covers ② forwards and close them.

## Inserting the head restraint

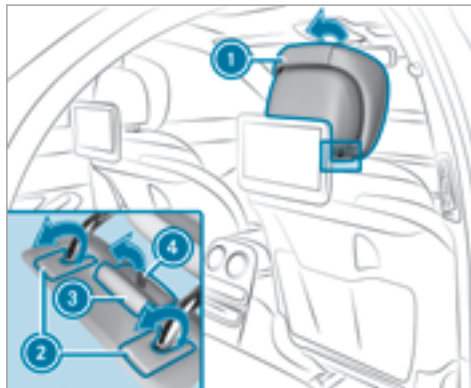

- ▶ Fold head restraint bar covers ② towards the rear.

- ▶ Pull adjuster lever ③ towards the rear. Red pin ④ protrudes from the adjuster lever.
- ▶ Insert front passenger head restraint ① into the brackets. The front passenger head restraint must engage on both sides.
- ▶ Press down red pin ④. If pin ④ can be pressed down and is then no longer visible, the front passenger head restraint has engaged correctly.
- ▶ Fold covers ② forwards and close them. The front passenger head restraint folds into position automatically.

## Moving the front passenger seat into the normal position (chauffeur mode)

### Requirements:

- To select the front passenger seat: the power supply is switched on
- The front passenger head restraint is installed.

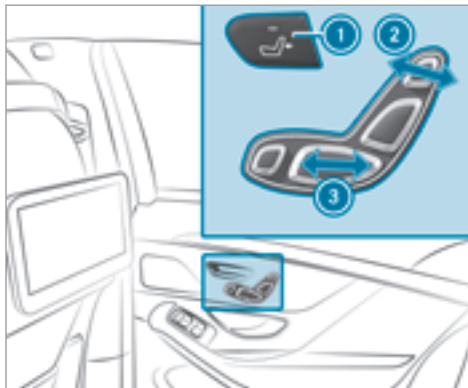

- ▶ **To select the front passenger seat:** press button ①. When the indicator lamp lights up, the front passenger seat is selected.

#### Setting the normal position

- ▶ Press button ③ towards the rear and hold it in this position. The front passenger seat moves to the threshold of the area for chauffeur mode.

The front passenger head restraint folds into position.

The front passenger seat then moves further towards the rear passenger compartment.

or

- ▶ Briefly press button ② back. The front passenger seat moves automatically to the threshold of the area for chauffeur mode. The front passenger head restraint folds into position.

- ① You can also set the normal position from the front passenger seat. To do so, press any button in the door control panel on the front passenger side.
- ▶ Call up the settings with the memory function (→ page 114).
- ① You can use the override feature in the rear passenger compartment to disable this function (→ page 56).

## Setting the fully reclined position of the front passenger seat (chauffeur mode)

### Setting the reclined position

This function is available in vehicles with the following equipment:

- Electrically adjustable rear seats.
- Individual rear seats without a leg rest.

You can move the front passenger seat into a fully reclined position. The rear seat and front passenger seat then provide a continuous surface.

- ▶ Put the seat cushion of the rear seat all the way back in the fore-and-aft position (→ page 93).
- ▶ Move the front passenger seat into position for chauffeur mode (→ page 96).
- ▶ Remove the front passenger head restraint (→ page 97).
- ▶ Move the front passenger seat so that the backrest is in a fully reclined position (→ page 89).

## Leaving the reclined position

- ▶ Fold the front passenger seat backrest upright to a suitable position.
- ▶ Install the front passenger head restraint (→ page 97).

## Head restraints

### Adjusting the front seat head restraints manually

**⚠ WARNING** Risk of injury from adjusting the vehicle settings while the vehicle is in motion

You could lose control of the vehicle in the following situations:

- if you adjust the driver's seat, the head restraint, the steering wheel or the mirror while the vehicle is in motion
- if you fasten your seat belt while the vehicle is in motion
- ▶ Before starting the engine: adjust the driver's seat, the head restraint, the

steering wheel or the mirror and fasten your seat belt.

**⚠ WARNING** Risk of injury due to head restraints which are not installed or are adjusted incorrectly

If head restraints are not installed or are adjusted incorrectly, the head restraints cannot provide protection as intended.

There is an increased risk of injury in the head and neck area, e.g. in the event of an accident or when braking.

- ▶ Always drive with the head restraints installed.
- ▶ Before driving off, make sure for every vehicle occupant that the center of the head restraint supports the back of the head at about eye level.

Do not rotate the head restraints of the front and rear seats. Otherwise, you cannot adjust the height and angle of the head restraints correctly.

Adjust the head restraint fore-and-aft position so that the head restraint is as close as possible to the back of your head.

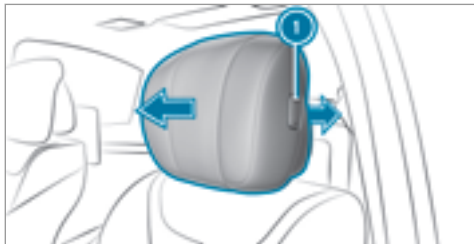

- ▶ **To move forwards:** pull the head restraint forwards.
- ▶ **To move backwards:** press release knob ① and push the head restraint towards the rear.

### Adjusting the front seat luxury head restraints manually

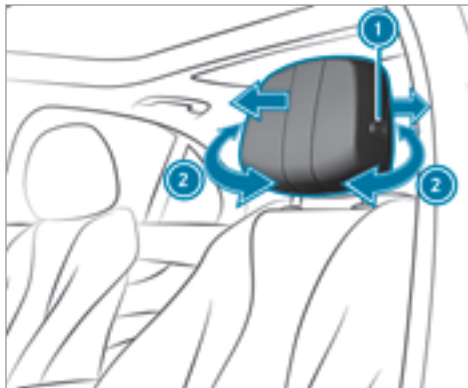

- ▶ **To adjust the side bolsters of the head restraint:** pull or push right or left-hand side bolster ②.
- ▶ **To move forwards:** pull the head restraint forwards.

- ▶ **To move backwards:** press release knob ① and push the head restraint towards the rear.

### Adjusting the EASY ADJUST luxury head restraints on the front seats manually



- ▶ **To adjust the side bolsters of the head restraint:** pull or push right or left-hand side bolster ①.
- ① The fore-and-aft position of the head restraint is adjusted automatically when you adjust the backrest using the buttons in the door control panel.

### Lowering the rear seat head restraints electrically from the front

#### Requirements:

- The power supply is switched on.

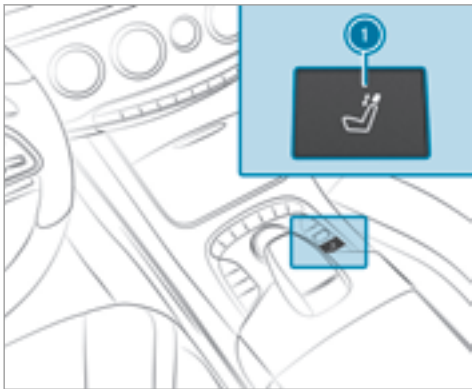

- ▶ Press button ①.

- ① Depending on the model, button ① is located in the door control panel on the driver's side.

- ① If all of the rear seat head restraints are lowered and button ① is pressed again, the outer rear head restraints move into the last stored position (→ page 103).

### Extending the outer rear seat head restraints electrically from the front

#### Requirements:

- The power supply is switched on.

This function is available on vehicles with electrically adjustable rear seats.

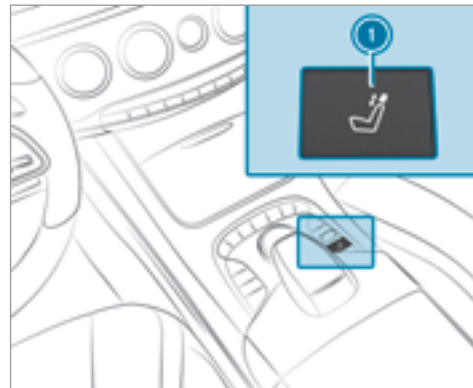

- ▶ Press and hold button ① until the head restraints have extended upwards.
- ① Depending on the model, button ① is located in the door control panel on the driver's side.



## Extending the outer rear seat head restraints to the last stored position

### Requirements:

- The power supply is switched on.

This function is available on vehicles with electrically adjustable rear seats.

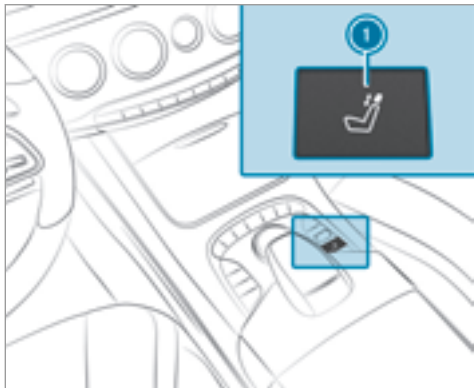

- ▶ Briefly press switch ①. The head restraints lower.
  - ▶ Briefly press switch ① again. The head restraints move to the last stored position.
- ① Depending on the model, button ① is located in the door control panel on the driver's side.

## Adjusting the rear seat outer head restraints manually

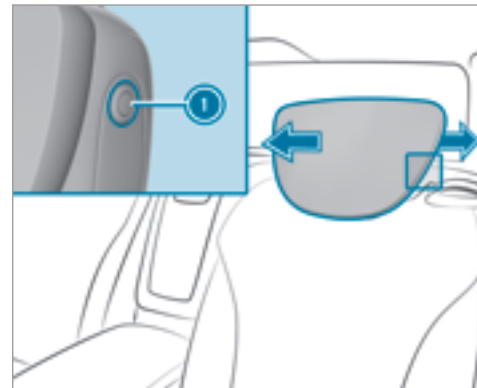

- ▶ **To move forwards:** pull the head restraint forwards.
- ▶ **To move backwards:** press release knob ① and push the head restraint towards the rear.

### Adjusting the outer luxury head restraints of the rear seats mechanically



- ▶ **To adjust the side bolsters:** push or pull right and/or left-hand side bolster ① into the desired position.
- ▶ **To adjust the angle of the head restraint:** pull or push the head restraint in the direction of arrow ②.

### Attaching and removing the supplementary cushion of the rear luxury head restraint

The supplementary cushion is available on vehicles with electrically adjustable rear seats.

Only use the supplementary cushion when the vehicle is stationary. The supplementary cushion is in the vehicle.

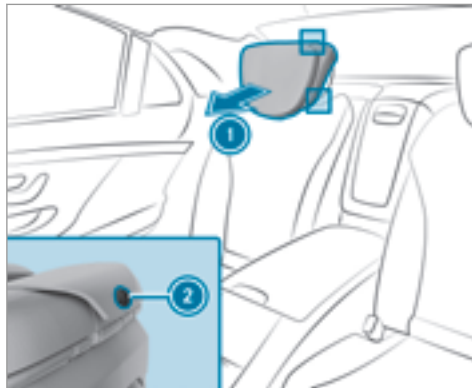

- ▶ Position the head restraint as far forwards as possible.
- ▶ **To attach the supplementary cushion:** hold supplementary cushion ① against the

head restraint and push press studs ② into the counterpieces.

- ▶ **To remove the supplementary cushion:** release press studs ② and remove supplementary cushion ①.

### Extending or retracting the rear seat center head restraint electrically

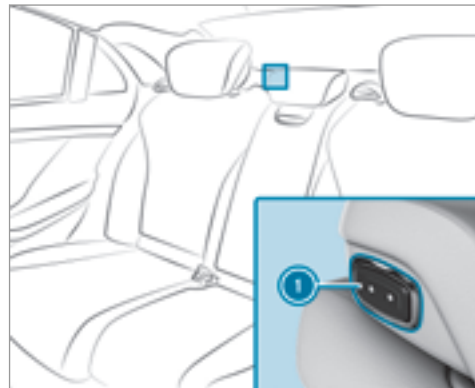

- ▶ Press and hold button ① until the head restraint has extended or retracted.

### Folding the center head restraint into position mechanically



- ▶ Pull the head restraint up until it engages.

### Configuring seat adjustment

---

#### Requirements:

- The ignition is switched on.

Multimedia system:

↳ Vehicle ▶ Seats

- ▶ Select **Driver's Seat** or **Passenger Seat**.

#### Adjusting the backrest side bolsters

- ▶ Select **Side Bolsters**.
- ▶ Select the setting.

#### Adjusting the seat contour in the lumbar region of the seat backrest

- ▶ Select **Lumbar**.
- ▶ Adjust the air cushion.

#### Setting the shoulder section

- ▶ Select **Shoulders**.
- ▶ Select the settings.

#### Setting seat heating balance

- ▶ Select **Seat Heating Balance**.
- ▶ Select the settings.

#### Memory function

- ▶ Save the seat adjustments with the memory function (→ page 113).

#### Setting automatic adjustment of the lateral support (active multicontour seat)

---

Multimedia system:

↳ Vehicle ▶ Seats

With this function, the lateral support of the active multicontour seat is automatically adjusted to the driving and cornering dynamics of the vehicle.

- ▶ Select **Driver's Seat** or **Passenger Seat**.
- ▶ Select **Dynamic Seat**.
- ▶ **Select setting:** **Off**, **Level 1** or **Level 2**.

## Overview of massage and workout programs

The following massage program can be selected:

Massage program for the front seats	Function
Hot Relaxing Massage for back	Relaxing massage program starting in the pelvic area. Warm pressure points can be felt, full back massage, stretching the pelvic area. Ending with gentle stroking motions.
Hot Relaxing Massage for shoulders	Relaxing massage program starting in the shoulder area. Warm pressure points can be felt, full twin-wave back massage, stretching the shoulder area. Ending with gentle stroking motions.
Activating Massage	Activating back massage with increasing twin-waves and then soothing movements.
Classic Massage	Massage with increasing twin-waves and soothing movements.
Mobilizing Massage	Mobilization of the spinal column and the complete upper body by means of a pressure point mobilizing massage at chest height.

### Active Workout programs

The Active Workout programs require your active co-operation and are a convenient way of exer-

cising your abdomen and back muscles during a traffic jam, for example, by tensing and releasing the specific muscle groups. Tensing and releas-

ing also helps to improve blood flow to your muscles. Press against a pressure point as soon as you feel it.

The following Active Workout programs can be selected:

Workout program	Function
Active Workout	To stimulate the muscles in your abdomen and back: press against the pressure points in the backrest. Keep the pressure under your feet even. Continue to breathe normally; do not hold your breath. When the pressure in the seat backrest recedes, stop pressing against it and relax briefly.

### Selecting the massage program for the front seats

Multimedia system:

↳ Vehicle ▶  Seats

- ▶ Select **Driver's Seat** or **Passenger Seat**.
- ▶ Select **Massage**.
- ▶ Select a massage program.  
The massage program runs for approximately 8 to 18 minutes, depending on the setting.
- ▶ To set the massage intensity: switch **High Intensity** on  or off .

### Resetting seat and massage settings

Multimedia system:

↳ Vehicle ▶  Seats ▶ Reset

- ▶ Select **Yes** or **No**.

Depending on whether the settings for the driver or front passenger seat are selected, only the selected seat can be reset.

### Switching the seat heater on/off

**⚠ WARNING** Risk of burns due to repeatedly switching on the seat heater

Repeatedly switching on the seat heater can cause the seat cushion and seat backrest padding to become very hot.

The health of persons with limited temperature sensitivity or a limited ability to react to excessively high temperatures may be affected or they may even suffer burn-like injuries.

- ▶ Do not repeatedly switch on the seat heater.

**!** **NOTE** Damage to the seats caused by objects or documents when the seat heater is switched on

When the seat heater is switched on, overheating can occur due to objects or documents placed on the seats e.g. seat cushions or child seats. This could cause damage to the seat surface.

- ▶ Make sure that no objects or documents are on the seats when the seat heater is switched on.

**Requirements:**

- The power supply is switched on.

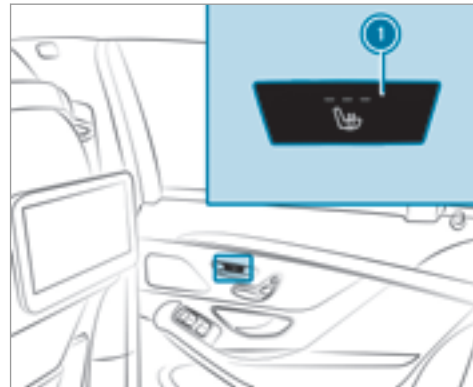
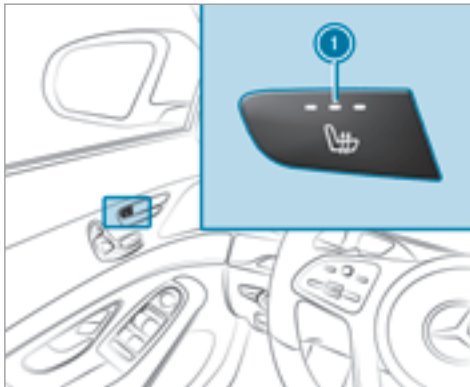

- ▶ **To switch on/increase the level:** press button ① repeatedly until the desired heating level is set. Depending on the heating level, up to three indicator lamps light up.

▶ **To switch off/reduce the level:** press button ① repeatedly until the desired heating level is set.

If all indicator lamps are off, the seat heater is switched off.

- ① The seat heater automatically switches down from the three heating levels after 8, 10 and 20 minutes until the seat heater is switched off.
- ① If you switch the power supply off and on again within 20 minutes, the previous setting of the seat heater for the driver's seat remains active.
- ① You can set the distribution of the heated sections of the seat cushions and seat backrests on the front and rear seats in the multimedia system (→ page 109).
- ① **Vehicles with the Warmth Comfort Package:** You can adjust the heating of the armrests in the door and center console in the multimedia system.

### Setting the panel heating

Multimedia system:

▶ Vehicle ▶  Vehicle Settings ▶ Panel Heating

When the seat heater is switched on, the armrests in the vehicle and the center console can be heated.

- ▶ Select **Front and Rear**, **Front Only**, **Rear Only** or **Off**.

### Switching the seat ventilation on/off

**Requirements:**

- The power supply is switched on.

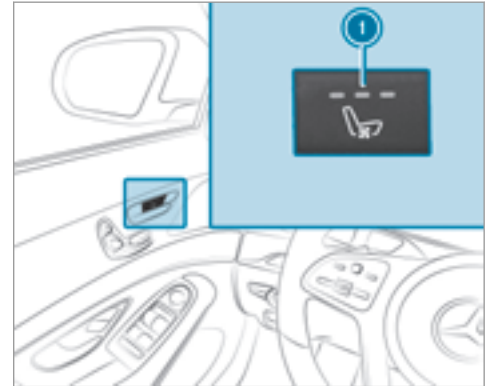

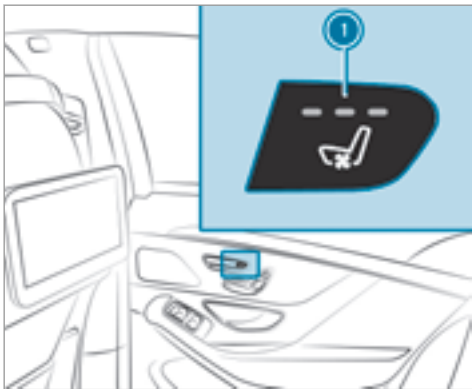

- ▶ **To switch on/increase the level:** press button ① repeatedly until the desired ventilation level is set. Depending on the ventilation level, up to three indicator lamps light up.

- ▶ **To switch off/reduce the level:** press button ① repeatedly until the desired ventilation level is set. If all indicator lamps are off, the seat ventilation is switched off.
- ① If you switch the power supply off and on again within 20 minutes, the previous setting of the seat ventilation for the driver's seat remains active.

## Steering wheel

### Adjusting the steering wheel electrically

- ⚠ **WARNING** Risk of injury from adjusting the vehicle settings while the vehicle is in motion

You could lose control of the vehicle in the following situations:

- if you adjust the driver's seat, the head restraint, the steering wheel or the mirror while the vehicle is in motion
- if you fasten your seat belt while the vehicle is in motion

- ▶ Before starting the engine: adjust the driver's seat, the head restraint, the steering wheel or the mirror and fasten your seat belt.

- ⚠ **WARNING** Risk of entrapment for children when adjusting the steering wheel

Children could injure themselves if they adjust the steering wheel.

- ▶ Never leave children unattended in the vehicle.
- ▶ When leaving the vehicle, always take the SmartKey with you and lock the vehicle.

The steering wheel can be adjusted when the power supply is switched off.



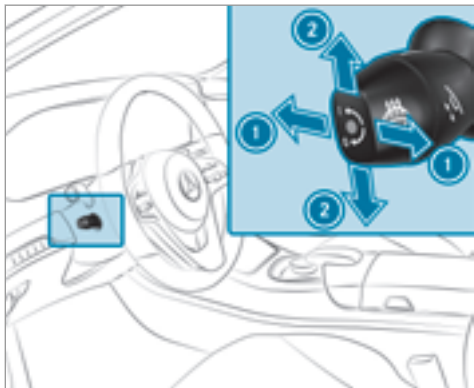

- ① Adjusts the distance to the steering wheel
- ② Adjusts the height
- ▶ Save the settings with the memory function (→ page 113).

### Overview of the steering wheel heater

The steering wheel heater can be operated when the power supply or ignition is switched on.

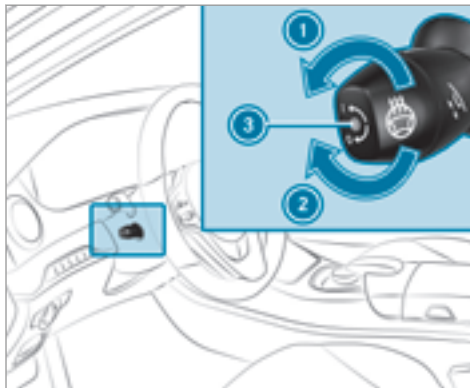

- ① To activate
- ② To deactivate
- ③ Indicator lamp

### Easy entry and exit feature

#### Function of the easy entry and exit feature

**⚠ WARNING** Risk of accident when driving off while adjusting the easy exit feature

- If you drive off while the easy entry and exit feature is making adjustments, you could lose control of the vehicle.

- ▶ Always wait until the adjustment process is complete before driving off.

**⚠ WARNING** Risk of becoming trapped while adjusting the easy entry and exit feature

When the easy entry and exit feature adjusts the steering wheel and the driver's seat, you and other vehicle occupants – particularly children – could become trapped.

- ▶ During the adjustment process of the easy entry and exit feature, make sure that no one has any body parts in the sweep of the seat or the steering wheel.

If there is a risk of becoming trapped by the steering wheel:

- ▶ Move the adjustment lever of the steering wheel.  
The adjustment process is stopped.

If there is a risk of becoming trapped by the driver's seat:

- ▶ Press the seat adjustment switch.  
The adjustment process is stopped.

Vehicles with memory function: you can stop the adjustment process by pressing one of the memory position switches of the memory function.

**⚠ WARNING** Risk of becoming trapped during activation of the easy entry and exit feature by children

If children activate the easy entry and exit feature, they can become trapped, particularly when unattended.

- ▶ Never leave children unattended in the vehicle.

- ▶ When leaving the vehicle, always take the SmartKey with you and lock the vehicle.

If the easy entry and exit feature is active, the steering wheel will move upwards and the driver's seat will move back in the following situations:

- You switch the ignition off when the driver's door is open
- You open the driver's door when the ignition is switched off

- ⓘ The steering wheel only moves upwards if it has not already reached the upper stop. The driver's seat moves backwards unless it is already in the rearmost position.

The steering wheel and the driver's seat move back to the last drive position in the following cases:

- You switch the power supply or the ignition on when the driver's door is closed
- You close the driver's door when the ignition is switched on

The last drive position of the steering wheel is stored in the following situations:

- You switch the ignition off
- You call up the seat settings via the memory function
- You save the seat setting using the memory function

If you press one of the memory function position buttons, the adjustment process is stopped.

**Setting the easy entry and exit feature**  
Multimedia system:

➔ Vehicle ➔  Vehicle Settings ➔ Easy Entry/Exit

- ▶ Select **Steering Wheel & Seat**, **Steering Wheel Only** or **Off**.

## Using the memory function

**⚠ WARNING** Risk of an accident if memory function is used while driving

If you use the memory function on the driver's side while driving, you could lose control of the vehicle as a result of the adjustments being made.

- ▶ Only use the memory function on the driver's side when the vehicle is stationary.

**⚠ WARNING** Risk of entrapment when setting the seat with the memory function

When the memory function adjusts the seat or steering wheel, you and other vehicle occupants – particularly children – could become trapped.

- ▶ During the setting procedure of the memory function, ensure that no body parts are in the sweep of the seat or the steering wheel.

- ▶ If somebody becomes trapped, immediately release the memory function position button.  
The adjustment process is stopped.

**⚠ WARNING** Risk of entrapment if the memory function is activated by children

Children could become trapped if they activate the memory function, particularly when unattended.

- ▶ Never leave children unattended in the vehicle.
- ▶ When leaving the vehicle, always take the key with you and lock the vehicle.

The memory function can be used when the ignition is switched off.

### Storing

The memory function is only available in vehicles with the memory package.

Seat adjustments for up to three people can be stored and called up using the memory function.

The following settings can be stored for the front seats:

- Seat, backrest, head restraint position and contour of the seat backrest in the lumbar region
- Active multicontour seat: side bolsters of the seat backrest, shoulder of the seat backrest, contour of the seat backrest, dynamic function level
- Seat heater: distribution of the heated sections of the seat cushion and seat backrest
- Driver's side: steering wheel position and position of the outside mirrors on the driver's and front passenger sides
- Head-up Display

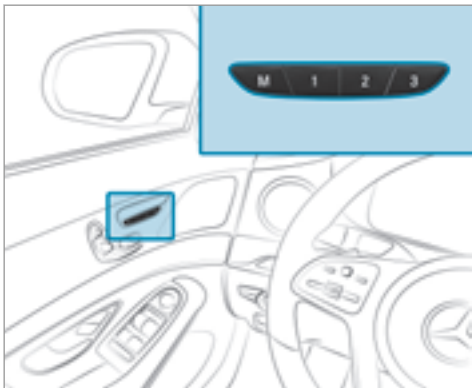

- ▶ Set the seat, the steering wheel, the Head-up Display and the outside mirror to the desired position.
- ▶ Briefly press memory button M and then press preset position button 1, 2 or 3 within three seconds.  
An acoustic signal sounds. The settings are stored.

▶ **To call up:** press and hold the relevant preset position button 1, 2 or 3 until the front seat, the steering wheel, Head-up Display and outside mirror is in the stored position.

ⓘ If you release the preset position button, the seat, steering wheel and mirror setting functions stop immediately.

**Vehicles with an Active Multicontour Package:**

The setting of the active multicontour seat or the 4-way lumbar support is still carried out.

**Vehicles without the Active Multicontour Package:**

Adjustment of the 4-way lumbar support is still carried out.

### Memory function in the rear passenger compartment

#### Operating rear seats via the memory function in the rear passenger compartment

##### Storing

Rear seat settings for up to three people can be stored and called up using the memory function in the rear passenger compartment.

The following settings can be stored for the rear seats:

- Position of the seat, backrest and head restraint
- Active multicontour seats: the seat side bolsters of the seat backrest as well as the contour of the seat backrest in the lumbar and shoulder regions
- Seat heater: distribution of the heated sections of the seat cushion and seat backrest

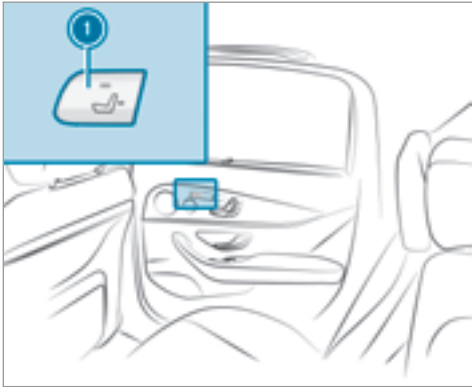

- ▶ Press button ①.  
The rear seat is selected if the indicator lamp in the button does not light up.
- ▶ Adjust the rear seat using the buttons in the door control panel (→ page 93).



Example: vehicles without reclining rear seat

- ▶ Briefly press memory button M and then press preset position button 1, 2 or 3 within three seconds.  
The settings for the rear seat are stored in the selected storage position.
- ① **Vehicles with reclining rear seat:** You cannot store any settings on the button for setting the reclined position.

### Calling up

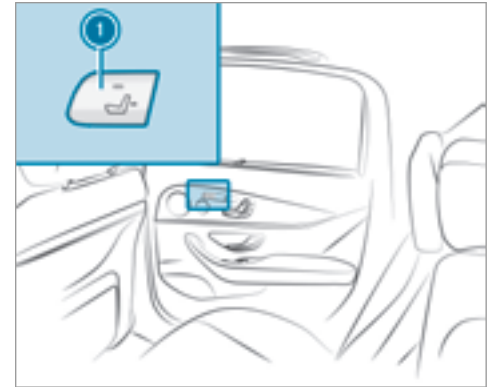

- ▶ Press button ①.  
The rear seat is selected if the indicator lamp in the button does not light up.



Example: vehicles without reclining rear seat

▶ Press and hold the relevant preset position button 1, 2 or 3 until the rear seat is in the stored position.

ⓘ Seat adjustment is interrupted as soon as you release the preset position button. The adjustment of the active multicontour seat is still carried out.

### Operating the front passenger seat and rear seats via the memory function in the rear passenger compartment

#### Requirements:

- To select the front passenger seat: the power supply is switched on

#### Storing

Front passenger seat adjustments and rear seat adjustments for up to three people can be stored and called up using the memory function in the rear passenger compartment.

The following settings can be stored for the front passenger seat:

- Position of the seat, backrest and head restraint

The following settings can be stored for the rear seats:

- Position of the seat, backrest and head restraint
- Active multicontour seats: the seat side bolsters of the seat backrest as well as the contour of the seat backrest in the lumbar and shoulder regions

- Seat heater: distribution of the heated sections of the seat cushion and seat backrest

The following settings are also stored to a memory position, if the indicator lamp in the  button lights up:

- Position of the footrest of the front passenger seat, if available
- Position of the screen, if available

Using the preset position buttons, you always store the current setting of each seat.



- ▶ Press button ①.  
The rear seat is selected if the indicator lamp in the button does not light up.
- ▶ Adjust the rear seat using the buttons in the door control panel (→ page 93).
- ▶ Press button ①.  
When the indicator lamp lights up, the front passenger seat is selected.

- ▶ Adjust the front passenger seat using the buttons in the door control panel in the rear passenger compartment (→ page 89).
- ▶ Ensure that the indicator lamp in button ① lights up.



Example: vehicles without reclining rear seat

- ▶ Briefly press memory button M and then press preset position button 1, 2 or 3 within three seconds.  
The settings for the front passenger seat and the rear seat are stored in the selected pre-set position.
- ① **Vehicles with reclining rear seat:** You cannot store any settings on the button for setting the reclined position.

## Calling up



- ▶ Press button ①. When the indicator lamp lights up, the front passenger seat is selected.



Example: vehicles without reclining rear seat

- ▶ Press and hold the relevant preset position button 1, 2 or 3 until both seats are in the stored position.
- ① The preset positions in the area for the chauffeur mode can only be set when the conditions for the chauffeur mode are fulfilled (→ page 95).

- ① Seat adjustment is interrupted as soon as you release the preset position button. The adjustment of the active multicontour seat is still carried out.
- ① You can use the rear passenger compartment child safety lock to deactivate this function (→ page 56).

### Storage areas

#### Notes on loading the vehicle

#### **⚠ WARNING** Risk of exhaust gas poisoning

Combustion engines emit poisonous exhaust gases such as carbon monoxide. Exhaust gases can enter the vehicle interior if the trunk lid is open when the engine is running, especially if the vehicle is in motion.

- ▶ Always switch off the engine before opening the trunk lid.
- ▶ Never drive with the trunk lid open.



**▲ WARNING** Risk of injury from unsecured items in the vehicle

If objects, luggage or loads are not secured or not secured sufficiently, they could slip, tip over or be thrown around and thereby hit vehicle occupants.

There is a risk of injury, particularly in the event of sudden braking or a sudden change in direction.

- ▶ Always stow objects in such a way that they cannot be thrown around.
- ▶ Before the journey, secure objects, luggage or loads against slipping or tipping over.

**▲ WARNING** Risk of injury from incorrectly stowed objects

If objects in the vehicle interior are stowed incorrectly, they can slide or be thrown around and hit vehicle occupants. In addition, cup holders, open stowage spaces and mobile phone brackets cannot always retain all objects they contain.

There is a risk of injury, particularly in the event of sudden braking or a sudden change in direction.

- ▶ Always stow objects so that they cannot be thrown around in such situations.
- ▶ Always make sure that objects do not protrude from stowage spaces, luggage nets or stowage nets.
- ▶ Close the lockable stowage spaces before starting a journey.
- ▶ Always stow and secure heavy, hard, pointed, sharp-edged, fragile or bulky objects in the trunk.

**▲ WARNING** Risk of burns from tailpipes and tailpipe trim

The tailpipe and tailpipe trim can become very hot. If you come into contact with these parts of the vehicle, you could burn yourself.

- ▶ Always be particularly careful around the tailpipe and the tailpipe trim.

- ▶ Allow the vehicle parts to cool down before you touch them.

The handling characteristics of your vehicle are dependent on the distribution of the load within the vehicle. You should bear the following in mind when loading the vehicle:

- Never exceed the maximum permissible gross mass or the permissible axle loads for the vehicle (including occupants). The values are specified on the vehicle identification plate on the vehicle's B-pillar.
- The load must not protrude above the upper edge of the seat backrests.
- Always place the load behind unoccupied seats if possible.
- Secure the load using the parcel net hooks. Distribute the load on the parcel net hooks evenly.

## Stowage spaces in the vehicle interior

### Overview of the front stowage compartments

**⚠ WARNING** Risk of injury from incorrectly stowed objects

If objects in the vehicle interior are stowed incorrectly, they can slide or be thrown around and hit vehicle occupants. In addition, cup holders, open stowage spaces and mobile phone brackets cannot always retain all objects they contain.

There is a risk of injury, particularly in the event of sudden braking or a sudden change in direction.

- ▶ Always stow objects so that they cannot be thrown around in such situations.
- ▶ Always make sure that objects do not protrude from stowage spaces, luggage nets or stowage nets.
- ▶ Close the lockable stowage spaces before starting a journey.

▶ Always stow and secure heavy, hard, pointed, sharp-edged, fragile or bulky objects in the trunk.

Observe the notes on loading the vehicle.

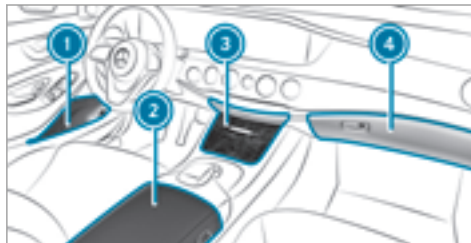

- ① Stowage compartment in the doors
- ② Stowage/telephone compartment in the armrest with multimedia and USB ports as well as stowage space, e.g. for an MP3 player
- ③ Stowage compartment in the front center console
- ④ Glove box

### Locking or unlocking the glove box

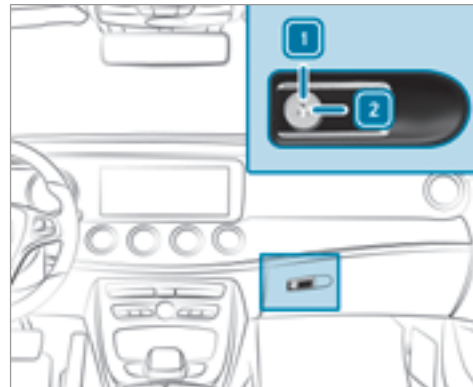

- ▶ Turn the mechanical key a quarter turn clockwise **2** (to lock) or counter-clockwise **1** (to unlock).

## Opening the glasses compartment



- ▶ Press button ①.

## Folding the folding table out or in

**⚠ WARNING** Risk of injury from the open folding table

If you are driving with the folding table open, vehicle occupants could strike against it, in particular in the event of an accident, sudden braking or an abrupt change of direction.

- ▶ Close the folding table before each journey.

**❗ NOTE** Damage to the folding tables when moving the seats back

Open folding tables may be damaged when moving the seats back.

- ▶ Make sure that the folding tables are folded in when moving the seats back.

## Folding out



- ▶ Open rear armrest ① (→ page 121).
- ▶ Pull the folding table forwards and upwards by handle recess ② or ③ and swing outwards.
- ▶ Fold the table panels apart.

- ▶ **To fold in:** fold the table panels together and swing in the folding table.

## Opening the stowage compartment in the rear armrest

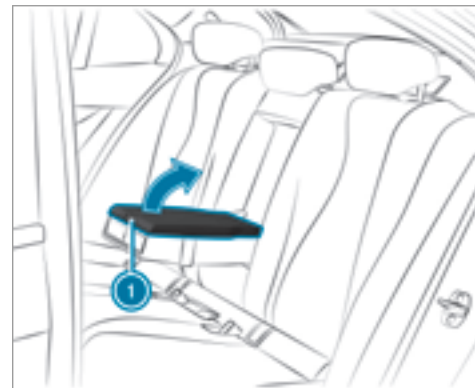

Vehicles with a rear bench seat

- ▶ Fold down the rear armrest.

- ▶ **To open:** press release catch ① and swing the cover of the armrest upwards.

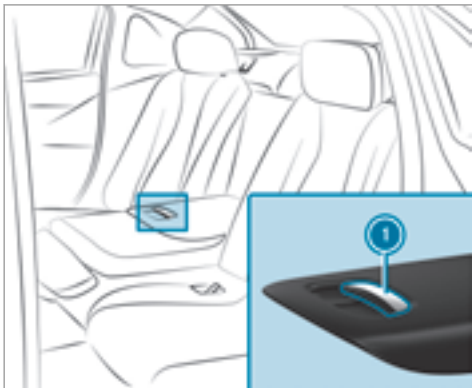

Vehicles with electrically adjustable outer seats

- ▶ Fold down the rear armrest.
- ▶ **To open:** pull handle ① and fold the cover of the armrest upwards.

### Opening the stowage compartment in the rear-compartment center console



Vehicles with individual rear seats

- ▶ Pull handle ① and fold the cover of the armrest upwards.

### Opening the stowage box in the rear seat backrest

**!** **NOTE** Damage to the rear armrest

When folded out, the rear armrest can be damaged by the weight of your body.

- ▶ Do not sit or support yourself on the rear armrest.

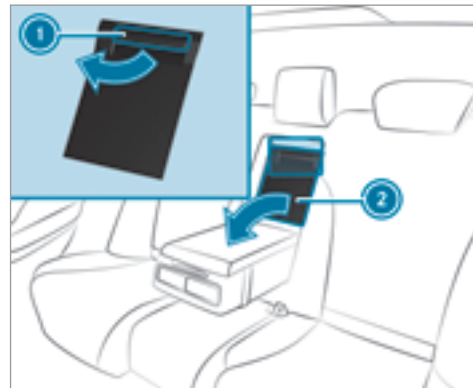

Vehicles with a rear bench seat

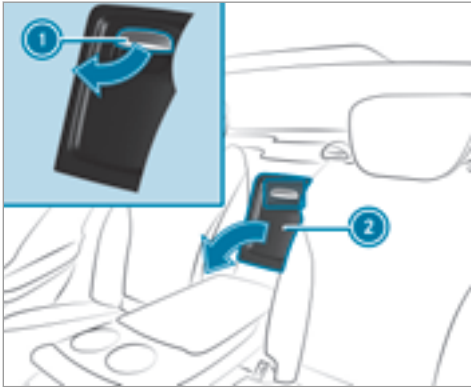

Vehicles with electrically adjustable outer seats

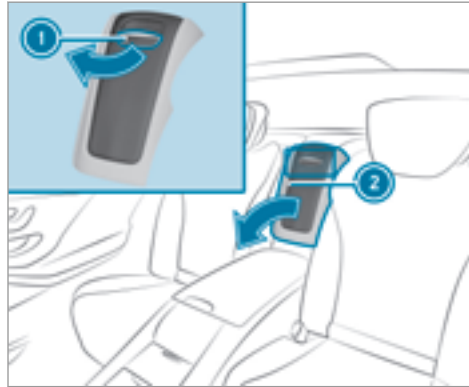

Vehicles with individual rear seats

- ▶ **Vehicles with a rear bench seat or electrically adjustable outer seats:** Fold down the rear armrest.
- ▶ Pull handle ① and fold down cover ②.

### Parcel net hooks

Observe the following notes:

- Secure the load using the parcel net hooks.
- Do not use elastic straps or nets to secure a load. These are intended only as anti-slip protection for light loads.
- Do not route tie downs across sharp edges or corners.
- Pad sharp edges for protection.

There are up to four parcel net hooks in the trunk depending on the equipment installed.

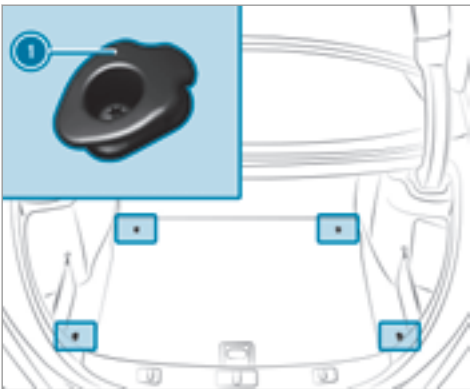

① Parcel net hooks

### Using the bag hooks

**⚠ WARNING** Risk of injury when using bag hooks with heavy objects

The bag hooks cannot restrain heavy objects or items of luggage.

Objects or items of luggage could be thrown around and thereby hit vehicle occupants when braking or abruptly changing directions.

- ▶ Only hang light objects on the bag hooks.
- ▶ Never hang hard, sharp-edged or fragile objects on the bag hooks.



▶ Pull bag hook ② down by tab ①.

① Observe the notes on loading the vehicle (→ page 118).

### EASY-PACK trunk box

#### Adjusting the height of the EASY-PACK trunk box to any position

**⚠ WARNING** Risk of becoming trapped and injured when moving the floor up

When the floor moves up, your hands may become trapped on the frame of the EASY-PACK trunk box and objects may be thrown up.

- ▶ When the floor moves up, make sure that your hands are not within the sweep of the floor.
- ▶ If someone becomes trapped, carefully push the center of the floor downward.
- ▶ Remove all objects from the floor before moving it up.

**⚠ WARNING** Risk of becoming trapped when pressing the EASY-PACK trunk box in

When the EASY-PACK trunk box is pressed into the retracted position, your hands may become trapped. Children, in particular, may injure themselves when doing so.

- ▶ When pressing the EASY-PACK trunk box in, make sure that your hands are not within the sweep of the EASY-PACK trunk box.
- ▶ When leaving the vehicle, always take the SmartKey with you and lock the vehicle.
- ▶ Never leave children unattended in the vehicle.

**! NOTE** Damage to the extended EASY-PACK trunk box

The EASY-PACK trunk box may be damaged when it is extended.

- ▶ Do not place any objects on or press down on the EASY-PACK trunk box frame.
- ▶ Do not close the trunk lid when the EASY-PACK trunk box is extended.

**! NOTE** Damage to the EASY-PACK trunk box by objects

Objects which are sharp-edged, pointed, fragile, rounded or heavy and objects that roll can damage the EASY-PACK trunk box and be thrown out.

- ▶ Do not transport objects which are sharp-edged, pointed, rounded or fragile and objects that roll in the EASY-PACK trunk box.
- ▶ Always stow and secure such objects outside of the box in the trunk.
- ▶ Always observe the maximum permitted load of the EASY-PACK trunk box.
- ▶ Do not use the EASY-PACK trunk box when the rear seats are folded forwards.

The maximum permissible load of the EASY-PACK trunk box is 22 lbs (10 kg). To prevent the box from being overloaded, the box floor lowers onto the trunk floor when the load reaches approximately 11 lbs (5 kg).

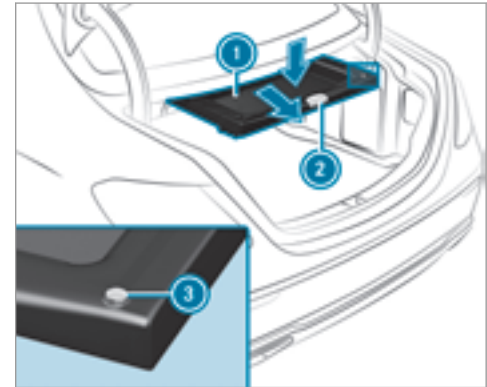

- ▶ **To remove:** pull handle (2) of the box.

- ▶ **To increase the load capacity:** press the center of floor ① downwards to the desired position and box size.
  - ▶ **To reduce the load capacity:** press button ③.
  - ▶ **To stow:** press the box in completely using handle ② until it locks in place.
- ⓘ Observe the notes on cleaning the EASY-PACK trunk box (→ page 390).

## Installing or removing the EASY-PACK trunk box

### Installing

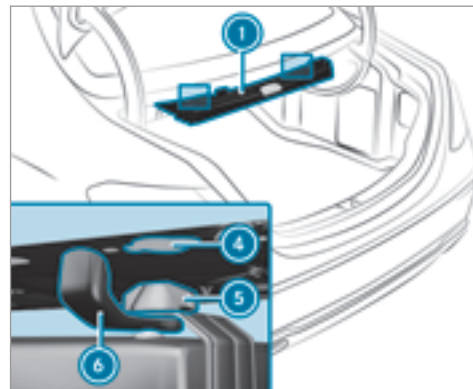
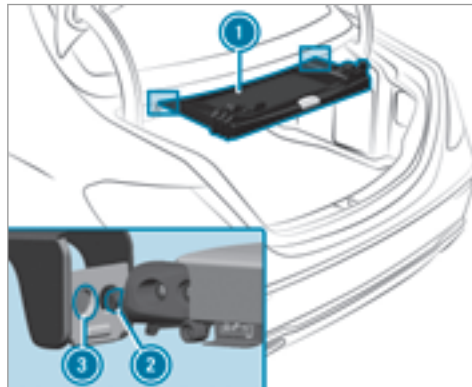

- ▶ Turn rotating catches ⑥ outward.
- ▶ Insert retainers ② of box ① into outer holes ③.
- ▶ Raise box ① and press hooks ⑤ into rear shelf ④.
- ▶ Turn rotating catches ⑥ inward.



## Removing

- ▶ Turn rotating catches ⑥ outward.
- ▶ Lower box ① and pull it out of anchorages ④.
- ▶ Pull box ① back out of openings ③.

## Opening the stowage space under the trunk floor

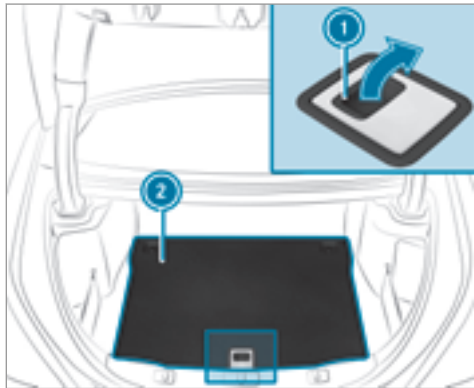

- ▶ Pull trunk floor ② upwards using handle ① until it rests against the trunk separator.

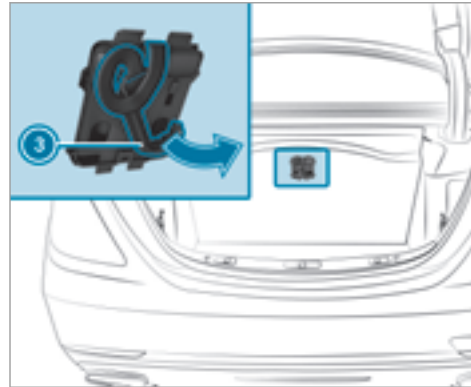

- ▶ Fold out hook ③ on the underside of the trunk floor.

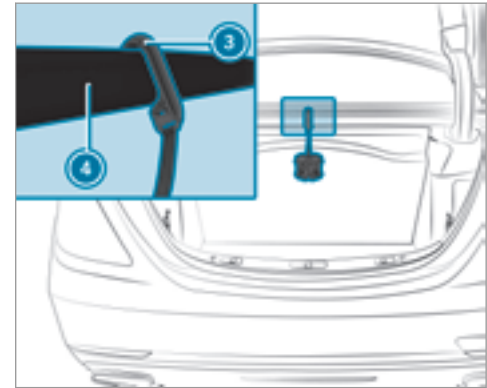

- ▶ Clip hook ③ into groove ④.

## Attaching the roof rack

**⚠ WARNING** Risk of injury by exceeding the maximum roof load

When you load the roof, the vehicle center of gravity rises and the driving characteristics change.

If you exceed the maximum roof load, the driving characteristics, as well as the steering and braking, will be greatly impaired.

▶ Never exceed the maximum roof load and adjust your driving style.

The maximum roof load can be found under "Technical data".

**! NOTE** Vehicle damage from non-approved roof racks

The vehicle could be damaged by roof racks which have not been tested and approved by Mercedes-Benz.

▶ Only use roof racks tested and approved by Mercedes-Benz.

▶ Depending on the vehicle equipment, ensure that when the roof rack is installed:

- The sliding sunroof can be fully raised.
- The trunk lid can be fully opened.

▶ Position the load on the roof rack in such a way that the vehicle will not sustain damage even when it is in motion.

**! NOTE** Damage to the sliding sunroof when a roof rack is installed

The sliding sunroof may be damaged by the roof rack if you attempt to open it when the roof rack is installed.

▶ Do not open the sliding sunroof when the roof rack is installed.

In order to allow ventilation of the vehicle interior, you can raise the sliding sunroof.

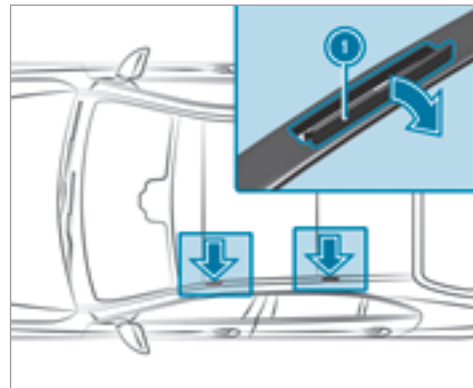

**! NOTE** Damage to the covers

The covers may be damaged and scratched when being opened.

▶ Do not use metallic or hard objects.

▶ Fold covers ① carefully upwards in the direction of the arrow.

- ▶ Secure the roof rack to the anchorage points under covers ①.
- ▶ Comply with the roof rack manufacturer's installation instructions.
- ▶ Secure the load on the roof rack.

### Cup holder

#### Removing or installing the cup holder in the center console

**⚠ WARNING** - Risk of accident or injury when using the cup holder while the vehicle is moving

The cup holder cannot secure containers while the vehicle is moving.

If you use a cup holder while the vehicle is moving, the container may be flung around and liquids may be spilled. The vehicle occupants may come into contact with the liquid and if it is hot, they could be scalded. You could be distracted from traffic conditions and you may lose control of the vehicle.

- ▶ Only use the cup holder when the vehicle is stationary.
- ▶ Only use the cup holder for containers of the right size.
- ▶ Close the container, particularly if the liquid is hot.

Observe the following for Mercedes-Maybach vehicles equipped with champagne glasses:

- Do not use the champagne glasses while the vehicle is in motion
- Do not use champagne glasses made of breakable glass, and store them in the trunk if possible.

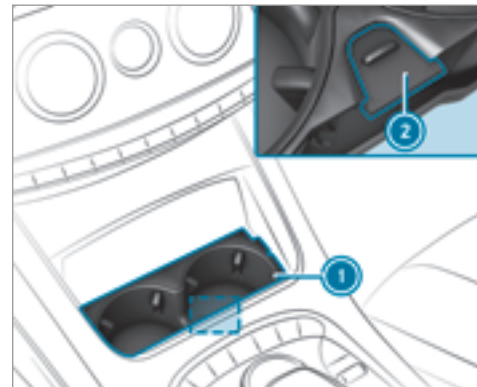

- ▶ **To remove:** slide catch ② forwards and pull out cup holder ①.
- ▶ **To install:** insert cup holder ① and slide back catch ②.
- ① The cup holder rubber mat can be removed for cleaning, e.g. using clean, lukewarm water.
- ① Observe the notes on loading the vehicle (→ page 118).

### Opening the cup holder in the rear armrest (vehicles with rear bench seat)

**!** **NOTE** Damage to the cup holder

When the rear armrest is folded back the cup holder could become damaged.

- ▶ Only fold the rear armrest back when the cup holder is closed.

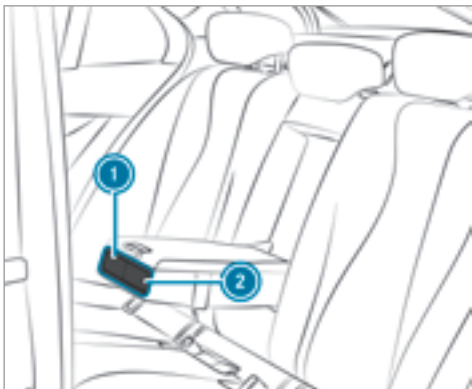

- ▶ **To open:** press cup holder ① or ②.
- ▶ Place or remove a container in cup holder ① or ②.

### Opening or closing the cup holder in the rear armrest (vehicles with electrically adjustable rear seats)

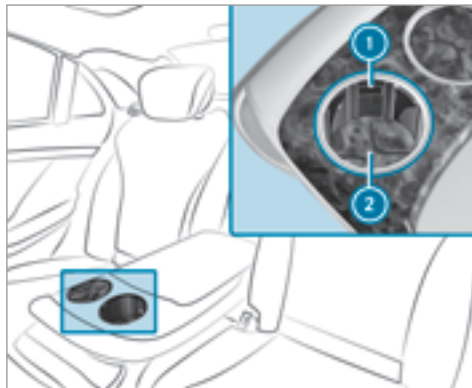

- ▶ **To open:** press down cup holder base ② in the middle until it engages.
- ▶ **To close:** press closing button ①.

- ⓘ The cup holder insert can be removed for cleaning, e.g. using clean, lukewarm water.

### Removing and fitting the cup holder insert in the rear armrest (vehicles with electrically adjustable rear seats)

#### Removing the insert

**!** **NOTE** Damage to the wooden trim

The wooden trim can be damaged by pulling out the cup holder insert.

- ▶ Do not pull the cup holder insert out from the rear armrest any farther than 0.6 in (15 mm).

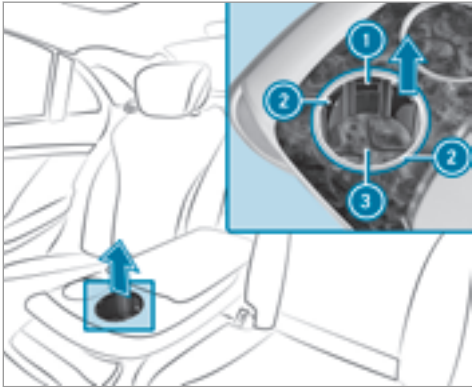

- ▶ Press down cup holder base ③ in the middle until it engages.
- ▶ Press both retaining clips ② and pull the cup holder insert upwards approximately 0.6 in (15 mm).
- ▶ Press button ①.  
Cup holder base ③ raises.
- ▶ Remove the cup holder insert from the rear armrest completely.

### Installing the insert

#### 1 NOTE Damage to the wooden trim

The wooden trim can be damaged by inserting the cup holder insert.

- ▶ Make sure that the cup holder insert has been inserted into the recess correctly.

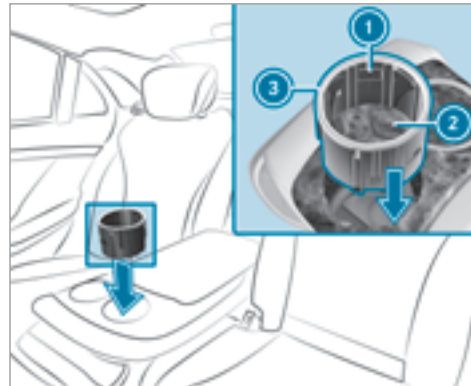

- ▶ Make sure that cup holder base ② is in the upper position.
- ▶ Place the cup holder insert into the recess in the rear armrest such that button ① is facing forwards.
- ▶ Press the cup holder insert down.
- ▶ Press outer ring ③ of the cup holder insert until the cup holder insert engages audibly.

### Switching the cooling or heating function for the temperature-controlled cup holder on or off

When the heating function is used, the metal insert of the cup holder is heated. For this reason, you must not reach into the cup holder insert.

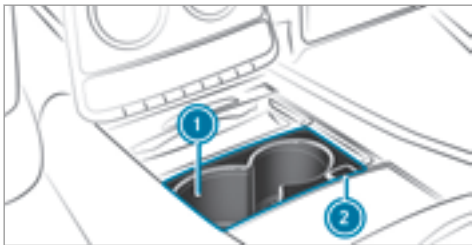

▶ **To switch on:** press button ② repeatedly until the blue (keep cool) or red (keep warm) indicator lamp on the button lights up.

▶ **To switch off:** press button ② repeatedly until the indicator lamp on the button goes out.

① Only clean the removable rubber mat with clear, lukewarm water, and cup holder ① with a damp cloth.

### Ashtray and cigarette lighter

#### Using the ashtray in the front center console

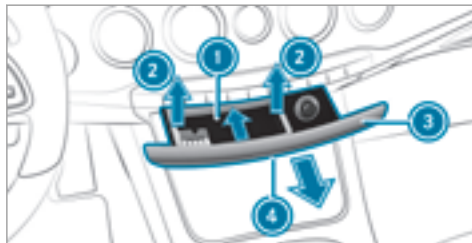

▶ **To open:** briefly press marking ④.

▶ **To remove the insert:** grip the sides of insert ①, push it forward and pull it upwards ②.

▶ **To re-install the insert:** press insert ① into the drawer until it engages.

▶ **To close:** press stowage compartment ③ closed until it locks.

#### Using the ashtray in the rear door

To use the ashtray, you can place it in a cup holder or hold it in your hand.

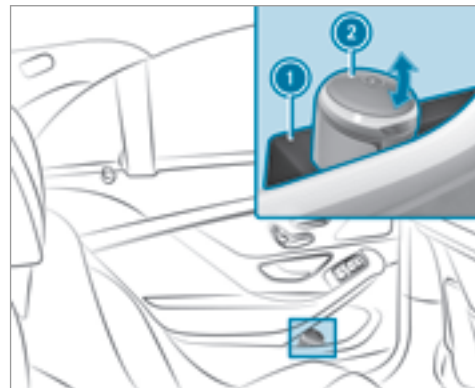

▶ Fold lid ② upwards.

If you are not using the ashtray, close it and place it in retainer ① in the rear door.

## Using the cigarette lighter in the front center console

**⚠ WARNING** - Risk of fire and injury from hot cigarette lighter

You can burn yourself if you touch the hot heating element or the socket of the cigarette lighter.

In addition, flammable materials may ignite if:

- you drop the hot cigarette lighter
  - a child holds the hot cigarette lighter to objects, for example
- ▶ Always hold the cigarette lighter by the knob.
- ▶ Always make sure that the cigarette lighter is out of reach of children.
- ▶ Never leave children unattended in the vehicle.

### Requirements:

- The ignition is switched on.



- ▶ Press in cigarette lighter ①.  
The cigarette lighter will pop out automatically when the heating element is red-hot.

## Using the cigarette lighter in the rear passenger compartment

### Requirements:

- The ignition is switched on.

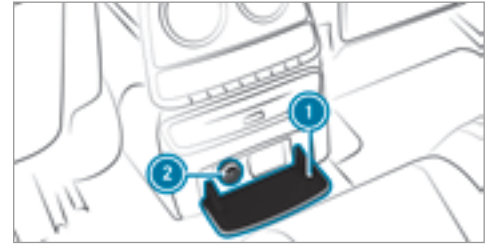

Vehicles with a rear bench seat or electrically adjustable outer seats



Vehicles with individual rear seats

- ▶ Lightly press cover ①.
- ▶ Press in cigarette lighter ②.  
The cigarette lighter will pop out automatically when the heating element is red-hot.

## Sockets

### Using the 12 V socket in the front center console

#### Requirements:

- Only connect devices up to a maximum of 180 watts (15 A).



- ▶ Lift up socket cap ①.

- ▶ Insert the plug of the device.

If you have connected a device to the 12 V socket, leave the cover of the stowage compartment open.

### Using the 12 V socket in the rear passenger compartment

#### Requirements:

- Only connect devices up to a maximum of 180 watts (15 A).



Vehicles with a rear bench seat or electrically adjustable outer seats

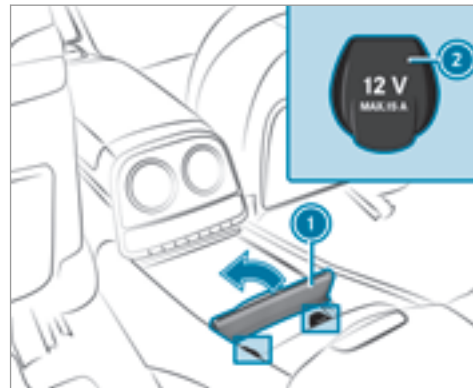

Vehicles with individual rear seats

- ▶ Lightly press cover ①.
- ▶ Lift up socket cap ②.
- ▶ Insert the plug of the device.

If you have connected a device to the 12 V socket, leave the cover of the stowage compartment open.



## Using the 115 V socket in the rear passenger compartment

**⚠ DANGER** Risk of fatal injury due to damaged connecting cables or sockets

If a suitable device is connected, the 115 V socket will be carrying a high voltage. If the connecting cable or the 115 V socket is pulled out of the trim or is damaged or wet, you could receive an electric shock.

- ▶ Only use dry and damage-free connecting cables.
- ▶ When the ignition is switched off, ensure that the 115 V socket is dry.
- ▶ If the 115 V socket is damaged or gets pulled out of the paneling, immediately have the socket checked or replaced at a qualified specialized workshop.
- ▶ Never plug the connecting cable into a 115 V socket that is damaged or has been pulled out of the trim.

**⚠ DANGER** Risk of fatal injury due to incorrect handling of the socket

You could receive an electric shock:

- if you reach into the socket.
  - if you insert unsuitable devices or objects into the socket.
- ▶ Only connect suitable devices to the socket.

### Requirements

- Only connect devices with a suitable plug which conforms to the standards specific to the country you are in.
- Only connect devices up to a maximum of 150 watts.
- Do not use multiple socket outlets.

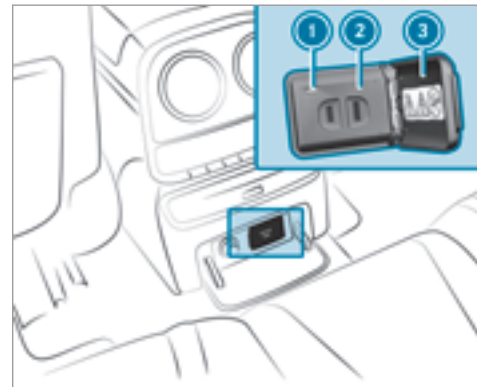

Vehicles with a rear bench seat or electrically adjustable outer seats

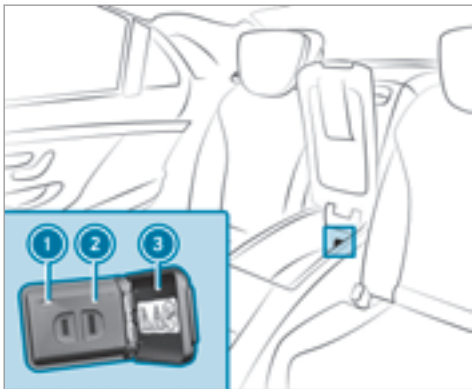

Vehicles with individual rear seats

- ▶ Open flap ③.
  - ▶ Insert the plug of the device into 115 V socket ②.
- When the on-board electrical system voltage is sufficient, indicator lamp ① lights up.

### Using the 12 V socket in the trunk

#### Requirements:

- Only connect devices up to a maximum of 180 watts (15 A).

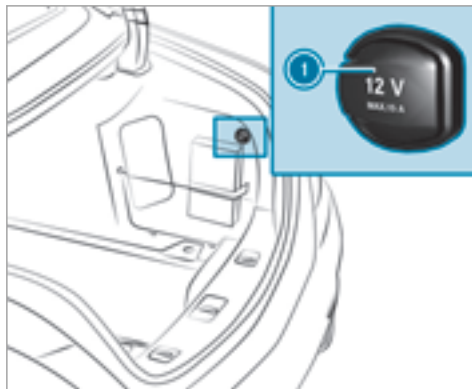

- ▶ Lift up cap ① of the socket and insert the plug of the device.

### USB port in the rear passenger compartment

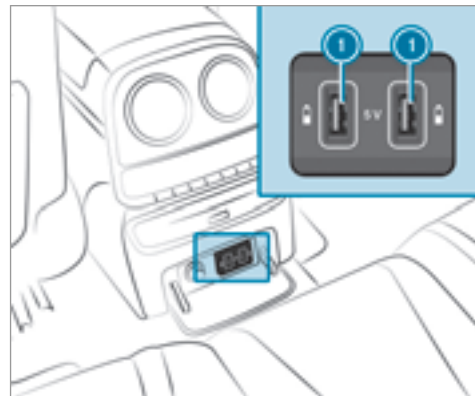

Vehicles with a rear bench seat or electrically adjustable outer seats

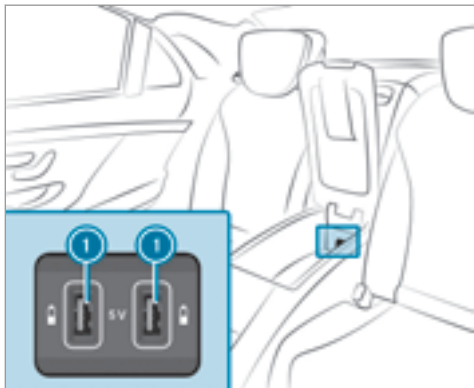

Vehicles with individual rear seats

You can charge a USB device, e.g. a mobile phone, at USB ports ❶ using a suitable charging cable. The devices can be charged with 5 V (2.1 A) and when the ignition is switched on.

## Refrigerator box

### Using the refrigerator box

**⚠ WARNING** Risk of fire due to a covered vent grille on the refrigerator box

If you cover the vent grille for the refrigerator box, it may overheat.

▶ Always make sure that the vent grille is not covered.

The vent grille for the refrigerator box is in the trunk.

The refrigerator box can bear a maximum load of 7.7 lb (3.5 kg).

Store only plastic bottles in the upper compartment of the refrigerator box. The contents of the bottle must be no more than 17 fl. oz. (0.5 l).

If you do not need to use the refrigerator box for an extended period you should switch it off, defrost it and clean it. After doing so, leave the lid open for a time.

The refrigerator box reduces its cooling capacity or switches off in the following cases:

- too many electrical consumers are turned on
- the starter battery is not sufficiently charged

If this is the case, the indicator lamps flash in the button to switch the refrigerator box on and off. The cooling function will automatically switch back on as soon as there is sufficient voltage.

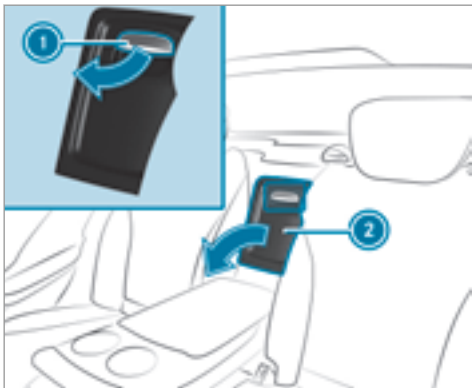

- ▶ Vehicles with a rear bench seat or electrically adjustable outer seats: fold down the rear armrest.
- ▶ Pull handle ① and fold down cover ②.

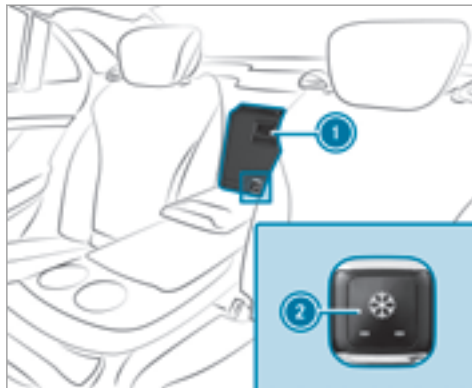

- ▶ **To open:** pull handle ① and fold down the cover.
- ▶ **To switch on:** press button ② repeatedly until an indicator lamp (low cooling) flashes or two indicator lamps (high cooling) flash.
- ▶ **To switch off:** press button ② repeatedly until both indicator lamps go out.

## Removing or installing the refrigerator box

### Removing

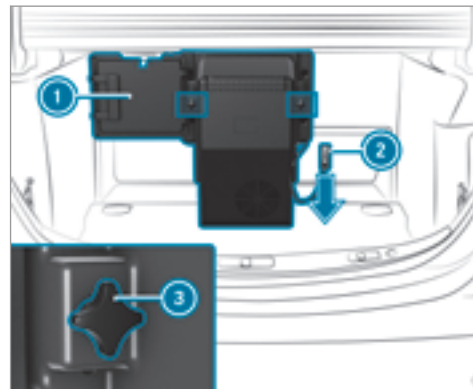

- ▶ Switch off the refrigerator box.
- ▶ Pull plug ② down and out.
- ▶ Unscrew both screws ③.
- ▶ Pull out the refrigerator box.
- ▶ Close flap ①.

## Installing

- ▶ Swing flap ① to the side until it is locked in place by the magnet.
- ▶ Insert the refrigerator box.
- ▶ Tighten both screws ③.
- ▶ Connect plug ②.

## Wireless charging of the mobile phone and connection with the exterior antenna

### Notes on wireless charging of the mobile phone

**⚠ WARNING** Risk of injury from incorrectly stowed objects

If objects in the vehicle interior are stowed incorrectly, they can slide or be thrown around and hit vehicle occupants. In addition, cup holders, open stowage spaces and mobile phone brackets cannot always retain all objects they contain.

There is a risk of injury, particularly in the event of sudden braking or a sudden change in direction.

- ▶ Always stow objects so that they cannot be thrown around in such situations.
- ▶ Always make sure that objects do not protrude from stowage spaces, luggage nets or stowage nets.
- ▶ Close the lockable stowage spaces before starting a journey.
- ▶ Always stow and secure heavy, hard, pointed, sharp-edged, fragile or bulky objects in the trunk.

Observe the notes on loading the vehicle.

**⚠ WARNING** Risk of fire from placing objects in the mobile phone stowage compartment

If you place objects in the mobile phone stowage compartment, they may heat up excessively and even catch fire.

- ▶ Do not place additional objects, especially those made of metal, in the mobile phone stowage compartment.

**! NOTE** Damage to objects caused by placing them in the mobile phone stowage compartment

If you place objects in the mobile phone stowage compartment, these may be damaged by electromagnetic fields.

- ▶ Do not place credit cards, storage media or other objects sensitive to electromagnetic fields in the mobile phone stowage compartment.

**! NOTE** Damage to the mobile phone stowage compartment caused by liquids

If liquids enter the mobile phone stowage compartment, the compartment may be damaged.

- ▶ Ensure that no liquids enter the mobile phone stowage compartment.

- Depending on the vehicle equipment, the mobile phone is connected to the vehicle's exterior antenna via the charging module.
- The charging function and wireless connection of the mobile phone to the vehicle's exterior antenna are only available if the ignition is switched on.
- Small mobile phones may not be able to be charged in every position of the mobile phone stowage compartment.
- Large mobile phones which do not rest flat in the mobile phone stowage compartment may not be able to be charged or connected with the vehicle's exterior antenna.
- The mobile phone may heat up during the charging process.
- To ensure more efficient charging and connection with the vehicle's exterior antenna, remove the protective cover from the mobile phone.
- When charging, the mat should be used if possible.

### Wireless charging of the mobile phone in the front

#### Requirements:

- The mobile phone must be suitable for wireless charging (Qi-compatible mobile phone). You can find a list of Qi-compatible mobile phones at:

<http://www.mercedes-benz.com/connect>

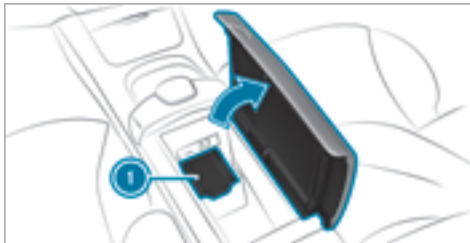

Example: vehicles without a rear air conditioning system

- ▶ Place the mobile phone as close to the center of mat ① as possible with the display facing upwards.

When the charging symbol is shown in the multimedia system, the mobile phone is being charged.

Malfunctions during the charging process are shown in the multimedia system display.

- ⓘ The mat can be removed for cleaning, e.g. using clean, lukewarm water.

### Wireless charging of a mobile phone in the rear passenger compartment

#### Requirements:

- The mobile phone must be suitable for wireless charging (Qi-compatible mobile phone). You can find a list of Qi-compatible mobile phones at:

<http://www.mercedes-benz.com/connect>

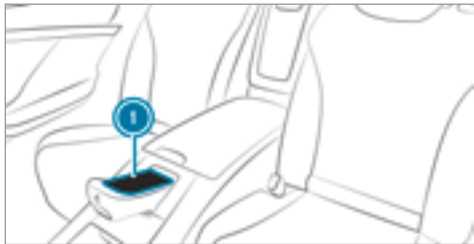

Example: vehicles with individual rear seats

- ▶ Place the mobile phone as close to the center of mat ① as possible with the display facing upwards. When the indicator lamp at the front of the mobile phone system lights up, the mobile phone is being charged.
- ① The mat can be removed for cleaning, e.g. using clean, lukewarm water.

### Installing or removing the floor mats

**⚠ WARNING** Risk of accident due to objects in the driver's footwell

Objects in the driver's footwell may impede pedal travel or block a depressed pedal.

This jeopardizes the operating and road safety of the vehicle.

- ▶ Stow all objects in the vehicle securely so that they cannot get into the driver's footwell.
- ▶ Always install the floor mats securely and as prescribed in order to ensure that there is always sufficient room for the pedals.
- ▶ Do not use loose floor mats and do not place floor mats on top of one another.

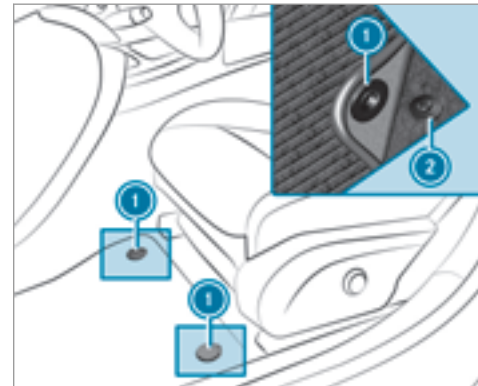

- ▶ **To install:** press studs ① onto holders ②.
- ▶ **To remove:** pull the floor mat off holders ②.

### Installing/removing the pennant holder

#### Installing

The pennant holder is installed or removed in identical fashion on both the driver's and front passenger sides.

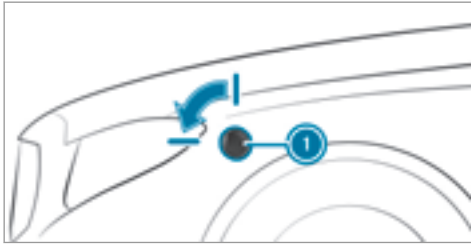

- ▶ Press cover ① and turn it forwards in the direction of travel.
- ▶ Remove the cover.

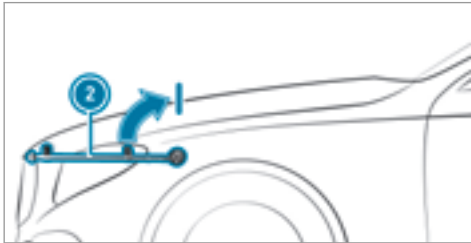

- ▶ Position pennant holder ② horizontally on the opening and press it in.
- ▶ Turn pennant holder ② in the opposite direction to the direction of travel until it is in a vertical position and engages in place.

### Removing

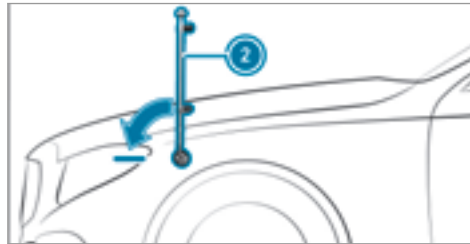

- ▶ Press pennant holder ② into the opening and turn it forwards in the direction of travel until it is in a horizontal position.
- ▶ Remove pennant holder ②.

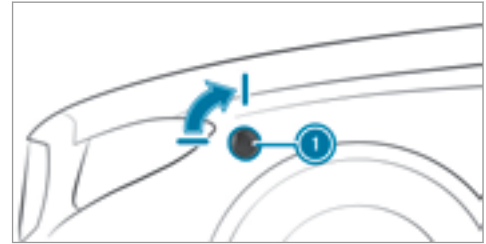

- ▶ Install cover ① and turn it backwards in the opposite direction to the direction of travel.

The pennant holder can be stowed in the parcel net in the trunk, for example.



## Exterior lighting

### Lighting systems and your responsibility

The various lighting systems of the vehicle are only aids. The driver of the vehicle is responsible for correct vehicle illumination in accordance with the prevailing light and visibility conditions, legal requirements and traffic situation.

## Light switch

### Operating the light switch

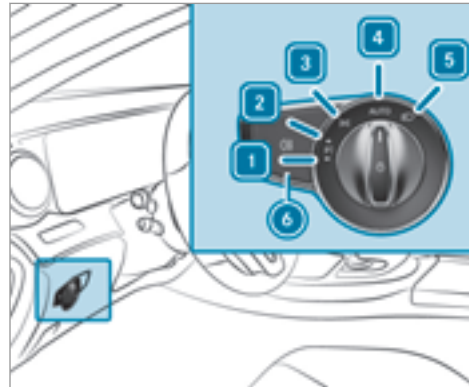

- ▶ 1 Left-hand standing lamps
- ▶ 2 Right-hand standing lamps
- ▶ 3 Parking lights and license plate lighting

- ▶ 4 **AUTO** Automatic driving lights (preferred light switch position)
- ▶ 5 Low beam/high beam
- ▶ 6 Switches the rear fog light on or off

When low beam is activated, the indicator lamp for the parking lights is deactivated and replaced by the low beam indicator lamp.

Always park your vehicle safely and in a well-lit area, in accordance with the relevant legal stipulations.

**!** **NOTE** Battery discharging by operating the standing lights

Operating the standing lights over a period of hours puts a strain on the battery.

- ▶ Where possible, switch on the right or left parking light.

In the case of severe battery discharging, the standing lamps or standing lamps are automatically switched off to facilitate a future engine start.

The exterior lighting (except parking and standing lamps) switches off automatically when the driver's door is opened.

- Observe the notes on surround lighting (→ page 147).

### Automatic driving lights

The parking lights, low beam and daytime running lamps are switched on automatically depending on the ignition status, whether the engine is running and on the ambient light.

**⚠ WARNING** Risk of accident when the low beam is switched off in poor visibility

When the light switch is set to **AUTO**, the low beam may not be switched on automatically if there is fog, snow or other causes of poor visibility such as spray.

- ▶ In such cases, turn the light switch to .

The automatic driving lights are only an aid. You are responsible for vehicle lighting.

### Activating/deactivating the rear fog light

#### Requirements:

- The light switch is in the  or **AUTO** position.

- ▶ Press the  button.

Please observe the country-specific laws on the use of rear fog lamps.

### Operating the light combination switch

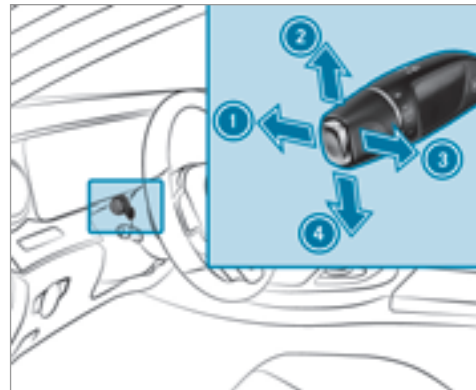

- ① High-beam headlamps
- ② Turn signal light, right
- ③ High-beam flasher
- ④ Turn signal light, left

- ▶ **To indicate briefly:** press the combination switch briefly up to the pressure point in the direction of arrow ② or ④.  
The corresponding turn signal light flashes three times.
- ▶ **To indicate permanently:** press the combination switch beyond the pressure point in the direction of arrow ② or ④.

#### Vehicles with Active Lane Keeping Assist:

Active Lane Keeping Assist can:

- Lengthen turn signal operation for the duration of the lane change if the driver has activated the turn signal indicator.
  - Automatically activate the turn signal indicator, if the driver indicated to turn in that direction immediately previously but a lane change was not immediately possible.
- ▶ **To switch on the high beam:** turn the light switch to the  position.
  - ▶ Press the combination switch beyond the pressure point in the direction of arrow ①.  
When the high beam is activated, the indicator lamp for low beam is deactivated and

replaced by the indicator lamp for the high beam.

- ▶ **To switch off the high beam:** move the combination switch back to its starting position.
- ▶ **High-beam flasher:** pull the combination switch in the direction of arrow ③.

#### Activating/deactivating the hazard warning light

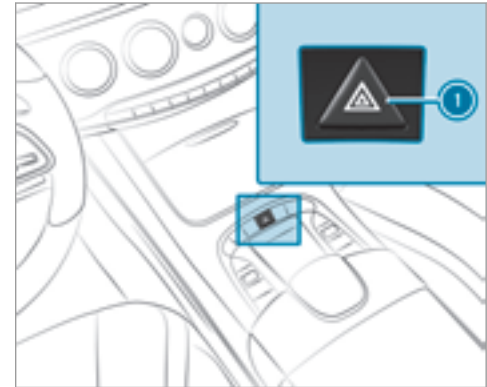

- ▶ Press button ①.

## Cornering light

### Cornering light function



Cornering light improves the illumination of the road over a wide angle in the turning direction, enabling better visibility in tight bends, for example. It can only be activated when low beam is switched on.

The function is active:

- At speeds below 25 mph (40 km/h) when the turn signal light is switched on or the steering wheel is turned.

- At speeds between 25 mph (40 km/h) and 45 mph (70 km/h) when the steering wheel is turned.

**Traffic circle and intersection function:** the cornering light is activated on both sides through an evaluation of the current GPS position of the vehicle. It remains active until after the vehicle has left the traffic circle or the intersection.

## Adaptive Highbeam Assist

### Function of Adaptive Highbeam Assist

**⚠ WARNING** Risk of accident despite Adaptive Highbeam Assist

Adaptive Highbeam Assist does not recognize the following road users:

- Road users without lights, e.g. pedestrians
- Road users with poor lighting, e.g. cyclists
- Road users whose lighting is obstructed, e.g. by a barrier

On very rare occasions, Adaptive Highbeam Assist may fail to recognize other road users with their own lighting, or may recognize them too late.

In these or similar situations, the automatic high beam is not deactivated or is activated despite the presence of other road users.

▶ Always observe the traffic carefully and switch off the high beam in good time.

### System limitations

Adaptive Highbeam Assist cannot take into account road, weather or traffic conditions.

Detection may be restricted if:

- Visibility is impaired, for example in fog, heavy rain or snow.
- There is dirt on the sensors or the sensors are obscured.

Adaptive Highbeam Assist is only an aid. You are responsible for adjusting the vehicle's lighting to the prevailing light, visibility and traffic conditions.



Adaptive Highbeam Assist switches automatically between:

- Low beam
- High beam

At speeds above 19 mph (30 km/h):

- If no other road users are detected, high beam is automatically switched on.

High beam switches off automatically:

- At speeds below 16 mph (25 km/h).
- If other road users are detected.
- If street lighting is sufficient.

At speeds above approx. 31 mph (50 km/h):

- The headlamp range of low beam is regulated automatically based on the distance to other road users.

The system's optical sensor is located behind the windshield near the overhead control panel.

### Switching Adaptive Highbeam Assist on/off

- ▶ **To switch on:** turn the light switch to the **AUTO** position.
- ▶ Switch on the high beam using the combination switch. When the high beam is switched on automatically in the dark, the  indicator lamp in the multifunction display comes on.
- ▶ **To switch off:** switch off the high beam using the combination switch.

### Switching the daytime running lamps on/off

Multimedia system:

➔ Vehicle ▶  Light Settings ▶ Day-time Run. Lights

▶ Activate  or deactivate  the function.

### Setting the surround lighting

**Requirement:**

- The ignition is switched on.

Multimedia system:

➔ Vehicle ▶  Light Settings ▶ Locator Lighting

**Exterior switch-off delay time:** the exterior lighting can be activated for a short time after the vehicle is parked.

▶ Set the switch-off delay time.

**Locator lighting:** if a switch-off delay time is set, the exterior lighting remains lit up for 40 seconds after the vehicle is unlocked. When you start the vehicle, the locator lighting is



switched off and automatic driving lights are activated.

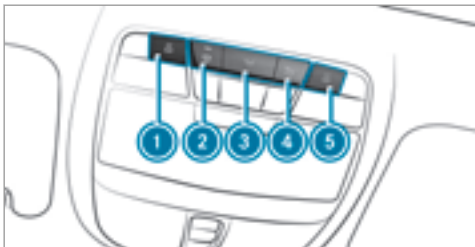

## Interior lighting

### Adjusting the interior lighting

#### Front overhead control panel



- ▶ ①  Switches the front left-hand reading lamp on/off
- ▶ ②  Switches the automatic interior lighting control on/off
- ▶ ③  Switches the front interior lighting on/off

- ▶ ④  Switches the rear interior lighting on/off
- ▶ ⑤  Switches the front right-hand reading lamp on/off

#### Control panel in the grab handle (rear passenger compartment)



You can switch the reading and make-up lamps on or off for one side or for both sides of the vehicle.

- ▶ Press button ① repeatedly until the reading lamp and the make-up lamp switch on or off on the respective side of the vehicle.

- ▶ Press button ② repeatedly until the reading lamp and the make-up lamp switch on or off on both sides of the vehicle.

### Adjusting the ambient lighting

Multimedia system:

➤ Vehicle ➤  Light Settings ➤ Ambient Light

#### Setting the color

- ▶ Select **Color**.
- ▶ Set the color.

#### Setting the brightness

- ▶ Select **Brightness**.
- ▶ Set the brightness value.

#### Activating the brightness for zones

- ▶ Select **Brightness Zones**.
- ▶ Activate  or deactivate  the function. The **Display**, **Front** and **Rear** zones can be set separately.

- ⓘ Setting brightness zones is not available for the Rear Seat Entertainment System.

### Activating multi-color lighting

- ▶ Select **Multi-color**.
- ▶ Activate  or deactivate  the function. There are ten preset color combinations available.

### Activating multi-color animation

- ▶ Select **Multi-color Animation**.
- ▶ Activate  or deactivate  the function. The chosen color combination varies in a pre-defined rhythm.

### Activating climate-dependent lighting

- ▶ Select **Climate**.
- ▶ Activate  or deactivate  the function. The color of the ambient lighting adapts to suit the climate control setting.

### Activating welcome lighting

- ▶ Select **Welcome**.

- ▶ Activate  or deactivate  the function. When the vehicle is unlocked, a special interior lighting sequence runs.

### Setting the interior lighting switch-off delay time

Multimedia system:







→ Vehicle →  Light Settings → Int. Light Switch Off

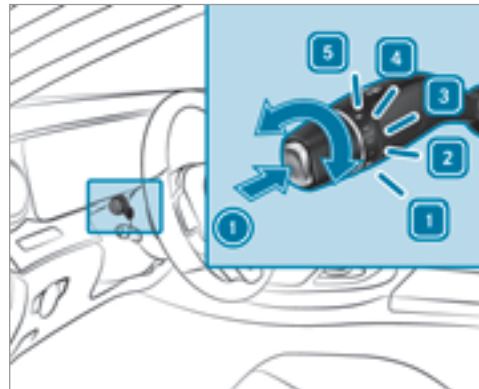

- ▶ Set the switch-off delay time.

## Windshield wiper and windshield washer system

### Switching the windshield wipers on/off



- ▶  Single wipe /  wiper with washer fluid
- ▶   Windshield wipers off
- ▶   Intermittent wiping, normal

- ▶ 3  Intermittent wiping, frequent
- ▶ 4  Continuous wiping, slow
- ▶ 5  Continuous wiping, fast

### Moving the wiper arms to a vertical position (service position)

**⚠ WARNING** Risk of becoming trapped if the windshield wipers are switched on while wiper blades are being replaced

If the windshield wipers begin to move while you are changing the wiper blades, you can be trapped by the wiper arm.

- ▶ Always switch off the windshield wipers and the ignition before changing the wiper blades.

### Activating the service position

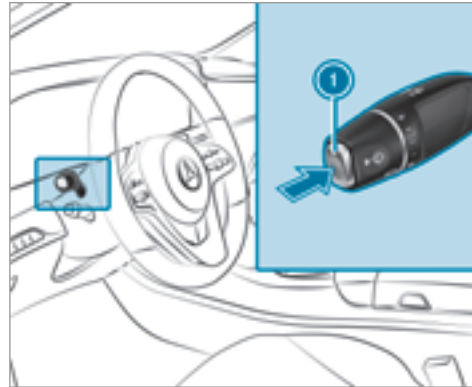

- ▶ Switch the power supply on and off again (→ page 165).
- ▶ Press and hold button ① for longer than a second. The wiper arms move to a position vertical to the hood.
- ▶ Fold the wiper arm away from the windshield.

### Deactivating the service position

- ▶ Switch the power supply on and off again (→ page 165).
- ▶ Press button ①. The wiper arms return to their normal position.



## Changing the windshield wiper blades

### Removing the wiper blades

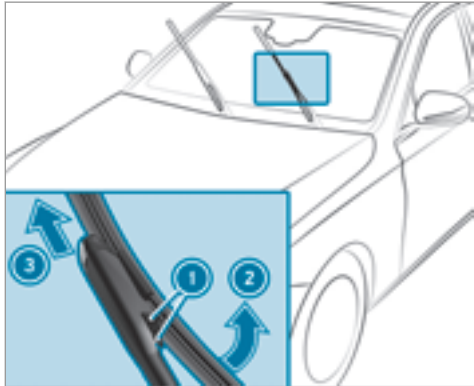

- ▶ Press both retaining clips ①.
- ▶ Fold the wiper blade in the direction of arrow ② away from the wiper arm.
- ▶ Remove the wiper blade in the direction of arrow ③.

### Installing the wiper blades

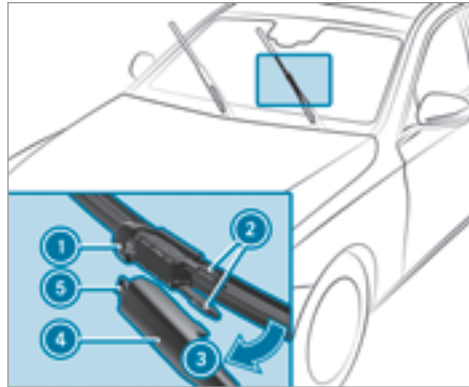

- ▶ Place recess ① of the new wiper blade on locking clip ⑤.
- ▶ Fold the wiper blade in the direction of arrow ③ onto the wiper arm until retaining clips ② engage in bracket ④.
- ▶ Make sure that the wiper blade sits correctly.
- ▶ Fold the wiper arm back onto the windshield.

## Replacing the windshield wiper blades (MAGIC VISION CONTROL)

### Removing the wiper blades

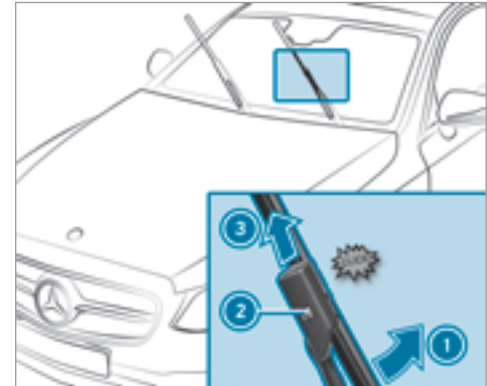

- ▶ **To bring the wiper blade into position to be removed:** hold the wiper arm firmly in one hand. With the other hand, turn the

wiper blade in the direction of arrow ① beyond the point of resistance.

The wiper blade engages in the removal position with a click.

- ▶ **To remove the wiper blade:** press release knob ②, pull the wiper blade in the direction of arrow ③ and remove.

### Installing the wiper blades

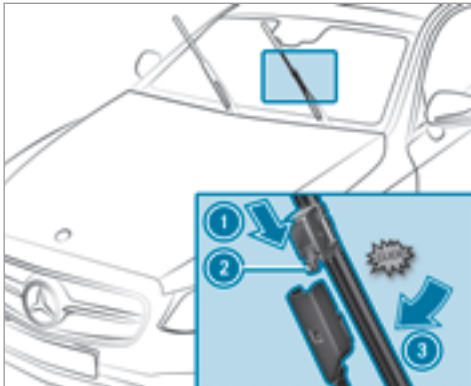

- ▶ Push the new wiper blade onto the wiper arm in the direction of arrow ① until release knob ② engages.
- ▶ Press the wiper blade beyond the point of resistance in the direction of arrow ③ on the wiper arm. The wiper blade engages with a noticeable click and moves freely again.
- ▶ Fold the wiper arm back onto the windshield.

## Mirrors

### Operating the outside mirrors

- ⚠ **WARNING** Risk of injury from adjusting the vehicle settings while the vehicle is in motion

You could lose control of the vehicle in the following situations:

- if you adjust the driver's seat, the head restraint, the steering wheel or the mirror while the vehicle is in motion

- if you fasten your seat belt while the vehicle is in motion
- ▶ Before starting the engine: adjust the driver's seat, the head restraint, the steering wheel or the mirror and fasten your seat belt.

- ⚠ **WARNING** Risk of accident due to misjudgment of distances when using the passenger mirror

The outside mirror on the front passenger side reflects objects on a smaller scale. The objects in view are in fact closer than they appear.

As a result, you may misjudge the distance between you and the road user driving behind you, for example, when changing lanes.

- ▶ Therefore, always look over your shoulder in order to ensure that you are aware of the actual distance between you and the road users driving behind you.

## Folding the outside mirrors in/out

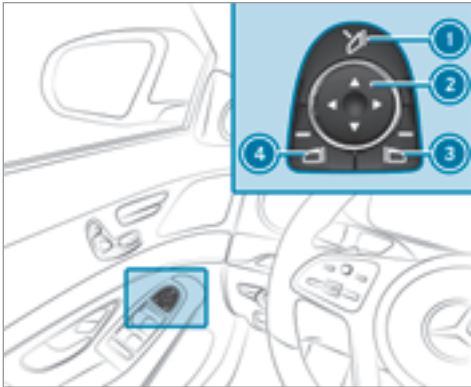

▶ Briefly press switch ①.

① If the battery has been disconnected or completely discharged, the outside mirrors must be reset. Only then will the automatic mirror folding function work properly.

## Adjusting the outside mirrors

- ▶ Select the required mirror using button ③ or ④.
- ▶ Use button ② to set the position of the mirror you have selected.

## Engaging the outside mirrors

- ▶ Press and hold button ①. You will hear a click and the mirror audibly engage in position. The mirror is set in the correct position.

## Information on automatic anti-glare mirrors

**⚠ WARNING** Risk of burns and poisoning due to the anti-glare mirror electrolyte

Electrolyte may escape if the glass in an automatic anti-glare mirror breaks.

The electrolyte is harmful and causes irritation. It must not come into contact with your skin, eyes, respiratory organs or clothing or be swallowed.

- ▶ If you come into contact with electrolyte, observe the following:
  - Rinse the electrolyte from your skin and seek medical attention immediately.
  - If electrolyte comes into contact with your eyes, rinse them thoroughly with clean water and seek medical attention immediately.
  - If the electrolyte is swallowed, immediately rinse your mouth out thoroughly. Do not induce vomiting. Seek medical attention immediately.
  - Immediately change out of clothing which has come into contact with electrolyte.
  - If an allergic reaction occurs, seek medical attention immediately.

The outside mirrors and inside rearview mirrors on the driver's side automatically go into anti-glare mode if light from a headlamp hits the inside rearview mirror.

**System limitations**

The system does not go into anti-glare mode in the following situations:

- the engine is switched off
- reverse gear is engaged
- interior lighting is switched on

**Function of the passenger outside mirror parking position**

The parking position makes parking easier.

The passenger outside mirror tilts downwards and shows the rear wheel on the front passenger side in the following situations:

- the parking position is stored
- the passenger mirror is selected
- reverse gear is engaged

The passenger outside mirror moves back to its original position in the following situations:

- if you shift the transmission to another transmission position
- when driving faster than 9 mph (15 km/h)

- if you press the button for the outside mirror on the driver's side

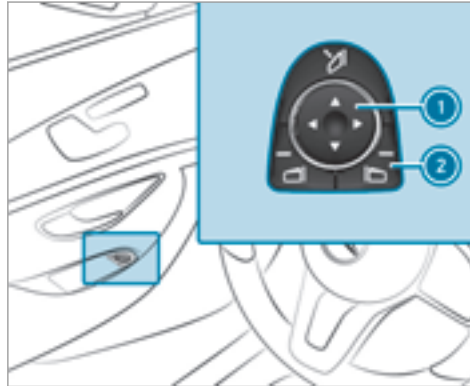
**Storing the parking position of the passenger outside mirror using reverse gear****Storing**

- ▶ Select the passenger outside mirror using button ②.
- ▶ Engage reverse gear.
- ▶ Move the passenger outside mirror into the desired parking position using button ①.

**Calling up**

- ▶ Select the passenger outside mirror using button ②.
- ▶ Engage reverse gear. The passenger outside mirror moves to the stored parking position.

**Activating/deactivating the automatic mirror folding function**

Multimedia system:

↳ Vehicle ▶  Vehicle Settings ▶ Autom. Mirror Folding

- ▶ Activate  or deactivate  the function.

## Operating the sun visors

### Using the single sun visor

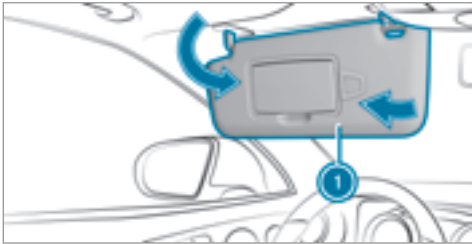

- ▶ **Glare from the front:** fold sun visor ❶ down.
- ▶ **Glare from the side:** swing sun visor ❶ to the side.

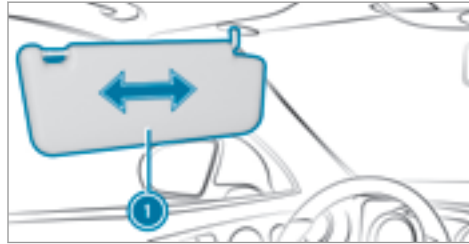

- ▶ Vehicles with an extendable sun visor: slide sun visor ❶ horizontally as required.

### Using the additional sun visor



- ▶ Vehicles with an additional sun visor: fold additional sun visor ❷ down.

## Function of the infrared reflective windshield

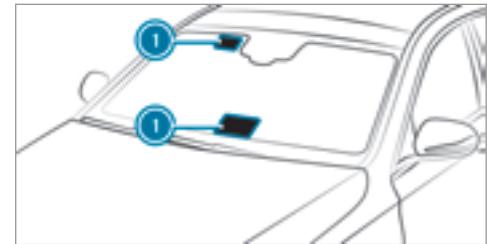

The infrared reflective windshield is coated and prevents an excessive build-up of heat in the vehicle interior.

The coating shields the vehicle interior against radio waves up into the gigahertz range.

Radio-controlled equipment, such as toll systems, can only be mounted on areas of the windshield which are permeable to radio waves ❶.

Areas permeable to radio waves ① are best visible from outside the vehicle when the windshield is illuminated using an external light source.

## Overview of climate control systems

### Overview of the control panel for automatic climate control

**Plug-in hybrid:** observe the notes in the Supplement. Otherwise, you may not recognize dangers.

The indicator lamps in the buttons indicate that the current function is activated.

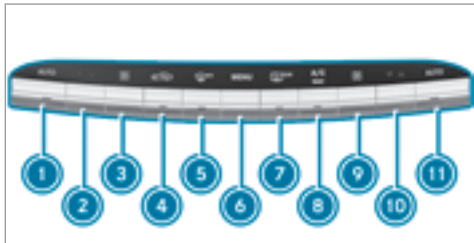

- ① **AUTO** To set climate control to automatic, left (→ page 158)
- ② **▼▲** To set the temperature, left
- ③ **☼** To set the airflow, left

- ④ **🔄** To switch air-recirculation mode on/off (→ page 160)
- ⑤ **MAX** To defrost the windshield
- ⑥ **MENU** To call up the air conditioning menu
- ⑦ **REAR** To switch the rear window heater on/off
- ⑧ **A/C REST** To switch the A/C function on/off (→ page 158)  
To switch the residual heat on or off (→ page 160)
- ⑨ **☼** To set the airflow, right
- ⑩ **▼▲** To set the temperature, right
- ⑪ **AUTO** To set climate control to automatic, right

### Overview of the rear operating unit

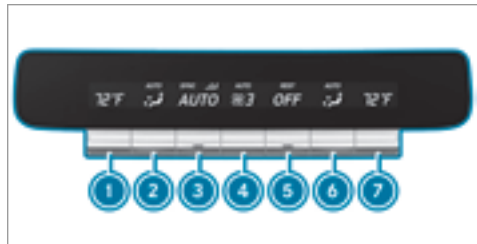



Example: USA

- ① Sets the temperature, left
- ② Sets the air distribution, left
- ③ Sets climate control to automatic mode (→ page 158)
- ④ Sets the airflow
- ⑤ Switches climate control on/off (→ page 158)  
Switches the residual heat on/off (→ page 160)
- ⑥ Sets the air distribution, right
- ⑦ Sets the temperature, right

## Operating the climate control system

### Switching front climate control on/off

- ▶ **To switch on:** set the airflow to level 1 or higher using the  button.
  - ▶ **To switch off:** set the airflow to level 0 using the  button.
- i* If climate control is switched off, the windows may fog up more quickly. Switch off climate control only briefly.

### Switching rear climate control on/off

- ▶ Press button .
- i* When rear climate control is switched off, the indicator lamp is activated and **OFF** is shown in the rear display.

### Activating/deactivating the A/C function via the control panel

The A/C function heats, cools and dehumidifies the vehicle's interior air.

- ▶ Press the  button.

Deactivate the A/C function only briefly otherwise the windows can fog up more quickly.

Condensation may drip from the underside of the vehicle when cooling mode is active. This is not a sign that there is a malfunction.

### Activating/deactivating the A/C function using the multimedia system

Multimedia system:



▶  Vehicle ▶  Climate Control ▶ A/C

The A/C function heats, cools and dehumidifies the vehicle's interior air.

- ▶ Activate  or deactivate  the function.

### Setting front climate control to automatic mode

In automatic mode, the set temperature is regulated by the temperature of the dispensed air and the airflow.

- ▶ Press the  button.
- ▶ **To switch to manual mode:** press the  button.

### Setting climate control in the rear to automatic mode

In automatic mode, the set temperature is regulated by the temperature of the dispensed air and the airflow.

- ▶ Press button .

### Climate style

#### Climate style function

In automatic mode you can select the following climate style settings for the driver's and front passenger areas:

- **FOCUS:** high airflow, slightly cooler setting
- **MEDIUM:** medium airflow, standard setting
- **DIFFUSE:** low airflow, slightly warmer and draft-free setting

#### Setting the climate style

Multimedia system:

▶  Vehicle ▶  Climate Control ▶ Climate Mode









- ▶ Select **FOCUS**, **MEDIUM** or **DIFFUSE**.



-  In order to feel the effect of the climate style, the **AUTO** function must be active (→ page 158).

### Air distribution settings



The symbols in the display indicate which vents the airflow is being directed through:

-  Defroster vents
-  Center and side air vents
-  footwell vents
-  Center, side and footwell vents
-  Defroster and footwell vents
-  All vents
-  Defroster, middle and side air vents
-  Automatic air distribution

### Setting the air distribution

Multimedia system:



 Vehicle   Climate Control  Air Distribution

-  Select **Driver** and/or **Passenger**.
-  Set the air distribution.

### Setting the footwell temperature

Multimedia system:

 Vehicle   Climate Control  Footwell Temperature

-  Select **Driver** and/or **Passenger**.
-  Set the footwell temperature.

### Setting the rear climate control using the multimedia system

Multimedia system:

 Vehicle   Climate Control  Rear

#### Activating rear climate control



If this function is activated, the settings from the front control panel are automatically adopted for rear climate control.

-  Select **Rear On**.
-  Activate  or deactivate  the function.

#### Controlling the rear climate control automatically

-  Select **AUTO**.
-  Activate  or deactivate  the function.

#### Setting the airflow

-  Select **Airflow**.
-  Set the airflow.

#### Setting the temperature

-  Select **Temperature**.

- ▶ Select **Rear Right** and/or **Rear Left**.
- ▶ Set the temperature.

### Setting the air distribution

- ▶ Select **Air Distribution**.
- ▶ Select **Rear Right** and/or **Rear Left**.
- ▶ Set the air distribution.

### Activating/deactivating the climate control synchronization function using the multimedia system

Multimedia system:

➔ Vehicle ➔  Climate Control ➔ SYNC

Climate control can be set centrally using the synchronization function. The temperature setting is automatically adopted for all climate zones.

- ▶ Activate  or deactivate  the function.

### Defrosting the windows

#### Windows fogged up on the inside

- ▶ Press the **AUTO** button.
- ▶ If the windows continue to fog up: press the  button.

#### Windows fogged up on the outside

- ▶ Switch on the windshield wiper.
- ▶ Press the **AUTO** button.

### Switching air-recirculation mode on/off

- ▶ Press the  button.  
The interior air will be recirculated.

Air-recirculation mode is switched off automatically.



- ⓘ If air-recirculation mode is switched on, the windows may fog up more quickly. Switch on air-recirculation mode only briefly.

### Switching the front residual heat on/off

#### Requirements:

- The vehicle is parked.

It is possible to make use of the residual heat from the engine to continue heating or ventilating the front compartment of the vehicle for approximately 30 minutes.

- ▶ **To switch on:** press the  or  button.

Residual heat is switched off automatically.

### Switching the rear residual heat on/off

#### Requirements:

- The vehicle is parked.

When the residual heat of the engine is activated in the rear passenger compartment, you can heat or ventilate the front and rear passenger compartments for approximately 15 minutes.

- ▶ Press button .

## Activating and deactivating ionization

Multimedia system:

➔ Vehicle ➔  Climate Control ➔ Ionization

Ionization cleans and refreshes the interior air of the vehicle. The ionization of the interior air is odorless.

▶ Switch the function on  or off .

## Perfume atomizer

### Setting the fragrance system

#### Requirements:

- Automatic climate control is activated.
- The glove box is closed.

Multimedia system:

➔ Vehicle ➔  Climate Control ➔ Air Freshener

The fragrance system distributes a pleasant fragrance throughout the vehicle interior from a flacon located in the glove box.

▶ **To set the intensity:** select **High**, **Medium**, **Low** or **Off**.

### Inserting or removing the flacon of the fragrance system

**⚠ WARNING** Risk of injury from liquid perfume

If children open the flacon, they could drink the liquid perfume or it could come into contact with their eyes.

- ▶ Consult a doctor immediately if liquid perfume has been drunk.
- ▶ If liquid perfume comes into contact with your eyes or skin, rinse your eyes with clean water.
- ▶ If symptoms continue, consult a doctor.

**🔥 ENVIRONMENTAL NOTE** Environmental damage due to improper disposal of full flacons



Full flacons must not be disposed of with household waste.



Full flacons must be taken to a harmful substance collection point.

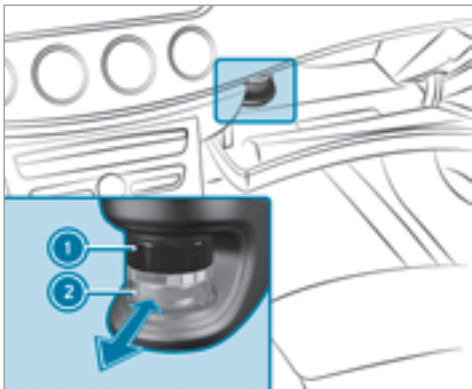

- ① Cap
- ② Flacon

▶ **To insert:** slide the flacon into the holder as far as it will go.

▶ **To remove:** pull out the flacon.

If you do not use genuine Mercedes-Benz interior perfumes, observe the manufacturers' safety notices on the perfume packaging.

Dispose of the genuine Mercedes-Benz interior perfume flacon when it is empty and do not refill it.

### Refillable flacon

- ▶ Unscrew the cap of the empty flacon.
- ▶ Fill the flacon with a maximum of 0.5 fl. oz. (15 ml).
- ▶ Screw the cap back on to the flacon.

Always refill the empty refillable flacon with the same perfume. Observe the separate information sheet attached to the flacon.

### Information on the windshield heater

The windshield heater is switched on automatically if the  button is activated.

After the vehicle is started the windshield heater is switched on automatically as needed.

## Air vents

### Adjusting the front air vents

**⚠ WARNING** - Danger of burns or frostbite due to being too close to the air vents

Very hot or very cold air can flow from the air vents.

This could result in burns or frostbite in the immediate vicinity of the air vents.

- ▶ Make sure that all vehicle occupants always maintain a sufficient distance to the air vents.
- ▶ If necessary, direct the airflow to another area of the vehicle interior.



- ▶ **To open or close:** turn controller ① to the left or right as far as it will go.
- ▶ **To adjust the air direction:** hold air vent ② in the center and move it up or down or to the left or right.

### Adjusting the rear air vents

#### Adjusting the rear center air vent



- ▶ **To open or close:** turn controller ② to the left or right as far as it will go.
- ▶ **To adjust the air direction:** hold air vent ① in the center and move it up or down or to the left or right.

### Adjusting the rear side air vents

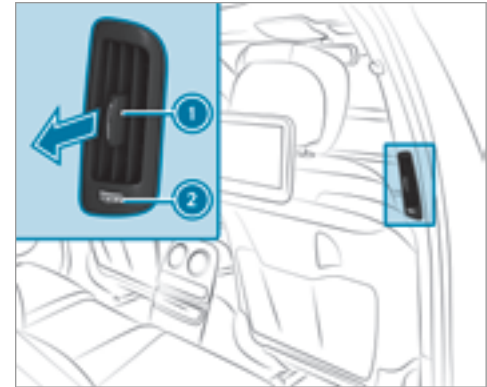

- ▶ **To open or close:** turn controller ② to the left or right.
- ▶ **To adjust the air direction:** hold air vent ① in the center and move it up or down or to the left or right.

## Opening/closing the air vent in the glove box

**!** **NOTE** Damage to temperature-sensitive objects in the glove box

Temperature-sensitive objects stored in the glove box may be damaged by the air vent located inside it.

- ▶ Close the air vent when you heat the vehicle.
- ▶ At high outside temperatures, open the air vent and switch on the A/C function.

### Requirements:

- Automatic climate control is activated.

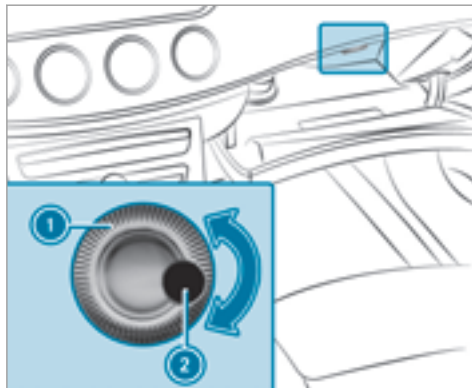

① Air vent controller

② Air vent

- ▶ **To open or close:** turn controller ① to the left or right.

## Driving

### Notes on Mercedes-AMG vehicles

Observe the notes on the following topics in the Supplement. Otherwise, you may not recognize dangers.

- AMG Performance exhaust system
- AMG high-performance brake system and AMG ceramic high-performance composite brake system
- AMG adaptive sport suspension system

### Switching on the power supply or ignition using the start/stop button

**⚠ WARNING** Risk of accident and injury due to children left unattended in the vehicle

If children are left unattended in the vehicle, they could:

- Open doors, thereby endangering other persons or road users

- Get out of the vehicle and be hit by oncoming traffic
- Operate vehicle equipment

In addition, the children could also set the vehicle in motion, for example, by:

- Releasing the parking brake
  - Shifting the transmission out of park position **P**
  - Starting the engine.
- ▶ Never leave children and animals unattended in the vehicle.
  - ▶ When leaving the vehicle, always take the SmartKey with you and lock the vehicle.
  - ▶ Keep the SmartKey out of the reach of children.

**⚠ WARNING** Risk of exhaust gas poisoning

Combustion engines emit poisonous exhaust gases such as carbon monoxide. Inhaling these exhaust gases causes poisoning.

- ▶ Never leave the engine running in an enclosed space without sufficient ventilation.

**⚠ WARNING** Risk of fire caused by flammable material on the exhaust system

Flammable materials brought in by either animals or environmental influences may ignite if they come into contact with hot parts of the engine or exhaust system.

- ▶ Therefore, check regularly that there are no flammable materials in the engine compartment or on the exhaust system.

#### Requirements:

- The SmartKey is located in the vehicle and the SmartKey battery is not discharged.

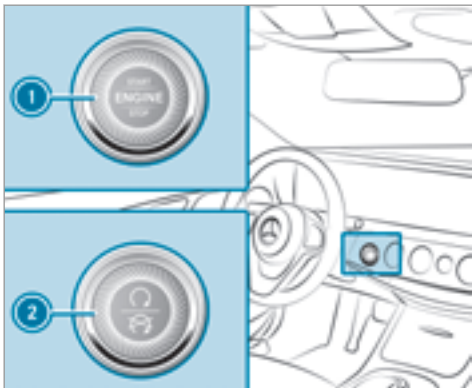

- ▶ **To switch on the power supply:** press button ① (USA) or ② (Canada) once. You can activate the windshield wiper, for example.

The power supply is switched off again if the following conditions are met:

- You open the driver's door.

- You press button ① (USA) or ② (Canada) twice.

- ▶ **To switch on the ignition:** press button ① (USA) or ② (Canada) twice. The indicator lamps in the instrument cluster light up.

The ignition is switched off again if one of the following conditions is met:

- You do not start the vehicle within 15 minutes.
- You press button ① (USA) or ② (Canada) once.

### Starting the vehicle

#### Starting the vehicle with the start/stop button

##### Requirements:

- The SmartKey is located in the vehicle and the SmartKey battery is not discharged.

- ▶ Shift the transmission to position **P** or **N**.

- ▶ Depress the brake pedal and push button ① (USA) or ② (Canada) once.

- ▶ If the vehicle does not start: switch off non-essential consumers and press button ① (USA) or ② (Canada) once.

- ▶ If the vehicle still does not start and the [Place the Key in the Marked Space See Operator's Manual](#) display message also appears in the multifunction display: start the vehicle in emergency operation mode.

You can switch off the engine while driving by pressing button ① (USA) or ② (Canada) for about three seconds. Be sure to observe the safety notes under "Driving instructions".

#### Starting the vehicle via Remote Online services

Cooling or heating the vehicle interior before starting the journey

If you start the vehicle via your smartphone, the previously selected air conditioning adjustment is active.



Before starting, make sure:

- The legal stipulations in the area where your vehicle is parked permit engine starting via smartphone.
- It is safe to start and run the engine where your vehicle is parked.
- The fuel tank is sufficiently filled.
- The starter battery has sufficient charge.

Starting the vehicle using a smartphone

**⚠ WARNING** Risk of crushing or entrapment due to unintentional starting of the engine

Limbs could be crushed or trapped if the engine is started unintentionally during service or maintenance work.

- ▶ Always secure the engine against unintentional starting before carrying out maintenance or repair work.

#### Requirements:

- Park position **P** is selected.
- The anti-theft alarm system is not armed.

- The panic alarm is not armed.
- The hazard warning lights are switched off.
- The engine hood is closed.
- The doors are closed and locked.
- The windows and sliding sunroof are closed.

- ▶ Start the vehicle using the smartphone:
  - After every vehicle start, the engine runs for ten minutes.
  - You can carry out a maximum of two consecutive starting attempts.
  - You can stop the vehicle again at any time.
  - Further information can be found in the smartphone app.

#### Securing the engine against starting before carrying out maintenance or repair work:

- ▶ Switch on the hazard warning lights.  
or
- ▶ Unlock the doors.  
or
- ▶ Open a side window or the sliding sunroof.

#### Starting the vehicle in emergency operation mode

If the vehicle does not start and the [Place the Key in the Marked Space See Operator's Manual](#) display message appears in the multifunction display, you can start the vehicle in emergency operation mode.



- ▶ Make sure that marked space ② is empty.
  - ▶ Remove SmartKey ① from the key ring.
  - ▶ Place SmartKey ① in marked space ②. The vehicle will start after a short while.
- If you remove SmartKey ① from marked space ② the engine continues running. For further vehicle starts however, SmartKey ①

must be located in marked space ② during the entire journey.

- ▶ Have SmartKey ① checked at a qualified specialist workshop.

#### If the vehicle does not start:

- ▶ Leave SmartKey ① in marked space ②.
  - ▶ Depress the brake pedal and start the vehicle using the start/stop button.
- ① You can also switch on the power supply or the ignition with the start/stop button.

#### Breaking-in notes

**Mercedes-AMG vehicles:** observe the notes in the Supplement. Otherwise, you may not recognize dangers.

To preserve the engine during the first 1,000 miles (1,500 km):

- Drive at varying road speeds and engine speeds.
- Drive in drive program **C** or **E**.

- Change gear before the tachometer needle is  $\frac{2}{3}$  of the way to the red area of the tachometer.
- Do not shift down a gear manually in order to brake.
- Avoid overstraining the vehicle, e.g. driving at full throttle.
- Do not depress the accelerator pedal beyond the pressure point (kickdown).
- Only increase the engine speed gradually and accelerate the vehicle to full speed after 1,000 miles (1,500 km).

This also applies when the engine or parts of the drivetrain have been replaced.

Please also observe the following breaking-in notes:

- In certain driving and driving safety systems, the sensors adjust automatically while a certain distance is driven after the vehicle has been delivered or after repairs. Full system effectiveness is not achieved until the end of this teach-in process.

- Brake linings, brake discs and tires that are either new or have been replaced only achieve optimum braking effect and grip after several hundred kilometers of driving. Compensate for the reduced braking effect by applying greater force to the brake pedal.

#### Notes on driving

**⚠ WARNING** Risk of accident due to objects in the driver's footwell

Objects in the driver's footwell may impede pedal travel or block a depressed pedal.

This jeopardizes the operating and road safety of the vehicle.

- ▶ Stow all objects in the vehicle securely so that they cannot get into the driver's footwell.
- ▶ Ensure floor mats and carpets cannot slip and provide sufficient room for the pedals.
- ▶ Do not lay multiple floor mats or carpets on top of one another.

**⚠ WARNING** Risk of accident due to unsuitable footwear

Operation of the pedals may be restricted due to unsuitable footwear such as:

- Shoes with platform soles
- Shoes with high heels
- Slippers

▶ When driving always wear suitable shoes in order to be able to operate the pedals safely.

**⚠ WARNING** Risk of accident due to the ignition being switched off whilst the vehicle is in motion

If you switch off the ignition whilst the vehicle is in motion safety-relevant functions will be restricted or no longer available. This may affect the power steering system and brake force boosting, for example.

You will need to use considerably more force to steer and brake.

▶ Do not switch off the ignition whilst the vehicle is in motion.

**⚠ WARNING** Risk of exhaust gas poisoning

Combustion engines emit poisonous exhaust gases such as carbon monoxide. Inhaling these exhaust gases causes poisoning.

▶ Never leave the engine running in an enclosed space without sufficient ventilation.

**⚠ WARNING** Risk of skidding and of an accident due to shifting down on slippery road surfaces

If you shift down on slippery road surfaces to increase the engine braking effect, the drive wheels may lose traction.

▶ Do not shift down on slippery road surfaces to increase the engine braking effect.

**⚠ DANGER** Risk of fatal injury due to poisonous exhaust gases

If the tailpipe is blocked or sufficient ventilation is not possible, poisonous exhaust gases such as carbon monoxide may enter the vehicle. This is the case if the vehicle gets stuck in snow, for example.

- ▶ Keep the tailpipe and the area around the vehicle free from snow when the engine or the stationary heater are running.
- ▶ Open a window on the windward side of the vehicle to ensure an adequate supply of fresh air.

**⚠ WARNING** Risk of accident and injury due to being under the influence of alcohol and drugs while driving

Driving when under the influence of alcohol and/or drugs is an extremely dangerous combination. Even small quantities of alcohol or drugs may affect your reflexes, perception and judgment.

The probability of a serious or even fatal accident greatly increases if you drive when under the influence of alcohol or drugs.

- ▶ Do not drink alcohol or take drugs while driving, and do not allow anyone to drive who has been drinking alcohol or taking drugs.

**⚠ WARNING** Risk of accident due to the brake system overheating

If you leave your foot on the brake pedal when driving, the brake system may overheat.

This increases the braking distance and the brake system may even fail.

- ▶ Never use the brake pedal as a footrest.
- ▶ Do not depress the brake pedal and the accelerator pedal at the same time while driving.

**! NOTE** Wearing out the brake linings by continuously depressing the brake pedal

- ▶ Do not depress the brake pedal continuously whilst driving.
- ▶ To use the braking effect of the engine, shift to a lower gear in good time.

**! NOTE** Damage to the drivetrain and the engine when pulling away

- ▶ Do not warm up the engine when the vehicle is stationary. Pull away immediately.
- ▶ Avoid high engine speeds and driving at full throttle until the engine has reached operating temperature.
- ▶ Do not allow the wheels to spin.

**! NOTE** Damage to the catalytic converter due to non-combusted fuel

The engine is not running smoothly and is misfiring.

Non-combusted fuel may get into the catalytic converter.

- ▶ Only depress the accelerator pedal slightly.
- ▶ Have the cause rectified immediately at a qualified specialist workshop.

Limited braking effect on salt-treated roads:

- Due to salt build-up on the brake discs and brake lining, the braking distance can increase considerably or result in braking only on one side.
- Maintain a much greater distance to the vehicle in front.

To prevent salt build-up:

- Brake occasionally while paying attention to the traffic conditions.
- Carefully depress the brake pedal at the end of the journey and when starting the next journey.

**Plug-in hybrid:** observe the notes in the Supplement. Otherwise, you may not recognize dangers.

### ECO start/stop function

#### Operation of the ECO start/stop function

**Mercedes-AMG vehicles:** be sure to observe the notes in the Supplement. Otherwise, you may not recognize dangers.

The engine is automatically switched off if the following conditions are met:

- If you brake the vehicle to a standstill in transmission position **D** or **N**.
- If all vehicle conditions for an automatic engine stop are met.

The **A** symbol appears in the multifunction display when the vehicle is stationary.

The engine is restarted automatically if:

- You release the brake pedal with the transmission in position **D** when the HOLD function is not active.
- You shift from transmission position **P**.

- You engage transmission position **D** or **R**.
- You depress the accelerator pedal.
- You change the vehicle level.
- An automatic engine start is necessary.

If the engine was switched off by the ECO start/stop function and you leave the vehicle, a warning tone sounds. The **Vehicle Operational Switch the Ignition Off Before Exiting** display message also appears in the multifunction display. If you do not switch off the ignition, the ignition is automatically switched off after one minute.

### Deactivating or activating the ECO start/stop function

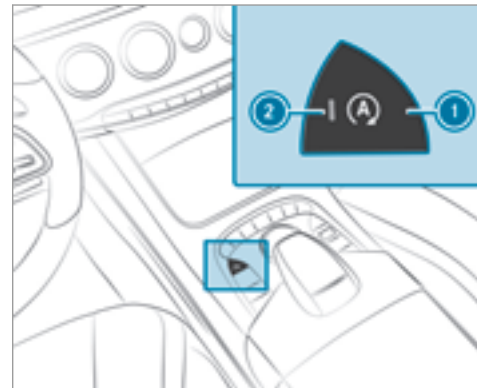

- ▶ Press button **1**.  
If indicator lamp **2** lights up, the ECO start/stop function is switched on.

## Function of the ECO display

The ECO display summarizes the driving style from the start of the journey to its completion and assists you in achieving the most economical driving style.

You can influence consumption if you:

- drive with particular care
- drive the vehicle in drive program **E**
- observe the gearshift recommendations



The inner segment lights up green and the outer segment fills up:

- ① Moderate acceleration

- ② Gentle deceleration and rolling
- ③ Consistent speed

The inner segment is gray and the outer segment empties:

- ① Sporty acceleration
- ② Heavy braking
- ③ Fluctuations in speed

You have driven economically when:

- the three outer segments are completely filled simultaneously.
- the ECO display border lights up.

The additional range achieved as a result of your driving style in comparison to a driver with a very sporty driving style is shown under **Bonus fr. Start**. The range displayed does not indicate a fixed reduction in consumption.

## DYNAMIC SELECT switch

### Function of the DYNAMIC SELECT switch

**Plug-in hybrid:** be sure to observe the notes in the Supplement. Otherwise, you may not recognize dangers.

**Mercedes-AMG vehicles:** be sure to observe the notes in the Supplement. Otherwise, you may not recognize dangers.

Use the DYNAMIC SELECT switch to change between the following drive programs:

- **I (Individual):** individual settings
- **S (Sport):** sporty driving style
- **C (Comfort):** comfortable and economical driving style
- **Vehicles with MAGIC BODY CONTROL: CV (CURVE):** comfortable driving with curve inclination function
- **E (Eco):** particularly economical driving style

Depending on the drive program selected, the following vehicle characteristics will change:

- Drive system

- Engine and transmission management
- Active Distance Assist DISTRONIC
- ESP®
- Suspension
- Steering

### Selecting the drive program

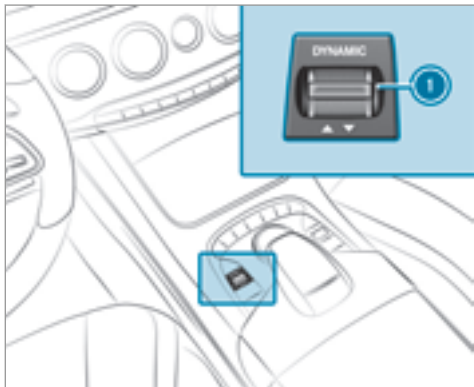

- ▶ Press DYNAMIC SELECT switch ① forwards or backwards.  
The drive program selected appears in the multifunction display.

### Configuring drive program I

Multimedia system:

↳ Vehicle ▶  DYNAMIC SELECT ▶ Individual

- ▶ Select the individual setting.

### Displaying vehicle data

Multimedia system:

↳ Vehicle ▶  DYNAMIC SELECT

- ▶ Select Vehicle Data.

### Displaying engine data

Multimedia system:

↳ Vehicle ▶  DYNAMIC SELECT

- ▶ Select Engine Data.

- ① The values for engine output and engine torque may deviate from the nominal values.  
Items that can influence this are, for example:
  - engine speed
  - sea level
  - fuel grade
  - outside temperature

### Automatic transmission

#### DIRECT SELECT lever

#### Function of the DIRECT SELECT lever

- ⚠ **WARNING** Risk of accident and injury due to children left unattended in the vehicle

If children are left unattended in the vehicle, they could:

- Open doors, thereby endangering other persons or road users

- Get out of the vehicle and be hit by oncoming traffic
- Operate vehicle equipment

In addition, the children could also set the vehicle in motion, for example, by:

- Releasing the parking brake
  - Shifting the transmission out of park position **P**
  - Starting the engine.
- ▶ Never leave children and animals unattended in the vehicle.
- ▶ When leaving the vehicle, always take the SmartKey with you and lock the vehicle.
- ▶ Keep the SmartKey out of the reach of children.

**⚠ WARNING** Risk of accident due to incorrect gearshifting

If the engine speed is higher than the idle speed and you engage the transmission posi-

tion **D** or **R**, the vehicle may accelerate sharply.

- ▶ If you engage the transmission position **D** or **R** always depress the brake pedal firmly and do not accelerate at the same time.

Use the DIRECT SELECT lever to shift the transmission position. The current transmission position is displayed in the multifunction display.

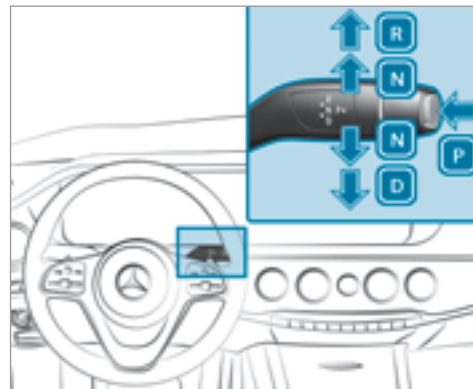

- P** Park position
- R** Reverse gear
- N** Neutral
- D** Drive position



### Engaging reverse gear R

- ▶ Depress the brake pedal and push the DIRECT SELECT lever up past the first point of resistance.  
The transmission position display shows **R** in the multifunction display.

### Shifting to neutral N

- ▶ Depress the brake pedal and push the DIRECT SELECT lever up or down to the first point of resistance.  
The transmission position display shows **N** in the multifunction display.

Subsequently releasing the brake pedal will allow you to move the vehicle freely, e.g. to push it or tow it away.

### If you want the automatic transmission to remain in neutral N even if the ignition is switched off:

- ▶ Start the vehicle.
- ▶ Depress the brake pedal and shift to neutral **N**.
- ▶ Release the brake pedal.
- ▶ Switch the ignition off.

- ⓘ If you then exit the vehicle leaving the SmartKey in the vehicle, the automatic transmission remains in neutral **N**.

### Engaging park position P

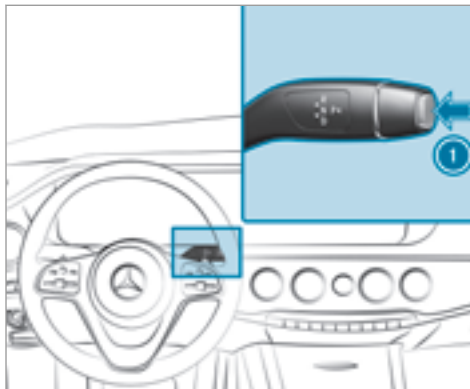

- ▶ Press button ⓘ. The transmission position display shows **P** in the multifunction display.

Park position **P** is engaged automatically if one of the following conditions is met:

- If you switch the engine off with the transmission in position **D** or **R**.
- If you open the driver's door when the vehicle is stationary or when driving at a very low speed and the transmission is in position **D** or **R**.

### Engaging drive position D

- ▶ Depress the brake pedal and push the DIRECT SELECT lever down past the first point of resistance.  
The transmission position display shows **D** in the multifunction display.

When the automatic transmission is in transmission position **D**, it shifts the gears automatically. This depends on the following factors:

- The selected drive program
- The position of the accelerator pedal
- The road speed

## Manual gear shifting

**⚠ WARNING** Risk of skidding and of an accident due to shifting down on slippery road surfaces

If you shift down on slippery road surfaces to increase the engine braking effect, the drive wheels may lose traction.

▶ Do not shift down on slippery road surfaces to increase the engine braking effect.



▶ **To activate:** pull steering wheel paddle shifter ① or ②.  
Manual gearshifting is activated for a short time. The current gear is displayed in the multifunction display.

▶ **To shift up:** pull steering wheel paddle shifter ②.

▶ **To shift down:** pull steering wheel paddle shifter ①.

▶ **To deactivate:** pull steering wheel paddle shifter ② and hold it in place.  
The transmission position **D** appears in the multifunction display.

ⓘ If you select the **Manual** drive setting in drive program **I**, manual gearshifting is permanently activated.

**Plug-in hybrid:** be sure to observe the notes in the Supplement. Otherwise, you may not recognize dangers.

**Mercedes-AMG vehicles:** be sure to observe the notes in the Supplement. Otherwise, you may not recognize dangers.

## Gearshift recommendation

**Mercedes-AMG vehicles:** observe the notes in the Supplement. Otherwise, you may not recognize dangers.

The gearshift recommendations assist you in adopting an economical driving style.

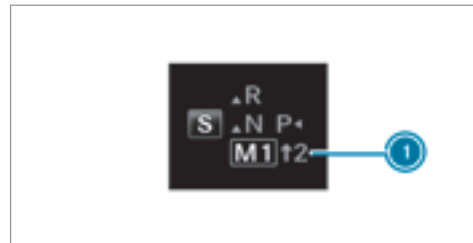

▶ If gearshift recommendation message ① is shown in the multifunction display, shift to the recommended gear.

## Using kickdown

**Mercedes-AMG vehicles:** be sure to observe the notes in the Supplement. Otherwise, you may not recognize dangers.

- ▶ **Maximum acceleration:** depress the accelerator pedal beyond the pressure point.

During kickdown, you cannot shift gears using the steering wheel paddle shifters. The automatic transmission shifts up to the next gear when the maximum engine speed is reached to protect the engine from overrevving.

- ▶ Ease off the accelerator pedal once the desired speed is reached.

## Glide mode function

**Plug-in hybrid:** be sure to observe the notes in the Supplement. Otherwise, you may not recognize dangers.

**Mercedes-AMG vehicles:** be sure to observe the notes in the Supplement. Otherwise, you may not recognize dangers.

With an anticipatory driving style, glide mode helps you to reduce fuel consumption.

Glide mode is characterized by the following:

- The combustion engine is disconnected from the drivetrain and the vehicle continues to roll in neutral.
- The transmission position **D** is displayed in green in the multifunction display.

Glide mode is activated if the following conditions are met:

- Drive program **E** is selected.
- The speed is within a suitable range.
- The course of the road is suitable, e.g. no steep uphill or downhill gradients or tight bends.
- You do not depress the accelerator or brake pedal.

- ⓘ Glide mode can also be activated if you have selected the "Eco" setting for the drive (engine management) when in drive program **I**.

Glide mode is deactivated again if one of the conditions is no longer met.

## Vehicles with Active Distance Assistant

**DISTRONIC:** When Active Distance Assistant DISTRONIC is active, the glide mode function is restricted.

## Refueling

### Refueling the vehicle

**⚠ WARNING** Risk of fire and explosion caused by fuel

Fuels are highly inflammable.

- ▶ You must avoid fire, open flames, creating sparks and smoking.
- ▶ Before refueling, switch off the engine and, if installed in your vehicle, the stationary heater.

**⚠ WARNING** Risk of injury from fuel

Fuels are poisonous and harmful to your health

- ▶ Do not swallow fuel or let it come into contact with skin, eyes or clothing.
- ▶ Do not inhale fuel vapors.
- ▶ Keep children away from fuel.

If you or other people come into contact with fuel, observe the following:

- ▶ Immediately rinse fuel off your skin with soap and water.
- ▶ If fuel comes into contact with your eyes, immediately rinse them thoroughly with clean water. Seek medical attention immediately.
- ▶ If you swallow fuel, seek medical attention immediately. Do not induce vomiting.
- ▶ Change immediately out of clothing that has come into contact with fuel.

**⚠ WARNING** Risk of explosion or fire due to electrostatic charge

Electrostatic charge can cause sparks and thereby ignite fuel vapors.

- ▶ Always touch the metal vehicle body before opening the fuel filler cap or touching the pump nozzle.

This discharges any electrostatic charge that may have built up.

**! NOTE** Damage caused by the wrong fuel

Vehicles with a gasoline engine:

Even small amounts of the wrong fuel could result in damage to the fuel system, the engine and the emission control system.

- ▶ Only refuel with low-sulfur premium grade fuel.

This fuel may contain up to 10 % ethanol. Your vehicle is suitable for use with E10 fuel.

Do not refuel using:

- Diesel
- E15, E85, E100
- Gasoline containing methanol (M15, M30, M85, M100)

- Gasoline with additives containing metal

If you accidentally refuel with the wrong fuel:

- ▶ Do not switch the ignition on.
- ▶ Consult a qualified specialist workshop.

**! NOTE** Do not use diesel to refuel vehicles with a gasoline engine.

If you accidentally refuel with the wrong fuel:

- Do not switch on the ignition. Otherwise fuel can enter the engine.  
Even small amounts of the wrong fuel could result in damage to the fuel system and the engine. The repair costs are high.
- ▶ Contact a qualified specialist workshop.
- ▶ Have the fuel tank and fuel lines drained completely.

**!** **NOTE** Damage to the fuel system caused by overfilled fuel tanks.

▶ Only fill the fuel tank until the pump nozzle switches off.

**!** **NOTE** Fuel may spray out when you remove the fuel pump nozzle.

▶ Only fill the fuel tank until the pump nozzle switches off.

#### Requirements:

- Unlock the vehicle.
- ① Do not get into the vehicle again during the refueling process. Otherwise, electrostatic charge could build up again.

Observe the notes on operating fluids (→ page 447).

**Plug-in hybrid:** observe the notes in the Supplement. Otherwise, you may not recognize dangers.

## Refueling

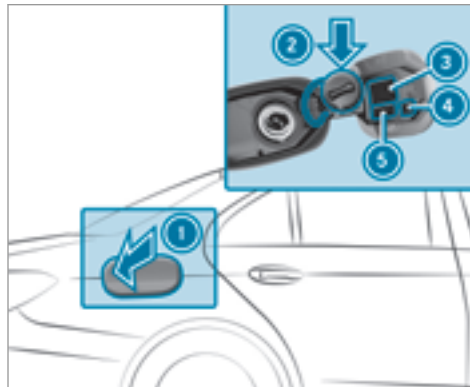

- ① Fuel filler flap
- ② Bracket for the fuel filler cap
- ③ Tire pressure table
- ④ QR code for rescue card
- ⑤ Fuel type

▶ Press fuel filler flap ①.

- ▶ Turn the fuel filler cap counter-clockwise and remove it.
- ▶ Insert the fuel filler cap into bracket ②.
- ▶ Completely insert the fuel pump nozzle into the tank filler neck, hook in place and refuel.
- ▶ Only fill the tank until the pump nozzle switches off.

## Parking

### Switching off the vehicle

**!** **WARNING** Risk of fire caused by hot exhaust system parts

Flammable material such as leaves, grass or twigs may ignite if they come into contact with hot parts of the exhaust system or exhaust gas flow.

- ▶ Park the vehicle so that no flammable material can come into contact with hot vehicle components.
- ▶ In particular, do not park on dry grass-land or harvested grain fields.

**⚠ WARNING** Risk of accident and injury due to children left unattended in the vehicle

If you leave children unaccompanied in the vehicle, they may be able to set the vehicle in motion, for example by:

- Releasing the parking brake.
- Shifting the transmission out of park position **P**.
- Starting the engine.

In addition, they may operate vehicle equipment.

- ▶ Never leave children and animals unattended in the vehicle.
- ▶ When leaving the vehicle, always take the SmartKey with you and lock the vehicle.

**! NOTE** Damage to the vehicle or the drivetrain caused by the vehicle rolling away

- ▶ Always properly secure the vehicle against rolling away.

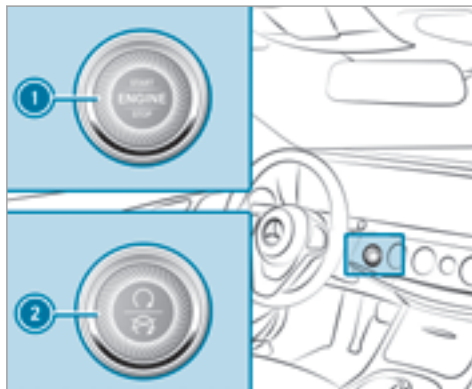

- ▶ On uphill or downhill inclines, turn the front wheels towards the curb.
- ▶ Select transmission position **P**.

- ▶ Apply the electric parking brake.

- ▶ Press button **1** (USA) or **2** (Canada) once.

**i** When you switch off the vehicle, you can still operate the side windows and the panoramic sliding sunroof for five minutes.

### Garage door opener

#### Programming buttons for the garage door opener

**⚠ WARNING** Risk of exhaust gas poisoning

Combustion engines emit poisonous exhaust gases such as carbon monoxide. Inhaling these exhaust gases causes poisoning.

- ▶ Never leave the engine running in an enclosed space without sufficient ventilation.

**⚠ WARNING** Risk of injury and entrapment when opening the garage door using the garage door opener

When you operate or program the garage door with the integrated garage door opener, persons in the range of movement of the garage door can become trapped or struck by the garage door.

▶ When using the integrated garage door opener, always make sure that nobody is within the sweep of the garage door.

Only operate the garage door opener on the following garage doors:

- Garage doors with a safety stop and reversing feature.
- Garage doors which conform to the current U.S. safety standards.

#### Requirements:

- The vehicle is parked outside of the garage.
- The engine is switched off.

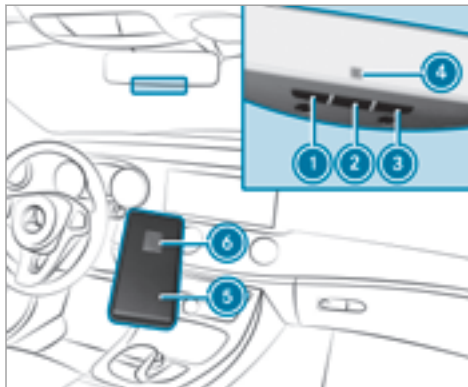

▶ Check if the transmitter frequency of the remote control has the frequency range of 280 to 868 MHz.

Radio equipment approval number:

- NZLMUAHL5 (USA)
- 4112A-MUAHL5 (Canada)

▶ Press and hold button ①, ② or ③ that you wish to program.

Indicator lamp ④ flashes yellow.

ⓘ It can take up to 20 seconds before the indicator lamp flashes yellow.

▶ Release the previously pressed button. Indicator lamp ④ continues to flash yellow.

▶ Point remote control ⑤ at a distance of 1 in (1 cm) to 3 in (8 cm) towards buttons ①, ② or ③.

▶ Press and hold button ⑥ of remote control ⑤ until:

- Indicator lamp ④ lights up green continuously. Programming is complete.
- Indicator lamp ④ flashes green. Programming was successful. Additionally, synchronization of the rolling code with the garage door system must also take place.

▶ If indicator lamp ④ does not light up or flash green: repeat the procedure.

▶ Release all of the buttons.

- ❶ The remote control for the garage door drive is not included in the scope of delivery of the garage door opener.

### Synchronizing the rolling code

#### Requirements:

- The garage door system uses a rolling code.
- The vehicle must be within range of the garage door or exterior gate drive.
- The vehicle as well as persons and objects, are located outside the sweep of the garage door.

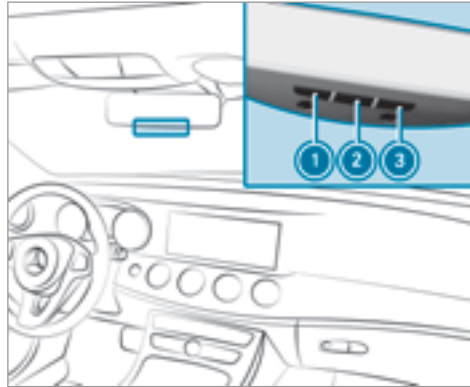

- ▶ Press the programming button on the door drive unit. Initiate the next step within approximately 30 seconds.
- ▶ Press previously programmed button ❶, ❷ or ❸ repeatedly, until the door closes. When the door closes, programming is completed.

- ❶ Please also read the operating instructions for the garage door drive.

### Troubleshooting when programming the remote control



- ▶ Check if the transmitter frequency of remote control ❶ is supported.
- ▶ Replace the batteries in remote control ❶.
- ▶ Hold remote control ❶ at various angles at a distance between 1 in (1 cm) to 3 in (8 cm) front of the inside rearview mirror. You should test every position for at least 25 seconds before trying another position.



- ▶ Hold remote control ⑤ at the same angles at various distances in front of the inside rear view mirror. You should test every position for at least 25 seconds before trying another position.
- ▶ Note that some remote controls transmit only for a limited period, press button ⑥ on remote control ⑤ again before transmission ends.
- ▶ Align the antenna line of the garage door opener unit with the remote control.

① Support and additional information on programming:

- On the toll free HomeLink® Hotline on 1-800-355-3515.
- On the Internet at <http://www.homelink.com/mercedes>.

### Opening/closing the garage door

#### Requirements:

- The corresponding button is programmed to operate the garage door.

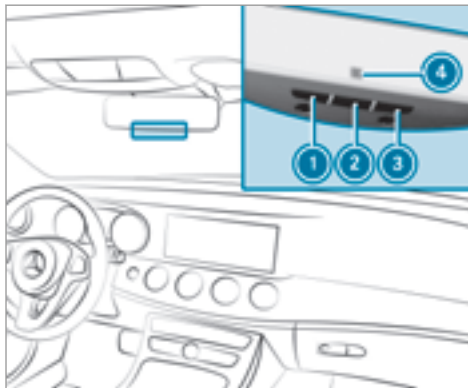

- ▶ Press and hold buttons ①, ② or ③ until the garage door opens or closes.
- ▶ If indicator lamp ④ flashes yellow after approximately 20 seconds: press and hold the previously pressed button again until the garage door opens or closes.

### Clearing the garage door opener memory

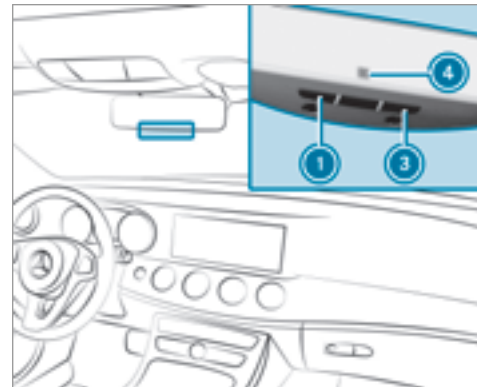

- ▶ Press and hold buttons ① and ③. Indicator lamp ④ lights up yellow.
- ▶ If indicator lamp ④ flashes green: release buttons ① and ③.

**Radio equipment approval numbers for the garage door opener****Radio equipment approval numbers**

Country	Radio type approval number
Egypt	TAC.2511151293.WIR
Andorra	CE
Australia	R-NZ
Barbados	MED1578
Chile	2488/DFRS20576/F-74
European Union	CE
Gibraltar	CE
Iceland	CE
Jordan	TRC/LPD/2015/299
Canada	IC: 4112A-MUAHL5
Kuwait	CE

Country	Radio type approval number
Liechtenstein	CE
Mexico	RCPGEMU15-0448
Monaco	CE
New Zealand	R-NZ
Norway	CE
Russian Federation	not required
Saudi Arabia	TA 10525
Switzerland	CE

Country	Radio type approval number
South Africa	 TA-2015/1386
Turkey	not required
United Arab Emirates	ER41849/15 Dealer No: DA35176/14
United States	FCC ID: NZLMUAHL5

## Brazil



Este equipamento opera em caráter secundário, isto é, não tem direito à proteção contra interferência prejudicial, mesmo de estações do mesmo tipo, e não pode causar interferência a sistemas operando em caráter primário.

Para maiores informações acessar [www.anatel.gov.br](http://www.anatel.gov.br)

Further information on the declaration of conformity for wireless vehicle components (→ page 23).

### Electric parking brake

#### Function of the electric parking brake (applying automatically)

**⚠ WARNING** Risk of accident and injury due to children left unattended in the vehicle

If you leave children unaccompanied in the vehicle, they may be able to set the vehicle in motion, for example by:

- Releasing the parking brake.
- Shifting the transmission out of park position **P**.
- Starting the engine.

In addition, they may operate vehicle equipment.

- ▶ Never leave children and animals unattended in the vehicle.
- ▶ When leaving the vehicle, always take the SmartKey with you and lock the vehicle.

The electric parking brake is applied if the transmission is in position **P** and one of the following conditions is fulfilled:

- The engine is switched off.
- The seat belt tongue is not inserted in the seat belt buckle of the driver's seat and the driver's door is opened.

**i** To prevent application: pull the handle of the electric parking brake.

In the following situations, the electric parking brake is also engaged:

- The Active Distance Assistant DISTRONIC is bringing the vehicle to a standstill.
- The HOLD function is keeping the vehicle stationary.
- Active Parking Assist is keeping the vehicle stationary.

This is only the case if one of the following conditions is also fulfilled:

- The engine is switched off.

- The seat belt tongue is not inserted in the seat belt buckle of the driver's seat and the driver's door is opened.
- There is a system malfunction.
- The power supply is insufficient.
- The vehicle is stationary for a lengthy period.

When the electric parking brake is applied, the **PARK** (USA) or **(P)** (Canada) indicator lamp lights up in the instrument cluster.

The electric parking brake is not automatically applied if the engine is switched off by the ECO start/stop function.

### Function of the electric parking brake (releasing automatically)

The electric parking brake is released when the following conditions are fulfilled:

- The engine is running.
- The seat belt tongue is inserted into the seat belt buckle of the driver's seat.
- The transmission is in position **D** or **R** and you depress the accelerator pedal or you

shift from transmission position **P** to **D** or **R**.

- If the transmission is in position **R**, the trunk lid must be closed.

If the seat belt tongue is not inserted into the seat belt buckle of the driver's seat, the following conditions must be fulfilled:

- The driver's door is closed.
- You move the transmission out of transmission position **P** or you have previously driven faster than 2 mph (3 km/h).
- If the transmission is in position **R**, the trunk lid must be closed.

If the electric parking brake is released, the **PARK** (USA) or **(P)** (CANADA) indicator lamp in the instrument cluster goes out.

### Applying or releasing the electric parking brake manually

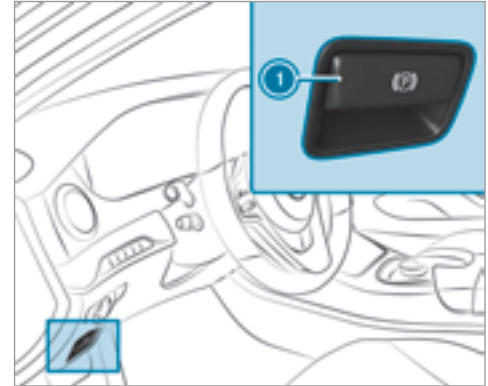

#### Applying





- ▶ Push handle ①.

The **PARK** (USA) or **(P)** (Canada) indicator lamp appears in the instrument cluster.

## Releasing

- ▶ Switch on the ignition.
  - ▶ Pull handle ①.
- The  (USA) or  (Canada) indicator lamp in the instrument cluster goes out.

## Emergency braking

- ▶ Press and hold handle ①.
- When the vehicle has been braked to a standstill, the electric parking brake is applied. The  (USA) or  (Canada) indicator lamp appears in the instrument cluster.

## Notes on parking the vehicle for a longer period

If you leave the vehicle parked for longer than four weeks, the battery may become damaged.

If you leave the vehicle parked for longer than six weeks, it may suffer damage as a result of lack of use.

- ① Further information can be obtained at a qualified specialist workshop.

**Plug-in hybrid:** observe the notes in the Supplement. Otherwise, you may not recognize dangers.

## Standby mode (extension of the starter battery's period out of use)

### Standby mode function

If standby mode is activated, the vehicle can be parked for an extended period of time without losing power.

Standby mode is characterized by the following:

- The starter battery is preserved.
- The maximum period out of use is displayed in the multimedia system display.
- Functions such as interior protection or the tow-away alarm are not available.
- The connection to online services is interrupted.

If the following conditions are fulfilled, standby mode can be activated or deactivated using the multimedia system:

- The engine is switched off.

- The ignition is switched on.

Exceeding the vehicle's displayed period out of use may cause inconvenience, i.e. it cannot be guaranteed that the starter battery will reliably start the engine.

The starter battery must be charged first in the following situations:

- The vehicle's period out of use must be extended.
- The [Battery Charge Insufficient for Standby Mode](#) message appears in the multimedia system display.

① Standby mode is automatically deactivated when the ignition is switched on.

### Activating or deactivating standby mode

Multimedia system:

▶ [Vehicle](#) ▶  [Vehicle Settings](#) ▶ [Standby Mode](#)

- ▶ Activate  or deactivate  the function. When you activate the function, a prompt appears.

- ▶ Select **Yes**.  
Standby mode is activated.

## Driving and driving safety systems

### Driving systems and your responsibility

Your vehicle is equipped with driving systems which assist you in driving, parking and maneuvering the vehicle. The driving systems are aids and do not relieve you of your responsibility. Pay attention to the traffic conditions at all times and intervene when necessary. Be aware of the limitations regarding the safe use of these systems.

### Function of the radar sensors

Some driving and driving safety systems use radar sensors to monitor the area in front of, behind or next to the vehicle (depending on the vehicle's equipment).

Depending on the vehicle's equipment, the radar sensors are integrated behind the bumpers and/or behind the radiator grill. Keep these parts free of dirt, ice and slush (→ page 389).

The sensors must not be covered, for example by bicycle racks, overhanging loads or radar-reflecting stickers. Following an impact and in the event of associated damage, which may not be visible, to the bumpers or radiator grille, have the function of the radar sensors checked at a qualified specialist workshop. The driver assistance system may no longer work properly.

### Overview of driving systems and driving safety systems

In this section, you will find information about the following driving systems and driving safety systems:

- 360° Camera (→ page 224)
- ABS (**A**nti-**l**ock **B**raking **S**ystem) (→ page 189)
- Active Distance Assist DISTRONIC (→ page 199)
- AIR BODY CONTROL (→ page 211)
- Active Brake Assist (→ page 192)
- Active Lane Keeping Assist (→ page 240)
- ATTENTION ASSIST (→ page 232)
- BAS (**B**rake **A**ssist **S**ystem) (→ page 189)
- EBD (**E**lectronic **B**rake force **D**istribution) (→ page 192)
- ESP® (**E**lectronic **S**tability **P**rogram) (→ page 189)
- HOLD function (→ page 210)
- STEER CONTROL (→ page 192)
- Active Steering Assist (→ page 204)
- MAGIC BODY CONTROL (→ page 214)
- Active Parking Assist (→ page 226)
- Parking Assist PARKTRONIC (→ page 218)
- Rear view camera (→ page 222)
- Cruise control (→ page 196)
- Blind Spot Assist and Active Blind Spot Assist (→ page 238)
- Traffic Sign Assist (→ page 233)

### Functions of ABS (anti-lock braking system)

ABS regulates the brake pressure in critical driving situations:

- During braking, e.g. at maximum full-stop braking or insufficient traction of the tires, the wheels are prevented from blocking.
- Vehicle steerability while braking is ensured.

If ABS intervenes when braking, you will feel a pulsing in the brake pedal. The pulsating brake pedal can be an indication of hazardous road conditions and can serve as a reminder to take extra care while driving.

#### System limitations

- ABS is active from speeds of approx. 5 mph (8 km/h).
- ABS may be impaired or may not function if a malfunction has occurred and the yellow  ABS warning lamp lights up continuously in the instrument cluster after the engine is started.

### Function of BAS (Brake Assist System)

**⚠ WARNING** Risk of an accident caused by a malfunction in BAS (Brake Assist System)

If BAS is malfunctioning, the braking distance in an emergency braking situation is increased.

- ▶ Depress the brake pedal with full force in emergency braking situations. ABS prevents the wheels from locking.

BAS supports your emergency braking situation with additional brake force.

If you depress the brake pedal quickly, BAS is activated:

- BAS automatically boosts the brake pressure.
- BAS can shorten the braking distance.
- ABS prevents the wheels from locking.

The brakes will function as usual once you release the brake pedal. BAS is deactivated.

### Functions of ESP® (Electronic Stability Program)

**⚠ WARNING** Risk of skidding if ESP® is malfunctioning

If ESP® is malfunctioning, ESP® cannot carry out vehicle stabilization. In addition, other driving safety systems are switched off.

- ▶ Drive on carefully.
- ▶ Have ESP® checked at a qualified specialist workshop.

**⚠ WARNING** Risk of skidding if ESP® is deactivated

If you deactivate ESP®, ESP® cannot carry out vehicle stabilization.

- ▶ ESP® should only be deactivated in the following situations.

**Mercedes-AMG vehicles:** observe the notes in the Supplement. Otherwise, you may not recognize dangers.

ESP® can monitor and improve driving stability and traction in the following situations, within physical limits:

- When pulling away on a wet or slippery road.
- When braking.
- In strong sidewinds when you are driving faster than 50 mph (80 km/h).

If the vehicle deviates from the direction desired by the driver, ESP® can stabilize the vehicle by intervening in the following ways:

- One or more wheels are braked.
- The engine output is adapted according to the situation.

ESP® is deactivated if the ESP® OFF  warning lamp lights up continuously in the instrument cluster:

- Driving stability will no longer be improved.
- Crosswind Assist is no longer active.
- The drive wheels could spin.

- ETS/4ETS traction control is still active.

 When ESP® is deactivated, you are still assisted by ESP® when braking.

ESP® is intervening if the ESP®  warning lamp flashes in the instrument cluster:

- Do not deactivate ESP®.
- Only depress the accelerator pedal as far as is necessary.
- Adapt your driving style to suit the current road and weather conditions.

Deactivate ESP® in the following situations to improve traction:

- When using snow chains
- In deep snow
- On sand or gravel.

 Spinning the wheels results in a cutting action which provides better grip.

If the ESP®  warning lamp lights up continuously, ESP® is not available due to a malfunction.

Observe the following information:

- Warning and indicator lamps (→ page 501)
- Display messages (→ page 457)

### ETS/4ETS (Electronic Traction System)

ETS/4ETS traction control is part of ESP® and makes it possible to pull away or accelerate on a slippery surface.

ETS/4ETS can improve the vehicle's traction by intervening in the following ways:

- The drive wheels are braked individually if they spin.
- More drive torque is transferred to the wheel or wheels with traction.

### Influence of drive programs on ESP®

The drive programs enable ESP® to adapt to different weather and road conditions as well as the driver's preferred driving style. You can select the drive programs using the DYNAMIC SELECT switch (→ page 173).



## ESP® characteristics per drive program

Drive program	ESP® mode	Characteristics
<b>S</b> (Sport)	ESP® Sport	This drive program continues to offer stability but with a sporty setup which allows the enthusiastic driver a more active driving style. Only select drive program <b>S</b> in good road conditions, for example on dry roads and clear stretches of road.
<b>C</b> (Comfort) <b>Vehicles with MAGIC BODY CONTROL: CV</b> (CURVE) <b>E</b> (Economy)	ESP® Comfort	These drive programs provide the ideal balance between traction and stability. Select drive program <b>C</b> , <b>CV</b> or <b>E</b> , in difficult road conditions, such as in snow or ice, or when the road is wet from rain.

### Activating/deactivating ESP® (Electronic Stability Program)

Multimedia system:

→ Vehicle ▶  Assistance ▶ ESP

**Mercedes-AMG vehicles:** observe the notes in the Supplement. Otherwise, you may not recognize dangers.

▶ Activate  or deactivate  the function.

ESP® is deactivated if the  ESP® OFF warning lamp lights up continuously in the instrument cluster.

Observe the information on warning lamps and display messages which may be shown in the instrument cluster.

### Functions of ESP® Crosswind Assist

ESP® Crosswind Assist detects sudden gusts of side wind and helps the driver to keep the vehicle in the lane:

- ESP® Crosswind Assist is active at vehicle speeds between 50 mph (80 km/h) and

125 mph (200 km/h) when driving straight ahead or cornering slightly.

- The vehicle is stabilized by means of individual brake application on one side.

### Function of EBD (electronic brake force distribution)

---

EBD is characterized by the following:

- Monitoring and regulating the brake pressure on the rear wheels.
- Improved driving stability when braking, especially on bends.

### Function of STEER CONTROL

---

STEER CONTROL helps you by transmitting a noticeable steering force to the steering wheel in the direction required for vehicle stabilization.

This steering recommendation is given particularly in the following situations:

- Both right wheels or both left wheels are on a wet or slippery road surface when you brake.

- The vehicle starts to skid.

### System limitations

STEER CONTROL may be impaired or may not function in the following situations:

- ESP® is deactivated.
- ESP® is malfunctioning.
- The steering is malfunctioning.

If ESP® is malfunctioning, you will be assisted further by the electric power steering.

### Function of Active Brake Assist

---

Active Brake Assist consists of:

- Distance warning function
- Autonomous braking function
- Situation-dependent braking assistance
- **Vehicles with Driving Assistance Package:** Evasive Steering Assist

Active Brake Assist can help you to minimize the risk of a collision with vehicles or pedestrians or to reduce the effects of such a collision.

If Active Brake Assist has detected a risk of collision, you will be warned visually and acoustically.

If you do not react to the visual or acoustic warning, autonomous braking can be initiated in critical situations.

In especially critical situations, Active Brake Assist can initiate autonomous braking directly. In this case, the visual and acoustic warning occurs simultaneously with the braking application.

If you apply the brake yourself in a critical situation or apply the brake during autonomous braking, situation-dependent braking assistance occurs. This increases the brake pressure up to maximum full-stop braking if necessary.

If the autonomous braking function or the situation-dependent braking assistance is triggered, additional preventive measures for occupant protection (PRE-SAFE®) may also be initiated, if the vehicle is equipped with these.

**▲ WARNING** Risk of an accident caused by limited detection performance of Active Brake Assist

Active Brake Assist cannot always clearly identify objects and complex traffic situations.

In such cases, Active Brake Assist might:

- Give a warning or brake without reason
- Not give a warning or not brake

▶ Always pay careful attention to the traffic situation; do not rely on Active Brake

Assist alone. Active Brake Assist is only an aid. The driver is responsible for maintaining a suitable distance to the vehicle in front, vehicle speed and for braking in good time.

▶ Be prepared to brake or swerve if necessary.

Also observe the system limitations of Active Brake Assist.

**The individual subfunctions are available in the following speed ranges:**  
**Distance warning function**

The distance warning function issues a warning at speeds:

- From approximately 4 mph (7 km/h), if your vehicle is critically close to a vehicle or pedestrian. An intermittent warning tone sounds and the  distance warning lamp lights up in the instrument cluster.

Brake immediately or take evasive action, provided it is safe to do so and the traffic situation allows this.

**The distance warning function can aid you in the following situations with an intermittent warning tone and a warning lamp:**

	Vehicles traveling in front	Stationary vehicles	Crossing vehicles	Crossing pedestrians	Stationary pedestrians
Vehicles without Driving Assistance package	up to approx. 155 mph (250 km/h)	up to approx. 50 mph (80 km/h)	no reaction	up to approx. 37 mph (60 km/h)	no reaction
Vehicles with Driving Assistance package	up to approx. 155 mph (250 km/h)	up to approx. 62 mph (100 km/h)	up to approx. 43 mph (70 km/h)	up to approx. 43 mph (70 km/h)	up to approx. 43 mph (70 km/h)

**Autonomous braking function**

The autonomous braking function may intervene at speeds starting from approximately 4 mph (7 km/h) in the following situations:

	Vehicles traveling in front	Stationary vehicles	Crossing vehicles	Crossing pedestrians	Stationary pedestrians
Vehicles without Driving Assistance package	up to approx. 124 mph (200 km/h)	up to approx. 31 mph (50 km/h)	no reaction	up to approx. 37 mph (60 km/h)	no reaction
Vehicles with Driving Assistance package	up to approx. 155 mph (250 km/h)	up to approx. 62 mph (100 km/h)	up to approx. 43 mph (70 km/h)	up to approx. 43 mph (70 km/h)	up to approx. 43 mph (70 km/h)

**Situation-dependent braking assistance**

Situation-dependent braking assistance may intervene at speeds starting from approximately 4 mph (7 km/h) in the following situations:

	Vehicles traveling in front	Stationary vehicles	Crossing vehicles	Crossing pedestrians	Stationary pedestrians
Vehicles without Driving Assistance package	up to approx. 155 mph (250 km/h)	up to approx. 50 mph (80 km/h)	no reaction	up to approx. 37 mph (60 km/h)	no reaction
Vehicles with Driving Assistance package	up to approx. 155 mph (250 km/h)	up to approx. 62 mph (100 km/h)	up to approx. 43 mph (70 km/h)	up to approx. 43 mph (70 km/h)	up to approx. 43 mph (70 km/h)

### Canceling a brake application of Active Brake Assist

You can cancel a brake application of Active Brake Assist at any time by:

- Depressing the accelerator pedal fully.
- Releasing the brake pedal.

Active Brake Assist cancels the intervention when at least one of the following conditions is fulfilled:

- You maneuver to avoid the obstacle.
- There is no longer a risk of collision.
- An obstacle is no longer detected in front of your vehicle.

### Evasive Steering Assist (only vehicles with Driving Assistance package)

Evasive Steering Assist has the following characteristics:

- Can detect stationary or crossing pedestrians.
- Can assist the driver with additional steering assistance if it detects a swerving maneuver.

- Can be activated by an abrupt steering movement during a swerving maneuver.
- Can assist during swerving and straightening of the vehicle.
- Can react from a speed of approximately 12 mph (20 km/h) up to a speed of approximately 43 mph (70 km/h).
- You can prevent the assistance at any time by active steering.

#### **WARNING** Risk of an accident despite Evasive Steering Assist

Evasive Steering Assist cannot always clearly identify objects and complex traffic situations.

In addition, the steering support of Evasive Steering Assist is generally not sufficient to avoid a collision.

In such cases Evasive Steering Assist can:

- give an unnecessary warning or provide assistance
- not give a warning or not provide assistance

- ▶ Always pay careful attention to the traffic situation; do not rely on Evasive Steering Assist alone.
- ▶ Be ready to brake and take evasive action if necessary.
- ▶ Prevent the assistance by actively steering in non-critical driving situations.
- ▶ Drive at an appropriate speed if pedestrians are close to the path of your vehicle.

Also observe the system limitations of Evasive Steering Assist.

#### **System limitations**

The system may be impaired or may not function in the following situations:

- In snow, rain, fog, heavy spray, if there is glare, in direct sunlight or in greatly varying ambient light.
- If the sensors are dirty, fogged up, damaged or covered.

- If the sensors malfunction due to other radar source interference, for example strong radar reflections in parking garages.
- If a loss of tire pressure or a defective tire has been detected and displayed.

The system may not react correctly:

- In complex traffic stations where objects cannot always be clearly identified.
- To pedestrians or vehicles if they move quickly into the sensor detection range.
- To pedestrians who are hidden by other objects.
- If the typical outline of a pedestrian cannot be distinguished from the background.
- If a pedestrian is not recognized as such, e.g. due to special clothing or other objects.
- On bends with a tight radius.

### Setting Active Brake Assist

Multimedia system:

↳ Vehicle ▶  Assistance ▶ Active Brake Assist

#### Vehicles without Driving Assistance pack-

**age:** The settings can be made after starting the vehicle.

#### Vehicles with Driving Assistance package:

The settings can be made when the ignition is switched on.

- ⓘ It is recommended that you always leave Active Brake Assist switched on.

Select one of the following settings:

- ▶ **Early:** your selection is retained when the vehicle is next started.
- ▶ **Medium:** your selection is retained when the vehicle is next started.
- ▶ **Late:** your selection is retained when the vehicle is next started.
- ▶ **Off:**

**Vehicles without Driving Assistance pack-**  
**age:** The distance warning function and the

autonomous braking function are deactivated. When the vehicle is next started, the middle setting is automatically selected.

#### Vehicles with Driving Assistance pack-

**age:** The distance warning function and the autonomous braking function are deactivated. Evasive Steering Assist is unavailable. When the ignition is next started, the middle setting is selected automatically and Evasive Steering Assist is available.

- ⓘ When Active Brake Assist is deactivated, the  symbol appears in the assistance graphic in the multifunction display.

### Speed control cruise control

#### Function of cruise control

Cruise control accelerates and brakes the vehicle automatically in order to maintain a previously stored speed.

If you accelerate to overtake, for example, the stored speed is not deleted. If you remove your foot from the accelerator pedal after overtaking, cruise control will resume speed regulation back to the stored speed.

Cruise control is operated using the corresponding steering wheel buttons. You can store any road speed above 15 mph (20 km/h).

If you fail to adapt your driving style, cruise control can neither reduce the risk of an accident nor override the laws of physics. It cannot take into account road, weather or traffic conditions. Cruise control is only an aid. You are responsible for the distance to the vehicle in front, for vehicle speed, for braking in good time and for staying in lane.

### Displays in the multifunction display

The status of cruise control and the stored speed are shown in the multifunction display.

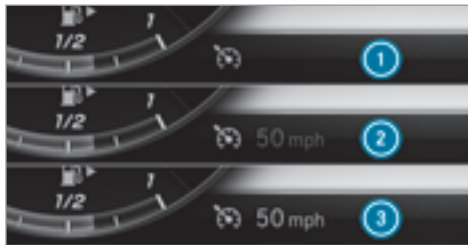

- ① Cruise control is selected
- ② Speed is saved, cruise control is deactivated
- ③ Speed is saved, cruise control is activated
- i The segments between the stored speed and the end of the segment display light up in the speedometer.

### System limitations

Cruise control may be unable to maintain the stored speed on uphill gradients. The stored speed is resumed when the gradient evens out.

Change into a lower gear in good time on long and steep downhill gradients. Take particular note of this when driving a laden vehicle. By

doing so, you will make use of the braking effect of the engine. This relieves the load on the brake system and prevents the brakes from overheating and wearing too quickly.

Do not use cruise control in the following situations:

- In traffic situations which require frequent changes of speed, e.g. in heavy traffic, on winding roads
- On slippery roads. Accelerating can cause the drive wheels to lose traction and the vehicle could then skid
- When visibility is poor

### Operating cruise control

**⚠ WARNING** Risk of accident due to stored speed

If you call up the stored speed and this is lower than your current speed, the vehicle decelerates.

- ▶ Take into account the traffic situation before calling up the stored speed.

**Requirements:**

- ESP® must be activated, but not intervening.
- The driving speed is at least 15 mph (20 km/h).

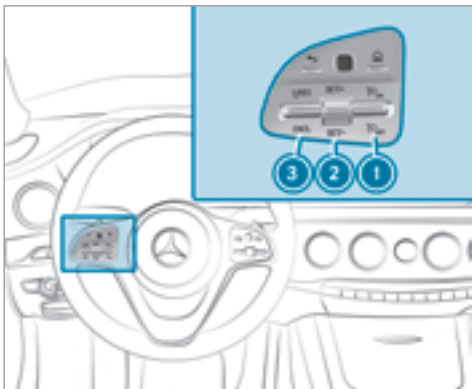

- ▶ **To switch on cruise control:** push rocker switch ① up.
- ▶ **To activate cruise control:** push rocker switch ② up (SET+) or down (SET-).

- ▶ Remove your foot from the accelerator pedal. The current speed is stored and maintained by the vehicle.
- ▶ **To increase/reduce speed:** press rocker switch ② up/down. The stored speed is increased or reduced by 1 mph (1 km/h).

or

- ▶ Press rocker switch ② beyond the pressure point. The stored speed is increased or reduced by 5 mph (10 km/h).

or

- ▶ Accelerate the vehicle to the desired speed.
  - ▶ Push rocker switch ② up.
- If cruise control is activated and Traffic Sign Assist has detected speed restriction signs, and these maximum permissible speeds are displayed in the instrument cluster:

- ▶ **To adopt the detected speed:** push rocker switch ③ up. The maximum permissible speed shown by the traffic sign is stored and the vehicle maintains this speed.

- ▶ **To deactivate cruise control:** push rocker switch ③ (CNCL) down.

When cruise control is deactivated:

- Rocker switch ② (SET+) or (SET-) saves the currently driven speed and the vehicle maintains this speed.
  - Rocker switch ③ (RES) calls up the speed last stored and the vehicle maintains this speed.
- ▶ **To switch off cruise control:** push rocker switch ① down.
- ⓘ If you brake, deactivate ESP® or if ESP® intervenes, cruise control is deactivated. When you switch off the vehicle, the last speed stored is cleared.

**Setting the speed limit for winter tires**

Multimedia system:

➔ [Vehicle](#) ➔ [Vehicle Settings](#) ➔ [Winter Tires Limit](#)

- ▶ Select a speed or deactivate the function.



## Active Distance Assist DISTRONIC

### Function of Active Distance Assist DISTRONIC



Active Distance Assist DISTRONIC maintains the set speed on free-flowing roads. If vehicles ahead are detected, the set distance is maintained, if necessary until the vehicle comes to a halt. The vehicle accelerates or brakes depending on the distance to the vehicle in front and the set speed. Speed (in the range between 15 mph (20 km/h) and 130 mph (210 km/h)) and the distance to the vehicle ahead are set and saved on the steering wheel.

Other features of Active Distance Assist DISTRONIC:

- Adjusts the driving style depending on the selected drive program (fuel-saving, comfortable or dynamic) (→ page 172)
- Responds in urban speed ranges to stationary vehicles (except bicycles, motorcycles and pedestrians) if conditions are sufficient to enable detection.
- Initiates rapid acceleration to the stored speed, if the turn signal indicator is switched on to change to the overtaking lane.
- Takes one-sided overtaking restrictions into account on freeways or on multi-lane roads with separate carriageways.

Vehicles with Active Parking Assist: if the vehicle has been braked to a standstill on multi-lane, separate carriageways by Active Distance Assist DISTRONIC, it can automatically follow the vehicle in front driving off again, within 30 seconds. If a critical situation is detected when driving off, a visual and acoustic warning is given indicating that the driver must now take control of the vehicle. The vehicle is not accelerated any further.

Active Distance Assist DISTRONIC is only an aid. The driver is responsible for the distance to the vehicle in front, for vehicle speed and for braking in good time.

### System limitations

The system may be impaired or may not function in the following instances, for example:

- In snow, rain, fog, heavy spray, if there is glare, in direct sunlight or in greatly varying ambient light.
- The windshield in the area of the camera is dirty, fogged up, damaged or covered.
- If the radar sensors are dirty or covered.
- On slippery roads, braking or accelerating can cause the drive wheels to lose traction and the vehicle could then skid.
- In parking garages or on roads with steep uphill or downhill gradients.

Do not use Active Distance Assist DISTRONIC in these situations.

**⚠ WARNING** Risk of accident from acceleration or braking by Active Distance Assist DISTRONIC

Active Distance Assist DISTRONIC may accelerate or brake in the following cases, for example:

- If the vehicle pulls away using Active Distance Assist DISTRONIC.
- If the stored speed is called up and is considerably faster or slower than the currently driven speed.
- If Active Distance Assist DISTRONIC no longer detects a vehicle in front or does not react to relevant objects.

▶ Always carefully observe the traffic conditions and be ready to brake at all times.

▶ Take into account the traffic situation before calling up the stored speed.

**⚠ WARNING** Risk of accident due to insufficient deceleration by Active Distance Assist DISTRONIC

Active Distance Assist DISTRONIC brakes your vehicle with up to 50 % of the maximum possible deceleration. If this deceleration is not sufficient, Active Distance Assist DISTRONIC alerts you with a visual and acoustic warning.

- ▶ In these cases, adjust your speed and keep a sufficient distance.
- ▶ Brake the vehicle yourself and/or take evasive action.

**⚠ WARNING** Risk of accident if detection function of Active Distance Assist DISTRONIC is impaired

Active Distance Assist DISTRONIC does not react or only partially reacts:

- When driving on a different line to the vehicle ahead or changing lane.

- To pedestrians, animals, bicycles or motor bikes, stationary vehicles or unexpected obstacles.
- To complex traffic situations.
- To oncoming vehicles and crossing traffic.

Active Distance Assist DISTRONIC can neither give warnings nor intervene in such situations.

▶ Always observe the traffic conditions carefully and react accordingly.

## Operating Active Distance Assist DISTRONIC

### Requirements:

- The vehicle has been started.
- The electric parking brake is released.
- ESP® is activated and is not intervening.
- The transmission is in position **D**.
- All the doors are closed.
- Check of the radar sensor system successfully completed (vehicle traveling faster than 12 mph (20 km/h)).

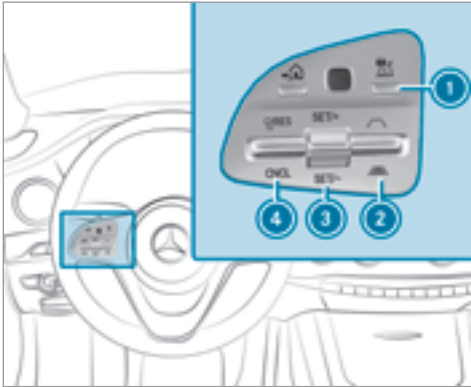

- ▶ **To activate/deactivate Active Distance Assist DISTRONIC:** press button ①.
- ▶ **To activate Active Distance Assist DISTRONIC:** press rocker switch ③ up (SET+) or down (SET-). Remove your foot from the accelerator pedal. The current speed is stored and maintained by the vehicle.

or

- ▶ **To activate Active Distance Assist DISTRONIC with a stored speed:** press rocker switch ④ up. Remove your foot from the accelerator pedal.

① If rocker switch ④ is pressed up twice, Active Distance Assist DISTRONIC is activated with the speed restriction displayed in the instrument cluster.

- ▶ **To accept the displayed speed restriction when Active Distance Assist DISTRONIC is active:** press rocker switch ④ (RES) up. The speed limit displayed in the instrument cluster is adopted as the stored speed. The vehicle adapts its speed to that of the vehicle in front, but only up to the stored speed.

- ▶ **To pull away with Distance Assist DISTRONIC activated:** remove your foot from the brake pedal.

- ▶ Push rocker switch ④ (RES) up.

or

- ▶ Depress the accelerator pedal briefly and distinctly. The functions of Active Distance Assist DISTRONIC continue to be carried out.

**⚠ WARNING** Risk of accident due to Active Distance Assist DISTRONIC still being activated when you leave the driver's seat

If you leave the driver's seat while the vehicle is being braked by Active Distance Assist DISTRONIC only, the vehicle can roll away.

- ▶ Always deactivate Active Distance Assist DISTRONIC and secure the vehicle to prevent it from rolling away before you leave the driver's seat.

- ▶ **To deactivate Active Distance Assist DISTRONIC:** press rocker switch ④ (CNCL) down.

- ▶ **To increase/reduce speed:** press rocker switch ③ up/down. The stored speed is increased or reduced by 1 mph (1 km/h).

or

- ▶ Press rocker switch ③ beyond the pressure point. The stored speed is increased or reduced by 5 mph (10 km/h).

- ▶ **To increase or reduce the specified distance from the vehicle in front:** press rocker switch ② up or down.

### Function of Active Speed Limit Assist

- ① The availability of the following function is country-dependent.



If a change in the speed limit is detected and Active Distance Assist DISTRONIC is activated, Active Distance Assist DISTRONIC assumes this new speed as the stored speed.

The driven speed is adjusted when the vehicle is level with the traffic sign at the latest. In the case of signs indicating entry into an urban area, the speed is adapted beforehand. The speed limit display in the Instrument Display is always updated when the vehicle is level with the traffic sign.

If there is no speed restriction on an unlimited stretch of road (e.g. on a freeway), the recommended speed is adopted as the stored speed. The system uses the speed stored on an unlimited stretch of road as the recommended speed. If you do not alter the stored speed on an unlimited stretch of road, the recommended speed is 80 mph (130 km/h).

If Active Distance Assist DISTRONIC has been put into passive mode by pressing the accelerator pedal, only speed limits which are higher than the set speed are adopted.

Active Speed Limit Assist can be configured in the multimedia system (→ page 235).

Active Speed Limit Assist is only an aid. The driver is responsible for the distance to the vehicle in front, for vehicle speed and for braking in good time. The maximum permissible speed also depends on factors such as the road surface and traffic conditions.

### System limitations

Temporary speed restrictions (e.g. for a certain time or due to weather conditions) cannot be properly detected by the system. The maximum permissible speed applying for a vehicle with a trailer is not detected by the system. In these situations you must adjust your speed yourself.

**⚠ WARNING** Risk of accident due to Active Speed Limit Assist adapting the vehicle's speed

The speed adopted by Active Speed Limit Assist may be too high or incorrect in some individual cases, such as:

- In the wet or in fog

- When towing a trailer
  - ▶ Ensure that the driven speed complies with traffic regulations.
  - ▶ Adjust the driving speed to suit current traffic and weather conditions.

### Function of route-based speed adjustment

- ① The availability of the following function is country-dependent.

When Distance Assist DISTRONIC is active, the function adjusts the speed depending on the route events ahead. Depending on the drive program selected, the vehicle negotiates the route event ahead in a fuel-saving, comfortable or dynamic manner. When the route event has been passed, the vehicle accelerates again to the stored speed. The set distance to the vehicle ahead, vehicles detected ahead and speed restrictions ahead are taken into account.

Route-based speed adjustment can be configured in the multimedia system (→ page 204).

Route events ahead are:

- Bends
  - T-intersections, traffic circles and toll stations
  - Turnings and exits
- ① When the toll station is reached, Active Distance Assist DISTRONIC adopts the speed as the stored speed.

Also, the speed is reduced if the turn signal to change lanes is switched on and one of the following situations is detected:

- Turning off at intersections
- On slowing-down lanes
- On lanes adjacent to slowing-down lanes

The driver is responsible for choosing the right speed and observing other road users. This applies in particular to intersections, traffic circles and sets of traffic lights, as route-based speed adjustment does not brake the vehicle to a standstill.

With active route guidance, the first speed adjustment is carried out automatically. If the

turn signal indicator is switched on, the selected route is confirmed and further speed adjustment is activated.

Speed adjustment is canceled in the following cases:

- If the turn signal indicator is switched off before the route event.
- If the driver depresses the accelerator or brake pedal during the process.

### System limitations

Route-based speed adjustment does not take right of way regulations into account. The driver is responsible for complying with road traffic regulations and driving at a suitable speed.

In difficult ambient conditions (e.g. unclear roads, narrow lanes, wet road surfaces, snow or ice) or when driving with a trailer, the speed adjustment made by the system may not always be suitable. In these situations the driver must intervene accordingly.

**⚠ WARNING** Risk of accident in spite of route-based speed adjustment

Route-based speed adjustment might malfunction or be temporarily unavailable in the following situations:

- If map data is not up to date or available
- If you do not follow the selected route guidance
- If the set route is re-planned
- In road construction areas
- When towing a trailer
- In bad weather or road conditions
- If the accelerator pedal is depressed
- ▶ Adjust the speed to the traffic situation.

### Setting route-based speed adjustment

**Requirement:**

- Active Distance Assist DISTRONIC is activated.

Multimedia system:

↳ Vehicle ▶  Assistance ▶ Speed Adjustment

▶ Select DYNAMIC SELECT Op. or Off .

### Active Steering Assist

#### Function of Active Steering Assist



Active Steering Assist assists the driver at speeds up to 130 mph (210 km/h) and helps the driver to stay in the center of the lane by means of moderate steering interventions. The system orients itself using detected lane markings. Depending on the speed driven, Active Steering

Assist uses the vehicles ahead as a reference. If the detection of lane markings and vehicles ahead is impaired, Active Steering Assist switches to passive mode. The system does not provide support in the form of steering interventions.

- The driver is required to keep their hands on the steering wheel at all times and be able to intervene at any time to correct the course of the vehicle and keep it in lane.
- The status of Active Steering Assist is displayed in the status bar of the multifunction display.

#### Steering and contact detection

The driver is required to keep their hands on the steering wheel at all times and to be able to intervene at any time. The driver must expect a change from active to passive mode or vice versa at any time.



If the system reaches a system limitation or the driver has not steered the vehicle for a considerable period of time or has removed their hands from the steering wheel, the system will, depending on the situation, first alert the driver with a visual warning. Display ① appears in the multifunction display. If the driver still does not steer the vehicle himself or herself, or still has not taken hold of the steering wheel, a repeated warning tone sounds in addition to the visual warning message to remind the driver to take control of the vehicle.

The warning message does not appear or disappears if one of the following conditions are met:

- The driver steers the vehicle.

- The driver presses a steering wheel button or operates Touch Control.

Active Steering Assist is only an aid. The driver is responsible for the distance to the vehicle in front, for vehicle speed, for braking in good time and for staying in lane. Before changing lanes, the driver must make sure that the neighboring lane is free (glance over the shoulder).

### System limitations

Active Steering Assist has a limited steering torque for lateral guidance. In some cases, the steering intervention is not sufficient to keep the vehicle in the lane or to drive past exits. Active Steering Assist cannot provide the driver with steering assistance at traffic circles, T-intersections, intersections, toll stations or turnings, for example.

The system may be impaired or may not function in the following instances:

- In snow, rain, fog, heavy spray, if there is glare or direct sunlight or if there are greatly varying ambient light or reflections, or strong shadows on the road.
- Insufficient road illumination.

- The windshield in the area of the camera is dirty, fogged up, damaged or covered.
- Absence of lane markings, or several unclear lane markings, or if the markings change rapidly.
- The distance to the vehicle in front is too small and the lane markings thus cannot be detected.
- The road is narrow and winding.
- Obstacles on the lane or projecting out into the lane.

The system does not provide assistance in the following conditions:

- On tight bends, traffic circles and when turning.
- If you actively change lane without switching on the turn signal indicator.

- ⚠ WARNING** Risk of accident if Active Steering Assist unexpectedly stops functioning

If the system limitations of Active Steering Assist are reached there is no guarantee that the system will remain active or will keep the vehicle in lane.

- ▶ Always keep your hands on the steering wheel and observe the traffic carefully.
- ▶ Always steer the vehicle paying attention to traffic conditions.

- ⚠ WARNING** Risk of accident if Active Steering Assist unexpectedly intervenes

A malfunction in the detection of lane markings and objects can occur.

This could cause unexpected steering intervention.

- ▶ Steer according to traffic conditions.

## Activating Active Steering Assist

### Requirements:

- ESP<sup>®</sup> must be activated, but not intervening.
- Active Distance Assist DISTRONIC is activated.

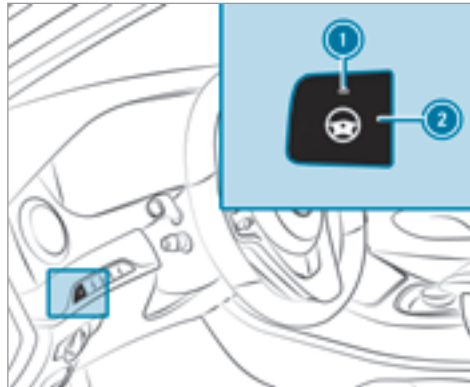

- ▶ If indicator lamp ① is off: press button ②.

## Function of Active Lane Change Assist

- ⓘ The availability of the following function is country-dependent.

Active Lane Change Assist supports the driver when changing lanes, by applying steering torques.

Assistance when changing lanes is provided if all the following conditions are met:

- You are driving on a freeway or road with multiple lanes in the direction of travel.
- The neighboring lane is separated by a broken lane marking.
- No vehicle is detected in the adjacent lane.
- The driven speed is between 50 mph (80 km/h) and 110 mph (180 km/h).
- Active Lane Change Assist is activated by the driver with the turn signal indicator.
- Active Lane Change Assist is switched on in the multimedia system.
- Active Steering Assist is switched on and active.





If no vehicle is detected in the adjacent lane and a lane change is permitted, the steering wheel symbol and the arrow are shown in green ②. The **Lane Change to the Left** message appears, for example. If Active Lane Change Assist is activated with the turn signal indicator but a lane change is not immediately possible, the steering wheel symbol remains green and the arrow appears gray ①. When the lane change support starts, the turn signal indicator is automatically activated. If a lane change is not possible within the defined length of time, the arrow fades out and a new lane change must be initiated. An immediate lane change is only possible on free-way sections without speed limits.

If the system is impaired, Active Lane Change Assist may be canceled. If it is canceled the **Lane Change Canceled** message appears in the multifunction display and a warning tone sounds.

**⚠ WARNING** Risk of accident from changing lane to an occupied adjacent lane

Lane Change Assist cannot always detect clearly if the adjacent lane is free.

The lane change might be initiated although the adjacent lane is not free.

- ▶ Before changing lanes, make sure that the neighboring lane is free and there is no danger to other road users.
- ▶ Monitor the lane change.

**⚠ WARNING** Risk of accident if Lane Change Assist unexpectedly stops functioning

If the system limitations for Lane Change Assist have been reached, there is no guarantee that the system will remain active.

Lane Change Assist cannot then assist you by applying steering torques.

- ▶ Always monitor the lane change and keep your hands on the steering wheel. Observe the traffic conditions and steer and/or brake if necessary.

### System limitations

The system limitations of Active Steering Assist apply to Lane Change Assist (→ page 204).

### Activating/deactivating Active Lane Change Assist

Multimedia system:

➔ Vehicle ➔  Assistance

▶ Select **Lane Change Assist**.

▶ Activate  or deactivate  the function.

### Function of Active Emergency Stop Assist

If the driver continues to ignore the acoustic warning to put their hands on the steering wheel, Active Distance Assist DISTRONIC reduces the speed. If the driver still does not respond, the **Beginning Emergency Stop** message is shown in the multifunction display. The

vehicle is decelerated in stages to a standstill. At speeds below 40 mph (60 km/h) the hazard warning lights switch on automatically.

When stationary:

- The vehicle is secured with the electric parking brake.
- Active Distance Assist DISTRONIC is ended.
- The vehicle is unlocked.
- If possible, an emergency call is placed to the Mercedes-Benz emergency call center.

The driver can cancel the deceleration at any time by performing one of the following actions:

- Steering
- Depressing the brake or accelerator pedal
- Pressing a steering wheel button or operating Touch Control
- Activating or deactivating Active Distance Assist DISTRONIC

### Active Distance Assist DISTRONIC displays in the instrument cluster

The assistance graphic and the status display show the status of the following functions in the instrument cluster.

- Active Distance Assist DISTRONIC
- Route-based speed adjustment
- Active Steering Assist

### Assistance graphic

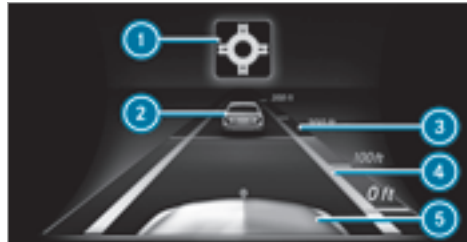

- ① Route-based speed adjustment (type of route event)
- ② Vehicle ahead

- ③ Distance indicator
- ④ Set specified distance
- ⑤ Own vehicle

### Active Distance Assist DISTRONIC status display and route-based speed adjustment



- ① Active Distance Assist DISTRONIC selected, set specified distance
- ② Active Distance Assist DISTRONIC deactivated, speed stored

- ③ Active Distance Assist DISTRONIC active, speed stored, no vehicle detected (gray vehicle symbol)
  - ④ Active Distance Assist DISTRONIC active, speed stored, vehicle detected (green vehicle symbol)
  - ⑤ Active Distance Assist DISTRONIC and route-based speed adjustment active, speed stored
- ① On freeways or high-speed major roads, the green  vehicle symbol is displayed cyclically when the vehicle is ready to pull away.



### Speedometer

The stored speed is highlighted on the speedometer. If the speed of the vehicle ahead or the speed adjustment is less than the stored speed due to the route event ahead, the segments in the speedometer light up. Activation or deactivation of Active Distance Assist DISTRONIC as well as alterations in the saved speed and the distance to be maintained, are displayed in the individual control feedback of the multifunction display.

### Active Steering Assist status display



- ① Gray steering wheel: Active Steering Assist switched on and passive
- ② Green steering wheel: Active Steering Assist switched on and active
- ③ Yellow steering wheel flashing: transition from active to passive status (system limitation detected or prompt to the driver to actively confirm)

During the transition from the active to passive status, the  symbol is shown as enlarged and flashes yellow. Once the system is passive the  symbol is shown as gray in the multifunction display.

## Information on Hill Start Assist

Hill Start Assist holds the vehicle for a short time when pulling away on a hill under the following conditions:

- The transmission is in position **D** or **R**.
- The electric parking brake is released.

This gives you enough time to move your foot from the brake pedal to the accelerator pedal and depress it before the vehicle begins to roll.

**⚠ WARNING** Risk of accident and injury caused by the vehicle rolling away

After a short time, Hill Start Assist no longer holds the vehicle and it can roll away.

- ▶ Therefore, swiftly move your foot from the brake pedal to the accelerator pedal. Never attempt to leave the vehicle if it is being held by Hill Start Assist.

## HOLD function

### HOLD function

The HOLD function holds the vehicle at a standstill without requiring you to depress the brake pedal, e.g. when pulling away on steep slopes.

### System limitations

- The incline must not be greater than 30%.

### Activating/deactivating the HOLD function

**⚠ WARNING** Risk of an accident due to the HOLD function being activated when you leave the vehicle

If you leave the vehicle while only the HOLD function is braking the vehicle, the vehicle can roll away in the following situations:

- If there is a malfunction in the system or in the power supply.
- If the HOLD function is deactivated by depressing the accelerator pedal or the brake pedal, e.g. by a vehicle occupant.

- If the electrics in the engine compartment, the battery or the fuses are tampered with or if the battery is disconnected.

- ▶ Always deactivate the HOLD function and secure the vehicle against rolling away before leaving the vehicle.

**!** **NOTE** Damage from automatic braking

When Active Brake Assist, Active Distance Assist DISTRONIC or the HOLD function are activated, the vehicle brakes autonomously in certain situations.

To avoid damage to the vehicle, deactivate these systems in the following or similar situations:

- ▶ During towing
- ▶ In a car wash

### Requirements:

- The vehicle is stationary.
- The driver's door is closed or the seat belt on the driver's side is fastened.

- The engine is running or has been automatically switched off by the ECO start/stop function.
- The electric parking brake is released.
- Active Distance Assist DISTRONIC is deactivated.
- The transmission is in position **D**, **R** or **N**.

### Activating the HOLD function

- ▶ Depress the brake pedal and after a short time quickly depress further until the **HOLD** display appears in the multifunction display.
- ▶ Release the brake pedal.

### Deactivating the HOLD function

- ▶ Depress the accelerator pedal to pull away.  
or
- ▶ Depress the brake pedal until the **HOLD** display disappears from the multifunction display.

The HOLD function is deactivated in the following situations:

- Active Distance Assist DISTRONIC is activated.
- The transmission is switched to position **P**.
- The vehicle is secured with the electric parking brake.

In the following situations, the vehicle is held by the transmission position **P** or by the electric parking brake:

- The seat belt is unfastened and the driver's door is opened.
- The engine is switched off.
- There is a malfunction in the system or the power supply is insufficient.

## AIR BODY CONTROL

### AIR BODY CONTROL function

AIR BODY CONTROL is an air suspension system with variable damping for improved driving com-

fort. The all-round level control system ensures the best possible suspension and constant ground clearance, even with a laden vehicle. When driving at speed, the vehicle is lowered automatically to improve driving safety and to reduce fuel consumption. The option of manually adjusting the vehicle level is also available.

AIR BODY CONTROL comprises:

- Air suspension with automatic all-round level control
- Speed-dependent lowering to reduce fuel consumption
- Manual level adjustment
- ADS PLUS (Adaptive Damping System with constant damping force adjustment)
- DYNAMIC SELECT switch and level button

**Available suspension settings**

Drive program	Characteristics
<b>S</b> (Sport)	<ul style="list-style-type: none"><li>• The suspension tuning is firmer.</li><li>• The vehicle is lowered by 0.4 in (10 mm) compared to the normal level.</li><li>• When driving at speeds above 75 mph (120 km/h), the vehicle is lowered by a further 0.4 in (10 mm).</li><li>• The vehicle is not lowered any further if you are traveling at higher speeds.</li><li>• When driving at speeds below 50 mph (80 km/h), the vehicle is raised again.</li></ul>
<b>C</b> (Comfort) <b>E</b> (Economy)	<ul style="list-style-type: none"><li>• The suspension tuning is comfortable.</li><li>• The vehicle is set to the normal level.</li><li>• When driving at speeds above 77 mph (125 km/h), the vehicle is lowered by 0.4 in (10 mm) compared to the normal level.</li><li>• When driving at speeds below 50 mph (80 km/h), the vehicle is raised again.</li><li>• When driving at speeds above 100 mph (160 km/h), the vehicle is lowered by a further 0.4 in (10 mm).</li><li>• When driving at speeds between 75 mph (120 km/h) and 100 mph (160 km/h), the vehicle is raised again by 0.4 in (10 mm).</li></ul>

## Setting the vehicle level

**⚠ WARNING** Risk of accident because vehicle level is too high

If you drive at a higher vehicle level, the driving characteristics may be impaired due to the higher vehicle center of gravity.

The vehicle may tip over more quickly on a bend, for example.

- ▶ Always select as low a vehicle level as possible and adapt your driving style accordingly.

**⚠ WARNING** Risk of entrapment from vehicle lowering

When lowering the vehicle, people could become trapped if their limbs are between the vehicle body and the tires or underneath the vehicle.

- ▶ Make sure no one is underneath the vehicle or in the immediate vicinity of the wheel arches when you lower the vehicle.

**⚠ WARNING** Risk of entrapment from vehicle lowering

**Vehicles with AIR BODY CONTROL or level control system:** When you unload luggage or leave the vehicle, the vehicle first rises slightly and then returns to the set level shortly afterwards.

You or anyone else in the vicinity of the wheel arches or the underbody could thus become trapped.

The vehicle can also be lowered after being locked.

- ▶ When leaving the vehicle, make sure that nobody is in the vicinity of the wheel arches or the underbody.

### Requirements:

- The vehicle has been started.
- The vehicle must not be moving faster than 50 mph (80 km/h).

## Raising the vehicle

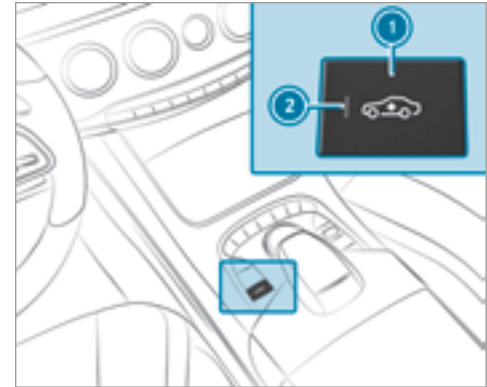

- ▶ Press button ①.  
Indicator lamp ② lights up.  
The vehicle is raised by 1 in (25 mm) compared to the normal level.

Your selection is saved.

The vehicle is lowered again in the following situations:

- When driving faster than 75 mph (120 km/h).
- When driving between 50 mph (80 km/h) and 75 mph (120 km/h) for approximately three minutes.
- After selecting a drive program using the DYNAMIC SELECT switch.

The vehicle is adjusted to the height of the last active drive program.

### Lowering the vehicle

- ▶ Press button ①.
- Indicator lamp ② goes out. The vehicle is adjusted to the height of the last active drive program.

## MAGIC BODY CONTROL

---

### MAGIC BODY CONTROL function

MAGIC BODY CONTROL is an electrohydraulic suspension with variable damping for improved driving comfort. The all-round level control system ensures the best possible suspension and constant ground clearance, even with a laden vehicle. When driving at speed, the vehicle is lowered automatically to improve driving safety and to reduce fuel consumption. The suspension tuning is adjusted depending on the road surface, vehicle load and the drive program selected. The ROAD SURFACE SCAN function detects areas of unevenness in the road before you drive over them by means of a multifunction camera. This reduces chassis movements. The option of manually adjusting the vehicle level is also available.

The damping is adjusted individually to each wheel and depends on:

- The driving style, e.g. sporty

- The road surface condition, e.g. bumps
- The individual selection of "Sport", "Comfort", "CURVE" or "Economy"

MAGIC BODY CONTROL comprises:

- Active Body Control ABC
- ROAD SURFACE SCAN
- Curve inclination function CURVE
- Automatic level control system
- Automatic vehicle stabilization in the event of sidewinds
- Speed-dependent lowering to reduce fuel consumption
- Manual level adjustment
- DYNAMIC SELECT switch and level button



## Available suspension settings

Drive program	Characteristics
<b>S</b> (Sport)	<ul style="list-style-type: none"> <li>• The suspension tuning is firmer.</li> <li>• When driving at speeds between 40 mph (65 km/h) and 87 mph (140 km/h), the vehicle is lowered steadily by a further 0.6 in (15 mm) and remains at this level up to the maximum vehicle speed.</li> <li>• When returning to speeds between 87 mph (140 km/h) and 40 mph (65 km/h), the vehicle is raised again by 0.6 in (15 mm).</li> <li>• ROAD SURFACE SCAN is deactivated.</li> </ul>
<b>C</b> (Comfort)	<ul style="list-style-type: none"> <li>• The suspension tuning is comfortable.</li> <li>• The vehicle is set to the normal level.</li> <li>• ROAD SURFACE SCAN is active.</li> </ul>
<b>CV</b> (Curve)	<ul style="list-style-type: none"> <li>• The suspension tuning is comfortable.</li> <li>• The vehicle is set to the normal level.</li> <li>• The curve inclination function is active.</li> <li>• ROAD SURFACE SCAN is active.</li> </ul>
<b>E</b> (Economy)	<ul style="list-style-type: none"> <li>• The suspension tuning is comfortable.</li> <li>• The vehicle is set to the normal level.</li> <li>• ROAD SURFACE SCAN is deactivated.</li> </ul>

### Crosswind Assist

The crosswind stabilization:

- Operates by changing wheel loads through adjusting the ABC spring struts.
- Reduces disruptions when driving straight ahead.
- Supports countersteering.
- Is active in the speed range between 50 mph (80 km/h) and 130 mph (210 km/h) when driving straight ahead or cornering gently.

### ROAD SURFACE SCAN

 This function is not available in all countries.

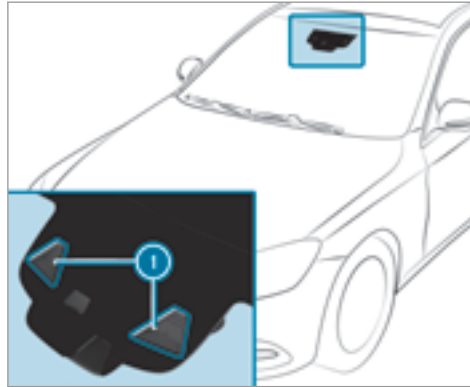

ROAD SURFACE SCAN:

- Monitors the road in front of the vehicle using multifunction camera .
- Is active when drive program **Comfort** or **CURVE** is selected.
- Detects unevenness in the road surface, e.g. bumps, before the vehicle drives over them.
- Reduces chassis movements.

### System limitations

ROAD SURFACE SCAN can be impaired in the following situations or can stop functioning:

- If the road is insufficiently lit, e.g. at night.
- In snow, rain, fog, heavy spray, if there is glare, in direct sunlight or in greatly varying ambient light.
- If the windshield in the area of multifunction camera  is dirty, fogged up, damaged or covered.
- If the road surface has no optic structure or reflects light.
- If the distance to the vehicle in front is too short.
- If sections of the route have a very small radius of curvature.
- In dynamic driving maneuver, e.g. if you accelerate or brake the vehicle sharply.
- At speeds below 5 mph (7 km/h) or above 112 mph (180 km/h).
- If the vehicle is at a raised level or in drive program **Sport**.

Observe the notes on cleaning the multifunction camera (→ page 389).

### Setting the vehicle level

**⚠ WARNING** Risk of entrapment from vehicle lowering

When lowering the vehicle, people could become trapped if their limbs are between the vehicle body and the tires or underneath the vehicle.

▶ Make sure no one is underneath the vehicle or in the immediate vicinity of the wheel arches when you lower the vehicle.

**⚠ WARNING** Risk of entrapment from vehicle lowering

**Vehicles with AIR BODY CONTROL or level control system:** When you unload luggage or leave the vehicle, the vehicle first rises slightly and then returns to the set level shortly afterwards.

You or anyone else in the vicinity of the wheel arches or the underbody could thus become trapped.

The vehicle can also be lowered after being locked.

▶ When leaving the vehicle, make sure that nobody is in the vicinity of the wheel arches or the underbody.

### Requirements:

- The vehicle has been started.
- The vehicle must not be moving faster than 75 mph (120 km/h).
- **Only when lowering the vehicle:** when the vehicle is stationary, all the doors have to be closed.

### Raising the vehicle

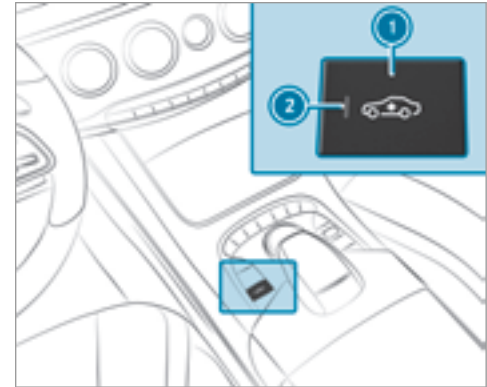

- ▶ Press button ①.  
Indicator lamp ② lights up.  
The vehicle is raised by 1.2 in (30 mm) compared to the normal level.

Your selection is saved.

The vehicle is lowered again in the following situations:

- When driving faster than 75 mph (120 km/h).
- When driving between 50 mph (80 km/h) and 75 mph (120 km/h) for approximately three minutes.
- After selecting a drive program using the DYNAMIC SELECT switch.

The vehicle is adjusted to the height of the last active drive program.

### Lowering the vehicle

- ▶ Press button ①. Indicator lamp ② goes out. The vehicle is adjusted to the height of the last active drive program.

## Parking Assist PARKTRONIC

### Function of Parking Assist PARKTRONIC

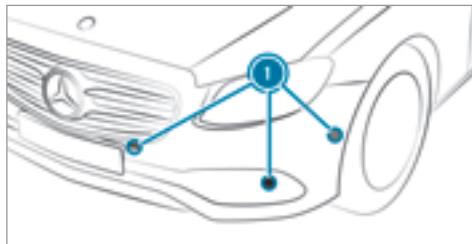

Parking Assist PARKTRONIC is an electronic parking assistance system with ultrasound. It monitors the area around your vehicle using six sensors ① in the front bumper and six sensors in the rear bumper. Parking Assist PARKTRONIC indicates visually and audibly the distance between your vehicle and an object.

Parking Assist PARKTRONIC is only an aid. It is not a substitute for your attention to the surroundings. The responsibility for safe maneuvering and parking remains with you. Make sure that there are no persons, animals or objects in

the maneuvering area while maneuvering and parking in/exiting parking spaces.

In the standard setting, an intermittent warning tone sounds from a distance of approximately 1.0 ft (0.3 m) to an obstacle. A continuous tone sounds from a distance of approximately 0.7 ft (0.2 m). You can set the warning tone in the multimedia system so that it will sound earlier at a greater distance of approximately 3.3 ft (1.0 m) (→ page 221).

If Parking Assist PARKTRONIC is deactivated, Active Parking Assist is unavailable.

### Parking Assist PARKTRONIC display in the multimedia system

If Active Parking Assist is not activated and an obstacle is detected in the path of the vehicle, a pop-up window for Parking Assist PARKTRONIC ① appears in the multimedia system at speeds up to approximately 6 mph (10 km/h).

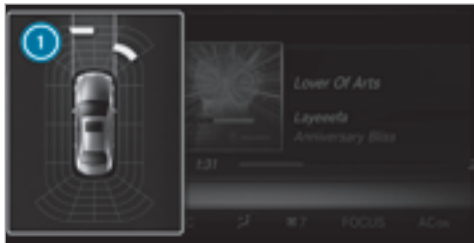

Vehicles with Active Parking Assist without a 360° Camera



Vehicles with Active Parking Assist and a 360° Camera

### System limitations

Parking Assist PARKTRONIC does not necessarily take into account the following obstacles:

- Obstacles below the detection range, e.g. persons, animals or objects.
- Obstacles above the detection range, e.g. overhanging loads, overhangs or loading ramps of trucks.

The sensors must be free of dirt, ice and slush. Otherwise, they may not function correctly. Clean the sensors regularly, taking care not to scratch or damage them.

### Function of the passive side impact protection

Passive side impact protection is an additional Parking Assist PARKTRONIC function which warns the driver about obstacles at the side of the vehicle. A warning is issued when obstacles are detected between the front and rear detection range. In order for an object to be detected, the sensors in the front or rear bumper must detect the object while you are driving past it.

During the parking procedure or maneuvering, objects are detected as the vehicle drives past. If you steer in the direction of a detected obstacle and there is a risk of a lateral collision, a warning is issued. The lateral segments light up orange or red, depending on the distance to the obstacle.

### Segment color depending on distance

Color	Lateral distance in cm
Red	Approx. < 30
Orange	Approx. 30 - 60

In order for lateral front or rear segments to be displayed, the vehicle must first travel a distance of at least half of the vehicle length. Once the vehicle has traveled the length of the vehicle, all of the lateral front and rear segments can be displayed.



Vehicles without 360° Camera

- ① Parking Assist PARKTRONIC is only operational in the front and rear
- ② Parking Assist PARKTRONIC is operational and can also warn the driver about obstacles at the side of the vehicle
- ③ Obstacles detected at the front right (orange) and rear (red)



Vehicles with 360° Camera

- ① Parking Assist PARKTRONIC is only operational in the front and rear
- ② Parking Assist PARKTRONIC is operational and can also warn the driver about obstacles at the side of the vehicle
- ③ Obstacles detected at the front right (orange) and rear (red)

Saved obstacles are deleted in the following situations, for example:

- You switch off the vehicle
- You open the doors

After the engine is restarted, obstacles must be detected again, before a new warning can be issued.

### System limitations

The system limitations for Parking Assist PARKTRONIC apply for passive side impact protection.

The following objects are not detected, for example:

- Pedestrians who approach the vehicle from the side
- Objects placed next to the vehicle

### Deactivating/activating Parking Assist PARKTRONIC

**!** **NOTE** Risk of an accident from objects at close range

Parking Assist PARKTRONIC may not detect certain objects at close range.

- ▶ When parking or maneuvering the vehicle, pay particular attention to any objects which are above or below the sensors, e.g. flower pots or drawbars.

The vehicle or other objects could otherwise be damaged.

If indicator lamp ② is not lit, Parking Assist PARKTRONIC is active. If the indicator lamp is lit and the  symbol appears in the multifunction display, Parking Assist PARKTRONIC is not active.

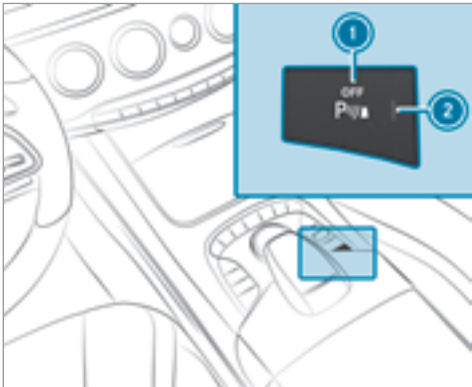

▶ Press button ① .

① Parking Assist PARKTRONIC is automatically activated when the vehicle is started.

### Adjusting the warning tones of Parking Assist PARKTRONIC

Multimedia system:

▶  Vehicle ▶  Assistance ▶ Camera & Parking ▶ Set Warning Tones

### Adjusting the volume of the warning tones

- ▶ Select **Warning Tone Volume**.
- ▶ Set a value.

### Adjusting the pitch of the warning tones

- ▶ Select **Warning Tone Pitch**.
- ▶ Set a value.

### Specifying the starting point for the warning tones

You can specify whether the Parking Assist PARKTRONIC warning tones should commence when the vehicle is further away from an obstacle.

- ▶ Select **Warn Early**.
- ▶ Activate  or deactivate  the function.

### Activating/deactivating audio fadeout

You can specify whether the volume of a media source in the multimedia system is to be reduced when Parking Assist PARKTRONIC gives an audible warning.

- ▶ Select **Audio Fadeout During Warning Tones**.
- ▶ Activate  or deactivate  the function.

## Reversing camera

### Function of the rear view camera

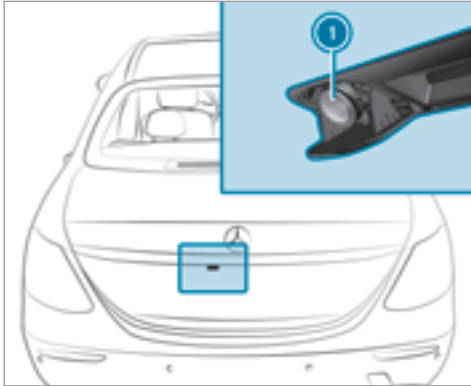

When you engage reverse gear, the image from rear view camera ① is shown in the multimedia system. Dynamic guide lines show the path the vehicle will take with the steering wheel in its current position. This helps you to orientate

yourself and to avoid obstacles when backing up.

The rear view camera is only an aid. It is not a substitute for your attention to the surroundings. You are always responsible for safe maneuvering and parking. Make sure that there are no persons, animals or objects in the maneuvering area while maneuvering and parking in parking spaces.

You can select from the following views:

- Normal view
- Wide-angle view

The area behind the vehicle is displayed as a mirror image, as in the inside rearview mirror.

### Camera views in the multimedia system

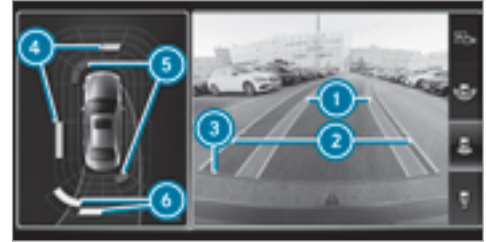

Normal view

- ① Yellow lane marking the course the tires will take at the current steering wheel angle (dynamic)
- ② Yellow guide line, vehicle width (driven surface) depending on the current steering wheel angle (dynamic)
- ③ Red guide line at a distance of approximately 12 in (0.3 m) from the rear area
- ④ Orange warning display of Parking Assist PARKTRONIC: obstacles are a medium distance away (between approximately 1.0 ft (0.3 m) and 2.0 ft (0.6 m))



- ⑤ Red warning display of Parking Assist PARKTRONIC: obstacles are very close (approximately 1.0 ft (0.3 m) or less)
- ⑥ Yellow warning display of Parking Assist PARKTRONIC: obstacles are at a distance of between approximately 2.0 ft (0.6 m) and 3.3 ft (1.0 m)
- ① If the entire system fails, the inner segments of the warning display are shown in red. The indicator lamp on the Parking Assist PARKTRONIC button lights up and the  symbol appears in the multifunction display. If the system fails at the rear of the vehicle:
  - The rear segments are shown in red when backing up.
  - The rear segments are hidden when driving forwards.

When Active Parking Assist is active, the lanes are displayed in green. If Parking Assist PARKTRONIC is deactivated, the warning display fades out.



Wide-angle view

### System failure

If there is no operational readiness, the following message appears in the multimedia system:



### System limitations

The rear view camera will not function or will only partially function in the following situations:

- The trunk lid is open.
- There is heavy rain, snow or fog.
- The ambient light is poor, e.g. at night.
- The camera lens is obstructed, dirty or fogged up. Observe the notes on cleaning the rear view camera (→ page 389).
- The camera or rear of your vehicle is damaged. In this case, have the camera and its position and setting checked at a qualified specialist workshop.

The field of vision and other functions of the rear view camera may be restricted due to additional accessories on the rear of the vehicle (e.g. license plate bracket or bicycle rack).

- ① The contrast of the display may be impaired by direct sunlight or by other light sources, e.g. when driving out of a garage. In this case, pay particular attention.

- ⓘ Have the display repaired or replaced if, for example, pixel errors considerably restrict its use.

Observe the notes on cleaning the rear view camera (→ page 389).

### 360° camera

#### Function of the 360° Camera

The 360° Camera is a system that consists of four cameras. The cameras cover the immediate vehicle surroundings. The system assists you, e.g. when parking or at exits with reduced visibility.

The 360° Camera is only an aid. It is not a substitute for your attention to the surroundings. You are always responsible for safe maneuvering and parking. Make sure that there are no persons, animals or objects in the maneuvering area while maneuvering and parking in parking spaces.

The system evaluates images from the following cameras:

- Rear view camera

- Front camera
- Two side cameras in the outside mirrors

#### Views of the 360° Camera

You can select from different views:



- 1 Wide-angle view, front
- 2 Top view with image from the front camera
- 3 Top view with images from the side cameras in the outside mirrors
- 4 Wide-angle view, to the rear
- 5 Top view with image from the rear view camera
- 6 Top view with trailer view (if trailer hitch is installed)

#### Top view



- 1 Lane indicating the route the vehicle will take with the steering wheel in its current position
- 2 Yellow warning display of Parking Assist PARKTRONIC: obstacles at a distance of approximately 3.3 ft (1.0 m) or less
- 3 Your vehicle from above

If the distance to the object lessens, the color of the warning display changes ②. From a distance of approximately 2.0 ft (0.6 m) the warning display is shown in orange. From a distance of approximately 1.0 ft (0.3 m) the warning display is shown in red.

When Parking Assist PARKTRONIC is operational and no object is detected, the segments of the warning display are shown in gray.

- ① If the entire system fails, the segments of the warning display are shown in red. The indicator lamp on the PARKTRONIC button lights up and the  symbol appears in the multifunction display.

If the system fails at the rear of the vehicle:

- The rear segments are shown in red when backing up.
- The rear segments are hidden when driving forwards.

If Parking Assist PARKTRONIC is deactivated, the warning display fades out.

### Guide lines



- ① Yellow lane marking the course the tires will take at the current steering wheel angle (dynamic)
- ② Yellow guide line, vehicle width (driven surface) depending on the current steering wheel angle (dynamic)
- ③ Red guide line at a distance of approximately 12 in (0.3 m) from the rear area
- ④ Mark at a distance of approx. 3.3 ft (1.0 m)
- ① When Active Parking Assist is active, the lanes are displayed in green.

The guide lines in the multimedia system display show the distances to your vehicle. The distances only apply to road level.

### Side view of the mirror cameras

The sides of the vehicle can be seen in this view.

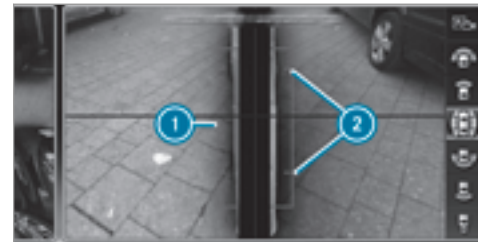

- ① Guide line of external vehicle dimensions with outside mirrors folded out
- ② Marker of the wheel contact points

### System limitations

The 360° Camera will not function or will only partially function in the following situations:

- If the doors are open.

- The side mirrors are folded in.
- If the trunk lid or tailgate is open.
- There is heavy rain, snow or fog.
- The ambient light is poor, e.g. at night.
- The camera lens is obstructed, dirty or fogged up.
- Cameras, or vehicle components in which the cameras are installed, are damaged. In this event, have the cameras, their positions and their setting checked at a qualified specialist workshop.

Do not use the 360° Camera under such circumstances. You could otherwise injure others or collide with objects when parking the vehicle.

On vehicles with height-adjustable suspension or if the vehicle is carrying a heavy load, leaving the standard height can result in inaccuracies in the guide lines and in the display of the generated images, depending on technical conditions.

The field of vision and other functions of the camera system may be restricted due to additional accessories (e.g. license plate bracket, bicycle rack).

See the notes on cleaning the 360° Camera (→ page 389).

### Selecting a view for the 360° Camera

#### Requirements:

- The [Auto. Rear View Cam.](#) function is selected in the multimedia system.
- ▶ Engage reverse gear.
  - ▶ In the multimedia system, select the desired view.

### Opening the camera cover of the rear view camera

Multimedia system:

↳ [Vehicle](#) ▶  [Assistance](#) ▶ [Camera & Parking](#)

- ▶ Select [Open Camera Cover](#).

 The camera cover closes automatically after some time or after an ignition cycle.

### Assigning the camera as a favorite

You can call up the camera view directly in the multimedia system by assigning it as a favorite.

- ▶ Press the  button on the touchpad or controller.  
The main functions are displayed.
- ▶ Navigate downwards twice.  
The Favorites menu appears.
- ▶ Select [New Favorite](#).
- ▶ Select [Vehicle](#).
- ▶ Select [Camera](#).

### Active Parking Assist

#### Function of Active Parking Assist

Active Parking Assist is an electronic parking assistance system which uses ultrasound and is automatically activated during forward travel.

The system is operational at speeds of up to approximately 22 mph (35 km/h). When all the conditions are fulfilled, the  symbol appears in the multifunction display and the system automatically searches for and measures parking spaces on both sides of the vehicle parallel and perpendicular to the direction of travel. If Active Parking Assist is activated, suitable parking spaces are displayed in the multimedia system.

The  symbol appears in the multifunction display. The arrows show on which side of the road free parking spaces are located.

The parking space and, if necessary, the parking direction can be selected as desired. Active Parking Assist calculates a suitable vehicle path and assists you in parking and exiting the parking space.

Active Parking Assist changes gear, accelerates, brakes and steers the vehicle.

Active Parking Assist is only an aid. It is not a substitute for your attention to the surroundings. The responsibility for safe maneuvering and parking remains with you. Make sure that no persons, animals or objects etc. are in the maneuvering range.

Active Parking Assist is canceled if, among other things, one of the following actions is carried out:

- You deactivate Parking Assist PARKTRONIC.
- You deactivate Active Parking Assist.
- You begin steering.
- You apply the parking brake.

- You engage transmission position .
- ESP® intervenes.
- You open the trunk lid.

### System limitations

Objects located above or below the detection range of Active Parking Assist are not detected when the parking space is being measured.

These are also not taken into account when the parking maneuver is calculated, e.g. overhanging loads, overhangs or loading ramps of trucks or the boundaries of parking spaces. In some circumstances, Active Parking Assist may therefore guide you into the parking space prematurely.

 **WARNING** Risk of accident due to objects located above or below the detection range of Active Parking Assist

If there are objects above or below the detection range, the following situations may arise:

- Active Parking Assist may steer too early.

- **Vehicles with automatic transmission:** The vehicle may not stop in front of these objects.

This could cause a collision.

 In these situations, do not use Active Parking Assist.

Snowfall or heavy rain may lead to a parking space being measured inaccurately. Parking spaces that are partially occupied by trailer drawbars might not be identified as such or be measured incorrectly. Only use Active Parking Assist on level, high-grip ground.

Do not use Active Parking Assist in the following situations:

- In extreme weather conditions such as ice, packed snow or in heavy rain.
- If you are transporting a load that protrudes beyond the vehicle.
- If the parking space is on a steep downhill or uphill gradient.
- If you have installed snow chains.

Active Parking Assist may also display parking spaces that are not suitable for parking, e.g.:

- Parking spaces where parking is prohibited.
- Parking spaces on unsuitable surfaces.

Active Parking Assist will not assist you with parking spaces at right angles to the direction of travel in the following situations:

- If two parking spaces are located immediately next to each other.
- If the parking space is directly next to a low obstacle such as a curb.

Active Parking Assist will not assist you with parking spaces at right angles to the direction of travel in the following situations:

- If the parking space is on a curb.
- If the parking space is bordered by an obstacle, e.g. a tree, a post or a trailer.

### Parking with Active Parking Assist

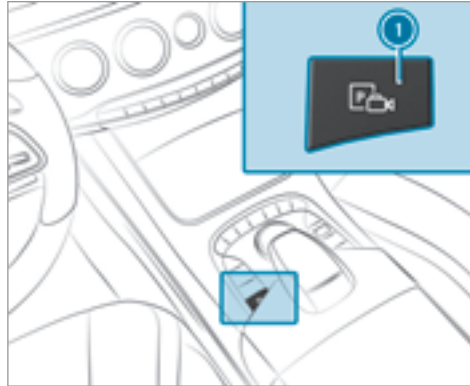

- ▶ Press button ①. The Active Parking Assist view appears on the multimedia system display. Area ② displays detected parking spaces ④ and vehicle path ③.

- ⓘ Vehicle path ③ shown on the multimedia system display may differ from the actual vehicle path.



- ▶ If you have driven past a suitable parking space: bring the vehicle to a standstill.
- ▶ Select desired parking space ④.
- ▶ Where necessary, select the parking direction: forwards or reverse. Vehicle path ③ is shown, depending on the selected parking space and parking direction.
- ▶ Confirm the selected parking space.

**⚠ WARNING** Risk of accident due to vehicle swinging out while parking or pulling out of a parking space

While parking or exiting a parking space, the vehicle swings out and can drive onto areas of the oncoming lane.

This could cause you to collide with objects or other road users.

- ▶ Pay attention to objects and other road users.
- ▶ Where necessary, stop the vehicle or cancel the parking procedure with Active Parking Assist.

- ▶ If, for example, the **Engage Reverse Gear** message appears in the multimedia system display: select the corresponding transmission position. The vehicle drives into the selected parking space.

On completion of the parking procedure, the **Parking Assist Finished, Take Control of Vehicle**

display message appears. Further maneuvering may still be necessary.

- ▶ After completion of the parking procedure, safeguard the vehicle against rolling away. When required by legal requirements or local conditions: turn the wheels towards the curb.
- ⓘ You can stop the vehicle and change the transmission position during the parking procedure. The system then calculates a new vehicle path. The parking procedure can then be continued. If no new vehicle path is available, the transmission position will be changed again. If the vehicle has not yet reached the parking space, the parking procedure will be canceled, should a gear be changed.

### Exiting a parking space with Active Parking Assist

#### Requirement:

You can only exit a parking space with Active Parking Assist if you have previously parked the vehicle with Active Parking Assist.

Please note that you are responsible for the vehicle and surroundings during the entire parking procedure.

- ▶ Start the vehicle.

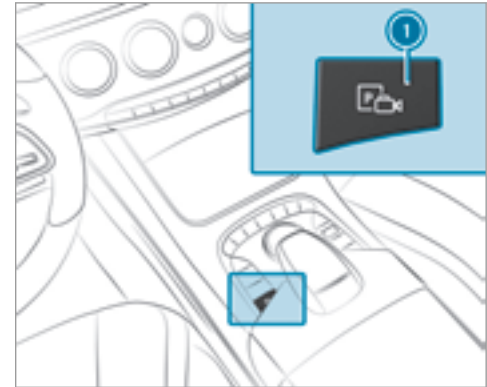

- ▶ Press button **1**. The Active Parking Assist view appears on the multimedia system display.



▶ If the vehicle has been parked at right angles to the direction of travel: in area ②, select direction of travel ③.

ⓘ The vehicle path shown on the multimedia system display may differ from the actual vehicle path.

▶ Confirm direction of exit ③ to drive out of the parking space.

**⚠ WARNING** Risk of accident due to vehicle swinging out while parking or pulling out of a parking space

While parking or exiting a parking space, the vehicle swings out and can drive onto areas of the oncoming lane.

This could cause you to collide with objects or other road users.

▶ Pay attention to objects and other road users.

▶ Where necessary, stop the vehicle or cancel the parking procedure with Active Parking Assist.

▶ If, for example, the **Engage Forward Gear** message appears in the multimedia system display: select the corresponding transmission position. The vehicle moves out of the parking space.



Example: vehicles with 360° Camera

After the exiting procedure has been completed, the **Parking Assist Finished, Take Control of Vehicle** message appears in the display of the multimedia system. A warning tone and the display ④ in the multimedia system prompt you to take over. You have to accelerate, brake, steer and change gear yourself again.

### Function of Drive Away Assist

Drive Away Assist can reduce the severity of an impact when pulling away. If an obstacle is detected in the direction of travel, the vehicle's speed is briefly reduced to approx. 1 mph (2 km/h). If a critical situation is detected, a



symbol appears on the camera image of the multimedia system.

**⚠ WARNING** Risk of accident caused by limited detection performance of Drive Away Assist

Drive Away Assist cannot always clearly identify objects and traffic situations.

In such cases, Drive Away Assist might:

- Warn you without reason and limit the vehicle speed.
- Not warn you or not limit the vehicle speed.

▶ Always pay careful attention to the traffic situation; do not rely on Drive Away Assist alone.

▶ Be prepared to brake or swerve as necessary, provided the traffic situation permits and that it is safe to take evasive action.

Drive Away Assist is only an aid. It is not a substitute for your attention to the surroundings.

You are always responsible for safe maneuvering, parking and exiting a parking space. Make sure that no persons, animals or objects etc. are in the maneuvering range.

A risk of a collision may arise in the following situations, for example:

- If the driver mixes up the accelerator and brake pedals.
- If the wrong gear is selected.

The Drive Away Assist function is active under the following conditions:

- If Parking Assist PARKTRONIC is activated.
- Every time the gear is changed to **R** or **D** when the vehicle is at a standstill.
- If the detected obstacle is less than approx. 3.3 ft (1.0 m) away.
- If the maneuvering assistance function is activated in the multimedia system.

**System limitations**

Drive Away Assist is not available on inclines.

**Function of Cross Traffic Alert**

**i** Also read the instructions on Blind Spot Assist (→ page 238).

**Vehicles with Blind Spot Assist:** Drivers can also be warned of any crossing traffic when backing up out of a parking space. If a critical situation is detected, a warning symbol appears on the camera image of the multimedia system. If the driver does not respond to the warning, the vehicle's brakes can be applied automatically. To do this, the function uses the radar sensors in the bumper. The area adjacent to the vehicle is continually monitored.

If the radar sensors are obstructed by vehicles or other objects, detection is not possible.

The Cross Traffic Alert function is active under the following conditions:

- If Blind Spot Assist is activated.
- If the vehicle is backing up at walking pace.
- If the maneuvering assistance function is activated in the multimedia system.

The Cross Traffic Alert function is not available on inclines.

## Deactivating/activating maneuvering assistance

Multimedia system:

↳ Vehicle ▶ Assistance ▶ Camera & Parking ▶ Maneuvering Assist.

▶ Switch the function on  or off .

## ATTENTION ASSIST

### Function of ATTENTION ASSIST

ATTENTION ASSIST assists you on long, monotonous journeys, e.g. on freeways and trunk roads. If ATTENTION ASSIST detects indicators of fatigue or increasing lapses in concentration on the part of the driver, it suggests taking a break.

ATTENTION ASSIST is only an aid. It cannot always detect fatigue or lapses in concentration until too late. The system is not a substitute for a well-rested and attentive driver. On long journeys, take regular breaks in good time that allow for adequate recuperation.

You can choose between two settings.

- **Standard:** normal system sensitivity.

- **Sensitive:** higher system sensitivity. The driver is warned earlier and the attention level detected by ATTENTION ASSIST is adapted accordingly.

If drowsiness or increasing lapses in concentration are detected, the **ATTENTION ASSIST: Take a Break!** warning appears in the Instrument Display. You can acknowledge the message and take a break where necessary. If you do not take a break and ATTENTION ASSIST continues to detect increasing lapses in concentration, you will be warned again after a minimum of 15 minutes.



You can have the following status information for ATTENTION ASSIST displayed in the assistance menu of the on-board computer:

- The length of the journey since the last break.
- The attention level determined by ATTENTION ASSIST.

If ATTENTION ASSIST is unable to calculate the attention level and cannot issue a warning, the **System Suspended** message appears.

If a warning is given in the Instrument Display, the multimedia system offers to search for a rest area. You can select a rest area and start navigation to this rest area. This function can be activated and deactivated in the multimedia system.

If ATTENTION ASSIST is deactivated, the  symbol appears in the assistance graphic in the Instrument Display when the engine is running. ATTENTION ASSIST is activated automatically when the engine is re-started. The last selected sensitivity level remains stored.

### System limitations

ATTENTION ASSIST is active in the 37 mph (60 km/h) to 124 mph (200 km/h) speed range.

The functionality of ATTENTION ASSIST is restricted, and warnings may be delayed or not occur at all in the following situations:

- If you have been driving for less than 30 minutes.
- If the road condition is poor (uneven road surface or potholes).
- If there is a strong side wind.
- If you adopt a sporty driving style (high cornering speeds or high rates of acceleration).
- If the Steering Assist function of Active Distance Assist DISTRONIC is active.
- If the time has been set incorrectly.
- In active driving situations, if you change lanes and vary your speed frequently.

The ATTENTION ASSIST tiredness or alertness assessment is deleted and restarted when continuing the journey in the following situations:

- If you switch off the engine.

- If you unfasten your seat belt and open the driver's door (e.g. change drivers or take a break).

### Setting ATTENTION ASSIST

Multimedia system:

➔ Vehicle ➔  Assistance ➔ ATTENTION ASSIST

### Setting options

▶ Select **Standard**, **Sensitive** or **Off**.

### Suggesting a rest area

- ▶ Select **Suggest Rest Area**.
- ▶ Activate  or deactivate the function . If ATTENTION ASSIST detects fatigue or increasing lack of attention, it suggests a rest area in the vicinity.
- ▶ **Selecting a suggested rest area.** You are guided to the selected rest area.

## Traffic Sign Assist

### Function of Traffic Sign Assist

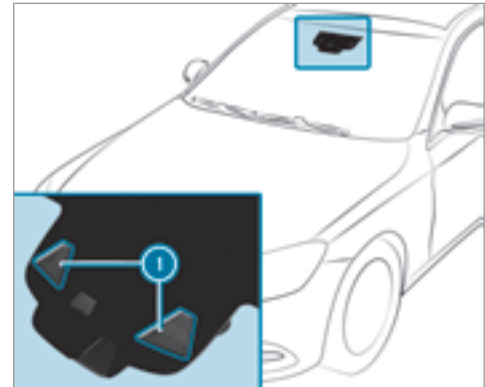

Traffic Sign Assist detects traffic signs with multifunction camera ① and assists you by displaying detected speed limits and overtaking restrictions in the instrument cluster. The camera also detects traffic signs with a restriction indicated by an additional sign (e.g. in wet conditions).

### Warning when the maximum permissible speed is exceeded

The system can warn you if you unintentionally exceed the maximum permissible speed. To do this, you can specify in the multimedia system by how much the maximum permissible speed can be exceeded before a warning is issued. You can specify whether the warning is to be just a visual warning or an acoustic one as well. If the automatic speed acceptance for Active Distance Assist DISTRONIC is activated, the warnings are suppressed.

### Display in the Instrument Display



- ① Permissible speed
- ② Permissible speed when there is a restriction
- ③ Additional sign with restriction
- i Display of speed restriction signs has priority over other recognized traffic signs, e.g. overtaking restriction signs.

Since Traffic Sign Assist also uses the data stored in the navigation system, it can update the display in the following situations without detecting traffic signs:

- When the vehicle changes roads, e.g. freeway exit or slip road.

- When a village or city boundary is passed which is stored in the digital map.



Traffic Sign Assist is not available in all countries. If it is unavailable, display ① is shown in the speedometer.

### System limitations

The system may be impaired or may not function in the following situations:

- There is poor visibility, e.g. due to insufficient illumination of the road, highly variable shade conditions, or due to rain, snow, fog or heavy spray.

- If there is glare, e.g. from oncoming traffic, direct sunlight or reflections.
- There is dirt on the windshield in the vicinity of the multifunction camera or the camera is fogged up, damaged or obscured.
- If the traffic signs are hard to detect, e.g. due to dirt or snow, or because they are covered or due to insufficient lighting.
- If the information in the navigation system's digital map is incorrect or out-of-date.
- If the signs are ambiguous, e.g. traffic signs on construction sites or in adjacent lanes.

### Setting Traffic Sign Assist

Multimedia system:

➔ Vehicle ➔  Assistance ➔ Traffic Sign Assist

### Activating /deactivating automatic adoption of speed limits

Requirements:

- Active Distance Assist DISTRONIC is activated.

- ▶ Select **Limit Adoption**.
- ▶ Activate  or deactivate  the function. The speed limits detected by Traffic Sign Assist are automatically adopted by Active Distance Assist DISTRONIC.

### Displaying detected traffic signs in the media display

- ▶ Select **Display in COMAND**.
- ▶ Activate  or deactivate  the function.

### Activating/deactivating the warning when a speed limit is exceeded

The point at which a warning is given once a speed is exceeded (warning threshold) can be set according to individual preferences.

- ▶ Select **Speed Limit Warning**.
- ▶ Select **Visual & Audible**, **Visual** or **None**.

### Setting the speed

- ▶ Select **Warning Threshold**.
- ▶ Set the desired speed.

## Night View Assist

### Function of Night View Assist

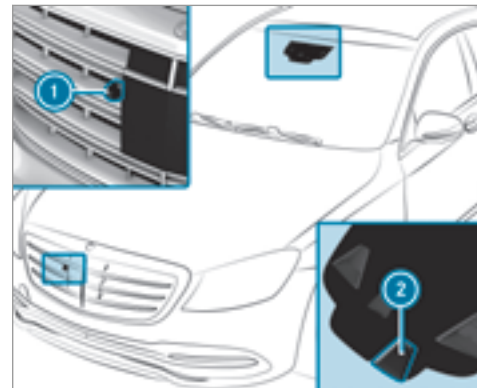

With the aid of camera ②, Night View Assist helps you to recognize the course of the road or obstacles in the dark. The multifunction display then shows a monochrome image of the surrounding area in front of the vehicle. Infrared

camera ❶ helps detect pedestrians and animals.

❶ As infrared light is not visible to the human eye, Night View Assist can remain activated when there is oncoming traffic. The infrared headlamps switch on in the dark from speeds of approximately 5 mph (10 km/h). This means that, while stationary, you do not have the full visual range and cannot check whether Night View Assist is working.

### System limitations

Night View Assist cannot display objects directly in front of or directly next to the vehicle. It may be the case that objects are highlighted as well as pedestrians or animals.

The system may be impaired or may not function in the following instances:

- Poor visibility, e.g. snow, rain, fog or spray.
- The windshield is dirty in the vicinity of the camera.
- The camera is fogged up, damaged or covered.

- The infrared camera in the radiator grill is damaged, dirty, fogged up or covered.
- On bends, on hilltops or in dips.
- At high ambient temperatures.

### Pedestrian and animal detection by Night View Assist

Night View Assist can detect pedestrians using typical characteristics, e.g. the body contours and posture of a person standing upright.

Large animals, such as deer, cows or horses can also be detected. Small animals such as dogs or cats are not detected.

Pedestrian and animal detection is automatically switched on when the following requirements are fulfilled:

- Night View Assist is activated.
- The driving speed is at least 5 mph (10 km/h).
- It is dark.



- ❶ Night View Assist display
- ❷ Standby symbol for active pedestrian detection
- ❸ Highlighting
- ❹ Pedestrian detected

If pedestrian detection is active, standby symbol ❷ appears. There is no separate symbol for animals. Detected pedestrians or animals are highlighted by a color frame.

### Activating or deactivating Night View Assist

#### Requirements:

- The vehicle has been started or the ignition is switched on.

- The light switch is in the **AUTO** or  position.
- Reverse gear has not been engaged.



- ▶ Press button ①.  
The appropriate Night View Assist display appears in the multifunction display.
- ① The infrared headlamps are deactivated at speeds below 3 mph (5 km/h). The Night

View image continues to be displayed until you switch it off by pressing button ①.

### Switching automatic activation on/off

#### Requirements:

- Pedestrian detection is active (→ page 236).
- The carriageway is not lit.
- The speed is at least 37 mph (60 km/h).

If all the requirements are fulfilled, the night vision image is automatically shown in the multifunction display as soon as people or animals are detected.

Multimedia system:

↗ Vehicle ▶  Assistance ▶ Aut.  
Night View Assist

▶ Activate  or deactivate  the function.

#### Spotlight function

The spotlight function is an additional function for Night View Assist. It runs in the background and flashes the headlamps at detected persons with four short impulses. This attracts the driver's attention to approaching pedestrians.

### Display in the assistance graphic

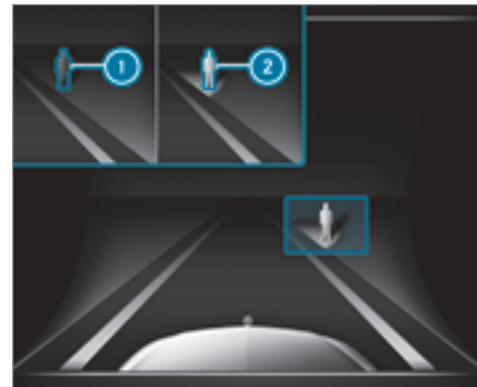

- ① Spotlight function switched on but not operating
- ② Spotlight function switched on and operating

The pedestrian symbol in the assistance graphic indicates the status of the spotlight function. If the pedestrian symbol is displayed dark ①, the function is switched on. If the symbol is dis-

played bright ②, the conditions for the Spotlight function are also fulfilled.

### System limitations

The spotlight function does not flash at animals.

The spotlight function is not active or is active only to a limited extent if:

- You are driving in city traffic.
- The pedestrians are located in the area of an oncoming vehicle or a vehicle in front.

### Activating/deactivating the spotlight function

#### Requirements:

- Pedestrian detection is active (→ page 236).
- The carriageway is not lit.
- The speed is at least 37 mph (60 km/h).
- Adaptive Highbeam Assist Plus is switched on.

If all the requirements are fulfilled, the headlamp flashes four short pulses at a pedestrian detected on or near to the road.

Multimedia system:

↳ Vehicle ▶  ▶ Light Settings ▶ Spotlight

▶ Switch the function on  or off .

### Blind Spot Assist and Active Blind Spot Assist

#### Function of Blind Spot Assist and Active Blind Spot Assist

Blind Spot Assist uses two lateral, rear-facing radar sensors to monitor the area up to 130 ft (40 m) behind your vehicle and 10 ft (3 m) directly next to your vehicle.

If a vehicle is detected at speeds above approximately 8 mph (12 km/h) and this vehicle subsequently enters the monitoring range directly next to your vehicle, the warning lamp in the outside mirror lights up red.

If a vehicle is detected close to your vehicle in the lateral monitoring range and you switch on the turn signal indicator in the corresponding direction, a warning tone sounds once. The red warning lamp in the outside mirror flashes. If the

turn signal indicator remains on, all other detected vehicles are indicated only by the flashing of the red warning lamp.

If you overtake a vehicle quickly, no warning is given.

#### **WARNING** Risk of accident despite Blind Spot Assist

Blind Spot Assist does not react to vehicles approaching and overtaking you at a greatly different speed.

As a result, Blind Spot Assist cannot warn drivers in this situation.

▶ Always pay careful attention to the traffic situation and maintain a safe distance at the side of the vehicle.

Blind Spot Assist and Active Blind Spot Assist are only aids. They may fail to detect some vehicles and are no substitute for attentive driving. Always ensure that there is sufficient distance to the side for other road users and obstacles.



### System limitations

The detection capability of Blind Spot Assist can be restricted in the following situations:

- There is dirt on the sensors or the sensors are obscured.
- When there is poor visibility, e.g. due to fog, heavy rain, snow or spray.
- If narrow vehicles are within the monitoring range, e.g. bicycles.

Warnings may be issued in error when driving close to crash barriers or similar solid lane borders. Warnings may be interrupted when driving alongside long vehicles, for example trucks, for a prolonged time.

Blind Spot Assist is not operational when reverse gear is engaged.

### Function of braking applications (Active Blind Spot Assist)

If Active Blind Spot Assist detects a risk of a side impact in the monitoring range, a course-correcting brake application is carried out. This is designed to help you avoid a collision.

The course-correcting brake application is available in the speed range between approximately 20 mph (30 km/h) and 125 mph (200 km/h).

**⚠ WARNING** Risk of accident despite brake application of Active Blind Spot Assist

A course-correcting brake application cannot always prevent a collision.

- ▶ Always steer, brake or accelerate yourself, especially if Active Blind Spot Assist warns you or makes a course-correcting brake application.
- ▶ Always maintain a safe distance at the sides.

**⚠ WARNING** Risk of accident despite Active Blind Spot Assist

Active Blind Spot Assist does not react to the following:

- Overtaking vehicles closely on the side, placing them in the blind spot area.

- Vehicles approaching and overtaking you at a very different speed.

As a result, Active Blind Spot Assist may neither give warnings nor intervene in such situations.

- ▶ Always pay careful attention to the traffic situation and maintain a safe distance at the side of the vehicle.

Active Blind Spot Assist is only an aid. It may fail to detect some vehicles and is not a substitute for attentive driving. Always ensure that there is sufficient distance to the side for other road users and obstacles.



If a course-correcting brake application occurs, the red warning lamp flashes in the outside mirror and a warning tone sounds. In addition, a display ① indicating the danger of a side collision appears in the multifunction display.

In rare cases, the system may make an inappropriate brake application. This brake application may be interrupted at any time if you steer slightly in the opposite direction or accelerate.

### System limitations

Either a course-correcting brake application appropriate to the driving situation, or none at all, may occur in the following situations:

- Vehicles or obstacles, e.g. crash barriers, are located on both sides of your vehicle.
- A vehicle approaches too closely on the side.
- You have adopted a sporty driving style with high cornering speeds.
- You brake or accelerate significantly.
- A driving safety system intervenes, such as ESP® or Active Brake Assist.
- ESP® is deactivated.

- A loss of tire pressure or a defective tire is detected.

### Activating or deactivating Blind Spot Assist or Active Blind Spot Assist

Multimedia system:

→ Vehicle → Assistance → Blind Spot Assist

▶ Activate  or deactivate  the function.

## Active Lane Keeping Assist

### Function of Active Lane Keeping Assist

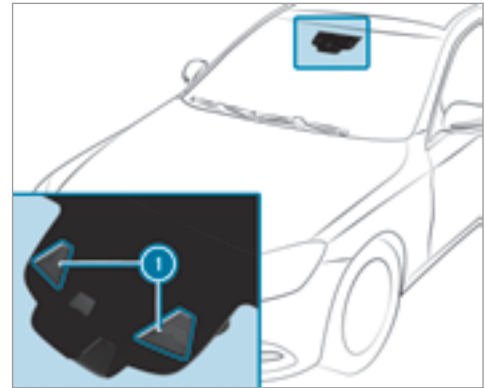

Active Lane Keeping Assist monitors the area in front of your vehicle by means of multifunction camera ①.

You are warned by vibration pulses in the steering wheel in the following circumstances:

- Active Lane Keeping Assist detects lane markings.
- A front wheel passes over the lane markings.

Whether a warning is issued and when this occurs also depends on the selected sensitivity setting (standard or adaptive).

If you fail to adapt your driving style, Active Lane Keeping Assist can neither reduce the risk of an accident nor override the laws of physics. It cannot take into account road, weather or traffic conditions. Active Lane Keeping Assist is only an aid. You are responsible for the distance to the vehicle in front, for vehicle speed, for braking in good time and for staying in lane.

**Vehicles with Lane Tracking package:** If the lane markings are solid lines and you do not react to the warning, a lane-correcting brake application can bring the vehicle back into the original lane.

**Vehicles with Driving Assistance package or Driving Assistance Plus package:** If you do not

react to the warning, a lane-correcting brake application can bring the vehicle back into the original lane. In the case of a broken lane marking being detected, a brake application will only be made if a vehicle has been detected in the adjacent lane. Oncoming vehicles, overtaking vehicles and vehicles in adjacent lanes can be detected.

The brake application is available in the speed range between 40 mph (60 km/h) and 120 mph (200 km/h).

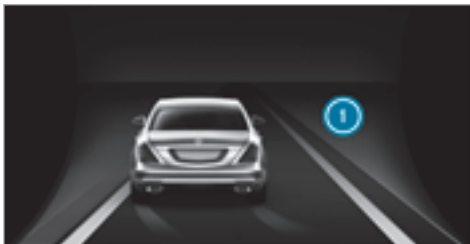

If a lane-correcting brake application occurs, display  appears in the multifunction display.

### System limitations

No lane-correcting brake application occurs in the following situations:

- You clearly and actively steer, brake or accelerate.
- You have switched on the turn signal indicator.
- A driving safety system intervenes, such as ESP®, Active Brake Assist or Active Blind Spot Assist.
- You have adopted a sporty driving style with high cornering speeds or high rates of acceleration.
- ESP® is deactivated.
- If a loss of tire pressure or a defective tire has been detected and displayed.

The system may be impaired or may not function in the following situations:

- There is poor visibility, e.g. due to insufficient illumination of the road, highly variable shade conditions, or due to rain, snow, fog or heavy spray.

- There is glare, e.g. from oncoming traffic, the sun or reflections.
- There is dirt on the windshield in the vicinity of the multifunction camera or the camera is fogged up, damaged or obscured.
- No or several, unclear lane markings are present for one lane, e.g. in a construction area.
- The lane markings are worn, dark or covered.
- The distance to the vehicle in front is too small and the lane markings thus cannot be detected.
- The lane markings change quickly, e.g. lanes branch off, cross one another or merge.
- The road is very narrow and winding.

**Vehicles with Driving Assistance package or Driving Assistance Plus package:**

Active Lane Keeping Assist uses radar sensors to monitor several areas around the vehicle. If the radar sensors in the rear bumper are dirty or covered with snow, the system may be impaired or may not function. If an obstacle in the lane in which

you are driving has been detected, no lane-correcting brake application occurs.

**Activating Active Lane Keeping Assist**

**⚠ WARNING** Risk of accident despite Active Lane Keeping Assist warning

A lane-correcting brake application cannot always bring the vehicle back into the original lane.

- ▶ Always steer, brake or accelerate yourself, especially if Active Lane Keeping Assist warns you or makes a lane-correcting brake application.

**⚠ WARNING** Risk of accident despite intervention of Active Lane Keeping Assist

Active Lane Keeping Assist does not detect traffic conditions or road users. In very rare cases, the system may make an inappropriate brake application, e.g. after intentionally driving over a solid lane marking.

The brake application can be interrupted at any time if you steer slightly in the opposite direction.

- ▶ Always make sure that there is sufficient distance to the side for other traffic or obstacles.

**⚠ WARNING** Risk of accident despite Lane Keeping Assist

Lane Keeping Assist cannot always clearly detect lane markings.

In such cases, Lane Keeping Assist can:

- give an unnecessary warning
- not give a warning
- ▶ Always pay particular attention to the traffic situation and keep within the lane, especially if Active Lane Keeping Assist alerts you.

**Requirement:**

The driving speed is at least 40 mph (60 km/h).

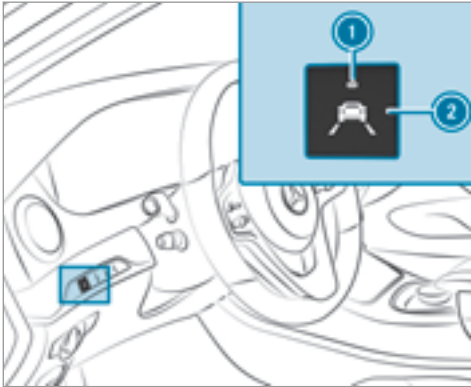

- ▶ Press button ②.  
If indicator lamp ① lights up, Lane Keeping Assist is activated. When lane markings are detected, the lines in the assistance graphic are shown in white.

### Sensitivity of Active Lane Keeping Assist

With the standard or adaptive setting, you can influence when the warning vibration of Lane Keeping Assist takes place.

In both the standard and adaptive settings, no warning vibration occurs in the following situations:

- You have switched on the turn signal indicator.
- A driving safety system intervenes, such as ABS, BAS or ESP®.

In the adaptive setting, there will also be no warning vibration in the following situations:

- The vehicle is accelerated or braked considerably.
- You steer actively, e.g. swerve to avoid an obstacle or change lane quickly.
- You cut the corner on a sharp bend.

### Setting the sensitivity of Active Lane Keeping Assist

Multimedia system:

↳ Vehicle ▶  Assistance ▶ Act.  
Lane Keep. Assist

- ▶ Select a setting.

## Instrument Display overview

**⚠ WARNING** Risk of accident due to an instrument display malfunction

If the instrument display has failed or malfunctioned, you cannot recognize function restrictions applying to safety relevant systems.

The operating safety of your vehicle may be impaired.

- ▶ Drive on carefully.
- ▶ Have the vehicle checked immediately at a qualified specialist workshop.

**Mercedes-AMG vehicles:** observe the notes in the Supplement. Otherwise, you may not recognize dangers.

**Plug-in hybrid:** observe the notes in the Supplement. Otherwise, you may not recognize dangers.

If the operating safety of your vehicle is impaired, park the vehicle safely as soon as possible. Contact a qualified specialist workshop.

## Instrument display



- ① Speedometer
- ② Multifunction display
- ③ Tachometer
- ④ Coolant temperature gauge
- ⑤ Fuel level and fuel filler flap location indicator

ⓘ This display is an example. Instead of tachometer ③ other displays are also possible.

The segments in speedometer ① indicate the system status for the following:

- Cruise control (→ page 196)

- Active Distance Assist DISTRONIC (→ page 199)

**Vehicles with Traffic Sign Assist:** detected instructions and traffic signs appear in the speedometer (→ page 233).

**! NOTE** Engine damage due to excessively high engine speeds

The engine will be damaged if you drive with the engine in the overrevving range.

- ▶ Do not drive with the engine in the overrevving range.

In tachometer ③ the overrevving range is shown in red. When the overrevving range is reached, the fuel supply is interrupted to protect the engine.

During normal operating conditions, coolant temperature display ④ may rise to 248°F (120°C).





**⚠ WARNING** Danger of burns when opening the hood

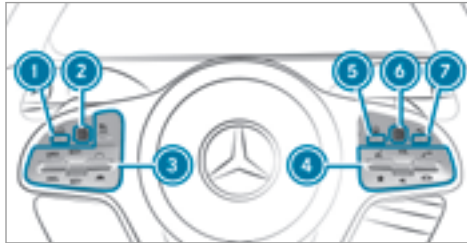

If you open the hood when the engine has overheated or during a fire in the engine compartment, you could come into contact with hot gases or other escaping operating fluids.

- ▶ Before opening the hood, allow the engine to cool down.
- ▶ In the event of a fire in the engine compartment, keep the hood closed and call the fire service.

### Overview of the buttons on the steering wheel



- ①  Back button, left (on-board computer)
- ② Touch Control, left (on-board computer)
- ③ Button group for cruise control or Active Distance Assist DISTRONIC
- ④ Button group:
  -  Voice Control System
  -  Displays favorites (multimedia system)
  - VOL: Increases/decreases volume using the control knob or switches off the sound
  -  Makes/accepts a call
  -  Rejects/ends a call

- ⑤  Main menu button (multimedia system)
- ⑥ Touch Control, right (multimedia system)
- ⑦  Back button, right (multimedia system)

### Operating the on-board computer

**⚠ WARNING** Risk of distraction from information systems and communications equipment

If you operate information and communication equipment integrated in the vehicle when driving, you will be distracted from the traffic situation. This could also cause you to lose control of the vehicle.

- ▶ Only operate this equipment when the traffic situation permits.
- ▶ If you cannot be sure of this, stop the vehicle whilst paying attention to road and traffic conditions and operate the equipment with the vehicle stationary.

You must observe the legal requirements for the country in which you are currently driving when operating the on-board computer.

- ① The on-board computer displays appear in the multifunction display (→ page 247).

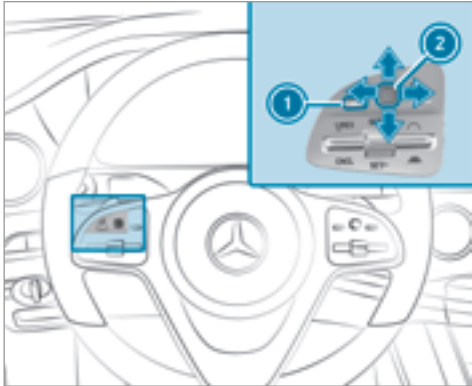

The on-board computer can be operated using Touch Control ② and back button ① on the left-hand side of the steering wheel.

The following menus are available:

- Service
- DriveAssist
- Trip
- Navigation
- Radio
- Media
- Phone
- Head-up Disp.
- Designs

The menus can be called up from the menu bar in the multifunction display.



- ▶ **To call up the menu bar:** press left back button ① repeatedly or press and hold once.

- ① **Vehicles without Active Distance Assist DISTRONIC:** press the  button to call up the menu bar of the on-board computer.

- ▶ **To scroll in the menu bar:** swipe to the left or right on Touch Control ②.

- ▶ **To call up the menu or confirm the selection:** press the left-hand side of Touch Control ②.

- ▶ **To scroll through displays or lists in the menu:** swipe upwards or downwards on Touch Control ②.

- ▶ **To call up the submenu or confirm the selection:** press the left-hand side of Touch Control ②.

- ▶ **To exit the submenu:** press left back button ①.



## Overview of displays in the multifunction display









- ① Outside temperature
- ② Drive program
- ③ Transmission position
- ④ Time
- ⑤ Display section

ⓘ The position of the displays deviates from those displayed here.

Further displays in the multifunction display:

↑ Gearshift recommendation (→ page 176)

 Active Parking Assist activated

-  Parking Assist PARKTRONIC deactivated
-  Cruise control (→ page 196)
-  Active Distance Assist DISTRONIC (→ page 199)
-  Active Steering Assist (→ page 204)
-  HOLD function (→ page 210)
-  Adaptive Highbeam Assist (→ page 146)

## Adjusting the instrument lighting

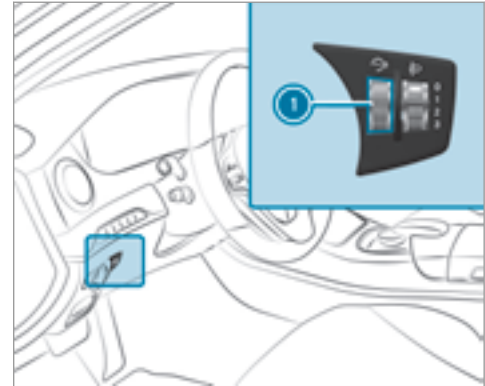

- ▶ Turn brightness control ① up or down. The lighting of the Instrument Display and in the control elements in the vehicle interior is adjusted.

## Menus and submenus

### Functions in the Service menu of the on-board computer

On-board computer:

#### ↳ Service

▶ **To select the function:** swipe upwards or downwards on the left-hand side of Touch Control.

▶ Press the left-hand side of Touch Control.

Functions in the **Service** menu:

- Message memory (→ page 457)
- **Tires:**
  - Checking the tire pressure with the tire pressure monitoring system (→ page 419)
  - Restarting the tire pressure monitoring system (→ page 420)
- **ASSYST PLUS:** calling up the service due date (→ page 377)

### Calling up the Assistance graphic display

On-board computer:

#### ↳ DriveAssist

ⓘ When you have set the style to **Progressive**, you can view the assistance graphic menu contents in the left-hand portion of the instrument display.

The following displays are available from the Assistance graphic menu:

- Assistance graphic
- Attention level (→ page 232)

▶ **To switch between the displays:** swipe upwards or downwards on the left-hand side of Touch Control.

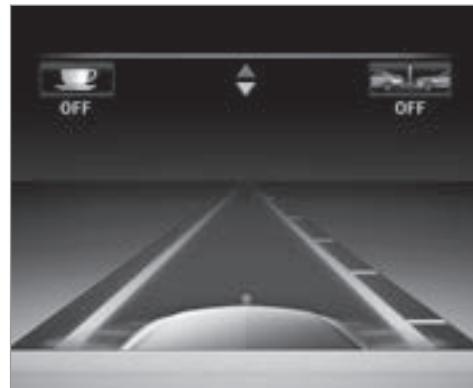

Status displays in the Assistance graphic:

- ☕ OFF: ATTENTION ASSIST deactivated
- 🚗 OFF: Active Brake Assist deactivated
- Light lane markings: Active Lane Keeping Assist activated
- Green lane markings: Active Lane Keeping Assist active

- Gray radar waves next to vehicle: Blind Spot Assist activated
- Green radar waves next to vehicle: Blind Spot Assist active
- Active Distance Assist DISTRONIC displays (→ page 199).

### Calling up displays in the Trip menu

On-board computer:



- **i** When you have the style set to **Progressive**, you can view information on the journey in the left-hand area of the Instrument Display.
- **To select a display:** swipe upwards or downwards on the left-hand side of Touch Control.

Displays in the **Trip** menu:

- Standard display
  - Range and current fuel consumption
- A recuperation display is also available for certain engines. If there is only a small amount of fuel left in the fuel tank, the dis-

play shows a vehicle being refueled instead of the range.

- ECO display (→ page 172)
- Trip computer **From Start** and **From Reset**
- Digital speedometer
- **i** The digital speedometer only appears in the **Classic** and **Sport** styles.



Example: standard display

- **1** Trip distance
- **2** Odometer



Example: trip computer

- **1** Odometer
- **2** Driving time
- **3** Average speed
- **4** Average fuel consumption

### Resetting values in the Trip menu of the on-board computer

On-board computer:



Trip

- ① The spelling may differ in the main menu displayed. Therefore, observe the menu overview for the Instrument Display (→ page 245).

You can reset the values of the following functions:

- Trip distance
- Trip computer "From start" and "From reset"
- ECO display

- ▶ **To select the function to be reset:** swipe upwards or downwards on the left-hand side of Touch Control.
- ▶ Press the left-hand side of Touch Control.
- ▶ Select **Yes**.
- ▶ Press the left-hand side of Touch Control.

If you press and hold the left-hand side of Touch Control, the function will be reset immediately.

### Calling up navigation instructions in the on-board computer

On-board computer:



Navigation



Example: no change of direction announced

- ① Distance to the next destination
- ② Estimated arrival time
- ③ Distance to the next change of direction
- ④ Current road

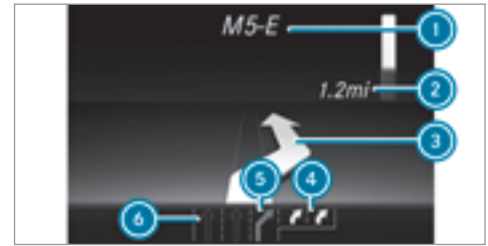

Example: change of direction announced

- ① Road to which the change of direction leads
- ② Distance to the change of direction
- ③ Change-of-direction symbol
- ④ Recommended lane and new lane during a change of direction (white)
- ⑤ Possible lane
- ⑥ Lane not recommended (dark gray)

Further possible displays in the [Navigation](#) menu:

- [Calculate New Route](#) or [Calculating Route...](#): a new route is calculated.

- **Road Not Mapped:** the road is unknown, e.g. newly built roads.
- **No Route:** no route could be calculated to the selected destination.
-  : you have reached the destination or an intermediate destination.

▶ **To exit the menu:** press the back button on the left.

In the **Navigation** menu, you can also start navigation to one of the previous destinations:

- ▶ Press the left-hand side of Touch Control.
- ▶ **To select the destination:** swipe upwards or downwards on the left-hand side of Touch Control.
- ▶ Press the left-hand side of Touch Control. Route guidance is started.  
If route guidance has already been activated, a request will appear asking whether you wish to end the current route guidance.
- ▶ Select **Yes**.
- ▶ Press the left-hand side of Touch Control. Route guidance is started.

## Selecting radio stations using the on-board computer

On-board computer:

➔ Radio



- ① Frequency range
- ② Station
- ③ Name of track
- ④ Name of artist

When you select a station in the presets, the preset appears next to the station name. When you select a saved station in the frequency range, an asterisk appears next to the station name.

▶ **To select a radio station:** swipe upwards or downwards on the left-hand side of Touch Control.

### Selecting frequency range or station preset list

- ▶ Press the left-hand side of Touch Control.
- ▶ **To select the frequency range/station preset list:** swipe upwards or downwards on the left-hand side of Touch Control.
- ▶ Press the left-hand side of Touch Control.

## Playing back media using the on-board computer

On-board computer:

→ Media

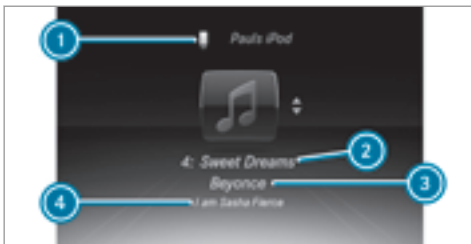

- ① Media source
- ② Current track and track number
- ③ Name of artist
- ④ Name of album

▶ **To change tracks in the active media source:** swipe upwards or downwards on the left-hand side of Touch Control.

## Changing the media source

- ▶ Press the left-hand side of Touch Control.
- ▶ **To select a media source:** swipe upwards or downwards on the left-hand side of Touch Control.
- ▶ Press the left-hand side of Touch Control.

## Dialing telephone numbers using the on-board computer

### Requirement:

- The mobile phone is connected to the multi-media system.

On-board computer:

→ Phone

**⚠ WARNING** Risk of distraction from information systems and communications equipment

If you operate information and communication equipment integrated in the vehicle when driving, you will be distracted from the

traffic situation. This could also cause you to lose control of the vehicle.

- ▶ Only operate this equipment when the traffic situation permits.
- ▶ If you cannot be sure of this, stop the vehicle whilst paying attention to road and traffic conditions and operate the equipment with the vehicle stationary.

When telephoning, you must observe the legal requirements for the country in which you are currently driving. The most recent telephone connections (dialed, received and missed calls) are displayed in the **Phone** menu.

- ▶ **To select the telephone number:** swipe upwards or downwards on the left-hand side of Touch Control.
- ▶ Press the left-hand side of Touch Control. **If there is only one telephone number saved to an entry:** the telephone number is selected.



- ▶ **If there are multiple telephone numbers saved to an entry:** swipe upwards or downwards on the left-hand side of Touch Control to select the desired telephone number.
- ▶ Press the left-hand side of Touch Control. The telephone number is dialed.

The following displays may appear instead of the telephone numbers dialed:



- **Please Wait...:** the application is starting. When a Bluetooth® connection to the mobile phone is not established, the menu for authorizing and connecting a mobile phone is displayed in the multimedia system (→ page 316).
- **Importing Contacts...:** the contacts from the mobile phone or from a storage medium are being imported.

### Accepting/rejecting a call

When you receive a call, the **Incoming Call** - message appears in the Head-up Display.

- ▶ Swipe upwards or downwards on the left-hand side of Touch Control and select  (Accept) or  (Reject).

- ▶ Press the left-hand side of Touch Control.

The call may be accepted/rejected using the  or  buttons on the steering wheel.

### Adjusting the Head-up Display settings in the on-board computer

On-board computer:

- ▶ **Head-up Disp.**

The following characteristics of the Head-up Display can be adjusted:

- **Position**
- **Brightness**
- **Display Content**

- ▶ **To select characteristics:** swipe upwards or downwards on the left-hand side of Touch Control.
- ▶ Press the left-hand side of Touch Control.
- ▶ **To adjust the value:** swipe upwards or downwards on the left-hand side of Touch Control.
- ▶ Press the left-hand side of Touch Control.



- ① Currently selected setting
- ② Digital speedometer
- ③ Traffic Sign Assist
- ④ Navigation displays

## Setting the design

On-board computer

### ↳ Designs

**i** This function is only available for vehicles with a Widescreen Cockpit.

The following designs can be selected:

- Sport
- Classic
- Progressive

▶ **To select a design:** swipe upwards or downwards on the left-hand Touch Control.

▶ Press the left-hand Touch Control. The Instrument Display is shown in the selected design.

## Head-up Display

### Function of the Head-up Display

**Mercedes-AMG vehicles:** observe the notes in the Supplement. Otherwise, you may not recognize dangers.

The Head-up Display projects information from the navigation system, the driver assistance system and some warning messages above the cockpit into the driver's field of vision.

### Display elements

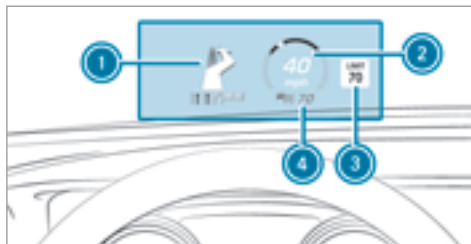

- ① Navigation messages
- ② Current speed
- ③ Detected instructions and traffic signs
- ④ Set speed in the driver assistance system (e.g. cruise control)

When you receive a call, the  Incoming Call message appears in the Head-up Display.

### System limitations

The visibility is influenced by the following conditions:

- Seat position
  - The positioning of the display image
  - Light conditions
  - Wet roads
  - Objects on the display cover
  - Polarization in sunglasses
- i** In extreme sunlight, sections of the display may be faded. This can be corrected by switching the Head-up Display off and on again.



### Switching the Head-up Display on/off

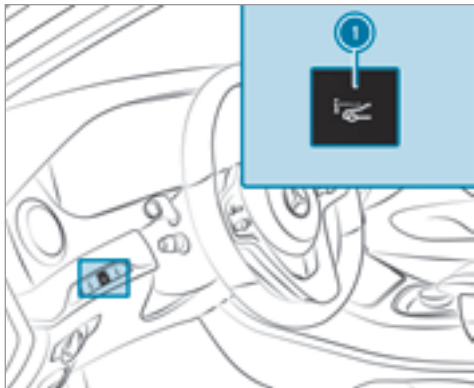

▶ Press button ①.

## Operating safety

**⚠ WARNING** Risk of distraction from information systems and communications equipment

If you operate information and communication equipment integrated in the vehicle when driving, you will be distracted from the traffic situation. This could also cause you to lose control of the vehicle.

- ▶ Only operate this equipment when the traffic situation permits.
- ▶ If you cannot be sure of this, stop the vehicle whilst paying attention to road and traffic conditions and operate the equipment with the vehicle stationary.

**⚠ WARNING** Risk of distraction from operating mobile communication equipment while the vehicle is in motion

If you operate communication equipment integrated in the vehicle when driving, you will be distracted from the traffic situation.

This could also cause you to lose control of the vehicle.

Only operate this equipment when the vehicle is stationary.

For your own safety, always observe the following points when operating mobile communications equipment and especially your voice control system:



- Observe the legal requirements for the country in which you are driving.
- While driving, only operate mobile communications equipment and your voice control system when the traffic conditions permit it. You may otherwise be distracted from the traffic conditions and cause an accident, injuring yourself and others.
- Do not use the voice control system in an emergency as your voice can change and your telephone call can be unnecessarily delayed.
- Familiarize yourself with the voice control system functions before starting the journey.

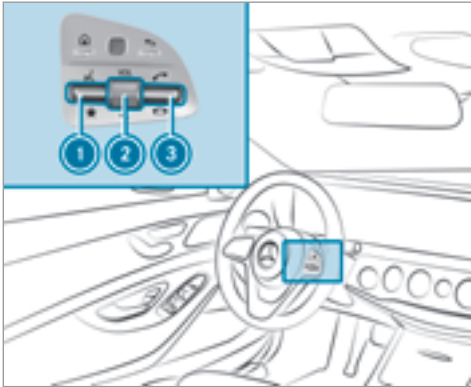

## Operation

### Multifunction steering wheel operation overview

The Voice Control System is operational approximately thirty seconds after the ignition is switched on.



- ① Press the rocker switch up:  starts Voice Control System
- ② Press the control knob:  switches the sound off or on (ends Voice Control System)  
Turn the rotary control up/down: increases/decreases the volume

- ③ Press the rocker switch up:  makes/accepts a call  
Press the rocker switch down:  rejects/ends a call (ends Voice Control System)

### Conducting a dialog

- ▶ **To start or continue a dialog:** press the  rocker switch on the multifunction steering wheel up.  
You can say a voice command after an acoustic signal.
- ▶ **To correct an entry:** say the Correction voice command.
- ▶ **To select an entry from the selection list:** say the line number or the contents.
- ▶ **To browse the selection list:** say the Next or Back voice command.
- ▶ **To interrupt the dialog:** say the Pause voice command.
- ▶ **To cancel the dialog:** say the Cancel voice command.

### Operable functions

You can use the Voice Control System to operate the following equipment regardless of the features:

- Telephone
- Text messages
- Navigation
- Address book
- Radio
- Audio (memory card, Media Interface, USB and Bluetooth® audio)
- Vehicle

### Types of voice commands

A distinction is made between the following voice commands:

- **Global voice commands** can be said at any time and regardless of the current application, e.g. the voice commands Navigate to, Call or Text message to.

- **Application-specific voice commands** are only available for the active application.

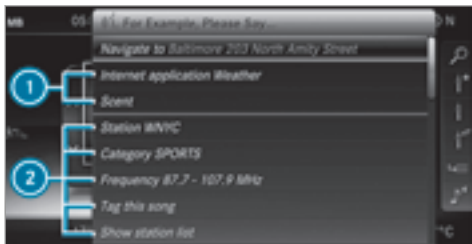

- ① Global voice commands
- ② Application-specific voice commands

On the display next to the active application, examples of global voice commands and the corresponding application-specific voice commands are displayed on an autocue. This makes entry easier and supports interactive operation. The list can be scrolled or it can be operated by speech or the controller/touchpad.

### Entering numbers

- The numbers allowed are zero to nine.
- Telephone numbers can be entered as single digits.

### Information on the language setting

You can change the language of the Voice Control System via the system language settings. If the set system language is not supported by the Voice Control System, English will be selected.

The Voice Control System is available in English, French, Portuguese and Spanish.

### Using the Voice Control System effectively

#### Audible help functions

You receive information and help for:

- **Optimal operation:** say the Help Voice Control System voice command.
- **Current application:** push the  rocker switch on the multifunction steering wheel up and say the Help voice command.

- **Continued dialog:** say the Help voice command during a voice dialog.
- **A specific system:** say the voice commands for the desired system, e.g. Help telephone.

### Speech quality improvement

**If the Voice Control System does not understand you:**

- only operate the Voice Control System from the driver's seat.
- say the voice commands coherently and clearly, but do not exaggerate the words.
- avoid loud noises, e.g. the blower, that cause interference while making a voice command entry.
- say the voice tag with the same intonation when creating voice tags.

**If an address book entry voice tag is not recognized:**

- only create sensible address book entries in the system/mobile phone, e.g. enter surname and first name in the correct field.

- do not use any abbreviations, unnecessary spaces or special characters.

**If a station list entry is not recognized:**

- say the Read out station list voice command.

### Essential voice commands

#### Switch voice commands

Switch voice commands can be used to open certain applications. The voice command selection can be used regardless of the application that is currently active.

Voice command	Function
Navigation	To switch to navigation mode
Map	To switch to map display
Address book	To switch to address book
Telephone	To switch to telephone mode
Text message	To switch to text messages
Radio	To switch to radio mode
Media	To switch to media mode
USB	To switch to USB
Memory card	To switch to memory card
Internet application <Name>	To start a Mercedes-Benz online application. The application must be called up by touch once prior to use.

Voice command	Function
Mercedes-Benz Apps	To switch to Mercedes-Benz Apps
Connect	To switch to Internet mode
Vehicle menu	To switch to vehicle settings
System settings menu	To switch to system settings

### Navigation voice commands

Using navigation voice commands, you can enter POIs or conventional addresses as well as directly change important navigation settings.

Voice command	Function
Navigate to <Address/POI/Contact>	Universal search for destinations of all types. A search is also performed in the address book contacts, in the navigation database and on the Internet (POIs). The order of the details, e.g. city, street or house number, can be changed.
Address in <Country>	Destination entry in a desired country, e.g. address in France
Home	Starts navigation to home address
Work	Starts navigation to your workspace

Voice command	Function
POI <POI>	Destination entry for a POI, e.g. the POI Brandenburg Gate. A search is also performed in the navigation database and on the Internet.
POI online search <POI>	Conducts a POI search on the Internet only
Navigate to contact <Name>	Destination entry to a contact in the address book
Enter country Enter town Enter district Enter street Enter intersection Enter house number Enter ZIP code	Enters a country/city/district/street/intersection/house number/ZIP code
Nearest restaurant Nearest parking lot Nearest rest area with restrooms Nearest gas station	Searches for nearby restaurants, parking spaces, rest areas with toilets and gas stations
Last destinations	Selects a destination from the list of last entered destinations

<b>Voice command</b>	<b>Function</b>
Alternative routes	Switches route guidance to another route
Start route guidance	Starts route guidance after entering a valid destination
Cancel route guidance	Cancels route guidance
Guidance instructions on Guidance instructions off	Switches the route guidance voice output on/off
Show traffic map Hide traffic map	Switches the traffic map on/off
Switch on POI symbols Switch off POI symbols	Switches the POI symbols display on the map on/off

### **Telephone voice commands**

---

You can use the telephone voice commands to make phone calls or search through the address book.



Voice command	Function
Call <Name>	Makes a phone call. All address book names are available.
Find contact <Name>	Searches for and displays a contact. All address book names are available.
Outgoing calls	Displays the last call
Redial number	Selects the last phone number dialed

### Radio voice commands

Radio voice commands can also be used when the radio application is running in the background.

Voice command	Function
Station <Name>	To call up receivable or saved stations
<Frequency>	To enter a frequency directly
Next station Previous station	To switch to the next available station
Save station	To save a station in the station list
Show station list	To display the names of all receivable stations

<b>Voice command</b>	<b>Function</b>
Read out station list	To listen to the names of all receivable stations
Traffic information on Traffic information off	To switch the traffic information service on/off
Radio info on Radio info off	To switch the current station information on/off

### **Media player voice commands**

---

Media player voice commands can also be used when the media player is running in the background.

Voice command	Function
Play <Tracks> Play <Albums> Play <Artists> Play<Composers> Play <Genres> Play <Playlists>	The names of all available tracks, albums, artists, composers, genres or playlists are accepted during the search.
Media search <Track> Media search <Albums> Media search <Artists> Media search <Composers> Media search <Genres> Media search <Playlists>	The names of all available tracks, albums, artists, composers, genres or playlists are accepted during the search.

Voice command	Function
Show all albums Show all artists Show all composers Show all genres Show all tracks Show all playlists	Available albums, artists, composers, genres, tracks or playlists are searched for.
Next track	To select the next track
Previous track	To select the previous track
Random track list on Random track list off	To switch the random track list on/off

### Message voice commands

---

Text messages can be created, edited and listened to using the message voice commands.

Voice command	Function
Text message to <Name>	To create a message. All address book names are available.
Reply	To reply to a message
Forward text message	To forward a message

### Vehicle voice commands

You can use the vehicle voice commands to directly call up the corresponding menus for the vehicle settings.

Voice command	Function
Ambient light menu	To display ambient light settings
Ambient light blue	To display the blue ambient light
Display and styles menu	To show display settings
Assistance menu	To display assistance settings
Scent menu	To display fragrance settings
Energy flow	To display energy flow settings
Ionization menu	To display ionization settings

Voice command	Function
Climate control menu	To display climate control settings
Automatic climate control driver on	To switch on the automatic climate control settings on the driver's side
Light menu	To display light settings
Massage menu	To display massage settings
Driver's seat massage on	To switch on the massage function for the driver's seat
Driver's seat massage off	To switch off the massage function for the driver's seat
Outside temperature	To display the outside temperature
Engine data	To display engine data
Seats menu	To display seat adjustment settings
Front-passenger seat heating level 2	To set the seat heater for the front passenger seat to level 2
Consumption menu	To display consumption
Vehicle data	To display vehicle data

## Overview and operation

### Overview of the multimedia system

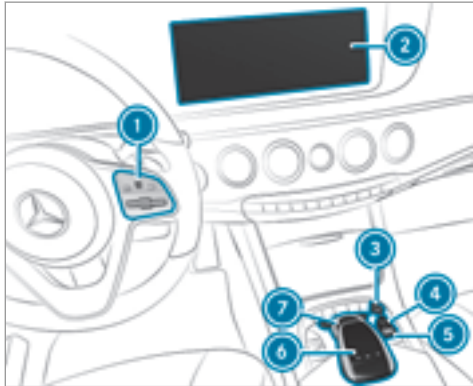

- ① Touch Control
  - ② Media display
  - ③ Main function button group (→ page 272)
  - ④ Button 
- Switches multimedia system on/off

- ⑤ Control knob  
Adjusts volume and switches the sound on/off
- ⑥ Touchpad
- ⑦ Controller

### Notes on the media display

#### ! NOTE Scratching of the display

The display has a highly sensitive, high-gloss surface. There is a risk of it becoming scratched.

Avoid touching the display.

Observe the notes on cleaning.

Observe the notes on caring for the interior (→ page 390).

**Automatic temperature-controlled switch-off feature:** if the temperature is too high, the brightness is initially reduced automatically. The media display may then switch off completely for a while.

- ⓘ If you are wearing polarized sunglasses, it may be difficult to read the media display.

### Central control elements overview



- ① Touch Control
- ② Controller
- ③ Touchpad

## Touch Control

### Operating Touch Control

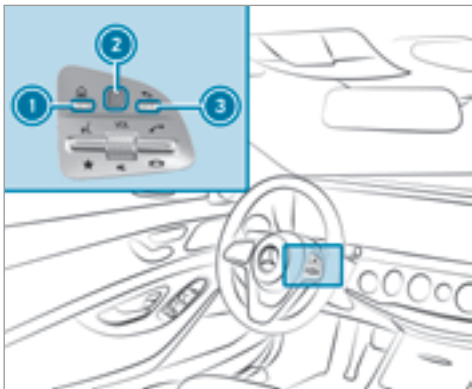

- ▶ **To call up main functions:** press button ①.

or

- ▶ Press and hold button ③.
- ▶ **To call up favorites:** press button ①.
- ▶ Swipe down on Touch Control ②.

- ▶ **To open a list:** press Touch Control ②.

- ▶ **To close a list:** press button ③.

or

- ▶ Swipe right on Touch Control ②.
- ▶ **To select a menu item:** swipe up, down, left or right on Touch Control ②.
- ▶ Press Touch Control ②.
- ▶ **To move the digital map:** swipe in any direction.

### Setting the sensitivity for Touch Control

Multimedia system:

➔ System ➔ Input ➔ Touch Control Sensitivity

- ▶ Select **Fast**, **Medium** or **Slow**.

## Operating the controller

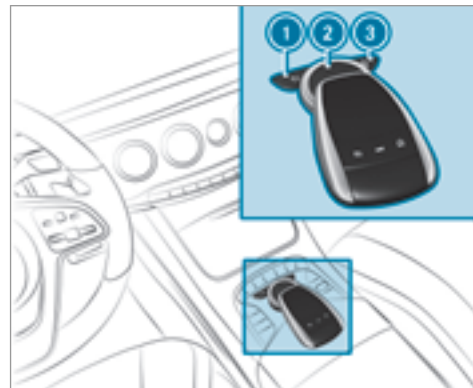

- ①  button

Press briefly: returns to the previous display  
Press and hold: calls up main functions

- ② Controller





- ③  button



Calling up the main functions

To call up favorites: when the main functions are displayed, slide controller ② down.

Controller ② operating options:

- ▶ Turn  left or right.
- ▶ Slide  left or right.
- ▶ Slide  up or down.
- ▶ Slide  diagonally.
- ▶ Press  briefly or press and hold.

## Touchpad

### Switching the touchpad on/off

Multimedia system:

 System  Input

- ▶ Switch Touchpad on  or off .

### Operating the touchpad

#### Requirement:

- The touchpad is switched on (→ page 271).

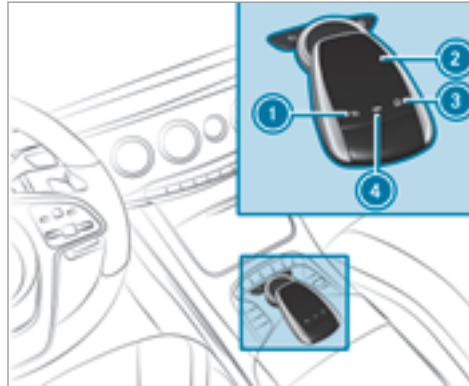

① Button 

Press briefly: returns to the previous display  
Press and hold: calls up main functions

② Touchpad

③ Button 

Calling up the main functions

To call up favorites: when the main functions are displayed, swipe down on touchpad ②.

④ Button 

Calls up the control menu of the last active audio source

You can navigate in menus and lists via the touch-sensitive surface of touchpad ② by using a **single-finger swipe**.

- ▶ **To open or close lists:** swipe left or right.
- ▶ **To select the menu item:** swipe up, down, left or right.
- ▶ Press touchpad ②.
- ▶ **To move the digital map:** swipe in any direction.

### Use the following functions with a two-finger swipe:

- ▶ **To call up main functions and favorites:** swipe down with two fingers.
- ▶ **To zoom in and out of the map:** move two fingers together or apart.
- ▶ **To call up the control menu of the last active audio source:** swipe up with two fingers.

## Setting the sensitivity for the touchpad

Multimedia system:

➤ System ➤  Input

▶ Select **Touchpad Sensitivity**.

▶ Select **Fast**, **Medium** or **Slow**.

▶ **To set the pressure sensitivity:** switch **Touchpad Tap** on  or off .

If the function is switched on , a tap on the touchpad is enough to select a menu item.

## Handwriting recognition: switching the read-aloud function on/off

Multimedia system:

➤ System ➤  Audio ➤ System Feedback

▶ Switch **Read Out Handwriting Recognition** on  or off .

## Selecting a station and track using the touchpad

▶ Press the  button on the touchpad.

or

- ▶ Swipe upwards using two fingers on the touchpad.  
The control menu appears for the audio source that was last selected.
- ▶ Use one finger to swipe up or down.  
Radio: the previous or the next station is set.  
Media source: the previous or the next music track is selected.
- ▶ **To hide the control menu:** swipe down on the touchpad using two fingers.

## Main functions

### Calling up the main functions



- ① **NAVI** button  
To call up navigation
- ② **RADIO** button  
To call up the radio
- ③ **MEDIA** button  
To call up media
- ④ **TEL** button  
To call up the telephone
- ⑤  button  
To set vehicle functions

- ▶ Alternatively: press the  button on the controller, the touchpad or Touch Control. The main functions are displayed.
- ▶ Select a main function.

## Favorites

### Overview of favorites

Favorites offer you quick access to frequently used applications. It is possible to create 20 favorites in total.

The following functions are available:

- add **pre-defined favorites** from the following categories (→ page 273):
  - [Navigation](#)
  - [Entertainment](#)
  - [Phone](#)
  - [Connect](#)
  - [Vehicle](#)
  - [System Settings](#)
- add **your own favorites** (→ page 273).
- rename a favorite (→ page 273).

- move a favorite (→ page 274).
- delete a favorite (→ page 274).
- reset all favorites (→ page 274).

### Calling up favorites

- ▶ Press the  button. The main functions are displayed.
- ▶ Navigate downwards once. Navigating means:
  - swiping on Touch Control or the touchpad
  - sliding the controller

### Leaving the favorites menu

- ▶ Press the  button.

### Adding a favorite

#### Adding a pre-defined favorite

- ▶ Press the  button. The main functions are displayed.
- ▶ Navigate downwards twice. The Favorites menu appears.
- ▶ Select [New Favorite](#). The categories are displayed.

- ▶ Select a category. The favorites are displayed.
- ▶ Select a favorite.
- ▶ Store the favorite at the desired position. If a favorite has already been added at this position, it will be overwritten.

### Example: adding your own favorite

- ▶ Select [Vehicle](#).
- ▶ Select [Full Screen: Consumption](#).
- ▶ Press and hold the  button until the favorites are displayed.
- ▶ Store the favorite at the desired position.

### Renaming a favorite

- ▶ Press the  button. The main functions are displayed.
- ▶ Navigate downwards once.
- ▶ Select a favorite.
- ▶ Navigate downwards once. The Favorites menu appears.
- ▶ Select [Rename](#).
- ▶ Enter the characters.

- ▶ **To confirm the entry:** select **ok**.

### Moving a favorite

- ▶ Press the  button. The main functions are displayed.
- ▶ Navigate downwards once.
- ▶ Select a favorite.
- ▶ Navigate downwards once. The Favorites menu appears.
- ▶ Select **Move**.
- ▶ Move the favorite to the desired position. If a favorite has already been added at this position, it will be overwritten.

### Deleting a favorite

- ▶ Press the  button. The main functions are displayed.
- ▶ Navigate downwards once.
- ▶ Select a favorite.
- ▶ Navigate downwards once. The Favorites menu appears.
- ▶ **To delete:** select **Delete**.
- ▶ Select **Yes**.

- ▶ **To restore all favorites:** select **Reset All**. A query appears.
- ▶ Select **Yes**. The favorites are reset to the factory settings.

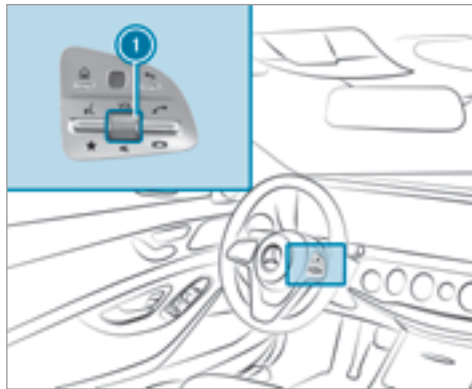

### Switching the sound on/off

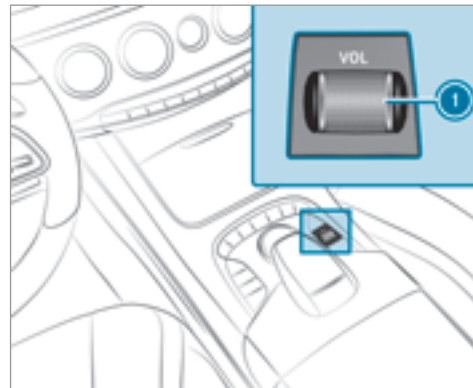

On the multifunction steering wheel



On the multimedia system

- ▶ **To mute:** press volume control . The  symbol appears in the status line of the display. You will also hear traffic announcements and navigation announcements even when the sound is muted.

- ▶ **To switch on:** change the media source or turn volume control ①.

### Adjusting the volume

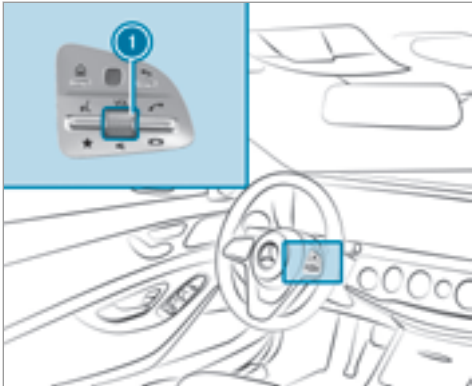

On the multifunction steering wheel

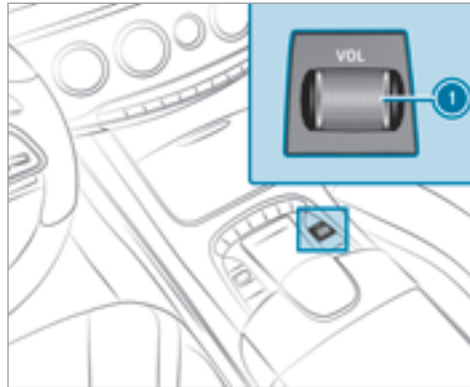

On the multimedia system

- ▶ Turn volume control ①.  
The volume of the current radio or media source is set. The volume of other audio sources can be adjusted separately.  
Adjust this in the following situations:
  - during a traffic announcement
  - during a navigation announcement

The volume of the navigation announcement changes in accordance with the volume of the current media source.

- during a telephone call
- when entering or exiting a parking space while using Active Parking Assist

or

- ▶ Select **System**.
- ▶ Select **Audio**.
- ▶ Select a volume setting.
- ▶ Set the volume.

### Entering characters

#### Using the character input function

The following functions are available:

- selecting a character in the character bar
- writing a character on the touchpad

Character input can be started with a control element and resumed with another.

▶ **On Touch Control and controller:** select a character in the character bar.

Depending on the destination entered, the following is available:

- the full set of characters
- characters which are useful for the current input string

Other characters are grayed out.

▶ **On the touchpad:** select a character in the character bar.

or

▶ Write the characters on the touch-sensitive surface of the touchpad. Handwriting recognition supports you by means of character suggestions and a read-aloud function.

Examples of character entry:

- Renaming a favorite
- Entering a POI or an address using free or step-by-step search
- Entering a web address

## Character input using the controller

### Example: renaming a favorite



▶ Calling up the "Renaming a favorite" function (→ page 273).

▶ **To enter a character:** turn **[⊙]**, slide **↑⊙↓** and press the controller. The character is entered in the input line.

Use the following entry functions:

- [X]** To delete a character: press the controller.
- To delete an entry: press and hold the controller until the entire entry is deleted.

- [...]** To switch to special characters and symbols.
- [↑]** To switch to upper-case or lower-case letters.
- [🌐]** To switch the language.
- [👉]** To switch to character entry on the touchpad.

**[i]** The available editing functions depend on the editing task, the language set and the character level.

▶ **To confirm the entry:** select **[ok]**.

**Example: entering a destination (navigation)**

▶ Enter the POI or address (→ page 292).

## Entering characters on the touchpad

### Requirements:

- The touchpad is switched on (→ page 271).
- The entered or selected character should be read out: the handwriting recognition read-aloud function is switched on (→ page 272).

### Example: renaming a favorite



- ▶ Calling up the "Renaming a favorite" function (→ page 273).
- ▶ **To enter a character:** use your finger to write characters on the touchpad. The character is entered in the input line. If different interpretations are possible, character suggestions are displayed.
- ▶ **To select a character suggestion:** turn the controller.
- ▶ Resume character input.
- ▶ **To enter a space:** swipe right when the cursor is located in the input line.

- ▶ **To delete a character:** swipe left when the cursor is located in the input line.
- ▶ **To confirm the entry:** press the touchpad.
- ▶ **To finish character entry:** swipe upwards.

or

- ▶ Press the  button.

### Example: entering a destination (navigation)

- ▶ Enter the POI or address (→ page 292).

## System settings

### Display

#### Configuring display settings

Multimedia system:

- ↳ System ▶  Display and Designs

#### Designs

- ▶ Select [Designs](#).
- ▶ Select [Sport](#), [Classic](#) or [Progressive](#).

#### Adapting the ambient lighting for the style

- ▶ Select [Adjust Amb. Lighting](#).  
Activate  or deactivate  the function.  
This function adjusts the ambient lighting for the selected display style.

#### Additional display area

Depending on the vehicle, various items of additional information can be shown. The additional display area comprises the left-hand or right-hand third of the display.

- ▶ Select [Additional Disp. Area](#).

The following display content can be selected:

- [Dynamic](#)
- [Navigation Map](#)
- [Consumption](#)
- [Time and Date](#)

#### Display brightness

- ▶ Select [Display Brightness](#).
- ▶ Select a brightness value.

#### Switching the display off/on

- ▶ **Off:** select [Display off](#).

▶ **On:** press a button, , for example.

## Display design

- ▶ Select [Day/Night Design](#).
- ▶ Select [Automatic](#), [Day Design](#) or [Night Design](#).

## Time and date

### Setting the time and date automatically

Multimedia system:

↳ [System](#) ▶▶  [Time and Date](#)

- ▶ Deactivate  [Manual Time Adjustment](#).  
The time and date are set automatically for the selected time zone and summer time option.

 The correct time is required for the following functions:

- route guidance with time-dependent traffic guidance
- calculation of expected time of arrival

### Setting the time zone

Multimedia system:

↳ [System](#) ▶▶  [Time and Date](#) ▶▶ [Time Zone](#):

The list of countries is displayed.

- ▶ Select a country •.  
Depending on the country, time zones are displayed.
- ▶ Select a time zone.  
The time zone set is displayed after [Time Zone](#):

### Setting summer time

The [Automatic Daylight Saving Time](#) and [Daylight Saving Time](#) options cannot be selected in all countries.

Multimedia system:

↳ [System](#) ▶▶  [Time and Date](#)

### Automatically

- ▶ Switch [Automatic Daylight Saving Time](#) on  or off .

### Manually

- ▶ Deactivate  [Automatic Daylight Saving Time](#).
- ▶ Select [Daylight Saving Time](#).
- ▶ Select [On](#) or [Off](#).

### Setting the time and date format

Multimedia system:

↳ [System](#) ▶▶  [Time and Date](#) ▶▶ [Set Format](#)

- ▶ Set the date and time format •.

### Setting the time manually

#### Prerequisite

- The [Manual Time Adjustment](#) function is switched on.

Multimedia system:

↳ [System](#) ▶▶  [Time and Date](#) ▶▶ [Set Time](#)

- ▶ Set the hours.
- ▶ Navigate to the right to set the minutes.
- ▶ Set the minutes.



- ▶ Confirm changes when exiting the menu.

The date is set automatically via GPS.

### Activating/deactivating voice amplification to the rear

#### Mercedes-Maybach vehicles and vehicles with a long wheelbase only

Requirements:

- Your vehicle is equipped with the Burmester® surround sound system or the Burmester® high-end 3D surround sound system.
- The ignition is switched on.
- Doors, side windows and the panorama roof with power tilt/sliding panel are closed.

Multimedia system:

↳ System ▶▶ Audio ▶▶ Voice Amplification to Rear

The function supports communication between the driver and front passenger with passengers in the rear passenger compartment. When voice amplification to rear is activated, the signals

picked up by the microphone are amplified and played back over the speakers in the rear passenger compartment, depending upon vehicle noise levels. An automatic adjustment occurs based on speaker volume and ambient noise in order to improve speech intelligibility and maintain the naturalness of speech.

- ▶ Activate  or deactivate  the function.

### Connectivity

#### Switching transmission of the vehicle position on/off

Multimedia system:

↳ System ▶▶  Connectivity

- ▶ Select **Transmit Vehicle Position**.
- ▶ Switch the function on  or off .

### Bluetooth®

#### Information about Bluetooth®

Bluetooth® technology is a standard for short-range wireless data transfer up to approximately 32.8 ft (10 m). You can use Bluetooth® to con-

nect your mobile phone to the multimedia system and use the following functions, for example:

- hands-free system with access to the following options:
  - contacts (→ page 320)
  - call lists (→ page 322)
  - text messages
- Internet connection
- listening to music via Bluetooth® audio (→ page 346)
- transferring business cards (vCards) into the vehicle

Bluetooth® is a registered trademark of Bluetooth Special Interest Group (SIG) Inc.

 Internet connection via Bluetooth® is not available in all countries.

#### Activating/deactivating Bluetooth®

##### Prerequisite

- Apple CarPlay™ is not active.

Multimedia system:

 System  Connectivity

 Activate  or deactivate  Bluetooth®.

If Android Auto is active, a prompt appears asking whether Bluetooth® should be deactivated.

 Select **Yes**.

Android Auto is closed and Bluetooth® is deactivated.

## Wi-Fi

### Wi-Fi connection overview

You can use Wi-Fi to establish a connection with a Wi-Fi network and to access the Internet or other network devices.

The following connection options are available:

- Wi-Fi connection

The Wi-Fi connection is established to a Wi-Fi-capable device, e.g. to the customer's mobile phone or tablet PC.

- multimedia system as a Wi-Fi hotspot

Using this function, a tablet PC or notebook can be connected, for example.

To establish a connection, you can use the following methods:

- WPS PIN

The connection to a secure Wi-Fi network is made via a PIN.

- WPS PBC

The connection to a secure Wi-Fi network is made by pressing a button (push button).

- security key

The connection to a secure Wi-Fi network is made via a security key.

### Setting up Wi-Fi

#### Requirement:

- The device to be connected supports one of the three means of connection described.

Multimedia system:

 System  Connectivity

### Activating/deactivating Wi-Fi

 Activate  or deactivate  Wi-Fi.

If Wi-Fi is deactivated , communication via Wi-Fi to all devices is interrupted. This also means that a connection to the HERMES communication module cannot be established. Functions such as dynamic route guidance with Live Traffic Information are then unavailable.

### Connecting the multimedia system with a device via Wi-Fi

This function is available if a HERMES communication module is not installed.

The type of connection established must be selected on the multimedia system and on the device to be connected.

 The connection procedure may differ depending on the device. Follow the instructions that are shown in the display. Further information (see the manufacturer's operating instructions).

- ▶ Select [Internet Settings](#).
- ▶ Select [Search for Wi-Fi Networks](#).

### Using a WPS PIN:



- ▶ Highlight a Wi-Fi network in the list.
- ▶ Select  [Connect via WPS PIN Input](#). The multimedia system generates an eight-digit PIN.
- ▶ Enter this PIN on the device to be connected.
- ▶ Confirm the entry.

### Using a button:



Requirements:

- This function is only available in a Wi-Fi frequency of 2.4 GHz.
- ▶ Highlight a Wi-Fi network in the list.
- ▶ Select  [Connect via WPS PBC](#).
- ▶ Select "Connect via WPS PBC" in the options on the device to be connected.
- ▶ Press the WPS button on the device to be connected.
- ▶ Select [Continue](#) in the multimedia system.

### Using a security key:

- ▶ Highlight a Wi-Fi network in the list.
  - ▶ Select  [Connect Using Security Key](#).
  - ▶ Have the security key displayed on the device to be connected (see the manufacturer's operating instructions).
  - ▶ Enter this security key on the multimedia system.
  - ▶ Confirm the entry with .
-  All devices support a security key as a means of connection.

### Device has already been connected:

- ▶ **To automatically connect:** highlight a Wi-Fi network in the list.
- ▶ Activate   [Connect Automatically](#).
- ▶ **To connect:** highlight a Wi-Fi network in the list.
- ▶ Select  [Connect](#). The connection is established again. These functions are possible when the device has already been connected to the Wi-Fi network.

### Setting up a Wi-Fi hotspot

Multimedia system:

 [System](#) ▶▶  [Connectivity](#)

### Configuring the multimedia system as a Wi-Fi hotspot

The type of connection established depends on the device to be connected. The function must be supported by the multimedia system and by the device to be connected. The type of connection established must be selected on the multimedia system and on the device to be connected.

- ▶ Select [Set Up Hotspot](#).
- ▶ Highlight [Connect Device to Vehicle Hotspot](#).

### Generating a WPS PIN

- ▶ Select  [Connect via WPS PIN Generation](#).
- ▶ Enter the PIN shown in the multimedia system display on the device to be connected and confirm.

### Connecting using a WPS PIN

- ▶ Select  [Connect via WPS PIN Input](#).

- ▶ Select [Enter WPS PIN](#).
- ▶ Enter the PIN that is shown on the external device's display on the multimedia system.
- ▶ Select [Continue](#).

### Connecting using a button

Requirements:

- This function is only available in a Wi-Fi frequency of 2.4 GHz.
- ▶ Select  [Connect via WPS PBC](#).
- ▶ Press the WPS button on the device to be connected or select [Connect](#).
- ▶ Select [Continue](#) in the multimedia system.

### Connecting using a security key

- ▶ Select [Connect Device to Vehicle Hotspot](#). A security key is displayed.
- ▶ Select the vehicle from the device to be connected. The vehicle is displayed with the SSID [MB Hotspot XXXXX](#).
- ▶ Enter the security key which is shown in the multimedia system display on the device to be connected.

- ▶ Confirm the entry.

### Connecting using NFC

- ▶ Select [Connection via NFC](#).
- ▶ Activate NFC on the mobile device (see the manufacturer's operating instructions).
- ▶ Bring the mobile device into the NFC area of the vehicle (→ page 317).
- ▶ Select [Done](#).  
The mobile device is now connected to the multimedia system hotspot via NFC.

### To generate a new security key:

- ▶ Select [Set Up Hotspot](#).
- ▶ Select [Generate Security Key](#).  
A connection will be established with the newly created security key.
- ▶ **To save a security key:** select [Save](#).  
When a new security key is saved, all existing Wi-Fi connections are then disconnected. If the Wi-Fi connections are being re-established, the new security key must be entered.

## Managing COMAND Touch devices

### Requirements:

- The COMAND Touch App is installed on the external device (e.g. tablet or smartphone).
- Wi-Fi is activated (→ page 280) and the multimedia system is configured as a Wi-Fi Hotspot (→ page 281).

Multimedia system:

 [System](#) ▶ [COMAND Touch](#)

### Connecting a new device

- ▶ Select [Authorize a New Device](#).
- ▶ Select [Connect New Device](#).
- ▶ [Accept](#) the connection request from the new device.  
A security key is displayed.
- ▶ Enter the security key in the external device.  
The device is authorized.

### Selecting a connected device

- ▶ Select [Authorize a New Device](#).  
The devices already connected are displayed.

- ▶ Select **Continue Using Connected Devices**. The **Please start COMAND Touch on your device and follow the instructions.** message appears.
- ▶ Select **Continue**. Follow the instructions to authorize the selected device.

### De-authorizing the device

- ▶ Select a connected device from the list. The **Please start COMAND Touch on your device and follow the instructions.** message appears.
- ▶ Select **Continue**. A prompt will appear asking whether you would like to de-authorize the selected device.
- ▶ Select **Yes**. The device is de-authorized.

### Activating/deactivating parental control

Multimedia system:

↪ System ▶ Parental Control

#### Locking the Rear Seat Entertainment System

- ▶ Select **Rear Left** or **Rear Right**.
- ▶ Select **Lock**. The Rear Seat Entertainment System is locked  or unlocked .

#### Switching off the Rear Seat Entertainment System display

- ▶ Select **Rear Left** or **Rear Right**.
- ▶ Select **Display On**.
- ▶ Switch the display on  or off .

#### Locking an external device

- ▶ Select an external device.
- ▶ Select **Lock**. The device connected via the COMAND Touch App is locked  or unlocked .

### System language

#### Notes on the system language

This function allows you to determine the language for the menu displays and the navigation announcements. The selected language affects the characters available for entry. The navigation announcements are not available in all languages. If a language is not available, the navigation announcements will be in English.

#### Setting the system language

Multimedia system:

↪ System ▶ Language

- ▶ Set the language.
- ⓘ If you are using Arabic map data, the text information can also be shown in Arabic on the navigation map. To do so, select العربية as the language from the language list. Navigation announcements are then also made in Arabic.

## Setting the distance unit

Multimedia system:

↳ System ▶  Units

- ▶ Select **km** or **mi**.
- ▶ In the multifunction display of the instrument display, switch the **Additional Speedometer** display on .

## Data import and export

### Data import/export function

The following functions are possible:

- Transferring data from one system or vehicle to another system or vehicle.
- Creating a backup copy of your personal data and loading it again.
- Protecting your personal data against unwanted export with PIN protection.

You can either use an SD card or a USB storage device as temporary storage.

- ⓘ Please note that the NTFS file system is not supported. The FAT32 file system is recommended.

### Importing/exporting data

#### NOTE Data loss

- ▶ Do not remove the data storage medium when data is being exported.

Mercedes-Benz is not liable for any loss of data.

#### Requirements:

- The vehicle is stationary.
- The ignition is switched on or the vehicle has been started.
- The SD card is inserted (→ page 339) or the USB device is connected (→ page 341).

Multimedia system:

↳ System ▶ System Backup

- ▶ Select **Import Data** or **Export Data**.

### Importing

- ▶ Select a data storage medium. A prompt appears asking whether you really wish to overwrite the current data. If data originates from another vehicle, this is recognized during data reading.

The multimedia system is restarted once the data has been imported.

- ⓘ Current vehicle settings can be edited after the import.

### Exporting

If PIN protection is activated, your PIN is requested.

- ▶ Enter the four-digit PIN.
- ▶ Select a data storage medium. The data is exported. The data export may take several minutes.

## Activating/deactivating PIN protection

Multimedia system:

↳ System ▶▶ PIN Protection

### Setting the PIN

- ▶ Select [Set PIN](#).
- ▶ Enter a four-digit PIN.
- ▶ Enter the four-digit PIN again.  
If both PINs match, PIN protection is active.

### Changing the PIN

Prerequisite

- A current PIN must be set.
- ▶ Select [Change Settings](#).
- ▶ Enter the current PIN.
- ▶ Select [Change PIN](#).
- ▶ Set a new PIN.

### Activating PIN protection for data export

- ▶ Select [Change Settings](#).  
Confirm with the PIN.

- ▶ Select [Protect Data Export](#).  
Activate  or deactivate  the function.

### Activating PIN protection for offline mode

- ▶ Select [Change Settings](#).  
Confirm with the PIN.
- ▶ Select [Protect Deactivation of Offline Mode](#).  
Activate  or deactivate  the function.

### Unblocking the PIN

Requirements:

- There is an Internet connection.
- A Mercedes me account exists at <http://www.mercedes.me>.
- The [Personalization](#) (→ page 286) service is activated.

If the PIN has been entered incorrectly three times, the PIN will be blocked. You can have a single-use password sent to you via the Mercedes me connect online portal to reset the PIN protection.

- ▶ Select [Unblock PIN](#).

- ▶ Enter the single-use password.  
PIN protection is reset, and you can set a new PIN.
- ⓘ Alternatively, you can have PIN protection reset at an authorized Mercedes-Benz Center.

## User profile

### Setting a user profile

Multimedia system:

↳ System ▶▶  Personalization

### Displaying a user profile when starting

If this function is active, a prompt appears when starting the system asking which user profile to use.

- ▶ Select [Display Profile Selection after Start](#).
- ▶ Activate  or deactivate  the function.

### Selecting a user profile

- ▶ Select [Guest Profile](#) or individual profile •.
- ⓘ Some settings from the user profile are only loaded when the vehicle is stationary or when the ignition is switched on.

### Automatic synchronization

Each time the ignition is switched off or on, the individual user profiles are synchronized on the multimedia system and on the server. This ensures that the latest user profiles are always available.

- ▶ Select **Automatic Synchronization**.
- ▶ Activate  or deactivate  the function.
- ⓘ For more information about importing/exporting user profiles (→ page 286).

### Creating a user profile

Multimedia system:

↳ System ▶  Personalization ▶ Create Profile

- ▶ Enter a name.
- ▶ Select .

Individual settings are saved in the user profile, e.g.:

- System settings
- settings in the TV tuner's channel list
- navigation and traffic information

The settings differ depending on the vehicle equipment.

### Importing/exporting user profiles

#### Requirements:

- There is an Internet connection .
- A Mercedes me account exists at <http://www.mercedes.me>.
- The **Personalization** service is active.

Multimedia system:

↳ System ▶  Personalization ▶ Manual Export/Import

This function is not available in all countries. Only individual profiles can be imported or exported.

The individual profiles are always collectively imported or exported.

- ▶ **Import:** select **Import Profiles from Server**. The **The profile data import overwrites all existing profile data. Do you want to continue?** message appears.

- ▶ Select **Yes**.  
User profiles are imported.
- ▶ **Export:** select **Export Profiles to the Server**.  
User profiles are exported.
- ⓘ Certain settings, such as address book entries or previous destinations from the navigation system, are not exported.

### Setting user profile options

Multimedia system:

↳ System ▶  Personalization

- ▶ Highlight a profile.
- ▶ Select  options.

The following options are available:

- **Rename**
- **Delete**
- **Reset**
- ⓘ The guest profile cannot be deleted or renamed.



## Software update

### Information on software updates

The multimedia system provides a message when an update is available.

Depending on the source, you can perform various updates:

### Software update

Source of the update	Update type
Internet	Navigation map, system updates, Digital Operator's Manual
External storage medium, e.g. USB flash drive	Navigation maps

Software updates ensure your vehicle's technology is always up-to-date.

In order to constantly improve the quality of our services you will receive future updates for your multimedia system, the Mercedes-Benz mbrace<sup>®</sup> services and your vehicle's communication mod-

ule. These will conveniently be sent to you via the mobile phone connection in your vehicle and, in many cases, installed automatically. You can monitor the status of your updates at any time on the Mercedes me portal and find information about potential innovations.

Your advantages at a glance:

- conveniently receive software updates via the mobile phone network
- the long-term quality and availability of Mercedes-Benz mbrace<sup>®</sup> is guaranteed
- keep your multimedia system and communication module up-to-date

Further information about software updates can be found at <http://me.mercedes-benz.com>

### Performing a software update

#### Requirements:

- An Internet connection is required for updates which are obtained online .

Multimedia system:

↳ System ▶▶ Software Update

### Automatically

Prerequisite

- Your vehicle has a built-in communication module.

▶ Activate [Automatic Online Update](#) .

Updates are performed.

The current status of the updates is displayed.

### Manually

▶ Deactivate [Automatic Online Update](#) .

▶ Select an update from the list and start the update.

### Searching for new Updates

Requirements:

- Your vehicle does not have a built-in communication module.
- An Internet-enabled mobile phone is connected to the multimedia system (→ page 316).

- ▶ Select **Search for New Updates**.  
The list of available updates is refreshed.
- ▶ Select an update and start the update.  
The selected update is downloaded via the connected mobile phone.

### Activating the software update

- ▶ Restart the system.

### Important system updates

Important system updates may be necessary for the security of your multimedia system's data. Please install these updates, or else the security of your multimedia system cannot be ensured.

- ① If automatic software updates are activated, the system updates will be downloaded automatically (→ page 287).

As soon as an update is available for download, a corresponding message appears on the multimedia system display.

You have the following selection options:

- **Download**  
The update will be downloaded in the background.

- **Details**  
Information about the pending system update is displayed.
- **Later**  
The update can be downloaded manually at a later time (→ page 287).

If the download is completed and the update is ready for installation, you will be informed of this after the next ignition cycle, for example.

Requirements for the installation:

- The ignition is switched off.
- Notes and warnings have been read and accepted.
- The electric parking brake is applied.

If all requirements are met, the update will be installed. The multimedia system cannot be operated while the update is being installed and vehicle functions are restricted.

If errors should occur during the installation, the multimedia system automatically attempts to restore the previous version. If restoration of the previous version is not possible, a symbol

appears on the center console display. Please consult a qualified specialist workshop to resolve the problem.

### Reset function

Multimedia system:

↪ **System** ▶ **Reset**

Personal data is deleted, for example:

- station presets
- connected mobile phones

- ▶ Select **Yes**.

If PIN protection is activated, a prompt appears asking if you also wish to restore this to the factory settings during a reset.

- ▶ Select **Yes**
- ▶ Enter the current PIN.  
The PIN is reset.

Or

- ▶ Select **No**.  
The current PIN stays the same after resetting.

 If you have forgotten your PIN, an authorized Mercedes-Benz Center can deactivate your PIN protection for you.

A prompt appears again asking whether you really wish to reset.

 Select **Yes**.  
The multimedia system is reset to the factory settings.

## ENERGIZING comfort

### ENERGIZING comfort program overview

#### Program overview

Programs	Function
<b>Refresh</b>	Can make targeted changes to the interior climate to refresh vehicle occupants. Cooling airflow and ionization purify the air. The vehicle interior is illuminated with cool colors, and the seat is ventilated.
<b>Warmth</b>	Can increase the comfort level of the occupants. The vehicle's panel, seat and steering wheel heater produce a cozy warmth. The air is purified using ionization and a pleasant fragrance is released. The vehicle interior is illuminated with warm lighting.
<b>Vitality</b>	Can counteract fatigue in monotonous driving situations. Fast-paced music and a vitalizing massage provide invigorating stimulation for the vehicle occupants. The air is purified using ionization and a pleasant fragrance is released. The vehicle interior is illuminated in a stimulating hue and the seat is ventilated.
<b>Pleasure</b>	Can promote a positive mood in the occupants. Moderately fast music is played and a massage program is activated. The air is purified using ionization and a pleasant fragrance is released. The vehicle interior is illuminated with amicable lighting.

Programs	Function
<b>Well being</b>	Can aid the physical and mental relaxation of occupants. A back massage combined with local warmth provide relaxation. The air is purified using ionization and a pleasant fragrance is released. The music player plays selections of calming music and the vehicle interior is illuminated with pleasant lighting.
<b>Training</b>	Can counteract the onset of muscle tension, limbs falling asleep or stress with targeted relaxation or stimulation trainings. The exercises are demonstrated in short videos. The air is purified using ionization and a pleasant fragrance is released. The vehicle interior is illuminated with lighting appropriate for the training.

**i** Please note that the available programs and the associated functions are dependent on your vehicle equipment. Depending on your equipment, fewer functions may be available.

### Starting the ENERGIZING comfort program

#### Requirements:

- The ignition is switched on.

**i** ENERGIZING comfort is available approximately 5 minutes after starting the multimedia system.

Multimedia system:

↩️ **Vehicle** ➡️ **ENERGIZING Comfort**

▶ Select **Refresh, Warmth, Vitality, Enjoyment** or **Well-being**.

The selected program will run for 10 minutes.

#### Starting training

▶ Select **Training**.

▶ Select **Muscle Relaxation, Muscle Stimulation** or **Balance**.

The selected training video starts and is displayed in the media display.

▶ Select **Full Screen: Video**.

The training video is displayed in full screen.

**i** For information about pausing or skipping videos, see Media playback(→ page 341).

If, during an active program, a function requirement is no longer met, a corresponding message appears. The active program is canceled.

## Navigation

### Switching navigation on

Multimedia system:

↳ Navigation

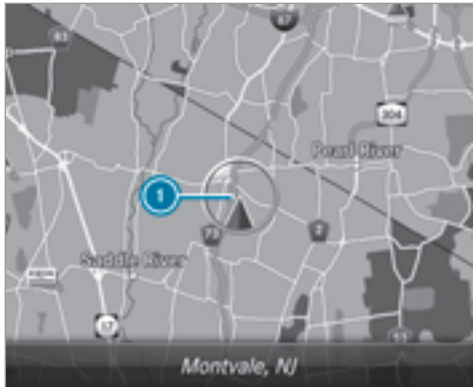

- ▶ Alternatively: press the **NAVI** button. The map appears and shows current vehicle position ①.

- ① If a climate control setting is changed, a climate bar appears briefly.

### Showing/hiding the navigation menu

#### Requirements:

- The map shows the vehicle's current position.

↳ Navigation



- ▶ **To show:** swipe left on the touchpad or Touch Control.

or

- ▶ Slide the controller to the left.
- ▶ **To hide:** swipe right on the touchpad or Touch Control.

or

▶ Slide the controller to the right.

- ① To show or hide lower menu levels, swipe or slide to the left or right as many times as necessary.

## Destination entry

### Entering a POI or address

Multimedia system:

↳ Navigation



▶ Show the navigation menu.

- ▶ Select  **Enter Destination**.  
The state or province in which the vehicle is located is set ①.

There are two available methods of destination entry:

- free search ②
- step-by-step search ③

### Method 1: free search

▶ Enter the POI or address in ②. The entries can be made in any order. During destination entry, suggestions are made by the multimedia system. A selection of destinations appears in a list.

Enter these address elements, for example:

- city, street, house number
- street, city
- ZIP code
- POI name
- POI category, e.g. **Gas Station**
- city, POI name

▶ **To switch to handwriting recognition:** select ⑤ .

▶ Write the character on the touchpad.

▶ **To switch to character selection:** press the  button.

or

▶ Press the touchpad.

▶ **To delete an entry:** select ④  (if available).

- Press briefly: deletes the last character entered or the last suggestion adopted.
- Press and hold: deletes the entire entry.

▶ **To set the language:** select ⑧.

▶ Select the language.

- ① This function is useful for countries in which several character sets are supported. An example is Russia, which uses Cyrillic and Latin characters.

▶ **To call up the online search function:** select ⑥ **Online Search**.

Once an Internet connection is established, a list appears. It shows online destinations related to the previous entry.

Online destinations are provided by the Internet service provider.

▶ Select the online destination.

or

▶ Enter an online destination in the input line.

ⓘ Online search is not available in all countries.

ⓘ Requirement (USA): Mercedes-Benz mbrace® is activated.

▶ **To call up the list:** press the  button.

or

▶ If the top line of the character bar is highlighted, navigate upwards.

▶ Select the destination in the list.

▶ **To adopt a destination:** select **Select Destination** .

If there are several listings for a destination, a list appears.

▶ Select the destination.  
The destination address is shown.

### Method 2: search step-by-step

▶ Press the  button.

or

▶ If the top line of the character bar is highlighted, navigate upwards.

The character bar is hidden. **City or ZIP** is highlighted. Additional entry fields, e.g. for **POI**, are available.

▶ Select **City or ZIP**.

The character bar appears.

▶ Enter the city or the ZIP code.

During destination entry, suggestions are made by the multimedia system. A selection of destinations appears in a list.

The address entries can be made in any order, for example:

- **City or ZIP, Street, House No.**  
Enter an intersecting street, if available.
- **Street, City or ZIP**
- **POI**, e.g. **Gas Station, City or ZIP**

ⓘ During destination entry, use the following functions:

- switching to handwriting recognition
- switching to character selection
- deleting an entry

An entry, e.g. a **POI**, can be deleted with  in a step-by-step search. Navigate to the left to do so.

- calling up online search function (if available)
- calling up a list

The functions are described in the free search.

▶ **To change the state/province:** select the state or the province.

▶ Enter the state or the province. You only need to enter the first character.

▶ Select the state or the province in the list.

▶ **To change the country:** select the country.

▶ Enter the country. You only need to enter the first character.

▶ Select the country on the list.

▶ **To adopt a destination:** select **Select Destination**.

If there are several listings for a destination, a distance-orientated list appears.

- ▶ Select the destination.  
The destination address is shown.

### Selecting a POI

Multimedia system:

↳ [Navigation](#) ▶▶ [Previous and Other Destinations](#) ▶▶ [POIs](#)

#### Method 1

- ▶ Select the category.  
If route guidance is not active: the search begins in the vicinity of the current vehicle position. The list is sorted by distance in ascending order.  
If route guidance is active: the search begins after selecting a search position.  
The POIs show the following information:
  - name of POI
  - linear distance to the POI
  - the direction of the linear distance to the POI (arrow) is displayed when searching for the vehicle's current position
- ▶ Select the POI.

- ▶ **Route guidance is active:** select the search position prior to choosing a POI.
- ▶ If intermediate destinations are set, these can also be selected as the search position after selecting [Near Destination](#).

#### Method 2

- ▶ Select [All Categories](#).
- ▶ Select the category.
- ▶ Select the POI.
- ▶ **Route guidance is active:** select the search position prior to choosing a POI.
- ▶ If intermediate destinations are set, these can also be selected as the search position after selecting [Near Destination](#).

#### Alternatively filtering the display by POI

- ▶ Enter a search term in the  [Search:](#) line.  
The results list shows relevant POIs.
- ▶ Select .
- ▶ The first POI in the list is highlighted.
- ▶ Select the POI.

#### Example: setting the search position for the parking category during active route guidance

- ▶ Select [In the Vicinity](#), [Near Destination](#) or [Along the Route](#).  
The list shows the located POIs or opens an overview of the route destination after selecting [Near Destination](#).
- ▶ Select the POI.
- ▶ Select [Near Destination](#): select the intermediate destination or the destination.

#### Selecting previous destinations

Multimedia system:

↳ [Navigation](#) ▶▶ [Previous and Other Destinations](#)

- ▶ Select [Previous Destinations](#).
- ▶ Select the destination suggestion or the destination.  
The destination address is shown.
- ⓘ If [Learn Journeys](#) is switched on , destination suggestions are displayed (→ page 306).



- ▶ **Alternatively:** if a favorite has been saved (→ page 305), select [From Global Favorites](#).
- ▶ Select the favorite.  
The destination address is shown.

### Selecting a contact

#### Requirements:

- a mobile phone is connected to the multimedia system (→ page 316).

Multimedia system:

↳ [Navigation](#) ▶ [Previous and Other Destinations](#) ▶ [Contacts](#)

- ▶ Select the contact.  
The contact details are displayed.
- ▶ Select the address.

### Alternatively filtering the display by contacts

- ▶ Enter a name or telephone number into the search field.
- ▶ Select .
- ▶ The first contact in the list is highlighted.
- ▶ Select the contact.
- ▶ Select the address.

### Entering geo-coordinates

Multimedia system:

↳ [Navigation](#) ▶ [Previous and Other Destinations](#) ▶ [Geo-coordinates](#)

- ▶ Enter geo-coordinates as latitude and longitude coordinates in degrees, minutes and seconds.  
The map shows the position.
- ▶ Confirm the entry.
- ▶ **To calculate a route:** select [Start Route Guidance](#).
- ▶ If a route has already been created, select [Start New Route Guidance](#) or [Set as Intermediate Destination](#).

### Selecting from the map

Multimedia system:

↳ [Navigation](#) ▶  [Options](#) ▶ [Map Menu](#)

- ▶ **Alternatively:** if the map is displayed in full screen mode, press Touch Control, the controller or the touchpad.  
The map menu appears.

- ▶ Select "Move map" in map menu  (→ page 309).
  - ▶ Swipe in any direction on Touch Control or touchpad.
- or
- ▶ Slide the controller in any direction.  
The map moves in the corresponding direction under the crosshair. The more you move your finger away from the starting position on the touchpad, the faster the map moves.
  - ▶ Press Touch Control, the controller or the touchpad.  
If several destinations are located around the crosshair, a list shows the available POIs and roads.
  - ▶ If a destination is located exactly on the crosshair, the destination address is displayed.
  - ▶ Select the destination in the list.  
The destination address is shown.

### Setting the map orientation to 2D or 3D

- ▶ Highlight [Map Orientation: 2D/3D](#).

- ▶ Press Touch Control, the touchpad or the controller.  
The map will be displayed in the selected map orientation.

### Showing traffic messages in the vicinity of the map

- ▶ Select [Traffic Messages for the Vicinity](#).  
The map appears.
- ▶ Swipe left or right on the touchpad.

or

- ▶ Slide the controller to the left or right.  
The previous or next traffic incident is highlighted on the map. Information on the traffic incident is displayed.

### Showing POIs in the vicinity of the map

- ▶ Select [POIs in the Vicinity](#).
- ▶ Swipe left or right on the touchpad.

or

- ▶ Slide the controller to the left or right.  
The previous or next POI is highlighted on the map. The name or the address is shown.

- ▶ **Alternatively, to filter the display by POI category:** swipe down on Touch Control or the touchpad.

or

- ▶ Slide the controller down.
- ▶ Select the POI category.



- ▶  [User Defined](#) allows personal POI symbols to be selected (→ page 311).

### Entering an intermediate destination

#### Requirements:

- A destination is entered.

Multimedia system:

 [Navigation](#)  [Intermediate Destinations and Info](#)

- ▶ Select [Search for an Intermediate Destination](#).
- ▶ Enter the intermediate destination as a POI or address (→ page 292).
- ▶ Select the intermediate destination.
- ▶ Select [Set as Destination](#).

or

- ▶ Select an intermediate destination using  [Enter Destination](#) during route guidance.
- ▶ Select [Set as Next Intermediate Destination](#) after entering the destination.

### Calculating a route with intermediate destinations

#### Requirements:

- Enter the destination and at least one intermediate destination.

Multimedia system:

 [Navigation](#)  [Intermediate Destinations and Info](#)

- ▶ Select [Start New Route Guidance](#).  
The route is calculated with the set intermediate destinations.



### Editing intermediate destinations

#### Requirements:

- A destination is entered.

Multimedia system:

↳ Navigation ▶ Intermediate Destinations and Info

- ▶ **To change the order of destinations:** highlight the destination or the intermediate destination.
- ▶ Select  Move.
- ▶ Move the intermediate destination to the desired position.
- ▶ Press Touch Control, the controller or the touchpad.
- ▶ **To call up the map:** highlight the destination or the intermediate destination.
- ▶ Select  Map.
- ▶ Move the map (→ page 310).
- ▶ Select destination on the map (→ page 295).
- ▶ **To delete a destination:** highlight the destination or the intermediate destination.
- ▶ Select  Delete.

## Starting an automatic gas station search

### Requirements:

- The automatic gas station search is activated  (→ page 300).

### Driving situation

Route guidance is active. The fuel level in the fuel tank reaches the reserve fuel level.

The [Reserve Fuel Would you like to start a search for surrounding gas stations?](#) message is shown.

- ▶ Select [Yes](#).  
The automatic gas station search begins. The available gas stations along the route and in the vicinity of the vehicle's current position are displayed.
- ▶ Select the gas station.  
The address of the gas station is displayed.
- ▶ Method 1: if route guidance is not activated, select [Start Route Guidance](#).  
The selected gas station is set as the destination. Route guidance begins.

- ▶ Method 2: if route guidance is activated, select [Start New Route Guidance](#) or [Set as Next Intermediate Destination](#).  
[Start New Route Guidance](#): the selected gas station is set as a new destination. The previous destinations and intermediate destinations are deleted. Route guidance to the gas station begins.  
[Set as Next Intermediate Destination](#): the selected gas station is set as the next intermediate destination. Route guidance begins.
- ▶ **If there are already four intermediate destinations:** select [Yes](#) in the prompt.  
The selected gas station is entered into position 1 of the intermediate destinations menu. Intermediate destination 4 is deleted. Route guidance begins.

## Route

---

### Calculating a route

#### Requirements:

- The destination has been entered.
- The destination address is shown.



- ▶ **Method 1:** if route guidance is not activated, select [Start Route Guidance](#). The route to the destination is calculated. The map shows the route. Route guidance then begins.
- ▶ **Method 2:** if route guidance is activated, select [Start New Route Guidance](#) or [Set as Next Intermediate Destination](#).  
**Start New Route Guidance:** the selected destination address is set as a new destination. The previous destinations and intermediate destinations are deleted. Route guidance to the new destination begins.  
**Set as Next Intermediate Destination:** the selected destination address is set as the next intermediate destination. Route guidance begins.

### Taking alternative routes into consideration

- ▶ Select an alternative route (→ page 300).

### Other menu functions

- ▶ **To save the destination:** select  [Store in "Previous Destinations"](#).

- ▶ **To display on the map:** select  [Map](#).
- ▶ **To call a telephone number:** select  [Call](#).
- ▶ **To call up an Internet address:** select  [www](#) (if available).

### Selecting a route type

Multimedia system:

➔ [Navigation](#) ➔  [Route and Position](#)

- ▶ Select [Route Settings](#).
- ▶ Select the route type.  
 A route has already been created: the route is calculated on the basis of the new route type.  
 A route has not been created: the next route is calculated on the basis of the new route type.
  - [Eco Route](#)  
 An economical route is calculated. The journey time may be somewhat longer than for quicker routes.  
 The symbol for the current vehicle position is displayed in green.

- [Fast Route](#)  
 A route with a quick journey time is calculated.
- [Short Route](#)  
 A route with a short driving distance is calculated.

[Automatic Traffic Jam Avoidance](#) can be switched on  or off  for these route types. If [Automatic Traffic Jam Avoidance](#) is switched on, [Ask in the Event of Traffic Jam Avoidance](#) can be selected.

The route types [Automatic Traffic Jam Avoidance](#) and [Ask in the Event of Traffic Jam Avoidance](#) are not available in every country.

- [Automatic Traffic Jam Avoidance](#)  
 The route is calculated with the currently set route type.  
 Traffic reports via Live Traffic Information are taken into account.  
 Live Traffic Information is not available in all countries.
- [Ask in the Event of Traffic Jam Avoidance](#)

A prompt appears when a new route is detected with a shorter journey time based on traffic reports. You can continue to use the current route or use the dynamic route instead.

### Selecting route options

Multimedia system:

Navigation  >> Route and Position  >> Avoid Options

### Avoiding areas

Select **Areas** (→ page 312).

### Avoiding highways, ferries, motorail trains, tunnels, unpaved roads

Select  or deselect  avoid option.

### Using toll roads

Select **Use Toll Roads**.

Select **Cash** or **Electronic Billing** or **Off**.

The route takes into account roads that require the payment of a usage fee (toll).

If **Off** is selected, toll roads are not taken into account.

The selected route options cannot always be implemented. Therefore, a route may include a ferry, for instance, even though the avoid **Ferries** option is enabled. A message appears and you will hear a corresponding message.

### Using carpool lanes

Select **Number of Occupants in the Vehicle**.

Select number.

When using carpool lanes, observe the applicable legal requirements as well as any conditions pertaining to when and where such lanes may be used. Carpool lanes may only be used if certain conditions are met.

These route options are not available in every country.

### Selecting notifications

Multimedia system:

Navigation  >> **Options**  >> **Announcements**

Switch announcements on  or off .

- **Announce Traffic Warnings**

This function is not available in all countries.

- **Announce Street Names**

The multimedia system announces the names of the roads that will follow the upcoming change of direction.

This function is not available in all countries and languages.

### Displaying destination information

#### Requirement:

- A destination is entered.

Multimedia system:

Navigation 

Select **Intermediate Destinations and Info**.

The following information is displayed:

- intermediate destinations and destination

The route can also include up to four intermediate destinations.

- Name, address
- Remaining driving distance
- Time of arrival

## Selecting an alternative route

Multimedia system:

→ Navigation ►  Route and Position

- ▶ Select **Alternative Route**.  
The routes are displayed in accordance with the setting made in the route settings.  
The currently selected route is shown with a dark blue line.
- ▶ Select the alternative route.

## Switching the automatic gas station search on/off

Multimedia system:

→ Navigation ►  Options

- ▶ Switch **Reserve Fuel** on  or off .  
Switched on : when the fuel reserve level is reached, a prompt appears asking whether you want to start searching for gas stations.

## Starting the automatic service station search

### Requirements:

- ATTENTION ASSIST and the **Suggest Rest Area** function are activated (→ page 233).

## Driving situation

The **Attention Assist Do you want to search for a rest area?** message is shown.

- ▶ Select **Yes**.  
The service station search starts. The available service stations along the route or in the vicinity of the vehicle's current position are displayed.
- ▶ Select the service station.  
The service station address is displayed.
- ▶ Method 1: if route guidance is not activated, select **Start Route Guidance**.  
The selected service station is set as a destination. Route guidance begins.
- ▶ Method 2: if route guidance is activated, select **Start New Route Guidance** or **Set as Next Intermediate Destination**.  
**Start New Route Guidance**: the selected service station is set as a new destination. The previous destination and all intermediate destinations are deleted. Route guidance to the service station begins.

**Set as Next Intermediate Destination**: the selected service station is set as the next destination. Route guidance begins.

## Route guidance

### Notes on route guidance

**⚠ WARNING** Risk of distraction from operating integrated communication equipment while the vehicle is in motion

If you operate communication equipment integrated in the vehicle when driving, you will be distracted from the traffic situation. This could also cause you to lose control of the vehicle.

- ▶ Only operate this equipment when the traffic situation permits.
- ▶ If you cannot be sure of this, stop the vehicle whilst paying attention to road and traffic conditions and operate the equipment with the vehicle stationary.

Route guidance begins once a route has been calculated.

The road and traffic rules and regulations always have priority over multimedia system driving recommendations.

Driving recommendations are:

- Navigation announcements
- Route guidance displays
- Lane recommendations

If you do not follow the navigation announcements or if you leave the calculated route, a new route is calculated automatically.

Driving recommendations may differ from the actual road and traffic conditions if:

- the route is diverted.
- the direction of a one-way street has been changed.

For this reason, you must always observe road and traffic rules and regulations during your journey.

The route may differ from the ideal route due to the following:

- roadworks

- incomplete digital map data

### Changing direction overview



There are three phases when changing direction:

- Preparation phase

If there is enough time between the changes of direction, the multimedia system prepares you for the upcoming change of direction. A

navigation announcement, e.g. "Prepare to turn right", is issued.

The map appears in full-screen mode.

- Announcement phase

The multimedia system announces the upcoming change of direction, e.g. by announcing "Turn right in 300 feet (100 m)".

The display is split into two parts. The map is displayed on the left; on the right, there is a detailed image of the intersection or a 3D image of the upcoming change of direction.

- Change-of-direction phase

The multimedia system announces the imminent change of direction, e.g. by announcing "Now turn right".

The display is split into two parts.

The vehicle has successfully changed direction when the light-colored bar on the right drops down to 0 feet (0 meters) and the current vehicle position symbol has reached the highlighted change-of-direction point.

When the change of direction is complete, the map appears in full-screen mode.

**i** Changes of direction are also shown in the Instrument Display.

### Lane recommendations overview

This display appears for multi-lane roads.

If the digital map contains the relevant data, the multimedia system can display lane recommendations for the next two changes of direction.



- 1** Recommended lane
- 2** Possible lane
- 3** Lanes not recommended

- Recommended lane **1**

In this lane, you will be able to complete both the next change of direction and the one after that.

- Possible lane **2**

In this lane, you will only be able to complete the next change of direction.

- Lane not recommended **3**

In this lane, you will not be able to complete the next change of direction without changing lane.

During the change of direction, new lanes may be added.

**i** Lane recommendations can also be displayed in the Instrument Display and in the head-up display.

### Destination reached

Once the destination is reached, you will see the checkered flag . Route guidance is finished.

When an intermediate destination has been reached, you will see the intermediate destination flag with the number of your intermediate destination . After this, route guidance is continued.

### Switching navigation announcements on/off

#### Requirements:

- a route has already been created.



- route guidance is active.

▶ **To switch off:** press the volume control on the multifunction steering wheel during a navigation announcement (→ page 274).

or

▶ Press on the volume control to the right of the controller during a navigation announcement (→ page 274).  
The **Spoken driving recommendations have been deactivated.** message appears.

or

▶ Show the navigation menu (→ page 291).

▶ Select  **Driving Recommendation**.  
The symbol changes to .

▶ **To switch on:** select  **Driving Recommendation**.

The current navigation announcement is played.

ⓘ In the following situations, navigation announcements are switched on automatically:

- A new route guidance is started.

- The route is recalculated.

ⓘ You can access and add this function as a favorite under **Spoken Driving Recommendations On/Off**.

### Switching navigation announcements on/off during a phone call

▶ Select **System**.

▶ Select  **Audio**.

▶ Select **Navigation and Traffic Announcements**.

▶ Switch **Driving Recommendations During Phone Call** on  or off .

### Adjusting the volume of navigation announcements

#### Requirements:

- a route has already been created.
- route guidance is active.

### On the multifunction steering wheel or next to the controller

▶ Turn the volume control on the multifunction steering wheel during a navigation announcement.

or

▶ Turn the volume control to the right of the controller during a navigation announcement (→ page 275).

ⓘ In the following situations, the volume is raised to the minimum volume or lowered to the maximum volume:

- A new route guidance is started.
- The route is recalculated.

ⓘ The minimum volume can be individually set at an authorized Mercedes-Benz Center.

### Via system settings

▶ Select **System**.

▶ Select  **Audio**.

▶ Select **Navigation and Traffic Announcements**.

▶ Select **Driving Recommendation Volume**.

- ▶ Set the volume.

### Switching audio fadeout on/off during navigation announcements

- ▶ Select **System**.
- ▶ Select  **Audio**.
- ▶ Select **Navigation and Traffic Announcements**.
- ▶ Switch **Audio Fadeout During Driving Recommendation** on  or off .

### Repeating navigation announcements

#### Requirements:

- a route has already been created.
- route guidance is active.

Multimedia system:

- ↳ **Navigation**

- ▶ Select  **Driving Recommendation**.
- ▶ Select  **Driving Recommendation**.  
The current navigation announcement is repeated.

- ⓘ You can access and add this function as a favorite under **Repeat Spoken Driving Recommendation**.

### Cancels route guidance

#### Requirements

- A route has already been created.
- Route guidance is active.

Multimedia system:

- ↳ **Navigation**

- ▶ Select **Cancel Route Guidance**.

### Route guidance to an off-road destination

Off-road destination: the destination is within the digital map. However, the map contains no roads that lead to the destination.

You can enter off-road destinations on the map. Route guidance guides you for as long as possible with navigation announcements and displays on roads that are known to the multimedia system.

Shortly before you reach the last known position on the map, you will hear the "Please follow the direction arrow" announcement. The display

shows a direction arrow and the linear distance to the destination.

### Route guidance from an off-road location to a destination

Off-road position: the current vehicle position is located within the digital map on roads that are not available.

The following displays appear when route guidance begins:

- the **Road Not Mapped** message
- a direction arrow showing the linear direction to the POI

When the vehicle is back on a road known to the multimedia system, route guidance continues as normal.

### Notes on the off-road status during route guidance

Due to roadworks, for example, there may be differences between the data on the digital map and the actual course of the road. In such cases, the multimedia system will temporarily be unable to locate the vehicle's current position on the digital map. The vehicle is off-road.

The following displays appear when the vehicle is off-road:

- the **Road Not Mapped** message
- a direction arrow showing the linear direction to the POI

When the vehicle is back on a road known to the multimedia system, route guidance continues as normal.

## Destination

### Saving the current vehicle position

Multimedia system:

#### Navigation

- ▶ Alternatively: if the map is displayed in full screen mode, press Touch Control, the controller or the touchpad. The map menu appears.
- ▶ Select ❶ on the map menu (→ page 309). The current vehicle position is saved to the "Previous destinations" memory.

### Storing a map position

Multimedia system:

#### Navigation





The map is in full-screen mode.

- ▶ Press Touch Control, the controller or the touchpad.
- ▶ Select "Move map" in map menu ❷ (→ page 309).
- ▶ Select a position on the map. If multiple entries are available for a map position, a list appears.
- ▶ Highlight an entry.
- ▶ Select  **Store in "Previous Destinations"**. The map position is saved to the "Previous destinations" memory.

### Editing the previous destinations

Multimedia system:

- ▶ **Navigation** ▶  **Previous and Other Destinations** ▶ **Previous Destinations**
- ▶ Highlight one of the previous destinations.

- ▶ **To save as a favorite:** select  **Save as Global Favorite**. The favorites are displayed.
- ▶ Move the favorite to the desired position. If a favorite has already been added at this position, it will be overwritten.
- ▶ **To save as "Home" address:** select  **Save as "Home"**.
- ▶ **To save as "Work" address:** select  **Save as "Work"**.
- ▶ **To delete a single or all destinations:** select  **Delete** or **Delete All**. A prompt appears.
- ▶ Select **Yes**.
- ▶ **To display destination information:** select  **Details**.

## Using intelligent destination suggestions

Multimedia system:

Navigation ► Options ► Intelligent Destination Suggestions

The navigation system learns the user habits of the driver. The most probable destinations are suggested.

- ▶ Activate  **Learn Journeys**.  
The destination suggestions are displayed in previous destinations and can be selected for route guidance.
- ▶ **To not use the function:** switch **Learn Journeys** off .
- ▶ **To delete destination suggestions:** select **Reset**.

## Using external destinations and routes

External destinations and routes can be received from the following sources:

- Mercedes-Benz Apps
- door-to-door navigation with Companion App (USA)

- via an MB Info call to the Mercedes-Benz Customer Assistance Center
- Rear Seat Entertainment System

A prompt appears on the media display. Received destinations and routes are saved in the previous destinations.

▶ **If a destination is received:** select **Yes** and continue with method 1 or 2.

or

- ▶ If a destination was received with photo information, select **Start Route Guidance**. Route guidance starts.
- ▶ Method 1: if route guidance is not activated, select **Start Route Guidance**. The route to the destination is calculated. The map shows the route. Route guidance then begins.
- ▶ Method 2: if route guidance is activated, select **Start New Route Guidance** or **Set as Next Intermediate Destination**.  
**Start New Route Guidance:** the received destination address is set as a new destination. The previous destinations and intermediate

destinations are deleted. Route guidance to the new destination begins.

**Set as Next Intermediate Destination:** the received destination address is set as the next new destination. Route guidance begins.

- ▶ **If a route is received:** select **Start Route Guidance from Beginning of Route** or **Start Route Guidance from Current Position**. Route guidance starts from the selected position.

## Route guidance with current traffic reports

### Traffic information overview

Traffic reports are received using Live Traffic Information and are used for route guidance.

This service is unavailable in some countries.

There may be differences between the traffic reports received and the actual road and traffic conditions.

Important information on Live Traffic Information:

- Current traffic reports are received via the Internet connection.

- The traffic situation is updated at short, regular intervals.
- The subscription information shows the status (→ page 307).

Information on the vehicle's position is regularly sent to Daimler AG. The data is immediately rendered anonymous by Daimler AG and forwarded to the traffic data provider. Using this data, traffic reports relevant to the vehicle's position are sent to the vehicle. The vehicle acts as a sensor for the flow of traffic and helps to improve the quality of the traffic reports.

If you do not wish to transmit your vehicle position, you can have this service deactivated at an authorized Mercedes-Benz Center.

### Displaying subscription information

#### Requirements:

- The vehicle is equipped with Live Traffic Information.

Multimedia system:

↳ [Navigation](#) ▶  [Options](#)

The subscription expiration date is automatically displayed:

- one month before the expiration date
- one week before the expiration date
- on the expiration date

▶ **To display manually:** select [Live Traffic Subscription Info](#).

Depending on the status, one of the following messages appears:

- the period of validity for the subscription is displayed.
- the subscription has expired.

 The subscription can be extended:

- at any authorized Mercedes-Benz Center
- via an MB Info call to the Mercedes-Benz Customer Assistance Center

### Displaying the traffic map

#### Requirements:

- For Live Traffic Information: the vehicle is equipped with a communication module featuring an activated, integrated SIM card.
- When the vehicle is started, the communication module automatically establishes an Internet connection. Traffic information is made available shortly afterwards.

Multimedia system:

↳ [Navigation](#) ▶  [Options](#) ▶ [Map Menu](#)

▶ Alternatively: if the map is displayed in full screen mode, press Touch Control, the controller or the touchpad. The map menu appears.

▶ Activate  .

The traffic map shows the following information, for example:

- traffic incidents, for example:
  - roadworks
  - road blocks

- warning messages

The symbols for traffic incidents are displayed in color (on the route) or gray (off the route).

- traffic flow information:
  - traffic jam (red line)
  - slow-moving traffic (yellow line)
  - free-flowing traffic (green line)
- display for traffic delays on the route lasting at least one minute
- warning message symbols:
  - symbol 
  - additional road safety notes when approaching a traffic incident, e.g. the end of a traffic jam

If the vehicle approaches a danger area on the route, a warning message is displayed on the map. A warning message may also be issued (→ page 309).

### Displaying traffic incidents

Multimedia system:

Navigation   Options  Map  
Content

- ▶ Activate  **Traffic Incidents**.  
Roadworks, road blocks, local area reports (e.g. fog) and warning messages are displayed.

### Activating free flow and traffic display

- ▶ Activate  **Free Flowing Traffic** and **Traffic Delays**.
-  The traffic delay is displayed for the current route. Traffic delays lasting one minute or longer are taken into consideration.

### Displaying details

- ▶ Displaying the traffic map (→ page 307).
- ▶ Moving the map (→ page 310).
- ▶ When a traffic report symbol is under the crosshair, press Touch Control, the controller or the touchpad.  
The traffic report details are displayed.

or

- ▶ Press Touch Control, the controller or the touchpad.
- ▶ Select **Information on Traffic Reports**.  
The map shows the traffic report symbols in the vicinity.  
Traffic report information is displayed in the status line:
  - traffic report symbol
  - reason for the traffic report, e.g. traffic jam
  - warning message (highlighted in red)
- ▶ **To select a traffic report symbol:** select **Next** or **Previous**.
- ▶ Press Touch Control, the controller or the touchpad.  
The traffic report details are displayed.

## Issuing hazard alerts

Multimedia system:

Navigation ► ►  Options ► ► Announcements

- Activate  **Announce Traffic Warnings.** Warning messages are issued and tailbacks which pose a risk are announced.

## Map and compass

### Map and compass overview



- ① To save the current vehicle position
- ② To move the map
- ③ To select the map orientation and map view
- ④ To select the function depending on the equipment:
  - To transmit a hazard alert (Car-to-X)

- To filter the display of POIs in the vicinity according to POI category
- ⑤ To switch the display of personal POI symbols on the map on or off
- ⑥ To switch one of the following displays on or off depending on the equipment:
  - Weather information
  - Satellite map
  - Traffic incidents
- ⑦ To switch the traffic map display on or off

The map and satellite images are shown in globe projection. This allows for a realistic map display in all map scales. The map uses elevation modeling.

Depending on the map data, important buildings in many cities are depicted realistically on the map in small map scales (1/32 mi (20 m), 1/16 mi (50 m)). Other buildings are shown as models.

- ① You can set the unit of measurement of the map scale (→ page 284).

If online information is available, fuel prices and the availability of parking spaces in parking garages are displayed, for example.

- ❶ Online information is not available in all countries.
- ❷ Requirement (USA): Mercedes-Benz mbrace® is activated.

If **Display in COMAND** is activated in Traffic Sign Assist (→ page 235), speed limits and overtaking restrictions are displayed on the map.

- ❸ Company logos displayed on the map are trademarks of the respective companies and used solely for the purpose of indicating the locations of these companies. The use of such logos on the map does not indicate approval of, support of or advertising by these companies for the navigation system itself.

### Setting the map scale

#### Requirements:

- The map is shown.

Multimedia system:

↳ **Navigation**

- ▶ **To zoom in:** swipe down on Touch Control.

or

- ▶ Turn the controller counter-clockwise.

or

- ▶ Move two fingers apart on the touchpad.

- ▶ **To zoom out:** swipe up on Touch Control.

or

- ▶ Turn the controller clockwise.

or

- ▶ Move two fingers together on the touchpad.

- ❶ You can set the unit of measurement of the map scale (→ page 284).

### Moving the map

Multimedia system:

↳ **Navigation** ▶  **Options** ▶ **Map Menu**

- ▶ Alternatively: if the map is displayed in full screen mode, press Touch Control, the controller or the touchpad. The map menu appears.

- ▶ Select "Move map" in map menu ❷ (→ page 309).

- ▶ Swipe in any direction on Touch Control or touchpad.

or

- ▶ Slide the controller in any direction. The map moves in the corresponding direction under the crosshair. The further you move your finger away from the starting position on the touchpad, the faster the map moves.



## Selecting the map orientation

Multimedia system:

Navigation  Options  Map Menu

- ▶ Alternatively: if the map is displayed in full screen mode, press Touch Control or the touchpad. The map menu appears.
- ▶ In map menu , select **N**, **2D** or **3D**(→ page 309).
  - **N**: the 2D map view is displayed so that north is always at the top.
  - **2D**: the 2D map view is aligned to the direction of travel.
  - **3D**: the 3D map view is aligned to the direction of travel.

## Selecting POI symbols

Multimedia system:

Navigation  Options  Map Content

POIs include gas stations and hotels which can be displayed as symbols on the map, for example. Not all POIs are available everywhere.

- ▶ Select **POI Symbols**. The • dot indicates the current setting. **Standard** displays symbols of predefined categories on the map. **User Defined** allows you to personally select the symbols for the available categories. **None** switches the display off.
- ▶ Select a setting.
- ▶ **User Defined**: select categories. The POI symbols of the selected categories are displayed  or not displayed .

## Selecting text information

Multimedia system:

Navigation  Options  Text Information

- ▶ Select text information. **Current Street** shows the street you are currently driving on at the bottom of the display. When the map is moved, the following information appears under the crosshair:
  - street name
  - POI name

- area name

**Geo-coordinates** displays the following information:

- longitude and latitude
  - elevation
- The elevation shown may deviate from the actual elevation.
- number of satellites from which a signal can be received
- When the map is moved, this information does not appear.

**Climate Control** displays the current climate control settings.

**None** switches the display off.

## Displaying the next intersecting street

### Requirements:

- Route guidance is not active.

Multimedia system:

Navigation ► Options

- ▶ Activate  **Next Intersecting Street**.  
The name of the next intersecting street will be displayed at the upper edge of the display.

### Displaying the map version

Multimedia system:

Navigation ► Options

- ▶ Select **Map Version**.
- ▶ Select **Details**.

 Information about new versions of the digital map can be obtained from an authorized Mercedes-Benz Center.

### Avoiding an area

You can define areas along a route that you would like to avoid.

### Avoiding a new area

Multimedia system:

Navigation ► Route and Position ► Avoid Options ► Areas

- ▶ Select **Avoid New Area**.

- ▶ **To search for an area via the map:** select **Using Map**.

- ▶ Move the map

or

- ▶ **To search for an area using an address:** select **Address Entry**.

- ▶ Enter the address.

- ▶ Select **Select Destination**.  
The map appears.

- ▶ **To display an area:** press Touch Control, the touchpad or the controller.  
A red rectangle appears. This designates the area that should be avoided.

- ▶ **To change the size of the area:** swipe up or down on Touch Control or the touchpad.

or

- ▶ Slide the controller up or down.  
The map scale is enlarged or reduced and changes the size of the area.

- ▶ **To set the area:** press Touch Control, the touchpad or the controller.  
The area is entered into the list.

### Changing an area

Multimedia system:

Navigation ► Route and Position ► Avoid Options ► Areas

- ▶ Highlight an area in the list.
- ▶ Select  **Edit**.

### Moving the area on the map

- ▶ Swipe in any direction on Touch Control or touchpad.

or

- ▶ Slide the controller in any direction.

### Changing the size of the area

- ▶ **To start:** press Touch Control, the touchpad or the controller.

- ▶ **To change:** swipe up or down on Touch Control or the touchpad.

or

- ▶ Slide the controller up or down.
- ▶ **To stop:** press Touch Control, the touchpad or the controller.



### Taking the area for the route into account

- ▶ Avoid  an area in the list.  
If route guidance is active, a new route is calculated.
- If there is no route yet, the setting is carried over to the next route guidance.
- The route can include an area that is to be avoided in the following cases:
  - the destination is located in an area that is to be avoided
  - there is no sensible alternative route

### Deleting one or all areas

Multimedia system:

↳ Navigation ▶  Route and Position ▶ Avoid Options ▶ Areas

- ▶ Highlight an area in the list.
- ▶ Select  Delete or  Delete All.
- ▶ Confirm the prompt with **Yes**.  
One or all areas are deleted.

### Map data update overview

#### Updating at an authorized Mercedes-Benz Center

The digital maps generated by the map software become outdated in the same way as conventional road maps. Optimal route guidance can only be provided by the navigation system in conjunction with the most up-to-date map data. Information about new versions of the digital map can be obtained from an authorized Mercedes-Benz Center.

You can receive updates to the digital map there.

#### Map data

Your vehicle is supplied with map data at the factory. Depending on the country, map data for your region is either pre-installed or the map data is supplied on a data storage medium. You do not require an activation code for the map data which is provided with your vehicle.

If the map data on your vehicle has been installed at the factory and you wish to reinstall it, you do not need to enter the activation code.

An activation code is required for purchased map data.

Observe the following notes:

- the activation code can be used for one vehicle
- the activation code is not transferable
- the activation code has six digits

In the event of the following problems, please contact an authorized Mercedes-Benz Center:

- the multimedia system does not accept the activation code
- you have lost the activation code

### Displaying the compass

Multimedia system:

↳ Navigation ▶  Route and Position

- ▶ Select **Compass**.

The compass display shows the following information:

- the current direction of travel with bearing (360 degree format) and compass direction
- longitude and latitude coordinates in degrees, minutes and seconds

- height (rounded)
- number of GPS satellites from which a signal can be received

### Setting the map scale automatically

Multimedia system:

↳ [Navigation](#) ▶▶  [Options](#)

The map scale is set automatically depending on your driving speed.

For journeys in cities with detailed city models, a map view from the driver's perspective is used.

▶ Switch [Auto Zoom](#) on  or off .

- ⓘ The automatically selected map scale can be changed manually for a short time. The setting is reset automatically after a few seconds.

### Displaying the satellite map

Multimedia system:

↳ [Navigation](#) ▶▶  [Options](#) ▶▶ [Map Content](#)

▶ Switch [Satellite Map](#) on  or off .

or

▶ If satellite map display  is available in the map menu, switch it on  or off  (→ page 309).  
Switched on : satellite maps are displayed in map scales of 2 mi (2 km).

Switched off : satellite maps are not displayed in map scales from 2 mi (2 km) to 10 mi (10 km).

- ⓘ Satellite maps for these map scales are not available in all countries.

### Displaying weather information

Multimedia system:

↳ [Navigation](#) ▶▶  [Options](#) ▶▶ [Map Content](#)

▶ Activate  [Weather Information](#).

or

▶ If weather information display  is available in the map menu, activate  (→ page 309) it.  
Current weather information is displayed on the navigation map, e.g. temperature or cloud cover.

- ⓘ Weather information is not available in all countries.

- ⓘ Requirement (USA): Mercedes-Benz mbrace® is activated.

- ⓘ This function is not available in all countries.

### Calling up the Digital Operator's Manual (navigation)

#### Information on navigation

Multimedia system:

↳ [Navigation](#) ▶▶  [Options](#) ▶▶ [Navigation Info](#)

▶ Select the topic.



## Telephone

### Telephony

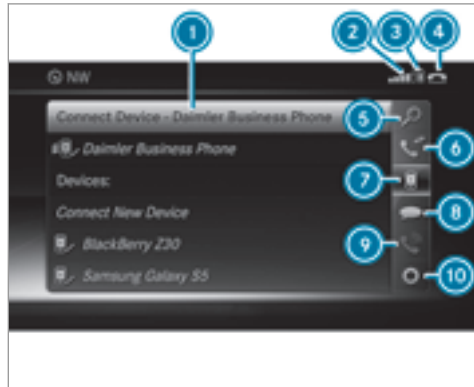
#### Telephone menu overview



- ① Bluetooth® device name of the currently connected mobile phone
- ② Signal strength of the mobile phone network

- ③ Battery status of the connected mobile phone
- ④  (telephone ready) or  (call active)
- ⑤ [Contacts](#) (→ page 320)
- ⑥ [Call List](#) (→ page 322)
- ⑦ [Connect Device](#) (→ page 316)
- ⑧ [Text Message](#)
- ⑨ Active call
- ⑩ [Options](#)

Symbols ① to ④ are not shown until after a mobile phone has been connected to the multimedia system. The symbols depend on your mobile phone and your mobile phone network provider.

#### Bluetooth® profile overview

Bluetooth® profile of the mobile phone	Function
PBAP (Phone Book Access Profile)	Contacts are automatically displayed in the multimedia system
MAP (Message Access Profile)	Message functions can be used

#### Telephony operating modes overview

Depending on your equipment, the following telephony operating modes are available:

- A mobile phone is connected to the multimedia system via Bluetooth® (→ page 316).

## Notes on telephony

**⚠ WARNING** Risk of distraction from operating integrated communication equipment while the vehicle is in motion

If you operate communication equipment integrated in the vehicle when driving, you will be distracted from the traffic situation. This could also cause you to lose control of the vehicle.

- ▶ Only operate this equipment when the traffic situation permits.
- ▶ If you cannot be sure of this, stop the vehicle whilst paying attention to road and traffic conditions and operate the equipment with the vehicle stationary.

**⚠ WARNING** Risk of distraction from operating mobile communication equipment while the vehicle is in motion

If you operate communication equipment integrated in the vehicle when driving, you will be distracted from the traffic situation.

This could also cause you to lose control of the vehicle.

Only operate this equipment when the vehicle is stationary.

You must observe the legal requirements for the country in which you are currently driving when operating mobile communication equipment in the vehicle.

Further information can be obtained from an authorized Mercedes-Benz Center or at: <http://www.mercedes-benz.com/connect>.

To improve voice quality, the multimedia system supports telephone calls in HD Voice®.

In order to use this function, the mobile phones and the mobile phone network provider of the person you are calling must support HD Voice®.

Depending on the quality of the connection, the voice quality may fluctuate.

The following situations can lead to the call being disconnected while the vehicle is in motion:

- There is insufficient network coverage in the area.
- You move from one GSM or UMTS transmitter/receiver area (cell) into another and no communication channels are free.
- The SIM card used is not compatible with the network available.
- A mobile phone with "Twincard" is logged into the network with the second SIM card at the same time.

### Connecting a mobile phone (Bluetooth® telephony)

#### Requirements:

- Bluetooth® is activated on the mobile phone (see the manufacturer's operating instructions).
- Bluetooth® is activated on the multimedia system (→ page 279).

Multimedia system:

➤ Phone ➤  Connect Device

### Searching for a mobile phone

- ▶ Select **Connect New Device**.
- ▶ Select **Start Search on System**.  
The available mobile phones are displayed. If a new mobile phone is found, it is indicated by the  symbol.

### Connecting a mobile phone (authorization using Secure Simple Pairing)

- ▶ Select the mobile phone.  
A code is displayed in the multimedia system and on the mobile phone.
- ▶ **If the codes match:** confirm the code on the mobile phone.

### Connecting a mobile phone (authorization by entering a passkey)

- ▶ Select the mobile phone.
- ▶ Choose a one to sixteen-digit number combination as a passkey.

▶ **On the multimedia system:** enter the passkey and select .

▶ **On the mobile phone:** enter the passkey again and confirm.

- ⓘ Up to 15 mobile phones can be authorized on the multimedia system.  
Authorized mobile phones are reconnected automatically.

### Disconnecting a mobile phone (deauthorizing)

Multimedia system:

➤ Phone ➤  Connect Device

- ▶ Select the mobile phone from the device list.
- ▶ Select .
- ▶ Select **Deauthorize**.
- ▶ Select **Yes**.

### Switching mobile phones

#### Requirements:

- The mobile phones are authorized (→ page 316).

Multimedia system:

➤ Phone ➤  Connect Device

- ▶ In the device list, select a mobile phone which has already been authorized.
- ⓘ Only one mobile phone can be connected at any one time. The connected mobile phone is displayed at the top of the list.

### Using the mobile phone with Near Field Communication (NFC)

#### Requirements:

- NFC is activated on the mobile phone (see the manufacturer's operating instructions)
- the mobile phone's screen is switched on and unlocked (see the manufacturer's operating instructions)

NFC enables short-range wireless data transfer.



- ▶ **To connect a mobile phone:** open the cover of the armrest on the center console.
- ▶ Place the NFC area of the mobile phone (see manufacturer's operating instructions) on NFC logo ①. The mobile phone is connected to the multimedia system.

▶ **To change mobile phones:** place the NFC area of the mobile phone on NFC logo ①. If the mobile phone has already been authorized on the multimedia system, it is now connected.

If the mobile phone is authorized on the multimedia system for the first time, it is connected after confirming the mobile phone instructions (see the manufacturer's operating instructions).

Further information can be found at: <http://www.mercedes-benz.com/connect>

Further functions without having a mobile phone authorized on the multimedia system (see manufacturer's operating instructions):

- transferring a contact or a business card, e.g. for direct navigation to an entered address
- transferring a URL to be viewed in the multimedia system
- setting up the vehicle's Wi-Fi access data via the system settings (→ page 281)

## Setting the reception and transmission volume

### Requirements:

- A mobile phone is authorized (→ page 316).

Multimedia system:

☛ Phone ▶  Connect Device

This function ensures optimal language quality.

- ▶ Highlight the mobile phone in the device list.
- ▶ Select .
- ▶ Select **Reception Volume** or **Transmission Volume**.
- ▶ Set the volume.

Further information on the recommended reception and transmission volume: <http://www.mercedes-benz.com/connect>

### Adjusting the call and ringtone volume

Multimedia system:

☛ System ▶  Audio ▶ Phone

- ▶ Select **Call Volume** or **Ringtone Volume**.
- ▶ Set the volume.



## Starting/stopping mobile phone voice recognition

### Requirements:

- the mobile phone is connected to the multimedia system (→ page 316).

### Starting mobile phone voice recognition

- Press and hold the  button on the multi-function steering wheel for more than one second.  
You can use mobile phone voice recognition.

### Stopping mobile phone voice recognition

- Press the  or  button on the multi-function steering wheel.

## Calls

### Using the telephone

Multimedia system:

 Phone   Contacts

### Making a call

- Select **Numerical Keypad**.

- Enter the number.
- Select .  
The call is made.

### Accepting a call

- Select **Accept**.

### Rejecting a call

- Select **Reject**.

### Ending a call

- Select .

### Activating functions during a call

- To show all functions, navigate down.

The following functions are available during a call:

- End Call**
- Make Additional Call**
- Keyboard** (show to send DTMF tones)
- Switch **Mute Mic** on  or off .
- Private Mode** (an active call in hands-free mode is transferred over to the telephone)

## Conducting calls with several participants

### Requirements:

- There is an active call (→ page 319).
- Another call is being made.

### Switching between calls

- Select call ●.  
The selected call is active. The other call is on hold.



### Activating or ending a call on hold

- Select **Continue Call** or **End Call**.

### Conducting a conference call

- Select **Create Conference Call** in the telephone menu.  
The new participant is included in the conference call.

### Ending an active call

- Select .
-  On some mobile phones, the call on hold is activated as soon as the active call is ended.

## Accepting/rejecting a waiting call

### Requirements:

- There is an active call (→ page 319).

If you receive a call while already in a call, a message is displayed. An acoustic signal also sounds.

#### ▶ Select [Accept](#).

The incoming call is active. The previous call is on hold.

#### ▶ Select [Reject](#).

- ① This function and behavior depends on your mobile phone network provider and the mobile phone (see the manufacturer's operating instructions).

## Contacts

### Information about the contacts menu

The contacts menu contains all contacts from existing data sources, e.g. mobile phone or memory card.

It is possible to store up to 6,000 contacts:

- 3,000 entries are for permanently saved contacts.
- 3,000 for contacts loaded from the mobile phone.

From the contacts menu, you can perform the following actions:

- Telephone operation
  - Calling a contact (→ page 322)
  - Calling a new number (→ page 319)
- Navigation (→ page 295)
- Compose messages (→ page 323)

If a mobile phone is connected to the multimedia system (→ page 316) and automatic calling up (→ page 320) is activated, the mobile phone's contacts are displayed in the address book.

### Downloading mobile phone contacts

Multimedia system:

↳ Phone ▶ ⚙️ Options

### Automatically

- ▶ Activate  [Synchronize Contacts Automatically](#).

### Manually

- ▶ Deactivate  [Synchronize Contacts Automatically](#).
- ▶ Select [Synchronize Contacts](#).

### Calling up contacts

Multimedia system:

↳ Phone ▶ 🔍 Contacts

Depending on the character set, the following options can be used to search for contacts:

- searching by initials
- searching by name
- searching by phone number

- ▶ Enter characters into the search field. A selection of possible contacts appears. Entering more characters into the search field narrows down the number of possible selections.

- ▶ Select the contact.

A contact can contain the following details:

- phone numbers
- navigation addresses

- geo-coordinates
- Internet address

### Editing the format of a contact's name

Multimedia system:

Phone ▶▶ Options ▶▶ Name Format



The following options are available:



- Last Name, First Name
- Last Name First Name
- First Name Last Name

▶ Select an option.

### Overview of importing contacts

#### Importing contacts as electronic business cards

Source	Requirements:
 Memory card	The SD memory card is inserted.
 USB device	The USB device is inserted in the USB port.

Source	Requirements:
 Bluetooth® connection	<p>If the sending of vCards via Bluetooth® is supported, vCards can be received on mobile phones or notebooks, for example.</p> <p>Bluetooth® is activated in the multimedia system and on the respective device (see the manufacturer's operating instructions).</p>
 Mobile phone	The mobile phone is connected to the multimedia system.

#### Importing contacts into the contacts menu

Multimedia system:



Phone ▶▶ Options

- ▶ Select Import.
- ▶ Select an option.

### Saving a mobile phone contact

Multimedia system:

➤ Phone ➤ 🔍 Contacts

- ▶ Select the  mobile phone contact.
- ▶ Select .
- ▶ Select **Save to Vehicle**.  
The contact saved in the multimedia system is identified by the  symbol.

### Calling a contact

Multimedia system:

➤ Phone ➤ 🔍 Contacts

- ▶ Enter characters into the search field.
- ▶ Select the contact.
- ▶ Select the telephone number.  
The number is dialed.

### Selecting further options in the contacts menu

Multimedia system:

➤ Phone ➤ 🔍 Contacts

- ▶ Select a contact.
- ▶ Select .

Depending on the stored data, the following options are available:

- **Call**
- **Send Text Message**
- **Show Website** (if a web address has been stored)
- **Navigate** (if an address has been stored)
- **Save as Global Favorite**
- **Send DTMF Tones** (for a number with DTMF tones)

▶ Select an option.

### Deleting a contact

Multimedia system:

➤ Phone ➤ 🔍 Contacts

You can delete contacts stored in the vehicle.

- ▶ Search for the contact.
- ▶ Select the contact.
- ▶ Select .
- ▶ Select **Delete Contact**.
- ▶ Select **Yes**.

## Call list

### Call list overview

If your mobile phone supports the PBAP Bluetooth® profile:

- The call lists from the mobile phone are displayed in the multimedia system.
- When connecting the mobile phone, you may have to confirm the connection for the PBAP Bluetooth® profile.

If your mobile phone does not support the PBAP Bluetooth® profile:

- The multimedia system generates its own call lists.
- The call list is not synchronized with the call lists in the mobile phone.

### Making a call from the call list

Multimedia system:

➤ Phone ➤ 📞 Call List - Mobile phone

- ▶ Select an entry.  
The call is made.

## Options in the call list

Multimedia system:

Phone ▶▶ Call List - Mobile phone

- ▶ Highlight an entry.
- ▶ Select .

The following options are available:

- [Send Text Message](#)
- [Open Contact](#)

## Text messages

### Notes on the text message functions

If the connected mobile phone supports the MAP Bluetooth® profile, the text message functions can be used on the multimedia system.

You can obtain further information about settings and supported functions of Bluetooth®-capable mobile phones from an authorized Mercedes-Benz Center or at: <http://www.mercedes-benz.com/connect>

Some mobile phones require further settings after being connected to the multimedia system (see manufacturer's operating instructions).

New messages are identified by the  symbol in the multimedia system's display and an audible signal.

Depending on the mobile phone, the multimedia system only displays new incoming text messages or the 100 newest text messages.

### Configuring the displayed text messages

Multimedia system:

Phone ▶▶ Options ▶▶ Message Display

- ▶ Select .

A menu with the following options is shown:

- [All Messages](#)
- [New and Unread Messages](#)
- [New Messages](#)
- [Off](#) (The text messages are not displayed automatically.)

- ▶ Select an option.

### Reading text messages

Multimedia system:

Phone ▶▶  Text Message

### Reading a text message

- ▶ Select a text message.  
The message text is displayed.

### Using the read-aloud function

- ▶ Select a text message.
- ▶ Select [Read Aloud](#).  
The text message is read aloud.

### Composing and sending a text message

Multimedia system:

Phone ▶▶  Text Message

- ▶ Navigate to the left twice.
- ▶ Select [Write New Text Message](#).

### Adding a recipient

- ▶ Select [Press to Add Recipient](#).
- ▶ Select the contact.

## Dictating text

- ▶ Select **Press to Dictate**.  
The App for the dictation function is loaded.  
If there was no prior Internet connection, a connection is now established.
- ▶ **To start the dictation function:** press the controller or touchpad.
- ▶ Say the message.  
The dictation ends automatically after you have finished speaking.  
After the voice message has been processed, it is shown as text.

## Editing text

- ▶ Select the word.
- ▶ **To call up the correction menu:** press the controller or touchpad.  
The following options are available:
  - adjusting the capitalization of words (if supported by the character set)
  - expanding the choice of words
  - deleting the selection

- recording a new dictation
- ▶ **To leave the menu:** select **Done**.

## Sending text messages

- ▶ Select **Send Text Message**.

## Replying to a text message

Multimedia system:

↳ Phone ▶  Text Message

- ▶ Select the text message.
- ▶ Select .
- ▶ Select **Reply**.

## Calling a text message sender

Multimedia system:

↳ Phone ▶  Text Message

- ▶ Select the text message.
- ▶ Select .
- ▶ Select **Call Sender**.

## Further options in the text message menu

Multimedia system:

↳ Phone ▶  Text Message

- ▶ Select .
  - ▶ **To delete a text message:** select **Delete**.
  - ▶ **To change folders:** select **Switch Folder**.
  - ▶ **Outbox**
- or
- ▶ Select **Drafts**.

## Apple CarPlay™

### Overview of Apple CarPlay™

iPhone® functions can be used via the multimedia system using Apple CarPlay™. They are operated using the controller or the Siri® voice-operated control system. You can activate the voice-operated control system by pressing and holding the  button on the multifunction steering wheel.

When using Apple CarPlay™ via the voice-operated control system, the multimedia system can

still be operated via the Voice Control System (→ page 256).

Only one mobile phone at a time can be connected via Apple CarPlay™ to the multimedia system.

The availability of Apple CarPlay™ may vary according to the country.

The service provider is responsible for this application and the services and content connected to it.

### Notes on Apple CarPlay™

While using Apple CarPlay™ various functions of the multimedia system, e.g. telephony or the media sources Bluetooth® audio and iPod®, are unavailable.

Only one route guidance can be active at a time. If route guidance is active on the multimedia system, it is closed when route guidance is started on the mobile phone.

### Connecting an iPhone® via Apple CarPlay™

#### Requirements:

- Apple® operating system version iOS 8.3 or above is installed on the iPhone®.
- There is an Internet connection for the full range of functions for Apple CarPlay™.
- The iPhone® is connected to the multimedia system via the USB port  using a suitable cable (→ page 341).

Multimedia system:

 [Connect](#)  [Apple CarPlay](#)

#### Setting automatic or manual start

A message appears when connected for the first time.

- ▶ **Automatic start:** select [Automatically](#). [Start Automatically](#) is activated . Apple CarPlay™ will now start immediately after the iPhone® is connected to the multimedia system using a USB cable.
- ▶ **Manual start:** select [Manually](#).
- ▶ Select the iPhone® in the device list.

### Accepting/rejecting the data protection regulations

A message with the data protection regulations appears.

▶ Select [Accept & Start](#).

or

▶ Select [Decline & End](#).

If you selected automatic start, you will have to start Apple CarPlay™ manually the next time you want to use it.

### Exiting Apple CarPlay™

▶ Press the  button on the multifunction steering wheel, for example.

ⓘ If Apple CarPlay™ was not displayed in the foreground before disconnecting, the application starts in the background when reconnected. You can call up Apple CarPlay® in the main menu.

### Calling up Apple CarPlay™ sound settings

Multimedia system:

 [Connect](#)  [Apple CarPlay](#)  [Sound](#)

▶ Select the tone menu (→ page 358).

**Ending Apple CarPlay™**

Multimedia system:

↪ **Connect** ▶ **Apple CarPlay**

▶ Select **Disconnect**.

The connection is ended.

The mobile phone continues to be supplied with electricity.

or

▶ Disconnect the connecting cable between the mobile phone and multimedia system. Mercedes-Benz recommends disconnecting the connecting cable only when the vehicle is stationary.

**Android Auto****Android Auto overview**

Mobile phone functions can be used with Android Auto using the Android operating system on the multimedia system. It is operated using the controller or the voice-operated control system. You can activate the voice-operated control system by pressing and holding the  button on the multifunction steering wheel.

When using Android Auto via the voice-operated control system, the multimedia system can still be operated via the Voice Control System (→ page 256).

Only one mobile phone at a time can be connected via Android Auto to the multimedia system.

The availability of Android Auto and Android Auto Apps may vary according to the country.

The service provider is responsible for this application and the services and content connected to it.

**Notes on Android Auto**

While using Android Auto, various functions of the multimedia system, for example, the media source Bluetooth® audio, are not available.

Only one route guidance can be active at a time. If route guidance is active on the multimedia system, it is closed when route guidance is started on the mobile phone.

**Connecting a mobile phone via Android Auto****Requirements:**

- The first activation of Android Auto on the multimedia system must be carried out when the vehicle is stationary for safety reasons.
- The mobile phone supports Android Auto from Android 5.0.
- The Android Auto App is installed on the mobile phone.
- In order to use the telephone functions, the mobile phone must be connected to the multimedia system via Bluetooth® (→ page 316).  
If there was no prior Internet connection, this is established with the use of the mobile phone with Android Auto.
- The mobile phone is connected to the multimedia system via the USB port  using a suitable cable (→ page 341).
- There is an Internet connection for the full range of functions for Android Auto.



Multimedia system:

➤ Connect ➤ Android Auto

▶ Select the mobile phone from the device list.

### Accepting/rejecting the data protection regulations

A message with the data protection regulations appears.

▶ Select **Accept & Start**.

or

▶ Select **Decline & End**.

### Activating automatic start

▶ Select **Start Automatically** .

### Starting manually

▶ Select the mobile phone from the device list.

### Exiting Android Auto

▶ Press the  button on the multifunction steering wheel, for example.

 If Android Auto was not displayed in the foreground before disconnecting, the application starts in the background when reconnected.

You can call up Android Auto in the main menu.

### Calling up the Android Auto sound settings

Multimedia system:

➤ Connect ➤ Android Auto ➤ Sound

▶ Select the tone menu (→ page 358).

### Ending Android Auto

Multimedia system:

➤ Connect ➤ Android Auto

▶ Select **Disconnect**.

The connection is ended.

The mobile phone continues to be supplied with electricity.

or

▶ Disconnect the connecting cable between the mobile phone and multimedia system. Mercedes-Benz recommends disconnecting the connecting cable only when the vehicle is stationary.

## Transferred vehicle data when using Apple CarPlay™ and Android Auto

### Notes on transferred vehicle data

When using Android Auto or Apple CarPlay™, certain vehicle data is transferred to the mobile phone. This enables you to get the best out of selected mobile phone services. Vehicle data is not directly accessible.

System information:

- software release of the multimedia system
- system ID (anonymized)

The transfer of this data is used to optimize communication between the vehicle and the mobile phone.

To do this, and to assign several vehicles to the mobile phone, a vehicle ID is randomly generated.

This has no connection to the vehicle identification number (VIN) and is deleted when the multimedia system is reset (→ page 288).

Driving status data:

- transmission position engaged

- distinction between parked, standstill, rolling and driving
- day/night mode of the instrument cluster

The transfer of this data is used to alter how content is displayed to correspond to the driving situation.

Position data:

- coordinates
- speed
- compass direction
- acceleration direction

This data is only transferred while the navigation system is active in order to improve it (e.g. so it can continue functioning when in a tunnel).

### Mercedes-Benz mbrace® (USA)

#### Making a call via the overhead control panel

Mercedes-Benz mbrace® is available in the USA.

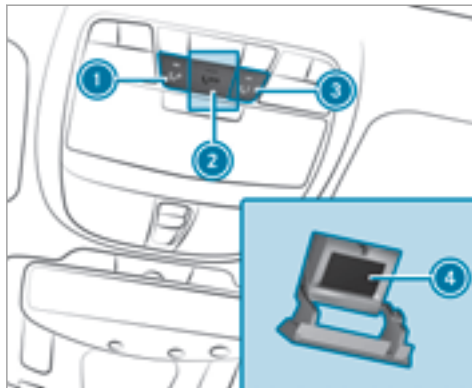

- ① Breakdown assistance call
- ② SOS button cover
- ③ MB Info call
- ④ SOS button

▶ **To make a breakdown assistance call:** press button ①. This initiates a call to the Mercedes-Benz Customer Assistance Center.

▶ **To make an emergency call:** press SOS button cover ② briefly to open.

▶ Press and hold SOS button ④ for at least one second. This initiates a call to the Mercedes-Benz Customer Assistance Center.

▶ **To make an MB Info call:** press button ③. This initiates a call to the Mercedes-Benz Customer Assistance Center.

An emergency call can be initiated even if a breakdown assistance or MB Info call is active. This has priority over all other active calls.

Calls via the overhead control panel are only possible with an available mobile phone network.

Further information on Mercedes-Benz mbrace® and other services can be found at: <http://www.mbusa.com>

## Information on the emergency call system

### **⚠ WARNING** Risk of accident and injury despite pressing the SOS button

Even if you press the SOS button in an emergency, remaining in the vehicle may be dangerous for the following reasons:

- you see smoke inside or outside of the vehicle, e.g. if there is a fire after an accident
  - the vehicle is on a dangerous section of road
  - the vehicle is not visible or cannot easily be seen by other road users, particularly when dark or in poor visibility conditions
- ▶ Leave the vehicle immediately in this or similar situations as soon as it is safe to do so.
- ▶ Move to a safe location along with other vehicle occupants.
- ▶ In such situations, secure the vehicle in accordance with national regulations, e.g. with a warning triangle.

## Automatic emergency call

The emergency call is initiated:

- when an air bag is deployed
- when an Emergency Tensioning Device is triggered

You can end an automatically initiated emergency call yourself after 60 seconds.

## Manual emergency call

An emergency call can be initiated manually via the SOS button in the overhead control panel (→ page 328).

If you leave the vehicle immediately after pressing the SOS button, you do not know if Mercedes-Benz mbrace<sup>®</sup> has successfully made the emergency call.

## Initiated emergency call

A voice connection between the Customer Assistance Center and the vehicle occupants is established:

- if the vehicle occupants are responsive, the Mercedes-Benz Customer Assistance Center

asks for more detailed information on the emergency.

- if no vehicle occupant answers, an ambulance is sent to the vehicle immediately.

## Transferred data

During the voice connection to the Customer Assistance Center, the following data is transferred:

- current vehicle location
- vehicle identification number

## Emergency call not possible

- if the mobile phone network is unavailable, Mercedes-Benz mbrace<sup>®</sup> is not able to make an emergency call.

A corresponding message appears in the multimedia system display.

The indicator lamp flashes continuously.

In this case, seek assistance by other means.

## Information on the MB Info call

An Info call to the Mercedes-Benz Customer Assistance Center has been initiated via the overhead control panel (→ page 328).

You can find information on the following topics:

- Mercedes-Benz mbrace® activation
- operating the vehicle
- nearest authorized Mercedes-Benz Center
- other products and services from Mercedes-Benz

Data is transmitted during the connection to the Mercedes-Benz Customer Assistance Center (→ page 330).

### Information on the Roadside Assistance call

A Roadside Assistance call to the Mercedes-Benz Customer Assistance Center has been initiated via the overhead control panel:

- The problem with the vehicle is analyzed using remote diagnosis.  
Further information about this can be obtained at: <http://www.mbusa.com>
- A qualified Mercedes-Benz technician carries out repairs on site and/or the vehicle will be towed to the nearest authorized Mercedes-Benz Center.

You may be charged for these services.

Data is transmitted during the connection to the Mercedes-Benz Customer Assistance Center (→ page 330).

### Transferred data during a service call

In certain countries you must confirm the data transfer.

If you make service calls using Mercedes-Benz mbrace® (USA), transferred data includes the following:

#### Overview of transferred data

Service call	Transferred data
MB Info call Roadside Assistance call	<ul style="list-style-type: none"> <li>• Current vehicle location</li> <li>• Vehicle identification number</li> <li>• Service code</li> <li>• Selected data about the status of the vehicle</li> </ul>

## Online and Internet functions

### Internet connection

#### Information on connecting to the Internet

**⚠ WARNING** Risk of distraction from information systems and communications equipment

If you operate information and communication equipment integrated in the vehicle when driving, you will be distracted from the traffic situation. This could also cause you to lose control of the vehicle.

- ▶ Only operate this equipment when the traffic situation permits.
- ▶ If you cannot be sure of this, stop the vehicle whilst paying attention to road and traffic conditions and operate the equipment with the vehicle stationary.

You must observe the legal requirements for the country in which you are currently driving when operating the multimedia system.

**USA:** to use Mercedes-Benz Apps and access the Internet, Mercedes-Benz mbrace® must be activated and operational. Furthermore, mbrace® must be activated for Mercedes-Benz Apps and Internet access.

**Canada:** the multimedia system must be connected to a mobile phone via Bluetooth® or to an external device acting as a Wi-Fi hotspot. Furthermore, you need a valid mobile service contract with a data option, which is used to calculate the associated connection costs.

The Internet functions can only be used to a limited degree whilst driving.

## Setting up an Internet connection via Wi-Fi

### Requirements:



- the Wi-Fi function is activated on the multimedia system (→ page 280).
- the Wi-Fi function is activated on the external device (see the manufacturer's operating instructions).
- Internet access via Wi-Fi is activated (see the manufacturer's operating instructions).

The Internet connection via Wi-Fi is restricted or does not function if:

- the mobile phone is switched off
- mobile data use is deactivated on the mobile phone
- the Wi-Fi function is deactivated on the multimedia system
- the Wi-Fi function is deactivated on the external device
- Internet access via Wi-Fi is deactivated on the external device

Multimedia system:

 System >>  Connectivity >> Internet Settings >> Search for Wi-Fi Networks

-  Select the network.
-  Logging in to Wi-Fi network (→ page 280).

## Setting up an Internet connection via Bluetooth®

### Requirements:

- A mobile phone is connected to the multimedia system via Bluetooth® (→ page 316).

To connect via Bluetooth®, the mobile phone supports one of the following Bluetooth® profiles:

- DUN (Dial-Up Networking)
- PAN (Personal Area Network)

The Internet connection via Bluetooth® is restricted or does not function if:

- the mobile phone is switched off
- the mobile phone network coverage is insufficient
- mobile data use is deactivated on the mobile phone
- the Bluetooth® function on the multimedia system is switched off and the mobile phone is to be connected via Bluetooth®
- the Bluetooth® function is switched off on the mobile phone and the mobile phone is to be connected via Bluetooth®
- neither the mobile phone network nor the mobile phone allow simultaneous use of a phone and an Internet connection

- the mobile phone has not been enabled for Internet access via Bluetooth®

If a mobile phone is connected to the multimedia system for the first time via Bluetooth®, you will be assisted through the process of setting up an Internet connection.

The Internet connection can also be configured manually.

Further information can be obtained at <http://www.mercedes-benz.com/connect> or from an authorized Mercedes-Benz Center.

Multimedia system:

➤ System ➤  Connectivity ➤ Internet Settings

### Bluetooth® connection via PAN

- Select the mobile phone.  
The Internet connection is established.

### Bluetooth® connection via DUN

- Select the mobile phone.

- **To select the predefined access data of the mobile phone network provider:** select [Predefined Settings](#).

A list of countries appears.

- Select the country of your mobile phone network provider.

The list of available providers appears.

- Select your mobile phone network provider. When an overview of the provider settings appears, make the necessary settings.

- Select [Confirm Settings](#).

- **To manually set the access data of the mobile phone network provider:** select [Manual Settings](#).

An overview of the provider settings appears.

- Set the access data.

- Select [Confirm Settings](#).

-  Set the access data in accordance with your data package. Otherwise, additional costs may be incurred. You can contact your mobile phone network provider to obtain the precise access data.

### Switching the Bluetooth® profile

#### Requirements:

- The mobile phone supports the DUN and PAN Bluetooth® profiles.

Multimedia system:

➤ System ➤  Connectivity ➤ Internet Settings

- **To switch from DUN to PAN:** select the mobile phone.

- Select .

- Select [Change Configuration](#).

- Activate  [Automatic Configuration](#).  
The Internet connection is automatically configured using the PAN Bluetooth® profile.

- **To switch from PAN to DUN:** select the mobile phone.

- Select .

- Select [Change Configuration](#).

- Deactivate  [Automatic Configuration](#).

- Select [Configure Settings Using COMAND](#).

- ▶ Configuring the Internet connection using preset or manual access data (→ page 331).

### Editing access data

#### Requirements:

- The mobile phone supports the Bluetooth® DUN profile.

Multimedia system:

➤ System ➤  Connectivity ➤ Internet Settings

- ▶ Highlight the mobile phone.
- ▶ Select .
- ▶ Select **Change Configuration**.

- ▶ **For mobile phones with PAN and DUN:** select **Configure Settings Using COMAND**.
- ▶ Configure the Internet connection using preset or manual access data (→ page 331).

### Canceling Internet access permission for a mobile phone

Multimedia system:

➤ System ➤  Connectivity ➤ Internet Settings

- ▶ Highlight the mobile phone.
- ▶ Select .
- ▶ Select **Delete Configuration**.
- ▶ Select **Yes**.

### Displaying mobile phone details

Multimedia system:

➤ System ➤  Connectivity ➤ Internet Settings

- ▶ Highlight the mobile phone.
- ▶ Select .
- ▶ Select **Details**.

### Establishing an Internet connection

Multimedia system:

➤ **Connect**

- ▶ For example, select  **Browser**.

- ① The multimedia system usually establishes the Internet connection automatically. If the multimedia system is not connected to the Internet, the Internet connection is established when an Internet application is used.

## Connection status

### Connection status overview



- ① Display of existing connection and reception field strength of the connected device

## Displaying the connection status

Multimedia system:

➔ System ➔  Connectivity

▶ Select **Internet Status**.

- ⓘ Depending on the means of connection, the approximate data volume transmitted is displayed.

## Mercedes-Benz Apps

### Calling up Mercedes-Benz Apps

#### Requirements:

- The registration for the use of Mercedes-Benz Apps has been completed.
- The general terms and conditions have been confirmed.

Multimedia system:

➔ Connect ➔  MB Apps

▶ Select an App.

Further Mercedes-Benz Apps and information can be obtained at: <http://apps.mercedes-benz.com/apps/>

- ⓘ The available features are country-dependent. License fees may be applicable.

### Using Mercedes-Benz Apps voice control

#### Requirements:

- The registration for the use of Mercedes-Benz Apps has been completed.
- The general terms and conditions have been confirmed.

The  symbol indicates that a Mercedes-Benz App can be used via voice control.

- ▶ Select a Mercedes-Benz App (→ page 334). The App menu is displayed.
- ▶ **To use voice control:** select  **Language**.
- ▶ Say the question or command.
- ⓘ Voice control is not available in all countries and languages.

## Web browser

### Calling up a web page

Multimedia system:

➔ Con-  
nect ➔  Browser ➔  Enter URL

- ▶ Enter a web address.
- ▶ **To finish the entry and call up the website:** select  .

### Showing/hiding the web browser menu

If you call up a website by selecting a link, for example, the web browser menu is hidden.

- ▶ **To show/hide:** press the  button.
- ⓘ The web browser supports video playback.
- ⓘ No websites or videos are displayed while the vehicle is in motion.



## Web browser overview



- ① URL entry
- ② Bookmarks
- ③ Web page, back
- ④ Web page, forwards
- ⑤ Options
- ⑥ To close the browser

## Calling up web browser options

Multimedia system:

↳ Connect ► Browser ► Options

The following functions are available:

- Refresh Page/Cancel
- Zoom
- Browser Settings
- Delete Browser Data

- ▶ Select an option.
- ▶ Make the desired changes to the settings.

## Calling up the web browser settings

Multimedia system:

↳ Connect ► Browser ► Options ► Browser Settings

The following functions are available:

- Block Pop-Ups
- Activate Javascript
- Allow Cookies

- ▶ Switch the function on  or off .

## Deleting browser data

Multimedia system:

↳ Connect ► Browser ► Options ► Delete Browser Data

The following options are available:

- All
- Cache
- Cookies
- Entered URLs
- Form Data

- ▶ Select an option.
- ▶ Select Yes.

## Managing bookmarks

Multimedia system:

↳ Connect ► Browser ► Bookmarks

## Selecting a bookmark

- ▶ Select an entry.

### Creating a bookmark

- ▶ Select **Add New Bookmark**.
- ▶ Enter a URL and a name.
- ▶ Select **OK**.

### Editing a bookmark

- ▶ Highlight a bookmark.
- ▶ Select **Edit**.
- ▶ Enter a URL and a name.
- ▶ Select **OK**.

### Deleting a bookmark

- ▶ Highlight a bookmark.
- ▶ Select **Delete**.
- ▶ Select **Yes**.

### Closing the browser

Multimedia system:

- ▶ **Connect** ▶ **Browser**
- ▶ Select **Close Browser**.

### Internet radio

#### Calling up the Internet radio

##### Requirements:

- The Internet radio service is activated.
- The data volume is available.  
Depending on the country, data volume may need to be purchased.
- A fast Internet connection for data transmission free of interference.  
The services are country-dependent.  
For more information, consult an authorized Mercedes-Benz Center.

Multimedia system:

▶ **Radio** ▶ **Radio Source**

- ▶ Select **TuneIn radio**.  
The Internet radio display appears. The last station set starts playing.
- ⓘ The connection quality depends on the local mobile phone reception.

### Internet radio overview

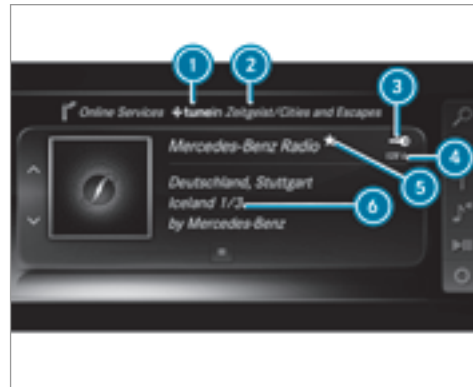

- ① Internet radio provider
- ② Selected category
- ③ Display (if connected to private user account)
- ④ Data transfer rate
- ⑤ Current station is stored as a favorite
- ⑥ Additional information on the current station

## Selecting and connecting to Internet radio stations

Multimedia system:

➤ Radio ➤  Radio Source ➤ Tuneln radio ➤  Search

- ▶ Select a category.
  - ▶ Select a station.
- The connection is established automatically.
- or

- ▶ Select [Free Search](#).
  - ▶ Enter a station name using the entry field.
-  A relatively large volume of data can be transmitted when using Internet radio.

## Saving/deleting Internet radio stations as favorites

Multimedia system:

➤ Radio ➤  Radio Source ➤ Tuneln Radio

- ▶ Select a station.



▶ Press and hold the touchpad or controller until an audible signal sounds. The  symbol appears by the station name.

▶ Select  [Favorites](#).  
The list of saved favorite stations appears.

or

▶ Create an account for the online provider (Tuneln radio) and then log in on the multimedia system.  
Your favorites are imported to the multimedia system.

## Deleting favorites

- ▶ Select  [Favorites](#).
- ▶ Select a station.
- ▶ Press and hold the touchpad or controller until an audible signal sounds. The  symbol by the station name disappears.

## Setting the Internet radio options

Multimedia system:

➤ Radio ➤  Radio Source ➤ Tuneln radio ➤  Options

The following options are available:

- [Select Stream](#): select the stream quality.
  - [Login to Tuneln Account](#): log in to your Tuneln user account.
  - [Log Out of Account](#): log out of your Tuneln user account.
- ▶ Select an option.

## Media

### Audio mode

#### Information on the audio mode

 **WARNING** Risk of distraction when handling data storage media

If you handle a data storage medium while driving, your attention is diverted from the

traffic conditions. This could also cause you to lose control of the vehicle.

- ▶ Only handle a data storage medium when the vehicle is stationary.

Permissible file systems:

- FAT32
- exFAT
- NTFS

Permissible data storage medium:

- SD card
- USB storage device
- iPod®/iPhone®
- MTP devices
- Bluetooth® audio equipment

- ① • The multimedia system supports a total of up to 50,000 files.
- Data storage media up to 2 TB are supported (32-bit address space).

Supported formats:

- MP3
- WMA
- AAC
- WAV
- FLAC
- ALAC

① Observe the following notes:

- Due to the large variety of available music files regarding encoders, sampling rates and bit rates, playback cannot always be guaranteed.
- Due to the wide range of USB devices available on the market, playback cannot be guaranteed for all USB devices.
- Copy-protected music files or DRM encrypted files cannot be played back.
- MP3 players must support Media Transfer Protocol (MTP).



Manufactured under license from Dolby Laboratories. Dolby, Dolby Audio and the double-D symbol are trademarks of Dolby Laboratories.



Gracenote, the Gracenote logo and logotype, "Powered by Gracenote", MusicID and Playlist Plus are either registered trademarks or trademarks of Gracenote, Inc. in the United States and/or other countries.

### Notes on copyright

Audio files that you create or reproduce yourself for playback are generally subject to copyright protection. In many countries, reproductions, even for private use, are not permitted without the prior consent of the copyright holder. Make sure that you know about the applicable copyright regulations and that you comply with these.

### Activating media mode

Multimedia system:

→ Media →  Media Sources

- ▶ Select a media source.  
Playable music files are played back.

### Inserting/removing an SD card

**⚠ DANGER** Risk of fatal injury from swallowing SD cards

SD cards are small parts.

They could be swallowed and lead to choking.

- ▶ Keep SD cards out of the reach of children.
- ▶ Seek medical attention immediately if an SD card has been swallowed.

**!** **NOTE** Damage caused by high temperatures

High temperatures can damage the SD memory card.

- ▶ Remove the SD memory card after use and take it out of the vehicle.

Multimedia system:

→ Media →  Media Sources → Mem. Card

### Inserting

The multimedia connection unit is located in the stowage compartment under the armrest.

- ▶ Insert the SD memory card into the SD card slot until it engages. The side with the contacts must face downwards.  
Playable music files are played back.

### Removing

- ▶ Press the SD card.
- ▶ Remove the SD card.

## Overview of the audio mode

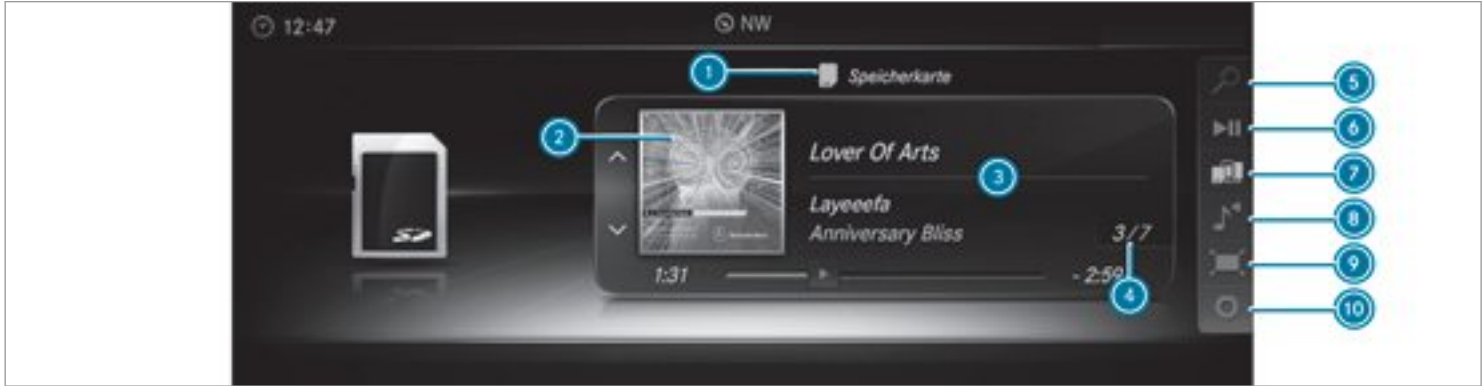

① Active data storage medium

② Album cover

③ Track, artist, album

④ Track number and number of tracks in the track list

⑤ Search

⑥ Playback Control

⑦ Media Sources

⑧ Sound

⑨ Full Screen (for video playback)

⑩ Options

## Connecting USB devices

**!** **NOTE** Damage caused by high temperatures

High temperatures can damage USB devices.

- ▶ Remove the USB device after use and take it out of the vehicle.

The multimedia connection unit is found in the stowage compartment under the armrest and has two USB ports. Depending on the vehicle's equipment, additional USB ports can be found in the stowage compartment of the front center console or rear folding compartment.

- ▶ Connect the USB device to the USB port. Playable music files are played back only if the corresponding media display is activated.
- ① Use the USB port identified by  to use Apple CarPlay™ and Android Auto.

## Selecting a track

Multimedia system:

 **Media**

## Selecting a track by skipping to a track

- ▶ **To skip backwards or forwards to a track:** navigate up or down.

## Selecting a track using the current track list

- ▶ Select .
- ▶ Select **Current Track List**.
- ▶ Select a track.

## Selecting playback options

Multimedia system:

 **Media**  **Options**

## Playing back similar tracks

- ▶ Select **Play Similar Tracks**.  
A track list with similar tracks is created and played back.

## Playback mode



- ▶ Select **Random Mode - Current Playlist**.  
The current track list is played in random order.
- ▶ Select **Random Mode - Current Medium**.  
All tracks on the active data storage medium are played in random order.
- ▶ Select **Normal Track Sequence**.  
The current track list is played in the order it appears on the data storage medium.

## Controlling media playback

Multimedia system:

 **Media**  **Playback Control**

A bar with playback controls is shown.

- ▶ **To pause playback:** press the controller. The  symbol is displayed.
- ▶ **To continue playback:** press the controller again. The  symbol is displayed.

## Fast forward/rewinding

- ▶ Move  on the timeline: turn the controller.

### Hiding the playback controls

- ▶ Press the  button.

### Video mode

---

#### Switching to video mode

Multimedia system:

 Media  Media Sources

- ▶ Select a data storage medium.  
Playable video files are played back.

The multimedia system supports the following formats:

- MPEG
  - AVI, DivX, MKV
  - MP4, M4V
  - WMV
-  Due to the large variety of available video files regarding encoders, sampling rates and data transfer rates, playback cannot always be guaranteed.  
Videos up to FullHD (1920x1080) are supported.

Copy-protected video files or DRM (Digital Rights Management) encrypted files cannot be played back.



## Overview of video mode

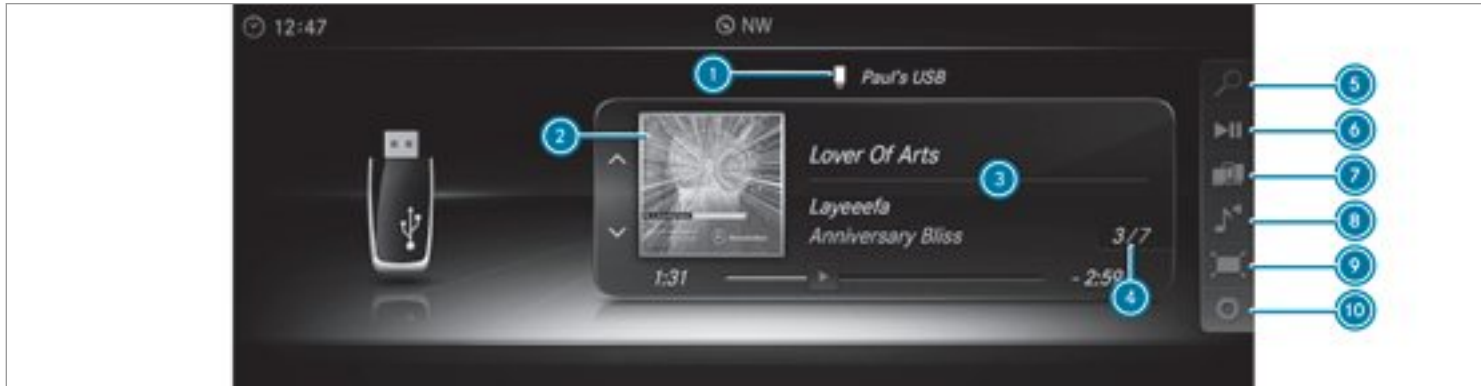

- ① Active data storage medium
- ② Preview window
- ③ Track, artist and album or film and scene
- ④ Track number and number of tracks in the track list

- ⑤ Search
- ⑥ Playback Control
- ⑦ Media Sources
- ⑧ Sound

- ⑨ Full Screen
- ⑩ Options

### Activating/deactivating full-screen mode

Multimedia system:

↳ Media ▶▶  Media Sources

- ▶ Select a data storage medium.  
Playable video files are played back.

- ▶ **To activate full-screen mode:** select  Full Screen.

- ▶ **To deactivate full-screen mode:** press the touchpad.

### Changing video settings

Multimedia system:

↳ Media ▶▶  Options ▶▶ Picture Format

The following picture formats are available:

- Automatic
  - 16:9
  - 4:3
  - Zoom
- ▶ Select a picture format.

### Adjusting the brightness manually

- ▶ Select **Brightness**.
- ▶ Adjust the brightness.

### Media search

#### Starting the media search

Multimedia system:

↳ Media ▶▶  Search

Depending on the connected media sources and files, the following categories are listed:

- Current Track List
- Keyword Search
- Playlists
- Artists
- Albums
- Tracks
- Folder
- Music Genres
- Year
- Composers

- Videos
- Podcasts (Apple® devices)
- Audiobooks (Apple® devices)

- ▶ Select a category.

- ⓘ The categories are available as soon as the entire media content has been read in and analyzed.

### Media Interface

#### Information about the Media Interface

Media Interface is a universal interface for the connection of mobile audio equipment. The multimedia system has two USB ports. The USB ports are located in the stowage compartment under the armrest.

#### Supported devices

The Media Interface allows you to connect the following data storage media:

- iPod®
- iPhone®
- MP3 player

- USB devices

For details and a list of supported devices, visit our website at <http://www.mercedes-benz.com/connect>. Follow the instructions in the "Media Interface" section.

### Switching to Media Interface

Multimedia system:

↳ Media ▶▶  Media Sources

- ▶ Connect a data storage medium to the USB port (→ page 341).

- ▶ Select a media device.  
▶ Playable music files are played back.

## Overview of Media Interface

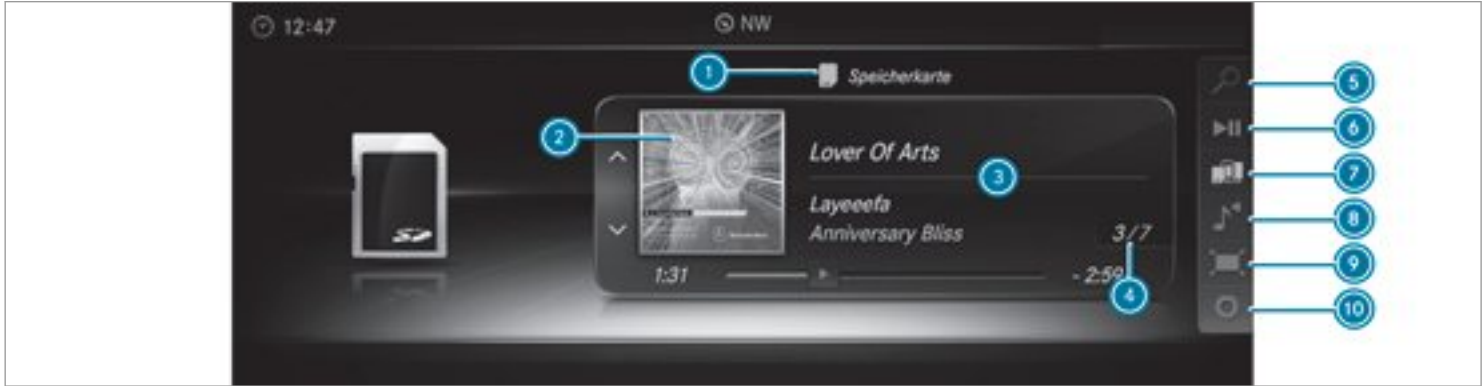

① Active data storage medium

② Cover

③ Artist, track and album

④ Track number and number of tracks in the track list

⑤ Search

⑥ Playback Control

⑦ Media Sources

⑧ Sound

⑨ Full Screen (video playback only)

⑩ Options

### Bluetooth® audio

### Information about Bluetooth® audio

Before using your Bluetooth® audio equipment with the multimedia system for the first time, you will need to authorize it (→ page 348).

### Bluetooth® Audio overview



- ① Active data storage medium
- ② Cover art

- ③ Track, artist, album

- ④ Track number and number of tracks in the track list

- 5 Search
- 6 Playback Control

### Searching for and authorizing a Blue tooth® audio device

#### Requirements:

- Blue tooth® is activated on the multimedia system and on the audio equipment (→ page 279).
- The audio equipment supports the Blue tooth® audio profiles A2DP and AVRCP.
- The audio equipment is "visible" for other devices.

Multimedia system:

↳ Media ▶  Media Sources ▶  Bluetooth Audio

### Authorizing new Blue tooth® audio equipment

- ▶ Select .
- ▶ Select **Add New Bluetooth Audio Device.**

- 7 Media Sources
- 8 Sound

- ▶ Select **Start Search on System.**  
Detected audio equipment is displayed in the device list.
- ▶ Select a Blue tooth® audio device.  
Authorization starts. A code is displayed on the multimedia system and on the mobile phone.
- ▶ If the codes are identical, confirm on the audio equipment.  
The audio equipment is connected and playback starts.

### Selecting Blue tooth® audio equipment that has already been authorized

- ▶ Select .
- ▶ Select a Blue tooth® audio device.

### Establishing a connection from the Blue tooth® audio equipment

The Blue tooth® device name of the multimedia system is **MB BLUETOOTH XXXXX.**

- 9 Full Screen (video playback only)
- 10 Options

- ▶ Select **Search from Device.**
- ▶ Start the authorization on the audio device (see manufacturer's operating instructions).  
A code is displayed on the multimedia system and on the mobile phone.
- ▶ Confirm on both devices if the codes are identical.  
The audio equipment is connected and playback starts.

With some audio equipment, playback must be initially started on the device itself so that the multimedia system can play the audio files.

- ⓘ Device-specific information on authorizing and connecting Bluetooth®-capable mobile phones can be obtained at <http://www.mercedes-benz.com/connect> or from an authorized Mercedes-Benz Center.

## Activating Bluetooth® audio

Multimedia system:

➤ Media ➤  Media Sources

- ▶ Select  Bluetooth Audio.  
The multimedia system activates the connected Bluetooth® audio equipment.

## Selecting a music player

Multimedia system:

➤ Media ➤  Media Sources ➤  Bluetooth Audio

- ▶ Select a Bluetooth® audio device.  
If multiple music players are present on the Bluetooth® audio equipment a list appears.
- ▶ Select a music player.  
Playback starts.

## Searching for a track

Multimedia system:

➤ Media ➤  Media Sources ➤  Bluetooth Audio

- ▶ Select .

- ▶ Select a category.  
A track list appears.

- ▶ Select a track.

- ⓘ The function is only available when the mobile phone and the music player selected on the mobile phone support this function.

## Switching Bluetooth® audio equipment via NFC

### Requirements:

- Observe the notes on using NFC (→ page 317).
- The Bluetooth® audio overview is displayed (→ page 349).

- ▶ Lightly press the NFC area on the mobile phone (see the manufacturer's operating instructions).  
If the mobile phone has already been authorized on the multimedia system as Bluetooth® audio equipment, it is now connected.  
If the mobile phone is authorized on the multimedia system as Bluetooth® audio equipment for the first time, it is connected after

confirming the instructions for the mobile phone (see the manufacturer's operating instructions).

## Disconnecting Bluetooth® audio equipment

Multimedia system:

➤ Phone ➤  Media Sources

- ▶ Select a Bluetooth® audio device.
- ▶ Select  Deauthorize.
- ▶ Select Yes.

## Starting cinema mode

Multimedia system:

➤ Media ➤  Media Sources ➤ Loudspeaker Audio Source

In cinema mode, a media source connected to the Rear Seat Entertainment System is simultaneously played in the multimedia system.

- ▶ Select the Rear Seat Entertainment System device.  
The media source is also played on the multimedia system.

## Radio

### Switching on the radio

---

Multimedia system:

↳ Radio

▶ Alternatively: press the RADIO button.  
The radio display appears. You will hear the last station played on the last frequency band selected.



## Radio overview



- ① Active frequency band
- ② Station name or set frequency
- ③ Artist, title, album and radio text

- ④ Station list
- ⑤ Presets
- ⑥ Radio Source

- ⑦ Sound
- ⑧ Tag This Song
- ⑨ Options

## Switching HD Radio on/off

Multimedia system:

↳ Radio ▶  Options ▶ HD Radio



- ▶ Activate  or deactivate  the function.
- ① HD Radio Technology manufactured under license from iBiquity Digital Corporation. U.S. and Foreign Patents. HD Radio™ and the HD, HD Radio and "Arc" logos are proprietary trademarks of iBiquity Digital Corp.

## Setting the waveband

Multimedia system:

↳ Radio ▶  Radio Source

HD Radio FM HD Radio AM and SiriusXM Radio can be selected.

- ▶ Select a frequency band.

## Selecting a radio station

Multimedia system:

↳ Radio

- ▶ Navigate up or down.

## Calling up the radio station list

Multimedia system:

↳ Radio ▶ 

- ▶ Select a station.

## Searching for radio stations using station names or direct frequency entry

Multimedia system:

↳ Radio ▶  ▶ 

- ▶ Enter a station name or frequency.
- ▶ Select . The search results are displayed.
- ▶ Select a station.

## Storing radio stations

Multimedia system:

↳ Radio ▶  Presets

- ▶ Select Store Current Station in the Presets.

## Editing radio station presets

Multimedia system:

↳ Radio ▶  Presets

## Moving stations:

- ▶ Highlight a preset entry and navigate to the left.

- ▶ Select **Move Highlighted Station**.
- ▶ Select a preset.

#### Deleting stations:

- ▶ Highlight a preset entry and navigate to the left.
- ▶ Select **Delete Highlighted Station**.
- ▶ Select **Yes**.

#### Tagging music tracks

Multimedia system:



If radio stations provide the relevant information, this function allows you to transfer information on the music track currently playing to an Apple® device. You can then purchase the audio file from the iTunes Store®.

- ▶ Select **🎵→ Tag This Song**.  
The track information is saved.

#### Activating/deactivating radio text

Multimedia system:

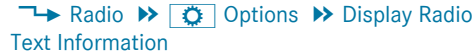

- ▶ Activate  or deactivate  the function.

#### Satellite radio

##### Information on the satellite radio

SIRIUS XM® Satellite Radio offers more than 175 digital-quality radio channels providing 100% commercial-free music, sports, news and entertainment, for example. SIRIUS XM satellite radio employs a fleet of high-performance satellites to broadcast around the clock throughout the USA and Canada. The satellite radio program is available for a monthly fee. Information about this can be obtained from a Sirius XM® Service Center and at <http://www.siriusxm.com> (USA) or <http://www.siriusxm.ca> (Canada). Your new Mercedes-Benz vehicle comes with SIRIUS XM® Satellite Radio pre-installed at the factory. This service is free for a six-month trial period. About a month before the trial period ends, information

will be provided on how to extend this subscription. A message is shown, describing how the subscription can be extended.

- ⓘ Sirius, XM and all related marks and logos are trademarks of Sirius XM Radio Inc. and its subsidiaries. All other marks, channel names and logos are the property of their respective owners. All rights reserved.

##### Satellite radio restrictions

Satellite radio mode may be temporarily unavailable or interrupted for a variety of reasons. These include environmental or topographical conditions beyond the control of Mercedes-Benz USA, LLC. Thus, operation at certain locations may not be possible.

##### Registering satellite radio

##### Requirements:

- satellite radio equipment
- registration with a satellite radio provider
- if registration is not included when purchasing the system, your credit card details will be required to activate your account

Multimedia system:

↳ Radio ▶▶  Radio Source ▶▶ SiriusXM Radio ▶▶  Options

- ▶ Select **Service Information**.  
The service information screen appears showing the radio ID and the current subscription status.

- ▶ Establish a telephone connection.
- ▶ Follow the service staff's instructions.  
The activation process may take up to ten minutes.
- ⓘ You can also have the satellite service activated online. To do so, please visit <http://www.siriusxm.com> (USA) or <http://www.siriusxm.ca> (Canada).

[www.siriusxm.com](http://www.siriusxm.com) (USA) or <http://www.siriusxm.ca> (Canada).

### Switching on satellite radio

Multimedia system:

- ↳ Radio ▶▶  Radio Source
- ▶ Select **SiriusXM Radio**.

## Overview of the satellite radio



- ① Active frequency band
- ② Logo or album art (if available)
- ③ Category
- ④ Channel name

- ⑤ Channel information
- ⑥ SiriusXM Radio Channels
- ⑦ Presets
- ⑧ Radio Source

- ⑨ Sound
- ⑩ Playback Control
- ⑪ Options

**Selecting a satellite radio category**

Multimedia system:

↳ Radio ▶▶  Radio Source ▶▶ SiriusXM Radio ▶▶  SiriusXM Radio Channels ▶▶ Category

- ▶ Select a category.

**Selecting a satellite radio channel**

Multimedia system:

↳ Radio ▶▶  Radio Source ▶▶ SiriusXM Radio

- ▶ Navigate up or down.

**Saving or deleting a satellite radio channel**

Multimedia system:

↳ Radio ▶▶  Radio Source ▶▶ SiriusXM Radio ▶▶  Presets

- ▶ Select Store Current Station in the Presets.

**Moving a channel**

- ▶ Select Options.
- ▶ Select Move Highlighted Station.
- ▶ Select a preset.

**Deleting a channel**

- ▶ Select Delete Highlighted Station.
- ▶ Select a preset.

**Displaying EPG information for the current channel**



Multimedia system:

↳ Radio ▶▶  Radio Source ▶▶ SiriusXM Radio ▶▶  Options

- ▶ Select EPG Information about Current Channel.

**Setting the parental control**

Multimedia system:

↳ Radio ▶▶  Radio Source ▶▶ SiriusXM Radio ▶▶  Options ▶▶ Parental Control

- ▶ Activate the function .
- ▶ Determine a four-digit character sequence and select **ok**.
- ▶ All channels with adult content are locked.

**Unlocking a channel**

- ▶ Enter the four-digit character sequence and select **ok**.
- ▶ All channels with adult content are unlocked.

**Music and sport alerts function**

This function enables you to program an alert for your favorite artists, tracks or sporting events. Music alerts can be saved whilst a track is being played and sport alerts can be saved during a live game. You can also specify sport alerts via the menu option. The system then continuously searches through all the channels. If a match is found with a stored alert, you will be informed.

**Setting music and sport alerts**

Multimedia system:

↳ Radio ▶▶  Radio Source ▶▶ SiriusXM Radio ▶▶  Options ▶▶ Alert for Artist, Song & Sporting Event

**Setting a music alert**

- ▶ Select Add New Alert.
- or
- ▶ Select Manage Artist & Song Alerts.

- ▶ Select  **Options**.

The following options are available:

- [Mark or unmark this entry](#)
- [Mark All Entries](#)
- [Unmark All Entries](#)
- [Delete This Entry](#)
- [Delete All Entries](#)

- ▶ Select an option.

- ▶ [Activate Artist & Song Alerts](#) .

The alert is set for the current artist or track. If a match is found, a prompt appears asking whether you wish to change to the station.

### Setting a sport alert

- ▶ Select [Add New Alert](#).

or

- ▶ Select [Manage Sports Alerts](#).
- ▶ Select [Select New Alerts](#).

or

- ▶ Select [Edit Alerts](#).
- ▶ Select a team from a league.
- ▶ [Activate Sports Alerts](#) .

### Information on smart favorites and Tune Start

Stations in the station presets can be added as smart favorites. Smart favorites stations are automatically saved to temporary storage in the background. If you change to a smart favorite station, you can replay, pause or actively skip forward or back to broadcasts which you have missed. If Tune Start is activated and you change to another smart favorite station, the music track currently playing on the station is automatically restarted from the beginning of the track.

### Activating/deactivating Tune Start

Multimedia system:

 [Radio](#) ▶▶  [Options](#) ▶▶ [TuneStart](#)



- ▶ Activate  or deactivate  the function.

### Playback controls

Multimedia system:

 [Radio](#) ▶▶ ▶| [Playback Control](#)

You can pause the playback of the current station or skip forward or backward in the timeline. This leaves live mode to access the internal temporary storage.

- ▶ To fast forward/rewind: select  or .
- ▶ To pause playback: select .
- ▶ To return to live mode: navigate to the end of the timeline.

### Displaying satellite radio service information

Multimedia system:

 [Radio](#) ▶▶  [Radio Source](#) ▶▶ [SiriusXM Radio](#) ▶▶  [Options](#)

- ▶ Select [Service Information](#).

## Sound

### Tone settings

### Information about the sound system

The sound system has a total output of 100 watts and is equipped with 10 speakers. It is available for all functions in the radio and media modes.

### Calling up the sound menu

Multimedia system:

↳ Media ▶▶  Sound

The following functions are available:

- Equalizer
- Balance and Fader
- Automatic Volume Adjustment
- Other Sound Settings

▶ Select a sound menu.

### Adjusting treble, mid-range and bass settings

Multimedia system:

↳ Media ▶▶  Sound ▶▶ Equalizer

▶ Select **Treble**, **Mid Range** or **Bass**.

▶ Change the settings.

### Activating/deactivating automatic volume adjustment

Multimedia system:

↳ Media ▶▶  Sound ▶▶ Automatic Volume Adjustment

Automatic volume adjustment compensates for differing volumes when changing between audio sources.

▶ Activate  or deactivate  the function.

### Adjusting the balance/fader

Multimedia system:

↳ Media ▶▶  Sound ▶▶ Balance and Fader

▶ Adjust the balance and fader.

▶ **To exit the menu:** press the  button.

### Burmester® surround sound system

#### Information about the Burmester® surround sound system

The Burmester® surround sound system has a total output of 590 watts and is equipped with

13 speakers. It is available for all functions in the radio and media modes.

### Calling up the sound menu in the Burmester® surround sound system

Multimedia system:

↳ Media ▶▶  Sound

The following functions are available:

- Equalizer
- Balance and Fader
- Automatic Volume Adjustment
- Surround Sound
- Sound Focus
- Other Sound Settings

▶ Select a function.

### Adjusting the treble, mid and bass settings on the Burmester® surround sound system

Multimedia system:

↳ Media ▶▶  Sound ▶▶ Equalizer

▶ Select **Treble**, **Mid Range** or **Bass**.

▶ Set the desired values.



### Activating/deactivating volume adjustment in the Burmester® surround sound system

Multimedia system:

➤ Media ➤  Sound ➤ Automatic Volume Adjustment

Automatic volume adjustment compensates for differing volumes when changing between audio sources.

▶ Activate  or deactivate  the function.

### Adjusting the balance/fader in the Burmester® surround sound system

Multimedia system:

➤ Media ➤  Sound ➤ Balance and Fader

▶ Adjust the balance and fader.

▶ **To exit the menu:** press the  button.

### Switching surround sound on/off in the Burmester® surround sound system

Multimedia system:

➤ Media ➤  Sound ➤ Surround Sound

▶ Activate  or deactivate  the function.

### Adjusting the sound focus in the Burmester® surround sound system

Multimedia system:

➤ Media ➤  Sound ➤ Sound Focus

▶ Adjust the sound focus.

### Burmester® high-end 3D surround sound system

#### Information on the Burmester® high-end 3D surround sound system

The Burmester® high-end 3D surround sound system has a total output of 1590 watts and is equipped with 27 speakers. It is available for all functions in the radio and media modes.

### Calling up the sound menu in the Burmester® high-end 3D surround sound system

Multimedia system:

➤ Media ➤  Sound

The following functions are available:

- Equalizer
- Balance and Fader
- Automatic Volume Adjustment
- VIP Seat (seat-based sound optimization)
- Sound Profiles
- Other Sound Settings

▶ Select a sound menu.

### Adjusting the treble, mid-range and bass settings on the Burmester® high-end 3D surround sound system

Multimedia system:

➤ Media ➤  Sound ➤ Equalizer

▶ Select **Treble**, **Mid Range** or **Bass**.

▶ Set the desired values.

### Activating/deactivating volume adjustment in the Burmester® high-end 3D surround sound system

Multimedia system:

→ Media →  Sound → Automatic Volume Adjustment

Automatic volume adjustment compensates for differing volumes when changing between audio sources.

▶ Activate  or deactivate  the function.

### Adjusting the balance/fader in the Burmester® high-end 3D surround sound system

Multimedia system:

→ Media →  Sound → Balance and Fader

▶ Adjust the balance and fader.

▶ **To exit the menu:** press the  button.

### Adjusting the seat-based sound optimization in the Burmester® high-end 3D surround sound system

Multimedia system:

→ Media →  Sound → VIP Seat

This setting optimizes the sound playback for the selected seat position.

▶ Activate the function .

▶ Select a seat position.

### Selecting the sound profile in the Burmester® high-end 3D surround sound system

Multimedia system:

→ Media →  Sound → Sound Profiles

The following profiles are available:

- Pure
- Easy Listening
- Live
- Surround
- 3D-Sound

▶ Select a sound profile.

## Rear Seat Entertainment System

### Operating safety

**⚠ WARNING** Risk of injury from laser radiation from the Blu-ray drive

The Blu-ray drive is a class 1 laser product. If you open the housing of the Blu-ray drive, there is a risk of exposure to invisible laser radiation.

Laser radiation can damage your retina.

- ▶ Do not open the housing.
- ▶ Always have maintenance work and repairs carried out by a qualified specialist workshop.

**⚠ WARNING** Risk of injury from unsecured items in the vehicle

If objects such as headphones/headsets or external audio/video sources are not secured in the vehicle interior, they can be flung around and hit vehicle occupants.

- ▶ Always stow these items or similar objects carefully so that they cannot be flung around, for example in a lockable vehicle stowage compartment.

### Replacing batteries (Rear Seat Entertainment System)

Batteries are required for the remote control and the cordless headphones.

**⚠ DANGER** Serious damage to health caused by swallowing batteries

Batteries contain toxic and corrosive substances. Swallowing batteries may cause serious damage to health.

There is a risk of fatal injury.

- ▶ Keep batteries out of the reach of children.
- ▶ If batteries are swallowed, seek medical attention immediately.



**ENVIRONMENTAL NOTE** Environmental damage caused by improper disposal of batteries



Batteries contain pollutants. It is illegal to dispose of them with the household rubbish.



▶ Dispose of batteries in an environmentally responsible manner. Take discharged batteries to a qualified specialist workshop or to a collection point for used batteries.

### Rear Seat Entertainment System overview

The Rear Seat Entertainment System includes:

- two rear seat displays
- two remote controls

- up to two cordless headphones
  - the Blu-ray drive
  - ports for USB (two) and HDMI
- i** The function of the remote control and the cordless headphones can be impaired by other radio-based electronic devices, e.g. mobile phones.

## Rear passenger compartment displays

### Rear passenger compartment displays overview

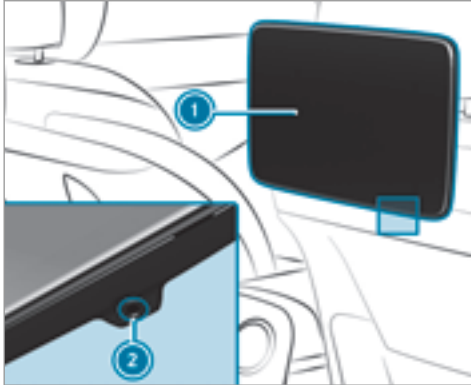

- ① Display
- ② Socket for corded headphones with a 3.5 mm stereo jack

The rear passenger compartment displays are located behind the head restraints of the front seats.

### Setting the display angle

- ▶ Selecting a rear display on the remote control (→ page 363).
- ▶ Press the **CAR** button.
- ▶ **To show the menu:** press the ◀ button.
- ▶ Select **Entertainment settings**.
- ▶ Select **Display angle**.
- ▶ Select **Up** or **Down**.

## Remote control

### Remote control overview

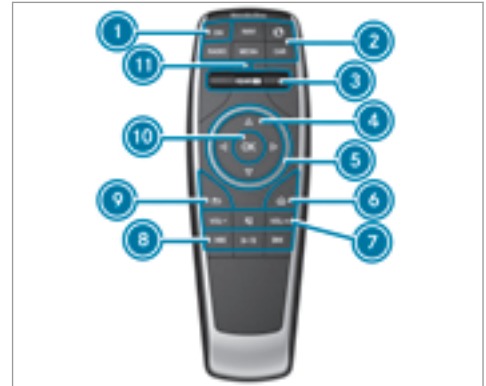

- ① To switch the display on and off
- ② Main functions button group:
  - NAVI** To switch navigation on
  - To call up online and Internet functions
  - RADIO** To switch on the radio

**MEDIA** To switch to media mode

**CAR** To set vehicle functions

③ To select a display (→ page 363)

④ To select a menu function with



⑤ To select menu functions using the selector wheel

⑥ To display main functions

⑦ To lower/raise the volume (corded headphones), to switch the sound off/on

⑧ Media playback button group:

To skip to the beginning of a scene

To skip to the end of a scene

Play

Pause

⑨ Back button

⑩ To confirm a menu function

⑪ Indicator lamp

## Displays of indicator lamp

LED color	Meaning
Green The LED flashes once.	Entry being transmitted. The batteries are fully charged. The batteries have been inserted correctly.
Red The LED flashes once.	Entry being transmitted. The batteries are almost discharged.
Orange The LED flashes three times.	Entry not correctly transmitted.
No display	The batteries are discharged.

## Switching the display on/off

Press the Start/Stop button once.

Press the **ON** button on the remote control.

or

Press **ON** on the touchkey on the rear passenger compartment display.  
The display is switched on/off.

The displays are switched off after 30 minutes at the latest in the following situations:

- The ignition is switched off.
- The SmartKey is not in place.

Please note that the battery continues to discharge by switching the system on again.

## Selecting a display



- ▶ Turn dial ①.  
COMAND: multimedia system
- L REAR: left rear passenger compartment display
- R REAR: right rear passenger compartment display

### Replacing batteries (remote control)

#### Requirements:

- The remote control requires two type AAA, 1.5 V batteries.

Observe the safety and environmental note (→ page 360).

The battery compartment is located on the reverse side.

- ▶ Push the catch tab downwards and take off the battery compartment cover.
- ▶ Remove discharged batteries from the battery compartment.
- ▶ Insert new batteries. Observe the polarity markings on the batteries and battery compartment.

- ▶ First place the battery compartment cover on the retaining lugs in the battery compartment.
- ▶ Allow the catch tab to engage in the battery compartment.

## Headphones

### Headphones overview



- ① Indicator lamp
- ② On/off switch
- ③ Volume control

Adjust the fit of the headphones:

- Pull both sides of the headphones outwards.

- Pull the headphone band in the direction of the arrow.

### Indicator lamp ①

LED color	Meaning
Green	The batteries are fully charged. The batteries have been inserted correctly.
Red	The batteries are almost discharged.
The LED lights up.	The cordless headphones are switched on and connected to a rear display.
The LED flashes.	The cordless headphones are searching for a connection to a rear display.
The LED is dark.	The cordless headphones are switched off. The batteries are discharged.

The headphones automatically switch off if they have not received an audio signal for approx-

imately three minutes. This preserves the batteries.

### Switching headphones on/off

- ▶ Press ② (→ page 364).

### Selecting a rear passenger compartment display



- ▶ Move switch ① to L (left rear passenger compartment display) or R (right rear passenger compartment display).

### Adjusting the volume

- ▶ Turn volume control ③ (→ page 364).

### Replacing batteries (headphones)

#### Requirements:

- The cordless headphones require two type AAA, 1.5 V batteries.

Observe the safety and environmental note (→ page 360).

- ① The operating duration of the headphones with a set of batteries is up to 40 hours.



The battery compartment is located on the left headphone.

- ▶ Switch the headphones off.
- ▶ Turn battery compartment cover ❶ counter-clockwise and remove.
- ▶ Remove discharged batteries from the battery compartment.

- ▶ Insert new batteries. Observe the polarity markings on the batteries and battery compartment.
- ▶ Replace battery compartment cover ❶ and turn it clockwise until it engages.
- ▶ Switch the headphones on. If the batteries have been inserted correctly, the indicator lamp will light up green.

### Blu-ray drive overview

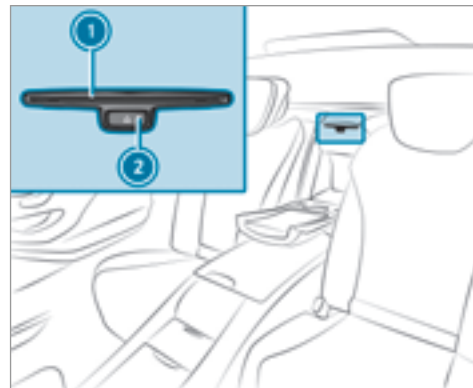

- ❶ Disc slot
- ❷ To insert/eject data storage medium

Depending on the vehicle equipment, the Blu-ray drive is located:

- At the rear of the center console under the automatic climate control panel.



- Between the rear shelf and through-load ski bag.

## Ports

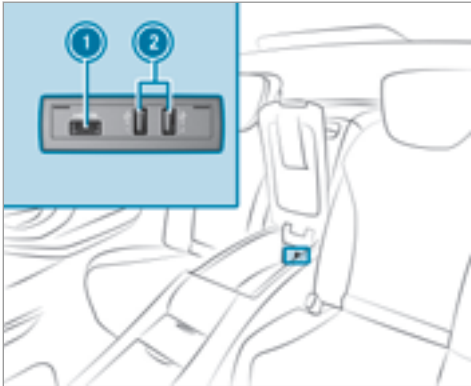

- ① HDMI port
- ② USB ports

Depending on the vehicle equipment, the ports are located:

- In the stowage box between the rear seats.
- In the rear armrest.

## Rear seats

### Adjusting the rear seats

Rear Seat Entertainment System:

↪ System ▶  Seat

- ▶ Select **Side Bolsters** or **Lumbar**.
- ▶ Select the setting.

### Memory function

- ▶ Save the seat adjustments with the memory function (→ page 114).

### Selecting the massage program for the rear seats

Rear Seat Entertainment System:

↪ System ▶  Seat

- ▶ Select **Massage**.

- ▶ Select a massage program.

The massage program runs for approximately 8 to 18 minutes, depending on the setting.

- ▶ To set the massage intensity: switch **High Intensity** on  or off .

### Overview of massage and workout programs

Overview of massage and workout programs (→ page 106).

### Resetting the rear seat

Rear Seat Entertainment System:

↪ System ▶  Seat ▶ Reset

- ▶ Select **Yes** or **No**.

## Setting the rear climate control

Rear Seat Entertainment System:

↪ System ▶  Climate Control

### Activating the SYNC function

- ▶ Select **SYNC**.
- ▶ Switch the function on  or off .

### Activating the A/C function

- ▶ Select **A/C**.
- ▶ Activate  or deactivate  the function.

### Controlling the rear climate control automatically

- ▶ Select **AUTO**.
- ▶ Activate  or deactivate  the function.

### Setting the airflow

- ▶ Select **Airflow**.
- ▶ Set the airflow.

### Setting the temperature

- ▶ Select **Temperature**.
- ▶ Set the temperature.

### Setting the air distribution

- ▶ Select **Air Distribution**.
- ▶ Set the air distribution.

### Setting ENERGIZING comfort in the rear passenger compartment

- Rear Seat Entertainment System:
- ↳ System ▶ ENERGIZING Comfort

### Starting the program

- ▶ For information on starting ENERGIZING comfort program (→ page 290).

### ENERGIZING comfort program overview

- ▶ For an overview of the available ENERGIZING comfort programs (→ page 289).

### Adjusting the ambient lighting in the rear passenger compartment

- Rear Seat Entertainment System:
- ↳ System ▶ Ambient Light
  - ▶ For information about adjusting the ambient lighting (→ page 148).

### Activating/deactivating the panel heating

- Rear Seat Entertainment System:
- ↳ System ▶  Panel Heating
  - ▶ Activate or deactivate the function.

### Adjusting the entertainment system settings

- Rear Seat Entertainment System:
- ↳ System ▶ Entertainment System settings

### Setting the display brightness

- ▶ Select **Display settings**.
- ▶ Select **Brightness**.
- ▶ Adjust the brightness.

### Tilting the display

- ▶ Select **Display settings**.
- ▶ Select **Display angle**.
- ▶ Tilt the display **Up** or **Down**.

### Setting the display design

- ▶ Select **Display settings**.

- ▶ Select **Day Design**, **Night Design** or **Automatic**.

### Adjusting the equalizer

- ▶ Select **Audio settings**.
  - ▶ Select **Equalizer**.
  - ▶ Set the equalizer.
-  For further information about the equalizer (→ page 358).

### Activating audio on cabin

- ▶ Select **Audio settings**.
- ▶ Select **Switch the speaker source on or off**. If the function is switched on, the current media source is output via the vehicle's speakers.

### Setting the language

Rear Seat Entertainment System:

 **System**

- ▶ Select **Language**.
- ▶ Set the desired language.

### Switching off the display

Rear Seat Entertainment System:

 **System**

- ▶ Select **Display Off**.  
The display is switched off.

### Navigation



#### Switching navigation on

Rear Seat Entertainment System:

 **Navigation**

- ▶ Alternatively: press the **NAVI** button on the remote control.  
The map appears and shows the current vehicle position.

If a route is active, the following is displayed to the left of the map:

- for the destination : remaining distance and arrival time
- for intermediate destinations : remaining distance and arrival time

The route can include up to four intermediate destinations.

- if there is a traffic delay on the current route, it will be displayed with the duration
- the compass needle 

The following information is displayed is displayed to the right of the map:

- elevation  
The elevation shown may deviate from the actual elevation.
- number of satellites from which a signal can be received
- longitude and latitude



### Displaying destination information

#### Requirements:

- A destination is entered. The route can also include up to four intermediate destinations.

Rear Seat Entertainment System:

### Navigation

- ▶ Select the symbol in the bottom right-hand corner of the display. Names and addresses are displayed for the destination  and intermediate destinations .
- ▶ **To return to the map:** select the  symbol.

## Online and Internet functions

### Overview of the Internet functions in the rear passenger compartment

The following functions and displays are available in the rear passenger compartment depending on the country and vehicle equipment:

- Connectivity status display (→ page 370)
- Calling up the web browser (→ page 334)
- Calling up Mercedes-Benz Apps (→ page 334)
- Re-establishing an Internet connection (→ page 370)

### Displaying the Internet connectivity status

#### Requirements:

An Internet connection is set up in multimedia system at the front, depending on the vehicle equipment:

- using the communication module (USA) (→ page 333)
- via Wi-Fi (→ page 331)
- via Bluetooth® (→ page 331)

Rear Seat Entertainment System:

### System

- ▶ Select **Internet Status**.

#### Re-establishing an Internet connection

Observe the requirements for using the Internet functions in the rear passenger compartment (→ page 370).

If an Internet connection is temporarily disconnected, it can be re-established in the rear passenger compartment.

- ▶ Calling up the web browser (→ page 334).
- ▶ Enter a URL and call it up.

## Media

### Information about media mode in the rear passenger compartment

The Rear Seat Entertainment System includes a Blu-ray drive (→ page 366), two USB ports and an HDMI port (→ page 367).

Depending on the vehicle model and equipment level, the Blu-ray drive is found:

- at the rear of the center console under the automatic climate control panel
- between the rear shelf and through-load ski bag

Data storage media and devices supported by the Rear Seat Entertainment System:

- SD cards
- USB storage device
- Audio CD
- Data CD
- Data DVD
- Video DVD
- BD (Blu-ray disc) video

- iPod®
- iPhone®
- MTP devices
- Bluetooth® audio

Bluetooth® audio equipment can only be authorized using the multimedia system.

The Rear Seat Entertainment System supports a total of up to 50,000 files. The Rear Seat Entertainment System can also access files on the multimedia system.

Further information about audio mode (→ page 337).

Further information about Bluetooth® audio (→ page 346).



is a trademark of DVD Format/Logo Licensing Corporation.



Blu-ray Disc™, Blu-ray™ and the logos are trademarks of the Blu-ray Disc Association.



Java is a registered trademark of Oracle and/or its affiliates.



The terms HDMI and HDMI High-Definition Multimedia Interface, and the HDMI Logo are trademarks or registered trademarks of HDMI Licensing LLC in the United States and other countries.



Gracenote, the Gracenote logo and logotype, "Powered by Gracenote", MusicID and Playlist Plus are either registered trademarks or trademarks of Gracenote, Inc. in the United States and/or other countries.



Manufactured under license from Dolby Laboratories. Dolby, Dolby Audio and the double-D symbol are trademarks of Dolby Laboratories.



For DTS Patents, see <http://patents.dts.com>. Manufactured under license from DTS Licensing Limited. DTS, DTS-HD, the Symbol, & DTS and the Symbol together are registered trademarks of DTS, Inc. © DTS, Inc. All Rights Reserved.



"Made for iPod", and "Made for iPhone," mean that an electronic accessory has been designed to connect specifically to iPod, or iPhone, respectively, and has been certified by the developer to meet Apple performance standards. Apple is not responsible for the operation of this device or its compliance with safety and regulatory standards. Please note that the use of this accessory with iPod, or iPhone may affect wireless performance.

**For the USA:** iPhone®, iPod®, iPod classic®, iPod nano®, and iPod touch® are trademarks of Apple Inc., registered in the U.S. and other countries. Lightning™ is a trademark of Apple Inc.

**For Canada:** iPhone, iPod, iPod classic, iPod nano, and iPod touch are trademarks of Apple Inc., registered in the U.S. and other countries. Lightning is a trademark of Apple Inc.

**Cinavia notice:** this product uses Cinavia technology to limit the use of unauthorized copies of some commercially-produced film and videos and their soundtracks. When a prohibited use of an unauthorized copy is detected, a message will be displayed and playback or copying will be

interrupted. More information about Cinavia technology is provided at Cinavia Online Consumer Information Center at <http://www.cinavia.com>. To request additional information about Cinavia by mail, send a postcard with your mailing address to: Cinavia Consumer Information Center, P.O. Box 86851, San Diego, CA, 92138, USA.

This product incorporates proprietary technology under license from Verance Corporation and is protected by U.S. Patent 7,369,677 and other U.S. and worldwide patents issued and pending as well as copyright and trade secret protection for certain aspects of such technology. Cinavia is a trademark of Verance Corporation. Copyright 2004-2012 Verance Corporation. All rights reserved by Verance. Reverse Engineering or disassembly is prohibited.

### Inserting a disc

**⚠ WARNING** Risk of injury from laser radiation from the Blu-ray drive

The Blu-ray drive is a class 1 laser product. If you open the housing of the Blu-ray drive,

there is a risk of exposure to invisible laser radiation.

Laser radiation can damage your retina.

- ▶ Do not open the housing.
- ▶ Always have maintenance work and repairs carried out by a qualified specialist workshop.

Rear Seat Entertainment System:

 [Media](#) ▶  [Media Sources](#) ▶  [Disc](#)

### Inserting

- ▶ Insert the disc into the drive (→ page 366).  
The side to be played must face downwards.

### Removing

- ▶ Press the button to eject the disc (→ page 366).
- ▶ Remove the disc.

## Switching on media mode - rear passenger compartment

Rear Seat Entertainment System:

➤ Media ➤  Media Sources

Media sources connected to the multimedia system are named with the addition "COMAND".

▶ Select the media source.

## Blu-ray/DVD mode

DVD/Blu-ray functions overview

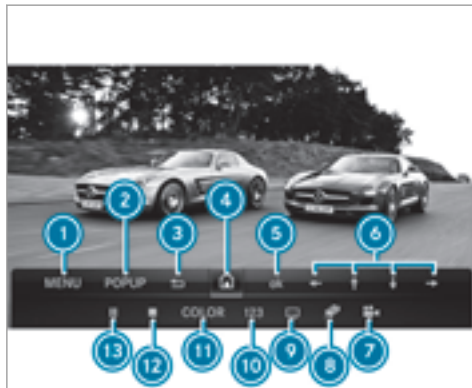

- ① Activates the DVD/Blu-ray control menu
- ② Calls up the Blu-ray pop-up menu (only available for Blu-ray Discs)
- ③ Exits DVD/Blu-ray functions or go up a level in the DVD/Blu-ray menu

- ④ Opens the video display of the Rear Seat Entertainment System
- ⑤ Confirms entry in control menu
- ⑥ Navigates through the Blu-ray/DVD menu
- ⑦ Changes camera perspectives
- ⑧ Changes the audio language
- ⑨ Shows or hides subtitles
- ⑩ Selects a scene
- ⑪ Color selection menu
- ⑫ Stops playback
- ⑬ Pauses playback

Blu-ray/DVD menu

Rear Seat Entertainment System:

➤ Media ➤  Media Sources ➤ Disc



## Calling up the Blu-ray or DVD menu

The Blu-ray or DVD menu is the menu saved on the disc itself.

- ▶ To show disc functions: press the **OK** button on the remote control.
- ▶ Select **Menu**.  
The Blu-ray or DVD menu appears.



### Selecting menu items in the Blu-ray or DVD menu

- ▶ Select a menu item.
- ▶ Press the  button on the remote control.
- ▶ Select **Select**.
- ▶ Press the  button on the remote control. The action is carried out or a submenu appears.

### Exiting the Blu-ray or DVD menu





- ▶ Press the  button on the remote control until you see the film.

Playback options in Blu-ray/DVD mode

Rear Seat Entertainment System:

 **Media** ▶  **Media Sources** ▶ **Disc**

### Pausing or continuing playback

- ▶ To show disc functions: press the  button on the remote control.
- ▶ To pause playback: select .
- ▶ To stop playback: select .
- ▶ To continue playback: select .



### Fast forwarding or rewinding

- ▶ Press and hold the << or >> button in the DVD/Blu-ray control menu until the desired position has been reached.

Selecting a Blu-ray/DVD chapter

Rear Seat Entertainment System:

 **Media** ▶  **Media Sources** ▶ **Disc**

- ▶ Call up the Blu-ray or DVD menu (→ page 374). The Blu-ray or DVD menu appears.
- ▶ Select a scene or chapter.
- ▶ Press the  button on the remote control.
- ▶ Select the chapter number.
- ▶ Press the  button on the remote control. After a short time, playback starts from the selected position.

Selecting a film/title

Rear Seat Entertainment System:

 **Media** ▶  **Media Sources** ▶ **Disc**

- ▶ Call up the Blu-ray or DVD menu (→ page 374). The Blu-ray or DVD menu appears.
- ▶ Select the film or track.
- ▶ Press the  button on the remote control.
- ▶ Call up the selection list.
- ▶ Select a film or track.

### Switching to HDMI mode

#### Requirements:

- a media source is connected to the Rear Seat Entertainment System via the HDMI port (→ page 367).
- there is an HDMI signal to the Rear Seat Entertainment System.

Rear Seat Entertainment System:

 **Media** ▶  **Media Sources**

- ▶ **To show the menu:** press the  button.

- ▶ Select **HDMI**.  
The **Playback content** display appears.
- ▶ **To show the menu:** press the  button.
- ▶ Select **Full Screen**.

## Radio

### Switching on the radio

Rear Seat Entertainment System:

 **Radio**

- ▶ Alternatively: press the  button on the remote control. Further information about radio mode (→ page 351).

## Sound

### Overview of the Rear Seat Entertainment System sound settings

The equalizer functions, automatic volume adjustment and dynamic range control are available in the sound menu of the Rear Seat Entertainment System.

Further information about the sound system (→ page 357).

### Information about dynamic range limitation

The dynamic range of the audio signal can be adjusted for the playback device. The **Dynamic Range Control** function compensates for differences in the quietest and loudest sounds. This raises the volume of quiet dialog compared to loud sound effects, for example.

The following settings are available:

- **Automatic**  
The dynamic range is set automatically.  
This setting is only available for Blu-ray discs.
- **Standard**  
The dynamic range is restricted to improve the listening experience and comprehension.
- **Maximum**  
The dynamic range is not restricted. The playback volume is the same as the original soundtrack.

### Setting dynamic range limitation

#### Prerequisite

- There is no media playback.

Rear Seat Entertainment System:

 **Media** ▶▶  **Sound** ▶▶ **Dynamic Range Control**

- ▶ Select the setting.

## ASSYST PLUS service interval display

### Function of the ASSYST PLUS service interval display

The ASSYST PLUS service interval display in the Instrument Display provides information on the remaining time or distance before the next service due date.

You can hide this service message using the back button on the left-hand side of the steering wheel.

You can obtain further information concerning the servicing of your vehicle from a qualified specialist workshop, e.g. an authorized Mercedes-Benz Center.

### Displaying the service due date

On-board computer:

↩️ Service ➡️ ASSYST PLUS

The next service due date is displayed.

▶ **To exit the display:** press the back button on the left-hand side of the steering wheel.

Make sure to observe the following further related subject:

- Operating the on-board computer (→ page 245).

### Carrying out service work at regular intervals

**!** **NOTE** Premature wear through failure to observe service due dates

Service work which is not carried out at the right time or incompletely can lead to increased wear and damage to the vehicle.

- ▶ Always observe the prescribed service intervals.
- ▶ Always have the prescribed service work carried out at a qualified specialist workshop.

### Special service requirements

The prescribed service interval is based on normal operation of the vehicle. Service work will

need to be performed more often if the vehicle is operated under arduous conditions or increased loads, for example:

- regular city driving with frequent intermediate stops.
- if the vehicle is primarily used to travel short distances.
- for frequent operation in mountainous terrain or on poor road surfaces.
- if the engine is often left idling for long periods.
- in particularly dusty conditions and/or if air-recirculation mode is frequently used.

In these or similar operating conditions, have the interior air filter, engine air filter, engine oil, oil filter etc. changed more frequently. The tires must be checked more frequently if the vehicle is operated under increased loads. Further information can be obtained at a qualified specialist workshop.

## Battery disconnection periods

The ASSYST PLUS service interval display can only calculate the service due date when the battery is connected.

- ▶ Note down the service due date displayed in the Instrument Display before disconnecting the battery (→ page 377).

## Engine compartment

### Active hood (pedestrian protection)

#### Operation of the active hood (pedestrian protection)

In certain accident situations, the risk of injury to pedestrians can be reduced by the actuation of the active hood. The rear area of the hood is raised by approximately 80 mm.

For the drive to the workshop, reset the triggered active hood yourself. If the active hood has been triggered, pedestrian protection may be limited.

A qualified specialist workshop must re-instate the full functionality of the active hood.

The active hood is not available in all countries.

#### Resetting the active hood

**⚠ WARNING** Risk of burns from hot component parts in the engine compartment

Certain component parts in the engine compartment can be very hot, e.g. the engine, the cooler and parts of the exhaust system.

- ▶ Let the engine cool down and only touch the component parts described as follows.

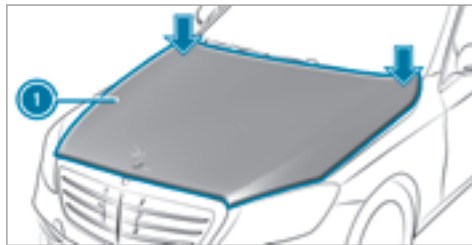

- ▶ With your hand flat, push down active hood ① in the area around the hinges on both sides (arrows). The hood must engage in position.
- ▶ If the active hood can be raised slightly at the rear in the area of the hinges, repeat the step until it engages correctly.

### Opening/closing the hood

**⚠ WARNING** Risk of accident if the engine hood is unlatched while driving

An unlocked engine hood may open up when the vehicle is in motion and block your view.

- ▶ Never unlatch the engine hood while driving.
- ▶ Before every trip, ensure that the engine hood is latched.

**⚠ WARNING** Risk of accident and injury when opening and closing the engine hood

When opening or closing the engine hood, it may suddenly drop into the end position.

There is a risk of injury for anyone in the engine hood's range of movement.

- ▶ Only open or close the engine hood when there are no persons in the engine hood's range of movement.

**⚠ WARNING** Danger of burns when opening the hood

If you open the hood when the engine has overheated or during a fire in the engine compartment, you could come into contact with hot gases or other escaping operating fluids.

- ▶ Before opening the hood, allow the engine to cool down.

- ▶ In the event of a fire in the engine compartment, keep the hood closed and call the fire service.

**⚠ WARNING** Risk of injury due to moving parts

Certain components in the engine compartment may continue to move or suddenly move again even after the ignition has been switched off, e.g. the cooler fan.

Make sure of the following before performing tasks in the engine compartment:

- ▶ Switch the ignition off.
- ▶ Never touch the danger zone surrounding moving component parts, e.g. the rotation area of the fan.
- ▶ Remove jewelry and watches.
- ▶ Keep items of clothing and hair away from moving parts.

**⚠ WARNING** Risk of injury from touching component parts under voltage

The ignition system and the fuel injection system work under high voltage. If you touch component parts which are under voltage, you could receive an electric shock.

- ▶ Never touch component parts of the ignition system or the fuel injection system when the ignition is switched on.

**⚠ WARNING** Risk of burns from hot component parts in the engine compartment

Certain component parts in the engine compartment can be very hot, e.g. the engine, the cooler and parts of the exhaust system.

- ▶ Let the engine cool down and only touch the component parts described as follows.

**⚠ WARNING** Risk of injury from using the windshield wipers while the engine hood is open

When the engine hood is open and the windshield wipers are set in motion, you can be trapped by the wiper linkage.

- ▶ Always switch off the windshield wipers and ignition before opening the engine hood.

**Plug-in hybrid:** observe the notes in the Supplement. Otherwise, you may not recognize dangers.

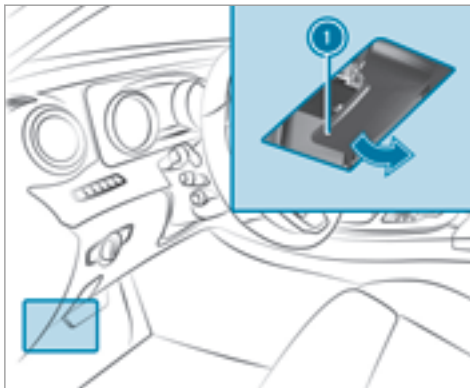

- ▶ **To open:** pull lever ① to release the engine hood.

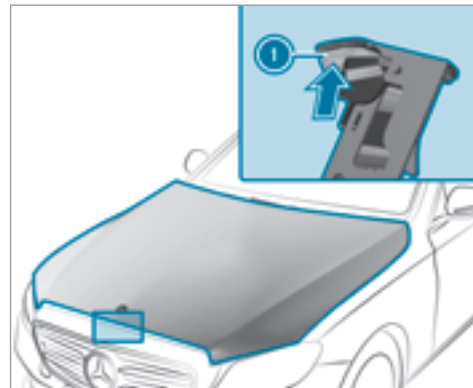

- ▶ Push hood catch ① upwards and lift the hood by approximately 15 in (40 cm).
- ▶ **To close:** lower the hood and let it fall from a height of approximately 8 in (20 cm).
- ▶ If the hood can still be lifted slightly, open the hood again and close it with a little more force until it engages correctly.

## Engine oil

### Checking the engine oil level using the oil dipstick (S 450, S 450 4MATIC)

**⚠ WARNING** Risk of burns from hot component parts in the engine compartment

Certain component parts in the engine compartment can be very hot, e.g. the engine, the cooler and parts of the exhaust system.

▶ Let the engine cool down and only touch the component parts described as follows.

**Plug-in hybrid:** observe the notes in the Supplement. Otherwise, you may not recognize dangers.

Depending on the engine, the oil dipstick may be installed in the engine compartment in different locations.

Waiting time before checking the oil level:

- Engine at normal operating temperature: five minutes.

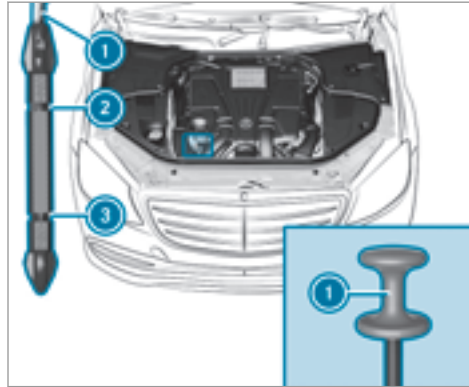

- ▶ Park the vehicle on a flat surface.
- ▶ Remove oil dipstick ① and wipe off.
- ▶ Slowly slide oil dipstick ① into the guide tube to the stop, and take it out again after approximately three seconds.
  - Oil level is correct: oil level is between ② and ③.
  - Oil level too low: oil level is at ③ or below.

- Oil level too high: oil level is above ②.

- ▶ If the oil level is too low, add 1.1 US qt (1 l) of engine oil.
- ▶ If the engine oil level is too high, have the excess engine oil removed as soon as possible at a qualified specialist workshop.

### Checking the engine oil level using the on-board computer (except S 450, S 450 4MATIC)

The engine oil level is determined during driving. The oil level display is only available after a driving time of up to 30 minutes and if the ignition is switched on, depending on the driving profile.

It is not possible to correctly measure the oil level if:

- The vehicle is not level during the measuring process.
- The engine hood was previously opened.

The engine must be restarted and the engine oil level will be determined again during driving.

On-board computer:

↪ Service ➤ Engine Oil Level

**You will see one of the following display messages in the multifunction display:**

- ▶ **Measuring Engine Oil Level...:** measurement of the oil level is not yet possible. Repeat the request after a maximum of 30 minutes' driving.
- ▶ **Engine Oil Level OK** and the bar display for indicating the oil level in the multifunction display is green and is between "min" and "max": the oil level is correct.
- ▶ **Engine Oil Level Add 1.0 l** and the bar display for indicating the oil level in the multifunction display is orange and is below "min": add 1.1 US qt (1 l) of engine oil.
- ▶ **Reduce Engine Oil Level** and the bar display for indicating the oil level in the multifunction display is orange and is above "max": drain off the excess engine oil. Consult a qualified specialist workshop.

- ▶ **For Engine Oil Level Switch Ignition On:** switch on the ignition to check the engine oil level.
- ▶ **Engine Oil Level System Inoperative:** sensor defective or not connected. Consult a qualified specialist workshop.
- ▶ **Engine Oil Level System Currently Unavail.:** close the engine hood.

**Adding engine oil**

**⚠ WARNING** Risk of burns from hot component parts in the engine compartment

Certain component parts in the engine compartment can be very hot, e.g. the engine, the cooler and parts of the exhaust system.

- ▶ Let the engine cool down and only touch the component parts described as follows.

**⚠ WARNING** Risk of fire and injury from engine oil

If engine oil comes into contact with hot component parts in the engine compartment, it may ignite.

- ▶ Make sure that no engine oil is spilled next to the filler opening.
- ▶ Allow the engine to cool off and thoroughly clean the engine oil from component parts before starting the vehicle.

**! NOTE** Engine damage caused by an incorrect oil filter, incorrect oil or additives

- ▶ Do not use engine oils or oil filters which do not correspond to the specifications explicitly prescribed for the service intervals.
- ▶ Do not alter the engine oil or oil filter in order to achieve longer change intervals than prescribed.
- ▶ Do not use additives.



- ▶ Follow the instructions in the service interval display regarding the oil change.

**!** **NOTE** Damage caused by topping up too much engine oil

Adding too much engine oil can cause damage to the engine or the catalytic converter.

- ▶ Have excess engine oil removed at a qualified specialist workshop.



- ▶ Turn cap ① counter-clockwise and remove it.
- ▶ Add engine oil.
- ▶ Replace cap ① and turn it clockwise as far as it will go.
- ▶ Check the oil level again (→ page 381).

## Checking coolant level

**!** **WARNING** Risk of burns from hot component parts in the engine compartment

Certain component parts in the engine compartment can be very hot, e.g. the engine, the cooler and parts of the exhaust system.

- ▶ Let the engine cool down and only touch the component parts described as follows.

**!** **WARNING** Danger of burns from hot coolant

The engine cooling system is pressurized, particularly when the engine is warm. If you open the cap, you could be scalded by hot coolant spraying out.

- ▶ Let the motor cool down before opening the cap.
- ▶ When opening the cap, wear gloves and protective eyewear.
- ▶ Slowly turn the cap half a turn to allow pressure to escape.

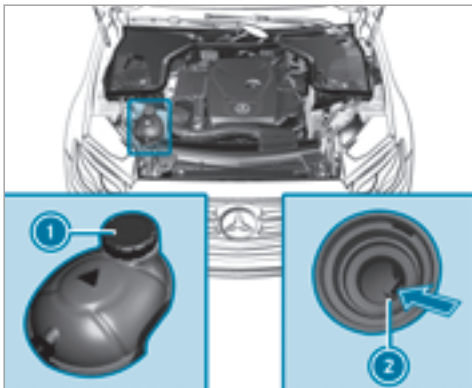

- ▶ Park the vehicle on a flat surface.
- ▶ Check the coolant temperature display in the instrument cluster. The coolant temperature must be below 158 °F (70 °C).
- ▶ Slowly turn cap ① counter-clockwise to relieve overpressure.

- ▶ Continue turning cap ① counter-clockwise and remove it.

The coolant level is correct:

- If the engine is cold, up to marker bar ②
  - If the engine is warm, up to 0.6 in (1.5 cm) over marker bar ②
- ▶ If necessary, add coolant that has been approved by Mercedes-Benz.
  - Further information on coolant (→ page 451)

### Adding washer fluid to the windshield washer system

- ▲ **WARNING** Risk of burns from hot component parts in the engine compartment

Certain component parts in the engine compartment can be very hot, e.g. the engine, the cooler and parts of the exhaust system.

- ▶ Let the engine cool down and only touch the component parts described as follows.

- ▲ **WARNING** Danger of burns when opening the hood

If you open the hood when the engine has overheated or during a fire in the engine compartment, you could come into contact with hot gases or other escaping operating fluids.

- ▶ Before opening the hood, allow the engine to cool down.
- ▶ In the event of a fire in the engine compartment, keep the hood closed and call the fire service.

- ▲ **WARNING** - Risk of fire and injury from windshield washer concentrate

Windshield washer concentrate is highly flammable. It could ignite if it comes into contact with hot engine component parts or the exhaust system.

- ▶ Make sure that no windshield washer concentrate spills out next to the filler opening.

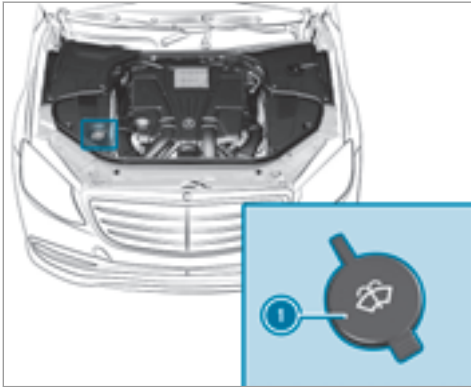

- ▶ Remove cap ① by the tab, place on the edge of the filler opening and engage in place.
- ▶ Add washer fluid.

## Cleaning and care

### Information on washing the vehicle in a car wash

**⚠ WARNING** Risk of accident due to reduced braking effect after washing the vehicle

The braking effect is reduced after washing the vehicle.

- ▶ After the vehicle has been washed, brake carefully while paying attention to the traffic conditions until the braking effect has been fully restored.

To avoid damage to your vehicle when using a car wash, ensure the following beforehand:

- Active Distance Assist DISTRONIC and the HOLD function are deactivated.
- The 360° Camera or the rear view camera is switched off.
- The side windows and sliding sunroof are completely closed.

- The blower for the ventilation/heating is switched off.
  - The windshield wiper switch is in position **0**.
  - In car washes with a towing mechanism: neutral **N** is engaged.
  - The SmartKey is at a distance of at least 10 ft (3 m) away from the vehicle, otherwise the trunk lid could open unintentionally.
- ① If, after the car wash, you remove the wax from the windshield and wiper rubber, this will prevent smearing and reduce wiper noise.

### Information on using a power washer

**⚠ WARNING** Risk of accident when using high-pressure cleaning equipment with round-spray nozzles

The water jet from a round-spray nozzle (dirt grinder) may cause damage to tires and suspension components that is not visible.

Components damaged in this way may fail unexpectedly.

- ▶ Do not use high-pressure cleaning equipment with round-spray nozzles to clean your vehicle.
- ▶ Damaged tires or suspension components must be replaced immediately.

To avoid damage to your vehicle, observe the following when using a power washer:

- Keep the SmartKey at least 10 ft (3 m) away from the vehicle. Otherwise the trunk lid could open unintentionally.
- Maintain a distance of at least 11.8 in (30 cm) to the vehicle.

- **Vehicles with decorative foil:** parts of your vehicle are covered with a decorative foil. Maintain a distance of at least 27.6 in (70 cm) between the foil-covered parts of the vehicle and the nozzle of the high pressure cleaner. Move the power washer nozzle around whilst cleaning.
- Observe the information on the correct distance in the equipment manufacturer's operating instructions.
- Do not point the nozzle of the power washer directly at sensitive parts such as tires, slits, electrical component parts, batteries, light sources and ventilation slots.

### Washing the vehicle by hand

Observe the legal requirements, e.g. in a number of countries, washing by hand is only permitted in specially designated washing areas.

- ▶ Use a mild cleaning agent, e.g. car shampoo.
- ▶ Wash the vehicle with lukewarm water using a soft car sponge. When doing so, do not expose the vehicle to direct sunlight.
- ▶ Carefully hose the vehicle off with water and dry using a chamois. Take care not to point the water jet directly towards the air inlet grille.

## Notes on paintwork/matt finish paintwork care

Observe the following information:

	Information on cleaning and care	Avoiding damage to the paintwork
<b>Paint</b>	<ul style="list-style-type: none"> <li>• Insect remains: soak with insect remover and rinse off the treated areas afterwards.</li> <li>• Bird droppings: soak with water and rinse off afterwards.</li> <li>• Coolant, brake fluid, tree resins, oils, fuel and greases: gently rub with a cloth soaked in petroleum ether or lighter fluid.</li> <li>• Tar stains: use tar remover.</li> <li>• Wax: use silicone remover.</li> </ul>	<ul style="list-style-type: none"> <li>• Do not apply stickers, films etc.</li> <li>• Remove dirt immediately, where possible.</li> </ul>
<b>Matt finish</b>	<ul style="list-style-type: none"> <li>• The vehicle should preferably be washed by hand using a soft sponge, car shampoo and plenty of water.</li> <li>• Only use care products recommended by Mercedes-Benz.</li> </ul>	<ul style="list-style-type: none"> <li>• Do not polish the vehicle and alloy wheels.</li> <li>• Do not have your vehicle cleaned at an automatic car wash too frequently and do not use wash programs which finish with a hot wax vehicle treatment.</li> <li>• Do not use paint cleaner, buffing or polishing products such as a gloss preserver, e.g. wax.</li> <li>• Always have paintwork repairs carried out at a qualified specialist workshop.</li> </ul>

## Cleaning Night View Assist

### Camera behind the windshield

**!** **NOTE** Damage to the camera lens when cleaning

If you clean the camera lens yourself or spray glass cleaner on the camera lens, you could damage the camera lens.

- ▶ When cleaning the field of vision of the driving systems, do not spray glass cleaner on the camera lens.
- ▶ If the camera lens is dirty, please contact a qualified specialist workshop.

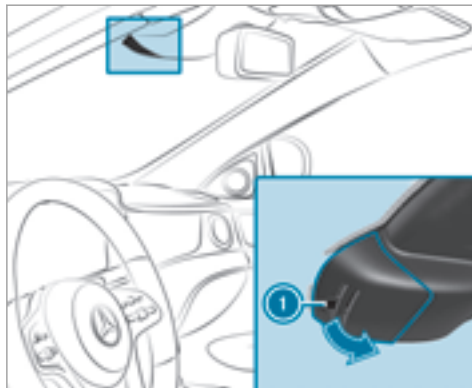

- ▶ Fold down the camera cover by handle recess ①.
- ▶ Use a cloth to clean the windshield in front of the camera.

### Camera in the radiator grill

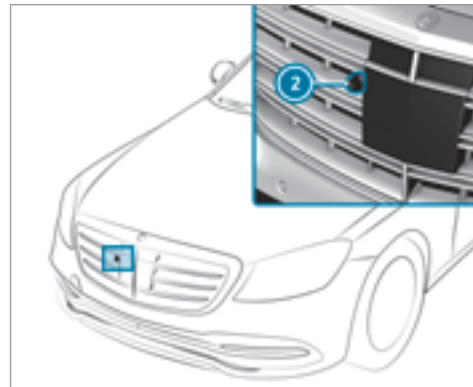

Camera lens ② is cleaned at regular intervals by operating the windshield washer system.

- ▶ Use clear water and a soft cloth to clean camera lens ② when it is very dirty.

### Notes on care of vehicle parts

**⚠ WARNING** Risk of entrapment if the windshield wipers are switched on while the windshield is being cleaned

If the windshield wipers are set in motion while you are cleaning the windshield or wiper blades, you can be trapped by the wiper arm.

▶ Always switch off the windshield wipers and the ignition before cleaning the windshield or wiper blades.

**⚠ WARNING** Risk of burns from tailpipes and tailpipe trim

The tailpipe and tailpipe trim can become very hot. If you come into contact with these parts of the vehicle, you could burn yourself.

▶ Always be particularly careful around the tailpipe and the tailpipe trim.  
▶ Allow the vehicle parts to cool down before you touch them.

### Observe the following information:

Information on cleaning and care		Avoiding vehicle damage
<b>Wheels/rims</b>	Use water and acid-free wheel cleaners.	<ul style="list-style-type: none"> <li>Do not use acidic wheel cleaners to remove brake dust. This could damage wheel bolts and brake components.</li> <li>To avoid corrosion of the brake discs and brake linings, drive the vehicle for a few minutes after cleaning before parking it. The brake discs and brake linings warm up and dry out.</li> </ul>
<b>Windows</b>	Clean the windows on the inside and outside using a damp cloth and cleaning products recommended by Mercedes-Benz.	Do not use dry cloths, abrasive products or cleaning agents containing solvents to clean the inside of the windows.

Information on cleaning and care		Avoiding vehicle damage
<b>Wiper blades</b>	Fold out the wiper blades and clean them using a damp cloth.	Do not clean the wiper blades too often.
<b>Exterior lighting</b>	Clean the lenses with a wet sponge and mild detergent, e.g. car shampoo.	Only use cleaning agents or cleaning cloths that are suitable for plastic lenses.
<b>Sensors</b>	Clean the sensors in the front and rear bumpers and in the radiator grill with a soft cloth and car shampoo.	When using a high-pressure water jet, maintain a minimum distance of 11.8 in (30 cm).
<b>Rear view camera and 360° Camera</b>	<ul style="list-style-type: none"> <li>• Open the camera cover with the multimedia system (→ page 226) .</li> <li>• Use clear water and a soft cloth to clean the camera lens.</li> </ul>	Do not use a high-pressure water jet.
<b>Tailpipes</b>	Clean with cleaning agents recommended by Mercedes-Benz, particularly in the winter and after washing the vehicle.	Use acid-free cleaning agents.

### Notes on care of the interior

**⚠ WARNING** Risk of injury from plastic parts breaking off after the use of solvent-based care products

Care and cleaning products containing solvents can cause surfaces in the cockpit to become porous.

When the airbags are deployed, plastic parts may break away.

▶ Do not use any care or cleaning products containing solvents to clean the cockpit.

**⚠ WARNING** Risk of injury or death from bleached seat belts

Bleaching or dyeing seat belts can severely weaken them.

This can, for example, cause seat belts to tear or fail in an accident.

▶ Never bleach or dye seat belts.



## Observe the following information:

Information on cleaning and care		Avoiding vehicle damage
<b>Seat belts</b>	Clean with warm water and soap solution.	<ul style="list-style-type: none"> <li>Do not use chemical cleaning agents.</li> <li>Do not dry seat belts by heating them to over 176 °F (80 °C) or exposing them to direct sunlight.</li> </ul>
<b>Display</b>	Clean the surface carefully with a microfiber cloth and TFT/LCD display cleaner.	<ul style="list-style-type: none"> <li>Switch off the display and allow to cool.</li> <li>Do not use any other cleaning products.</li> </ul>
<b>Plastic trim</b>	<ul style="list-style-type: none"> <li>Clean with a damp microfiber cloth.</li> <li>If the trim is very dirty: use a cleaning agent recommended by Mercedes-Benz.</li> </ul>	<ul style="list-style-type: none"> <li>Do not apply stickers, films etc.</li> <li>Do not allow cosmetics, insect repellent or sun cream to come in contact with the plastic trim.</li> </ul>
<b>Genuine wood/trim elements</b>	<ul style="list-style-type: none"> <li>Clean with a microfiber cloth.</li> <li>Black piano-lacquer look: clean with a damp cloth and soap solution.</li> <li>If the trim is very dirty: use a cleaning agent recommended by Mercedes-Benz.</li> </ul>	Do not use solvent-based cleaning agents, polishes or waxes.
<b>Headliner</b>	Clean with a brush or dry shampoo.	
<b>Carpet</b>	Use carpet and textile cleaning agents recommended by Mercedes-Benz.	

Information on cleaning and care		Avoiding vehicle damage
<b>Genuine leather seat covers</b>	<ul style="list-style-type: none"><li>• Clean with a damp cloth and then wipe with a dry cloth.</li><li>• Leather care: use leather care agents that have been recommended by Mercedes-Benz.</li></ul>	Do not allow the leather to become too damp. Do not use a microfiber cloth.
<b>DINAMICA seat covers</b>	Clean with a damp cloth.	Do not use a microfiber cloth.
<b>Artificial leather seat covers</b>	Clean with a damp cloth and 1% soap solution.	Do not use a microfiber cloth.
<b>Cloth seat covers</b>	Clean with a damp cloth and 1% soap solution and allow to dry.	
<b>EASY-PACK trunk box</b>	Clean with a damp cloth.	Do not use any alcohol-based thinners, gasoline or abrasive cleaning agents.

## Emergency

### Removing the safety vest

The safety vests are located in door storage compartments ① in the front door.



- ▶ **To remove:** pull out the safety vest bag containing the safety vest.
- ▶ Open the safety vest bag and pull out the safety vest.
- ① Safety vests can also be stored in the rear door storage compartments.

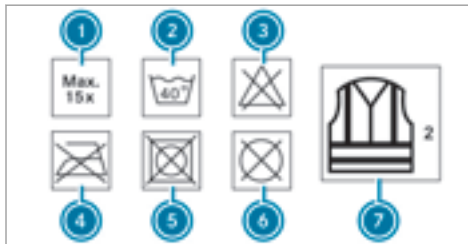

- ① Maximum number of washes
- ② Maximum wash temperature
- ③ Do not bleach
- ④ Do not iron
- ⑤ Do not use a laundry dryer
- ⑥ Do not dry-clean
- ⑦ This is a class 2 vest

The requirements defined by the legal standard are only fulfilled if the safety vest is the correct size and is fully closed.

Replace the safety vest if:

- It is damaged or dirt on the reflective strips can no longer be removed

- The maximum number of washes is exceeded
- The fluorescence of the safety vest has faded

## Flat tire

### Notes on flat tires

**⚠ WARNING** Risk of accident due to a flat tire

A flat tire severely affects the driving characteristics as well as the steering and braking of the vehicle.

#### Tires without run-flat characteristics:

- ▶ Do not drive on with a flat tire.
- ▶ Change the flat tire immediately with the emergency spare wheel or spare wheel. Alternatively, consult a qualified specialist workshop.

#### Tires with run-flat characteristics:

- ▶ Observe the information and warning notes on MOExtended tires (run-flat tires).

In the event of a flat tire, the following options are available depending on your vehicle's equipment:

- **Vehicles with MOExtended tires:** it is possible to continue the journey for a short period of time. Make sure you observe the notes on MOExtended tires (run-flat tires) (→ page 394).
- **Vehicles with a TIREFIT kit:** you can repair the tire so that it is possible to continue the journey for a short period of time. To do this, use the TIREFIT kit (→ page 395).
- **Vehicles with Mercedes-Benz mbrace®(USA only):** you can make a call for Roadside Assistance via the overhead control panel in the case of a breakdown (→ page 328).
- **All vehicles:** change the wheel (→ page 437).

### MOExtended tires (tires with run-flat properties)

**⚠ WARNING** Risk of accident when driving in limp-home mode

When driving in emergency mode the handling characteristics are impaired, e.g. when cornering, when accelerating strongly and when braking.

- ▶ Do not exceed the specified maximum speed.
- ▶ Avoid any abrupt steering and driving maneuvers as well as driving over obstacles (curbs, pot holes, off-road). This applies, in particular, to a loaded vehicle.
- ▶ Stop driving in the emergency mode if you notice:
  - banging noise
  - vehicle vibration
  - smoke which smells like rubber
  - continuous ESP® intervention

- cracks in tire side walls
- ▶ After driving in emergency mode have the rims checked by a qualified specialist workshop with regard to their further use.
- ▶ The defective tire must be replaced in every case.

With MOExtended tires (run-flat tires), you can continue to drive your vehicle even if there is a total loss of pressure in one or more tires. However, the tire affected must not show any clearly visible damage.

You can recognize MOExtended tires by the MOExtended marking which appears on the side wall of the tire.

**Vehicles with tire pressure monitoring system:** MOExtended tires may only be used in conjunction with an activated tire pressure monitoring system.

If a pressure loss warning message appears in the multifunction display:

- Check the tire for damage.

- If driving on, observe the following notes.

### Driving distance possible in limp-home mode after the pressure loss warning:

Load condition	Driving distance possible in limp-home mode
Partially laden	50 miles (80 km)
Fully laden	19 miles (30 km)

- The driving distance possible in limp-home mode may vary depending on the driving style.
- Maximum permissible speed 50 mph (80 km/h).

If a tire has gone flat and cannot be replaced with an MOExtended tire, you can use a standard tire as a temporary measure.

### TIREFIT kit storage location

The TIREFIT kit is located under the trunk floor.

**Mercedes-AMG vehicles:** observe the notes in the Supplement. Otherwise, you may not recognize dangers.

**Plug-in hybrid:** observe the notes in the Supplement. Otherwise, you may not recognize dangers.

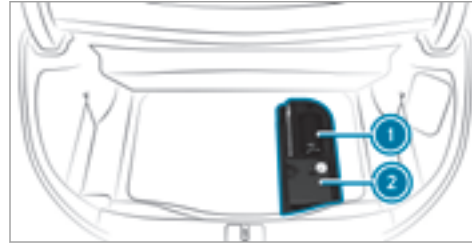

- 1 Tire sealant filler bottle
- 2 Tire inflation compressor

### Using the TIREFIT kit

Have the following readily available:

- Tire sealant filler bottle

- Enclosed TIREFIT sticker
- Tire inflation compressor
- Disposable gloves

You can use TIREFIT tire sealant to seal punctures of up to 0.16 in (4 mm), particularly those in the tire contact surface. You can use TIREFIT in outside temperatures down to  $-4^{\circ}\text{F}$  ( $-20^{\circ}\text{C}$ ).

**⚠ WARNING** Risk of accident when using tire sealant.

In the following situations, the tire sealant is unable to provide sufficient breakdown assistance, as it is unable to seal the tire properly:

- There are cuts or punctures in the tire larger than those previously mentioned.
  - The wheel rim is damaged.
  - You have driven at a very low tire pressure or on a flat tire.
- ▶ Do not continue driving.  
▶ Consult a qualified specialist workshop.

**⚠ WARNING** Risk of injury and poisoning from tire sealant

The tire sealant is harmful and causes irritation. Do not allow it to come into contact with the skin, eyes or clothing, and do not swallow it. Do not inhale tire sealant fumes. Keep the tire sealant away from children.

If you come into contact with the tire sealant, observe the following:

- ▶ Rinse off the tire sealant from your skin immediately using water.
- ▶ If tire sealant gets into your eyes, thoroughly rinse out the eyes using clean water.
- ▶ If tire sealant has been swallowed, immediately rinse out the mouth thoroughly and drink plenty of water. Do not induce vomiting and seek medical attention immediately.
- ▶ Change out of any clothes contaminated with tire sealant immediately.
- ▶ If allergic reactions occur, seek medical attention immediately.

**! NOTE** Overheating due to the tire inflation compressor running too long

- ▶ Do not run the tire inflation compressor for longer than eight minutes without interruption.

Comply with the manufacturer's safety notes on the sticker on the tire inflation compressor.

Have the tire sealant bottle replaced every four years at a qualified specialist workshop.

- ▶ Do not remove any foreign objects which have penetrated the tire.

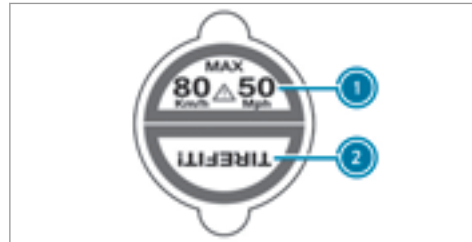

- ▶ Affix part ① of the TIREFIT sticker to the instrument cluster within the driver's field of vision.
- ▶ Affix part ② of the TIREFIT sticker near the valve on the wheel with the defective tire.

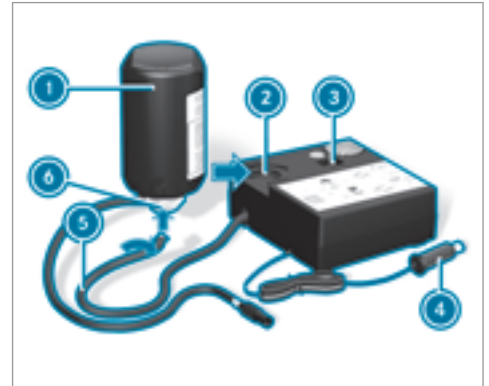

- ▶ Pull plug ④ with the cable and hose ⑤ out of the tire inflation compressor housing.

- ▶ Push the plug of hose ⑤ into flange ⑥ of tire sealant bottle ① until the plug engages.
- ▶ Place tire sealant bottle ① head downwards into recess ② of the tire inflation compressor.



- ▶ Remove the cap from valve ⑦ on the defective tire.
- ▶ Screw filling hose ⑧ onto valve ⑦.
- ▶ Insert plug ④ into a 12-V-socket in your vehicle.
- ▶ Switch on the ignition.

- ▶ Press on and off switch ③ on the tire inflation compressor. The tire inflation compressor is switched on. The tire is inflated. First, tire sealant is pumped into the tire. The pressure may briefly rise to approximately 500 kPa (5 bar/73 psi).

**Do not switch off the tire inflation compressor during this phase.**

- ▶ Let the tire inflation compressor run for a maximum of eight minutes. The tire should then have attained a tire pressure of at least 180 kPa (1.8 bar/26 psi).

If tire sealant leaks out, make sure you clean the affected area as quickly as possible. It is preferable to use clean water.

If you get tire sealant on your clothing, have it cleaned as soon as possible with perchloroethylene.

**If a tire pressure of 180 kPa (1.8 bar/26 psi) has not been attained after eight minutes:**

- ▶ Switch off the tire inflation compressor.

- ▶ Unscrew the filling hose from the valve of the defective tire.

Please note that tire sealant may leak out when unscrewing the filling hose.

- ▶ Very slowly drive forwards or reverse approximately 33 ft (10 m).
- ▶ Pump up the tire again. After a maximum of eight minutes the tire pressure must be at least 180 kPa (1.8 bar/26 psi).

**⚠ WARNING** Risk of accident due to the specified tire pressure not being reached

If the specified tire pressure is not reached after the specified time, the tire is too badly damaged. The tire sealant cannot repair the tire in this instance.

Damaged tires and a tire pressure that is too low can significantly impair braking and handling characteristics.

- ▶ Do not continue driving.
- ▶ Consult a qualified specialist workshop.

**If a tire pressure of 180 kPa (1.8 bar/26 psi) has been attained after eight minutes:**

**⚠ WARNING** Risk of accident from driving with sealed tires

A tire temporarily sealed with tire sealant impairs the handling characteristics and is not suitable for higher speeds.

- ▶ Adapt your driving style accordingly and drive carefully.
- ▶ Do not exceed the specified maximum speed with a tire that has been repaired using tire sealant.

Observe the maximum permissible speed for a tire sealed with tire sealant 50 mph (80 km/h).

- ▶ Affix the upper section of the TIREFIT sticker to the instrument cluster where it will be easily seen by the driver.

**! NOTE** Staining caused by leaking tire sealant

After use, excess tire sealant may leak out from the filling hose.

- ▶ Therefore, place the filling hose in the plastic bag that contained the TIREFIT kit.

**🌿 ENVIRONMENTAL NOTE** Environmental pollution caused by environmentally irresponsible disposal

Tire sealant contains pollutants.

- ▶ Have the tire sealant bottle disposed of professionally, e.g. at an authorized Mercedes-Benz Center.

- ▶ Switch off the tire inflation compressor.
- ▶ Unscrew the filling hose from the valve of the defective tire.
- ▶ Stow the tire sealant bottle, the tire inflation compressor and the warning triangle.
- ▶ **Pull away immediately.**
- ▶ Stop after driving for approximately ten minutes and check the tire pressure using the tire inflation compressor. The tire pressure must now be at least 130 kPa (1.3 bar/ 19 psi).

**⚠ WARNING** Risk of accident due to the specified tire pressure not being reached

If the specified tire pressure is not reached after a brief drive, the tire is too badly damaged. The tire sealant cannot repair the tire in this instance.

Damaged tires and tire pressure that is too low can significantly impair the braking properties and the handling characteristics.

- ▶ Do not continue driving.
- ▶ Consult a qualified specialist workshop.

In cases such as the one mentioned above, contact an authorized Mercedes-Benz Center. Or call 1-800-FOR-MERCEDES (in the USA) or 1-800-387-0100 (in Canada).

- ▶ Correct the tire pressure if it is still at least 130 kPa (1.3 bar/ 19 psi). See the Tire and Loading Information placard on the driver's side B-pillar or the tire pressure table in the fuel filler flap for values.
- ▶ **To increase the tire pressure:** switch on the tire inflation compressor.





- ▶ **To reduce the tire pressure:** press pressure release button ① next to manometer ②.
- ▶ When the tire pressure is correct, unscrew the filling hose from the valve of the sealed tire.
- ▶ Screw the valve cap onto the tire valve of the sealed tire.
- ▶ Pull the tire sealant bottle out of the tire inflation compressor. The filling hose stays on the tire sealant bottle.
- ▶ Drive to the nearest qualified specialist workshop and have the tire, tire sealant bottle and filling hose replaced there.

## Battery (vehicle)

### Notes on the 12 V battery

**Plug-in hybrid:** be sure to observe the notes in the Supplement. Otherwise, you may not recognize dangers.

**⚠ WARNING** Risk of an accident due to work carried out incorrectly on the battery

Work carried out incorrectly on the battery can, for example, lead to a short circuit. This can lead to function restrictions in safety-relevant systems, for example the lighting system, ABS (anti-lock braking system) or ESP® (Electronic Stability Program). The operating safety of your vehicle may be restricted.

You could lose control of the vehicle in the following situations:

- when braking
- in the event of abrupt steering maneuvers and/or when the vehicle's speed is not adapted to the road conditions

- ▶ In the event of a short circuit or a similar incident, contact a qualified specialist workshop immediately.
- ▶ Do not continue driving.
- ▶ Always have work on the battery carried out at a qualified specialist workshop.

- Further information on ABS (→ page 189)
- Further information on ESP®(→ page 189)

For safety reasons, Mercedes-Benz recommends that you only use batteries which have been tested and approved for your vehicle by Mercedes-Benz. These batteries provide increased impact protection to prevent vehicle occupants from suffering acid burns should the battery be damaged in the event of an accident.

**All vehicles except vehicles with a lithium-ion battery**

**⚠ WARNING** Risk of explosion due to electrostatic charge

Electrostatic charge can cause sparks which may ignite the highly flammable gas mixture in the battery.

- ▶ To discharge any electrostatic charge that may have built up, touch the metal vehicle body before handling the battery.

The highly flammable gas mixture is created while the battery is charging and during starting assistance.

**⚠ WARNING** Danger of chemical burns from the battery acid

Battery acid is caustic.

- ▶ Avoid contact with the skin, eyes or clothing.
- ▶ Do not lean over the battery.

- ▶ Do not inhale battery gases.
- ▶ Keep children away from the battery.
- ▶ Immediately rinse battery acid off thoroughly with plenty of clean water and seek medical attention immediately.

**All vehicles**

**🔥 ENVIRONMENTAL NOTE** Environmental damage caused by improper disposal of batteries



Batteries contain pollutants. It is illegal to dispose of them with the household rubbish.



▶ Dispose of batteries in an environmentally responsible manner. Take discharged batteries to a qualified

specialist workshop or to a collection point for used batteries.

If you have to connect the 12 volt battery, contact a qualified specialist workshop.

Comply with safety notes and take protective measures when handling batteries.



Risk of explosion



Fire, open flames and smoking are prohibited when handling the battery. Avoid creating sparks.



Electrolyte or battery acid is corrosive. Avoid contact with the skin, eyes or clothing. Wear suitable protective clothing, in particular gloves, an apron and a face mask. Immediately rinse electrolyte or acid splashes off with clean water. Consult a doctor if necessary.



Wear safety glasses.



Keep children away.



Observe this Operator's Manual.

If you do not intend to use the vehicle over an extended period of time:

- Activate standby mode, or
- Connect the battery to a battery charger approved by Mercedes-Benz, or
- Consult a qualified specialist workshop to disconnect the battery

## Starting assistance and charging the 12 V battery

### Vehicles with a lithium-ion battery

- ▶ When charging the battery and during starting assistance, always use the jump-start connection point in the engine compartment.

**!** **NOTE** Damage to the battery from over-voltage

When charging using a battery charger without a maximum charging voltage, the battery or the on-board electronics may be damaged.

- ▶ Only use battery chargers with a maximum charging voltage of 14.4 V.

**!** **NOTE** Shortening the service life of the battery by charging the battery at low temperatures

Charging the battery at very low temperatures may shorten the service life of the battery and have a negative effect on starting.

- ▶ Do not charge the battery at very low temperatures.

### All other vehicles

- ▶ When charging the battery and during starting assistance, always use the jump-start connection point in the engine compartment.

**!** **NOTE** Damaging the battery through overvoltage

When charging using a battery charger without a maximum charging voltage, the battery or the vehicle electronics may be damaged.

- ▶ Only use battery chargers with a maximum charging voltage of 14.8 V.

**!** **WARNING** Risk of explosion from hydrogen gas igniting

A battery generates hydrogen gas during the charging process. If there is a short circuit or sparks start to form, there is a danger of the hydrogen gas igniting.

- ▶ Make sure that the positive terminal of the connected battery does not come into contact with vehicle parts.
- ▶ Never place metal objects or tools on a battery.
- ▶ When connecting and disconnecting the battery, you must observe the described order for the battery clamps.
- ▶ When giving starting assistance, always make sure that you only connect battery terminals with identical polarity.
- ▶ During starting assistance, you must observe the described order for connecting and disconnecting the jumper cables.
- ▶ Do not connect or disconnect the battery clamps while the engine is running.

**⚠ WARNING** Risk of explosion during charging process and starting assistance

During the charging process and starting assistance, the battery may release an explosive gas mixture.

- ▶ Avoid fire, open flames, creating sparks and smoking.
- ▶ Make sure that there is sufficient ventilation during the charging process and during starting assistance.
- ▶ Do not lean over a battery.

If the indicator/warning lamps in the instrument cluster do not light up at low temperatures, it is very likely that the discharged battery has frozen.

**⚠ WARNING** Risk of explosion from a frozen battery

A discharged battery may freeze at temperatures slightly above or below freezing point. During starting assistance or battery charging, battery gas may be released.

- ▶ Always thaw a frozen battery out first before charging it or performing starting assistance.

The service life of a battery that has been thawed may be dramatically shortened.

It is recommended that you have a thawed battery checked at a qualified specialist workshop.

### All vehicles

**Plug-in hybrid:** observe the notes in the Supplement. Otherwise, you may not recognize dangers.

**!** **NOTE** Damage caused by numerous or extended attempts to start the engine

Numerous or extended attempts to start the engine may damage the catalytic converter due to non-combusted fuel.

- ▶ Avoid numerous and extended attempts to start the engine.

Observe the following points during starting assistance and when charging the battery:

- Only use undamaged jumper cables/charging cables with a sufficient cross-section and insulated terminal clamps.
- Non-insulated parts of the terminal clamps must not come into contact with other metal parts while the jumper cable/charging cable

is connected to the battery/jump-start connection point.

- The jumper cable/charging cable must not come into contact with any parts which may move when the engine is running.
- Always make sure that neither you nor the battery is electrostatically charged.
- Keep away from fire and open flames.
- Do not lean over the battery.
- **When charging:** only use battery chargers tested and approved by Mercedes-Benz, and please read the battery charger's operating instructions before charging the battery.

Observe the additional following points during starting assistance:

- Starting assistance may only be provided using batteries with a nominal voltage of 12 V.
- The vehicles must not touch.
- **Gasoline engine:** Only accept starting assistance if the engine and exhaust system are cold.

- ▶ Secure the vehicle by applying the electric parking brake.
- ▶ **Automatic transmission:** Shift the transmission to position **P**.
- ▶ Make sure that the ignition and all electrical consumers are switched off.
- ▶ Open the hood.

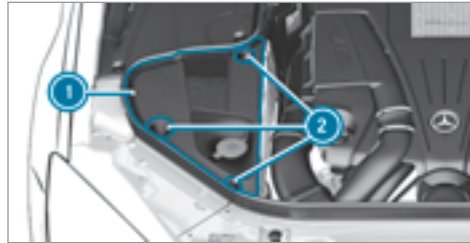

- ▶ **Vehicles with ground point cover:** turn screws **2** from ground point cover **1** counter-clockwise and remove ground point cover **1**.

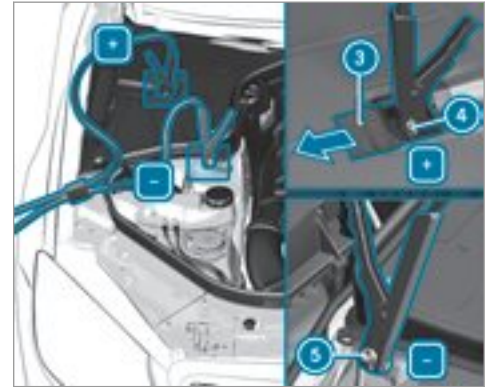

- ▶ Slide cover **3** of positive clamp **4** on the jump-starting connection point in the direction of the arrow.
- ▶ Connect positive clamp **4** on your vehicle to positive pole of the donor battery using the jumper cable/charging cable. Always begin with positive clamp **4** on your own vehicle first.

- ▶ **During the starting assistance procedure:** start the engine of the donor vehicle and run at idle speed.
- ▶ Connect the negative pole of the donor battery and ground point ⑤ of your own vehicle by using the jumper cable/charging cable. Begin with the donor battery first.
- ▶ **During starting assistance:** start the engine of your own vehicle.
- ▶ **During the charging process:** start the charging process.
- ▶ **During starting assistance:** let the engines run for several minutes.
- ▶ **During starting assistance:** before disconnecting the jumper cable, switch on an elec-

trical consumer on your own vehicle, e.g. the rear window heater or lighting.

When the starting assistance/charging process is complete:

- ▶ First, remove the jumper cable/charging cable from ground point ⑤ and negative pole of the donor battery, then from positive clamp ④ and positive pole of the donor battery. Begin each time with the contacts on your own vehicle first.
- ▶ After removing the jumper cable/charging cable, close cover ③ of positive clamp ④.
- ▶ **Vehicles with ground point cover:** replace ground point cover ① and turn screws ② clockwise.

You can obtain further information on starting assistance at any qualified specialist workshop.

## Tow starting or towing away

### Permitted towing methods



**Plug-in hybrid:** observe the notes in the Supplement. Otherwise, you may not recognize dangers.

Mercedes-Benz recommends transporting your vehicle in the case of a breakdown, rather than towing it away.

**!** **NOTE** Damage to the vehicle due to towing away incorrectly

▶ Observe the instructions and notes on towing away.

## Permitted towing methods

Vehicle equipment/towing method	 Both axles on the ground	 Front axle raised	 Rear axle raised
Vehicles with automatic transmission	Yes, maximum 31 miles (50 km) at 31 mph (50 km/h)	No	Yes, if the steering wheel is fixed in the center position with a steering wheel lock.
4MATIC vehicles	Yes, maximum 31 miles (50 km) at 31 mph (50 km/h)	No	No

**Towing with a raised axle:** towing should be performed by a towing company.

### Towing the vehicle with both axles on the ground

- ▶ Observe the notes on the permitted towing methods (→ page 404).
- ▶ Make sure that the battery is connected and charged.

When the battery is discharged:

- the engine cannot be started.
- the electric parking brake cannot be released or applied.
- the automatic transmission cannot be shifted to position **N** or **P**.

**i** If the automatic transmission cannot be shifted to position **N**, transport the vehicle (→ page 407). A towing vehicle with lifting

equipment is required for vehicle transportation.

**!** **NOTE** Damage due to towing away at excessively high speeds or over long distances

The drivetrain could be damaged when towing at excessively high speeds or over long distances.

- ▶ A towing speed of 30 mph (50 km/h) must not be exceeded.
- ▶ A towing distance of 30 miles (50 km) must not be exceeded.

**⚠ WARNING** Risk of accident when towing a vehicle which is too heavy

If the vehicle being tow-started or towed away is heavier than the permissible gross mass of your vehicle, the following situations can occur:

- The towing eye may become detached.
  - The vehicle/trailer combination may swerve or even overturn.
- ▶ If another vehicle is tow-started or towed away, its weight must not exceed the permissible gross mass of your own vehicle.

If a vehicle must be tow-started or towed away, its weight must not exceed the permissible gross mass of the towing vehicle.

- ▶ Information on the permissible gross mass of the vehicle can be found on the vehicle identification plate (→ page 445).
- ▶ Do not open the driver's door or front passenger door, otherwise the automatic transmission automatically shifts to position **P**.
- ▶ Install the towing eye (→ page 409).
- ▶ Attach the tow bar.

**! NOTE** Damage due to incorrect connection

- ▶ Only connect the tow rope or tow bar to the towing eyes.

- ▶ Deactivate the automatic locking mechanism (→ page 64).
- ▶ Do not activate the HOLD function.
- ▶ Deactivate Active Brake Assist (→ page 196).
- ▶ Shift the automatic transmission to position **N**.
- ▶ Release the electric parking brake.

**⚠ WARNING** Risk of accident due to limited safety-related functions during the towing process

Safety-related functions are limited or no longer available in the following situations:

- the ignition is switched off.
- the brake system or power steering system is malfunctioning.
- the energy supply or the on-board electrical system is malfunctioning.

When your vehicle is then towed away, significantly more effort may be required to steer and brake than is normally required.

- ▶ Use a tow bar.
- ▶ Make sure that the steering wheel can move freely, before towing the vehicle away.



**!** **NOTE** Damage due to excessive tractive power

If you pull away sharply, the tractive power may be too high and the vehicles could be damaged.

▶ Pull away slowly and smoothly.

### Loading the vehicle for transport

- ▶ Observe the notes on towing away (→ page 405).
- ▶ Connect the tow bar to the towing eye to load the vehicle.
- ▶ Shift the automatic transmission to position **N**.
- i** The automatic transmission may be locked in position **P** in the event of damage to the electrics. To shift to **N**, provide the on-board electrical system with power (→ page 401).
- ▶ Load the vehicle onto the transporter.

- ▶ Shift the automatic transmission to position **P**.
- ▶ Only secure the vehicle by the wheels.

### Vehicles with ADS PLUS (Adaptive Damping System PLUS)

**!** **WARNING** Risk of an accident when transporting vehicles with Adaptive Damping System PLUS

The reduced damping forces on the vehicle being transported can cause the vehicle/trailer combination to start to swing.

As a result, when transporting vehicles with the Adaptive Damping System PLUS, the vehicle/trailer combination may start to skid. Consequently, you could lose control of your vehicle.

- ▶ When transporting, ensure that:
  - The vehicle has been loaded onto the transporter correctly
  - The vehicle is secured at all four wheels with suitable tensioning straps

- The maximum permissible speed of 35 mph (60 km/h) is not exceeded when transporting

**!** **NOTE** Damage to the vehicle from securing it incorrectly

- ▶ After loading, the vehicle must be secured on all four wheels. Otherwise, the vehicle could be damaged.
- ▶ A minimum distance of 4 in (10 cm) upwards and 8 in (20 cm) downwards must be kept to the transport platform.

- i** Transport level is not available for the following vehicles:
- Mercedes-AMG vehicles
  - Vehicles with MAGIC BODY CONTROL

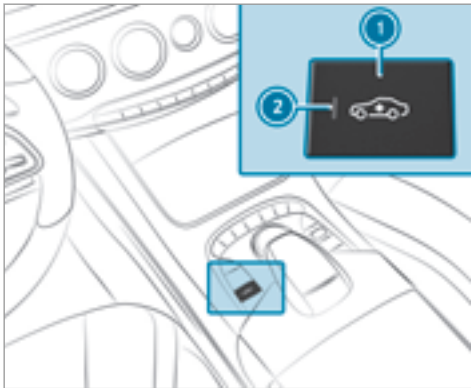

- ▶ **To activate transport level:** press button ①. Indicator lamp ② lights up. The vehicle is raised by 1.2 in (30 mm) compared to the normal level.
- ▶ Press button ① again and hold it for at least five seconds. The vehicle is raised from the raised level to the transport level.

The transport level is reached when indicator lamp ② flashes and the **Max. speed 35 km/h** display message appears in the multifunction display.

Load the vehicle and lash it down at all four wheels. Otherwise, the vehicle could be damaged.

- ① A minimum distance of 4 in (10 cm) upwards and 8 in (20 cm) downwards must be kept to the transport platform.

The vehicle is lowered again in the following situations:

- When driving faster than 21 mph (35 km/h).
- After selecting a drive program using the DYNAMIC SELECT switch.

The vehicle is adjusted to the height of the last active drive program.

- ▶ **To deactivate transport level:** start the engine when the vehicle is at a standstill. If transport level is activated, indicator lamp ② flashes.

- ▶ Press and hold button ① for at least five seconds. The vehicle is adjusted to the height of the last active drive program. Indicator lamp ② goes out.
- ▶ Drive the vehicle off the transporter.

#### 4MATIC vehicles

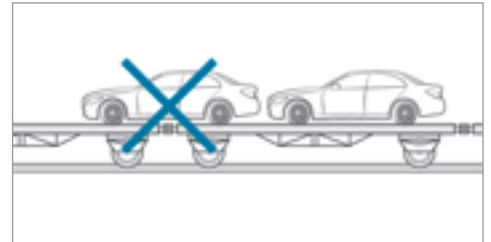

- ▶ Make sure that the front and rear axles come to rest on the same transport vehicle.

**!** **NOTE** Damage to the drivetrain due to incorrect positioning

- ▶ Do not position the vehicle above the connection point of the transport vehicle.

## Towing eye

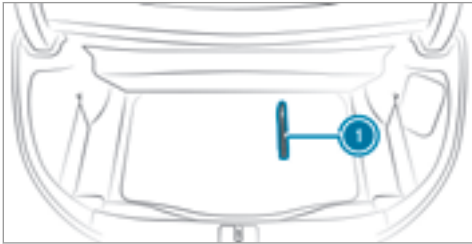

Towing eye ① is located with the vehicle tool kit under the trunk floor.

## Installing the towing eye

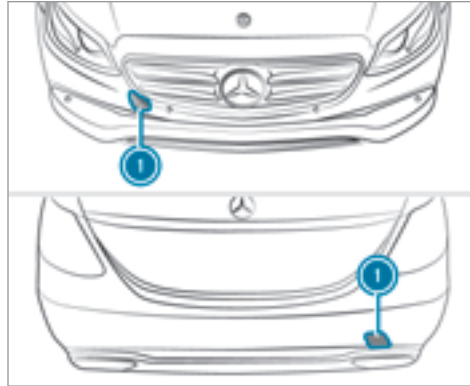

- ▶ Press the mark on cover ① inwards and remove.
- ▶ Screw in the towing eye clockwise to the stop.
- ① Make sure that cover ① engages in the bumper when you remove the towing eye.

**!** **NOTE** Damage due to incorrect use of the towing eye

When a towing eye is used to recover a vehicle, the vehicle may be damaged in the process.

- ▶ Only use the towing eye to tow away or tow start the vehicle.

## Tow-starting the vehicle (emergency engine start)

**!** **NOTE** Damage to the automatic transmission due to tow starting

The automatic transmission may be damaged in the process of tow starting vehicles with automatic transmission.

- ▶ Vehicles with automatic transmission must not be tow started.

- ▶ Vehicles with automatic transmission must not be tow-started.

## Electrical fuses

### Notes on electrical fuses

**⚠ WARNING** Risk of accident and injury due to overloaded lines

If you manipulate or bridge a faulty fuse or if you replace it with a fuse with a higher amperage, the electric line could be overloaded.

This could result in a fire.

- ▶ Always replace faulty fuses with specified new fuses containing the correct amperage.

**⚠ NOTE** Damage caused by incorrect fuses

Incorrect fuses may cause damage to electrical components or systems.

- ▶ Only use Mercedes-Benz approved fuses with the correct fuse rating.

Blown fuses must be replaced with fuses of the same rating, which you can recognize by the color and fuse rating. The fuse ratings are listed

in the fuse assignment diagram. The fuse assignment diagram is in the vehicle document wallet.

**⚠ NOTE** Damage or malfunctions caused by moisture

Moisture may cause damage to the electrical system or cause it to malfunction.

- ▶ When the fuse box is open, make sure that no moisture can enter the fuse box.
- ▶ When closing the fuse box, make sure that the seal of the lid is positioned correctly on the fuse box.

If the newly inserted fuse also blows, have the cause traced and rectified at a qualified specialist workshop, e.g. an authorized Mercedes-Benz Center.

Ensure the following before replacing a fuse:

- The vehicle is secured against rolling away.
- All electrical consumers are switched off.
- The ignition is switched off.

The electrical fuses are located in various fuse boxes:

- Fuse box in the engine compartment on the driver's side (→ page 410)
- Fuse box on the driver's side of the dashboard (→ page 412)
- Fuse box in the front-passenger footwell (→ page 412)
- Fuse box in the trunk on the right-hand side of the vehicle, when viewed in the direction of travel (→ page 412)

### Fuse box in the engine compartment

#### Requirements:

- Observe the notes on electrical fuses (→ page 410).

Have the following readily available:

- A dry cloth
- A screwdriver

## Opening

**⚠ WARNING** Risk of injury from using the windshield wipers while the engine hood is open

When the engine hood is open and the windshield wipers are set in motion, you can be trapped by the wiper linkage.

▶ Always switch off the windshield wipers and ignition before opening the engine hood.

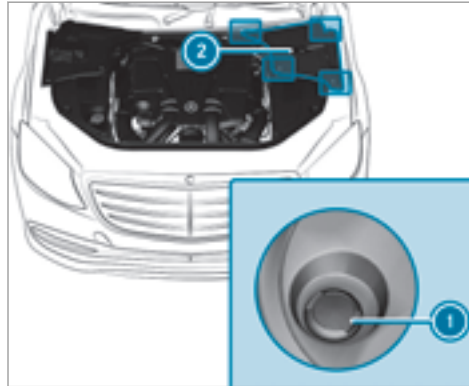

- ▶ Release retaining clips ①. Pull cover ② up.

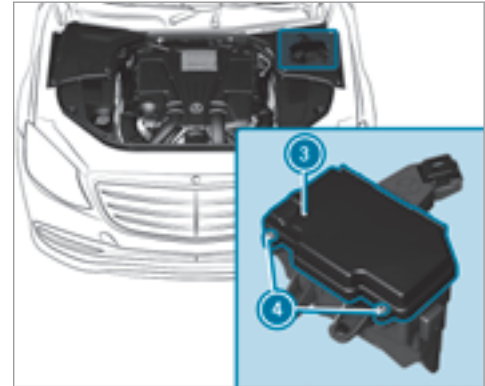

- ▶ Remove any existing moisture from the fuse box using a dry cloth.
- ▶ Loosen screws ④, remove fuse box lid ③ from the top.

## Closing

- ▶ Check whether the seal is positioned correctly in the lid.

- ▶ Insert the lid into the bracket at the rear of the fuse box.
- ▶ Fold down lid of the fuse box and tighten screws ④.
- ▶ Insert cover ② on both sides and engage retaining clips ①.
- ▶ Close the hood.

### Dashboard fuse box

The fuse box is on the side of the dashboard under a cover.

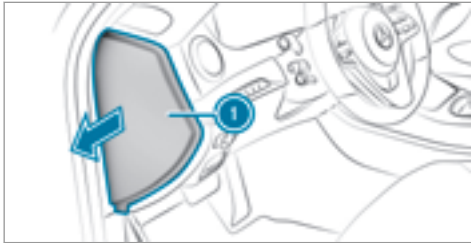

- ▶ Open cover ① in the direction of the arrow and remove it.

### Fuse box in the front-passenger footwell

#### Requirement:

- Observe the notes on electrical fuses (→ page 410).

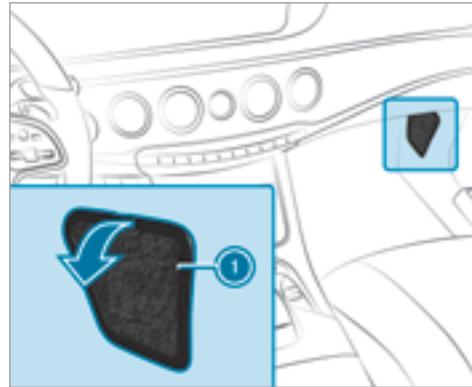

- ▶ Open cover ① in the direction of the arrow and remove it.

### Fuse box in the trunk

#### Requirement:

- Observe the notes on electrical fuses (→ page 410).



- ▶ Fold cover ① down in the direction of the arrow.

### Noise or unusual handling characteristics

While driving, pay attention to vibrations, noises and unusual handling characteristics, e.g. pulling to one side. This may indicate that the wheels or tires are damaged. If you suspect that a tire is defective, reduce your speed immediately. Stop the vehicle as soon as possible to check the wheels and tires for damage. Hidden tire damage could also be causing the unusual handling characteristics. If you find no signs of damage, have the tires and wheels checked at a qualified specialist workshop.

### Checking wheels and tires regularly

**⚠ WARNING** Risk of accident from damaged tires

Damaged tires can cause tire pressure loss. As a result, you could lose control of your vehicle.

▶ Check the tires regularly for signs of damage and replace any damaged tires immediately.

**⚠ WARNING** Risk of aquaplaning due to insufficient tire tread

Insufficient tire tread will result in reduced tire grip. The tire tread is no longer able to dissipate water.

This means that in heavy rain or slush the risk of hydroplaning is increased, in particular if vehicle speed is not adapted to suit the conditions.

If the tire pressure is too high or too low, tires may exhibit different levels of wear at different locations on the tire contact surface.

▶ Thus, you should regularly check the tread depth and the condition of the tire contact surface across the entire width of all tires.

Minimum tread depth for:

- Summer tires:  $\frac{1}{8}$  in (3 mm)
- M+S tires:  $\frac{1}{6}$  in (4 mm)

▶ For safety reasons, replace the tires before the legally prescribed limit for the minimum tread depth is reached.

Carry out the following checks on all wheels regularly, at least once a month or as required, e.g. prior to a long journey or driving off-road:

- Check the tire pressure (→ page 414).
- Visual inspection of wheels and tires for damage.
- Check the valve caps.

The valves must be protected against moisture and dirt by the valve caps approved especially for your vehicle by Mercedes-Benz.

- Visual check of the tread depth and the tire contact surface across the entire width.

The minimum tread depth for summer tires is  $\frac{1}{8}$  in (3 mm) and for winter tires  $\frac{1}{6}$  in (4 mm).

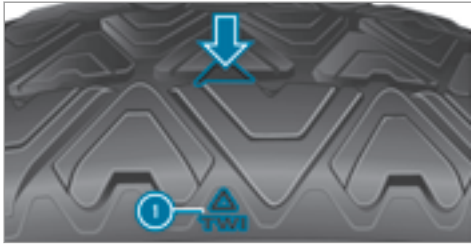

Six marks  show where the bar indicators (arrow) are integrated into the tire tread. They are visible once a tread depth of approximately  $\frac{1}{16}$  in (1.6 mm) has been reached.

### Notes on snow chains

 **WARNING** Risk of accident due to incorrect mounting of snow chains

If you have mounted snow chains to the front wheels, the snow chains may drag against the vehicle body or chassis components.

This could cause damage to the vehicle or the tires.

- ▶ Never mount snow chains on the front wheels.
- ▶ Only mount snow chains on the rear wheels in pairs.

 **NOTE** Damage to the wheel trim from mounted snow chains

If snow chains are mounted to steel wheels, the wheel trims can be damaged.

- ▶ Remove the wheel trims of steel wheels before mounting snow chains.

- Snow chains are only permissible for certain wheel/tire combinations. You can obtain information about this from an authorized Mercedes-Benz Center.
- For safety reasons, only use snow chains that have been specifically approved for your vehicle by Mercedes-Benz, or snow chains with the same quality standard.

- If snow chains are installed, the maximum permissible speed is 30 mph (50 km/h).
  - **Vehicles with Active Parking Assist:** Do not use Parking Assist PARKTRONIC when snow chains have been installed.
  - **Vehicles with AIR BODY CONTROL or MAGIC BODY CONTROL:** If snow chains are installed, only drive at raised vehicle level.
-  You can deactivate ESP<sup>®</sup> to pull away (→ page 191). This allows the wheels to spin, achieving an increased driving force.

### Tire pressure

#### Notes on tire pressure

 **WARNING** Risk of accident due to insufficient or excessive tire pressure

Underinflated or overinflated tires pose the following risks:

- The tires may burst, especially as the load and vehicle speed increase.



- The tires may wear excessively and/or unevenly, which may greatly impair tire traction.
  - The driving characteristics, as well as steering and braking, may be greatly impaired.
- ▶ Comply with the recommended tire pressure and check the tire pressure of all tires including the spare wheel regularly:
- at least once a month
  - when the load changes
  - before embarking on a longer journey
  - if operating conditions change, e.g. off-road driving
- ▶ Adjust the tire pressure as necessary.

Driving with tire pressure that is too high or too low can:

- Shorten the service life of the tires.
- Cause increased tire damage.

- Adversely affect handling characteristics and thus driving safety, e.g. due to hydroplaning.

**⚠ WARNING** Risk of an accident due to insufficient tire pressure

Tires with pressure that is too low can overheat and burst as a result.

In addition, they also suffer from excessive and/or irregular wear, which can significantly impair the braking properties and the handling characteristics.

- ▶ Avoid excessively low tire pressures in all the tires, including the spare wheel.

Tire pressure which is too low can cause:

- Tire defects as a result of overheating
- Impaired handling characteristics
- Irregular wear
- Increased fuel consumption

**⚠ WARNING** Risk of accident from excessive tire pressure

Tires with excessively high pressure can burst because they are damaged more easily by highway fill, pot holes etc.

In addition, they also suffer from irregular wear, which can significantly impair the braking properties and the handling characteristics.

- ▶ Avoid excessively high tire pressures in all the tires, including the spare wheel.

Excessively high tire pressure can result in:

- Increased braking distance
- Impaired handling characteristics
- Irregular wear
- Impaired driving comfort
- Susceptibility to damage

**⚠ WARNING** Risk of accident caused by repeated drop in tire pressure

If the tire pressure drops repeatedly, the wheel, valve or tire may be damaged.

Insufficient tire pressure can cause the tires to burst.

- ▶ Inspect the tire for signs of foreign objects.
- ▶ Check whether the wheel or valve has a leak.
- ▶ If you are unable to rectify the damage, contact a qualified specialist workshop.

You can find information on tire pressure for the vehicle's factory-mounted tires on the following labels:

- Tire and Loading Information placard on the B-pillar of your vehicle (→ page 420).
- Tire pressure table on the inside of the fuel filler flap (→ page 416).

Observe the maximum tire pressure (→ page 428).

Use a suitable pressure gauge to check the tire pressure. The outer appearance of a tire does not permit any reliable conclusion about the tire pressure.

**Vehicles with a tire pressure monitoring system:** You can also check the tire pressure using the on-board computer.

Only correct tire pressure when the tires are cold. Conditions for cold tires:

- The vehicle has been parked with the tires out of direct sunlight for at least three hours.
- The vehicle has traveled less than 1 mile (1.6 km).

A rise in the tire temperature of 18 °F (10 °C) increases the tire pressure by approx. 10 kPa (0.1 bar/1.5 psi). Take this into account when checking the tire pressure of warm tires.

The tire pressure recommended for increased load/speed in the tire pressure table can affect the ride comfort.

**⚠ WARNING** Risk of accident from unsuitable accessories on the tire valves

If you mount unsuitable accessories onto tire valves, the tire valves may be overloaded and malfunction, which can cause tire pressure loss. Tire pressure monitoring systems for retrofitting will cause the tire valve to remain open. This can also result in tire pressure loss.

- ▶ Only screw standard valve caps or valve caps specifically approved by Mercedes-Benz for your vehicle onto the tire valve.

### Tire pressure table

The tire pressure table is on the inside of the fuel filler flap.

- ⓘ The data shown in the images is example data.



The tire pressure table shows the recommended tire pressure for all tires approved for this vehicle. The recommended tire pressures apply for cold tires under various operating conditions, i.e. loading and/or speed of the vehicle.

If one or more tire sizes precede a tire pressure, the tire pressure information following is only valid for those tire sizes.

The load conditions "partially laden" and "fully laden" are defined in the table for different numbers of passengers and amounts of luggage. The actual number of seats may differ from this.

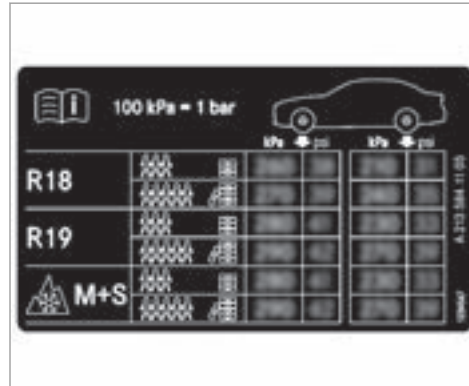

Some tire pressure tables only show the rim diameter instead of the complete tire size, e.g. **R18**. The rim diameter is part of the tire size and can be found on the tire side wall (→ page 428).

Be sure to also observe the following further related subjects:

- Notes on tire pressure (→ page 414)
- Tire and Loading Information placard (→ page 420)

- Maximum tire pressure (→ page 428)

### Checking tire pressures manually

- ▶ Read the tire pressure for the current operating conditions from the Tire and Loading Information placard or the tire pressure table. Observe the notes on tire pressure.
- ▶ Remove the valve cap of the tire to be checked.
- ▶ Press the tire pressure gauge securely onto the valve.
- ▶ Read the tire pressure.
- ▶ If the tire pressure is lower than the recommended value, increase the tire pressure to the recommended value.
- ▶ If the tire pressure is higher than the recommended value, release air. To do so, press down the metal pin in the valve, e.g. using the tip of a pen for example. Then check the tire pressure again using the tire pressure gauge.
- ▶ Screw the valve cap onto the valve.

Further related subjects:

- Notes on tire pressure (→ page 414)
- Tire pressure table (→ page 416)
- Tire and Loading Information placard (→ page 420)

## Tire pressure monitoring system

### Function of the tire pressure monitoring system

**⚠ DANGER** Risk of accident due to incorrect tire pressure

Every tire, including the spare (if provided), should be checked when cold at least once a month and inflated to the pressure recommended by the vehicle manufacturer (see Tire and Loading Information placard on the B-pillar on the driver's side or the tire pressure label on the inside of the fuel filler flap of your vehicle). If your vehicle has tires of a different size than the size indicated on the Tire and Loading Information placard or the

tire pressure table, you need to determine the proper tire pressure for those tires.

As an added safety feature, your vehicle has been equipped with a tire pressure monitoring system (TPMS) that illuminates a low tire pressure indicator lamp when one or more of your tires are significantly underinflated. Accordingly, if the low tire pressure indicator lamp lights up, you should stop and check your tires as soon as possible, and inflate them to the proper pressure. Driving on a significantly underinflated tire causes the tire to overheat and can lead to tire failure. Underinflation also increases fuel consumption and reduces tire tread life, and may affect the vehicle's handling and braking ability. Please note that the TPMS is not a substitute for proper tire maintenance, and it is the driver's responsibility to maintain correct tire pressure, even if underinflation has not reached the level to trigger illumination of the TPMS low tire pressure indicator lamp.

Your vehicle has also been equipped with a TPMS malfunction indicator to indicate when

the system is not operating properly. The TPMS malfunction indicator is combined with the low tire pressure indicator lamp. When the system detects a malfunction, the indicator lamp will flash for approximately a minute and then remain continuously illuminated. This sequence will continue upon subsequent vehicle start-ups as long as the malfunction exists.

When the malfunction indicator is illuminated, the system may not be able to detect or signal low tire pressure as intended. TPMS malfunctions may occur for a variety of reasons, including the installation of incompatible replacement or alternate tires or wheels on the vehicle that prevent the TPMS from functioning properly.

Always check the TPMS malfunction warning lamp after replacing one or more tires or wheels on your vehicle to ensure that the replacement or alternate tires and wheels allow the TPMS to continue to function properly.

The system checks the tire pressure and the tire temperature of the tires mounted on the vehicle by means of a tire pressure sensor.

New tire pressure sensor, e.g. in winter tires, are automatically taught-in the first time they are driven.

The tire pressure appears in the multifunction display (→ page 247).

If there is a substantial pressure loss or if the tire temperature is excessive, a warning will be given:

- Via display messages (→ page 487).
- Via the  warning lamp in the instrument cluster (→ page 517).

It is the driver's responsibility to set the tire pressure to the recommended cold tire pressure suitable for the operating situation. Set the tire pressure for cold tires using a tire pressure gauge. Note that the correct tire pressure for the current operating situation must first be taught-in to the tire pressure monitoring system.

In most cases, the tire pressure monitoring system will automatically update the new reference

values after you have changed the tire pressure. You can, however, also update the reference values by restarting the tire pressure monitoring system manually (→ page 420).

### System limitations

The system may be impaired or may not function in the following situations:

- If the tire pressure is set incorrectly.
- If there is a sudden pressure loss caused, for example by a foreign object penetrating the tire.
- If there is a malfunction caused by another radio signal source.

Make sure to observe the following further related subject:

- Notes on tire pressure (→ page 414)

### Checking the tire pressure with the tire pressure monitoring system

#### Requirement:

- The ignition is switched on.

On-board computer:

➔ [Service](#) ➔ [Tires](#)

One of the following displays appears:

- Current tire pressure of each wheel:



- [Tire pressure will be displayed after driving a few minutes](#)
- [Tire Pressure Monitor Active](#): the teach-in process of the system is not yet complete. The tire pressures are already being monitored.

▶ Compare the tire pressure with the recommended tire pressure for the current operat-

ing condition (→ page 416). Observe the notes on tire temperature (→ page 414).

- ① The values displayed in the multifunction display may deviate from those of the tire pressure gauge as they refer to sea level. At high altitudes, the tire pressure values indicated by pressure gauges are higher than those shown by the on-board computer. In this case, do not reduce the tire pressure.

Make sure to observe the following further related subject:

- Notes on tire pressure (→ page 414)

### Restarting the tire pressure monitoring system

#### Requirements:

- The recommended tire pressure is correctly set for the respective operating condition on each of the four wheels (→ page 414).

Restart the tire pressure monitoring system in the following situations:

- The tire pressure has changed.

- The wheels or tires have been changed or newly installed.

On-board computer:

↪ [Service](#) ▶ [Tires](#)

- ▶ Swipe downwards on the Touch Control on the left-hand side of the steering wheel. The [Use Current Pressures as New Reference Values](#) message is shown in the multifunction display.
- ▶ Press  to confirm the restart. The [Run Flat Indicator Restarted](#) message is shown in the multifunction display. Current warning messages are deleted and the  yellow warning lamp goes out. After you have driven for a few minutes, the system checks whether the current tire pressures are within the specified range. The current tire pressures are then accepted as reference values and monitored.

Make sure to observe the following further related subject:

- Notes on tire pressure (→ page 414)

### Radio-equipment approval of the tire pressure monitoring system

#### Radio equipment approval numbers

Country	Radio equipment approval number
Canada	FCC ID: MRXAG5SP4
USA	FCC ID: MRXMFR IC: 2546A-AG5SP4

Further information on the declaration of conformity for wireless vehicle components (→ page 23).

### Loading the vehicle

#### Tire and Loading Information placard

**⚠ WARNING** Risk of accident from overloaded tires

Overloaded tires may overheat and burst as a consequence. Overloaded tires can also impair the steering and handling characteristics and lead to brake failure.

- ▶ Observe the load rating of the tires.
- ▶ The load rating must be at least half the permissible axle load of the vehicle.
- ▶ Never overload the tires by exceeding the maximum load.

The Tire and Loading Information placard is on the B-pillar on the driver's side of the vehicle.



① Tire and Loading Information placard

TIRE AND LOADING INFORMATION RENSEIGNEMENTS SUR LES PNEUS ET LE CHARGEMENT			
SEATING CAPACITY NOMBRE DE PLACES	TOTAL	FRONT AVANT	REAR ARRIÈRE
5	4500 kg (9900 lb)	2000 kg (4400 lb)	2500 kg (5500 lb)
The combined weight of occupants and cargo should never exceed XXX kg or XXX lb. Le poids total des occupants et de la cargaison ne doit jamais dépasser XXX kg ou XXX lb.			
TIRE PNEU	SIZE DIMENSIONS	COLD TIRE PRESSURE PRESSION DES PNEUS À FROID	SEE OWNER'S MANUAL FOR ADDITIONAL INFORMATION
FRONT AVANT	205/60-16 HP XL	200 kPa, 29 PSI	VOIR LE MANUEL DE L'USAGER POUR PLUS DE RENSEIGNEMENTS
REAR ARRIÈRE	205/60-16 HP XL	200 kPa, 29 PSI	
SPARE DE SECOURS	175/70-16 HP	420 kPa, 60 PSI	

① The data shown in the image is example data.

The Tire and Loading Information placard shows:

- Maximum number of seats ② according to the maximum number of people permitted to travel in the vehicle.
- Maximum permissible load ③ comprises the gross weight of all vehicle occupants, load and luggage.

- Recommended tire pressures ① for cold tires. The recommended tire pressures are valid for the maximum permissible load and up to the maximum permissible vehicle speed.

Please also note:

- Information on permissible weights and loads on the vehicle identification plate (→ page 445).
- Information on tire pressure on the tire pressure table (→ page 416).

Further related subjects:

- Determining the maximum permissible load (→ page 421)
- Notes on tire pressure (→ page 414)

### Determining the maximum permissible load

The following steps have been developed as required of all manufacturers under Title 49, Code of U.S. Federal Regulations, Part 575, pursuant to the "National Traffic and Motor Vehicle Safety Act of 1966".

- ▶ **Step 1:** locate the statement "The combined weight of occupants and cargo should never exceed XXX kg or XXX lbs." ("The combined weight of occupants and cargo should never exceed XXX kg or XXX lbs.") on your vehicle's Tire and Loading Information placard.
- ▶ **Step 2:** determine the combined weight of the driver and passengers that will be traveling in your vehicle.
- ▶ **Step 3:** subtract the combined weight of the driver and passengers from XXX kg or XXX lbs.
- ▶ **Step 4:** the resulting figure equals the permissible cargo and luggage load capacity. For example: If "XXX" equals 1400 lbs and there are five occupants in your vehicle with a weight of 150 lbs each, the maximum cargo and luggage load capacity is 650 lbs (1400 - 750 (5 x 150) = 650 lbs).
- ▶ **Step 5:** determine the combined weight of luggage and cargo that the vehicle will be carrying. For safety reasons, this weight may not safely exceed the available cargo and luggage load capacity calculated in step 4.

Even if you have calculated the total load carefully, you should still make sure that the maximum permissible gross mass and the maximum permissible axle load of your vehicle are not exceeded. Details can be found on the vehicle identification plate.

- ▶ Have your loaded vehicle – including driver, occupants and load – weighed on a vehicle weighbridge.  
The measured values may not exceed the maximum permissible values stated on the vehicle identification plate.

Further related subjects:

- Calculation example for determining the maximum load (→ page 422)
- Tire and Loading Information placard (→ page 420)
- Tire pressure table (→ page 416)
- Vehicle identification plate

### Calculation example for determining the maximum load

---

The following table shows examples of how to calculate total and load capacities with varying seating configurations and different numbers and sizes of occupants. The following examples use a maximum load of 1500 lbs (680 kg). **This is for illustration purposes only.** Make sure you are using the actual load limit for your vehicle stated on your vehicle's Tire and Loading Information placard (→ page 420).

The higher the weight of all the occupants, the smaller the maximum load for luggage.



**Step 1**

	Example 1	Example 2
Combined maximum weight of occupants and load (data from the Tire and Loading Information placard)	1500 lbs (680 kg)	1500 lbs (680 kg)

**Step 2**

	Example 1	Example 2
Number of people in the vehicle (driver and occupants)	5	1
Distribution of the occupants	Front: 2 Rear: 3	Front: 1
Weight of occupants	Occupant 1: 150 lbs (68 kg) Occupant 2: 180 lbs (82 kg) Occupant 3: 160 lbs (73 kg) Occupant 4: 140 lbs (63 kg) Occupant 5: 120 lbs (54 kg)	Occupant 1: 200 lbs (91 kg)
Total weight of all occupants	750 lbs (340 kg)	200 lbs (91 kg)

**Step 3**

	<b>Example 1</b>	<b>Example 2</b>
Permissible load (maximum gross vehicle weight rating from the Tire and Loading Information placard minus the gross weight of all occupants)	1500 lbs (680 kg) - 750 lbs (340 kg) = 750 lbs (340 kg)	1500 lbs (680 kg) - 200 lbs (91 kg) = 1300 lbs (589 kg)

## Tire labeling

### Overview of tire labeling

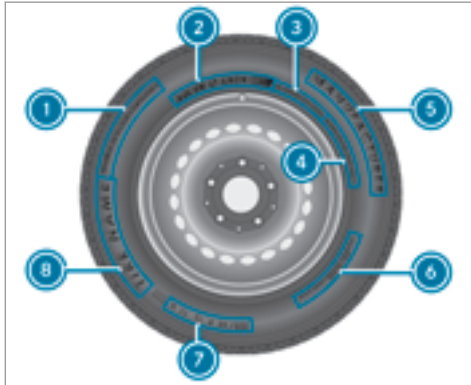

- ① Uniform Tire Quality Grading Standard (→ page 425)
- ② DOT, Tire Identification Number (→ page 426)
- ③ Maximum tire load (→ page 427)
- ④ Maximum tire pressure (→ page 428)

- ⑤ Manufacturer
- ⑥ Characteristics of the tire (→ page 428)
- ⑦ Tire size designation, load-bearing capacity, speed rating and load index (→ page 428)
- ⑧ Tire name
- ① The data shown in the image is example data.

### Tire Quality Grading

In accordance with the US Department of Transportation's "Uniform Tire Quality Grading Standards", tire manufacturers are required to grade their tires on the basis of the following three performance factors:

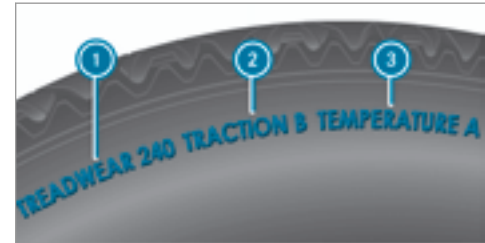

- ① Tread wear grade
- ② Traction grade
- ③ Temperature grade
- ① The data shown in the image is example data.
- ① The classification is not legally stipulated for Canada, but it is generally stated.

### Tread wear grade

The tread wear grade is a comparative rating based on the wear rate of the tire when tested under controlled conditions on a specified test track of the US Department of Transportation. For example, a tire graded 150 would wear one

and one-half times as well on the government test track as a tire graded 100.

The relative performance of tires depends upon the actual conditions of their use, however, and may depart significantly from the norm due to variations in driving habits, service practices and differences in road characteristics and climate conditions.

### Traction grade

**⚠ DANGER** Risk of accident due to inadequate traction

The traction grade assigned to this tire is based on straight-ahead braking traction tests, and does not include either acceleration, cornering, hydroplaning or peak traction characteristics.

- ▶ Always adapt your driving style and drive at a speed to suit the prevailing traffic and weather conditions.

**! NOTE** Damage to the drivetrain from wheelspin

- ▶ Avoid wheelspin.

The traction grades – from highest to lowest – are AA, A, B and C. Those grades represent the tire's ability to stop on wet pavement as measured under controlled conditions on specified government test surfaces made of asphalt and concrete.

### Temperature grade

**⚠ WARNING** Risk of accident from tire overheating and tire failure

The temperature grade for this tire is established for a tire that is properly inflated and not overloaded. Excessive speed, underinflation, or excessive loading, either separately or in combination, can cause excessive heat build-up and possible tire failure.

- ▶ Observe the recommended tire pressures and regularly check the tire pres-

sure of all tires including the spare wheel.

- ▶ Adjust the tire pressure as necessary.

The temperature grades are A (the highest), B and C. They represent the tire's resistance to the generation of heat and its ability to dissipate heat when tested under controlled conditions on a specified indoor laboratory test wheel. Sustained high temperature can cause the material of the tire to degenerate and reduce tire life, and excessive temperature can lead to sudden tire failure. Grade C corresponds to a level of performance which all passenger car tires must meet under the requirements of the US Department of Transportation.

### DOT, Tire Identification Number (TIN)

US tire regulations stipulate that every tire manufacturer or retreader must imprint a TIN in or on the side wall of each tire produced.



**i** The data shown in the image is example data.

The TIN is a unique identification number to identify tires and comprises the following:

- **DOT (Department of Transportation):** tire symbol marks **1** indicating that the tire complies with the requirements of the US Department of Transportation.
- **Manufacturer identification code:** manufacturer identification code **2** contains details of the tire manufacturer. New tires have a code with two symbols. Retreaded tires have a code with four symbols. Further information on retreaded tires (→ page 433).

- **Tire size:** identifier **3** describes the tire size.
- **Tire type code:** tire type code **4** can be used by the manufacturer as a code to describe specific characteristics of the tire.
- **Manufacturing date:** manufacturing date **5** provides information about the age of a tire. The 1st and 2nd positions represent the calendar week and the 3rd and 4th positions state the year of manufacture (e.g. "3208" represents the 32nd week of 2008).

### Information on the maximum tire load



**i** The data shown in the image is example data.

Maximum tire load **1** is the maximum permissible weight for which the tire is approved.

Do not overload the tires by exceeding the specified load limit. The maximum permissible load can be found on the vehicle's Tire and Loading Information placard on the B-pillar on the driver's side (→ page 420).

### Specifications for maximum tire pressure



**i** The data shown in the image is example data.

Never exceed maximum tire pressure ❶ specified for the tire.

### Information on tire characteristics



❶ The data shown in the image is example data.

This information describes the type of tire cord and the number of layers in side wall ❶ and under tire tread ❷.

### Tire size designation, load-bearing capacity, speed rating and load index

**⚠ WARNING** Risk of injury through exceeding the specified tire load rating or the permissible speed rating

Exceeding the specified tire load rating or the permissible speed rating may lead to tire damage and to the tires bursting.

- ▶ Therefore, only use tire types and sizes approved for your vehicle model.
- ▶ Observe the tire load rating and speed rating required for your vehicle.

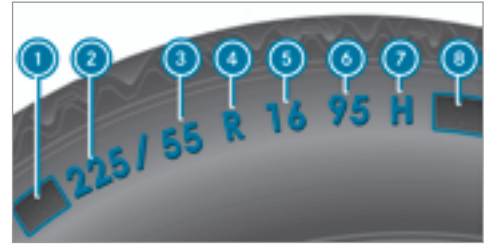

- ❶ Preceding letter
- ❷ Nominal tire width in millimeters
- ❸ Aspect ratio in %
- ❹ Tire code
- ❺ Rim diameter
- ❻ Load-bearing index
- ❼ Speed rating
- ❽ Load index

❶ The data shown in the image is example data.

Information about reading tire data can be obtained from any qualified specialist workshop.

**Preceding letter 1:**

- Without: passenger vehicle tires according to European manufacturing standards.
- "P": passenger vehicle tires according to US manufacturing standards.
- "LT": light truck tires according to US manufacturing standards.
- "T": compact emergency spare wheels with high tire pressure that are only designed for temporary use in an emergency.

**Aspect ratio 3:**

Ratio between tire height and tire width in percent (tire height divided by tire width).

**Tire code 4 (tire type):**

- "R" radial tire
- "D": bias ply tire
- "B": bias belted tires
- "ZR": radial tire with a maximum speed above 149 mph (240 km/h) (optional)

**Rim diameter 5:**

The diameter of the bead seat (not the diameter of the rim flange). The rim diameter is specified in inches (in).

**Load-bearing index 6:**

Numerical code that specifies the maximum load-bearing capacity of a tire (e.g. "91" corresponds to 1356 lbs (615 kg)).

The load-bearing capacity of the tire must be at least half the permissible axle load of your vehicle. Do not overload the tires by exceeding the specified load limit.

See also:

- Maximum permissible load on the Tire and Loading Information placard (→ page 420)
- Maximum tire load (→ page 427)
- Load index

**Speed rating 7:**

Specifies the approved maximum speed of the tire.





- ⓘ An electronic speed limiter prevents your vehicle from exceeding a speed of 130 mph (210 km/h).

Make sure that your tires have the required speed rating. You can obtain information on the required speed rating from an authorized Mercedes-Benz Center.

**Summer tires**

Index	Speed rating
Q	up to 100 mph (160 km/h)
R	up to 106 mph (170 km/h)
S	up to 112 mph (180 km/h)
T	up to 118 mph (190 km/h)
H	up to 130 mph (210 km/h)
V	up to 149 mph (240 km/h)
W	up to 168 mph (270 km/h)
Y	up to 186 mph (300 km/h)

Index	Speed rating
ZR...Y <sup>1</sup>	up to 186 mph (300 km/h)
ZR...(..Y) <sup>1</sup>	over 186 mph (300 km/h)
ZR <sup>1</sup>	over 149 mph (240 km/h)

- Specifying the speed rating as the "ZR" index in tire code  is optional for tires up to 186 mph (300 km/h).
- If your tire code  includes "ZR" and there is no speed rating , find out what the maximum speed is from the tire manufacturer.
- If load-bearing index  and speed rating  are in brackets, the maximum speed rating of your tire is above 186 mph (300 km/h). To find out the maximum speed, ask the tire manufacturer.

### All-weather tires and winter tires

Index	Speed rating
Q M+S <sup>2</sup>	up to 100 mph (160 km/h)
T M+S <sup>2</sup>	up to 118 mph (190 km/h)
H M+S <sup>2</sup>	up to 130 mph (210 km/h)
V M+S <sup>2</sup>	up to 149 mph (240 km/h)

Winter tires bear the  snowflake symbol and fulfill the requirements of the Rubber Manufacturers Association (RMA) and the Rubber Association of Canada (RAC) regarding the tire traction on snow.

### Load index :

- No specification given: standard load (SL) tire
- "XL" or "Extra Load": extra load tire or reinforced tire
- "Light Load": light load tire

- "C", "D", "E": a load range that depends on the maximum load that the tire can carry at a certain pressure

### Definition of terms for tires and loading

**Tire structure and characteristics:** describes the number of layers or the number of rubber-coated belts in the tire contact surface and the tire wall. These are made of steel, nylon, polyester and other materials.

**Bar:** metric unit for tire pressure. 14.5038 pounds per square inch (psi) and 100 kilopascal (kPa) is the equivalent of one bar.

**DOT (Department of Transportation):** DOT-marked tires fulfill the requirements of the US Department of Transportation.

**Average weight of the vehicle occupants:** the number of vehicle occupants for which the vehicle is designed, multiplied by 150 lb (68 kg).

<sup>1</sup> "ZR" stated in the tire code.

<sup>2</sup> Or "M+S  " for winter tires



**Uniform Tire Quality Grading Standards:** a uniform standard to grade the quality of tires with regard to tread quality, tire traction and temperature characteristics. The quality grading assessment is made by the manufacturer following specifications from the U.S. government. The quality grade of a tire is imprinted on the side wall of the tire.

**Recommended tire pressure:** the recommended tire pressure is the tire pressure specified for the tires mounted to the vehicle at the factory.

The tire and information table contains the recommended tire pressures for cold tires, the maximum permissible load and the maximum permissible vehicle speed.

The tire pressure table contains the recommended tire pressures for cold tires under various operating conditions, i.e. loading and/or speed of the vehicle.

**Increased vehicle weight due to optional equipment:** the combined weight of all standard and optional equipment available for the vehicle,

regardless of whether it is actually installed on the vehicle or not.

**Rim:** the part of the wheel on which the tire is installed.

**GAWR (Gross Axle Weight Rating):** the GAWR is the maximum permissible axle load. The actual load on an axle must never exceed the gross axle weight rating. The gross axle weight rating can be found on the vehicle identification plate on the B-pillar on the driver's side.

**Speed rating:** the speed rating is part of the tire identification. It specifies the speed range for which a tire is approved.

**GVW (Gross Vehicle Weight):** the gross vehicle weight comprises the weight of the vehicle including fuel, tools, the spare wheel, accessories installed, occupants, luggage and the trailer drawbar noseweight, if applicable. The gross vehicle weight must not exceed the gross vehicle weight rating GVWR as specified on the vehicle identification plate on the B-pillar on the driver's side.

**GVWR (Gross Vehicle Weight Rating):** the GVWR is the maximum permitted gross weight

of the fully laden vehicle (weight of the vehicle including all accessories, occupants, fuel, luggage and the trailer drawbar noseweight if applicable). The gross vehicle weight rating is specified on the vehicle identification plate on the B-pillar on the driver's side.

**Maximum weight of the laden vehicle:** the maximum weight is the sum of the curb weight of the vehicle, the weight of the accessories, the maximum load and the weight of optional equipment installed at the factory.

**Kilopascal (kPa):** metric unit for tire pressure. 6.9 kPa corresponds to 1 psi. Another unit for tire pressure is bar. 100 kilopascal (kPa) equals 1 bar.

**Load index:** in addition to the load-bearing index, the load index may also be imprinted on the side wall of the tire. This specifies the load-bearing capacity of the tire more precisely.

**Curb weight:** the weight of a vehicle with standard equipment including the maximum capacity of fuel, oil and coolant. It also includes the air conditioning system and optional equipment if

these are installed on the vehicle, but does not include passengers or luggage.

**Maximum tire load:** the maximum tire load is the maximum permissible weight in kilograms or lbs for which a tire is approved.

**Maximum permissible tire pressure:** maximum permissible tire pressure for one tire.

**Maximum load on one tire:** maximum load on one tire. This is calculated by dividing the maximum axle load of one axle by two.

**PSI (pounds per square inch):** standard unit of measurement for tire pressure.

**Aspect ratio:** ratio between tire height and tire width in percent.

**Tire pressure:** pressure inside the tire applying an outward force to every square inch of the tire. The tire pressure is specified in pounds per square inch (psi), in kilopascals (kPa) or in bar. The tire pressure should only be corrected when the tires are cold.

**Cold tire pressure:** the tires are cold when the vehicle has been parked for at least 3 hours

without direct sunlight on the tires or the vehicle has been driven for less than 1 mile (1.6 km).

**Tire contact surface:** the part of the tire that comes into contact with the road.

**Tire bead:** the purpose of the tire bead is to ensure that the tire sits securely on the wheel rim. There are several wire cores in the tire bead to prevent the tire from changing length on the wheel rim.

**Side wall:** the part of the tire between the tread and the tire bead.

**Weight of optional equipment:** the combined weight of the optional equipment weighing more than the replaced standard parts and more than 5 lbs (2.3 kg). This optional equipment, such as high-performance brakes, level control system, a roof luggage rack or high-performance batteries, is not included in the curb weight and the weight of the accessories.

**TIN (Tire Identification Number):** a unique identification number which can be used by a tire manufacturer to identify tires, for example, in a product recall, and thus identify the purchasers. The TIN is made up of the manufactur-

er's identity code, tire size, tire type code and the manufacturing date.

**Load-bearing index:** the load-bearing index is a code that contains the maximum load-bearing capacity of a tire.

**Traction:** traction is the grip resulting from friction between the tires and the road surface.

**Wear indicator:** narrow bars (tread wear bars) that are distributed over the tire contact surface. If the tire tread is level with the bars, the wear limit of 1/16 in (1.6 mm) has been reached.

**Distribution of vehicle occupants:** distribution of vehicle occupants over designated seat positions in a vehicle.

**Maximum permissible payload weight:** nominal load and luggage load plus 150 lb (68 kg) multiplied by the number of seats in the vehicle.

## Changing a wheel

### Notes on selecting, mounting and replacing tires

**Mercedes-AMG vehicles:** be sure to observe the notes in the Supplement. Otherwise, you may not recognize dangers.

You can ask for information regarding permitted wheel/tire combinations at an authorized Mercedes-Benz Center.

**⚠ WARNING** Risk of accident due to incorrect dimensions of wheels and tires

If wheels and tires of the wrong size are installed, the wheel brakes or wheel suspension components may be damaged.

▶ Always replace wheels and tires with those that fulfill the specifications of the original part.

When replacing wheels, make sure to fit the correct:

- Designation

- Model

When replacing tires, make sure to install the correct:

- Designation
- Manufacturer
- Model

**⚠ WARNING** Risk of injury through exceeding the specified tire load rating or the permissible speed rating

Exceeding the specified tire load rating or the permissible speed rating may lead to tire damage and to the tires bursting.

- ▶ Therefore, only use tire types and sizes approved for your vehicle model.
- ▶ Observe the tire load rating and speed rating required for your vehicle.

**! NOTE** Damage to vehicle and tires due to non-approved tire types and sizes

For safety reasons, only use wheels, tires and accessories which have been approved for your vehicle by Mercedes-Benz.

These tires have been specially adapted for use with the control systems, e.g. ABS or ESP®, and are marked as follows:

- MO = Mercedes-Benz Original
- MOE = Mercedes-Benz Original Extended (run-flat tires only for certain wheels)
- MO1 = Mercedes-Benz Original (only certain AMG tires)

Certain characteristics, e.g. handling, vehicle noise emissions or fuel consumption, may otherwise be adversely affected. In addition, when driving with a load, tire dimension variations could cause the tires to come into contact with the body and axle components. This could result in damage to the tires or the vehicle.

Only use tires, wheels or accessories tested and approved by Mercedes-Benz.

**!** **NOTE** Risk to driving safety from retreaded tires

Retreaded tires are neither tested nor recommended by Mercedes-Benz, since previous damage cannot always be detected on retreaded tires.

For this reason driving safety cannot be guaranteed.

▶ Do not use used tires if you have no information about their previous usage.

**!** **NOTE** Possible damage to wheels or tires when driving over obstacles

Large wheels have a lower tire section width. The lower the tire section width, the greater is the risk of damage to wheels or tires when driving over obstacles.

▶ Avoid obstacles or drive particularly carefully.

**!** **NOTE** Damage to electronic component parts from the use of tire-mounting tools

**Vehicles with a tire pressure monitoring system:** Electronic component parts are located in the wheel. Tire-mounting tools should not be used in the area of the valve.

This could otherwise damage the electronic component parts.

▶ Have the tires changed at a qualified specialist workshop only.

**!** **NOTE** Damage to summer tires at low ambient temperatures

Using summer tires at very low ambient temperatures can cause cracks to form, thereby damaging the tires permanently.

▶ At temperatures below 45 °F (7 °C) use M+S tires.

Accessory parts that are not approved for your vehicle by Mercedes-Benz or are not being used correctly can impair the operating safety.

Before purchasing and using non-approved accessories, visit a qualified specialist workshop and inquire about:

- Suitability
- Legal stipulations
- Factory recommendations

**!** **WARNING** Risk of accident with high performance tires

The special tire tread in combination with the optimized tire compound means that the risk of skidding or hydroplaning on wet roads is increased.

In addition, the tire grip is greatly reduced at a low outside temperature and tire running temperature.

- ▶ Switch on the ESP<sup>®</sup> and adapt your driving style accordingly.
- ▶ Use M+S tire at outside temperatures of less than 10 °C (50 °F).

Observe the following when selecting, mounting and replacing tires:

- Only use tires and wheels of the same type (summer tires, winter tires, MOExtended tires) and the same make.
- Only mount wheels of the same size on one axle (left and right).  
It is only permissible to install a different wheel size in the event of a flat tire in order to drive to the specialist workshop.
- Only mount tires of the correct size onto the wheels.
- **Vehicles with a tire pressure monitoring system:** All mounted wheels must be equipped with functioning sensors for the tire pressure monitoring system.
- At temperatures below 45 °F (7 °C), use winter tires or all-season tire marked M+S for all wheels.

Winter tires bearing the  snowflake symbol in addition to the M+S marking provide the best possible grip in wintry road conditions.

- For M+S tires, only use tires with the same tread.
- Observe the maximum permissible speed for the M+S tire mounted.  
If this is below the vehicle's maximum speed, this must be indicated in an appropriate label in the driver's field of vision.
- Break in new tires at moderate speeds for the first 60 miles (100 km).
- Replace the tires after six years at the latest, regardless of wear.
- **When replacing with tires that do not feature run-flat characteristics:** vehicles with MOExtended tires are not equipped with a TIREFIT kit at the factory. Equip the vehicle with a TIREFIT kit after replacing with tires that do not feature run-flat characteristics, e.g. winter tires.

For more information on wheels and tires, contact a qualified specialist workshop.

Be sure to also observe the following further related subjects:

- Notes on tire pressure (→ page 414)

- Tire and Loading Information placard (→ page 420)
- Tire size designation, load-bearing capacity, speed rating and load index (→ page 428)
- Tire pressure table (→ page 416)

### Notes on interchanging wheels

 **WARNING** Risk of injury through different wheel sizes

Interchanging the front and rear wheels if the wheels or tires have different dimensions may severely impair the driving characteristics.

The wheel brakes or wheel suspension components may also be damaged.

 Rotate front and rear wheels only if the wheels and tires are of the same dimensions.

The wear patterns on the front and rear wheels differ:

- Front wheels wear more on the shoulder of the tire.
- Rear wheels wear more in the center of the tire.

On vehicles that have the same size front and rear wheels, interchange the wheels according to the intervals in the tire manufacturer's warranty book in your vehicle documents. If this is not available, interchange the tires every 3000 to 6000 miles (5000 to 10000 km), depending on the wear. Ensure that the direction of rotation is maintained.

It is imperative to observe the instructions and safety notes on "Wheel change" when doing so.

### Notes on storing wheels

- After removing wheels, store them in a cool, dry and preferably dark place.
- Protect the tires from contact with oil, grease or fuel.

### Overview of the tire-change tool kit

Apart from some country-specific variants, vehicles are not equipped with a tire-change tool kit. For more information on which tire-changing tools are required and approved for performing a wheel change on your vehicle, consult a qualified specialist workshop.

Required tire-change tools may include, for example:

- Jack
- chock
- Lug wrench
- Centering pin

The tire-change tool kit is located under the trunk floor.

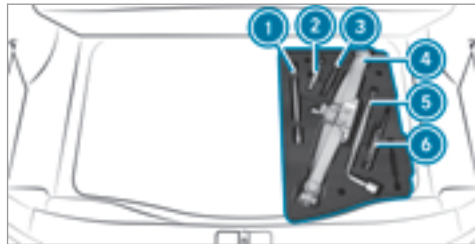

- ① Ratchet
- ② Centering pin
- ③ Jacking support
- ④ Jack
- ⑤ Lug wrench
- ⑥ Folding chock

## Setting up the folding wheel chock

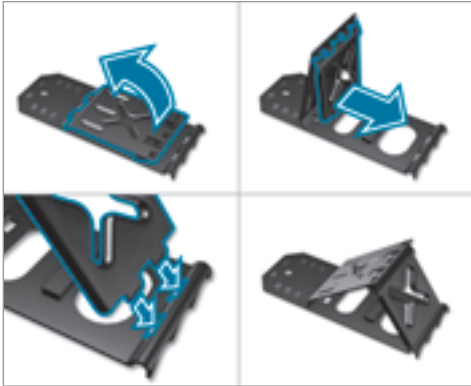

## Preparing the vehicle for a wheel change

### Requirements:

- The required tire-change tool kit is available. If your vehicle is not equipped with the tire-change tool kit, consult a qualified specialist workshop to find out about suitable tools.

- The vehicle is not on a slope.
  - The vehicle is on solid, non-slippery and level ground.
- ▶ Apply the electric parking brake manually.
  - ▶ Move the front wheels to the straight-ahead position.
  - ▶ Shift the transmission to position **P**.
  - ▶ **Vehicles with AIR BODY CONTROL or MAGIC BODY CONTROL:** Set the normal vehicle level.
  - ▶ Switch off the engine.
  - ▶ Make sure that the engine cannot be started.
  - ▶ Place chocks or other suitable items under the front and rear of the wheel that is diagonally opposite the wheel you wish to change.
  - ▶ Remove the hub caps if necessary (→ page 437).
  - ▶ Raise the vehicle (→ page 438).

## Removing and mounting hub caps

### Requirement:

- The vehicle is prepared for a wheel change (→ page 437).

### Plastic hub cap

- ▶ **To remove:** turn the center cover of the hub cap counter-clockwise and remove the hub cap.
- ▶ **To mount:** make sure that the center cover of the hub cap is turned counter-clockwise.
- ▶ Position the hub cap and turn the center cover clockwise until the hub cap engages physically and audibly.

## Aluminum hub cap

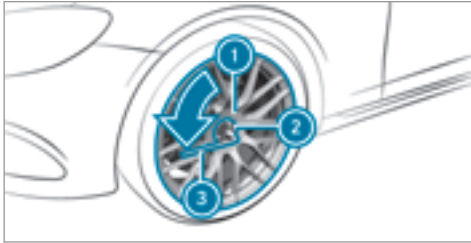

▶ **To remove:** position socket ② on hub cap ①.

① The socket can be found in the tire-change tool kit.

▶ Position wheel wrench ③ on socket ②.

▶ Using wheel wrench ③, turn hub cap ① counter-clockwise and remove it.

▶ **To mount:** position hub cap ① and turn until it is completely flush with the wheel.

▶ Position socket ② on hub cap ①.

▶ Attach wheel wrench ③ to socket ② and tighten the hub cap clockwise.

**Specified tightening torque:** 18 lb-ft (25 Nm).

▶ Raising the vehicle (→ page 438).

## Raising the vehicle when changing a wheel

### Requirements:

- There are no persons in the vehicle.
- The vehicle is prepared for a wheel change (→ page 437).
- The hub caps have been removed (→ page 437).

### Important notes on using the jack:

- Use only the vehicle-specific jack that has been tested and approved by Mercedes-Benz to raise the vehicle.
- The jack is only designed for raising and holding the vehicle for a short time while a wheel is being changed and not for maintenance work under the vehicle.

- The jack must be placed on a firm, flat and non-slip surface. If necessary, use a large, load-bearing, non-slip underlay.
- The base of the jack must be positioned vertically under the jack support point.

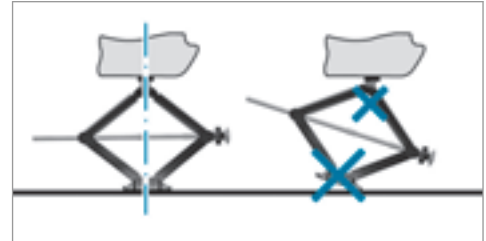

### Rules of conduct when the vehicle is raised:

- Never place your hands or feet under the vehicle.
- Do not lie under the vehicle.
- Do not start the engine and do not release the electric parking brake.
- Do not open or close any doors or the trunk lid.





- ▶ Using the wheel wrench, loosen the wheel bolts on the wheel you wish to change by about one full turn. Do not unscrew the screws completely.

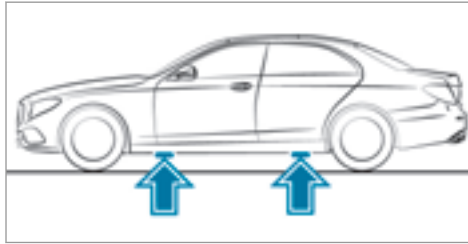

Position of jack support points

- ⚠ **WARNING** Risk of injury from incorrect positioning of the jack

If you do not position the jack correctly at the appropriate jacking point of the vehicle, the jack could tip with the vehicle raised.

- ▶ Only position the jack at the appropriate jacking point of the vehicle. The base of the jack must be positioned vertically under the jacking point of the vehicle.

- ⓘ **NOTE** Vehicle damage from the jack

If you do not position the jack correctly at the appropriate jack support point of the vehicle, the jack could tip over with the vehicle raised.

- ▶ The jack is designed exclusively for jacking up the vehicle at the jack support points.

- ▶ Take the box wrench out of the tire-change tool kit and place it on the hexagon nut of the jack so that the letters AUF are visible.

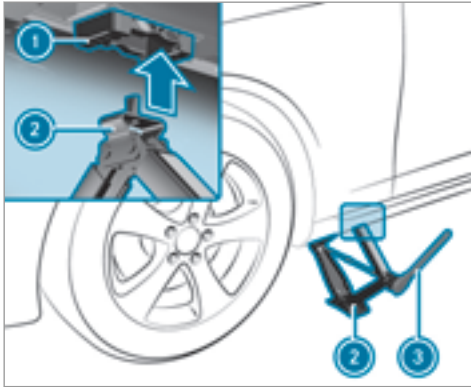

- ▶ Position jack ② at jack support point ①.
- ▶ Turn box wrench ③ clockwise until jack ② sits completely on jack support point ① and the base of the jack lies evenly on the ground.
- ▶ Continue to turn box wrench ③ until the tire is raised a maximum of 1.2 in (3 cm) off the ground.
- ▶ Loosen and remove the wheel (→ page 440).

## Removing a wheel

### Requirement:

- The vehicle is raised (→ page 438).

When changing a wheel, avoid applying any force to the brake discs, since this could impair the level of comfort when braking.

**!** **NOTE** Damage to threading from dirt on wheel bolts

▶ Do not place wheel bolts in sand or on a dirty surface.

- ▶ Unscrew the uppermost wheel bolt completely.

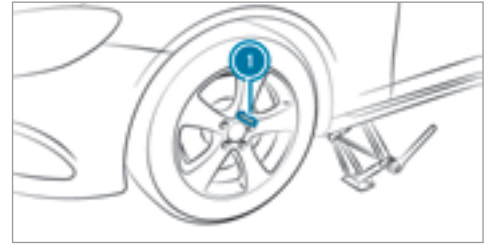

- ▶ Screw centering pin ① instead of the wheel bolt into the threading.
- ▶ Unscrew the remaining wheel bolts fully.
- ▶ Remove the wheel.
- ▶ Mount the new wheel (→ page 440).

## Mounting a new wheel

### Requirement:

- The wheel is removed (→ page 440).

**⚠ WARNING** Risk of accident from losing a wheel

Oiled, greased or damaged wheel bolt/wheel nut threads or wheel hub/wheel mounting bolt threads can cause the wheel bolts/wheel nuts to come loose.

As a result, you could lose a wheel while driving.

- ▶ Never oil or grease the threads.
- ▶ In the event of damage to the threads, contact a qualified specialist workshop immediately.
- ▶ Have the damaged wheel bolts or damaged hub threads replaced.
- ▶ Do not continue driving.

- ▶ Observe the information on the choice of tires (→ page 433).

For tires with a specified direction of rotation, an arrow on the side wall of the tire indicates the correct direction of rotation. Observe the direction of rotation when installing.

- ▶ Slide the wheel to be mounted onto the centering pin and push it on.

**⚠ WARNING** Risk of injury from tightening wheel bolts and nuts

If you tighten the wheel bolts or wheel nuts when the vehicle is raised, the jack could tip.

- ▶ Only tighten wheel bolts or wheel nuts when the vehicle is on the ground.

- ▶ For safety reasons, only use wheel bolts which have been approved for Mercedes-Benz and the wheel in question.

**! NOTE** Damage to paintwork of the wheel rim when screwing on the first wheel bolt

If the wheel has too much play when screwing in the first wheel bolt, the wheel rim paint can be damaged.

- ▶ Press the wheel firmly against the wheel hub when screwing on the first wheel bolt.

- ▶ Tighten the wheel bolts until they are finger-tight.
- ▶ Unscrew the centering pin.
- ▶ Tighten the last wheel bolt until it is finger-tight.
- ▶ Lower the vehicle (→ page 441).

### Lowering the vehicle after a wheel change

**Requirements:**

- The new wheel has been mounted (→ page 440).
- ▶ Place the ratchet wrench onto the hexagon nut of the jack so that the letters "AB" are visible.
- ▶ **To lower the vehicle:** turn the ratchet wrench of the jack counter-clockwise.

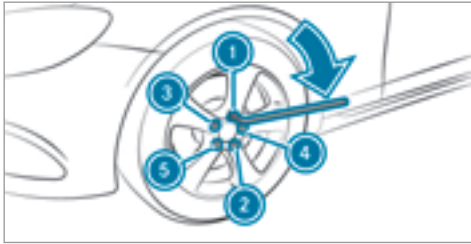

- ▶ Tighten the wheel bolts evenly in a crosswise pattern in the sequence indicated (① to ⑤).  
**Specified tightening torque:** 111 lb-ft (150 Nm).

**⚠ WARNING** Risk of accident due to incorrect tightening torque

The wheels could come loose if the wheel bolts or wheel nuts are not tightened to the prescribed tightening torque.

- ▶ Have the tightening torque checked immediately at a qualified specialist workshop after changing a wheel.

- ▶ Check the tire pressure of the newly mounted wheel and adjust accordingly.
- ▶ **Vehicles with a tire pressure monitoring system:** Restart the tire pressure monitoring system (→ page 420).

Make sure to observe the following further related subject:

- Notes on tire pressure (→ page 414)

### Notes on technical data

**Plug-in hybrid:** observe the notes in the Supplement. Otherwise, you may not recognize dangers.

**Mercedes-AMG vehicles:** observe the notes in the Supplement. Otherwise, you may not recognize dangers.

The data stated only applies to vehicles with standard equipment. You can obtain further information from an authorized Mercedes-Benz Center.

### Vehicle electronics

#### Two-way radios

##### Notes on installing two-way radios

**⚠ WARNING** Risk of accident due to improper work on two-way radios

The electromagnetic radiation from two-way radios can interfere with the on-board electronics if RF transmitters are manipulated or retrofitted incorrectly.

This could jeopardize the operating safety of the vehicle.

- ▶ You should have all work on electrical and electronic components carried out at a qualified specialist workshop.

**⚠ WARNING** Risk of accident from incorrect operation of two-way radios

If you operate two-way radios incorrectly in the vehicle, the electromagnetic radiation could interfere with the on-board electronics, e.g.:

- if the two-way radio is not connected to an exterior antenna
- if the exterior antenna is not correctly mounted or is not of low reflection

This could jeopardize the operating safety of the vehicle.

- ▶ Have the low-reflection exterior antenna installed at a qualified specialist workshop.

- ▶ When operating two-way radios in the vehicle, always connect them to the low-reflection exterior antenna.

**! NOTE** Invalidation of the operating permit due to failure to comply with the instructions for installation and use

The operating permit may be invalidated if the instructions for installation and use of two-way radios are not observed.

- ▶ Only use approved frequency bands.
- ▶ Observe the maximum permissible output power in these frequency bands.
- ▶ Only use approved antenna positions.

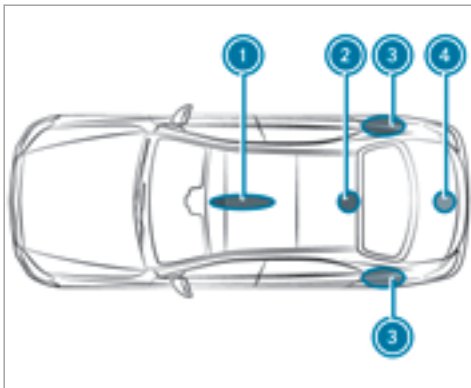

- ① Front roof area
- ② Rear roof area
- ③ Rear fender
- ④ Trunk lid

On vehicles with a panoramic sliding sunroof, installing an antenna to the front or rear roof area is not permitted.

On the rear fenders, it is recommended that you position the antenna on the side of the vehicle closest to the center of the road.

Use Technical Specification ISO/TS 21609 (Road Vehicles - "EMC guidelines for installation of aftermarket radio frequency transmitting equipment") when retrofitting two-way radios. Comply with the legal requirements for detachable parts.

If your vehicle has installations for two-way radio equipment, use the power supply or antenna connections intended for use with the basic wiring. Observe the manufacturer's supplements when installing.

#### Two-way radio transmission output

The maximum transmission output (PEAK) at the base of the antenna must not exceed the values in the following table:

#### Frequency band and maximum transmission output

Frequency band	Maximum transmission output
Short wave 3 - 54 MHz	100 W
4 m waveband 74 - 78 MHz	30 W
2 m waveband 144 - 174 MHz	50 W
Trunked radio system/Tetra 380 - 460 MHz	10 W
70 cm waveband 400 - 460 MHz	35 W
Mobile communications (2G/3G/4G)	10 W

The following can be used in the vehicle without restrictions:

- RF transmitters with a maximum transmission output of up to 100 mW
- RF transmitters with transmitter frequencies in the 380 - 410 MHz frequency band and a maximum transmission output of up to 2 W (trunked radio system/Tetra)
- Mobile phones (2G/3G/4G)

There are no restrictions when positioning the antenna on the outside of the vehicle for some frequency bands.

This applies to the following frequency bands:

- Trunked radio system/Tetra
- 70 cm waveband
- 2G/3G/4G

### Vehicle identification plate, VIN and engine number overview

#### Vehicle identification plate

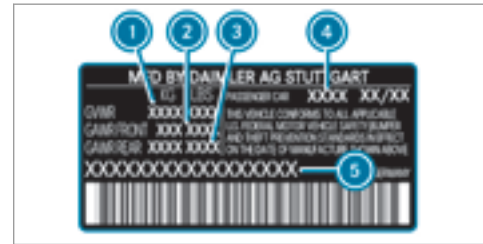
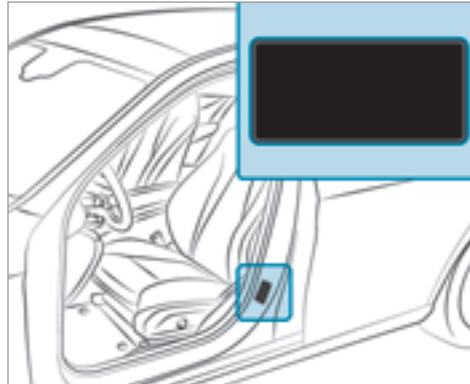

Vehicle identification plate (USA only)

- 1 Permissible gross mass
- 2 Permissible front axle load
- 3 Permissible rear axle load
- 4 Paint code
- 5 VIN (vehicle identification number)

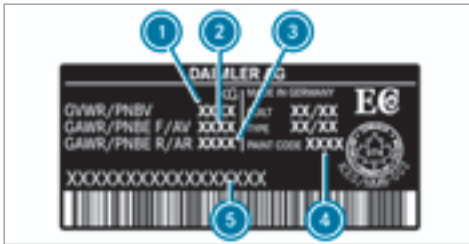

Vehicle identification plate (Canada only)

- ① Permissible gross mass
- ② Permissible front axle load
- ③ Permissible rear axle load
- ④ Paint code
- ⑤ VIN (vehicle identification number)

The maximum permissible gross vehicle weight is made up of the vehicle weight, all vehicle occupants, the fuel and the load. The maximum permissible axle load is the maximum weight that can be carried by one axle (front or rear axle).

Never exceed the maximum permissible gross vehicle weight or the maximum permissible axle load for the front or rear axle.

### VIN in front of the front seat

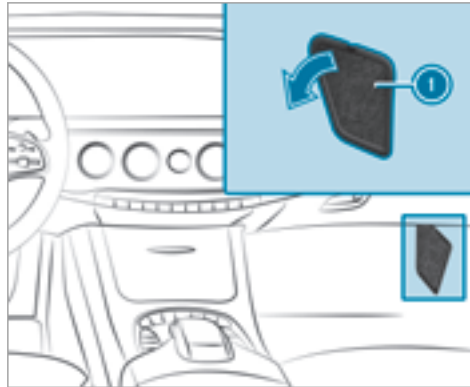

- ① VIN (vehicle identification number)

### Additional plates

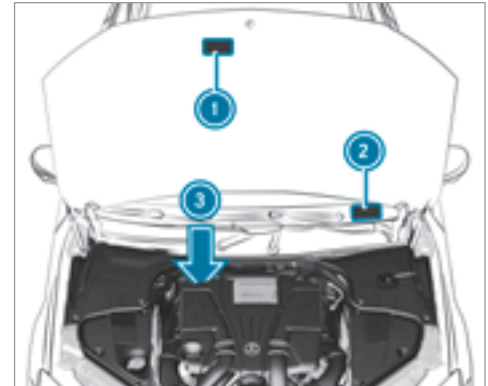

- ① Plate with information about emissions testing, including confirmation of emissions guidelines at the U.S. federal level as well as for California
- ② VIN (vehicle identification number)
- ③ Engine number stamped into the crankcase



## Operating fluids

### Notes on operating fluids

**Mercedes-AMG vehicles:** observe the notes in the Supplement. Otherwise, you may not recognize dangers.

**⚠ WARNING** Risk of injury from operating fluids harmful to your health

Operating fluids may be poisonous and harmful to your health.

- ▶ Observe the text on the original containers when using, storing or disposing of operating fluids.
- ▶ Always store operating fluids sealed in their original containers.
- ▶ Always keep children away from operating fluids.

**⚠ WARNING** Risk of fire and explosion caused by fuel

Fuels are highly inflammable.

- ▶ You must avoid fire, open flames, creating sparks and smoking.
- ▶ Before refueling, switch off the engine and, if installed in your vehicle, the stationary heater.

**⚠ WARNING** Risk of injury from fuel

Fuels are poisonous and harmful to your health

- ▶ Do not swallow fuel or let it come into contact with skin, eyes or clothing.
- ▶ Do not inhale fuel vapors.
- ▶ Keep children away from fuel.

If you or other people come into contact with fuel, observe the following:

- ▶ Immediately rinse fuel off your skin with soap and water.
- ▶ If fuel comes into contact with your eyes, immediately rinse them thoroughly with clean water. Seek medical attention immediately.

- ▶ If you swallow fuel, seek medical attention immediately. Do not induce vomiting.
- ▶ Change immediately out of clothing that has come into contact with fuel.

**🔥 ENVIRONMENTAL NOTE** Environmental pollution caused by environmentally irresponsible disposal

- ▶ Dispose of operating fluids in an environmentally responsible manner.

Operating fluids include the following:

- Fuels
- Lubricants
- Coolant
- Brake fluid
- Windshield washer fluid
- Climate control system refrigerant

Only use products recommended by Mercedes-Benz.

You can identify operating fluids approved by Mercedes-Benz by the following inscriptions on the container:

- MB-Freigabe (e.g. MB-Freigabe 229.51)
- MB-Approval (e.g. MB-Approval 229.51)

Further information on approved operating fluids:

- In the Mercedes-Benz Specifications for Operating Fluids at <http://bevo.mercedes-benz.com> (by entering the designation)
- At a qualified specialist workshop

## Fuel

### Information on fuel grades for vehicles with a gasoline engine

Observe the notes on operating fluids (→ page 447).

#### **!** NOTE Damage caused by the wrong fuel

Even small amounts of the wrong fuel could result in damage to the fuel system, the engine and the emission control system.

▶ Only refuel with low-sulfur premium grade fuel.

This fuel may contain up to 10 % ethanol. Your vehicle is suitable for use with E10 fuel.

Do not refuel using:

- Diesel
- E15, E85, E100
- Gasoline containing methanol (M15, M30, M85, M100)
- Gasoline with additives containing metal

If you accidentally refuel with the wrong fuel:

- ▶ Do not switch the ignition on.
- ▶ Consult a qualified specialist workshop.

If the available fuel is not sufficiently low in sulfur, this can produce unpleasant odors.

Only refuel with fuel, that has at least the octane number specified in the information table in the fuel filler flap (→ page 177).

**If you want maximum engine output:** only refuel with unleaded premium grade gasoline

with an octane number of at least 91 AKI/95 RON.

As a temporary measure, if the recommended fuel is not available, you may also use unleaded regular gasoline with an octane number of at least 87 AKI/91 RON.

#### **!** NOTE Premature wear through unleaded regular gasoline

Unleaded regular gasoline can cause the engine to wear more quickly and impair longevity and performance.

If unleaded premium grade gasoline is unavailable and you have to refuel using unleaded regular gasoline with 87 AKI/91 RON:

- ▶ Only fill the fuel tank to half full with unleaded regular gasoline and top up as soon as possible with unleaded premium grade gasoline.
- ▶ Do not drive at the maximum speed.
- ▶ Avoid sudden acceleration and engine speeds over 3000 rpm.

This may reduce engine performance and increase fuel consumption. Never refuel using gasoline with a lower octane number.

Further information on fuel can be found:

- At a gas station
- At a qualified specialist workshop
- **USA only:** Under <http://www.mbusa.com>

### Information on additives in gasoline

Observe the notes on operating fluids (→ page 447).

**!** **NOTE** Damage caused by non-approved additives

Even small amounts of the wrong additive may lead to malfunctions occurring.

- ▶ Only add cleaning additives recommended by Mercedes-Benz to the fuel.

Mercedes-Benz recommends that you use fuel brands that have additives.

The fuel grade available in some countries may not be sufficient. Residue could build up in the fuel injection system as a result. In this case, in

consultation with an authorized Mercedes-Benz Center, the fuel may be mixed with the cleaning additive recommended by Mercedes-Benz. Be sure to observe the notes and mixing ratios specified on the container.

### Tank capacity and reserve fuel level

The total capacity of the fuel tank may vary, depending on the vehicle equipment.

Model	Total capacity
All models	21.1 gal (80.0 l)
Model	Of which reserve
All models	2.1 gal (8.0 l)

### Engine oil

#### Notes on engine oil

Observe the notes on operating fluids (→ page 447).



**!** **NOTE** Engine damage caused by an incorrect oil filter, incorrect oil or additives

- ▶ Do not use engine oils or oil filters other than those which meet the specifications necessary for the prescribed service intervals.
- ▶ Do not alter the engine oil or oil filter in order to achieve longer change intervals than prescribed.
- ▶ Do not use additives.
- ▶ Have the engine oil changed after the prescribed intervals.

Mercedes-Benz recommends that you have the oil change carried out at a qualified specialist workshop.

Further information on engine oils and oil filters:

- In the Mercedes-Benz Specifications for operating fluids at <http://bevo.mercedes-benz.com> (by entering the designation)
- At a qualified specialist workshop

### Quality and filling capacity of engine oil

#### MB-Freigabe or MB-Approval

Sedan	MB-Freigabe or MB-Approval
S 450 4MATIC	229.5, 229.6
S 560 4MATIC	229.52, 229.61

Long wheelbase vehicles	MB-Freigabe or MB-Approval
S 450 4MATIC S 450	229.5, 229.6
S 600	229.5
All other models	229.52, 229.61

Mercedes-Maybach	MB-Freigabe or MB-Approval
S 650 Mercedes-Maybach	229.5
S 560 4MATIC Mercedes-Maybach	229.52, 229.61

The following values refer to an oil change, including the oil filter.

### Capacity

Sedan	Capacity
S 450 4MATIC	6.9 US qt (6.5 l)
S 560 4MATIC	9.5 US qt (9.0 l)

Long wheelbase vehicles	Capacity
S 450 4MATIC S 450	6.9 US qt (6.5 l)
S 600	11.1 US qt (10.5 l)
All other models	9.5 US qt (9.0 l)

Mercedes-Maybach	Capacity
S 650 Mercedes-Maybach	11.1 US qt (10.5 l)
S 560 4MATIC Mercedes-Maybach	9.5 US qt (9.0 l)

## Notes on brake fluid

Observe the notes on operating fluids (→ page 447).

**⚠ WARNING** Risk of an accident due to vapor pockets forming in the brake system

The brake fluid constantly absorbs moisture from the air. This lowers the boiling point of the brake fluid. If the boiling point is too low, vapor pockets may form in the brake system when the brakes are applied hard.

This causes the braking effect to be impaired.

▶ Have the brake fluid renewed at the specified intervals.

Have the brake fluid regularly changed at a qualified specialist workshop.

Only use brake fluid approved by Mercedes-Benz according to MB-Freigabe or MB-Approval 331.0.

Further information on brake fluid:

- In the Mercedes-Benz Specifications for Operating Fluids at <http://bevo.mercedes-benz.com>
- At a qualified specialist workshop

## Coolant

### Notes on coolant

Observe the notes on operating fluids (→ page 447).

**⚠ WARNING** - Risk of fire and injury from antifreeze

If antifreeze comes into contact with hot component parts in the engine compartment, it may ignite.

- ▶ Allow the engine to cool down before adding antifreeze.
- ▶ Make sure that no antifreeze spills out next to the filler opening.

▶ Thoroughly clean off any antifreeze from component parts before starting the vehicle.

**! NOTE** Damage caused by incorrect coolant

▶ Only add coolant that has been pre-mixed with the required antifreeze protection.

Further information on coolant:

- In the Mercedes-Benz Specifications for Operating Fluids 310.1, e.g. online at <http://bevo.mercedes-benz.com>.
- At a qualified specialist workshop.

**! NOTE** Overheating at high outside temperatures

If an inappropriate coolant is used, the engine cooling system is not sufficiently protected against overheating and corrosion at high outside temperatures.

- ▶ Always use coolant approved by Mercedes-Benz.
- ▶ Observe the instructions in the Mercedes-Benz Specifications for Operating Fluids 310.1.

Have the coolant regularly changed at a qualified specialist workshop.

The proportion of corrosion inhibitor/ antifreeze concentrate in the engine cooling system should be:

- A minimum of 50% (antifreeze protection down to approximately -35 °F (-37 °C)).
- A maximum of 55% (antifreeze protection down to -49 °F (-45 °C)).

### Coolant filling capacity

Sedan	Capacity
S 450 4MATIC	13.9 US qt (13.2 l)
S 560 4MATIC	15.0 US qt (14.2 l)

Long wheelbase vehicles	Capacity
S 450 4MATIC S 450	13.9 US qt (13.2 l)
S 600	16.9 US qt (16.0 l)
All other models	15.0 US qt (14.2 l)

Mercedes-Maybach	Capacity
S 650 Mercedes-Maybach	16.9 US qt (16.0 l)
S 560 4MATIC Mercedes-Maybach	15.0 US qt (14.2 l)

### Notes on windshield washer fluid

Observe the notes on operating fluids (→ page 447).

**⚠ WARNING** - Risk of fire and injury from windshield washer concentrate

Windshield washer concentrate is highly flammable. It could ignite if it comes into contact with hot engine component parts or the exhaust system.

- ▶ Make sure that no windshield washer concentrate spills out next to the filler opening.

**! NOTE** Blocked spray nozzles caused by mixing windshield washer fluids

- ▶ Do not mix MB SummerFit and MB WinterFit with other windshield washer fluids.

Do not use distilled or de-ionized water as the fill level sensor may be triggered erroneously.

Recommended windshield washer fluid:

- Above freezing point: e.g. MB SummerFit
- Below freezing point: e.g. MB WinterFit

For the correct mixing ratio refer to the information on the antifreeze container.

Mix the washer fluid with the windshield washer fluid all year round.

## Refrigerant

### Notes on refrigerants

Observe the notes on operating fluids (→ page 447).

**!** **NOTE** Damage due to incorrect refrigerant

If a non-approved refrigerant is used, the climate control system may be damaged.

▶ Only use the refrigerant R-134a

**!** **NOTE** Damage to the climate control system due to incorrect refrigerant compressor oil

▶ Only use refrigerant compressor oil that has been approved by Mercedes-Benz.

▶ Do not mix the approved refrigerant compressor oil with a different refrigerant compressor oil.

Work on the climate control system may only be carried out by a qualified specialist workshop. All applicable regulations, as well as SAE standard J639, must be adhered to.



- ① Warning symbols
- ② Refrigerant filling capacity
- ③ Applicable standards
- ④ PAG oil part number
- ⑤ Refrigerant type

Warning symbols ① advise you about:

- possible dangers
- having service work carried out at a qualified specialist workshop

### Refrigerant filling capacity and PAG oil

Sedan, vehicles with a long wheel-base	Refrigerant
All models	23.3 ± 0.4 oz (660 ± 10 g)
Mercedes-Maybach	Refrigerant
All models	27.2 ± 0.4 oz (770 ± 10 g)
Sedan	PAG oil
All models	3.9 ± 0.4 oz (110 ± 10 g)

Long wheelbase vehicles	PAG oil
S 600	4.2 ± 0.4 oz (120 ± 10 g)
All other models	3.9 ± 0.4 oz (110 ± 10 g)
Mercedes-Maybach	PAG oil
All models	4.2 ± 0.4 oz (120 ± 10 g)

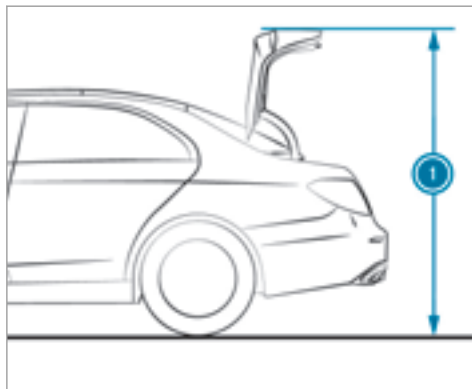

### Opening height

Sedan	① Opening height
S 450 4MATIC	71.0 in (1803 mm)
S 560 4MATIC	71.1 in (1806 mm)

Long wheelbase vehicles	① Opening height
S 450 4MATIC S 450	70.9 in (1803 mm)
All other models	71.1 in (1806 mm)
Mercedes-Maybach	① Opening height
All models	71.1 in (1806 mm)

### Vehicle dimensions

Sedan	
Vehicle length	201.8 in (5125 mm)
Vehicle width including exterior mirrors	83.9 in (2130 mm)

## Vehicle data

### Vehicle dimensions

The heights specified may vary as a result of the:

- Tires
- Load
- Condition of the suspension
- Optional equipment



<b>Sedan</b>	
Vehicle width without exterior mirrors	74.8 in (1899 mm)
Wheelbase	119.5 in (3035 mm)
<b>Long wheelbase vehicles</b>	
Vehicle length	206.9 in (5255 mm)
Vehicle width including exterior mirrors	83.9 in (2130 mm)
Vehicle width without exterior mirrors	74.8 in (1899 mm)
Wheelbase	124.6 in (3165 mm)

<b>Mercedes-Maybach</b>	
Vehicle length	215 in (5462 mm)
Vehicle width including exterior mirrors	83.9 in (2130 mm)
Vehicle width without exterior mirrors	74.8 in (1899 mm)
Wheelbase	132.5 in (3365 mm)

#### **Vehicle height**

<b>Sedan</b>	
S 450 4MATIC	58.9 in (1496 mm)
S 560 4MATIC	59.0 in (1499 mm)

<b>Long wheelbase vehicles</b>	
S 450 4MATIC S 450	58.8 in (1494 mm)
All other models	58.9 in (1497 mm)
<b>Mercedes-Maybach</b>	
All models	59 in (1498 mm)

#### **Weights and loads**

Please note that for the specified vehicle data:

- Items of optional equipment increase the curb weight and reduce the maximum payload.

**Roof load**

<b>All models (sedan)</b>	
Maximum roof load	220 lb (100 kg)
<b>All other models (vehicles with a long wheelbase)</b>	
Maximum roof load	220 lb (100 kg)

## Display messages

### Introduction

#### Notes on display messages

Display messages appear in the multifunction display.



Display messages with graphic symbols are simplified in the Operator's Manual and may differ from the symbols in the multifunction display. The multifunction display shows high-priority display messages in red. Certain display messages are accompanied by a warning tone.

Please respond in accordance with the display messages and follow the additional notes in this Operator's Manual.

For some display messages, a symbol is also shown:

-  Further information

-  Hide display message

You can select the desired symbol by swiping left or right on the left-hand side of Touch Control. Press the  symbol to show further information. Press the  symbol to hide the display message.

You can hide low-priority display messages by pressing the  button or the left-hand side of Touch Control. The display messages are then stored in the message memory.

Rectify the cause of a display message as quickly as possible.

High-priority display messages cannot be hidden. The multifunction display shows these display messages continuously until the cause for the message has been rectified.

#### Calling up stored display messages

On-board computer:

 Service  1 Message

If there are no display messages, **No Messages** appears in the multifunction display.

 Scroll through the display messages by swiping upwards or downwards on Touch Control on the left-hand side of the steering wheel.

 **To exit the message memory:** press the  button.

## Safety systems

Display messages	Possible causes/consequences and ► Solutions
<div data-bbox="67 236 263 339" data-label="Image"> </div> <div data-bbox="67 344 263 448" data-label="Image"> </div> <p data-bbox="57 453 394 515">Inoperative See Operator's Manual</p>	<p data-bbox="466 236 1377 311">* ABS and ESP® are malfunctioning. Other driving systems and driving safety systems may also malfunction.</p> <div data-bbox="492 332 1923 387" data-label="Text"> <p><b>▲ WARNING</b> Risk of skidding if ABS and ESP® are malfunctioning</p> </div> <p data-bbox="506 397 1847 459">If ABS and ESP® are malfunctioning, the wheels could lock when braking and ESP® cannot carry out vehicle stabilization.</p> <p data-bbox="506 470 1892 539">The steering capability and braking characteristics are thus severely impaired. The braking distance in an emergency braking situation can increase. In addition, other driving safety systems are switched off.</p> <ul data-bbox="506 550 1504 629" style="list-style-type: none"> <li>▶ Drive on carefully.</li> <li>▶ Have ABS and ESP® checked immediately at a qualified specialist workshop.</li> </ul> <ul data-bbox="486 660 1146 736" style="list-style-type: none"> <li>▶ Drive on carefully.</li> <li>▶ Visit a qualified specialist workshop immediately.</li> </ul>

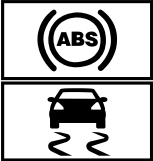

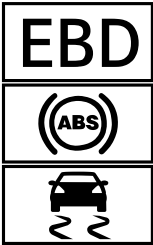

Display messages	Possible causes/consequences and ► Solutions
 <p data-bbox="122 407 445 467">Currently Unavailable See Operator's Manual</p>	<p data-bbox="527 184 1441 262">* ABS and ESP<sup>®</sup> are temporarily unavailable. Other driving systems and driving safety systems may also malfunction.</p> <div data-bbox="553 283 1984 591" style="border: 1px solid gray; padding: 5px;"><p data-bbox="578 296 1414 329"><b>▲ WARNING</b> Risk of skidding if ABS and ESP<sup>®</sup> are malfunctioning</p><p data-bbox="578 350 1909 412">If ABS and ESP<sup>®</sup> are malfunctioning, the wheels could lock when braking and ESP<sup>®</sup> cannot carry out vehicle stabilization.</p><p data-bbox="578 427 1954 490">The steering capability and braking characteristics are thus severely impaired. The braking distance in an emergency braking situation can increase. In addition, other driving safety systems are switched off.</p><ul data-bbox="578 505 1565 578" style="list-style-type: none"><li>▶ Drive on carefully.</li><li>▶ Have ABS and ESP<sup>®</sup> checked immediately at a qualified specialist workshop.</li></ul></div> <p data-bbox="553 614 1892 676">▶ Carefully drive on a suitable stretch of road, making slight steering movements at a speed above 19 mph (30 km/h).</p> <p data-bbox="553 692 1964 717">▶ If the display message does not disappear, consult a qualified specialist workshop immediately. Drive carefully.</p>

Display messages	Possible causes/consequences and ► Solutions
 <p data-bbox="57 301 392 360">Inoperative See Operator's Manual</p>	<p data-bbox="466 184 784 218">* ESP® is malfunctioning.</p> <p data-bbox="488 231 1375 265">Other driving systems and driving safety systems may also malfunction.</p> <p data-bbox="488 272 1839 334">The brake system continues to operate normally. The braking distance in an emergency braking situation can increase.</p> <div data-bbox="492 360 1921 591"><p data-bbox="517 370 1222 405"><b>▲ WARNING</b> Risk of skidding if ESP® is malfunctioning</p><p data-bbox="511 425 1876 487">If ESP® is malfunctioning, ESP® cannot carry out vehicle stabilization. In addition, other driving safety systems are switched off.</p><ul data-bbox="511 500 1232 576" style="list-style-type: none"><li data-bbox="511 500 778 534">► Drive on carefully.</li><li data-bbox="511 544 1232 576">► Have ESP® checked at a qualified specialist workshop.</li></ul></div> <ul data-bbox="488 612 1142 685" style="list-style-type: none"><li data-bbox="488 612 758 646">► Drive on carefully.</li><li data-bbox="488 653 1142 685">► Visit a qualified specialist workshop immediately.</li></ul>

Display messages	Possible causes/consequences and ► Solutions
<div data-bbox="130 187 327 291" data-label="Image"> </div> <p data-bbox="118 301 445 363">Currently Unavailable See Operator's Manual</p>	<p data-bbox="527 184 1441 262">* ESP® is temporarily unavailable. Other driving systems and driving safety systems may also malfunction.</p> <div data-bbox="553 283 1984 339" data-label="Text"> <p><b>▲ WARNING</b> Risk of skidding if ESP® is malfunctioning</p> </div> <p data-bbox="568 350 1943 412">If ESP® is malfunctioning, ESP® cannot carry out vehicle stabilization. In addition, other driving safety systems are switched off.</p> <ul data-bbox="568 425 1297 503" style="list-style-type: none"> <li>▶ Drive on carefully.</li> <li>▶ Have ESP® checked at a qualified specialist workshop.</li> </ul> <p data-bbox="553 536 1896 603">▶ Carefully drive on a suitable stretch of road, making slight steering movements at a speed above 19 mph (30 km/h).</p> <p data-bbox="553 614 1968 643">▶ If the display message does not disappear, consult a qualified specialist workshop immediately. Drive carefully.</p>

Display messages	Possible causes/consequences and ► Solutions
 <p data-bbox="57 513 394 570">Inoperative See Operator's Manual</p>	<p data-bbox="466 184 1377 262">* EBD, ABS and ESP® are malfunctioning. Other driving systems and driving safety systems may also malfunction.</p> <div data-bbox="492 283 1919 588" style="border: 1px solid gray; padding: 5px;"><p data-bbox="517 296 1418 329"><b>▲ WARNING</b> Risk of skidding if EBD, ABS and ESP® are malfunctioning</p><p data-bbox="513 350 1890 412">If EBD, ABS and ESP® are malfunctioning, the wheels can lock when braking and ESP® cannot carry out vehicle stabilization.</p><p data-bbox="513 427 1890 490">The steering capability and braking characteristics are thus severely impaired. The braking distance in an emergency braking situation can increase. In addition, other driving safety systems are switched off.</p><ul data-bbox="513 505 1535 578" style="list-style-type: none"><li data-bbox="513 505 778 531">▶ Drive on carefully.</li><li data-bbox="513 547 1535 578">▶ Have the brake system checked immediately at a qualified specialist workshop.</li></ul></div> <p data-bbox="492 609 1142 681"><b>►</b> Drive on carefully. <b>►</b> Visit a qualified specialist workshop immediately.</p>



Display messages	Possible causes/consequences and ► Solutions
<div data-bbox="130 187 324 291" data-label="Image"></div> <p data-bbox="130 298 257 329">(USA only)</p> <div data-bbox="130 346 324 449" data-label="Image"></div> <p data-bbox="130 456 298 487">(Canada only)</p> <p data-bbox="122 501 449 562">Turn On the Ignition to Release the Parking Brake</p>	<p data-bbox="527 184 1627 256">* The red  (USA only) or  (Canada only) indicator lamp is lit. You have attempted to release the electric parking brake with the ignition switched off.</p> <ul data-bbox="553 270 874 301" style="list-style-type: none"> <li>► Switch on the ignition.</li> </ul>
<div data-bbox="130 581 324 684" data-label="Image"></div> <p data-bbox="130 692 257 723">(USA only)</p> <div data-bbox="130 739 324 843" data-label="Image"></div> <p data-bbox="130 850 298 881">(Canada only)</p> <p data-bbox="122 895 408 956">Please Release Parking Brake</p>	<p data-bbox="527 581 1436 653">* The red  (USA only) or  (Canada only) indicator lamp flashes. The electric parking brake is applied while driving:</p> <ul data-bbox="564 667 1555 739" style="list-style-type: none"> <li>• A condition for automatic release of the electric parking brake is not fulfilled .</li> <li>• You are performing emergency braking using the electric parking brake .</li> </ul> <ul data-bbox="553 760 1698 832" style="list-style-type: none"> <li>► Check that the conditions for automatic release of the electric parking brake are fulfilled.</li> <li>► Release the electric parking brake manually.</li> </ul>

## Display messages



(USA only)



(Canada only)

Parking Brake See Operator's Manual

## Possible causes/consequences and ► Solutions



\* The yellow  indicator lamp is lit. The electric parking brake is malfunctioning.

**To apply:**

- Switch off the ignition and turn it back on.
- Apply the electric parking brake manually .

If it is not possible to apply the electric parking brake:

- Visit a qualified specialist workshop.
- Where necessary, also safeguard the parked vehicle against rolling away.

The yellow  and the red  (USA only) or  (Canada only) indicator lamps are lit. The electric parking brake is malfunctioning.

**To release:**



- Switch off the ignition and turn it back on.
- Release the electric parking brake manually .

or





- Release the electric parking brake automatically .

If it is still not possible to release the electric parking brake:





- Do not drive on. Consult a qualified specialist workshop.

The yellow  indicator lamp is lit and the red  (USA only) or  (Canada only) indicator lamp is flashing. The electric parking brake is malfunctioning.

The electric parking brake could not be applied or released.

Display messages	Possible causes/consequences and ► Solutions
	<ul style="list-style-type: none"><li>► Switch off the ignition and turn it back on.</li></ul> <p><b>To apply:</b></p> <ul style="list-style-type: none"><li>► Release and then apply the electric parking brake manually .</li></ul> <p><b>To release:</b></p> <ul style="list-style-type: none"><li>► Apply and then release the electric parking brake manually.</li></ul> <p>If the electric parking brake cannot be applied or the red  (USA only) or  (Canada only) indicator lamp continues to flash:</p> <ul style="list-style-type: none"><li>► Do not drive on. Consult a qualified specialist workshop.</li><li>► Where necessary, also safeguard the parked vehicle against rolling away.</li></ul> <p>The yellow indicator lamp  is on and the red  indicator lamp (USA only) or  (Canada only) indicator lamp flashes for approximately ten seconds after the electric parking brake has been applied or released. It then remains lit or goes out. The electric parking brake is malfunctioning.</p> <p><b>If the battery charge level is too low:</b></p> <ul style="list-style-type: none"><li>► Charge the battery.</li></ul> <p><b>To apply:</b></p> <ul style="list-style-type: none"><li>► Switch the ignition off. The electric parking brake is applied automatically.</li></ul>

Display messages	Possible causes/consequences and ► Solutions
	<p>If you do not wish the electric parking brake to be applied, leave the ignition switched on, e.g. when washing the vehicle in an automatic car wash or when having the vehicle towed away. Do not do this when having the vehicle towed with the rear axle raised.</p> <p>If the electric parking brake is not applied automatically:</p> <ul style="list-style-type: none"><li>► Switch off the ignition and turn it back on.</li><li>► Release and then apply the electric parking brake manually .</li></ul> <p>If it is still not possible to apply the electric parking brake:</p> <ul style="list-style-type: none"><li>► Visit a qualified specialist workshop.</li><li>► Where necessary, also safeguard the parked vehicle against rolling away.</li></ul> <p><b>To release:</b></p> <ul style="list-style-type: none"><li>► If the conditions for automatic release are fulfilled and the electric parking brake is not released automatically, release the electric parking brake manually .</li></ul> <p>If it is still not possible to release the electric parking brake:</p> <ul style="list-style-type: none"><li>► Do not drive on. Consult a qualified specialist workshop.</li></ul>



Display messages	Possible causes/consequences and ► Solutions
 <p>(USA only)</p>  <p>(Canada only)</p> <p>Check Brake Fluid Level</p>	<p>* There is not enough brake fluid in the brake fluid reservoir.</p> <div style="background-color: #f0f0f0; padding: 5px; border: 1px solid #ccc;"> <p><b>▲ WARNING</b> Risk of an accident due to low brake fluid level</p> <p>If the brake fluid level is too low, the braking effect and the braking characteristics may be impaired.</p> <ul style="list-style-type: none"> <li>► Pull over and stop the vehicle safely as soon as possible, paying attention to road and traffic conditions. Do not continue driving under any circumstances.</li> <li>► Consult a qualified specialist workshop. Do not add brake fluid.</li> </ul> </div> <ul style="list-style-type: none"> <li>► Pull over and stop the vehicle safely as soon as possible, paying attention to road and traffic conditions. Do not continue driving under any circumstances.</li> <li>► Consult a qualified specialist workshop. Do not add brake fluid.</li> </ul>
 <p>Check Brake Pad Wear</p>	<p>* The brake linings have reached the wear limit.</p> <ul style="list-style-type: none"> <li>► Visit a qualified specialist workshop.</li> </ul>
 <p>Inoperative</p>	<p>* One or more of the mbrace system's main features are malfunctioning.</p> <ul style="list-style-type: none"> <li>► Visit a qualified specialist workshop.</li> </ul>

Display messages	Possible causes/consequences and ► Solutions
<p>Active Brake Assist Functions Currently Limited See Operator's Manual</p>	<p>* <b>Vehicles with the Driving Assistance Package:</b> Active Brake Assist with cross-traffic function, Evasive Steering Assist or PRE-SAFE® PLUS are temporarily unavailable or only partially available.</p> <p><b>Vehicles without the Driving Assistance Package:</b> Active Brake Assist is temporarily unavailable.</p> <p>The ambient conditions are outside the system limitations .</p> <ul style="list-style-type: none"> <li>► Drive on. As soon as the ambient conditions are within the system limitations, the system will become available again.</li> <li>► If the display message does not disappear, stop the vehicle while paying attention to road and traffic conditions and restart the engine.</li> </ul>
<p>Active Brake Assist Functions Limited See Operator's Manual</p>	<p>* <b>Vehicles with Driving Assistance Package:</b> Active Brake Assist with cross-traffic function, Evasive Steering Assist or PRE-SAFE® PLUS is malfunctioning.</p> <p><b>Vehicles without the Driving Assistance Package:</b> Active Brake Assist is malfunctioning.</p> <ul style="list-style-type: none"> <li>► Visit a qualified specialist workshop.</li> </ul>
<p>PRE-SAFE Inoperative See Operator's Manual</p>	<p>* PRE-SAFE® functions are malfunctioning.</p> <ul style="list-style-type: none"> <li>► Visit a qualified specialist workshop.</li> </ul>

Display messages	Possible causes/consequences and ► Solutions
<a href="#">Radar Sensors Dirty See Operator's Manual</a>	<p>* The radar sensor system is malfunctioning. Possible causes are:</p> <ul style="list-style-type: none"><li>• Soiling of the sensors</li><li>• Heavy rain</li><li>• Extended country driving without moving traffic, e.g. in the desert</li></ul> <p>Driving systems and driving safety systems may be malfunctioning or temporarily unavailable. Once the cause of the problem is no longer present, driving systems and driving safety systems are available again. If the display message does not disappear:</p> <ul style="list-style-type: none"><li>► Pull over and stop the vehicle safely as soon as possible, paying attention to road and traffic conditions.</li><li>► Clean all sensors .</li><li>► Restart the engine.</li></ul>

Display messages	Possible causes/consequences and ► Solutions
<p><a href="#">Radar Sensors Dirty See Operator's Manual</a></p>	<p>* The radar sensor system is malfunctioning. Possible causes are:</p> <ul style="list-style-type: none"><li>• Soiling of the sensors</li><li>• Heavy rain</li><li>• Extended driving on inter-urban roads without moving traffic, e.g. in the desert</li></ul> <p>Driving systems and driving safety systems may be malfunctioning or temporarily unavailable. Once the cause of the problem is no longer present, driving systems and driving safety systems are available again. If the display message does not disappear:</p> <ul style="list-style-type: none"><li>► Pull over and stop the vehicle safely as soon as possible, paying attention to road and traffic conditions.</li><li>► Clean all sensors .</li><li>► Restart the engine.</li></ul>







Display messages	Possible causes/consequences and ► Solutions
 <p data-bbox="118 301 429 363">SRS Malfunction Service Required</p>	<p data-bbox="527 184 927 215">* The restraint system is faulty .</p> <div data-bbox="553 239 1984 288" style="background-color: #e0e0e0; padding: 5px;"><p data-bbox="578 249 1655 280">▲ <b>WARNING</b> Risk of injury or fatal injury due to a malfunction in the restraint system</p></div> <p data-bbox="574 298 1917 394">If the restraint system is malfunctioning, restraint system components may be triggered unintentionally or might not be triggered at all in the event of an accident. This may affect the Emergency Tensioning Device or airbag, for example.</p> <p data-bbox="574 408 1798 439">► Have the restraint system checked and repaired immediately at a qualified specialist workshop.</p> <p data-bbox="553 472 1099 503">Detection of a restraint system malfunction:</p> <ul data-bbox="562 513 1761 588" style="list-style-type: none"><li data-bbox="562 513 1725 544">• The  restraint system warning lamp does not light up when the ignition is switched on.</li><li data-bbox="562 555 1761 588">• The  restraint system warning lamp lights up continuously or repeatedly during a journey.</li></ul> <p data-bbox="553 609 1205 640">► Visit a qualified specialist workshop immediately.</p>

Display messages	Possible causes/consequences and ► Solutions
<a href="#">Front Passenger Airbag Enabled See Operator's Manual</a>	<p>* The front passenger air bag and knee air bags are enabled during the journey:</p> <ul style="list-style-type: none"><li>• even when a child, a small adult or an object weighing less than the system weight threshold is located on the front passenger seat</li><li>• even when the front passenger seat is not occupied</li></ul> <p>The system may detect objects or forces that are adding to the weight applied to the seat.</p> <p><b>⚠ WARNING</b> Risk of injury or fatal injury when using a child restraint system while the front passenger air bag is enabled</p> <p>If you secure a child in a child restraint system on the front passenger seat and the front passenger air bag is enabled, the front passenger air bag can deploy in the event of an accident.</p> <p>The child could be struck by the air bag.</p> <p>► Ensure, both before and during the journey, that the status of the front passenger air bag is correct.</p> <p>NEVER use a rearward facing child restraint on a seat protected by an ACTIVE FRONT AIR BAG; DEATH or SERIOUS INJURY to the CHILD can occur.</p> <ul style="list-style-type: none"><li>► Pull over and stop the vehicle safely as soon as possible, paying attention to road and traffic conditions.</li><li>► Check the status of the automatic front passenger air bag shutoff .</li><li>► If necessary, consult a qualified specialist workshop immediately.</li></ul>

Display messages	Possible causes/consequences and ► Solutions
<p>Front Passenger Airbag Disabled See Operator's Manual</p>	<p>* The front passenger air bag and the knee air bag are deactivated, even though an adult or a person of a corresponding stature is seated on the front passenger seat. If additional forces are applied to the seat, the weight the system detects may be too low.</p> <p><b>▲ WARNING</b> Risk of injury or fatal injury due to a disabled front passenger airbag</p> <p>If the front passenger airbag is disabled, the front passenger airbag will not be deployed in the event of an accident and cannot perform its intended protective function.</p> <p>A person in the front passenger seat could then, for example, come into contact with the vehicle's interior, especially if the person is sitting too close to the cockpit.</p> <p>► Make sure, both before and during the journey, that the status of the front passenger airbag is correct.</p> <ul style="list-style-type: none"><li>► Pull over and stop the vehicle safely as soon as possible, paying attention to road and traffic conditions.</li><li>► Check the status of the automatic front passenger air bag shutoff .</li><li>► If necessary, consult a qualified specialist workshop immediately.</li></ul>

## Driving systems

Display messages	Possible causes/consequences and ► Solutions
 <p data-bbox="57 350 396 410">ATTENTION ASSIST: Take a Break!</p>	<ul style="list-style-type: none"> <li data-bbox="466 236 1770 296">* ATTENTION ASSIST has detected fatigue or an increasing lack of concentration on the part of the driver (→ page 232).</li> <li data-bbox="486 308 860 339">► If necessary, take a break.</li> </ul>
 <p data-bbox="57 547 396 607">ATTENTION ASSIST Inoperative</p>	<ul style="list-style-type: none"> <li data-bbox="466 433 956 464">* ATTENTION ASSIST is malfunctioning.</li> <li data-bbox="486 474 983 505">► Visit a qualified specialist workshop.</li> </ul>
 <p data-bbox="57 740 233 767">Vehicle Rising</p>	<ul style="list-style-type: none"> <li data-bbox="466 626 1167 657">* Your vehicle is adjusting to the level you have selected.</li> </ul>
 <p data-bbox="57 899 384 930">Vehicle Rising Please Wait</p>	<ul style="list-style-type: none"> <li data-bbox="466 785 1443 816">* The vehicle level is too low and the vehicle rises to the selected vehicle level.</li> <li data-bbox="486 826 1306 857">► Wait until the display message disappears before pulling away.</li> </ul>

Display messages	Possible causes/consequences and ► Solutions
 <p data-bbox="118 301 431 360">Stop Vehicle Vehicle Too Low</p>	<p data-bbox="527 184 1304 215">* You have pulled away despite the vehicle level being too low.</p> <ul style="list-style-type: none"> <li data-bbox="553 228 1882 288">► Pull over and stop the vehicle safely as soon as possible, paying attention to road and traffic conditions. The vehicle rises to the selected vehicle level.</li> <li data-bbox="553 301 1371 332">► Wait until the display message disappears before pulling away.</li> </ul> <p data-bbox="553 363 1970 394">If the display message does not disappear and a warning tone also sounds, AIR BODY CONTROL is malfunctioning:</p> <ul style="list-style-type: none"> <li data-bbox="553 408 1835 439">► Do not drive faster than 50 mph (80 km/h) and consult a qualified specialist workshop immediately.</li> </ul> <div data-bbox="553 470 1982 653" style="border: 1px solid black; padding: 5px;"> <p data-bbox="580 480 1872 511"><b>!</b> <b>NOTE</b> The tires of the front axle or the front fenders could be damaged by large steering movements</p> <ul style="list-style-type: none"> <li data-bbox="574 532 1565 563">► Avoid large steering movements while driving and listen for scraping sounds.</li> <li data-bbox="574 573 1923 636">► If you hear scraping sounds, pull over and stop the vehicle safely, paying attention to road and traffic conditions, and set a higher vehicle level if possible.</li> </ul> </div> <ul style="list-style-type: none"> <li data-bbox="553 674 1242 736">► Set a higher vehicle level . Depending on the malfunction, the vehicle is raised.</li> </ul>

Display messages	Possible causes/consequences and ► Solutions
 <p>Malfunction Drive at Max. 50 mph</p>	<p>* The AIR BODY CONTROL function is restricted. The vehicle's handling characteristics may be affected.</p> <div data-bbox="492 239 1917 420" style="border: 1px solid gray; padding: 5px;"> <p><b>!</b> <b>NOTE</b> The tires of the front axle or the front fenders could be damaged by large steering movements</p> <ul style="list-style-type: none"> <li>► Avoid large steering movements while driving and listen for scraping sounds.</li> <li>► If you hear scraping sounds, pull over and stop the vehicle safely, paying attention to road and traffic conditions, and set a higher vehicle level if possible.</li> </ul> </div> <ul style="list-style-type: none"> <li>► Do not drive faster than 50 mph (80 km/h).</li> <li>► Visit a qualified specialist workshop.</li> </ul>
<p>Active Lane Keeping Assist Currently Unavailable See Operator's Manual</p>	<p>* Active Lane Keeping Assist is temporarily unavailable. The ambient conditions are outside the system limitations (→ page 240).  <b>Vehicles with Active Steering Assist:</b> The camera view may be restricted by the windshield.</p> <ul style="list-style-type: none"> <li>► Drive on. As soon as the ambient conditions are within the system limitations, the system will become available again.</li> </ul> <p>If the display message does not disappear on vehicles with Active Steering Assist:</p> <ul style="list-style-type: none"> <li>► Pull over and stop the vehicle safely as soon as possible, paying attention to road and traffic conditions.</li> <li>► Clean the windshield.</li> </ul>
<p>Active Lane Keeping Assist Inoperative</p>	<p>* Active Lane Keeping Assist is malfunctioning.</p> <ul style="list-style-type: none"> <li>► Visit a qualified specialist workshop.</li> </ul>



Display messages	Possible causes/consequences and ► Solutions
<p>Active Blind Spot Assist Currently Unavailable See Operator's Manual</p>	<ul style="list-style-type: none"> <li>* Active Blind Spot Assist is temporarily unavailable. The system limitations have been reached (→ page 238).                             <ul style="list-style-type: none"> <li>► Drive on. Once the cause of the problem is no longer present, the system will be available again.</li> <li>► If the display message does not disappear, stop the vehicle while paying attention to road and traffic conditions and restart the engine.</li> </ul> </li> </ul>
<p>Active Blind Spot Assist Inoperative</p>	<ul style="list-style-type: none"> <li>* Active Blind Spot Assist is malfunctioning.                             <ul style="list-style-type: none"> <li>► Visit a qualified specialist workshop.</li> </ul> </li> </ul>
<p>Active Blind Spot Asst. Not Available When Towing a Trailer See Operator's Man- ual</p>	<ul style="list-style-type: none"> <li>* When you establish the electrical connection to the trailer, Active Blind Spot Assist is unavailable.                             <ul style="list-style-type: none"> <li>► Press the left-hand side of Touch Control and confirm the display message.</li> </ul> </li> </ul>

Display messages	Possible causes/consequences and ► Solutions
<p>Blind Spot Assist Currently Unavailable See Operator's Manual</p>	<ul style="list-style-type: none"> <li>* Blind Spot Assist is temporarily unavailable. The system limitations have been reached (→ page 238).               <ul style="list-style-type: none"> <li>► Drive on. Once the cause of the problem is no longer present, the system will be available again.</li> <li>or</li> <li>► If the display message does not disappear, stop the vehicle while paying attention to road and traffic conditions and restart the engine.</li> <li>► If necessary, clean the rear bumper. If the bumper is extremely dirty, the sensors in the bumper may be malfunctioning.</li> </ul> </li> </ul>
<p>Blind Spot Assist Inoperative</p>	<ul style="list-style-type: none"> <li>* Blind Spot Assist is malfunctioning.               <ul style="list-style-type: none"> <li>► Visit a qualified specialist workshop.</li> </ul> </li> </ul>
<p>Example:Active Parking Assist Parking Canceled</p>	<ul style="list-style-type: none"> <li>* Active Parking Assist was interrupted. You have opened the driver's door or touched the steering wheel, for example.               <ul style="list-style-type: none"> <li>► Steer and brake manually.</li> </ul> </li> </ul>
<p>Active Parking Assist and PARKTRONIC Inoperative See Operator's Manual</p>	<ul style="list-style-type: none"> <li>* Active Parking Assist and Parking Assist PARKTRONIC are malfunctioning.               <ul style="list-style-type: none"> <li>► Stop the vehicle, paying attention to road and traffic conditions, and restart the engine.</li> <li>► If the display message continues to be displayed, consult a qualified specialist workshop.</li> </ul> </li> </ul>





Display messages	Possible causes/consequences and ► Solutions
<p>Active Parking Assist Maneuvering Assistance Restricted See Operator's Manual</p>	<p>* Active Parking Assist and Parking Assist PARKTRONIC are temporarily unavailable. The ambient conditions are outside the system limitations (→ page 226). Beware of the entire vehicle surroundings.</p> <p>► As soon as the ambient conditions are within the system limitations, the system will become available again.</p>
<p>Traffic Sign Assist Inoperative</p>	<p>* Traffic Sign Assist is malfunctioning.</p> <p>► Visit a qualified specialist workshop.</p>
<p>Traffic Sign Assist Currently Unavailable See Operator's Manual</p>	<p>* Traffic Sign Assist is temporarily unavailable.</p> <p>► Drive on. Once the cause of the problem is no longer present, the system will be available again.</p>
<p>Traffic Sign Assist Camera View Restricted See Operator's Manual</p>	<p>* The camera view is restricted. Possible causes are:</p> <ul style="list-style-type: none"> <li>• Dirt on the windshield in the camera's field of vision</li> <li>• Heavy rain, snow or fog</li> </ul> <p>Driving systems and driving safety systems may be malfunctioning or temporarily unavailable. Once the cause of the problem is no longer present, driving systems and driving safety systems are available again. If the display message does not disappear:</p> <p>► Pull over and stop the vehicle safely as soon as possible, paying attention to road and traffic conditions.</p> <p>► Clean the windshield.</p>

Display messages	Possible causes/consequences and ► Solutions
 <p>Off</p>	<ul style="list-style-type: none"> <li>* The HOLD function is deactivated because the vehicle is skidding or a condition for activation is not met.                             <ul style="list-style-type: none"> <li>► Reactivate the HOLD function later or check the activation conditions for the HOLD function .</li> </ul> </li> </ul>
<p>Active Distance Assist Now Available</p>	<ul style="list-style-type: none"> <li>* Active Distance Assist DISTRONIC is operational again and can be activated (→ page 200).</li> </ul>
<p>Active Distance Assist Currently Unavailable See Operator's Manual</p>	<ul style="list-style-type: none"> <li>* Active Distance Assist is temporarily unavailable. The ambient conditions are outside the system limitations(→ page 199).                             <ul style="list-style-type: none"> <li>► Drive on. As soon as the ambient conditions are within the system limitations, the system will become available again.</li> </ul> </li> </ul>
<p>Active Distance Assist Inoperative</p>	<ul style="list-style-type: none"> <li>* Active Distance Assist is malfunctioning. Other driving systems and driving safety systems may also malfunction.                             <ul style="list-style-type: none"> <li>► Visit a qualified specialist workshop.</li> </ul> </li> </ul>
<p>Active Steering Assist Currently Unavailable See Operator's Manual</p>	<ul style="list-style-type: none"> <li>* Active Steering Assist is temporarily unavailable. The ambient conditions are outside the system limitations (→ page 204).                             <ul style="list-style-type: none"> <li>► Drive on. As soon as the ambient conditions are within the system limitations, the system will become available again.</li> <li>► If necessary, clean the windshield in the camera's field of vision.</li> </ul> </li> </ul>



Display messages	Possible causes/consequences and ► Solutions
Active Steering Assist Inoperative	<ul style="list-style-type: none"> <li>* Active Steering Assist is malfunctioning. Active Distance Assist remains available.               <ul style="list-style-type: none"> <li>► Visit a qualified specialist workshop.</li> </ul> </li> </ul>
 --- mph	<ul style="list-style-type: none"> <li>* Cruise control cannot be activated as not all activation conditions are fulfilled.               <ul style="list-style-type: none"> <li>► Observe the activation conditions for cruise control .</li> </ul> </li> </ul>
Cruise Control Canceled	<ul style="list-style-type: none"> <li>* Cruise control has been deactivated. If there is an additional warning tone, cruise control has been switched off automatically (→ page 196).</li> </ul>
Cruise Control Inoperative	<ul style="list-style-type: none"> <li>* Cruise control is malfunctioning.               <ul style="list-style-type: none"> <li>► Visit a qualified specialist workshop.</li> </ul> </li> </ul>
 Lowering	<ul style="list-style-type: none"> <li>* The vehicle level may be lowered for the following reasons:               <ul style="list-style-type: none"> <li>• you have selected a different drive program.</li> <li>• you have exceeded a critical speed.</li> <li>• you have changed the vehicle level by pressing a button.</li> </ul> </li> </ul>
 Max. Speed 22 mph	<ul style="list-style-type: none"> <li>* The vehicle has been set to transport level. Transport level is not a permissible driving level. Only suitable for transporting the vehicle.               <ul style="list-style-type: none"> <li>► Do not drive faster than 22 mph (35 km/h).</li> </ul> </li> </ul>



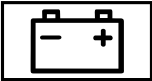
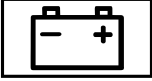
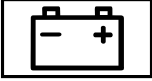

## Engine

Display messages	Possible causes/consequences and ► Solutions
<p>Check Coolant Level See Operator's Manual</p>	<p>* The coolant level is too low.</p> <div data-bbox="492 288 1917 339" style="border: 1px solid black; padding: 5px;"> <p><b>!</b> <b>NOTE</b> Engine damage due to insufficient coolant</p> </div> <div data-bbox="492 342 1917 394" style="border: 1px solid black; padding: 5px;"> <p>► Avoid long journeys with insufficient coolant.</p> </div> <p>► Add coolant .</p>
<div data-bbox="69 464 263 567" style="border: 1px solid black; padding: 5px; text-align: center;">  </div> <p>Coolant Too Hot Stop Vehicle Turn Engine Off</p>	<p>* The coolant is too hot.</p> <p>► Pull over and stop the vehicle safely and switch off the engine, paying attention to road and traffic conditions.</p> <div data-bbox="492 567 1917 619" style="border: 1px solid black; padding: 5px;"> <p><b>!</b> <b>WARNING</b> Danger of burns when opening the hood</p> </div> <div data-bbox="492 622 1917 692" style="border: 1px solid black; padding: 5px;"> <p>If you open the hood when the engine has overheated or during a fire in the engine compartment, you could come into contact with hot gases or other escaping operating fluids.</p> </div> <div data-bbox="492 695 1917 788" style="border: 1px solid black; padding: 5px;"> <p>► Before opening the hood, allow the engine to cool down.</p> <p>► In the event of a fire in the engine compartment, keep the hood closed and call the fire service.</p> </div> <p>► Wait until the engine has cooled down.</p> <p>► Make sure that the air supply to the radiator is not obstructed.</p> <p>► Avoiding high loads on the engine, drive on to the nearest qualified specialist workshop. In doing so, ensure that the coolant temperature display remains below 248 °F (120 °C).</p>

Display messages	Possible causes/consequences and Solutions
	<ul style="list-style-type: none"><li>* The fan motor is defective.<ul style="list-style-type: none"><li>▶ Avoiding high loads on the engine, drive on to the nearest qualified specialist workshop. In doing so, ensure that the coolant temperature display remains below 248 °F (120 °C).</li></ul></li></ul>
 <p data-bbox="118 427 408 456">See Operator's Manual</p>	<ul style="list-style-type: none"><li>* The battery is not being charged.<div data-bbox="553 366 1984 518" style="border: 1px solid black; padding: 5px;"><p data-bbox="578 377 1291 408"><b>!</b> <b>NOTE</b> Possible engine damage if you continue driving</p><ul style="list-style-type: none"><li>▶ Do not continue driving under any circumstances.</li><li>▶ Consult a qualified specialist workshop.</li></ul></div><ul style="list-style-type: none"><li>▶ Pull over and stop the vehicle safely and switch off the engine, paying attention to road and traffic conditions.</li><li>▶ Consult a qualified specialist workshop.</li></ul></li></ul>



Display messages	Possible causes/consequences and ► Solutions
 <p data-bbox="57 301 363 360">Stop Vehicle See Operator's Manual</p>	<p data-bbox="466 184 1453 213">* The battery is no longer being charged and the battery charge level is too low.</p> <div data-bbox="492 236 1917 387" style="border: 1px solid black; padding: 5px;"> <p data-bbox="513 249 1228 278"><b>!</b> <b>NOTE</b> Possible engine damage if you continue driving</p> <ul style="list-style-type: none"> <li data-bbox="513 301 1173 330">▶ Do not continue driving under any circumstances.</li> <li data-bbox="513 342 1050 371">▶ Consult a qualified specialist workshop.</li> </ul> </div> <ul style="list-style-type: none"> <li data-bbox="492 410 1909 469">▶ Pull over and stop the vehicle safely as soon as possible, paying attention to road and traffic conditions. Do not continue driving under any circumstances.</li> <li data-bbox="492 482 805 511">▶ Switch off the engine.</li> <li data-bbox="492 524 1024 553">▶ Consult a qualified specialist workshop.</li> </ul>
 <p data-bbox="57 693 363 752">Start Engine See Operator's Manual</p>	<p data-bbox="466 576 1183 605">* The engine is off and the battery charge level is too low.</p> <ul style="list-style-type: none"> <li data-bbox="492 617 1197 646">▶ Switch off electrical consumers that are not required.</li> <li data-bbox="492 658 1447 717">▶ Leave the engine running for a few minutes, or drive for a longer distance. The battery charges.</li> </ul>
 <p data-bbox="57 886 390 945">Stop Vehicle Leave Engine Running</p>	<p data-bbox="466 769 1191 798">* The battery charge level is too low and must be charged.</p> <ul style="list-style-type: none"> <li data-bbox="492 811 1909 870">▶ Pull over and stop the vehicle safely as soon as possible, paying attention to road and traffic conditions. Do not continue driving under any circumstances.</li> <li data-bbox="492 883 744 912">▶ Start the engine.</li> <li data-bbox="492 925 1306 954">▶ Wait until the display message disappears before pulling away.</li> </ul>

Display messages	Possible causes/consequences and ► Solutions
 <p data-bbox="118 301 437 363">Check Engine Oil At Next Refueling</p>	<p data-bbox="527 184 1228 215">* The engine oil level has dropped to the minimum level.</p> <div data-bbox="553 239 1984 344" style="border: 1px solid gray; padding: 5px;"><p data-bbox="578 249 1457 280"><b>!</b> <b>NOTE</b> Engine damage caused by driving with insufficient engine oil</p><p data-bbox="578 301 1203 332">► Avoid long journeys with insufficient engine oil.</p></div> <p data-bbox="553 363 1173 394">► Check the engine oil level when next refueling.</p> <p data-bbox="553 415 915 446">Add engine oil (→ page 382).</p> <p data-bbox="553 456 977 487">Notes on engine oil (→ page 449).</p>
 <p data-bbox="118 622 437 684">DEF System Fault Engine Start Not Possible</p>	<p data-bbox="527 510 1418 541">* The DEF system is malfunctioning. You can no longer start the engine.</p> <p data-bbox="553 552 1248 583">► Consult a qualified specialist workshop immediately.</p>
 <p data-bbox="118 814 396 876">DEF System Fault See Operator's Manual</p>	<p data-bbox="527 702 977 733">* The DEF system is malfunctioning.</p> <p data-bbox="553 743 1208 774">► Visit a qualified specialist workshop immediately.</p>

Display messages	Possible causes/consequences and ► Solutions
 <p data-bbox="57 301 349 394">DEF System Fault Perf. Reduced in XXX ml See Operator's Manual</p>	<ul style="list-style-type: none"> <li data-bbox="466 184 1545 215">* The DEF system is malfunctioning. Performance is limited above the speed displayed.</li> <li data-bbox="486 225 1140 256">► Visit a qualified specialist workshop immediately.</li> </ul>
 <p data-bbox="57 529 390 622">Refill DEF Perf. Reduced in ### miles See Operator's Manual</p>	<ul style="list-style-type: none"> <li data-bbox="466 412 1520 443">* The low DEF level leads to limited performance after driving the distance displayed.</li> <li data-bbox="486 453 825 484">► Refill DEF immediately .</li> <li data-bbox="486 495 1835 526">ⓘ The message disappears after driving at a speed above 10 mph (15 km/h) for approximately one minute.</li> </ul>
 <p data-bbox="57 757 247 788">Gas Cap Loose</p>	<ul style="list-style-type: none"> <li data-bbox="466 640 1851 702">* There has been pressure loss in the fuel system. The fuel filler cap is not closed correctly or the fuel system is leaking.</li> <li data-bbox="486 712 825 743">► Close the fuel filler cap.</li> <li data-bbox="486 754 1678 785">► <b>If the fuel filler cap was already properly closed:</b> Consult a qualified specialist workshop.</li> </ul>
 <p data-bbox="57 923 241 951">Fuel Level Low</p>	<ul style="list-style-type: none"> <li data-bbox="466 806 1099 837">* The fuel level has dropped into the reserve range.</li> <li data-bbox="486 847 621 878">► Refuel.</li> </ul>





## Tires



Display messages	Possible causes/consequences and ► Solutions
 <p data-bbox="118 350 431 410">Please Correct Tire Pressure</p>	<p data-bbox="527 236 1933 296">* The tire pressure is too low in at least one of the tires, or the tire pressure difference between the wheels is too great.</p> <ul style="list-style-type: none"> <li data-bbox="553 311 1201 339">► Check the tire pressure and add air, if necessary.</li> <li data-bbox="553 355 1565 383">► When the tire pressure is correct, restart the tire pressure monitoring system .</li> </ul>
 <p data-bbox="118 547 267 574">Check Tires</p>	<p data-bbox="527 433 1739 461">* The tire pressure in one or more tires has dropped significantly. The wheel position is displayed.</p> <div data-bbox="553 481 1984 533" style="background-color: #f0f0f0; padding: 5px;"> <p data-bbox="578 492 1402 520">▲ <b>WARNING</b> Risk of an accident due to insufficient tire pressure</p> </div> <p data-bbox="578 543 1299 571">Tire pressures that are too low pose the following hazards:</p> <ul style="list-style-type: none"> <li data-bbox="584 587 1488 615">• The tires may burst, especially as the load and vehicle speed increase.</li> <li data-bbox="584 630 1698 658">• The tires may wear excessively and/or unevenly, which may greatly impair tire traction.</li> <li data-bbox="584 674 1663 702">• The driving characteristics, as well as steering and braking, may be greatly impaired.</li> </ul> <p data-bbox="578 723 1095 751">You could then lose control of the vehicle.</p> <ul style="list-style-type: none"> <li data-bbox="578 766 1130 794">► Observe the recommended tire pressure.</li> <li data-bbox="578 810 1075 838">► Adjust the tire pressure if necessary.</li> </ul> <ul style="list-style-type: none"> <li data-bbox="553 874 1385 902">► Stop the vehicle, paying attention to road and traffic conditions.</li> <li data-bbox="553 917 1060 945">► Check the tire pressure and the tires.</li> </ul>

Display messages	Possible causes/consequences and ► Solutions
 <p data-bbox="57 301 369 329">Warning Tire Malfunction</p>	<p data-bbox="466 184 1637 212">* The tire pressure in one or more tires has dropped suddenly. The wheel position is displayed.</p> <div data-bbox="492 236 1917 565" style="border: 1px solid gray; padding: 5px;"> <p data-bbox="513 246 1279 274"><b>▲ WARNING</b> Risk of an accident from driving with a flat tire</p> <p data-bbox="513 298 1079 326">Flat tires are dangerous in the following ways:</p> <ul data-bbox="513 342 1596 412" style="list-style-type: none"> <li data-bbox="513 342 1044 370">• The tires can overheat and cause a fire.</li> <li data-bbox="513 384 1596 412">• The driving characteristics, as well as steering and braking, may be greatly impaired.</li> </ul> <p data-bbox="513 436 1030 464">You could then lose control of the vehicle.</p> <ul data-bbox="513 477 942 547" style="list-style-type: none"> <li data-bbox="513 477 895 505">► Do not drive with a flat tire.</li> <li data-bbox="513 519 942 547">► Observe the notes on flat tires.</li> </ul> </div> <p data-bbox="486 588 895 616">Notes on flat tires (→ page 393).</p> <ul data-bbox="486 629 1324 699" style="list-style-type: none"> <li data-bbox="486 629 1324 657">► Stop the vehicle, paying attention to road and traffic conditions.</li> <li data-bbox="486 671 731 699">► Check the tires.</li> </ul>
<p data-bbox="57 726 355 785">Tire Press. Monitor Currently Unavailable</p>	<p data-bbox="466 718 1876 778">* No signals can be received from the tire pressure sensor due to strong radio signal source interference. The tire pressure monitoring system is temporarily unavailable.</p> <ul data-bbox="486 791 1759 850" style="list-style-type: none"> <li data-bbox="486 791 1759 850">► Drive on. The tire pressure monitoring system restarts automatically as soon as the cause has been rectified.</li> </ul>

Display messages	Possible causes/consequences and ► Solutions
 <p data-bbox="118 301 431 329">Wheel Sensor(s) Missing</p>	<ul style="list-style-type: none"> <li data-bbox="527 184 1917 246">* There is no signal from the tire pressure sensor of one or more wheels. The pressure of the affected tire is not displayed.               <ul style="list-style-type: none"> <li data-bbox="553 260 1627 288">► Have the defective tire pressure sensor replaced at a qualified specialist workshop.</li> </ul> </li> </ul>
<p data-bbox="118 353 461 415">Tire Pressure Monitor Inoperative No Wheel Sensors</p>	<ul style="list-style-type: none"> <li data-bbox="527 344 1978 372">* The wheels installed do not have suitable tire pressure sensors. The tire pressure monitoring system is deactivated.               <ul style="list-style-type: none"> <li data-bbox="553 386 1208 414">► Install wheels with suitable tire pressure sensors.</li> </ul> </li> </ul>
<p data-bbox="118 440 468 502">Tire Press. Monitor Inoperative</p>	<ul style="list-style-type: none"> <li data-bbox="527 432 1228 459">* The tire pressure monitoring system is malfunctioning.               <div data-bbox="553 484 1984 708" style="border: 1px solid black; padding: 10px; margin-top: 10px;"> <p data-bbox="580 495 1821 523"><b>⚠ WARNING</b> There is a risk of an accident if the tire pressure monitoring system is malfunctioning</p> <p data-bbox="574 547 1958 609">If the tire pressure monitoring system is malfunctioning, it is not able to issue a warning if there is pressure loss in one or more of the tires.</p> <p data-bbox="574 622 1723 650">Underinflated tires may, for example, impair the driving, steering and braking characteristics.</p> <ul style="list-style-type: none"> <li data-bbox="574 664 1667 692">► Have the tire pressure monitoring system checked at a qualified specialist workshop.</li> </ul> </div> </li> <li data-bbox="553 726 1048 754">► Visit a qualified specialist workshop.</li> </ul>

## SmartKey

Display messages	Possible causes/consequences and ► Solutions
 <p>Obtain a New Key</p>	<ul style="list-style-type: none"> <li>* The SmartKey needs to be replaced.                             <ul style="list-style-type: none"> <li>► Visit a qualified specialist workshop.</li> </ul> </li> </ul>
 <p>Replace Key Battery</p>	<ul style="list-style-type: none"> <li>* The SmartKey battery is discharged.                             <ul style="list-style-type: none"> <li>► Replace the battery .</li> </ul> </li> </ul>
 <p>Key Not Detected (white display message)</p>	<ul style="list-style-type: none"> <li>* The SmartKey is currently undetected.                             <ul style="list-style-type: none"> <li>► Change the location of the SmartKey in the vehicle.</li> <li>► If the SmartKey is still not recognized, start the engine with the SmartKey in the stowage compartment .</li> </ul> </li> </ul>

Display messages	Possible causes/consequences and ► Solutions
 <p data-bbox="118 301 461 365">Key Not Detected (red display message)</p>	<ul style="list-style-type: none"> <li>* The SmartKey cannot be detected and may no longer be in the vehicle. The SmartKey is no longer in the vehicle and you switch off the engine:             <ul style="list-style-type: none"> <li>• You can no longer start the engine.</li> <li>• you cannot centrally lock the vehicle</li> </ul> </li> <li>► Ensure that the SmartKey is in the vehicle.</li> </ul> <p>If the SmartKey detection function has a malfunction due to a strong radio signal source:</p> <ul style="list-style-type: none"> <li>► Pull over and stop the vehicle safely as soon as possible, paying attention to road and traffic conditions.</li> <li>► Place the SmartKey in the stowage compartment for starting the engine with the SmartKey .</li> </ul>
 <p data-bbox="118 674 396 705">Don't Forget Your Key</p>	<ul style="list-style-type: none"> <li>* A warning tone also sounds. This message reminds you to take your SmartKey with you when you leave the vehicle.</li> </ul>
 <p data-bbox="118 835 449 928">Place the Key in the Marked Space See Operator's Manual</p>	<ul style="list-style-type: none"> <li>* The SmartKey detection function is malfunctioning.             <ul style="list-style-type: none"> <li>► Change the location of the SmartKey in the vehicle.</li> <li>► Start the vehicle with the SmartKey in the stowage compartment .</li> </ul> </li> </ul>

## Vehicle



Display messages	Possible causes/consequences and ▶ Solutions
Apply Brake to Shift from 'P'	<ul style="list-style-type: none"> <li>* You have attempted to shift the transmission out of position <b>P</b> and into another transmission position.               <ul style="list-style-type: none"> <li>▶ Depress the brake pedal.</li> </ul> </li> </ul>
To Deselect P or N, Depress Brake and Start Engine	<ul style="list-style-type: none"> <li>* You have attempted to shift the transmission out of position <b>P</b> or <b>N</b> into another transmission position.               <ul style="list-style-type: none"> <li>▶ Depress the brake pedal.</li> <li>▶ Start the engine.</li> </ul> </li> </ul>
Driver's Door Open & Transmission Not in P Risk of Vehicle Rolling Away	<ul style="list-style-type: none"> <li>* The driver's door is not fully closed and the transmission is in position <b>R</b>, <b>N</b> or <b>D</b>.               <ul style="list-style-type: none"> <li>▶ Shift the transmission to position <b>P</b> when you park the vehicle.</li> </ul> </li> </ul>
N Permanently Active Risk of Rolling Away	<ul style="list-style-type: none"> <li>* While the vehicle is rolling or while you are driving, the transmission has been shifted to position <b>N</b>.               <ul style="list-style-type: none"> <li>▶ Depress the brake pedal to stop and, when the vehicle is stationary, shift the transmission to position <b>P</b>.</li> <li>▶ To continue your journey, shift the transmission to position <b>D</b> or <b>R</b>.</li> </ul> </li> </ul>
Only Shift to 'P' when Vehicle is Stationary	<ul style="list-style-type: none"> <li>* The transmission can only be shifted to position <b>P</b> when the vehicle is stationary.</li> </ul>



Display messages	Possible causes/consequences and ► Solutions
<p>Service Required Do Not Shift Gears Visit Dealer</p>	<ul style="list-style-type: none"> <li>* The transmission is malfunctioning. The transmission position can no longer be shifted.               <ul style="list-style-type: none"> <li>► When the transmission is in position <b>D</b>, consult a qualified specialist workshop and do not shift the transmission position.</li> <li>► For all other transmission positions, park the vehicle safely.</li> <li>► Consult a qualified specialist workshop or breakdown service.</li> </ul> </li> </ul>
<div style="text-align: center;">  </div> <p>Vehicle Operational Switch the Ignition Off Before Exiting</p>	<ul style="list-style-type: none"> <li>* You are leaving the vehicle when it is in a ready-to-drive state.               <ul style="list-style-type: none"> <li>► When you leave the vehicle, switch off the ignition and take the SmartKey with you.</li> <li>► If you do not leave the vehicle, switch off the electrical consumers, e.g. the seat heater. Otherwise, the 12 V battery might discharge and it will then only be possible to start the vehicle using a second battery (starting assistance).</li> </ul> </li> </ul>
<p>Transmission Malfunction Stop</p>	<ul style="list-style-type: none"> <li>* The transmission is malfunctioning. The transmission shifts to position <b>N</b> automatically.               <ul style="list-style-type: none"> <li>► Pull over and stop the vehicle safely as soon as possible, paying attention to road and traffic conditions.</li> <li>► Before leaving the vehicle, apply the electric parking brake.</li> <li>► Switch the transmission to position <b>P</b>.</li> <li>► Consult a qualified specialist workshop.</li> </ul> </li> </ul>
<p>Reversing Not Possible Service Required</p>	<ul style="list-style-type: none"> <li>* The transmission is malfunctioning. Reverse gear can no longer be engaged.               <ul style="list-style-type: none"> <li>► Visit a qualified specialist workshop.</li> </ul> </li> </ul>



Display messages	Possible causes/consequences and ► Solutions
<p>Stop Vehicle Leave Engine Running Wait Transmission Cooling</p>	<ul style="list-style-type: none"> <li>* The transmission has overheated. Pulling away can be temporarily impaired or not possible.               <ul style="list-style-type: none"> <li>► Pull over and stop the vehicle safely as soon as possible, paying attention to road and traffic conditions. Do not continue driving under any circumstances.</li> <li>► Start the engine.</li> <li>► Wait until the display message disappears before pulling away.</li> </ul> </li> </ul>
<p>Auxiliary Battery Malfunction</p>	<ul style="list-style-type: none"> <li>* The auxiliary battery for the transmission is no longer being charged.               <ul style="list-style-type: none"> <li>► Visit a qualified specialist workshop.</li> <li>► Until then, manually set the transmission to position <b>P</b> before you switch off the engine.</li> <li>► Before leaving the vehicle, apply the electric parking brake.</li> </ul> </li> </ul>
<p>Air Conditioning Malfunction See Operator's Manual</p>	<ul style="list-style-type: none"> <li>* Operation of the climate control system is temporarily restricted. Airflow and fresh air supply are set to automatic mode.               <ul style="list-style-type: none"> <li>► Have the climate control system checked at a qualified specialist workshop.</li> </ul> </li> </ul>





Display messages	Possible causes/consequences and ► Solutions
<p>Let fresh air into the vehicle interior. Air Conditioning Malf. Visit Workshop</p>	<p>* The climate control system is malfunctioning.</p> <div data-bbox="553 236 1984 418" style="border: 1px solid black; padding: 5px;"> <p><b>▲ WARNING</b> Risk of injury and accident due to an insufficient supply of fresh air</p> <p>If the climate control system is malfunctioning, carbon dioxide levels may increase in the vehicle interior. Breathing in carbon dioxide may cause dizziness.</p> <p>► Open the window to ensure that there is a sufficient supply of fresh air.</p> </div> <p>► Open the window to ensure that there is a sufficient supply of fresh air.</p> <p>► Visit a qualified specialist workshop immediately.</p>
<div data-bbox="130 529 327 632" style="border: 1px solid black; padding: 5px; text-align: center;">  </div> <p>Steering Malfunction Drive Carefully Service Required</p>	<p>* The power assistance of the steering is malfunctioning. You may need to use more force to steer.</p> <p>► Drive on carefully.</p> <p>► Visit a qualified specialist workshop.</p>

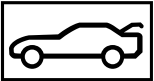



Display messages	Possible causes/consequences and ► Solutions
 <p data-bbox="57 301 384 391">Steering Malfunction Stop Immediately See Operator's Manual</p>	<p data-bbox="466 184 1422 215">* The steering is malfunctioning. Steering capability is considerably impaired.</p> <div data-bbox="492 239 1917 288" style="background-color: #f0f0f0; padding: 5px;"> <p data-bbox="513 249 1304 280">▲ <b>WARNING</b> Risk of accident if steering capability is impaired</p> </div> <p data-bbox="513 298 1627 329">If the steering does not function as intended, the vehicle's operating safety is jeopardized.</p> <ul style="list-style-type: none"> <li data-bbox="513 339 1841 405">▶ Pull over and stop the vehicle safely as soon as possible, paying attention to road and traffic conditions. Do not continue driving under any circumstances.</li> <li data-bbox="513 415 1044 446">▶ Consult a qualified specialist workshop.</li> </ul> <ul style="list-style-type: none"> <li data-bbox="492 477 1913 542">▶ Pull over and stop the vehicle safely as soon as possible, paying attention to road and traffic conditions. Do not continue driving under any circumstances.</li> <li data-bbox="492 553 1024 584">▶ Consult a qualified specialist workshop.</li> </ul>
 <p data-bbox="57 717 369 808">Steering Malfunction Increased Physical Effort See Operator's Manual</p>	<p data-bbox="466 600 1173 631">* The power assistance of the steering is malfunctioning.</p> <div data-bbox="492 655 1917 704" style="background-color: #f0f0f0; padding: 5px;"> <p data-bbox="513 666 1422 697">▲ <b>WARNING</b> Risk of an accident due to altered steering characteristics</p> </div> <p data-bbox="513 711 1841 742">If the power assistance of the steering fails partially or completely, you will need to use more force to steer.</p> <ul style="list-style-type: none"> <li data-bbox="513 753 1111 784">▶ If safe steering is possible, drive on carefully.</li> <li data-bbox="513 794 1295 825">▶ Visit or consult a qualified specialist workshop immediately.</li> </ul> <ul style="list-style-type: none"> <li data-bbox="492 867 1091 898">▶ If safe steering is possible, drive on carefully.</li> <li data-bbox="492 908 1275 939">▶ Visit or consult a qualified specialist workshop immediately.</li> </ul>

Display messages	Possible causes/consequences and ► Solutions
<p>Active Hood Malfunction See Operator's Manual</p>	<ul style="list-style-type: none"> <li>* The active hood (pedestrian protection) is malfunctioning or inoperative after having already been triggered.               <ul style="list-style-type: none"> <li>► Visit a qualified specialist workshop.</li> </ul> </li> </ul>
	<ul style="list-style-type: none"> <li>* The engine hood is open.           <div style="background-color: #f0f0f0; padding: 5px; margin: 5px 0;"> <p><b>⚠ WARNING</b> Risk of accident if the engine hood is unlatched while driving</p> <p>An unlocked engine hood may open up when the vehicle is in motion and block your view.</p> <ul style="list-style-type: none"> <li>► Never unlatch the engine hood while driving.</li> <li>► Before every trip, ensure that the engine hood is latched.</li> </ul> </div> <ul style="list-style-type: none"> <li>► Pull over and stop the vehicle safely as soon as possible.</li> <li>► Close the engine hood.</li> </ul> </li> </ul>
	<ul style="list-style-type: none"> <li>* At least one door is open.           <ul style="list-style-type: none"> <li>► Close all doors.</li> </ul> </li> </ul>

Display messages	Possible causes/consequences and ► Solutions
 <p data-bbox="57 643 343 705">Rear Left Backrest Not Latched (example)</p>	<ul style="list-style-type: none"><li>* The trunk lid is open.<ul style="list-style-type: none"><li><b>▲ WARNING</b> Risk of exhaust gas poisoning</li><li>Combustion engines emit poisonous exhaust gases such as carbon monoxide. Exhaust gases can enter the vehicle interior if the trunk lid is open when the engine is running, especially if the vehicle is in motion.<ul style="list-style-type: none"><li>▶ Always switch off the engine before opening the trunk lid.</li><li>▶ Never drive with the trunk lid open.</li></ul></li></ul></li><li>▶ Close the trunk lid.</li></ul>
 <p data-bbox="57 643 343 705">Rear Left Backrest Not Latched (example)</p>	<ul style="list-style-type: none"><li>* The corresponding seat backrest of the rear bench seat is not engaged.<ul style="list-style-type: none"><li>▶ Fold the corresponding seat backrest back until it engages.</li></ul></li></ul>
 <p data-bbox="57 837 302 867">Check Washer Fluid</p>	<ul style="list-style-type: none"><li>* The washer fluid level in the washer fluid reservoir has dropped below the minimum.<ul style="list-style-type: none"><li>▶ Add washer fluid .</li></ul></li></ul>

## Lights

Display messages	Possible causes/consequences and ► Solutions
 <p data-bbox="118 350 322 412">Check Left Low Beam (example)</p>	<ul style="list-style-type: none"> <li data-bbox="527 236 1093 264">* The corresponding light source is defective.</li> <li data-bbox="551 277 1046 305">► Visit a qualified specialist workshop.</li> <li data-bbox="551 319 1982 381">ⓘ LED light bulbs: the display message for the corresponding lamp only appears when all the light-emitting diodes in the lamp have failed.</li> </ul>
 <p data-bbox="118 545 459 608">Active Headlamps Inoperative</p>	<ul style="list-style-type: none"> <li data-bbox="527 432 1079 459">* The active light function is malfunctioning.</li> <li data-bbox="551 473 1046 501">► Visit a qualified specialist workshop.</li> </ul>
 <p data-bbox="118 741 419 803">Malfunction See Operator's Manual</p>	<ul style="list-style-type: none"> <li data-bbox="527 627 1026 655">* The exterior lighting is malfunctioning.</li> <li data-bbox="551 669 1046 697">► Visit a qualified specialist workshop.</li> </ul>

Display messages	Possible causes/consequences and ► Solutions
 <p data-bbox="57 301 406 360">Auto Lamp Function Inoperative</p>	<ul style="list-style-type: none"> <li data-bbox="459 184 983 256">* The light sensor is malfunctioning.               <ul style="list-style-type: none"> <li data-bbox="490 225 983 256">► Visit a qualified specialist workshop.</li> </ul> </li> </ul>
 <p data-bbox="57 499 271 526">Switch Off Lights</p>	<ul style="list-style-type: none"> <li data-bbox="459 382 1259 454">* You are leaving the vehicle and the lights are still switched on.               <ul style="list-style-type: none"> <li data-bbox="490 423 1054 454">► Turn the light switch to the <b>AUTO</b> position.</li> </ul> </li> </ul>
 <p data-bbox="57 658 333 685">Switch On Headlamps</p>	<ul style="list-style-type: none"> <li data-bbox="459 541 1156 614">* You are driving without low-beam headlamps.               <ul style="list-style-type: none"> <li data-bbox="490 583 1156 614">► Turn the light switch to the  or <b>AUTO</b> position.</li> </ul> </li> </ul>
<p data-bbox="57 709 384 768">Adaptive Highbeam Assist Inoperative</p>	<ul style="list-style-type: none"> <li data-bbox="459 701 1038 773">* Adaptive Highbeam Assist is malfunctioning.               <ul style="list-style-type: none"> <li data-bbox="490 742 983 773">► Visit a qualified specialist workshop.</li> </ul> </li> </ul>
<p data-bbox="57 801 384 891">Adaptive Highbeam Assist Currently Unavailable See Operator's Manual</p>	<ul style="list-style-type: none"> <li data-bbox="459 793 1907 970">* Adaptive Highbeam Assist is temporarily unavailable. The system limitations have been reached (→ page 146).               <ul style="list-style-type: none"> <li data-bbox="490 876 1907 970">► Drive on. Once the cause of the problem is no longer present, the system will be available again. The <a href="#">Adaptive Highbeam Assist Now Available</a> display message appears.</li> </ul> </li> </ul>

Display messages	Possible causes/consequences and ► Solutions
<p data-bbox="118 194 451 288">Adaptive Highbeam Assist Camera View Restricted See Operator's Manual</p>	<p data-bbox="527 184 1187 210">* The camera view is restricted. Possible causes are:</p> <ul data-bbox="560 228 1242 298" style="list-style-type: none"> <li data-bbox="560 228 1242 254">• Dirt on the windshield in the camera's field of vision</li> <li data-bbox="560 270 891 298">• Heavy rain, snow or fog</li> </ul> <p data-bbox="553 324 1712 350">Driving systems and driving safety systems may be malfunctioning or temporarily unavailable.</p> <p data-bbox="553 365 1978 391">Once the cause of the problem is no longer present, driving systems and driving safety systems are available again.</p> <p data-bbox="553 407 1085 433">If the display message does not disappear:</p> <ul data-bbox="553 448 1882 521" style="list-style-type: none"> <li data-bbox="553 448 1882 474">► Pull over and stop the vehicle safely as soon as possible, paying attention to road and traffic conditions.</li> <li data-bbox="553 490 864 521">► Clean the windshield.</li> </ul>

## Warning and indicator lamps

### Overview of warning and indicator lamps

Some systems perform a self-test when the ignition is switched on. Some warning and indicator lamps may briefly light up or flash. This behavior is non-critical. These warning and indicator lamps only indicate a malfunction if they light up or flash after the engine is started or during a journey.

### Instrument Display in the Widescreen Cockpit













### Progressive setting (Widescreen Cockpit)



If you select the progressive display setting in vehicles with a Widescreen Cockpit, the position of the indicator lamps in the Instrument Display changes.

#### Warning and indicator lamps:

-  Low beam (→ page 143)
-  Parking lights (→ page 143)
-  High beam (→ page 144)
-   Turn signal light (→ page 144)
-  Rear fog light (→ page 143)
-  Seat belt is not fastened (→ page 510)
- BRAKE** USA: brakes (red) (→ page 503)
-  Canada: brakes (red) (→ page 503)
-  ABS malfunction (→ page 503)
-  ESP® (→ page 503)
-  ESP® OFF (→ page 503)
- PARK** USA: electric parking brake applied (red) (→ page 503)



Canada: electric parking brake applied (red) (→ page 503)



Electric parking brake (yellow) (→ page 503)



Steering assistance malfunction (→ page 512)



Electrical malfunction (→ page 513)



Restraint system (→ page 503)



Check Engine (→ page 513)



Fuel reserve with fuel filler cap location indicator (→ page 513)



Coolant too hot/cold (→ page 513)



Distance warning (→ page 511)



Tire pressure monitoring system (→ page 517)



## Safety systems

## Warning/indicator lamp



Brake warning lamp (USA)



Brakes warning lamp (Canada)

## Possible causes/consequences and ► Solutions

The red brake system warning lamp is lit while the engine is running.

Possible causes are:

- The brake force boosting is malfunctioning and the braking characteristics may be affected.
- There is not enough brake fluid in the brake fluid reservoir.

**▲ WARNING** There is a risk of an accident if brake force boosting is malfunctioning

If brake force boosting is malfunctioning, the wheels may lock when braking. Braking characteristics may be impaired. The braking distance in an emergency braking situation can increase.



- Pull over and stop the vehicle safely as soon as possible, paying attention to road and traffic conditions. Do not continue driving under any circumstances.
- Consult a qualified specialist workshop.

**▲ WARNING** Risk of an accident due to low brake fluid level

If the brake fluid level is too low, the braking effect and the braking characteristics may be impaired.

- Pull over and stop the vehicle safely as soon as possible, paying attention to road and traffic conditions. Do not continue driving under any circumstances.
- Consult a qualified specialist workshop.  
Do not add brake fluid.

Warning/indicator lamp	Possible causes/consequences and ► Solutions
	<ul style="list-style-type: none"><li data-bbox="439 177 1927 239">► Pull over and stop the vehicle safely as soon as possible, paying attention to road and traffic conditions. Do not continue driving under any circumstances.</li><li data-bbox="439 249 1927 280">► Observe the messages in the multifunction display.</li><li data-bbox="439 291 1927 322">► Consult a qualified specialist workshop.</li></ul> <p data-bbox="439 327 1927 389"><b>USA only:</b> if an additional display message appears with the  symbol in the multifunction display, the brake linings have reached their wear limit.</p> <ul style="list-style-type: none"><li data-bbox="439 399 1927 430">► Visit a qualified specialist workshop.</li></ul>

Warning/indicator lamp	Possible causes/consequences and ► Solutions
 <p data-bbox="118 301 349 329">ABS warning lamp</p>	<p data-bbox="502 184 1273 215">The yellow ABS warning lamp is lit while the engine is running.</p> <p data-bbox="502 228 782 260">ABS is malfunctioning.</p> <p data-bbox="502 270 1250 301">If there is an additional warning tone, EBD is malfunctioning.</p> <p data-bbox="502 314 1238 346">Other driving and driving safety systems may also be faulty.</p> <div data-bbox="502 366 1984 629" style="border: 1px solid black; padding: 5px;"> <p data-bbox="519 377 1410 408"><b>⚠ WARNING</b> There is risk of skidding if EBD or ABS is malfunctioning</p> <p data-bbox="519 428 1371 459">If EBD or ABS is malfunctioning, the wheels could lock when braking</p> <p data-bbox="519 470 1907 532">The steering capability and braking characteristics are thus severely impaired. The braking distance in an emergency braking situation can increase. In addition, other driving safety systems are switched off.</p> <ul style="list-style-type: none"> <li data-bbox="519 542 793 573">► Drive on carefully.</li> <li data-bbox="519 584 1549 615">► Have the brake system checked immediately at a qualified specialist workshop.</li> </ul> </div> <ul style="list-style-type: none"> <li data-bbox="502 646 772 677">► Drive on carefully.</li> <li data-bbox="502 687 1181 718">► Observe the messages in the multifunction display.</li> <li data-bbox="502 729 997 760">► Visit a qualified specialist workshop.</li> </ul>
 <p data-bbox="118 901 459 929">ESP® warning lamp flashes</p>	<p data-bbox="502 784 1351 815">The yellow ESP® warning lamp flashes while the vehicle is in motion.</p> <p data-bbox="502 828 758 859">ESP® is intervening .</p> <ul style="list-style-type: none"> <li data-bbox="502 870 1340 901">► Adapt your driving style to suit the road and weather conditions.</li> </ul>

**Warning/indicator lamp**

ESP<sup>®</sup> warning lamp lights up

**Possible causes/consequences and ► Solutions**

The yellow ESP<sup>®</sup> warning lamp is lit while the engine is running.

ESP<sup>®</sup> is malfunctioning.

Other driving and driving safety systems may also be malfunctioning.



**⚠ WARNING Risk of skidding if ESP<sup>®</sup> is malfunctioning**

If ESP<sup>®</sup> is malfunctioning, ESP<sup>®</sup> cannot carry out vehicle stabilization. In addition, other driving safety systems are switched off.

- ▶ Drive on carefully.
- ▶ Have ESP<sup>®</sup> checked at a qualified specialist workshop.

- ▶ Drive on carefully.
- ▶ Observe the messages in the multifunction display.
- ▶ Consult a qualified specialist workshop.

Warning/indicator lamp	Possible causes/consequences and ► Solutions
 <p data-bbox="118 303 421 334">ESP® OFF warning lamp</p>	<p data-bbox="502 187 1344 262">The yellow ESP® OFF warning lamp is lit while the engine is running. ESP® is deactivated.</p> <div data-bbox="502 288 1984 342"><p data-bbox="519 298 1365 332"><b>▲ WARNING</b> Risk of skidding when driving with ESP® deactivated</p></div> <p data-bbox="523 353 1943 415">If ESP® is deactivated, ESP® cannot carry out vehicle stabilization. The availability of further driving safety systems is also limited.</p> <ul data-bbox="523 430 1289 508" style="list-style-type: none"><li data-bbox="523 430 793 462">▶ Drive on carefully.</li><li data-bbox="523 472 1289 508">▶ Only deactivate ESP® for as long as the situation requires.</li></ul> <p data-bbox="523 539 1177 570">If ESP® cannot be activated, ESP® is malfunctioning.</p> <ul data-bbox="523 586 1402 617" style="list-style-type: none"><li data-bbox="523 586 1402 617">▶ Have ESP® checked immediately at a qualified specialist workshop.</li></ul> <p data-bbox="502 653 1058 684">► Observe the notes on deactivating ESP® .</p>

Warning/indicator lamp	Possible causes/consequences and ► Solutions
 <p>Red indicator lamp, electric parking brake applied (USA only)</p>	<p>The red electric parking brake indicator lamp flashes or is lit. The yellow indicator lamp is also lit if the electric parking brake malfunctions.</p> <p>► Observe the messages in the multifunction display.</p>
 <p>Red indicator lamp, electric parking brake applied (Canada only)</p>	
 <p>Yellow electric parking brake indicator lamp is malfunctioning</p>	

**Warning/indicator lamp**

Restraint system warning lamp

**Possible causes/consequences and ► Solutions**

The red restraint system warning lamp is lit while the engine is running.

The restraint system is malfunctioning.



**⚠ WARNING Risk of injury or fatal injury due to a malfunction in the restraint system**

If the restraint system is malfunctioning, restraint system components may be triggered unintentionally or might not be triggered at all in the event of an accident. This may affect the Emergency Tensioning Device or airbag, for example.

► Have the restraint system checked and repaired immediately at a qualified specialist workshop.



- Drive on carefully.
- Observe the messages in the multifunction display.
- Visit a qualified specialist workshop immediately.

## Seat belts

Warning/indicator lamp	Possible causes/consequences and ► Solutions
 <p data-bbox="57 350 347 412">Seat belt warning lamp lights up</p>	<p data-bbox="441 236 1434 265">After starting the engine, the red seat belt warning lamp lights up for 6 seconds.</p> <p data-bbox="441 277 1048 306">In addition, an acoustic warning tone may sound.</p> <p data-bbox="441 319 1582 348">The seat belt warning lamp reminds the driver and front passenger to fasten their seat belts.</p> <ul data-bbox="441 360 760 389" style="list-style-type: none"><li>► Fasten your seat belt .</li></ul> <p data-bbox="441 414 1533 443">If you have placed objects on the front passenger seat, the warning lamp may remain lit.</p>
 <p data-bbox="57 581 347 643">Seat belt warning lamp flashes</p>	<p data-bbox="441 461 1438 490">The red seat belt warning lamp flashes and an intermittent warning tone sounds.</p> <p data-bbox="441 502 1567 531">The driver or front passenger has not fastened their seat belt while the vehicle is in motion.</p> <ul data-bbox="441 543 1116 651" style="list-style-type: none"><li>► Fasten your seat belt .</li><li>► There are objects on the front passenger seat.</li><li>► Remove the objects from the front passenger seat.</li></ul>

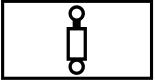

Driving systems

Warning/indicator lamp	Possible causes/consequences and ► Solutions
 <p data-bbox="118 353 410 412">Air suspension warning lamp</p>	<p data-bbox="502 236 1136 308">The yellow AIR BODY CONTROL warning lamp is lit. AIR BODY CONTROL is faulty.</p> <ul data-bbox="502 322 1181 353" style="list-style-type: none"><li data-bbox="502 322 1181 353">► Observe the messages in the multifunction display.</li></ul>
 <p data-bbox="118 547 404 578">Distance warning lamp</p>	<p data-bbox="502 433 1371 505">The red distance warning lamp lights up while the vehicle is in motion. The distance to the vehicle in front is too small for the speed selected.</p> <p data-bbox="502 519 1627 550">If there is an additional warning tone, you are approaching an obstacle at too high a speed.</p> <ul data-bbox="502 560 972 632" style="list-style-type: none"><li data-bbox="502 560 972 591">► Be prepared to brake immediately.</li><li data-bbox="502 601 819 632">► Increase the distance.</li></ul> <p data-bbox="502 653 758 684">Active Brake Assist .</p>

## Vehicle

### Warning/indicator lamp



Power steering system warning lamp

### Possible causes/consequences and ► Solutions

The red power steering system warning lamp is lit while the engine is running.  
The power steering assistance or the steering itself is malfunctioning.



**⚠ WARNING** Risk of accident if steering capability is impaired

If the steering does not function as intended, the vehicle's operating safety is jeopardized.

- Pull over and stop the vehicle safely as soon as possible, paying attention to road and traffic conditions. Do not continue driving under any circumstances.
- Consult a qualified specialist workshop.

► Observe the messages in the multifunction display.

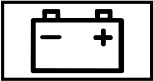
## Engine

Warning/indicator lamp	Possible causes/consequences and ► Solutions
 <p data-bbox="118 353 437 412">Engine diagnosis warning lamp</p>	<p data-bbox="502 236 1430 267">The yellow engine diagnosis warning lamp is lit while the engine is running.</p> <p data-bbox="502 277 1508 308">A malfunction has occurred in the engine, the exhaust system or the fuel system.</p> <p data-bbox="502 319 1829 350">The emissions limit values may be exceeded and the engine may be running in emergency operation mode.</p> <p data-bbox="502 360 1974 425">In some states, legal requirements stipulate that you must immediately consult a qualified specialist workshop as soon as the yellow engine diagnosis warning lamp lights up.</p> <ul data-bbox="502 436 1541 467" style="list-style-type: none"> <li>► Have the vehicle checked as soon as possible at a qualified specialist workshop.</li> </ul>
 <p data-bbox="118 601 472 660">Electrical malfunction warning lamp</p>	<p data-bbox="502 484 1113 515">The red electrical malfunction warning lamp is lit.</p> <p data-bbox="502 526 977 557">There is a malfunction in the electrics.</p> <ul data-bbox="502 567 1181 598" style="list-style-type: none"> <li>► Observe the messages in the multifunction display.</li> </ul>
 <p data-bbox="118 795 451 826">Fuel reserve warning lamp</p>	<p data-bbox="502 678 1246 709">The yellow fuel reserve warning lamp lights up while driving.</p> <p data-bbox="502 720 1968 751">There has been pressure loss in the fuel system. The fuel filler cap is not closed correctly or the fuel system is leaking.</p> <ul data-bbox="502 761 1688 833" style="list-style-type: none"> <li>► Close the fuel filler cap.</li> <li>► <b>If the fuel filler cap was already properly closed:</b> consult a qualified specialist workshop.</li> </ul>

**Warning/indicator lamp**



Fuel reserve warning lamp

**Possible causes/consequences and ► Solutions**

The yellow fuel reserve warning lamp is lit while the engine is running.  
The fuel level has dropped into the reserve range.

► Refuel.

## Warning/indicator lamp



Coolant warning lamp

## Possible causes/consequences and ► Solutions

The red coolant warning lamp is lit while the engine is running.

Possible causes are:

- The temperature sensor is malfunctioning
- Coolant level too low
- The air supply to the radiator is obstructed
- The radiator fan is defective

If there is an additional warning tone, the coolant temperature has exceeded the maximum permissible temperature.

**▲ WARNING** Danger of burns when opening the hood

If you open the hood when the engine has overheated or during a fire in the engine compartment, you could come into contact with hot gases or other escaping operating fluids.

- Before opening the hood, allow the engine to cool down.
- In the event of a fire in the engine compartment, keep the hood closed and call the fire service.

- Stop the vehicle immediately, paying attention to road and traffic conditions, and switch off the engine. Do not continue driving under any circumstances.
- Observe the messages in the multifunction display.

If the coolant temperature display is at the lower end of the temperature scale:

- Consult a qualified specialist workshop.

Warning/indicator lamp	Possible causes/consequences and ► Solutions
	<p>Otherwise:</p> <ul style="list-style-type: none"><li data-bbox="437 215 1937 249">► Leave the vehicle and keep a safe distance from the vehicle until the engine has cooled down.</li><li data-bbox="437 254 1937 289">► Check the coolant level .</li><li data-bbox="437 294 1937 328">► Make sure that the air supply to the radiator is not obstructed.</li><li data-bbox="437 333 1937 409">► Avoiding high loads on the engine, drive on to the nearest qualified specialist workshop. In doing so, ensure that the coolant temperature display remains below the red area.</li></ul>

Tires

Warning/indicator lamp	Possible causes/consequences and ► Solutions
 <p>Tire pressure monitoring system warning lamp lights up</p>	<p>The yellow tire pressure monitoring system warning lamp (pressure loss/malfunction) is lit. The tire pressure monitoring system has detected tire pressure loss in at least one of the tires.</p> <p><b>⚠ WARNING</b> Risk of an accident due to insufficient tire pressure</p> <p>Tire pressures that are too low pose the following hazards:</p> <ul style="list-style-type: none"><li>• The tires may burst, especially as the load and vehicle speed increase.</li><li>• The tires may wear excessively and/or unevenly, which may greatly impair tire traction.</li><li>• The driving characteristics, as well as steering and braking, may be greatly impaired.</li></ul> <p>You could then lose control of the vehicle.</p> <ul style="list-style-type: none"><li>► Observe the recommended tire pressure.</li><li>► Adjust the tire pressure if necessary.</li></ul> <p>► Stop the vehicle, paying attention to road and traffic conditions.</p> <p>► Check the tire pressure and the tires.</p>

**Warning/indicator lamp**



Tire pressure monitoring system warning lamp flashes

**Possible causes/consequences and ► Solutions**

The yellow tire pressure monitoring system warning lamp (pressure loss/malfunction) flashes for approximately one minute and then remains lit.

The tire pressure monitoring system is malfunctioning.

**▲ WARNING** There is a risk of an accident if the tire pressure monitoring system is malfunctioning

If the tire pressure monitoring system is malfunctioning, it is not able to issue a warning if there is pressure loss in one or more of the tires.

Underinflated tires may, for example, impair the driving, steering and braking characteristics.

► Have the tire pressure monitoring system checked at a qualified specialist workshop.

► Consult a qualified specialist workshop.



## 1, 2, 3 ...

**12 V socket**

see Socket (12 V)

**115 V socket**

see Socket (115 V)

**360° camera** ..... 224

Assigning as a favorite ..... 226

Care ..... 389

Function ..... 224

Selecting a view ..... 226

**A****A/C function**

Activating/deactivating (multimedia system) ..... 158

Switching on/off (control panel) ..... 158

**ABS (Anti-lock Braking System)** ..... 189**Acceleration**

see Kickdown

**Access data**

Editing ..... 333

Setting ..... 331

**Acoustic locking verification signal**

Activating/deactivating ..... 59

**Active Blind Spot Assist** ..... 238

Activating/deactivating ..... 240

Brake application ..... 239

Function ..... 238

System limitations ..... 238

Towing a trailer ..... 239

**Active Brake Assist**

Function/notes ..... 192

Setting ..... 196

**Active Distance Assist DISTRONIC** ..... 199

Active Emergency Stop Assist ..... 207

Active Lane Change Assist ..... 206

Calling up a speed ..... 200

Displays in the Instrument Display ..... 208

Function ..... 199

Increasing/decreasing speed ..... 200

Requirements ..... 200

Route-based speed adjustment ..... 203

Steering wheel buttons ..... 200

Storing a speed ..... 200

Switching off/deactivating ..... 200

Switching on/activating ..... 200

System limitations ..... 199

**Active Emergency Stop Assist** ..... 207**Active hood (pedestrian protection)** ..... 378

Method of operation ..... 378

Resetting ..... 378

**Active Lane Change Assist**

Function ..... 206

Switching on/off ..... 207

**Active Lane Keeping Assist** ..... 240

Function ..... 240

Sensitivity (function/notes) ..... 243

Setting the sensitivity ..... 243

Switching on/off ..... 242

System limitations ..... 240

Towing a trailer ..... 240

**Active Parking Assist** ..... 226

Cross Traffic Alert ..... 231

Drive Away Assist ..... 230

Exiting a parking space ..... 229

Function ..... 226

Parking ..... 228

System limitations ..... 226

**Active Speed Limit Assist** ..... 202, 235

Display ..... 202

Function ..... 202

- Setting ..... 235
- Active Steering Assist** ..... 204
  - Activating/deactivating ..... 206
  - Active Emergency Stop Assist ..... 207
  - Active Lane Change Assist ..... 206
  - Displays in the Instrument Display ..... 208
  - Function ..... 204
  - System limitations ..... 204
- Adaptive cruise control**
  - see Active Distance Assist DISTRONIC
- Adaptive Highbeam Assist**
  - Function ..... 146
  - Switching on/off ..... 147
- Additives** ..... 449
  - Engine oil ..... 449
  - Fuel ..... 449
- Additives (engine oil)**
  - see Additives
- Additives (fuel)**
  - see Fuel
- Address book**
  - see Contacts
- Adjusting the balance/fader**
  - Burmester® high-end 3D surround sound system ..... 360
  - Burmester® surround sound system ... 359
- Adjusting the bass, mid-range and treble**
  - Burmester® high-end 3D surround sound system ..... 359
- Adjusting the mid-range, treble and bass**
  - Burmester® high-end 3D surround sound system ..... 359
- Adjusting the sound focus**
  - Burmester® surround sound system ... 359
- Adjusting the sound optimization**
  - Burmester® high-end 3D surround sound system ..... 360
- Adjusting treble, mid-range and bass settings**
  - Burmester® high-end 3D surround sound system ..... 359
- ADS PLUS damping system**
  - see AIR BODY CONTROL
- After-sales service center**
  - see ASSYST PLUS
- Air bag** ..... 38
  - Activation ..... 32
  - Belt air bag ..... 36
  - Cushionbag ..... 38
  - Front air bag (driver, front passenger) ... 38
  - Installation locations ..... 38
  - Knee air bag ..... 38
  - Overview ..... 38
  - Protection ..... 39
  - Reduced protection ..... 40
  - Side air bag ..... 38
  - Window air bag ..... 38
- AIR BODY CONTROL** ..... 211
  - Setting ..... 213
  - Suspension ..... 211
- Air distribution**
  - Setting (multimedia system) ..... 159
- Air freshener system**
  - see Fragrance system
- Air pressure**
  - see Tire pressure

- Air suspension**  
see AIR BODY CONTROL
- Air vents** ..... 162
  - Adjusting (front) ..... 162
  - Adjusting (rear) ..... 163
  - Glove box ..... 164
  - Rear center air vent ..... 163
  - Rear side air vent ..... 163
- Air vents**  
see Air vents
- Air-recirculation mode** ..... 160
- Alarm**  
see Panic alarm
- Alarm system**  
see ATA (anti-theft alarm system)
- Alternative route**  
see Route
- Ambient lighting** ..... 148
- Android Auto** ..... 326
  - Connecting a mobile phone ..... 326
  - Ending ..... 327
  - Notes ..... 326
  - Overview ..... 326
- Sound settings ..... 327
- Transferred vehicle data ..... 327
- Animals**  
Pets in the vehicle ..... 56
- Anti-lock braking system**  
see ABS (Anti-lock Braking System)
- Anti-theft alarm system**  
see ATA (anti-theft alarm system)
- Anti-theft protection**  
Immobilizer ..... 86
- Anti-theft protection**  
see ATA (anti-theft alarm system)
- Anticipatory occupant protection**  
see PRE-SAFE<sup>®</sup> (anticipatory occupant protection)  
see PRE-SAFE<sup>®</sup> PLUS (anticipatory occupant protection plus)
- Apple CarPlay™** ..... 324
  - Connecting an iPhone<sup>®</sup> ..... 325
  - Ending ..... 326
  - Notes ..... 325
  - Overview ..... 324
  - Sound settings ..... 325
- Transferred vehicle data ..... 327
- Ashtray**  
Front center console ..... 132  
Rear door ..... 132
- Assistance graphic**  
Menu (on-board computer) ..... 248
- Assistance systems**  
see Driving safety system
- ASSYST PLUS** ..... 377
  - Battery disconnection periods ..... 378
  - Displaying the service due date ..... 377
  - Function/notes ..... 377
  - Regular service work ..... 377
  - Special service requirements ..... 377
- ATA (anti-theft alarm system)** ..... 86
  - Deactivating the alarm ..... 87
  - Function ..... 86
- ATTENTION ASSIST** ..... 232, 233
  - Function ..... 232
  - Setting ..... 233
  - System limitations ..... 232
- Attention assistant**  
see ATTENTION ASSIST

- Audio mode**
- Activating media mode ..... 339
  - Connecting USB devices ..... 341
  - Copyright ..... 339
  - Information ..... 337
  - Inserting/removing an SD card ..... 339
  - Media search ..... 344
  - Overview ..... 340
  - Pause and playback function ..... 341
  - Selecting a track ..... 341
  - Selecting playback options ..... 341
  - Track list ..... 341
- Authorized Mercedes-Benz Center**  
see Qualified specialist workshop
- Authorized workshop**  
see Qualified specialist workshop
- Automatic activation**  
Activating/deactivating ..... 237
- Automatic distance control**  
see Active Distance Assist DISTRONIC
- Automatic driving lights** ..... 144
- Automatic engine start (ECO start/stop function)** ..... 171
- Automatic engine stop (ECO start/stop function)** ..... 171
- Automatic front-passenger front air bag deactivation system** ..... 41, 43
- Function of the automatic front passenger air bag shutoff ..... 41
  - PASSENGER AIR BAG indicator lamp ..... 43
- Automatic lateral support adjustment**  
Setting ..... 105
- Automatic mirror folding function**  
Switching on/off ..... 154
- Automatic transmission**
- DIRECT SELECT lever ..... 173
  - Drive program display ..... 173
  - Drive programs ..... 172
  - DYNAMIC SELECT switch ..... 172
  - Engaging drive position ..... 175
  - Engaging reverse gear ..... 175
  - Kickdown ..... 177
  - Manual gear shifting ..... 176
  - Selecting park position ..... 175
  - Shifting to neutral ..... 175
  - Steering wheel gearshift paddles ..... 176
  - Transmission position display ..... 173
- Transmission positions ..... 173
- B**
- Bag hook** ..... 124
- BAS (Brake Assist System)** ..... 189
- Battery**  
SmartKey ..... 60
- Battery (vehicle)**
- Charging ..... 401
  - Jump-starting ..... 401
  - Notes ..... 399
- Belt**  
see Seat belts
- Belt air bag**
- Activation ..... 32
  - Function/notes ..... 36
- Blind Spot Assist** ..... 238
- Activating/deactivating ..... 240
  - Function ..... 238
  - System limitations ..... 238
- Blu-ray drive (Rear Seat Entertainment System)**  
Overview ..... 366

**Bluetooth®**

Activating/deactivating .....	279
Setting up an Internet connection .....	331
Settings .....	279
Switching profile (DUN/PAN) .....	332

**Bluetooth® audio**

Activating .....	349
De-authorizing (de-registering) the device .....	349
Information .....	346
Overview .....	347
Searching for a track .....	349
Searching for and authorizing the device .....	348
Selecting a music player .....	349
Switching device via NFC .....	349

**Brake Assist System**

see BAS (Brake Assist System)

**Brake fluid**

Notes .....	451
-------------	-----

**Brake force distribution**

EBD (electronic brake force distribution) .....	192
---	-----

**Brakes**

ABS (Anti-lock Braking System) .....	189
Active Brake Assist .....	192
BAS (Brake Assist System) .....	189
Driving tips .....	168
EBD (electronic brake force distribution) .....	192
HOLD function .....	210
Limited braking effect (salt-treated roads) .....	168
New/replaced brake linings/brake discs .....	168
Notes on breaking-in a new vehicle .....	168

**Braking assistance**

see BAS (Brake Assist System)

**Breakdown**

Assistance overview .....	16
Changing a wheel .....	437
Roadside Assistance .....	21
Tow-starting .....	409
Towing away .....	405
Transporting the vehicle .....	407

**Breakdown**

see Flat tire

**Burmester® high-end 3D surround sound system**

Adjusting the balance/fader .....	360
Adjusting the sound optimization .....	360
Adjusting treble, mid-range and bass settings .....	359
Automatic volume adjustment .....	360
Calling up the sound menu .....	359
Information .....	359
Setting the sound profile .....	360

**Burmester® surround sound system**

Adjusting the balance/fader .....	359
Adjusting the sound focus .....	359
Adjusting treble, mid-range and bass settings .....	358
Automatic volume adjustment .....	359
Calling up the sound menu .....	358
Information .....	358
Switching the surround sound on/off .....	359

**Buttons**

Steering wheel .....	245
----------------------	-----

## C

**California**

Important information for private customers and lessees ..... 22

**Call list**

Making a call ..... 322  
Options in the call list ..... 323  
Overview ..... 322

**Calling up the sound menu**

Burmester® high-end 3D surround sound system ..... 359  
Burmester® surround sound system ... 358

**Calls** ..... 319

Accepting ..... 319  
Activating functions during a call ..... 319  
Calls with several participants ..... 319  
Declining ..... 319  
Ending a call ..... 319  
Incoming call during an existing call ... 320  
Making ..... 319

**Camera**

see 360° camera  
see Rear view camera

**Car wash**

see Care

**Car wash (care)** ..... 385

**Care** ..... 390

Car wash ..... 385  
Carpet ..... 390  
Display ..... 390  
EASY-PACK trunk box ..... 390  
Exterior lighting ..... 389  
Genuine wood/trim elements ..... 390  
Headliner ..... 390  
Matt finish ..... 387  
Night View Assist ..... 388  
Paint ..... 387  
Plastic trim ..... 390  
Power washer ..... 385  
Rear view camera/360° Camera ..... 389  
Seat belts ..... 390  
Seat cover ..... 390  
Sensors ..... 389  
Tailpipes ..... 389  
Washing by hand ..... 386  
Wheels/rims ..... 389  
Windows ..... 389  
Wiper blades ..... 389

**Carpet (Care)** ..... 390

**Champagne glass** ..... 129

**Change of address** ..... 21

**Change of ownership** ..... 21

**Changing a wheel**

Lowering the vehicle ..... 441  
Mounting a new wheel ..... 440  
Preparation ..... 437  
Raising the vehicle ..... 438  
Removing a wheel ..... 440  
Removing/mounting hub caps ..... 437

**Changing hub caps** ..... 437

**Channel list**

Calling up ..... 352

**Character entry**

Function/notes ..... 275  
On the touchpad ..... 276  
Using the controller ..... 276

**Charging**











Battery (vehicle) ..... 401  
Mobile phone (wireless) ..... 139  
USB port ..... 136





















<b>Chassis level (AIR BODY CONTROL)</b>			
Setting .....	213		
<b>Chassis level (MAGIC BODY CONTROL)</b>			
Setting .....	217		
<b>Chauffeur mode</b> .....	95		
Fully reclined position .....	100		
Information .....	95		
Installing/removing the head restraint ..	97		
Moving the front passenger seat into the chauffeur position .....	96		
Moving the front passenger seat into the normal position .....	98		
<b>Child safety lock</b>			
Rear door .....	55		
Rear side windows .....	56		
Setting .....	283		
<b>Child seat</b>			
Front passenger seat (notes) .....	53		
Front passenger seat (rearward-facing/forward-facing) .....	54		
LATCH-type (ISOFIX) (installing) .....	51		
LATCH-type (ISOFIX) (notes) .....	50		
Notes .....	47		
		Top Tether .....	52
<b>Child seat safety feature</b> .....	50		
<b>Children</b>			
Child seat safety feature .....	50		
Restraint systems .....	47		
<b>Cigarette lighter</b>			
Front center console .....	133		
Rear passenger compartment .....	133		
<b>Cleaning</b>			
see Care			
<b>Climate control</b>			
Activating/deactivating the A/C function (control panel) .....	158		
Activating/deactivating the A/C function (multimedia system) .....	158		
Activating/deactivating the synchronization function (multimedia system) .....	160		
Adjusting the climate mode settings ...	158		
Air distribution settings .....	159		
Air vent, rear center air vent .....	163		
Air vent, rear side air vent .....	163		
Air-recirculation mode .....	160		
Automatic control (front) .....	158		
		Automatic control (rear passenger compartment) .....	158
		Climate style function .....	158
		Control panel for 3-zone automatic climate control .....	157
		Defrosting the windows .....	160
		Filling capacity for PAG oil .....	453
		Front air vents .....	162
		Front residual heat .....	160
		Glove box air vent .....	164
		Inserting/removing the flacon (fragrance system) .....	161
		Ionization .....	161
		Rear air vents .....	163
		Rear operating unit .....	157
		Refrigerant .....	453
		Refrigerant filling capacity .....	453
		Residual heat in the rear .....	160
		Setting the fragrance system .....	161
		Switching on/off (front) .....	158
		Switching on/off (rear) .....	158
		Ventilating the vehicle (convenience opening) .....	75
		Windshield heater .....	162



















- Climate style**
  - Function ..... 158
  - Setting ..... 158
- Cockpit** ..... 6
  - Overview ..... 6
- COMAND**
  - see Multimedia system
- COMAND Touch**
  - Managing devices ..... 282
- Combination switch**
  - see Turn signal light
- Compass** ..... 313
- Computer**
  - On-board computer ..... 245
- Connection status**
  - Displays ..... 334
  - Overview ..... 333
- Contacts** ..... 320
  - Calling up ..... 320
  - Deleting ..... 322
  - Downloading (from mobile phone) ..... 320
  - Importing ..... 321
  - Information ..... 320
  - Making a call ..... 322
  - Name format ..... 321
  - Options ..... 322
  - Storing ..... 322
- Controller**
  - Operating ..... 270
- Convenience closing feature** ..... 75
- Convenience opening** ..... 75
- Coolant (engine)**
  - Filling capacity ..... 452
  - Level check ..... 383
  - Notes ..... 451
- Copyright**
  - Licenses ..... 30
  - Trademarks ..... 30
- Cornering light function** ..... 146
- Cover**
  - see Side windows
- Cross Traffic Alert** ..... 231
- Crosswind Assist**
  - Function/notes ..... 191
- Crosswind Assist**
  - see MAGIC BODY CONTROL
- Cruise control** ..... 196
  - Buttons ..... 197
  - Calling up a speed ..... 197
  - Function ..... 196
  - Requirements: ..... 197
  - Selecting ..... 197
  - Setting a speed ..... 197
  - Storing a speed ..... 197
  - Switching off ..... 197
  - Switching on ..... 197
  - System limitations ..... 196
- Cup holder** ..... 129
  - Installing/removing (center console) ... 129
  - Rear passenger compartment (vehicles with a rear bench seat) ..... 130
  - Rear passenger compartment (vehicles with electrically adjustable rear seats) ..... 130
  - Removing/installing the insert (vehicles with electrically adjustable rear seats) ..... 130
  - Switching the cooling/heating function on/off ..... 131



- Cushionbag ..... 38
- Customer Assistance Center (CAC) ..... 25
- Customer Relations Department ..... 25
- D**
- Dashboard**
  - see Cockpit
- Dashboard lighting**
  - see Instrument lighting
- Data acquisition**
  - Vehicle ..... 26
- Data import/export**
  - Function/notes ..... 284
  - Importing/exporting ..... 284
- Date**
  - Setting the time and date automatically ..... 278
- Daytime running lights** ..... 147
  - Activating/deactivating ..... 147
- Daytime running lights mode**
  - see Daytime running lights
- Deactivating the alarm (ATA)** ..... 87
- Declaration of conformity**
  - Wireless vehicle components ..... 23
- Definitions (tires and loading)** ..... 430
- Designs**
  - Menu (on-board computer) ..... 254
- Destination** ..... 305
  - Editing intermediate destinations ..... 296
  - Editing the previous destinations ..... 305
  - External ..... 306
  - Saving (current vehicle position) ..... 305
  - Saving as global favorite ..... 305
  - Storing a map position ..... 305
  - Using intelligent destination suggestions ..... 306
- Destination entry** ..... 292, 294
  - Enter geo-coordinates ..... 295
  - Entering a POI or address ..... 292
  - Entering an intermediate destination .. 296
  - Selecting a contact ..... 295
  - Selecting a POI ..... 294
  - Selecting from the map ..... 295
  - Selecting previous destinations ..... 294
- Detecting inattentiveness**
  - see ATTENTION ASSIST
- Diagnostics connection** ..... 24
- Digital Operator's Manual** ..... 18
- Digital speedometer** ..... 249
- DIRECT SELECT lever** ..... 173
  - Engaging drive position ..... 175
  - Engaging park position automatically .. 175
  - Engaging reverse gear ..... 175
  - Function ..... 173
  - Selecting park position ..... 175
  - Shifting to neutral ..... 175
- Display**
  - Care ..... 390
- Display (multimedia system)**
  - Notes ..... 269
  - Settings ..... 277
- Display (on-board computer)**
  - Displays in the multifunction display ... 247
- Display message** ..... 457
  - Calling up (on-board computer) ..... 457
  - Notes ..... 457
- Display messages**
  -  ..... 497

	.....	497	Active Hood Malfunction See Operator's Manual .....	497	Adaptive Highbeam Assist Inoperative .....	500
	.....	498	Active Lane Keeping Assist Currently Unavailable See Operator's Manual .....	476	Apply Brake to Shift from 'P' .....	492
	.....	481	Active Lane Keeping Assist Inoperative .....	476	 ATTENTION ASSIST Inoperative ...	474
Active Blind Spot Assist Currently Unavailable See Operator's Manual .....		477	Active Parking Assist and PARKTRONIC Inoperative See Operator's Manual .....	478	 ATTENTION ASSIST: Take a Break! .....	474
Active Blind Spot Assist Inoperative .....		477	Active Parking Assist Maneuvering Assistance Restricted See Operator's Manual .....	479	 Auto Lamp Function Inoperative .....	500
Active Blind Spot Asst. Not Available When Towing a Trailer See Operator's Manual .....		477	Active Steering Assist Currently Unavailable See Operator's Manual .....	480	Auxiliary Battery Malfunction .....	494
Active Brake Assist Functions Currently Limited See Operator's Manual .....		468	Active Steering Assist Inoperative .....	481	Blind Spot Assist Currently Unavailable See Operator's Manual .....	478
Active Brake Assist Functions Limited See Operator's Manual .....		468	Adaptive Highbeam Assist Camera View Restricted See Operator's Manual .....	501	Blind Spot Assist Inoperative .....	478
Active Distance Assist Currently Unavailable See Operator's Manual .....		480	Adaptive Highbeam Assist Currently Unavailable See Operator's Manual .....	500	 Check Brake Fluid Level .....	467
Active Distance Assist Inoperative .....		480			Check Coolant Level See Operator's Manual .....	482
Active Distance Assist Now Available .....		480			 Check Engine Oil At Next Refueling .....	485
 Active Headlamps Inoperative .....		499			 Check Left Low Beam (example) .....	499
					 Check Tires .....	487

- |   |     |   |  |
|---|-----|---|--|
|  Check Washer Fluid .....        | 498 | Example: Active Parking Assist Park-  | Let fresh air into the vehicle interior.   |
|  Coolant Too Hot Stop Vehicle    |     | ing Canceled .....  | Air Conditioning Malf. Visit Work-   |
| Turn Engine Off .....   | 482 | Front Passenger Airbag Disabled See   | shop .....   |
| Cruise Control Canceled .....   | 481 | Operator's Manual .....   | 495  |
| Cruise Control Inoperative .....  | 481 | Front Passenger Airbag Enabled See  | Lowering .....   |
|  Currently Unavailable See Oper- |     | Operator's Manual .....   | 481  |
| ator's Manual .....   | 459 | Front Passenger Airbag Enabled See  | Malfunction Drive at Max. 50 mph .....   |
|  Currently Unavailable See Oper- |     | Operator's Manual .....   | 476  |
| ator's Manual .....   | 461 |  Fuel Level Low .....          |  Malfunction See Operator's         |
|  DEF System Fault Engine Start   |     | 486   | Manual .....   |
| Not Possible .....  | 485 |  Gas Cap Loose .....           | 499  |
|  DEF System Fault Perf.          |     | 486   | Max. Speed 22 mph .....  |
| Reduced in XXX ml See Operator's  |     |  Inoperative See Operator's    | N Permanently Active Risk of Rolling   |
| Manual .....  | 486 | Manual .....  | Away .....   |
|  DEF System Fault See Opera-     |     |  Inoperative See Operator's    | 492  |
| tor's Manual .....  | 485 | Manual .....  |  Obtain a New Key .....             |
|  Don't Forget Your Key .....     | 491 |  Inoperative See Operator's    | 490  |
| Driver's Door Open & Transmission   |     | Manual .....  |  Off .....                          |
| Not in P Risk of Vehicle Rolling Away ..  | 492 | 462   | 480  |
|   |     |  Inoperative .....             | Only Shift to 'P' when Vehicle is Sta-   |
|   |     | 467   | tionary .....  |
|   |     |  Key Not Detected (red display | 492  |
|   |     | message) .....  |  Parking Brake See Operator's       |
|   |     | 491   | Manual .....   |
|   |     |  Key Not Detected (white dis-  | 464  |
|   |     | play message) .....   |  Place the Key in the Marked        |
|   |     | 490   | Space See Operator's Manual .....  |
|   |     |   | 491  |
|   |     |   |  Please Correct Tire Pressure ..... |
|   |     |   | 487  |
|   |     |   |  Please Release Parking Brake ....  |
|   |     |   | 463  |

- PRE-SAFE Inoperative See Operator's Manual ..... 468
- Radar Sensors Dirty See Operator's Manual ..... 469, 470
-  Rear Left Backrest Not Latched (example) ..... 498
-  Replace Key Battery ..... 490
- Reversing Not Possible Service Required ..... 493
-  See Operator's Manual ..... 483
- Service Required Do Not Shift Gears Visit Dealer ..... 493
-  SRS Malfunction Service Required ..... 471
-  Start Engine See Operator's Manual ..... 484
-  Steering Malfunction Drive Carefully Service Required ..... 495
-  Steering Malfunction Increased Physical Effort See Operator's Manual ..... 496
-  Steering Malfunction Stop Immediately See Operator's Manual ... 496
- Stop Vehicle Leave Engine Running Wait Transmission Cooling ..... 494
-  Stop Vehicle Leave Engine Running ..... 484
-  Stop Vehicle See Operator's Manual ..... 484
-  Stop Vehicle Vehicle Too Low ..... 475
-  Switch Off Lights ..... 500
-  Switch On Headlamps ..... 500
- Tire Press. Monitor Currently Unavailable ..... 488
- Tire Press. Monitor Inoperative ..... 489
- Tire Pressure Monitor Inoperative No Wheel Sensors ..... 489
- To Deselect P or N, Depress Brake and Start Engine ..... 492
- Traffic Sign Assist Camera View Restricted See Operator's Manual ..... 479
- Traffic Sign Assist Currently Unavailable See Operator's Manual ..... 479
- Traffic Sign Assist Inoperative ..... 479
- Transmission Malfunction Stop ..... 493
-  Turn On the Ignition to Release the Parking Brake ..... 463
-  Vehicle Operational Switch the Ignition Off Before Exiting ..... 493
-  Vehicle Rising Please Wait ..... 474
-  Vehicle Rising ..... 474
-  Warning Tire Malfunction ..... 488
-  Wheel Sensor(s) Missing ..... 489
- Display on the windshield**  
see Head-up Display
- Distance control**  
see Active Distance Assist DISTRONIC

- Distance recorder**
  - see Trip distance
- DISTRONIC**
  - see Active Distance Assist DISTRONIC
- Door**
  - Locking (mechanical key) ..... 65
  - Opening (from inside) ..... 62
  - Power closing function ..... 65
  - Unlocking (from inside) ..... 62
  - Unlocking (mechanical key) ..... 65
- Door control panel** ..... 12
- Door control panel (rear passenger compartment)** ..... 14
- DOT, Tire Identification Number (TIN)** ... 426
- Drinking and driving** ..... 168
- Drinks holder**
  - see Cup holder
- Drive Away Assist** ..... 230
- Drive position**
  - Selecting ..... 175
- Drive program display** ..... 173
- Drive programs**
  - see DYNAMIC SELECT
- Driving light**
  - see Automatic driving lights
- Driving safety system** ..... 188
  - ABS (Anti-lock Braking System) ..... 189
  - Active Brake Assist ..... 192
  - BAS (Brake Assist System) ..... 189
  - EBD (electronic brake force distribution) ..... 192
  - ESP® (Electronic Stability Program)
    - Crosswind Assist ..... 191
    - Overview ..... 188
  - Radar sensors ..... 188
  - Responsibility ..... 188
  - STEER CONTROL ..... 192
- Driving system**
  - see 360° camera
  - see Active Blind Spot Assist
  - see Active Distance Assist DISTRONIC
  - see Active Lane Keeping Assist
  - see Active Parking Assist
  - see Active Speed Limit Assist
  - see Active Steering Assist
  - see AIR BODY CONTROL
- see ATTENTION ASSIST
  - see Blind Spot Assist
  - see Cruise control
  - see Driving safety system
  - see HOLD function
  - see MAGIC BODY CONTROL
  - see Night View Assist
  - see Parking Assist PARKTRONIC
  - see Rear view camera
  - see Traffic Sign Assist
- Driving tips**
  - Drinking and driving ..... 168
  - General driving tips ..... 168
  - Notes on breaking-in a new vehicle .... 168
- Drowsiness detection**
  - see ATTENTION ASSIST
- Dynamic handling control system**
  - see ESP® (Electronic Stability Program)
- DYNAMIC SELECT** ..... 172
  - Configuring drive program I ..... 173
  - Displaying engine data ..... 173
  - Displaying vehicle data ..... 173
  - Drive program display ..... 173
  - Drive programs ..... 172

- Function ..... 172
  - Operating (DYNAMIC SELECT switch) ..... 173
  - Selecting the drive program ..... 173
- E**
- E10** ..... 448
  - Easy entry feature**
    - Function/notes ..... 111
    - Setting ..... 112
  - Easy exit feature**
    - Function/notes ..... 111
    - Setting ..... 112
  - EASY-PACK trunk box** ..... 126
    - Adjusting the height to any position .... 124
    - Care ..... 390
    - Installing/removing ..... 126
  - EBD (electronic brake force distribution)**
    - Function/notes ..... 192
  - ECO display**
    - Function ..... 172
    - Resetting ..... 250
  - ECO start/stop function** ..... 171
    - Automatic engine start ..... 171
    - Automatic engine stop ..... 171
    - Method of operation ..... 171
    - Switching off/on ..... 171
  - Electric parking brake** ..... 185, 186, 187
    - Applying automatically ..... 185
    - Applying or releasing manually ..... 186
    - Emergency braking ..... 187
    - Releasing automatically ..... 186
  - Electrical fuses**
    - Before replacing a fuse ..... 410
  - Electrical fuses**
    - see Fuses
  - Electronic Stability Program**
    - see ESP® (Electronic Stability Program)
  - Electronics** ..... 443
  - Emergency**
    - Assistance overview ..... 16
    - Safety vest ..... 393
  - Emergency braking** ..... 187
  - Emergency call system**
    - Mercedes-Benz mbrace® (USA) ..... 329
  - Emergency engine start** ..... 409
  - Emergency operation mode**
    - Starting the vehicle ..... 167
  - Emergency release**
    - Trunk lid (from inside) ..... 71
  - Emergency Tensioning Devices**
    - Activation ..... 32
  - ENERGIZING comfort**
    - Overview of programs ..... 289
    - Starting the program ..... 290
  - Energy consumption**
    - Key ..... 59
  - Engine**
    - ECO start/stop function ..... 171
    - Engine number ..... 445
    - Jump-starting ..... 401
    - Starting (emergency operation mode) ..... 167
    - Starting (smartphone) ..... 167
    - Starting (start/stop button) ..... 166
    - Switching off (start/stop button) ..... 179
  - Engine data**
    - Displaying ..... 173

- |  |     |                            |     |  |     |
|--|-----|----------------------------|-----|--|-----|
| <b>Engine number</b> .....                                   | 445 | <b>External device</b>     |     | <b>Fragrance</b>   |     |
| <b>Engine oil</b> .....                                      | 382 | Locking .....              | 283 | see Fragrance system   |     |
| Adding .....   | 382 |                            |     | <b>Fragrance system</b> .....                                      | 161 |
| Additives .....  | 449 | <b>F</b>                   |     | Inserting/removing the flacon .....                                | 161 |
| Capacity .....   | 450 | <b>Fatigue detection</b>   |     | <b>Free software</b> .....   | 30  |
| Checking the oil level using the oil<br>dipstick .....       | 381 | see ATTENTION ASSIST       |     | <b>Frequencies</b>   |     |
| Checking the oil level using the on-<br>board computer ..... | 381 | <b>Favorites</b>           |     | Two-way radio .....  | 444 |
| MB-Freigabe or MB-Approval .....                             | 450 | Adding .....               | 273 | <b>Frequency band</b>  |     |
| Quality .....  | 450 | Calling up .....           | 273 | Dialing (on-board computer) .....                                  | 251 |
| <b>ESC (Electronic Stability Control)</b>                    |     | Deleting .....             | 274 | <b>Front air bag (driver, front passenger)</b> ....                | 38  |
| see ESP® (Electronic Stability Program)                      |     | Moving .....               | 274 | <b>Front passenger air bag shutoff</b>                             |     |
| <b>ESP®</b>  |     | Overview .....             | 273 | see Automatic front-passenger front<br>air bag deactivation system |     |
| Crosswind Assist .....                                       | 191 | Renaming .....             | 273 | <b>Front passenger head restraint</b>                              |     |
| <b>ESP® (Electronic Stability Program)</b> .....             | 189 | <b>Flacon</b>              |     | Installing/removing (chauffeur mode) ...                           | 97  |
| Function/notes .....   | 189 | Inserting/removing .....   | 161 | <b>Front passenger seat</b>  |     |
| Switching on/off .....                                       | 191 | <b>Flat tire</b> .....     | 393 | Adjusting from the driver's seat .....                             | 91  |
| <b>Exterior lighting</b>                                     |     | Changing a wheel .....     | 437 | Adjusting from the rear passenger<br>compartment .....             | 91  |
| Care .....   | 389 | MOExtended tires .....     | 394 | Installing/removing the head<br>restraint (chauffeur mode) .....   | 97  |
| <b>Exterior lighting</b>                                     |     | Notes .....                | 393 | <b>Fuel</b> .....  | 449 |
| see Lights   |     | TIREFIT kit .....          | 395 | Additives .....  | 449 |
|  |     | <b>Floor mats</b> .....    | 141 |  |     |
|  |     | <b>Folding table</b> ..... | 121 |  |     |

- |   |     |   |     |
|---|-----|---|-----|
| E10 .....   | 448 |   |     |
| Gasoline .....                                    | 448 |   |     |
| Quality (gasoline) .....                          | 448 |   |     |
| Refuel .....                                      | 177 |   |     |
| Reserve fuel level .....                          | 449 |   |     |
| Sulfur content .....                              | 448 |   |     |
| Tank capacity .....                               | 449 |   |     |
| <b>Fuel consumption</b>                           |     |   |     |
| On-board computer .....                           | 249 |   |     |
| <b>Function seat</b>                              |     |   |     |
| see Door control panel                            |     |   |     |
| <b>Function seat (rear passenger compartment)</b> |     |   |     |
| see Seat (rear passenger compartment)             |     |   |     |
| <b>Fuse insert</b>                                |     |   |     |
| see Fuses   |     |   |     |
| <b>Fuses</b> .....                                | 410 |   |     |
| Assignment diagram .....                          | 410 |   |     |
| Dashboard fuse box .....                          | 412 |   |     |
| Fuse box in the engine compartment ...            | 410 |   |     |
| Fuse box in the front-passenger footwell .....    | 412 |   |     |
| Fuse box in the trunk .....                       | 412 |   |     |
| Notes .....                                       | 410 |   |     |
|   |     | <b>G</b>  |     |
|   |     | <b>Garage door opener</b>                               |     |
|   |     | Clearing the memory .....                               | 183 |
|   |     | Opening/closing the garage door .....                   | 183 |
|   |     | Programming buttons .....                               | 180 |
|   |     | Radio equipment approval numbers ...                    | 184 |
|   |     | Resolving problems .....                                | 182 |
|   |     | Synchronizing the rolling code .....                    | 182 |
|   |     | <b>Gas station search</b>                               |     |
|   |     | Starting an automatic gas station search .....          | 297 |
|   |     | Switching the automatic gas station search on/off ..... | 300 |
|   |     | <b>Gasoline</b> .....                                   | 448 |
|   |     | <b>Gearshift paddles</b>                                |     |
|   |     | see Steering wheel gearshift paddles                    |     |
|   |     | <b>Gearshift recommendation</b> .....                   | 176 |
|   |     | <b>Genuine parts</b> .....                              | 19  |
|   |     | <b>Genuine wood (Care)</b> .....                        | 390 |
|   |     | <b>Glass roof</b>                                       |     |
|   |     | see MAGIC SKY CONTROL                                   |     |
|   |     | <b>Glasses compartment</b> .....                        | 121 |
|   |     | <b>Glide mode</b> .....                                 | 177 |
|   |     | <b>Glove box</b>  |     |
|   |     | Air vent .....  | 164 |
|   |     | Locking/unlocking .....                                 | 120 |
|   |     | <b>H</b>  |     |
|   |     | <b>Handbrake</b>  |     |
|   |     | see Electric parking brake                              |     |
|   |     | <b>Handling characteristics (unusual)</b> .....         | 413 |
|   |     | <b>HANDS-FREE ACCESS</b> .....                          | 69  |
|   |     | <b>Hazard warning lamps</b> .....                       | 145 |
|   |     | <b>Head restraint</b> .....                             | 100 |
|   |     | Attaching/removing the supplementary cushion .....      | 104 |
|   |     | EASY ADJUST luxury head restraint (front) .....         | 101 |
|   |     | Front (adjusting manually) .....                        | 100 |
|   |     | Front (luxury head restraint) .....                     | 101 |
|   |     | Rear (adjusting electrically) .....                     | 104 |
|   |     | Rear (adjusting) .....                                  | 103 |
|   |     | Rear (extending from the front) .....                   | 102 |
|   |     | Rear (folding into position mechanically) .....         | 105 |
|   |     | Rear (lowering from the front) .....                    | 102 |



- Rear (luxury head restraint) ..... 104  
 Rear (setting the last position) ..... 103
- Head-up Display** ..... 253  
 Adjusting brightness (on-board computer) ..... 253  
 Adjusting display elements (on-board computer) ..... 253  
 Function ..... 254  
 Menu (on-board computer) ..... 253  
 Setting the position (on-board computer) ..... 253  
 Switching on/off ..... 255  
 Using the memory function ..... 113
- Headlamp flashing** ..... 144
- Headliner (care)** ..... 390
- Headphones (Rear Seat Entertainment System)**  
 Activating/deactivating ..... 365  
 Adjusting the volume ..... 365  
 Overview ..... 364  
 Replacing batteries ..... 365  
 Selecting a rear passenger compartment display ..... 365
- High beam**  
 Switching on/off ..... 144
- High-beam headlamps**  
 Adaptive Highbeam Assist ..... 146
- Hill start assist** ..... 210
- HOLD function** ..... 210  
 Function/notes ..... 210  
 Switching on/off ..... 210
- Hood**  
 Function (active hood) ..... 378  
 Opening/closing ..... 378  
 Resetting (active hood) ..... 378
- Hotspot**  
 Setting up (Wi-Fi) ..... 281
- Hydropneumatic suspension**  
 see MAGIC BODY CONTROL
- I**
- Identification plate**  
 Engine ..... 445  
 Refrigerant ..... 453  
 Vehicle ..... 445
- Ignition**  
 Switching on (start/stop button) ..... 165
- Ignition key**  
 see SmartKey
- Immobilizer** ..... 86
- Indicator lamp**  
 see Warning/indicator lamps
- Individual drive program**  
 Configuring ..... 173  
 Selecting ..... 173
- Instrument cluster**  
 see Instrument display  
 see Warning/indicator lamps
- Instrument display** ..... 244  
 Adjusting the lighting ..... 247  
 Function/notes ..... 244  
 Overview ..... 244  
 Warning and indicator lamps (overview) .. 8  
 Warning/indicator lamps ..... 501
- Instrument lighting** ..... 247
- Intelligent Light System**  
 Cornering light function ..... 146
- Interchanging wheels** ..... 435

- Interior lighting** ..... 148
    - Ambient lighting ..... 148
    - Setting ..... 148
    - Switch-off delay time ..... 149
  - Interior lighting**
    - see Interior lighting
  - Intermediate destination**
    - Calculating a route with intermediate destinations ..... 296
    - Editing ..... 296
    - Entering ..... 296
    - Starting an automatic gas station search ..... 297
    - Starting the automatic service station search ..... 300
  - Internet**
    - Deleting a bookmark ..... 335
    - Deleting browser data ..... 335
    - Managing bookmarks ..... 335
  - Internet connection**
    - Canceling permission ..... 333
    - Connection status ..... 333
    - Displaying the connection status ..... 334
    - Editing access data ..... 333
    - Establishing ..... 333
    - Information ..... 330
    - Mobile phone details ..... 333
    - Restrictions ..... 330
    - Setting access data ..... 331
    - Setting up (Bluetooth®) ..... 331
    - Switching Bluetooth® profile (DUN/PAN) ..... 332
    - Via Bluetooth® ..... 331
    - Via Wi-Fi ..... 331
  - Internet radio**
    - Calling up ..... 336
    - Deleting stations ..... 337
    - Logging in ..... 337
    - Logging out ..... 337
    - Overview ..... 336
    - Saving stations ..... 337
    - Selecting and connecting to a station ..... 337
    - Selecting stream ..... 337
    - Setting options ..... 337
    - Terms of use ..... 337
  - Ionization** ..... 161
  - iPhone®**
    - see Apple CarPlay™
- J**
- Jack**
    - Storage location ..... 436
  - Jump-start connection** ..... 401
  - Jump-starting**
    - see Jump-start connection
- K**
- Key**
    - Energy consumption ..... 59
  - KEYLESS-GO**
    - Locking the vehicle ..... 63
    - Problem ..... 64
    - Unlocking setting ..... 59
    - Unlocking the vehicle ..... 63
  - Kickdown** ..... 177
    - Using ..... 177
  - Knee air bag** ..... 38

<b>L</b>	
<b>Labeling (tires)</b>	
see Tire labeling	
<b>Laden</b>	
Bag hook .....	124
Notes .....	118
Roof rack .....	128
Stowage space under the trunk floor ...	127
<b>Lamp</b>	
see Interior lighting	
<b>Lamp (Instrument Display)</b>	
see Warning/indicator lamps	
<b>Lane Keeping Assist</b>	
see Active Lane Keeping Assist	
<b>Language</b>	
Notes .....	283
Setting .....	283
<b>LATCH-type (ISOFIX) child seat attachment</b>	
Installing .....	51
Notes .....	50
<b>Level control system</b>	
see AIR BODY CONTROL	
	see MAGIC BODY CONTROL
<b>Light switch</b>	
Overview .....	143
<b>Lighting</b>	
see Lights	
<b>Lights</b> .....	143
Adaptive Highbeam Assist .....	146
Adjusting the instrument lighting .....	247
Automatic driving lights .....	144
Combination switch .....	144
Cornering light function .....	146
Hazard warning lights .....	145
Headlamp flashing .....	144
High beam .....	144
Light switch .....	143
Low beam .....	143
Parking lights .....	143
Rear fog light .....	144
Responsibility for lighting systems .....	143
Setting the surround lighting .....	147
Standing lights .....	143
Turn signal light .....	144
<b>Limited Warranty</b>	
Vehicle .....	26

**Live Traffic Information**

Displaying subscription information ....	307
Displaying the traffic map .....	307
Displaying traffic incidents .....	308
Extending a subscription .....	307
Issuing hazard alerts .....	309
<b>Load index (tires)</b> .....	428
<b>Load-bearing capacity (tires)</b> .....	428
<b>Loading</b>	
Definitions .....	430
<b>Loading guidelines</b> .....	118
<b>Loading information table</b> .....	420
<b>Loads</b>	
Securing .....	118
<b>Locking/unlocking</b>	
KEYLESS-GO .....	63
Unlocking and opening doors from the inside .....	62
<b>Low beam</b>	
Switching on/off .....	143
<b>Lubricant additives</b>	
see Additives	

- Luggage**
  - Net hooks ..... 123
  - Securing ..... 118
- M**
- MAGIC BODY CONTROL** ..... 214
  - Setting ..... 217
  - Suspension ..... 214
- MAGIC SKY CONTROL** ..... 81
  - Function ..... 81
  - Operating ..... 82
- MAGIC VISION CONTROL**
  - Windshield wipers ..... 151
- Maintenance**
  - Vehicle ..... 21
- Maintenance**
  - see ASSYST PLUS
- Making a call via the overhead control panel**
  - Mercedes-Benz mbrace® (USA) ..... 328
- Malfunction**
  - Restraint system ..... 32
- Malfunction message**
  - see Display message
- Map** ..... 307, 309, 310
  - Avoiding an area ..... 312
  - Avoiding an area (overview) ..... 312
  - Changing an area ..... 312
  - Deleting an area ..... 313
  - Displaying the compass ..... 313
  - Displaying the map version ..... 312
  - Displaying the next intersecting street ..... 311
  - Displaying the satellite map ..... 314
  - Displaying the traffic map ..... 307
  - Displaying weather information ..... 314
  - Map data ..... 313
  - Moving ..... 310
  - Overview ..... 309
  - Selecting POI symbols ..... 311
  - Selecting text information ..... 311
  - Selecting the map orientation ..... 311
  - Setting the map scale ..... 310
  - Setting the map scale automatically .... 314
  - Updating ..... 313
- Map and compass**
  - Overview ..... 309
- Massage programs**
  - Overview ..... 106
  - Selecting the front seats ..... 107
- Massage settings**
  - Resetting ..... 107
- Matt finish (cleaning instructions)** ..... 387
- Maximum load rating** ..... 427
- Maximum permissible load**
  - Calculation example ..... 422
  - Determining ..... 421
- Maximum tire pressure** ..... 427
- Mechanical key**
  - Inserting/removing ..... 60
  - Locking a door ..... 65
  - Unlocking a door ..... 65
  - Unlocking the trunk lid ..... 71
- Media**
  - Menu (on-board computer) ..... 252
  - Searching ..... 344
  - Starting cinema mode ..... 349
- Media display**
  - Notes ..... 269

- Media Interface**
  - Activating ..... 345
  - Information ..... 344
  - Overview ..... 346
- Media mode**
  - Activating ..... 339
- Media playback**
  - Operating (on-board computer) ..... 252
- Media search**
  - Starting ..... 344
- Media source**
  - Dialing (on-board computer) ..... 252
- Memory function**
  - Head-up Display – Calling up saved settings ..... 113
  - Head-up Display – Saving settings ..... 113
  - Operating ..... 113
  - Outside mirror – Calling up saved settings ..... 113
  - Outside mirror – Saving settings ..... 113
  - Seat – Calling up saved settings ..... 113
  - Seat – Saving settings ..... 113
  - Steering wheel – Calling up saved settings ..... 113
  - Steering wheel – Saving settings ..... 113
- Memory function in the rear passenger compartment**
  - Operating rear seats ..... 114
  - Operating the front passenger seat and rear seat ..... 116
- Menu (on-board computer)**
  - Assistance graphic ..... 248
  - Designs ..... 254
  - Head-up Display ..... 253
  - Media ..... 252
  - Navigation ..... 250
  - Overview ..... 245
  - Radio ..... 251
  - Service ..... 248
  - Telephone ..... 252
  - Trip ..... 249
- Mercedes-AMG vehicles**
  - Notes ..... 165
- Mercedes-Benz Apps**
  - Calling up ..... 334
  - Using voice control ..... 334
- Mercedes-Benz mbrace® (USA)**
  - Emergency call system ..... 329
- Making a call via the overhead control panel ..... 328
- MB Info call ..... 329
- Roadside Assistance call ..... 330
- Transferred data ..... 330
- Message (multifunction display)**
  - see Display message
- Message memory** ..... 457
- Messages**
  - see Text messages
- Mirrors**
  - see Outside mirrors
- Mobile phone**
  - Canceling permission for Internet connection ..... 333
  - Wireless charging ..... 140
  - Wireless charging (rear passenger compartment) ..... 140
- Mobile phone**
  - see Android Auto
  - see Apple CarPlay™
  - see Telephone

**Mobile phone voice recognition**

- Starting ..... 319
- Stopping ..... 319

**Model type** ..... 445**MOExtended tires** ..... 394**Multifunction camera**

- ROAD SURFACE SCAN ..... 216

**Multifunction display (on-board computer)** ..... 247**Multifunction steering wheel**

- Overview of buttons ..... 245

**Multifunction steering wheel**

- see Steering wheel

**Multimedia system** ..... 269, 277

- Activating/deactivating standby mode ..... 187
- Adjusting the volume ..... 275
- Central control elements ..... 269
- Configuring display settings ..... 277
- ENERGIZING comfort program overview ..... 289
- Main functions ..... 272
- Overview ..... 269

- Rear climate control ..... 159
- Restoring the factory settings ..... 288
- Setting the footwell temperature ..... 159
- Starting the ENERGIZING comfort program ..... 290
- Switching the sound on or off ..... 274

**N****Navigation**

- Calling up the Digital Operator's Manual ..... 314
- Menu (on-board computer) ..... 250
- Showing/hiding the menu ..... 291
- Switching on ..... 291
- Updating the map data ..... 313
- Voice commands (Voice Control System) ..... 260

**Navigation**

- see Destination
- see Destination entry
- see Map
- see Route
- see Route guidance
- see Traffic information

**Navigation announcements**

- Activating/deactivating ..... 302
- Adjusting the volume ..... 303
- Repeating ..... 304
- Switching audio fadeout on/off ..... 303
- Switching on/off during a phone call .. 302

**Navigation messages**

- On-board computer ..... 250

**Near Field Communication (NFC)** ..... 317

- Connecting the mobile phone to the multimedia system ..... 317
- Switching Bluetooth® audio equipment ..... 349
- Switching mobile phones ..... 317

**Neutral**

- Selecting ..... 175

**NFC**

- see Near Field Communication (NFC)

**Night view**

- see Night View Assist

**Night View Assist** ..... 235

- Activating/deactivating ..... 236
- Automatic activation ..... 237
- Care ..... 388

- Function ..... 235
  - Pedestrian detection ..... 236
  - Spotlight function ..... 237
  - Notes on breaking-in a new vehicle** ..... 168
- O**
- Occupant safety**
    - Pets in the vehicle ..... 56
  - Occupant safety**
    - see Air bag
    - see Automatic front-passenger front air bag deactivation system
    - see PRE-SAFE® (anticipatory occupant protection)
    - see PRE-SAFE® PLUS (anticipatory occupant protection plus)
    - see Restraint system
    - see Seat belts
  - Odometer**
    - see Total distance
  - Oil**
    - see Engine oil
  - On-board computer**
    - Assistance graphic menu ..... 248
    - Displaying the service due date ..... 377
    - Head-up Display menu ..... 253
    - Media menu ..... 252
    - Menu designs ..... 254
    - Menu overview ..... 245
    - Multifunction display ..... 247
    - Navigation system menu ..... 250
    - Operating ..... 245
    - Radio menu ..... 251
    - Service menu ..... 248
    - Telephone menu ..... 252
    - Trip menu ..... 249
  - On-board diagnostics interface**
    - see Diagnostics connection
  - Open-source software** ..... 30
  - Opening the trunk lid using your foot**
    - HANDS-FREE ACCESS ..... 69
  - Operating fluids**
    - Additives (fuel) ..... 449
    - Brake fluid ..... 451
    - Coolant (engine) ..... 451
    - Engine oil ..... 449
    - Fuel (gasoline) ..... 448
    - Notes ..... 447
  - Refrigerant (air conditioning system) ... 453
  - Windshield washer fluid ..... 452
  - Operating safety**
    - Declaration of conformity (wireless vehicle components) ..... 23
    - Information ..... 22
  - Operating system**
    - On-board computer ..... 245
  - Operator's Manual**
    - Vehicle equipment ..... 20
  - Operator's Manual (digital)** ..... 18
  - Outside mirrors** ..... 152, 153, 154
    - Anti-glare mode (automatic) ..... 153
    - Automatic mirror folding function ..... 154
    - Folding in/out ..... 152
    - Parking position ..... 154
    - Setting ..... 152
    - Using the memory function ..... 113
  - Overhead control panel**
    - Overview ..... 10
- P**
- Paint (cleaning instructions)** ..... 387

- Paint code** ..... 445
- Panel heating**  
Setting ..... 109
- Panic alarm** ..... 59  
Activating/deactivating ..... 59
- Panoramic sliding sunroof**  
see Sliding sunroof
- Parcel net hooks** ..... 123
- Park position**  
Selecting ..... 175  
Selecting automatically ..... 175
- Parking** ..... 187
- Parking**  
see Electric parking brake
- Parking aid**  
see Parking Assist PARKTRONIC
- Parking Assist**  
Maneuvering assistance ..... 232
- Parking Assist PARKTRONIC** ..... 218  
Activating ..... 220  
Adjusting warning tones ..... 221  
Deactivating ..... 220
- Function ..... 218  
Side impact protection ..... 219  
System limitations ..... 218
- Parking assistance systems**  
see Active Parking Assist
- Parking brake**  
see Electric parking brake
- Parking lights** ..... 143
- Parking position**  
Outside mirrors ..... 154  
Storing the position of the passenger  
outside mirror using reverse gear ..... 154
- PASSENGER AIR BAG status display**  
see Automatic front-passenger front  
air bag deactivation system
- Payload**  
Calculation example ..... 422  
Determining the maximum ..... 421
- Pedestrian protection**  
see Active hood (pedestrian protection)
- Pennant holder** ..... 141
- Perfume**  
see Fragrance system
- Perfume atomizer**  
Setting ..... 161
- Perfume vial**  
see Fragrance system
- Period out of use**  
Activating/deactivating standby  
mode ..... 187
- Permitted towing methods** ..... 404
- Personalization**  
see User profile
- Pets in the vehicle** ..... 56
- Phone book**  
see Contacts
- Picture formats**  
see Video mode
- Picture settings**  
see Video mode
- PIN protection**  
Activating/deactivating ..... 285
- Plastic trim (Care)** ..... 390
- Playback options**  
Selecting ..... 341



<b>POI symbols</b>				
Custom .....	311			
<b>Ports (Rear Seat Entertainment System)</b>				
Overview .....	367			
<b>Power closing function</b>				
Door .....	65			
Trunk lid .....	67			
<b>Power supply</b>				
Switching on (start/stop button) .....	165			
<b>Power washer (care)</b> .....	385			
<b>PRE-SAFE® (anticipatory occupant protection)</b> .....	45			
Function .....	45			
PRE-SAFE® Sound .....	45			
Reversing the measures .....	46			
<b>PRE-SAFE® PLUS (anticipatory occupant protection plus)</b> .....	46			
Function .....	46			
Reversing the measures .....	46			
<b>Preventative occupant protection system</b>				
see PRE-SAFE® (anticipatory occupant protection)				
<b>Previous destinations</b>				
Selecting .....	294			
<b>Programs</b>				
see DYNAMIC SELECT				
<b>Protecting the environment</b>				
Notes .....	19			
<b>Q</b>				
<b>QR code</b>				
Rescue card .....	26			
<b>Qualified specialist workshop</b> .....	25			
<b>R</b>				
<b>Radar sensors</b> .....	188			
<b>Radio</b>				
Activating .....	350			
Activating/deactivating radio text .....	353			
Calling up the channel list .....	352			
Deleting stations .....	352			
Direct frequency entry .....	352			
Displaying information .....	353			
Displaying radio text .....	353			
Editing station presets .....	352			
Menu (on-board computer) .....	251			
Moving stations .....	352			
Overview .....	351			
Searching for stations .....	352			
Setting a station .....	352			
Setting the waveband .....	352			
Storing radio stations .....	352			
Switching HD Radio on/off .....	352			
Tagging music tracks .....	353			
Voice commands (Voice Control System) .....	263			
<b>Radio stations</b>				
Dialing (on-board computer) .....	251			
<b>Rain closing function</b>				
Sliding sunroof .....	80			
<b>Range</b>				
Displaying .....	249			
<b>Reading lamp</b>				
see Interior lighting				

**Rear climate control**

Setting ..... 159

**Rear display**

Activating/deactivating ..... 283

Locking ..... 283

Overview ..... 362

**Rear door (child safety lock)** ..... 55**Rear fog light** ..... 144**Rear passenger compartment display**

Setting the angle ..... 362

**Rear passenger compartment Internet functions**

Overview ..... 370

**Rear Seat Entertainment System**

Activating media mode ..... 374

Activating/deactivating the panel

heating ..... 368

Adjusting the ambient lighting ..... 368

Adjusting the rear seats ..... 367

Blu-ray drive ..... 366

Blu-ray functions overview ..... 374

Blu-ray/DVD menu ..... 374

Climate control ..... 367

Displaying destination information

(navigation) ..... 369

Dynamic range limitation ..... 376

ENERGIZING comfort ..... 368

Entertainment system settings ..... 368

Headphones overview ..... 364

Information about dynamic range

limitation ..... 376

Information about media mode ..... 370

Inserting a disc ..... 373

Internet connectivity status ..... 370

Internet functions overview ..... 370

Operating safety ..... 360

Overview ..... 361

Overview of massage and workout

programs ..... 367

Overview of the sound settings ..... 376

Playback option in Blu-ray/DVD

mode ..... 375

Ports overview ..... 367

Re-establishing an Internet connec-

tion ..... 370

Rear display overview ..... 362

Remote control overview ..... 362

Resetting the rear seat ..... 367

Selecting a film/track in Blu-

ray/DVD mode ..... 375

Selecting a massage program ..... 367

Selecting the scene/chapter in Blu-

ray/DVD mode ..... 375

Setting the language ..... 369

Switching navigation on ..... 369

Switching off the display ..... 369

Switching on the radio ..... 376

Switching to HDMI mode ..... 375

**Rear view camera** ..... 222

Assigning as a favorite (360° Cam-

era) ..... 226

Function ..... 222

Opening the camera cover (360°

Camera) ..... 226

**Rear view camera/ 360° Camera**

Care ..... 389

**Rear window**

Roller sunblind ..... 72

**Rear-view mirror**

see Outside mirrors

**Refrigerant (air conditioning system)**

Notes ..... 453

- Refrigerator box**
  - Installing/removing ..... 138
  - Using ..... 137
- Refueling**
  - Refueling the vehicle ..... 177
- Remote control (Rear Seat Entertainment System)**
  - Overview ..... 362
  - Replacing batteries ..... 364
  - Selecting a display ..... 363
  - Switching the display on/off ..... 363
- Reporting malfunctions relevant to safety** ..... 25
- Rescue card** ..... 26
- Reserve**
  - Fuel ..... 449
- Reset function (multimedia system)** ..... 288
- Residual heat**
  - Front ..... 160
  - Rear ..... 160
- Restoring (factory settings)**
  - see Reset function (multimedia system)
- Restraint system** ..... 31
  - Children ..... 47
  - Function in an accident ..... 32
  - Functionality ..... 32
  - Malfunction ..... 32
  - Protection ..... 31
  - Reduced protection ..... 31
  - System self-test ..... 32
  - Warning lamp ..... 32
- Reverse gear**
  - Selecting ..... 175
- Rims (Care)** ..... 389
- ROAD SURFACE SCAN**
  - Multifunction camera ..... 216
- Roadside Assistance** ..... 21
- Roadside Assistance call**
  - Mercedes-Benz mbrace® (USA) ..... 330
- Roll away protection**
  - see HOLD function
- Roller sunblind**
  - Rear window ..... 72
  - Side windows (electric) ..... 72
- Roof load** ..... 455
- Roof rack** ..... 128
- Route** ..... 297, 300
  - Calculating ..... 297
  - Displaying destination information ..... 299
  - Displaying destination information (Rear Seat Entertainment System) ..... 369
  - External ..... 306
  - Selecting a type ..... 298
  - Selecting an alternative route ..... 300
  - Selecting notifications ..... 299
  - Selecting options ..... 299
  - Starting the automatic service station search ..... 300
  - Switching the automatic gas station search on/off ..... 300
  - With intermediate destinations ..... 296
- Route guidance** ..... 300
  - Canceling ..... 304
  - Changing direction ..... 301
  - Destination reached ..... 302
  - From an off-road location ..... 304
  - Lane recommendations ..... 302
  - Notes ..... 300
  - Off-road ..... 304
  - To an off-road destination ..... 304

- Route-based speed adjustment** ..... 203
    - Displays in the Instrument Display ..... 208
    - Setting ..... 204
  - Run-flat characteristics**
    - MOExtended tires ..... 394
- S**
- Safety systems**
    - see Driving safety system
  - Safety vest** ..... 393
  - Satellite map** ..... 314
  - Satellite radio**
    - Activating/deactivating Tune Start ..... 357
    - Deleting a channel ..... 356
    - Displaying EPG information ..... 356
    - Displaying service information ..... 357
    - Information ..... 353
    - Information on smart favorites and Tune Start ..... 357
    - Logging in ..... 353
    - Moving a channel ..... 356
    - Music and sport alerts function ..... 356
    - Overview ..... 355
    - Pause and playback function ..... 357
    - Restrictions ..... 353
    - Selecting a category ..... 356
    - Selecting a channel ..... 356
    - Setting music and sport alerts ..... 356
    - Setting the parental control ..... 356
    - Storing a channel ..... 356
    - Switching on ..... 354
  - SD card**
    - Inserting/removing ..... 339
  - Seat**
    - Adjusting (electrically) ..... 89
    - Adjusting (Seat Comfort) ..... 93
    - Adjusting a reclining rear seat ..... 93
    - Adjusting the front passenger seat from the rear passenger compartment .. 91
    - Adjusting the front-passenger seat from the driver's seat ..... 91
    - Configuring settings ..... 105
    - Correct driver's seat position ..... 88
    - Massage program overview ..... 106
    - Panel heating ..... 109
    - Rear passenger compartment (adjusting electrically) ..... 93
    - Resetting the settings ..... 107
    - Selecting a massage program ..... 107
    - Setting automatic lateral support adjustment ..... 105
    - Setting options ..... 12
    - Setting the reclined position ..... 94
    - Using the memory function ..... 113
  - Seat**
    - see Chauffeur mode
    - see Head restraint
  - Seat (rear passenger compartment)** ..... 14
    - Setting options ..... 14
  - Seat belt** ..... 38
    - Activating/deactivating seat belt adjustment ..... 38
    - Belt air bag ..... 36
    - Reduced protection ..... 34
    - Releasing ..... 38
    - Seat belt adjustment (function) ..... 36
    - Seat belt buckle extender ..... 37
    - Warning lamp ..... 38
  - Seat belt adjustment**
    - Activating/deactivating ..... 38
    - Function ..... 36
  - Seat belt buckle extender** ..... 37

- Seat belt warning**  
see Seat belt
- Seat belts** ..... 33
  - Adjusting the height ..... 36
  - Care ..... 390
  - Fastening ..... 36
  - Protection ..... 33
- Seat cover (Care)** ..... 390
- Seat heater**  
Switching on/off ..... 107
- Seat ventilation**  
Switching on/off ..... 109
- Selecting a gear**  
see Shifting gears
- Selecting a POI**  
see Destination entry
- Selector lever**  
see DIRECT SELECT lever
- Sensors (Care)** ..... 389
- Service**  
Menu (on-board computer) ..... 248
- Service**  
see ASSYST PLUS
- Service center**  
see Qualified specialist workshop
- Service interval display**  
see ASSYST PLUS
- Setting a speed**  
see Cruise control
- Setting summer time** ..... 278
- Setting the date format** ..... 278
- Setting the distance unit** ..... 284
- Setting the footwell temperature**  
Setting ..... 159
- Setting the map scale**  
see Map
- Setting the sound profile**  
Burmester® high-end 3D surround  
sound system ..... 360
- Shifting gears** ..... 176
  - Gearshift recommendation ..... 176
  - Manual ..... 176
- Short text messages**  
see Text messages
- Side air bag** ..... 38
- Side impact protection** ..... 219
- Side windows** ..... 72, 73
  - Child safety lock in the rear  
passenger compartment ..... 56
  - Closing ..... 73
  - Closing using the SmartKey ..... 75
  - Convenience closing feature ..... 75
  - Convenience opening ..... 75
  - Opening ..... 73
  - Opening with the SmartKey ..... 75
  - Problem ..... 76
  - Roller sunblind (electric) ..... 72
- Size designation (tires)** ..... 428
- Skid chains**  
see Snow chains
- Sliding sunroof** ..... 77
  - Automatic features ..... 80
  - Closing ..... 77
  - Closing using the SmartKey ..... 75
  - MAGIC SKY CONTROL (function) ..... 81
  - MAGIC SKY CONTROL (operating) ..... 82
  - Opening ..... 77
  - Opening with the SmartKey ..... 75
  - Problem ..... 83

- Rain closing function ..... 80
- SmartKey** ..... 58
  - Battery ..... 60
  - Features ..... 58
  - Key ring attachment ..... 60
  - Mechanical key ..... 60
  - Overview ..... 58
  - Panic alarm ..... 59
  - Problem ..... 61
  - Unlocking setting ..... 59
- Smartphone**
  - Cooling or heating the vehicle interior ..... 166
  - Starting the vehicle ..... 167
- Smartphone**
  - see Android Auto
  - see Apple CarPlay™
  - see Telephone
- Snow chains** ..... 414
- Socket (12 V)** ..... 134
  - Front center console ..... 134
  - Rear passenger compartment ..... 134
  - Trunk ..... 136
- Socket (115 V)** ..... 135
  - Rear passenger compartment ..... 135
- Software update**
  - Important system updates ..... 288
  - Information ..... 287
  - Performing ..... 287
- Sound**
  - PRE-SAFE® Sound ..... 45
  - Wheels and tires ..... 413
- Sound**
  - see Burmester® surround sound system
  - see Sound settings
- Sound settings** ..... 357
  - Adjusting the balance/fader ..... 358
  - Adjusting treble, mid-range and bass settings ..... 358
  - Automatic volume adjustment ..... 358
  - Calls up the sound menu ..... 358
  - Information ..... 357
- Speech dialog system**
  - see Voice Control System
- Speed index (tires)** ..... 428
- Speed limit for winter tires**
  - Setting ..... 198
- Speedometer**
  - Digital ..... 249
- Spotlight function**
  - Activating/deactivating ..... 238
- Standby mode**
  - Activating/deactivating ..... 187
  - Function ..... 187
- Standing lights** ..... 143
- Start/Stop button**
  - Starting the vehicle ..... 166
  - Switching off the vehicle ..... 179
  - Switching on the power supply or ignition ..... 165
- Start/stop function**
  - see ECO start/stop function
- Starting the engine**
  - see Vehicle
- Starting-off aid**
  - see Hill start assist
- Station**
  - Deleting ..... 352

- Direct frequency entry ..... 352
- Moving ..... 352
- Searching ..... 352
- Setting ..... 352
- Storing ..... 352
- Station presets**
  - Editing ..... 352
- STEER CONTROL**
  - Function/notes ..... 192
- Steering wheel** ..... 245
  - Adjusting (electrically) ..... 110
  - Buttons ..... 245
  - Steering wheel heater ..... 111
  - Using the memory function ..... 113
- Steering wheel gearshift paddles** ..... 176
- Steering wheel heater**
  - Switching on/off ..... 111
- Stowage areas**
  - see Stowage compartment
- Stowage compartment** ..... 120
  - Armrest ..... 120
  - Center console ..... 120
  - Door ..... 120
  - Folding table ..... 121
  - Glasses compartment ..... 121
  - Glove box ..... 120
  - Parcel net hooks ..... 123
  - Rear armrest ..... 121
  - Rear seat backrest ..... 122
  - Rear-compartment center armrest ..... 122
- Stowage compartments**
  - see Stowage compartment
- Stowage space under the trunk floor** .... 127
- Sulfur content** ..... 448
- Sun visor**
  - Operating ..... 155
- Surround lighting**
  - Setting ..... 147
- Surround View**
  - see 360° camera
- Suspension**
  - Adjusting the chassis level (AIR BODY CONTROL) ..... 213
  - Adjusting the chassis level (MAGIC BODY CONTROL) ..... 217
- Suspension**
  - see AIR BODY CONTROL
  - see MAGIC BODY CONTROL
- Switch-off delay time**
  - Interior ..... 149
- Switching the surround sound on/off**
  - Burmester® surround sound system ... 359
- Synchronization function**
  - Activating/deactivating (multimedia system) ..... 160
- System self-test**
  - Automatic front-passenger front air bag deactivation system ..... 43
- System settings**
  - Language ..... 283
  - Notes on language selection ..... 283
  - Reset function (multimedia system) .... 288
  - Setting the distance unit ..... 284
  - Software update ..... 287
- System settings**
  - see Multimedia system

## T

**Table**

see Folding table

**Tailpipes (Care)** ..... 389

**Tank capacity**

Fuel ..... 449

Reserve (fuel) ..... 449

**Technical data**

Information ..... 443

Tire pressure monitoring system ..... 420

Vehicle identification plate ..... 445

**Telephone** ..... 252, 315

Activating functions during a call ..... 319

Call and ringtone volume ..... 318

Calls with several participants ..... 319

Connecting a mobile phone (Near

Field Communication (NFC)) ..... 317

Connecting a mobile phone (Pass-

key) ..... 316

Connecting a mobile phone (Secure

Simple Pairing) ..... 316

Disconnecting a mobile phone ..... 317

Importing contacts ..... 321

Incoming call during an existing call ... 320

Menu (on-board computer) ..... 252

Mobile phone voice recognition ..... 319

Notes ..... 316

Operating modes ..... 315

Reception and transmission volume ... 318

Switching mobile phones ..... 317

Switching mobile phones (Near Field

Communication (NFC)) ..... 317

Telephone menu overview ..... 315

Telephone operation ..... 319

Using Near Field Communication

(NFC) ..... 317

Voice commands (Voice Control Sys-

tem) ..... 262

Wireless charging (mobile phone in

the rear passenger compartment) ..... 140

Wireless charging (mobile phone) ..... 140

**Telephone number**

Dialing (on-board computer) ..... 252

**Telephony operating modes**

Bluetooth® Telephony ..... 315

**Temperature grade** ..... 425

**Text messages** ..... 323

Calling a message sender ..... 324

Changing folders ..... 324

Composing ..... 323

Configuring the displayed text mes-

sages ..... 323

Deleting ..... 324

Drafts ..... 324

Notes ..... 323

Options ..... 324

Outbox ..... 324

Read-aloud function ..... 323

Reading ..... 323

Replying ..... 324

Sending ..... 323

Voice commands (Voice Control Sys-

tem) ..... 266

**Time**

Manual time setting ..... 278

Setting summer time ..... 278

Setting the time and date automati-

cally ..... 278

Setting the time zone ..... 278

Setting the time/date format ..... 278

**TIN (Tire Identification Number)** ..... 426

**Tire and Loading Information placard** ... 420























- Tire characteristics** ..... 428
- Tire inflation compressor**  
see TIREFIT kit
- Tire information table** ..... 420
- Tire labeling** ..... 425
  - Characteristics ..... 428
  - DOT, Tire Identification Number (TIN)  
..... 426
  - Load index ..... 428
  - Load-bearing capacity ..... 428
  - Maximum tire load ..... 427
  - Maximum tire pressure ..... 427
  - Overview ..... 425
  - Speed rating ..... 428
  - Temperature grade ..... 425
  - Tire Quality Grading ..... 425
  - Tire size designation ..... 428
  - Traction grade ..... 425
  - Tread wear grade ..... 425
- Tire load (maximum)** ..... 427
- Tire pressure** ..... 417
  - Checking (manually) ..... 417
  - Checking (tire pressure monitoring  
system) ..... 419
  - Maximum ..... 427
  - Notes ..... 414
  - Restarting the tire pressure monitor-  
ing system ..... 420
  - Tire pressure monitoring system  
(function) ..... 418
  - Tire pressure table ..... 416
  - TIREFIT kit ..... 395
- Tire pressure monitor**
  - Checking the tire pressures ..... 419
  - Function ..... 418
  - Restarting ..... 420
- Tire pressure monitoring system**
  - Technical data ..... 420
- Tire pressure table** ..... 416
- Tire Quality Grading** ..... 425
- Tire tread** ..... 413
- Tire-change tool kit**
  - Overview ..... 436
- TIREFIT kit** ..... 395
  - Storage location ..... 395
  - Using ..... 395
- Tires**
  - Changing hub caps ..... 437
  - Characteristics ..... 428
  - Checking ..... 413
  - Checking the tire pressure (man-  
ually) ..... 417
  - Checking the tire pressure (tire pres-  
sure monitoring system) ..... 419
  - Definitions ..... 430
  - DOT, Tire Identification Number (TIN)  
..... 426
  - Flat tire ..... 393
  - Load index ..... 428
  - Load-bearing capacity ..... 428
  - Maximum tire load ..... 427
  - Maximum tire pressure ..... 427
  - MOExtended tires ..... 394
  - Mounting ..... 440
  - Noise ..... 413
  - Notes on mounting ..... 433
  - Overview of tire labeling ..... 425
  - Removing ..... 440
  - Replacing ..... 433, 437
  - Restarting the tire pressure monitor-  
ing system ..... 420
  - Selection ..... 433

- Snow chains ..... 414
- Speed rating ..... 428
- Storing ..... 436
- Temperature grade ..... 425
- Tire and Loading Information placard  
..... 420
- Tire pressure (notes) ..... 414
- Tire pressure monitoring system  
(function) ..... 418
- Tire pressure table ..... 416
- Tire Quality Grading ..... 425
- Tire size designation ..... 428
- TIREFIT kit ..... 395
- Traction grade ..... 425
- Tread wear grade ..... 425
- Unusual handling characteristics ..... 413
- Tool**  
see Vehicle tool kit
- Top Tether** ..... 52
- Total distance** ..... 249  
  Displaying ..... 249
- Touch Control**  
  On-board computer ..... 245  
  Operating ..... 270
- Setting the sensitivity ..... 270
- Touchpad**  
  Activating/deactivating ..... 271  
  Operating ..... 271  
  Reading the handwriting recognition  
  aloud ..... 272  
  Selecting a station and track ..... 272  
  Setting the sensitivity ..... 272
- Tow-starting** ..... 409
- Towing a trailer**  
  Active Blind Spot Assist ..... 239  
  Active Lane Keeping Assist ..... 240
- Towing away** ..... 405
- Towing eye**  
  Installing ..... 409  
  Storage location ..... 409
- Towing methods** ..... 404
- Track**  
  Selecting (audio mode) ..... 341
- Traction grade** ..... 425
- Traffic information** ..... 306  
  Displaying the traffic map ..... 307  
  Displaying traffic incidents ..... 308
- Issuing hazard alerts ..... 309  
  Live Traffic Information ..... 307  
  Overview ..... 306
- Traffic map**  
  see Map
- Traffic Sign Assist** ..... 233  
  Function/notes ..... 233  
  Setting ..... 235  
  System limitations ..... 233
- Transferred vehicle data**  
  Android Auto ..... 327  
  Apple CarPlay™ ..... 327
- Transmission position display** ..... 173
- Transporting**  
  Loading guidelines ..... 118  
  Vehicle ..... 407
- Tread wear grade** ..... 425
- Trim element (Care)** ..... 390
- Trip**  
  Menu (on-board computer) ..... 249
- Trip computer**  
  Displaying ..... 249  
  Resetting ..... 250

- |                                       |     |                                     |     |   |     |
|---------------------------------------|-----|-------------------------------------|-----|---|-----|
| <b>Trip distance</b> .....            | 249 | Notes on installation .....         | 443 | Data acquisition .....                  | 26  |
| Displaying .....                      | 249 | Transmission output (maximum) ..... | 444 | Diagnostics connection .....            | 24  |
| Resetting .....                       | 250 |                                     |     | Equipment .....                         | 20  |
| <b>Trip odometer</b>                  |     |                                     |     | Limited Warranty .....                  | 26  |
| see Trip distance                     |     |                                     |     | Locking (automatically) .....           | 64  |
| <b>Trunk box</b>                      |     |                                     |     | Locking (from inside) .....             | 63  |
| see EASY-PACK trunk box               |     |                                     |     | Locking (KEYLESS-GO) .....              | 63  |
| <b>Trunk lid</b>                      |     |                                     |     | Locking (mechanical key) .....          | 64  |
| Activating/deactivating the trunk lid |     |                                     |     | Lowering .....                          | 441 |
| opening height restriction .....      | 71  |                                     |     | Maintenance .....                       | 21  |
| Closing .....                         | 67  |                                     |     | Parking .....                           | 187 |
| Emergency release (from inside) ..... | 71  |                                     |     | Problem notification .....              | 25  |
| HANDS-FREE ACCESS .....               | 69  |                                     |     | QR code rescue card .....               | 26  |
| Locking separately .....              | 70  |                                     |     | Qualified specialist workshop .....     | 25  |
| Opening .....                         | 66  |                                     |     | Raising .....                           | 438 |
| Opening dimensions .....              | 454 |                                     |     | Starting (emergency operation           |     |
| Power closing function .....          | 67  |                                     |     | mode) .....                             | 167 |
| Unlocking (mechanical key) .....      | 71  |                                     |     | Starting (smartphone) .....             | 167 |
| <b>Turn signal indicator</b>          |     |                                     |     | Starting (start/stop button) .....      | 166 |
| see Turn signal light                 |     |                                     |     | Switching off (start/stop button) ..... | 179 |
| <b>Turn signal light</b> .....        | 144 |                                     |     | Unlocking (from inside) .....           | 63  |
| Switching on/off .....                | 144 |                                     |     | Unlocking (KEYLESS-GO) .....            | 63  |
| <b>Two-way radios</b>                 |     |                                     |     | Ventilating (convenience opening) ..... | 75  |
| Frequencies .....                     | 444 |                                     |     | Voice commands (Voice Control Sys-      |     |
|                                       |     |                                     |     | tem) .....                              | 267 |
- 
- |                                |     |
|--------------------------------|-----|
| <b>U</b>                       |     |
| <b>Units of measurement</b>    |     |
| Setting .....                  | 284 |
| <b>Unlocking setting</b> ..... | 59  |
| <b>USB devices</b>             |     |
| Connecting .....               | 341 |
| <b>USB port</b> .....          | 136 |
| <b>User profile</b> .....      | 285 |
| Creating .....                 | 286 |
| Importing/exporting .....      | 286 |
| Options .....                  | 286 |
| Selecting .....                | 285 |
| <b>Using the telephone</b>     |     |
| see Calls                      |     |
- 
- |                                 |          |
|---------------------------------|----------|
| <b>V</b>                        |          |
| <b>Vehicle</b> .....            | 166, 167 |
| Activating/deactivating standby |          |
| mode .....                      | 187      |
| Correct use .....               | 25       |

- Vehicle data**
  - Displaying (DYNAMIC SELECT) ..... 173
  - Roof load ..... 455
  - Turning radius ..... 454
  - Vehicle height ..... 454
  - Vehicle length ..... 454
  - Vehicle width ..... 454
  - Wheelbase ..... 454
- Vehicle data storage**
  - COMAND/mbrace ..... 28
  - Electronic control units ..... 26
  - Event data recorders ..... 29
  - Service providers ..... 28
- Vehicle dimensions** ..... 454
- Vehicle electronics**
  - Notes ..... 443
  - Two-way radios ..... 443
- Vehicle identification number**
  - see VIN
- Vehicle identification plate**
  - Paint code ..... 445
  - VIN ..... 445
- Vehicle identification plate**
  - see Model type
- Vehicle interior**
  - Cooling or heating (smartphone) ..... 166
- Vehicle key**
  - see SmartKey
- Vehicle maintenance**
  - see ASSYST PLUS
- Vehicle operation**
  - Outside the USA or Canada ..... 21
- Vehicle position**
  - Transmitting ..... 279
- Vehicle tool kit** ..... 395
  - TIREFIT kit ..... 395
  - Towing eye ..... 409
- Ventilating**
  - Convenience opening ..... 75
- Vents**
  - see Air vents
- Video mode** ..... 344
  - Activating ..... 342
  - Activating/deactivating full-screen mode ..... 344
  - Overview ..... 343
  - Settings ..... 344
- VIN** ..... 445
  - Identification plate ..... 445
  - Seat ..... 445
  - Windshield ..... 445
- Visibility**
  - Defrosting the windows ..... 160
  - Windshield heater ..... 162
- Voice command types (Voice Control System)** ..... 257
- Voice Control System** ..... 256
  - Application-specific voice commands ..... 257
  - Audible help functions ..... 258
  - Entering numbers ..... 258
  - Global voice commands ..... 257
  - Improving speech quality ..... 258
  - Language setting ..... 258
  - Media player voice commands ..... 264
  - Message voice commands ..... 266
  - Multifunction steering wheel (operating) ..... 256
  - Navigation voice commands ..... 260
  - Operable functions ..... 257
  - Operating safety ..... 256
  - Radio voice commands ..... 263

- Switch voice commands ..... 259
  - Telephone voice controls ..... 262
  - Text message voice commands ..... 266
  - Types of voice commands ..... 257
  - Vehicle voice commands ..... 267
  - Voice prompting ..... 257
- Voice control system**  
see Voice Control System
- W**
- Warning lamp**  
see Warning/indicator lamps
- Warning system**  
see ATA (anti-theft alarm system)
- Warning/indicator lamp**
-  ABS warning lamp ..... 505
  -  Air suspension warning lamp ..... 511
  -  BRAKE Brake warning lamp (USA) ..... 503
  -  Brakes warning lamp (Canada) .... 503
  -  Coolant warning lamp ..... 515
  -  Distance warning lamp ..... 511
  -  Electrical malfunction warning lamp ..... 513
  -  Engine diagnosis warning lamp .... 513
  -  ESP® OFF warning lamp ..... 507
  -  ESP® warning lamp flashes ..... 505
  -  ESP® warning lamp lights up ..... 506
  -  Fuel reserve warning lamp ... 513, 514
  -  Power steering system warning lamp ..... 512
  -  Red indicator lamp, electric parking brake applied (Canada only) ... 508
  -  PARK Red indicator lamp, electric parking brake applied (USA only) ..... 508
  -  Restraint system warning lamp ... 509
  -  Seat belt warning lamp flashes .... 510
  -  Seat belt warning lamp lights up ..... 510
  -  Tire pressure monitoring system warning lamp flashes ..... 518
  -  Tire pressure monitoring system warning lamp lights up ..... 517
  -  Yellow electric parking brake indicator lamp is malfunctioning ..... 508
- Warning/indicator lamps** ..... 8, 501
- Instrument Display (overview) ..... 8
  - Overview ..... 501
  - PASSENGER AIR BAG ..... 43
- Warranty** ..... 26
- Washer fluid**  
see Windshield washer fluid
- Washing by hand (care)** ..... 386
- Weather information** ..... 314
- Web browser**
- Calling up a web page ..... 334
  - Calling up options ..... 335
  - Calling up the settings ..... 335
  - Deleting a bookmark ..... 335
  - Deleting browser data ..... 335
  - Ending ..... 336
  - Managing bookmarks ..... 335
  - Overview ..... 335
  - Showing/hiding the menu ..... 334

- Website**  
 Calling up ..... 334  
 Showing/hiding the web browser menu ..... 334
- Wheel chock** ..... 436  
 Storage location ..... 436
- Wheel chock**  
 see Wheel chock
- Wheels**  
 Care ..... 389  
 Changing hub caps ..... 437  
 Checking ..... 413  
 Checking the tire pressure (manually) ..... 417  
 Checking the tire pressure (tire pressure monitoring system) ..... 419  
 Definitions ..... 430  
 DOT, Tire Identification Number (TIN) ..... 426  
 Flat tire ..... 393  
 Interchanging ..... 435  
 Load index ..... 428  
 Load-bearing capacity ..... 428  
 Maximum tire load ..... 427  
 Maximum tire pressure ..... 427
- MOExtended tires ..... 394  
 Mounting ..... 440  
 Noise ..... 413  
 Notes on mounting ..... 433  
 Overview of tire labeling ..... 425  
 Removing ..... 440  
 Replacing ..... 433, 437  
 Restarting the tire pressure monitoring system ..... 420  
 Selection ..... 433  
 Snow chains ..... 414  
 Speed rating ..... 428  
 Storing ..... 436  
 Temperature grade ..... 425  
 Tire and Loading Information placard ..... 420  
 Tire characteristics ..... 428  
 Tire pressure (notes) ..... 414  
 Tire pressure monitoring system (function) ..... 418  
 Tire pressure table ..... 416  
 Tire Quality Grading ..... 425  
 Tire size designation ..... 428  
 TIREFIT kit ..... 395  
 Traction grade ..... 425  
 Tread wear grade ..... 425
- Unusual handling characteristics ..... 413
- Wi-Fi**  
 Overview ..... 280  
 Setting ..... 280  
 Setting up a hotspot ..... 281  
 Setting up an Internet connection ..... 331
- Window air bag** ..... 38
- Window lifter**  
 see Side windows
- Windows**  
 see Side windows
- Windows (Care)** ..... 389
- Windshield** ..... 151  
 Infrared reflective ..... 155  
 Replacing the wiper blades ..... 151  
 Replacing wiper blades (MAGIC VISION CONTROL) ..... 151
- Windshield**  
 see Windshield
- Windshield heater** ..... 162
- Windshield heating**  
 see Windshield heater

<b>Windshield washer fluid</b> .....	452	Mobile phone (rear passenger com- partment) .....	140
Notes .....	452	<b>Wireless vehicle components</b>	
<b>Windshield washer system</b>		Declaration of conformity .....	23
Refilling .....	384	<b>Workout program</b>	
<b>Windshield wipers</b>		Overview .....	106
Replacing the wiper blades .....	151	<b>Workshop</b>	
Replacing wiper blades (MAGIC VISION CONTROL) .....	151	see Qualified specialist workshop	
Service position .....	150		
Switching on/off .....	149		
<b>Winter operation</b>			
Snow chains .....	414		
<b>Winter tires</b>			
Setting the permanent speed limit .....	198		
<b>Wiper blades</b>			
Activating/deactivating the service position .....	150		
Care .....	389		
Replacing .....	151		
Replacing (MAGIC VISION CONTROL) .....	151		
<b>Wireless charging</b>			
Function/notes .....	139		
Mobile phone .....	140		







