



Operator's Manual
SLK-Class



Mercedes-Benz



Order No. 6515 3269 13 Part No. 171 584 16 82 Edition B 2007

SLK-Class

SLK 280

SLK 350

SLK 55 AMG

Our company and staff congratulate you on the purchase of your new Mercedes-Benz.

Your selection of our product is a demonstration of your trust in our company name. Furthermore, it exemplifies your desire to own an automobile that will be as easy as possible to operate and provide years of service.

Your Mercedes-Benz represents the efforts of many skilled engineers and craftsmen. To help assure your driving pleasure, and also the safety of you and your passengers, we ask you to make a small investment of time:

- Please read this manual carefully, then return it to your vehicle where it will be handy for your reference.
- Please follow the recommendations contained in this manual. They are designed to acquaint you with the operation of your Mercedes-Benz.

- Please pay attention to the warnings and cautions contained in this manual. They are designed to help improve the safety of the vehicle operator and occupants.

We extend our best wishes for many miles of safe, pleasurable driving.

Mercedes-Benz USA, LLC
A DaimlerChrysler Company

Introduction	9
Product information.....	9
Operator's Manual.....	10
Service and warranty information ..	10
Important notice for California retail buyers and lessees of Mercedes-Benz automobiles	11
Maintenance	12
Roadside Assistance	12
Change of address or ownership....	12
Operating your vehicle outside the USA or Canada.....	13
Where to find it.....	14
Symbols.....	15
Operating safety	16
Proper use of the vehicle	16
Problems with your vehicle.....	17
Reporting safety defects.....	18
Reporting safety defects	18
Vehicle data recording.....	19
Information regarding electronic recording devices.....	19

At a glance	21
Exterior view.....	22
Cockpit.....	24
Instrument cluster	26
Multifunction steering wheel	28
Center console	29
Upper part	29
Lower part	30
Overhead control panel	31
Storage compartments.....	32
Door control panel.....	34

Getting started	35
Unlocking	36
Unlocking with the SmartKey	36
Starter switch positions.....	37
Adjusting.....	39
Seats	39
Steering wheel.....	43
Mirrors.....	46
Driving.....	48
Fastening the seat belts	48
Starting the engine	51
Parking brake	53
Driving off	53
Switching on headlamps.....	55
Turn signals	55
Windshield wipers.....	56
Problems while driving.....	58
Parking and locking.....	59
Parking brake	59
Switching off headlamps.....	61
Turning off engine.....	61
Releasing seat belts.....	61
Locking.....	62

Safety and Security	63	Controls in detail	93	Instrument cluster	118
Occupant safety	64	Locking and unlocking	94	Adjusting instrument cluster	
Air bags	66	SmartKey	94	illumination	118
Occupant Classification System	71	Opening the doors from		Tachometer	119
Seat belts	76	the inside	99	Outside temperature indicator	119
Children in the vehicle	79	Opening the trunk	100	Resetting trip odometer	120
Panic alarm	83	Closing the trunk	100	Clock	120
Activating	83	Trunk lid emergency release	101	Control system	121
Deactivating	83	Automatic central locking	102	Multifunction display	121
Driving safety systems	84	Locking and unlocking from the		Multifunction steering wheel	122
ABS	84	inside	102	Menus	124
BAS	86	Seats	104	Standard display menu	127
ESP®	86	Seat heating*	104	AMG menu	128
Anti-theft systems	90	AIRSCARF neck-level heating*	105	AUDIO menu	133
Immobilizer	90	Memory function*	107	NAV* menu	135
Anti-theft alarm system	90	Storing positions into memory	108	Vehicle status message	
Tow-away alarm	91	Recalling positions from memory	108	memory menu	135
		Lighting	109	Settings menu	136
		Exterior lamp switch	109	Trip computer menu	148
		Combination switch	113	TEL* menu	149
		Corner-illuminating front		Manual transmission	153
		fog lamps*	114	Shifting into reverse	154
		Hazard warning flasher	115		
		Interior lighting	116		
		Door entry lamps	117		

Automatic transmission*	155	Climate control.....	172	Audio system.....	193
Gear selector lever.....	155	Switching climate control		Audio and telephone*, operation..	193
Shifting procedure	156	system on/off.....	175	Operating safety	193
Gear selector lever positions	157	Setting the temperature.....	175	Operating and display elements ...	194
Driving tips.....	159	Adjusting air distribution.....	176	Button and soft key operation	196
Gear ranges	160	Adjusting air volume	177	Operation.....	196
Automatic shift program	161	Basic settings	177	Radio operation	199
Gear selector lever one-touch		Front defroster.....	177	Introduction to satellite radio*	
gearshifting.....	162	Air recirculation mode	178	(USA only).....	203
Steering wheel gearshift control		Air conditioning.....	180	CD mode.....	208
one-touch gearshifting*	163	Residual engine heat utilization ...	181	GSM network phones	219
Manual shift program*	165	Automatic climate control*	182	TDMA or CDMA network phones ..	226
Emergency operation		Deactivating the climate control		Emergency calls “911”	233
(Limp-Home Mode)	167	system	185	Power windows	235
Good visibility	168	Operating the climate control		Opening and closing the windows	235
Headlamp cleaning system*	168	system in automatic mode.....	186	Synchronizing power windows.....	239
Rear view mirrors.....	168	Setting the temperature.....	186	Retractable hardtop	240
Sun visors	170	Adjusting air distribution.....	187	Opening and closing the	
Rear window defroster	170	Adjusting air volume	188	retractable hardtop.....	240
		Front defroster.....	188	Wind screen*	246
		Maximum cooling MAX COOL	189	Driving systems.....	247
		Air recirculation mode	189	Cruise control	247
		Air conditioning.....	191		
		Residual heat and ventilation	192		

Contents

Loading	251	Operation	277	At the gas station	291
Roof rack	251	The first 1000 miles (1500 km).....	278	Refueling.....	291
Useful features	252	Driving instructions.....	279	Check regularly and before a long trip	292
Storage compartments.....	252	Drive sensibly – save fuel.....	279	Engine compartment	294
Shelf behind roll bars	254	Drinking and driving.....	279	Hood	294
Cup holder.....	254	Pedals	279	Engine oil	296
Ashtray.....	255	Power assistance	280	Transmission fluid level*	300
Cigarette lighter	256	Brakes.....	280	Coolant level.....	300
Power outlet.....	257	Driving off	282	Windshield washer system and headlamp cleaning system*	302
Floor mat (driver's side only).....	257	Parking.....	282	Battery	303
Telephone*	258	Tires	283	Tires and wheels.....	304
Tele Aid*	261	Hydroplaning.....	284	Important guidelines	304
Garage door opener*	270	Tire traction.....	284	Tire care and maintenance.....	305
Heated steering wheel*		Tire speed rating	285	Direction of rotation.....	307
(SLK 280, SLK 350, Canada only)	276	Winter driving instructions	286	Loading the vehicle	307
		Standing water.....	287	Recommended tire inflation pressure.....	312
		Passenger compartment	287	Checking tire inflation pressure ...	314
		Driving abroad.....	287	MO <i>Extended</i> system*	317
		Control and operation of radio transmitter	287	Tire labeling	318
		Catalytic converter.....	288	Load identification	322
		Emission control	289		
		Coolant temperature.....	289		

DOT, Tire Identification			
Number (TIN)	322	Practical hints	345
Maximum tire load	324	What to do if	346
Maximum tire inflation pressure ..	324	Lamps in instrument cluster	346
Uniform Tire Quality Grading		Lamp in center console.....	354
Standards (U.S. vehicles)	325	Vehicle status messages in the	
Tire ply material	327	multifunction display.....	356
Tire and loading terminology	327	Where will I find...?	382
Rotating tires	330	First aid kit.....	382
Winter driving	332	Vehicle tool kit, vehicle jack	382
Winter tires	332	Spare wheel with collapsible tire ..	385
Snow chains.....	333	Spare wheel bolts	386
Maintenance.....	334	Unlocking/locking in an emergency... ..	387
Maintenance service indicator		Unlocking the vehicle.....	387
message.....	334	Locking the vehicle	388
Clearing the maintenance		Manually unlocking the gear	
service indicator message.....	335	selector lever	
Maintenance service term		(automatic transmission*)	389
exceeded	335	Opening/closing in an emergency	390
Calling up the maintenance		Raising retractable hardtop	
service indicator display.....	335	manually	390
Resetting the maintenance		Replacing SmartKey batteries	391
service indicator.....	336	SmartKey	391
Vehicle care.....	337		
Cleaning and care of vehicle	337	Replacing bulbs.....	393
		Bulbs.....	393
		Replacing bulbs for front lamps	396
		Replacing bulbs for rear lamps	397
		Replacing wiper blades	399
		Placing wiper arms in vertical	
		position.....	399
		Removing wiper blades.....	400
		Installing wiper blades	400
		Flat tire.....	401
		Preparing the vehicle	401
		Sealing tires with TIREFIT	401
		Mounting the spare wheel	407
		MO <i>Extended</i> system*	414
		Battery	415
		Disconnecting the battery	416
		Removing the battery	417
		Charging and reinstalling battery..	417
		Reconnecting the battery	418
		Jump starting.....	419
		Towing the vehicle.....	421
		Installing towing eye bolt.....	422
		Fuses.....	425
		Fuse box in passenger	
		compartment.....	425
		Fuse box in engine compartment .	426

Contents

Technical data	427	Fuels, coolants, lubricants, etc.	443	Index	451
Parts service	428	Capacities	443		
Warranty coverage.....	429	Engine oils.....	445		
Loss of Service and Warranty		Engine oil additives	445		
Information Booklet.....	429	Air conditioning refrigerant	445		
Identification labels.....	430	Brake fluid.....	446		
Layout of poly-V-belt drive	432	Premium unleaded gasoline	446		
SLK 280, SLK 350	432	Fuel requirements	447		
SLK 55 AMG.....	432	Gasoline additives.....	447		
Engine.....	433	Coolants.....	448		
Rims and tires.....	434	Windshield washer system and			
Same size tires.....	435	headlamp cleaning system*	450		
Mixed size tires	437				
Spare wheel with collapsible tire..	439				
Electrical system.....	440				
Main Dimensions	441				
Weights.....	442				

▼ Product information

Please observe the following in your own best interest:

We recommend using Genuine Mercedes-Benz Parts as well as conversion parts and accessories explicitly approved by us for your vehicle model.

We have tested these parts to determine their reliability, safety and special suitability for Mercedes-Benz vehicles.

We are unable to make an assessment for other products and therefore cannot be held responsible for them, even if in individual cases an official approval or authorization by governmental or other agencies should exist. Use of such parts and accessories could adversely affect the safety, performance or reliability of your vehicle. Please do not use them.

Genuine Mercedes-Benz Parts as well as conversion parts and accessories approved by us are available at your authorized Mercedes-Benz Center where you will receive comprehensive information, also on permissible technical modifications, and where proper installation will be performed.

This Operator's Manual contains a great deal of useful information. We urge you to read it carefully and familiarize yourself with the vehicle before driving.

For your own safety and longer service life of the vehicle, we urge you to follow the instructions and warnings contained in this manual. Ignoring them could result in damage to the vehicle or personal injury to you or others. Vehicle damage caused by failure to follow instructions is not covered by the Mercedes-Benz Limited Warranty.

Your vehicle may have some or all of the equipment described in this manual. Therefore, you may find explanations for optional equipment not installed in your vehicle. If you have any questions about the operation of any equipment, your authorized Mercedes-Benz Center will be glad to demonstrate the proper procedures.

We continuously strive to improve our product, and ask for your understanding that we reserve the right to make changes in design and equipment.

Therefore, information, illustrations and descriptions in this Operator's Manual might differ from your vehicle.

Optional equipment is also described in this manual, including operating instructions wherever necessary. Since they are special-order items, the descriptions and illustrations herein may vary slightly from the actual equipment of your vehicle.

If there are any equipment details that are not shown or described in this Operator's Manual, your authorized Mercedes-Benz Center will be glad to inform you of correct care and operating procedures.

The Operator's Manual and Maintenance Booklet are important documents and should be kept with the vehicle.

Service and warranty information

The Service and Warranty Information Booklet contains detailed information about the warranties covering your Mercedes-Benz, including:

- New Car Limited Warranty
- Emission System Warranty
- Emission Performance Warranty
- California, Maine, Massachusetts, and Vermont Emission Control System Warranty (California, Maine, Massachusetts, and Vermont only)
- State Warranty Enforcement Laws (Lemon Laws)

Important notice for California retail buyers and lessees of Mercedes-Benz automobiles

Under California law you may be entitled to a replacement of your vehicle or a refund of the purchase price or lease price, if Mercedes-Benz USA, LLC and/or its authorized repair or service facilities fail to fix one or more substantial defects or malfunctions in the vehicle that are covered by its express warranty after a reasonable number of repair attempts. During the period of 18 months from original delivery of the vehicle or the accumulation of 18 000 miles (approximately 29 000 km) on the odometer of the vehicle, whichever occurs first, a reasonable number of repair attempts is presumed for a retail buyer or lessee if one or more of the following occurs:

- (1) the same substantial defect or malfunction results in a condition that is likely to cause death or serious bodily injury if the vehicle is driven, that defect or malfunction has been subject to repair two or more times, and you have directly notified Mercedes-Benz USA, LLC in writing of the need for its repair,
- (2) the same substantial defect or malfunction of a less serious nature than category (1) has been subject to repair four or more times and you have directly notified us in writing of the need for its repair, or
- (3) the vehicle is out of service by reason of repair of the same or different substantial defects or malfunctions for a cumulative total of more than 30 calendar days.

Written notification should not be sent to a dealer, it should be addressed to:
Mercedes-Benz USA, LLC
Customer Assistance Center
One Mercedes Drive
Montvale, NJ 07645-0350

Maintenance

The Maintenance Booklet describes all the necessary maintenance work which should be performed at regular intervals.

Always have the Maintenance Booklet with you when you take the vehicle to your authorized Mercedes-Benz Center for service. The service advisor will record each service in the booklet for you.

Roadside Assistance

The Mercedes-Benz Roadside Assistance Program provides factory-trained technical help in the event of a breakdown. Calls to the toll-free Roadside Assistance number

1-800-FOR-MERCEdes (in the USA)
1-800-387-0100 (in Canada)

will be answered by Mercedes-Benz Customer Assistance Representatives 24 hours a day, 365 days a year.

For additional information refer to the Mercedes-Benz Roadside Assistance Program Brochure in your vehicle literature portfolio.

Change of address or ownership

If you change your address, be sure to send in the "Change of Address Notice" found in the Service and Warranty Information Booklet, or simply call the Mercedes-Benz Customer Assistance Center (in the USA) at 1-800-FOR-MERCEdes, or Customer Service (in Canada) at 1-800-387-0100. It is in your own interest that we can contact you should the need arise.

If you sell your Mercedes, please leave all literature with the vehicle to make it available to the next operator.

If you bought this vehicle used, be sure to send in the "Notice of Purchase of Used Car" found in the Service and Warranty Information Booklet, or call the Mercedes-Benz Customer Assistance Center (in the USA) at 1-800-FOR-MERCEdes, or Customer Service (in Canada) at 1-800-387-0100.

Operating your vehicle outside the USA or Canada

If you plan to operate your vehicle in foreign countries, please be aware that:

- service facilities or replacement parts may not be readily available,
- unleaded gasoline for vehicles with catalytic converters may not be available; the use of leaded fuels will damage the catalysts,
- gasoline may have a considerably lower octane rating, and improper fuel can cause engine damage.

Certain Mercedes-Benz models are available for delivery in Europe under our European Delivery Program. For details, consult an authorized Mercedes-Benz Center or write to:

In the USA:

Mercedes-Benz USA, LLC
European Delivery Department
One Mercedes Drive
Montvale, NJ 07645-0350

In Canada:

Mercedes-Benz Canada Inc.
European Delivery Department
98 Vanderhoof Avenue
Toronto, Ontario M4G 4C9

Where to find it

This Operator's Manual is designed to provide comprehensive support information for you, the vehicle operator. Each section has its own reference color.

At a glance

Here you will find an overview of all the controls that can be operated from the driver's seat.

Getting started

Here you will find all the information you need for your first drive. You should read this section first if this is your first Mercedes-Benz vehicle or if you are renting or borrowing this vehicle.

Safety and Security

Here you will find descriptions of the safety and security features of your vehicle.

Controls in detail

Here you will find detailed information about the equipment installed in your vehicle. This section expands on the "Getting started" section and also describes technical innovations. If you are already familiar with the basic functions of your vehicle, this section will be of particular interest to you.

Operation

Here you will find all the information you need for the proper operation of your vehicle.

Practical hints

This section provides fast assistance for dealing with problems you may encounter.

Technical data

All important technical data for your vehicle can be found in this section.

Indexes

The table of contents and the index are designed to help you find information quickly and easily.

The following publications are part of your vehicle documentation:

- this Operator's Manual
- the Maintenance Booklet

Separate operating instructions will be provided as required depending on the equipment options installed in your vehicle.

▼ Symbols

Trademarks:

- ESP® is a registered trademark of DaimlerChrysler.
- HomeLink® is a registered trademark of Prince, a Johnson Controls Company.
- SIRIUS and related marks are trademarks of SIRIUS Satellite Radio Inc.

The following symbols are found in this Operator's Manual:

- * Optional equipment is identified with an asterisk. Since standard equipment varies between models, the descriptions and illustrations in this manual may differ slightly from the actual equipment of your vehicle.

Warning!



Warning notices draw your attention to hazards that may endanger your health or life, or the health or life of others.

! *Highlights hazards that may result in damage to your vehicle.*

i *Helpful hints or further information you may find useful.*

- ▶ This symbol points to instructions for you to follow.
- ▶ A number of these symbols appearing in succession indicates a multiple-step procedure.
- ▷ page This symbol tells you where to look for further information on a topic.
- ▷▷ This continuation symbol marks a warning which is continued on the next page.
- ▷▷ This continuation symbol marks a procedure which is continued on the next page.
- > This symbol is used to indicate cross-references to term definitions.
- Display Words appearing in the multi-function display are printed in the type shown here.

Warning!



Work improperly carried out on electronic components and associated software could cause them to cease functioning. Because the vehicle's electronic components are interconnected, any modification made may produce an undesired effect on other systems.

Contact an authorized Mercedes-Benz Center for repairs or modifications to electronic components.

Other improper work or modifications on the vehicle could also have a negative impact on the operating safety of the vehicle.

Some safety systems only function while the engine is running. You should therefore never turn off the engine while driving.

Warning!



Heavy blows against the vehicle undercarriage or tires/wheels, for example when running over an obstacle, road debris or a pothole, may cause serious damage and impair the operating safety or your vehicle. If you feel a sudden significant vibration or ride disturbance, or you suspect that damage to your vehicle has occurred, you should turn on your hazard warning flashers, carefully slow down, and drive with caution to an area which is a safe distance from the road.

Inspect the vehicle undercarriage or tires/wheels for possible damage. If the vehicle appears unsafe, have it towed to the nearest authorized Mercedes-Benz Center or other qualified maintenance or repair facility for further inspection or repairs.

Proper use of the vehicle

Proper use of the vehicle requires that you are familiar with the following information and rules:

- the safety precautions in this manual
- the “Technical data” section (▷ page 427) in this manual
- the traffic rules and regulations
- the motor vehicle laws and safety standards

Warning!



Various labels are attached to your vehicle. These warning labels are intended to make you and others aware of various risks. You should not remove any of these warning labels unless explicitly instructed to do so by information on the label itself. Removal of any of these labels may cause you and others to be unaware of certain risks which may result in an accident and/or personal injury.

▼ Problems with your vehicle

If you should experience a problem with your vehicle, particularly one that you believe may affect its safe operation, we urge you to immediately contact an authorized Mercedes-Benz Center to have the problem diagnosed and corrected if required. If the matter is not handled to your satisfaction, please discuss the problem with the Mercedes-Benz Center management, or if necessary contact us at one of the following addresses:

In the USA:

Customer Assistance Center
Mercedes-Benz USA, LLC
One Mercedes Drive
Montvale, NJ 07645-0350

In Canada:

Customer Relations Department
Mercedes-Benz Canada Inc.
98 Vanderhoof Avenue
Toronto, Ontario M4G 4C9

Reporting safety defects

For the USA only:

The following text is published as required of manufacturers under Title 49, Code of U.S. Federal Regulations, Part 575 pursuant to the “National Traffic and Motor Vehicle Safety Act of 1966”.

Reporting safety defects

If you believe that your vehicle has a defect which could cause a crash or could cause injury or death, you should immediately inform the National Highway Traffic Safety Administration (NHTSA) in addition to notifying Mercedes-Benz USA, LLC.

If NHTSA receives similar complaints, it may open an investigation, and if it finds that a safety defect exists in a group of vehicles, it may order a recall and remedy campaign. However, NHTSA cannot become involved in individual problems between you, your dealer, or Mercedes-Benz USA, LLC.

To contact NHTSA, you may call the Vehicle Safety Hotline toll-free at 1-888-327-4236 (TTY: 1-800-424-9153); go to <http://www.safercar.gov>; or write to: Administrator, NHTSA, 400 Seventh Street, SW., Washington, D.C. 20590. You can also obtain other information about motor vehicle safety from <http://www.safercar.gov>.

▼ Vehicle data recording

Information regarding electronic recording devices

(Including notice pursuant to California Code § 9951)

Please note that your vehicle is equipped with devices that can record vehicle systems data and, if equipped with the Tele Aid* system, may transmit some data in certain accidents.

This information helps, for example, to diagnose vehicle systems after a collision and to continuously improve vehicle safety. DaimlerChrysler may access the information and share it with others

- for safety research or vehicle diagnosis purposes
- with the consent of the vehicle owner or lessee
- in response to an official request by law enforcement or other government agency
- for use in dispute resolution involving DaimlerChrysler, its affiliates or sales/service organization and/or
- as otherwise required or permitted by law.

Please check the Tele Aid* subscription service agreement for details regarding the information that may be recorded or transmitted via that system.



Exterior view

Cockpit

Instrument cluster

Multifunction steering wheel

Center console

Overhead control panel

Storage compartments

Door control panel

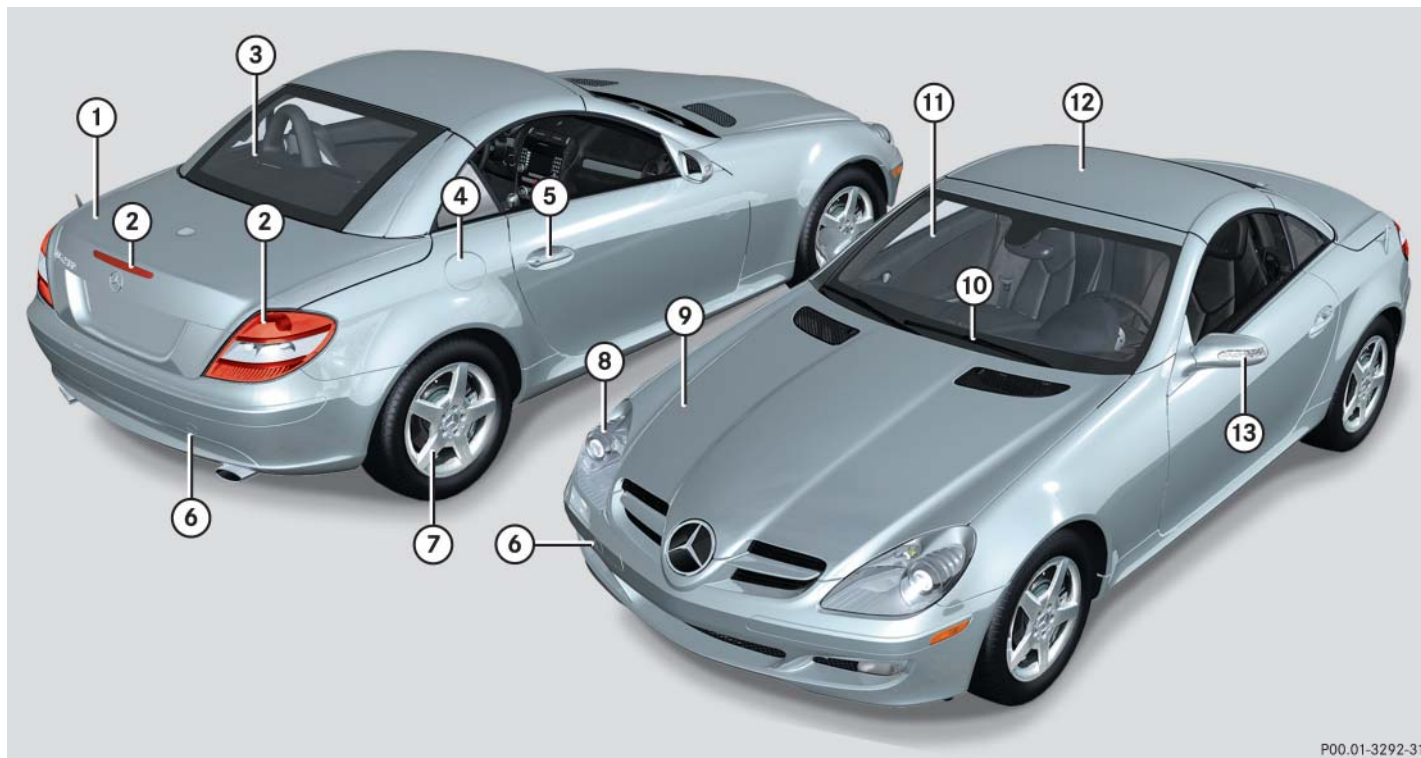

P00.01-3292-31

	Item	Page
①	Trunk	
	Opening the trunk	100
	Closing the trunk	100
	Spare wheel	385
	Vehicle tool kit	382
②	Rear lamps	393
③	Rear window defroster	170
④	Fuel filler flap	291
	Refueling	291
	Gasoline	446
⑤	Doors	
	Locking and unlocking	94
	Opening	99
	Locking/unlocking in an emergency	387

	Item	Page
⑥	Towing	421
	Installing towing eye bolt	422
⑦	Tires and wheels	304
	Checking tire inflation pressure	314
	Run Flat Indicator*	315
	General information	304
	Flat tire	401
⑧	Front lamps	393
⑨	Hood	
	Opening	294
	Engine oil	296, 445
	Coolant	300, 448

	Item	Page
⑩	Windshield wipers	56
	Wiper blades, replacing	399
	Wiper blades, cleaning	340
⑪	Windshield	
	Cleaning with wiper fluid	58
	Cleaning	340
⑫	Retractable hardtop	240
	Opening/closing	242
	Wind screen	246
	Luggage cover	241
⑬	Exterior rear view mirrors	
	Adjusting	46
	Auto-dimming rear view mirrors*	169

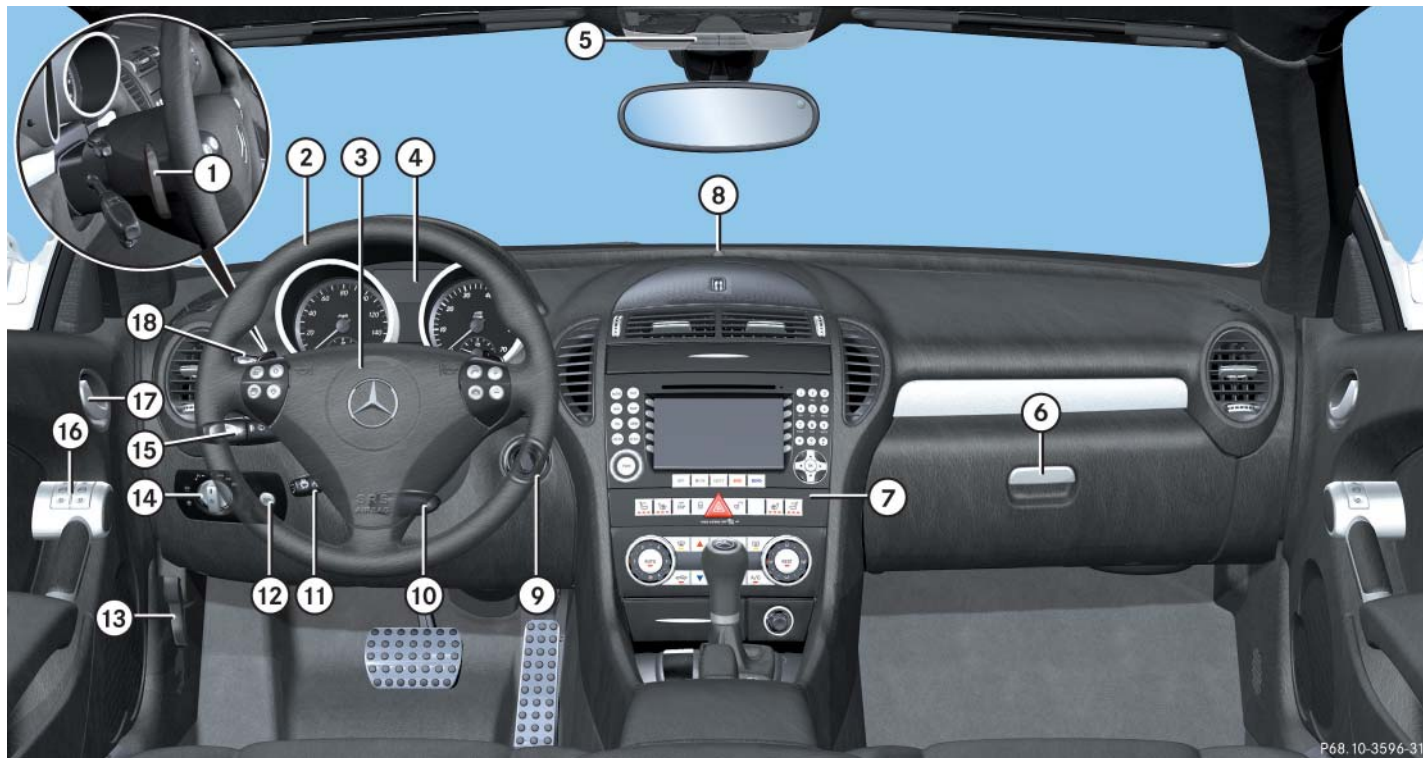





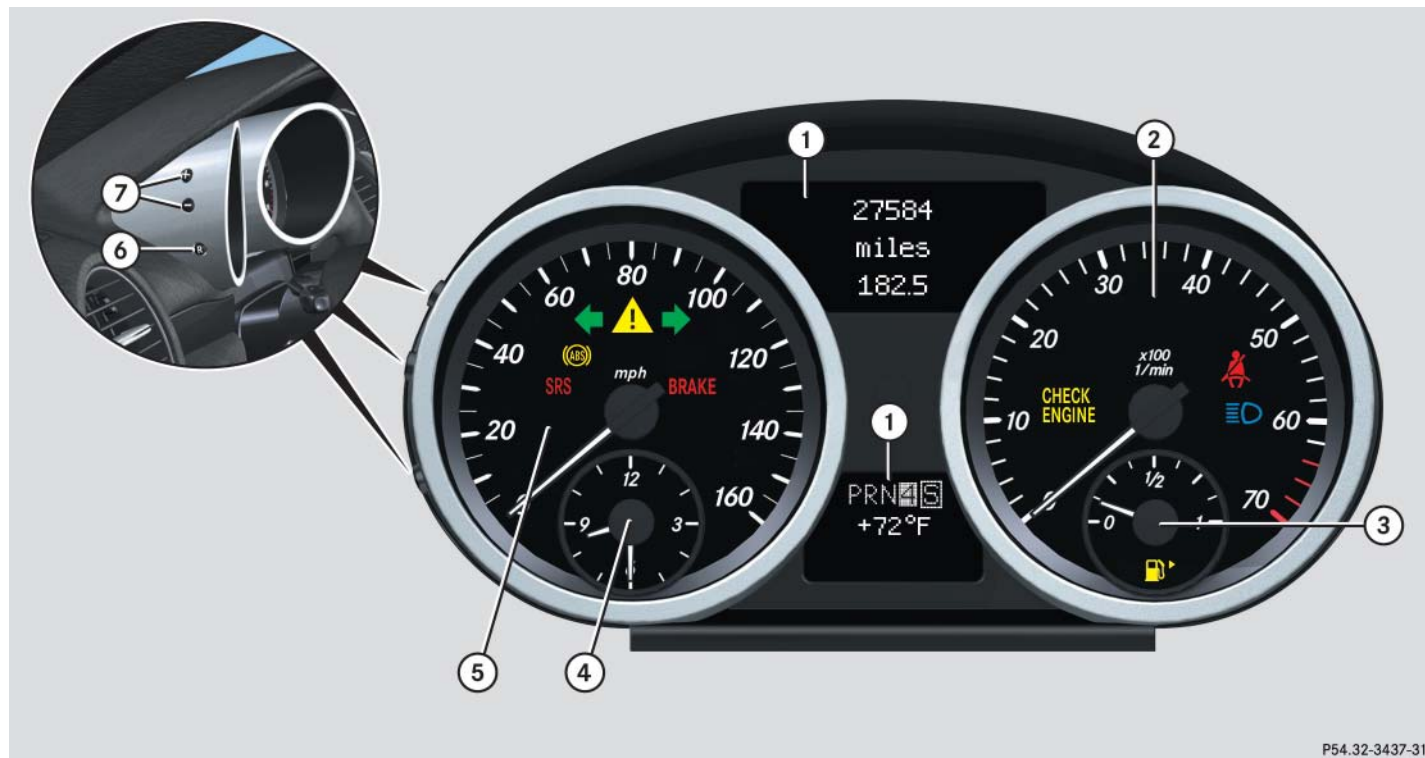

Item	Page
① Automatic transmission*: Steering wheel gearshift control*	163
② Multifunction steering wheel	28, 122
③ Horn	
④ Instrument cluster	26, 118
⑤ Overhead control panel	31, 116
⑥ Glove box CD changer*	252 216, 252
⑦ Center console	29, 30
⑧ Sun sensor for automatic climate control*	
⑨ Starter switch	37





Item	Page
⑩ Steering wheel adjustment release handle, manual	43
⑪ Steering wheel adjustment stalk, electrical*	44
Heated steering wheel stalk* (SLK 280, SLK 350, Canada only)	276
⑫ Headlamp cleaning button*	168
⑬ Hood lock release lever	294
⑭ Exterior lamp switch	55, 109
⑮ Combination switch	
• High beam	55
• Turn signals	55
• Windshield wipers	56
⑯ Power window switches	235
⑰ Inside door handle	99
⑱ Cruise control lever	247



P54.32-3437-31

Item	Page
① Multifunction display with:	
Main odometer	127
Trip odometer	120
Automatic transmission*: Gear range indicator	52, 160
Automatic transmission*: Program mode indicator	161
Outside temperature indicator (or digital speed- ometer when selected)	140
② Tachometer with:	
 Engine malfunction indicator lamp, USA only	349
 Engine malfunction indicator lamp, Canada only	349





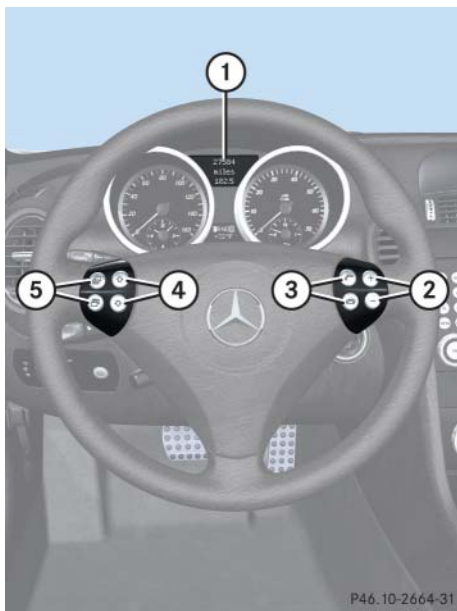

Item	Page
 Seat belt telltale	78, 351
 High beam headlamp indicator lamp	55, 113
③ Fuel gauge with:	
 Fuel reserve warning lamp	353
The arrow indicates that the fuel filler flap is on the rear right-hand side.	291
④ Clock	120
⑤ Speedometer with:	
 Supplemental Restraint System (SRS) indicator lamp	64, 353
 Antilock Brake System (ABS) indicator lamp	84, 346





Item	Page
 Left turn signal indicator lamp	55
 Right turn signal indicator lamp	
 Electronic Stability Program (ESP®) warning lamp	86, 350
 Brake warning lamp, USA only	59, 348
 Brake warning lamp, Canada only	59, 348
⑥ Reset button for:	
• Resetting trip odometer	120
• Resetting all settings	136
⑦ Knobs for instrument cluster illumination	118

Multifunction steering wheel



P46_10-2664-31

	Item	Page
①	Multifunction display	118
	Operating control system	121
②	Selecting a submenu or setting the volume: Press button	
	 up/to increase	
	 down/to decrease	
③	Telephone*: Press button	
	 to take a call	
	 to dial	
	 to redial	
	 to end a call	
	 to reject an incoming call	

	Item	Page
④	Moving within a menu: Press button	
	 for next display	
	 for previous display	
⑤	Menu systems: Press button	
	 for next menu	
	 for previous menu	

SLK 55 AMG:

The steering wheel in this vehicle will vary from steering wheel shown. However, multifunction steering wheel symbols and feature description apply to AMG vehicles as well.

▼ Center console

Upper part



P68.20-3616-31

Item	Page
① Cup holder	254
② Audio system or COMAND* system (see separate operating instructions)	193
③ AIRSCARF* switch, passenger-side	105
④ Seat heating* switch, passenger-side	104
⑤ Central unlocking switch	102
⑥ Hazard warning flasher switch	115
⑦ Central locking switch	102
Alarm system indicator lamp	92

Item	Page
⑧ ESP® switch	86
⑨ Seat heating* switch, driver's side	104
⑩ AIRSCARF* switch, driver's side	105
⑪ Passenger front air bag off indicator lamp	71, 354
⑫ Climate control Automatic climate control*	172 182
Rear window defroster switch	170
⑬ Cigarette lighter	256
⑭ Ashtray	255

Center console

Lower part



P68.20-3402-31

Item	Page
① Automatic transmission*: Gear selector lever	155, 157
Manual transmission: Gearshift lever	153
② Retractable hardtop switch	240
③ Tow-away alarm deactivation switch	91
④ Parking brake lever	53, 59
⑤ Storage/telephone* compartment	252
Telephone* compartment (depending on vehicle production date)	253

Item	Page
⑥ Passenger-side exterior rear view mirror button	46, 168
⑦ Driver's side exterior rear view mirror button	46, 168
⑧ Exterior rear view mirror adjustment button	46
⑨ Automatic transmission*: Program mode selector switch	161

▼ Overhead control panel

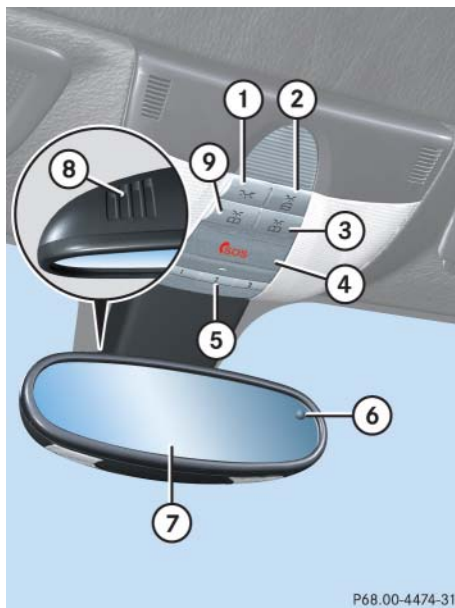

P68.00-4474-31

Item	Page
① Interior lighting on/off	116
② Interior lighting automatic control switch	116
③ Right reading lamp on/off	117
④ Tele Aid* (emergency call system) button	261
⑤ Garage door opener*	270
⑥ Sensor for auto-dimming rear view mirrors*	169
⑦ Interior rear view mirror	46, 168
⑧ Microphone for Tele Aid* and telephone*	261, 258
⑨ Left reading lamp on/off	117

Storage compartments

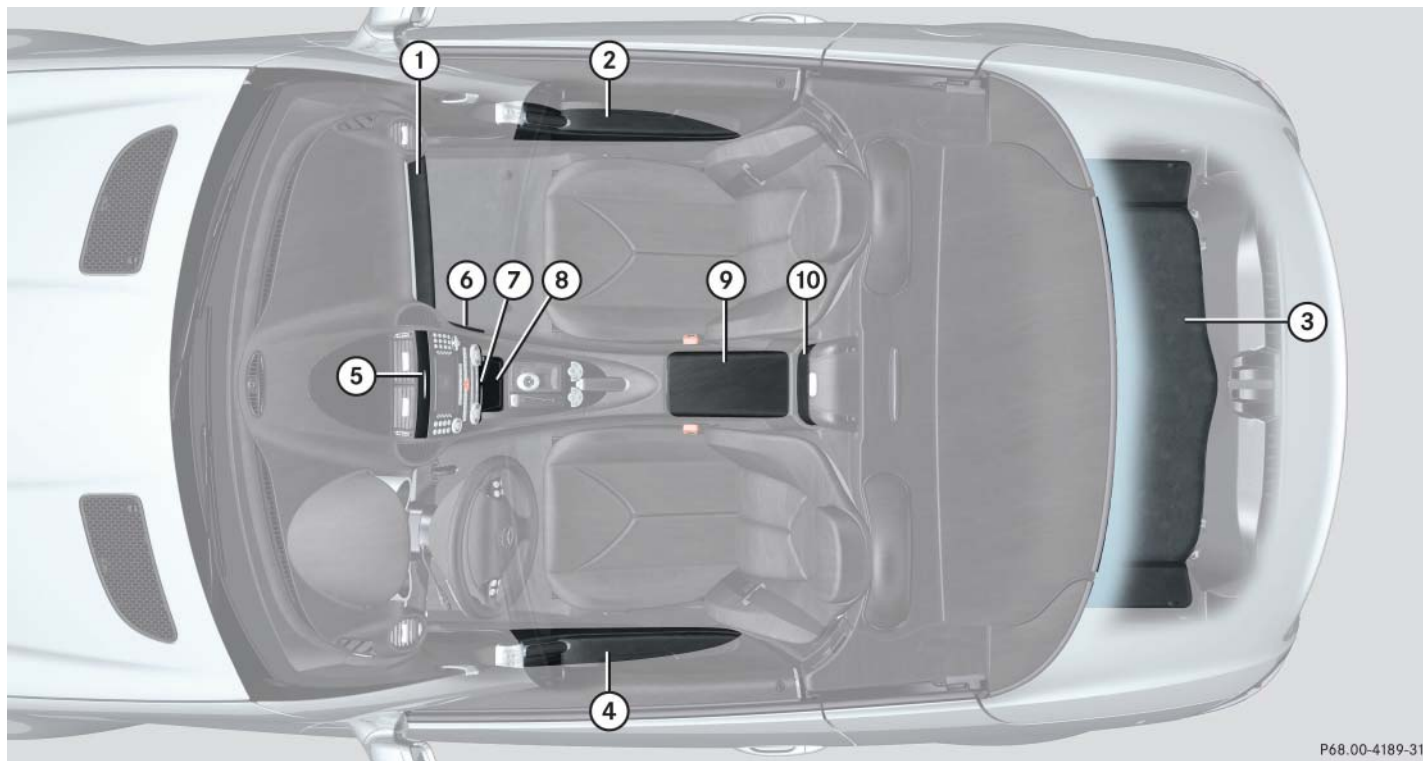

P68.00-4189-31

	Item	Page
①	Glove box	252
②	Door pocket	
③	Trunk	
	Vehicle tool kit, jack, spare wheel	382
	Luggage cover	241
	Trunk load	442
	Load limit	309
④	Door pocket	
⑤	Cupholder	254

	Item	Page
⑥	Parcel net in passenger footwell	253
⑦	Ashtray	255
	Cigarette lighter	256
⑧	Storage tray	
⑨	Storage/telephone* compartment	252
	Telephone* compartment (depending on vehicle production date)	253
⑩	Storage compartment between seat backrests	253

Door control panel



	Item	Page
①	Inside door handle	99
②	Power window switch for opening/closing passenger-side window	235
③	Power window switch for opening/closing driver's side window	235

Unlocking

Adjusting

Driving

Parking and locking



Unlocking





The “Getting started” section provides an overview of the vehicle’s most basic functions. First-time Mercedes-Benz owners should pay special attention to the information given here.

If you are already familiar with the basic functions described here, the “Controls in detail” section (▷ page 93) will provide you with further information. The corresponding page references are located at the end of each segment.

Unlocking with the SmartKey



SmartKey with remote control

- ①  Lock button
- ②  Unlock button for trunk lid
- ③  Unlock button
- ④  Panic button (▷ page 83)

Warning!



When leaving the vehicle, always remove the SmartKey from the starter switch, take it with you, and lock the vehicle. Do not leave children unattended in the vehicle, or with access to an unlocked vehicle. A child’s unsupervised access to a vehicle could result in an accident and/or serious personal injury.

! *Opening a door causes the windows on that side of the car to open slightly. They will return to the up position when the door is closed.*

The side windows will not open or close if the battery is discharged or the windows are impeded by ice. As a result, you may no longer be able to properly close the door. Do not attempt to force the door shut. Doing so may damage the door or the side window. Correct the condition that prevents the windows from operating before attempting to close the door.

- ▶ Press unlock button  on the SmartKey.
 - All turn signal lamps flash once.
 - An acoustic warning sounds once (if equipped and feature activated). For more information, see “Factory setting” (▷ page 96).
 - The locking knobs in the doors move up.
 - The anti-theft alarm system is disarmed.
- ▶ Enter the vehicle and insert the SmartKey in the starter switch.

i Without the antenna on the left rear side of the vehicle installed, the SmartKey signaling range is considerably reduced. Hold the SmartKey in close proximity towards the antenna base when locking or unlocking the vehicle.

For more information, see “SmartKey” (▷ page 94).

Starter switch positions

Warning!



When leaving the vehicle, always remove the SmartKey from the starter switch, take it with you, and lock the vehicle. Do not leave children unattended in the vehicle, or with access to an unlocked vehicle. A child's unsupervised access to a vehicle could result in an accident and/or serious personal injury.

SmartKey



Starter switch

- 0** For removing the SmartKey
The steering is locked when the SmartKey is removed from the starter switch.
- 1** Power supply for some electrical consumers, such as seat adjustment*
- 2** Ignition (power supply for all electrical consumers) and driving position
All lamps (except high beam headlamp indicator lamp and turn signal indicator lamps unless activated) in the instrument cluster come on. If a lamp in the instrument cluster fails to come on when the ignition is switched on, have it checked and replaced if necessary. If a lamp in the instrument cluster remains on after starting the engine or comes on while driving, see “Lamps in instrument cluster” (▷ page 346).
- 3** Starting position

Unlocking

i When you switch on ignition, the indicator and warning lamps (except high beam headlamp indicator lamp and turn signal indicator lamps unless activated) in the instrument cluster come on. The indicator and warning lamps (except high beam headlamp indicator lamp and turn signal indicator lamps if activated) will go out when the engine is running. This indicates that the respective systems are operational.

i Vehicles with automatic transmission*: The SmartKey can only be removed from the starter switch with the gear selector lever in position **P**.

i If the SmartKey is left in starter switch position **0** for an extended period of time, it can no longer be turned in the starter switch. In this case the steering is locked. To unlock, remove SmartKey from the starter switch and reinsert.

! If the SmartKey cannot be turned in the starter switch, the vehicle battery may not be sufficiently charged.

- Check the vehicle battery and charge it if necessary (▷ page 415).
- Get a jump start (▷ page 419).

To prevent accelerated vehicle battery discharge or a completely discharged vehicle battery, always remove the SmartKey from the starter switch when the engine is not in operation.

For information on starting the engine, see (▷ page 51).

▼ Adjusting

Warning!



All seat, head restraint, steering wheel, and rear view mirror adjustments, as well as fastening of seat belts, must be done before the vehicle is put into motion.

Seats

The seats can be adjusted either manually or electrically, depending on the vehicle's equipment.

Warning!



Do not adjust the driver seat while driving. Adjusting the seat while driving could cause the driver to lose control of the vehicle.

Never ride in a moving vehicle with the seat back in an excessively reclined position as this can be dangerous. You could slide under the seat belt in a collision. If you slide under it, the seat belt would apply force at the abdomen or neck. That could cause serious or fatal injuries. The seat backrest and seat belts provide the best restraint when the wearer is in a position that is as upright as possible and seat belts are properly positioned on the body.

Your seat must be adjusted so that you can correctly fasten your seat belt (▷ page 48).

Observe the following points:

- Adjust the seat backrest until your arms are slightly angled when holding the steering wheel.
- Adjust the seat to a comfortable seating position that still allows you to reach the accelerator/brake pedal safely. The position should be as far back as possible with the driver still able to operate the controls properly.
- Adjust head restraint so that it is as close to the head as possible and the center of the head restraint supports the back of the head at eye level.
- Never place hands under the seat or near any moving parts while a seat is being adjusted.

Failure to do so could result in result in an accident and/or serious personal injury.

Adjusting

Warning!



When leaving the vehicle, always remove the SmartKey from the starter switch, take it with you, and lock the vehicle.

Even with the SmartKey removed from the starter switch, the power seats* can be operated when the respective door is open. Therefore, do not leave children unattended in the vehicle, or with access to an unlocked vehicle. A child's unsupervised access to a vehicle could result in an accident and/or serious personal injury.

Warning!



Children 12 years old and under must be seated and properly secured in an appropriate infant, or toddler restraint, or booster seat recommended for the size and weight of the child. For additional information, see "Children in the vehicle" (▷ page 79).

A child's risk of serious or fatal injuries is significantly increased if the child restraints are not properly secured in the vehicle and/or the child is not properly secured in the child restraint.

! *When moving the seats, make sure there are no items in the footwell or behind the seats; otherwise you could damage the seats.*

Manual seat adjustment



- ① Seat fore and aft adjustment
- ② Seat height
- ③ Seat backrest tilt

Seat fore and aft adjustment

- ▶ Pull handle ①.
- ▶ Slide the seat to the desired position.
- ▶ Allow handle ① to reengage with an audible click.
- ▶ Check for proper engagement before driving.

Seat height

- ▶ Pull or push handle ② up or down and adjust the seat height until your legs are slightly supported.

Seat backrest tilt

- ▶ Pull handle ③ and adjust the backrest until your arms are slightly angled when holding the steering wheel.
- ▶ Release handle ③ when the desired backrest tilt is reached.

When you hear an audible click, the backrest is again fixed into place.

For more information, see “Seats” (▷ page 104).

Power seat* adjustment

The seat adjustment switches are located on the outer side of each seat.

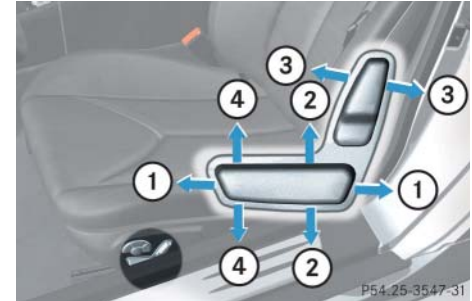

- ① Seat fore and aft adjustment
- ② Seat height
- ③ Seat backrest tilt
- ④ Seat cushion tilt

- ▶ Switch on the ignition (▷ page 37).

or

- ▶ Open the respective door.

Adjusting

i The memory function* (▷ page 107) lets you store the settings for power seats*, steering wheel adjustment (electrical)*, and exterior rear view mirrors.

Seat fore and aft adjustment

- ▶ Press the horizontal switch forward or backward in direction of arrows ①.

Seat height

- ▶ Press the horizontal switch up or down in direction of arrows ② and adjust the seat height until your legs are slightly supported.

Seat backrest tilt

- ▶ Press the vertical switch forward or backward in direction of arrows ③.

Seat cushion tilt

- ▶ Press the horizontal switch up or down in direction of arrows ④ until your upper legs are lightly supported.

Head restraint height

Warning!



For your protection, drive only with properly positioned head restraints.

Adjust head restraint so that the head restraint supports the back of the head at eye level. This will reduce the potential for injury to the head and neck in the event of an accident or similar situation.

Do not drive the vehicle without the seat head restraints. Head restraints are intended to help reduce injuries during an accident.



P91.16-2262-31

Head restraint

- ▶ Adjust the height of head restraints manually by pulling them upwards or pushing them downwards.

i Adjust the head restraint in such a way that it is as close to the head as possible.

Steering wheel

Warning!



Do not adjust the steering wheel while driving. Adjusting the steering wheel while driving, or driving without the steering wheel adjustment feature locked could cause the driver to lose control of the vehicle.

When leaving the vehicle, always remove the SmartKey from the starter switch, take it with you, and lock the vehicle.

Even with the SmartKey removed from the starter switch, the electrical steering wheel adjustment feature* can be operated when the driver's door is open. Therefore, do not leave children unattended in the vehicle, or with access to an unlocked vehicle.

A child's unsupervised access to a vehicle could result in an accident and/or serious personal injury.

Make sure that

- you can reach the steering wheel with your arms slightly bent at the elbows
- you can move your legs freely
- all displays (including malfunction and indicator lamps) on the instrument cluster are clearly visible

Steering wheel adjustment, manual

The steering wheel adjustment release handle is located on the lower left of the steering column.



- ① Steering wheel adjustment release handle

- ▶ To unlock the steering wheel, pull handle ① out to its stop limit.
- ▶ Move the steering wheel to the desired position.
- ▶ To lock the steering wheel, push handle ① in all the way until it engages.

The steering wheel is locked into position again.

- ▶ Make sure the steering column is securely locked by trying to move the steering wheel up and down, in and out before driving off.

! Do not drive the vehicle until you have properly locked the steering wheel.

Adjusting

Steering wheel adjustment, electrical*

The steering wheel adjustment stalk is located on the lower left of the steering column.

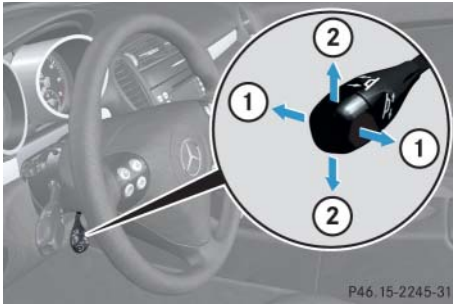

- ① Adjusting steering wheel, in or out
- ② Adjusting steering wheel, up or down

► Switch on the ignition (▷ page 37).

or

► Open the driver's door.

i *The memory function* (▷ page 107) lets you store the settings for the steering wheel together with the settings for the exterior rear view mirrors and the driver's seat position.*

Adjusting steering wheel in or out

► Move stalk forward or back in direction of arrows ① until a comfortable steering wheel position is reached with your arms slightly bent at the elbow.

Adjusting steering wheel up or down

► Move the stalk up or down in direction of arrows ②.

Easy-entry/exit feature*

This feature allows for easier entry into and exit from the vehicle. When entering and exiting the vehicle, the steering wheel is in its uppermost position.

The easy-entry/exit feature can be activated or deactivated in the Convenience submenu of the control system (▷ page 147).

Warning!

You must make sure no one can become trapped or injured by the moving steering wheel when the easy-entry/exit feature is activated.

To cancel steering wheel movement, do one of the following:

- Move steering wheel adjustment stalk* (▷ page 44).
- Press one of the memory position buttons* or the memory button **M*** (▷ page 107).

Do not leave children unattended in the vehicle, or with access to an unlocked vehicle. Children could open the driver's door and unintentionally activate the easy-entry/exit feature, which could result in an accident and/or serious personal injury.

With the easy-entry/exit feature activated, the steering wheel will return to its last set position when you:

- close the driver's door with the ignition switched on
- or
- insert the SmartKey into the starter switch

i *The last set steering wheel position is stored when*

- *the ignition is switched off*
- *the position is stored in memory* (▷ page 107)

With the easy-entry/exit feature activated, the steering wheel tilts upwards when you:

- remove the SmartKey from the starter switch
- or
- open the driver's door with the SmartKey in starter switch position **0** or **1**

i *If the current position for the steering wheel is in the uppermost tilt position, the steering wheel will no longer be able to move upward when the easy-entry/exit feature is activated.*

The adjustment procedure is briefly interrupted when the engine is started.

Warning!



Let the system complete the adjustment procedure before setting the vehicle in motion. All steering wheel adjustment must be completed before setting the vehicle in motion. Driving off with the steering wheel still adjusting could cause the driver to lose control of the vehicle.

Mirrors

Adjust the interior and exterior rear view mirrors before driving so that you have a good view of the road and traffic conditions.

Interior rear view mirror

- ▶ Adjust the interior rear view mirror manually.

For more information, see “Rear view mirrors” (▷ page 168).

Exterior rear view mirrors

Warning!



Exercise care when using the passenger-side exterior rear view mirror. The mirror surface is convex (outwardly curved surface for a wider field of view). Objects in mirror are closer than they appear. Check your interior rear view mirror or glance over your shoulder before changing lanes.

! *If an exterior rear view mirror housing is forcibly pushed forward (hit from the rear) or rearward (hit from the front), reposition it by applying firm pressure until it snaps into place. The exterior rear view mirror housing is now properly positioned and you can adjust the mirror in the usual manner.*

The buttons are located on the lower part of the center console.

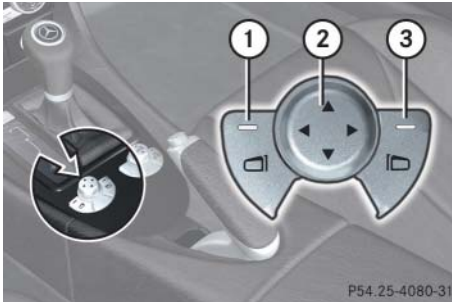

- ① Driver's side exterior rear view mirror button
 - ② Adjustment button
 - ③ Passenger-side exterior rear view mirror button
- ▶ Switch on the ignition (▷ page 37).

- ▶ Press button ① for the driver's side exterior rear view mirror or button ③ for passenger-side exterior rear view mirror.

The indicator lamp in the respective button comes on for approximately 10 seconds.

- i** If you do not make adjustments to the selected exterior rear view mirror within 10 seconds, the indicator lamp goes out. You will then have to select the desired exterior rear view mirror again before any adjustments can be made. Adjustments can only be made with the indicator lamp for the respective exterior rear view mirror button illuminated.

- ▶ Press adjustment button ② up, down, left, or right according to the desired setting.

i At low ambient temperatures, the exterior rear view mirrors will be heated automatically.

i The memory function* (▷ page 107) lets you store the settings for the exterior rear view mirrors together with the settings for the steering wheel and the driver's seat position.

Warning!



Make sure that absolutely no objects are obstructing the pedal's range of movement. Keep the driver's footwell clear of all obstacles. If there are any floor mats or carpets in the footwell, make sure the pedals still have sufficient clearance.

During sudden driving or braking maneuvers, the objects could get caught between the pedals. You could then no longer brake or accelerate. This could lead to accidents and injury.

Fastening the seat belts

Warning!



Always fasten your seat belt before driving off. Always make sure your passenger is properly restrained.

Failure to wear and properly fasten and position your seat belt greatly increases your risk of injuries and their likely severity in an accident. You and your passenger should always wear seat belts.

If you are ever in an accident, your injuries can be considerably more severe without your seat belt properly buckled. Without your seat belt buckled, you are much more likely to hit the interior of the vehicle or be ejected from it. You can be seriously injured or killed.

In the same crash, the possibility of injury or death is lessened if you are wearing your seat belt. The air bags can only provide the protection they were designed to afford if the occupants are using their seat belts (▷ page 64).

Warning!



Children 12 years old and under must be seated and properly secured in an appropriate infant, or toddler restraint, or booster seat recommended for the size and weight of the child. For additional information, see "Children in the vehicle" (▷ page 79).

A child's risk of serious or fatal injuries is significantly increased if the child restraints are not properly secured in the vehicle and/or the child is not properly secured in the child restraint.

Warning!

Never let more people ride in the vehicle than there are seat belts available. Be sure everyone riding in the vehicle is correctly restrained with a separate seat belt. Never use a seat belt for more than one person at a time.

Warning!

Never ride in a moving vehicle with the seat backrest in an excessively reclined position as this can be dangerous. You could slide under the seat belt in a collision. If you slide under it, the seat belt would apply force at the abdomen or neck. That could cause serious or even fatal injuries. The seat backrest and seat belt provide the best restraint when the wearer is in a position that is as upright as possible and the seat belt is properly positioned on the body.

Warning!

Read and observe the additional warning notices printed in the “Safety and Security” section (▷ page 68) and (▷ page 76).



- ① Loop for seat belt guidance
- ② Latch plate
- ③ Release button
- ④ Buckle

- ▶ With a smooth motion, pull the seat belt from the seat belt outlet.
- ▶ Place the shoulder portion of the seat belt across the top of your shoulder and the lap portion across your hips.
- ▶ Push latch plate ② into buckle ④ until it clicks.
- ▶ If necessary, tighten the lap portion to a snug fit by pulling shoulder portion up.

For more information, see “Safety guidelines for the seat belt, emergency tensioning device and air bag” (▷ page 68).

Driving

Proper use of seat belts

- Do not twist the seat belt when fastening.
- Adjust seat belt so that the shoulder portion is located as close as possible to the middle of the shoulder (it should not touch the neck). Never pass the shoulder portion of the seat belt under your arm.
- Position the lap belt as low as possible on your hips (over hip joint) and not across the abdomen.
- Place the seat backrest in a position that is as upright as possible.
- Never use a seat belt for more than one person at a time.
- Do not fasten a seat belt around a person and another object at the same time. When using a seat belt to secure infant or toddler restraints or children in booster seats, always follow the child seat manufacturer's instructions.
- Check your seat belt during travel to make sure it is properly positioned.
- Make sure the seat belt is always fitted snugly. Take special care of this when wearing loose clothing.

Warning!



Do not pass seat belts over sharp edges. They could tear.

Do not allow the seat belt to get caught in the door or in the seat adjustment mechanism. This could damage the seat belt.

Never attempt to make modifications to seat belts. This could impair the effectiveness of the seat belts.

Do not bleach or dye seat belts as this may severely weaken them. In a crash, they may not be able to provide adequate protection.

Damaged seat belts or seat belts that were highly stressed in an accident must be replaced. Contact an authorized Mercedes-Benz Center.

Starting the engine

Warning!



Inhalation of exhaust gas is hazardous to your health. All exhaust gas contains carbon monoxide (CO), and inhaling it can cause unconsciousness and possible death.

Do not run the engine in confined areas (such as a garage) which are not properly ventilated. If you think that exhaust gas fumes are entering the vehicle while driving, have the cause determined and corrected immediately. If you must drive under these conditions, drive only with at least one window fully open.

Manual transmission



Gearshift pattern for manual transmission

For more information, see “Manual transmission” (▷ page 153).

Starting

- ▶ Depress brake pedal.
 - ▶ Make sure the gearshift lever is in neutral position (no gear selected).
 - ▶ Fully depress clutch pedal.
- Otherwise the engine cannot be started due to the integrated safety interlock.
- ▶ Do not depress accelerator.
 - ▶ Turn the SmartKey in the starter switch to position **3** (▷ page 37) and hold until the engine starts.

For information on turning off the engine, see “Turning off engine” (▷ page 61).

Automatic transmission*



Gearshift pattern for automatic transmission

- P** Park position with gear selector lever lock
- R** Reverse gear
- N** Neutral position
- D** Drive position

For more information, see “Automatic transmission*” (▷ page 155).

Starting

- ▶ Place the gear selector lever in position **P**.
- ▶ Do not depress accelerator.
- ▶ Turn the SmartKey in the starter switch to position **3** (▷ page 37) and release it again immediately. The engine starts automatically.

For information on turning off the engine, see “Turning off engine” (▷ page 61).

Starting difficulties

If the SmartKey is left in starter switch position **0** for an extended period of time, it can no longer be turned in the starter switch. In this case the steering is locked.

- ▶ To unlock, remove SmartKey from the starter switch and reinsert.

If the engine does not start as described, carry out the following steps:

- ▶ Turn the SmartKey in the starter switch to position **0** and repeat the starting procedure.

Remember that extended starting attempts can drain the vehicle battery.

- ▶ Get a jump start (▷ page 419).

If the engine does not start after several starting attempts, there could be a malfunction in the engine electronics or in the fuel supply system.

- ▶ Contact an authorized Mercedes-Benz Center or call Roadside Assistance.

Parking brake

Warning!



When leaving the vehicle, always remove the SmartKey from the starter switch, take it with you, and lock the vehicle. Do not leave children unattended in the vehicle, or with access to an unlocked vehicle. Children could release the parking brake, which could result in an accident and/or serious personal injury.



- ① Parking brake lever
- ② Release button

- ▶ Pull up slightly on parking brake lever ① and press release button ②.
- ▶ Push parking brake lever ① down to its original position.

The brake warning lamp **BRAKE** (USA only) or **(P)** (Canada only) in the instrument cluster goes out.

Driving off

Warning!



On slippery road surfaces, never downshift in order to obtain braking action. This could result in drive wheel slip and reduced vehicle control. Your vehicle's ABS will not prevent this type of loss of control.

! If you hear a warning signal and the message **Release parking brake** appears in the multifunction display when driving off, you have forgotten to release the parking brake.

Release the parking brake (▷ page 53).

! Do not run cold engine at high engine speed. Running a cold engine at high engine speed may shorten the service life of the engine.

! Simultaneously depressing the accelerator pedal and applying the brakes reduces engine performance and causes premature brake and drivetrain wear.

Driving

i Once the vehicle is in motion, the automatic central locking system engages and the locking knobs drop down.

The automatic door lock feature can be deactivated (▷ page 146).

You can open a locked door from the inside. Open door only when conditions are safe to do so.

Manual transmission

- ▶ Depress the brake pedal.
- ▶ Fully depress the clutch pedal.
- ▶ Move gearshift lever to first gear to drive forward, or to reverse gear to drive rearward.
- ▶ Simultaneously release the brake pedal and slowly the clutch pedal.
- ▶ Carefully depress the accelerator pedal.

Automatic transmission*

- ▶ Depress the brake pedal.
- ▶ Move the gear selector lever to position **D** or **R**.

Warning!



It is dangerous to shift the gear selector lever out of **P** or **N** if the engine speed is higher than idle speed. If your foot is not firmly on the brake pedal, the vehicle could accelerate quickly forward or in reverse. You could lose control of the vehicle and hit someone or something. Only shift into gear when the engine is idling normally and when your right foot is firmly on the brake pedal.

! In order to avoid damage to the transmission:

- Wait for the gear selection process to complete before setting the vehicle in motion.
 - Place the gear selector lever in position **D** or **R** only when the vehicle is stopped.
- ▶ Release the brake pedal.
 - ▶ Carefully depress the accelerator pedal.

After a cold start, the transmission engages at a higher revolution. This allows the catalytic converter to reach its operating temperature earlier.

Switching on headlamps

Low beam headlamps

The exterior lamp switch is located on the dashboard to the left of the steering wheel.



Exterior lamp switch

- 1 Off
- 2 Low beam headlamps on

- ▶ Turn the exterior lamp switch to position .
- The low beam headlamps come on.

High beam

The combination switch is located on the left of the steering column.

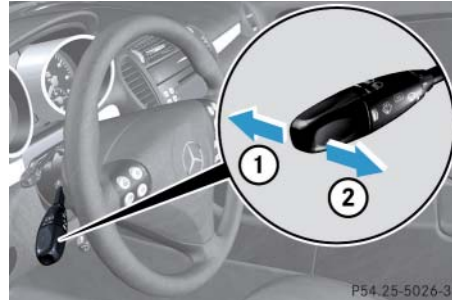

Combination switch

- ① High beam
- ② High beam flasher

- ▶ Push the combination switch in direction of arrow ①.

The high beam headlamps and high beam headlamp indicator lamp  in the instrument cluster come on (▷ page 26).

For more information on headlamps, see “Lighting” (▷ page 109).

Turn signals

The combination switch is located on the left of the steering column.

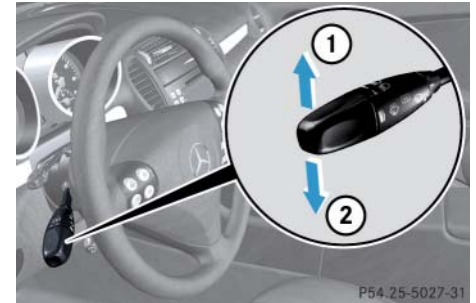



Combination switch

- ① Turn signals, right
- ② Turn signals, left

Driving

- ▶ Press the combination switch in direction of arrow ① or ②.

The corresponding turn signal indicator lamp  or  in the instrument cluster flashes (▷ page 26).

The combination switch resets automatically after major directional changes.

- i** To signal minor directional changes such as changing lanes, press combination switch only to point of resistance and release. The corresponding turn signals will flash three times.

Windshield wipers

The combination switch is located on the left of the steering column.

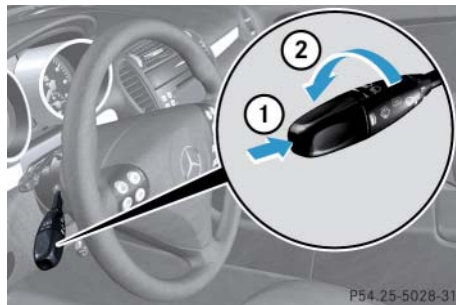

Combination switch

- ① Single wipe
Wiping with windshield washer fluid
- ② Switching on windshield wipers
- ▶ Switch on the ignition (▷ page 37).

! Do not operate the windshield wipers when the windshield is dry. Dust that accumulates on a windshield might scratch the glass and/or damage the wiper blades when wiping occurs on a dry windshield. If it is necessary to operate the windshield wipers in dry weather conditions, always operate the windshield wipers with windshield washer fluid (▷ page 58).

! If anything blocks the windshield wipers (leaves, snow, etc.), switch them off immediately.

- For safety reasons, stop the vehicle in a safe location, turn off the engine and remove the SmartKey from the starter switch before attempting to remove any blockage.
- Remove blockage.
- Turn the windshield wipers on again.

If the windshield wipers fail to function at all with the combination switch in position I,

- set the combination switch to the next higher wiper speed
- have the windshield wipers checked at the nearest authorized Mercedes-Benz Center

Switching on windshield wipers

- ▶ Turn the combination switch to the desired position depending on the intensity of the rain.

- O** Windshield wipers off
- I** Intermittent wiping
- II** Normal wiper speed
- III** Fast wiper speed

Intermittent wiping

! *Vehicles with rain sensor*:
Do not leave windshield wipers on an intermittent setting when the vehicle is taken to an automatic car wash or during windshield cleaning. Windshield wipers will operate in the presence of water sprayed on the windshield, and windshield wipers may be damaged as a result.*

! *Vehicles with rain sensor*:
If you have set intermittent wiping, dirt on the surface of the rain sensor or optical effects may cause the windshield wipers to wipe in an undesired fashion. This could then damage the windshield wiper blades or scratch the windshield. You should therefore switch off the windshield wipers when weather conditions are dry.*

Vehicles with rain sensor*:
Intermittent wiping interval is dependent on wetness of windshield.

- ▶ Turn the combination switch to position **I**.

Vehicles with rain sensor*:
After the initial wipe, pauses between wipes are automatically controlled by the rain sensor.

i *Intermittent wiping is interrupted when the vehicle is at a standstill and a door is opened. This protects persons getting into or out of the vehicle from being sprayed.*

Intermittent wiping will be continued when all doors are closed and

- *the clutch pedal is depressed (vehicles with manual transmission)*
or
- *the gear selector lever is in position **D** or **R** (vehicles with automatic transmission*)*
or
- *the wiper setting is changed using the combination switch*

Driving

Single wipe

- ▶ Press the combination switch briefly in direction of arrow ① (▷ page 58) to the resistance point.

The windshield wipers wipe one time without washer fluid.

Wiping with windshield washer fluid

- ▶ Press the combination switch in direction of arrow ① (▷ page 58) past the resistance point.

The windshield wipers operate with washer fluid.

i *To prevent smears on the windshield or noisy/chattering wiper blades, wipe with windshield washer fluid every now and then even when it is raining.*

For information on filling up the washer reservoir, see “Windshield washer system and headlamp cleaning system*” (▷ page 302).

Problems while driving

The engine runs erratically and misfires

- An ignition cable may be damaged.
- The engine electronics may not be operating properly.
- Unburned gasoline may have entered the catalytic converter and damaged it.
- ▶ Give very little gas.
- ▶ Have the problem repaired by an authorized Mercedes-Benz Center as soon as possible.

The coolant temperature is above 248°F (120°C)

The coolant is too hot and is no longer cooling the engine.

- ▶ Stop the vehicle as soon as possible and turn off the engine. Allow engine and coolant to cool off.
- ▶ Check the coolant level and add coolant if necessary (▷ page 300).

In case of accident

If the vehicle is leaking gasoline:

- ▶ Do not start the engine under any circumstances.
- ▶ Notify local fire and/or police authorities.

If the extent of the damage cannot be determined:

- ▶ Contact an authorized Mercedes-Benz Center or call Roadside Assistance.

If no damage can be determined on the

- Major assemblies
- Fuel system
- Engine mount
- ▶ Start the engine in the usual manner.

▼ Parking and locking

You have now completed your first drive. You have properly stopped and parked your vehicle. End your drive as follows.

Warning!



Vehicles with manual transmission: Wait until the vehicle is stationary before removing the SmartKey from the starter switch. The vehicle cannot be steered when the SmartKey is removed.

Warning!



With the engine not running, there is no power assistance for the brake and steering system. In this case, it is important to keep in mind that a considerably higher degree of effort is necessary to brake and steer the vehicle.

Warning!



Do not park this vehicle in areas where combustible materials such as grass, hay or leaves can come into contact with the hot exhaust system, as these materials could be ignited and cause a vehicle fire.

To reduce the risk of personal injury or damage to the vehicle drivetrain as a result of vehicle movement, before turning off the engine and leaving the vehicle always:

- Keep right foot on brake pedal.
- Pull the parking brake lever up as many notches as possible.
- Manual transmission: Move the gear-shift lever into first or reverse gear.
- Automatic transmission*: Move the gear selector lever to position **P**.
- Slowly release brake pedal.
- When parked on an incline, turn front wheels towards the road curb.

- Turn the SmartKey in the starter switch to position **0** and remove.
- Take the SmartKey with you and lock vehicle when leaving.

Parking brake

Warning!



Engaging the parking brake while the vehicle is in motion can cause the rear wheels to lock up. You could lose control of the vehicle and cause an accident. In addition, the vehicle's brake lights do not light up when the parking brake is engaged.

Parking and locking



① Parking brake lever

- ▶ Pull up parking brake lever ① firmly.

When the ignition is switched on or the engine is running, the brake warning lamp **BRAKE** (USA only) or **①** (Canada only) in the speedometer dial comes on.

Warning!



Getting out of your vehicle with the gear selector lever* not fully engaged in position **P** (manual transmission: first or reverse gear) is dangerous. Also, when parked on an incline, position **P** (manual transmission: first or reverse gear) alone may not prevent your vehicle from moving, possibly hitting people or objects.

Always set the parking brake in addition to shifting to position **P** (manual transmission: first or reverse gear).

When parked on an incline, also turn the front wheels towards the road curb.

Warning!



When leaving the vehicle, always remove the SmartKey from the starter switch, take it with you, and lock the vehicle. Do not leave children unattended in the vehicle, or with access to an unlocked vehicle. Children could release the parking brake and/or move the gear selector lever* from position **P** (manual transmission: into Neutral), either of which could result in an accident and/or serious personal injury.

Switching off headlamps

- ▶ Turn the exterior lamp switch to **0** (▷ page 109).

For more information, see “Lighting” (▷ page 109).

Turning off engine

- ▶ Manual transmission: Move the gear-shift lever into first or reverse gear.
- ▶ Automatic transmission*: Place the gear selector lever in position **P**.
- ▶ Apply the parking brake (▷ page 59).

i Always set the parking brake in addition to shifting into first or reverse gear (automatic transmission*: gear selector lever in position **P**).

When parked on an incline, also turn the front wheels towards the road curb.

- ▶ Turn the SmartKey in the starter switch to position **0** and remove the SmartKey from the starter switch.

The immobilizer is activated.

i Vehicles with automatic transmission*: The SmartKey can only be removed from the starter switch with the gear selector lever in position **P**.

Releasing seat belts

- ▶ Press the seat belt release button (▷ page 49).

Allow the retractor to completely rewind the seat belt by guiding the latch plate.

! Make sure the seat belt retracts fully so that the seat belt and/or latch plate cannot get caught or pinched in the door or in the seat mechanism. This can damage the seat belt and impair the effectiveness of the seat belt, and/or cause damage to the door and/or door trim panel. Such damage is not covered by the Mercedes-Benz Limited Warranty.

Damaged seat belts must be replaced. Contact an authorized Mercedes-Benz Center.

Locking

Warning!



To prevent possible personal injury, always keep hands and fingers away from the door openings when closing the doors.

Be especially careful when small children are around.

Before closing doors, make sure there is no possibility of someone getting caught in a door during closing.

Warning!



When leaving the vehicle, always remove the SmartKey from the starter switch, take it with you, and lock the vehicle. Do not leave children unattended in the vehicle, or with access to an unlocked vehicle.

A child's unsupervised access to a vehicle could result in an accident and/or serious personal injury.

- ▶ Exit the vehicle and close all doors.

i *If you hear a warning signal, you have forgotten to switch off the headlamps before opening the driver's door.*

In addition, the message Turn off lights appears in the multifunction display.

Switch off the headlamps.

! *Failure to switch off the headlamps when leaving the vehicle may result in a discharged battery.*

! *Opening a door causes the windows on that side of the car to open slightly. They will return to the up position when the door is closed.*

The side windows will not open or close if the battery is discharged or the windows are impeded by ice. As a result, you may no longer be able to properly close the door. Do not attempt to force the door shut. Doing so may damage the door or the side window. Correct the condition that prevents the windows from operating before attempting to close the door.

- ▶ Press the lock button  on the SmartKey (▶ page 36).

- All turn signal lamps flash three times.
- An acoustic warning sounds three times (if equipped and feature activated). For more information, see “Factory setting” (▶ page 96).
- The locking knobs in the doors move down.
- The anti-theft alarm system is armed.

i *Without the antenna on the left rear side of the vehicle installed, the SmartKey signaling range is considerably reduced. Hold the SmartKey in close proximity towards the antenna base when locking or unlocking the vehicle.*

For more information, see “Locking and unlocking” (▶ page 94).

Occupant safety

Panic alarm

Driving safety systems

Anti-theft systems



Occupant safety

In this section you will learn the most important facts about the restraint system components of the vehicle.

- Seat belts (▷ page 76)
- Child restraints (▷ page 80)

Additional protection potential provided by

- Supplemental Restraint System (SRS) with
 - Air bags (▷ page 66)
 - Air bag control unit (with crash sensors)
 - Emergency Tensioning Device (ETD) for seat belts (▷ page 79)

Air bag system components with

- Front passenger front air bag off indicator lamp (▷ page 74)
- Passenger seat with Occupant Classification System (OCS) (▷ page 71)

Although independent systems, their protective functions work in conjunction with each other.

i For information on infants and children traveling with you in the vehicle and restraint systems for infants and children, see “Children in the vehicle” (▷ page 79).

The SRS system conducts a self-test when the ignition is switched on and in regular intervals while the engine is running. This facilitates detection of malfunctions. The **SRS** indicator lamp in the instrument cluster comes on when the ignition is switched on and goes out no later than a few seconds after the engine has been started.

The SRS components are in operational readiness if the **SRS** indicator lamp is not lit when the engine is running.

A malfunction in the system has been detected if the **SRS** indicator lamp:

- fails to go out after approximately 4 seconds after the engine was started
- does not come on at all
- comes on after the engine was started or while driving

Warning!

Modifications to or work improperly conducted on restraint systems (such as seat belts and anchors, emergency tensioning devices, seat belt force limiters or air bags) or their wiring, as well as tampering with interconnected electronic systems, can lead to the restraint systems no longer functioning as intended.

Air bags or emergency tensioning devices, for example, could deploy inadvertently or fail to deploy in accidents although the deceleration threshold for air bag deployment is exceeded. Therefore, never modify the restraint systems. Do not tamper with electronic components or their software.

Warning!

In the event that the **SRS** indicator lamp comes on during driving or does not come on at all, the SRS self-check has detected a malfunction. For your safety, we strongly recommend that you contact an authorized Mercedes-Benz Center immediately to have the system checked; otherwise the SRS may not deploy when needed in an accident, which could result in serious or fatal injury, or it might deploy unexpectedly and unnecessarily which could also result in injury.

In addition, improper repair work on the SRS creates a risk of rendering the SRS inoperative or causing unintended air bag deployment. Work on the SRS must therefore only be performed by qualified technicians. Contact an authorized Mercedes-Benz Center.

If it is necessary to modify an air bag system to accommodate a person with disabilities, contact your local authorized Mercedes-Benz Center or call our Customer Assistance Center at 1-800-FOR-MERCEdes (1-800-367-6372) for details.

Occupant safety

Air bags

Warning!



Air bags are designed to reduce the potential of injury in certain frontal impacts (front air bags, knee bags), or side impacts (head-thorax air bags) which may cause significant injuries. However, no system available today can completely eliminate injuries and fatalities.

The deployment of the air bags temporarily releases a small amount of dust from the air bags. This dust, however, is neither injurious to your health, nor does it indicate a fire in the vehicle. The dust might cause some temporary breathing difficulty for people with asthma or other breathing trouble. To avoid this, you may wish to get out of the vehicle as soon as it is safe to do so. If you have any breathing difficulty but cannot get out of the vehicle after the air bag inflates, then get fresh air by opening a window or door.

Warning!



To reduce the risk of injury when the front air bags inflate, it is very important for the driver and passenger to always be in a properly seated position and to wear their seat belts.

For maximum protection in the event of a collision always be in normal seated position with your back against the backrest.

Fasten your seat belt and ensure it is properly positioned on your body (▷ page 48).

Since the air bag inflates with considerable speed and force, a proper seating and hands on steering wheel position will help to keep you at a safe distance from the air bag. Occupants who are unbelted, out of position or too close to the air bag can be seriously injured or killed by an air bag as it inflates with great force in the blink of an eye:

- Sit properly belted in a position that is as upright as possible with your back against the seat backrest.

- Adjust the driver's seat as far as possible rearward, still permitting proper operation of vehicle controls. The distance from the center of the driver's breastbone to the center of the air bag cover on the steering wheel must be at least 10 inches (25 cm) or more. You should be able to accomplish this by a combination of adjustments to the seat and steering wheel. If you have any problems, please contact an authorized Mercedes-Benz Center.
- Do not lean your head or chest close to the steering wheel or dashboard.
- Keep hands on the outside of the steering wheel rim. Placing hands and arms inside the rim can increase the risk and potential severity of hand/arm injury when the driver's front air bag inflates.
- Adjust the passenger seat as far as possible rearward from the dashboard when the seat is occupied.

- Occupants, especially children, should always sit as upright as possible, properly use the seat belts and use an appropriately sized infant restraint, toddler restraint, or booster seat recommended for the size and weight of the child.

Failure to follow these instructions can result in severe injuries to you or other occupants.

If you sell your vehicle, it is important that you make the buyer aware of this safety information. Be sure to give the buyer this Operator's Manual.

Warning!



There is a possibility of a head-thorax air bag related injury if occupants, especially children, are not properly seated or restrained when next to a head-thorax air bag which needs to deploy rapidly in a side impact in order to do its job.

To help avoid the possibility of injury, please follow these guidelines:

- (1) Occupants, especially children, should never place their bodies or lean their heads in the area of the door where the head-thorax air bag inflates. This could result in serious injuries or death should the head-thorax air bag be deployed.
- (2) Always sit as upright as possible, properly use the seat belts, and for all children 12 years old or under, use an appropriately sized infant restraint, toddler restraint, or booster seat recommended for the size and weight of the child.
- (3) Always wear seat belts properly.

If you believe that, even with the use of these guidelines, it would be safer for your passenger seat occupants to have the passenger side head-thorax air bag deactivated, then deactivation can be accomplished upon your written election to do so at an authorized Mercedes-Benz Center at an additional cost.

Please contact your local authorized Mercedes-Benz Center or call the Customer Assistance Center (in the USA) at 1-800-FOR-MERCEdes (1-800-367-6372), or Customer Service (in Canada) at 1-800-387-0100 for details.

Occupant safety

i Air bags are designed to activate only in certain frontal impacts (front air bags, knee bags) and in side impacts (head-thorax air bags) which exceed preset thresholds. Only during these events will they provide their supplemental protection.

The driver and passenger should always wear their seat belts. Otherwise it is not possible for the air bags to provide their supplemental protection.

In case of other types of impacts and impacts below air bag deployment thresholds, air bags will not deploy. The driver and passenger will then be protected to the extent possible by a properly fastened seat belt. A properly fastened seat belt is also needed to provide the best possible protection in a rollover.

We caution you not to rely on the presence of the air bags in order to avoid wearing your seat belt.

It is important to your safety and that of your passenger that you replace deployed air bags and repair any malfunctioning air bags to make sure that the vehicle will continue to provide supplemental crash protection for occupants.

Safety guidelines for the seat belt, emergency tensioning device and air bag

Warning!



- Damaged seat belts or seat belts that were highly stressed in an accident must be replaced and their anchoring points must also be checked. Only use seat belts installed or supplied by an authorized Mercedes-Benz Center.
- Air bags and Emergency Tensioning Devices (ETDs) are designed to function on a one-time-only basis. An air bag or ETD that has deployed must be replaced.
- Do not pass seat belts over sharp edges. They could tear.
- Do not make any modification that could change the effectiveness of the seat belts.

- No modifications of any kind may be made to any components or wiring of the SRS. This includes changing or removing any component or part of the SRS, the installation of additional trim material, badges, etc. over the steering wheel hub, passenger front air bag cover, door frame trims, or door trim panels, and installation of additional electrical/electronic equipment on or near SRS components and wiring. Keep area between air bags and occupants free from objects (e.g. packages, purses, umbrellas, etc.).
- Do not bleach or dye seat belts as this may severely weaken them. In a crash, they may not be able to provide adequate protection.
- Air bag system components will be hot after an air bag has inflated. Do not touch.
- Never place your feet on the instrument panel, dashboard, or on the seat. Always keep both feet on the floor in front of the seat.

- In addition, improper repair work on the SRS creates a risk of rendering the SRS inoperative or causing unintended air bag deployment. Work on the SRS must therefore only be performed by qualified technicians. Contact an authorized Mercedes-Benz Center.
- For your protection and the protection of others, when scrapping the air bag unit or emergency tensioning device, our safety instructions must be followed. These instructions are available from your authorized Mercedes-Benz Center.
- Given the considerable deployment speed, required inflation volume, and the textile structure of the air bags, there is the possibility of abrasions or other, potentially more serious injuries resulting from air bag deployment.

Warning!



Only use seat covers which have been tested and approved by Mercedes-Benz for your vehicle model. Using other seat covers may interfere with or prevent the deployment of the head-thorax air bags. Contact an authorized Mercedes-Benz Center for availability.

When you sell your vehicle, we strongly urge you to give notice to the subsequent owner that it is equipped with an SRS by alerting them to the applicable section in the Operator's Manual.

Front air bags



- ① Driver air bag
- ② Passenger air bag
- ③ Knee bag (passenger side)
- ④ Knee bag (driver's side)

Driver and passenger air bags and knee bags are deployed

- in the event of certain frontal impacts
- if impact exceeds a preset deployment threshold
- independently of the head-thorax air bags

Occupant safety

i The front air bags in this vehicle have been designed to inflate in two stages. This allows the air bag to have different rates of inflation that are based on the rate of relevant vehicle deceleration as assessed by the air bag control unit.

On the passenger side, the front air bag deployment is additionally influenced by the passenger's weight category as identified by the Occupant Classification System (OCS) (▷ page 71).

The lighter the passenger side occupant, the higher the vehicle deceleration rate required for the second stage inflation of the air bag.

The air bags will not deploy in impacts which do not exceed the system's deployment thresholds. You will then be protected by the fastened seat belts.

The passenger air bag will only be deployed if

- the system, based on OCS weight sensor readings, senses that the front passenger seat is occupied
- the **PASS AIR BAG OFF**  indicator lamp in the center console is not lit (▷ page 74)
- the impact exceeds a preset deployment threshold

Knee bags

The driver-side knee bag is located on the driver's side lower instrument panel. The passenger-side knee bag is located on the passenger side below the glove box. They are designed to operate together with the front air bags in certain frontal impacts exceeding a preset threshold. The knee bags operate best in conjunction with properly positioned and fastened seat belts.

Head-thorax air bags



① Head-thorax air bag

The head-thorax air bags are deployed

- in impacts exceeding a preset deployment threshold
- on the impacted side of the vehicle
- independently of the front air bags

The head-thorax air bags are not deployed in impacts which do not exceed the system's deployment threshold.

Warning!

Only use seat covers which have been tested and approved by Mercedes-Benz for your vehicle model. Using other seat covers may interfere with or prevent the deployment of the head-thorax air bags. Contact an authorized Mercedes-Benz Center for availability.

Occupant Classification System

The Occupant Classification System (OCS) automatically turns the passenger front air bag and passenger-side knee bag on or off based on the classified occupant weight category determined by weight sensor readings from the passenger seat.

i *The system does not deactivate the head-thorax air bag and the emergency tensioning device.*

Occupants must sit properly belted in a position that is as upright as possible with their back against the seat backrest and feet on the floor to be correctly classified. If the occupant's weight is transferred to another object in the vehicle (e.g. by leaning on armrests), the OCS may not be able to properly approximate the occupant's weight category.

i *If the seat, including the trim cover and cushion needs to be serviced in any way, take the vehicle to an authorized Mercedes-Benz Center.*



Only seat accessories approved by Mercedes-Benz may be used.

Both driver and the passenger should always use the **PASS AIR BAG OFF**  indicator lamp as an indication of whether or not the passenger is properly positioned (> page 76).

Occupant safety

Warning!







If the **PASS AIR BAG OFF**  indicator lamp illuminates when an adult or someone larger than a small individual is in the passenger seat, have the passenger re-position himself or herself in the seat until the **PASS AIR BAG OFF**  indicator lamp goes out.

More information about air bag display messages (▷ page 361).



In the event of a collision, the air bag control unit will not allow passenger front air bag deployment when the OCS classified the passenger seat occupant as being up to or less than the weight of a typical 12-month-old child in a standard child restraint or if the passenger seat is sensed as being empty.



When the OCS senses that the passenger seat occupant is classified as being up to or less than the weight of a typical 12-month-old child in a standard child restraint, the **PASS AIR BAG OFF**  indicator lamp will illuminate when the engine is started and remain illuminated, indicating that the passenger front air bag is deactivated.

When the OCS senses that the passenger seat is classified as being empty, the **PASS AIR BAG OFF**  indicator lamp will illuminate when the engine is started and remain illuminated, indicating that the passenger front air bag is deactivated.

When the OCS senses that the passenger seat occupant is classified as being heavier than the weight of a typical 12-month-old child seated in a standard child restraint or as being a small individual (such as a young teenager or a small adult), the **PASS AIR BAG OFF**  indicator lamp will illuminate for approximately 6 seconds when the engine is started and then, depending on occupant weight sensor readings from the seat, remain illuminated or go out. With the **PASS AIR BAG OFF**  indicator lamp illuminated, the passenger front air bag is deactivated. With the **PASS AIR BAG OFF**  indicator lamp out, the passenger front air bag is activated.

When the OCS senses that the passenger seat occupant is classified as an adult or someone larger than a small individual, the **PASS AIR BAG OFF**  indicator lamp will illuminate for approximately 6 seconds when the engine is started and then go out, indicating that the passenger front air bag is activated.

If the   indicator lamp is illuminated, the passenger front air bag is deactivated and will not be deployed.

If the   indicator lamp is not illuminated, the passenger front air bag is activated and will be deployed:

- in the event of certain frontal impacts
- if impact exceeds a preset deployment threshold
- independently of the head-thorax air bags

If the passenger front air bag is deployed, the rate of inflation will be influenced by:

- the rate of relevant vehicle deceleration as assessed by the air bag control unit
- passenger's weight category as identified by the Occupant Classification System (OCS)

Warning!













Children 12 years old and under must be seated and properly secured in an appropriate infant or child restraint recommended for the size and weight of the child.

The infant or child restraint must be properly secured with the vehicle's seat belt fully in accordance with the child seat manufacturer's instructions.

Children can be killed or seriously injured by an inflating air bag. Note the following important information:

- Your vehicle is equipped with air bag technology designed to turn off the passenger front air bag in your vehicle when the system senses the weight of a typical 12-month-old child or less along with the weight of a standard appropriate child restraint on the passenger seat.

- A child in a rear-facing child restraint on the passenger seat will be seriously injured or even killed if the passenger front air bag inflates in a collision which could occur under some circumstances, even with the air bag technology installed in your vehicle.
- If you install a rear-facing child restraint on the passenger seat, make sure that the   indicator lamp is illuminated, indicating that the passenger front air bag is deactivated. Should the   indicator lamp not illuminate or go out while the restraint is installed, please check installation. Periodically check the   indicator lamp while driving to make sure the   indicator lamp is illuminated. If the   indicator lamp goes out or remains out, do not transport a child on the passenger seat until the system has been repaired. A child in a rear-facing child restraint on the passenger seat will be seriously injured or even killed if the passenger front air bag inflates.



Occupant safety



- If you place a child in a forward-facing child restraint on the passenger seat, move the seat as far back as possible, use the proper child restraint recommended for the age, size and weight of the child, and secure child restraint with the vehicle's seat belt according to the child seat manufacturer's instructions. For children larger than the typical 12-month-old child, the passenger front air bag may or may not be activated (▷ page 72).

i *Deployment of the driver front air bag does not mean that the passenger front air bag also should have deployed.*

The Occupant Classification System (▷ page 71) may have determined:

- *that the seat was empty or occupied by the weight up to or less than that of a typical 12-month-old child seated in a standard child restraint – both instances where the system suppresses deployment of the passenger front air bag even though the impact met the criteria and was of sufficient severity to deploy the driver front air bag.*
- *that the seat was occupied by a small individual (such as a young teenager or a small adult) or a child weighing more than the weight of a typical 12-month-old child in a standard child restraint – instances where the system may suppress deployment of the passenger front air bag even though the impact met the criteria and was of sufficient severity to deploy the driver front air bag.*

The **PASS AIR BAG OFF**  indicator lamp is located in the center console.



① Passenger front air bag off indicator lamp

The **PASS AIR BAG OFF**  indicator lamp ① will be illuminated, except with the SmartKey removed or in starter switch position 0.

Warning!

If the **SRS** indicator lamp and the **PASS AIR BAG OFF**  indicator lamp are lit at the same time, there is a malfunction in the Occupant Classification System. The passenger front air bag will be deactivated in this case.



In order to ensure proper operation of the air bag system and OCS:

- Have the system checked as soon as possible by qualified technicians. Contact an authorized Mercedes-Benz Center.
- Sit properly belted in a position that is as upright as possible with your back against the seat backrest.
- Do not lean on the armrests or lift yourself from the seat by using the handle over the door as this may cause the OCS to be unable to correctly approximate the occupant weight category.

- Only have the seat repaired or replaced by an authorized Mercedes-Benz Center.
- Read and observe all warnings in this chapter.

Self-test Occupant Classification System

After turning the SmartKey in the starter switch to position **1** or **2**, the

PASS AIR BAG OFF  indicator lamp located in the center console illuminates. If an adult occupant is properly sitting on the passenger seat and the system senses the occupant as being an adult, the **PASS AIR BAG OFF**  indicator lamp will illuminate and go out after approximately 6 seconds.

If the seat is not occupied and the system senses the passenger seat as being empty, the **PASS AIR BAG OFF**  indicator lamp will illuminate and not go out.

Warning!

If the **PASS AIR BAG OFF**  indicator lamp should not illuminate, the system is not functioning. You must contact an authorized Mercedes-Benz Center before seating any child on the passenger seat.

More information can be found in the “Practical hints” section (▷ page 354).

Warning!

Never place anything between seat cushion and child seat (e.g. pillow), since it reduces the effectiveness of the Occupant Classification System. The bottom of the child seat must make full contact with the passenger seat cushion. An incorrectly mounted child seat could cause injuries to the child in case of an accident, instead of increasing protection for the child.

Follow the manufacturer’s instructions for installation of child seats.

Occupant safety

Seat belts

The use of seat belts and infant and child restraint systems is required by law in all 50 states, the District of Columbia, the U.S. territories and all Canadian provinces.

Even where this is not the case, all vehicle occupants should have their seat belts fastened whenever the vehicle is in motion.

For information on fastening seat belts, see “Fastening the seat belts” (▷ page 48).

i For information on infants and children traveling with you in the vehicle and restraint systems for infants and children, see “Children in the vehicle” (▷ page 79).

Warning!



Always fasten your seat belt before driving off. Always make sure your passenger is properly restrained.

Failure to wear and properly fasten and position your seat belt greatly increases your risk of injuries and their likely severity in an accident. You and your passenger should always wear seat belts.

If you are ever in an accident, your injuries can be considerably more severe without your seat belt properly buckled. Without your seat belt buckled, you are much more likely to hit the interior of the vehicle or be ejected from it. You can be seriously injured or killed.

In the same crash, the possibility of injury or death is lessened if you are properly wearing your seat belt. Air bags can only protect as they are designed if the occupants are properly wearing their seat belts.

Warning!



Never ride in a moving vehicle with the seat backrest in an excessively reclined position as this can be dangerous. You could slide under the seat belt in a collision. If you slide under it, the seat belt would apply force at the abdomen or neck. This could cause serious or even fatal injuries. The seat backrest and seat belt provide the best restraint when the wearer is in a position that is as upright as possible and the seat belt is properly positioned on the body.

Warning!



Never let more people ride in the vehicle than there are seat belts available. Be sure everyone riding in the vehicle is correctly restrained with a separate seat belt. Never use a seat belt for more than one person at a time.

Warning!

Damaged seat belts or seat belts that were highly stressed in an accident must be replaced and their anchoring points must also be checked.

Only use seat belts which have been approved by Mercedes-Benz.

Do not make any modifications to the seat belts. This can lead to unintended activation of the ETDs or to their failure to activate when necessary.

Do not bleach or dye seat belts as this may severely weaken them. In a crash, they may not be able to provide adequate protection.

Have all work carried out only by qualified technicians. Contact an authorized Mercedes-Benz Center.

Warning!**USE SEAT BELTS PROPERLY**

- Seat belts can only work when used properly. Never wear seat belts in any other way than as described in this section, as that could result in serious injuries in case of an accident.
- Each occupant should wear their seat belt at all times, because seat belts help reduce the likelihood of and potential severity of injuries in accidents, including rollovers. The integrated restraint system includes SRS (driver air bag, knee bags, passenger front air bag, head-thorax air bags) and ETD (seat belt emergency tensioning device). The system is designed to enhance the protection offered to properly belted occupants in certain frontal (front air bags, knee bags and ETD) and side (head-thorax air bags and ETD) impacts which exceed preset deployment thresholds.

- Never wear the shoulder belt under your arm, against your neck or off your shoulder. In a frontal crash, your body would move too far forward. That would increase the chance of head and neck injuries. The belt would also apply too much force to the ribs or abdomen, which could severely injure internal organs such as your liver or spleen.
- Never wear seat belts over rigid or breakable objects in or on your clothing, such as eyeglasses, pens, keys, etc., as these might cause injuries.
- Position the lap belt as low as possible on your hips and not across the abdomen. If the belt is positioned across your abdomen, it could cause serious injuries in a crash.
- Never use a seat belt for more than one person at a time. Do not fasten a seat belt around a person and another person or other objects.



Occupant safety





- Seat belts should not be worn twisted. In a crash, you would not have the full width of the seat belt to manage impact forces. The twisted seat belt against your body could cause injuries.
- Pregnant women should also always use a lap-shoulder belt. The lap belt portion should be positioned as low as possible on the hips to avoid any possible pressure on the abdomen.
- Never place your feet on the instrument panel, dashboard or on the seat. Always keep both feet on the floor in front of the seat.
- When using a seat belt to secure infant or toddler restraints or children in booster seats, always follow the child seat manufacturer's instructions.

Enhanced seat belt reminder system

When the engine is started, the seat belt telltale  will always illuminate for 6 seconds to remind you and your passenger to fasten your seat belts.

If the driver's seat belt is not fastened when the engine is started, an additional warning chime will also sound for a maximum of 6 seconds or until the driver's seat belt is fastened.

If after these 6 seconds, the driver's or the passenger's seat belt (with the passenger seat occupied) are not fastened with both doors closed,

- the seat belt telltale  remains illuminated for as long as either the driver's or passenger's seat belt is not fastened.
- and if the vehicle speed once exceeds 15 mph (25 km/h), the seat belt telltale  starts flashing and a warning chime sounds with increasing

intensity for a maximum of 60 seconds or until both the driver's and passenger's seat belt are fastened.

If the driver's or the passenger's seat belt remains unfastened after 60 seconds, the warning chime stops sounding. The seat belt telltale  stops flashing but continues to be illuminated.

The seat belt telltale  will only go out if both the driver's and the passenger's seat belt (with the passenger seat occupied) are fastened, or the vehicle is standing still and a door is opened.

For more information, see the "Practical hints" section (> page 351).

Emergency tensioning device (ETD), seat belt force limiter

The seat belts are equipped with emergency tensioning devices and seat belt force limiters.

The ETD is designed to activate in the following cases:

- in frontal or rear-end impacts exceeding the system deployment threshold
- if the restraint systems are operational and functioning correctly, see **SRS** indicator lamp (▷ page 64)
- in certain vehicle rollovers if the system determines an additional degree of protection

i *The ETDs will only activate if the seat belts are fastened (latch plate properly inserted into buckle).*

When activated, emergency tensioning devices remove slack from the seat belts in such a way that the seat belts fit more snugly against the body. Seat belt force limiters reduce the force exerted by the seat belts on occupants during a crash.

Warning!



An emergency tensioning device (ETD) that was activated must be replaced.

When disposing of the emergency tensioning device, our safety instructions must be followed. These are available at your authorized Mercedes-Benz Center.

Children in the vehicle

If an infant or child is traveling with you in the vehicle:

- ▶ Secure the child using an infant or child restraint appropriate to the age and size of the child.
- ▶ Make sure the infant or child is properly secured at all times while the vehicle is in motion.

Warning!



Do not leave children unattended in the vehicle, even if they are secured in a child restraint system. The children could

- injure themselves on parts of the vehicle
- be seriously or fatally injured through excessive exposure to extreme heat or cold



Occupant safety



Do not expose the child restraint system to direct sunlight. The child restraint system's metal parts, for example, could become very hot, and the child could be burned on these parts.

If children open a door, they could

- injure other persons
- get out of the car and injure themselves or be injured by following traffic

Do not carry heavy or hard objects in the passenger compartment unless they are firmly secured in place.

For more information, please refer to the “Useful features” section (▷ page 252) through (▷ page 254).

Unsecured or improperly positioned cargo increases a child's risk of injury in the event of

- strong braking maneuvers
- sudden changes of direction
- an accident

Infant and child restraint systems

We recommend all infants and children be properly restrained at all times while the vehicle is in motion.

The passenger lap-shoulder belt has a special seat belt retractor for secure fastening of child restraints.

To fasten a child restraint follow child restraint instructions for mounting. Then pull the shoulder belt out completely and let it retract. During seat belt retraction, a ratcheting sound can be heard to indicate that the special seat belt retractor is activated. The seat belt is now locked. Push down on child restraint to take up any slack.

To deactivate, release seat belt buckle and let seat belt retract completely.

The seat belt can again be used in the usual manner.

Warning!



Never release the seat belt buckle while the vehicle is in motion, since the special seat belt retractor will be deactivated.

The use of infant or child restraints is required by law in all 50 states, the District of Columbia, the U.S. territories, and all Canadian provinces.

Infants and small children should be seated in an appropriate infant or child restraint system which is properly secured by a lap-shoulder belt and that complies with U.S. Federal Motor Vehicle Safety Standards 213 and 255 and Canadian Motor Vehicle Safety Standards 213 and 210.2.

A statement by the child restraint manufacturer of compliance with these standards can be found on the instruction label on the restraint and in the instruction manual provided with the restraint.

When using any infant, or toddler restraint, or booster seat, be sure to carefully read and follow all manufacturer's instructions for installation and use.

Please read and observe warning labels affixed to inside of the vehicle and to infant or child restraints.

Warning!







Children 12 years old and under must be seated and properly secured in an appropriate infant or child restraint recommended for the size and weight of the child.

The infant or child restraint must be properly secured with the vehicle's seat belt fully in accordance with the child seat manufacturer's instructions.

Occupants, especially children, should never place their bodies or lean their heads in the area of the door where the head-thorax air bag inflates. This could result in serious injuries or death should the head-thorax air bag be triggered. Always sit as upright as possible, properly use the seat belt and use an appropriately sized infant restraint, toddler restraint, or booster seat recommended for the size and weight of the child.

Children can be killed or seriously injured by an inflating air bag. Note the following important information when you place a child in the passenger seat:

- Your vehicle is equipped with air bag technology designed to turn off the passenger front air bag in your vehicle when the OCS senses the weight of a typical 12-month-old child or less along with the weight of a standard appropriate child restraint on the front passenger seat.

- A child in a rear-facing child restraint on the passenger seat will be seriously injured or even killed if the passenger front air bag inflates in a collision which could occur under some circumstances, even with the air bag technology installed in your vehicle.
- If you install a rear-facing child restraint on the passenger seat, make sure that the  indicator lamp is illuminated, indicating that the passenger front air bag is deactivated. Should the  indicator lamp not illuminate or go out while the restraint is installed, please check installation. Periodically check the  indicator lamp while driving to make sure the  indicator lamp is illuminated. If the  indicator lamp goes out or remains out, do not transport a child on the passenger seat until the system has been repaired. A child in a rear-facing child restraint on the passenger seat will be seriously injured or even killed if the passenger front air bag inflates.



Occupant safety



- If you place a child in a forward-facing child restraint on the passenger seat, move the seat as far back as possible, use the proper child restraint recommended for the age, size and weight of the child, and secure child restraint with the vehicle's seat belt according to the child seat manufacturer's instructions. For children larger than the typical 12-month-old child, the passenger front air bag may or may not be activated (▷ page 72).

Warning!



Infants and small children should never share a seat belt with another occupant. During an accident, they could be crushed between the occupant and seat belt.

A child's risk of serious or fatal injuries is significantly increased if the child restraints are not properly secured in the vehicle and/or the child is not properly secured in the child restraint.

Warning!



Children too big for a toddler restraint must ride in seats using regular seat belts. Position the shoulder belt across chest and shoulder, not face or neck. A booster seat may be necessary to achieve proper seat belt positioning for children over 41 lbs until they reach a height where a lap/shoulder belt fits properly without a booster.

When the child restraint is not in use, remove it from the vehicle or secure it with the seat belt to prevent the child restraint from becoming a projectile in the event of an accident.

Do not leave children unattended in the vehicle, even if the children are secured in a child restraint system. Unsupervised children in a child restraint system may use vehicle equipment and may cause an accident and/or serious personal injury.

▼ Panic alarm



① PANIC button

i USA only:

This device complies with Part 15 of the FCC Rules. Operation is subject to the following two conditions:

- (1) *This device may not cause harmful interference, and*
- (2) *this device must accept any interference received, including interference that may cause undesired operation.*

Any unauthorized modification to this device could void the user's authority to operate the equipment.

i Canada only:

This device complies with RSS-210 of Industry Canada. Operation is subject to the following two conditions:

- (1) *This device may not cause interference, and*
- (2) *this device must accept any interference received, including interference that may cause undesired operation of the device.*

Any unauthorized modification to this device could void the user's authority to operate the equipment.

Activating

- ▶ Press and hold button ① for at least 1 second.

An audible alarm and flashing exterior lamps will operate briefly.

i *Without the antenna on the left rear side of the vehicle installed, the SmartKey signaling range for the panic alarm is considerably reduced. The panic alarm then only functions if the SmartKey is held in close proximity towards the antenna base.*

Deactivating

- ▶ Press button ① again.

or

- ▶ Insert the SmartKey in the starter switch.

Driving safety systems

In this section you will find information on the following driving safety systems:

- ABS (Antilock Brake System)
- BAS (Brake Assist System)
- ESP® (Electronic Stability Program)

Warning!



The following factors increase the risk of accidents:

- Excessive speed, especially in turns
- Wet and slippery road surfaces
- Following another vehicle too closely

The driving systems described in this section cannot reduce these risks or prevent the natural laws of physics from acting on the vehicle.

Always adjust your driving style to the prevailing road and weather conditions and keep a safe distance to other road users and objects on the street.

i In winter operation, the maximum effectiveness of the ABS, the BAS, and the ESP® is only achieved with winter tires (▷ page 332) or snow chains as required.

ABS

Warning!



Do not pump the brake pedal. Use firm, steady brake pedal pressure instead. Pumping the brake pedal defeats the purpose of the ABS and significantly reduces braking effectiveness.

The Antilock Brake System (ABS) regulates the brake pressure so that the wheels do not lock during braking. This allows you to maintain the ability to steer your vehicle.

The ABS is functional above a speed of approximately 5 mph (8 km/h) independent of road surface conditions.

On slippery road surfaces, the ABS will respond even to light brake pressure.

The  indicator lamp in the instrument cluster (▷ page 26) comes on when you switch on the ignition. It goes out when the engine is running.

Braking

At the instant one of the wheels is about to lock up, a slight pulsation can be felt in the brake pedal, indicating that the ABS is in the regulating mode.

- ▶ Keep firm and steady pressure on the brake pedal while experiencing the pulsation.

Continuous, steady brake pedal pressure yields the advantages provided by the ABS, namely braking power and the ability to steer the vehicle.

The pulsating brake pedal can be an indication of hazardous road conditions and functions as a reminder to take extra care while driving.

Emergency brake maneuver

- ▶ Keep continuous full pressure on the brake pedal.

Warning!



When the ABS is malfunctioning, the BAS and the ESP[®] are also switched off. The basic driving and braking functions are still available.

When the ABS is malfunctioning, the wheels may lock during hard braking, reducing steering capability and extending the braking distance.

Warning!



The ABS cannot prevent the natural laws of physics from acting on the vehicle, nor can it increase braking or steering efficiency beyond that afforded by the condition of the vehicle brakes and tires or the traction afforded. The ABS cannot prevent accidents, including those resulting from excessive speed in turns, following another vehicle too closely, or hydroplaning. Only a safe, attentive, and skillful driver can prevent accidents. The capabilities of an ABS equipped vehicle must never be exploited in a reckless or dangerous manner which could jeopardize the user's safety or the safety of others.

For more information, see "Practical hints" (▷ page 346).

Driving safety systems

BAS

The Brake Assist System (BAS) operates in emergency situations. If you apply the brakes very quickly, the BAS automatically provides full brake boost, thereby potentially reducing braking distance.

- ▶ Apply continuous full braking pressure until the emergency braking situation is over.

The ABS will prevent the wheels from locking.

When you release the brake pedal, the brakes function again as normal. The BAS is then deactivated.

Warning!



If the BAS is malfunctioning, the brake system is still functioning normally, but without the additional brake boost available that BAS would normally provide in an emergency braking maneuver. Therefore, the braking distance may increase.

Warning!





The BAS cannot prevent the natural laws of physics from acting on the vehicle, nor can it increase braking efficiency beyond that afforded by the condition of the vehicle brakes and tires or the traction afforded. The BAS cannot prevent accidents, including those resulting from excessive speed in turns, following another vehicle too closely, or hydroplaning. Only a safe, attentive, and skillful driver can prevent accidents. The capabilities of a BAS equipped vehicle must never be exploited in a reckless or dangerous manner which could jeopardize the user's safety or the safety of others.

ESP®

The Electronic Stability Program (ESP®) is operational as soon as the engine is running and monitors the vehicle's traction (force of adhesive friction between the tires and the road surface) and handling.

The ESP® recognizes when a wheel is spinning or if the vehicle starts to skid. By applying the brakes to the appropriate wheel and by limiting the engine output, the ESP® works to stabilize the vehicle. The ESP® is especially useful while driving off and on wet or slippery road surfaces. The ESP® also stabilizes the vehicle during braking and steering maneuvers.

The ESP® warning lamp  in the instrument cluster flashes when the ESP® is engaged.

The ESP® warning lamp  in the instrument cluster comes on when you switch on the ignition. It goes out when the engine is running.

Warning!

Never switch off the ESP[®] when you see the ESP[®] warning lamp  flashing in the instrument cluster. In this case, proceed as follows:

- While driving off, apply as little throttle as possible.
- While driving, ease up on the accelerator.
- Adapt your speed and driving style to the prevailing road conditions.

Failure to observe these guidelines could cause the vehicle to skid.

The ESP[®] cannot prevent accidents resulting from excessive speed.

Warning!

The ESP[®] cannot prevent the natural laws of physics from acting on the vehicle, nor can it increase the traction afforded. The ESP[®] cannot prevent accidents, including those resulting from excessive speed in turns, or hydroplaning. Only a safe, attentive, and skillful driver can prevent accidents. The capabilities of an ESP[®] equipped vehicle must never be exploited in a reckless or dangerous manner which could jeopardize the user's safety or the safety of others.

! Because the ESP[®] operates automatically, the engine must be turned off (SmartKey in starter switch position **0** or **1**) when

- the parking brake is being tested on a brake test dynamometer
- the vehicle is being towed with the front axle raised

Active braking action through the ESP[®] may otherwise seriously damage the brake system.

i The ESP[®] will only function properly if you use wheels of the recommended tire size (▷ page 434).

For more information, see the “Practical hints” section (▷ page 350) and (▷ page 359).

Driving safety systems

Electronic traction system

The electronic traction system is a component of ESP®.

The electronic traction system improves the vehicle's ability to utilize available traction, especially under slippery road conditions by applying the brakes to a spinning wheel.

When you switch off the ESP®, the electronic traction system is still enabled.

Warning!



If you are driving too fast, the electronic traction system cannot reduce the risk of an accident.

The electronic traction system cannot prevent the natural laws of physics from acting on the vehicle.

Switching off the ESP®

Warning!



The ESP® should not be switched off during normal driving other than in the circumstances described below. Disabling of the system will reduce vehicle stability in standard driving maneuvers.

Do not switch off the ESP® when a spare wheel is mounted.

To improve the vehicle's traction, turn off the ESP® in driving situations where it would be advantageous to have the drive wheels spin and thus cut into surfaces for better grip such as:

- when driving with snow chains
- in deep snow
- in sand or gravel

Warning!



Switch on the ESP® immediately if the aforementioned circumstances do not apply anymore. Otherwise the ESP® will not stabilize the vehicle when it is starting to skid or a wheel is spinning.

When you switch off the ESP®

- the ESP® does not stabilize the vehicle
- the engine output is not limited, which allows the drive wheels to spin and thus cut into surfaces for a better grip
- the traction control will still apply the brakes to a spinning wheel
- the ESP® continues to operate when you are braking
- you cannot activate the cruise control
- the cruise control switches off if currently activated

i When the ESP[®] is switched off and one or more drive wheels are spinning, the ESP[®] warning lamp  in the instrument cluster flashes. However, the ESP[®] will then not stabilize the vehicle.

The ESP[®] switch is located on the upper part of the center console.



① ESP[®] switch

- ▶ With the engine running, press ESP[®] switch ① until the ESP[®] warning lamp  in the instrument cluster comes on.

The ESP[®] is switched off.

Warning!



When the ESP[®] warning lamp  is illuminated continuously, the ESP[®] is switched off or is not operational due to a malfunction. Vehicle stability in standard driving maneuvers reduces.

Adapt your speed and driving to the prevailing road conditions and to the non-operating status of the ESP[®].

! Avoid spinning of a drive wheel for an extended period with the ESP[®] switched off. This may cause serious damage to the drivetrain which is not covered by the Mercedes-Benz Limited Warranty.

Switching on the ESP[®]

- ▶ Press ESP[®] switch ① until the ESP[®] warning lamp  in the instrument cluster goes out.

You are now again in normal driving mode with the ESP[®] switched on.

Anti-theft systems

Immobilizer

The immobilizer prevents unauthorized persons from starting your vehicle.

Activating

- ▶ Remove the SmartKey from the starter switch.

Deactivating

- ▶ Switch on the ignition (▷ page 37).

i Starting the engine will also deactivate the immobilizer.

In case the engine cannot be started (yet the vehicle's battery is charged), the system is not operational. Contact an authorized Mercedes-Benz Center or call 1-800-FOR-MERCEdes (in the USA), or 1-800-387-0100 (in Canada).

Anti-theft alarm system

Once the alarm system has been armed, a visual and audible alarm is triggered when someone opens

- a door
- the trunk lid
- the hood
- the glove box
- the storage/telephone* compartment in the center console

The alarm system will also be triggered when

- someone attempts to raise the vehicle
- opening the vehicle with the mechanical key
- someone opens a door from the inside
- someone opens the trunk lid with the emergency release button

i The alarm will stay on, even if the activating element (e.g. a door) is immediately closed.

i If the alarm stays on for more than 30 seconds, a call to the Response Center is initiated automatically by the Tele Aid* system (▷ page 261), provided Tele Aid* service was subscribed to and properly activated, and that necessary cellular service and GPS coverage are available (▷ page 261).

Arming the alarm system

- ▶ Lock your vehicle with the SmartKey.

The turn signal lamps flash three times and an acoustic warning sounds three times (if equipped and feature activated) to indicate that the alarm system is armed.

The indicator lamp in the central locking switch starts flashing (▷ page 103).

i *If the turn signal lamps do not flash three times and no acoustic warning sounds three times (though equipped and feature activated), a door or the trunk lid may not be properly closed:*

Close the respective element and lock the vehicle again.



Disarming the alarm system

- ▶ Unlock your vehicle with the SmartKey.

The turn signal lamps flash once and an acoustic warning sounds once (if equipped and feature activated) to indicate that the alarm system is disarmed.

Canceling the alarm

To cancel the alarm:

- ▶ Press the  or  button on the SmartKey.

or

- ▶ Insert the SmartKey in the starter switch.

Tow-away alarm

Once the tow-away alarm is armed, a visual and audible alarm will be triggered when someone attempts to raise the vehicle.

i *The tow-away protection alarm is triggered, for example, if the vehicle is lifted on one side.*

If the alarm stays on for more than 30 seconds, a call to the Response Center is initiated automatically by the Tele Aid system (▷ page 261), provided Tele Aid* service was subscribed to and properly activated, and that necessary cellular service and GPS coverage are available (▷ page 261).*

Anti-theft systems

Arming tow-away alarm

- ▶ Lock your vehicle with the SmartKey.

The tow-away alarm is automatically armed after about 30 seconds.

i When you unlock your vehicle, the tow-away protection disarms automatically. The tow-away alarm remains disarmed until you lock the vehicle again.

Disarming tow-away alarm

To prevent triggering the tow-away alarm, switch off the tow-away alarm feature before towing the vehicle, or when parking on a surface subject to movement, such as a ferry or auto train.

The switch is located on the lower part of the center console.

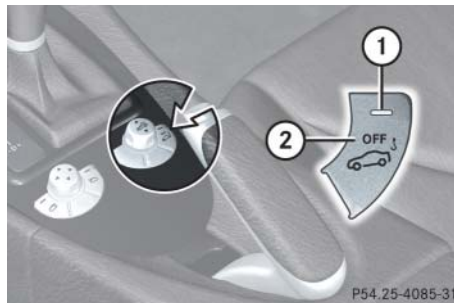

- ① Indicator lamp
- ② Tow-away alarm deactivation switch

- ▶ Switch off the ignition (▷ page 37).
- ▶ Remove the SmartKey from the starter switch.

i You cannot disarm the tow-away alarm while the ignition is switched on.

- ▶ Press tow-away alarm deactivation switch ②.



Indicator lamp ① in the tow-away alarm deactivation switch comes on briefly.

- ▶ Exit your vehicle.
- ▶ Lock your vehicle with the SmartKey.

The tow-away alarm remains disarmed until you lock your vehicle again.

Canceling tow-away alarm

To cancel the alarm:

- ▶ Press the  or  button on the SmartKey.

or

- ▶ Insert the SmartKey in the starter switch.

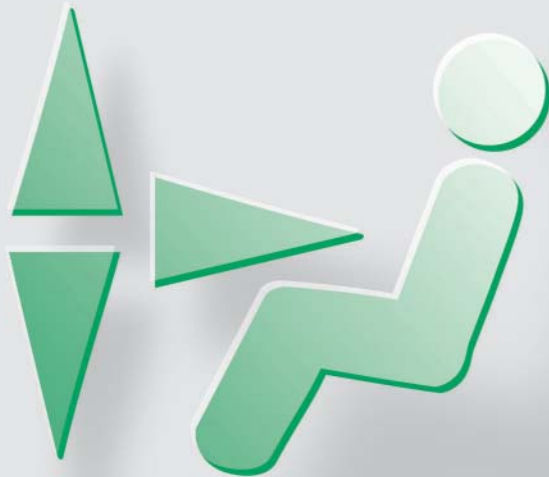

Locking and unlocking

Seats

Memory function*

Lighting

Instrument cluster

Control system

Manual transmission

Automatic transmission*

Good visibility

Climate control

Automatic climate control*

Audio system

Power windows

Retractable hardtop

Driving systems

Loading

Useful features

Locking and unlocking

In the “Controls in detail” section you will find detailed information on how to operate the equipment installed in your vehicle. If you are already familiar with the basic functions of your vehicle, this section will be of particular interest to you.

To quickly familiarize yourself with the basic functions of the vehicle, refer to the “Getting started” section of this manual. The corresponding page numbers are given at the beginning of each segment.

For more information on unlocking and locking, see (▷ page 36) and (▷ page 59).

SmartKey

Your vehicle comes supplied with two SmartKeys, each with remote control and a removable mechanical key.

The locking tabs for the mechanical key portion of the two SmartKeys are a different color to help distinguish each SmartKey unit.





The SmartKey provides an extended operating range. To prevent theft, however, it is advisable to only unlock the vehicle when you are in close proximity to it.

The SmartKey centrally locks and unlocks:

- the doors
- the trunk
- the fuel filler flap
- the glove box
- the storage/telephone* compartment under the armrest



SmartKey with remote control

- ①  Lock button
- ②  Unlock button for the trunk (▷ page 100)
- ③ Mechanical key locking tab
- ④  Unlock button
- ⑤ Battery check lamp
- ⑥  PANIC Panic button (▷ page 83)

Warning!

When leaving the vehicle, always remove the SmartKey from the starter switch, take it with you, and lock the vehicle. Do not leave children unattended in the vehicle, or with access to an unlocked vehicle. A child's unsupervised access to a vehicle could result in an accident and/or serious personal injury.

! Opening a door causes the windows on that side of the car to open slightly. They will return to the up position when the door is closed.

The side windows will not open or close if the battery is discharged or the windows are impeded by ice. As a result, you may no longer be able to properly close the door. Do not attempt to force the door shut. Doing so may damage the door or the side window. Correct the condition that prevents the windows from operating before attempting to close the door.

! To prevent possible malfunction, avoid exposing the SmartKey to high levels of electromagnetic radiation.

! If you can no longer lock or unlock the vehicle with the SmartKey, the batteries in the SmartKey are discharged, the SmartKey is malfunctioning, or the vehicle battery is drained.

- Check the batteries in the SmartKey and replace them if necessary (▷ page 391).
- Use the mechanical key to unlock the driver's door (▷ page 387) and the trunk (▷ page 388).
- Use the mechanical key to lock the vehicle (▷ page 388).
- Have the vehicle battery and the battery connections checked (▷ page 415).

If the SmartKey is malfunctioning, contact Roadside Assistance or an authorized Mercedes-Benz Center.

i Without the antenna on the left rear side of the vehicle installed, the SmartKey signaling range is considerably reduced. Hold the SmartKey in close proximity towards the antenna base when locking or unlocking the vehicle.

i You can also open and close the retractable hardtop using the SmartKey* (▷ page 244).

i USA only:

This device complies with Part 15 of the FCC Rules. Operation is subject to the following two conditions:

- (1) This device may not cause harmful interference, and
- (2) this device must accept any interference received, including interference that may cause undesired operation.

Any unauthorized modification to this device could void the user's authority to operate the equipment.

i Canada only:

This device complies with RSS-210 of Industry Canada. Operation is subject to the following two conditions:

- (1) This device may not cause interference, and
- (2) this device must accept any interference received, including interference that may cause undesired operation of the device.

Any unauthorized modification to this device could void the user's authority to operate the equipment.

Locking and unlocking

Factory setting

 Your vehicle may be equipped with an acoustic lock and unlock confirmation signal feature. If your vehicle is equipped with this feature and the feature is activated, an acoustic signal will sound when the vehicle is locked or unlocked using the SmartKey.

To determine whether or not your vehicle is equipped with this feature, contact an authorized Mercedes-Benz Center. If equipped and you wish to activate or deactivate, or adjust its signal volume, also contact an authorized Mercedes-Benz Center.

Global unlocking

- ▶ Press button .
- All turn signal lamps flash once.
- An acoustic warning sounds once (if equipped and feature activated). For more information, see “Factory setting” (▷ page 96).
- The locking knobs in the doors move up.
- The anti-theft alarm system is disarmed.

The vehicle will lock again automatically and rearm the anti-theft alarm system within approximately 40 seconds of unlocking if:

- neither door nor trunk is opened
- the SmartKey is not inserted in the starter switch
- the central locking switch is not activated

Global locking



- ▶ Press button .

With all doors and the trunk closed:

- All turn signal lamps flash three times.
- An acoustic warning sounds three times (if equipped and feature activated). For more information, see “Factory setting” (▷ page 96).
- The locking knobs in the doors move down.
- The anti-theft alarm system is armed.

Selective setting

If you frequently travel alone, you may wish to reprogram the SmartKey so that pressing button  only unlocks the driver's door, the storage/telephone* compartment under the armrest, the glove box, and the fuel filler flap.

- ▶ Press and hold buttons  and  simultaneously for about 5 seconds until battery check lamp  (▷ page 94) flashes twice.

The SmartKey will then function as follows:

Unlocking driver's door and fuel filler flap

- ▶ Press button  once.
 - All turn signal lamps flash once.
 - An acoustic warning sounds once (if equipped and feature activated). For more information, see “Factory setting” (▷ page 96).
 - The locking knob in the driver's door moves up.
 - The anti-theft alarm system is disarmed.

Global unlocking

- ▶ Press button  twice.
 - All turn signal lamps flash once.
 - An acoustic warning sounds once (if equipped and feature activated). For more information, see “Factory setting” (▷ page 96).
 - The locking knobs in the doors move up.
 - The anti-theft alarm system is disarmed.

Locking and unlocking



Global locking

- ▶ Press button .



With all doors and the trunk closed:

- All turn signal lamps flash three times.
- An acoustic warning sounds three times (if equipped and feature activated). For more information, see “Factory setting” (▷ page 96).
- The locking knobs in the doors move down.
- The anti-theft alarm system is armed.

Restoring to factory setting

- ▶ Press and hold buttons  and  simultaneously for about 5 seconds until battery check lamp  (▷ page 94) flashes twice.

Checking the batteries



- ▶ Press button  or .

The battery check lamp (▷ page 94) comes on briefly to indicate that the SmartKey batteries are in order.

 *If the battery check lamp (▷ page 94) does not come on briefly during check, the SmartKey batteries are discharged.*

- *Replace the batteries (▷ page 391).*

You can obtain the required batteries at any authorized Mercedes-Benz Center.

 *If the batteries are checked within signal range of the vehicle, pressing button  or  will lock or unlock the vehicle accordingly.*

Loss of SmartKey or mechanical key

If you lose a SmartKey or mechanical key, you should do the following:

- ▶ Have the SmartKey deactivated by an authorized Mercedes-Benz Center.
- ▶ Report the loss of the SmartKey or the mechanical key to your car insurance company immediately.
- ▶ If necessary have the mechanical lock replaced.

Your authorized Mercedes-Benz Center will be glad to supply you with a replacement.

Opening the doors from the inside

You can open a locked door from the inside. Open door only when conditions are safe to do so.

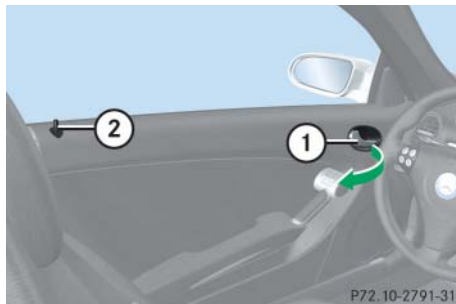

- ① Inside door handle
- ② Locking knob

► Pull on door handle ① on the respective door.

If the door was locked, locking knob ② will move up.

i If you hear a warning signal, you have forgotten to switch off the headlamps before opening the driver's door.



In addition, the message Turn off lights appears in the multifunction display.

Switch off the headlamps.

! Failure to switch off the headlamps when leaving the vehicle may result in a discharged battery.

i If the vehicle has previously been centrally locked with the SmartKey, opening a door from the inside will trigger the anti-theft alarm system.

To cancel the alarm, do one of the following:

- Press button  or  on the SmartKey.
- Insert the SmartKey in the starter switch.

! Opening a door causes the windows on that side of the car to open slightly. They will return to the up position when the door is closed.

The side windows will not open or close if the battery is discharged or the windows are impeded by ice. As a result, you may no longer be able to properly close the door. Do not attempt to force the door shut. Doing so may damage the door or the side window. Correct the condition that prevents the windows from operating before attempting to close the door.

Locking and unlocking

Opening the trunk

Warning!



Make sure the trunk is closed when the engine is running and while driving. Among other dangers, deadly carbon monoxide (CO) gases may enter vehicle interior resulting in unconsciousness and death.

You can open the trunk when if vehicle is stationary.

A minimum height clearance of 5.78 ft (1.76 m) is required to open the trunk lid.

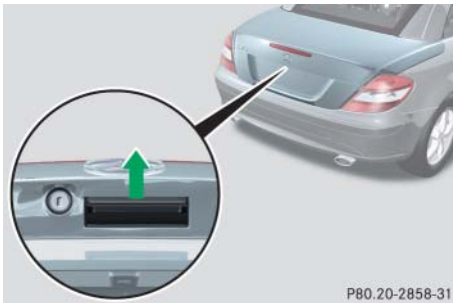

P80.20-2858-31

- ▶ Press and hold button  on the SmartKey.

The trunk is unlocked.

- ▶ Pull on the handle.
- ▶ Lift the trunk lid.

! *When the trunk lid is lifted slightly, it swings open upwards automatically. Always make sure there is sufficient overhead clearance.*

i *The vehicle or trunk must be unlocked before the trunk lid can be opened.*

The trunk lid can only be opened when the vehicle is not in motion and the retractable hardtop is fully opened or closed.

The trunk lid can also be opened from the inside in an emergency, see “Trunk lid emergency release” (▷ page 101).

Closing the trunk

Warning!



Make sure the trunk is closed when the engine is running and while driving. Among other dangers, deadly carbon monoxide (CO) gases may enter vehicle interior resulting in unconsciousness and death.

i *Do not place the SmartKey in the open trunk. You may lock yourself out.*



P80.20-2700-31

① Handle

- ▶ Lower the trunk lid using handle ①.
- ▶ Close the trunk lid with hands placed flat on the trunk lid.

i *If the vehicle was previously centrally locked, the trunk lid will lock automatically when closed. The turn signal lamps will flash three times to confirm locking.*

Warning!



To prevent possible personal injury, always keep hands and fingers away from the trunk lid opening when closing the trunk lid. Be especially careful when small children are around.

Warning!



When leaving the vehicle, always remove the SmartKey from the starter switch, take it with you, and lock the vehicle. Do not leave children unattended in the vehicle, or with access to an unlocked vehicle. A child's unsupervised access to a vehicle could result in an accident and/or serious personal injury.

Trunk lid emergency release

With the emergency release button, the trunk can be opened from inside the trunk.

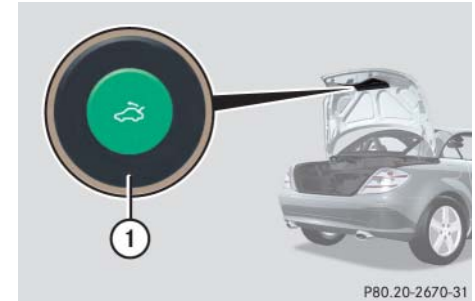

① Emergency release button

- ▶ Briefly press emergency release button ①.

The trunk lid unlocks and opens slightly.

- ▶ Push up the trunk lid to fully open.

Locking and unlocking

i *The emergency release button unlocks the trunk while the vehicle is standing still or in motion.*



Illumination of the emergency release button:

- The button flashes for 30 minutes after opening the trunk.
- The button flashes for 60 minutes after closing the trunk.

i *The emergency release button does not unlock the trunk if the vehicle battery is discharged or disconnected.*

i *If the vehicle has previously been centrally locked with the SmartKey, opening the trunk from the inside will trigger the anti-theft alarm system.*

To cancel the alarm, do one of the following:

- Press button  or  on the SmartKey.
- Insert the SmartKey in the starter switch.

Automatic central locking

The doors and the trunk automatically lock when the vehicle is set into motion.

i *You can open a locked door from the inside. Open door only when conditions are safe to do so.*

i *The doors unlock automatically after an accident if the force of the impact exceeds a preset threshold.*

The vehicle locks automatically when the ignition is switched on and the wheels are turning at a vehicle speed of approximately 9 mph (15 km/h) or more. You could therefore lock yourself out when the vehicle

- *is pushed or towed*
- *is on a test stand*

You can deactivate the automatic locking using the control system, see “Setting automatic locking” (▷ page 146).

Locking and unlocking from the inside

Warning!



When leaving the vehicle, always remove the SmartKey from the starter switch, take it with you, and lock the vehicle. Do not leave children unattended in the vehicle, or with access to an unlocked vehicle. A child's unsupervised access to a vehicle could result in an accident and/or serious personal injury.

You can lock or unlock the doors and the trunk from the inside using the central locking or unlocking switch. This can be useful, for example, if you want to lock the vehicle before starting to drive.

The fuel filler flap will not be locked or unlocked with the central locking or unlocking switch, respectively.



- ① Central locking switch
- ② Central unlocking switch

i You can open a locked door from the inside. Open door only when conditions are safe to do so.

If the vehicle was previously centrally locked using the SmartKey, it will not unlock using the central unlocking switch.

If the vehicle was previously locked with the central locking switch

- *and the SmartKey is set to factory settings, the complete vehicle is unlocked when a door is opened from the inside*
- *and the SmartKey is set to selective settings, only the door opened from inside is unlocked*

Locking

- ▶ Press central locking switch ①.
If all doors are closed, the vehicle locks.

Unlocking

- ▶ Press central unlocking switch ②.
The vehicle unlocks.

Seats

For information on seat adjustment, see “Adjusting” (▷ page 39).

Seat heating*



- ① Seat heating switch
- ② Indicator lamps

Red indicator lamps ② on seat heating switch ① show which heating level you have selected:

Level	
3	Three indicator lamps on (highest level). After approximately 5 minutes, seat heating is automatically switched to level 2.
2	Two indicator lamps on. After approximately 10 minutes, seat heating is automatically switched to level 1.
1	One indicator lamp on (lowest level). After approximately 20 minutes, seat heating is automatically switched to off.
off	No indicator lamp on.

- ▶ Switch on the ignition (▷ page 37).

Switching on seat heating

- ▶ Press switch ① repeatedly until the desired heating level is set.

One or more red indicator lamps ② show the selected heating level.

Switching off seat heating

- ▶ Press switch ① repeatedly until all indicator lamps ② go out.

i If one or more indicator lamps ② on the seat heating switch are flashing, there is insufficient voltage available since too many electrical consumers are turned on. The seat heating switches off automatically.

The seat heating will switch back on again automatically as soon as sufficient voltage is available.

AIRSCARF neck-level heating*

The AIRSCARF neck-level heating provides the area surrounding the occupants' necks with a heated air stream flowing from openings in the head restraints.



- ① AIRSCARF switch
- ② Indicator lamps

Warning!



When switching on the AIRSCARF neck-level heating, the air streaming from the openings may be very hot. When in close proximity to the openings, you could be seriously burned. To help avoid serious personal injuries, switch the AIRSCARF to a lower heating level.

Red indicator lamps ② on AIRSCARF switch ① show which heating level you have selected:

Level	
3	Three indicator lamps on (highest level).
2	Two indicator lamps on.
1	One indicator lamp on (lowest level).
off	No indicator lamp on.

- ▶ Switch on the ignition (▷ page 37).

Switching on

- ▶ Press the AIRSCARF switch ① for the desired side.

All three indicator lamps ② on respective AIRSCARF switch ① come on. After a preheating time of approximately 7 seconds, the blower starts.

- ▶ Press AIRSCARF switch ① repeatedly until the desired AIRSCARF heating level for the corresponding seat is reached.

Switching off

- ▶ Press AIRSCARF switch ① repeatedly until all indicator lamps ② on AIRSCARF switch ① go out.

i After switching off the AIRSCARF neck-level heating, the AIRSCARF fan continues to operate for approximately 10 seconds to cool down the heater elements.

i If one or more indicator lamps ② on AIRSCARF switch ① are flashing, there is insufficient voltage available since too many electrical consumers are turned on. The AIRSCARF neck-level heating switches off automatically.

The AIRSCARF neck-level heating will switch back on again automatically as soon as sufficient voltage is available.

▼ Memory function*

Prior to operating the vehicle, the driver should check and adjust the seat height, seat position fore and aft, and seat backrest angle if necessary, to ensure adequate control, reach and comfort. The head restraint should also be adjusted for proper height. See also the section on air bags (▷ page 66) for proper seat positioning.

In addition, adjust the steering wheel to ensure adequate control, reach, operation and comfort. Both the interior and exterior rear view mirrors should be adjusted for adequate rear vision.

Fasten seat belts. Infants and small children should be seated in an appropriate infant or child restraint system which is properly secured by a lap-shoulder belt and that complies with U.S. Federal Motor Vehicle Safety Standards 213 and 255 and Canadian Motor Vehicle Safety Standards 213 and 210.2.

With the memory function you can store up to three different configurations.

Each store position on the driver's side includes the following settings:

- Seat position
- Steering wheel position
- Exterior rear view mirrors' position

Warning!



Do not activate the memory function while driving. Activating the memory function while driving could cause the driver to lose control of the vehicle.

Each store position on the passenger side includes the following setting:

- Seat position

The memory button and memory position switch are located on the outer side of each seat.

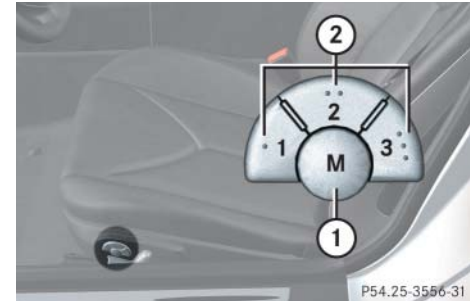

- ① Memory button **M**
- ② Memory position switch

▶ Switch on the ignition (▷ page 37).

or

▶ Open the respective door.

Memory function*

Storing positions into memory

- ▶ Adjust the seat, on the driver's side also the steering wheel and exterior rear view mirrors, to the desired positions (▷ page 39).
- ▶ Press memory button **M**.
- ▶ Release memory button **M** and press a memory position switch ② within 3 seconds.

All settings are stored to the selected position.

Recalling positions from memory

! *Do not operate the power seats using the memory position switches if the seat backrest is in an excessively reclined position. Doing so could cause damage to the seats.*

- ▶ Press and hold desired memory position switch ② until the seat, on the driver's side also the steering wheel and exterior rear view mirrors, have completely moved to the stored positions.

i *Releasing the memory position switches immediately stops movement to the stored positions.*

▼ Lighting

For information on how to switch on the headlamps and use the turn signals, see “Switching on headlamps” (▷ page 55) and “Turn signals” (▷ page 55).

i If you drive in countries where vehicles drive on the other side of the road than the country in which the vehicle is registered, you must have the headlamps modified for symmetrical low beams. Relevant information can be obtained at your authorized Mercedes-Benz Center.

i Vehicles with active Bi-Xenon* headlamps: The active Bi-Xenon* headlamps monitor the vehicle’s steering angle and speed, then automatically shift their beams to either side to better follow the curvature of the road ahead, increasing usable illumination over conventional headlamps.

Exterior lamp switch



Exterior lamp switch

- 1 **→P←** Standing lamps, left (turn left two stops)
- 2 **P←→** Standing lamps, right (turn left one stop)
- 3 **0** Off
Daytime running lamp mode (▷ page 111)
- 4 **AUTO** Automatic headlamp mode
Daytime running lamp mode (▷ page 111)

- 5 **☰☷☹** Parking lamps (also side marker lamps, tail lamps, license plate lamps, instrument panel lamps)
- 6 **☰☷** Low beam headlamps or high beam headlamps when the combination switch is pushed forward. The tail lamps, license plate lamps, side marker lamps, parking lamps and instrument panel lamps also come on.
- 7 **☰☷** Front fog lamps
- 8 **☰☷** Rear fog lamp

i If you hear a warning signal, you have forgotten to switch off the headlamps before opening the driver’s door.

In addition, the message Turn off lights appears in the multifunction display.

Switch off the headlamps.

! Failure to switch off the headlamps when leaving the vehicle may result in a discharged battery.

Lighting

Manual headlamp mode

The low beam headlamps and the parking lamps can be switched on and off with the exterior lamp switch.

- ▶ Turn the exterior lamp switch to position .

Automatic headlamp mode

The following lamps switch on and off automatically depending on the brightness of the ambient light:

- Low beam headlamps
- Tail and parking lamps
- License plate lamps
- Side marker lamps



Warning!



If the exterior lamp switch is set to **AUTO**

- the headlamps may switch off unexpectedly when the system senses bright ambient light, for example light from oncoming traffic.
- the headlamps will not be automatically switched on under foggy conditions.

To minimize risk to you and to others, activate headlamps by turning exterior lamp switch to  when driving or when traffic and/or ambient lighting conditions require you to do so.

In low ambient lighting conditions, only switch from position **AUTO** to  with the vehicle at a standstill in a safe location. Switching from **AUTO** to  will briefly switch off the headlamps. Doing so while driving in low ambient lighting conditions may result in an accident.

The automatic headlamp feature is only an aid to the driver. The driver is responsible for the operation of the vehicle's lights at all times.

- ▶ Turn the exterior lamp switch to position **AUTO**.

With the SmartKey in starter switch position **1**, only the parking lamps and the side marker lamps will switch on and off automatically.

When the engine is running, the low beam headlamps, the tail and parking lamps, the license plate lamps, and the side marker lamps will switch on and off automatically.

 *USA only:*

With the automatic headlamp mode activated you can switch on the high beam headlamps in low ambient lighting conditions.

Daytime running lamp mode

- ▶ Turn the exterior lamp switch to position **0** or **AUTO**.

When the engine is running, the low beam headlamps are switched on.

In low ambient light conditions, the following lamps will switch on additionally:

- Tail and parking lamps
- License plate lamps
- Side marker lamps

For nighttime driving you should turn the exterior lamp switch to position **HD** to permit activation of the high beam headlamps.

i *With the daytime running lamp mode activated and the engine running, the low beam headlamps cannot be switched off manually.*

Canada only:

The daytime running lamp mode is mandatory and therefore in a constant mode.

i *With the exterior lamp switch in position **0** or **AUTO** you cannot switch on the high beam headlamps.*

The high beam flasher is available at all times.

*For nighttime driving you should turn the exterior lamp switch to position **HD** to permit activation of the high beam headlamps.*

Vehicles with automatic transmission*:

When the engine is running, and you shift from a driving position to position **N** or **P**, the low beam headlamps will switch off with a three-minute delay.

When the engine is running, and you

- turn the exterior lamp switch to position **300E**, the parking lamps and the side marker lamps switch on additionally.
- turn the exterior lamp switch to position **HD**, the manual headlamp mode has priority over the daytime running lamp mode.

The corresponding exterior lamps switch on (▷ page 109).



USA only:

By default, the daytime running lamp mode is deactivated. Activate the daytime running lamp mode using the control system, see “Setting daytime running lamp mode” (▷ page 143).

Lighting

i With the daytime running lamp mode activated and the exterior lamp switch in position **0**, you cannot switch on the high beam headlamps. The high beam flasher is available at all times.

For nighttime driving, turn the exterior lamp switch in position  or **AUTO** to permit activation of the high beam headlamps.

When the engine is running, and you turn the exterior lamp switch to position  or , the manual headlamp mode has priority over the daytime running lamp mode.

The corresponding exterior lamps switch on (▷ page 109).



Locator lighting and night security illumination

The locator lighting and the night security illumination are described in the “Control system” section, see “Setting locator lighting” (▷ page 144) and “Setting night security illumination” (▷ page 144).

Fog lamps

Warning!





In low ambient lighting or foggy conditions, only switch from position **AUTO** to  with the vehicle at a standstill in a safe location. Switching from **AUTO** to  will briefly switch off the headlamps. Doing so while driving in low ambient lighting conditions may result in an accident.



i Fog lamps will operate with the parking lamps and/or low beam headlamps on. Fog lamps should only be used in conjunction with low beam headlamps. Consult your State or Province Motor Vehicle Regulations regarding allowable lamp operation.

i Fog lamps cannot be switched on with the exterior lamp switch in position **AUTO**. To switch on the fog lamps, turn the exterior lamp switch to position  first.

Front fog lamps

- ▶ Switch on the low beam headlamps  (▷ page 109).
- ▶ Pull out the exterior lamp switch to first stop.
The front fog lamps switch on.
The green indicator lamp  in the exterior lamp switch comes on (▷ page 109).
- ▶ Push in the exterior lamp switch.
The front fog lamps switch off.
The green indicator lamp  in the exterior lamp switch goes out.

Rear fog lamp (driver's side only)

- ▶ Switch on the low beam headlamps  (▷ page 112).
- ▶ Pull out the exterior lamp switch to second stop.
The front fog lamps and the rear fog lamp switch on.
The yellow indicator lamp  in the exterior lamp switch comes on (▷ page 109).
- ▶ Push in the exterior lamp switch to first stop.

The rear fog lamp switches off.

The yellow indicator lamp  in the exterior lamp switch goes out.

The front fog lamps remain lit.

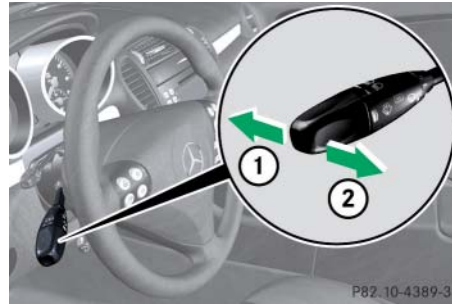
Combination switch

- ① High beam
- ② High beam flasher

High beam

- ▶ Turn the exterior lamp switch to position  (▷ page 109).
- ▶ Push the combination switch in direction of arrow ① to switch on the high beam.

The high beam headlamp indicator lamp  in the instrument cluster comes on (▷ page 26).

- ▶ Pull the combination switch in direction of arrow ② to its original position to switch off the high beam.

The high beam headlamp indicator lamp  in the instrument cluster goes out.

High beam flasher

- ▶ Pull the combination switch briefly in direction of arrow ②.

Lighting

Corner-illuminating front fog lamps*

i Corner-illuminating front fog lamps are not available for the following models:

- SLK 280 and SLK 350 without Bi-Xenon* headlamps
- SLK 280 and SLK 350 with Sport Package*
- SLK 55 AMG

The corner-illuminating front fog lamps improve illumination of the area in the direction into which you are turning.

The corner-illuminating front fog lamps will operate with the engine running and with

- the exterior lamp switch in position  (▷ page 109)
- or
- the exterior lamp switch in position **AUTO** (▷ page 109)
- or
- the daytime running lamp mode activated (▷ page 111)

i With automatic headlamp mode activated: Corner-illuminating front fog lamps will only come on in low ambient lighting conditions.

i If you are driving faster than 25 mph (40 km/h) or have the front fog lamps switched on, the corner-illuminating front fog lamps function is not available.

Driving forward

Switching on corner-illuminating front fog lamps

- ▶ Switch on the left or right turn signal (▷ page 55), depending on whether you are turning left or right.

The respective front fog lamp comes on and illuminates the area in the direction into which you are turning.

or

- ▶ Turn the steering wheel in the desired direction.

The front fog lamp on the side of your steering direction comes on.

i If you have switched on the turn signal for one side but turn the steering wheel in the opposite direction, the corner-illuminating front fog lamp the corner-illuminating lamp comes on for the side indicated by the turn signal.

The corner-illuminating front fog lamp remains lit for a maximum of 3 minutes. Afterwards, it goes out even if the turn signal is still switched on.

i The corner-illuminating front fog lamps temporarily come on on both sides of the vehicle if you turn the steering wheel in one direction and then again in the other direction shortly thereafter.

i The corner-illuminating front fog lamps will come on automatically depending on the steering angle, even if you did not switch on either turn signal.

If the corner-illuminating front fog lamps came on automatically, they will also go out automatically depending on the steering angle.

Switching off corner-illuminating front fog lamps

The combination switch for the turn signal resets automatically after major steering wheel movements. This will switch off the corner-illuminating front fog lamps if they were activated by switching on the left or right turn signal.

If the turn signal should stay on after making the turn, the turn signal and corner-illuminating front fog lamp can be switched off by returning the combination switch to its original position.

i There may be a brief delay before the corner-illuminating front fog lamps switch off.

Driving in reverse

Switching on corner-illuminating front fog lamps

- ▶ Place the gearshift lever (automatic transmission*: gear selector lever) in position **R**.

The front fog lamp opposite to your steering direction comes on.

Switching off corner-illuminating front fog lamps

- ▶ Place the gearshift lever (automatic transmission*: gear selector lever) out of position **R**.

The respective front fog lamp goes out.

Hazard warning flasher

The hazard warning flasher can be switched on at all times, even with the SmartKey removed from the starter switch.

The hazard warning flasher switches on automatically when an air bag deploys.

The hazard warning flasher switch is located on the upper part of the center console.



① Hazard warning flasher switch

Lighting

Switching on hazard warning flasher

- ▶ Press hazard warning flasher switch ①.

All turn signal lamps are flashing.

i With the hazard warning flasher activated and the combination switch set for either left or right turn, only the respective turn signals will operate when the ignition is switched on.

Switching off hazard warning flasher

- ▶ Press hazard warning flasher switch ① again.

i If the hazard warning flasher has been activated automatically, press hazard warning flasher switch ① once to switch it off.

Interior lighting

The controls are located in the overhead control panel.

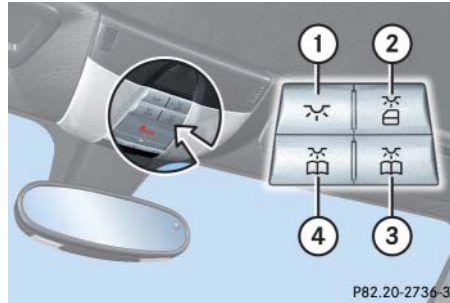

- ① Interior lighting on/off
- ② Automatic control on/off
- ③ Right reading lamp on/off
- ④ Left reading lamp on/off

! An interior lamp switched on manually does not go out automatically.

Leaving an interior lamp switch in the ON position for extended periods of time with the engine turned off could result in a discharged battery.

Automatic control

i The interior lighting is factory-set to automatic mode.

Deactivating

- ▶ Press automatic control switch ② until it engages at a deeper position than the other switches.

The interior lighting remains switched off in darkness, even when you

- unlock the vehicle
- remove the SmartKey from the starter switch
- open a door

i When you open the trunk, the trunk lighting switches on automatically.

Activating

- ▶ Press automatic control switch ② until it is flush to the other switches.

The interior lighting switches on in darkness, when you

- unlock the vehicle
- remove the SmartKey from the starter switch
- open a door

The interior lighting switches off automatically following a preset time delay.

For more information, see “Setting interior lighting delayed shut-off” (▷ page 145).

i *If the door remains open, the interior lighting switches off automatically after approximately 5 minutes.*

Manual control

Switching interior lighting on and off

- ▶ Press interior lighting switch ①.
The interior lighting switches on.
- ▶ Press interior lighting switch ① again.
The interior lighting switches off.

i *The footwell lighting* is switched on and off simultaneously with the manual control.*

Switching reading lamps on and off

The standard reading lamps are located to the left and right of the overhead control panel. Reading lamps as part of the interior lighting package* are located on the lower edge of the interior rear view mirror.

- ▶ Press reading lamp switch ③ or ④ to switch on the desired reading lamp.
- ▶ Press reading lamp switch ③ or ④ again to switch off the respective reading lamp.

Door entry lamps

For better orientation in the dark, the corresponding door entry lamps will switch on in darkness when you open a door and the automatic control is activated.

The door entry lamps switch off when the corresponding door is closed.

i *If you turn the SmartKey in the starter switch to position 0 and switch off the exterior headlamps, the door entry lamps will remain lit for approximately 5 minutes.*

Instrument cluster

A full view illustration of the instrument cluster can be found in the “At a glance” section (▷ page 26).

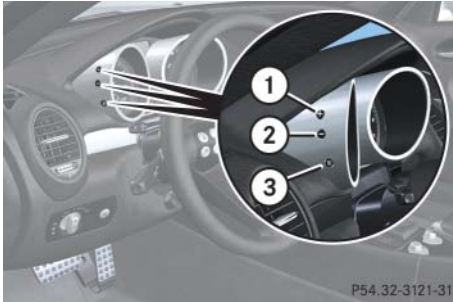

- ① To brighten instrument cluster illumination (knob +)
- ② To dim instrument cluster illumination (knob -)
- ③ Reset button **R**

The instrument cluster is activated when you

- open a door
- switch on the ignition (▷ page 37)
- press reset button **R**
- switch on the exterior lamps

i Opening a door or pressing the reset button **R** without switching on the ignition or the exterior lighting activates the multifunction display illumination only for 30 seconds.

For information on changing the instrument cluster settings, e.g. the language, see “Instrument cluster submenu” (▷ page 139).

Warning!



No messages will be displayed if either the instrument cluster or the multifunction display is inoperative.

As a result, you will not be able to see information about your driving conditions, such as speed or outside temperature, warning/indicator lamps, malfunction/warning messages or the failure of any systems. Driving characteristics may be impaired.

If you must continue to drive, do so with added caution. Contact an authorized Mercedes-Benz Center as soon as possible.

Adjusting instrument cluster illumination

Adjusting

Use knobs ① or ② to adjust the illumination brightness of the instrument cluster.

i The instrument cluster illumination automatically adjusts to the ambient light.

You can only adjust the brightness of the instrument cluster illumination when it is dark outside.

i With the exterior lighting switched on, the brightness of the switches in the center console will also be adjusted when using knob ① or ②.

To brighten illumination

- ▶ Press knob ① briefly.

The instrument cluster illumination brightens.

To dim illumination

- ▶ Press knob ② briefly.

The instrument cluster illumination dims.

Tachometer

The red marking on the tachometer (▷ page 26) denotes excessive engine speed.

! *Avoid driving at excessive engine speeds, as it may result in serious engine damage that is not covered by the Mercedes-Benz Limited Warranty.*

To help protect the engine, the fuel supply is interrupted if the engine is operated within the red marking.

Outside temperature indicator

Warning!



The outside temperature indicator is not designed to serve as an ice-warning device and is therefore unsuitable for that purpose.

Indicated temperatures just above the freezing point do not guarantee that the road surface is free of ice. The road may still be icy, especially in wooded areas or on bridges.



The outside temperature is displayed in the multifunction display (▷ page 128).

The temperature sensor is located in the front bumper area. Due to its location, the sensor can be affected by road or engine heat during idling or slow driving. Therefore, the accuracy of the displayed temperature can only be verified by comparison to a thermometer placed next the sensor, not by comparison to external displays, e.g. bank signs, etc.

When moving the vehicle into colder ambient temperatures (e.g. when leaving your garage), you will notice a delay before the lower temperature is displayed.

A delay also occurs when ambient temperatures rise. This prevents inaccurate temperature displays caused by heat radiated from the engine during idling or slow driving.

Resetting trip odometer

- ▶ Make sure you are viewing the standard display menu (▷ page 127).
- ▶ If it is not displayed, press button  or  repeatedly until the standard display appears in the multifunction display.
- ▶ Press and hold reset button  until the trip odometer is reset.

Clock

Vehicles with COMAND*:

The clock in the instrument cluster can be synchronized with the time set in COMAND using the time synchronization with head unit feature (▷ page 141), or set independently from COMAND using the control system (▷ page 141) with the time synchronization with head unit feature set to Off.

For setting the time in COMAND, see separate COMAND operating instructions.

For setting the time with audio system, (▷ page 141).

▼ Control system

The control system is activated as soon as the SmartKey in the starter switch is turned to position **1**. The control system enables you to

- call up information about your vehicle
- change vehicle settings

For example, you can use the control system to find out when your vehicle is next due for service, to set the language for messages in the instrument cluster display, and much more.

i *The displays for the audio systems (radio, CD player) will appear in English, regardless of the language selected.*

Warning!



A driver's attention to the road and traffic conditions must always be his/her primary focus when driving.

For your safety and the safety of others, selecting features through the multifunction steering wheel should only be done by the driver when traffic and road conditions permit it to be done safely.

Bear in mind that at a speed of just 30 mph (approximately 50 km/h), your vehicle is covering a distance of 44 feet (approximately 14 m) every second.

The control system relays information to the multifunction display.

Multifunction display



- ① Main odometer
- ② Trip odometer
- ③ Current program mode (automatic transmission* only)
- ④ Status indicator (outside temperature/digital speedometer)
- ⑤ Current gear selector lever position/gear range (automatic transmission* only)

Control system

Multifunction steering wheel

The displays in the multifunction display and the settings in the control system are controlled by the buttons on the multifunction steering wheel.



P46.10-2664-31

① Multifunction display

Operating the control system

② Selecting the submenu or setting the volume:

Press button

 up/to increase

 down/to decrease

③ Telephone*:

Press button

 to take a call
to dial
to redial

 to end a call
to reject an incoming call

④ Moving within a menu:

Press button

 for next display

 for previous display

⑤ Menu systems:

Press button

 for next menu





 for previous menu

Depending on the selected menu, pressing the buttons on the multifunction steering wheel will alter what appears in the multifunction display.

The information available in the multifunction display are arranged in menus, each containing a number of functions or sub-menus.

The individual functions are then found within the relevant menu (radio or CD operations under *Audio*, for example). These functions serve to call up relevant information or to customize the settings for your vehicle.

It is helpful to think of the menus, and the functions within each menu, as being arranged in a circular pattern.

- If you press button  or  repeatedly, you will pass through each menu one after the other.
- If you press button  or  repeatedly, you will pass through each function display, one after the other, in the current menu.

In the *Settings...* menu, you will find a number of submenus instead of functions for calling up and changing settings. For instructions on using these submenus, see “Settings menu” (▷ page 136).

The number of menus available in the system depends on which optional equipment is installed in your vehicle.

 *The headings used in the menu table are designed to facilitate navigation within the system and are not necessarily identical to those shown in the control system displays.*

The first function displayed in each menu will automatically show you which part of the system you are in.

 **SLK 55 AMG:**

The steering wheel in this vehicle will vary from steering wheel shown. However, multifunction steering wheel symbols and feature description apply to AMG vehicles as well.

Control system

Menus

This is what you will see when you scroll through the menus.

The table below provides an overview of the individual menus.

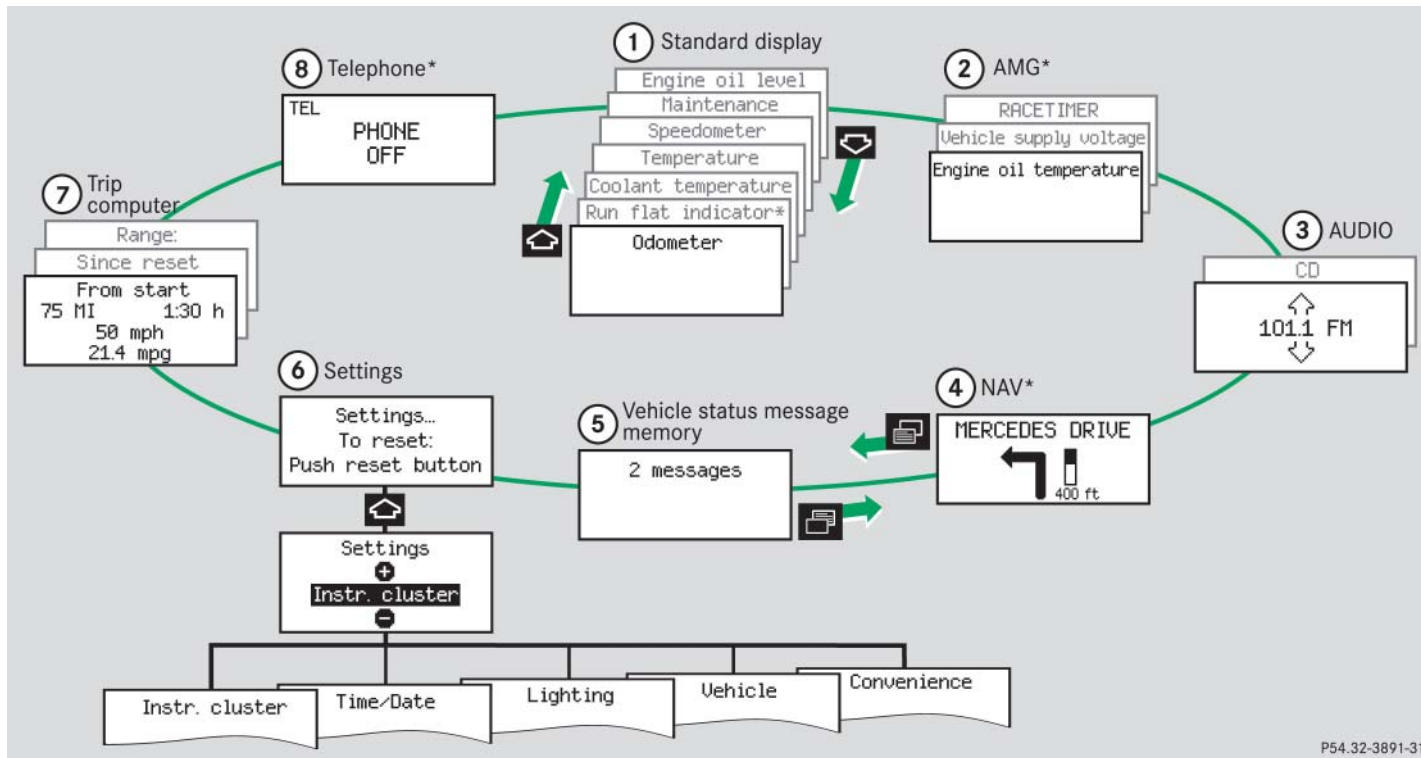

P54.32-3891-31

Menus, submenus and functions

	Menu ① Standard display (▷ page 127)	Menu ② AMG ¹ (▷ page 128)	Menu ③ AUDIO (▷ page 133)	Menu ④ NAV* (▷ page 135)
Commands/submenus	Run Flat Indicator*	Engine oil temperature	Selecting radio station	Show route guidance instructions, current direction traveled
	Checking coolant temperature	Vehicle supply voltage	Selecting satellite radio station* (USA only)	
	Digital speedometer/outside temperature	RACETIMER	Operating the CD player	
	Calling up maintenance service indicator	Overall analysis		
	Checking engine oil level (SLK 55 AMG only)	Lap analysis		

¹ AMG vehicles only.

Table continued on next page.

Control system

Menus, submenus and functions

	Menu ⑤ Vehicle status message memory¹ (▷ page 135)	Menu ⑥ Settings (▷ page 136)	Menu ⑦ Trip computer (▷ page 148)	Menu ⑧ TEL* (▷ page 149)
Commands/submenus	Calling up vehicle malfunction, warning and system status messages stored in memory	Resetting to factory settings Instrument cluster submenu Time/Date submenu Lighting submenu Vehicle submenu Convenience* submenu	Fuel consumption statistics since start Fuel consumption statistics since last reset Resetting fuel consumption statistics Distance to empty	Loading phone book Searching for name in phone book Redialing

¹ The vehicle status message memory menu is only displayed if there is a message stored.



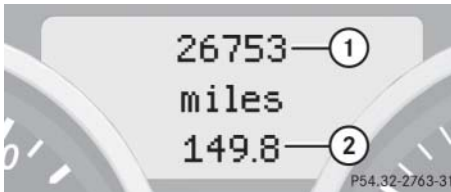

Standard display menu

The multifunction display shows the main odometer and trip odometer. This default setting is referred to as the standard display.



- ① Main odometer
- ② Trip odometer

If another display is shown instead of the standard display:

- ▶ Press button  or  repeatedly until the standard display appears in the multifunction display.
- ▶ Press button  or  to select the functions in the standard display menu.

The following functions are available:

Function	Page
Run Flat Indicator*	315
Checking coolant temperature	127
Displaying digital speedometer or outside temperature	128
Calling up maintenance service indicator	334
Checking engine oil level (SLK 55 AMG only)	296

Checking coolant temperature

Warning!



- Driving when your engine is overheated can cause some fluids which may have leaked into the engine compartment to catch fire. You could be seriously burned.
- Steam from an overheated engine can cause serious burns and can occur just by opening the hood. Stay away from the engine if you see or hear steam coming from it.



Stop the vehicle in a safe location away from other traffic. Turn off the engine, get out of the vehicle and do not stand near the vehicle until the engine has cooled down.

Control system

! Excessive coolant temperature triggers a warning message in the multifunction display (▷ page 368).



The engine should not be operated with a coolant temperature above 248°F (120°C). Doing so may cause serious engine damage which is not covered by the Mercedes-Benz Limited Warranty.

i During severe operating conditions, e.g. stop-and-go city traffic, the coolant temperature may rise close to 248°F (120°C).

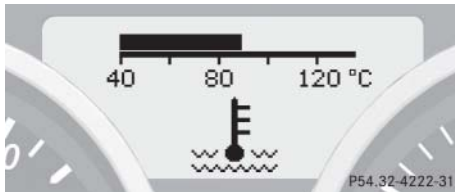
▶ When in the standard display menu, press button  or  repeatedly until the coolant temperature appears in the multifunction display.



Displaying digital speedometer or outside temperature

▶ Press button  or  repeatedly until the digital speedometer appears in the multifunction display.

The current vehicle speed or the outside temperature is appears in the multifunction display.

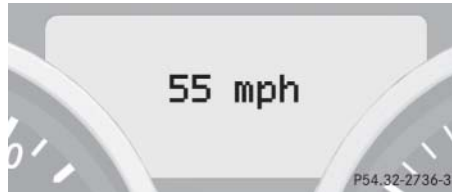



Example illustration for selected vehicle speed

i You can select to either display the digital speedometer or the outside temperature indicator (▷ page 140).

AMG menu

i This function is only available in AMG vehicles.



The main screen of the AMG menu shows you the gear currently engaged as well as the engine oil temperature.

▶ Press button  or  repeatedly until the AMG menu appears in the multifunction display.



- ① Gear indicator
- ② Engine oil temperature



i The engine oil temperature symbol flashes if the engine oil temperature has not yet reached 80°C. During this time, avoid driving at full engine speed.

- ▶ Use buttons  or  to select the following functions in the AMG menu:

Function	Page
Vehicle supply voltage	129
RACETIMER	129
Overall analysis	132
Lap analysis	132

i If the engine reaches the overspeed range in the manual shift program (▷ page 165), the menu will be shown in red. In addition, you will see **UP** next to gear indicator ① as a reminder to upshift.

Vehicle supply voltage

- ▶ Press button  or  repeatedly until you see the AMG menu.
- ▶ Press button  repeatedly until the vehicle supply voltage appears in the multifunction display.



- ① Gear indicator
- ② Vehicle supply voltage



RACETIMER

Warning!



The RACETIMER feature is only for use on roads and in conditions where high speed driving is permitted. Racing on public roads is prohibited under all circumstances and the driver is and must always remain responsible for following posted speed limits.

The RACETIMER allows you to time and save driving stretches in hours, minutes and seconds.

- ▶ Press button  or  repeatedly until the AMG menu appears in the multifunction display.



Control system

- ▷▷ Press button  repeatedly until the RACETIMER appears in the multifunction display.

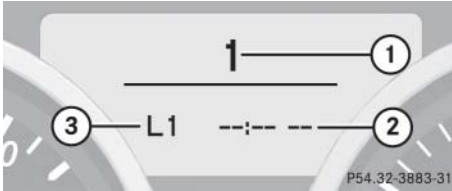

- ① Gear indicator
- ② RACETIMER
- ③ Lap number

i You can start the RACETIMER when the engine is running or the starter switch is in position **2** (▷ page 37).

i While the RACETIMER is being displayed, you cannot adjust the audio volume using buttons **+** or **-**.

Starting the RACETIMER

- ▶ Press button **+**.
- The timer starts.

Displaying intermediate time

- ▶ Press button **-** while the timer is running.
- The intermediate time is shown for 5 seconds.

Stopping the RACETIMER

- ▶ Press button **+**.
- The timer stops.

i When you stop the vehicle and turn the SmartKey to position **1** (▷ page 37), the RACETIMER stops timing. Timing is resumed when you switch the ignition back on (▷ page 37) or restart the engine (▷ page 51) and then press the **+** button.

Saving lap time and starting a new lap

i You can save up to nine laps.

- ▶ Press button **—** while the timer is running.

The intermediate time will be shown for 5 seconds.

- ▶ Press button **—** within 5 seconds.

The intermediate time shown will be saved as a lap time.

The RACETIMER begins timing the new lap. The new lap begins to be timed as soon as the intermediate time is called up.

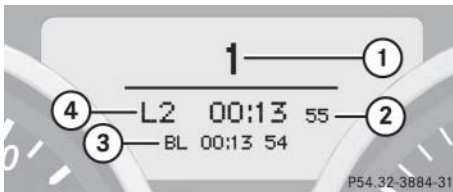

- ① Gear indicator
- ② RACETIMER
- ③ Best lap time
- ④ Lap number

Resetting current lap

- ▶ Press button **+** while the timer is running.

The timer stops.

- ▶ Press button **—**.

The lap time is reset to “0”.

Deleting all laps

i It is not possible to delete a single saved lap.

- ▶ Press button **+** while the timer is running.

The timer stops.

- ▶ Press the reset button twice (▷ page 26).

- ▶ Press button **+**.



The timer starts. The saved laps are deleted.

i When you turn off the engine, the RACETIMER will be reset to “0” after 30 seconds. All laps are deleted.

Control system

Overall analysis

i These functions are only available if you have saved at least one lap and have stopped the RACETIMER.

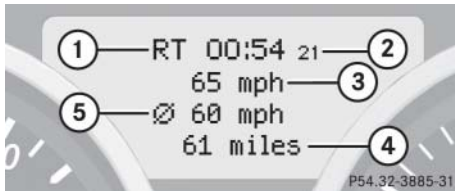

- ▶ Press button  or  repeatedly until the AMG menu appears in the multifunction display.
- ▶ Press button  repeatedly until the overall analysis appears in the multifunction display.



- ① Overall analysis of RACETIMER
- ② Overall driving time
- ③ Maximum speed
- ④ Overall distance driven
- ⑤ Average speed

Lap analysis

i These functions are only available if you have saved at least two laps and have stopped the RACETIMER.

- ▶ Press button  or  repeatedly until the AMG menu appears in the multifunction display.
- ▶ Press button  repeatedly until the lap analysis appears in the multifunction display.

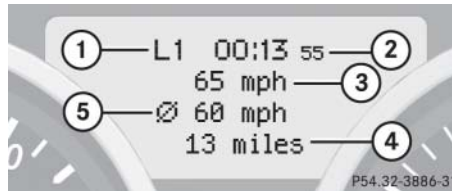

- ① Lap number
- ② Lap time
- ③ Maximum speed
- ④ Lap length
- ⑤ Average speed during lap

- ▶ Press button  or  to see other lap analyses.

i Each lap is shown in its own submenu. The fastest lap is indicated by flashing symbol ①.

AUDIO menu

The functions in the AUDIO menu operate the audio equipment which you currently have turned on.

If no audio equipment is currently switched on, the message **AUDIO off** appears in the multifunction display.



The following functions are available:

Function	Page
Selecting radio station	133
Selecting satellite radio station* (USA only)	134
Operating the CD player	134

Selecting radio station

- ▶ Switch on the radio (▷ page 199).

Vehicles with COMAND*:
Refer to the separate operating instructions.

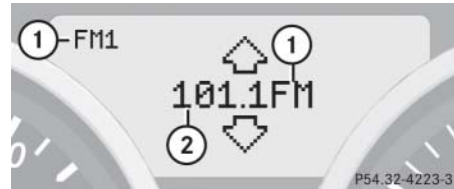

- ▶ Press button  or  repeatedly until the currently tuned station appears in the multifunction display.



- ① Waveband setting or stored memory position (FM1 through FM9)
- ② Tuned station

- ▶ Press button  or  repeatedly until the desired station is found.

The station search depends on the selected setting in the **Vehicle** submenu of the control system (▷ page 146).

Pressing button  or  will either start a frequency scan or select the next stored radio station.

- i** You can only store new stations using the corresponding feature on the radio (▷ page 201).

Vehicles with COMAND*:
Refer to the separate operating instructions.

Control system



Selecting satellite radio station* (USA only)

The Sirius satellite radio is treated as a radio application.

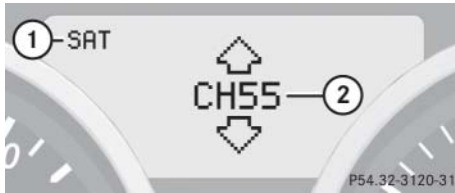
- ▶ Select satellite radio with the corresponding soft key (SAT) in the radio menu.



- ① SAT mode and preset number
- ② Channel name or number

- ▶ Press button  or  repeatedly until the desired channel is found.

i For more information on satellite radio operation, see "Introduction to satellite radio* (USA only)" (▷ page 203).

Vehicles with COMAND*:



Refer to separate operating instructions.

Operating the CD player

- ▶ Switch on the radio and select the CD player (▷ page 212).

Vehicles with COMAND*:

Refer to the separate operating instructions.

- ▶ Press button  or  repeatedly until the settings for the CD currently being played appear in the multifunction display.





- ① Current CD (CD0 for single CD drive in head unit, CD1 through CD6 for CD in CD changer*)
- ② Current track

- ▶ Press button  or  repeatedly until the desired track is selected.

i To select a CD from the magazine, press a number on the audio system or the COMAND* system key pad located in the center dashboard.

NAV* menu

The NAV menu contains the functions needed to operate your navigation system.

- ▶ Press button  or  repeatedly until you see the message NAV in the multifunction display.
 - If the COMAND* system is switched off, the message NAV off appears in the multifunction display.
 - With COMAND* switched on but route guidance not activated, the direction of travel and, if available, the name of the street currently traveled on appear in the multifunction display.
 - With COMAND* switched on and route guidance activated, the direction of travel and maneuver instructions appear in the multifunction display.

Please refer to the COMAND* manual for instructions on how to activate the route guidance system.

Vehicle status message memory menu

Use the vehicle status message memory menu to scan malfunction and warning messages that may be stored in the system. Such messages appear in the multifunction display and are based on conditions or system status the vehicle's system has recorded.



The vehicle status message memory menu only appears if there are any messages stored in the system.

Warning!



Malfunction and warning messages are only indicated for certain systems and are intentionally not very detailed. The malfunction and warning messages are simply a reminder with respect to the operation of certain systems and do not replace the owner's

and/or driver's responsibility to maintain the vehicle's operating safety by having all required maintenance and safety checks performed on the vehicle and by bringing the vehicle to an authorized Mercedes-Benz Center to address the malfunction and warning messages (▷ page 356).

- ▶ Press button  or  repeatedly until the vehicle status message memory menu appears in the multifunction display.



If the vehicle status message memory menu does not appear, no messages have been stored. ▷▷

Control system

- ▷▷ If conditions have occurred causing status messages to be recorded, the number of messages appears in the multifunction display:



① Number of recorded status messages

- ▶ Press button  or .

The stored messages will now be displayed in the order in which they have occurred. For malfunction and warning messages, see “Vehicle status messages in the multifunction display” (▷ page 356).



Should the vehicle’s system record any conditions while driving, the number of messages will reappear in the multifunction display when the SmartKey in the starter switch is turned to position **0** or removed from the starter switch:

i The vehicle status message memory will be cleared when you turn the SmartKey in the starter switch to position **1** or **2**.

You will then only see high-priority messages in the multifunction display (▷ page 356).

Settings menu

In the Settings... menu are two functions:

- The function To reset: Push reset button for 3 seconds for resetting all settings to factory standard.
 - A collection of submenus for performing individual settings for your vehicle.
- ▶ Press button  or  repeatedly until the Settings... menu appears in the multifunction display.





The following settings and submenus are available in the Settings... menu:

Function	Page
Resetting all settings	136
Submenus in the Settings menu	137
Instrument cluster submenu	139
Time/date submenu	139
Lighting submenu	143
Vehicle submenu	146
Convenience* submenu	147

Resetting all settings

You can reset all the functions of most of the submenus to the factory settings.

For safety reasons, the function Headlamp mode in the Lighting submenu cannot be reset while driving.

- ▶ Press button  or  repeatedly until the Settings... menu appears in the multifunction display.

- ▶ Press the reset button **R** on the instrument cluster (▷ page 26) for approximately 3 seconds.

The request to press the reset button **R** once more to confirm appears in the multifunction display.

- ▶ Press the reset button **R** once more.

The functions of all submenus will be reset to the factory settings.

The message **Reset to factory settings** appears in the multifunction display.

- i** *Your individual settings will not be reset unless you confirm the action by pressing the reset button **R** again. After 5 seconds the Settings... menu reappears in the multifunction display.*

Submenus in the Settings menu

- ▶ Press button **☰** or **☷** repeatedly until the Settings... menu appears in the multifunction display.

- ▶ Press button **△**.

In the multifunction display you see the collection of the submenus. There are more submenus than can be simultaneously displayed.



- ▶ Press button **—**.

The selection marker moves to the next submenu.

- ▶ Scroll up with button **+**, and scroll down with button **—**.

- ▶ With the selection marker on the desired submenu, use the **△** button to access the individual functions within that submenu.
- ▶ Once within the submenu, use the **△** button to move to the next function or the **▽** button to move to the previous function within that submenu.
- ▶ Use buttons **+** or **—** to change the settings of the respective function.

Control system

The table below shows what settings can be changed within the various submenus.

Detailed instructions on making individual settings can be found on the following pages.

Instrument cluster (▷ page 139)	Time/Date (▷ page 141)	Lighting (▷ page 143)	Vehicle (▷ page 146)	Convenience* (▷ page 147)
Selecting digital speedometer display mode	Synchronizing time and date with head unit*	Setting daytime running lamp mode (USA only)	Selecting audio search function	Activating easy-entry/exit feature*
Selecting language	Setting the time	Setting locator lighting	Setting automatic locking	
Selecting display (speed display or outside temperature) for status indicator	Setting the date	Setting night security illumination		
		Setting interior lighting delayed shut-off		

Instrument cluster submenu

Access the Instr. cluster submenu via the Settings... menu. Use the Instr. cluster submenu to change the instrument cluster display settings.

The following functions are available:

Function	Page
Selecting speedometer display mode	139
Selecting language	139
Selecting display (speed display or outside temperature) for status indicator	140

Selecting digital speedometer display mode

- ▶ Move the selection marker with button **+** or **-** to the Instr. cluster submenu.
- ▶ Press button **▲** or **▼** repeatedly until the message **Display unit Digital speedometer** appears in the multifunction display.

The selection marker is on the current setting.



- ▶ Press button **+** or **-** to set the speedometer unit to km or miles.

Selecting language

- ▶ Move the selection marker with button **+** or **-** to the Instr. cluster submenu.
- ▶ Press button **▲** or **▼** repeatedly until the message **Language** appears in the multifunction display.

The selection marker is on the current setting.



- ▶ Press button **+** or **-** to select the desired language to be used for the multifunction display messages.

Control system

Available languages:

- German
- English
- French
- Italian
- Spanish
- Dutch
- Danish
- Swedish
- Portuguese
- Turkish

Selecting display (speed display or outside temperature) for status indicator

- ▶ Move the selection marker with button **+** or **-** to the Instr. cluster submenu.
- ▶ Press button **▲** or **▼** repeatedly until the message *Select display* appears in the multifunction display. The selection marker is on the current setting.



- ▶ Press button **+** or **-** to select the desired setting.

The selected display is then shown continuously in the lower display.

The other display now appears in the menu of the standard display:

- Digital speedometer
or
- Outside temperature

Time/Date submenu

Access the Time/Date submenu via the Settings... menu. Use the Time/Date submenu to change the instrument cluster display settings.

The following functions are available:

Function	Page
Time and date synchronization with head unit*	141
Setting the time	141
Setting the date	142

Time and date synchronization with head unit*

This function is only available in vehicles with COMAND* and navigation module*.

- ▶ Move the selection marker with button **+** or **-** to the Time/Date submenu.
- ▶ Press button **▲** or **▼** repeatedly until the message Time synchronization with Head Unit appears in the multifunction display.

The selection marker is on the current setting.

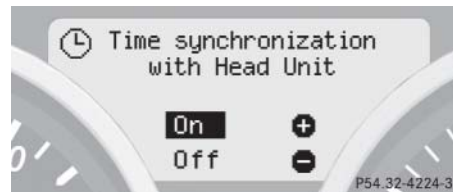

- ▶ Press button **+** or **-** to select the desired setting.

Setting the time

This function is only available in vehicles with audio system, or in vehicles with COMAND* and navigation module*, if the time and date synchronization with head unit* feature was set to Off (> page 141).

i *Vehicles with COMAND*:*
For information on setting the time in COMAND, refer to the separate COMAND operating instructions.

Control system

- ▶ Move the selection marker with button **+** or **-** to the Time/Date submenu.
- ▶ Press button **↶** or **↷** repeatedly until the message Time, hours Press R to confirm or Time, minute(s) Press R to confirm appears in the multifunction display.

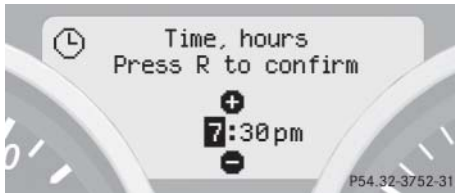

Example illustration for setting the hour

- ▶ Press button **+** or **-** to set the hours or minute(s).
- ▶ Press reset button **R** to confirm.

Setting the date

This function is only available in vehicles with audio system, or in vehicles with COMAND* and navigation module*, if the time and date synchronization with head unit* feature was set to Off (▷ page 141).

i *Vehicles with COMAND*:*
For information on setting the time in COMAND, refer to the separate COMAND operating instructions.

- ▶ Move the selection marker with button **+** or **-** to the Time/Date submenu.
- ▶ Press button **↶** or **↷** repeatedly until the message Set date Month, Set date Day, or Set date Year appears in the multifunction display.



Example illustration for setting the month

- ▶ Press button **+** or **-** to set the month, day, or year.

Lighting submenu

Access the Lighting submenu via the Settings... menu. Use the Lighting submenu to change the lamp and lighting settings on your vehicle.

The following functions are available:

Function	Page
Setting daytime running lamp mode (USA only)	143
Setting locator lighting	144
Setting night security illumination	144
Setting interior lighting delayed shut-off	145

Setting daytime running lamp mode (USA only)

i This function is not available in countries where the daytime running lamp mode is mandatory and therefore in a constant mode.

- ▶ Move the selection marker with button **+** or **-** to the Lighting submenu.
- ▶ Press button **▲** or **▼** repeatedly until the message **Headlamp mode** appears in the multifunction display.

The selection marker is on the current setting.

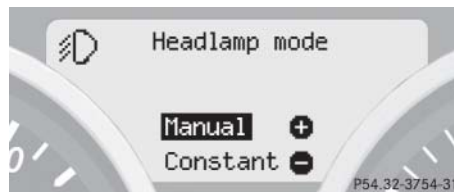

- ▶ Press button **+** or **-** to select manual operation (Manual) or daytime running lamp mode (Constant).

With daytime running lamp mode activated and the exterior lamp switch at position **0** or **AUTO**, the low beam headlamps are switched on when the engine is running.

In low ambient light conditions the following lamps will switch on additionally:

- Parking lamps
- Tail lamps
- License plate lamps
- Side marker lamps

For more information on the daytime running lamp mode, see "Lighting" (▷ page 109).

i For safety reasons, resetting all the functions of all submenus to the factory settings while driving (▷ page 136) will not deactivate the daytime running lamp mode.

The following message appears in the multifunction display:

Lighting Cannot be completely reset to factory settings while driving.

Control system

Setting locator lighting

With the locator lighting feature activated and the exterior lamp switch in position **AUTO**, the following lamps will switch on during darkness when the vehicle is unlocked with the SmartKey:

- Parking lamps
- Tail lamps
- License plate lamps
- Side marker lamps
- Front fog lamps

The locator lighting switches off when the driver's door is opened.

If you do not open a door after unlocking the vehicle with the SmartKey, the lamps will switch off automatically after approximately 40 seconds.

- ▶ Move the selection marker with button **+** or **-** to the Lighting submenu.
- ▶ Press button **▲** or **▼** repeatedly until the message **Function Surround lighting** appears in the multifunction display.

The selection marker is on the current setting.



- ▶ Press button **+** or **-** to switch the locator lighting function **On** or **Off**.
- ▶ Turn the exterior lamp switch to position **AUTO** when exiting the vehicle (▷ page 55).

The locator lighting feature is activated.

Setting night security illumination (Headlamps delayed shut-off)

Use this function to set whether you would like the exterior lamps to remain on for 15 seconds during darkness after exiting the vehicle and closing all doors.

With the headlamps delayed shut-off feature activated and the exterior lamp switch in position **AUTO** before the engine is turned off, the following lamps will switch on when the engine is turned off:

- Parking lamps
- Tail lamps
- License plate lamps
- Side marker lamps
- Front fog lamps

If after turning off the engine you do not open a door or do not close an opened door, the lamps will automatically switch off after 60 seconds.

▶ Move the selection marker with button **+** or **-** to the **Lighting** submenu.

▶ Press button **▲** or **▼** repeatedly until the message **Headlamps delayed shut-off** appears in the multifunction display.

The selection marker is on the current setting.



▶ Press button **+** or **-** to switch the headlamps delayed shut-off feature **On** or **Off**.

▶ Turn the exterior lamp switch to position **AUTO** before turning off the engine (▶ page 55).

The headlamps delayed shut-off feature is activated.

You can temporarily deactivate the delayed shut-off feature:

▶ Before exiting the vehicle, turn the SmartKey in the starter switch to position **0**.

▶ Then turn it to position **2** and back to position **0**.

The delayed shut-off feature is deactivated. It will reactivate as soon as you reinsert the SmartKey in the starter switch.

Setting interior lighting delayed shut-off

Use this function to set whether you would like the interior lighting to remain on for 10 seconds during darkness after you have removed the SmartKey from the starter switch.

▶ Move the selection marker with button **+** or **-** to the **Lighting** submenu.

▶ Press button **▲** or **▼** repeatedly until the message **Interior lighting delayed shut-off** appears in the multifunction display.

The selection marker is on the current setting.



▶ Press button **+** or **-** to switch the interior delayed shut-off feature **On** or **Off**.

Control system

Vehicle submenu

Access the **Vehicle** submenu via the **Settings...** menu. Use the **Vehicle** submenu to make general vehicle settings.

The following functions are available:

Function	Page
Selecting audio search function	146
Setting automatic locking	146

For additional information on central locking, see “Automatic central locking” (▷ page 102).

Selecting audio search function

Use of the **Audio search** function to select a radio station (▷ page 133) will enable you to start a frequency scan (**Frequency**) or select a radio station stored in memory (**Memory**).

- ▶ Move the selection marker with button **+** or **-** to the **Vehicle** submenu.
- ▶ Press button **▲** or **▼** repeatedly until the message **Audio Search** function appears in the multifunction display.

The selection marker is on the current setting.



- ▶ Press button **+** or **-** to select **Frequency** or **Memory**.

Setting automatic locking

Use this function to activate or deactivate the automatic locking system. With the automatic locking system activated, the vehicle is centrally locked at vehicle speeds of approximately 9 mph (15 km/h).

- ▶ Move the selection marker with button **+** or **-** to the **Vehicle** submenu.
- ▶ Press button **▲** or **▼** repeatedly until the message **Automatic door lock** appears in the multifunction display.

The selection marker is on the current setting.

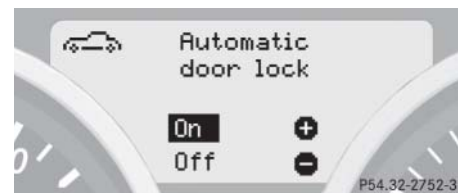

- ▶ Press button **+** or **-** to set the automatic central locking to **On** or **Off**.

Convenience* submenu

Access the Convenience submenu via the Settings... menu. Use the Convenience submenu to change the settings for a number of convenience features.

The following function is available:

Function	Page
Activating easy-entry/exit feature*	147

Activating easy-entry/exit feature*

Use this function to activate and deactivate the easy-entry/exit feature (▷ page 44).

Warning!



You must make sure no one can become trapped or injured by the moving steering wheel when the easy-entry/exit feature is activated.

To cancel steering wheel movement, do one of the following:

- Move steering wheel adjustment stalk* (▷ page 44).
- Press one of the memory position buttons* or the memory button **M*** (▷ page 107).

Do not leave children unattended in the vehicle, or with access to an unlocked vehicle. Children could open the driver's door and unintentionally activate the easy-entry/exit feature, which could result in an accident and/or serious personal injury.

- ▶ Move the selection marker with button **+** or **-** to the Convenience submenu.
- ▶ Press button **↶** or **↷** repeatedly until the message Easy-entry function appears in the multifunction display.

The selection marker is on the current setting.



- ▶ Press button **+** or **-** to switch the easy-entry function On or Off.

Control system



Trip computer menu

Use the trip computer menu to call up statistical data on your vehicle.

The following information is available:

Function	Page
Fuel consumption statistics since start	148
Fuel consumption statistics since last reset	148
Resetting fuel consumption statistics	149
Calling up range (distance to empty)	149

Fuel consumption statistics since start

- ▶ Press button  or  repeatedly until the message **From start** appears in the multifunction display.

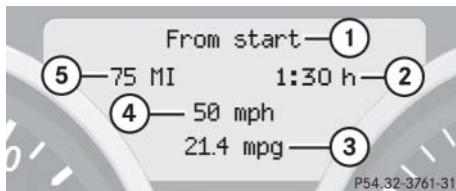





- ① Statistics called up: since start
- ② Time elapsed since start
- ③ Average fuel consumption since start
- ④ Average speed since start
- ⑤ Distance driven since start

i All statistics stored since the last engine start will be reset approximately four hours after the SmartKey in the starter switch is turned to position **0** or removed from the starter switch.

Resetting will not occur if you turn the SmartKey back to position **1** or **2** within this time period.

Fuel consumption since last reset

- ▶ Press button  or  repeatedly until the message **From start** appears in the multifunction display.
- ▶ Press button  or  repeatedly until the message **Since reset** appears in the multifunction display.

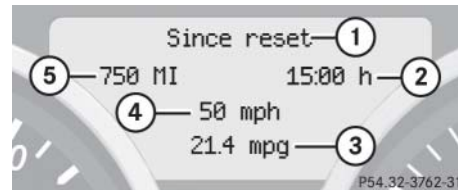

- ① Statistics called up: since last reset
- ② Time elapsed since last reset
- ③ Average fuel consumption since last reset
- ④ Average speed since last reset
- ⑤ Distance driven since last reset





Resetting fuel consumption statistics

- ▶ Press and hold reset button **R** until the values of the statistics are reset to 0.

i The fuel consumption statistics reset automatically to 0 when either of the following values is exceeded:

- distance covered: 100 000 miles (100 000 km)
- time elapsed: 10 000 hours

Calling up range (distance to empty)

- ▶ Press button  or  repeatedly until the message **From start** appears in the multifunction display.
- ▶ Press button  or  repeatedly until the message **Range:** appears in the multifunction display.

The calculated remaining driving range based on the current fuel tank level appears in the multifunction display.

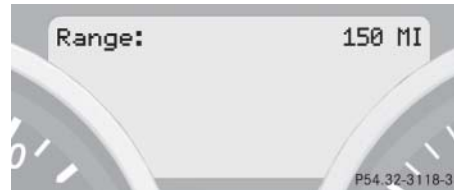

i If only very little fuel is left in the tank, a vehicle at the fuel pump is shown instead of the range.

TEL* menu

Warning!



A driver's attention to the road must always be his/her primary focus when driving. For your safety and the safety of others, we recommend that you pull over to a safe location and stop before placing or taking a telephone call. If you choose to use the telephone while driving, please use the hands-free device and only use the telephone when weather, road, and traffic conditions permit.



Some jurisdictions prohibit the driver from using a cellular telephone while driving a vehicle.

Bear in mind that at a speed of just 30 mph (approximately 50 km/h), your vehicle is covering a distance of 44 feet (approximately 14 m) every second. ▷▷

Control system

- ▷▷ Never operate radio transmitters equipped with a built-in or attached antenna (i.e. without being connected to an external antenna) from inside the vehicle while the engine is running. Doing so could lead to a malfunction of the vehicle's electronic system, possibly resulting in an accident and/or personal injury.

You can use the functions in the TEL menu to operate your telephone, provided it is connected to a hands-free system and switched on.

- ▶ Switch on the telephone and Audio or COMAND*.
See separate operating instructions.
- ▶ Press button  or  repeatedly until the TEL menu appears in the multifunction display.

Which messages will appear in the multifunction display depends on whether your telephone is switched on or off:

- If the telephone is switched off, the message in the multifunction display is: PHONE OFF.
- If the telephone is switched on:

The telephone will then search for a network. During this time the multifunction display is empty.

As soon as the telephone has found a network, Ready is indicated in the multifunction display.

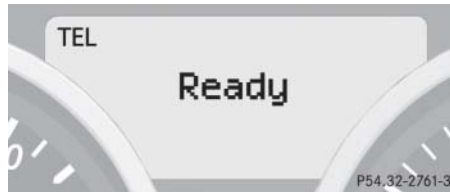

This standby message indicates that your telephone is ready for use and you can operate it using the control system.

Answering a call

When your telephone is ready to receive calls, you can answer a call at any time. In the multifunction display you will see the message, or if available, the caller ID (name and number):

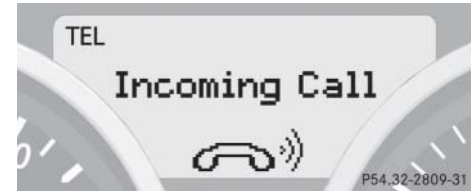

Audio system



COMAND*

- ▶ Press button .

You have answered the call.





The duration of the call appears in the multifunction display.

Ending a call or rejecting an incoming call

- ▶ Press button .



Dialing a number from the phone book

If your telephone is ready to receive calls, you may select and dial a number from the phone book at any time.

- ▶ Press button  or  repeatedly until the TEL menu and the standby message appear in the multifunction display.
- ▶ Press button  or .

The control system reads the phone book which is stored in the telephone. This may take up to 30 seconds. In the multifunction display you will see the message `Please wait`.



When the message `Please wait` disappears, the phone book has been loaded.

- ▶ Press button  or  repeatedly until the desired name appears in the multifunction display.

The stored names are displayed in ascending or descending alphabetical order.



① Selected name from phone book

i If you press and hold button  or  for longer than 1 second, the system scrolls rapidly through the list of names until you release the button again.

Cancel the quick search mode by pressing button .

- ▶ Press button .

The control system dials the selected phone number.

- If the connection is successful, the name of the party you called and the duration of the call will appear in the display.



- If no connection is made, the control system stores the dialed number in the redial memory.



or

- ▶ Cancel the call you have intended to make by pressing button .

Control system



Redialing

The control system stores the most recently dialed phone numbers. This eliminates the need to search through your entire phone book.

- ▶ Press button  or  repeatedly until the TEL menu and the standby message appear in the multifunction display.
- ▶ Press button .

In the multifunction display you will see the first number in the redial memory.



- ▶ Press button  or  repeatedly until the desired number or name appears in the multifunction display.
- ▶ Press button .

The control system dials the selected phone number.

If the connection is successful, the duration of the call will appear in the multifunction display, and

- the name of the party if stored in the phone book
- or
- instead of it the dialed number

or

- ▶ Cancel the call you have intended to make by pressing button .

▼ Manual transmission

Manual transmission is standard equipment on select models and not available on all models.

For information on driving with a manual transmission, see “Manual transmission” (▷ page 51).

Warning!



For vehicles equipped with a manual transmission, getting out of your vehicle with the gearshift lever not engaged in first or reverse gear and the parking brake not engaged is dangerous.

Also, when parked on an incline, an engaged first or reverse gear alone may not prevent your vehicle from moving, possibly hitting people or objects.

Always set the parking brake in addition to engaging first or reverse gear (▷ page 59).

When parked on an incline, turn front wheels towards the road curb.

Do not park this vehicle in areas where combustible materials such as grass, hay or leaves can come into contact with the hot exhaust system, as these materials could be ignited and cause a vehicle fire.

Warning!



When leaving the vehicle, always remove the SmartKey from the starter switch, take it with you, and lock the vehicle. Do not leave children unattended in the vehicle, or with access to an unlocked vehicle. Children could move the gearshift lever, which could result in an accident and/or serious personal injury.

Warning!



On slippery road surfaces, never downshift in order to obtain braking action.

This could result in drive wheel slip and reduced vehicle control. Your vehicle's ABS will not prevent this type of loss of control.

Manual transmission

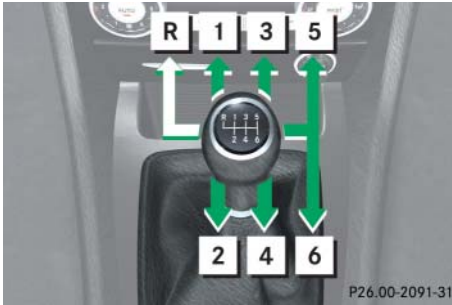

Gearshift pattern for manual transmission

! When you are shifting into the **5th** or **6th** gear, make sure that you press the gearshift lever to the right. Otherwise, you could accidentally shift into the **3rd** or **4th** gear and damage the transmission.

Downshifting gears leading to overrevving the engine can result in engine damage that is not covered by the Mercedes-Benz Limited Warranty.

Never hold the vehicle stopped on a hill by using the clutch pedal. The clutch may be damaged which is not covered by the Mercedes-Benz Limited Warranty.

Do not exceed the engine speed limits. Refer to tachometer (▷ page 119) for engine speeds.

Shifting into reverse

! Only shift into reverse gear **R** when the vehicle is stationary, as the transmission could otherwise be damaged.

- ▶ Stop the vehicle completely.
- ▶ Fully depress the clutch pedal.
- ▶ Move the gearshift lever to the neutral position (no gear selected).
- ▶ Move the gearshift lever to the left until you feel a certain resistance.
- ▶ Push the gearshift lever past this resistance.
- ▶ Then move the gearshift lever forward into position **R**.

▼ Automatic transmission*

For more information on driving with an automatic transmission, see “Automatic transmission*” (▷ page 52).

Your vehicle’s transmission adapts its gear shifting process to your individual driving style by continually adjusting the shift points up or down. These shift point adjustments are performed based on current operating and driving conditions.

If the operating conditions change, the automatic transmission reacts by adjusting its shift program.

i During the brief warm-up, transmission upshifting is delayed. This allows the catalytic converter to heat up more quickly to operating temperature.

Warning!



Make sure that absolutely no objects are obstructing the pedals’ range of movement. Keep the driver’s footwell clear of all obstacles. If there are any floor mats or carpets in the footwell, make sure that the pedals still have sufficient clearance.

During sudden driving or braking maneuvers the objects could get caught between the pedals. You could then no longer brake or accelerate. This could lead to accidents and injury.

Gear selector lever

The gear selector lever is located on the lower part of the center console.

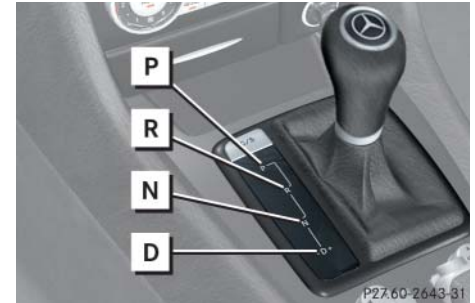

Gearshift pattern for automatic transmission

- P** Park position
- R** Reverse gear
- N** Neutral
- D** Drive position

i The current gear selector lever position **P**, **R**, **N** or **D** appears in the multifunction display (▷ page 157).

Automatic transmission*

Warning!



It is dangerous to shift the gear selector lever out of park position **P** or neutral position **N** if the engine speed is higher than idle speed. If your foot is not firmly on the brake pedal, the vehicle could accelerate quickly forward or reverse. You could lose control of the vehicle and hit someone or something. Only shift into gear when the engine is idling normally and when your right foot is firmly on the brake pedal.

There are additional indicators on the cover of the shifting gate showing the current gear selector lever position.

The indicators come on when you insert the SmartKey into the starter switch, and go out when you remove the SmartKey from the starter switch.

Shifting procedure

The automatic transmission selects individual gears automatically, depending on:

- gear selector lever position **D** (▷ page 157) with gear ranges (▷ page 160)
- the selected program mode:
(**C/S**) (▷ page 161)
or
(**M/C/S**)* (▷ page 165)
- the position of the accelerator pedal (▷ page 159)
- the vehicle speed

! Allow engine to warm up under low load use. Do not place full load on the engine until the operating temperature has been reached.

Shift into reverse gear **R** or park position **P** only when the vehicle is stopped.

Avoid spinning of a drive wheel for an extended period when driving off on slippery road surfaces. This may cause serious damage to the drivetrain which is not covered by the Mercedes-Benz Limited Warranty.

When the gear selector lever is in drive position **D**, you can influence transmission shifting by:

- limiting the gear range
- changing gears manually

Gear selector lever positions

The current gear selector lever position appears in the multifunction display.

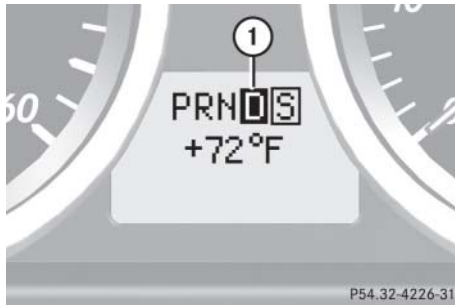

① Current gear selector lever position

Effect

P Park position

Gear selector lever position when the vehicle is parked. Place gear selector lever in park position **P** only when vehicle is stopped. The park position is not intended to serve as a brake when the vehicle is parked. Rather, the driver should always set the parking brake in addition to placing the gear selector lever in park position **P** to secure the vehicle.

Effect

The SmartKey can only be removed from the starter switch with the gear selector lever in park position **P**. With the SmartKey removed, the gear selector lever is locked in park position **P**.

If the vehicle's electrical system is malfunctioning, the gear selector lever could remain locked in park position **P** (▷ page 389).

R Reverse gear

Place gear selector lever in position **R** only when vehicle is stopped.

Automatic transmission*

	Effect
N	<p>Neutral</p> <p>No power is transmitted from the engine to the drive axle. When the brakes are released, the vehicle can be moved freely (pushed or towed).</p> <p>To avoid damage to the transmission, never engage neutral position N while driving.</p> <p>If the ESP[®] is deactivated or malfunctioning: Move gear selector lever to neutral position N only if the vehicle is in danger of skidding, e.g. on icy roads.</p>
D	<p>Drive</p> <p>The transmission shifts automatically. All forward gears are available.</p>

! *Coasting the vehicle, or driving for any other reason with gear selector lever in neutral position **N** can result in transmission damage that is not covered by the Mercedes-Benz Limited Warranty.*

Warning!



Getting out of your vehicle with the gear selector lever not fully engaged in park position **P** is dangerous. Also, park position **P** alone is not intended to or capable of preventing your vehicle from moving, possibly hitting people or objects.

Always set the parking brake in addition to shifting to park position **P** (▷ page 59).

When parked on an incline, turn the front wheels towards the road curb.

Do not park this vehicle in areas where combustible materials such as grass, hay or leaves can come into contact with the hot exhaust system, as these materials could be ignited and cause a vehicle fire.

Warning!



When leaving the vehicle, always remove the SmartKey from the starter switch, take it with you, and lock the vehicle. Do not leave children unattended in the vehicle, or with access to an unlocked vehicle. Children could move the gear selector lever from park position **P**, which could result in an accident and/or serious personal injury.

Driving tips

Accelerator position

Your driving style influences the transmission's shifting behavior:

Less throttle	Earlier upshifting
More throttle	Later upshifting

Kickdown

Use kickdown when you want maximum acceleration.

- ▶ Press the accelerator past the point of resistance.

Depending on the engine speed the transmission shifts into a lower gear.

- ▶ Ease on the accelerator when you have reached the desired speed.

The transmission shifts up again.

Stopping

When you stop briefly, e.g. at traffic lights:

- ▶ Leave the transmission in gear.
- ▶ Hold the vehicle with the brake.

When you stop for a longer period of time with the engine idling and/or on a hill:

- ▶ Set the parking brake.
- ▶ Move the gear selector lever to park position **P**.

Maneuvering

When you maneuver in tight areas, e.g. when pulling into a parking space:

- ▶ Control the vehicle speed by gradually releasing the brakes.
- ▶ Accelerate gently.
- ▶ Never abruptly step on the accelerator.

Working on the vehicle

Warning!



When working on the vehicle, set the parking brake and move gear selector lever to park position **P**. Otherwise the vehicle could roll away.

Automatic transmission*

Gear ranges

With the gear selector lever in drive position **D** and driving in program mode **C** or **S**, you can select a gear range for the automatic transmission to operate within.

Gear selector lever (▷ page 162):

You can limit the gear range by pressing the gear selector lever to the left (**D-**), and reverse the gear range limit by pressing the gear selector lever to the right (**D+**).

Steering wheel gearshift control* (▷ page 163):

You can limit the gear range by pulling the left gearshift paddle on the steering wheel gearshift control, and reverse the gear range limit by pulling the right gearshift paddle on the steering wheel gearshift control.

The selected gear range appears in the multifunction display.

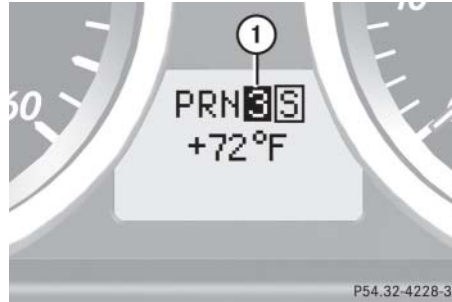

① Current gear range

	Effect
6	The transmission shifts through sixth gear only.
5	The transmission shifts through fifth gear only.
4	The transmission shifts through fourth gear only.

	Effect
3	<p>The transmission shifts through third gear only.</p> <p>With this selection you can use the braking effect of the engine.</p>
2	<p>The transmission shifts through second gear only.</p> <p>Allows the use of engine's braking power when driving</p> <ul style="list-style-type: none"> • on steep downgrades • in mountainous regions • under extreme operating conditions
1	<p>The transmission operates in first gear only.</p> <p>For maximum use of engine's braking effect on very steep or lengthy downgrades.</p>

Automatic shift program

The program mode selector switch is located on the lower part of the center console.



Program mode selector switch

- C** Comfort For comfort driving
- S** Sport For standard driving



Program mode selector switch on vehicles with AMG-Sport Package* and SLK 55 AMG only

- M** Manual For manual gear shifting (▷ page 165)
- C** Comfort For comfort driving
- S** Sport For standard driving

The selected program mode appears in the multifunction display.

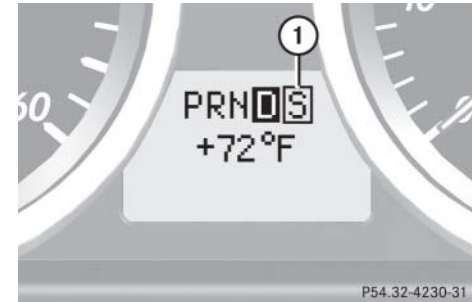

① Current program mode

! *Never change the program mode when the gear selector lever is out of park position P. This could result in a change of driving characteristics for which you may not be prepared.*

i *The last selected program mode (C or S) is switched on when the engine is restarted.*

Automatic transmission*

- ▶ Press program mode selector switch repeatedly until the letter of the desired program mode appears in the multifunction display.

Select **C** for comfort driving:

- The vehicle starts out in second gear (both forward and reverse) for gentler starts. This does not apply if full throttle is applied or gear range **1** is selected.
- Traction and driving stability are improved on icy roads.
- Upshifts occur earlier even when you give more gas. The engine then operates at lower rpms and the wheels are less likely to spin.

Select **S** for standard driving:

- The vehicle starts out in first gear.
- Upshifts occur later.

Gear selector lever one-touch gearshifting

With the gear selector lever in drive position **D** and driving in program mode **C** or **S**, you can limit or extend the gear range.

If your vehicle is equipped with manual shift program **M**, you can use the gear selector lever to manually shift the gears.

 *For information on using the gear selector lever in program mode **M**, see “Manual shift program*” (▷ page 165).*

 *Allow engine to warm up under low load use. Do not place full load on the engine until the operating temperature has been reached.*

*Shift into reverse gear **R** or park position **P** only when the vehicle is stopped.*

Avoid spinning of a drive wheel for an extended period when driving off on slippery road surfaces. This may cause serious damage to the drivetrain which is not covered by the Mercedes-Benz Limited Warranty.

The following instructions describe operation of the gear selector lever when driving in the automatic program mode **C** or **S**.

Limiting gear range

Warning!



On slippery road surfaces, never downshift in order to obtain braking action. This could result in drive wheel slip and reduced vehicle control. Your vehicle's ABS will not prevent this type of loss of control.

- ▶ Briefly press the gear selector lever to the left in the **D**- direction.

The transmission will shift to the next lower gear as permitted by the shift program. This action simultaneously limits the gear range of the transmission (▷ page 160).

 *To avoid overrevving the engine when downshifting, the transmission will not shift to a lower gear if the engine's max. speed would be exceeded.*

Extending gear range

- ▶ Briefly press the gear selector lever to the right in the **D+** direction.

The transmission will shift to the next higher gear as permitted by the shift program. This action simultaneously extends the gear range of the transmission.

i *If you press on the accelerator when the engine has reached its rpm limit, the transmission will upshift beyond any gear range limit selected.*

Canceling gear range limit

- ▶ Press and hold the gear selector lever in the **D+** direction until **D** reappears in the multifunction display (▷ page 157).

The transmission will shift from the current gear range directly to gear range **D**.

Shifting into optimal gear range

- ▶ Press and hold the gear selector lever in the **D-** direction.

The transmission will automatically select the gear range suited for optimal acceleration and deceleration. This will involve shifting down one or more gears.

Steering wheel gearshift control one-touch gearshifting*

With the gear selector lever in drive position **D** and driving in program mode **C** or **S**, you can limit or extend the gear range.

If your vehicle is equipped with manual shift program **M**, you can use the steering wheel gearshift control to manually shift the gears.

i *For information on using the steering wheel gearshift control in program mode **M**, see "Manual shift program*" (▷ page 165).*

! *Allow engine to warm up under low load use. Do not place full load on the engine until the operating temperature has been reached.*

*Shift into reverse gear **R** or park position **P** only when the vehicle is stopped.*

Avoid spinning of a drive wheel for an extended period when driving off on slippery road surfaces. This may cause serious damage to the drivetrain which is not covered by the Mercedes-Benz Limited Warranty.

Automatic transmission*



Gearshift paddles (example illustration vehicles with AMG-Sport Package*)

- ① Left shift paddle: limiting gear range or downshift (in program mode **M**)
- ② Right shift paddle: extending gear range or upshift (in program mode **M**)

i You cannot shift with the steering wheel gearshift paddles when the gear selector lever is in position **P**, **N** or **R**.

The following instructions describe operation of the steering wheel gearshift control when driving in the automatic program mode **C** or **S**.

Limiting gear range

Warning!



On slippery road surfaces, never downshift in order to obtain braking action. This could result in drive wheel slip and reduced vehicle control. Your vehicle's ABS will not prevent this type of loss of control.

- ▶ Briefly pull left shift paddle ①.

The transmission will shift to the next lower gear as permitted by the shift program. This action simultaneously limits the gear range of the transmission (▷ page 160).

i To avoid overrevving the engine when downshifting, the transmission will not shift to a lower gear if the engine's max. speed would be exceeded.

Extending gear range

- ▶ Briefly pull right shift paddle ②.

The transmission will shift to the next higher gear as permitted by the shift program. This action simultaneously extends the gear range of the transmission.

i If you press on the accelerator when the engine has reached its rpm limit, the transmission will upshift beyond any gear range limit selected.

Canceling gear range limit

- ▶ Pull and hold right shift paddle ② until **D** reappears in the multifunction display (▷ page 157).

The transmission will shift from the current gear range directly to gear range **D**.

Shifting into optimal gear range

- ▶ Pull and hold left shift paddle ①.

The transmission will automatically select the gear range suited for optimal acceleration and deceleration. This will involve shifting down one or more gears.

Manual shift program*

Manual shift program is available on vehicles with AMG-Sport Package* and SLK 55 AMG only.

In addition to the automatic shift program **C** or **S**, your vehicle is equipped with the manual shift program **M**.

In the manual program mode **M**, system-controlled automatic gearshifting is switched off and you need to change the gears by manually upshifting or downshifting using the steering wheel gearshift paddles (▷ page 164) or the gear selector lever.

! Allow engine to warm up under low load use. Do not place full load on the engine until the operating temperature has been reached.

Shift into reverse gear **R** or park position **P** only when the vehicle is stopped.

Avoid spinning of a drive wheel for an extended period when driving off on slippery road surfaces. This may cause serious damage to the drivetrain which is not covered by the Mercedes-Benz Limited Warranty.

The program mode selector switch is located on the lower part of the center console.



Program mode selector switch

M Manual	For manual gear shifting
C Comfort	For comfort driving
S Sport	For standard driving

The selected program mode appears in the multifunction display (▷ page 161).

i For information on automatic program modes **C** or **S**, see “Automatic shift program” (▷ page 161), “Gear selector lever one-touch gearshifting” (▷ page 162), and “Steering wheel gearshift control one-touch gearshifting*” (▷ page 163).

Automatic transmission*

Activating manual shift program

- ▶ Press program mode selector switch repeatedly until the **M** for manual program mode **M** appears in the multifunction display.

The transmission switches to the manual program mode **M**. Automatic shifting is switched off. The gear range is not limited.

You can change the gears manually when the gear selector lever is in drive position **D**. You can upshift or downshift through the gears in succession.

i The manual program mode **M** will not be stored. When the engine is turned off with the manual program mode **M** selected, the transmission will go to the automatic program mode (**C** or **S**) when the engine is restarted.

Upshifting

! In the manual program mode **M**, the transmission will not upshift, even if the engine has reached its overrevving range. Shift up to the next gear before the engine has reached its overrevving range. Make absolutely certain that the engine speed does not reach the red marking on the tachometer (▷ page 26). Otherwise the engine could be damaged which is not covered by the Mercedes-Benz Limited Warranty.

- ▶ Briefly press the gear selector lever to the right in the **D+** direction.

or

- ▶ Briefly pull right shift paddle ② (▷ page 164).

The transmission shifts to the next higher gear.

If, instead of the manual program mode symbol **M**, the **^** symbol appears in the multifunction display (▷ page 161), shift to the next higher gear. The fuel supply will otherwise be interrupted to prevent the engine from overrevving.

If you have selected the AMG menu in the control system and you are driving in the manual program mode **M**, upshift indicator ② in the multifunction display advises you to upshift before the engine reaches the overspeed range. Thus you can drive at the maximum engine speed for each gear without overrevving the engine.



- ① Gear indicator
- ② Upshift indicator

- ▶ Shift to the next higher gear.

The fuel supply will otherwise be interrupted to prevent the engine from overrevving.

Downshifting

Warning!



On slippery road surfaces, never downshift in order to obtain braking action. This could result in drive wheel slip and reduced vehicle control. Your vehicle's ABS will not prevent this type of loss of control.

- ▶ Briefly press the gear selector lever to the left in the **D**- direction.

or

- ▶ Briefly pull left shift paddle ① (▷ page 164).

The transmission shifts to the next lower gear.

i When you brake or stop, the transmission shifts down to a gear from which you can easily accelerate or take off.

Kickdown

Using the kickdown when driving in the manual program mode **M** is not possible.

Deactivating manual shift program

- ▶ Press the program mode selector switch (▷ page 165) repeatedly until **C** or **S** appears in the multifunction display.

or

- ▶ Restart the engine.

The transmission will go to the automatic program mode (**C** or **S**).

The manual program mode **M** is not stored.

Emergency operation (Limp-Home Mode)

If vehicle acceleration becomes less responsive or sluggish or the transmission no longer shifts, the transmission is most likely operating in limp-home (emergency operation) mode. In this mode only second gear and reverse gear can be selected.

- ▶ Stop the vehicle in a safe location.
- ▶ Move the gear selector lever to park position **P**.
- ▶ Turn off the engine.
- ▶ Wait at least 10 seconds before restarting.
- ▶ Restart the engine.
- ▶ Move the gear selector lever to position **D** (for second gear) or position **R**.
- ▶ Have the transmission checked at an authorized Mercedes-Benz Center as soon as possible.

Good visibility

For information on the windshield wipers, see “Windshield wipers” (▷ page 56).

Headlamp cleaning system*

The button is located on the left side of the dashboard.

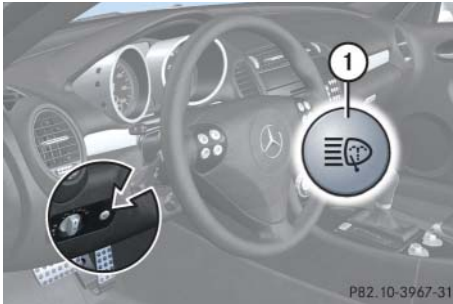

① Headlamp cleaning button

- ▶ Switch on the ignition (▷ page 37).
- ▶ Press button ①.

The headlamps are cleaned with a high-pressure water jet.

i The headlamps will automatically be cleaned when you have

- switched on the headlamps and
- operated the windshield wipers with windshield washer fluid fifteen times

When you switch off the ignition, the counter resets.

For information on filling up the washer reservoir, see “Windshield washer system and headlamp cleaning system*” (▷ page 302).

Rear view mirrors

For more information on setting the rear view mirrors, see “Mirrors” (▷ page 46).

Interior rear view mirror, antiglare position



- ▶ Tilt the mirror to the antiglare night position by moving the lever towards the windshield.

The interior rear view mirror is dimmed.

Auto-dimming rear view mirrors*

The reflection brightness of the exterior rear view mirrors and the interior rear view mirror will respond automatically to glare when

- ignition is switched on
and
- incoming light from headlamps falls on the sensor in the interior rear view mirror

The rear view mirrors will not react if

- reverse gear **R** is engaged
- interior lighting is switched on

Warning!



The auto-dimming function does not react if incoming light is not aimed directly at sensors in the interior rear view mirror.

The interior rear view mirror and the exterior rear view mirror on the driver's side do not react, for example, if the wind screen* is installed.

Light hitting the mirror(s) at certain angles (incident light) could blind you. As a result, you may not be able to observe traffic conditions and could cause an accident.

Warning!



Exercise care when using the passenger-side exterior rear view mirror. The mirror surface is convex (outwardly curved surface for a wider field of view). Objects in mirror are closer than they appear. Check your interior rear view mirror or glance over your shoulder before changing lanes.

Good visibility

Sun visors

The sun visors protect you from sun glare while driving.

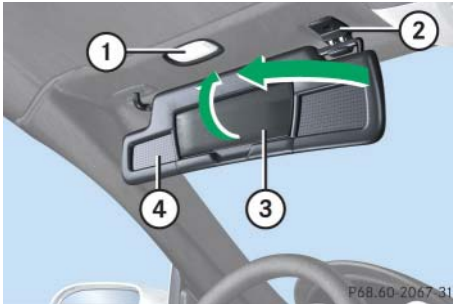

- ① Mirror lamp*
- ② Mounting
- ③ Mirror cover
- ④ Sun visor

Warning!



Do not use the vanity mirror while driving.

Keep the mirrors in the sun visors closed while vehicle is in motion. Reflected glare can endanger you and others.

- ▶ Swing sun visors down when you experience glare.
- ▶ To use mirror and switch on mirror lamp*, lift up mirror cover ③.

i *Vehicles with interior lighting package*: If sunlight enters through a side window, disengage sun visor from mounting ② and pivot it to the side. You then can slide the sun visor along the pivot arm to a different position if so desired.*

Mirror lamp ① will switch off as soon as sun visor is disengaged from mounting ②.*

! *Vehicles with interior lighting package*: Close mirror cover ③ if open before you disengage the sun visor ④ from mounting ② and pivot it to the side.*

Rear window defroster

The rear window defroster uses a large amount of power. To keep the battery drain to a minimum, switch off the defroster as soon as the rear window is clear.

The defroster is automatically deactivated after approximately 6 to 17 minutes of operation depending on the outside temperature.

Warning!



Any accumulation of snow and ice should be removed from the rear window before driving. Visibility could otherwise be impaired, endangering you and others.

Switching on

- ▶ Press the rear window defroster switch  in the control panel of the climate control (▷ page 174) or the automatic climate control* (▷ page 184).

The indicator lamp on the rear window defroster switch  comes on.

! *The rear window defroster cannot be switched on when the retractable hardtop is open. The indicator lamp starts flashing if the hardtop is open.*

- *Close the retractable hardtop first.*

The rear window defroster can be switched on again.

Switching off

- ▶ Press the rear window defroster switch  again in the control panel of the climate control or the automatic climate control*.

The indicator lamp on the rear window defroster switch  goes out.

! *If the rear window defroster switches off too soon and the indicator lamp starts flashing, this means that too many electrical consumers are operating simultaneously and there is insufficient voltage in the battery. The system responds automatically by deactivating the rear window defroster.*

As soon as the battery has sufficient voltage, the rear window defroster automatically turns itself back on.

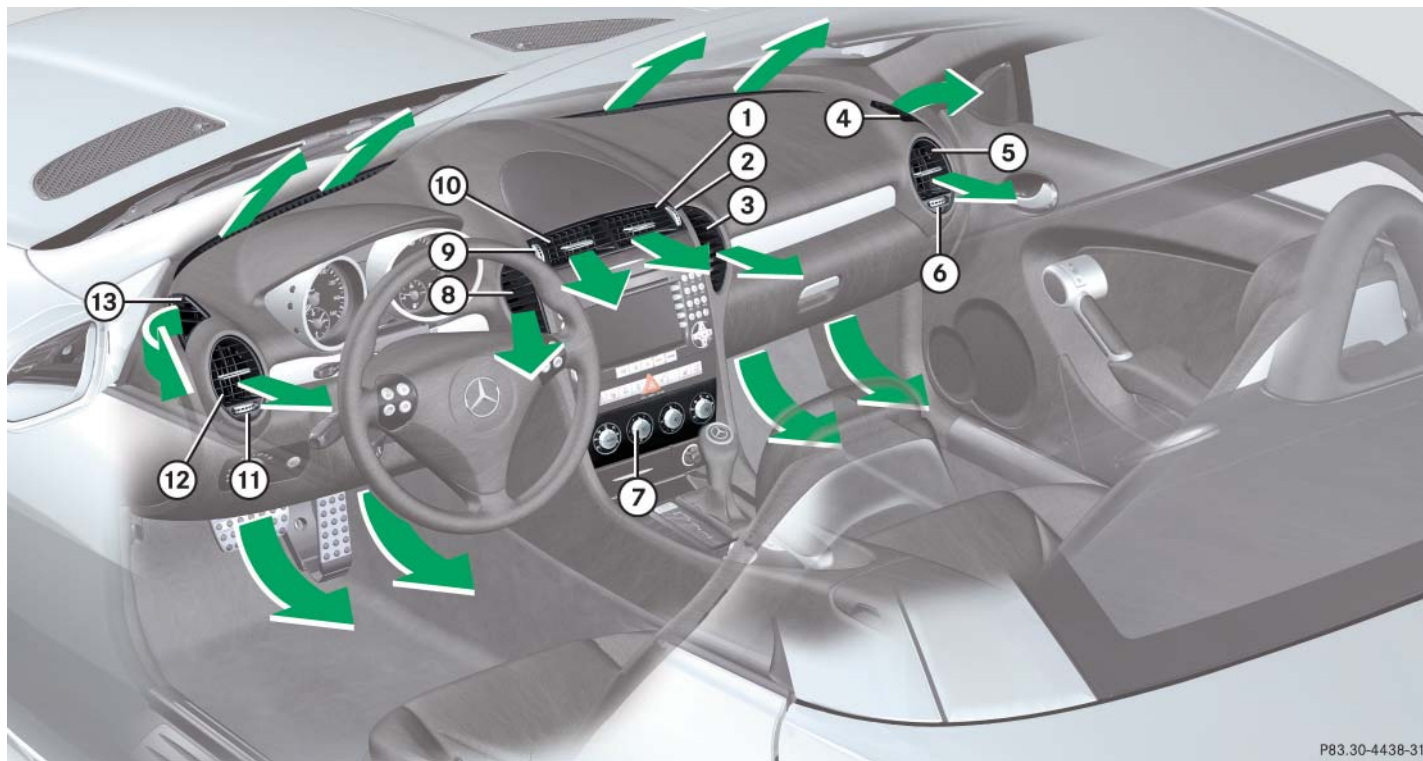

P83.30-4438-31

Item
① Right center air vent, adjustable
② Thumbwheel for air volume control for fixed/adjustable right center air vents
③ Right center air vent, fixed
④ Right side defroster air vent, fixed
⑤ Right side air vent, adjustable
⑥ Thumbwheel for air volume control for adjustable right side air vent
⑦ Climate control panel

Item
⑧ Left center air vent, fixed
⑨ Thumbwheel for air volume control for fixed/adjustable left center air vents
⑩ Left center air vent, adjustable
⑪ Thumbwheel for air volume control for adjustable left side air vent
⑫ Left side air vent, adjustable
⑬ Left side defroster air vent, fixed

i For draft-free ventilation, move the sliders for center air vents and side air vents to the middle position.

Climate control

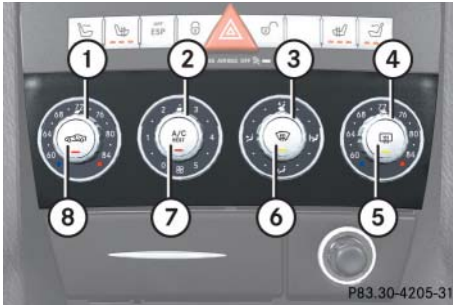

Climate control panel

Item
① Temperature control, left side
② Air volume control, climate control on/off
③ Air distribution control
④ Temperature control, right side
⑤ Rear window defroster (▷ page 170)
⑥ Front defroster
⑦ AC cooling on/off, Residual heat/ventilation
⑧ Air recirculation

The climate control is operational whenever the engine is running. The system cools or heats the interior depending on the selected interior temperature and the current outside temperature.

Warning!



When operating the climate control, the air that enters the passenger compartment through the air vents can be very hot or very cold (depending on the set temperature). This may cause burns or frostbite to unprotected skin in the immediate area of the air vents. Always keep sufficient distance between unprotected parts of the body and the air vents. If necessary, use the air distribution controls (▷ page 174) to direct the air to air vents in the vehicle interior that are not in the immediate area of unprotected skin.

Nearly all dust particles, pollutants and odors are filtered out before outside air enters the interior through the air distribution system.

The air conditioning will not engage (no cooling) if the **A/C** mode is deactivated (▷ page 174).

Warning!



Follow the recommended settings for heating and cooling given on the following pages. Otherwise the windows could fog up, impairing visibility and endangering you and others.

i Severe conditions (e.g. strong air pollution) may require replacement of the filter before its scheduled interval. A clogged filter will reduce the air volume to the interior.

If the vehicle interior is hot, ventilate the interior before driving off. The climate control will then adjust the interior temperature to the set value much faster.

Keep the air intake grille in front of the windshield free of snow and debris.

When the retractable hardtop is closed, do not obstruct air flow by placing objects on the air flow-through exhaust slots below the rear window.

Switching climate control system on/off

Warning!



When the climate control is switched off, the outside air supply and circulation are also switched off. Only choose this setting for a short time. Otherwise the windows could fog up, impairing visibility and endangering you and others.

Switching off

- ▶ Set air volume control ② (▷ page 174) to position **0**.

Switching on

- ▶ Switch on the ignition (▷ page 37).
- ▶ Set air volume control ② to any speed (▷ page 174).

The previous settings are once again in effect.

Setting the temperature

Use temperature controls ① and ④ (▷ page 174) to separately adjust the air temperature on each side of the passenger compartment. You should raise or lower the temperature setting in small increments, preferably starting at 72°F (22°C). The climate control will adjust to the set temperature as fast as possible.

Increasing

- ▶ Turn temperature control ① and/or ④ (▷ page 174) slightly clockwise.

The climate control system will correspondingly adjust the interior air temperature.

Climate control

Decreasing





- ▶ Turn temperature control ① and/or ④ (▷ page 174) slightly counterclockwise.

The climate control system will correspondingly adjust the interior air temperature.

Adjusting air distribution

Use air distribution control ③ (▷ page 174) to adjust the air distribution.

The following symbols are found on the control:

Symbol	Function
	Directs air through the center and side air vents
	Directs air to the windshield and through the side air vents
	Directs air into the entire vehicle interior
	Directs air to the footwells and through the side air vents

- ▶ Turn the air distribution control to the desired symbol (▷ page 174).

The climate control system will correspondingly adjust the interior air distribution.

i You can also turn the control to a position between two symbols.

Opening the center air vents

- ▶ Turn thumbwheels ② and ⑨ (▷ page 172) upward to the first stop. Center air vents ①, ③, ⑧ and ⑩ are open.
- ▶ Turn thumbwheels ② and ⑨ (▷ page 172) upward all the way. Only center air vents ① and ⑩ are open.

Closing the center air vents

- ▶ Turn thumbwheels ② and ⑨ (▷ page 172) downward all the way. Center air vents ①, ③, ⑧ and ⑩ are closed.

Opening and closing side air vents

- ▶ Turn thumbwheels ⑥ and ⑪ (▷ page 172) in the required direction. Side air vents ⑤ and ⑫ are open or closed.



Adjusting air volume

Ten blower speeds are available.

- ▶ Use air volume control ② (▷ page 174) to adjust the air volume.

Basic settings

Heating (winter)

- ▶ Turn temperature controls ① and ④ (▷ page 174) to the desired position.
- ▶ Turn air volume control ② (▷ page 174) to level **2** or higher.
Otherwise the windows may fog over.
- ▶ Turn air distribution control ③ (▷ page 174) to a position between  and .
- ▶ Open the side air vents if necessary.
- ▶ Close the center air vents.

Heating (summer)

- ▶ Turn air temperature control ① and ④ (▷ page 174) to the desired position.
- ▶ Turn air volume control ② (▷ page 174) to level **1** or higher.
- ▶ Turn air distribution control ③ (▷ page 174) to position .
- ▶ Open the center and side air vents.

Front defroster

You can use this setting to defrost the windshield, for example if it is iced up. You can also defog the windshield and the side windows.

 *Keep this setting selected only until the windshield or the side windows are clear again.*



Activating

- ▶ Press button  (▷ page 174).

The indicator lamp on the button comes on.

The air conditioning switches automatically to the following functions:

- cooling on to dehumidify
- maximum blowing and heating power
- air flows onto the windshield and the front side windows

 *When you have activated the front defroster using button , no other settings are possible.*

Climate control

Deactivating



- ▶ Press button  (▷ page 174) again.

The indicator lamp on the button goes out.

The previous settings are once again in effect.

 *The cooling remains switched on.*

Windshield fogged on the outside

- ▶ Switch the windshield wipers on (▷ page 56).
- ▶ Turn air distribution control  to position  or  (▷ page 174).

Air recirculation mode

Switch to air recirculation mode to prevent unpleasant odors from entering the vehicle from the outside (e.g. before driving through a tunnel). This setting cuts off the intake of outside air and recirculates the air in the interior.

Warning!





Fogged windows impair visibility, endangering you and others. If the windows begin to fog on the inside, switching off the air recirculation mode immediately should clear interior window fogging. If interior window fogging persists, make sure the air conditioning (▷ page 180) is activated, or press button .

Activating

- ▶ Briefly press button  (▷ page 174).

The indicator lamp on the button comes on.

 *The air recirculation mode is activated automatically at high outside temperatures.*

The indicator lamp on button  is not lit when the air recirculation mode is automatically switched on.

A quantity of outside air is added after approximately 30 minutes.

Deactivating

- ▶ Press button  (▷ page 174) again.

The indicator lamp on the button goes out.

 *The air recirculation mode is deactivated automatically:*

- *after 5 minutes if the outside temperature is below approximately 41 °F (5 °C)*
- *after 5 minutes if the air conditioning is turned off*
- *after 30 minutes if the outside temperature is above approximately 41 °F (5 °C)*

Air recirculation mode with convenience closing or opening feature

Warning!



Never operate the side windows if there is the possibility of anyone being harmed by the closing procedure.

When using the air recirculation mode with convenience closing feature, should the upward movement of a window be blocked by some obstruction including but not limited to arms, hands, fingers, etc., the automatic reversal feature will not operate.



In the event that the closing procedure causes potential danger, the closing of the door windows can be immediately halted by releasing the  button or by pressing the respective power window switch.

The closing of the rear side windows can be immediately halted by releasing the  button.

Convenience closing

- ▶ Press and hold button  until the windows are closed or have reached the desired position.



The indicator lamp on the button comes on. The air recirculation mode is activated.

 *The closing of the windows can be immediately halted by releasing button .*

Convenience opening

- ▶ Press and hold button  until the windows are opened or have reached the desired position.

The indicator lamp on the button goes out. The air recirculation mode is deactivated.

 *The opening of the windows can be immediately halted by releasing button .*

A window will only return to its previous position if it has not been moved to another position using the respective window switch after it was closed with button .

A window that has been moved will remain in its current position if button  is used to reopen the remaining windows.

Climate control

Air conditioning

The cooling function, only operational when the engine is running, cools the vehicle interior down to the selected temperature. The cooling function also dehumidifies the air in the vehicle interior, thus preventing the windows from fogging up.

Warning!



If you turn off the cooling function, the interior air is not dried. The windows can fog up more quickly. Window fogging may impair visibility and endanger you and others.

i Condensation may drip from underneath the vehicle. This is normal and not an indication of a malfunction.

Deactivating

It is possible to deactivate the air conditioning (cooling) function of the climate control system. The air in the vehicle will then no longer be cooled or dehumidified.

- ▶ Press button  (▷ page 174).

The indicator lamp on the button goes out. The cooling function switches off after a short delay.

Activating

Moist air can fog up the windows. You can dehumidify the air with the air conditioning.

- ▶ Press button  (▷ page 174) again.

The indicator lamp on the button comes on.

The air conditioning uses the refrigerant R134a. This refrigerant is free of CFCs which are harmful to the ozone layer.

Maximum cooling

- ▶ Turn thumbwheels ② and ⑨ (▷ page 172) upwards to the first stop.

The fixed center air vents ③ and ⑧ (▷ page 172) and the adjustable air vents ① and ⑩ (▷ page 172) are open.

- ▶ For draft-free ventilation, move the sliders for the center air vents ① and ⑩ (▷ page 172) to the middle position.

- ▶ Turn thumbwheels ⑥ and ⑪ (▷ page 172) for the adjustable side air vents ⑤ and ⑫ (▷ page 172) to the fully open position.

- ▶ Set air distribution control ③ (▷ page 176) to position .

The air distribution directs the air through the center and side air vents.

- ▶ Set air volume control ② (▷ page 177) to position **5**.

The ventilation operates with maximum blower speed.

- ▶ Turn temperature controls ① and ④ (▷ page 174) completely counterclockwise to their end stops.

The lowest temperature for both sides is set.

i *When the vehicle's interior has cooled down enough, reduce the air volume and increase the air temperature to comfortable settings if desired.*

Residual engine heat utilization

With the engine switched off, it is possible to continue to heat or ventilate the interior for up to 30 minutes. This feature makes use of the residual heat produced by the engine.

Activating

- ▶ Switch off the ignition (▷ page 37).
- ▶ Press button  (▷ page 174).

The indicator lamp on the button comes on.

i *How long the system will provide heating depends on*

- *the coolant temperature*
- *the temperature set by the operator*

*The blower will run at speed setting **1** regardless of the air distribution control setting.*

Deactivating

- ▶ Press button  (▷ page 174) again.

The indicator lamp on the button goes out.

- i** *The residual heat is automatically turned off*
 - *when the ignition is switched on (▷ page 37)*
 - *after about 30 minutes*
 - *if the battery voltage drops*

Automatic climate control*

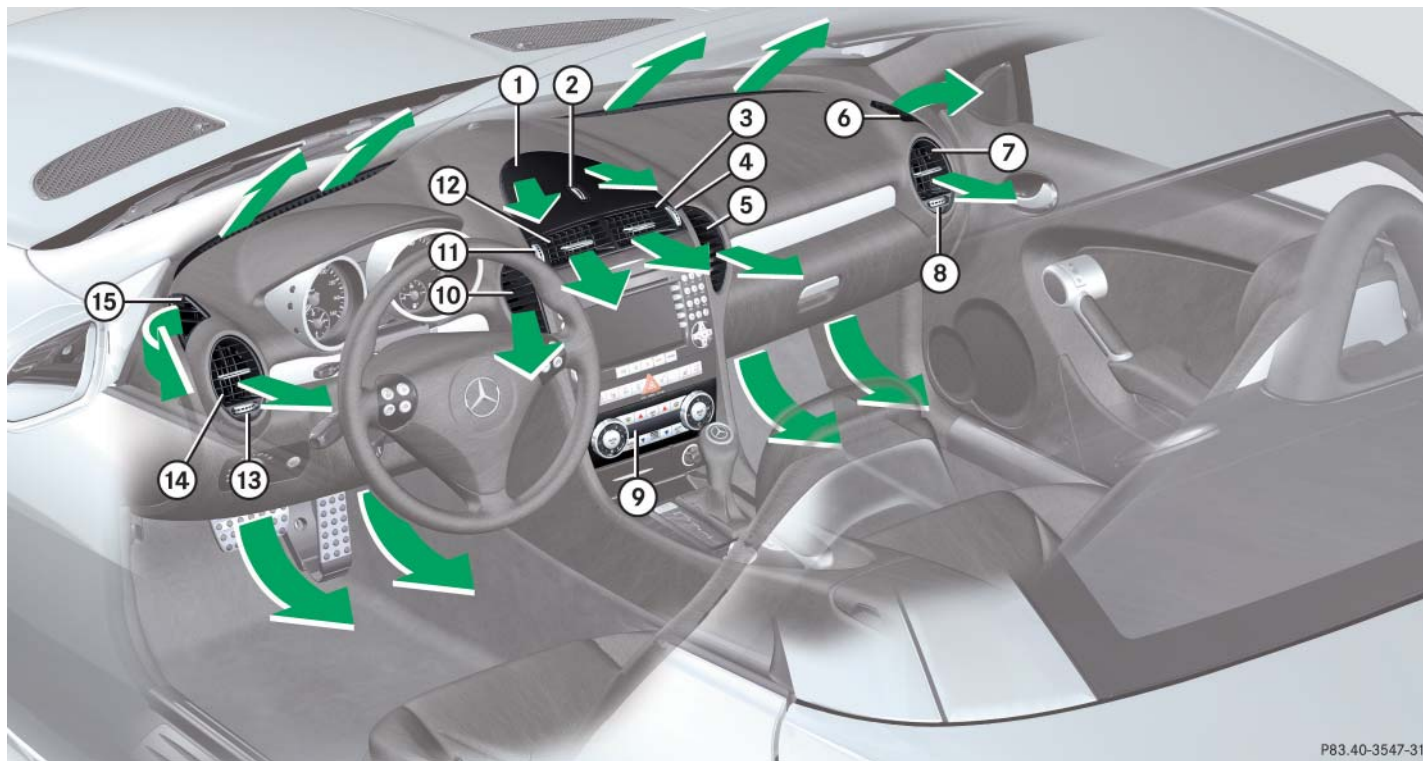

P83.40-3547-31

Item
① Cockpit air vent
② Thumbwheel for air volume control for cockpit air vent
③ Right center air vent, adjustable
④ Thumbwheel for air volume control for fixed/adjustable right center air vents
⑤ Right center air vent, fixed
⑥ Right side defroster air vent, fixed
⑦ Right side air vent, adjustable
⑧ Thumbwheel for air volume control for adjustable right side air vent

Item
⑨ Automatic climate control panel
⑩ Left center air vent, fixed
⑪ Thumbwheel for air volume control for fixed/adjustable left center air vents
⑫ Left center air vent, adjustable
⑬ Thumbwheel for air volume control for adjustable left side air vent
⑭ Left side air vent, adjustable
⑮ Left side defroster air vent, fixed

i For draft-free ventilation, move the sliders for center air vents and side air vents to the middle position.

Automatic climate control*



	Item
①	Air volume control, manual
②	Air distribution and air volume (automatic mode)
③	Front defroster
④	Temperature control, left, raising
⑤	Automatic climate control on/off (complete system)
⑥	Temperature control, right, raising
⑦	Rear window defroster
⑧	Air distribution control, manual
⑨	Residual heat/ventilation
⑩	AC cooling on/off
⑪	Temperature control, right, lowering
⑫	Temperature control, left, lowering
⑬	Air recirculation
⑭	Display

The automatic climate control is operational whenever the engine is running. You can operate the automatic climate control system in either the automatic or manual mode. The system cools or heats the interior depending on the selected interior temperature and the current outside temperature.

Warning!



When operating the automatic climate control, the air that enters the passenger compartment through the air vents can be very hot or very cold (depending on the set temperature). This may cause burns or frostbite on unprotected skin in the immediate area of the air vents. Always keep sufficient distance between unprotected parts of the body and the air vents. If necessary, use the air distribution controls (▷ page 184) to direct the air to air vents in the vehicle interior that are not in the immediate area of unprotected skin.

Nearly all dust particles, pollutants and odors are filtered out before outside air enters the interior through the air distribution system.

The air conditioning will not engage (no cooling) if the **A/C** mode is deactivated (▷ page 184).

Warning!



Follow the recommended settings for heating and cooling given on the following pages. Otherwise the windows could fog up, impairing visibility and endangering you and others.

i *Severe conditions (e.g. strong air pollution) may require replacement of the filter before its scheduled interval. A clogged filter will reduce the air volume to the interior.*

If the vehicle interior is hot, ventilate the interior before driving off. The automatic climate control will then adjust the interior temperature to the set value much faster.

Keep the air intake grille in front of the windshield free of snow and debris.

When the retractable hardtop is closed, do not obstruct air flow by placing objects on the air flow-through exhaust slots below the rear window.

Deactivating the climate control system

Warning!



When the automatic climate control is switched off, the outside air supply and circulation are also switched off. Only choose this setting for a short time. Otherwise the windows could fog up, impairing visibility and endangering you and others.

Deactivating

- ▶ Press button **OFF** (▷ page 184).
The indicator lamp on the button comes on.

Automatic climate control*

Reactivating

- ▶ Switch on the ignition (▷ page 37).
- ▶ Press button **OFF** (▷ page 184) again.

The previous settings are once again in effect.

or

- ▶ Press button **AUTO** (▷ page 184).

The indicator lamp on the button comes on. Air volume and air distribution are adjusted automatically.

Operating the climate control system in automatic mode

i When operating the automatic climate control system in automatic mode, you will only rarely need to adjust the temperature, air volume and air distribution.

In automatic mode, cooling with dehumidify is switched on. This function can be switched off if necessary.

Activating

- ▶ Press button **AUTO** (▷ page 184) while the engine is running.

The indicator lamp on the button comes on. The air volume and air distribution are adjusted automatically.

- ▶ Use temperature controls ④ and ⑥ or ⑪ and ⑫ (▷ page 184) to separately adjust the air temperature on each side of the passenger compartment.

The temperature of the vehicle interior is adjusted automatically.

Deactivating

- ▶ Press button **AUTO** (▷ page 184) again.

The indicator lamp on the button goes out. The air volume changes to level **2** and the air distribution changes to . Automatic control of air volume and air distribution is switched off.

Setting the temperature

Use temperature controls ④ and ⑫ for the driver's side or ⑥ and ⑪ for the passenger side (▷ page 184) to separately adjust the air temperature on each side of the passenger compartment. You should raise or lower the temperature setting in small increments, preferably starting at 72°F (22°C). The automatic climate control will adjust to the set temperature as fast as possible.

Automatic climate control*

Increasing

- ▶ Press temperature button(s) ④ and/or ⑥ (▷ page 184) until the desired temperature appears in the control panel display ⑭ (▷ page 184).

The automatic climate control system will correspondingly adjust the interior air temperature.





Decreasing

- ▶ Press temperature button(s) ⑩ and/or ⑫ (▷ page 184) until the desired temperature appears in the control panel display ⑭ (▷ page 184).

The automatic climate control system will correspondingly adjust the interior air temperature.

Adjusting air distribution

Use air distribution control ⑧ (▷ page 184) to adjust the air distribution. The following symbols are found on the control:

Symbol	Function
	Directs air through the center and side air vents
	Directs air to the windshield and through the side air vents
	Directs air into the entire vehicle interior
	Directs air to the footwells and through the side air vents

- ▶ Turn air distribution control ⑧ (▷ page 184) to the desired position.

The indicator lamp on the button **AUTO** (▷ page 184) goes out.

The automatic air distribution is switched off. The air distribution is controlled according to the selected control setting.

i You can also turn the control to a position between two symbols.

Opening the cockpit air vent and center air vents

- ▶ Turn thumbwheels ④ and ⑪ (▷ page 182) to the first stop and turn thumbwheel ② (▷ page 182) upward all the way.

The cockpit air vent ① and the center air vents ③ , ⑤, ⑩ and ⑫ are open.

- ▶ Turn thumbwheels ④ and ⑪ (▷ page 182) upward all the way.

Only center air vents ③ and ⑫ are open.

Automatic climate control*

Closing the cockpit air vent and center air vents

- ▶ Turn thumbwheels ②, ④ and ⑪ (▷ page 182) downward.

The cockpit air vent and the center air vents are closed.

Opening and closing side air vents

- ▶ Turn thumbwheels ⑧ and ⑬ (▷ page 182) in the corresponding direction.

Side air vents ⑦ and ⑭ are open or closed.

Adjusting air volume

Use button **AUTO** (▷ page 184) for automatic mode or air volume control ① (▷ page 184) to adjust air volume manually.

Eleven blower speeds are available.

- ▶ Turn air volume control ① (▷ page 184) to the desired position.

The indicator lamp on button **AUTO** (▷ page 184) goes out.

The automatic operation of air volume switches off.

Front defroster

You can use this setting to defrost the windshield, for example if it is iced up. You can also defog the windshield and the side windows.

i *Keep this setting selected only until the windshield or the side windows are clear again.*

Activating

- ▶ Press button  (▷ page 184).

The indicator lamp on the button comes on.

The air conditioning switches automatically to the following functions:

- cooling on to dehumidify
- maximum blowing and heating power
- air flows onto the windshield and the front side windows

i *When you have activated the front defroster using button , no other settings are possible.*

Deactivating

- ▶ Press button  (▷ page 184) again.

The indicator lamp on the button goes out.

The previous settings are once again in effect.

 *The cooling remains switched on.*



Windows fogged on the outside

 *Keep this setting selected only until the windshield is clear again.*

- ▶ Switch the windshield wipers on (▷ page 56).
- ▶ Press button **AUTO** (▷ page 184).

The indicator lamp on the button comes on. Air distribution and air volume are adjusted automatically.

If the automatic air distribution and air volume are switched off:

- ▶ Turn air distribution control  (8) to position  or  (▷ page 184).

Maximum cooling MAX COOL

When operating the automatic climate control system in automatic mode **AUTO** and there is a high need for cooling, MAX COOL is activated. This provides the fastest possible cooling of the vehicle's interior (when retractable hardtop is closed).

MAX COOL will appear in display  (▷ page 184).

Air recirculation mode

Switch to air recirculation mode to prevent unpleasant odors from entering the vehicle from the outside (e.g. before driving through a tunnel). This setting cuts off the intake of outside air and recirculates the air in the interior.

Warning!



Fogged windows impair visibility, endangering you and others. If the windows begin to fog on the inside, switching off the air recirculation mode immediately should clear interior window fogging. If interior window fogging persists, make sure the air conditioning (▷ page 180) is activated, or press button .

Automatic climate control*

Activating

- ▶ Press button  (▷ page 184).

The indicator lamp on the button comes on.

i *The air recirculation mode activates automatically at high outside temperatures.*

The indicator lamp on button  is not lit when the air recirculation mode is automatically switched on.

A quantity of outside air is added after approximately 30 minutes.

Deactivating

- ▶ Press button  (▷ page 184) again.

The indicator lamp on the button goes out.

i *The air recirculation mode is deactivated automatically:*

- *after 5 minutes if the outside temperature is below approximately 41 °F (5 °C)*
- *after 5 minutes if the air conditioning is turned off (▷ page 191)*
- *after 30 minutes if the outside temperature is above approximately 41 °F (5 °C)*

Air recirculation mode with convenience closing or opening feature

Warning!



Never operate the side windows if there is the possibility of anyone being harmed by the closing procedure.

When using the air recirculation mode with convenience closing feature, should the upward movement of a window be blocked by some obstruction including but not limited to arms, hands, fingers, etc., the automatic reversal feature will not operate.

In the event that the closing procedure causes potential danger, the closing of the door windows can be immediately halted by releasing the  button or by pressing the respective power window switch.

The closing of the rear side windows can be immediately halted by releasing the  button.

Convenience closing

- ▶ Press and hold button  until the windows are closed or have reached the desired position.

The indicator lamp on the button comes on. The air recirculation mode is activated.

i The closing of the windows can be immediately halted by releasing button .

Convenience opening

- ▶ Press and hold button  until the windows are opened or have reached the desired position.

The indicator lamp on the button goes out. The air recirculation mode is deactivated.

i The opening of the windows can be immediately halted by releasing button .

A window will only return to its previous position if it has not been moved to another position using the respective window switch after it was closed with button .

A window that has been moved will remain in its current position if button  is used to reopen the remaining windows.

Air conditioning

The cooling function, only operational when the engine is running, cools the vehicle interior down to the selected temperature. The cooling function also dehumidifies the air in the vehicle interior, thus preventing the windows from fogging up.

The air conditioning uses the refrigerant R134a. This refrigerant is free of CFCs which are harmful to the ozone layer.

Warning!



If you turn off the cooling function, the vehicle will not be cooled when weather conditions are warm. The windows can fog up more quickly. Window fogging may impair visibility and endanger you and others.

i Condensation may drip from underneath the vehicle. This is normal and not an indication of a malfunction.

Automatic climate control*

Deactivating

It is possible to deactivate the air conditioning (cooling) function of the automatic climate control system. The air in the vehicle will then no longer be cooled or dehumidified.

- ▶ Press button **A/C** (▷ page 184).

The indicator lamp on the button goes out.

Activating

Moist air can fog up the windows. You can dehumidify the air with the air conditioning.

- ▶ Press button **A/C** (▷ page 184).

The indicator lamp on the button comes on.

Residual heat and ventilation

With the engine switched off, it is possible to continue to heat or ventilate the interior for up to 30 minutes. This feature makes use of the residual heat produced by the engine.

i *How long the system will provide heating depends on*

- *the coolant temperature*
- *the temperature set by the operator*

The blower will run at speed setting 1 regardless of the air volume control setting.

Activating

- ▶ Switch off the ignition (▷ page 37).
- ▶ Press button **REST** (▷ page 184).

The indicator lamp on the button comes on. The display in the automatic climate control panel remains switched off.

Deactivating

- ▶ Press button **REST** (▷ page 184) again.

The indicator lamp on the button goes out.

- i** *The residual heat is automatically turned off:*
- *when the ignition is switched on (▷ page 37)*
 - *after about 30 minutes*
 - *if the battery voltage drops*

▼ Audio system

Audio and telephone*, operation

These instructions are intended to help you become familiar with your Mercedes-Benz audio system. They contain useful tips and a detailed description of the user functions.

Warning!



In order to avoid distraction which could lead to an accident, the driver should enter system settings with the vehicle at a standstill and operate the system only when road and traffic conditions permit. Always pay full attention to traffic conditions first before operating system controls while driving.

Bear in mind that at a speed of just 30 mph (approximately 50 km/h), your vehicle is covering a distance of 44 feet (approximately 14 m) every second.

Operating safety

Warning!



Any alterations made to electronic components can cause malfunctions.

The radio, amplifier, CD changer*, satellite radio* and telephone* are interconnected. When one of the components is not operational or has not been removed/replaced properly, the function of other components may be impaired.

This condition might seriously impair the operating safety of your vehicle.

We recommend that you have any service work on electronic components carried out by an authorized Mercedes-Benz Center.

Audio system

Operating and display elements

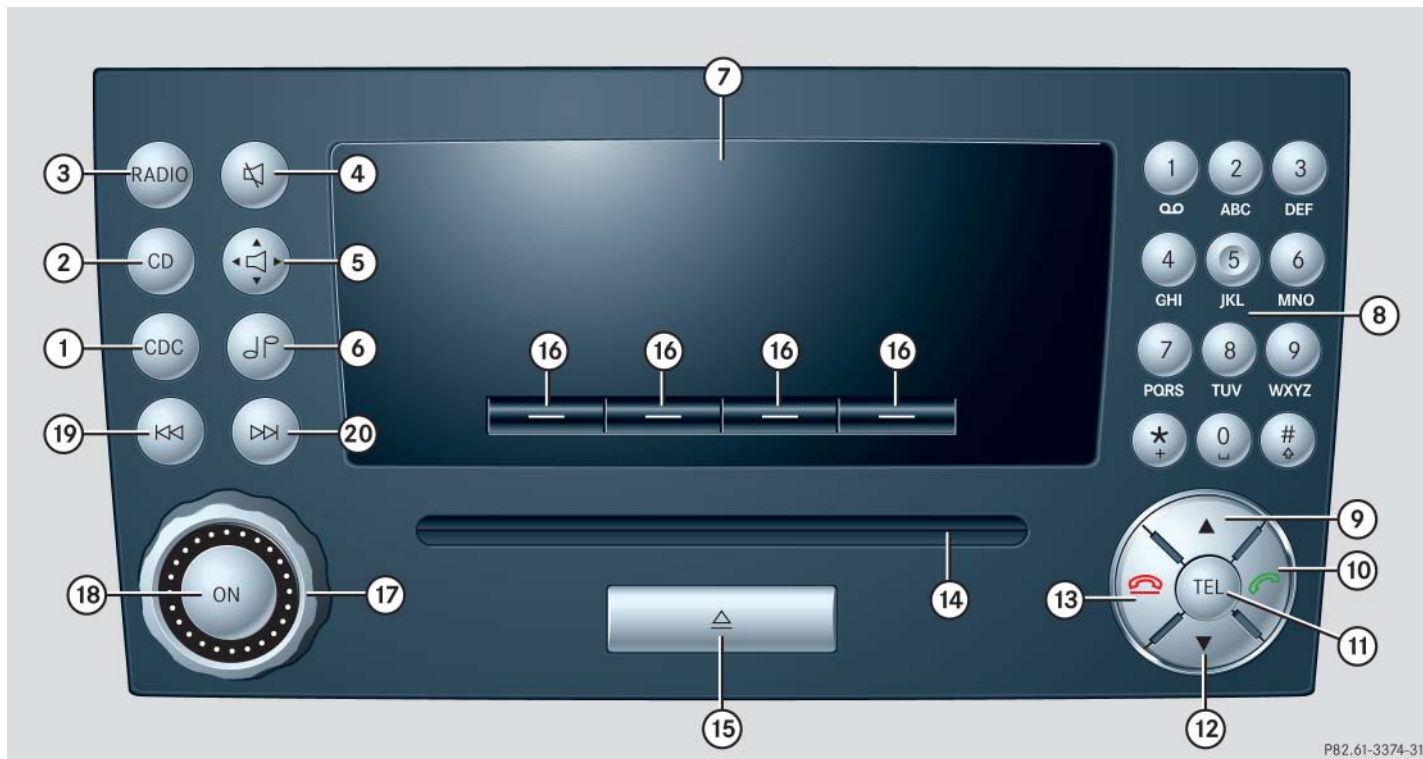

P82.61-3374-31

Item	Page
① CD changer mode selector	208
② Single CD mode selector	212
③ Radio mode selector	
④ Mute function (radio)	202
Pause (CD)	218
⑤ Volume distribution	198
⑥ Sound settings	197
⑦ Display	
⑧ Alphanumeric keypad	

Item	Page
⑨ Speed dialing memory (telephone*) in descending order	
⑩ Accepting a call (telephone*)	224
⑪ Telephone* mode selector	219
⑫ Speed dialing memory (telephone*) in ascending order	221
⑬ Terminating a call (telephone*)	225
⑭ CD slot	
⑮ CD ejection	212

Item	Page
⑯ Soft keys	196
⑰ Volume	196
⑱ Switching on/off	196
⑲ Manual tuning / seek tuning (radio)	201
Track search, reverse (CD)	217
⑳ Manual tuning / seek tuning (radio)	201
Track search, fast forward (CD)	217

Audio system

Button and soft key operation

In these instructions, the alphanumeric keypad (right side of radio panel) and the function buttons (left side of radio panel) are referred to as “buttons”. The four keys below the display panel are referred to as “soft keys”.

! Do not press directly in the display face. Otherwise, the display will be damaged.

Operation

Switching the unit on/off

Switching on

- ▶ Turn the SmartKey in the starter switch to position **1** or **2** (▷ page 37).
- ▶ If the audio system was on as you removed the SmartKey from the starter switch, the audio system will automatically come back on as you turn the SmartKey to position **1** or **2**.

or

- ▶ Press **ON** button.

i If the radio is switched on without the SmartKey in the starter switch, it will automatically switch off again after approximately 30 minutes.

If your vehicle is equipped with a mobile telephone*, the display may prompt you to enter your PIN (GSM network) or code (TDMA or CDMA network).

Switching off

- ▶ Remove the SmartKey from the starter switch.

or

- ▶ Press **ON** button.

i Should excessively high temperatures occur while the audio system is being operated, the display will dim. If temperatures continue to rise, HIGH TEMP will appear in the display, after which the audio system will be switched off for a cooling-down period.

Adjusting the volume

- ▶ Turn rotary control of **ON** button.

The volume will increase or decrease depending on the direction turned.

i If your vehicle equipment includes a Mercedes-Benz specified mobile telephone*, you can adjust its volume separately from the volume of the audio system while the telephone is being used.

Adjusting sound functions

The bass and treble functions are called up by pressing the **⏸** button.

Settings for bass and treble are stored separately for the AM and FM wavebands, weather band, CD mode and telephone mode.

Bass

- ▶ Press **⏸** button repeatedly until BASS appears in the display.



- ▶ Press + or - soft key to increase or decrease tone level accordingly.

or

- ▶ Press RES soft key briefly to reset bass tones to their center level.

The radio switches back to the standard radio menu 8 seconds after the last soft key is pressed.

Adjusting treble

- ▶ Press **⏸** button repeatedly until TREBLE appears in the display.



- ▶ Press + or - soft key to increase or decrease tone level accordingly.

or

- ▶ Press RES soft key briefly to reset treble tones to their center level.

The radio switches back to the standard radio menu 8 seconds after the last soft key is pressed.

Audio system

Returning sound functions to factory settings

- ▶ Press  button to call up settings menu in the display.



P82.60-4452-31

- ▶ Press RES soft key briefly; the respective sound function is reset to its center level.

or

- ▶ Press and hold RES soft key until RESET appears in the display.

The sound settings for bass and treble are returned to their center level and the volume is set to a predefined level.

The radio switches back to the standard radio menu 4 seconds after the last soft key is pressed.

Adjusting balance

- ▶ Press  button.

BALANCE appears in the display.



P82.60-4453-31

- ▶ Press <<< or >>> soft key.

The volume is distributed between the left and right sides of the vehicle.

or

- ▶ Press RES soft key briefly.

The balance is reset to its center level.

The radio switches back to the standard radio menu 8 seconds after the last button is pressed.

Returning volume distribution to factory settings

- ▶ Press  button to call up settings menu in the display.



P82.60-4452-31

- ▶ Press RES soft key briefly; the respective volume distribution is reset to its center (flat) level.

or

- ▶ Press and hold RES soft key until RESET appears in the display.

The volume distribution settings for the balance is set to the center level.

The radio switches back to the standard radio menu 4 seconds after the last soft key is pressed.

Telephone* muting

If your vehicle equipment includes a Mercedes-Benz specified mobile telephone*, you can adjust its volume separately from the volume of the audio system while the telephone* is being used.

Radio operation

Selecting radio mode

- ▶ Press **RADIO** button.

Calling up wavebands

You can choose from among the FM, AM and WB wavebands.

Weather band (> page 202).

i *FM waveband: 87.7.....107.9 MHz*

AM waveband: 530.....1 710 KHz

Calling up wavebands for radios without SAT

- ▶ Press FM or AM soft key to switch between FM and AM.

The FM and AM wavebands are called up one after another.

or

- ▶ Press WB soft key.

The weather band menu is called up.

The waveband currently selected appears in the upper left-hand corner of the display.

Audio system

Calling up wavebands for radios with SAT

- ▶ Press FM, AM or WB soft key repeatedly until desired waveband has been selected.

The FM, AM and WB wavebands are called up one after another.

The waveband currently selected appears in the upper left-hand corner of the display.

Selecting a station

The following options are available for selecting a station:

- Direct frequency input (▷ page 200)
- Manual tuning (▷ page 201)
- Automatic seek tuning (▷ page 201)
- Scan search (▷ page 201)
- Station memory (▷ page 201)
- Automatic station memory (Autostore) (▷ page 202)

The station search proceeds in the following frequency increments:

- 0.2 MHz in FM range
- 10 kHz in AM range

Direct frequency input

- ▶ Select desired waveband.



- ▶ Press ***** button.
- ▶ Enter desired frequency with buttons **1** to **0**.

i You can only enter frequencies within the respective waveband.

If a button is not pressed within 4 seconds, the radio will return to the last station tuned.

Manual tuning

- ▶ Select desired waveband.
- ▶ Press **◀◀** or **▶▶** button for approximately 3 seconds.
- ▶ Press button repeatedly until the desired frequency has been reached.

Step-by-step station tuning takes place in ascending or descending order. Each time the button is pressed, the radio tunes further by 0.2 MHz. During manual tuning, the radio is muted.

Automatic seek tuning

- ▶ Select desired waveband.
- ▶ Press **◀◀** or **▶▶** button briefly.

The radio will tune to the next highest or next lowest receivable frequency.

i *If no station is received after two consecutive scans of the complete frequency range, then the scan stops at the frequency from which it began.*

Scan search

- Starting scan search
 - ▶ Select desired waveband.



- ▶ Press SC soft key.

SC will appear in the display. The radio briefly (approximately 8 seconds) tunes in all receivable stations on the waveband selected.
- Ending scan search
 - ▶ Press SC soft key or **◀◀** or **▶▶**.

The station last played will be selected and SC disappears from the display.

Station memory

You can store ten AM and ten FM stations in the memory.

- Storing stations
 - ▶ Tune in desired station.
 - ▶ Press and hold desired station button **1** to **0** until a brief signal tone is heard.

The frequency is stored on the selected station button.

- Calling up stations
 - ▶ Press desired station button **1** to **0** briefly.

Audio system

Autostore – automatic station memory

The Autostore memory function provides an additional memory level. The station memory for manually stored stations is not overwritten.

- Calling up Autostore memory level and storing stations

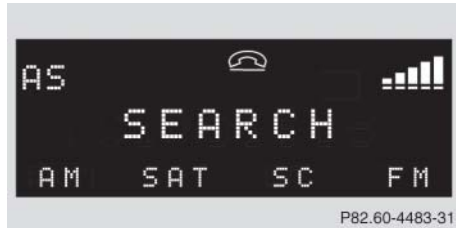

- ▶ Press AS soft key briefly.

The radio switches to the Autostore memory level. AS and SEARCH appear in the display and the radio finds the ten stations with the strongest signals. These stations are stored on the station buttons **1** to **0** in order of signal strength.

- Calling up stations
 - ▶ Press desired station button **1** to **0**.
- Leaving the Autostore memory level
 - ▶ Press FM or AM soft key briefly.

Interrupting radio mode

The radio mode is interrupted by an incoming call on the telephone* (▷ page 224).

- Mute on
 - ▶ Press  button.

The radio mode is interrupted and MUTED appears in the display.
- Mute off
 - ▶ Press  button.

The radio mode is again active.

Weather band



- ▶ Press WB soft key.

The weather band station last received is tuned in.

Selecting a weather band station directly

- ▶ Select desired weather band station with buttons **1** to **7** PQRS.

If a station cannot be tuned in, a search is automatically started.

Search

- ▶ Press **◀◀** or **▶▶** button to tune in the next receivable weather band station.

i *If no weather band station is received after three consecutive scans of the complete frequency range, then the scan stops at the channel with which it began and NO WB FOUND appears in the display.*

If this happens, switch back to standard radio mode.

Scan search

- Starting scan search
 - ▶ Press **SC** soft key.
SC will appear in the display. The radio briefly (approximately 8 seconds) tunes in all receivable weather band stations.
- Ending scan search
 - ▶ Press **SC** soft key or **◀◀** or **▶▶**.
The weather band station last played will be selected and **SC** disappears from the display.

Introduction to satellite radio* (USA only)

SIRIUS satellite radio provides 100 channels of digital-quality radio, among others music, sports, news, and entertainment, free of commercials. SIRIUS satellite radio uses a fleet of high-power satellites to broadcast 24 hours per day, coast to coast, in the contiguous U.S.

This diverse, satellite-delivered programming is available for a monthly subscription fee.

For more information and service availability, call the SIRIUS Service Center (▷ page 208), or contact www.sirius.com

Audio system

i Additional satellite radio equipment and a subscription to a satellite radio service provider are required for the satellite radio operation described here.

Contact an authorized Mercedes-Benz Center for details and availability for your vehicle.

Note that categories and channels shown in illustrations are dependent on programming content delivered by the service provider.

Programming content is subject to change.

Therefore, channels and categories shown in illustrations and descriptions contained in this manual may differ from the channels and categories delivered by the service provider.

i Satellite radio service may be unavailable or interrupted from time to time for a variety of reasons, such as environmental or topographic conditions and other things beyond the service provider's or our control. Service might also not be available in certain places (e.g., in tunnels, parking garages, or within or next to buildings) or near other technologies.

Program categories

The channels are categorized. Categories allow you to tune to stations broadcasting a certain type of program (category mode) (▷ page 206).

Calling up the SAT main menu

- ▶ Press SAT soft key.

SAT is displayed in the upper left-hand corner of the display.

Prior to activation of the satellite radio service (▷ page 204).

After activation of satellite radio service (▷ page 205).

Prior to activation of the satellite radio service



The telephone number of the SIRIUS Service Center (888-539-7474) is displayed.

- ▶ Press ESN soft key.

The twelve-digit electronic serial number (ESN) of the SAT tuner* installed in your vehicle is displayed.

This information is required to call the SIRIUS Service Center for an activation request.

i Credit card information may also be required for your application.

The activation process takes approximately 5 to 10 minutes after calling the SIRIUS Service Center.

After activation of the satellite radio service

The satellite radio main menu appears. The radio station selected last is audible, provided it can be received.

i The system will tune to a default station if no station had been selected previously.



The first channel 001 is called up and the PTY system changes to All categories.

If no station can be received, ACQUIRING appears in the display.

If the Satellite radio service is not activated, ACQUIRING will also appear in the radio display and NO SAT will appear in the multifunction display.

Selecting a station

The following options are available:

- Selecting a station using the selected category (▷ page 206).
- Tuning via station presets (▷ page 205).
- Tuning via scan search (▷ page 207).
- Tuning via manual channel input (▷ page 206).
- Tuning via the program category list (▷ page 206).

Tuning via station presets

Ten satellite radio station presets are available.

You can access the presets via number keys.

Audio system

Accessing via number keys

- ▶ Enter number of preset you wish to select, e.g. **1**.

The radio plays the station stored under this number and the PTY function changes to the category corresponding to the station.

Tuning via manual channel input



Example: tuning in channel 16

- ▶ Press *** .**

Input line appears in the main radio menu.

- ▶ Use number keys to enter desired channel within 8 seconds, e.g. **1 6**.

The system tunes to channel 16.

The station you have selected begins to play.

i You can only enter available channel numbers.

Tuning via the program category list

The category list contains all currently receivable categories of programs. It is arranged alphabetically.

- Selecting a category
 - ▶ Press PTY soft key.



The current PTY category of the station is displayed.

- ▶ Press <<< or >>> soft key.

This switches between the individual categories.

When changing the category, the channel selected last in the new category becomes audible.

The system will automatically switch to a station of the selected category if the currently selected station is not of the selected category. Otherwise, the currently selected station remains tuned.

- Tuning a station within the selected category

The channels identified for the currently selected category are arranged numerically. Only one entry is visible at a time.

- ▶ Press **⏮** or **⏭** button briefly.

The next station within the category is started.

or

- ▶ Press and hold **⏮** or **⏭** button for approximately 3 seconds until desired station has been reached.

Tuning via scan search

Scan search is characterized as follows:

- Scan search plays a channel for approximately 8 seconds and then skips to the next channel within the current category.
- Scan search can be terminated manually.
- ▶ Press **SC** soft key.

The search starts. **SC** appears in the display.

- ▶ Press **SC** soft key again.

The search stops.

Obtaining additional text information

Additional text information (artist, title) related to the current channel can be displayed.

- ▶ Press **INF** soft key.

The title being played is displayed.

- ▶ Press **INF** soft key again.

The name of the artist performing the title being played is displayed.

i *If a button is not pressed within 4 seconds, the radio will return to the standard display.*

Audio system

Storing stations

- ▶ Tune in desired station.
- ▶ Press and hold desired station button **1** to **0** until a brief signal tone is heard.

The frequency is stored on the selected station button.

The radio saves the current station at the memory preset selected. The memory preset selected appears in the status line, e.g. S3.

i *There are ten presets available.*

An existing entry is overwritten in the memory list when a new entry is given.

Calling up the ESN information menu

- ▶ Press INF soft key.
- ▶ Press ESN soft key.

The twelve-digit electronic serial number (ESN) of the SAT tuner* installed in your vehicle is displayed.

- ▶ Press RET soft key to exit the menu.

CD mode

Safety precautions

Warning!



The single CD player and the CD changer* are Class 1 laser products. There is a danger of invisible laser radiation if the housing is opened or damaged.

Do not open the housing. The single CD player and the CD changer* do not contain any parts that can be serviced by the user. For safety reasons, have any service work which may be necessary performed only by qualified personnel.

Warning!

In order to avoid distraction which could lead to an accident, the driver should insert CDs with the vehicle at a standstill and operate the audio system only if permitted by road, weather and traffic conditions.

Bear in mind that at a speed of just 30 mph (approximately 50 km/h), your vehicle is covering a distance of 44 feet (approximately 14 m) every second.

General notes

The system may not be able to play audio CDs with copy protection.

Playing copied CDs may cause malfunctions during playback.

i *The audio system plays both CD-Rs and CD-RWs with audio data.*

! *If you affix stickers to the CDs, they can become warped due to the heat that develops in the CD drive or CD changer.*

In certain situations, the CDs can then no longer be ejected and cause damage to the drive. Such damage is not covered by the Mercedes-Benz Limited Warranty.

! *Your CD drive or CD changer has been designed to play CDs which correspond to the EN 60908 standard. You can therefore only use CDs with a maximum thickness of 1.3 mm.*

If you insert thicker data carriers, e.g. ones that have data on both sides (one side with DVD data, the other side with audio data), they cannot be ejected and will damage the drive.

! *Do not use CDs with an 8 cm diameter, not even with a CD adapter. Attempting to play CDs with an 8 cm diameter or playing such CDs with an adapter may cause damage to the CD drive. Such damage is not covered by the Mercedes-Benz Limited Warranty.*

Should excessively high or low temperatures occur while in CD changer mode*, CD TEMP will appear in the display, and the CD will be muted until the temperature has reached an acceptable level for the system to continue operation.

The single CD player and the CD changer* play audio CDs.

Audio system

Tips on handling CDs

- Handle CDs carefully to prevent interference during playback.
- Avoid scratches, fingerprints and dust on the CDs.
- Do not write on CDs or apply any labels or other material to them.
- Clean CDs from time to time with a commercially available cleaning cloth. Never wipe the CD in a circular motion; instead, wipe it in a straight line starting in the center and moving outward. Do not use solvents, anti-static sprays, etc. for cleaning.
- Replace the CD in its case after use.
- Protect CDs from heat and direct sunlight.

MP3

The CD changer* can play audio CDs as well as CDs with MP3 files.

Information on MP3 data carriers

i *CD media, CD burning software and CD writers are available in great variety. Due to this variety, it cannot be guaranteed that the CD changer will be able to play every user-written CD.*

The burning process can lead to data errors and aging of the medium may result in data loss. Therefore, the CD changer may be restricted in its ability to play MP3 data carriers; it may play them with reduced sound quality, or it may not be able to play them at all.

Problems may be encountered during playback of user-written CDs with a storage capacity of more than 700 MB. These CDs do not meet valid standards as of this printing.

Compatible MP3 data carriers

The CD changer can read the following data carriers in MP3 mode:

- CD-DA
- CD-R
- CD-RW

Compatible file systems and compression methods

Use Romeo or Joliet. Depending on file format used, up to 128 characters are possible.

The following compression methods are compatible:

- MP3
- WMA
- WAV

Compatible bit and sampling rates

Fixed and variable bit rates of up to 320 kBit/s are possible.

The following table lists possible sampling rates:

MPEG1 Audio Layer3	44.1 KHz, 48 KHz, 32 KHz
MPEG2 Audio Layer3	22.5 KHz, 24 KHz, 16 KHz
MPEG2.5 Audio Layer3	11.025 KHz, 12 KHz, 8 KHz
WMA	32 KHz, 44.1 KHz, 48 KHz

i Only use MP3 tracks with a bit rate of 128 kBit/s or higher and with the specified sampling rates.

The use of rates other than those specified may lead to noticeably inferior sound quality.

Information on copyright

The music tracks that you create for use in MP3 mode or that you play in MP3 mode are subject to copyright laws under applicable international and national regulations.

In many countries, the reproduction of copyrighted materials is not permitted, even if only for personal use, without the express prior consent of the copyright holder.

Please check the current copyright laws for your country and comply with them.

These restrictions do not apply, for example, to your own compositions and recordings, or for recordings for which authorization has been obtained from the copyright holder.

MP3 playback

You can play an MP3 CD on the CD changer* as you would any standard audio CD. All of the functions described for the CD changer also apply for the playback of MP3 CDs. Keep in mind that the single CD player in the audio system unit is not able to read MP3 CDs.

The first 99 tracks on the CD, including tracks in subdirectories, are recognized and played. Any additional tracks will not be played.

i Due to the branched data structure, playback of the first track may be delayed slightly.

Audio system

Operating the single CD player in the audio system unit

Loading a CD

The single CD player in the audio system unit has capacity for one CD. The CD slot for loading the drive is located underneath the soft keys.

- ▶ Make sure the system is switched on.
- ▶ Insert CD into CD slot. The label side of the CD must face upwards.

The system automatically pulls the CD into the CD slot. The audio CD begins to play.

! *If a CD is already loaded, it must be ejected before inserting a new CD. Inserting a second CD in the slot with another CD still loaded will cause damage to the CD drive not covered by the Mercedes-Benz Limited Warranty.*

i *If a CD has been inserted incorrectly or cannot be read, WRONG CDO will appear in the display.*

Ejecting a CD

- ▶ Make sure the system is switched on.
- ▶ Press  button.
The system ejects the CD. Remove CDO will appear in the display.
- ▶ Remove CD from slot.

With the CD removed, NO CD will appear in the display.

i *If you do not take the CD out of the CD slot within approximately 15 seconds, the system automatically pulls the CD back in and plays it.*

If a CD is pulled back in, press  button, the CD will then be ejected.

Operational readiness of CD changer*

If a CD changer has been installed in the vehicle, it can be operated from the front control panel of the audio system.

The CD changer is located in the glove box.

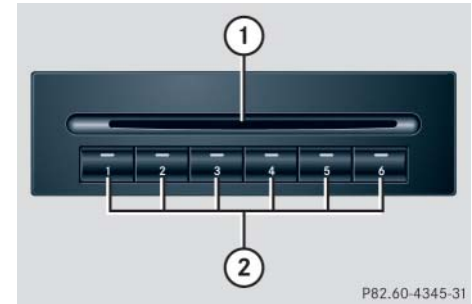

- ① CD loading slot
- ② Magazine slot button

A magazine is integrated into the CD changer as a fixed element. It holds a maximum of six CDs.

The CD changer features six magazine slot buttons ② for controlling the loading procedure.

A light-emitting diode in the buttons shows the status of the corresponding magazine slot.

CD loading slot ① is above buttons ② and is used to load CDs.

LEDs	
no LED is lit	Magazine slot is empty.
green LED flashes	CD can be loaded.
red LED is lit	Magazine slot is in use.
red LED flashes	CD is being ejected.

Loading the CD magazine

i If a CD has been inserted incorrectly or cannot be read, **WRONG CD** will appear in the display.

Loading one or more CDs interrupts the CD playback.

Loading single CDs

- ▶ Open the glove box (> page 252).

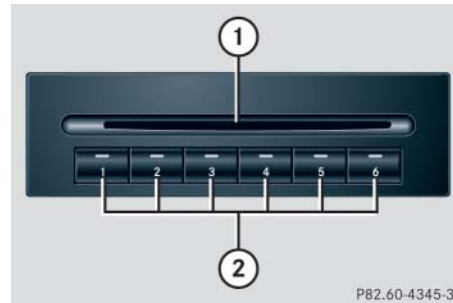

- ① CD loading slot
- ② Magazine slot button

- ▶ Briefly press button ② for the empty magazine slot that you would like to use.

The light-emitting diode in the magazine slot button flashes in green. **INSERT CD** appears in the display along with the slot number.

The flashing light indicates that the CD changer is ready to receive a CD.

- ▶ Insert an audio CD into CD loading slot ① within 5 seconds, label side up. The CD is pulled in and played.
- ▶ Close the glove box.

Audio system

Loading several CDs

- ▶ Open the glove box.
- ▶ Press button ② of an empty magazine slot for more than 2 seconds.

The light-emitting diodes in all the magazine slot buttons light up several times in green, and ALL LOAD appears in the display.

- ▶ Wait until the light-emitting diode for the first magazine slot flashes in green.

The flashing light indicates that the CD changer is ready to receive a CD.

- ▶ Insert an audio CD into CD loading slot ① within 5 seconds, label side up.

The CD is pulled in and the light-emitting diode in the magazine slot button lights up in red. The magazine slot is loaded.

The light-emitting diode in the next available magazine slot button flashes in green. The CD changer is ready to receive the next CD.

- ▶ Repeat the previous step until all six magazine slots are loaded.

Once all magazine slots are loaded, the CD in the sixth magazine slot is played.

i *If, for example, you only want to load magazine slots 1 - 4 instead of all six, simply do not insert a fifth CD into the CD loading slot. The CD changer will first try to load a CD but will then cancel the procedure, after which the radio will play the fourth CD.*

- ▶ Close the glove box.

Ejecting CDs

i *The CD playback is interrupted while one or more CDs are being ejected.*

Ejecting single CDs

- ▶ Open the glove box.
- ▶ Briefly press desired magazine slot button.

The light-emitting diode in the magazine slot button flashes in red. The corresponding CD is ejected. EJECTING CD appears in the display along with the magazine slot number.

- ▶ Remove CD from CD loading slot within 15 seconds.

If after removing a single CD no other CDs remain loaded in the magazine, MAG. EMPTY appears in the display.

i If you do not take the CD from the CD loading slot within 15 seconds, the CD changer will automatically pull the CD back in. The system will then play the CD.

If you are listening to a CD while ejecting another CD from the changer: The Audio system stops playing the CD while another CD is being ejected. Once the CD has been ejected, the Audio system will continue playing where it left off.

- ▶ Close the glove box.

Ejecting all loaded CDs

- ▶ Open the glove box.
- ▶ Press the button of a loaded magazine slot for more than 2 seconds.

The light-emitting diodes in all magazine slot buttons light up several times in red, and ALL EJECT appears in the display.

The CD changer ejects the CDs one after another.

The light-emitting diode for the magazine slot being emptied flashes in red.

- ▶ Take corresponding CD from CD loading slot within 15 seconds.

The ejection procedure is finished once you have removed all CDs from the CD loading slot or if the CD changer cancels the procedure.

With all CDs removed from the magazine, MAG. EMPTY appears in the display.

i If you do not take the CD from the CD loading slot within 15 seconds, the CD changer will automatically pull the CD back in. The system will then play the CD.

With all CDs ejected, press the **RADIO** button to switch back to the radio mode.

- ▶ Close the glove box.

Audio system

Playing CDs

Single CD player in the audio unit

- ▶ Press **CD** button.

CD0 will appear in the upper left-hand corner of the display.

The CD will resume playback at the point where it was switched off.

CD changer*

- ▶ Press **cdc** button.

CD and the selected magazine slot number appear in the upper left-hand corner of the display.

If you have not removed a CD since the last time the CD audio source was activated, the last CD listened to will begin to play at the point where it was switched off.

After the last track on a CD has finished, the next CD is automatically played.

Playing tracks

You have the following options:

- Audio system with CD changer*:
selecting CDs
- Direct track entry
- Track skip forward/reverse
- Fast forward/reverse
- Scan
- Random tracks
- Repeat track

Selecting CDs in the audio unit with CD changer*

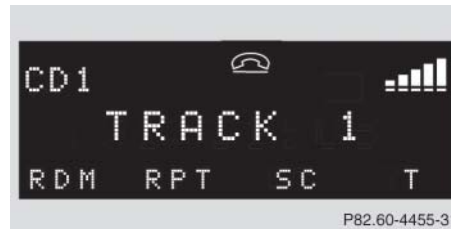

- ▶ You can select from among the inserted CDs with buttons

0 to **6**.

0 = CD player in the audio unit

1 to **6** = CDs in the CD changer*

The magazine slot number of the selected CD appears next to CD in the display, and the number of the currently played track appears next to TRACK.

i If there is no CD in the selected magazine slot, NO CD appears in the display with the corresponding slot number.

Direct track entry



You can make a direct selection from among the tracks on a CD.

- ▶ Press ***** button.
- ▶ Enter track number using buttons **1** to **0**.

The number of the track being played appears next to **TRACK** in the display.

You can only enter available track numbers.

Skipping tracks forward/backward

- Skipping tracks forward
 - ▶ Press **>>>** button briefly.
The next track will be played.
- Skipping tracks backward
 - ▶ Press **<<<** button briefly.

If the track has been playing for more than 10 seconds, the unit skips back to the beginning of the track currently playing. If less than 10 seconds have been played, the unit skips back to the beginning of the previous track.

Pressing the **<<<** or **>>>** button repeatedly will result in multiple tracks being skipped.

Fast forward/reverse

- Fast forward
 - ▶ Press and hold **>>>** button until desired point has been reached.
- Reverse
 - ▶ Press and hold **<<<** button until desired point has been reached.

i *The track number and the relative time of the track is shown in the display during the search.*

Scan

- Starting scan
 - ▶ Press **SC** soft key.
SC will appear in the display.
Each track on the current CD will be played for approximately 8 seconds in ascending order.
- Ending scan
 - ▶ Press **SC** soft key or **<<<** or **>>>**.

Audio system

Random play

The random function (RDM) plays the tracks of the current CD in random order.

i When you start the RDM function, the RPT function is automatically switched off.

- Switching on random

- ▶ Press RDM soft key.

RDM appears in the display.
A randomly selected track is played.

- Switching off random

- ▶ Press RDM soft key again.

Repeat

The track being played is repeated until the repeat function (RPT) is switched off.

i When you start the RPT function, the RDM function is automatically switched off.

- Switching on repeat

- ▶ Press RPT soft key.

RPT appears in the display.

- Switching off repeat

- ▶ Press RPT soft key again.

Pause function

The CD changer mode is interrupted by an incoming call on the telephone* (▷ page 224).

- Switching on pause function



- ▶ Press  button.

The CD changer mode is interrupted and PAUSE appears in the display.

- Switching off pause function

- ▶ Press  button.

The CD changer mode is active again.

Track and time display



- ▶ Press T soft key.

The number of the track being played and the elapsed playing time appear in the display.

- ▶ Press T soft key again.

The total number of tracks and the total playing time of the CD appear in the display.

- ▶ Press T soft key.

The standard CD playback menu appears in the display.

GSM network phones

Using your Mercedes-Benz specified mobile telephone*, a number of functions and operating steps can be performed and displayed in the audio system display.

Warning!



A driver's attention to the road must always be his/her primary focus when driving. For your safety and the safety of others, we recommend that you pull over to a safe location and stop before placing or taking a telephone call. If you choose to use the telephone¹ while driving, please use the hands-free device and only use the telephone when weather, road, and traffic conditions permit.

Some jurisdictions prohibit the driver from using a cellular telephone while driving a vehicle.

Bear in mind that at a speed of just 30 mph (approximately 50 km/h), your vehicle is covering a distance of 44 feet (approximately 14 m) every second.

¹ Observe all legal requirements.

Audio system

Further operating instructions not covered here can be found in the operating instructions for the multifunction steering wheel and the mobile telephone*.

If your audio system is set up for telephone operation, the  symbol will appear in the display.

When you insert your Mercedes-Benz specified mobile telephone* into the telephone cradle, you will be prompted to enter your PIN for 30 seconds (▷ page 220). This display disappears when you press any button.

When your mobile telephone* is inserted into the telephone cradle, you will see the reception strength in the upper right-hand corner of the display.

Switching on the telephone

Switching on the telephone

- ▶ Press **TEL** button.

If the telephone was previously switched off, PROCESSING appears in the display and you will then be prompted to enter your PIN.

Switching off the telephone

- ▶ Press **TEL** button for approximately 3 seconds.

PROCESSING appears in the display until the telephone is off. Afterward, PHONE OFF appears in the display.

PIN entry



- ▶ Enter PIN number using buttons **1** to **0**.
- ▶ If necessary, correct number entered with the CLR soft key. Press soft key briefly to delete the last digit entered; press soft key and hold to delete the complete number.
- ▶ Press OK soft key after entering correct PIN.
- ▶ READY or ROAMING will appear in the display.

i If the PIN is entered incorrectly three times, NEED PUK will appear in the display. Enter PUK via your telephone. Please refer to the separate telephone operating instructions for more information.

Adjusting the volume

- ▶ Turn rotary control of  button during a telephone call.

The volume will increase or decrease depending on the direction turned.

 *The volume can be adjusted separately for telephone mode and audio mode.*



Adjusting sound

- ▶ Adjust sound during a telephone call. Sound adjustment see “Adjusting sound functions” (▷ page 197).

Placing a call

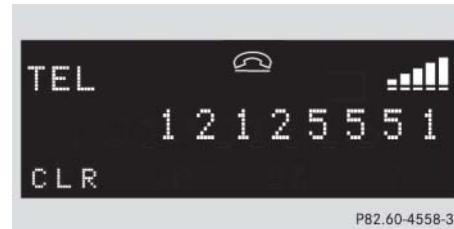
Entering a telephone number and starting the dialing process



- ▶ Enter desired telephone number using buttons  to .

The number can have up to 32 digits, but only twelve of these are visible in the display.

- ▶ If necessary, correct number entered with the CLR soft key. Press soft key briefly to delete the last digit entered; press soft key and hold to delete the complete number.
- ▶ After correct telephone number has been entered, press .

 *If the telephone number has been saved together with a name in the telephone book, the name will appear in the display.*

Phone book

The numbers stored in the phone book of the telephone can be called up either by name or number.

In addition, incoming calls are stored in the phone book.



 *This is only possible, however, when the call information transmitted includes the number of the person calling. If the telephone number is not transmitted, NO NUMBER will be stored in the phone book.*



Audio system

- Searching and calling up telephone book entries by name

You can access your mobile telephone's phone book using the audio system. You can access both the main entries and the sub-entries of your phone book.





- ▶ Press MEM soft key or press button  or .



- ▶ Press desired numerical key  to .

The stored entries are selected according to the alphabetical order of the initial letters (e.g. for S-Schneider, press button  four times).



or

- ▶ Press and hold button  or .

The system jumps from one initial letter to the next in ascending or descending order.

- ▶ Press and hold button  or  until desired initial letter has been reached.

or

- ▶ Press button  or  repeatedly until desired entry has been reached.

The stored entries are selected in alphabetical order with the sub-entries.

 Several sub-entries can be stored for each main entry (name). These entries are marked by a corresponding abbreviation that appears in the upper left-hand corner of the display. The following abbreviations for sub-entries are possible:

CEL = Mobile phone

HOM = Home

WOR = Work

FAX = Fax

PAG = Pager

TEL = Main

- ▶ When you have selected a number, press .

The call will be made.

- Viewing the telephone number of a telephone book entry

- ▶ Search for desired entry.
- ▶ Press NUM soft key.

The telephone number of the phone book entry appears in the display.

- Returning calls received



- ▶ Press MEM soft key or press button or .
- ▶ Press RCV soft key (received calls).
The number of received calls and then the call last received appear briefly in the display.

- ▶ Select desired telephone number with button or .
- The letter R and the number of the memory position appear in the upper left-hand corner of the display. The numbers are stored in the order of the calls received.
- ▶ When you have selected a number, press button.
The call will be made.

- Speed dial

If you have stored telephone numbers as speed dial numbers in your telephone, you can also enter these with buttons to on the radio head unit.

- ▶ Press desired button to briefly.
- ▶ Press button.
The call will be made.

- Turbo dial

If you have stored telephone numbers as turbo dial numbers in your telephone, you can also enter these with buttons to on the radio head unit.

- ▶ Press desired button to until the call is made.

Audio system

Redial

If the number you have dialed is busy, you can again place calls to the last ten telephone numbers dialed using the redial function.

i If you have activated the automatic redial function on your telephone, the number of the person being called is automatically redialed after a short waiting period if there is a busy signal. Refer to the separate operating instructions for the mobile telephone.

- Manual redial



- ▶ Press  button.

The telephone number last dialed will appear in the display.

- ▶ Select desired telephone number with button  or .

The letter L and the number of the memory position appears in the left-hand corner of the display. The numbers are stored in the order of the calls received.

- ▶ When you have selected a number, press  button.

The call will be made.

Accepting an incoming call

If the telephone is active in the background (reception symbol is visible in the display), the audio source is muted when an incoming call is received. A ringing tone can be heard and the caller's telephone number, or the name under which the telephone number has been saved in the phone book, appears in the display. If the caller's number is not transmitted with the call, CALL will appear in the display.

- ▶ Press  button.

The call is accepted.

Muting a call

It is possible to mute a call; the caller is then no longer able to hear you.

- Mute on
 - ▶ Press MUT soft key.
 - ▶ MIC MUTE will appear in the display.
- Mute off
 - ▶ Press MUT soft key again.



Terminating a call

- ▶ Press  button.

The current call is terminated and the muted audio source becomes active again.



Talking with two callers at the same time

If you wish to receive or place another call during an already active call, you can accept or place the second call and switch between the callers or combine them into one call. Note that the feature described here is dependent on availability from your mobile phone service provider.



- Placing/accepting a second call
 - ▶ Place new call by entering telephone number manually.
 - ▶ Press  button.
You are connected to the second caller; the first caller is kept on hold.
or
 - ▶ Press  button to accept a second call.

 You will be notified of the second call acoustically, but you will not see this in the display.

You are connected with the second caller; the first caller is kept on hold.

- Switching between calls
 - ▶ Press  and  buttons.
This switches between the calls.
The non-active call is kept on hold.
- Terminating a call
 - ▶ Press  button.
The current call is terminated. You are again connected with the caller previously placed on hold.

Audio system

- Combining two calls
 - ▶ Press  and  buttons.
The calls are combined into one call.
- Terminating a combined call
 - ▶ Press  button.
The connection to both callers is terminated.

TDMA or CDMA network phones

Warning!



A driver's attention to the road must always be his/her primary focus when driving. For your safety and the safety of others, we recommend that you pull over to a safe location and stop before placing or taking a telephone call. If you choose to use the telephone¹ while driving, please use the hands-free device and only use the telephone when weather, road, and traffic conditions permit.

Some jurisdictions prohibit the driver from using a cellular telephone while driving a vehicle.

Bear in mind that at a speed of just 30 mph (approximately 50 km/h), your vehicle is covering a distance of 44 feet (approximately 14 m) every second.

¹ Observe all legal requirements.

Using your Mercedes-Benz specified mobile telephone*, a number of functions and operating steps can be performed and displayed in the audio system display.

Further operating instructions not covered here can be found in the operating instructions for the multifunction steering wheel and the mobile telephone*.

If your audio system is set up for telephone operation, the  symbol will appear in the display.

When you insert your Mercedes-Benz specified mobile telephone* into the telephone cradle, you will be prompted to enter your PIN for 30 seconds (> page 227). This display disappears when you press any button.

When your mobile telephone* is inserted into the telephone cradle, you will see the reception strength in the upper right-hand corner of the display.

Switching on the telephone

Switching on the telephone

- ▶ Press **TEL** button.

If you have programmed an unlock code for the telephone, you must now enter the code.



- ▶ Enter code using buttons **1** to **0**.
- ▶ If necessary, correct number entered with the CLR soft key. Press soft key briefly to delete the last digit entered; press soft key and hold to delete the complete number.

- ▶ Press OK soft key after entering correct code.

The telephone is unlocked. If you have entered an incorrect code, you must enter the correct code.

Switching off the telephone

- ▶ Press **TEL** button for approximately 3 seconds.

PROCESSING appears in the display until the telephone is off. Afterward, PHONE OFF appears in the display.

Adjusting the volume

- ▶ Turn rotary control of **ON** button during a telephone call.

The volume will increase or decrease depending on the direction turned.

i *The volume can be adjusted separately for telephone mode and audio mode.*

Adjusting sound

- ▶ Adjust sound during a telephone call. Sound adjustment see “Adjusting sound functions” (> page 197).

Placing a call

Entering a telephone number and starting the dialing process



- ▶ Enter desired telephone number using buttons **1** to **0**.

The number can have up to 32 digits, but only twelve of these are visible in the display.



Audio system

▷▷ If necessary, correct number entered with the CLR soft key. Press soft key briefly to delete the last digit entered; press soft key and hold to delete the complete number.

▶ After correct telephone number has been entered, press  button.

i *If the telephone number has been saved together with a name in the phone book, the name will appear in the display.*

Phone book

The numbers stored in the phone book of the mobile telephone can be called up either by name or number.



In addition, incoming calls are stored in the phone book.



i *This is only possible, however, when the call information transmitted includes the number of the person calling. If the telephone number is not transmitted, NO NUMBER will be stored in the phone book.*

- Searching and calling up phone book entries by name

You can access your mobile telephone's phone book with the audio system. You can access both the main entries and the sub-entries of your phone book.





- ▶ Press MEM soft key or press button  or .



- ▶ Press desired numerical key  to .

The stored entries are selected according to the alphabetical order of the initial letters (e.g. for S -Schneider, press button  four times).



or

- ▶ Press and hold button  or .

The system jumps from one initial letter to the next in ascending or descending order.

- ▶ Press and hold button  or  until desired initial letter has been reached.

or

- ▶ Press button  or  repeatedly until desired entry has been reached.

The stored entries are selected in alphabetical order with the sub-entries.

i Several sub-entries can be stored for each main entry (name). These entries are marked by a corresponding abbreviation that appears in the upper left-hand corner of the display. The following abbreviations for sub-entries are possible:

CEL = Mobile phone
 HOM = Home
 WOR = Work
 FAX = Fax
 PAG = Pager
 TEL = Main

- ▶ When you have selected a number, press  button.



The call will be made.

- Viewing the telephone number of a phone book entry
 - ▶ Search for desired entry.
 - ▶ Press NUM soft key.

The telephone number of the phone book entry appears in the display.

- Returning calls received



- ▶ Press MEM soft key or press button  or .
- ▶ Press RCV soft key (received calls).

The number of received calls and then the call last received appear briefly in the display.

- ▶ Select desired telephone number with button  or .

The letter R and the number of the memory position appear in the upper left-hand corner of the display. The numbers are stored in the order of the calls received.

- ▶ When you have selected a number, press  button.

The call will be made.

Audio system

- Speed dial

If you have stored telephone numbers as speed dial numbers in your telephone, you can also enter these with buttons **1** to **0** on the radio unit.

- ▶ Press desired button **1** to **0** briefly.
- ▶ Press  button.
The call will be made.

- Turbo dial

If you have stored telephone numbers as turbo dial numbers in your telephone, you can also enter these with buttons **1** to **0** on the radio unit.

- ▶ Press desired button **1** to **0** until the call is made.

Redial

If the number you have dialed is busy, you can again place calls to the last ten telephone numbers dialed using the redial function.

 *If you have activated the automatic redial function on your mobile telephone, the number of the person being called is automatically redialed after a short waiting period if there is a busy signal. Refer to the separate operating instructions for the mobile telephone.*

- Manual redial



- ▶ Press  button.

The telephone number last dialed will appear in the display.

- ▶ Select desired telephone number with button  or .

The letter L and the number of the memory position appears in the left-hand corner of the display. The numbers are stored in the order of the calls received.

- ▶ When you have selected a number, press  button.

The call will be made.

Accepting an incoming call

If the telephone is active in the background (reception symbol is visible in the display), the audio source is muted when an incoming call is received. A ringing tone can be heard and the caller's telephone number, or the name under which the telephone number has been saved in the telephone book, appears in the display. If the caller's number is not relayed, CALL will appear in the display.

- ▶ Press  button.

The call is accepted.

Muting a call

It is possible to mute a call; the caller is then no longer able to hear you.

- Mute on
 - ▶ Press MUT soft key.
 - ▶ MIC MUTE will appear in the display.
- Mute off
 - ▶ Press MUT soft key again.

Terminating a call

- ▶ Press  button.

The current call is terminated and the muted audio source becomes active again.

Accepting a second incoming call



If you receive another call during an already active call, you can accept the second call and switch between the two.

- Accepting a second call
 - ▶ Place new call by entering telephone number manually.

 *You will be notified of the second call acoustically, but you will not see this in the display.*

You are connected to the second caller; the first caller is kept on hold.



Audio system

- Switching between calls
 - ▶ Press  button.
This switches between the calls.
The non-active call is kept on hold.
- Terminating a call
 - ▶ Press  button.
The current call is terminated. The connection to the caller previously kept on hold is also interrupted; however, reconnection is indicated by an acoustic signal.

Placing a second call

If you wish to place another call during an already active call, you can place the second call and switch between the callers or combine them into one call. Note that this feature is dependent on availability from your mobile phone service provider.

- Placing a second call
 - ▶ Place a new call by entering telephone number manually.
 - ▶ Press  button.
You are connected to the second caller; the first caller is kept on hold.

- Terminating a call
 - ▶ Press  button.
The current call is terminated. The connection to the caller previously kept on hold is also interrupted; however, reconnection is indicated by an acoustic signal.
- Combining two calls
 - ▶ Press  button.
The calls are combined into one call.
- Terminating a combined call
 - ▶ Press  button.
The connection to both callers is terminated.

Emergency calls “911”

The following describes how to dial a “911” emergency call using the audio system head unit when a Mercedes-Benz specified mobile phone* is inserted in the phone cradle. Unless otherwise specified, the descriptions refer to the audio system head unit.

Consult the separate telephone operating instructions that came with your mobile phone* for information on how to place a “911” emergency call on the mobile phone*.

Warning!



The “911” emergency call system is a public service. Using it without due cause is a criminal offense.

The following conditions must be met for a “911” emergency call:

- Telephone must be switched on.
- The corresponding mobile communications network must be available.

i *Emergency calls may not be possible with all telephone networks or if certain network services and/or telephone functions are active. Check with your local service providers.*

If you cannot make an emergency call, you will have to initiate rescue measures yourself.

GSM network phones

Placing a “911” emergency call using audio head unit with the phone locked

- ▶ Press **TEL** button to switch to telephone operation.
PIN? appears in the audio display.
- ▶ Enter 911 using the number keypad on the audio head unit.
- ▶ Press **OK** soft key or  button for dialing to begin.
DIALING appears in the audio display while the telephone establishes the connection.
- ▶ Wait until the emergency call center answers, then describe the emergency.

Audio system

Placing a “911” emergency call using audio head unit with the phone unlocked

- ▶ Press **TEL** button to switch to telephone operation.
- ▶ Enter 911 using the number keypad on the audio head unit.
- ▶ Press  button for dialing to begin.
DIALING appears in the audio display while the telephone establishes the connection.
- ▶ Wait until the emergency call center answers, then describe the emergency.

i *If no SIM card is in the mobile phone, NO SERVICE appears in the audio display. In that case, you only can make an emergency call on the mobile phone itself, without the use of the head unit.*

TDMA/CDMA network phones

Placing a “911” emergency call using audio head unit with the phone locked

- ▶ Press **TEL** button to switch to telephone operation.
CODE? appears in the audio display.
- ▶ Enter 911 using the number keypad on the audio head unit.
- ▶ Press OK soft key or  button for dialing to begin.
DIALING appears in the audio display while the telephone establishes the connection.
- ▶ Wait until the emergency call center answers, then describe the emergency.

Placing a “911” emergency call using audio head unit with the phone unlocked

- ▶ Press **TEL** button to switch to telephone operation.
- ▶ Enter 911 using the number keypad on the audio head unit.
- ▶ Press  button for dialing to begin.
DIALING appears in the audio display while the telephone establishes the connection.
- ▶ Wait until the emergency call center answers, then describe the emergency.

▼ Power windows

Opening and closing the windows

The windows are opened and closed electrically. The switches for both door windows are located on the driver's door. The switch for operating the passenger-side door window is located on the passenger door.

The door windows can also be operated using the retractable hardtop switch (▷ page 237). The rear side windows can only be operated using the retractable hardtop switch (▷ page 237) or the SmartKey* (▷ page 238).



- ① Left door window
- ② Right door window



Warning!



When closing the windows, make sure there is no danger of anyone being harmed by the closing procedure.

The closing of the door windows can be immediately halted by releasing the switch or, if the switch was pressed past the resistance point and released, by pressing the respective switch.

The door windows are equipped with the express-close and automatic reversal function. If a door window encounters an obstruction that blocks its path in a circumstance where you pressed the switch past the resistance point and released it to close the window, the automatic reversal function will stop the window and open it slightly.

If a door window encounters an obstruction that blocks its path in a circumstance where you are closing the window by pressing and holding the switch, by pressing and holding button  on the SmartKey, by pushing and holding the retractable hardtop switch, or by pressing and holding the  button on the climate control panel or automatic climate control* panel, the automatic reversal function will not operate.

When leaving the vehicle, always remove the SmartKey from the starter switch, take it with you, and lock the vehicle. Do not leave children unattended in the vehicle, or with access to an unlocked vehicle.

A child's unsupervised access to a vehicle could result in an accident and/or serious personal injury.

Power windows

i You can also open or close the windows using the SmartKey* (▷ page 238) or the retractable hardtop switch (▷ page 237).

You can close and open the windows using the air recirculation switch  in the control panel of the climate control (▷ page 178) or the automatic climate control* (▷ page 189).

i After switching off the ignition (▷ page 37) or removing the SmartKey from the starter switch, the door windows can be operated:

- until you open a door
 - for at least 5 minutes if no door was opened
- ▶ Switch on the ignition (▷ page 37).

Opening the door windows

- ▶ Press and hold switch ① or ② at the symbol  to the resistance point.

The corresponding window will move downwards until you release the switch.

Closing the door windows

- ▶ Press and hold switch ① or ② at the symbol  to the resistance point.

The corresponding window will move upwards until you release the switch.

Warning!



If you press and hold the switch when closing the window, and upward movement of the window is blocked by some obstruction including but not limited to arms, hands, fingers, etc., the automatic reversal will not operate.

Fully opening the door windows (Express-open)

- ▶ Press switch ① or ② at the symbol  past the resistance point and release.

The corresponding window opens completely.

Fully closing the door windows (Express-close)

- ▶ Press switch ① or ② at the symbol  past the resistance point and release.

The corresponding window closes completely.

Warning!



Driver's door only:



If the switch is pressed again past the resistance point and released within 5 seconds, the automatic reversal will not operate.

! If the upward movement of the window is blocked during the closing procedure, the window will stop and open slightly.

Remove the obstruction, press the respective switch at the symbol  again past the resistance point and release.

If the window still does not close when there is no obstruction, press and hold the respective switch at the symbol . The window will then close without the obstruction sensor function.

Stopping windows during Express-operation

- ▶ Briefly press the respective switch at the symbol  or  again.

Opening and closing the windows with the retractable hardtop switch

All windows can be opened or closed with the retractable hardtop switch.

The retractable hardtop switch is located on the lower part of the center console.



Retractable hardtop switch

- ① Opening all side windows
- ② Closing all side windows

Warning!



Never operate the windows if there is the possibility of anyone being harmed by the opening or closing procedure.

In case the procedure causes potential danger, the procedure can be immediately halted by releasing the retractable hardtop switch.

If a door window encounters an obstruction that blocks its path in a circumstance where you are closing the windows using the retractable hardtop switch, the automatic reversal function will not operate.

- ▶ Switch on the ignition (▷ page 37).

Power windows

Opening

- ▶ Push the retractable hardtop switch in quick succession twice in direction of arrow ①.

All side windows open.

i You can operate the rear side windows only by using the retractable hardtop switch.

Closing

- ▶ Push the retractable hardtop switch in quick succession twice in direction of arrow ②.
- ▶ Keep the retractable hardtop switch pushed the second time until all windows are closed.

The windows in the driver's and passenger door will close first, followed by the rear side windows.

i When the retractable hardtop is open, only the windows in the driver's and passenger door will close. The rear side windows remain open.

Opening and closing the windows with the SmartKey*

The retractable hardtop (▷ page 240) will also be opened or closed when the power windows are operated with the SmartKey.



- ▶ Aim transmitter eye at the outside driver's or passenger door handle.
The SmartKey must be in close proximity to the respective outside door handle.

Opening (Summer opening feature)

- ▶ Press and hold button .

The windows and retractable hardtop begin to open after approximately 1 second.

In the multifunction display you will see the message *Retractable roof in operation*.

- ▶ Release button  on the SmartKey to interrupt procedure.

Closing (Convenience closing feature)

- ▶ Press and hold lock button .

The windows and retractable hardtop begin to close after approximately 1 second.



In the multifunction display you will see the message *Retractable roof in operation*.

- ▶ Release button  on the SmartKey to interrupt procedure.

Warning!

When closing the side windows and retractable hardtop, make sure that there is no danger of anyone being harmed by the closing procedure.

If potential danger exists, proceed as follows:

- Release button  to stop the closing procedure. To open, press and hold button . To continue the closing procedure after making sure that there is no danger of anyone being harmed by the closing procedure, press and hold button .

Warning!

If the retractable hardtop does not completely open or close, the roof hydraulics will lose pressure and the retractable hardtop is lowered

- after approximately 7 minutes when the ignition is switched on.
- after approximately 15 seconds when the ignition is switched off.

Shortly before the hardtop is lowered, a warning will sound. In the multifunction display you will see  and the message Retractable roof being opened.

Properly lock the retractable hardtop (▷ page 242) before continuing to drive.

Synchronizing power windows

The power windows must be synchronized

- after the battery has been disconnected or discharged.
- if the power windows cannot be fully opened (Express-open) or closed (Express-close).

Each power window must be synchronized.

- ▶ Close all doors.
- ▶ Switch on the ignition (▷ page 37).
- ▶ Press and hold both switches ① and ② (▷ page 235) at the symbol  until the windows are completely closed.
- ▶ Hold on to switches ① and ② for approximately 1 second.

The power windows are synchronized.

Retractable hardtop

Opening and closing the retractable hardtop

For safety reasons, the retractable hardtop can only be opened and closed when the vehicle is standing still.

Warning!



Before operating the switch for the retractable hardtop, make sure no persons are injured by the moving parts (retractable hardtop, roof frame, and trunk lid).

Hands must never be placed near the roof frame, upper windshield area, retractable hardtop, shelf behind roll bars, or trunk lid while the retractable hardtop is being raised or lowered. Serious personal injury may occur.

If potential danger exists, release the retractable hardtop switch. This immediately interrupts the raising or lowering procedure. You can then operate the retractable hardtop switch to raise or lower the retractable hardtop away from the danger zone.

Warning!



When leaving the vehicle, always remove the SmartKey from the starter switch, take it with you, and lock the vehicle. Do not leave children unattended in the vehicle, or with access to an unlocked vehicle. A child's unsupervised access to a vehicle could result in an accident and/or serious personal injury.

! Never sit or place heavy objects on the rear shelf. Doing so could cause damage to the retractable hardtop and the rear shelf.

! Please keep in mind that weather conditions can sometimes change rapidly. Make sure to close the retractable hardtop when leaving the vehicle. If water enters the vehicle interior, vehicle electronics could be damaged which is not covered by the Mercedes-Benz Limited Warranty.

! When opening and closing the retractable hardtop, make sure

- there is sufficient clearance for the retractable hardtop to move up and the trunk lid to move back
- the luggage cover is extended and closed
- the trunk is only loaded to the height of the luggage cover
- the luggage/cargo does not push the closed luggage cover up
- the trunk lid is closed
- no roof luggage carrier is installed
- the outside temperature is above +5°F (-15°C)

Otherwise the roof and other parts of the vehicle could be damaged.

Luggage cover

The luggage cover is located in the trunk.

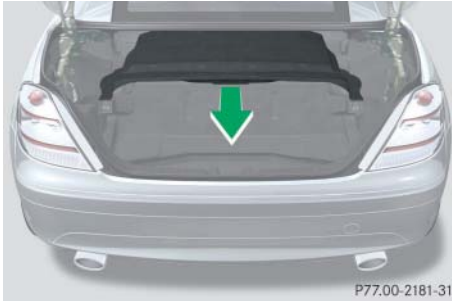

Luggage cover

Closing

- ▶ Pull the luggage cover at the handle in direction of the arrow until it engages on both sides at the trunk sill.

Opening

- ▶ Press the release handle on the luggage cover.
- ▶ Guide the luggage cover forward to its end stop.

! To prevent damage to the retractable hardtop or luggage/cargo when lowering the roof:

- Load trunk only to the height of the luggage cover.
- Do not permit luggage/cargo to push up the closed luggage cover.
- Do not place anything on top or in front of the luggage cover.
- Do not place anything on the shelf behind the roll bar.

Retractable hardtop

Warning!



To prevent possible accidents, drive the vehicle only with the retractable hardtop either completely closed and locked, or fully lowered into its storage compartment.

i For safety reasons, the retractable hardtop cannot be opened or closed while driving.

Make sure the retractable hardtop and the rear window are dry before you open it. Otherwise water may enter the interior and/or trunk.

i Before operating the retractable hardtop via the retractable hardtop switch, do the following first:

- Engage the parking brake (▷ page 59).
- Close the luggage cover.
- Close the trunk lid.
- Switch on the ignition (▷ page 37).

Retractable hardtop

The switch for opening/closing the retractable hardtop is on the lower part of the center console.



Retractable hardtop switch

- ① Opening
- ② Closing

For operating the power windows with the retractable hardtop switch (> page 237).

Opening

- ▶ Push and hold the retractable hardtop switch in direction of arrow ① until the retractable hardtop is completely lowered into the trunk.

Closing

- ▶ Push and hold the retractable hardtop switch in direction of arrow ② until the retractable hardtop is completely closed and locked.

Locking the retractable hardtop after raising/lowering

Warning!



Be sure to keep the hardtop switch pushed until the hardtop is fully opened or closed. The hydraulic pump will then shut off.

To prevent possible accidents, drive the vehicle only with the hardtop either completely closed and locked, or fully lowered into its storage compartment.

Warning!

If the retractable hardtop does not completely open or close, the roof hydraulics will lose pressure and the retractable hardtop is lowered

- after approximately 7 minutes when the ignition is switched on.
- after approximately 15 seconds when the ignition is switched off.

Shortly before the hardtop is lowered, a warning will sound. In the multifunction display you will see  and the message `Retractable roof being opened`.

- Properly lock the retractable hardtop before continuing to drive (▷ page 243).

Warning!

The hardtop is not fully closed and locked or not fully opened and locked if:

- the message `Retractable roof in operation` is shown in the multifunction display
- a warning sounds for 10 seconds when driving and a message in the multifunction display appears (▷ page 374).

If the retractable hardtop is not properly locked, lock it as described below.

Unlocked status noticed when stopped

- ▶ Switch on the ignition (▷ page 37).
- ▶ To lock the retractable hardtop in its fully closed position, push the retractable hardtop switch forward until the retractable hardtop is fully closed.
or:
- ▶ To lock the retractable hardtop in its fully opened position, push the retractable hardtop switch rearward until the retractable hardtop is fully open.

Retractable hardtop

Unlocked status noticed while driving

Warning!



Stop the vehicle and lock the retractable hardtop before continuing to drive. You could otherwise endanger yourself and others.

- ▶ Stop the vehicle and leave the ignition switched on.
- ▶ To lock the retractable hardtop in its fully closed position, push the retractable hardtop switch forward until the retractable hardtop is fully closed.
or:
- ▶ To lock the retractable hardtop in its fully opened position, push the retractable hardtop switch rearward until the retractable hardtop is fully open.

Opening and closing the retractable hardtop with the SmartKey*



The power windows (▷ page 235) will also be opened or closed when you operate the retractable hardtop with the SmartKey.

Warning!



Before operating the retractable hardtop, make sure no persons can be injured by the moving parts (retractable roof, roof frame, and trunk lid) due to negligence.

Hands must never be placed near the roof frame, upper windshield area, hardtop, shelf behind roll bars, or trunk lid while the retractable hardtop is being raised or lowered. Serious personal injury may occur.

If potential danger exists, release the respective button on the SmartKey. This immediately interrupts the raising or lowering procedure. You can then operate  or  to raise or lower the hardtop away from the danger zone.



- ▶ Aim transmitter eye at the outside driver's or passenger door handle.
The SmartKey must be in close proximity to the respective outside door handle.

Opening (Summer opening feature)

- ▶ Press and hold unlock button  until the retractable hardtop is completely open.

The retractable hardtop and windows begin to open after approximately 1 second. In the multifunction display you will see the message `Retractable roof in operation`.

- ▶ Release button  on the SmartKey to interrupt procedure.

Closing (Convenience closing feature)

- ▶ Press and hold lock button  until the retractable hardtop is fully closed.



The retractable hardtop and windows begin to close after approximately 1 second. In the multifunction display you will see the message `Retractable roof in operation`.

- ▶ Release button  on the SmartKey to interrupt procedure.

Warning!

When closing the side windows and retractable hardtop, make sure that there is no danger of anyone being harmed by the closing procedure.

If potential danger exists, proceed as follows:

- Release button  to stop the closing procedure. To open, press and hold button . To continue the closing procedure after making sure that there is no danger of anyone being harmed by the closing procedure, press and hold button .

Warning!

If the retractable hardtop does not completely open or close, the roof hydraulics will lose pressure and the retractable hardtop is lowered

- after approximately 7 minutes when the ignition is switched on.
- after approximately 15 seconds when the ignition is switched off.

Shortly before the hardtop is lowered, a warning will sound. In the multifunction display you will see  and the message `Retractable roof being opened`.

- Properly lock the retractable hardtop before continuing to drive (> page 243).

Retractable hardtop

Wind screen*

Warning!



The wind screen can restrict the driver's vision to the rear of the vehicle. To prevent a possible accident when visibility is limited (e.g. in darkness), the upper part of the wind screen should be folded back.

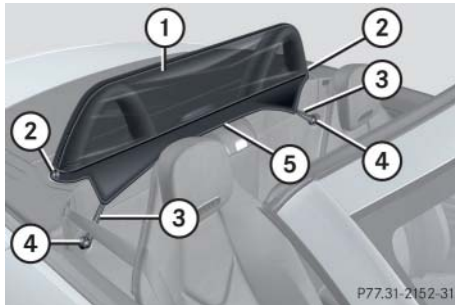

- ① Wind screen
- ② Snap fastener (with handle cap)
- ③ Supporting strap
- ④ Fastening pin
- ⑤ Gap

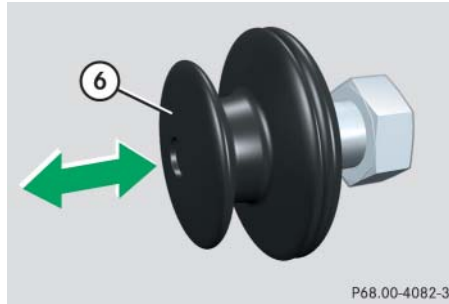

⑥ Handle cap

Installing

- ▶ Remove wind screen ① from its storage bag and unfold.

The storage bag is located on the wall behind the seat backrests.

- ▶ Attach supporting straps ③ to fastening pins ④.

i Make sure the lower wind screen edging is inserted through the gap ⑤ between the storage compartment and the rear panel.

- ▶ Close snap fasteners ② by pushing in handle cap ⑥.
- ▶ Pull wind screen ① on molding over roll bars.

Pull the wind screen edging, not on the netting itself.

Removing

- ▶ Pull off wind screen ① from roll bars.
- ▶ Open snap fasteners ② by pulling out handle cap ⑥.
- ▶ Loosen supporting straps ③ from fastening pins ④.
- ▶ Fold wind screen ① and put it back into storage bag.

▼ Driving systems

The driving system of your vehicle is described on the following pages:

- Cruise control, with which the vehicle can maintain a preset speed.

The BAS, ABS and ESP® driving systems are described in the “Safety and Security” section (▷ page 84).

Cruise control

The cruise control automatically maintains the speed you set for your vehicle.

Use of cruise control is recommended for driving at a constant speed for extended periods of time.

You can set or resume cruise control at any speed over 20 mph (30 km/h).

The cruise control function is operated by means of the cruise control lever.

The cruise control lever is the uppermost lever on the left-hand side of the steering column (▷ page 24).

Warning!



The cruise control is a convenience system designed to assist the driver during vehicle operation. The driver is and must remain at all times responsible for the vehicle speed and for safe brake operation.

Only use the cruise control if the road, traffic, and weather conditions make it advisable to travel at a steady speed.

- The use of cruise control can be dangerous on winding roads or in heavy traffic because conditions do not allow safe driving at a steady speed.
- The use of cruise control can be dangerous on slippery roads. Rapid changes in tire traction can result in wheel spin and loss of control.
- Deactivate the cruise control when driving in fog.

The “Resume” function should only be operated if the driver is fully aware of the previously set speed and wishes to resume this particular preset speed.

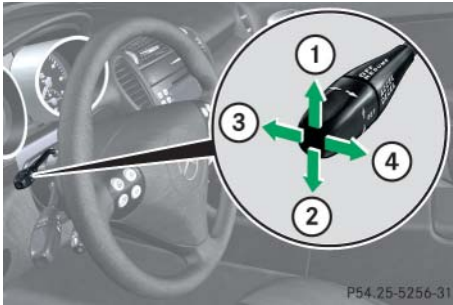

- ① Set current or higher speed
- ② Set current or lower speed
- ③ Cancel cruise control
- ④ Resume to last set speed

Warning!



Cruise control brakes automatically so that the set speed is not exceeded. The brake pedal is depressed automatically to do this.

Keep in mind that cruise control is a convenience system designed to assist the driver during vehicle operation. The driver is and must always remain responsible for the vehicle's speed and for safe braking operation.

Keep driver's foot area clear at all times, including the area under the brake pedal. Objects stored in this area may impair pedal movement which could interfere with the braking ability of the cruise control system.

Do not place your foot under the brake pedal – your foot could become caught.

Setting current speed

- ▶ Accelerate or decelerate to the desired speed.
- ▶ Briefly lift ① or depress ② the cruise control lever (> page 248).

The current speed is set.

- ▶ Remove your foot from the accelerator pedal.

The cruise control is activated.

The selected speed appears in the multi-function display.

i On uphill or downhill grades, the cruise control may not be able to maintain the set speed. Once the grade eases, the set speed will be resumed.

On downhill grades, the cruise control maintains the set speed with braking from the vehicle's braking system.

In addition, on longer downhill grades the automatic transmission* will automatically downshift.

i Vehicles with manual transmission: If you depress the clutch pedal when shifting into another gear, the engine speed may increase.

- Drive with sufficient engine speed.
- Shift gears in a timely manner.
- If possible, do not shift down more than one gear.

Canceling cruise control

There are several ways to cancel the cruise control:

- ▶ Step on the brake pedal.

The cruise control is canceled. The last speed set is stored for later use.

or

- ▶ Briefly push the cruise control lever in direction of arrow ③ (▷ page 248).

The cruise control is canceled. The last speed set is stored for later use.

i The last stored speed is canceled when you turn off the engine.

i The cruise control switches off automatically, if

- you step on the brake pedal.
- you pull up the parking brake lever firmly.
- the vehicle speed is below 20 mph (30 km/h).
- ESP® is in operation or switched off with the ESP® switch (▷ page 86).
- Vehicles with manual transmission: you depress the clutch pedal for longer than 6 seconds during shifting into another gear.
- Vehicles with automatic transmission*: you move the gear selector lever to position **N** while driving.

! Vehicles with automatic transmission*: Moving gear selector lever to position **N** while driving also cancels cruise control. However, the gear selector lever should not be moved to position **N** while driving except to coast when the vehicle is in danger of skidding (e.g. on icy roads).

i Depressing the accelerator pedal does not deactivate the cruise control. After brief acceleration (e.g. for passing), the cruise control will resume the last speed set.

Driving systems

Setting a higher speed

- ▶ Lift the cruise control lever in direction of arrow ① (▷ page 248) and hold it up until the desired speed is reached.
- ▶ Release the cruise control lever.
The new speed is set.

Setting a lower speed

- ▶ Depress the cruise control lever in direction of arrow ② (▷ page 248) and hold it down until the desired speed is reached.
- ▶ Release the cruise control lever.
The new speed is set.

i *When you use the cruise control lever to decelerate, the brake system will automatically brake the vehicle if the engine's braking power does not brake the vehicle sufficiently.*

Fine adjustment in 1 mph (Canada: 1 km/h) increments

Faster

- ▶ Briefly tip the cruise control lever in direction of arrow ① (▷ page 248).

Slower

- ▶ Briefly tip the cruise control lever in direction of arrow ② (▷ page 248).

Setting to last stored speed ("Resume" function)

Warning!



The speed stored in memory should only be set again if prevailing road conditions permit. Possible acceleration or deceleration differences arising from returning to the pre-set speed could cause an accident and/or serious injury to you and others.

- ▶ Briefly pull the cruise control lever in direction of arrow ④ (▷ page 248).
The cruise control resumes the last set speed.
- ▶ Remove your foot from the accelerator pedal.

The last set speed appears in the multi-function display.

▼ Loading

Roof rack

! *This vehicle is not designed to carry items on its roof. Roof rails and any roof-mounted devices, unless expressly approved by Mercedes-Benz for use on this vehicle model, must not be used as they will damage the vehicle and retractable hardtop.*

At time of printing, Mercedes-Benz does not offer any roof racks or any other roof-mounted devices for use on this vehicle.

! *This vehicle is not designed to carry any items on its trunk lid or accommodate any type of trunk lid rack or device. Using such devices may damage the vehicle and retractable hardtop mechanism.*

Storage compartments

Warning!



To help avoid personal injury during a collision or sudden maneuver, exercise care when storing objects in the vehicle. Put luggage or cargo in the trunk if possible. Do not place anything on shelf behind the roll bars.

Parcel nets cannot secure hard or heavy objects.

Keep compartment lids closed. This will help to prevent stored objects from being thrown around and injuring vehicle occupants during an accident.

i The glove box and the storage/telephone* compartment under the armrest are centrally locked and unlocked.

Glove box

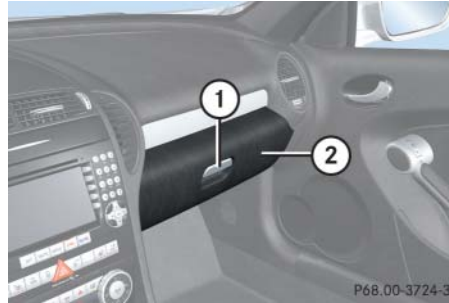

- ① Glove box lid release
- ② Glove box lid

▶ Pull glove box lid release ① to open the glove box.

The glove box lid opens downward.



▶ Push glove box lid ② up until it engages to close the glove box.

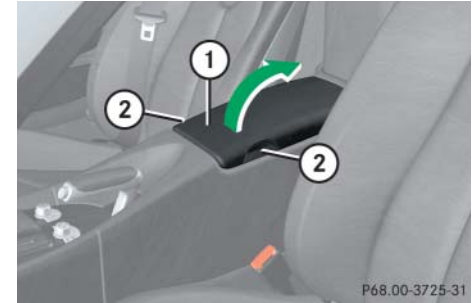

i The CD changer* is located in the glove box.

Storage/telephone* compartment under armrest



- ① Armrest
- ② Recess for opening storage compartment and telephone* compartment

i The mobile phone cradle* (▷ page 259), Roadside Assistance button  (▷ page 265) and the Information button  (▷ page 267) are located in the telephone* compartment, see “Telephone* compartment” (▷ page 253).

Depending on production date, your vehicle may be equipped with a storage compartment only. To access the mobile phone cradle*, the Roadside Assistance button  and the Information button , see “Storage compartment” (▷ page 253).

Storage compartment

- ▶ Reach into recess ② on the left or right side and lift armrest ① in direction of arrow to open the storage compartment.
- ▶ Lower armrest ① until it engages to close storage compartment.

Telephone* compartment

i Depending on production date, your vehicle may not be equipped with a separate telephone* compartment.

- ▶ Reach into recess ② on the left or right side, press in and fold up armrest to the right or left side to open it.
The telephone compartment is opened.
- ▶ Fold armrest back until it engages to close the telephone compartment.

Storage compartment between the seat backrests



- ① Storage compartment lid release
- ② Storage compartment
- ▶ Press storage compartment lid release ① to open.
The storage compartment lid opens downward.
- ▶ Push storage compartment lid up until it engages to close it.

Parcel net in passenger footwell

A small convenience parcel net is located in the passenger footwell and behind the driver's seat. It is for small and light items, such as road maps, mail, etc.

Warning!



Do not place heavy or fragile objects, or objects having sharp edges, in the parcel net.

In an accident, during hard braking or sudden maneuvers, they could be thrown around inside the vehicle, and cause injury to vehicle occupants.

Useful features

Shelf behind roll bars

Warning!



The shelf behind the roll bars should not be used to carry objects. This will prevent such objects from being thrown around and injuring vehicle occupants during an accident or sudden maneuver.

The trunk is the preferred place to carry objects.

Cup holder

Warning!



In order to help prevent spilling liquids on vehicle occupants and/or vehicle equipment, only use containers that fit into the cup holder. Use lids on open containers and do not fill containers to a height where the contents, especially hot liquids, could spill during braking, vehicle maneuvers, or in an accident. Liquids spilled on vehicle occupants may cause serious personal injury. Liquids spilled on vehicle equipment may cause damage not covered by the Mercedes-Benz Limited Warranty.

When not in use, keep the cup holder closed. An open cup holder may cause injury to you or others when contacted during braking, vehicle maneuvers, or in an accident.

Keep in mind that objects placed in the cup holder may come loose during hard braking, vehicle maneuvers, or in an accident and be thrown around in the vehicle interior. Objects thrown around in the vehicle interior may cause an accident and/or serious personal injury.



① Cover plate

- ▶ Press briefly on cover plate ① to open the cup holder.

The cup holder opens automatically.

- ▶ Press cover plate ① until the cup holder engages to close it.

Ashtray



① Cover plate

- ▶ Press cover plate ① briefly in direction of the arrow.

The ashtray opens automatically.

- ▶ To close the ashtray again, press cover plate ① until the ashtray engages.

Removing ashtray insert

Warning!



Remove front ashtray only with vehicle standing still. Set the parking brake to secure vehicle from movement. Move gear selector lever to position **N** (manual transmission: into second gear). With gear selector lever in position **N** (manual transmission: into second gear), turn off the engine.

- ▶ Secure vehicle from movement by setting the parking brake.
- ▶ Move the selector lever to position **N** (manual transmission: second gear).
Now you have more room to take out the ashtray insert.

- ▶ Open the ashtray.
- ▶ Reach into both recesses on the left and right side of the retainer and pull out the ashtray insert.

Installing ashtray insert

- ▶ Place the ashtray insert into the retainer.
- ▶ Push the ashtray insert down into the retainer until it engages.

Useful features

Cigarette lighter

Warning!



Never touch the heating element or sides of the cigarette lighter; they are extremely hot. Hold the knob only.

Make sure that any children traveling with you do not injure themselves or start a fire with the hot cigarette lighter.

When leaving the vehicle, always remove the SmartKey from the starter switch, take it with you, and lock the vehicle. Do not leave children unattended in the vehicle, or with access to an unlocked vehicle.

A child's unsupervised access to a vehicle could result in an accident and/or serious personal injury.

- ▶ Switch on the ignition (▷ page 37).



① Cigarette lighter

- ▶ Push in cigarette lighter ①.

Cigarette lighter ① will pop out automatically when hot.

- ▶ Reinsert cigarette lighter ① in its socket after use.

! The lighter socket can be used to accommodate 12V DC electrical accessories (up to a maximum of 85 W) designed for use with the standard “cigarette lighter” plug type. Keep in mind, however, that connecting accessories to the lighter socket (for example extensive connecting and disconnecting, or using plugs that do not fit properly) can damage the lighter socket. With the socket damaged, the lighter may no longer be able to be placed in the heating (pushed-in) position, or the lighter may pop out too early with the lighter not hot enough.

To help avoid damaging the cigarette lighter socket, we recommend connecting 12V DC electrical accessories designed for use with the standard “cigarette lighter” plug type to the 12V power outlets (▷ page 257) in your vehicle whenever possible.

Power outlet

A power outlet is located in the passenger footwell on the side panel of the center console.

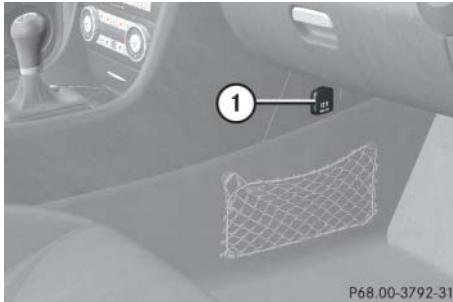

① Power outlet

- ▶ Switch on the ignition (▷ page 37).
- ▶ Flip up cover of power outlet ① and insert electrical plug (cigarette lighter type).

i The power outlet can be used to accommodate 12V DC electrical accessories (e.g. air pump, auxiliary lamps) up to a maximum of 180 W.

Floormat (driver's side only)

Warning!



Whenever you are using floormats, make sure there is enough clearance and the floormats are securely fastened.

Floormats should always be securely fastened using eyelets ④ and retainer pins ⑤.

Before driving off, check that the floormats are securely in place and adjust them if necessary. A loose floormat could slip and hinder proper functioning of the pedals.

Do not place several floormats on top of each other as this may impair pedal movement.

i To install or remove the floormat more easily, move the driver's seat as far to the rear as possible (▷ page 39).

Removing

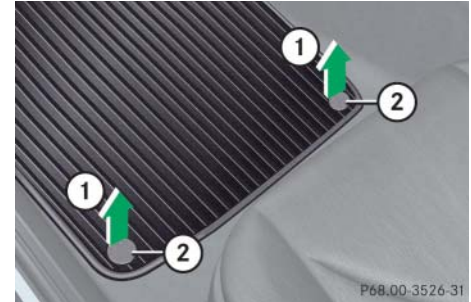

- ① Removing
- ② Retainer pin

- ▶ Pull floormat off of retainer pin ② in direction of arrow ①.
- ▶ Remove the floormat.

Useful features

Installing

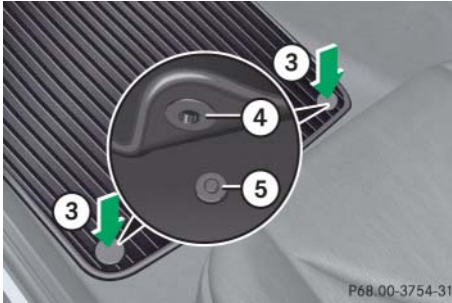

- ③ Installing
- ④ Eyelet
- ⑤ Retainer pin

- ▶ Lay down the floormat.
- ▶ Press the floormat eyelet ④ onto retainer pin ⑤ in direction of arrow ③.

Telephone*

Warning!



Never operate radio transmitters equipped with a built-in or attached antenna (i.e. without being connected to an external antenna) from inside the vehicle while the engine is running. Doing so could lead to a malfunction of the vehicle's electronic system, possibly resulting in an accident and/or serious personal injury.

Radio transmitters, such as a portable telephone or a citizens band unit, should only be used inside the vehicle if they are connected to an antenna that is installed on the outside of the vehicle.

The external antenna must be approved by Mercedes-Benz. Please contact an authorized Mercedes-Benz Center for information on the installation of an approved external antenna. Refer to the radio transmitter operation instructions regarding use of an external antenna.

Warning!



Please do not forget that your primary responsibility is to drive the vehicle. A driver's attention to the road must always be his/her primary focus when driving. For your safety and the safety of others, we recommend that you pull over to a safe location and stop before placing or taking a telephone call.

If you choose to use the telephone¹ while driving, please use the hands-free device and only use the telephone when road, weather and traffic conditions permit. Some jurisdictions prohibit the driver from using a mobile telephone while driving a vehicle.

Only operate the audio system or COMAND*¹ if road, weather and traffic conditions permit.



Bear in mind that at a speed of just 30 mph (approximately 50 km/h), your vehicle is covering a distance of 44 feet (approximately 14 m) every second.

¹ Observe all legal requirements.

i Various mobile phone cradles can be installed in the center armrest, see separate installation instructions for the mobile phone cradle. These mobile phone cradles can be obtained from an authorized Mercedes-Benz Center.

The functions and services available to you while using the mobile phone depend on your service provider and the type of mobile phone you are using. See also separate operating manual for instructions on how to use your mobile phone.

When the mobile phone is inserted in the cradle, you can operate the telephone using the following devices:

- mobile phone keypad
- COMAND* (see separate operating instructions)
- buttons  and  on the multi-function steering wheel (▷ page 149)
- audio system (▷ page 219)

Please note that these functions are only available with Mercedes-Benz approved mobile phones. Please contact an authorized Mercedes-Benz Center for information on features available for your mobile phone of choice.

The cradle is located in the front center armrest.

i Depending on production date, your vehicle may be equipped with a storage compartment only. The mobile phone cradle is then located in the storage compartment (▷ page 252).

- ▶ Open the telephone* compartment or, depending on production date, open the storage compartment, see “Storage/telephone* compartment under armrest” (▷ page 252).

Inserting mobile phone in mobile phone cradle

Once the mobile phone has been inserted in the mobile phone cradle, you have to use the hands-free device to respond during phone calls.

! Do not try to remove the mobile phone along with the cradle. You could otherwise damage the mobile phone cradle.

- ▶ If applicable, remove the cover for the external antenna connection from the back of the mobile phone and store it in a safe place. Be sure to comply with the mobile phone’s operating instructions as well. ▷▷

Useful features



Example illustration

- ① Insert the mobile phone
 - ② Connector contact
 - ③ Mobile phone cradle
- ▶ Slide the lower end of the mobile phone into connector contact ② on mobile phone cradle ③.
 - ▶ Push the top of the mobile phone in direction of arrow ①, until the lug on the mobile phone release button engages.

The mobile phone is connected to the network via the external antenna.

The mobile phone is linked to the hands-free device and the multifunction steering wheel.

The battery is charged depending on its charge status and the position of the SmartKey in the starter switch. The charge procedure will be indicated in the mobile phone's display.

You can place or receive phone calls. You can control other functions of the mobile phone via the control system (▷ page 149), audio system (▷ page 219), or COMAND* (see separate operating instructions).

i When you take the SmartKey out of the starter switch, the mobile phone remains switched on for approximately 10 minutes. If you place or receive a call during this time, the mobile phone switches off 10 minutes after the call has been completed.

Removing mobile phone from mobile phone cradle



Example illustration

- ① Release catch for mobile phone
 - ② Mobile phone cradle
- i** When using a flip-style mobile phone, open flip top before removing from the cradle while a call is connected. Otherwise, the call will be disconnected.
- ▶ Press release catch in direction of arrow ① and take mobile phone out of mobile phone cradle ②.

Changing mobile phone cradle

If you require a different cradle for your mobile phone, remove the present cradle before installing a new one.

Removing an existing mobile phone cradle

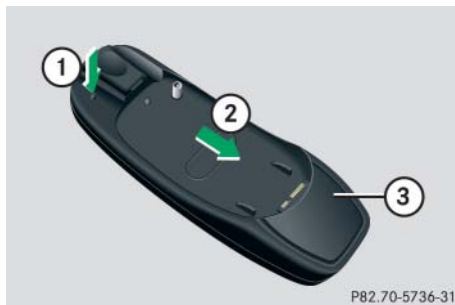

Example illustration

- ① To release the mobile phone cradle
 - ② To remove the mobile phone cradle
 - ③ Mobile phone cradle
- ▶ Press release button in direction of arrow ① and take mobile phone cradle ③ out in direction of arrow ②.

Installing a different mobile phone cradle

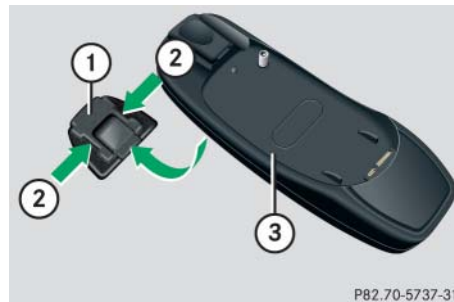

Example illustration

- ① Contact plate
 - ② Recesses
 - ③ Mobile phone cradle
- ▶ Insert mobile phone cradle ③ into recesses ② of contact plate ①.
- ▶ Push mobile phone cradle ③ forward until it engages.

Tele Aid*

! The initial activation of the Tele Aid system may only be performed by completing the subscriber agreement and placing an acquaintance call using the  button. Failure to complete either of these steps will result in a system that is not activated.

If you have any questions regarding activation, please call the Response Center at 1-800-756-9018 (in the USA) or 1-888-923-8367 (in Canada).

Shortly after the completion of your Tele Aid acquaintance call, you will receive a user ID and password. By visiting www.mbusa.com and selecting “Tele Aid” (USA only), you will have access to account information, remote door unlock and more.

Useful features



The Tele Aid* system



(Telematic Alarm Identification on Demand)

The Tele Aid system consists of three types of response:



- Automatic and manual emergency
- Roadside Assistance
- Information

The Tele Aid system is operational providing that the vehicle's battery is charged, properly connected, not damaged and cellular and GPS coverage is available.

The speaker volume of a Tele Aid call can be adjusted when using the volume control on the multifunction steering wheel. To raise, press button  and to lower, press button  or use the volume knob on your audio system or COMAND* head unit.

- ▶ To activate, press the SOS button, the Roadside Assistance button  or the Information button , depending on the type of response required.



 The SOS button is located in the overhead control panel.

The Roadside Assistance button  (▷ page 265) and the Information button  (▷ page 267) are located below the center armrest cover.

 The Tele Aid system utilizes the cellular network for communication and the GPS (Global Positioning System) satellites for vehicle location. If either of these signals are unavailable, the Tele Aid system may not function and if this occurs, assistance must be summoned by other means.

 When a Tele Aid call has been initiated, the audio system or COMAND* system audio is muted and the selected mode (radio, tape or CD) pauses. The optional cellular phone* (if installed) and inserted in cradle switches off. If you must use this phone, we recommend that you use it only with the vehicle at a standstill in a safe location. Remove the phone from the cradle and place the call. The COMAND* navigation system (if engaged) will continue to run. The display in the instrument cluster is available for use, and spoken commands are only available by pressing the RPT button on the COMAND* unit. A pop-up window will appear in the COMAND* display to indicate that a Tele Aid call is in progress. After the Tele Aid call has ended, the optional cellular phone switches on again. A PIN entry might be necessary.

System self-check

Initially, after switching on ignition, malfunctions are detected and indicated (the indicator lamps in the SOS button, the Roadside Assistance button , and the Information button  stay on longer than 10 seconds or do not come on). The message `Tele Aid inoperative` appears for approximately 10 seconds in the multifunction display.

Warning!



If the indicator lamps in the SOS button, in the Roadside Assistance button, and/or in the Information button do not come on during the system self-check or if any of these indicators remain illuminated constantly in red and/or the message `Tele Aid inoperative` is displayed in the multifunction display after the system self-check, a malfunction in the system has been detected.

If a malfunction is indicated as outlined above, the system may not operate as expected. Have the system checked at the nearest Mercedes-Benz Center as soon as possible.

Emergency calls

An emergency call is initiated automatically following an accident in which the emergency tensioning devices (ETDs) or air bags deploy.

An emergency call can also be initiated manually by opening the cover next to the interior rear view mirror labeled SOS, then briefly pressing the button located under the cover. See (▷ page 264) for instructions on initiating an emergency call manually.

Once the emergency call is in progress, the indicator lamp in the SOS button will begin to flash. The message `Connecting call` appears in the multifunction display and the audio system is muted. When the connection is established, the message `Call connected` appears in the multifunction display. All information relevant to the emergency, such as the location of the vehicle (determined by the GPS satellite location system), vehicle model, identification number and color are generated.

Useful features

A voice connection between the Response Center and the occupants of the vehicle will be established automatically soon after the emergency call has been initiated. The Response Center will attempt to determine more precisely the nature of the emergency provided they can speak to an occupant of the vehicle.

The Tele Aid system is available if:

- it has been activated and is operational. Activation requires a subscription for monitoring services, connection and cellular air time.
- the relevant cellular phone network and GPS signals are available and pass the information on to the Response Center.

i Location of the vehicle on a map is only possible if the vehicle is able to receive signals from the GPS satellite network and pass the information on to the Response Center.

Warning!



If the indicator lamp in the SOS button is flashing continuously and there was no voice connection to the Response Center established, then the Tele Aid system could not initiate an emergency call (e.g. the relevant cellular phone network is not available). The message *Call failed* appears in the multifunction display for approximately 10 seconds.

Should this occur, assistance must be summoned by other means.

Initiating an emergency call manually



① Cover

② SOS button

► Briefly press on cover ①.

The cover opens.

- ▶ Press SOS button ② briefly.
The indicator lamp in SOS button ② flashes until the emergency call is concluded.
- ▶ Wait for a voice connection to the Response Center.
- ▶ Close cover ① after the emergency call is concluded.

Warning!



If you feel at any way in jeopardy when in the vehicle (e.g. smoke or fire in the vehicle, vehicle in a dangerous road location), please do not wait for voice contact after you have pressed the emergency button. Carefully leave the vehicle and move to a safe location. The Response Center will automatically contact local emergency officials with the vehicle's approximate location if they receive an automatic SOS signal and cannot make voice contact with the vehicle occupants.

Roadside Assistance button

The Roadside Assistance button  is located below the center armrest cover.

i Depending on production date, your vehicle may be equipped with a storage compartment only. The Roadside Assistance button  is then located in the rear of the storage compartment (▷ page 252).



Vehicles with separate telephone* compartment

- ① Roadside Assistance button



Vehicles with storage compartment

- ① Roadside Assistance button
- ▶ Open the telephone* compartment or, depending on production date, open the storage compartment see “Storage/telephone* compartment under armrest” (▷ page 252). ▷▷

Useful features

- ▷▷▶ Press and hold button  (for longer than 2 seconds).
- A call to a Mercedes-Benz Roadside Assistance dispatcher will be initiated. The button will flash while the call is in progress. The message *Connecting call* will appear in the multifunction display and the audio system is muted.

When the connection is established, the message *Call connected* appears in the multifunction display. The Tele Aid system will transmit data generating the vehicle identification number, model, color and location (subject to availability of cellular and GPS signals).



A voice connection between the Roadside Assistance dispatcher and the occupants of the vehicle will be established.

- ▶ Describe the nature of the need for assistance.

The Mercedes-Benz Roadside Assistance dispatcher will either dispatch a qualified Mercedes-Benz technician or arrange to tow your vehicle to the nearest Mercedes-Benz Center. For services such as labor and/or towing, charges may apply. Refer to the Roadside Assistance manual for more information.

The following is only available in the USA:

- Sign and Drive services: Services such as jump start, a few gallons of fuel or the replacement of a flat tire with the vehicle spare tire are obtainable.

 *The indicator lamp in the Roadside Assistance button  remains illuminated in red for approximately 10 seconds during the system self-check after switching on ignition (together with the SOS button and the Information button .*



See “System self-check” (▷ page 263) when the indicator lamp does not come on in red or stays on longer than approximately 10 seconds.

*If the indicator lamp in the Roadside Assistance button  is flashing continuously and there was no voice connection to the Response Center established, then the Tele Aid system could not initiate a Roadside Assistance call (e.g. the relevant cellular phone network was not available). The message *Call failed* appears in the multifunction display.*

Roadside Assistance calls can be terminated using the button  on the multifunction steering wheel or the respective button for ending a telephone call on the audio system or COMAND head unit.*

Information button

The Information button  is located below the center armrest cover.

 Depending on production date, your vehicle may be equipped with a storage compartment only. The Information button  is then located in the rear of the storage compartment (▷ page 252).



Vehicles with separate telephone* compartment

 Information button



Vehicles with storage compartment

 Information button

- ▶ Open the telephone* compartment or, depending on production date, open the storage compartment see “Storage/telephone* compartment under armrest” (▷ page 252).

- ▶ Press and hold button  (for longer than 2 seconds).



A call to the Customer Assistance Center will be initiated. The button will flash while the call is in progress. The message `Connecting call` will appear in the multifunction display and the audio system is muted.

When the connection is established, the message `Call connected` appears in the multifunction display. The Tele Aid system will transmit data generating the vehicle identification number, model, color and location (subject to availability of cellular and GPS signals).

A voice connection between the Customer Assistance Center representative and the occupants of the vehicle will be established. Information regarding the operation of your vehicle, the nearest Mercedes-Benz Center or Mercedes-Benz USA products and services is available to you.

Useful features

For more details concerning the Tele Aid system, please visit www.mbusa.com and use your ID and password (sent to you separately) to learn more (USA only).

i The indicator lamp in the Information button  remains illuminated in red for approximately 10 seconds during the system self-check after switching on ignition (together with the SOS button and the Roadside Assistance button ).

See “System self-check” (▷ page 263) when the indicator lamp does not come on in red or stays on longer than approximately 10 seconds.

If the indicator lamp in the Information button  is flashing continuously and there was no voice connection to the Response Center established, then the Tele Aid system could not initiate an Information call (e.g. the relevant cellular phone network is not available). The message Call failed appears in the multifunction display.

Information calls can be terminated using the button  on the multifunction steering wheel or the respective button for ending a telephone call on the audio system or COMAND* head unit.

! If the indicator lamps do not start flashing after pressing one of the buttons or remain illuminated (in red) at any time, the Tele Aid system has detected a malfunction or the service is not currently active, and may not initiate a call. Visit your Mercedes-Benz Center and have the system checked or contact the Response Center at 1-800-756-9018 (in the USA) or 1-888-923-8367 (in Canada) as soon as possible.

Call priority

If other service calls such as a Roadside Assistance call or Information call are active, an Emergency call is still possible. In this case, the Emergency call will take priority and override all other active calls.

i The indicator lamp in the respective button flashes until the call is concluded. Calls can only be terminated by a Response Center or Customer Assistance Center representative, except Roadside Assistance and Information calls, which can also be terminated by pressing the  button on the multifunction steering wheel or the respective button for ending a telephone call on the audio system or COMAND* head unit.

! If the indicator lamp continues to flash or the system does not reset, contact the Response Center at 1-800-756-9018 (in the USA) or 1-888-923-8367 (in Canada), or Mercedes-Benz Customer Assistance at 1-800-FOR-MERCEDES (1-800-367-6372) in the USA or Customer Service at 1-800-387-0100 in Canada.

Remote door unlock

In case you have locked your vehicle unintentionally (e.g. SmartKey inside vehicle), and the reserve SmartKey is not handy:

- ▶ Contact the Mercedes-Benz Response Center at 1-800-756-9018 (in the USA) or 1-888-923-8367 (in Canada).

You will be asked to provide your password which you provided when you completed the subscriber agreement.

- ▶ Then return to your vehicle and pull the trunk recessed handle for a minimum of 20 seconds until the SOS button is flashing.

The message *Connecting call* appears in the multifunction display.

As an alternative, you may unlock the vehicle via Internet using the ID and password sent to you shortly after the completion of your acquaintance call.

The Response Center will then unlock your vehicle with the remote door unlocking feature.

i *The remote door unlock feature is available if the relevant cellular phone network is available.*

The SOS button will flash and the message Connecting call will appear in the multifunction display to indicate receipt of the door unlock command.

Once the vehicle is unlocked, a Response Center specialist may attempt to establish voice contact with the vehicle occupants.

If the trunk recessed handle was pulled for more than 20 seconds before door unlock authorization was received by the Response Center, you must wait 15 minutes before pulling the trunk handle again.

Stolen Vehicle Recovery services

In the event your vehicle was stolen:

- ▶ Report the incident to the police.

The police will issue a numbered incident report.

- ▶ Pass this number on to the Mercedes-Benz Response Center along with your password issued to you when you subscribed to the service.

The Response Center will then attempt to covertly contact the vehicle's Tele Aid system. Once the vehicle is located, the Response Center will contact the local law enforcement and you. The vehicle's location will only be provided to law enforcement.

i *When the anti-theft alarm or the tow-away alarm stays on for more than 30 seconds, a call is initiated automatically to the Response Center. See "Anti-theft alarm system" (▷ page 90) and "Tow-away alarm" (▷ page 91).*

Useful features

Garage door opener*

The integrated remote control is capable of operating up to three separately controlled devices. It provides a convenient way to replace up to three hand-held remote controls used to operate devices such as garage door openers, gate openers, or other devices compatible with HomeLink® or some other systems.

Before the integrated remote control can be used, it must be programmed to the garage door opener, gate operator or other device you wish to operate. See the following instructions for programming information.

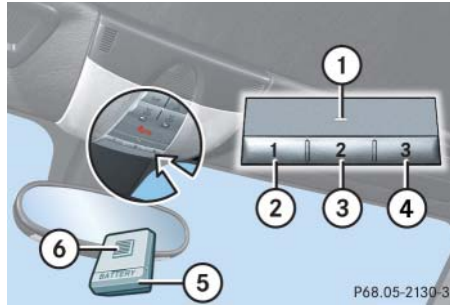

Overhead control panel with integrated remote control

- ① Indicator lamp
 - ② ③ ④ Signal transmitter button
- Needed for programming (not part of vehicle equipment):
- ⑤ Hand-held remote control of garage door opener, gate operator or other device
 - ⑥ Hand-held remote control button

Warning!



Before programming the integrated remote control to a garage door opener or gate operator, make sure people and objects are out of the way of the device to prevent potential harm or damage. When programming a garage door opener, the door moves up or down. When programming a gate operator, the gate opens or closes.

Do not use the integrated remote control with any garage door opener that lacks safety stop and reverse features as required by U.S. federal safety standards (this includes any garage door opener model manufactured before April 1, 1982). A garage door that cannot detect an object – signaling the door to stop and reverse – does not meet current U.S. federal safety standards.

When programming a garage door opener, it is advised to park outside the garage.

Do not run the engine while programming the integrated remote control. Inhalation of exhaust gas is hazardous to your health.

All exhaust gas contains carbon monoxide (CO), and inhaling it can cause unconsciousness and possible death.

Programming the integrated remote control

Step 1:

- ▶ Switch on the ignition (▷ page 37).

Step 2:

- ▶ If you have previously programmed a signal transmitter button and wish to retain its programming, proceed to step 3.

If you are programming the integrated remote control for the first time, press and hold the two outer signal transmitter buttons ② and ④ and release them only when indicator lamp ① begins to flash after approximately 20 seconds (do not hold the button for longer than 30 seconds). This procedure erases any previous settings for all three channels and initializes the memory.

If you later wish to program a second and/or third hand-held transmitter to the remaining two signal transmitter buttons, do not repeat this step and begin directly with step 3.

Step 3:

- ▶ Hold the end of hand-held remote control ⑤ of the device you wish to train approximately 2 to 5 in (5 to 12 cm) away from the signal transmitter button (②, ③ or ④) to be programmed, while keeping indicator lamp ① in view.

Step 4:

- ▶ Using both hands, simultaneously press hand-held remote control button ⑥ and the desired signal transmitter button (②, ③ or ④). Do not release the buttons until step 5 is completed.

Indicator lamp ① will flash, first slowly and then rapidly.

i Indicator lamp ① flashes immediately the first time the signal transmitter button is programmed. If this button has already been programmed, the indicator lamp will only start flashing after 20 seconds.



Useful features

▷▷Step 5:

- ▶ After indicator lamp ① changes from a slow to a rapidly flashing light, release the hand-held remote control button and the signal transmitter button.

Step 6:

- ▶ Press and hold the just-trained signal transmitter button (②, ③ or ④) and observe indicator lamp ①.

If indicator lamp ① stays on constantly, programming is complete and your device should activate when the respective signal transmitter button (②, ③ or ④) is pressed and released.

i *If indicator lamp ① flashes rapidly for about 2 seconds and then turns to a constant light, continue with programming steps 8 through 12 as your garage door opener may be equipped with the “rolling code” feature.*

Step 7:

- ▶ To program the remaining two signal transmitter buttons, repeat the steps above starting with step 3.

Rolling code programming

To train a garage door opener (or other rolling code devices) with the rolling code feature, follow these instructions after completing the “Programming” portion (steps 1 through 6) of this text. (A second person may make the following training procedures quicker and easier.)

Step 8:

- ▶ Locate “training” button on the garage door opener motor head unit.

Exact location and color of the button may vary by garage door opener brand. Depending on manufacturer, the “training” button may also be referred to as “learn” or “smart” button. If there is difficulty locating the transmitting button, refer to the garage door opener Operator’s Manual.

Step 9:

- ▶ Press the “training” button on the garage door opener motor head unit.

The “training light” is activated.

You have 30 seconds to initiate the following step.

Step 10:

- ▶ Return to the vehicle and firmly press, hold for 2 seconds and release the programmed signal transmitter button (②, ③ or ④).

Step 11:

- ▶ Press, hold for 2 seconds and release same signal transmitter button a second time to complete the training process.

i *Some garage door openers (or other rolling code equipped devices) may require you to press, hold for 2 seconds and release the same signal transmitter button a third time to complete the training process.*

Step 12:

- ▶ Confirm the garage door operation by pressing the programmed signal transmitter button (②, ③ or ④).

Step 13:

- ▶ To program the remaining two signal transmitter buttons, repeat the steps above starting with step 3.

Gate operator/Canadian programming

Canadian radio-frequency laws require transmitter signals to “time-out” (or quit) after several seconds of transmission which may not be long enough for the integrated signal transmitter to pick up the signal during programming. Similar to this Canadian law, some U.S. gate operators are designed to “time-out” in the same manner.

If you live in Canada or if you are having difficulties programming a gate operator (regardless of where you live) by using the programming procedures, replace step 4 with the following:

Step 4:

- ▶ Press and hold the signal transmitter button (②, ③ or ④). Do not release this button until it has been successfully trained.

- ▶ While still holding down the signal transmitter button (②, ③ or ④), “cycle” your hand-held remote control button ⑥ as follows: Press and hold button ⑥ for 2 seconds, then release it for 2 seconds, and again press and hold it for 2 seconds. Repeat this sequence on the hand-held remote control until the frequency signal has been learned. Upon successful training, indicator lamp ① will flash slowly and then rapidly after several seconds.
- ▶ Proceed with programming step 5 and step 6 to complete.

i *Upon completion of programming the integrated remote control, make sure you retain the hand-held remote control that came with the garage door opener, gate operator or other device. You may need it for use in other vehicles, for future programming of an integrated remote control, or simply for continued use as a hand-held remote control to operate the respective device in other situations.*

Useful features

Reprogramming a single signal transmitter button

To program a device using a signal transmitter button previously trained, follow these steps:

- ▶ Switch on the ignition (▷ page 37).
- ▶ Press and hold the desired signal transmitter button (②, ③ or ④). Do not release the button.
- ▶ Indicator lamp ① will begin to flash after 20 seconds. Without releasing the signal transmitter button, proceed with programming starting with step 3.

Operation of integrated remote control

- ▶ Switch on the ignition (▷ page 37).
- ▶ Select and press the appropriate integrated signal transmitter button (②, ③ or ④) to activate the remote controlled device.

The integrated remote control transmitter continues to send the signal as long as the button is pressed – up to 20 seconds.

Erasing the integrated remote control memory

- ▶ Switch on the ignition (▷ page 37).
- ▶ Simultaneously press and hold outer signal transmitter buttons ② and ④, for approximately 20 seconds, until indicator lamp ① flashes rapidly. Do not hold for longer than 30 seconds.

The codes of all three channels are erased.

i *If you sell your vehicle, erase the codes of all three channels.*

Programming tips

If you are having difficulty programming the integrated remote control, here are some helpful tips:

- Check the frequency of the hand-held remote control ⑤ (typically located on the reverse side of the remote). The integrated remote control is compatible with radio-frequency devices operating between 280-390 MHz.
 - Put a new battery in hand-held remote control ⑤. This will increase the likelihood of the hand-held remote control sending a faster and more accurate signal to the integrated remote control.
 - While performing step 3, hold hand-held remote control ⑤ at different lengths and angles from the signal transmitter button (②, ③ or ④) you are programming. Attempt varying angles at the distance of 2 to 5 in (5 to 12 cm) away or the same angle at varying distances.
- If another hand-held remote control is available for the same device, try the programming steps again using that other hand-held remote control. Make sure new batteries are in the hand-held remote control before beginning the procedure.
 - Straighten the antenna wire from the garage door opener assembly. This may help improve transmitting and/or receiving signals.

i *Certain types of garage door openers are incompatible with the integrated remote control. If you should experience further difficulties with programming the integrated remote control, contact an authorized Mercedes-Benz Center, or call Mercedes-Benz Customer Assistance Center (in the USA only) at 1-800-FOR-MERCEdes, or Customer Service (in Canada) at 1-800-387-0100.*

i *USA only:
This device complies with Part 15 of the FCC Rules. Operation is subject to the following two conditions:*

- (1) *This device may not cause harmful interference, and*
- (2) *this device must accept any interference received, including interference that may cause undesired operation.*

Any unauthorized modification to this device could void the user's authority to operate the equipment.

i *Canada only:
This device complies with RSS-210 of Industry Canada. Operation is subject to the following two conditions:*

- (1) *This device may not cause interference, and*
- (2) *this device must accept any interference received, including interference that may cause undesired operation of the device.*

Any unauthorized modification to this device could void the user's authority to operate the equipment.

Useful features

Heated steering wheel* (SLK 280, SLK 350, Canada only)

The steering wheel heating warms up the leather area of the steering wheel.

The stalk is located on the lower left-hand side of the steering wheel.



- ① Switching on
- ② Indicator lamp
- ③ Switching off

Switching on

- ▶ Switch on the ignition (▷ page 37).
- ▶ Turn switch at tip of stalk in direction of arrow ① and release it.

The steering wheel is heated. Indicator lamp ② comes on.

i The steering wheel heating is temporarily suspended while indicator lamp ② remains on when

- the temperature of the vehicle interior is above 86°F (30°C)
- the temperature of the steering wheel is above 95°F (35°C)

When these conditions do not apply anymore, steering wheel heating continues.

Switching off

- ▶ Turn switch at tip of stalk in direction of arrow ③ and release it.

The steering wheel heating is switched off. Indicator lamp ② goes out.

i Indicator lamp ② flashes or switches off in case of

- power surge or undervoltage
- steering wheel heating malfunction

i The steering wheel heating switches off automatically when you remove the SmartKey from the starter switch.

The first 1000 miles (1500 km)

Driving instructions

At the gas station

Engine compartment

Tires and wheels

Winter driving

Maintenance

Vehicle care



The first 1 000 miles (1 500 km)

In the “Operation” section you will find detailed information on operating, maintaining and caring for your vehicle.

The more cautiously you treat your vehicle during the break-in period, the more satisfied you will be with its performance later on.

- Drive your vehicle during the first 1 000 miles (1 500 km) at varying but moderate vehicle and engine speeds.
- During this period, avoid heavy loads (full throttle driving) and excessive engine speeds (no more than $\frac{2}{3}$ of maximum rpm in each gear).
- Vehicles with automatic transmission*: Do not attempt to slow the vehicle down by shifting to a lower gear using the gear selector lever*.
- Shift gears in a timely manner.
- Avoid accelerating by kickdown.
- Vehicles with automatic transmission*: Select gear **3**, **2**, or **1** (▷ page 160) only when driving at moderate speeds (for hill driving).

- Vehicles with automatic transmission*: Select **C** as the preferred shift program (▷ page 161) for the first 1 000 miles (1 500 km).

After 1 000 miles (1 500 km), you may gradually increase vehicle and engine speeds to the permissible maximum.

! *Additional instructions for SLK 55 AMG:*

- *During the first 1 000 miles (1 500 km), do not exceed a speed of 85 mph (140 km/h).*
- *During this period, avoid engine speeds above 4 500 rpm in each gear.*

All of the above instructions, as may apply to your vehicle type, also apply when driving the first 1 000 miles (1 500 km) after the engine or the rear differential has been replaced.

i *Always obey applicable speed limits.*

▼ Driving instructions

Drive sensibly – save fuel

Fuel consumption, to a great extent, depends on driving habits and operating conditions.

To save fuel you should:

- Keep tires at the recommended inflation pressures.
- Remove unnecessary loads.
- Allow engine to warm up under low load use.
- Avoid frequent acceleration and deceleration.
- Have all maintenance work performed at the intervals specified in the Maintenance Booklet and as required by the Maintenance System. Contact an authorized Mercedes-Benz Center.

Fuel consumption is also increased by driving in cold weather, in stop-and-go traffic, on short trips and in hilly area.

Drinking and driving

Warning!



Drinking and driving and/or taking drugs and driving are very dangerous combinations. Even a small amount of alcohol or drugs can affect your reflexes, perceptions and judgment.

The possibility of a serious or even fatal accident are greatly increased when you drink or take drugs and drive.

Do not drink or take drugs and drive or allow anyone to drive who has been drinking or taking drugs.

Pedals

Warning!



Make sure that absolutely no objects are obstructing the pedal's range of movement. Keep the driver's footwell clear of all obstacles. If there are any floor mats or carpets in the footwell, make sure the pedals still have sufficient clearance.

During sudden driving or braking maneuvers, the objects could get caught between the pedals. You could then no longer brake or accelerate. This could lead to accidents and injury.

Driving instructions

Power assistance

Warning!



With the engine not running, there is no power assistance for the brake and steering systems. In this case, it is important to keep in mind that a considerably higher degree of effort is necessary to brake and steer the vehicle.

Brakes

Warning!



After driving in heavy rain for some time without applying the brakes or through water deep enough to wet brake components or salty road conditions, the first braking action may be somewhat reduced and increased pedal pressure may be necessary to obtain expected braking effect. Maintain a safe distance from vehicles in front.

Resting your foot on the brake pedal will cause excessive and premature wear of the brake pads.

It can also result in the brakes overheating, thereby significantly reducing their effectiveness. It may not be possible to stop the vehicle in sufficient time to avoid an accident.

! Because the ESP® operates automatically, the engine must be turned off (SmartKey in starter switch position **0** or **1**) when

- the parking brake is being tested on a brake test dynamometer
- the vehicle is being towed with the front axle raised

Active braking action through the ESP® may otherwise seriously damage the brake system.

To help prevent brake disc corrosion after driving on wet road surfaces (particularly salted roads), it is advisable to brake the vehicle with considerable force prior to parking. The heat generated serves to dry the brakes.

If your brake system is normally only subjected to moderate loads, you should occasionally test the effectiveness of the brakes by applying above-normal braking pressure at higher speeds. This will also enhance the grip of the brake pads.

Warning!

Make sure not to endanger any other road users when carrying out these braking maneuvers.

Refer to the description of the Brake Assist System (BAS) (▷ page 86).

Brake pad wear or a leak in the system may be the reason for low brake fluid in the reservoir.

The brake fluid level in the reservoir may be too low if the brake warning lamp in the instrument cluster (▷ page 26) comes on although the parking brake is released (▷ page 348). Observe additional messages that may appear in the multi-function display (▷ page 367).

Have the brake system inspected immediately. Contact an authorized Mercedes-Benz Center.

All checks and service work on the brake system should be carried out by qualified technicians only. Contact an authorized Mercedes-Benz Center.

Install only brake pads and brake fluid recommended by Mercedes-Benz.

Warning!

If other than recommended brake pads are installed, or other than recommended brake fluid is used, the braking properties of the vehicle can be degraded to an extent that safe braking is substantially impaired. This could result in an accident.

! *When driving down long and steep grades, relieve the load on the brakes by shifting into a lower gear to use the engine's braking power. This helps prevent overheating of the brakes and reduces brake pad wear.*

After hard braking, it is advisable to drive on for some time, rather than immediately park, so that the air stream will cool down the brakes faster.

High-performance brake system (SLK 55 AMG only)

The high-performance brake system is designed to operate under the extremely high operating demands required to accommodate the performance capabilities of the vehicle. The brakes may produce a squeaking-type noise depending on the

- vehicle speed
- brake force applied
- ambient conditions, e.g. temperature and humidity

As with any brake system, the wear of individual brake system components such as brake pads or discs strongly depends on your driving style and the conditions under which you operate the vehicle. Thus, a driving style calling for high demand braking will cause your vehicle's brakes to wear more quickly.

Driving instructions

Warning!



New vehicle brake pads and discs, and replacement brake pads and discs may take several hundred miles of driving until they provide optimum braking efficiency. Until that time, you may need to use increased brake pedal pressure while braking. Please be aware of this and adjust your driving and braking accordingly during this break-in period.

Excessive high demand braking will cause correspondingly high brake wear. Please be attentive to the brake warning lamp in the instrument cluster and brake condition messages in the multifunction display. Especially for high performance driving, it is important to maintain the brake system and have it checked regularly.

Driving off

Apply the brakes to test them briefly after driving off. Perform this procedure only when the road is clear of other traffic.

Warm up the engine smoothly. Do not place full load on the engine until the operating temperature has been reached.

! *When starting off on a slippery surface, do not allow a drive wheel to spin for an extended period with the ESP[®] switched off. Doing so may cause serious damage to the drivetrain which is not covered by the Mercedes-Benz Limited Warranty.*

! *Simultaneously depressing the accelerator pedal and applying the brake reduces engine performance and causes premature brake and drivetrain wear.*

Parking

Warning!



Do not park this vehicle in areas where combustible materials such as grass, hay or leaves can come into contact with the hot exhaust system, as these materials could be ignited and cause a vehicle fire.

To reduce the risk of personal injury or damage to the vehicle drivetrain as a result of vehicle movement, before turning off the engine and leaving the vehicle always:

- Keep right foot on brake pedal.
- Pull the parking brake lever up as many notches as possible.
- Manual transmission: Move the gear-shift lever into first or reverse gear.
- Automatic transmission*: Move the gear selector lever to position **P**.

- Slowly release brake pedal.
- When parked on an incline, turn front wheels towards the road curb.
- Turn the SmartKey in the starter switch to position **0** and remove.
- Take the SmartKey with you and lock vehicle when leaving.

Tires

Warning!



If you feel a sudden significant vibration or ride disturbance, or you suspect that possible damage to your vehicle has occurred, you should turn on the hazard warning flashers, carefully slow down, and drive with caution to an area which is a safe distance from the road.

Inspect the tires and the vehicle undercarriage for possible damage. If the vehicle or tires appear unsafe, have the vehicle towed to the nearest Mercedes-Benz Center or tire dealer for repairs.

Treadwear indicators (TWI) are required by law. These indicators are located in six places on the tread circumference and become visible at a tread depth of approximately $\frac{1}{16}$ in (1.6 mm), at which point the tire is considered worn and should be replaced.

The treadwear indicator appears as a solid band across the tread.

Warning!



Although the applicable federal motor vehicle safety laws consider a tire to be worn when the treadwear indicators (TWI) become visible at approximately $\frac{1}{16}$ in (1.6 mm), we recommend that you do not allow your tires to wear down to that level. As tread depth approaches $\frac{1}{8}$ in (3.0 mm), the adhesion properties on a wet road are sharply reduced.

Depending upon the weather and/or road surface (conditions), the tire traction varies widely.

Specified tire inflation pressures must be maintained. This applies particularly if the tires are subject to high loads (e.g. high speeds, heavy loads, high ambient temperatures).

Driving instructions

Warning!



Do not drive with a flat tire. A flat tire affects the ability to steer or brake the vehicle. You may lose control of the vehicle. Continued driving with a flat tire or driving at high speed with a flat tire will cause excessive heat build-up and possibly a fire.

For more information, see “Tires and wheels” (▷ page 304).

Hydroplaning

Depending on the depth of the water layer on the road, hydroplaning may occur, even at low speeds and with new tires. Reduce vehicle speed, avoid track grooves in the road and apply brakes cautiously in the rain.

Tire traction

The safe speed on a wet, snow-covered or icy road is always lower than on a dry road.

You should pay particular attention to the condition of the road whenever the outside temperatures are close to the freezing point.

Warning!



If ice has formed on the road, tire traction will be substantially reduced. Under such weather conditions, drive, steer and brake with extreme caution.

Mercedes-Benz recommends winter tires (▷ page 332) with a minimum tread depth of approximately $\frac{1}{6}$ in (4 mm) on all four wheels for the winter season to ensure normal balanced handling characteristics. On packed snow, they can reduce your stopping distance as compared with summer tires.

Stopping distance, however, is still considerably greater than when the road is not covered with snow or ice. Exercise appropriate caution.

! *Avoid spinning of a drive wheel. This may cause serious damage to the drivetrain which is not covered by the Mercedes-Benz Limited Warranty.*

Tire speed rating

Regardless of the tire speed rating, local speed limits should be obeyed. Use prudent driving speeds appropriate to prevailing conditions.

Warning!



Even when permitted by law, never operate a vehicle at speeds greater than the maximum speed rating of the tires.

Exceeding the maximum speed for which tires are rated can lead to sudden tire failure, causing loss of vehicle control and possibly resulting in an accident and/or personal injury and possible death, for you and for others.

An electronic speed limiter prevents your vehicle from exceeding a speed of:

- SLK 280
SLK 280 (Sport Package*)
SLK 280 (Appearance Package*):
149 mph (240 km/h)
- SLK 350
SLK 350 (Sport Package*)
SLK 350 (Appearance Package*)
SLK 55 AMG:
155 mph (250 km/h)
- SLK 55 AMG (Performance Package*):
174 mph (280 km/h)

The factory equipped tires on your vehicle may have a tire speed rating above the maximum speed permitted by the electronic speed limiter.

Make sure your tires have the required tire speed rating as specified for your vehicle in the “Technical data” section (▷ page 434), for example when purchasing new tires.

For information on how to identify the tire speed rating on a tire’s sidewall, see “Tire size designation, load and speed rating” (▷ page 318).

If you are uncertain about the correct reading of the information given on a tire’s sidewall, any authorized Mercedes-Benz Center will be glad to assist you.

 For information on speed rating for winter tires, see “Winter tires” (▷ page 332).

For additional general information on tire speed markings on tire sidewall, see “Tire speed rating” (▷ page 318).

Driving instructions

Winter driving instructions

The most important rule for slippery or icy roads is to drive sensibly and to avoid abrupt acceleration, braking and steering maneuvers. Do not use the cruise control system under such conditions.

When the vehicle is in danger of skidding, move gear selector lever* to position **N** or declutch in case of manual transmission. Try to keep the vehicle under control by corrective steering action.

i For information on driving with snow chains, see “Snow chains” (▷ page 333).

Warning!



On slippery road surfaces, never downshift in order to obtain braking action. This could result in drive wheel slip and reduced vehicle control. Your vehicle’s ABS will not prevent this type of control loss.

Road salts and chemicals can adversely affect braking efficiency. Increased pedal force may become necessary to produce the normal brake effect.

Depressing the brake pedal periodically when traveling at length on salt-strewn roads can bring road-salt-impaired braking efficiency back to normal.

If the vehicle is parked after being driven on salt-treated roads, the braking efficiency should be tested as soon as possible after driving is resumed.

Warning!



Make sure not to endanger any other road users when carrying out these braking maneuvers.

Warning!



If the vehicle becomes stuck in snow, make sure snow is kept clear of the exhaust pipe and from around the vehicle with the engine running. Otherwise, deadly carbon monoxide (CO) gases may enter the vehicle interior, resulting in unconsciousness and death.

To assure sufficient fresh air ventilation, open a window slightly on the side of the vehicle not facing the wind.

Warning!



The outside temperature indicator is not designed to serve as an ice-warning device and is therefore unsuitable for that purpose. Indicated temperatures just above the freezing point do not guarantee that the road surface is free of ice.

For more information, see “Winter driving” (▷ page 332).

Standing water

! Do not drive through flooded areas or water of unknown depth. Before driving through water, determine its depth. Never accelerate before driving into water. The bow wave could force water into the engine and auxiliary equipment, thus damaging them.

If you must drive through standing water, drive slowly to prevent water from entering the passenger compartment or the engine compartment. Water in these areas could cause damage to electrical components or wiring of the engine or transmission, or could result in water being ingested by the engine through the air intake, causing severe internal engine damage. Any such damage is not covered by the Mercedes-Benz Limited Warranty.

Passenger compartment

Warning!



Always fasten items being carried as securely as possible.

In an accident, during hard braking or sudden maneuvers, loose items will be thrown around inside the vehicle, and cause injury to vehicle occupants unless the items are securely fastened in the vehicle.

The trunk is the preferred place to carry objects.

Driving abroad

Abroad, there is an extensive Mercedes-Benz service network at your disposal. If you plan to drive into areas which are not listed in the index of your Mercedes-Benz Center directory, you should request pertinent information from an authorized Mercedes-Benz Center.

Control and operation of radio transmitter

COMAND*, radio, and telephone*

Warning!



Please do not forget that your primary responsibility is to drive the vehicle safely. Only operate the COMAND*, radio or telephone¹ if road, traffic and weather conditions permit.

Bear in mind that at a speed of just 30 mph (approximately 50 km/h), your vehicle is covering a distance of 44 feet (approximately 14 m) every second.

¹ Observe all legal requirements.

Driving instructions

Telephones and two-way radios

Warning!



Never operate radio transmitters equipped with a built-in or attached antenna (i.e. without being connected to an external antenna) from inside the vehicle while the engine is running. Doing so could lead to a malfunction of the vehicle's electronic system, possibly resulting in an accident and/or personal injury.

Radio transmitters, such as a portable telephone or a citizens band unit should only be used inside the vehicle if they are connected to an antenna that is installed on the outside of the vehicle.

Refer to the radio transmitter operation instructions regarding use of an external antenna.

Catalytic converter

Your Mercedes-Benz is equipped with monolithic-type catalytic converters, an important element in conjunction with the oxygen sensors to achieve substantial control of the pollutants in the exhaust emissions. Keep your vehicle in proper operating condition by following our recommended maintenance instructions as outlined in your Maintenance Booklet.

! *To prevent damage to the catalytic converters, use only premium unleaded gasoline in this vehicle.*

Any noticeable irregularities in engine operation should be repaired promptly. Otherwise, excessive unburned fuel may reach the catalytic converter, causing it to overheat and potentially start a fire.

Warning!



As with any vehicle, do not idle, park or operate this vehicle in areas where combustible materials such as grass, hay or leaves can come into contact with the hot exhaust system, as these materials could be ignited and cause a vehicle fire.

Emission control

Certain engine systems serve to keep the toxic components of the exhaust gases within permissible limits required by law.

These systems, of course, will function properly only when maintained strictly according to factory specifications. Any adjustments on the engine should therefore only be carried out by qualified Mercedes-Benz Center authorized technicians.

Engine adjustments should not be altered in any way. Moreover, the specified service jobs must be carried out regularly according to Mercedes-Benz servicing requirements. For details refer to the Maintenance Booklet.

Warning!



Inhalation of exhaust gas is hazardous to your health. All exhaust gas contains carbon monoxide (CO), and inhaling it can cause unconsciousness and possible death.

Do not run the engine in confined areas (such as a garage) which are not properly ventilated. If you think that exhaust gas fumes are entering the vehicle while driving, have the cause determined and corrected immediately. If you must drive under these conditions, drive only with at least one window fully open at all times.

Coolant temperature

Warning!



- Driving when your engine is overheated can cause some fluids, which may have leaked into the engine compartment, to catch fire. You could be seriously burned.
- Steam from an overheated engine can cause serious burns and can occur just by opening the hood. Stay away from the engine if you see or hear steam coming from it.

Turn off the engine, get out of the vehicle and do not stand near the vehicle until the engine has cooled down.

Driving instructions

! Excessive coolant temperature triggers a warning message in the multifunction display (▷ page 368).

The engine should not be operated with a coolant temperature above 248°F (120°C). Doing so may cause serious engine damage which is not covered by the Mercedes-Benz Limited Warranty.

i During severe operating conditions, e.g. stop-and-go city traffic, the coolant temperature may rise close to 248°F (120°C).

▼ At the gas station

Refueling

Warning!



Gasoline is highly flammable and poisonous. It burns violently and can cause serious personal injury.

Never allow sparks, flame or smoking materials near gasoline!

Turn off the engine before refueling.

Whenever you are around gasoline, avoid inhaling fumes and skin contact, extinguish all smoking materials.

Direct skin contact with fuels and the inhalation of fuel vapors are damaging to your health.

The fuel filler flap is located on the right-hand side of the vehicle towards the rear.

Locking and unlocking the vehicle with the SmartKey automatically locks and unlocks the fuel filler flap.

i In case that the central locking system does not release the fuel filler flap, or the opening mechanism is clamping, contact Roadside Assistance or an authorized Mercedes-Benz Center.

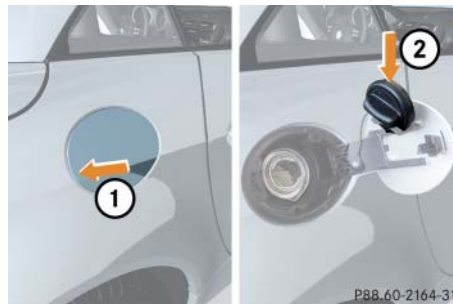

- ① To open fuel filler flap
- ② To insert fuel filler cap

- ▶ Remove the SmartKey from the starter switch.
- ▶ Open fuel filler flap by pushing at point indicated by arrow ①.

The fuel filler flap springs open.

- ▶ Turn fuel filler cap counterclockwise and hold on to it until possible pressure is released.
- ▶ Take off fuel filler cap and set it in direction of arrow ② in the recess on the inside of fuel filler flap.

To prevent fuel vapors from escaping into open air, fully insert filler nozzle unit.

- ▶ Only fill your tank until the filler nozzle unit cuts out – **do not top off or overfill.**

Warning!



Overfilling of the fuel tank may create pressure in the system which could cause a gas discharge. This could cause the gas to spray back out when removing the fuel pump nozzle, which could cause personal injury.

- ▶ Replace the fuel filler cap by turning it clockwise until it audibly engages. ▷▷

At the gas station

▷▷ **i** Make sure to close the fuel filler flap before locking your vehicle as the flap locking pin prevents closing after you have locked the vehicle.

▶ Close the fuel filler flap.

i Only use premium unleaded gasoline with a minimum Posted Octane Rating of 91 (average of 96 RON/86 MON).

Information on gasoline quality can normally be found on the fuel pump. Please contact gas station personnel in case labels on the pump cannot be found.

For more information on gasoline, see “Premium unleaded gasoline” (▷ page 446), refer to the Factory Approved Service Products pamphlet (USA only), or contact an authorized Mercedes-Benz-Center.

i Leaving the engine running and the fuel cap open can cause the yellow fuel tank reserve warning lamp to flash and the **CHECK ENGINE** malfunction indicator lamp (USA only) or the **malfunction indicator lamp (Canada only)** to illuminate.

For more information, see “Practical hints” (▷ page 349).

Check regularly and before a long trip

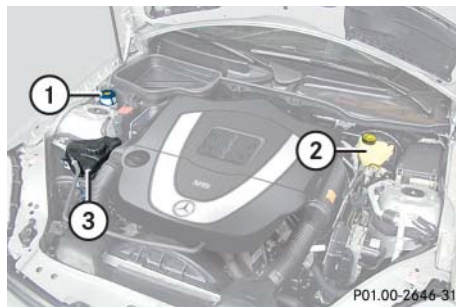

Engine compartment (example illustration, SLK 350)

- ① Windshield washer system and headlamp cleaning system* reservoir
- ② Brake fluid reservoir
- ③ Coolant expansion tank

i For opening the hood, see “Hood” (▷ page 294).

Windshield washer system and headlamp cleaning system*

For information on refilling the reservoir, see “Windshield washer system and headlamp cleaning system*” (▷ page 302).

Brake fluid

! If you find that the brake fluid in the brake fluid reservoir has fallen to the minimum mark or below, have the brake system checked for brake pad thickness and leaks immediately. Notify an authorized Mercedes-Benz Center immediately. Do not add brake fluid as this will not solve the problem.

For more information, see “Practical hints” (▷ page 348).

For information on brake fluid, see “Fuels, coolants, lubricants, etc.” (▷ page 443).

Coolant

For normal replenishing, use water (potable water quality).

For more information on coolant, see “Coolant level” (▷ page 300) and “Fuels, coolants, lubricants, etc.” (▷ page 443).

Engine oil level

For information on engine oil, see “Engine oil” (▷ page 296).

Vehicle lighting

Check function and cleanliness.

For more information on vehicle lighting, see “Replacing bulbs” (▷ page 393).

For information on switching on the exterior lighting, see “Exterior lamp switch” (▷ page 109).

Tire inflation pressure

For information on tire inflation pressure, see “Important notes on tire inflation pressure” (▷ page 313).

Engine compartment

Hood

Warning!



Do not pull the release lever while the vehicle is in motion. Otherwise the hood could be forced open by passing air flow.

This could cause the hood to come loose and injure you and/or others.

Opening

Warning!



If you see flames or smoke coming from the engine compartment, or if the coolant temperature gauge indicates that the engine is overheated, do not open the hood. Move away from the vehicle and do not open the hood until the engine has cooled. If necessary, call the fire department.

Warning!



You could be injured when the hood is open – even when the engine is turned off.

Parts of the engine can become very hot. To prevent burns, let the engine cool of completely before touching any components on the vehicle. Comply with all relevant safety precautions.

Warning!



To help prevent personal injury, stay clear of moving parts when the hood is open and the engine is running.

The radiator fan may continue to run for approximately 30 seconds or may even restart after the engine has been turned off. Stay clear of fan blades.

Warning!



The engine is equipped with a transistorized ignition system. Because of the high voltage it is dangerous to touch any components (ignition coils, spark plug sockets, diagnostic socket) of the ignition system

- with the engine running
- while starting the engine
- if ignition is “on” and the engine is turned manually

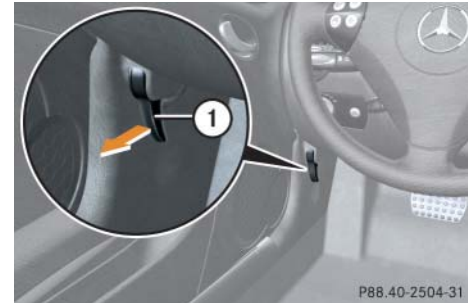

P88.40-2504-31

① Hood lock release lever

- ▶ Pull hood lock release lever ① in direction of arrow.

The hood is unlocked.

! To avoid damage to the windshield wipers or hood, never open the hood if the wiper arms are folded forward away from the windshield.



- ② Lever for opening the hood
- ▶ Push lever ② on the hood upward to release hood.

- ▶ With the hood released, lift the hood by lifting it at the front edge.

The hood will be automatically held open at shoulder height by gas-filled struts.

Closing

Warning!



When closing the hood, use extreme caution not to catch hand or fingers. Be careful that you do not close the hood on anyone.

Make sure the hood is securely engaged before driving. Do not continue driving if the hood can no longer engage after an accident for example. The hood could otherwise come loose while the vehicle is in motion and injure you and/or others.

- ▶ Let the hood drop from a height of approximately 1 ft (30 cm). The hood will lock audibly.
- ▶ Check to make sure the hood is fully closed.

If you can raise the hood at a point above the headlamps, then it is not properly closed. Open it again and let it drop with somewhat greater force.

Engine compartment

Engine oil

The amount of oil your engine needs will depend on a number of factors, including driving style. Higher oil consumption can occur when

- the vehicle is new
- the vehicle is driven frequently at higher engine speeds

Engine oil consumption checks should only be made after the vehicle break-in period.

! *Do not use any special lubricant additives, as these may damage the drive assemblies. Using special additives not approved by Mercedes-Benz may cause damage not covered by the Mercedes-Benz Limited Warranty.*



More information on this subject is available at any authorized Mercedes-Benz Center.

Checking engine oil level with the control system (SLK 55 AMG only)

When checking the oil level

- the vehicle must be parked on level ground.
- with the engine at operating temperature, the vehicle must have been stationary for at least 5 minutes with the engine turned off.
- with the engine not at operating temperature, the vehicle must have been stationary for at least 30 minutes with the engine turned off.

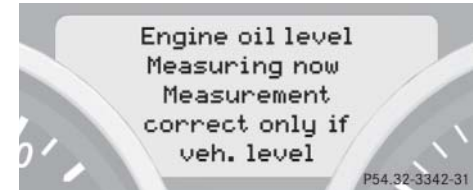

To check the engine oil level via the multifunction display, do the following:

- ▶ Switch on the ignition (▷ page 37).
The standard display appears in the multifunction display (▷ page 127).
- ▶ Press button  or  on the multifunction steering wheel repeatedly until the following message appears in the multifunction display (▷ page 122):



One of the following messages will subsequently appear in the multifunction display:

- Engine oil level OK
- Add 1.0 qt. (Canada: 1.0 liter) to reach max. oil level
- Add 1.5 qts. (Canada: 1.5 liters) to reach max. oil level
- Add 2.0 qts. (Canada: 2.0 liters) to reach max. oil level

i If you want to interrupt the checking procedure, press button  or  on the multifunction steering wheel (▷ page 122).

- ▶ If necessary, add engine oil.

For adding engine oil, see “Adding engine oil” (▷ page 299).

For more information on engine oil, see “Fuels, coolants, lubricants, etc.” (▷ page 443).

Other display messages

If the ignition is not switched on, the following message will appear:

Turn on ignition
to see engine oil level

- ▶ Switch on the ignition (▷ page 37).

If you see the message:



Observe waiting time

- ▶ If engine is at operating temperature, wait 5 minutes before repeating check procedure.
- ▶ If engine is not at operating temperature yet, you must wait 30 minutes before checking oil.

If you see the message:

Cannot check engine
level with engine on

- ▶ Turn off the engine.
- ▶ If the engine is at operating temperature, wait 5 minutes before checking oil.
- ▶ If the engine is not at operating temperature yet, you must wait 30 minutes before checking oil.

i If you want to interrupt the checking procedure, press button  or  on the multifunction steering wheel (▷ page 122).

Engine compartment

If there is excess engine oil with the engine at normal operating temperature, the following message will appear:

Engine oil level
Reduce oil level

- ▶ Have excess oil siphoned or drained off. Contact an authorized Mercedes-Benz Center.

! *Excess oil must be siphoned or drained off. It could cause damage to the engine and catalytic converter not covered by the Mercedes-Benz Limited Warranty.*

For more information on messages in the display concerning engine oil, see the “Practical hints” section (▷ page 356).

Checking engine oil level with the oil dipstick (SLK 280, SLK 350 only)

When checking the oil level

- the vehicle must be parked on level ground.
- with the engine at operating temperature, the vehicle must have been stationary for at least 5 minutes with the engine turned off.
- with the engine not at operating temperature, the vehicle must have been stationary for at least 30 minutes with the engine turned off.

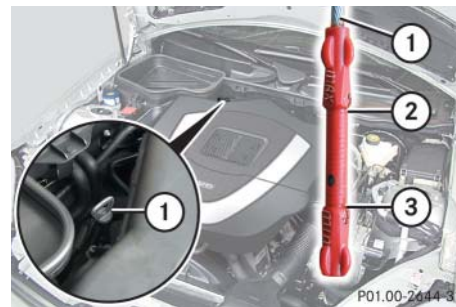

- ① Oil dipstick
- ② Upper (max) mark
- ③ Lower (min) mark

To check the engine oil level with the oil dipstick, do the following:

- ▶ Open the hood (▷ page 294).
- ▶ Pull out oil dipstick ①.
- ▶ Wipe oil dipstick ① clean.
- ▶ Fully insert oil dipstick ① into the dipstick guide tube.

- ▶ Pull out oil dipstick ① again after approximately 3 seconds to obtain accurate reading.

The oil level is correct when it is between the lower (min) mark ③ and upper (max) mark ② of oil dipstick ①.

i The filling quantity between the upper and lower marks on the oil dipstick is approximately 2.1 US qt. (2.0 l).

- ▶ If necessary, add engine oil.

For adding engine oil, see “Adding engine oil” (▷ page 299).

For more information on engine oil, see “Fuels, coolants, lubricants, etc.” (▷ page 443).

For more information on messages in the multifunction display concerning engine oil, see the “Practical hints” section (▷ page 356).

Adding engine oil

Only use approved engine oils and oil filters required for vehicles with Maintenance System. For a listing of approved engine oils and oil filters, refer to the Factory Approved Service Products pamphlet (USA only) in your vehicle literature portfolio, or contact an authorized Mercedes-Benz Center.

Using engine oils and oil filters of specification other than those expressly required for the Maintenance System, or changing of oil and oil filter at change intervals longer than those called for by the Maintenance System will result in engine or emission control system damage not covered by the Mercedes-Benz Limited Warranty.



SLK 350 (example illustration)

- ① Filler cap



SLK 55 AMG

- ① Filler cap

Engine compartment

- ▶ Unscrew filler cap ① from filler neck.
- ▶ Add engine oil as required.

Be careful not to overfill with oil.

Be careful not to spill any oil when adding. Avoid environmental damage caused by oil entering the ground or water.

! *Excess oil must be siphoned or drained off. It could cause damage to the engine and emission control system not covered by the Mercedes-Benz Limited Warranty.*

- ▶ Screw filler cap ① back on filler neck.

For more information on engine oil, see “Technical data” (▷ page 443) and (▷ page 445).

Transmission fluid level*

Vehicles with automatic transmission*: The transmission fluid level does not need to be checked. If you notice transmission fluid loss or gear shifting malfunctions, have an authorized Mercedes-Benz Center check the transmission.

Coolant level

The engine coolant is a mixture of water and anticorrosion/antifreeze. To check the coolant level, the vehicle must be parked on level ground and the engine must be cool.

Warning!



In order to avoid any potentially serious burns:

- Use extreme caution when opening the hood if there are any signs of steam or coolant leaking from the cooling system, or if the coolant temperature gauge indicates that the coolant is overheated.
- Do not remove pressure cap on coolant reservoir if coolant temperature is above 158°F (70°C). Allow engine to cool down before removing cap. The coolant reservoir contains hot fluid and is under pressure.

- Using a rag, slowly open the cap approximately $1/2$ turn to relieve excess pressure. If opened immediately, scalding hot fluid and steam will be blown out under pressure.
- Do not spill antifreeze on hot engine parts. Antifreeze contains ethylene glycol which may burn if it comes into contact with hot engine parts.

The coolant expansion tank is located on the passenger side of the engine compartment.

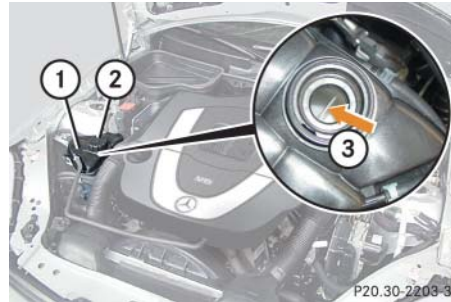

SLK 350 (example illustration)

- ① Coolant expansion tank
- ② Cap
- ③ Marking bar in the expansion tank

- ▶ Using a rag, turn cap ② slowly approximately one half turn counterclockwise to release any excess pressure.
- ▶ Continue turning cap ② counterclockwise and remove it.

The coolant level is correct if the level

- for cold coolant: reaches marking bar ③ in expansion tank ①
- for warm coolant: is approximately 0.6 in (1.5 cm) higher
- ▶ Add coolant as required.
- ▶ Replace and tighten cap ②.

For more information on coolant, see “Coolants” (▷ page 448).

Engine compartment

Windshield washer system and headlamp cleaning system*

The windshield washer reservoir is located on the passenger side of the engine compartment.



SLK 350 (example illustration)

① Cap for windshield washer reservoir

Fluid for the windshield washer system and the headlamp cleaning system* is supplied from the windshield washer reservoir. It has a capacity of approximately 7.4 US qt (7 l).

During all seasons, add MB Windshield Washer Concentrate “MB SummerFit” to water. Premix the windshield washer fluid in a suitable container.

Warning!



Washer solvent/antifreeze is highly flammable. Do not spill washer solvent/antifreeze on hot engine parts, because it may ignite and burn. You could be seriously burned.

- ▶ Use the tab to pull cap ① upwards.
- ▶ Refill the reservoir with MB Windshield Washer Concentrate “MB SummerFit” and water (or commercially available premixed windshield washer solvent/antifreeze, depending on ambient temperatures).

! Always use washer solvent/antifreeze where temperatures may fall below freezing point. Failure to do so could result in damage to the washer system/reservoir.

! Only use washer fluid which is suitable for plastic lenses. Improper washer fluid can damage the plastic lenses of the headlamps.

For more information, see “Windshield washer system and headlamp cleaning system*” (▷ page 450).

Battery

Your vehicle's battery is located in the engine compartment.

The battery should always be sufficiently charged in order to achieve its rated service life. Refer to the Maintenance Booklet for battery maintenance intervals.

If you use your vehicle mostly for short-distance trips, you will need to have the battery charge checked more frequently.

When replacing the battery, always use batteries approved by Mercedes-Benz.

If you do not intend to operate your vehicle for an extended period of time, consult an authorized Mercedes-Benz Center about steps you need to observe.

Warning!



Observe all safety instructions and precautions when handling automotive batteries.



Risk of explosion.



Fire, open flames and smoking are prohibited when handling batteries. Avoid creating sparks.



Battery acid is caustic. Do not allow it to come into contact with skin, eyes or clothing.

Wear suitable protective clothing, especially gloves, apron and faceguard.



Wear eye protection.

Rinse any acid spills immediately with clear water. Contact a physician if necessary.



Keep children away.



Follow the instructions in this Operator's Manual.

Batteries contain materials that can harm the environment if disposed of improperly. Recycling of batteries is the preferred method of disposal. Many states require sellers of batteries to accept old batteries for recycling.

Tires and wheels

Contact an authorized Mercedes-Benz Center for information on tested and recommended rims and tires for summer and winter operation. They can also offer advice concerning tire service and purchase.

Warning!



Replace rims or tires with the same designation, manufacturer and type as shown on the original part. Contact an authorized Mercedes-Benz Center for further information. If incorrectly sized rims and tires are mounted:

- The wheel brakes or suspension components can be damaged.
- The operating clearance of the wheels and the tires may no longer be correct.

Warning!



Worn, old tires can cause accidents. If the tire tread is badly worn, or if the tires have sustained damage, replace them.

When replacing rims, only use genuine Mercedes-Benz wheel bolts specified for the particular rim type. Failure to do so can result in the bolts loosening and may lead to an accident.

Retreaded tires are not tested or recommended by Mercedes-Benz, since previous damage cannot always be recognized on retreads. Mercedes-Benz therefore cannot assure the operating safety of the vehicle when such tires are used.

Important guidelines

- Only use sets of tires and rims of the same type and make.
- Tires must be of the correct size for the rim.
- Break in new tires for approximately 60 miles (100 km) at moderate speeds.
- Regularly check the tires and rims for damage. Dented or bent rims can cause tire inflation pressure loss or damage the tire beads.
- If vehicle is heavily loaded, check tire inflation pressure and correct as required.
- Do not allow your tires to wear down too far. Adhesion properties on wet roads are sharply reduced at tread depths of less than $\frac{1}{8}$ in (3 mm).
- When replacing individual tires, you should mount new tires on the front wheels first (on vehicles with same-sized wheels all around).

Tire care and maintenance

Warning!



Regularly check the tires for damage. Damaged tires can cause tire inflation pressure loss. As a result, you could lose control of your vehicle.

Worn, old tires can cause accidents. If the tire tread is badly worn, or if the tires have sustained damage, replace them.

Regularly check your tire inflation pressure at least once a month. For more information on checking tire inflation pressure, see “Recommended tire inflation pressure” (▷ page 312).

Tire inspection

Every time you check your tire inflation pressure, you should also inspect your tires for the following:

- excessive treadwear (▷ page 306)
- cord or fabric showing through the tire’s rubber
- bumps, bulges, cuts, cracks or splits in the tread or side of the tire

Replace the tire if you find any of the above conditions.

Make sure you also inspect the spare tire periodically for condition and inflation. Spare tires will age and become worn over time even if never used, and thus should be inspected and replaced when necessary.

Life of tire

The service life of a tire is dependent upon varying factors including but not limited to:

- Driving style
- Tire inflation pressure
- Distance driven

Warning!



Tires and spare tire should be replaced after 6 years, regardless of the remaining tread.

Tires and wheels

Tread depth

Do not allow your tires to wear down too far. Adhesion properties on wet roads are sharply reduced at tread depths of less than $\frac{1}{8}$ in (3 mm).

Treadwear indicators (TWI) are required by law. These indicators are located in six places on the tread circumference and become visible at a tread depth of approximately $\frac{1}{16}$ in (1.6 mm), at which point the tire is considered worn and should be replaced.

Recommended minimum tire tread depth:

- Summer tires $\frac{1}{8}$ in (3 mm)
- Winter tires $\frac{1}{6}$ in (4 mm)

Warning!



Although the applicable federal motor safety laws consider a tire to be worn when the treadwear indicators (TWI) become visible at approximately $\frac{1}{16}$ in (1.6 mm), we recommend that you do not allow your tires

to wear down to that level. As tread depth approaches $\frac{1}{8}$ in (3 mm), the adhesion properties on a wet road are sharply reduced.

Depending upon the weather and/or road surface (conditions), the tire traction varies widely.

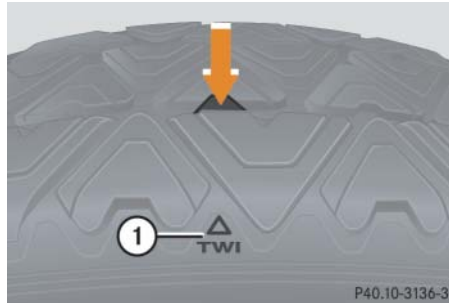

① TWI (Tread Wear Indicator)

The treadwear indicator appears as a solid band across the tread.

Storing tires

! Keep unmounted tires in a cool, dry place with as little exposure to light as possible. Protect tires from contact with oil, grease and gasoline.

Cleaning tires

! Never use a round nozzle to power wash tires. The intense jet of water can result in damage to the tire.

Always replace a damaged tire.

Direction of rotation

Unidirectional tires offer added advantages, such as better hydroplaning performance. To benefit, however, you must make sure the tires rotate in the direction specified.

An arrow on the sidewall indicates the intended direction of rotation (spinning) of the tire.

i *Spare wheels may be mounted against the direction of rotation (spinning) even with a unidirectional tire for temporary use only until the regular drive wheel has been repaired or replaced. Always observe and follow applicable temporary use restrictions and speed limitations indicated on the spare wheel.*

Loading the vehicle

Two labels on your vehicle show how much weight it may properly carry.

- 1) The Tire and Loading Information placard can be found on the driver's door B-pillar. This placard tells you important information about the number of people that can be in the vehicle and the total weight that can be carried in the vehicle. It also contains information on the proper size and recommended tire inflation pressures for the original equipment tires on your vehicle.
- 2) The certification label, also found on the driver's door B-pillar. It tells you about the gross weight capacity of your vehicle, called the Gross Vehicle Weight Rating (GVWR). The GVWR includes the weight of the vehicle, all occupants, fuel and cargo. The certification label also tells you about the front and rear axle weight capacity, called the Gross Axle Weight Rating (GAWR). The GAWR is the total allow-

able weight that can be carried by a single axle (front or rear). Never exceed the GVWR or GAWR for either the front axle or rear axle.

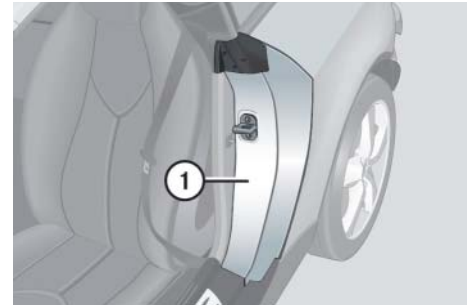

① Driver's door B-pillar

Following is a discussion on how to work with the information contained on the Tire and Loading Information placard with regards to loading your vehicle.

Tire and Loading Information

Warning!



Do not overload the tires by exceeding the specified load limit as indicated on the Tire and Loading Information placard on the driver's door B-pillar. Overloading the tires can overheat them, possibly causing a blowout. Overloading the tires can also result in handling or steering problems, or brake failure.

Tire and Loading Information placard

i Data shown on Tire and Loading Information placard example are for illustration purposes only. Load limit data are specific to each vehicle and may vary from data shown in the illustration below. Refer to Tire and Loading Information placard on vehicle for actual data specific to your vehicle.

TIRE AND LOADING INFORMATION			
SEATING CAPACITY		TOTAL 5 * FRONT 2 * REAR 3	
The combined weight of occupants and cargo should never exceed XXX kg or XXX lbs.*			
TIRE	SIZE	COLD TIRE PRESSURE	SEE OWNER'S MANUAL FOR ADDITIONAL INFORMATION
FRONT	P195/70R14	200KPA, 29PSI	
REAR	P195/70R14	200KPA, 29PSI	
SPARE	T125/70D15	420KPA, 60PSI	

P40.00-2062-31

① Load limit information on the Tire and Loading Information placard

The Tire and Loading Information placard showing the load limit information is located on the driver's door B-pillar (▷ page 307).

- ▶ Locate the statement “The combined weight of occupants and cargo should never exceed XXX kilograms or XXX lbs.” on the Tire and Loading Information placard.

The combined weight of all occupants, cargo/luggage and trailer tongue load (if applicable) should never exceed the weight referenced in that statement.

Seating capacity

The seating capacity gives you important information on the number of occupants that can be in the vehicle. The Tire and Loading Information placard showing the seating capacity is located on the driver's door B-pillar (▷ page 307).

i Data shown on Tire and Loading Information placard example are for illustration purposes only. Seating data are specific to each vehicle and may vary from data shown in the illustration below. Refer to Tire and Loading Information placard on vehicle for actual data specific to your vehicle.

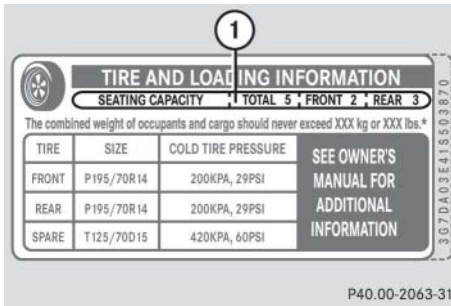

① Seating capacity information on the Tire and Loading Information placard

Steps for determining correct load limit

The following steps have been developed as required of all manufacturers under Title 49, Code of U.S. Federal Regulations, Part 575 pursuant to the “National Traffic and Motor Vehicle Safety Act of 1966”.

Step 1

- ▶ Locate the statement “The combined weight of occupants and cargo should never exceed XXX kg or XXX lbs.” on your vehicle’s Tire and Loading Information placard.

Step 2

- ▶ Determine the combined weight of the driver and passenger that will be riding in your vehicle.

Step 3

- ▶ Subtract the combined weight of the driver and passenger from XXX kilograms or XXX lbs.

Step 4

- ▶ The resulting figure equals the available amount of cargo and luggage load capacity. For example, if the “XXX” amount equals 1 400 lbs and there will be five 150 lbs passengers in your vehicle, the amount of available cargo and luggage load capacity is 650 lbs (1 400-750 (5 x 150) = 650 lbs).

Step 5

- ▶ Determine the combined weight of luggage and cargo being loaded on the vehicle. That weight may not safely exceed the available cargo and luggage load capacity calculated in step 4.

Step 6 (if applicable)

- ▶ If your vehicle will be towing a trailer, load from your trailer will be transferred to your vehicle. Consult this manual to determine how this reduces the available cargo and luggage load capacity of your vehicle (▷ page 311).

The following table shows examples on how to calculate total and cargo load capacities with varying seating configurations and number and size of occupants. The following examples use a load limit of 1 500 lbs. **This is for illustration purposes only.** Make sure you are using the actual load limit for your vehicle stated on the vehicle’s Tire and Loading Information placard (▷ page 308).

Tires and wheels

Example	Combined weight limit of occupants and cargo from Tire and Loading Information placard	Number of occupants (driver and passengers)	Occupants weight	Combined weight of all occupants	Available cargo/luggage and trailer tongue weight (total load limit from Tire and Loading Information placard minus combined weight of all occupants)
1	1 500 lbs	1	Occupant 1: 175 lbs	175 lbs	1 500 lbs - 175 lbs = 1 325 lbs
2	1 500 lbs	2	Occupant 1: 175 lbs Occupant 2: 195 lbs	370 lbs	1 500 lbs - 370 lbs = 1 130 lbs

The higher the weight of all occupants, the less cargo and luggage load capacity is available.

For more information, see “Trailer tongue load” (▷ page 311).

Certification label

Even after careful determination of the combined weight of all occupants, cargo and the trailer tongue load (if applicable) (▷ page 311) as to not exceed the permissible load limit, you must make sure that your vehicle never exceeds the Gross Vehicle Weight Rating (GVWR) and the Gross Axle Weight Rating (GAWR) for either the front or rear axle. You can obtain the GVWR and GAWR from the certification label. The certification label can be found on the driver's door B-pillar, see "Technical data" (▷ page 430).

Gross Vehicle Weight Rating (GVWR):

The total weight of the vehicle, all occupants, all cargo, and the trailer tongue load (▷ page 311) must never exceed the GVWR.

Gross Axle Weight Rating (GAWR): The total allowable weight that can be carried by a single axle (front or rear).

To assure that your vehicle does not exceed the maximum permissible weight limits (GVWR and GAWR for front and rear axle), have the loaded vehicle (including driver, passengers and all cargo and, if applicable, trailer fully loaded) weighed on a suitable commercial scale.

Trailer tongue load

The tongue load of any trailer is an important weight to measure because it affects the load you can carry in your vehicle. If a trailer is towed, the tongue load must be added to the weight of all occupants riding and any cargo you are carrying in the vehicle. The tongue load typically is 10 percent of the trailer weight and everything loaded in it.

Your Mercedes-Benz has been designed primarily to carry passengers and their cargo. Mercedes-Benz does not recommend trailer towing with your vehicle.

Recommended tire inflation pressure

Warning!



Follow recommended tire inflation pressures.

Do not underinflate tires. Underinflated tires wear excessively and/or unevenly, adversely affect handling and fuel economy, and are more likely to fail from being overheated.

Do not overinflate tires. Overinflated tires can adversely affect handling and ride comfort, wear unevenly, increase stopping distance, and result in sudden deflation (blowout) because they are more likely to become punctured or damaged by road debris, potholes etc.

Do not overload the tires by exceeding the specified load limit as indicated on the Tire and Loading Information placard on the driver's door B-pillar. Overloading the tires can overheat them, possibly causing a blowout. Overloading the tires can also result in handling or steering problems, or brake failure.

Your vehicle is equipped with the Tire and Loading Information placard located on the driver's door B-pillar (▷ page 307).

The tire inflation pressure should be checked regularly and should only be adjusted on cold tires. The tires can be considered cold if the vehicle has been parked for at least three hours or driven less than one mile (1.6 km).

Follow recommended cold tire inflation pressures listed on the Tire and Loading Information placard on the driver's door B-pillar.

Keeping the tires properly inflated provides the best handling, tread life and riding comfort.

In addition to the Tire and Loading Information placard on the driver's door B-pillar, also consult the tire inflation pressure label (if available) on the fuel filler flap (▷ page 291) for any additional information pertaining to special driving situations. For more information, see "Important notes on tire inflation pressure" (▷ page 313).

i Data shown on Tire and Loading Information placard example are for illustration purposes only. Tire data are specific to each vehicle and may vary from data shown in the illustration below. Refer to Tire and Loading Information placard on vehicle for actual data specific to your vehicle.

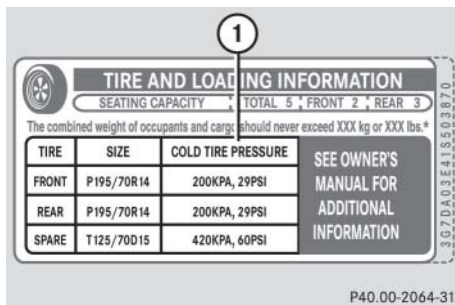

① Tire and Loading Information placard with recommended cold tire inflation pressures

The Tire and Loading Information placard lists the recommended cold tire inflation pressures for maximum loaded vehicle weight. The tire inflation pressures listed apply to the tires installed as original equipment.

Important notes on tire inflation pressure

Warning!



If the tire inflation pressure drops repeatedly:

- Check the tires for punctures from foreign objects.
- Check to see whether air is leaking from the valves or from around the rim.

Tire temperature and tire inflation pressure are also increased while driving, depending on the driving speed and the tire load.

If you will be driving your vehicle at high speeds of 100 mph (160 km/h) or higher, where it is legal and conditions allow, consult the tire inflation pressure label (if available) on the inside of the fuel filler flap on how to adjust the cold tire inflation pressure. If you do not adjust the tire inflation pressure, excessive heat can build up and result in sudden tire failure.

If your vehicle is not equipped with the tire inflation pressure label on the inside of the fuel filler flap, contact an authorized Mercedes-Benz Light Truck Center for proper tire inflation pressure.

i Driving comfort may be reduced when the tire inflation pressure is adjusted to the value for speeds above 100 mph (160 km/h) as specified on the tire inflation pressure label located on the inside of the fuel filler flap.

Be sure to readjust the tire inflation pressure for normal driving speeds. You should wait until the tires are cold before adjusting the tire inflation pressure.

Some vehicles may have supplemental tire inflation pressure information for vehicle loads less than the maximum loaded vehicle condition. If such information is provided, it can be found on the tire inflation pressure label located on the inside of the fuel filler flap (> page 291).

Tires and wheels

Tire inflation pressure changes by approximately 1.5 psi (0.1 bar) per 18°F (10°C) of air temperature change. Keep this in mind when checking tire inflation pressure where the temperature is different from the outside temperature.

Checking tire inflation pressure

Regularly check your tire inflation pressure at least once a month.

Check and adjust the tire inflation pressure when the tires are cold. The tires can be considered cold if the vehicle has been parked for at least 3 hours or driven less than 1 mile (1.6 km).

If you check the tire inflation pressure when the tires are warm (the vehicle has been driven for several miles or sitting less than 3 hours), the reading will be approximately 4 psi (0.3 bar) higher than the cold reading. This is normal. Do not let air out to match the specified cold tire inflation pressure. Otherwise, the tire will be underinflated.

Warning!



Follow recommend tire inflation pressures.

Do not underinflate tires. Underinflated tires wear excessively and/or unevenly, adversely affect handling and fuel economy, and are more likely to fail from being overheated.

Do not overinflate tires. Overinflated tires can adversely affect handling and ride comfort, wear unevenly, increase stopping distance, and result in sudden deflation (blowout) because they are more likely to become punctured or damaged by road debris, potholes etc.

Do not overload the tires by exceeding the specified load limit as indicated on the Tire and Loading Information placard on the driver's door B-pillar. Overloading the tires can overheat them, possibly causing a blowout. Overloading the tires can also result in handling or steering problems, or brake failure.

Checking tire inflation pressure manually

Follow the steps below to achieve correct tire inflation pressure:

- ▶ Remove the cap from the valve on one tire.
- ▶ Firmly press a tire gauge onto the valve.
- ▶ Read tire inflation pressure on tire gauge and check against the recommended tire inflation pressure on the Tire and Loading Information placard on the driver's door B-pillar (▷ page 307). If necessary, add air to achieve the recommended tire inflation pressure.

i *If you have overfilled the tire, release tire inflation pressure by pushing the metal stem of the valve with e.g. a tip of a pen. Then recheck the tire inflation pressure with the tire gauge.*

- ▶ Install the valve cap.
- ▶ Repeat this procedure for each tire.

Run Flat Indicator*

While the vehicle is being driven, the Run Flat Indicator monitors the set tire inflation pressures by evaluating each wheel's rotational speed. This allows the system to detect a significant loss of pressure in a tire. If a wheel's rotational speed changes due to falling tire inflation pressure, you will see a corresponding warning message in the multifunction display.

The Run Flat Indicator may function in a restricted manner or with a delay if:

- snow chains are mounted to the vehicle
- winter road conditions prevail
- you are driving on a loose surface (e.g. sand or gravel)
- you are driving in a very sporty manner (involving rapid acceleration or high speeds in curves)

Warning!



When the multifunction display shows the message **Tire pressure Check tires**, one or more of your tires is significantly underinflated. You should stop and check your tires as soon as possible, and inflate them to the proper tire inflation pressure as indicated on the vehicle's Tire and Loading Information placard or, if available, on the tire inflation pressure label. Driving on a significantly underinflated tire causes the tire to overheat and can lead to tire failure. Underinflation also reduces fuel efficiency and tire tread life, and may affect the vehicle's handling and stopping ability. Each tire, including the spare, should be checked monthly when cold and set to the recommended tire inflation pressure as specified on the Tire and Loading Information placard on the driver's door B-pillar (▷ page 307) or, if available, on the tire inflation pressure label located on the inside of the fuel filler flap (▷ page 291).

Warning!



The Run Flat Indicator does not indicate a warning for wrongly selected tire inflation pressures. Always adjust tire inflation pressure according to the Tire and Loading Information placard on the driver's door B-pillar (▷ page 307) or, if available, on the tire inflation pressure label located on the inside of the fuel filler flap (▷ page 291).

The Run Flat Indicator does not replace regular checks of the tire inflation pressures since a gradual pressure loss in more than one tire cannot be detected by the Run Flat Indicator.

The Run Flat Indicator is not able to issue a warning due to a sudden dramatic loss of tire inflation pressure (e.g. tire blowout caused by a foreign object). In this case bring the vehicle to a halt by carefully applying the brakes and avoiding abrupt steering maneuvers.

Tires and wheels

Reactivating the Run Flat Indicator

The tire inflation pressure monitor must be restarted in the following situations:

- If you have changed the tire inflation pressure
- If you have replaced the wheels or tires
- If you have installed new wheels or tires
- ▶ Using the Tire and Loading Information placard on the driver's door B-pillar or, if available, the tire inflation pressure label on the inside of the fuel filler flap, make sure the tire inflation pressure of all four tires is correct.

Warning!





The Run Flat Indicator can only warn you in a reliable manner if you have set the correct tire inflation pressures for each tire.

If an incorrect tire inflation pressure was set, the system will monitor the pressure according to the incorrect value.

- ▶ Switch on the ignition (▷ page 37).

The standard display menu appears in the multifunction display (▷ page 127).

- ▶ Press button  or  repeatedly until the following message appears in the multifunction display:
Run Flat Indicator
active
Menu: R-Button
- ▶ Press reset button  (▷ page 26).

The following message will appear in the multifunction display:

Restart
Run Flat Indicator?

If you wish to confirm activation:

- ▶ Press button .

The following message will appear in the multifunction display:

Run Flat Indicator
restarted

After a certain “learning phase”, the Run Flat Indicator checks the set pressure values for all four tires.

If you wish to cancel activation:

- ▶ Press button .

or

- ▶ Wait until the message
Restart
Run Flat Indicator?
disappears.

Potential problems associated with underinflated and overinflated tires

Underinflated tires

Underinflated tires can:

- cause excessive and uneven tire wear
- adversely affect fuel economy
- lead to tire failure from being overheated
- adversely affect handling characteristics

Warning!



Follow recommended tire inflation pressures.

Do not underinflate tires. Underinflated tires wear excessively and/or unevenly, adversely affect handling and fuel economy, and are more likely to fail from being overheated.

Overinflated tires

Overinflated tires can:

- adversely affect handling characteristics
- cause uneven tire wear
- be more prone to damage from road hazards
- adversely affect ride comfort
- increase stopping distance

Warning!



Follow recommended tire inflation pressures.

Do not overinflate tires. Overinflated tires can adversely affect handling and ride comfort, wear unevenly, increase stopping distance, and result in sudden deflation (blowout) because they are more likely to become punctured or damaged by road debris, potholes etc.

*MOExtended system**

The *MOExtended* system allows you to continue driving your vehicle even if there is a total loss of pressure in one or more tires.

You may only use the *MOExtended* system in conjunction with the Run Flat Indicator*.

For information on driving in case of pressure loss in one or more tires (emergency mode), see the “Practical hints” section (> page 414).

Tires and wheels

Tire labeling

Besides tire name (sales designation) and manufacturer name, a number of markings can be found on a tire.

Following are some explanations for the markings on your vehicle's tires:

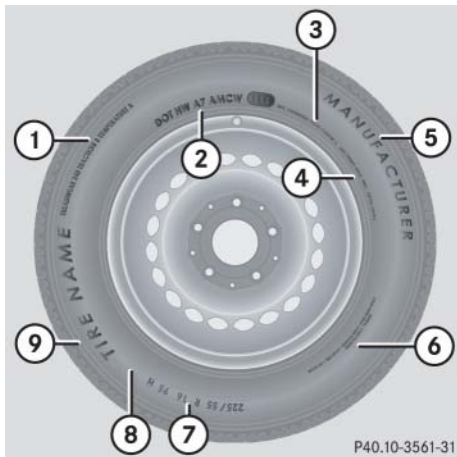

- ① Uniform Quality Grading Standards (▷ page 325)
- ② DOT, Tire Identification Number (TIN) (▷ page 322)
- ③ Maximum tire load (▷ page 324)
- ④ Maximum tire inflation pressure (▷ page 324)
- ⑤ Manufacturer
- ⑥ Tire ply material (▷ page 327)
- ⑦ Tire size designation, load and speed rating (▷ page 318)
- ⑧ Load identification (▷ page 322)
- ⑨ Tire name

i For illustration purposes only. Actual data on tires are specific to each vehicle and may vary from data shown in above illustration.

For more information, see “Rims and tires” (▷ page 434).

Tire size designation, load and speed rating

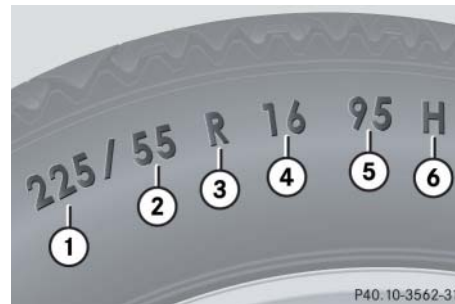

- ① Tire width
- ② Aspect ratio in %
- ③ Radial tire code
- ④ Rim diameter
- ⑤ Tire load rating
- ⑥ Tire speed rating

i For illustration purposes only. Actual data on tires are specific to each vehicle and may vary from data shown in above illustration.

General:

Depending on the design standards used, the tire size molded into the sidewall may have no letter or a letter preceding the tire size designation.

No letter preceding the size designation (as illustrated above): Passenger car tire based on European design standards.

Letter “P” preceding the size designation: Passenger car tire based on U.S. design standards.

Letter “LT” preceding the size designation: Light Truck tire based on U.S. design standards.

Letter “T” preceding the size designation: Temporary spare tires which are high pressure compact spares designed for temporary emergency use only.

Tire width

The tire width ① (▷ page 318) indicates the nominal tire width in mm.

Aspect ratio

The aspect ratio ② (▷ page 318) is the dimensional relationship between tire section height and section width and is expressed in percentage. The aspect ratio is arrived at by dividing section height by section width.

Tire code

The tire code ③ (▷ page 318) indicates the tire construction type. The “R” stands for radial tire type. Letter “D” means diagonal or bias ply construction; letter “B” means belted-bias ply construction.

At the tire manufacturer’s option, any tire with a speed capability above 149 mph (240 km/h) can include a “ZR” in the size designation (for example: 245/40 ZR 18). For additional information, see “Tire speed rating” (▷ page 320).

Rim diameter

The rim diameter ④ (▷ page 318) is the diameter of the bead seat, not the diameter of the rim edge. Rim diameter is indicated in inches (in).

Tire load rating

The tire load rating ⑤ (▷ page 318) is a numerical code associated with the maximum load a tire can support.

For example, a load rating of 91 corresponds to a maximum load of 1356 lbs (615 kg) the tire is designed to support. See also “Maximum tire load” (▷ page 324) where the maximum load associated with the load index is indicated in kilograms and lbs.

Tires and wheels

Warning!



The tire load rating must always be at least half of the GAWR (▷ page 328) of your vehicle. Otherwise, tire failure may be the result which may cause an accident and/or serious personal injury to you or others.

Always replace rims and tires with the same designation, manufacturer and type as shown on the original part.

Warning!



Do not overload the tires by exceeding the specified load limit as indicated on the Tire and Loading Information placard located on the driver's door B-pillar. Overloading the tires can overheat them, possibly causing a blowout. Overloading the tires can also result in handling or steering problems, or brake failure.

For additional information on tire load rating, see “Load identification” (▷ page 322).

i *Tire load rating ⑤ (▷ page 318) and Tire speed rating ⑥ (▷ page 318) are also referred to as “service description”.*

Tire speed rating

The tire speed rating ⑥ (▷ page 318) indicates the approved maximum speed for the tire.

Warning!



Even when permitted by law, never operate a vehicle at speeds greater than the maximum speed rating of the tires.

Exceeding the maximum speed for which tires are rated can lead to sudden tire failure, causing loss of vehicle control and possibly resulting in an accident and/or personal injury and possible death, for you and for others.

i *Tire load rating ⑤ (▷ page 318) and Tire speed rating ⑥ (▷ page 318) are also referred to as “service description”.*

Summer tires

Index	Speed rating
Q	up to 100 mph (160 km/h)
R	up to 106 mph (170 km/h)
S	up to 112 mph (180 km/h)
T	up to 118 mph (190 km/h)
H	up to 130 mph (210 km/h)
V	up to 149 mph (240 km/h)
W	up to 168 mph (270 km/h)
Y	up to 186 mph (300 km/h)
(Y)	above 186 mph (300 km/h)
ZR	above 149 mph (240 km/h)

- At the tire manufacturer’s option, any tire with a speed capability above 149 mph (240 km/h) can include a “ZR” in the size designation (for example: 245/40 ZR18). To determine the maximum speed capability of the tire, the service description for the tire must be referred to.

The service description is comprised of the tire load rating ⑤ (▷ page 318) and the tire speed rating ⑥ (▷ page 318).

If your tire includes “ZR” in the size designation and no service description ⑤ and ⑥ (▷ page 318) is given, the tire manufacturer must be consulted for the maximum speed capability.

If a service description ⑤ and ⑥ (▷ page 318) is given, the speed capability is limited by the speed symbol in the service description.

Example: 245/40 ZR18 97Y.



In this example, “97Y” is the service description. The letter “Y” designates the speed rating and the speed capability of the tire is limited to 186 mph (300 km/h).

- Any tire with a speed capability above 186 mph (300 km/h) must include a “ZR” in the size designation AND the service description must be placed in parenthesis. Example: 275/40 ZR 18 (99Y). The “(Y)” speed rating in parenthesis designates the maximum speed capability of the tire as being above 186 mph (300 km/h). Consult the tire manufacturer for the actual maximum permissible speed of the tire.

All-season and winter tires

Index	Speed rating
Q M+S ¹	up to 100 mph (160 km/h)
T M+S ¹	up to 118 mph (190 km/h)
H M+S ¹	up to 130 mph (210 km/h)
V M+S ¹	up to 149 mph (240 km/h)

¹ or M+S  for winter tires.

 *Not all M+S rated tires provide special winter performance. Make sure the tires you use show M+S and the mountain/snowflake  marking on the tire sidewall. These tires meet specific snow traction performance requirements of the Rubber Manufacturers Association (RMA) and the Rubber Association of Canada (RAC) and have been designed specifically for use in snow conditions.*

Tires and wheels

Load identification



① Load identification

i For illustration purposes only. Actual data on tires are specific to each vehicle and may vary from data shown in above illustration.

In addition to tire load rating, special load identification ① may be molded into the tire sidewall following the letter designating the tire speed rating (▷ page 318).

No specification given: absence of any text (like in above example) indicates a standard load (SL) tire.

XL or Extra Load: designates an extra load (or reinforced) tire.

Light Load: designates a light load tire.

C, D, E: designates load range associated with the maximum load a tire can carry at a specified pressure.

DOT, Tire Identification Number (TIN)

U.S. tire regulations require each new tire manufacturer or tire retreader to mold a TIN into or onto a sidewall of each tire produced.

The TIN is a unique identifier which facilitates efforts by tire manufactures to notify purchasers in recall situations or other safety matters concerning tires and gives purchasers the means to easily identify such tires.

The TIN is comprised of “Manufacturer’s identification mark”, “Tire size”, “Tire type code”, and “Date of manufacture”.

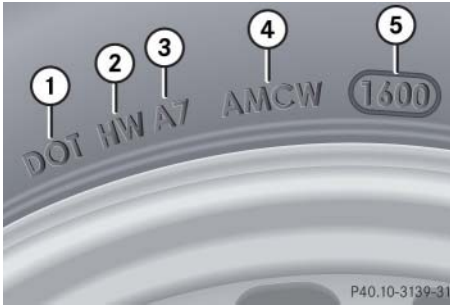

- ① DOT
- ② Manufacturer's identification mark
- ③ Tire size
- ④ Tire type code (at the option of the tire manufacturer)
- ⑤ Date of manufacture

i For illustration purposes only. Actual data on tires are specific to each vehicle and may vary from data shown in above illustration.

DOT (Department of Transportation)

A tire branding symbol ① (▷ page 323) which denotes the tire meets requirements of the U.S. Department of Transportation.

Manufacturer's identification mark

The manufacturer's identification mark ② (▷ page 323) denotes the tire manufacturer.

New tires have a mark with two symbols.

Retreaded tires have a mark with four symbols. For more information on retreaded tires, see (▷ page 304).

Tire size

The code ③ (▷ page 323) indicates the tire size.

Tire type code

The code ④ (▷ page 323) may, at the option of the manufacturer, be used as a descriptive code for identifying significant characteristics of the tire.

Date of manufacture

The date of manufacture ⑤ (▷ page 323) identifies the week and year of manufacture.

The first two figures identify the week, starting with "01" to represent the first full week of the calendar year. The second two figures represent the year.

For example, "3202" represents the 32nd week of 2002.

Tires and wheels

Maximum tire load



① Maximum tire load rating

i For illustration purposes only. Actual data on tires are specific to each vehicle and may vary from data shown in above illustration.

The maximum tire load is the maximum weight the tires are designed to support.

Warning!



Do not overload the tires by exceeding the specified load limit as indicated on the Tire and Loading Information placard located on the driver's door B-pillar. Overloading the tires can overheat them, possibly causing a blowout. Overloading the tires can also result in handling or steering problems, or brake failure.

For more information on tire load rating (▷ page 319).

For information on calculating total and cargo load capacities (▷ page 309).

Maximum tire inflation pressure

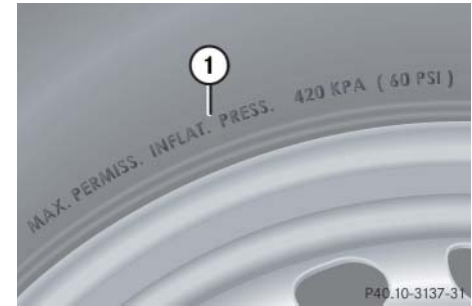

① Maximum permissible tire inflation pressure

i For illustration purposes only. Actual data on tires are specific to each vehicle and may vary from data shown in above illustration.

This is the maximum permissible tire inflation pressure for the tire.

Always follow the recommended tire inflation pressure (▷ page 3 12) for proper tire inflation.

Warning!



Never exceed the max. tire inflation pressure. Follow recommended tire inflation pressures.

Do not underinflate tires. Underinflated tires wear excessively and/or unevenly, adversely affect handling and fuel economy, and are more likely to fail from being overheated.

Do not overinflate tires. Overinflated tires can adversely affect handling and ride comfort, wear unevenly, increase stopping distance, and result in sudden deflation (blowout) because they are more likely to become punctured or damaged by road debris, potholes etc.

Uniform Tire Quality Grading Standards (U.S. vehicles)

Tire manufacturers are required to grade tires based on three performance factors: treadwear, traction and temperature resistance.

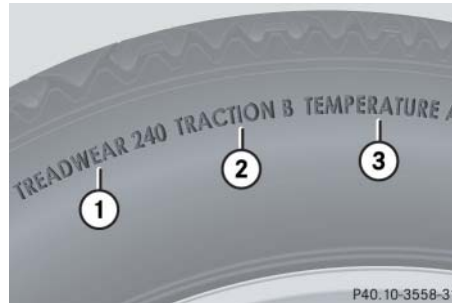

- ① Treadwear
- ② Traction
- ③ Temperature resistance

i For illustration purposes only. Actual data on tires are specific to each vehicle and may vary from data shown in above illustration.

Quality grades can be found, where applicable, on the tire sidewall between tread shoulder and maximum section width. For example:

Treadwear	Traction	Temperature
200	AA	A

All passenger car tires must conform to federal safety requirements in addition to these grades.

Tires and wheels

Treadwear

The treadwear grade is a comparative rating based on the wear rate of the tire when tested under controlled conditions on a specified government test course. For example, a tire graded 150 would wear one and one-half ($1\frac{1}{2}$) times as well on the government course as a tire graded 100. The relative performance of tires depends upon the actual conditions of their use, however, and may depart significantly from the norm due to variations in driving habits, service practices and differences in road characteristics and climate.

Traction

The traction grades, from highest to lowest, are AA, A, B, and C. Those grades represent the tire's ability to stop on wet pavement as measured under controlled conditions on specified government test surfaces of asphalt and concrete. A tire marked C may have poor traction performance.

Warning!



The traction grade assigned to this tire is based on straight-ahead braking traction tests, and does not include acceleration, cornering, hydroplaning, or peak traction characteristics.

Temperature

The temperature grades are A (the highest), B, and C, representing the tire's resistance to the generation of heat and its ability to dissipate heat when tested under controlled conditions on a specified indoor laboratory test wheel. Sustained high temperature can cause the material of the tire to degenerate and reduce tire life, and excessive temperature can lead to sudden tire failure. The grade C corresponds to a level of performance which all passenger car tires must meet under the Federal Motor Vehicle Safety Standard No. 109. Grades B and A represent higher levels of performance on the laboratory test wheel than the minimum required by law.

Warning!

The temperature grade for this tire is established for a tire that is properly inflated and not overloaded. Excessive speed, underinflation, or excessive loading, either separately or in combination, can cause excessive heat build-up and possible tire failure.

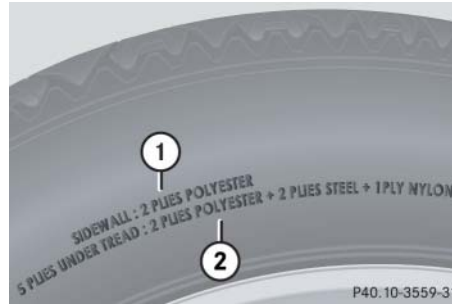
Tire ply material

- ① Plies in sidewall
- ② Plies under tread

i *For illustration purposes only. Actual data on tires are specific to each vehicle and may vary from data shown in above illustration.*

This marking tells you about the type of cord and number of plies in the sidewall and under the tread.

Tire and loading terminology**Accessory weight**

The combined weight (in excess of those standard items which may be replaced) of automatic transmission, power steering, power brakes, power windows, power seats, radio, and heater, to the extent that these items are available as factory-installed equipment (whether installed or not).

Air pressure

The amount of air inside the tire pressing outward on each square inch of the tire. Air pressure is expressed in pounds per square inch (psi), or kilopascal (kPa), or bars.

Aspect ratio

Dimensional relationship between tire section height and section width expressed in percentage.

Tires and wheels

Bar

Another metric unit for air pressure. There are 14.5038 pounds per square inch (psi) to 1 bar; there are 100 kilopascals (kPa) to 1 bar.

Bead

The tire bead contains steel wires wrapped by steel cords that hold the tire onto the rim.

Cold tire inflation pressure

Tire inflation pressure when your vehicle has been sitting for at least three hours or driven no more than 1 mile (1.6 km).

Curb weight

The weight of a motor vehicle with standard equipment including the maximum capacity of fuel, oil, and coolant, and, if so equipped, air conditioning and additional optional equipment, but without passengers and cargo.

DOT (Department of Transportation)

A tire branding symbol which denotes the tire meets requirements of the U.S. Department of Transportation.

GAWR (Gross Axle Weight Rating)

The GAWR is the maximum permissible axle weight. The gross vehicle weight on each axle must never exceed the GAWR for the front and rear axle indicated on the certification label located on the driver's door B-pillar.

GVW (Gross Vehicle Weight)

The GVW comprises the weight of the vehicle including fuel, tools, spare wheel, installed accessories, passengers and cargo and, if applicable, trailer tongue load. The GVW must never exceed the GVWR indicated on the certification label located on the driver's door B-pillar.

GVWR (Gross Vehicle Weight Rating)

This is the maximum permissible vehicle weight of the fully loaded vehicle (weight of the vehicle including all options, passengers, fuel, and cargo and, if applicable, trailer tongue load). It is indicated on certification label located on the driver's door B-pillar.

Kilopascal (kPa)

The metric unit for air pressure. There are 6.9 kPa to 1 psi; another metric unit for air pressure is bars. There are 100 kilopascals (kPa) to 1 bar.

Maximum load rating

The maximum load in kilograms and pounds that can be carried by the tire.

Maximum loaded vehicle weight

The sum of curb weight, accessory weight, total load limit and production options weight.

Maximum tire inflation pressure

This number is the greatest amount of air pressure that should ever be put in the tire under normal driving conditions.

Normal occupant weight

The number of occupants the vehicle is designed to seat, multiplied by 68 kilograms (150 lbs).

Occupant distribution

The distribution of occupants in a vehicle at their designated seating positions.

Production options weight

The combined weight of those installed regular production options weighing over 5 lbs (2.3 kilograms) in excess of those standard items which they replace, not previously considered in curb weight or accessory weight, including heavy duty brakes, ride levelers, roof rack, heavy duty battery, and special trim.

PSI (Pounds per square inch)

A standard unit of measure for air pressure -> bar, kilopascal (kPa).

Recommended tire inflation pressure

Recommended tire inflation pressure for normal driving conditions is listed on the Tire and Loading Information placard located on the driver's door B-pillar. Provides best handling, tread life and riding comfort. If so equipped, supplemental information pertaining to special driving situations can be found on the tire inflation pressure label on the inside of the fuel filler flap.

Rim

A metal support for a tire or a tire and tube assembly upon which the tire beads are seated.

Sidewall

The portion of a tire between the tread and the bead.

TIN (Tire Identification Number)

Unique identifier which facilitates efforts by tire manufacturers to notify purchasers in recall situations or other safety matters concerning tires and gives purchases the means to easily identify such tires. The TIN is comprised of "Manufacturer's identification mark", "Tire size", "Tire type code", and "Date of manufacture".

Tire load rating

Numerical code associated with the maximum load a tire can support.

Tire ply composition and material used

This indicates the number of plies or the number of layers of rubber-coated fabric in the tire tread and sidewall. Tire manufacturers also must indicate the ply materials in the tire and sidewall, which include steel, nylon, polyester, and others.

Tires and wheels

Tire speed rating

Part of tire designation; indicates the speed range for which a tire is approved.

Total load limit

Rated cargo and luggage load plus 68 kilograms (150 lbs) times the vehicle's designated seating capacity.

Traction

Force exerted by the vehicle on the road via the tires. The amount of grip provided.

Tread

The portion of a tire that comes into contact with the road.

Treadwear indicators

Narrow bands, sometimes called “wear bars” that show across the tread of a tire when only $\frac{1}{16}$ in (1.6 mm) of tread remains.

Uniform Tire Quality Grading Standards

A tire information system that provides consumers with ratings for a tire's traction, temperature and treadwear. Ratings are determined by tire manufacturers using government testing procedures. The ratings are molded into the sidewall of the tire.

Vehicle maximum load on the tire

Load on an individual tire that is determined by distributing to each axle its share of the maximum loaded vehicle weight and dividing it by two.

Rotating tires

Warning!



Rotate front and rear wheels only if the tires are of the same dimension.

If your vehicle is equipped with mixed-size tires (different tire dimensions front vs. rear), tire rotation is not possible.

Tire rotation can be performed on vehicles with tires of the same dimension all around. If your vehicle is equipped with tires of the same dimension all around, tires can be rotated, observing a front-to-rear rotation pattern that will maintain the intended rotation (spinning) direction of the tire (▷ page 307).

In some cases, such as when your vehicle is equipped with mixed-size tires (different tire dimension front vs. rear), tire rotation is not possible.

If applicable to your vehicle's tire configuration, tires can be rotated according to the tire manufacturer's recommended intervals in the tire manufacturer's warranty pamphlet located in your vehicle literature portfolio. If none is available, tires should be rotated every 3 000 to 6 000 miles (5 000 to 10 000 km), or sooner if necessary, according to the degree of tire wear. The same rotation (spinning) direction must be maintained (▷ page 307).

Rotate tires before the characteristic tire wear pattern becomes visible (shoulder wear on front tires and tread center wear on rear tires).

Thoroughly clean the mounting face of wheels and brake discs, i.e. the inner side of the wheels/tires, during each rotation. Check for and ensure proper tire inflation pressure.

Warning!

Have the tightening torque checked after changing a wheel. Wheels could become loose if not tightened with a torque of 80 lb-ft (110 Nm).

Only use genuine Mercedes-Benz wheel bolts specified for your vehicle's rims.

For information on wheel change, see the "Practical hints" section (▷ page 385) and (▷ page 401).

Winter driving

Before the onset of winter, have your vehicle winterized at an authorized Mercedes-Benz Center. This service includes:

- Checking anticorrosion and antifreeze concentration.
- Adding of cleaning concentrate to the water of the windshield and headlamp cleaning* system. Add MB Windshield Washer Concentrate “MB SummerFit” to a pre-mixed windshield washer solvent/antifreeze which is formulated for temperatures below freezing point (▷ page 450).
- Battery test. Battery capacity drops with decreasing ambient temperature. A well charged battery helps to make sure the engine can be started, even at low ambient temperatures.
- Tire change.

! *When scraping ice or snow from the rear window, be careful not to damage the sealing strip or apertures along the side of the window.*

Winter tires

Always use winter tires at temperatures below 45°F (7°C) and whenever wintry road conditions prevail. Not all M+S rated tires provide special winter performance. Make sure the tires you use show M+S and the mountain/snowflake symbol  marking on the tire sidewall. These tires meet specific snow traction performance requirements of the Rubber Manufacturers Association (RMA) and the Rubber Association of Canada (RAC) and have been designed specifically for use in snow conditions. Use of winter tires is the only way to achieve the maximum effectiveness of the ABS and ESP® in winter operation.

For safe handling, make sure all mounted winter tires are of the same make and have the same tread design.

Warning!



Winter tires with a tread depth of less than $\frac{1}{6}$ in (4 mm) must be replaced. They are no longer suitable for winter operation.

Always observe the speed rating of the winter tires mounted to your vehicle. If the maximum speed for which your tires are rated is below the speed rating of your vehicle, you must place a notice to this effect where it will be seen by the driver. Such notices are available at your tire dealer or any authorized Mercedes-Benz Center.

Warning!

If you use your spare tire when winter tires are fitted on the other wheels, be aware that the difference in tire characteristics may very well impair turning stability and that overall driving stability may be reduced.

Adapt your driving style accordingly.

Have the spare tire replaced with a winter tire at the nearest authorized Mercedes-Benz Center.

Snow chains

! *Some tire sizes do not leave adequate clearance for snow chains. To help avoid serious damage to your vehicle or tires, make sure that the use of snow chains is permissible as specified in the “Technical data” section of this Operator’s Manual, see “Rims and tires” (▷ page 434).*

Snow chains should only be driven on snow-covered roads at speeds not higher than 30 mph (50 km/h). Remove chains as soon as possible when driving on roads without snow.

Please observe the following guidelines when using snow chains:

- Use of snow chains is not permissible with all wheel/tire combinations (▷ page 434).
- Use snow chains in pairs and on rear wheels only. Follow the manufacturer’s mounting instructions.

! *If snow chains are mounted to the front wheels, they may scrape against the body or axle components. The tires or the vehicle could be damaged as a result.*

- Only use snow chains that are approved by Mercedes-Benz. Any authorized Mercedes-Benz Center will be glad to advise you on this subject.
- Use of snow chains may be prohibited depending on location. Always check local and state laws before installing snow chains.
- Do not use snow chains on the spare wheel (▷ page 439).

i *When driving with snow chains, you may wish to deactivate the ESP® (▷ page 88) before setting the vehicle in motion. This will improve the vehicle’s traction.*

We strongly recommend that you have your vehicle serviced by an authorized Mercedes-Benz Center, in accordance with the Maintenance Booklet at the times called for by the maintenance service indicator.

! *Failure to have the vehicle maintained in accordance with the Maintenance Booklet and the maintenance service indicator at the designated times/mileage will result in vehicle damage not covered by the Mercedes-Benz Limited Warranty.*

Maintenance service indicator message

The maintenance service indicator message will notify you when the next maintenance service is due.

Starting approximately 1 month before the next maintenance service is due, one of the following messages will appear in the multifunction display while you are driving or when you switch on the ignition (example service A):

Service A due in XXXXX miles (km)
Service A due in XXX days
Service A due in X day
Service A due now

The maintenance services will be indicated by showing a service type A through type H in the multifunction display. Types A through H are classified based on estimated time needed to perform the maintenance service, ranging:

from Service A
(approximately 1 hour)
to Service H
(approximately 8 hours)



Refer to Maintenance Booklet for a listing of maintenance services and intervals the need to be performed at.

i *The Maintenance System tracks distance driven and the time elapsed since the last maintenance service, calculates other maintenance service work required, and calls for the next maintenance service accordingly.*

Clearing the maintenance service indicator message

The maintenance service indicator message is automatically cleared:

- after approximately 10 seconds when you switch on the ignition or when reaching the service threshold while driving
- after approximately 30 seconds once the suggested maintenance service term has passed

You can also clear it yourself.

- ▶ Press reset button  (▷ page 26) on the instrument cluster.

The maintenance service indicator message is cleared and the standard display appears in the multifunction display (▷ page 127).

Maintenance service term exceeded

If you have exceeded the suggested maintenance service term, you will see the following message in the multifunction display:

Service A exceeded by XXXXX miles (km)
 Service A exceeded by XXX days
 Service A exceeded by X day

In addition, a signal sounds when the message appears.

Any authorized Mercedes-Benz Center will reset the maintenance service indicator following a completed maintenance service.



Calling up the maintenance service indicator display

 *The menu overview can be found on (▷ page 124).*

You can call up the maintenance service indicator display at any time to check when the next maintenance service is due.

- ▶ Switch on the ignition (▷ page 37).

The standard display menu appears in the multifunction display (▷ page 127).

- ▶ Press button  or  on the multifunction steering wheel repeatedly until the maintenance service indicator display with the service symbol  appears in the multifunction display. ▷▷

▷▷ **i** *If the battery is disconnected, the days of disconnection will not be included in the count shown by the maintenance service indicator. To arrive at the true maintenance service deadline, you will need to subtract these days from the days shown in the maintenance service indicator message or maintenance service indicator display.*

Do not confuse the maintenance service indicator with the engine oil level indicator .

Resetting the maintenance service indicator

In the event that the maintenance service on your vehicle is not carried out by an authorized Mercedes-Benz Center, you can have the maintenance service indicator reset. The automotive maintenance facility carrying out the maintenance service will find the information for resetting the maintenance service indicator in the maintenance-relevant literature for your vehicle. Such literature is available from either your authorized Mercedes-Benz Center or directly from Mercedes-Benz.

i *If the maintenance service indicator was inadvertently reset, have an authorized Mercedes-Benz Center correct it.*

Only reset if the proper maintenance service has been performed. Resetting the system without performing the proper maintenance service as called for by the maintenance service indicator will result in engine damage and/or other vehicle damage not covered by the Mercedes-Benz Limited Warranty.

▼ Vehicle care

Cleaning and care of vehicle

Regular and proper care will help to maintain the value of your vehicle. The best way to protect your vehicle from harmful environmental influences is to wash it and use protective treatments regularly.

Warning!



Many cleaning products can be hazardous. Some are poisonous, others are flammable. Always follow the instructions on the particular container. Always open your vehicle's doors or windows when cleaning the inside.

Never use fluids or solvents that are not designed for cleaning your vehicle.

Always lock away cleaning products and keep them out of reach of children.

While in operation, even while parked, your vehicle is subjected to varying external influences which, if gone unchecked, can attack the paintwork as well as the undercarriage and cause lasting damage.

Such damage is caused not only by extreme and varying climatic conditions, but also by:

- Air pollution
- Road salt
- Tar
- Gravel and stone chipping

To avoid paint damage, you should immediately remove:

- Grease and oil
- Fuel
- Coolant
- Brake fluid
- Bird droppings
- Insects
- Tree resins, etc.

Frequent washing reduces and/or eliminates the aggressiveness and potency of the above adverse influences.

More frequent washings are necessary to deal with unfavorable conditions:

- near the ocean
- in industrial areas (smoke, exhaust emissions)
- during winter operation

You should check your vehicle from time to time for stone chipping or other damage. Any damage should be repaired as soon as possible to prevent corrosion.

In doing so, do not neglect the underbody of the vehicle. A prerequisite for a thorough check is a washing of the underbody followed by a thorough inspection. Damaged areas need to be re-undercoated.

Your vehicle has been treated at the factory with a wax-base rustproofing in the body cavities which will last for the lifetime of the vehicle. Post-production treatment is neither necessary nor recommended by Mercedes-Benz because of the possibility

of incompatibility between materials used in the production process and others applied later.

We have selected car-care products and compiled recommendations which are specially matched to our vehicles and which always reflect the latest technology. You can obtain Mercedes-Benz approved car-care products at an authorized Mercedes-Benz Center.

Scratches, corrosive deposits, corrosion or damage due to negligent or incorrect care cannot always be removed or repaired with the car-care products recommended here. In such cases it is best to seek aid at an authorized Mercedes-Benz Center.

The following topics deal with the cleaning and care of your vehicle and give important “how-to” information as well as references to Mercedes-Benz approved car-care products.

Power washer

! *Follow the instructions provided by the power washer manufacturer on maintaining a distance between the vehicle and the nozzle of the power washer.*

Never use a round nozzle to power-wash tires. The intense jet of water can result in damage to the tire.

Always replace a damaged tire.

Always keep the jet of water moving across the surface. Do not aim directly at electrical parts, electrical connectors, seals, or other rubber parts.

Tar stains

Quickly remove tar stains before they dry and become more difficult to remove. A tar remover is recommended.

Paintwork, painted body components

! *Affixing stickers, adhesive tape or similar materials to painted body components may damage the paintwork.*

Mercedes-Benz approved Paint Care should be applied when water drops on the paint surface do not “bead up”. This should normally be done every 3 to 5 months, depending on the climate and washing detergent used.

Mercedes-Benz approved Paint Cleaner should be applied if the paint surface shows signs of embedded dirt (i.e. loss of gloss).

Do not apply any of these products or wax if your vehicle is parked in the sun or if the hood is still hot.

- ▶ Use the appropriate MB-Touch-Up Stick for quick and provisional repairs of minor paint damage (i.e. chips from stones, vehicle doors, etc.).

Engine cleaning

Prior to cleaning the engine compartment, make sure to protect electrical components and connectors from the intrusion of water and cleaning agents.

Corrosion protection, such as MB Anticorrosion Wax should be applied to the engine compartment after every engine cleaning. Before applying, all control linkage bushings and joints should be lubricated. The poly-V-belt and all pulleys should be protected from any wax.

Vehicle washing

In the winter, thoroughly remove all traces of road salt as soon as possible.

When washing the vehicle underbody, do not forget to clean the inner sides of the wheels.

Hand-wash

Do not use hot water or wash your vehicle in direct sunlight.

- ▶ Use only a mild car wash detergent, such as Mercedes-Benz approved Car Shampoo.
- ▶ Thoroughly spray the vehicle with a diffused jet of water.

Direct only a very weak spray towards the ventilation intake.

- ▶ Use plenty of water and rinse the sponge and chamois frequently.
- ▶ Rinse with clean water and thoroughly dry with a chamois.

Do not allow cleaning agents to dry on the finish.

! *Do not use scouring agents on these parts. Never apply strong force and only use a soft, non-scratching cloth when cleaning the vehicle. Do not attempt to wipe the surface with a dry cloth or sponge.*

Otherwise you may scratch or damage the paint.

Automatic car wash

You can have your car washed in an automatic car wash from the start. Automatic car washes without brushes are preferable.

- ▶ To protect the filter system, switch the climate control (> page 178) or automatic climate control (> page 189) to air recirculation mode.

! *Do not clean your vehicle in an automatic touchless car wash which uses caustic spray. Otherwise the caustic spray will damage the paint or ornamental moldings.*

If the vehicle is very dirty, prewash it before running it through the automatic car wash.

! *Make sure that the windshield wiper switch is set to 0 (> page 56). Otherwise, the rain sensor* could activate and cause the wipers to move unintentionally. This may lead to vehicle damage.*

Due to the width of the vehicle, fold in exterior rear view mirrors prior to running the vehicle through an automatic car wash to prevent damage to the mirrors.

Vehicle care

i After running the vehicle through an automatic car wash, wipe any wax off of the windshield (▷ page 340). This will prevent smears and reduce wiping noise which can be caused by residual wax on the windshield.

When leaving the car wash, make sure that the mirrors are folded out. Otherwise they may vibrate.

Ornamental moldings

For regular cleaning and care of very dirty chrome-plated parts, use a chrome cleaner.

! Do not use chrome cleaner on ornamental moldings. Although ornamental moldings may have chrome appearance, they could be made of anodized aluminum that will be damaged when cleaned with chrome cleaner. Instead, use a damp cloth to clean those ornamental moldings.

For very dirty ornamental moldings of which you are sure are chrome-plated, use a chrome cleaner. If in doubt whether an ornamental molding is chrome-plated, contact an authorized Mercedes-Benz Center.

Headlamps, tail lamps, side makers, turn signal lenses

▶ Use a mild car wash detergent, such as Mercedes-Benz approved Car Shampoo, with plenty of water.

! Only use window cleaners that are suitable for plastic lamp lenses. Window cleaning solutions which are not suitable may damage the plastic lamp lenses of the headlamps. Therefore, do not use abrasives, solvents or cleaners that contain solvents.

Never apply strong force and use only a soft, non-scratchy cloth when cleaning the lenses. Do not attempt to wipe dirty lenses with a dry cloth or sponge.

Otherwise you may scratch or damage the lens surface.

Cleaning the windows and the wiper blades

! The windshield wipers must be in a vertical position before folding them away from the windshield. They could otherwise damage the hood.

Never open the hood when the wiper arms are folded forward.

- ▶ Make sure the hood is fully closed.
- ▶ Switch on the ignition (▷ page 37).
- ▶ Turn combination switch to wiper setting II (▷ page 56).
- ▶ With wiper arms in vertical position, switch off the ignition (▷ page 37).

Warning!



For safety reasons, switch off wipers and remove SmartKey from starter switch before cleaning the windshield and/or the wiper blades. Otherwise, the wiper motor could suddenly turn on and cause injury.

- ▶ Fold the wiper arms forward until they snap into place.

! Do not pull on the wiper blade inserts. They could tear.

- ▶ Clean the wiper blade inserts with a clean cloth and detergent solution.
- ▶ Use a clean cloth and a mild window cleaning solution on all outside and inside glass surfaces.

An automotive glass cleaner is recommended.

! Fold the windshield wiper arms back onto the windshield before turning the SmartKey in the starter switch.

Hold on to the wiper when folding the wiper arm back. If released, the force of the impact from the tensioning spring could crack the windshield.

! To clean the window interior, do not use a dry cloth, abrasives, solvents or cleaners containing solvents. Do not touch the inside of the front, rear or side windows with hard objects such as an ice scraper or ring. Doing so may damage the windows.

Rear window cleaning

Clean the rear window with the hardtop fully raised and closed.

Warning!



Do not clean the rear window with the hardtop in a position other than the fully raised and closed position. Otherwise, the hardtop may move unexpectedly which may result in personal injury to you or others.

- ▶ Use a clean cloth and a mild window cleaning solution on all outside and inside glass surfaces.

An automotive glass cleaner is recommended.

Light alloy wheels

If possible, clean wheels once a week.

- ▶ Use Mercedes-Benz approved Wheel Care, a soft bristle brush and a strong spray of water for cleaning the light alloy wheels.

! Only use acid-free cleaning materials. Acid may cause corrosion or damage the clear coat.

! The vehicle should not be parked for an extended period of time immediately after it has been cleaned, especially not after the wheel rims have been cleaned with wheel rim cleaner. Wheel rim cleaners can lead to increased corrosion of the brake discs and brake pads. Non-approved wheel cleaners may also damage the wheel paint if the car is not driven after cleaning. Therefore, the vehicle's brake system should always be warmed-up before it is parked after cleaning. To do so, please drive your vehicle for several minutes to allow the brakes to dry.

When applying Mercedes-Benz approved Tire Care and Mercedes-Benz approved Wheel Care products, take care not to spray them on the brake discs.

Vehicle care

Plastic and rubber parts

- ▶ Use a gentle dishwashing detergent or mild detergent for delicate fabrics as a washing solution.
- ▶ Wipe with a cloth moistened in a luke-warm solution.

The surface may temporarily change color. If this is the case, wait for it to dry.

Warning!



Do not use cleaners or cockpit care sprays containing solvents to clean the cockpit or the steering wheel. Cleaners containing solvents will make the surface porous and vehicle occupants could suffer serious injuries from plastic parts coming loose in the event of air bag deployment.

! Do not use oil, wax or scouring agents on these parts.

Never apply strong force and only use a soft, non-scratching cloth when cleaning the surface. Do not attempt to wipe the surface with a dry cloth or sponge.

Otherwise you may scratch or damage the surface.

Hard plastic trim items

- ▶ Use Mercedes-Benz approved Interior Care, a soft, lint-free cloth and apply with light pressure.

! *Never apply strong force and only use a soft, non-scratching cloth when cleaning the surface. Do not attempt to wipe the surface with a dry cloth or sponge.*

Otherwise you may scratch or damage the surface.

Steering wheel and gearshift/gear selector lever

- ▶ Wipe with a damp cloth and dry thoroughly or clean with Mercedes-Benz approved Leather Care.

Carpets

- ▶ Use Mercedes-Benz approved Carpet and Fabric Care for cleaning the carpets.

Headliner

- ▶ Use a soft bristle brush or a dry-shampoo cleaner in case of excessive dirt.

Seat belts

- ▶ Use only clear, lukewarm water and soap.

! *The seat belts must not be treated with chemical cleaning agents. Do not dry the seat belts at temperatures above 176°F (80°C) or in direct sunlight.*

Warning!



Do not bleach or dye seat belts as this may severely weaken them. In a crash they may not be able to provide adequate protection.

Upholstery

Using aftermarket seat covers or wearing clothing that have the tendency to give off coloring (e.g. when wet, etc.) may cause the upholstery to become permanently discolored. By lining the seats with a proper intermediate cover, contact-discoloration will be prevented.

Warning!



Only use seat covers which have been tested and approved by Mercedes-Benz for your vehicle model. Using other seat covers may interfere with or prevent the deployment of the head-thorax air bags. Contact an authorized Mercedes-Benz Center for availability.

Leather upholstery

Please note that leather upholstery is a natural product and is therefore subject to a natural aging process. Leather upholstery may also react to certain ambient influences such as high humidity or high temperature by showing wrinkles for example.

- ▶ Wipe leather upholstery with a damp cloth and dry thoroughly or clean with Mercedes-Benz approved Leather Care.

! *Wipe with light pressure, to avoid damage to the upholstery.*

Exercise particular care when cleaning perforated leather as its underside should not become wet.

Wood trims

- ▶ Dampen cloth using water and use damp cloth to clean wood trims in your vehicle.

! *Do not use solvents like tar remover or wheel cleaner nor polishes or waxes as these may be abrasive.*

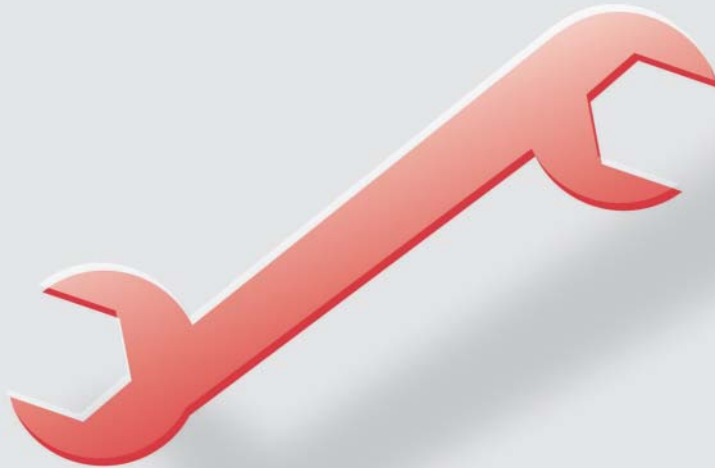

What to do if ...

Where will I find...?

Unlocking/locking in an emergency

Opening/closing in an emergency

Replacing SmartKey batteries

Replacing bulbs

Replacing wiper blades

Flat tire

Battery

Jump starting

Towing the vehicle

Fuses

What to do if ...

Lamps in instrument cluster

General information:



If any of the following lamps in the instrument cluster fails to come on during the

bulb self-check when switching on ignition (▷ page 37), have the respective bulb checked and replaced if necessary.

Problem	Possible cause/consequence	Suggested solution
 <p>The yellow ABS indicator lamp comes on when the engine is running.</p>	<p>The ABS has detected a malfunction and has switched off. The BAS and ESP® are also switched off (see messages in the multifunction display).</p> <p>The brake system is still functioning normally but without the systems specified above.</p> <p>If the ABS control unit is malfunctioning, other systems such as the navigation system* or the automatic transmission* may also be malfunctioning.</p>	<ul style="list-style-type: none"> ▶ Continue driving with added caution. Wheels may lock during hard braking, reducing steering capability. ▶ Read and observe messages in the multifunction display (▷ page 356). ▶ Have the system checked at an authorized Mercedes-Benz Center as soon as possible. <p>Failure to follow these instructions increases the risk of an accident.</p>
	<p>The charging voltage has fallen below 10 volts. The ABS has switched off.</p> <p>The battery might not be charged sufficiently.</p>	<p>When the voltage is above this value again, the ABS is operational again and the ABS indicator lamp should go out.</p> <p>If the ABS indicator lamp does not go out:</p> <ul style="list-style-type: none"> ▶ Have the generator (alternator) and battery checked.

Problem	Possible cause/consequence	Suggested solution
 <p>The yellow ABS indicator lamp comes on when the engine is running.</p>	<p>The ABS is temporary not available. The ESP® and the BAS are also unavailable.</p> <p>The system's self-diagnosis may not be completed yet.</p> <p>The brake system is still functioning normally but without the systems specified above.</p>	<ul style="list-style-type: none"> ▶ Drive a short distance with added caution at a vehicle speed of above 12 mph (20 km/h). When the ABS indicator lamp goes out, the ABS, the ESP®, and the BAS are available again. <p>If the yellow ABS indicator lamp does not go out:</p> <ul style="list-style-type: none"> ▶ Continue driving with added caution. ▶ Have the system checked at an authorized Mercedes-Benz Center as soon as possible. <p>Failure to follow these instructions increases the risk of an accident.</p>

What to do if ...

Problem	Possible cause/consequence	Suggested solution
USA only: 	The red brake warning lamp comes on when the engine is running and an acoustic warning sounds.	You are driving with the parking brake set.
Canada only: 	The red brake warning lamp comes on when the engine is running.	You are driving with the parking brake set.
	There is insufficient brake fluid in the reservoir.	Risk of accident! ► Carefully stop the vehicle in a safe location or as soon as it is safe to do so. ► Apply the parking brake (▷ page 59). ► Read and observe messages in the display (▷ page 356). ► Contact an authorized Mercedes-Benz Center. Do not add brake fluid! This will not solve the problem.



Warning!



Driving with the brake warning lamp illuminated can result in an accident. Have your brake system checked immediately if the brake warning lamp stays on.

Do not add brake fluid before checking the brake system. Overfilling the brake fluid reservoir can result in spilling brake fluid on hot engine parts and the brake fluid catching fire. You can be seriously burned.



! *If you find that the brake fluid in the brake fluid reservoir has fallen to the minimum mark or below, have the brake system checked for brake pad thickness and leaks.*

Problem	Possible cause/consequence	Suggested solution
<p>USA only: </p> <p>Canada only: </p> <p>The yellow engine malfunction indicator lamp comes on when the engine is running.</p>	<p>There is a malfunction in:</p> <ul style="list-style-type: none"> • The fuel injection system • The ignition system • The emission control system • Systems which effect emissions <p>Such malfunctions may result in excessive emissions values and may switch the engine to its limp-home (emergency operation) mode.</p>	<p>► Have the vehicle checked as soon as possible by an authorized Mercedes-Benz Center.</p> <p>An on-board diagnostic connector is used by the service station to link the vehicle to the shop diagnostics system. It allows the accurate identification of system malfunctions through the readout of diagnostic trouble codes. It is located in the front left area of the footwell near the hood release.</p>

 *Some states may by law require you to visit a workshop as soon as the engine malfunction indicator lamp comes on. Check local requirements.*

What to do if ...



Problem	Possible cause/consequence	Suggested solution
<p> The yellow ESP® warning lamp comes on when the engine is running.</p>	<p>The ESP® has been switched off with the ESP® switch or has been switched off due to a malfunction.</p> <p>Risk of accident!</p> <p>When the ESP® is switched off, it will not stabilize the vehicle if the system recognizes that the vehicle starts to skid or that a wheel is spinning.</p> <p>The cruise control is deactivated and cannot be switched on.</p>	<ul style="list-style-type: none"> ▶ Switch the ESP® back on (▷ page 89). Exceptions: (▷ page 86). ▶ If leaving the ESP® switched off, adapt your speed and driving to the prevailing road, weather and traffic conditions. <p>If the ESP® cannot be switched back on:</p> <ul style="list-style-type: none"> ▶ Continue driving with added caution. ▶ Observe additional messages that may appear in the multifunction display (▷ page 359). ▶ Have the system checked at an authorized Mercedes-Benz Center as soon as possible.
<p>The yellow ESP® warning lamp flashes when the engine is running.</p>	<p>The ESP® or traction control has come into operation because of detected traction loss in at least one tire.</p> <p>The cruise control is deactivated.</p>	<ul style="list-style-type: none"> ▶ When driving off, apply as little throttle as possible. ▶ While driving, ease up on the accelerator. ▶ Adapt your speed and driving to the prevailing road and weather conditions. ▶ Do not deactivate the ESP®. Exceptions: (▷ page 86). <p>Failure to follow these instructions increases the risk of an accident.</p>

Problem	Possible cause/consequence	Suggested solution
 The red seat belt telltale comes on for a maximum of 6 seconds after starting the engine.	The seat belt telltale reminds you and your passenger to fasten your seat belts before driving off.	<ul style="list-style-type: none"> ▶ Fasten your seat belts. <p>Regardless of whether the seat belts are fastened or not, the seat belt telltale always comes on and remains lit for 6 seconds after starting the engine.</p>
 Your hear a warning chime for a maximum of 6 seconds after starting the engine.	You have forgotten to fasten your seat belt.	<ul style="list-style-type: none"> ▶ Fasten your seat belt. <p>The warning chime stops sounding.</p>
 The red seat belt telltale comes on while the vehicle is standing still and the engine is running or during driving.	<p>You and/or your passenger have forgotten to fasten your seat belts.</p> <p>There are items placed on the passenger seat and therefore the system senses the passenger seat as being occupied.</p>	<ul style="list-style-type: none"> ▶ Fasten your seat belts. <p>The seat belt telltale goes out.</p> <ul style="list-style-type: none"> ▶ Remove the items from the passenger seat and put them in a safe place. <p>The seat belt telltale goes out.</p>

What to do if ...

Problem	Possible cause/consequence	Suggested solution
 <p>During driving the red seat belt telltale flashes and you additionally hear an intermittent warning chime sound with increasing intensity.</p>	<p>The vehicle's speed once exceeds 15 mph (25 km/h) and you and/or your passenger have forgotten to fasten your seat belts.</p>	<p>► Fasten your seat belts.</p> <p>The seat belt telltale goes out and the warning chime stops sounding.</p>
	<p>There are items placed on the passenger seat and therefore the system senses the passenger seat as being occupied.</p>	<p>► Remove the items from the passenger seat and put them in a safe place.</p> <p>The seat belt telltale goes out and the warning chime stops sounding.</p>

i After 60 seconds with an unfastened seat belt, the warning chime stops sounding and the seat belt telltale illuminates continuously. The seat belt telltale will only go out if both, the driver and passenger's seat belt are fastened, or the vehicle is standing still and a door is opened.

Problem	Possible cause/consequence	Suggested solution
 The yellow fuel reserve warning lamp flashes after starting the engine.	The fuel cap is not closed properly.	▶ Close the fuel cap.
The yellow fuel reserve warning lamp comes on when the engine is running. Additionally you see the message Reserve fuel in the multifunction display.	The fuel level has gone below the reserve mark.	▶ Refuel at the next gas station (▷ page 291). After refueling you will see the message 1 message in the multifunction display. ▶ Press reset button  to confirm the message (▷ page 26).
 The red SRS indicator lamp comes on when the engine is running.	There is a malfunction in the restraint systems. The air bags or emergency tensioning devices (ETDs) could deploy unexpectedly or fail to deploy in an accident.	▶ Drive with added caution to the nearest authorized Mercedes-Benz Center.

Warning!





In the event a malfunction of the SRS is indicated as outlined above, the SRS may not be operational. For your safety, we strongly recommend that you contact an authorized Mercedes-Benz Center immediately to have the system checked;

otherwise the SRS may not be deployed when needed in an accident, which could result in serious or fatal injury, or it might deploy unexpectedly and unnecessarily which could also result in an accident and/or injury to you or to others.



What to do if ...

Lamp in center console

Problem	Possible cause/consequence	Suggested solution
  The passenger front air bag off indicator lamp illuminates and remains illuminated with the weight of a typical adult or someone larger than a small individual on the passenger seat.	The system is malfunctioning.	<ul style="list-style-type: none">▶ Have the system checked as soon as possible by an authorized Mercedes-Benz Center.▶ Also read and observe any messages in the multifunction display and follow corrective steps (▷ page 361).

Warning!



If the   indicator lamp illuminates and remains illuminated with the weight of a typical adult or someone larger than a small individual on the passenger seat, do not have any passenger use the passenger seat until the system has been repaired.

Problem	Possible cause/consequence	Suggested solution
<p>PASS AIR BAG OFF  The front passenger front air bag off indicator lamp does not illuminate and/or does not remain illuminated with the weight of a typical 12-month-old child in a standard child restraint or less on the passenger seat.</p>	<p>The system is malfunctioning.</p>	<ul style="list-style-type: none"> ▶ Make sure there is nothing between seat cushion and child seat and check installation of the child seat. ▶ Make sure that no objects applying supplemental weight onto the seat are present. ▶ If the front passenger front air bag off indicator lamp remains out, have the system checked as soon as possible by an authorized Mercedes-Benz Center. Do not transport a child on the passenger seat until the system has been repaired. ▶ Also read and observe any messages in the multifunction display and follow corrective steps (▷ page 361).

Warning!



If the **PASS AIR BAG OFF**  indicator lamp does not illuminate or remains out with the

weight of a typical 12-month-old child in a standard child restraint or less on the passenger seat, do not transport a child on the passenger seat until the system has been repaired.

What to do if ...

Vehicle status messages in the multifunction display





Warning and malfunction messages appear in the multifunction display located in the instrument cluster.





Certain warning and malfunction messages are accompanied by an audible signal.

Address these messages accordingly and follow the additional instructions given in this Operator's Manual.

Selecting the vehicle status message memory menu in the control system (▷ page 135) displays both cleared and uncleared messages.

High-priority messages appear in the multifunction display in red color.

Certain messages of high priority cannot be cleared from the multifunction display using the reset button  (▷ page 26) or button , , , or  on the multifunction steering wheel.

Other high-priority messages and messages of less immediate priority (regular display colors) can be cleared from the multifunction display using the reset button  (▷ page 26) or button , , , or  on the multifunction steering wheel. They are then stored in the vehicle status message memory (▷ page 135). Remember that clearing a message will only make the message disappear. Clearing a message will not correct the condition that caused the message to appear.

Warning!



All categories of messages contain important information which should be taken note of and, where a malfunction is indicated, addressed as soon as possible at an authorized Mercedes-Benz Center.

Failure to repair condition noted may cause damage not covered by the Mercedes-Benz Limited Warranty, or result in property damage or personal injury.

Warning!

No messages will be displayed if either the instrument cluster or the multifunction display is inoperative.

Contact your nearest authorized Mercedes-Benz Center.

i *Switching on ignition (▷ page 37) causes all instrument cluster lamps (except high beam headlamp indicator lamp and turn signal indicator lamps unless activated) as well as the multifunction display to come on. Make sure the lamps and multifunction display are in working order before starting your journey.*

On the pages that follow, you will find a compilation of the most important warning and malfunction messages that may appear in the multifunction display.

For your convenience the messages are divided into two sections:

- Text messages (▷ page 358)
- Symbol messages (▷ page 366)

What to do if ...

Text messages

Display message	Possible cause/consequence	Possible solution
<p>ABS</p> <p>ABS, ESP inoperative See Operator's Manual</p>	<p>The ABS and ESP® are not available due to a malfunction.</p> <p>The BAS is also deactivated.</p> <p>The brake system is still functioning normally but without the systems specified above.</p>	<ul style="list-style-type: none"> ▶ Continue driving with added caution. Wheels may lock during hard braking, reducing steering capability. ▶ Have the system checked at an authorized Mercedes-Benz Center as soon as possible. <p>Failure to follow these instructions increases the risk of an accident.</p>
<p>Cruise control</p> <p>inoperative</p>	<p>The cruise control is malfunctioning.</p>	<ul style="list-style-type: none"> ▶ Have the cruise control checked by an authorized Mercedes-Benz Center.
<p>ESP</p> <p>inoperative See Operator's Manual</p>	<p>The ESP® has switched off due to a malfunction.</p> <p>The ABS and the BAS might not be operational.</p> <p>The brake system is still functioning normally but without the systems specified above.</p>	<ul style="list-style-type: none"> ▶ Continue driving with added caution. ▶ Have the system checked at an authorized Mercedes-Benz Center as soon as possible. <p>Failure to follow these instructions increases the risk of an accident.</p>

Display message	Possible cause/consequence	Possible solution
<p>ESP unavailable See Operator's Manual</p>	<p>The ESP® is temporarily not available.</p> <p>The system's self-diagnosis may not be completed yet.</p> <p>The ABS and the BAS might not be operational.</p> <p>The brake system is still functioning normally but without the systems specified above.</p>	<p>▶ Drive a short distance with added caution at a vehicle speed of above 12 mph (20 km/h). When the message disappears, the ESP® is available again.</p> <p>If the message does not disappear:</p> <p>▶ Continue driving with added caution.</p> <p>▶ Have the system checked at an authorized Mercedes-Benz Center as soon as possible.</p> <p>Failure to follow these instructions increases the risk of an accident.</p>
	<p>The charging voltage has fallen below 10 volts. The ESP® has switched off. The BAS may be switched off, too. The battery may not be charged. The battery or the generator may be malfunctioning.</p> <p>The ABS might not be operational.</p> <p>The brake system is still functioning normally but without the systems specified above.</p>	<p>▶ Continue driving with added caution.</p> <p>When the voltage is above this value again, the ESP® is operational again and the message in the multifunction display should disappear.</p> <p>If the message in the multifunction display does not disappear:</p> <p>▶ Have the generator (alternator) and battery checked.</p> <p>▶ Have the system checked at an authorized Mercedes-Benz Center as soon as possible.</p>

What to do if ...

Display message	Possible cause/consequence	Possible solution
SRS Restraint system malfunction Visit workshop	There is a malfunction in the supplemental restraint systems. The air bags or emergency tensioning devices (ETDs) could deploy unexpectedly or fail to activate in an accident.	► Drive with added caution to an authorized Mercedes-Benz Center and have the system checked immediately.
Transmission Visit workshop	Vehicles with automatic transmission*: The provided operating safety of the automatic transmission is reduced.	► Drive with added caution to the nearest authorized Mercedes-Benz Center.

Warning!





In the event a malfunction of the SRS is indicated as outlined above, the SRS may not be operational. For your safety, we strongly recommend that you contact an authorized Mercedes-Benz Center immediately to have the system checked; otherwise the SRS may not be deployed when needed in an accident, which could result in serious

or fatal injury, or it might deploy unexpectedly and unnecessarily which could also result in an accident and/or injury to you or to others.

Display message	Possible cause/consequence	Possible solution
<p>Front passenger airbag enabled See Operator's Manual</p>	<p>The passenger front air bag and the passenger-side knee bag are activated while driving even though a child, small individual, or object below the system's weight threshold is on the passenger seat, or the passenger seat is empty. Objects on the seat or forces acting on the seat may make the system sense supplemental weight.</p>	<p>Stop the vehicle in a safe location as soon as possible and check the passenger seat for the following:</p> <ul style="list-style-type: none"> ▶ Switch off the ignition (▷ page 37). ▶ Apply the parking brake (▷ page 59). ▶ Remove child and child restraint from passenger seat. ▶ Make sure that no objects which are applying supplemental weight onto the seat are present. The system may recognize such supplemental weight and sense that an occupant on the passenger seat is of a greater weight than actually present. ▶ Keep the seat unoccupied, close the passenger door and switch on the ignition (▷ page 37). <p>Monitor the  indicator lamp on the center console (▷ page 29) and the multifunction display in the instrument cluster (▷ page 121) for the following:</p> <p>(Continued on next page)</p>

What to do if ...

Display message	Possible cause/consequence	Possible solution
		<p>With the seat unoccupied and the ignition switched on,</p> <ul style="list-style-type: none"> the PASS AIR BAG OFF  indicator lamp on the center console should illuminate and remain illuminated, indicating that the OCS (▷ page 71) has deactivated the passenger front air bag and the passenger-side knee bag. the message Front passenger airbag enabled See Operator's Manual or the message Front passenger airbag disabled See Operator's Manual should not appear in the multifunction display at any time the seat is unoccupied. Wait at least 60 seconds for the system to complete the necessary check cycles and to make sure neither message appears in the multifunction display. <p>If above conditions are met, you can occupy the passenger seat again. Depending on the passenger classification sensed by the OCS (▷ page 71), the PASS AIR BAG OFF  indicator lamp will remain illuminated or go out.</p> <p>If above conditions are not met, the system is not working properly. Have the system checked as soon as possible by an authorized Mercedes-Benz Center.</p>

Warning!





If the **PASS AIR BAG OFF**  indicator lamp

remains illuminated with an adult occupant on the passenger seat even after performing the above corrective steps, do not have any

passenger use the passenger seat until the system has been repaired.

Display message	Possible cause/consequence	Possible solution
<p>Front passenger airbag disabled See Operator's Manual</p>	<p>The passenger front air bag and the passenger-side knee bag are deactivated while driving even though an adult or someone larger than a small individual is occupying the front passenger seat. Forces acting on the seat may make the system sense a decrease in weight.</p>	<p>Stop the vehicle in a safe location as soon as possible and check the passenger seat for the following:</p> <ul style="list-style-type: none"> ▶ Switch off the ignition (▷ page 37). ▶ Apply the parking brake (▷ page 59). ▶ Have the passenger vacate the seat and exit the vehicle. ▶ Keep the seat unoccupied, close the passenger door and switch on the ignition (▷ page 37). <p>Monitor the PASS AIR BAG OFF  indicator lamp on the center console (▷ page 29) and the multifunction display in the instrument cluster (▷ page 121) for the following:</p> <p>(Continued on next page)</p>

What to do if ...

Display message	Possible cause/consequence	Possible solution
		<p>With the seat unoccupied and the ignition switched on,</p> <ul style="list-style-type: none"> the PASS AIR BAG OFF  indicator lamp on the center console should illuminate and remain illuminated, indicating that the OCS has deactivated the passenger front air bag and the passenger-side knee bag. the message Front passenger airbag enabled See Operator's Manual or the message Front passenger airbag disabled See Operator's Manual should not appear in the multifunction display at any time the seat is unoccupied. Wait at least 60 seconds for the system to complete the necessary check cycles and to make sure neither message appears in the multifunction display. <p>If above conditions are met, you can occupy the passenger seat again. Depending on the passenger classification sensed by the OCS (▷ page 71), the PASS AIR BAG OFF  indicator lamp will remain illuminated or go out.</p> <p>If above conditions are not met, the system is not working properly. Have the system checked as soon as possible by an authorized Mercedes-Benz Center.</p>

Warning!



If the **PASS AIR BAG OFF**  indicator lamp

remains illuminated with an adult occupant on the passenger seat even after performing the above corrective steps, do not have any

passenger use the passenger seat until the system has been repaired.

Display message	Possible cause/consequence	Possible solution
Run Flat Indicator inoperative	The Run Flat Indicator* is malfunctioning.	▶ Have the Run Flat Indicator* checked by an authorized Mercedes-Benz Center.
	The Run Flat Indicator* has been switched off due to a malfunction.	
Tire pressure Check tires	The Run Flat Indicator* indicates that the pressure is too low in one or more tires.	<ul style="list-style-type: none"> ▶ Carefully bring the vehicle to a halt, avoiding abrupt steering and braking maneuvers. Observe the traffic situation around you. ▶ Check and adjust the tire inflation pressure as required (▷ page 314). ▶ If necessary, change the wheel (▷ page 401). ▶ Restart the Run Flat Indicator* after adjusting the tire inflation pressure values (▷ page 314).
Check tires Then restart Run Flat Indicator	There was a warning message about a loss in tire inflation pressure and the Run Flat Indicator* has not been restarted yet.	<ul style="list-style-type: none"> ▶ Make sure that the correct tire inflation pressure is set for each tire. ▶ Then restart the Run Flat Indicator* (▷ page 316).

Warning!









Do not drive with a flat tire. A flat tire affects the ability to steer or brake the vehicle.

You may lose control of the vehicle. Continued driving with a flat tire will cause excessive heat build-up and possibly a fire.

What to do if ...

Symbol messages

Display symbol	Display message	Possible cause/consequence	Possible solution
		<p>The battery is no longer charging. Possible causes:</p> <ul style="list-style-type: none"> • Alternator malfunctioning • Broken poly-V-belt <p>Do not forget that the brake system requires electrical energy and may be operating with restricted capability. Considerably greater brake pedal force is required and the stopping distance is increased.</p>	<p>► Stop the vehicle immediately in a safe location and check the poly-V-belt.</p> <p>If it is broken:</p> <ul style="list-style-type: none"> ► Do not continue to drive. Otherwise, the engine will overheat due to an inoperative water pump which may result in damage to the engine. Contact an authorized Mercedes-Benz Center. <p>If it is in order:</p> <ul style="list-style-type: none"> ► Contact an Mercedes-Benz Center immediately. Adjust driving to be consistent with reduced braking responsiveness.
<p>USA only:</p>  <p>Canada only:</p> 	<p>Release parking brake</p>	<p>You are driving with the parking brake set.</p>	<p>► Release the parking brake (▷ page 53).</p>

Display symbol	Display message	Possible cause/consequence	Possible solution
USA only:  Canada only: 	Check brake fluid level	There is insufficient brake fluid in the reservoir.	<ul style="list-style-type: none"> ▶ Risk of accident! ▶ Stop the vehicle in a safe location or as soon as it is safe to do so. ▶ Turn off the engine. ▶ Apply the parking brake (▷ page 59). ▶ Do not drive any further. ▶ Contact an authorized Mercedes-Benz Center. Do not add brake fluid! This will not solve the problem.
	Brake wear	The brake pads have reached their wear limit.	<ul style="list-style-type: none"> ▶ Have the brake pads replaced as soon as possible.

Warning!



Driving with the message **Check brake fluid level** displayed can result in an accident. Have your brake system checked immediately. Do not add brake fluid before checking the brake system.

Overfilling the brake fluid reservoir can result in spilling brake fluid on hot engine parts and the brake fluid catching fire. You can be seriously burned.

! *If you find that the brake fluid in the brake fluid reservoir has fallen to the minimum mark or below, have the brake system checked for brake pad thickness and leaks.*

! *Brake pad thickness must be visually checked by a qualified technician at the intervals specified in the Maintenance Booklet.*

What to do if ...

Display symbol	Display message	Possible cause/consequence	Possible solution
	Coolant Stop, turn engine off	The coolant is too hot. Among other possible causes, the poly-V-belt could be broken.	<ul style="list-style-type: none"> ▶ Stop the vehicle in a safe location or as soon as it is safe to do so. ▶ Turn off the engine. ▶ Apply the parking brake (▷ page 59). ▶ Check the poly-V-belt. <p>If it is broken:</p> <ul style="list-style-type: none"> ▶ Do not continue to drive. Otherwise, the engine will overheat due to an inoperative water pump which may result in damage to the engine. Contact an authorized Mercedes-Benz Center. <p>If it is intact:</p> <ul style="list-style-type: none"> ▶ Wait for the message to disappear before restarting the engine. <p>Doing otherwise could result in serious engine damage that is not covered by the Mercedes-Benz Limited Warranty.</p> <p>(Continued on next page)</p>

Display symbol	Display message	Possible cause/consequence	Possible solution
			<ul style="list-style-type: none"> ▶ Observe the coolant temperature display (▷ page 127). If the temperature rises again: ▶ Contact an authorized Mercedes-Benz Center immediately.

Warning!



Driving when your engine is overheated can cause some fluids which may have leaked into the engine compartment to catch fire. You could be seriously burned.



Steam from an overheated engine can cause serious burns and can occur just by opening the hood. Stay away from the engine if you see or hear steam coming from it.

Turn off the engine, get out of the vehicle and do not stand near the vehicle until the engine has cooled down.

During severe operating conditions, e.g. stop-and-go traffic, the coolant temperature may rise close to 248°F (120°C).

! *The engine should not be operated with the coolant temperature above 248°F (120°C). Doing so may cause serious engine damage which is not covered by the Mercedes-Benz Limited Warranty.*

What to do if ...



Display symbol	Display message	Possible cause/consequence	Possible solution
		The cooling fan for the coolant is malfunctioning.	<ul style="list-style-type: none"> ▶ Observe the coolant temperature display (▷ page 127). If the coolant temperature is below 120°C, you may continue driving to the nearest specialist workshop. ▶ Avoid heavy loads on the engine (e.g. by driving uphill) as well as stop-and-go traffic. ▶ Have the fan replaced as soon as possible.
	Top up coolant See Oper. Manual	The coolant level is too low.	<ul style="list-style-type: none"> ▶ Add coolant (▷ page 300). Comply with all warnings while doing so. ▶ If you have to add coolant frequently, have the cooling system checked by an authorized Mercedes-Benz Center.

Warning!





Do not spill antifreeze on hot engine parts. Antifreeze contains ethylene glycol which may burn if it comes into contact with hot engine parts. You could be seriously burned.

! Do not ignore the low engine coolant level warning. Extended driving with this message and symbol displayed may cause serious engine damage not covered by the Mercedes-Benz Limited Warranty. Do not drive without sufficient amount of coolant in the cooling system. The engine will overheat, causing major engine damage.

Display symbol	Display message	Possible cause/consequence	Possible solution
	Display malfunction Drive to workshop	Certain electronic systems are unable to relay information to the control system. The following systems may have failed: <ul style="list-style-type: none"> • Coolant temperature display • Tachometer • Cruise control display 	▶ Have the electronic systems checked by an authorized Mercedes-Benz Center.
		You are driving with one or more doors open.	▶ Close the doors.

What to do if ...

Display symbol	Display message	Possible cause/consequence	Possible solution
	Check oil level when next refueling	SLK 280 and SLK 350 only: The engine oil level has dropped to a critical level.	<ul style="list-style-type: none"> ▶ Check the engine oil level (▷ page 296) and add engine oil as required (▷ page 299). ▶ If you must add engine oil frequently, have the engine checked for possible leaks.
	USA only: Add 1 qt. engine oil when next refueling Canada only: Add 1 liter engine oil when next refueling	SLK 55 AMG only: The engine oil level is too low.	<ul style="list-style-type: none"> ▶ Add engine oil (▷ page 299) and check the engine oil level (▷ page 296).
	Cannot measure motor oil level	SLK 55 AMG only: The measuring system is malfunctioning.	<ul style="list-style-type: none"> ▶ Have the measuring system checked by an authorized Mercedes-Benz Center.

Display symbol	Display message	Possible cause/consequence	Possible solution
	Engine oil level Reduce oil level	SLK 55 AMG only: You have added too much engine oil. There is a risk of damaging the engine or the catalytic converter.	▶ Have oil siphoned or drained off. Observe all legal requirements with respect to its disposal.
	Engine oil level Stop, turn engine off	There is no oil in the engine. There is a danger of engine damage.	▶ Stop the vehicle in a safe location or as soon as it is safe to do so. ▶ Turn off the engine. ▶ Apply the parking brake (▷ page 59). ▶ Add engine oil (▷ page 299) and check the engine oil level (▷ page 296).



When the message Add 1 qt. (Canada: 1 liter) engine oil when next refueling (SLK 55 AMG) or Check oil level when next refueling (SLK 280, SLK 350) appears while the engine is running and at operating temperature, the engine oil level has dropped to approximately the minimum level.



When this occurs, the warning will first come on intermittently and then stay on if the oil level drops further.

Visually check for oil leaks. If no obvious oil leaks are noted, drive to the nearest service station where the engine oil should be topped to the required level with an approved engine oil. For information on approved engine oils, refer to the Factory Approved Service Products pamphlet (USA only) or contact an authorized Mercedes-Benz Center.

! *The engine oil level warnings should not be ignored. Extended driving with the symbol displayed could result in serious engine damage that is not covered by the Mercedes-Benz Limited Warranty.*

What to do if ...

Display symbol	Display message	Possible cause/consequence	Possible solution
	Reserve fuel	The fuel level has dropped below the reserve mark.	▶ Refuel at the next gas station (▷ page 291).
	Gas cap is open	A loss of pressure has been detected in the fuel system. The fuel cap may not be closed properly or the fuel system may be leaky.	▶ Check the fuel cap (▷ page 291). If it is not closed properly: ▶ Close the fuel cap. If it is closed properly: ▶ Have the fuel system checked by an authorized Mercedes-Benz Center.
	Retractable roof Open/Close completely	You are driving with the retractable hardtop not properly locked.	▶ Stop the vehicle in a safe location. Observe the traffic situation around you. ▶ Push the retractable hardtop switch forward or rearward until the retractable hardtop is completely closed or open (▷ page 240).
	Retractable roof being opened	The retractable hardtop is not completely opened or closed. The roof hydraulics will start to lose pressure.	▶ Make sure the retractable hardtop is completely opened or closed (▷ page 240).
	Retractable roof locked while vehicle is moving	You have attempted to open the retractable hardtop while driving.	▶ Stop the vehicle in a safe location and try to open the hardtop again.

Display symbol	Display message	Possible cause/consequence	Possible solution
		You are driving with the hood open.	<p>Risk of accident!</p> <ul style="list-style-type: none"> ▶ Stop the vehicle in a safe location or as soon as it is safe to do so. ▶ Apply the parking brake (▷ page 59). ▶ Close the hood (▷ page 294).
	Please get a new key	The SmartKey is malfunctioning.	▶ Contact an authorized Mercedes-Benz Center.
	Remove key	You have forgotten to remove the SmartKey from the starter switch.	▶ Remove the SmartKey from the starter switch.
	3rd brake lamp	The high mounted brake lamp is malfunctioning. This message will only appear if a critical number of LEDs have stopped working.	▶ Contact an authorized Mercedes-Benz Center as soon as possible.
	AUTO-Light inoperative	The light sensor is malfunctioning. The headlamps switch on automatically.	<p>▶ Contact an authorized Mercedes-Benz Center as soon as possible.</p> <p>To switch off the headlamps (U.S. vehicles only):</p> <ul style="list-style-type: none"> ▶ In the control system, set lamp operation to manual mode (▷ page 143). ▶ Switch off headlamps using the exterior lamp switch (▷ page 109).

What to do if ...

Display symbol	Display message	Possible cause/consequence	Possible solution
	Brake-/tail lamp left	The left brake lamp is malfunctioning. This message will only appear if a critical number of LEDs have stopped working.	► Contact an authorized Mercedes-Benz Center as soon as possible.
	Brake-/tail lamp right	The right brake lamp is malfunctioning. This message will only appear if a critical number of LEDs have stopped working.	► Contact an authorized Mercedes-Benz Center as soon as possible.
	Front foglamp left	The left front fog lamp is malfunctioning.	► Contact an authorized Mercedes-Benz Center as soon as possible.
	Front foglamp right	The right front foglamp is malfunctioning.	► Contact an authorized Mercedes-Benz Center as soon as possible.
	Rear foglamp Auxiliary bulb on	The rear fog lamp on the driver's side is malfunctioning. A backup bulb has been brought into use.	► Replace the bulb as soon as possible (▷ page 393).
	High beam left	The left high beam lamp (halogen headlamps)/high beam flasher lamp (Bi-Xenon* headlamps) is malfunctioning.	► Replace the bulb as soon as possible (▷ page 393).

Display symbol	Display message	Possible cause/consequence	Possible solution
	High beam right	The right high beam lamp (halogen headlamps)/high beam flasher lamp (Bi-Xenon* headlamps) is malfunctioning.	▶ Replace the bulb as soon as possible (▷ page 393).
	License plate lamp left	The left license plate lamp is malfunctioning.	▶ Replace the bulb as soon as possible (▷ page 393).
	License plate lamp right	The right license plate lamp is malfunctioning.	▶ Replace the bulb as soon as possible (▷ page 393).
	Reverse lamp left	The left backup lamp is malfunctioning.	▶ Replace the bulb as soon as possible (▷ page 393).
	Reverse lamp right	The right backup lamp is malfunctioning.	▶ Replace the bulb as soon as possible (▷ page 393).
	Low beam left	The left low beam lamp is malfunctioning.	Halogen headlamp: ▶ Replace the bulb as soon as possible (▷ page 393). Bi-Xenon* headlamp: ▶ Contact an authorized Mercedes-Benz Center as soon as possible.







What to do if ...

Display symbol	Display message	Possible cause/consequence	Possible solution
	Low beam right	The right low beam lamp is malfunctioning.	<p>Halogen headlamp:</p> <ul style="list-style-type: none"> ▶ Replace the bulb as soon as possible (▷ page 393). <p>Bi-Xenon* headlamp:</p> <ul style="list-style-type: none"> ▶ Contact an authorized Mercedes-Benz Center as soon as possible.
	Parking lamp, front left Auxiliary bulb on	The left front parking lamp is malfunctioning. A backup bulb has been brought into use.	<ul style="list-style-type: none"> ▶ Replace the bulb as soon as possible (▷ page 393).
	Parking lamp, front right Auxiliary bulb on	The right front parking lamp is malfunctioning. A backup bulb has been brought into use.	<ul style="list-style-type: none"> ▶ Replace the bulb as soon as possible (▷ page 393).
	Front left marker lamp	The left front side marker lamp is malfunctioning.	<ul style="list-style-type: none"> ▶ Contact an authorized Mercedes-Benz Center as soon as possible.
	Front right marker lamp	The right front side marker lamp is malfunctioning.	<ul style="list-style-type: none"> ▶ Contact an authorized Mercedes-Benz Center as soon as possible.
	Rear left marker lamp	The left rear side marker lamp is malfunctioning. This message will only appear if a critical number of LEDs have stopped working.	<ul style="list-style-type: none"> ▶ Contact an authorized Mercedes-Benz Center as soon as possible.

Display symbol	Display message	Possible cause/consequence	Possible solution
	Rear right marker lamp	The right rear side marker lamp is malfunctioning. This message will only appear if a critical number of LEDs have stopped working.	▶ Contact an authorized Mercedes-Benz Center as soon as possible.
	Tail lamp, left Auxiliary bulb on	The left tail lamp is malfunctioning. This message will only appear if a critical number of LEDs have stopped working. A backup bulb has been brought into use.	▶ Contact an authorized Mercedes-Benz Center as soon as possible.
	Tail lamp, right Auxiliary bulb on	The right tail lamp is malfunctioning. This message will only appear if a critical number of LEDs have stopped working. A backup bulb has been brought into use.	▶ Contact an authorized Mercedes-Benz Center as soon as possible.
	Turn off lights	You have removed the SmartKey from the starter switch, opened the driver's door and left the headlamps on.	▶ Switch off the headlamps (▷ page 61).
	Turn off lights or remove key	The exterior lamp switch is set to position AUTO , and you have forgotten to remove the SmartKey from the starter switch. The parking lamps remain switched on.	▶ Switch off the headlamps (▷ page 61). or ▶ Remove the SmartKey from the starter switch.

What to do if ...

Display symbol	Display message	Possible cause/consequence	Possible solution
	Left mirror turn signal	The left turn signal in the side mirror is malfunctioning. This message will only appear if a critical number of LEDs have stopped working.	► Contact an authorized Mercedes-Benz Center as soon as possible.
	Right mirror turn signal	The right turn signal in the side mirror is malfunctioning. This message will only appear if a critical number of LEDs have stopped working.	► Contact an authorized Mercedes-Benz Center as soon as possible.
	Front left turn signal	The left front turn signal is malfunctioning.	► Replace the bulb as soon as possible (▷ page 393).
	Front right turn signal	The right front turn signal is malfunctioning.	► Replace the bulb as soon as possible (▷ page 393).
	Rear left turn signal Auxiliary bulb on	The left rear turn signal is malfunctioning. A backup bulb has been brought into use.	► Replace the bulb as soon as possible (▷ page 393).
	Rear right turn signal Auxiliary bulb on	The right rear turn signal is malfunctioning. A backup bulb has been brought into use.	► Replace the bulb as soon as possible (▷ page 393).

Display symbol	Display message	Possible cause/consequence	Possible solution
	Driver Please fasten belt	The display reminds you to fasten your seat belt.	► Fasten your seat belt.
	Front passenger Please fasten belt	The display reminds you and your passenger to fasten your seat belts.	► Fasten your seat belts.
	PHONE OFF	This display appears if button  or  on the multifunction steering wheel is pressed and the vehicle is not equipped with a telephone*.	
		This message will appear whenever the trunk lid is open.	► Close the trunk lid.
	Close trunk partition	You are trying to open or close the retractable hardtop even though the luggage cover in the trunk is not closed and/or properly engaged.	► Close the luggage cover (▷ page 241).
	Top up washer fluid	The fluid level in the windshield washer fluid reservoir has dropped below its minimum mark.	► Add washer fluid (▷ page 302).

Where will I find...?

First aid kit

The first aid kit is stored in a parcel net behind the driver's seat.

i *Check expiration dates and contents for completeness at least once a year and replace missing/expired items.*

Vehicle tool kit, vehicle jack

The vehicle tool kit is stored in a storage compartment under the trunk floor.

The following is included:

- Collapsible wheel chock
- Vehicle jack
- Protective wrap (except SLK 55 AMG with Performance Package)
- Alignment bolt
- Towing eye bolt
- Wheel wrench
- Spare fuses
- Fuse extractor
- Valve extractor
- Electric air pump
- TIREFIT kit (SLK 55 AMG with Performance Package only)

Removing the vehicle tool kit

Vehicles with spare wheel

- ▶ Open the trunk (▷ page 100).
- ▶ Lift up trunk floor.
- ▶ Remove the spare wheel (▷ page 385).

You can now access the vehicle tool kit.

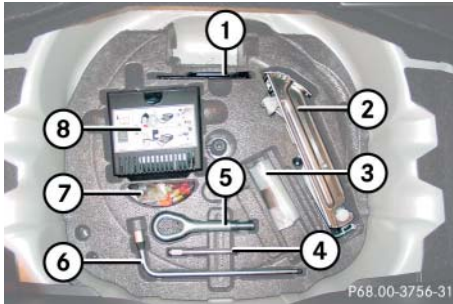

P68.00-3756-31

- ① Collapsible wheel chock
- ② Vehicle jack
- ③ Protective wrap
- ④ Alignment bolt
- ⑤ Towing eye bolt
- ⑥ Wheel wrench
- ⑦ Spare fuses, fuse extractor and valve extractor
- ⑧ Electric air pump

*Vehicles with TIREFIT**

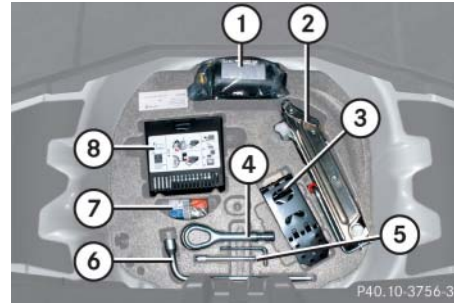

P40.10-3756-31

- ① TIREFIT kit
- ② Vehicle jack
- ③ Collapsible wheel chock
- ④ Towing eye bolt
- ⑤ Alignment bolt
- ⑥ Wheel wrench
- ⑦ Spare fuses, fuse extractor and valve extractor
- ⑧ Electric air pump

- ▶ Open the trunk (▷ page 100).
- ▶ Lift up trunk floor.

Vehicle jack

Warning!



The jack is designed exclusively for jacking up the vehicle at the jack take-up brackets built into both sides of the vehicle. To help avoid personal injury, use the jack only to lift the vehicle during a wheel change. Never get beneath the vehicle while it is supported by the jack. Keep hands and feet away from the area under the lifted vehicle. Always firmly set parking brake and block wheels before raising vehicle with jack.

Do not disengage parking brake while the vehicle is raised. Be certain that the jack is always vertical (plumb line) when in use, especially on hills. Always try to use the jack on level surface. Make sure the jack arm is fully seated in the jack take-up bracket. Always lower the vehicle onto sufficient capacity jackstands before working under the vehicle.

Where will I find...?

The vehicle jack is located in the storage compartment underneath the trunk floor.

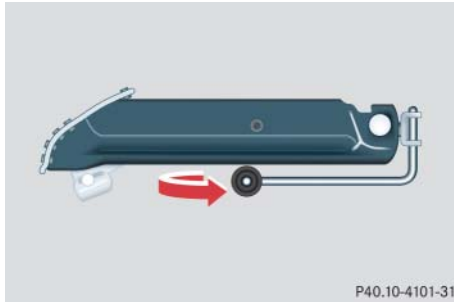

Storage position

- ▶ Remove vehicle jack from its compartment.
- ▶ Turn crank handle in the direction of arrow as far as it will go.

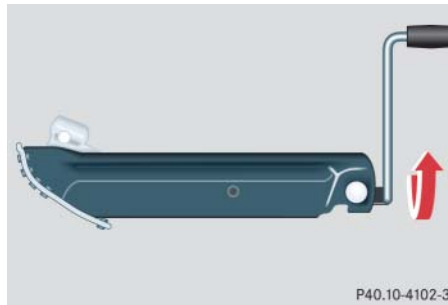

Operational position

- ▶ Turn crank handle clockwise.

Before storing the vehicle jack in its compartment:

- It should be fully collapsed.
- The handle must be folded in (storage position).

Setting up the collapsible wheel chock

The collapsible wheel chock serves to additionally secure the vehicle, e.g. while changing the wheel.

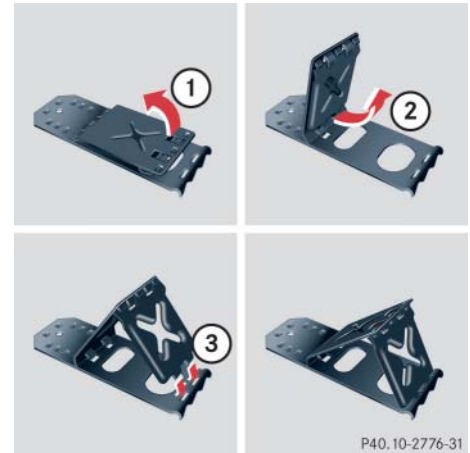

- ① Tilt the plate upward
- ② Fold the lower plate outward
- ③ Insert the plate

- ▶ Tilt both plates upward ①.
- ▶ Fold the lower plate outward ②.
- ▶ Guide the tabs of the lower plate all the way into the openings of the base plate ③.

For information on where to place wheel chocks when changing a wheel, see “Lifting the vehicle” (▷ page 407).

Spare wheel with collapsible tire

The spare wheel is located in the storage compartment underneath the trunk floor.

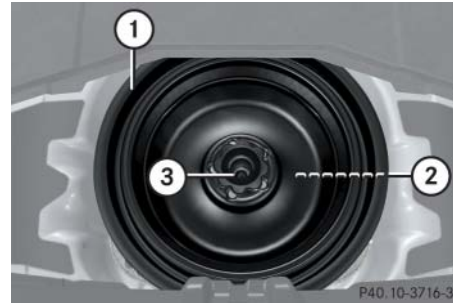

- ① Spare wheel, spare wheel bolts (located under plastic cover on the outside of spare wheel rim)
- ② Vehicle tool kit (under spare wheel)
- ③ Retaining screw

- ▶ Open the trunk (▷ page 100).
- ▶ Lift up trunk floor.
- ▶ Loosen retaining screw ③ by turning it counterclockwise.
- ▶ Remove spare wheel ①.
- ▶ Take off the wheel bolts for spare wheel ①.

Storing the spare wheel with collapsible tire

If you wish to store the spare wheel after use, carry out the following steps. Otherwise the spare wheel will not fit the storage compartment.

! *Make sure the collapsible tire is dry when storing it.*

- ▶ Unscrew the valve cap from the valve of the collapsible tire.
- ▶ Take the valve extractor from the vehicle tool kit (▷ page 382).

▷▷

Where will I find...?

- ▷▷ Unscrew the valve insert from the valve and allow the air to escape.

i It may take a few minutes for the collapsible tire to deflate completely.

- ▶ Screw the valve insert back into the valve.
- ▶ Screw the valve cap back on the valve.
- ▶ Pull the protective wrap provided with the vehicle tool kit over the spare wheel.
- ▶ Store the spare wheel and the valve extractor in the storage compartment underneath the trunk floor.
- ▶ Pierce the protective wrap with retaining screw ③.
- ▶ Secure the spare wheel by turning retaining screw ③ clockwise.

For information on mounting the spare wheel, see “Flat tire” (▷ page 401).

Spare wheel bolts

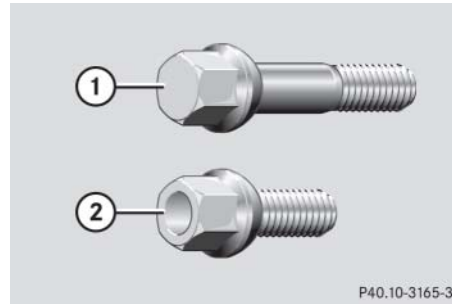

- ① Wheel bolt for light alloy rims
- ② Wheel bolt for spare wheel with collapsible tire (located under plastic cover on the outside of spare wheel rim)

! Wheel bolts ② must be used when mounting the spare wheel with collapsible tire. The use of any wheel bolts other than wheel bolts ② for the spare wheel with collapsible tire will physically damage the vehicle's brakes.

Unlocking/locking in an emergency

▼ **Unlocking/locking in an emergency**

Unlocking the vehicle

If you cannot unlock the vehicle with the SmartKey, open the driver's door and the trunk using the mechanical key.

i *Unlocking the vehicle with the mechanical key and opening the driver's door or the trunk will trigger the anti-theft alarm system (▷ page 90).*

To cancel the alarm, insert the SmartKey in the starter switch.

Removing the mechanical key

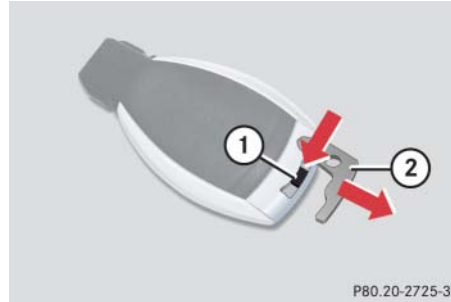

- ① Mechanical key locking tab
- ② Mechanical key

- ▶ Move locking tab ① in direction of arrow.
- ▶ Slide mechanical key ② out of the housing.

Unlocking the driver's door

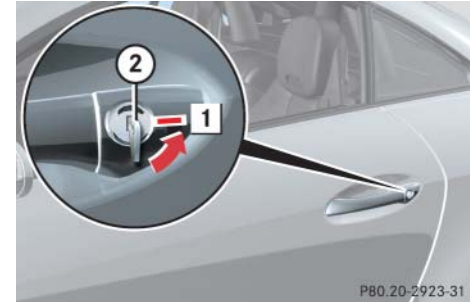

- 1 Unlocking
- ② Mechanical key

- ▶ Insert mechanical key ② into the driver's door lock until it stops.
- ▶ Turn mechanical key ② counterclockwise to position 1 until the locking knobs moves up.

The driver's door is unlocked.

- ▶ Pull the door handle to open the driver's door.

Unlocking/locking in an emergency

Unlocking and opening the trunk

A minimum height clearance of 5.78 ft (1.76 m) is required to open the trunk lid.

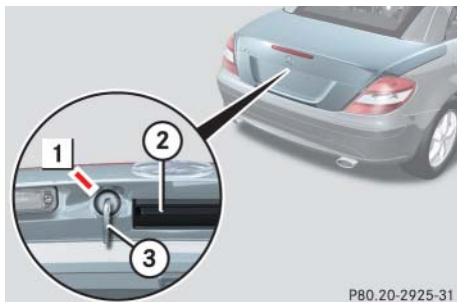

- | | |
|---|----------------|
| 1 | Unlocking |
| 2 | Handle |
| 3 | Mechanical key |

- ▶ Insert mechanical key ③ into the trunk lid lock until it stops.
- ▶ Turn mechanical key ③ counterclockwise to position 1 until it stops, and simultaneously
- ▶ pull trunk lid handle ② and lift lid.

! Always make sure there is sufficient overhead clearance.

- ▶ Turn mechanical key ③ back and remove it from the trunk lid lock.

Locking the vehicle

If you cannot lock the vehicle with the SmartKey, do the following:

- ▶ Close the passenger door and the trunk lid.
- ▶ Press the central locking switch in the upper part of the center console (▷ page 103).
- ▶ Check to see whether the locking knob on the passenger door has moved down.
- ▶ If necessary, push it down manually. The passenger door is locked.
- ▶ Exit the vehicle and close the driver's door.

Unlocking/locking in an emergency

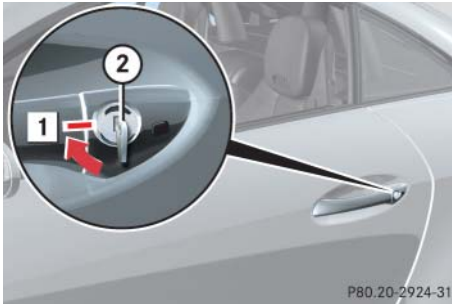

P80.20-2924-31

1 Locking

② Mechanical key

- ▶ Insert mechanical key ② into the driver's door lock until it stops.
- ▶ Turn mechanical key ② clockwise to position 1.

The driver's door is locked.

i This procedure does not arm the anti-theft alarm system, nor does it lock the fuel filler flap.

- ▶ Turn back mechanical key ② and remove it from driver's door lock.

Manually unlocking the gear selector lever (automatic transmission*)

In case of power failure, the gear selector lever can be manually unlocked, e.g. to tow the vehicle.

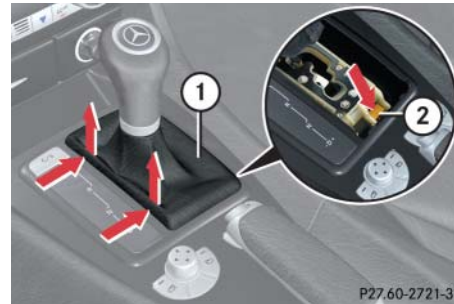

P27.60-2721-31

- ① Gear selector lever cover
- ② Release

- ▶ Insert flat, blunt object (e.g. screw-driver) into the left edge of cover ① at the position indicated by the arrows.
- ▶ Loosen cover ① using this object.
- ▶ Using your hands, pull cover ① out and remove.
- ▶ Push down and hold release ② in direction of arrow.
- ▶ Simultaneously move gear selector lever out of position P.

The gear selector lever is unlocked now.

i The gear selector lever is locked again as soon as you place it in position P again.

Opening/closing in an emergency

Raising retractable hardtop manually

Warning!



If the retractable hardtop does not completely open or close, the roof hydraulics will lose pressure and the retractable hardtop is lowered

- after approximately 7 minutes when the ignition is switched on
- after approximately 15 seconds when the ignition is switched off

Shortly before the hardtop is lowered, a warning will sound. In the multifunction display you will see  and the message Retractable roof being opened.

- Properly lock retractable hardtop before continuing to drive (▷ page 240).

Warning!



Manually closing the retractable hardtop is a complicated and technically demanding procedure and should only be performed by an authorized Mercedes-Benz Center or qualified technician. Attempting to manually close the retractable hardtop may cause damage to the retractable hardtop and/or personal injury.

Warning!



To prevent possible accidents, drive the vehicle only with the retractable hardtop either completely closed and locked, or fully lowered into its storage compartment.

Replacing SmartKey batteries

▼ Replacing SmartKey batteries

If the batteries in the SmartKey are discharged, the vehicle can no longer be locked or unlocked. It is recommended to have the batteries replaced at an authorized Mercedes-Benz Center.

Warning!



Batteries contain poisonous and corrosive substances. Therefore keep the batteries out of reach of children.

If a battery is swallowed, seek medical help immediately.

Batteries contain materials that can harm the environment if disposed of improperly. Recycling of batteries is the preferred method of disposal. Many states require sellers of batteries to accept old batteries for recycling.

i When inserting the batteries, make sure they are clean and free of lint.

i When replacing batteries, always replace both batteries.

The required replacement batteries are available at any Mercedes-Benz Center.

SmartKey

Replacement batteries: Lithium, type CR 2025 or equivalent.

- ▶ Remove the mechanical key from the SmartKey (> page 387).

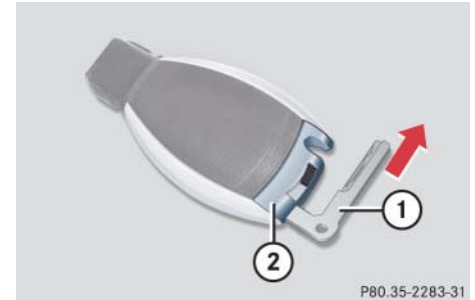

- ① Mechanical key
- ② Battery compartment

- ▶ Insert mechanical key ① into opening.
- ▶ Press mechanical key ① in direction of arrow.

Battery compartment ② is unlatched.

- ▶ Pull battery compartment ② out of the housing.



Replacing SmartKey batteries

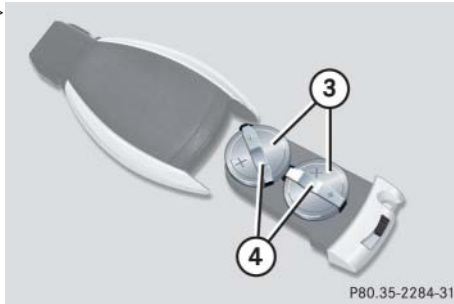

③ Batteries

④ Contact springs

▶ Pull out batteries ③.

- ▶ Using a lint-free cloth, insert new batteries ③ under contact springs ④ with the positive terminal (+) side facing up.
- ▶ Return battery compartment ② (▷ page 391) into the housing until it locks into place.
- ▶ Slide the mechanical key back into the SmartKey.
- ▶ Check the operation of the SmartKey.

▼ Replacing bulbs

Warning!



Bulbs and bulb sockets can be very hot. Allow the lamp to cool down before changing a bulb.

Keep bulbs out of reach of children.

Halogen lamps contain pressurized gas. A bulb can explode if you:

- touch or move it when hot
- drop the bulb
- scratch the bulb

Wear eye and hand protection.

Because of high voltage in Xenon lamps, it is dangerous to replace the bulb or repair the lamp and its components. We recommend that you have such work done by a qualified technician.

Bulbs

Safe vehicle operation depends on proper exterior lighting and signaling. It is therefore essential that all bulbs and lamp assemblies are in good working order at all times.

Correct headlamp adjustment is extremely important. Have headlamps checked and readjusted at regular intervals and when a bulb has been replaced. Contact an authorized Mercedes-Benz Center for headlamp adjustment.

i If the headlamps are fogged up on the inside as a result of high humidity, driving the vehicle a short distance with the lights on should clear up the fogging.

i Backup bulbs will be brought into use when lamps malfunction. Read and observe the messages in the multifunction display (▷ page 375).

Replacing bulbs

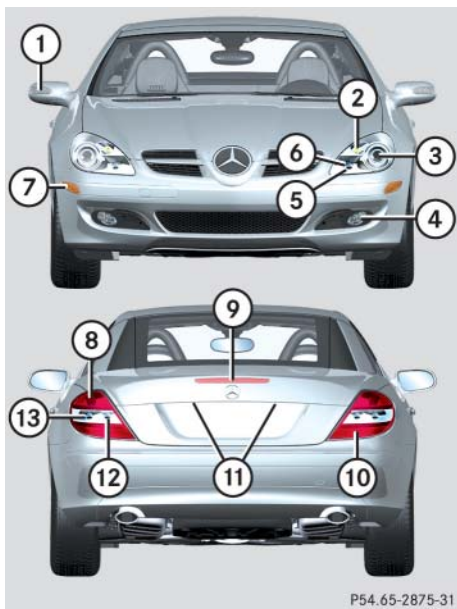

Front lamps

	Lamp	Type
①	Additional turn signal lamp	LED
②	Turn signal lamp	3457 AK
③	Halogen headlamp: Low beam	H7 (55 W)
	Bi-Xenon* headlamp: Low and high beam ¹	D2S-35 W
④	Front fog lamp	HB4 (51 W)
	Front fog lamp (vehicles with Sport Package* and SLK 55 AMG)	H7 (55 W)
	Corner illuminating front fog lamp*	H7 (55 W)

	Lamp	Type
⑤	Parking and standing lamp	W 5 W
⑥	Halogen headlamp: High beam/high beam flasher	H7 (55 W)
	Bi-Xenon* headlamp: High beam flasher	H7 (55 W)
⑦	Side marker lamp	W 5 W

¹ Vehicles with Bi-Xenon* headlamps: Low beam and high beam use the same D2S-35W lamp. Do not replace the Bi-Xenon* bulbs yourself. Contact an authorized Mercedes-Benz Center.

Rear lamps

Lamp	Type
⑧ Rear fog lamp (driver's side only)	P 21 W
⑨ High mounted brake lamp	LED
⑩ Tail, parking, standing, side marker lamp and brake lamp	LED
⑪ License plate lamps	C 5 W
⑫ Backup lamp	P 21 W
⑬ Turn signal lamp	PY 21 W

Notes on bulb replacement

- Only use 12-volt bulbs of the same type and with the specified watt rating.
- Switch the lights off before replacing a bulb to prevent short circuits.
- Always use a clean lint-free cloth when handling bulbs.
- Your hands should be dry and free of oil and grease.
- If the newly installed bulb does not come on, contact an authorized Mercedes-Benz Center.

Have the LEDs and bulbs for the following lamps replaced by an authorized Mercedes-Benz Center:

- Additional turn signal lamps in the exterior rear view mirrors
- Bi-Xenon* lamps
- Front fog lamps
- High mounted brake lamp
- Brake lamps
- Front and rear side marker lamps
- Parking/standing lamps in the tail lamp assemblies

! Do not replace the LEDs yourself. You could otherwise damage the LEDs or parts of the vehicle. Only have the LEDs replaced by an authorized Mercedes-Benz Center.

Replacing bulbs

Replacing bulbs for front lamps

Before you start to replace a bulb for a front lamp, do the following first:

- ▶ Turn the exterior lamp switch to position **0** (▷ page 109).
- ▶ Open the hood (▷ page 294).

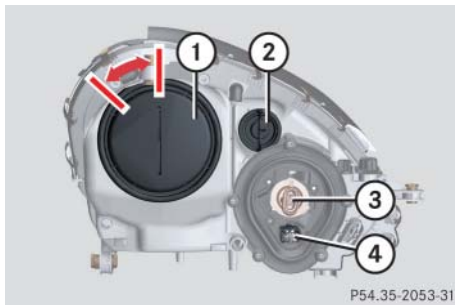

- ① Housing cover for low beam (halogen headlamps only)
Housing cover for Bi-Xenon* headlamps. **Do not remove.**
- ② Bulb socket for turn signal lamp
- ③ Bulb socket for high beam/high beam flasher lamp
- ④ Bulb socket for parking and standing light lamp

Warning!



Do not remove the cover ① for the Bi-Xenon* headlamp. Because of high voltage in Bi-Xenon lamps, it is dangerous to replace the bulb or repair the lamp and its components. We recommend that you have such work done by a qualified technician.

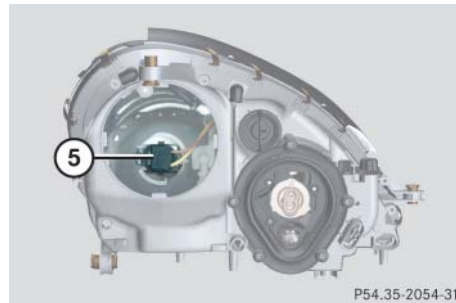

- ⑤ Bulb socket for low beam bulb (Halogen headlamps only)

Low beam bulb (Halogen headlamps only)

- ▶ Turn housing cover ① counterclockwise and remove.
- ▶ Turn bulb socket ⑤ with the bulb counterclockwise and remove.
- ▶ Pull the bulb out of bulb socket ⑤.
- ▶ Press the new bulb into bulb socket ⑤.
- ▶ Place bulb socket ⑤ back into the lamp and turn it clockwise.
- ▶ Reinstall housing cover ①.

High beam/high beam flasher bulb (Halogen headlamps) / High beam flasher bulb (Bi-Xenon* headlamps)

- ▶ Turn bulb socket ③ with the bulb counterclockwise and remove.
- ▶ Pull the bulb out of bulb socket ③.
- ▶ Press the new bulb into bulb socket ③.
- ▶ Place bulb socket ③ back into the lamp and turn it clockwise.

Front turn signal bulb

- ▶ Turn bulb socket ② with the bulb counterclockwise and remove.
- ▶ Press gently onto the bulb and turn it counterclockwise out of bulb socket ②.
- ▶ Press the new bulb gently into bulb socket ② and turn it clockwise.
- ▶ Place bulb socket ② back into the lamp and turn it clockwise.

Parking and standing lamp bulb

- ▶ Turn bulb socket ④ with the bulb counterclockwise and remove.
- ▶ Pull the bulb out of bulb socket ④.
- ▶ Press the new bulb into bulb socket ④.
- ▶ Place bulb socket ④ back into the lamp and turn it clockwise.

Replacing bulbs for rear lamps

Before you start to replace a bulb for a rear lamp, do the following first:

- ▶ Turn the exterior lamp switch to position **0** (▷ page 109).
- ▶ Open the trunk lid (▷ page 100).

Tail lamp unit

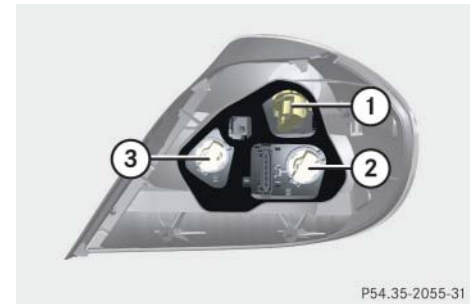

- ① Bulb socket for rear fog lamp (driver's side only)
- ② Bulb socket for turn signal lamp
- ③ Bulb socket for backup lamp

Replacing bulbs

- ▶ Fold corresponding trim to side.
- ▶ Turn the respective bulb socket counterclockwise and remove.
- ▶ Press gently onto the bulb and turn counterclockwise out of its bulb socket.
- ▶ Press the new bulb gently into its bulb socket and turn clockwise.
- ▶ Reinstall the bulb socket and turn clockwise until it engages.
- ▶ Reinstall trim.

License plate lamp

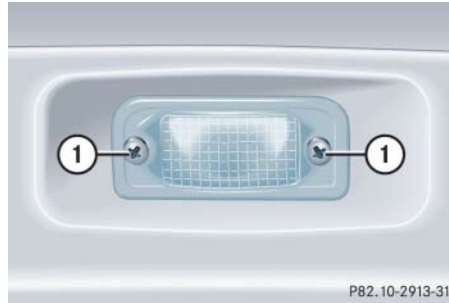

- ① Screws
- ▶ Loosen both screws ①.
- ▶ Remove the license plate lamp.
- ▶ Replace the bulb.
- ▶ Reinstall the license plate lamp.
- ▶ Retighten screws ①.

Replacing wiper blades

▼ Replacing wiper blades

Warning!



For safety reasons, switch off wipers and remove the SmartKey from the starter switch before replacing a wiper blade. Otherwise, the motor could suddenly turn on and cause injury.

Warning!



Wiper blades are components that are subject to wear and tear. Replace the wiper blades twice a year, preferably in the spring and fall. Otherwise the windows will not be properly wiped. As a result, you may not be able to observe surrounding traffic conditions and could cause an accident.

! To avoid damage to the hood:

- The wiper arms should only be folded forward when in the vertical position.
- Never open the hood when a wiper arm is folded forward.

! Hold on to the wiper when folding the wiper arm back. If released, the force of the impact from the tensioning spring could crack the windshield.

Do not allow the wiper arms to contact the windshield glass without a wiper blade inserted.

For your convenience, we recommend that you have this work carried out by an authorized Mercedes-Benz Center.

Placing wiper arms in vertical position

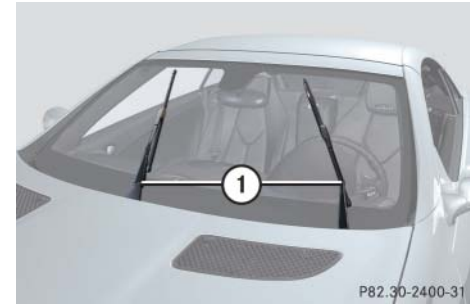

① Wiper arms

- ▶ Turn the SmartKey in the starter switch to position **1** (▷ page 37).
- ▶ Turn combination switch to wiper setting **II** (▷ page 56).
- ▶ With wiper arms ① in vertical position, turn the SmartKey in the starter switch to position **0**.
- ▶ Remove the SmartKey from the starter switch.

Replacing wiper blades

Removing wiper blades

! Do not pull on the wiper blade inserts. They could tear.

- ▶ Fold the wiper arms forward until they engage.

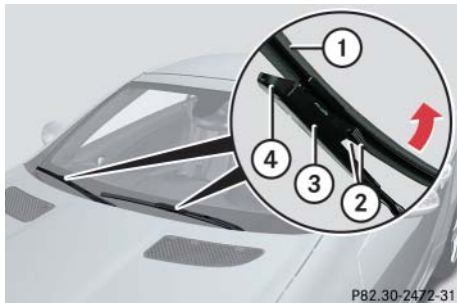

- ① Wiper blade
- ② Tabs
- ③ Attachment
- ④ Cover

- ▶ Press tabs ② together and tilt wiper blade ① in direction of arrow.
- ▶ Tabs ② on both recesses of attachment ③ are detached.
- ▶ Maintaining its tilted position, remove wiper blade ① out of attachment ③.

Installing wiper blades

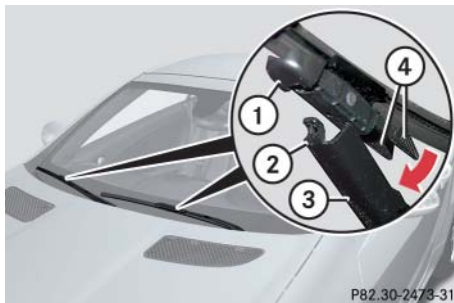

- ① Cover
- ② Guide tab
- ③ Attachment
- ④ Tabs

- ▶ Maintaining a tilted position of the wiper blade, place cover ① onto attachment ③ so that guide tab ② is under cover ①.
- ▶ Tilt the wiper blade in direction of the arrow towards the wiper arm.
- ▶ Simultaneously press tabs ④ together and let the wiper blade engage into both recesses of attachment ③.
- ▶ Check if the wiper blade is securely fastened.
- ▶ Fold the wiper arm backward to rest on the windshield.
- ▶ Make sure you hold on to the wiper arm when folding it back.

! Make sure the wiper blades are properly installed. Improperly installed wiper blades may cause windshield damage.

▼ Flat tire

The SLK 55 AMG with Performance Package* is equipped with a TIREFIT kit.

Preparing the vehicle

- ▶ Park the vehicle in a safe distance from moving traffic on a hard, flat surface when possible.
- ▶ Turn on the hazard warning flashers.
- ▶ Turn the steering wheel so that the front wheels are in a straight ahead position.
- ▶ Set the parking brake (▷ page 53).
- ▶ Move the gear selector lever* to **P** (manual transmission to first or reverse gear).
- ▶ Turn off the engine (▷ page 61).
- ▶ Remove the SmartKey from the starter switch.

i *Open door only when conditions are safe to do so.*

- ▶ Have any passenger exit the vehicle at a safe distance from the roadway.

Sealing tires with TIREFIT

i *SLK 55 AMG with Performance Package* only.*

Warning!

Keep TIREFIT away from sparks, open flame or heat source.

Do not smoke.

Small tire punctures, particularly those in the tread, can be sealed with TIREFIT. TIREFIT can be used in ambient temperatures down to -4°F (-20°C).

Warning!



TIREFIT is a limited repair device. TIREFIT cannot be used for cuts or punctures larger than approximately 0.16 in (4 mm) and tire damage caused by driving with extremely low tire inflation pressure, or on a flat tire, or a damaged wheel.

Do not drive the vehicle under such circumstances.

Contact the nearest Mercedes-Benz Center for assistance or call Roadside Assistance.

- ▶ Foreign objects (e.g. screws or nails) should not be removed from the tire.
- ▶ Take TIREFIT, the sticker, and the electric air pump out of the trunk (▷ page 382).



Flat tire

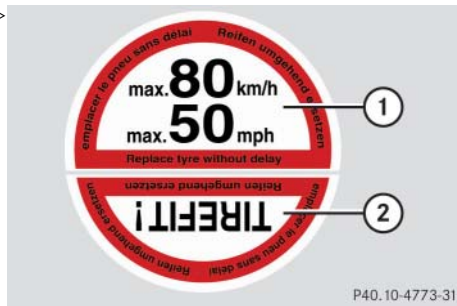

Two-part sticker

- ① Sticker for instrument cluster
 - ② Sticker for wheel
- ▶ Attach sticker part ① where it will be easily seen by the driver on the instrument cluster.
 - ▶ Attach sticker part ② to the damaged tire (close to the tire vent).

Warning!



Take care not to allow the contents of TIREFIT to come in contact with hair, eyes or clothing. TIREFIT is harmful if inhaled, swallowed or absorbed through the skin – causes skin, eye and respiratory irritation.

Any contact with eyes or skin should be flushed immediately with plenty of water.

If clothing comes in contact with TIREFIT, change clothing as soon as possible.

In case of allergic reaction or rash, consult a physician immediately.

Warning!



Keep TIREFIT out of reach of children.
If swallowed, rinse mouth immediately with plenty of water and drink plenty of water.
Do not induce vomiting!
Consult a physician immediately.
Keep away from open flame or heat source.

i If sealant has leaked out, let it dry. You can then peel it off.

Warning!



Observe safety instructions on air pump label.

i Your vehicle may be equipped with either of two versions of the electric air pump:

- Version 1

The air hose with pressure gauge and the electrical plug are located behind a flap.

- Version 2

The pressure gauge is located in the pump housing.

The following description applies to both versions. Differences in usage are expressly declared.

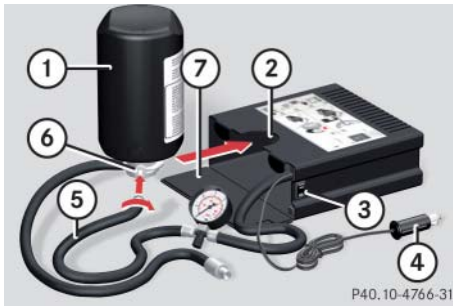

P40.10-4766-31

Version 1

- ① TIREFIT container
- ② Notch
- ③ Electric air pump switch
- ④ Electrical plug
- ⑤ Air hose
- ⑥ Flange
- ⑦ Flap

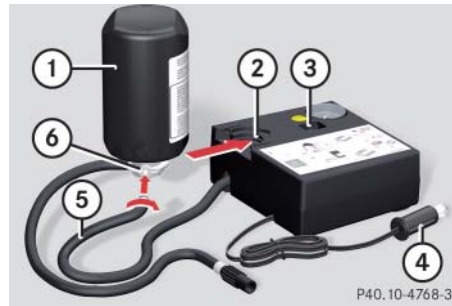

P40.10-4768-31

Version 2

- ① TIREFIT container
- ② Notch
- ③ Electric air pump switch
- ④ Electrical plug
- ⑤ Air hose
- ⑥ Flange

- ▶ Open flap ⑦ on the electric air pump **(version 1 only)**.
- ▶ Pull plug ④ and air hose ⑤ out of the pump housing.

- ▶ Screw the air pump's air hose ⑤ onto flange ⑥ of TIREFIT container ①.
- ▶ Stick TIREFIT container ① upside down into notch ② of the electric air pump.

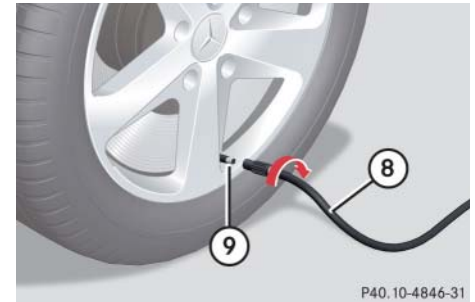

P40.10-4846-31

- ⑧ Filler hose
 - ⑨ Tire valve
- ▶ Unscrew the valve cap of the damaged tire from tire valve ⑨. >>

Flat tire

▷▷



Version 1

⑩ Vent screw

⑪ Pressure gauge

- ▶ Close vent screw ⑩ on pressure gauge ⑪ (**version 1 only**).
- ▶ Screw filler hose ⑧ onto tire valve ⑨ (▷ page 403).
- ▶ Insert electrical plug ④ (▷ page 403) into the cigarette lighter (▷ page 256).
- ▶ Turn the SmartKey in the starter switch to position **1** (▷ page 37).

- ▶ Press **I** on electric air pump switch ③ (▷ page 403).

The electric air pump is switched on and inflates the tire.

i First, the sealing is pumped into the tire. The pressure may briefly rise to up to 73 psi (5 bar). This is normal and not an indication of a malfunction. Do not switch off the electric air pump.

- ▶ Let the electric air pump inflate the tire for approximately 5 minutes.

The pressure gauge must display at least 26 psi (1.8 bar). The air hose can become hot during inflation. Please exercise appropriate caution.

! Do not operate the electric air pump longer than 6 minutes without interruption. Otherwise it may overheat.

You may operate the air pump again after it has cooled off.

- ▶ If the tire inflation pressure of at least 26 psi (1.8 bar) is not attained, turn off the electric air pump by pressing **0** on electric air pump switch ③ (▷ page 403).
- ▶ Detach filler hose ⑧ from tire valve ⑨ (▷ page 403).
- ▶ Drive vehicle back and forth very slowly approximately 30 ft (10 m). This serves to better distribute the TIREFIT sealant material inside the tire.
- ▶ Unscrew the air pump's air hose ⑤ from flange ⑥ of TIREFIT container ① (▷ page 403).
- ▶ Screw air hose ⑤ onto tire valve ⑨.
- ▶ Inflate the tire again.

Warning!



If a tire inflation pressure of 26 psi (1.8 bar) is not attained, the tire is too severely damaged for TIREFIT to provide a reliable tire repair.

In this case, TIREFIT cannot properly seal the tire.

Do not drive the vehicle.

Contact the nearest Mercedes-Benz Center or call Roadside Assistance.

- ▶ After attaining a tire inflation pressure of 26 psi (1.8 bar), press **0** on electric air pump switch **⑧** (▷ page 403).
The electric air pump is switched off.
- ▶ Turn the SmartKey in the starter switch to position **0** (▷ page 37).

- ▶ Detach the electric air pump.
The air hose may still be hot. Please exercise appropriate caution.
- ▶ Place the electrical air pump back in the trunk.
- ▶ Close the trunk lid.
- ▶ Drive off immediately.
The TIREFIT sealant will distribute itself evenly inside the tire.

Warning!



Do not exceed vehicle speed of 50 mph (80 km/h). A TIREFIT repair is not designed to operate at higher speeds.

The sticker must be attached on the instrument cluster where it will be easily seen by the driver.

Vehicle handling characteristics may change. Adapt your driving accordingly.

- ▶ After driving the vehicle for an initial 10 minutes, check the tire inflation pressure using pressure gauge **⑨** on the air pump.

Warning!



If tire inflation pressure has fallen below 20 psi (1.3 bar) do not continue to drive the vehicle.

Park your vehicle safely away from the roadway and contact the nearest authorized Mercedes-Benz Center or Roadside Assistance.

Have the damaged tire replaced.



Flat tire

▷▷

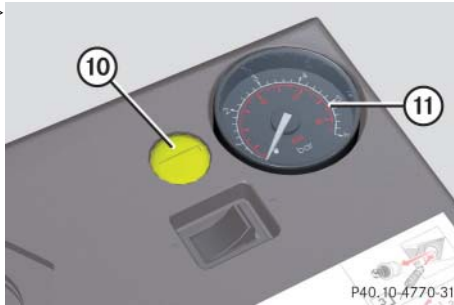

Version 2

- ⑩ Deflate button
- ⑪ Pressure gauge

- ▶ If the tire inflation pressure is at least 20 psi (1.3 bar), inflate or deflate the tire to correct tire inflation pressure (see placard on the driver's door B-pillar):
 - ▶ To increase tire inflation pressure: Switch on the electric air pump.
 - ▶ To decrease tire inflation pressure (**version 1**): Open vent screw ⑩ on pressure gauge ⑪ (▷ page 404).

- ▶ To decrease tire inflation pressure (**version 2**): Press yellow deflate button ⑩ located in air pump housing next to pressure gauge ⑪.

Warning!



Follow recommend inflation pressures.

Do not overinflate tires. Overinflating tires can result in sudden deflation (blowout) because they are more likely to become punctured or damaged by road debris, potholes, etc.

Do not underinflate tires. Underinflated tires wear unevenly, adversely affect handling and fuel economy, and are more likely to fail from being overheated.

Do not overload the tires by exceeding the specified vehicle capacity weight (as indicated by the label on the pillar in the driver's door opening). Overloading the tires can overheat them, possibly causing a blowout.

- ▶ Drive to the nearest qualified workshop, e.g. an authorized Mercedes-Benz Center, to have the damaged tire replaced.

Recommended duration of use:

A maximum of 300 miles (500 km) at 50 mph (80 km/h) or below with the recommended tire inflation pressure.

- ▶ Contact an authorized Mercedes-Benz Center as soon as possible to obtain a new TIREFIT kit.
- ▶ Bring used TIREFIT materials to an authorized Mercedes-Benz Center for proper disposal.
- ▶ Replace your TIREFIT container every 4 years. Replacement containers are available at your authorized Mercedes-Benz Center.

Mounting the spare wheel

Warning!



The dimensions of the spare wheel are different from those of the road wheels. As a result, the vehicle handling characteristics change when driving with a spare wheel with collapsible tire mounted. Adapt your driving style accordingly.

The spare wheel is for temporary use only. When driving with spare wheel mounted, ensure proper tire inflation pressure and do not exceed vehicle speed of 50 mph (80 km/h).

Drive to the nearest Mercedes-Benz Center as soon as possible to have the spare wheel replaced with a regular road wheel.

Never operate the vehicle with more than one spare wheel mounted.

Do not switch off the ESP® when a spare wheel is mounted.

Preparing the vehicle

- ▶ Prepare the vehicle as described (▷ page 401).
- ▶ Take the spare wheel, wheel wrench, wheel bolts, jack, and electric air pump out of the trunk (▷ page 382).

Lifting the vehicle

- ▶ Prevent the vehicle from rolling away by blocking wheels with wheel chocks (not included) or other sizeable objects.

One wheel chock is included with the vehicle tool kit (▷ page 383).

When changing wheel on a level surface:

- ▶ Place one wheel chock or other sizeable object in front of and another wheel chock or other sizeable object behind the wheel that is diagonally opposite to the wheel being changed.

Always try lifting the vehicle using the jack on a level surface. However, should circumstances require you to do so on a hill, place the wheel chock or other sizeable object and the other wheel chock or other sizeable object as follows:

- ▶ Place wheel chocks and other sizeable objects on the downhill side blocking both wheels of the axle not being worked on.

Flat tire

Warning!



The jack is designed exclusively for jacking up the vehicle at the jack take-up brackets built into either side of the vehicle. To help avoid personal injury, use the jack only to lift the vehicle during a wheel change. Never get beneath the vehicle while it is supported by the jack. Keep hands and feet away from the area under the lifted vehicle. Always firmly set parking brake and block wheels before raising vehicle with jack.

Do not disengage parking brake while the vehicle is raised. Be certain that the jack is always vertical (plumb line) when in use, especially on hills. Always try to use the jack on level surface. Be sure the jack arm is fully seated in the jack take-up bracket. Always lower the vehicle onto sufficient capacity jackstands before working under the vehicle.

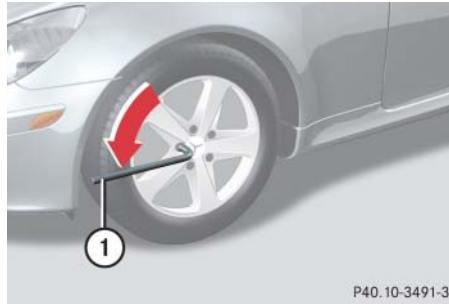

① Wheel wrench

- ▶ On wheel to be changed, loosen but do not yet remove the wheel bolts in direction of arrow (approximately one full turn with wheel wrench ①).

The jack take-up brackets are located directly behind the front wheel housings and in front of the rear wheel housings.

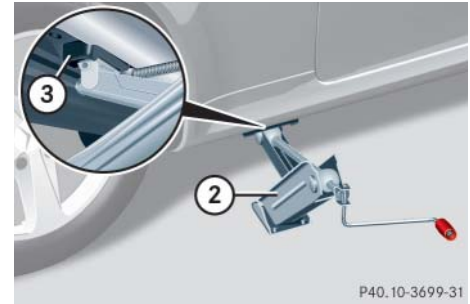

② Jack

③ Take-up bracket

- ▶ Place jack ② on firm ground.
- ▶ Position jack ② under take-up bracket ③ so that it is always vertical (plumb-line) as seen from the side, even if the vehicle is parked on an incline.

Warning!



Position the jack only on the jack take-up brackets designed for this purpose.

If the jack is not properly positioned, the vehicle may fall off of the jack.

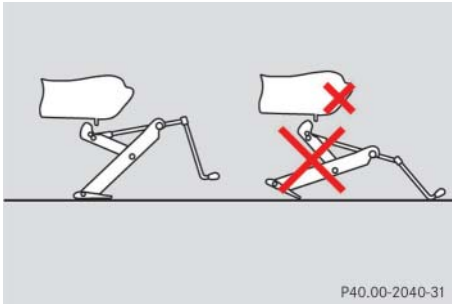

P40.00-2040-31

- ▶ Jack up the vehicle until the wheel is a maximum of 1.2 in (3 cm) from the ground.

Warning!



The jack is intended only for lifting the vehicle briefly for wheel changes. It is not suited for performing maintenance work under the vehicle.

- Never start the engine when the vehicle is raised.
- Never lie down under the raised vehicle.

Removing the wheel



P40.10-3492-31

- ④ Alignment bolt
- ▶ Unscrew the upper-most wheel bolt and remove.
- ▶ Replace this wheel bolt with alignment bolt ④ supplied in the vehicle tool kit (▷ page 382).
- ▶ Remove the remaining bolts.
- ⚠ *Do not place wheel bolts in sand or dirt. This could result in damage to the bolt and wheel hub threads.*
- ▶ Remove the wheel.

Mounting the spare wheel

Warning!



Inflate collapsible tire only after the wheel is properly mounted.

Inflate the collapsible tire using the electric pump (▷ page 411) before lowering the vehicle.

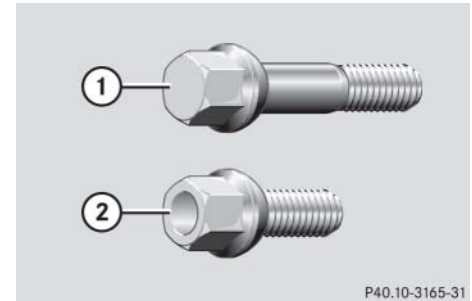

P40.10-3165-31

- ① Wheel bolt for light alloy rims
- ② Wheel bolt for spare wheel with collapsible tire (located under plastic cover on the outside of spare wheel rim)

Flat tire

❗ *Wheel bolts ② must be used when mounting the spare wheel with collapsible tire. The use of any wheel bolts other than wheel bolts ② for the spare wheel with collapsible tire will physically damage the vehicle's brakes.*

- ▶ Clean contact surfaces of wheel and wheel hub.

❗ *To avoid paint damage, place wheel flat against hub and hold it there while installing first wheel bolt.*

Warning!



Always replace wheel bolts that are damaged or rusted.

Never apply oil or grease to wheel bolts.

Damaged wheel hub threads should be repaired immediately. Do not continue to drive under these circumstances! Contact an authorized Mercedes-Benz Center or call Roadside Assistance.

Incorrect wheel bolts or improperly tightened wheel bolts can cause the wheel to come off. This could cause an accident. Be sure to use the correct wheel bolts.



- ▶ Guide the spare wheel onto the alignment bolt and push it on.
- ▶ Insert the wheel bolts and tighten them slightly.

Warning!



Use only genuine Mercedes-Benz wheel bolts. Other wheel bolts may come loose.

Do not tighten the wheel bolts when the vehicle is raised. Otherwise the vehicle could fall off the jack.

- ▶ Unscrew the alignment bolt, install last wheel bolt and tighten slightly.
- ▶ Inflate the collapsible tire (▷ page 411).

Inflating the collapsible tire

Warning!



Observe instructions on air pump label.

! Do not lower the vehicle before inflating the collapsible tire. Otherwise the rim may be damaged.

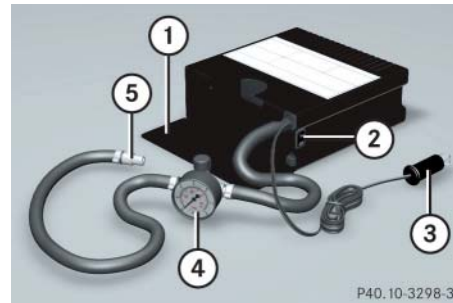

- ① Flap
- ② Air pump switch
- ③ Electrical plug
- ④ Air hose with pressure gauge and vent screw
- ⑤ Union nut

- ▶ Take the electric air pump out of the trunk (▷ page 383).
- ▶ Open flap ① on air pump.
- ▶ Pull out electrical plug ③ and air hose with pressure gauge ④.
- ▶ Close vent screw on air hose ④.
- ▶ Remove the valve cap from the tire valve.
- ▶ Screw union nut ⑤ onto the tire valve.
- ▶ Make sure electric air pump switch ② is set to 0.
- ▶ Insert electrical plug ③ into the power outlet in the passenger footwell (▷ page 257).

! The cigarette lighter (▷ page 256) is not designed for use with the electric air pump. Use the power outlet in the passenger footwell (▷ page 257) for electric air pump operation.

- ▶ Turn the SmartKey in the starter switch to position 1.



Flat tire

- ▷▷ Press **I** on electric air pump switch ②.

The electric air pump switches on and inflates the collapsible tire.

- ▶ Inflate the collapsible tire to approximately 51 psi (3.5 bar).

This takes about 5 minutes. Air hose ④ and union nut ⑤ can become hot during inflation. Exercise proper caution to avoid burning yourself when using the equipment.

! Compare the recommended tire inflation pressure for your vehicle with the tire inflation pressure on the yellow label located on the spare wheel rim.

If the tire inflation pressure on the yellow label on the spare wheel rim differs from the values given in this Operator's Manual, inflate the collapsible tire to the recommended tire inflation pressure given on the yellow label on the spare wheel rim.

! Do not operate the electric air pump longer than 6 minutes without interruption. Otherwise it may overheat.

You may operate the electric air pump again after it has cooled off.

- ▶ Press **0** on electric air pump switch ②.
- ▶ Turn the SmartKey in the starter switch to position **0**.
The electric air pump is switched off.
- ▶ If the tire inflation pressure is above 51 psi (3.5 bar), release excess tire inflation pressure using the vent screw on air hose ④.

Warning!



Follow recommended tire inflation pressures.

Do not underinflate tires. Underinflated tires wear excessively and/or unevenly, adversely affect handling and fuel economy, and are more likely to fail from being overheated.

Do not overinflate tires. Overinflated tires can adversely affect handling and ride comfort, wear unevenly, increase stopping distance, and result in sudden deflation (blowout) because they are more likely to become punctured or damaged by road debris, potholes etc.

- ▶ Detach the electric air pump.
- ▶ Reinstall tire valve cap.
- ▶ Store electrical plug ③ and air hose ④ behind flap ① and place the electric air pump back in the trunk.
- ▶ Lower the vehicle (▷ page 413).

Lowering the vehicle

Warning!



Inflate the collapsible tire using the electric pump (▷ page 411) before lowering the vehicle.

- ▶ Lower vehicle by turning the crank counterclockwise until vehicle is resting fully on its own weight.
- ▶ Remove the jack.

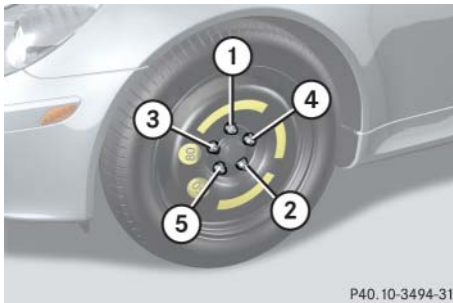

① - ⑤ Wheel bolts

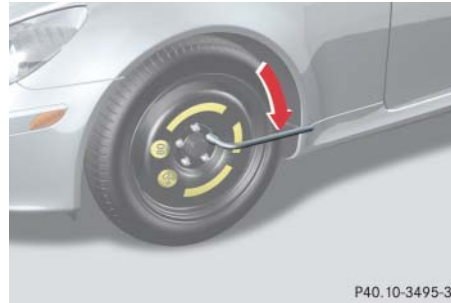

- ▶ Tighten the five wheel bolts evenly in the direction of the arrow, following the diagonal sequence illustrated (① to ⑤), until all bolts are tight. Observe a tightening torque of 80 lb-ft (110 Nm).

Warning!



Have the tightening torque checked after changing a wheel. The wheels could come loose if they are not tightened to a torque of 80 lb-ft (110 Nm).

- ▶ Fully collapse the jack.
- ▶ Place the vehicle tool kit, electric air pump, and the jack back in the storage compartment underneath the trunk floor.
- ▶ Wrap the damaged wheel in the protective sheet provided with the vehicle tool kit and put the wheel in the trunk.

i *The flat tire may be transported in the trunk when the retractable hardtop is closed.*

For information on storing the spare wheel in the trunk after it has been replaced by a regular road wheel, see “Storing the spare wheel with collapsible tire” (▷ page 385).

Flat tire

MOExtended system*

The MOExtended system allows you to continue driving your vehicle even if there is a total loss of pressure in one or more tires.

You may only use the MOExtended system in conjunction with the Run Flat Indicator* (▷ page 315).

! *The maximum distance in emergency mode depends on the vehicle's load. It is 30 miles (50 km) if the vehicle is partially loaded and 18 miles (30 km) if the vehicle is fully loaded.*

The point at which the maximum driving distance begins in emergency mode is when the warning message appears in the multifunction display indicating that there is a loss of tire inflation pressure.

Do not exceed the maximum speed of 50 mph (80 km/h).

Warning!



In emergency mode, your vehicle's driving characteristics are diminished in such situations as:

- driving around curves
- while braking
- while accelerating rapidly

Therefore, your driving style must be adapted accordingly. Avoid abrupt steering and driving maneuvers, as well as driving over obstacles (road curbs, potholes, or off-road areas). This is especially important if the vehicle is heavily loaded.

The emergency driving distance that can be achieved greatly depends on the demands placed on the vehicle. Depending on speed, load, driving maneuvers, road conditions, outside temperature, etc., the distance can be significantly shorter or, if the vehicle is driven cautiously, somewhat longer.

Do not continue driving in emergency mode if

- you notice knocking sounds
- the vehicle starts to shake
- smoke develops and you smell rubber
- ESP® is intervening continuously
- you notice tears on the tire sidewalls

After driving in emergency mode, you must have the rims inspected by an authorized Mercedes-Benz Center to check if they are suitable for further use. The failed tire must be replaced in any case.

i *When replacing individual or all tires on the vehicle, make sure only tires marked with "MOExtended" are mounted in the size specified for your vehicle (▷ page 434).*

▼ Battery

The battery is located in the engine compartment on the right-hand side below the water tray (▷ page 416).



- ① Battery
- ② Positive terminal
- ③ Negative terminal

Warning!



Failure to follow these instructions can result in severe injury or death.

Observe all safety instructions and precautions when handling automotive batteries (▷ page 303).

Never lean over batteries while connecting them, as you could otherwise be injured.

Battery fluid contains sulfuric acid. Do not allow this fluid to come into contact with eyes, skin or clothing. In case it does, immediately flush affected area with water and seek medical help if necessary.

A battery will also produce hydrogen gas, which is flammable and explosive. Keep flames or sparks away from battery, avoid improper connection of jumper cables, smoking, etc.

Warning!



Do not place metal objects on the battery as this could result in a short circuit.

Use leak-proof batteries only to avoid the risk of acid burns in the event of an accident.

! *Never loosen or detach battery terminal clamps while the engine is running or the SmartKey is in the starter switch. Otherwise the alternator and other electronic components could be severely damaged.*

Have the battery checked regularly by an authorized Mercedes-Benz Center.

Refer to Maintenance Booklet for maintenance intervals or contact an authorized Mercedes-Benz Center for further information.

Battery

Disconnecting the battery

Warning!



With a disconnected battery

- you will no longer be able to turn the SmartKey in the starter switch
- automatic transmission*: the gear selector lever will remain locked in position **P**

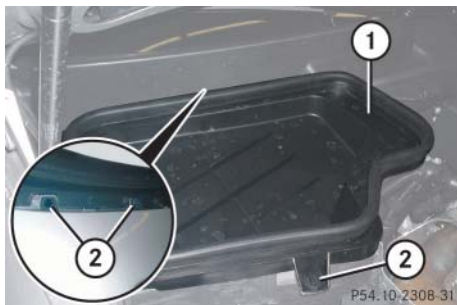

- ① Water tray
- ② Lock

! Always disconnect the battery in the order described below. Otherwise the vehicle's electronics can be damaged.

- ▶ Apply the parking brake (▷ page 59).
- ▶ Make sure the gear selector lever* is set to position **P** (manual transmission to Neutral).
- ▶ Turn off all electrical consumers.
- ▶ Remove the SmartKey from the starter switch.
- ▶ Open the hood (▷ page 294).
- ▶ Turn locks ② one quarter turn.
- ▶ Remove water tray ①.
- ▶ Read and observe safety instructions and precautions (▷ page 303) and (▷ page 415).
- ▶ Use a 10 mm open-end wrench to disconnect the negative lead from battery negative terminal ③ (▷ page 415).
- ▶ Remove the cover from battery positive terminal ② (▷ page 415).
- ▶ Use a 10 mm open-end wrench to disconnect the positive lead from battery positive terminal ② (▷ page 415).

Removing the battery

- ▶ Remove the screw on the swivel bar.
- ▶ Remove the swivel bar.
- ▶ Pull out the battery ventilation hose from the battery (depending on battery arrangement in your vehicle model, the ventilation hose is located either on the left or right side of the battery).
- ▶ Take out the battery.

Charging and reinstalling battery

Warning!



Never charge a battery while still installed in the vehicle unless the accessory battery charge unit approved by Mercedes-Benz is being used. Gases may escape during charging and cause explosions that may result in paint damage, corrosion or personal injury.

An accessory battery charge unit specially adapted for Mercedes-Benz vehicles and tested and approved by Mercedes-Benz is available, permitting the charging of the battery in its installed position. Contact an authorized Mercedes-Benz Center for information and availability. Charge battery in accordance with the separate instructions for the accessory battery charger.

- ▶ Charge battery in accordance with the instructions of the battery charger manufacturer.
- ▶ Reinstall the charged battery. Follow the previously described steps in reverse order.

! *The battery, its filler caps and the ventilation hose must always be securely installed when the vehicle is in operation.*

Battery

Reconnecting the battery

! *Always connect the battery in the order described below. Otherwise the vehicle's electronics can be damaged.*

- ▶ Turn off all electrical consumers.
- ▶ Connect the battery positive lead ② (▷ page 415) and fasten its cover.
- ▶ Connect the battery negative lead ③ (▷ page 415).

! *Never invert the terminal connections!*

- ▶ Reinsert water tray ① (▷ page 416).
- ▶ Push in locks ② (▷ page 416) and turn one quarter turn.

i *The following procedures must be carried out following any interruption of battery power (e.g. due to reconnection):*

- *Set the clock (▷ page 141).*
- *Synchronize the power windows (▷ page 239).*

▼ Jump starting

Warning!



Failure to follow these directions will cause damage to the electronic components, and can lead to a battery explosion and severe injury or death.

Never lean over batteries while connecting or jump starting, as you could otherwise be injured.

Battery fluid contains sulfuric acid. Do not allow this fluid to come in contact with eyes, skin or clothing. In case it does, immediately flush affected area with water, and seek medical help if necessary.

A battery will also produce hydrogen gas, which is flammable and very explosive. Keep flames or sparks away from battery, avoid improper connection of jumper cables, smoking, etc.

Attempting to jump start a frozen battery can result in it exploding, causing personal injury.

Read all instructions before proceeding.

! *Vehicles with automatic transmission*:
Do not tow-start vehicle.*

! *Avoid repeated and lengthy starting attempts.*

Do not attempt to start the engine using a battery quick charge unit.

If the engine does not run after several unsuccessful starting attempts, have it checked at the nearest authorized Mercedes-Benz Center.

Excessive unburned fuel generated by repeated failed starting attempts may damage the catalytic converter and may present a fire risk.

Make sure the jumper cables do not have loose or missing insulation.

Make sure the cable clamps do not touch any other metal part while the other end is still attached to a battery.

If the battery is discharged, the engine can be started with jumper cables and the battery of another vehicle. Observe the following:

- Jump starting should only be performed when the engine and catalytic converter are cold.
- Do not start the engine if the battery is frozen. Let the battery thaw out first.
- Only jump start from batteries with the same voltage rating (12 V). Jump starting with a higher voltage battery could damage the vehicle's electrical system, which will not be covered by the Mercedes-Benz Limited Warranty.
- Only use jumper cables with sufficient cross-section and insulated terminal clamps.
- Always make sure the jumper cables are not on or near pulleys, fans, or other parts that move when an engine is started or running.

Jump starting

Warning!



Keep flames or sparks away from battery.
Do not smoke.

Observe all safety instructions and precautions when handling automotive batteries (▷ page 303).

- ▶ Make sure the two vehicles do not touch.
- ▶ Turn off all electrical consumers.
- ▶ Apply the parking brake (▷ page 59).
- ▶ Make sure the gear selector lever* is set to position **P** (manual transmission to Neutral).
- ▶ Open the hood (▷ page 294).
- ▶ Flip up cover from positive under hood terminal ② in front of water tray ① (▷ page 416).

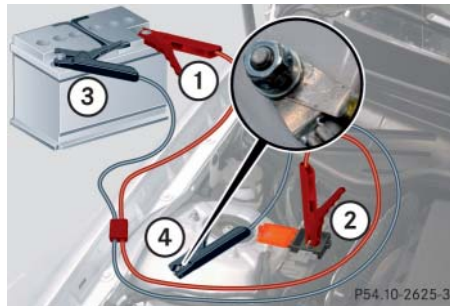

- ① Positive terminal of charged battery
- ② Positive terminal
- ③ Negative terminal of charged battery
- ④ Negative terminal

- ▶ Connect positive terminal ① of the charged battery with positive under-hood terminal ② in front of the water tray with one jumper cable. Clamp the cable to positive terminal ① of the charged battery first.

! *Never invert the terminal connections.*

- ▶ Start the engine of the vehicle with the charged battery and run at idle speed.

- ▶ Connect negative terminal ③ of the charged battery with negative under-hood terminal ④ with the second jumper cable. Clamp the cable to negative terminal ③ of the charged battery first.
- ▶ Start the engine of the disabled vehicle.

You can now turn on the electrical consumers. Do not switch on the headlamps under any circumstances.

- ▶ Remove the jumper cables first from negative terminals ③ and ④ and then from positive terminals ② and ①.

You can now switch on the headlamps.

- ▶ Have the battery checked at the nearest authorized Mercedes-Benz Center.

▼ Towing the vehicle

Mercedes-Benz recommends that the vehicle be transported with all wheels off the ground using flatbed or appropriate wheel lift/dolly equipment.

! *Vehicles with automatic transmission*: Do not tow-start vehicle.*

! *Use flatbed or wheel lift/dolly equipment with the SmartKey in the starter switch in position **0**.*

Do not tow with sling-type equipment. Towing with sling-type equipment over bumpy roads will damage radiator and supports.

To prevent damage during transport, do not tie down vehicle by its chassis or suspension parts. Use the towing eyes.

Switch off the tow-away alarm (▷ page 91) and the automatic central locking (▷ page 102).

When circumstances do not permit the recommended towing methods, the vehicle may be towed with all wheels on the ground or front wheels raised only so far as necessary to have the vehicle moved to a safe location where the recommended towing methods can be employed.

Warning!



If circumstances require towing the vehicle with all wheels on the ground, always tow with a tow bar if:

- the engine will not run
- there is a malfunction in the brake system
- there is a malfunction in the power supply or in the vehicle's electrical system

as that will be necessary to adequately control the towed vehicle.

Prior to towing the vehicle with all wheels on the ground, make sure the SmartKey is in starter switch position **2**.

If the SmartKey is left in starter switch position **0** for an extended period of time, it can no longer be turned in the switch. In this case, the steering is locked. To unlock, remove SmartKey from starter switch and reinsert.

Warning!



With the engine not running, there is no power assistance for the brake and steering systems. In this case, it is important to keep in mind that a considerably higher degree of effort is necessary to brake and steer the vehicle. Adapt your driving accordingly.

! *If the vehicle is towed with the front axle raised, the gear selector lever* must be in position **N** (manual transmission: gear shift lever in neutral position) and the engine must be shut off (SmartKey in starter switch position **0** or **1**). Active braking action through the ESP® may otherwise seriously damage the brake system.*

When towing the vehicle with all wheels on the ground, the gear selector lever must be in position **N** (manual transmission: gear shift lever in neutral position) and the SmartKey must be in starter switch position **2**.*

When towing the vehicle with all wheels on the ground or the front axle raised, the vehicle may be towed only for distances up to 30 miles (50 km) and at a speed not to exceed 30 mph (50 km/h).

Towing the vehicle

! Towing of the vehicle should only be done using the properly installed towing eye bolt. Never attach a tow cable, tow rope or tow rod to the vehicle chassis, frame or suspension parts.

i When towing the vehicle with all wheels on the ground, please note the following:

With the automatic central locking activated and the SmartKey in starter switch position **2**, the vehicle doors lock if the left front wheel as well as the right rear wheel are turning at vehicle speeds of approximately 9 mph (15 km/h) or more.

To prevent the vehicle door locks from locking, deactivate the automatic central locking (▷ page 102).

i To signal turns while being towed with the hazard warning flasher in use, switch on ignition and activate the combination switch for the left or right turn signal in the usual manner – only the selected turn signal will operate.

Upon canceling the turn signal, the hazard warning flasher will operate again.

i The gear selector lever* will remain locked in position **P** (vehicles with automatic transmission*) and the SmartKey will not turn in the starter switch if the battery is disconnected or discharged. For more information, see “Battery” (▷ page 415) or “Jump starting” (▷ page 419).

Vehicles with automatic transmission*:
For information on manual unlocking of gear selector lever, see (▷ page 389).

Installing towing eye bolt

The towing eye bolt is supplied with the vehicle tool kit, located in the compartment underneath the trunk floor (▷ page 382).

The towing eyes are located on the passenger side in the front and rear bumper.

- ▶ Take vehicle tool kit out of trunk (▷ page 382).

Front cover

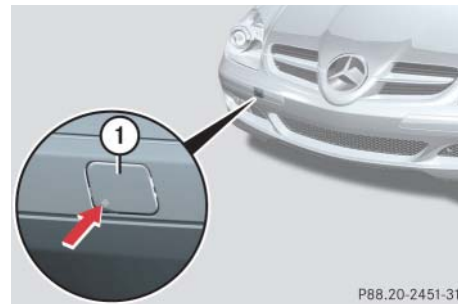

- ① Cover in front bumper

Removing

- ▶ Press mark on cover ①.
- ▶ Cover ① springs open at the top right corner.
- ▶ Pull at the protruding part of cover ① and fold cover down to reveal the threaded hole for the towing eye bolt.
Do not disconnect cover ① from its check strap.
- ▶ Screw towing eye bolt in to its end stop and tighten with lug wrench.

Installing

- ▶ Unscrew the towing eye bolt using the lug wrench.
- ▶ To reinstall cover ①, tilt the marked lower left corner towards the opening.
- ▶ Maintaining its tilted position, insert cover ① by applying the latches at the top left and lower right corner into the opening.
- ▶ To close cover ①, press on the diagonal opposite side of the marked corner until it fully engages.

i Make sure the cover's check strap does not get caught when closing.

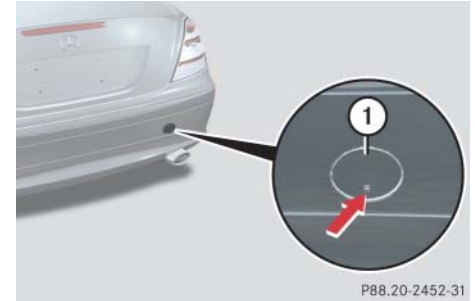
Rear cover

Example illustration (AMG vehicles and vehicles with Sport Package* have a square cover)

① Cover in rear bumper

Towing the vehicle

Removing

- ▶ Press mark on cover ①.
- ▶ Cover ① springs open at the top.
- ▶ Pull at the protruding part of cover ① and fold cover down to reveal the threaded hole for the towing eye bolt.

Do not disconnect cover ① from its check strap.

- ▶ Screw towing eye bolt in to its end stop and tighten with lug wrench.

Installing

- ▶ Unscrew the towing eye bolt using the lug wrench.
- ▶ To reinstall cover ①, tilt the marked lower edge towards the opening.
- ▶ Maintaining its tilted position, insert cover ① by applying the latches at the marked lower edge into the opening.
- ▶ To close cover ①, press on the unmarked top until it fully engages.

i *Make sure the cover's check strap does not get caught when closing.*

▼ Fuses

The electrical fuses in your vehicle serve to switch off malfunctioning power circuits.

If a fuse is blown, the components and systems secured by that fuse will stop operating.

Warning!



Only use fuses approved by Mercedes-Benz with the specified amperage for the system in question and do not attempt to repair or bridge a blown fuse. Using other than approved fuses or using repaired or bridged fuses may cause an overload leading to a fire, and/or cause damage to electrical components and/or systems. Have the cause determined and remedied by an authorized Mercedes-Benz Center.

i A blown fuse must be replaced by an appropriate spare fuse (recognizable by its color or the fuse rating given on the fuse) of the amperage recommended in the fuse chart. Any Mercedes-Benz Center will be glad to advise you on this subject.

If a newly inserted fuse blows again, have the cause determined and rectified by an authorized Mercedes-Benz Center.

The following aids are available to help you replace fuses. The spare fuses and the fuse extractor are located in the trunk with the vehicle tool kit (▷ page 382) and the fuse chart is located in the fuse box in the passenger compartment (▷ page 425).

- Fuse chart
The fuse chart explains the fuse allocation and fuse amperages.
- Spare fuses
- Fuse extractor

The electrical fuses are located in different fuse boxes:

- in the passenger compartment on the driver's side (▷ page 425)
- on the driver's side of the engine compartment (▷ page 426)

Before replacing fuses:

- ▶ Apply the parking brake (▷ page 59).
- ▶ Make sure the gear selector lever* is set to position **P** (▷ page 157) (manual transmission to Neutral).
- ▶ Turn off all electrical consumers.
- ▶ Turn off the engine (▷ page 61).
- ▶ Remove the SmartKey from the starter switch.

Fuse box in passenger compartment



① Fuse box cover

Fuses

! Do not use sharp objects such as a screw driver to open fuse box cover ① in the dashboard, as this could damage it.

Opening

- ▶ Open the driver's door.
- ▶ Insert flat, blunt object as a lever into recess on the edge of cover ① at the position indicated by the arrow.
- ▶ Loosen cover ① from dashboard using the lever.
- ▶ Pull cover ① out and remove.

Closing

- ▶ Attach cover ① in the front.
- ▶ Fold cover ① in until it engages.

Fuse box in engine compartment

The fuse box is located in the engine compartment on the driver's side.

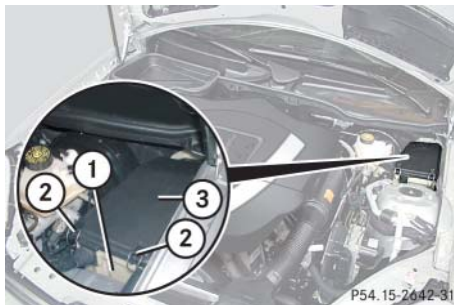

- ① Fuse box
- ② Clamp
- ③ Fuse box cover

Opening

- ▶ Open the hood (▷ page 294).
- ▶ With a dry cloth, remove any moisture from the fuse box.
- ▶ Release clamps ②.
- ▶ Remove fuse box cover ③.

Closing

- ▶ Make sure the sealing rubber is properly positioned.
- ▶ Press fuse box cover ③ down and secure with clamps ②.

! Fuse box cover ③ must be properly positioned as described to prevent moisture or dirt from entering the fuse box and possibly impairing fuse operation.



Parts service

Warranty coverage

Identification labels

Layout of poly-V-belt drive

Engine

Rims and tires

Electrical system

Main Dimensions

Weights

Fuels, coolants, lubricants, etc.

The “Technical data” section provides the necessary technical data for your vehicle.

All authorized Mercedes-Benz Centers maintain a stock of Genuine Mercedes-Benz Parts required for maintenance and repair work. In addition, strategically located parts distribution centers provide quick and reliable parts service.

More than 300 000 different parts for Mercedes-Benz models are available.

Genuine Mercedes-Benz Parts are subjected to stringent quality inspections. Each part has been specifically developed, manufactured or selected for and adapted to Mercedes-Benz vehicles.

Therefore, Genuine Mercedes-Benz Parts should be installed.

! *The use of non-genuine Mercedes-Benz parts and accessories not authorized by Mercedes-Benz could damage the vehicle, which is not covered by the Mercedes-Benz Limited Warranty, or could compromise the vehicle's durability or safety.*

▼ Warranty coverage

Your vehicle is covered under the terms of the warranties printed in the Service and Warranty Information booklet. Your authorized Mercedes-Benz Center will exchange or repair any defective parts originally installed in the vehicle in accordance with the terms of the following warranties:

- New Vehicle Limited Warranty
- Emission System Warranty
- Emission Performance Warranty
- California, Maine, Massachusetts, and Vermont Emission Control Systems Warranty

Replacement parts and accessories are covered by the Mercedes-Benz Parts and Accessories warranties, copies of which are available at any authorized Mercedes-Benz Center.

Loss of Service and Warranty Information Booklet

Should you lose your Service and Warranty Information booklet, have an authorized Mercedes-Benz Center arrange for a replacement. It will be mailed to you.

Identification labels



① Certification label (on driver's door B-pillar)

The VehicIde Identification Number (VIN) can be found in the following locations:

- on the certification label
- on the center tunnel, under a carpet cover behind the passenger seat (▷ page 431)
- on the lower edge of the windshield (▷ page 431)

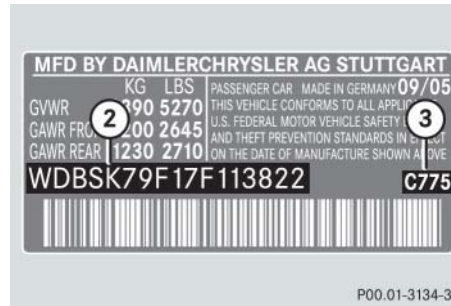

Example certification label (U.S. vehicles)

- ② VIN
- ③ Paintwork code



Example certification label (Canada vehicles)

- ② VIN
- ③ Paintwork code

i Data shown on certification label are for illustration purposes only. These data are specific to each vehicle and may vary from data shown in the illustration. Refer to certification label on vehicle for actual data specific to your vehicle.



④ VIN

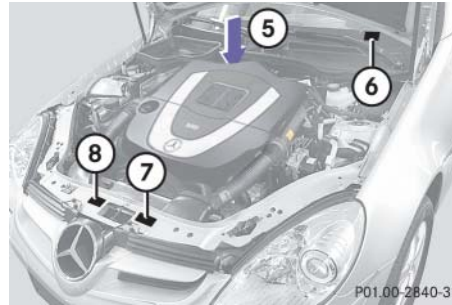

- ⑤ Engine number (engraved on engine)
- ⑥ VIN (lower edge of windshield)
- ⑦ Vacuum line routing diagram label
- ⑧ Emission control information label, includes both federal and California certification exhaust emission standards

i When ordering parts, please specify vehicle identification and engine numbers.

Layout of poly-V-belt drive

SLK 280, SLK 350

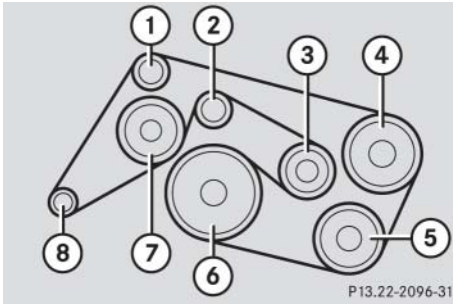

P13.22-2096-31

- ① Idler pulley
- ② Idler pulley
- ③ Automatic belt tensioner
- ④ Power steering pump
- ⑤ Air conditioning compressor
- ⑥ Crankshaft
- ⑦ Coolant pump
- ⑧ Generator (alternator)

SLK 55 AMG

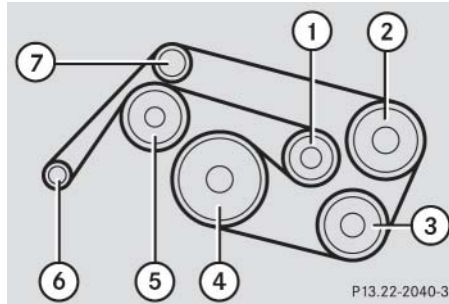

P13.22-2040-31

- ① Automatic belt tensioner
- ② Power steering pump
- ③ Air conditioning compressor
- ④ Crankshaft
- ⑤ Coolant pump
- ⑥ Generator (alternator)
- ⑦ Idler pulley

▼ Engine

Model	SLK 280 (171.454) ¹	SLK 350 (171.456) ¹	SLK 55 AMG (171.473) ¹
Engine	272	272	113
Mode of operation	4-stroke engine, gasoline injection	4-stroke engine, gasoline injection	4-stroke engine, gasoline injection
No. of cylinders	6	6	8
Bore	3.47 in (88.00 mm)	3.66 in (92.90 mm)	3.82 in (97.00 mm)
Stroke	3.23 in (82.20 mm)	3.39 in (86.00 mm)	3.60 in (92.00 mm)
Total piston displacement	182.8 cu in (2996 cm ³)	213.5 cu in (3498 cm ³)	331.8 cu in (5439 cm ³)
Compression ratio	11.3:1	10.7:1	11:1
Output according to SAE J 1349	228 hp/6 100 rpm ² (170 kW/6 100 rpm)	268 hp/6 000 rpm ² (200 kW/6 000 rpm)	355 hp/5 750 rpm ² (265 kW/5 750 rpm)
Maximum torque according to SAE J 1349	221 lb-ft/2 500 - 5 000 rpm (300 Nm/2 500 - 5 000 rpm)	258 lb-ft/2 400 - 5 000 rpm (350 Nm/2 400 - 5 000 rpm)	376 lb-ft/4 000 rpm (510 Nm/4 000 rpm)
Maximum engine speed	6 500 rpm	6 500 rpm	6 700 rpm
Firing order	1-4-3-6-2-5	1-4-3-6-2-5	1-5-4-2-6-3-7-8
Poly-V-belt	2 404 mm	2 404 mm	2 380 mm

¹ The quoted data apply only to the standard vehicle. Contact an authorized Mercedes-Benz Center for the corresponding data of all special bodies and special equipment.

² Premium fuel required. Performance may vary with fuel octane rating.

Rims and tires

! Only use tires which have been tested and approved by Mercedes-Benz. Tires approved by Mercedes-Benz are developed to provide best possible performance in conjunction with the driving safety systems on your vehicle such as ABS or ESP®. Tires specially developed for your vehicle and tested and approved by Mercedes-Benz can be identified by finding the following on the tire's sidewall:

- MO = Mercedes-Benz Original equipment tires

AMG vehicles:

Does not apply to all approved tires on AMG vehicles. For information on tested and approved tires for AMG vehicles, contact an authorized Mercedes-Benz Center.

- MOE = Mercedes-Benz Original Extended (tires with limited run-flat characteristics) original equipment tires

Using tires other than those approved by Mercedes-Benz may result in damage that is not covered by the Mercedes-Benz Limited Warranty.

i For information on driving with MOExtended tires, see "MOExtended system*" (▷ page 414).

! Using tires other than those approved by Mercedes-Benz can have detrimental effects, such as

- poor handling characteristics
- increased noise
- increased fuel consumption

Moreover, tires and rims not approved by Mercedes-Benz may, under load, exhibit dimensional variations and different tire deformation characteristics that could cause them to come into contact with the vehicle body or axle parts. Damage to the tires or the vehicle may be the result.



i Further information on tires and rims is available at any authorized Mercedes-Benz Center. A placard with the recommended tire inflation pressures is located on the driver's door B-pillar. Some vehicles may have supplemental tire inflation pressure information for driving at high speeds (▷ page 313) or for vehicle loads less than the maximum loaded vehicle condition (▷ page 313). If such information is provided, it can be found on the placard located on the inside of the fuel filler flap.

The tire inflation pressure should be checked regularly and should only be adjusted on cold tires. Follow tire manufacturer's maintenance recommendation included with vehicle.

i The following pages also list the approved wheel rim and tire sizes for equipping your vehicles with winter tires. Winter tires are not available as standard or optional factory equipment, but can be purchased from an authorized Mercedes-Benz Center.

Depending on vehicle model and the standard or optional factory-equipped wheel rim/tire configuration on your vehicle (Performance Package, Sport Package etc.), equipping your vehicle with winter tires approved for your vehicle model may also require the purchase of two or four wheel rims of the recommended size for use with these winter tires. Contact an authorized Mercedes-Benz Center for more information.

Same size tires

Model	SLK 280	SLK 280 SLK 280 (Appearance Package*) SLK 350 SLK 350 (Appearance Package*)
Rims (light alloy)	7 J x 16 H2	7.5 J x 17 H2
Wheel offset	1.34 in (34 mm)	1.42 in (36 mm)
Winter tires ^{1,2}	205/55 R16 91H M+S 	225/45 R17 91H M+S 
Rims (light alloy)	-	7.5 J x 17 H2
Wheel offset	-	1.42 in (36 mm)
Winter tires* ^{1,2,3}	-	225/45 R17 91H M+S  MOExtended

¹ Radial-ply tires

² Not available as factory equipment.

³ Must be used in conjunction with Run Flat Indicator* only.

Rims and tires

Model	SLK 280 (Sport Package*) SLK 350 (Sport Package*) SLK 55 AMG	SLK 55 AMG SLK 55 AMG (Performance Package*)
Rims (light alloy)	7.5 J x 17 H2	7.5 J x 18 H2
Wheel offset	1.46 in (37 mm)	1.46 in (37 mm)
Winter tires ^{1,2,3}	205/50 R17 89H M+S  or 225/45 R17 91H M+S 	225/40 R18 92H XL (Extra Load) M+S 

¹ Radial-ply tires

² Not available as factory equipment.

³ For use with snow chains contact an authorized Mercedes-Benz Center.

Mixed size tires

Model	SLK 280	SLK 280* SLK 280 (Appearance Package*) SLK 350 SLK 350 (Appearance Package*)
--------------	----------------	---

Front axle:

Rims (light alloy)	7 J x 16 H2	7.5 J x 17 H2
Wheel offset	1.34 in (34 mm)	1.42 in (36 mm)
Summer tires¹	205/55 R16 91V	225/45 R17 91W or 225/45 R17 91W MO <i>Extended*</i> ²

Rear axle:

Rims (light alloy)	8 J x 16 H2	8.5 J x 17 H2
Wheel offset	1.18 in (30 mm)	1.18 in (30 mm)
Summer tires^{1,3}	225/50 R16 92V	245/40 R17 91W or 245/40 R17 91W MO <i>Extended*</i> ²

¹ Radial-ply tires

² Must be used in conjunction with Run Flat Indicator* only.

³ Must not be used with snow chains.

Rims and tires

Model	SLK 280 (Sport Package*) SLK 350 (Sport Package*)	SLK 55 AMG SLK 55 AMG (Performance Package*)
Front axle:		
AMG rims (light alloy)	7.5 J x 17 H2	7.5 J x 18 H2
Wheel offset	1.46 in (37 mm)	1.46 in (37 mm)
Summer tires^{1,3}	225/45 ZR17 91Y or 225/45 R17 91W MO <i>Extended*</i> ²	225/40 ZR18 92Y XL (Extra Load)
Rear axle:		
AMG rims (light alloy)	8.5 J x17 H2	8.5 J x18 H2
Wheel offset	1.18 in (30 mm)	1.18 in (30 mm)
Summer tires^{1,3}	245/40 ZR17 91Y or 245/40 R17 91W MO <i>Extended*</i> ²	245/35 ZR18 92Y XL (Extra Load)

¹ Radial-ply tires

² Must be used in conjunction with Run Flat Indicator* only.

³ Must not be used with snow chains.

Spare wheel with collapsible tire

Model	All models (except SLK 55 AMG with Performance Package*)
Rim (light alloy)	4.5 B x 17 H2
Wheel offset	0.47 in (12 mm)
Collapsible tire	145/70-17 92P ¹

¹ Must not be used with snow chains.

! Please compare the recommended tire inflation pressure for your vehicle with the tire inflation pressure on the yellow label located on the spare wheel rim.

If the tire inflation pressure on the yellow label on the spare wheel rim differs from the values given in this Operator's Manual, inflate the collapsible tire to the recommended tire inflation pressure given on the yellow label on the spare wheel rim.

i Please note that the tire inflation pressure of the collapsible tire differs from the tire inflation pressure of the road tires.

Inflate the collapsible tire to approximately 51 psi (3.5 bar).

i The SLK 55 AMG with Performance Package* does not have a spare wheel. The SLK 55 AMG with Performance Package* is equipped with TIREFIT (▷ page 401).

Electrical system

Model	SLK 280	SLK 350	SLK 55 AMG
Generator (alternator)	14 V/150 A	14 V/150 A	14 V/150 A
Starter motor	12 V/1.4 kW	12 V/1.4 kW	12 V/1.7 kW
Battery	12 V/74 Ah	12 V/74 Ah	12 V/74 Ah
Spark plugs	NGK PLKR 6A	Bosch Platin Y 7 MPP33 NGK PLKR 6A	NGK IFR6D10
Electrode gap	0.031 in (0.8 mm)	0.031 in (0.8 mm)	0.039 in (1.0 mm)
Tightening torque	15 – 22 lb-ft (20 – 30 Nm)	15 – 22 lb-ft (20 – 30 Nm)	18 – 22 lb-ft (25 – 30 Nm)

▼ Main Dimensions

Model	SLK 280	SLK 350	SLK 55 AMG
Overall vehicle length	161.0 in (4089 mm)	161.0 in (4089 mm)	161.1 in (4093 mm)
Overall vehicle width	77.5 in (1969 mm)	77.5 in (1969 mm)	77.5 in (1969 mm)
Overall vehicle height	51.0 in (1296 mm)	51.1 in (1298 mm)	50.6 in (1286 mm)
Overall vehicle height when opening/closing hardtop	60.8 in (1544 mm)	60.8 in (1544 mm)	60.4 in (1534 mm)
Wheelbase	95.7 in (2430 mm)	95.7 in (2430 mm)	95.7 in (2430 mm)
Track, front	60.2 in (1530 mm)	60.1 in (1526 mm)	60.0 in (1524 mm)
Track, rear	61.0 in (1549 mm)	61.0 in (1549 mm)	61.0 in (1549 mm)
Turning circle	34.5 ft (10.51 m)	34.5 ft (10.51 m)	34.5 ft (10.51 m)

Weights

Model	SLK 280 SLK 350	SLK 55 AMG
Maximum roof load	110 lb (50 kg)	110 lb (50 kg)
Maximum trunk load	220 lb (100 kg)	220 lb (100 kg)

! *This vehicle is not designed to carry items on its roof. Roof rails and any roof-mounted devices, unless expressly approved by Mercedes-Benz for use on this vehicle model, must not be used as they will damage the vehicle and retractable hardtop.*

At time of printing, Mercedes-Benz does not offer any roof racks or any other roof-mounted devices for use on this vehicle.

! *This vehicle is not designed to carry any items on its trunk lid or accommodate any type of trunk lid rack or device. Using such devices may damage the vehicle and retractable hardtop mechanism.*

Fuels, coolants, lubricants, etc.

▼ **Fuels, coolants, lubricants, etc.**

Capacities

Vehicle components and their respective lubricants must match. Therefore, only use products tested and approved by Mercedes-Benz.

Please refer to the Factory Approved Service Products pamphlet (USA only), or inquire at an authorized Mercedes-Benz Center.

Warning!



Comply with all valid regulations with respect to handling, storing and disposing of service fluids. Otherwise you could endanger persons or the environment.

Keep service fluids out of the reach of children.

For health reasons, you should prevent service fluids from coming into direct contact with you skin or clothing.

If a service fluid is swallowed, contact a physician immediately.

	Model	Capacity	Fuels, coolants, lubricants etc.
Engine with oil filter	All models	8.5 US qt (8.0 l)	Approved engine oils
Automatic transmission*	SLK 280, SLK 350	9.5 US qt (9.0 l)	MB Automatic Transmission Fluid
	SLK 55 AMG	9.2 US qt (8.7 l)	
Manual transmission	SLK 280, SLK 350	1.6 US qt (1.5 l)	MB Manual Transmission Oil
Rear axle	SLK 280	1.1 US qt (1.0 l)	Hypoid gear oil SAE 85 W 90
	SLK 350	1.2 US qt (1.1 l)	
	SLK 55 AMG	1.3 US qt (1.2 l)	

Fuels, coolants, lubricants, etc.

	Model	Capacity	Fuels, coolants, lubricants etc.
Power steering	All models	1.1 US qt (1.0 l)	MB Power Steering Fluid (Pentosin CHF 11S or, depending on vehicle production date, Chevron Texaco PSF 9109) ¹
Front wheel hubs	All models	approx. 2.1 oz (60 g) each	High temperature roller bearing grease
Brake system	All models	0.5 US qt (0.5 l)	MB Brake Fluid (DOT 4+)
Cooling system	SLK 280	approx. 10.4 US qt (9.8 l)	MB 325.0 Anticorrosion/Antifreeze Agent
	SLK 350	approx. 10.4 US qt (9.8 l)	
	SLK 55 AMG	approx. 11.7 US qt (11.1 l)	
Fuel tank including a reserve of	All models	approx. 18.5 US gal (70.0 l)	Premium unleaded gasoline: Minimum posted Octane 91 (average of 96 RON/86 MON)
	SLK 280, SLK 350	approx. 2.4 US gal (9.0 l)	
	SLK 55 AMG	approx. 2.6 US gal (10.0 l)	
Air conditioning system	All models		R-134a refrigerant and special PAG lubricant oil (never R-12)
Hydraulic system for retractable hardtop	All models	0.19 US qt (0.18 l)	MB Hydraulic Fluid
Windshield washer system and headlamp cleaning system*	All models	7.4 US qt (7.0 l)	MB Windshield washer concentrate ²

¹ For detailed information, please refer to the Factory Approved Service Products pamphlet (USA only) or contact an authorized Mercedes-Benz Center.

² Use MB Windshield Washer Concentrate "MB SummerFit" and water for temperatures above freezing point or MB Windshield Washer Concentrate "MB SummerFit" and commercially available premixed windshield washer solvent/antifreeze for temperatures below freezing point. Follow suggested mixing ratios (> page 450).

Engine oils

Engine oils are specifically tested for their suitability in our engines and durability for our service intervals. Therefore, only use approved engine oils and oil filters required for vehicles with Maintenance System. For a listing of approved engine oils and oil filters, refer to the Factory Approved Service Products pamphlet (USA only), or contact an authorized Mercedes-Benz Center.

! *Using engine oils and oil filters of specification other than those expressly required for the Maintenance System, or changing of oil and oil filter at change intervals longer than those called for by the Maintenance System will result in engine or emission control system damage not covered by the Mercedes-Benz Limited Warranty.*

Please follow Maintenance System recommendations for scheduled oil changes. Failure to do so will result in engine or emission control system damage not covered by the Mercedes-Benz Limited Warranty.

Engine oil additives

! *Do not blend oil additives with engine oil. They may damage the engine. Damage or malfunctions resulting from blending oil additives are not covered by the Mercedes-Benz Limited Warranty.*

Air conditioning refrigerant

R-134a (HFC) refrigerant and special PAG lubricating oil are used in the air conditioning system.

! *Never use R-12 (CFC) or mineral-based lubricating oil, otherwise damage to the system will occur.*

Fuels, coolants, lubricants, etc.

Brake fluid

Warning!



During vehicle operation, the boiling point of the brake fluid is continuously reduced through the absorption of moisture from the atmosphere. Under extremely strenuous operating conditions, this moisture content can lead to the formation of bubbles in the system, thus reducing the system's efficiency.

Therefore, the brake fluid must be replaced regularly. Refer to your vehicle's Maintenance Booklet for replacement interval.

Only brake fluid approved by Mercedes-Benz is recommended. Any authorized Mercedes-Benz Center will provide you with additional information.

Premium unleaded gasoline

Warning!



Gasoline is highly flammable and poisonous. It burns violently and can cause serious personal injury.

Never allow sparks, flame or smoking materials near gasoline!

Turn off the engine before refueling.

Whenever you are around gasoline, avoid inhaling fumes and skin contact, extinguish all smoking materials.

Direct skin contact with fuels and the inhalation of fuel vapors are damaging to your health.

! To maintain the engine's durability and performance, premium unleaded gasoline must be used. If premium unleaded gasoline is not available and low octane fuel is used, follow these precautions:

- Have the fuel tank only partially filled with unleaded regular gasoline and fill up with premium unleaded gasoline as soon as possible.
- Avoid full throttle driving and abrupt acceleration.
- Do not exceed an engine speed of 3000 rpm if the vehicle is loaded with a light load such as two persons and no luggage.
- Do not exceed $\frac{2}{3}$ of maximum accelerator pedal position if the vehicle is fully loaded or operating in mountainous terrain.

Fuel requirements

Only use premium unleaded fuel:

- The octane number (posted at the pump) must be 91 min. It is an average of both the Research Octane Number (RON) and the Motor Octane Number (MON): $(RON+MON)/2$. This is also known as the ANTI-KNOCK INDEX.

Unleaded gasoline containing oxygenates such as ethanol, IPA, IBA, and TBA can be used provided the ratio of any one of these oxygenates to gasoline does not exceed 10%; MTBE not to exceed 15%.

The ratio of methanol to gasoline must not exceed 3% plus additional cosolvents.

Using mixtures of ethanol and methanol is not allowed. Gasohol, which contains 10% ethanol and 90% unleaded gasoline, can be used.

These blends must also meet all other fuel requirements, such as resistance to spark knock, boiling range, vapor pressure, etc.

Gasoline additives

A major concern among engine manufacturers is carbon build-up caused by gasoline. Mercedes-Benz only recommends only the use of quality gasoline containing additives that prevent the build-up of carbon deposits.

After an extended period of using fuels without such additives, carbon deposits can build up, especially on the intake valves and in the combustion area, leading to engine performance problems such as:

- Warm-up hesitation
- Unstable idle
- Knocking/pinging
- Misfire
- Power loss

In areas where carbon deposits may be encountered due to lack of availability of gasolines which contain these additives, Mercedes-Benz recommends the use of additives approved by us for use on Mercedes-Benz vehicles. Refer to Factory Approved Service Products pamphlet (USA only) or contact an authorized Mercedes-Benz Center for a listing of approved product(s). Follow directions on product label.

Do not blend other fuel additives with fuel. This only results in unnecessary costs and may be harmful to engine operation.

! *Damage or malfunction resulting from poor fuel quality or from blending additional fuel additives other than those tested and approved by us for use on Mercedes-Benz vehicles are not covered by the Mercedes-Benz Limited Warranty.*

Fuels, coolants, lubricants, etc.

Coolants

The engine coolant is a mixture of water and anticorrosion/antifreeze, which provides:

- Corrosion protection
- Freeze protection
- Boiling protection (by increasing the boiling point)

The cooling system was filled at the factory with a coolant providing freeze protection to approximately -35°F (-37°C) and corrosion protection.

! *Add premixed coolant solution only. Adding water and MB 325.0 Anticorrosion/Antifreeze separately from each other, could cause engine damage not covered by the Mercedes-Benz Limited Warranty.*

If the antifreeze mixture is effective to -35°F (-37°C), the boiling point of the coolant in the pressurized cooling system is reached at approximately 266°F (130°C).

The coolant solution must be used year round to provide the necessary corrosion protection and increase boil-over protection. Refer to Maintenance Booklet for replacement interval.

Coolant system design and coolant used determine the replacement interval. The replacement interval published in the Maintenance Booklet is only applicable if MB 325.0 Anticorrosion/Antifreeze solution or other Mercedes-Benz approved products of equal specification are used to renew the coolant concentration or bring it back up to the proper level.

For information on other Mercedes-Benz approved products of equal specification, refer to the Factory Approved Service Products pamphlet (USA only) or contact an authorized Mercedes-Benz Center.

To provide important corrosion protection, the solution must be at least 50% anticorrosion/antifreeze (equivalent to freeze protection to approximately -35°F [-37°C]). If you use a solution that is more than 55% anticorrosion/antifreeze (freeze protection to approximately -49°F [-45°C]), the engine temperature will increase due to the lower heat transfer capability of the solution. Therefore, do not use more than this amount of anticorrosion/antifreeze.

If the coolant level is low, water and MB 325.0 Anticorrosion/Antifreeze should be used to bring it up to the proper level (have cooling system checked for signs of leakage). Please make sure the mixture is in accordance with label instructions.

The water in the cooling system must meet minimum requirements, which are usually satisfied by normal drinking water. If you are not sure about the water quality, contact an authorized Mercedes-Benz Center.

Fuels, coolants, lubricants, etc.

Anticorrosion/antifreeze

Your vehicle contains a number of aluminum parts. The use of aluminum components in motor vehicle engines necessitates that anticorrosion/antifreeze coolant used in such engines be specifically formulated to protect the

aluminum parts. Failure to use such anti-corrosion/antifreeze coolant will result in a significantly shortened service life.

Therefore, the following product is strongly recommended for use in your vehicle:
 MB 325.0 Anticorrosion/Antifreeze agent.

Before the start of the winter season (or once a year in hot southern regions), you should have the anticorrosion/antifreeze concentration checked. The coolant is also regularly checked each time you bring your vehicle to an authorized Mercedes-Benz Center for service.

Anticorrosion/antifreeze quantity

Model	Approximate freeze protection	
	-35°F (-37°C)	-49°F (-45°C)
SLK 280, SLK 350	5.4 US qt (5.1 l)	6.0 US qt (5.6 l)
SLK 55 AMG	5.9 US qt (5.5 l)	6.4 US qt (6.1 l)

Fuels, coolants, lubricants, etc.

Windshield washer system and headlamp cleaning system*

Both the windshield washer system and headlamp cleaning system* are supplied from the windshield washer reservoir.

The windshield washer reservoir has a capacity of approximately 7.4 US qt (7.0 l).

- ▶ Refill the reservoir with MB Windshield Washer Concentrate “MB SummerFit” and water (or concentrate and commercially available premixed windshield washer solvent/antifreeze, depending on ambient temperatures).

Warning!



Washer solvent/antifreeze is highly flammable. Do not spill washer solvent/antifreeze on hot engine parts because it may ignite and burn. You could be seriously burned.

Windshield and headlamp washer fluid mixing ratio

For temperatures above freezing point, use MB Windshield Washer Concentrate “MB SummerFit” and water:

- 1 part “MB SummerFit” to 100 parts water
(1.34 fl oz [40 ml] “MB SummerFit” to 1 gal [4.0 l] water)

For temperatures below freezing point, use MB Windshield Washer Concentrate “MB SummerFit” and commercially available premixed windshield washer solvent/antifreeze:

- 1 part “MB SummerFit” to 100 parts solvent
(1.34 fl oz [40 ml] “MB SummerFit” to 1 gal [4.0 l] solvent)

- A**
- ABS 84
 - Indicator lamp 346, 347
 - Messages in the multifunction display 358
 - Accelerator position, automatic transmission 159
 - Accessory weight 327
 - Accident 58
 - Air bags 66
 - Children in the vehicle 79
 - Front 69
 - Head-thorax 70
 - Knee bag 70
 - Occupant Classification System (OCS) 71
 - Passenger 69
 - Passenger front air bag off indicator lamp 74
 - Safety guidelines 68
 - Air conditioning
 - Automatic climate control* 191
 - Climate control 180
 - Air conditioning refrigerant 445
 - Air pressure see Tire inflation pressure
 - AIRSCARF neck level heating* 105
 - Alarm system see Anti-theft systems
 - Alignment bolt
 - (Vehicle tool kit) 382, 409
 - Anticorrosion/antifreeze 449
 - Antilock Brake System see ABS
 - Anti-theft systems 90
 - Alarm system 90
 - Immobilizer 90
 - Tow-away alarm 91
 - Ashtray 32, 255
 - Aspect ratio 327
 - Audio search function 146
 - Air conditioning
 - Automatic climate control* 193
 - Audio and telephone*, operation 193
 - CD changer* 212
 - CD operation 208
 - Introduction to satellite radio* (USA only) 203
 - MP3 210
 - Operating and display elements 194
 - Auto-dimming*, Rear view mirrors 169
 - Automatic central locking 102
 - Control system 146
 - Automatic climate control* 182
 - Air conditioning refrigerant 444
 - Air conditioning, Cooling 191
 - Air recirculation mode 189
 - Air vents 182, 187
 - Air volume 188
 - Automatic mode 186
 - Control panel 184

- Deactivating 185
 - Defrosting 170, 188
 - Residual heat utilization 192
 - Sun sensor 25
 - Temperature 186
 - Automatic shift program 161
 - Automatic transmission*
 - Accelerator position 159
 - Automatic shift program 161
 - Automatic transmission fluid (ATF) 300
 - Driving 53
 - Emergency operation (limp-home mode) 167
 - Fluid level 300
 - Gear ranges 160
 - Gear selector lever 155
 - Gear selector lever (Unlocking manually) 389
 - Gear selector lever control one-touch gearshifting 162
 - Gear selector lever positions 157
 - Gear shifting malfunctions 167
 - Gearshift pattern 52
 - Kickdown 159
 - Kickdown, manual shift program* 167
 - Manual shift program* 165
 - Program mode selector switch 161
 - Shifting procedure 156
 - Steering wheel gearshift control one-touch gearshifting* 163
- B**
- Backup lamp
 - Messages in the multifunction display 377
 - Replacing bulbs 395
 - Bar 328
 - BAS 86
 - Batteries (SmartKey)
 - Replacing 391
 - Battery (Vehicle) 303, 415
 - Charging 417
 - Jump starting 419
 - Messages in the multifunction display 366
 - Bead 328
 - Bi-Xenon headlamps* 394
 - Brake Assist System see BAS
 - Brakes 280
 - Brake fluid 292, 446
 - Messages in the multifunction display 367
 - SLK 55 AMG 281
 - Warning lamp 348
 - Break-in period 278
 - Bulbs
 - Messages in the multifunction display 375–380
 - Replacing 393

- C**
- California retail buyers and lessees,
 - Important notice for 11
 - Call priority, Tele Aid* 268
 - Capacities and recommended
 - fuels/lubricants 443
 - Carpets, cleaning 342
 - Catalytic converter 288
 - CD
 - Changer* 208, 252
 - Player/Changer*, operation 134, 208
 - CD changer* (Audio system) 212
 - Center console
 - Lamp 354
 - Lower part 30
 - Upper part 29
 - Central locking
 - Automatic 102, 146
 - Locking/unlocking from inside 102
 - SmartKey 62
 - Certification label 430
 - CHECK ENGINE indicator lamp 349
 - Children in the vehicle
 - Air bags 79
 - Passenger front air bag off indicator lamp 74, 354
 - Infant and child restraint systems 79
 - Occupant Classification System (OCS) 71
 - Cigarette lighter 32, 256
 - Climate control 172
 - Air conditioning refrigerant 444
 - Air conditioning, Cooling 180
 - Air recirculation mode 178
 - Air vents 172
 - Air volume 177
 - Control panel 174
 - Defrosting 170, 177
 - Residual heat utilization 181
 - Switching on/off 175
 - Temperature 175
 - Clock 120
 - Cockpit 24
 - Cold tire inflation pressure 328
 - Collapsible wheel chock 384
 - COMAND* system 29
 - Driving instructions 287
 - Navigation 135

- Combination switch 113
 - High beam flasher 113
 - High beam headlamps 55, 113
 - Low beam headlamps 55
 - Turn signals 55
 - Windshield wipers 56
 - Control system 121
 - Control system menus 124
 - AMG 128
 - AUDIO 133
 - NAV* 135
 - Settings 136
 - Standard display 127
 - TEL* 149
 - Trip computer 148
 - Vehicle status message memory 135
 - Control system submenus
 - Convenience* 147
 - Instrument cluster 139
 - Lighting 143
 - Time/Date 141
 - Vehicle 146
 - Convenience opening/closing*
 - Power windows 238
 - Retractable hardtop 244
 - Coolant 448
 - Adding water 293
 - Anticorrosion/antifreeze 449
 - Checking coolant level 300
 - Messages in the multifunction display 368–370
 - Technical data 444
 - Temperature 289
 - Temperature gauge (Multifunction display) 127
 - Corner-illuminating front fog lamps* 114
 - Replacing bulbs 393
 - Cruise control 247
 - Messages in the multifunction display 358
 - Cup holder 254
 - Curb weight 328
- D**
- Date (Control system) 142
 - Daytime running lamp mode 111
 - Setting 143
 - Deep water see Standing water
 - Defrosting
 - Rear window 170
 - Windshield (Automatic climate control*) 188
 - Windshield (Climate control) 177

- Delayed shut-off
 - Exterior lamps 144
 - Interior lighting 145
- Department of Transportation see DOT
- Difficulties
 - Wile driving 58
 - With starting the engine 52
- Digital speedometer 128
- Dimensions, Vehicle 441
- Dipstick see Oil dipstick
- Direction of rotation (Tires) 307
- Display text see Messages in the multifunction display
- Displays
 - Digital speedometer 128
 - Maintenance service indicator 334
 - Multifunction display 121
 - Outside temperature 128
 - Symbol messages 366
 - Text messages 358
 - Vehicle status message memory 135
 - Vehicle status messages 356
- Distance to empty (range), Trip computer 149
- Door
 - Control panel 34
 - Entry lamps 117
 - Locking in an emergency 388
 - Locking/unlocking, SmartKey 94
 - Opening from inside 99
 - Remote door unlock, Tele Aid* 269
 - Unlocking in an emergency 387
- DOT 328
- Drink holder see Cup holder
- Drinking and driving 279
- Driver's air bag see Air bags
- Driving 53
 - Abroad 287
 - Accelerator position 159
 - Automatic transmission* 53
 - Driving off 282
 - Fuel saving 279
 - Hydroplaning 284
 - In winter 286
 - Instructions 48, 279
 - Kickdown 159
 - Manual transmission 53
 - Standing water 287
 - Tires 283
- Driving safety systems 84
 - ABS 84
 - BAS 86
 - Electronic traction system 88
 - ESP® 86
- Driving systems
 - Cruise control 247
- Driving tips 159

E

- Easy-entry/exit feature* 44, 147
- Electric air pump
 - Inflating collapsible tire 411
 - Sealing tires with TIREFIT 401
 - Vehicle tool kit 382
- Electrical system (Technical data) 440
- Electronic Stability Program see ESP®
- Emergency call (911) 233
- Emergency call system 262
 - Tele Aid* 263
- Emergency operations
 - Automatic transmission* (Limp-Home Mode) 167
 - Remote door unlock, Tele Aid* 269
 - Retractable hardtop 390
 - Selector lever*, unlocking
 - manually 389
 - Trunk lid, Releasing from the
 - inside 101
 - Unlocking/locking the vehicle 387
- Emergency Tensioning Device see ETD
- Emission control 289
 - Information label 431
 - System warranties 10
 - Vacuum line routing diagram 431
- Engine
 - Cleaning 339
 - Compartment 294
 - Malfunction indicator lamp 27, 349
 - Number 431
 - Poly-V-belt layout 432
 - Starting 51
 - Tachometer 119
 - Technical data 433
 - Turning off 61
- Engine oil 296, 445
 - Adding 299
 - Additives 445
 - Checking level (Control system) 296
 - Checking level (Dipstick) 298
 - Consumption 296
 - Messages in the multifunction display 297, 372-373
- ESP® 84, 86
 - Messages in the multifunction display 358, 359
 - Warning lamp 350
- ETD 79
 - Safety guidelines 68
 - Warning and indicator lamps 353
- Exterior lamp switch 109
- Exterior lighting
 - Lamps 393
 - Replacing bulbs 393
- Exterior rear view mirrors see Mirrors

F

- First aid kit 382
- Flat tire 401
 - Inflating collapsible spare tire 411
 - Lifting vehicle 407
 - Lowering vehicle 413
 - Mounting spare wheel 407, 409
 - TIREFIT kit* 401
- Floormat 257
- Fog lamps 112, 394
 - Corner-illuminating front fog lamps* 114
- Footwell lighting* 117
- FSS PLUS (Canada vehicles) 334
- Fuel
 - Additives 447
 - Consumption statistics (Control system) 148
 - Filler flap 291

- Fuel tank capacity 444
 - MON 292, 447
- Premium unleaded gasoline 292, 446
 - Refueling 291
 - Requirements 292, 447
 - Reserve warning lamp 353
 - RON 292, 447
 - Technical data 443
- Fuel filler flap 291
- Fuel gauge (Instrument cluster) 27
- Fuse extractor (Vehicle tool kit) 382
- Fuses 425
 - Fuse extractor 425
 - Replacing 425
 - Spare fuses 425
 - Spare fuses (Vehicle tool kit) 382

G

- Garage door opener* 270
- Gasoline see Fuel
- GAWR 328
- Gear range
 - Automatic transmission 160
 - Limiting 160
 - Shifting into optimal 163, 165
- Gear selector lever 155
 - Gearshift pattern 155
 - Position 156, 157
 - Shifting procedure 156
- Gear selector lever one-touch gearshifting
 - Automatic transmission 162
- Global locking/unlocking see SmartKey
- Glove box 252
- Good visibility 168
- GPS 90, 91
 - Tele Aid system* 262
- Gross Axle Weight Rating see GAWR
- Gross Vehicle Weight Rating see GVWR
- Gross Vehicle Weight see GVW
- GSM network phones (Telephone*) 219
- GVW 328
- GVWR 328

- H**
- Hard plastic trim items, cleaning 342
 - Hazard warning flasher 115, 116
 - Head restraint height (Seats) 42
 - Headlamps
 - Bi-Xenon* 394
 - Cleaning system* 168, 302, 450
 - Night security illumination (Control system) 144
 - Switching off 61
 - Switching on 55
 - Headliner, cleaning 342
 - Head-thorax air bag 70
 - Heating
 - Seats* 104
 - Steering wheel* 276
 - High beam
 - Flasher 113
 - Headlamps 55, 113
 - Headlamps, bulbs 394
 - High beam headlamps 109
 - High mounted brake lamp 395
 - High-performance brake system 281
 - Hood 294
 - Horn 25
 - Hydroplaning 284
- I**
- Identification labels see Labels
 - Ignition (Position in starter switch) 37
 - Immobilizer see Anti-theft systems
 - Infant and child restraint systems see Children in the vehicle
 - Instrument cluster 27, 118
 - Clock 120
 - Lamps, indicator and warning 346
 - Overview 26
 - Instruments and controls see Cockpit
 - Interior rear view mirror see Mirrors
 - Intermittent/interval wiping see Windshield wipers
- J**
- Jack (Vehicle tool kit) 382
 - Lifting vehicle 407
 - Lowering vehicle 413
 - Jump starting 419

- K**
- Kickdown 159
 - Kilopascal 328
 - Knee bag see Air bags
- L**
- Labels 430
 - Lamp in center console 354
 - Lamps in instrument cluster 346
 - Lamps, indicator and warning
 - ABS 346, 347
 - Battery (SmartKey) 97
 - Brakes 348
 - CHECK ENGINE 349
 - ESP® 87, 350
 - Passenger front air bag off 74, 354
 - Fuel reserve 353
 - Passenger front air bag off 354
 - Seat belts 351–352
 - SRS 65, 353

- Language in multifunction display (Control system) 139
 - Layout of poly-V-belt drive 432
 - License plate lamps 395
 - Light alloy wheels
 - Cleaning 341
 - Technical data 434
 - Lighter see Cigarette lighter
 - Lighting 109
 - Combination switch 113
 - Corner-illuminating front fog lamps* 114
 - Daytime running lamp mode 111
 - Door entry lamps 117
 - Exterior lamp switch 109
 - Exterior lamps, cleaning 340
 - Fog lamps 112
 - Footwell lighting* 117
 - Hazard warning flasher 115
 - Headlamp mode,
 - automatic/manual 110
 - High beam 113
 - High beam flasher 113
 - Individual settings (Control system) 143
 - Instrument cluster illumination 118
 - Interior lighting 116
 - Low beam headlamps 109
 - Night security illumination (Control system) 144
 - Reading lamps 117
 - Standing lamps 109
 - Trunk 116
 - Limp-home mode 167
 - Loading 251, 307, 327
 - Locator lighting (Control system) 144
 - Locking
 - And parking 59
 - Centrally (Control system) 146
 - Centrally from inside 102
 - Locking knob (Doors) 99
 - Locking the vehicle 62
 - Long trip, checking before 292
 - Loss of
 - Service and Warranty Booklet 429
 - SmartKey or mechanical key 98
 - Low beam headlamps 109, 394
 - Lubricants, technical data 443
 - Luggage cover 32, 241
- M**
- Main dimensions 441
 - Maintenance service indicator (Control system) 334
 - Maintenance System 334
 - Manual seat see Seats
 - Manual shift program* 165
 - Deactivating 167

- Manual transmission 153
 - Driving 53
 - Gearshift pattern 51
 - Starting with SmartKey 51
- Maximum inflation pressure 329
- Maximum load rating 328
- Maximum loaded vehicle weight 328
- Mechanical key see SmartKey
- Memory function* 107
- Menus see Control system menus
- Messages in the multifunction display see
 - Multifunction display messages
- Mirror lamp* see Sun visors
- Mirrors 168
 - Additional turn signals 394
 - Adjusting 46
 - Antiglare position 168
 - Auto-dimming* 169
 - Exterior rear view mirrors 46
 - Interior rear view mirror 46
- Mobile phone see Telephone*
- MOE tires* see MOExtended system*
- MOExtended system* 317, 414
- MON 292, 447
- Motor Octane Number see MON
- MP3 210
- Multifunction display 121
- Multifunction display messages 356
 - ABS 358
 - Air bags 361–364
 - Battery, Vehicle 366
 - Brake fluid 367
 - Brakes 367
 - Bulbs 375–380
 - Coolant 368–370
 - Cruise control 358
 - Doors 371
 - Engine oil 372–373
 - ESP® 358, 359
 - Passenger front air bag 363
 - Fuel 374
 - Hood 375
 - Maintenance service indicator 334
 - Parking brake 366
 - Retractable hardtop 374, 381
 - Run Flat Indicator* 365
 - Seat belt 381
 - SmartKey 375
 - SRS 360
 - Symbol messages 366
 - Telephone* 381
 - Text messages 358
 - Transmission 360
 - Trunk lid 381
 - Vehicle status message memory 135
 - Washer fluid 381
- Multifunction steering wheel 28, 122
 - Heating* 276

N

- Navigation system* 135
- Neck-level heating see AIRSCARF*
- Neutral gear position
 - Automatic transmission* 155, 157
 - Manual transmission 154
- Night security illumination (Control system) 144
- Normal occupant weight 329
- Number, Vehicle Identification (VIN) 430

O

- Occupant Classification System see OCS
- Occupant distribution 329
- Occupant safety 64
 - Passenger front air bag off indicator lamp 74
 - OCS 71
 - Seat belts 48, 68
 - SRS 64

OCS 71

- Self-test 75
- Oil see Engine oil
- One-touch gearshifting
 - Gear selector lever 162
 - Steering wheel gearshift control* 163
- Operating safety 16, 193
- Operating vehicle outside the USA and Canada 13
- Operator's Manual 10
- Ornamental moldings see Vehicle care
- Outside temperature indicator 119, 128
- Outside temperature/speed 140
- Overhead control panel 31
- Overspeed range 119

P

- Paintwork code 430
- Paintwork see Vehicle care
- Panic alarm 83
- Parcel net (Storage compartment) 253
- Parking 59, 282
- Parking brake 53, 59
- Parking lamps 109, 394
- Parts service 428
- PASS AIR BAG OFF indicator lamp see Passenger front air bag off indicator lamp
- Passenger air bag see Air bags
- Passenger compartment 287
- Passenger front air bag
 - Messages in the multifunction display 361–364
- Passenger front air bag off indicator lamp 74, 354
- Passenger safety see Occupant safety

- Phone book see Telephone*
 - Plastic parts, cleaning 342
 - Poly-V-belt drive 432
 - Potential problems associated with under-inflated and overinflated tires 317
 - Power outlet 257
 - Power seat* see Seats
 - Power washer see Vehicle care
 - Power windows 235
 - Operating rear side windows 237
 - Operating with retractable hardtop switch 237
 - Summer opening/convenience closing* 238
 - Synchronizing 239
 - Practical hints
 - Fuses 425
 - Lamps in instrument cluster 346
 - Spare wheel bolts 386
 - Towing vehicle 421
 - Vehicle jack 383
 - What to do if... 346
 - Premium unleaded gasoline 446
 - Problems
 - While driving 58
 - With vehicle 17
 - Product information 9
 - Production options weight 329
 - Program mode see Automatic transmission, Automatic shift program
 - Program mode selector switch
 - Automatic shift program 161
 - PSI 329
- R**
- RACETIMER see Control system menus, AMG
 - Radio
 - Operation (Audio system) 199
 - Operation (Control system) 133
 - Satellite* (USA only) 134
 - Radio transmitters, control and operation 287
 - Reading lamps 117
 - Rear view mirrors see Mirrors
 - Rear window defroster 170
 - Recommended inflation pressure 329
 - Recovery services for stolen vehicle (TeleAid*) 269
 - Refrigerant (Air conditioning) 445
 - Refueling 291
 - Regular checks 292
 - Remote control see SmartKey

- Remote door unlock with Tele Aid* 269
- Reporting, safety defects 18
- Research Octane Number see RON
- Reset button (Instrument cluster) 27
- Residual engine heat utilization see REST
- REST
 - Automatic climate control* 192
 - Climate control 181
- Restraint systems
 - Emergency Tensioning Device (ETD) 79
 - Seat belts 64, 76
- Retractable hardtop 240
 - Locking after raising/lowering 242
 - Opening and closing 240
 - Operating manually 390
 - Problems when operating 242
 - Summer opening/convenience closing* 244
 - Wind screen* 246
- Reverse gear position
 - Automatic transmission* 155, 157
 - Manual transmission 154
- Rims 329, 434
- Roadside Assistance 12, 265
- RON 292, 447
- Roof rack 251
- Rubber parts, cleaning 342
- Run Flat Indicator* 315
- S**
- Safety belts see Seat belts
- Safety defects, reporting 18
- Safety, occupant 64
- Satellite radio* (USA only) 134
- Seat belt force limiter 79
- Seat belts 64, 76
 - Cleaning 343
 - Fastening 48
 - Proper use of 50
 - Release button 49
 - Safety guidelines 68
 - Warning lamp 351–352
- Seating capacity 308
- Seats 104
 - Adjusting 39
 - Easy-entry/exit feature* 44
 - Head restraint height 42
 - Heating* 104
 - Power seats* 41
- Selective setting see SmartKey
- Selector lever see Gear selector lever
- Selector lever* lock 52
- Self-test
 - OCS 75
- Service
 - Information 12
 - Maintenance Booklet 12
- Service and warranty
 - Booklet 429
 - Information 10
- Service life (Tires) 305

- Service system
 - Maintenance service indicator 334
 - Parts service 428
- Settings menu (Control system) 136
- Shelf behind roll bar 254
- Shift program mode, Automatic transmission* 161
- Shifting, Automatic transmission 155
- Side marker lamps 394
- Side windows see Power windows
- Sidewall 329
- SmartKey 94
 - Checking batteries 98
 - Factory setting 96
 - Global locking 96
 - Global unlocking 96
 - Locking and unlocking 94
 - Loss of SmartKey or mechanical key 98
- Mechanical key 387
- Panic button 83
- Positions in starter switch 37
- Power windows,
 - opening/closing* 238
- Remote control 94
- Replacing batteries 391
- Restoring to factory setting 98
- Retractable hardtop,
 - opening/closing* 244
- Selective setting 97
- Starting engine 51
- Turning off engine 61
- Snow chains 333
- Spare fuses (Vehicle tool kit) 382
- Spare parts see Parts service
- Spare wheel 385
- SRS
 - Indicator lamp 353
 - Messages in the multifunction display 360
- Standard display menu (Control system) 127
- Standing lamps 109, 394
- Standing water, driving instructions 287
- Starter switch positions 37
- Starting 37, 51
 - Difficulties with 52
 - Position in starter switch 37
- Steering column see Steering wheel
- Steering wheel
 - Adjusting 43
 - Heating* 276
 - Lock 52

- Steering wheel gearshift control one-touch gearshifting
 - Automatic transmission* 163
 - Stolen vehicle, Recovery services (Tele Aid*) 269
 - Storage compartments 32, 252
 - Armrest 32, 252
 - Between seat backrests 32, 253
 - Cup holder 32, 254
 - Door pockets 32
 - Glove box 32, 252
 - Parcel net 32, 253
 - Storage tray 32
 - Telephone* compartment 32, 252
 - Trunk 32
 - Storing tires 306
 - Summer opening*
 - Power windows 238
 - Retractable hardtop 244
 - Sun visors 170
 - Symbols in display 366
- T**
- Tachometer 119
 - Tail lamps 395
 - Tar stains see Vehicle care
 - TDMA or CDMA network phones (Telephone*) 226
 - Technical data
 - Air conditioning refrigerant 445
 - Brake fluid 446
 - Coolants 448
 - Electrical system 440
 - Engine 433
 - Engine oil 445
 - Fuel additives 447
 - Fuel requirements 447
 - Fuels, coolants, lubricants, etc. 443
 - Headlamp cleaning system* 450
 - Main dimensions 441
 - Parts service 428
 - Premium unleaded gasoline 446
 - Rims and tires 434
 - Weights 442
 - Windshield washer system 450
 - Tele Aid system* 261
 - Call priority 268
 - Initiating an emergency call 264
 - Remote door unlock 269
 - Requirements 262
 - Roadside Assistance 265
 - Stolen Vehicle Recovery services 269
 - System self-check 263
 - Telephone* 258
 - Changing mobile phone cradle 261
 - Compartment 33, 252
 - GSM network phones 219
 - Inserting in cradle 259
 - Installing a different mobile phone cradle 261
 - Operation 149, 193
 - Removing from cradle 260
 - Tightening torque
 - Wheel bolts 413

- Time and date synchronization with head unit* (Control system) 141
- TIN 329
- Tire and Loading Information 308
- Tire and loading terminology 327
- Tire care and maintenance 305
- Tire Identification Number see TIN
- Tire inflation pressure 404
 - Air pressure 327
 - Checking 312, 314
- Tire inspection 305
- Tire load rating 329
- Tire ply composition and material used 329
- Tire speed rating 320, 330
- Tire terminology 327
- TIREFIT*
 - Instructions for use 401
 - Vehicle tool kit 382, 383
- Tires 304, 434
 - Cleaning 306
 - Direction of rotation 307
 - Driving instructions 283
 - Flat tire 401
 - Important guidelines 304
 - Inflating with air pump 411
 - MOExtended* 434
 - Mounting wheel 409
 - Removing wheel 409
 - Retreads 304
 - Rims and tires 434
 - Rotating 330
 - Run Flat Indicator* 315
 - Service life 305
 - Sizes 434
 - Snow chains 333
 - Spare wheel 385
 - Speed rating 285
- Storing 306
- Temperature 326
- Traction 284
- Tread depth 306, 332
- Treadwear indicators (TWI) 283
- Wear pattern 331
- Wheel chock (Vehicle tool kit) 382
- Winter 332
- Tools see Vehicle tool kit
- Tow-away alarm see Anti-theft systems
- Towing (Vehicle) 421
- Traction 88, 330
- Transmission
 - Messages in the multifunction display 360
- Transmission see Automatic transmission* or Manual Transmission
- Transporting the vehicle 92
- Traveling abroad 287

Tread 330
Tread depth 306, 332
Treadwear indicators 283, 330
Trip computer menu (Control system) 148
Trunk 100
 Lighting 116
 Luggage cover 241
 Trunk lid emergency release 101
 Trunk lid lock 388
Turn signals 55, 394
 Additional in mirrors 394
TWI see Treadwear indicators

U

Uniform Tire Quality Grading Standards 330
Unlocking 36
 Centrally from inside 102
 In an emergency 269
 With SmartKey 36
Upholstery
 Cleaning 343
Useful features
 Ashtray 255
 Cigarette lighter 256
 Cup holder 254
 Floormat (Driver's side only) 257
 Garage door opener* 270
 Heated steering wheel* 276
 Parcel net 253
 Power outlet 257
 Storage compartments, interior 252
 Tele Aid* 261

V

Valve extractor (Vehicle tool kit) 382
Vehicle
 Battery 303, 415
 Bulbs 393
 Fuses 425
 Individual settings (Control system) 136
 Jump starting 419
 Lifting with jack 407
 Locking 62
 Proper use of 16
 Towing 421
 Unlocking/locking in an emergency 387
Vehicle capacity weight 330
Vehicle care 337
Vehicle Identification Number see VIN
Vehicle jack 383

- Vehicle loading terminology 327
- Vehicle status message memory menu (Control system) 135
- Vehicle tool kit 32, 382
 - Collapsible wheel chock 384
- Vehicle washing see Vehicle care
- VIN 431
- W**
- Warning sounds
 - Anti-theft alarm system 90
 - Exterior lighting 62, 99, 109
 - Maintenance service indicator 335
 - Panic alarm 83
 - Parking brake 53, 348
 - Seat belts 78, 351, 352
 - Tow-away alarm 91
- Warranty coverage 429
- Washing the vehicle see Vehicle care
- Wear pattern (Tires) 331
- Weights 442
- Wheel bolts 386
- Wheel chock (Vehicle tool kit) 382
- Wheel wrench (Vehicle tool kit) 382
- Wheels
 - Tightening torque 413
- Wheels see Tires
- Where will I find...? 382
- Wind screen* 246
- Windows see Power windows
- Windshield
 - Washer fluid reservoir 302
 - Washer system 450
- Windshield wipers 56
 - Replacing wiper blades 399
 - Wiper blades, cleaning 340
- Winter driving 332
 - Instructions 286
 - Snow chains 333
 - Tires 332
- Winter tires 332
- Wood trims
 - Cleaning 343

Service and Literature

Your authorized Mercedes-Benz Center has trained technicians and Genuine Mercedes-Benz Parts to service your vehicle properly.
For expert advice and quality service, contact an authorized Mercedes-Benz Center.

If you are interested in obtaining service literature for your vehicle, please contact an authorized Mercedes-Benz Center.
We consider this the best way for you to obtain accurate information for your vehicle.

For further information you can find us on the Mercedes-Benz web-site www.mbusa.com or www.mercedes-benz.ca.

Warning!



To help avoid personal injury, be extremely careful when performing any service work or repairs. Improper or incomplete service or the use of incorrect or inappropriate parts or materials may damage the vehicle or its equipment, which may in turn result in personal injury.

If you have questions about carrying out any type of service, turn to the advice of an authorized Mercedes-Benz Center.

We reserve the right to make changes in design and equipment.

Therefore, information, illustrations and descriptions in this Operator's Manual might differ from your vehicle.
Reprinting, translation and copying, even of excerpts, are not permitted without our prior authorization in writing.

Press time October 13, 2006

GSP/TID

Printed in U. S. A.

