



ToyotaOwnersOnline.com

CUSTOMER EXPERIENCE CENTER

1-800-331-4331

VENZA

2 0 1 1

QUICK REFERENCE GUIDE



Mixed Sources

Product group from well-managed
forests, controlled sources and
recycled wood or fiber
www.fsc.org Cert no. SGSNA-COC-005612
© 1996 Forest Stewardship Council



2011 Venza

This *Quick Reference Guide* is a summary of basic vehicle operations. It contains brief descriptions of fundamental operations so you can locate and use the vehicle's main equipment quickly and easily.

The *Quick Reference Guide* is not intended as a substitute for the *Owner's Manual* located in your vehicle's glove box. We strongly encourage you to review the *Owner's Manual* and supplementary manuals so you will have a better understanding of your vehicle's capabilities and limitations.

Your dealership and the entire staff of Toyota Motor Sales, U.S.A., Inc. wish you many years of satisfied driving in your new Venza.

! A word about safe vehicle operations

This *Quick Reference Guide* is not a full description of Venza operations. Every Venza owner should review the *Owner's Manual* that accompanies this vehicle.

Pay special attention to the boxed information highlighted in color throughout the *Owner's Manual*. Each box contains safe operating instructions to help you avoid injury or equipment malfunction.

All information in this *Quick Reference Guide* is current at the time of printing. Toyota reserves the right to make changes at any time without notice.

Doors-Child safety locks

Rear door

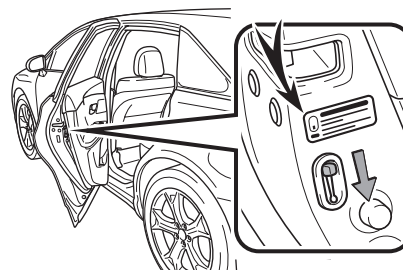

Moving the lever to "LOCK" will allow the door to be opened only from the outside.

Spare tire & tools

Tool location

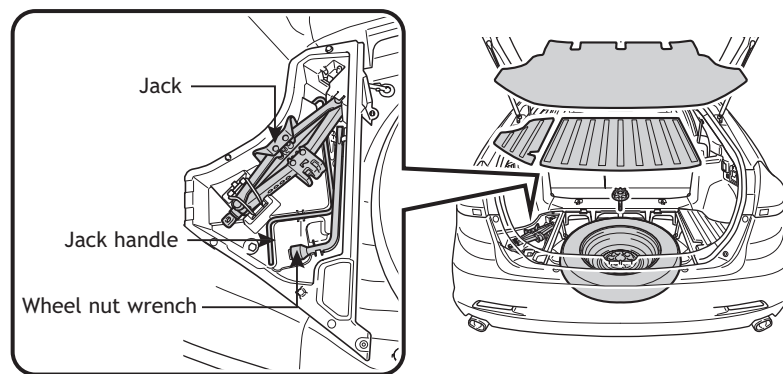

Removing the spare tire

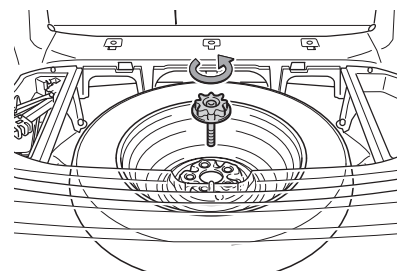

Loosen and remove the bolt

Refer to the *Owner's Manual* for tire changing and jack positioning procedures.

INDEX

OVERVIEW

Engine maintenance	9
Fuel tank door release and cap	8
Hood release	8
Indicator symbols	4-5
Instrument cluster	4
Instrument panel	2-3
Keyless entry^{1,2}	6
Light control-Instrument panel	8
Smart Key system^{1,2}	7

FEATURES/OPERATIONS

Air Conditioning/Heating	16-17
Audio	18-19
Auto lock functions¹	11
Automatic Transmission	10
Cruise control	20
Customizable features	23
Enhanced VSC OFF button	16
Garage door opener (HomeLink [®]) ³	21
Hill-start Assist Control (HAC)	15
Lights^{1,2} & turn signals	14-15
Moonroof	13
Multi-information display (clock)²	22
Parking brake	10
Power outlets-12V DC	21
Power outlet-120V AC	21
Rear seat entertainment system	20
Seat adjustments-Front	11
Seat adjustments-Rear	11
Seat heaters	17
Seats-Head restraints	12
Seats-Folding rear row seats	12
Tilt and telescopic steering wheel	10
Telephone controls (Bluetooth [®])	23
Windows-Power	13
Windshield wipers & washers	15

SAFETY AND

EMERGENCY FEATURES

Door locks^{1,2}	24
Doors-Child safety locks	25
Seat belts	24
Seat belts-Shoulder belt anchor	24
Spare tire & tools	25
Tire Pressure Monitoring (warning) System	24

¹ Visit your Toyota dealer for information on customizing this feature.

² Programmable by customer. Refer to the Owner's Manual for instructions and more information.

³ HomeLink[®] is a registered trademark of Johnson Controls, Inc.

OVERVIEW

Instrument panel

Steering wheel controls

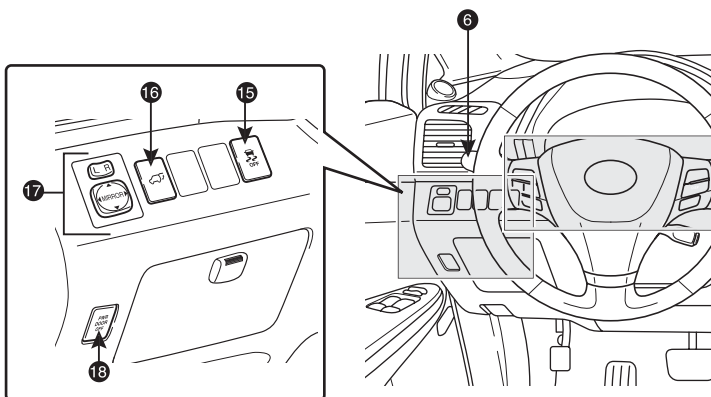
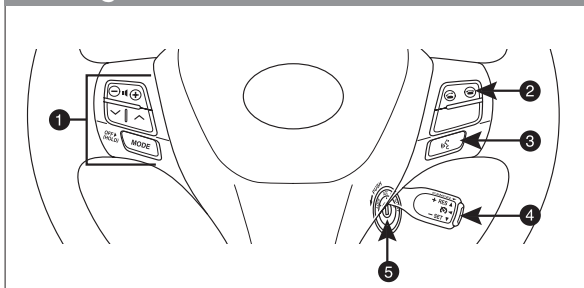

- ❶ Steering wheel audio controls
- ❷ Telephone controls^{1,2}
- ❸ Voice command button^{1,2}
- ❹ Cruise control
- ❺ Ignition switch (standard key)¹
- ❻ Headlight, turn signal and front fog light¹ controls
- ❼ Wiper and washer controls
- ❽ "ENGINE START STOP" button (Smart Key)¹
- ❾ Multi-information display
- ❿ Audio system²
- ⓫ Emergency flasher button
- ⓬ Multi-information display switches

With navigation system

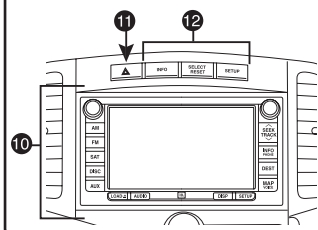

Without navigation system

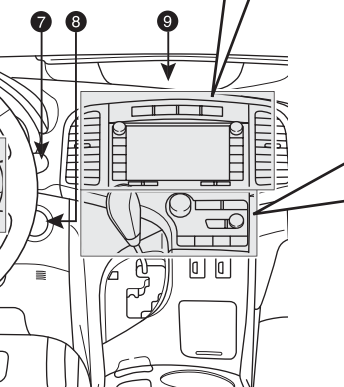
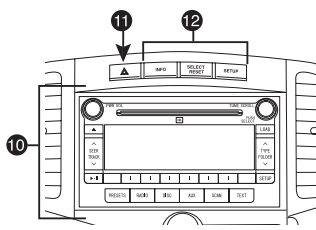

Automatic Air Conditioning system

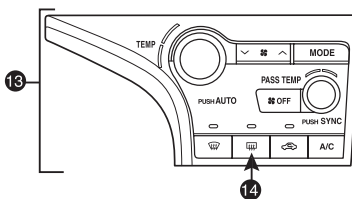

Manual Air Conditioning system

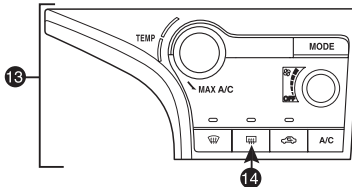

- 13 Air Conditioning controls
- 14 Outside rearview mirror defoggers¹/Rear window defogger button/Windshield wiper de-icer¹
- 15 Enhanced VSC/TRAC OFF switch
- 16 Power back door switch¹
- 17 Power outside rearview mirror controls
- 18 Power back door main switch¹

¹ If equipped

² For vehicles with navigation system, refer to the "Navigation System Owner's Manual."

Instrument cluster

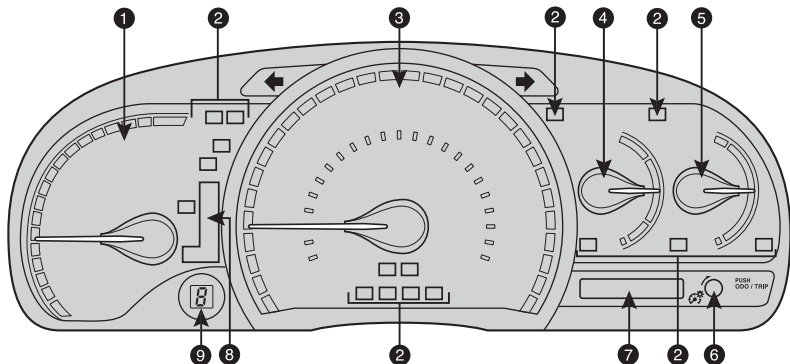

- ❶ Tachometer
- ❷ Service indicator and reminder
- ❸ Speedometer
- ❹ Fuel gauge
- ❺ Engine coolant temperature
- ❻ Odometer/Trip meter and trip meter reset button/Instrument panel light control
- ❼ Odometer and two trip meters
- ❽ Automatic Transmission shift position indicator
- ❾ Automatic Transmission shift range display

Indicator symbols

For details, refer to "Indicators and warning lights," Section 2-2, 2011 Owner's Manual.

BRAKE

Brake system warning¹



Driver seat belt reminder
(alarm will sound if speed is over 12 mph)



Front passenger seat belt reminder
(alarm will sound if speed is over 12 mph)



Charging system warning¹



AIR BAG ON and AIR BAG OFF indicator

























Malfunction/Check Engine indicator¹

AWD

Active torque control All-Wheel Drive system warning¹

¹ If indicator does not turn off within a few seconds of starting engine, there may be a malfunction. Have vehicle inspected by your Toyota dealer.

² If this light flashes, refer to "Cruise control," Section 2-4, 2011 Owner's Manual.

	Electric power steering system warning ¹
	Low windshield washer fluid level warning ¹
	Smart Key system warning
	Low fuel level warning
	Open door warning
	Airbag SRS warning ¹
	Master warning
	Low Tire Pressure Warning ¹
	 Headlight low/high beam indicator
	Turn signal indicator
	Fog light indicator
	Slip indicator/Hill-start Assist Control indicator ¹
	SET Cruise control/Cruise control SET indicator ²
	ABS Anti-lock Brake System warning ¹
	AUTO Automatic high beam indicator ³
	Security indicator
	OFF Vehicle Stability Control OFF indicator ¹
	TRAC OFF Traction Control OFF indicator
	Low Engine oil pressure warning ¹
	Automatic headlight leveling system warning ¹
	MAINT REQD Engine oil replacement reminder ¹

³ For details, refer to "Headlight switch," Section 2-3, 2011 Owner's Manual.

Keyless entry

Locking operation

Without Smart Key system



With Smart Key system



Unlocking operation

Without Smart Key system



With Smart Key system



Push ONCE: Driver door
TWICE: All doors



NOTE: If a door is not opened within 60 seconds of unlocking, all doors will relock for safety.

Panic button

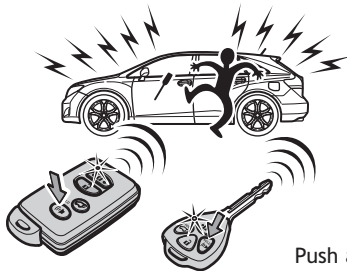

Push and hold

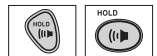

Smart Key system (if equipped)

Start function

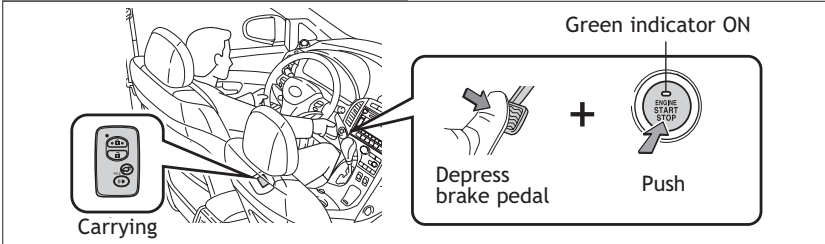

NOTE: Gear shift lever must be in Park and brake pedal depressed.

Power (without starting engine)

Without depressing the brake pedal, pressing the “ENGINE START STOP” button will change the operation mode in succession from:

ACCESSORY

Accessories such as the radio will operate.

ON

Power ON; the engine not running.

OFF

All systems OFF.

Locking operation

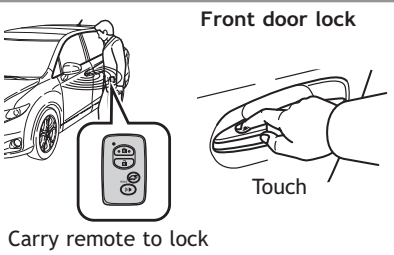

Unlocking operation

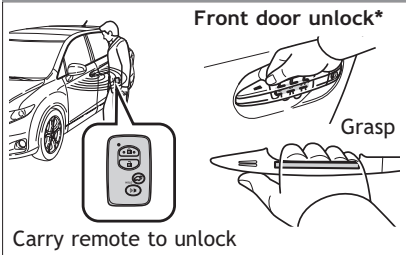

Back door lock/unlock

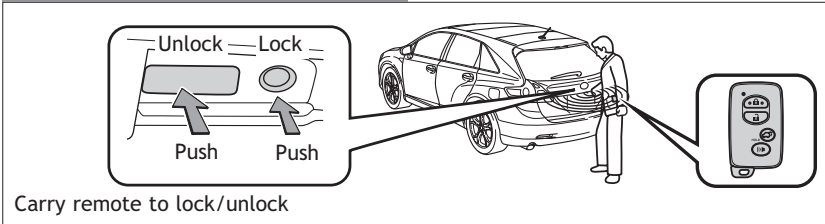

* Driver door unlocking function can be programmed to unlock driver door only, or all doors. Grasping passenger door handle will unlock all doors.

NOTE: Doors may also be locked/unlocked using remote.

Fuel tank door release and cap

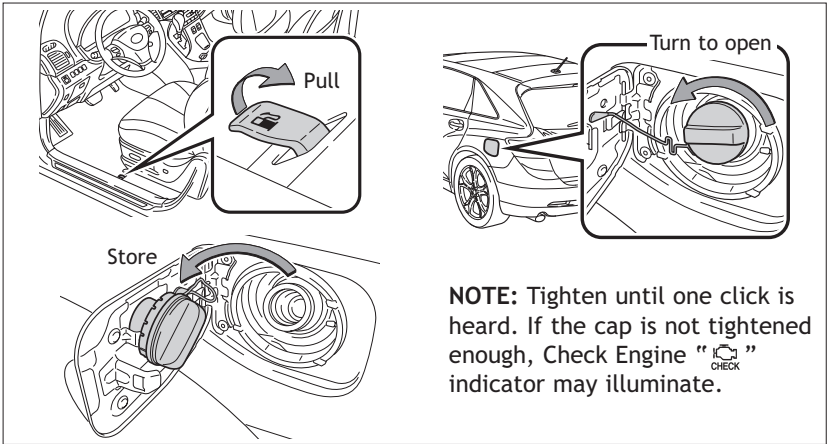

Light control-Instrument panel

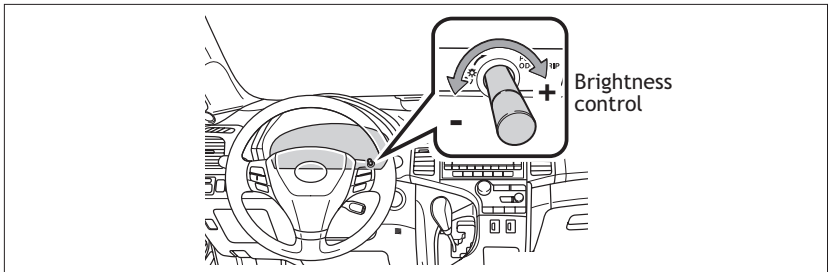

Hood release

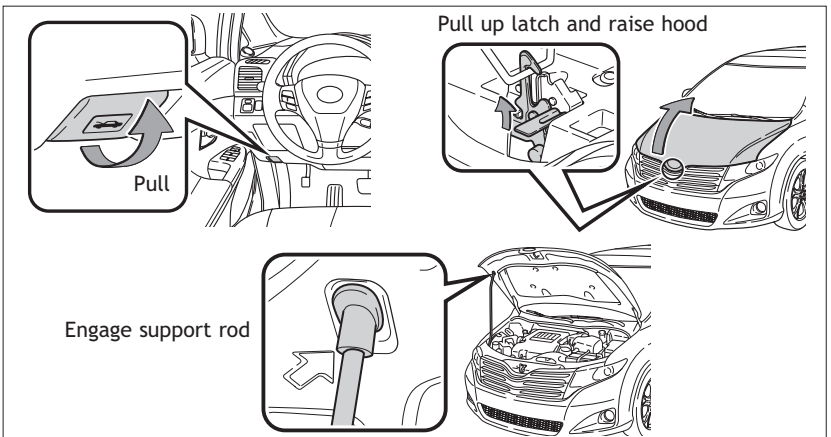

Engine maintenance

2.7 L 4-cylinder (1AR-FE) engine

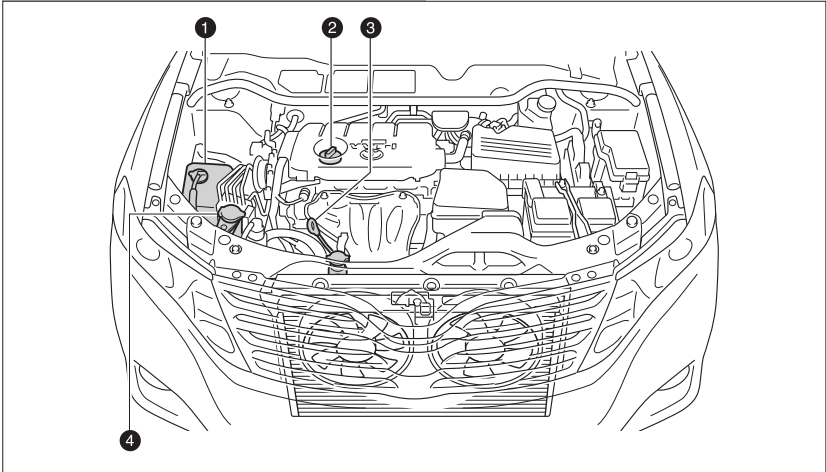

3.5 L V6 (2GR-FE) engine

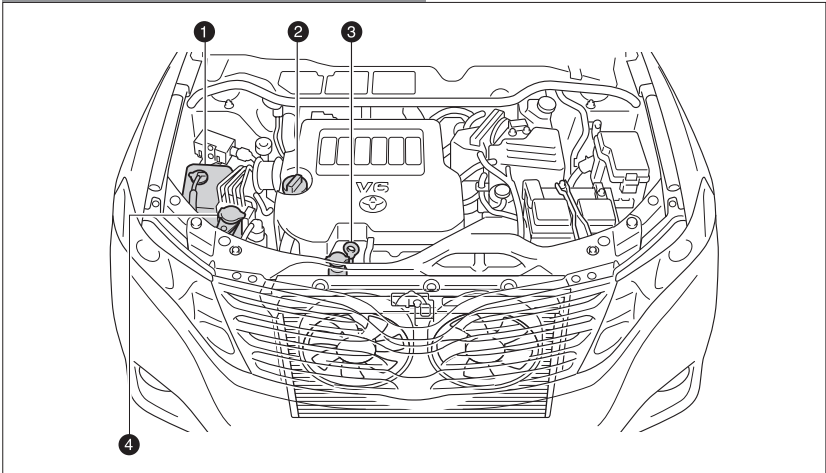

- ① Engine coolant reservoir
- ② Engine oil filler cap
- ③ Engine oil level dipstick
- ④ Windshield washer fluid tank

NOTE: Regularly scheduled maintenance, including oil changes, will help extend the life of your vehicle and maintain performance. Please refer to the "Warranty Maintenance Guide."

FEATURES/OPERATIONS

Automatic Transmission

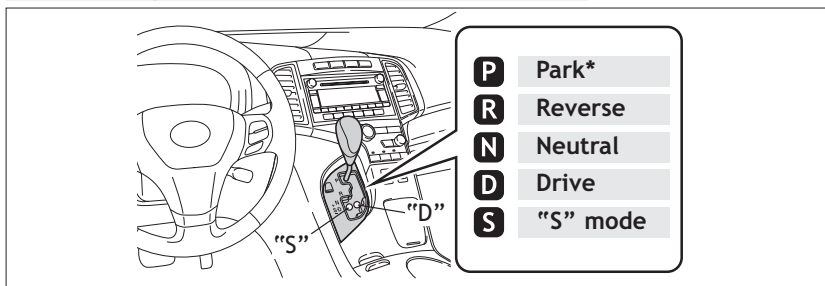

* The "ENGINE START STOP" switch/ignition switch must be "ON" and the brake pedal depressed to shift from Park.

"S" (Sequential) mode

Shift the shift lever to "S" position from "D" position.

- + : Upshift (push and release)
- : Downshift (pull and release)

Downshifting increases power going uphill, or provides engine braking downhill. For best fuel economy during normal driving conditions, always drive with the shift lever in the "D" position.

Parking brake

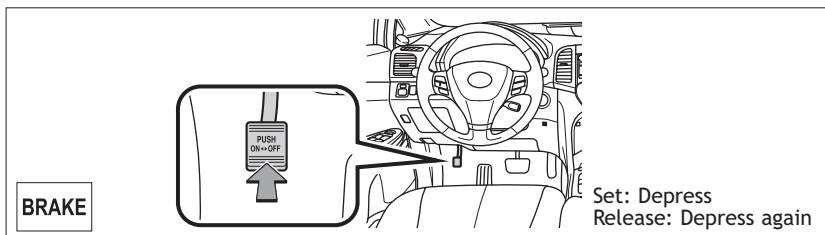

Tilt and telescopic steering wheel

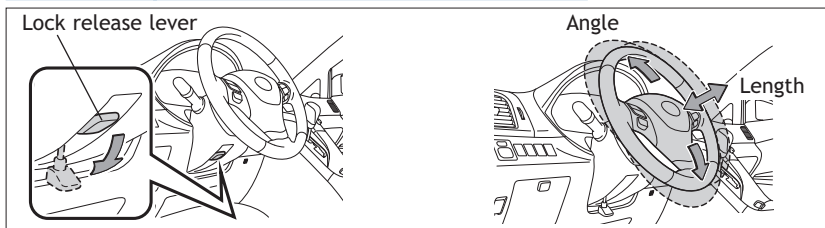

Hold wheel, push lever down, set angle and length, and return lever.

NOTE: Do not attempt to adjust while the vehicle is in motion.

Auto lock functions

Automatic door locks can be programmed to operate in four different modes, or turned OFF.

- Doors lock when shifting from Park.
- Doors lock when the vehicle speed is approximately 12 mph or higher.
- Doors unlock when shifting into Park.
- Doors unlock when the driver's door is opened within 10 seconds after turning the "ENGINE START STOP" switch or ignition switch OFF.

Refer to the *Owner's Manual* for more details.

Seat adjustments-Front

Manual seat



Power seat (if equipped)

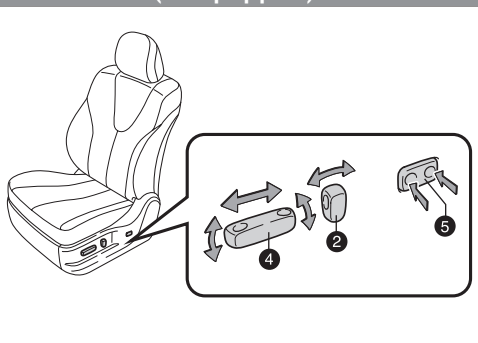

- ① Seat position (forward/backward)
- ② Seatback angle
- ③ Height crank (driver side only)
- ④ Seat position; cushion angle and height (driver side only)
- ⑤ Lumbar support

Seat adjustments-Rear

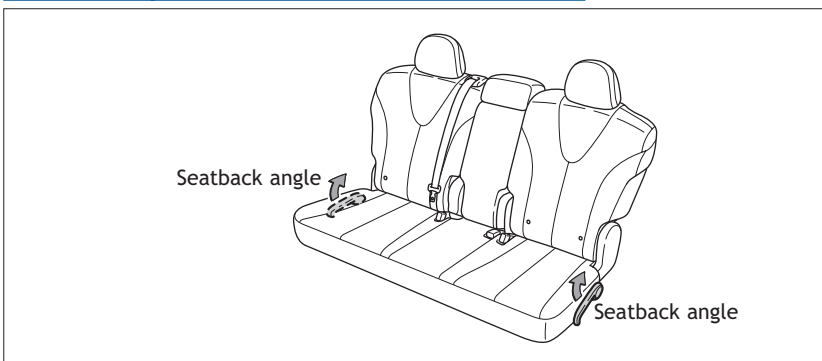

Refer to the *Owner's Manual* for more details.

Seats-Head restraints

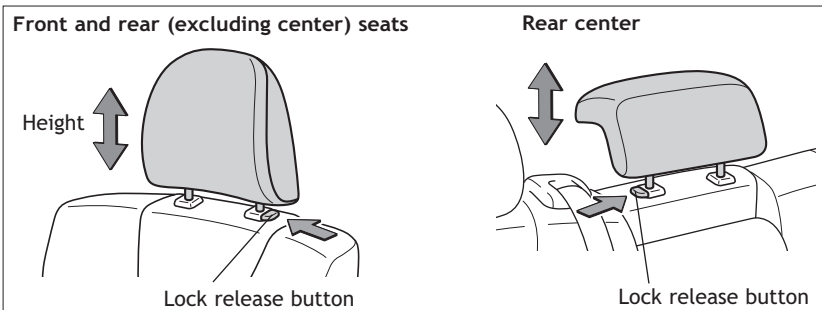

Seats-Folding rear row seats

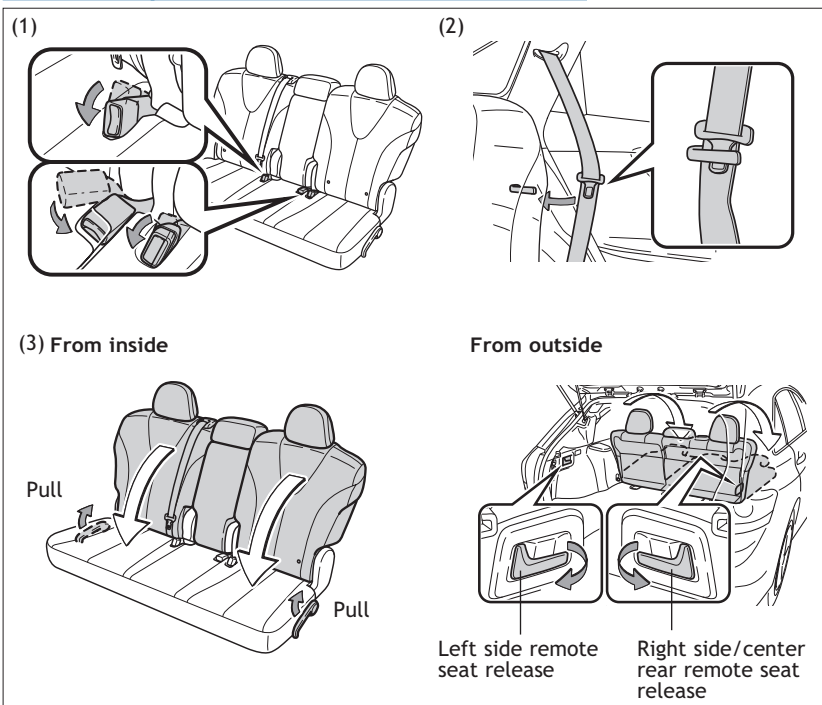

- (1) Stow the seat belt buckles.
- (2) Hook the seat belt to the seat belt hangers.
- (3) Fold down the seatbacks.

Windows-Power

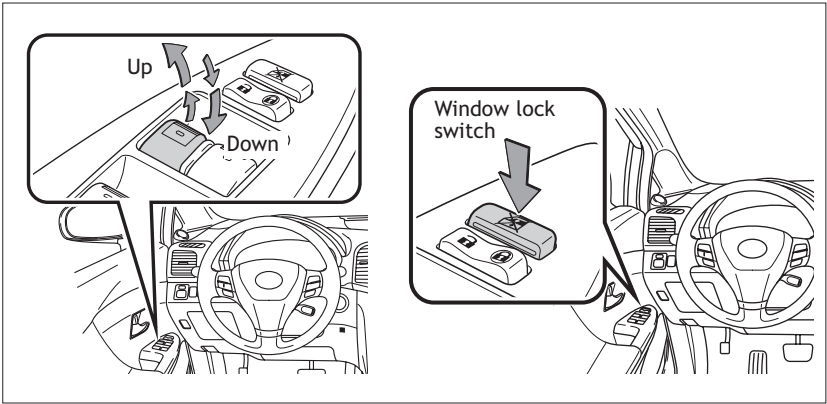

Automatic operation Push the switch completely down or pull it completely up and release to fully open or close. To stop window midway, lightly push the switch in the opposite direction.

Window lock switch Deactivates all passenger windows. Driver's window remains operable.

Moonroof (if equipped)

Sliding operation

Recommended open position to minimize wind noise.

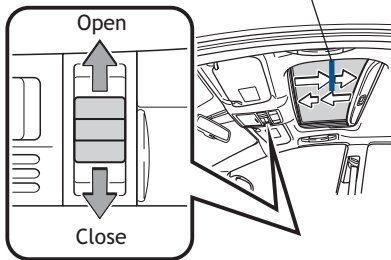

Push once to open partway; again to open completely.

Tilting operation

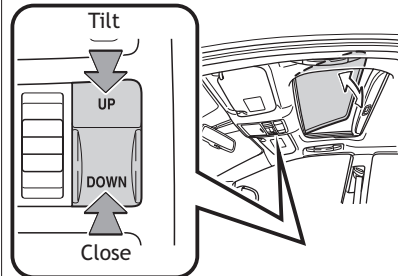

Close

Lights & turn signals

Headlights

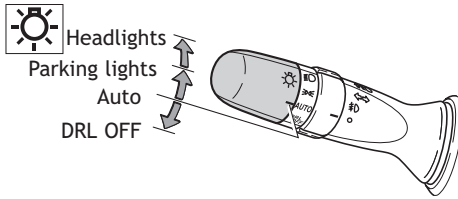

Without automatic high beam

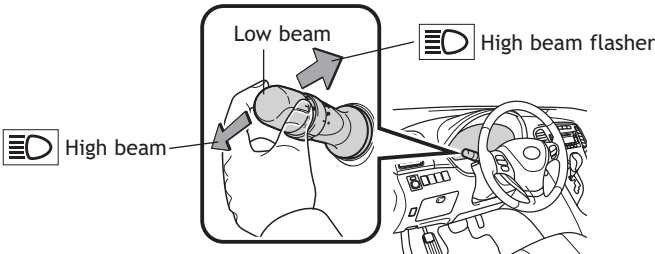

-Daytime Running Light system (DRL) Automatically turns on the headlights at a reduced intensity.

-Automatic light cut off system Automatically turns lights off after a delay of 30 seconds.

Automatic high beam (if equipped)

Activate*

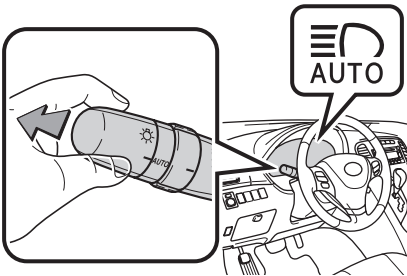

Manual high beam ON

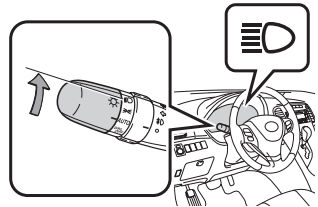

Deactivate

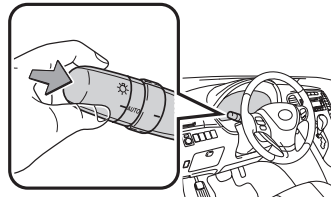

* Refer to the *Owner's Manual* for details on activating the automatic high beams.

Front fog lights (if equipped)

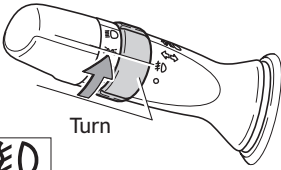

Front fog lights come on only when the headlights are on low beam.

Turn signals

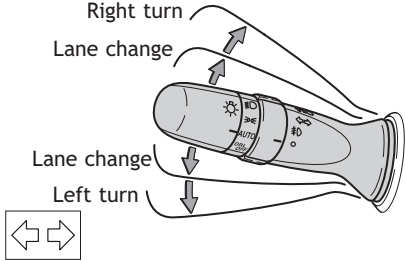

Windshield wipers & washers

Front

*** Intermittent windshield wiper frequency adjustment**
 Rotate to increase/decrease wiper frequency.

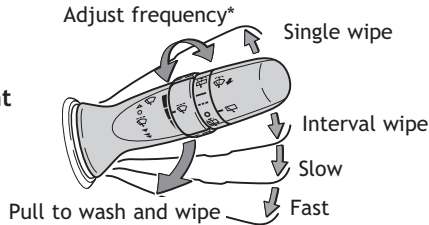

Rear

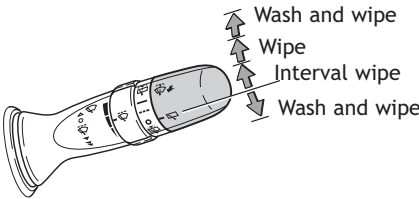

Hill-start Assist Control (HAC)

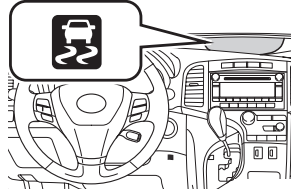
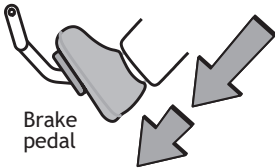

HAC helps prevent rolling backwards on an incline. To engage, push further down on brake pedal while at a complete stop until a beep sounds and slip indicator illuminates. HAC holds for approximately two seconds after releasing brake pedal.

Refer to the *Owner's Manual* for more details.

Enhanced VSC OFF button

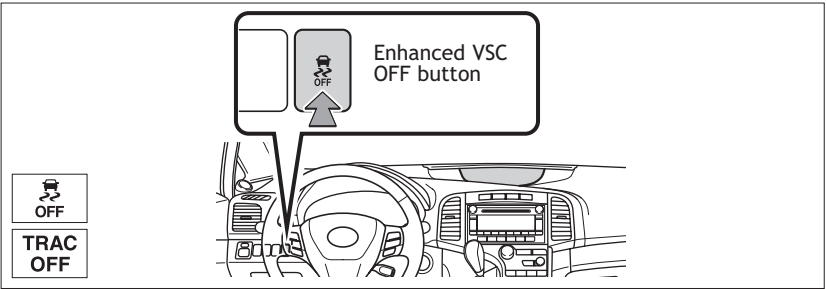

The Enhanced VSC OFF button is used to switch between modes related to the TRAC and Enhanced VSC functions.

Refer to Section 2-4 of the *Owner's Manual* for more information.

Air Conditioning/Heating

Manual Air Conditioning

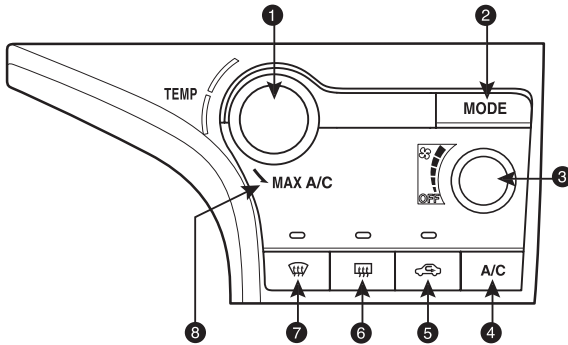

- 1 Temperature selector
- 2 Airflow vent
In “” mode, use fresh air (“” indicator OFF) to reduce window fogging. “” mode uses fresh air only.
- 3 Fan speed
- 4 Air Conditioning ON/OFF
Use fresh air to quickly cool interior, then change to recirculate for cooler air.
- 5 Recirculate cabin air (fresh air when OFF)
- 6 Rear window defogger/Windshield wiper de-icer (if equipped)
- 7 Windshield defogger
- 8 Select for maximum cooling. Air conditioning will automatically turn on.

Automatic Air Conditioning (if equipped)

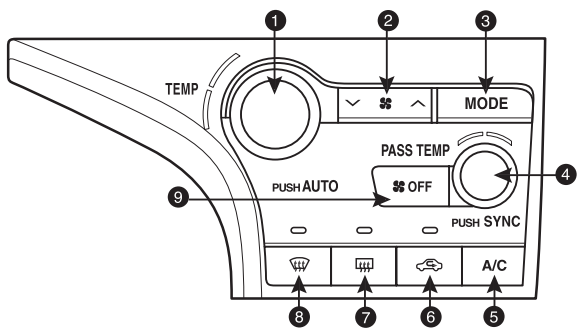

- 1** Push: Automatic climate control ON
Adjusting the temperature setting will cause the airflow vents, air intake and fan to adjust automatically.
Turn: Temperature selector (driver side)
- 2** Fan speed
- 3** Airflow vent
In "☁️" mode, use fresh air ("🚗" indicator OFF) to reduce window fogging. "🚗" mode uses fresh air only.
- 4** Push: Dual operation ON/OFF
Separate temperature setting or synchronize temperature setting for driver and passenger.
Turn: Temperature selector (front passenger side)
- 5** Air Conditioning ON/OFF
- 6** Recirculate cabin air (fresh air when OFF)
- 7** Outside rearview mirror/Rear window defogger/Windshield wiper de-icer (if equipped)
- 8** Windshield defogger
- 9** Climate control OFF

Seat heaters (if equipped)

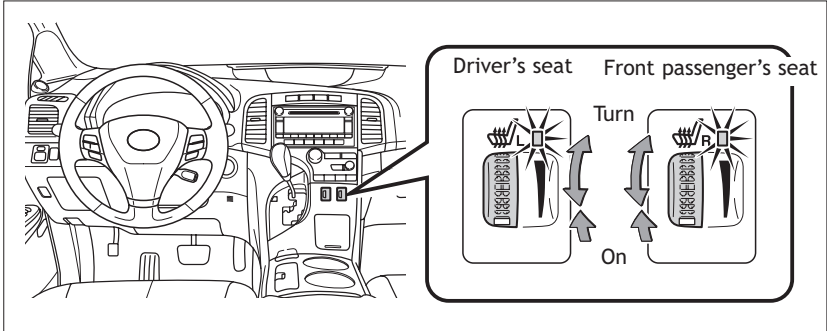

Audio

Type 1

Preset buttons - functions in other modes indicated above number

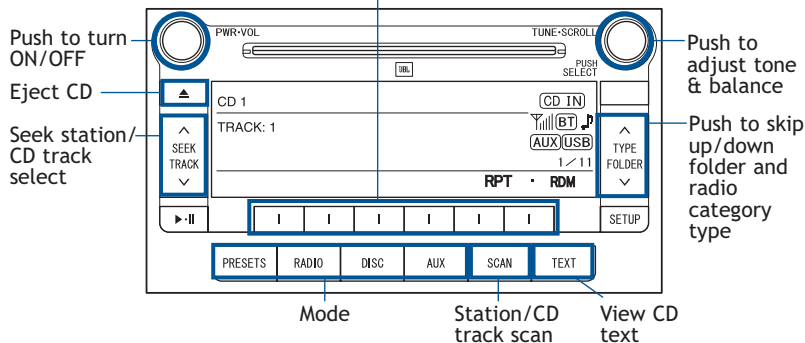

Type 2 - additional function

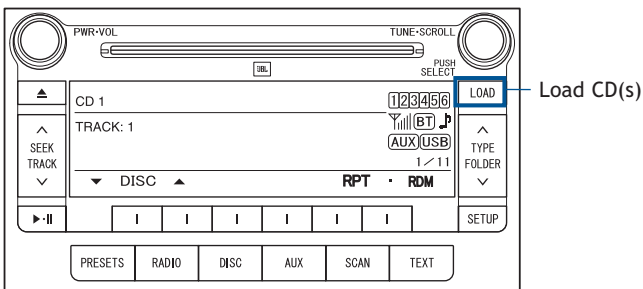

CD player

To scan tracks on a disc Push and hold "SCAN." Push again to hold selection.

CD changer (Type 2 only)

- To load one disc Push "LOAD" and insert one disc.
- To load multiple discs Push and hold "LOAD" until you hear a beep. Insert one disc. Shutter will close and then re-open for next disc.

To select a file (MP3/WMA only) Turn "TUNE-FILE," "TUNE-SCROLL" or either side of "SEEK TRACK."

To select a folder (MP3/WMA only) Push either side of "TYPE FOLDER."

Radio

To preset stations Tune in the desired station and hold down a preset button ([]) until you hear a beep.

To scan stations Push and hold "SCAN" to scan preset stations. Push again to hold selection.

AUX port/USB port

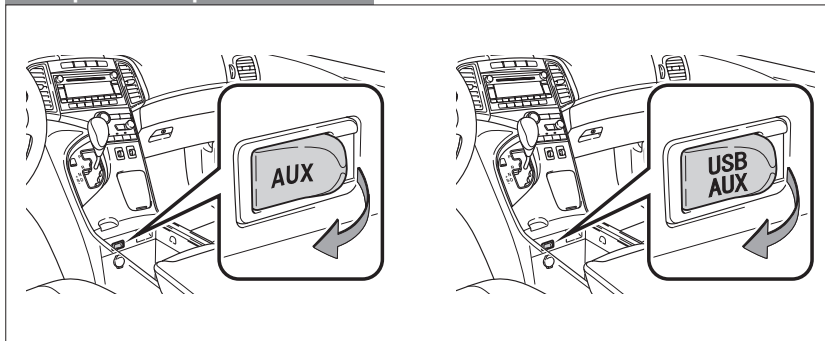

By connecting to the AUX port (or USB port), you can listen to music from a portable audio device (or USB memory) through the vehicle's speaker system while in AUX or USB mode.

Steering wheel switches

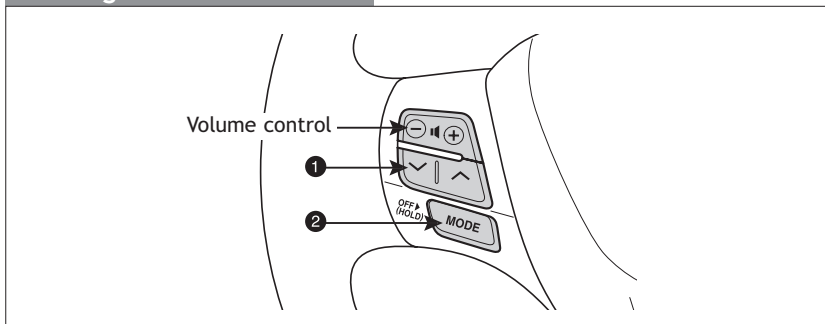

① "V Λ"

Use to search within the selected audio medium (radio, CD, iPod®, etc.).

② "MODE"

Push to turn audio ON and to select an audio mode. Push and hold to turn audio system OFF.

Rear seat entertainment system (if equipped)

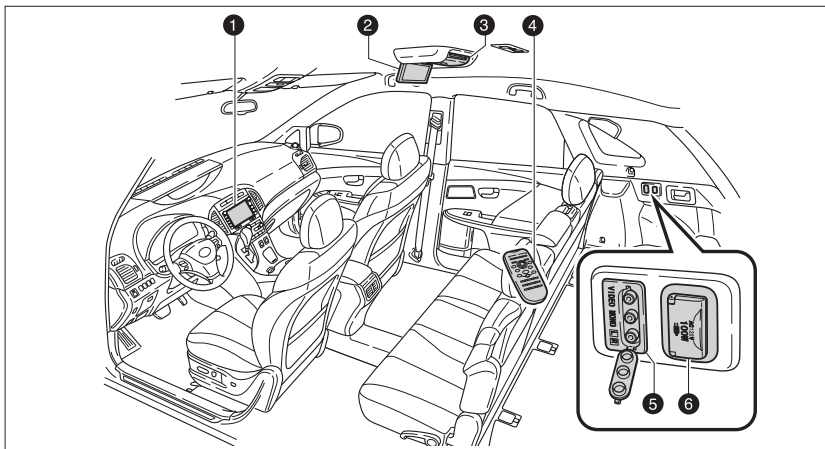

- 1 Front audio system
- 2 Display
- 3 DVD player
- 4 Remote controller
- 5 A/V input port
- 6 120V AC Power outlet

Cruise control

Turning system ON/OFF

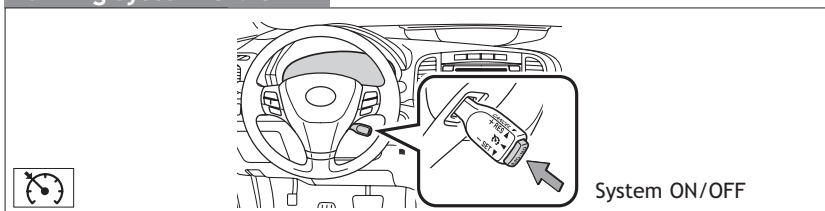

Functions

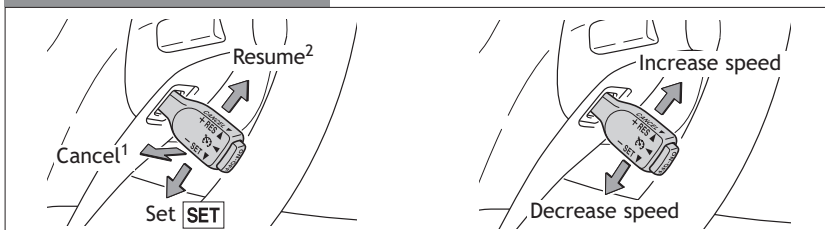

¹ The set speed may also be cancelled by depressing the brake pedal.

² The set speed may be resumed once vehicle speed exceeds 25 mph.

Power outlets-12V DC

Instrument panel

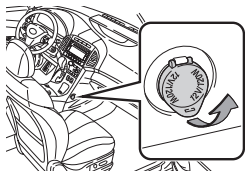

Inside center console

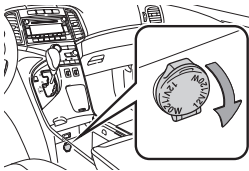

Luggage compartment

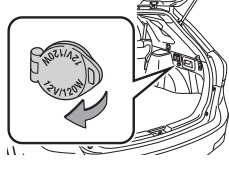

NOTE: Designed for car accessories. Engine switch/“ENGINE START STOP” switch must be in the ACCESSORY or ON position to be used.

Power outlet-120V AC (if equipped)

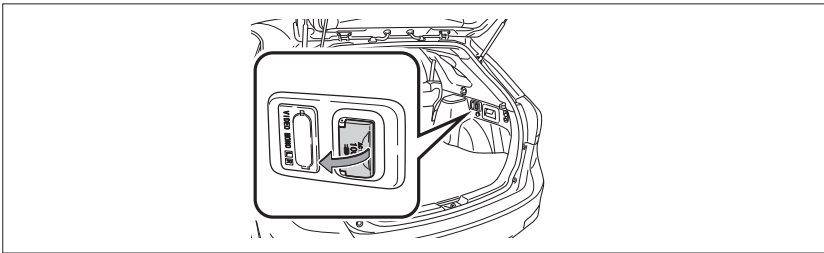

NOTE: Engine switch/“ENGINE START STOP” switch must be in the “ON” position to be used.

Garage door opener (HomeLink®)* (if equipped)

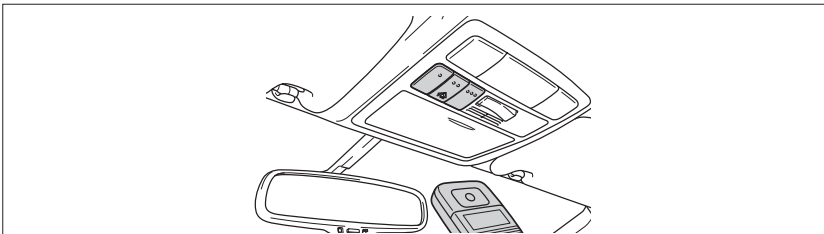

Garage door openers manufactured under license from HomeLink®* can be programmed to operate garage doors, estate gates, security lighting, etc.

Refer to “Garage door opener,” Section 3-8 in the *Owner’s Manual* for more details.

For programming assistance, contact HomeLink® at 1-800-355-3515, or visit <http://www.homelink.com>.

* HomeLink® is a registered trademark of Johnson Controls, Inc.

Multi-information display (clock)

TFT type*

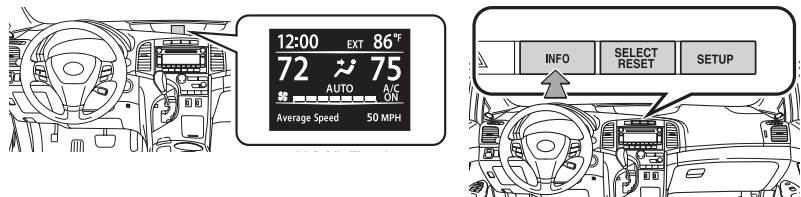

LCD type

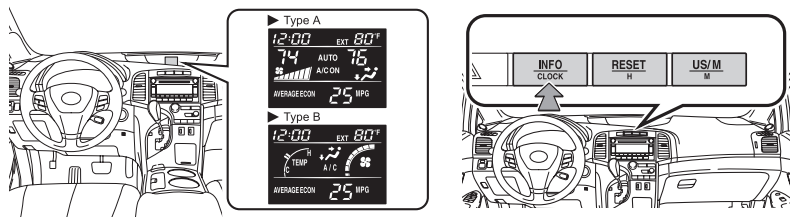

Push “INFO” or “INFO-CLOCK” to change information in the following:

- (1) Average fuel economy (AVERAGE ECON)
- (2) Current fuel economy (CURRENT ECON)
- (3) Distance to empty (RANGE)
- (4) Average speed (AVERAGE SPEED)
- (5) Trip timer (TFT type only)

Setting the clock

TFT type* (1) Press the “SETUP” button for the “Custom Settings” screen. (2) Select “Clock” on the Display Settings screen, and press the “SELECT RESET” button. (3) Press the “INFO” button to adjust the hours and the “SETUP” button to adjust the minutes. (4) Press the “SELECT RESET” button to set the clock.

LCD type (1) Press and hold the “INFO-CLOCK” button until part of the display begins to flash. (2) Press and hold the “RESET-H” button to adjust the hours and the “US/M-M” button to adjust the minutes. (3) Press the “INFO-CLOCK” button to complete the setting.

* On vehicles equipped with back-up camera

Telephone controls (Bluetooth®) (if equipped)

Audio unit

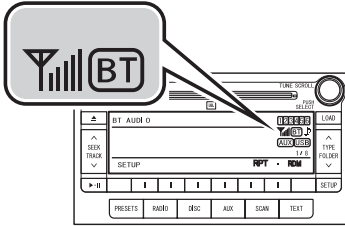

Microphone

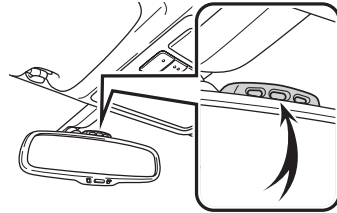

Steering wheel telephone switches

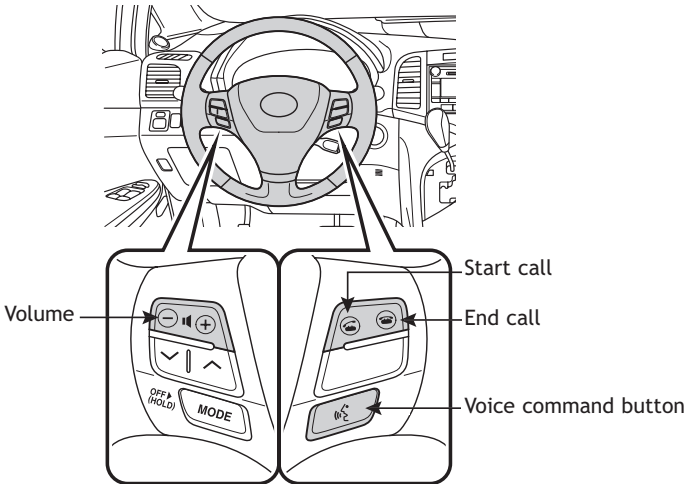

Bluetooth® technology allows dialing or receipt of calls without taking hands from the steering wheel or using a cable to connect the telephone and the system.

Refer to "Using the hands-free phone system (for cellular phone)," Section 3-5 in the *Owner's Manual*, or go to Toyota.LetsTalk.com for more information about phone connections and compatibility.

Customizable features

If your vehicle has a TFT type* multi-information display, you will be able to customize certain electronic features. Press the "SETUP" button while stopped to access the "Custom Settings" screen.

Please see the *Owner's Manual* for details.

* On vehicles equipped with back-up camera

SAFETY AND EMERGENCY FEATURES

Door locks

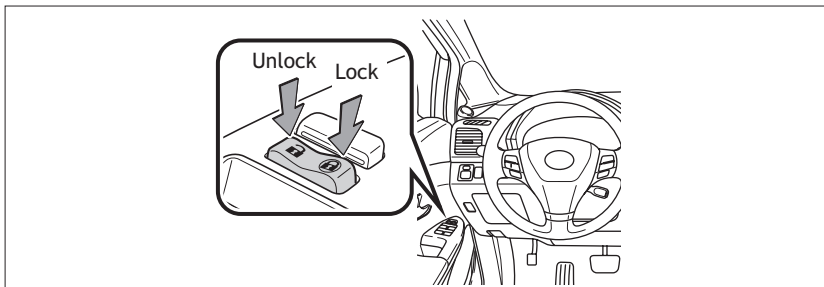

Seat belts

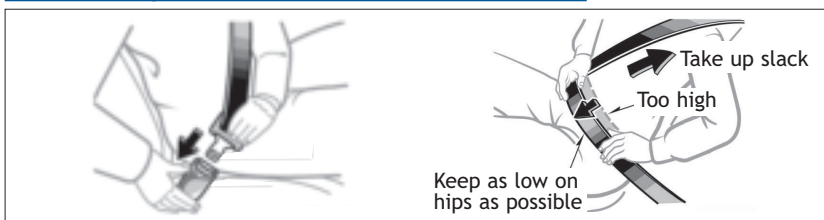

If belt is fully extended, then retracted even slightly, it cannot be re-extended beyond that point, unless fully retracted again. This feature is used to help hold child restraint systems securely.

To find more information about seat belts, and how to install a child restraint system, refer to the *Owner's Manual*.

Seat belts-Shoulder belt anchor

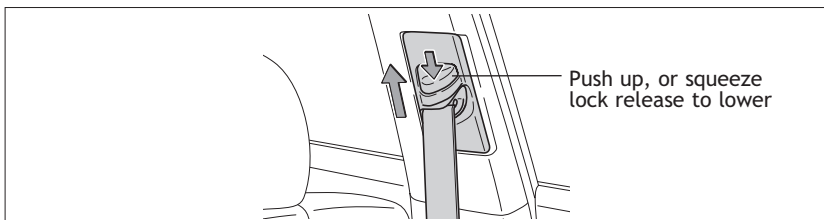

Tire Pressure Monitoring (warning) System

If tire pressure becomes critically low on any of the tires (excluding the spare), "⚠" indicator will illuminate. Correctly adjusting tire inflation will turn off the light after a few minutes. If the light does not turn off, have the system checked by your Toyota dealer.

Refer to the *Owner's Manual* for more details.