

	<b>Pictorial index</b>	Search by illustration	
1	<b>For safety and security</b>	Make sure to read through them	
2	<b>Instrument cluster</b>	How to read the gauges and meters, the variety of warning lights and indicators, etc.	
3	<b>Operation of each component</b>	Opening and closing the doors and windows, adjustment before driving, etc.	
4	<b>Driving</b>	Operations and advice which are necessary for driving	
5	<b>Audio system</b>	Operating the audio system	
6	<b>Interior features</b>	Usage of the interior features, etc.	
7	<b>Maintenance and care</b>	Caring for your vehicle and maintenance procedures	
8	<b>When trouble arises</b>	What to do in case of malfunction or emergency	
9	<b>Vehicle specifications</b>	Vehicle specifications, customizable features, etc.	
10	<b>For owners</b>	Reporting safety defects for U.S. owners, and seat belt and SRS airbag instructions for Canadian owners	
	<b>Index</b>	Search by symptom	
		Search alphabetically	

For your information..... 8  
 Reading this manual..... 12  
 How to search..... 13  
 Pictorial index ..... 14

**1 For safety and security**

**1-1. For safe use**

Before driving ..... 24  
 For safe driving ..... 26  
 Seat belts ..... 28  
 SRS airbags ..... 34  
 Front passenger occupant  
 classification system ..... 47  
 Safety information for  
 children ..... 53  
 Child restraint systems ..... 54  
 Installing child restraints ..... 58  
 Exhaust gas  
 precautions ..... 66

**1-2. Theft deterrent system**

Engine immobilizer  
 system..... 67  
 Alarm..... 69

**2 Instrument cluster**

**2. Instrument cluster**

Warning lights and  
 indicators ..... 72  
 Gauges and meters  
 (vehicles with a  
 monochrome display) ..... 77  
 Gauges and meters  
 (vehicles with a  
 color display) ..... 86  
 Fuel consumption  
 information..... 96  
 Eco Driving Indicator ..... 99

### 3 Operation of each component

<b>3-1. Key information</b>	
Keys .....	102
<b>3-2. Opening, closing and locking the doors</b>	
Doors .....	108
Trunk .....	117
Smart key system .....	122
<b>3-3. Adjusting the seats</b>	
Front seats .....	130
Rear seats .....	132
Head restraints .....	134
<b>3-4. Adjusting the steering wheel and mirrors</b>	
Steering wheel .....	137
Inside rear view mirror .....	139
Outside rear view mirrors .....	141
<b>3-5. Opening and closing the windows</b>	
Power windows .....	143
Moon roof .....	147

### 4 Driving

<b>4-1. Before driving</b>		
Driving the vehicle .....	152	1
Cargo and luggage .....	163	
Vehicle load limits .....	166	
Trailer towing .....	167	2
Dinghy towing (vehicles with a continuously variable transmission) .....	168	
Dinghy towing (vehicles with a manual transmission) .....	169	3
<b>4-2. Driving procedures</b>		4
Engine (ignition) switch (vehicles without a smart key system) .....	171	5
Engine (ignition) switch (vehicles with a smart key system) .....	174	6
Continuously variable transmission (vehicles without paddle shift switches) .....	181	7
Continuously variable transmission (vehicles with paddle shift switches) .....	184	8
Manual transmission .....	189	
Turn signal lever .....	191	9
Parking brake .....	192	
<b>4-3. Operating the lights and wipers</b>		10
Headlight switch .....	193	
Automatic High Beam .....	198	
Windshield wipers and washer .....	202	

<b>4-4. Refueling</b>		<b>5-3. Using Entune Audio</b>	
Opening the fuel tank cap .....	204	Selecting the audio source.....	284
<b>4-5. Using the driving support systems</b>		List screen operation .....	285
Toyota Safety Sense P .....	207	Optimal use of Entune Audio.....	287
PCS (Pre-Collision System) ....	214	<b>5-4. Using the radio</b>	
LDA (Lane Departure Alert with steering control).....	226	Radio operation .....	288
Dynamic radar cruise control .....	235	<b>5-5. Playing an audio CD and MP3/WMA/AAC discs</b>	
Rear view monitor system.....	247	CD player operation.....	290
Driving assist systems.....	257	<b>5-6. Using an external device</b>	
<b>4-6. Driving tips</b>		Listening to an iPod .....	296
Winter driving tips.....	263	Listening to a USB memory device .....	301
		Using the AUX port.....	305
		<b>5-7. Connecting Bluetooth®</b>	
<b>5 Audio system</b>		Preparations to use wireless communication .....	306
<b>5-1. Basic Operations</b>		Registering a Bluetooth® audio player for the first time.....	310
Audio system types .....	270	Registering a Bluetooth® phone for the first time.....	311
Steering wheel audio switches .....	271	Registering a Bluetooth® device .....	312
AUX port/USB port .....	272	Connecting a Bluetooth® device .....	315
Entune Audio.....	273	Displaying a Bluetooth® device details.....	318
Basic audio operations.....	276	Detailed Bluetooth® system settings.....	319
<b>5-2. Setup</b>			
Setup menu.....	278		
General settings .....	279		
Audio settings.....	281		
Display settings .....	282		
Voice settings.....	283		

<b>5-8. Bluetooth® Audio</b>	
Listening to Bluetooth® Audio.....	320
<b>5-9. Bluetooth® phone</b>	
Using a Bluetooth® Phone.....	322
Making a call .....	325
Receiving a call .....	328
Speaking on the phone .....	329
Bluetooth® phone message function.....	333
Using the steering wheel switches .....	338
Bluetooth® phone settings.....	339
Contact/ Call History Settings.....	341
What to do if... (Troubleshooting).....	351
<b>5-10. Bluetooth®</b>	
Bluetooth®.....	355
<b>5-11. Using the voice command system</b>	
Voice command system.....	359

## 6 Interior features

<b>6-1. Using the air conditioning system and defogger</b>	
Manual air conditioning system .....	366
Automatic air conditioning system .....	373
Heated steering wheel/ seat heaters.....	382
<b>6-2. Using the interior lights</b>	
Interior lights list.....	384
• Front interior light/ personal lights .....	385
• Rear interior light.....	386
<b>6-3. Using the storage features</b>	
List of storage features .....	387
• Glove box .....	388
• Console box .....	388
• Bottle holders .....	389
• Cup holders .....	390
<b>6-4. Other interior features</b>	
Other interior features.....	392
• Sun visors .....	392
• Vanity mirrors .....	392
• Clock .....	392
• Outside temperature display .....	393
• Power outlet .....	394
• Assist grips.....	395
Garage door opener .....	396
Compass .....	403

**7 Maintenance and care**

<b>7-1. Maintenance and care</b>	
Cleaning and protecting the vehicle exterior .....	408
Cleaning and protecting the vehicle interior .....	411
<b>7-2. Maintenance</b>	
Maintenance requirements .....	414
General maintenance .....	417
Emission inspection and maintenance (I/M) programs .....	421
<b>7-3. Do-it-yourself maintenance</b>	
Do-it-yourself service precautions .....	422
Hood .....	425
Positioning a floor jack .....	427
Engine compartment .....	429
Tires .....	440
Tire inflation pressure .....	448
Wheels .....	451
Air conditioning filter .....	453
Wireless remote control/electronic key battery .....	455
Checking and replacing fuses .....	458
Light bulbs .....	461

**8 When trouble arises**

<b>8-1. Essential information</b>	
Emergency flashers .....	470
If your vehicle has to be stopped in an emergency .....	471
<b>8-2. Steps to take in an emergency</b>	
If your vehicle needs to be towed .....	473
If you think something is wrong .....	478
Fuel pump shut off system .....	479
If a warning light turns on or a warning buzzer sounds .....	480
If a warning message or indicator is displayed .....	489
If you have a flat tire .....	509
If the engine will not start .....	521
If the electronic key does not operate properly .....	523
If the vehicle battery is discharged .....	526
If your vehicle overheats .....	531
If the vehicle becomes stuck .....	534

**9 Vehicle specifications****9-1. Specifications**

Maintenance data (fuel, oil level, etc.) .....	538
Fuel information .....	548
Tire information .....	551

**9-2. Customization**

Customizable features .....	564
-----------------------------	-----

**9-3. Items to initialize**

Items to initialize.....	573
--------------------------	-----

**10 For owners**

Reporting safety defects for U.S. owners .....	576
Seat belt instructions for Canadian owners (in French).....	577
SRS airbag instructions for Canadian owners (in French).....	579

**Index**

What to do if... (Troubleshooting).....	590
Alphabetical index.....	595

1

2

3

4

5

6

7

8

9

10

For vehicles with an Entune Premium Audio or Entune Audio Plus, refer to the "NAVIGATION AND MULTIMEDIA SYSTEM OWNER'S MANUAL" for information regarding Entune Premium Audio or Entune Audio Plus.

---

## For your information

### **Main Owner's Manual**

Please note that this manual applies to all models and explains all equipment, including options. Therefore, you may find some explanations for equipment not installed on your vehicle.

All specifications provided in this manual are current at the time of printing. However, because of the Toyota policy of continual product improvement, we reserve the right to make changes at any time without notice.

Depending on specifications, the vehicle shown in the illustrations may differ from your vehicle in terms of color and equipment.

### **Noise from under vehicle after turning off the engine**

Approximately five hours after the engine is turned off, you may hear sound coming from under the vehicle for several minutes. This is the sound of a fuel evaporation leakage check and, it does not indicate a malfunction.

### **Accessories, spare parts and modification of your Toyota**

A wide variety of non-genuine spare parts and accessories for Toyota vehicles are currently available in the market. You should know that Toyota does not warrant these products and is not responsible for their performance, repair, or replacement, or for any damage they may cause to, or adverse effect they may have on, your Toyota vehicle.

This vehicle should not be modified with non-genuine Toyota products. Modification with non-genuine Toyota products could affect its performance, safety or durability, and may even violate governmental regulations. In addition, damage or performance problems resulting from the modification may not be covered under warranty.



---

### Installation of a mobile two-way radio system

The installation of a mobile two-way radio system in your vehicle could affect electronic systems such as:

- Multiport fuel injection system/sequential multiport fuel injection system
- Toyota Safety Sense P
- Anti-lock brake system
- SRS airbag system
- Seat belt pretensioner system

Be sure to check with your Toyota dealer for precautionary measures or special instructions regarding installation of a mobile two-way radio system.

### Vehicle data recordings

Your Toyota is equipped with several sophisticated computers that will record certain data, such as:

- Engine speed
- Accelerator status
- Brake status
- Vehicle speed
- Shift position (vehicles with a continuously variable transmission)

The recorded data varies according to the vehicle grade level and options with which it is equipped. These computers do not record conversations or sounds, and only record images outside of the vehicle in certain situations.

- Data Transmission

Your vehicle may transmit the data recorded in these computers to Toyota without notification to you.

- Data usage

Toyota may use the data recorded in these computers to diagnose malfunctions, conduct research and development, and improve quality.

Toyota will not disclose the recorded data to a third party except:

- With the consent of the vehicle owner or with the consent of the lessee if the vehicle is leased
- In response to an official request by the police, a court of law or a government agency
- For use by Toyota in a lawsuit
- For research purposes where the data is not tied to a specific vehicle or vehicle owner

- To learn more about the vehicle data collected, used and shared by Toyota, please visit [www.toyota.com/privacyvts/](http://www.toyota.com/privacyvts/).

---

### Event data recorder

This vehicle is equipped with an event data recorder (EDR). The main purpose of an EDR is to record, in certain crash or near crash-like situations, such as an air bag deployment or hitting a road obstacle, data that will assist in understanding how a vehicle's systems performed. The EDR is designed to record data related to vehicle dynamics and safety systems for a short period of time, typically 30 seconds or less.

The EDR in this vehicle is designed to record such data as:

- How various systems in your vehicle were operating;
- Whether or not the driver and passenger safety belts were buckled/fastened;
- How far (if at all) the driver was depressing the accelerator and/or brake pedal; and,
- How fast the vehicle was traveling.

These data can help provide a better understanding of the circumstances in which crashes and injuries occur.

NOTE: EDR data are recorded by your vehicle only if a non-trivial crash situation occurs; no data are recorded by the EDR under normal driving conditions and no personal data (e.g., name, gender, age, and crash location) are recorded. However, other parties, such as law enforcement, could combine the EDR data with the type of personally identifying data routinely acquired during a crash investigation.

To read data recorded by an EDR, special equipment is required, and access to the vehicle or the EDR is needed. In addition to the vehicle manufacturer, other parties, such as law enforcement, that have the special equipment, can read the information if they have access to the vehicle or the EDR.

#### ● Disclosure of the EDR data

Toyota will not disclose the data recorded in an EDR to a third party except when:

- An agreement from the vehicle's owner (or the lessee for a leased vehicle) is obtained
- In response to an official request by the police, a court of law or a government agency
- For use by Toyota in a lawsuit

However, if necessary, Toyota may:

- Use the data for research on vehicle safety performance
- Disclose the data to a third party for research purposes without disclosing information about the specific vehicle or vehicle owner

### Scraping of your Toyota

The SRS airbag and seat belt pretensioner devices in your Toyota contain explosive chemicals. If the vehicle is scrapped with the airbags and seat belt pretensioners left as they are, this may cause an accident such as fire. Be sure to have the systems of the SRS airbag and seat belt pretensioner removed and disposed of by a qualified service shop or by your Toyota dealer before you scrap your vehicle.

### Perchlorate Material

Special handling may apply, See [www.dtsc.ca.gov/hazardouswaste/perchlorate](http://www.dtsc.ca.gov/hazardouswaste/perchlorate).

Your vehicle has components that may contain perchlorate. These components may include airbag, seat belt pretensioners, and wireless remote control batteries.

#### WARNING

##### ■ General precautions while driving

**Driving under the influence:** Never drive your vehicle when under the influence of alcohol or drugs that have impaired your ability to operate your vehicle. Alcohol and certain drugs delay reaction time, impair judgment and reduce coordination, which could lead to an accident that could result in death or serious injury.

**Defensive driving:** Always drive defensively. Anticipate mistakes that other drivers or pedestrians might make and be ready to avoid accidents.

**Driver distraction:** Always give your full attention to driving. Anything that distracts the driver, such as adjusting controls, talking on a cellular phone or reading can result in a collision with resulting death or serious injury to you, your occupants or others.

##### ■ General precaution regarding children's safety

Never leave children unattended in the vehicle, and never allow children to have or use the key.

Children may be able to start the vehicle or shift the vehicle into neutral. There is also a danger that children may injure themselves by playing with the windows, the moon roof, or other features of the vehicle. In addition, heat build-up or extremely cold temperatures inside the vehicle can be fatal to children.

## Reading this manual



### WARNING:

Explains something that, if not obeyed, could cause death or serious injury to people.



### NOTICE:

Explains something that, if not obeyed, could cause damage to or a malfunction in the vehicle or its equipment.



Indicates operating or working procedures. Follow the steps in numerical order.



Indicates the action (pushing, turning, etc.) used to operate switches and other devices.



Indicates the outcome of an operation (e.g. a lid opens).

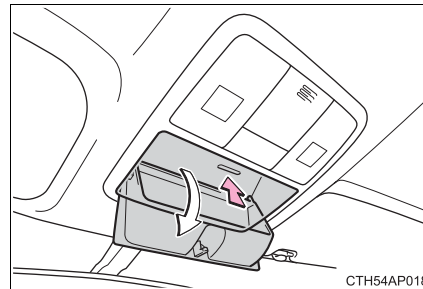

Indicates the component or position being explained.



Means “Do not”, “Do not do this”, or “Do not let this happen”.

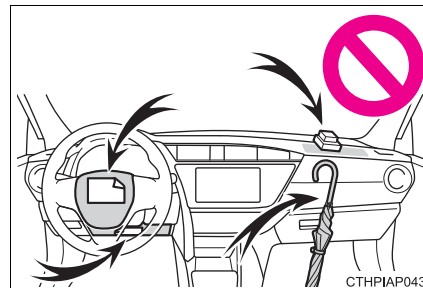

## How to search

### ■ Searching by name

- Alphabetical index .....P. 595

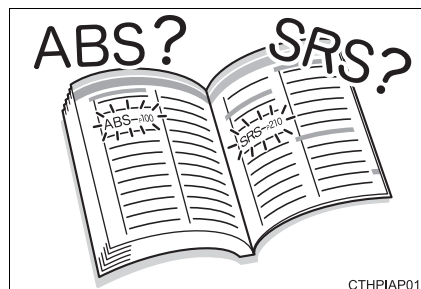

### ■ Searching by installation position

- Pictorial index .....P. 14

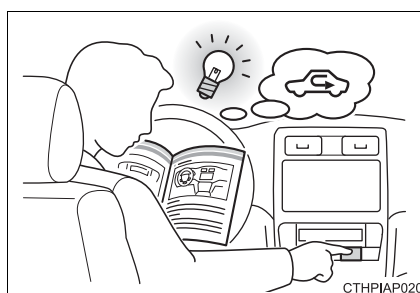

### ■ Searching by symptom or sound

- What to do if...  
(Troubleshooting) .....P. 590



### ■ Searching by title

- Table of contents .....P. 2

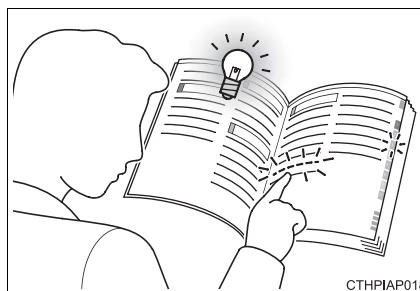

## Pictorial index

### ■ Exterior

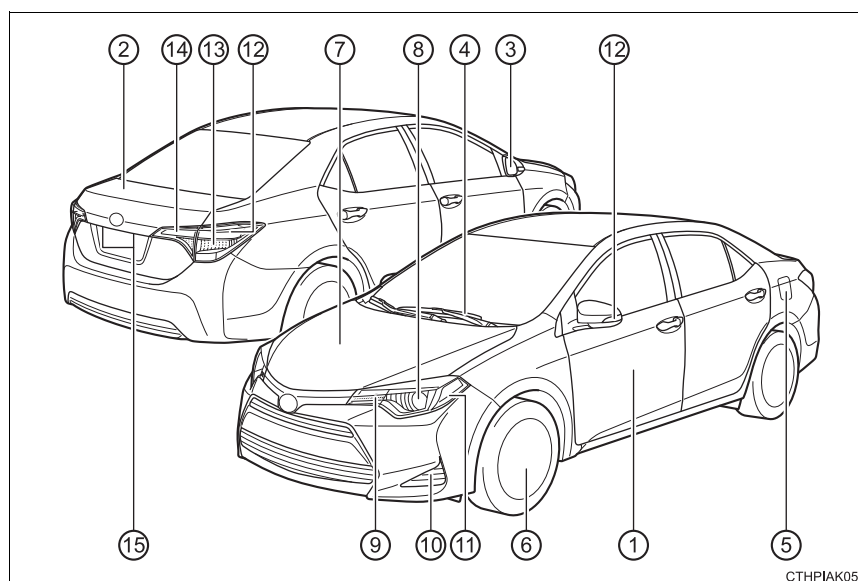

①	<b>Doors</b> .....	<b>P. 108</b>
	Locking/unlocking .....	P. 108
	Opening/closing the door glasses .....	P. 143
	Locking/unlocking by using the mechanical key* .....	P. 523
	Warning lights/warning messages .....	P. 480, 489
②	<b>Trunk</b> .....	<b>P. 117</b>
	Opening from inside .....	P. 117
	Opening from outside .....	P. 117
	Warning lights/warning messages .....	P. 480, 489
③	<b>Outside rear view mirrors</b> .....	<b>P. 141</b>
	Adjusting the mirror angle .....	P. 141
	Folding the mirrors .....	P. 141
	Defogging the mirrors* .....	P. 368, 376

- ④ **Windshield wipers** . . . . . **P. 202**  
     Precautions against winter season . . . . . P. 263  
     To prevent freezing (windshield wiper de-icer)\* . . . . . P. 376
- ⑤ **Fuel filler door** . . . . . **P. 204**  
     Refueling method . . . . . P. 204  
     Fuel type/fuel tank capacity . . . . . P. 540
- ⑥ **Tires** . . . . . **P. 440**  
     Tire size/inflation pressure . . . . . P. 546  
     Winter tires/tire chain . . . . . P. 263  
     Checking/rotation/tire pressure warning system\* . . . . . P. 440  
     Coping with flat tires . . . . . P. 509
- ⑦ **Hood** . . . . . **P. 425**  
     Opening . . . . . P. 425  
     Engine oil . . . . . P. 540  
     Coping with overheat . . . . . P. 531

#### Light bulbs of the exterior lights for driving

(Replacing method: P. 461, Watts: P. 547)

- ⑧ **Headlights/daytime running lights\*** . . . . . **P. 193**
- ⑨ **Front turn signal/parking lights** . . . . . **P. 193**
- ⑩ **Daytime running lights\*** . . . . . **P. 193**
- ⑪ **Front side marker lights** . . . . . **P. 193**
- ⑫ **Turn signal lights\*** . . . . . **P. 191**
- ⑬ **Stop/tail lights/rear side marker lights** . . . . . **P. 193**
- ⑭ **Back-up lights**  
     Shifting the shift lever to R. . . . . P. 181, 184, 189
- ⑮ **License plate lights** . . . . . **P. 193**

\*: If equipped

■ Instrument panel

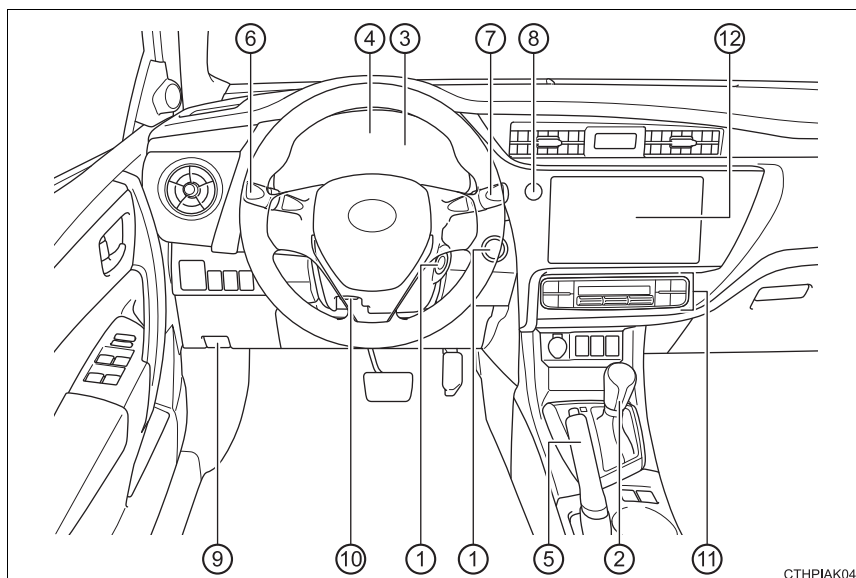

- ① **Engine switch** . . . . . **P. 171, 174**  
 Starting the engine/changing the modes . . . . . P. 171, 174  
 Emergency stop of the engine . . . . . P. 471  
 When the engine will not start . . . . . P. 521  
 Warning messages . . . . . P. 489
- ② **Shift lever** . . . . . **P. 181, 184, 189**  
 Changing the shift position . . . . . P. 181, 184, 189  
 Precautions against towing . . . . . P. 473  
 When the shift lever does not move\*1 . . . . . P. 183, 188
- ③ **Meters** . . . . . **P. 77, 86**  
 Reading the meters/adjusting the meter light . . . . . P. 77, 86  
 Warning lights/indicator lights . . . . . P. 72  
 When the warning lights come on . . . . . P. 480



- ④ **Multi-information display** . . . . . **P. 77, 86**  
When the warning messages are displayed . . . . . P. 489
- ⑤ **Parking brake** . . . . . **P. 192**  
Applying/releasing . . . . . P. 192  
Precautions against winter season . . . . . P. 264  
Warning buzzer/message . . . . . P. 489
- ⑥ **Turn signal lever** . . . . . **P. 191**  
**Headlight switch** . . . . . **P. 193**  
Headlights/front parking lights/tail lights/  
daytime running lights . . . . . P. 193
- ⑦ **Windshield wiper and washer switch** . . . . . **P. 202**  
Usage . . . . . P. 202  
Adding washer fluid . . . . . P. 439  
Warning messages\*<sup>1</sup> . . . . . P. 497
- ⑧ **Emergency flasher switch** . . . . . **P. 470**
- ⑨ **Hood lock release lever** . . . . . **P. 425**
- ⑩ **Tilt and telescopic steering control lever** . . . . . **P. 137**
- ⑪ **Air conditioning system** . . . . . **P. 366, 373**  
Usage . . . . . P. 366, 373  
Rear window defogger . . . . . P. 368, 376
- ⑫ **Entune Audio**\*<sup>1</sup> . . . . . **P. 273**  
**Entune Audio Plus**\*<sup>1, 2</sup>  
**Entune Premium Audio**\*<sup>1, 2</sup>

\*<sup>1</sup>: If equipped

\*<sup>2</sup>: For vehicles with an Entune Premium Audio or Entune Audio Plus, refer to  
"NAVIGATION AND MULTIMEDIA SYSTEM OWNER'S MANUAL".

■ Switches

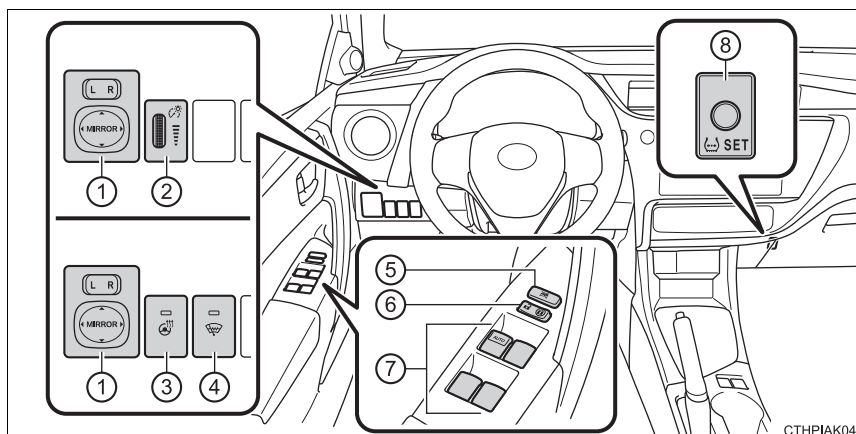

- ① Outside rear view mirror switches ..... P. 141
- ② Instrument panel light control dial\*<sup>1</sup> ..... P. 79, 88
- ③ Heated steering wheel switch\*<sup>1</sup> ..... P. 383
- ④ Windshield wiper de-icer switch\*<sup>1</sup> ..... P. 376
- ⑤ Window lock switch ..... P. 143
- ⑥ Door lock switch ..... P. 111
- ⑦ Power window switches ..... P. 143
- ⑧ Tire pressure warning reset switch\*<sup>1</sup> ..... P. 442

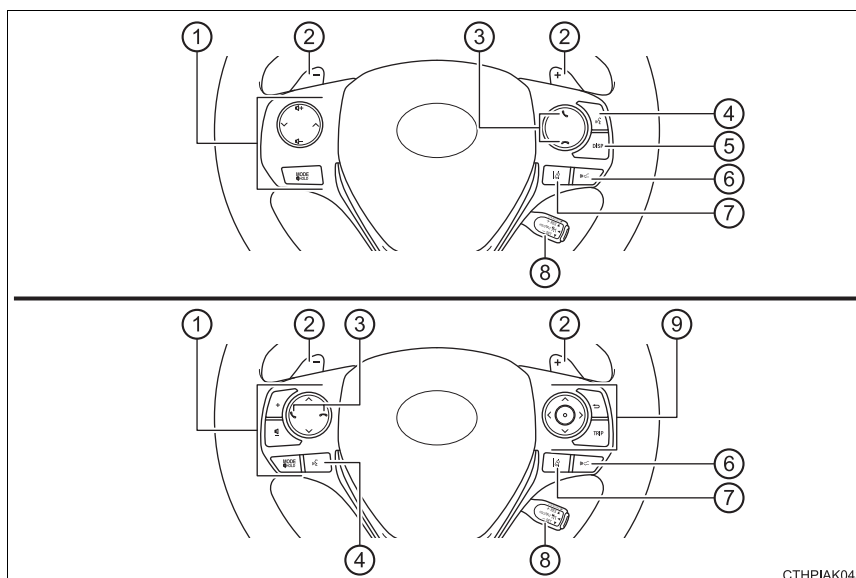

CTHPIAK043

- ① Audio remote control switches\*2 ..... P. 271
- ② Paddle shift switches\*1 ..... P. 184
- ③ Telephone switches\*2 ..... P. 338
- ④ Talk switch\*2 ..... P. 359
- ⑤ “DISP” switch\*1 ..... P. 81
- ⑥ Vehicle-to-vehicle distance switch ..... P. 235
- ⑦ LDA (Lane Departure Alert with steering control) switch ..... P. 229
- ⑧ Dynamic radar cruise control switch ..... P. 235
- ⑨ Meter control switches\*1 ..... P. 91

\*1: If equipped

\*2: For vehicles with an Entune Premium Audio or Entune Audio Plus, refer to “NAVIGATION AND MULTIMEDIA SYSTEM OWNER’S MANUAL”.

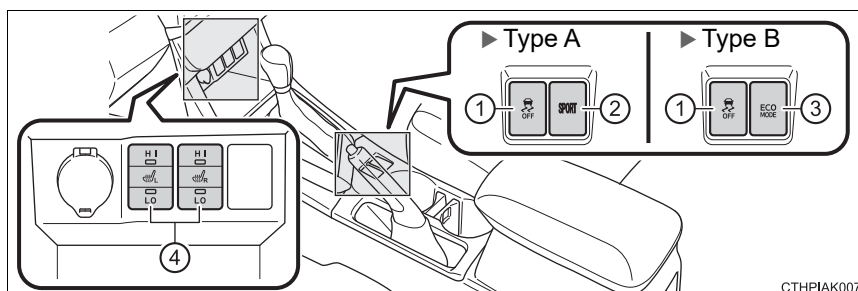

CTHPIAK007

- ① VSC OFF switch ..... P. 258
- ② Sport mode switch\* ..... P. 185
- ③ “ECO MODE” switch\* ..... P. 182
- ④ Seat heater switches\* ..... P. 383

**Interior**

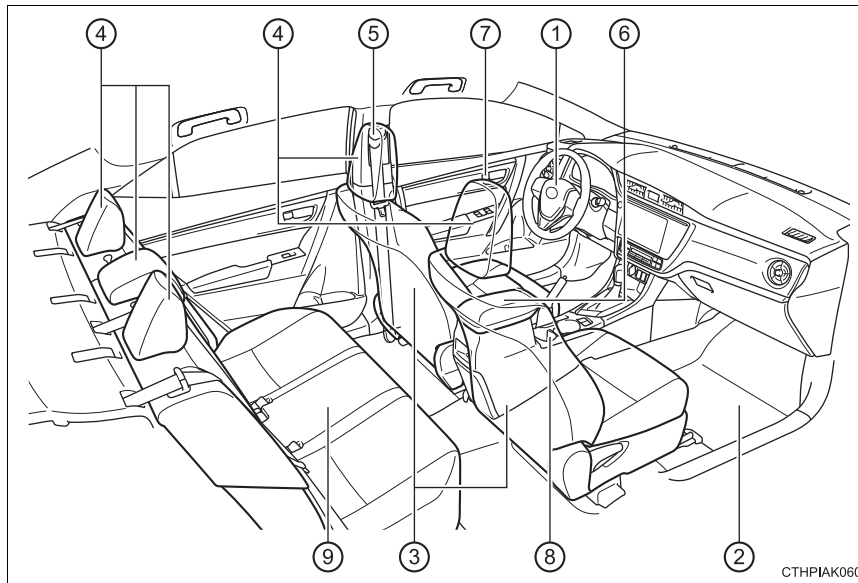

① SRS airbags .....	P. 34
② Floor mats .....	P. 24
③ Front seats .....	P. 130
④ Head restraints .....	P. 134
⑤ Seat belts .....	P. 28
⑥ Console box .....	P. 388
⑦ Inside lock buttons .....	P. 111
⑧ Cup holders .....	P. 390
⑨ Rear seats .....	P. 132

\*: If equipped

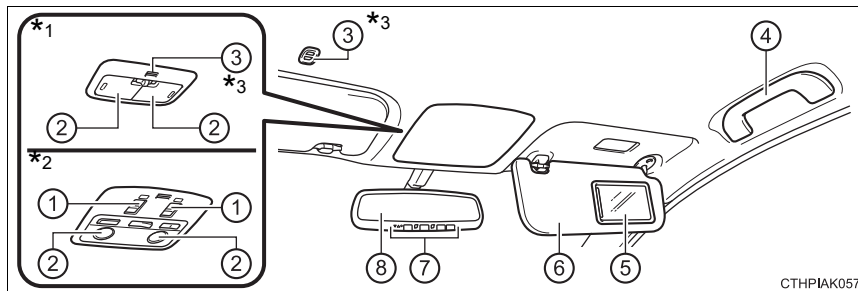

- ① Moon roof switches<sup>\*3</sup> ..... P. 147
- ② Interior light/personal lights<sup>\*4</sup> ..... P. 385, 386
- ③ Microphone<sup>\*5</sup> ..... P. 323
- ④ Assist grips ..... P. 395
- ⑤ Vanity mirrors ..... P. 392
- ⑥ Sun visors ..... P. 392
- ⑦ Auto anti-glare inside rear view mirror<sup>\*3</sup>/  
compass<sup>\*3</sup>/garage door opener switches<sup>\*3</sup> ... P. 139, 396, 403
- ⑧ Inside rear view mirror ..... P. 139

\*1: Vehicles without a moon roof

\*2: Vehicles with a moon roof

\*3: If equipped

\*4: The illustration shows the front, but they are also equipped in the rear.

\*5: For vehicles with an Entune Premium Audio or Entune Audio Plus, refer to  
"NAVIGATION AND MULTIMEDIA SYSTEM OWNER'S MANUAL".

**For safety and security****1****1-1. For safe use**

Before driving .....	24
For safe driving .....	26
Seat belts .....	28
SRS airbags.....	34
Front passenger occupant classification system .....	47
Safety information for children .....	53
Child restraint systems.....	54
Installing child restraints.....	58
Exhaust gas precautions.....	66

**1-2. Theft deterrent system**

Engine immobilizer system .....	67
Alarm.....	69

## Before driving

### Floor mat

Use only floor mats designed specifically for vehicles of the same model and model year as your vehicle. Fix them securely in place onto the carpet.

- 1 Insert the retaining hooks (clips) into the floor mat eyelets.

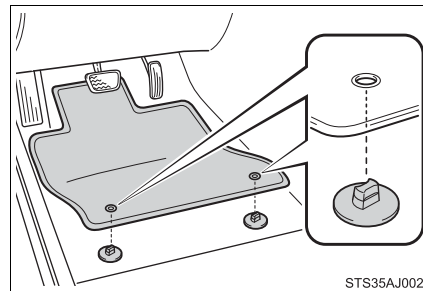

- 2 Turn the upper knob of each retaining hook (clip) to secure the floor mats in place.

\*: Always align the  $\triangle$  marks.

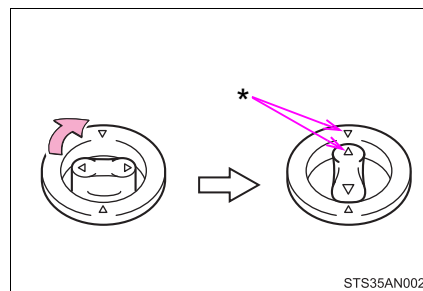

The shape of the retaining hooks (clips) may differ from that shown in the illustration.



**⚠ WARNING**

Observe the following precautions.

Failure to do so may cause the driver's floor mat to slip, possibly interfering with the pedals while driving. An unexpectedly high speed may result or it may become difficult to stop the vehicle. This could lead to an accident, resulting in death or serious injury.

**■ When installing the driver's floor mat**

- Do not use floor mats designed for other models or different model year vehicles, even if they are Toyota Genuine floor mats.
- Only use floor mats designed for the driver's seat.
- Always install the floor mat securely using the retaining hooks (clips) provided.
- Do not use two or more floor mats on top of each other.
- Do not place the floor mat bottom-side up or upside-down.

**■ Before driving**

- Check that the floor mat is securely fixed in the correct place with all the provided retaining hooks (clips). Be especially careful to perform this check after cleaning the floor.
- With the engine stopped and the shift lever in P (continuously variable transmission) or N (manual transmission), fully depress each pedal to the floor to make sure it does not interfere with the floor mat.

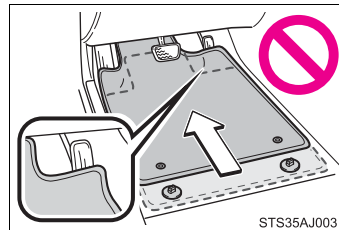

## For safe driving

**For safe driving, adjust the seat and mirror to an appropriate position before driving.**

### Correct driving posture

- ① Adjust the angle of the seat-back so that you are sitting straight up and so that you do not have to lean forward to steer. (→P. 130)
- ② Adjust the seat so that you can depress the pedals fully and so that your arms bend slightly at the elbow when gripping the steering wheel. (→P. 130)
- ③ Lock the head restraint in place with the center of the head restraint closest to the top of your ears. (→P. 134)
- ④ Wear the seat belt correctly. (→P. 28)

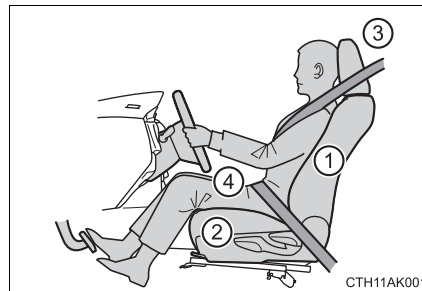

### Correct use of the seat belts

Make sure that all occupants are wearing their seat belts before driving the vehicle. (→P. 28)

Use a child restraint system appropriate for the child until the child becomes large enough to properly wear the vehicle's seat belt. (→P. 54)

### Adjusting the mirrors

Make sure that you can see backward clearly by adjusting the inside and outside rear view mirrors properly. (→P. 139, 141)

#### WARNING

Observe the following precautions.

Failure to do so may result in death or serious injury.

- Do not adjust the position of the driver's seat while driving.  
Doing so could cause the driver to lose control of the vehicle.
- Do not place a cushion between the driver or passenger and the seatback.  
A cushion may prevent correct posture from being achieved, and reduce the effectiveness of the seat belt and head restraint.
- Do not place anything under the front seats.  
Objects placed under the front seats may become jammed in the seat tracks and stop the seat from locking in place. This may lead to an accident and the adjustment mechanism may also be damaged.
- Always observe the legal speed limit when driving on public roads.
- When driving over long distances, take regular breaks before you start to feel tired.  
Also, if you feel tired or sleepy while driving, do not force yourself to continue driving and take a break immediately.

## Seat belts

**Make sure that all occupants are wearing their seat belts before driving the vehicle.**

### Correct use of the seat belts

- Extend the shoulder belt so that it comes fully over the shoulder, but does not come into contact with the neck or slide off the shoulder.
- Position the lap belt as low as possible over the hips.
- Adjust the position of the seat-back. Sit up straight and well back in the seat.
- Do not twist the seat belt.

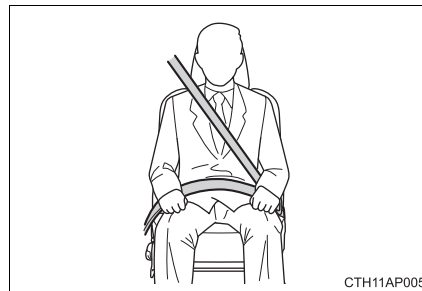

### Fastening and releasing the seat belt

- ① To fasten the seat belt, push the plate into the buckle until a click sound is heard.
- ② To release the seat belt, press the release button.

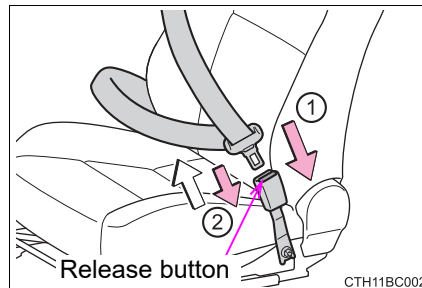

### Adjusting the seat belt shoulder anchor height (front seats)

- ① Push the seat belt shoulder anchor down while pressing the release button.
- ② Push the seat belt shoulder anchor up.

Move the height adjuster up and down as needed until you hear a click.

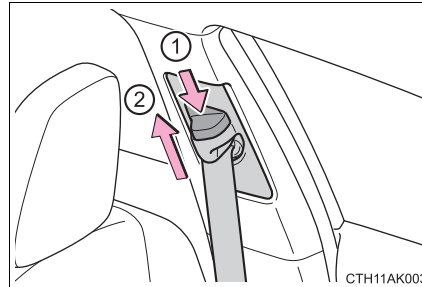

### Seat belt pretensioners (front seats)

The pretensioners help the seat belts to quickly restrain the occupants by retracting the seat belts when the vehicle is subjected to certain types of severe frontal or side collision or a vehicle rollover.

The pretensioners do not activate in the event of a minor frontal impact, a minor side impact or a rear impact.

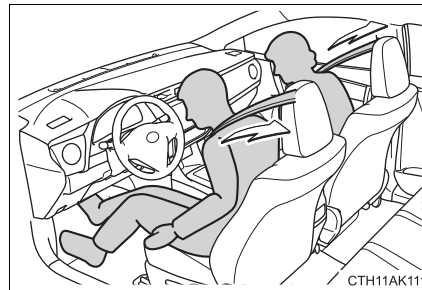

**■ Emergency locking retractor (ELR)**

The retractor will lock the belt during a sudden stop or on impact. It may also lock if you lean forward too quickly. A slow, easy motion will allow the belt to extend so that you can move around fully.

**■ Automatic locking retractor (ALR)**

When a passenger's shoulder belt is completely extended and then retracted even slightly, the belt is locked in that position and cannot be extended. This feature is used to hold the child restraint system (CRS) firmly. To free the belt again, fully retract the belt and then pull the belt out once more. (→P. 58)

**■ Child seat belt usage**

The seat belts of your vehicle were principally designed for persons of adult size.

- Use a child restraint system appropriate for the child, until the child becomes large enough to properly wear the vehicle's seat belt. (→P. 54)
- When the child becomes large enough to properly wear the vehicle's seat belt, follow the instructions regarding seat belt usage. (→P. 28)

**■ Replacing the belt after the pretensioner has been activated (front seats)**

If the vehicle is involved in multiple collisions, the pretensioner will activate for the first collision, but will not activate for the second or subsequent collisions.

**■ Seat belt extender**

If your seat belts cannot be fastened securely because they are not long enough, a personalized seat belt extender is available from your Toyota dealer free of charge.

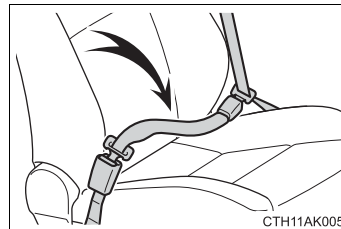

**⚠ WARNING**

Observe the following precautions to reduce the risk of injury in the event of sudden braking, sudden swerving or an accident. Failure to do so may cause death or serious injury.

**■ Wearing a seat belt**

- Ensure that all passengers wear a seat belt.
- Always wear a seat belt properly.
- Each seat belt should be used by one person only. Do not use a seat belt for more than one person at once, including children.
- Toyota recommends that children be seated in the rear seat and always use a seat belt and/or an appropriate child restraint system.
- To achieve a proper seating position, do not recline the seat more than necessary. The seat belt is most effective when the occupants are sitting up straight and well back in the seats.
- Do not wear the shoulder belt under your arm.
- Always wear your seat belt low and snug across your hips.

**■ Pregnant women**

Obtain medical advice and wear the seat belt in the proper way. (→P. 28)

Women who are pregnant should position the lap belt as low as possible over the hips in the same manner as other occupants, extending the shoulder belt completely over the shoulder and avoiding belt contact with the rounding of the abdominal area.

If the seat belt is not worn properly, not only the pregnant woman, but also the fetus could suffer death or serious injury as a result of sudden braking or a collision.

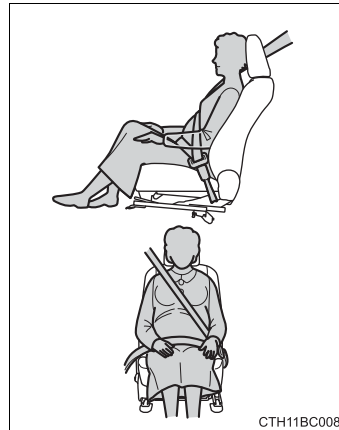

 **WARNING****■ People suffering illness**

Obtain medical advice and wear the seat belt in the proper way. (→P. 28)

**■ When children are in the vehicle**

Do not allow children to play with the seat belt. If the seat belt becomes twisted around a child's neck, it may lead to choking or other serious injuries that could result in death.

If this occurs and the buckle cannot be unfastened, scissors should be used to cut the belt.

**■ Seat belt pretensioners (front seats)**

- Do not place anything, such as a cushion, on the front passenger's seat. Doing so will disperse the passenger's weight, which prevents the sensor from detecting the passenger's weight properly. As a result, the seat belt pretensioner for the front passenger's seat may not activate in the event of a collision.

- If the pretensioner has activated, the SRS warning light will come on. In that case, the seat belt cannot be used again and must be replaced at your Toyota dealer.

**■ Adjustable shoulder anchor (front seats)**

Always make sure the shoulder belt is positioned across the center of your shoulder. The belt should be kept away from your neck, but not falling off your shoulder. Failure to do so could reduce the amount of protection in an accident and cause death or serious injuries in the event of a sudden stop, sudden swerve or accident. (→P. 29)

**■ Seat belt damage and wear**

- Do not damage the seat belts by allowing the belt, plate, or buckle to be jammed in the door.

- Inspect the seat belt system periodically. Check for cuts, fraying, and loose parts. Do not use a damaged seat belt until it is replaced. Damaged seat belts cannot protect an occupant from death or serious injury.

- Ensure that the belt and plate are locked and the belt is not twisted. If the seat belt does not function correctly, immediately contact your Toyota dealer.

- Replace the seat assembly, including the belts, if your vehicle has been involved in a serious accident, even if there is no obvious damage.

- Do not attempt to install, remove, modify, disassemble or dispose of the seat belts. Have any necessary repairs carried out by your Toyota dealer. Inappropriate handling may lead to incorrect operation.



 **WARNING****■ Using a seat belt extender**

- Do not wear the seat belt extender if you can fasten the seat belt without the extender.
- Do not use the seat belt extender when installing a child restraint system because the belt will not securely hold the child restraint system, increasing the risk of death or serious injury in the event of an accident.
- The personalized extender may not be safe on another vehicle, when used by another person, or at a different seating position other than the one originally intended.

 **NOTICE****■ When using a seat belt extender**

When releasing the seat belt, press on the buckle release button on the extender, not on the seat belt.  
This helps prevent damage to the vehicle interior and the extender itself.

## SRS airbags

The SRS airbags inflate when the vehicle is subjected to certain types of severe impacts that may cause significant injury to the occupants. They work together with the seat belts to help reduce the risk of death or serious injury.

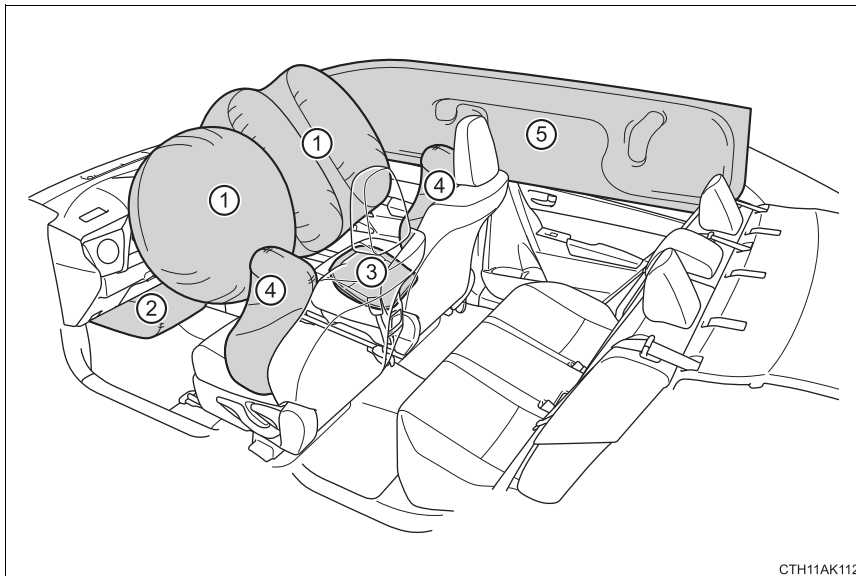

### ◆ SRS front airbags

- ① SRS driver airbag/front passenger airbag  
Can help protect the head and chest of the driver and front passenger from impact with interior components
- ② SRS driver's knee airbag  
Can help provide driver protection
- ③ SRS seat cushion airbag  
Can help restrain the front passenger

---

◆ **SRS side and curtain shield airbags**

---

- ④ SRS front side airbags
  - Can help protect the torso of the front seat occupants
- ⑤ SRS curtain shield airbags
  - Can help protect primarily the head of occupants in the outer seats
  - Can help prevent the occupants from being thrown from the vehicle in the event of vehicle rollover

1

For safety and security

### SRS airbag system components

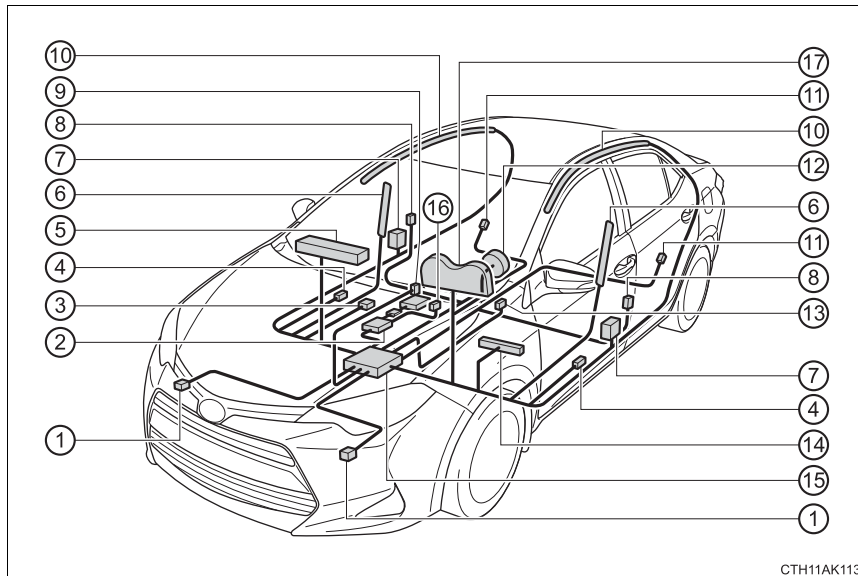

CTH11AK113

- |  |   |
|--|---|
| ① Front impact sensors   | ⑨ "AIR BAG ON" and "AIR BAG OFF" indicator lights |
| ② Front passenger occupant classification system (ECU and sensors) | ⑩ Curtain shield airbags                          |
| ③ Seat cushion airbag  | ⑪ Side impact sensors (rear)                      |
| ④ Side impact sensors (front doors)                                | ⑫ Driver airbag                                   |
| ⑤ Front passenger airbag   | ⑬ Driver's seat belt buckle switch                |
| ⑥ Side airbags   | ⑭ Driver's knee airbag                            |
| ⑦ Seat belt pretensioners and force limiters                       | ⑮ Airbag sensor assembly                          |
| ⑧ Side impact sensors (front)                                      | ⑯ Front passenger's seat belt buckle switch       |
|  | ⑰ SRS warning light                               |

Your vehicle is equipped with ADVANCED AIRBAGS designed based on the US motor vehicle safety standards (FMVSS208). The airbag sensor assembly (ECU) controls airbag deployment based on information obtained from the sensors etc. shown in the system components diagram above. This information includes crash severity and occupant information. As the airbags deploy, a chemical reaction in the inflators quickly fills the airbags with non-toxic gas to help restrain the motion of the occupants.

 **WARNING**

■ **SRS airbag precautions**

Observe the following precautions regarding the SRS airbags. Failure to do so may cause death or serious injury.

- The driver and all passengers in the vehicle must wear their seat belts properly.

The SRS airbags are supplemental devices to be used with the seat belts.

- The SRS driver airbag deploys with considerable force, and can cause death or serious injury especially if the driver is very close to the airbag. The National Highway Traffic Safety Administration (NHTSA) advises:

Since the risk zone for the driver's airbag is the first 2 - 3 in. (50 - 75 mm) of inflation, placing yourself 10 in. (250 mm) from your driver airbag provides you with a clear margin of safety. This distance is measured from the center of the steering wheel to your breastbone. If you sit less than 10 in. (250 mm) away now, you can change your driving position in several ways:

- Move your seat to the rear as far as you can while still reaching the pedals comfortably.
- Slightly recline the back of the seat.  
Although vehicle designs vary, many drivers can achieve the 10 in. (250 mm) distance, even with the driver seat all the way forward, simply by reclining the back of the seat somewhat. If reclining the back of your seat makes it hard to see the road, raise yourself by using a firm, non-slippery cushion, or raise the seat if your vehicle has that feature.
- If your steering wheel is adjustable, tilt it downward. This points the airbag toward your chest instead of your head and neck.

The seat should be adjusted as recommended by NHTSA above, while still maintaining control of the foot pedals, steering wheel, and your view of the instrument panel controls.

**⚠ WARNING****■ SRS airbag precautions**

● If the seat belt extender has been connected to the front seat belt buckles but the seat belt extender has not also been fastened to the latch plate of the seat belt, the SRS front airbags will judge that the driver and front passenger are wearing the seat belt even though the seat belt has not been connected. In this case, the SRS front airbags may not activate correctly in a collision, resulting in death or serious injury in the event of a collision. Be sure to wear the seat belt with the seat belt extender.

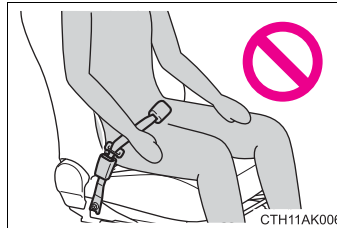

● The SRS front passenger airbag also deploys with considerable force, and can cause death or serious injury especially if the front passenger is very close to the airbag. The front passenger seat should be as far from the airbag as possible with the seatback adjusted, so the front passenger sits upright.

● Improperly seated and/or restrained infants and children can be killed or seriously injured by a deploying airbag. An infant or child who is too small to use a seat belt should be properly secured using a child restraint system. Toyota strongly recommends that all infants and children be placed in the rear seats of the vehicle and properly restrained. The rear seats are safer for infants and children than the front passenger seat. (→P. 54)

**⚠ WARNING**

■ **SRS airbag precautions**

- Do not sit on the edge of the seat or lean against the dashboard.

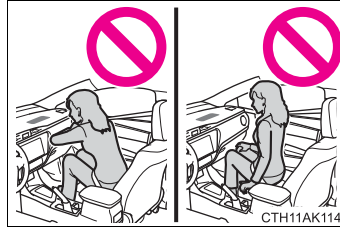

- Do not allow a child to stand in front of the SRS front passenger airbag unit or sit on the knees of a front passenger.

- Do not allow the front seat occupants to hold items on their knees.

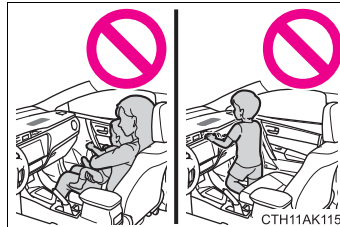

- Do not lean against the door, the roof side rail or the front, side and rear pillars.

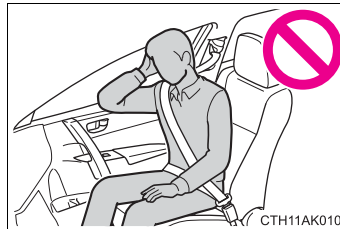

- Do not allow anyone to kneel on the passenger seats toward the door or put their head or hands outside the vehicle.

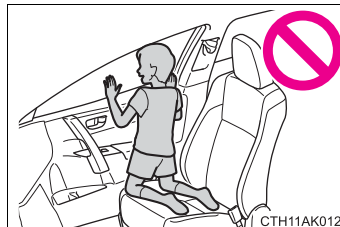

**⚠ WARNING****■ SRS airbag precautions**

- Do not attach anything to or lean anything against areas such as the dashboard, steering wheel pad and lower portion of the instrument panel. These items can become projectiles when the SRS driver, front passenger and driver's knee airbag deploy.

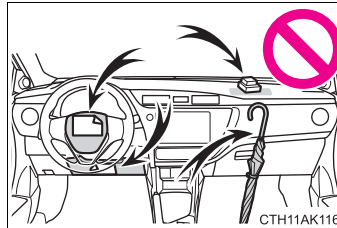

- Do not attach anything to areas such as the door, windshield glass, side door glass, front or rear pillar, roof side rail and assist grip.

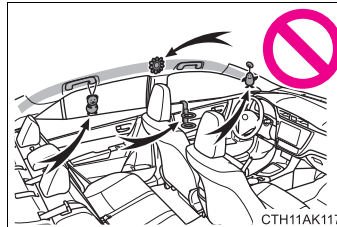

- Vehicles without a smart key system: Do not attach any heavy, sharp or hard objects such as keys and accessories to the key. The objects may restrict the SRS driver's knee airbag inflation or be thrust into the driver's seat area by the force of the deploying airbag, thus causing a danger.

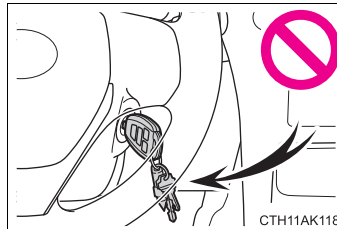



 **WARNING**

■ **SRS airbag precautions**

- If a vinyl cover is put on the area where the SRS driver's knee airbag will deploy, be sure to remove it.
- Do not use seat accessories which cover the parts where the SRS side airbags and SRS seat cushion airbag inflate as they may interfere with inflation of the SRS airbags. Such accessories may prevent the side airbags and seat cushion airbag from activating correctly, disable the system or cause the side airbags and seat cushion airbag to inflate accidentally, resulting in death or serious injury.
- Do not strike or apply significant levels of force to the area of the SRS airbag components.  
Doing so can cause the SRS airbags to malfunction.
- Do not touch any of the component parts immediately after the SRS airbags have deployed (inflated) as they may be hot.
- If breathing becomes difficult after the SRS airbags have deployed, open a door or window to allow fresh air in, or leave the vehicle if it is safe to do so. Wash off any residue as soon as possible to prevent skin irritation.
- If the areas where the SRS airbags are stored, such as the steering wheel pad and front and rear pillars garnishes, are damaged or cracked, have them replaced by your Toyota dealer.
- Do not place anything, such as a cushion, on the front passenger's seat. Doing so will disperse the passenger's weight, which prevents the sensor from detecting the passenger's weight properly. As a result, the SRS front airbags for the front passenger may not deploy in the event of a collision.

■ **Modification and disposal of SRS airbag system components**

Do not dispose of your vehicle or perform any of the following modifications without consulting your Toyota dealer. The SRS airbags may malfunction or deploy (inflate) accidentally, causing death or serious injury.

- Installation, removal, disassembly and repair of the SRS airbags
- Repairs, modifications, removal or replacement of the steering wheel, instrument panel, dashboard, seats or seat upholstery, front, side and rear pillars or roof side rails
- Repairs or modifications of the front fender, front bumper, or side of the occupant compartment
- Installation of a grille guard (bull bars, kangaroo bar, etc.), snow plows, winches or roof luggage carrier
- Modifications to the vehicle's suspension system
- Installation of electronic devices such as mobile two-way radios and CD players
- Modifications to your vehicle for a person with a physical disability

---

**■ If the SRS airbags deploy (inflate)**

- Slight abrasions, burns, bruising etc., may be sustained from SRS airbags, due to the extremely high speed deployment (inflation) by hot gases.
- A loud noise and white powder will be emitted.
- Parts of the airbag module (steering wheel hub, airbag cover and inflator) as well as the front seats, parts of the front and rear pillars, and roof side rails, may be hot for several minutes. The airbag itself may also be hot.
- The windshield may crack.

**■ SRS airbag deployment conditions (SRS front airbags)**

- The SRS front airbags will deploy in the event of an impact that exceeds the set threshold level (the level of force corresponding to an approximately 12 - 18 mph [20 - 30 km/h] frontal collision with a fixed wall that does not move or deform).

However, this threshold velocity will be considerably higher in the following situations:

- If the vehicle strikes an object, such as a parked vehicle or sign pole, which can move or deform on impact
- If the vehicle is involved in an underride collision, such as a collision in which the front of the vehicle “underrides”, or goes under, the bed of a truck
- Depending on the type of collision, it is possible that only the seat belt pretensioners will activate.
- The SRS front airbags for the front passenger will not activate if there is no passenger sitting in the front passenger seat. However, the SRS front airbags for the front passenger may deploy if luggage is put in the seat, even if the seat is unoccupied.
- The SRS seat cushion airbag on the front seats will not operate if the occupant is not wearing a seat belt.

**■ SRS airbag deployment conditions (SRS side and curtain shield airbags)**

- The SRS side and curtain shield airbags will deploy in the event of an impact that exceeds the set threshold level (the level of force corresponding to the impact force produced by an approximately 3300 lb. [1500 kg] vehicle colliding with the vehicle cabin from a direction perpendicular to the vehicle orientation at an approximate speed of 12 - 18 mph [20 - 30 km/h]).
- The SRS curtain shield airbags will deploy in the event of vehicle rollover.
- The SRS side and curtain shield airbags will deploy in the event of a severe frontal collision.

### ■ Conditions under which the SRS airbags may deploy (inflate), other than a collision

The SRS front airbags and SRS side and curtain shield airbags may also deploy if a serious impact occurs to the underside of your vehicle. Some examples are shown in the illustration.

- Hitting a curb, edge of pavement or hard surface
- Falling into or jumping over a deep hole
- Landing hard or falling

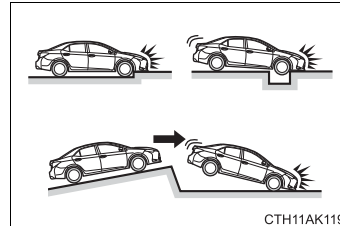

The SRS curtain shield airbags may also deploy under the situations shown in the illustration.

- The angle of vehicle tip-up is marginal.
- The vehicle skids and hits a curb stone.

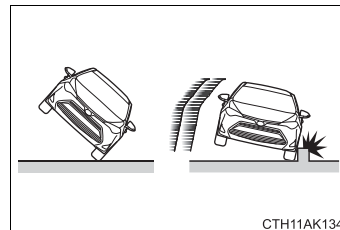

### ■ Types of collisions that may not deploy the SRS airbags (SRS front airbags)

The SRS front airbags do not generally inflate if the vehicle is involved in a side or rear collision, if it rolls over, or if it is involved in a low-speed frontal collision. But, whenever a collision of any type causes sufficient forward deceleration of the vehicle, deployment of the SRS front airbags may occur.

- Collision from the side
- Collision from the rear
- Vehicle rollover

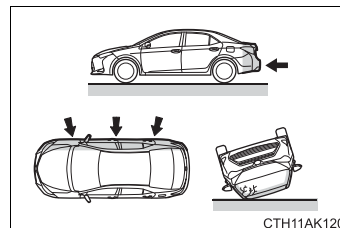

### ■ Types of collisions that may not deploy the SRS airbags (SRS side and curtain shield airbags)

The SRS side and curtain shield airbags may not activate if the vehicle is subjected to a collision from the side at certain angles, or a collision to the side of the vehicle body other than the passenger compartment.

- Collision from the side to the vehicle body other than the passenger compartment
- Collision from the side at an angle

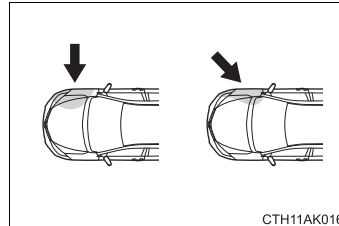

The SRS side airbags do not generally inflate if the vehicle is involved in a rear collision, if it rolls over, or if it is involved in a low-speed side or low-speed frontal collision.

- Collision from the rear
- Vehicle rollover

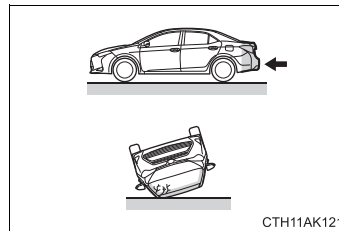

The SRS curtain shield airbags do not generally inflate if the vehicle is involved in a rear collision, if it pitches end over end, or if it is involved in a low-speed side or low-speed frontal collision.

- Collision from the rear
- Pitching end over end

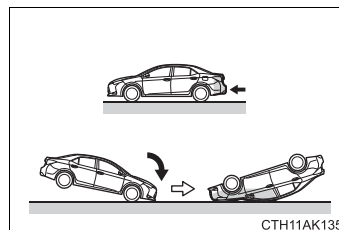

### ■ When to contact your Toyota dealer

In the following cases, the vehicle will require inspection and/or repair. Contact your Toyota dealer as soon as possible.

- Any of the SRS airbags have been inflated.
- The front of the vehicle is damaged or deformed, or was involved in an accident that was not severe enough to cause the SRS front airbags to inflate.

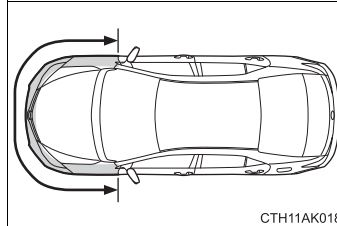

- A portion of a door or its surrounding area is damaged or deformed, or the vehicle was involved in an accident that was not severe enough to cause the SRS side airbags and curtain shield airbags to inflate.

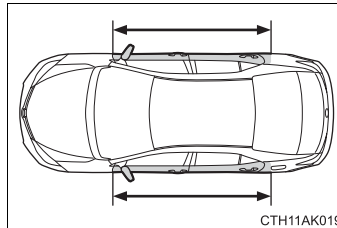

- The pad section of the steering wheel, dashboard near the front passenger airbag or lower portion of the instrument panel is scratched, cracked, or otherwise damaged.

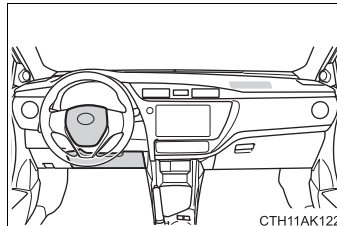

- The seat cushion surface is scratched, cracked, or otherwise damaged.

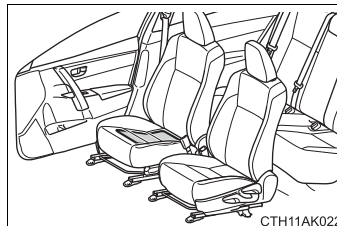

- The surface of the seats with the side airbag is scratched, cracked, or otherwise damaged.

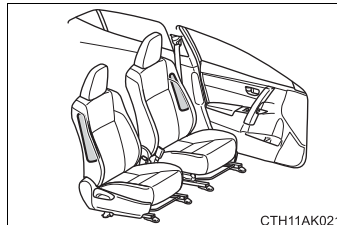

- The portion of the front pillars, rear pillars or roof side rail garnishes (padding) containing the curtain shield airbags inside is scratched, cracked, or otherwise damaged.

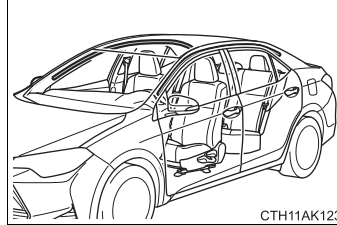

CTH11AK123

## Front passenger occupant classification system

Your vehicle is equipped with a front passenger occupant classification system. This system detects the conditions of the front passenger seat and activates or deactivates the devices for the front passenger.

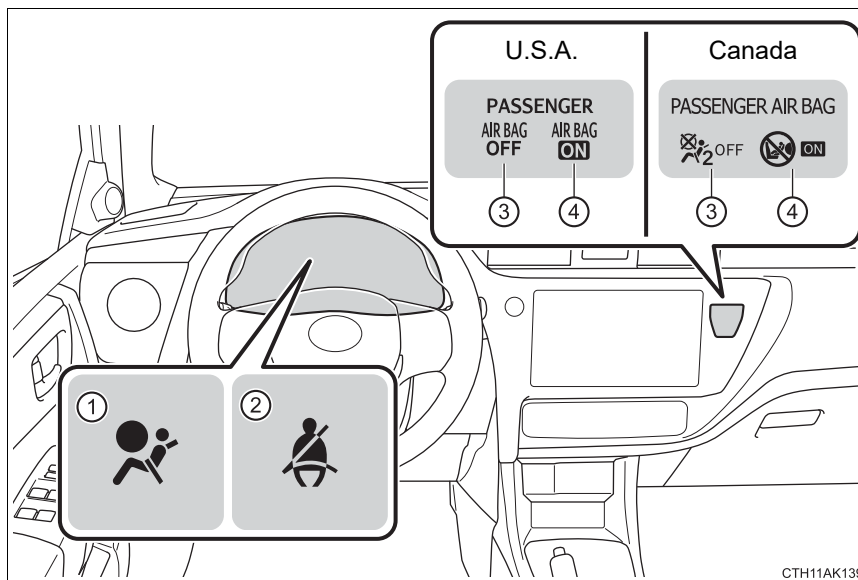

- ① SRS warning light
- ② Driver's and front passenger's seat belt reminder light
- ③ "AIR BAG OFF" indicator light
- ④ "AIR BAG ON" indicator light

### Condition and operation in the front passenger occupant classification system

#### ■ Adult\*1

Indicator/ warning light	“AIR BAG ON” and “AIR BAG OFF” indicator lights	“AIR BAG ON”
	SRS warning light	Off
	Driver’s and front passenger’s seat belt reminder light	Off*2 or flashing*3
Devices	Front passenger airbag	Activated
	Side airbag on the front passenger seat	
	Curtain shield airbag in the front passenger side	
	Seat cushion airbag in the front passenger side	Activated*2 or deactivated*3
	Front passenger’s seat belt pretensioner	Activated

#### ■ Child\*4

Indicator/ warning light	“AIR BAG ON” and “AIR BAG OFF” indicator lights	“AIR BAG OFF” or “AIR BAG ON”*4
	SRS warning light	Off
	Driver’s and front passenger’s seat belt reminder light	Off*2 or flashing*3
Devices	Front passenger airbag	Deactivated or activated*4
	Side airbag on the front passenger seat	Activated
	Curtain shield airbag in the front passenger side	
	Seat cushion airbag in the front passenger side	Deactivated or activated*4, 2
	Front passenger’s seat belt pretensioner	Activated



### ■ Child restraint system with infant\*5

Indicator/ warning light	“AIR BAG ON” and “AIR BAG OFF” indicator lights	“AIR BAG OFF”*6
	SRS warning light	Off
	Driver’s and front passenger’s seat belt reminder light	Off*2 or flashing*3
Devices	Front passenger airbag	Deactivated
	Side airbag on the front passenger seat	Activated
	Curtain shield airbag in the front passenger side	
	Seat cushion airbag in the front passenger side	Deactivated
	Front passenger’s seat belt pretensioner	Activated

### ■ Unoccupied

Indicator/ warning light	“AIR BAG ON” and “AIR BAG OFF” indicator lights	“AIR BAG OFF”
	SRS warning light	Off
	Driver’s and front passenger’s seat belt reminder light	
Devices	Front passenger airbag	Deactivated
	Side airbag on the front passenger seat	Activated
	Curtain shield airbag in the front passenger side	
	Seat cushion airbag in the front passenger side	Deactivated
	Front passenger’s seat belt pretensioner	Activated

1

For safety and security

■ **There is a malfunction in the system**

Indicator/ warning light	“AIR BAG ON” and “AIR BAG OFF” indicator lights	“AIR BAG OFF”
	SRS warning light	On
	Driver’s and front passenger’s seat belt reminder light	
Devices	Front passenger airbag	Deactivated
	Side airbag on the front passenger seat	Activated
	Curtain shield airbag in the front passenger side	
	Seat cushion airbag in the front passenger side	Deactivated
	Front passenger’s seat belt pretensioner	Activated

\*1: The system judges a person of adult size as an adult. When a smaller adult sits in the front passenger seat, the system may not recognize him/her as an adult depending on his/her physique and posture.

\*2: In the event the front passenger is wearing a seat belt.

\*3: In the event the front passenger does not wear a seat belt

\*4: For some children, child in seat, child in booster seat or child in convertible seat, the system may not recognize him/her as a child. Factors which may affect this can be the physique or posture.

\*5: Never install a rear-facing child restraint system on the front passenger seat. A forward-facing child restraint system should only be installed on the front passenger seat when it is unavoidable. (→P. 54)

\*6: In case the indicator light is not illuminated, consult this manual on how to install the child restraint system properly. (→P. 58)

 **WARNING****■ Front passenger occupant classification system precautions**

Observe the following precautions regarding the front passenger occupant classification system.

Failure to do so may cause death or serious injury.

- Wear the seat belt properly.
- Make sure the front passenger's seat belt plate has not been left inserted into the buckle before someone sits in the front passenger seat.
- Make sure the "AIR BAG OFF" indicator light is not illuminated when using the seat belt extender for the front passenger seat. If the "AIR BAG OFF" indicator light is illuminated, disconnect the extender tongue from the seat belt buckle, and reconnect the seat belt. Reconnect the seat belt extender after making sure the "AIR BAG ON" indicator light is illuminated. If you use the seat belt extender while the "AIR BAG OFF" indicator light is illuminated, the SRS airbags for the front passenger may not activate, which could cause death or serious injury in the event of a collision.
- Do not apply a heavy load to the front passenger seat or equipment (e.g. seatback pocket).
- Do not put weight on the front passenger seat by putting your hands or feet on the front passenger seat seatback from the rear passenger seat.
- Do not let a rear passenger lift the front passenger seat with their feet or press on the seatback with their legs.
- Do not put objects under the front passenger seat.

 **WARNING****■ Front passenger occupant classification system precautions**

- Do not recline the front passenger seatback so far that it touches the rear seat. This may cause the “AIR BAG OFF” indicator light to be illuminated, which indicates that the SRS airbags for the front passenger will not activate in the event of a severe accident. If the seatback touches the rear seat, return the seatback to a position where it does not touch the rear seat. Keep the front passenger seatback as upright as possible when the vehicle is moving. Reclining the seatback excessively may lessen the effectiveness of the seat belt system.
- If an adult sits in the front passenger seat, the “AIR BAG ON” indicator light is illuminated. If the “AIR BAG OFF” indicator is illuminated, ask the passenger to sit up straight, well back in the seat, feet on the floor, and with the seat belt worn correctly. If the “AIR BAG OFF” indicator still remains illuminated, either ask the passenger to move to the rear seat, or if that is not possible, move the front passenger seat fully rearward.
- When it is unavoidable to install a forward-facing child restraint system on the front passenger seat, install the child restraint system on the front passenger seat in the proper order. (→P. 58)
- Do not modify or remove the front seats.
- Do not kick the front passenger seat or subject it to severe impact. Otherwise, the SRS warning light may come on to indicate a malfunction of the front passenger occupant classification system. In this case, contact your Toyota dealer immediately.
- Child restraint systems installed on the rear seat should not contact the front seatbacks.
- Do not use a seat accessory, such as a cushion and seat cover, that covers the seat cushion surface.
- Do not modify or replace the upholstery of the front seat.

## Safety information for children

**Observe the following precautions when children are in the vehicle.**

**Use a child restraint system appropriate for the child, until the child becomes large enough to properly wear the vehicle's seat belt.**

- It is recommended that children sit in the rear seats to avoid accidental contact with the shift lever, wiper switch etc.
- Use the rear door child-protector lock or the window lock switch to avoid children opening the door while driving or operating the power window accidentally.
- Do not let small children operate equipment which may catch or pinch body parts, such as the power window, hood, trunk, seats etc.

### WARNING

Never leave children unattended in the vehicle, and never allow children to have or use the key.

Children may be able to start the vehicle or shift the vehicle into neutral. There is also a danger that children may injure themselves by playing with the windows or other features of the vehicle. In addition, heat build-up or extremely cold temperatures inside the vehicle can be fatal to children.

## Child restraint systems

**A child restraint system for a small child or baby must itself be properly restrained on the seat with the LATCH anchors or the lap portion of the lap/shoulder belt.**

**The laws of all 50 states of the U.S.A. and Canada now require the use of child restraint systems.**

### Points to remember

Studies have shown that installing a child restraint on a rear seat is much safer than installing one on the front passenger seat.

- Choose a child restraint system that suits your vehicle and is appropriate to the age and size of the child.
- For installation details, follow the instructions provided with the child restraint system.

General installation instructions are provided in this manual.

(→P. 58)

### Types of child restraints

Child restraint systems are classified into the following 3 types according to the age and size of the child:

- ▶ Rear facing — Infant seat/convertible seat
- ▶ Forward facing — Convertible seat

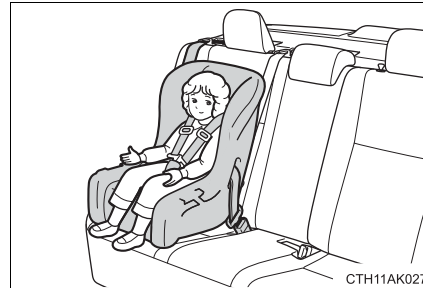
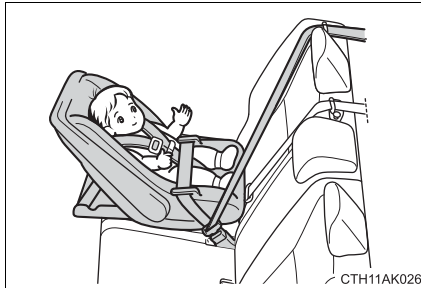

- ▶ Booster seat

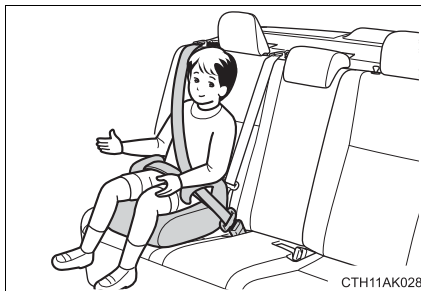

#### ■ Selecting an appropriate child restraint system

- Use a child restraint system appropriate for the child until the child becomes large enough to properly wear the vehicle's seat belt.
- If the child is too large for a child restraint system, sit the child on a rear seat and use the vehicle's seat belt. (→P. 28)

 **WARNING****■ Child restraint precautions**

- For effective protection in automobile accidents and sudden stops, a child must be properly restrained, using a seat belt or child restraint system depending on the age and size of the child. Holding a child in your arms is not a substitute for a child restraint system. In an accident, the child can be crushed against the windshield, or between you and the vehicle's interior.
- Toyota strongly urges the use of a proper child restraint system that conforms to the size of the child, installed on the rear seat. According to accident statistics, the child is safer when properly restrained in the rear seat than in the front seat.
- Never install a rear-facing child restraint system on the front passenger seat even if the "AIR BAG OFF" indicator light is illuminated. In the event of an accident, the force of the rapid inflation of the front passenger airbag can cause death or serious injury to the child if the rear-facing child restraint system is installed on the front passenger seat.
- A forward-facing child restraint system may be installed on the front passenger seat only when it is unavoidable. A child restraint system that requires a top tether strap should not be used in the front passenger seat since there is no top tether strap anchor for the front passenger seat. Adjust the seatback as upright as possible and always move the seat as far back as possible even if the "AIR BAG OFF" indicator light is illuminated, because the front passenger airbag could inflate with considerable speed and force. Otherwise, the child may be killed or seriously injured.
- Do not use the seat belt extender when installing a child restraint system on the front or rear passenger seat. If installing a child restraint system with the seat belt extender connected to the seat belt, the seat belt will not securely hold the child restraint system, which could cause death or serious injury to the child or other passengers in the event of a sudden stop, sudden swerve or accident.
- Do not allow the child to lean his/her head or any part of his/her body against the door or the area of the seat, front and rear pillars or roof side rails from which the SRS side airbags or SRS curtain shield airbags deploy even if the child is seated in the child restraint system. It is dangerous if the SRS side airbags and curtain shield airbags inflate, and the impact could cause death or serious injury to the child.
- Make sure you have complied with all installation instructions provided by the child restraint manufacturer and that the system is properly secured. If it is not secured properly, it may cause death or serious injury to the child in the event of a sudden stop or accident.



 **WARNING****■ When children are in the vehicle**

Do not allow children to play with the seat belt. If the seat belt becomes twisted around a child's neck, it may lead to choking or other serious injuries that could result in death.

If this occurs and the buckle cannot be unfastened, scissors should be used to cut the belt.

**■ When the child restraint system is not in use**

- Keep the child restraint system properly secured on the seat even if it is not in use. Do not store the child restraint system unsecured in the passenger compartment.
- If it is necessary to detach the child restraint system, remove it from the vehicle or store it securely in the trunk. If a head restraint was removed when installing a child restraint system, always install the head restraint before driving. This will prevent it from injuring passengers in the event of a sudden stop or accident.

## Installing child restraints

**Follow the child restraint system manufacturer's instructions. Firmly secure child restraints to the seats using the LATCH anchors or a seat belt. Attach the top tether strap when installing a child restraint.**

**The lap/shoulder belt can be used if your child restraint system is not compatible with the LATCH (Lower Anchors and Tethers for Children) system.**

Child restraint LATCH anchors  
(→P. 59)

LATCH anchors are provided for the outer rear seats. (Buttons displaying the location of the anchors are attached to the seats.)

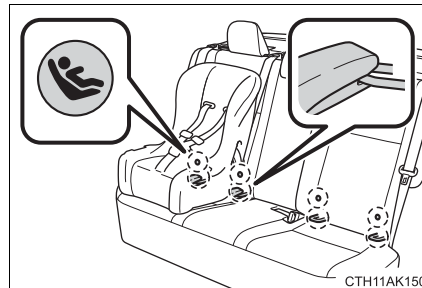

Installation with a seat belt  
(→P. 60)

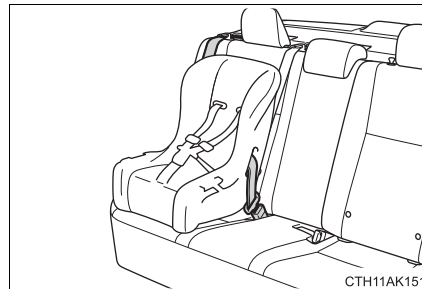

Anchor brackets (for top tether strap)  
(→P. 63)

An anchor bracket is provided for each rear seat.

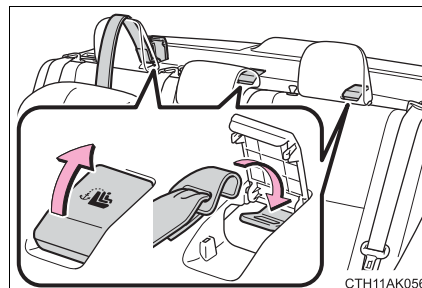

### Installation with LATCH system

- 1 Widen the gap between the seat cushion and seatback slightly.

► Type A

- 2 Latch the hooks of the lower straps onto the LATCH anchors. If the child restraint has a top tether strap, the top tether strap should be latched onto the top tether strap anchor.

For owners in Canada:

The symbol on a child restraint system indicates the presence of a lower connector system.

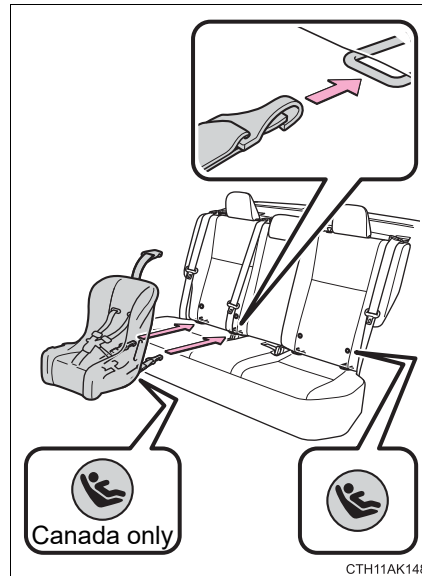

► Type B

- 2 Latch the buckles onto the LATCH anchors. If the child restraint has a top tether strap, the top tether strap should be latched onto the top tether strap anchor.

For owners in Canada:

The symbol on a child restraint system indicates the presence of a lower connector system.

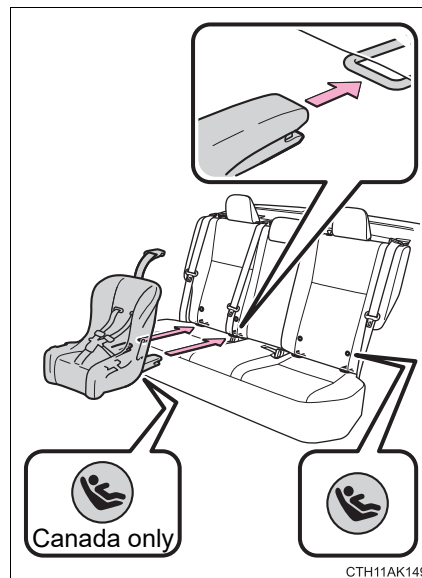

## Installing child restraints using a seat belt

### ■ Rear-facing — Infant seat/convertible seat

- 1 Place the child restraint system on the rear seat facing the rear of the vehicle.

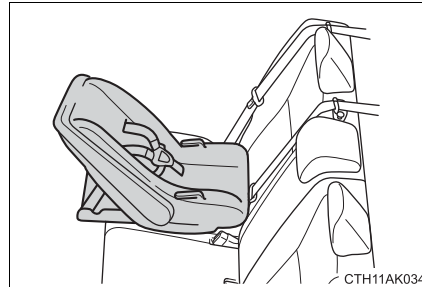

- 2 Run the seat belt through the child restraint system and insert the plate into the buckle. Make sure that the belt is not twisted.

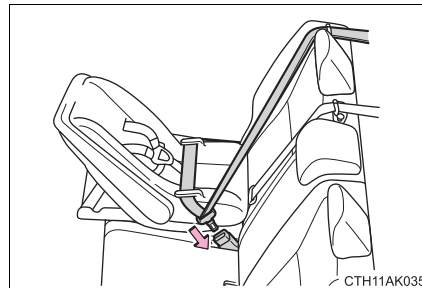

- 3 Fully extend the shoulder belt and allow it to retract to put it in lock mode. In lock mode, the belt cannot be extended.

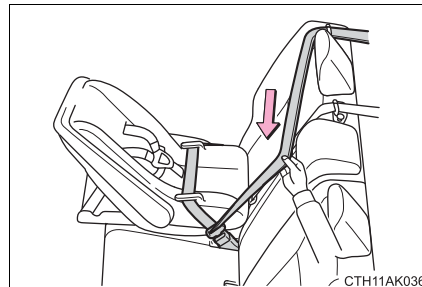

- 4 While pushing the child restraint system down into the rear seat, allow the shoulder belt to retract until the child restraint system is securely in place.

After the shoulder belt has retracted to a point where there is no slack in the belt, pull the belt to check that it cannot be extended.

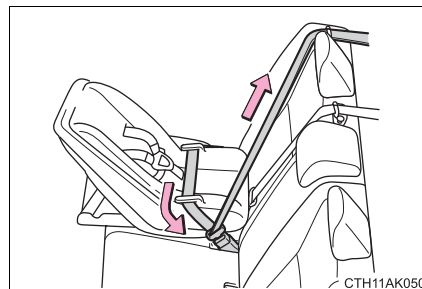

### ■ Forward-facing — Convertible seat

- 1 Place the child restraint system on the seat facing the front of the vehicle.

If your child restraint system interferes with a head restraint and cannot be installed properly, install the child restraint system after removing the head restraint. (→P. 135)

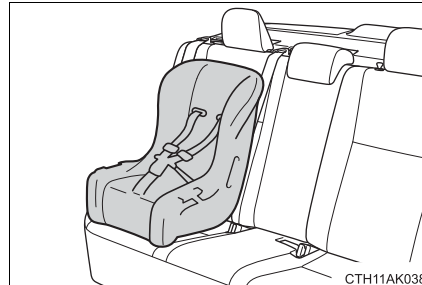

- 2 Run the seat belt through the child restraint system and insert the plate into the buckle. Make sure that the belt is not twisted.

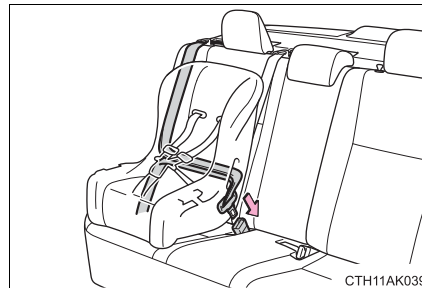

- 3 Fully extend the shoulder belt and allow it to retract to put it in lock mode. In lock mode, the belt cannot be extended.

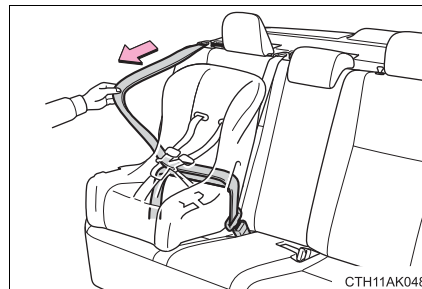

- 4 While pushing the child restraint system into the rear seat, allow the shoulder belt to retract until the child restraint system is securely in place.

After the shoulder belt has retracted to a point where there is no slack in the belt, pull the belt to check that it cannot be extended.

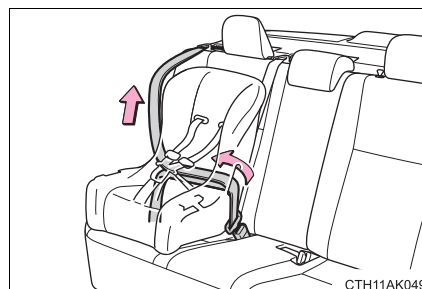

- 5 If the child restraint has a top tether strap, the top tether strap should be latched onto the top tether strap anchor. (→P. 63)

**■ Booster seat**

- 1 Place the child restraint system on the seat facing the front of the vehicle.

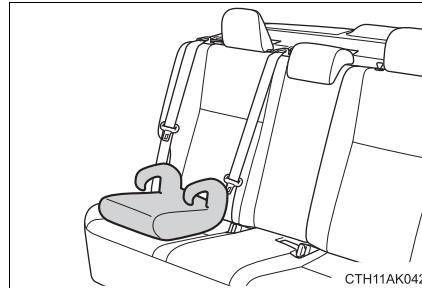

- 2 Sit the child in the child restraint system. Fit the seat belt to the child restraint system according to the manufacturer's instructions and insert the plate into the buckle. Make sure that the belt is not twisted.

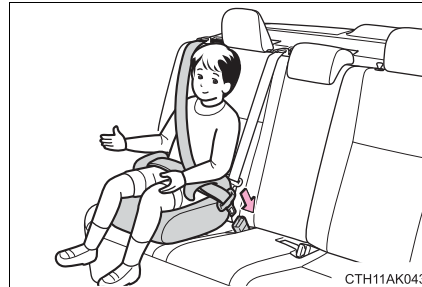

Check that the shoulder belt is correctly positioned over the child's shoulder and that the lap belt is as low as possible. (→P. 28)

**Removing a child restraint installed with a seat belt**

Push the buckle release button and fully retract the seat belt.

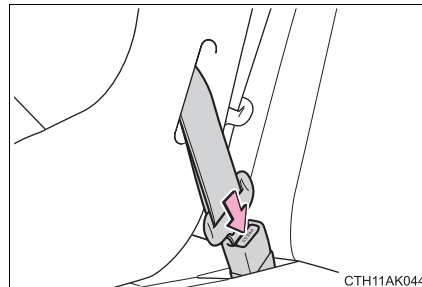

**Child restraint systems with a top tether strap**

- 1 Adjust the head restraint to the downmost position. (if equipped) (→P. 134)
- 2 Secure the child restraint system using the seat belt or LATCH anchors.

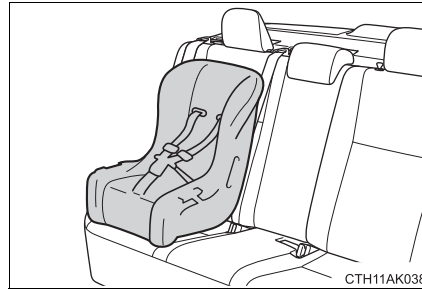

- 3 Open the anchor bracket cover, latch the hook onto the anchor bracket and tighten the top tether strap.

Make sure the top tether strap is securely latched.

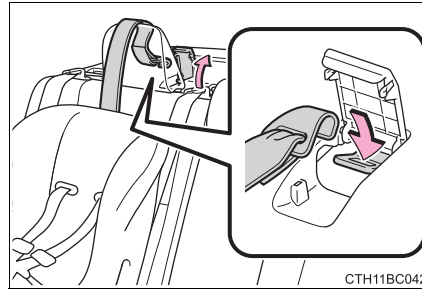

### ■ Laws and regulations pertaining to anchorages

The LATCH system conforms to FMVSS225 or CMVSS210.2.

Child restraint systems conforming to FMVSS213 or CMVSS213 specifications can be used.

This vehicle is designed to conform to SAE J1819.

### ⚠ WARNING

#### ■ When installing a booster seat

To prevent the belt from going into ALR lock mode, do not fully extend the shoulder belt. ALR mode causes the belt to tighten only. This could cause injury or discomfort to the child. (→P. 30)

#### ■ When installing a child restraint system

Follow the directions given in the child restraint system installation manual and fix the child restraint system securely in place.

If the child restraint system is not correctly fixed in place, the child or other passengers may be seriously injured or even killed in the event of a sudden braking or an accident.

- If the driver's seat interferes with the child restraint system and prevents it from being attached correctly, attach the child restraint system to the right-hand rear seat.

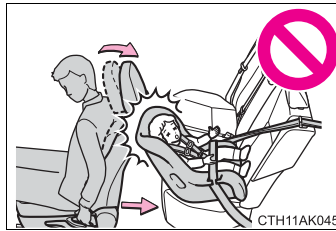

- Adjust the front passenger seat so that it does not interfere with the child restraint system.

- Only put a forward-facing child restraint system on the front seat when unavoidable. When installing a forward-facing child restraint system on the front passenger seat, move the seat as far back as possible even if the "AIR BAG OFF" indicator light is illuminated. Failure to do so may result in death or serious injury if the airbags deploy (inflate).

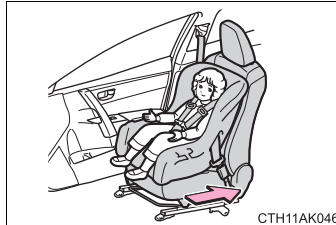



 **WARNING****■ When installing a child restraint system**

- When using the LATCH anchors for a child restraint system, move the seat as far back as possible, with the seatback close to the child restraint system.
- When a booster seat is installed, always ensure that the shoulder belt is positioned across the center of the child's shoulder. The belt should be kept away from the child's neck, but not so that it could fall off the child's shoulder. Failing to do so may result in death or serious injury in the event of sudden braking, sudden swerving or an accident.
- Ensure that the belt and plate are securely locked and the seat belt is not twisted.
- Shake the child restraint system left and right, and forward and backward to ensure that it has been securely installed.
- After securing a child restraint system, never adjust the seat.
- Follow all installation instructions provided by the child restraint system manufacturer.
- When securing some types of child restraint systems in rear seats, it may not be possible to properly use the seat belts in positions next to the child restraint without interfering with it or affecting seat belt effectiveness. Be sure your seat belt fits snugly across your shoulder and low on your hips. If it does not, or if it interferes with the child restraint, move to a different position. Failure to do so may result in death or serious injury.

**■ Do not use a seat belt extender**

If a seat belt extender is used when installing a child restraint system, the seat belt will not securely hold the child restraint system, which could cause death or serious injury to the child or other passengers in the event of a sudden braking, sudden swerving or an accident.

**■ To correctly attach a child restraint system to the anchors**

When using the LATCH anchors, be sure that there are no foreign objects around the anchors and that the seat belt is not caught behind the child restraint system. Make sure the child restraint system is securely attached, or it may cause death or serious injury to the child or other passengers in the event of a sudden braking, sudden swerve or an accident.

## Exhaust gas precautions

**Harmful substance to the human body is included in exhaust gases if inhaled.**

### WARNING

Exhaust gases include harmful carbon monoxide (CO), which is colorless and odorless. Observe the following precautions.

Failure to do so may cause exhaust gases enter the vehicle and may lead to an accident caused by light-headedness, or may lead to death or a serious health hazard.

#### ■ Important points while driving

- Keep the trunk lid closed.
- If you smell exhaust gases in the vehicle even when the trunk lid is closed, open the windows and have the vehicle inspected at your Toyota dealer as soon as possible.

#### ■ When parking

- If the vehicle is in a poorly ventilated area or a closed area, such as a garage, stop the engine.
- Do not leave the vehicle with the engine on for a long time.  
If such a situation cannot be avoided, park the vehicle in an open space and ensure that exhaust fumes do not enter the vehicle interior.
- Do not leave the engine running in an area with snow build-up, or where it is snowing. If snowbanks build up around the vehicle while the engine is running, exhaust gases may collect and enter the vehicle.

#### ■ Exhaust pipe

The exhaust system needs to be checked periodically. If there is a hole or crack caused by corrosion, damage to a joint or abnormal exhaust noise, be sure to have the vehicle inspected and repaired by your Toyota dealer.

## Engine immobilizer system

**The vehicle's keys have built-in transponder chips that prevent the engine from starting if a key has not been previously registered in the vehicle's on-board computer.**

**Never leave the keys inside the vehicle when you leave the vehicle.**

**This system is designed to help prevent vehicle theft but does not guarantee absolute security against all vehicle thefts.**

Vehicles without a smart key system:

The indicator light flashes after the key has been removed from the engine switch to indicate that the system is operating.

The indicator light stops flashing after the registered key has been inserted into the engine switch to indicate that the system has been canceled.

Vehicles with a smart key system:

The indicator light flashes after the engine switch has been turned off to indicate that the system is operating.

The indicator light stops flashing after the engine switch has been turned to ACCESSORY or IGNITION ON mode to indicate that the system has been canceled.

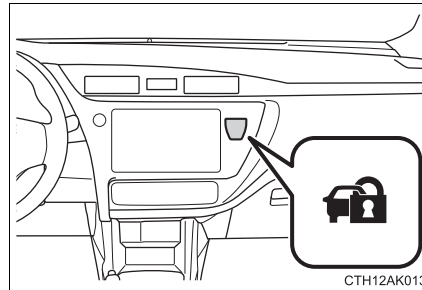

---

**■ System maintenance**

The vehicle has a maintenance-free type engine immobilizer system.

**■ Conditions that may cause the system to malfunction**

- If the grip portion of the key is in contact with a metallic object
- If the key is in close proximity to or touching a key to the security system (key with a built-in transponder chip) of another vehicle

**■ Certifications for the engine immobilizer system**

► For the U.S.A.

FCC ID: WRKRI-44BTY      FCC ID: NI4TMIMB-3

This device complies with part 15 of the FCC Rules. Operation is subject to the following two conditions: (1) This device may not cause harmful interference, and (2) this device must accept any interference received, including interference that may cause undesired operation.

Changes or modifications not expressly approved by the party responsible for compliance could void the user's authority to operate the equipment.

► For Canada

This device complies with Industry Canada's licence-exempt RSSs. Operation is subject to the following two conditions: (1) This device may not cause interference; and (2) This device must accept any interference, including interference that may cause undesired operation of the device.

Le présent appareil est conforme aux CNR d'Industrie Canada applicables aux appareils radio exempts de licence. L'exploitation est autorisée aux deux conditions suivantes : (1) l'appareil ne doit pas produire de brouillage; (2) l'utilisateur de l'appareil doit accepter tout brouillage radioélectrique subi, même si le brouillage est susceptible d'en compromettre le fonctionnement.

 **NOTICE****■ To ensure the system operates correctly**

Do not modify or remove the system. If modified or removed, the proper operation of the system cannot be guaranteed.

## Alarm\*

### The alarm

The alarm uses light and sound to give an alert when an intrusion is detected.

The alarm is triggered in the following situations when the alarm is set:

- A locked door or trunk is unlocked or opened in any way other than using the entry function, wireless remote control or mechanical key. (The doors will lock again automatically.)
- The hood is opened.

### Setting the alarm system

Close the doors, trunk and hood, and lock all the doors. The system will be set automatically after 30 seconds.

The indicator light changes from being on to flashing when the system is set.

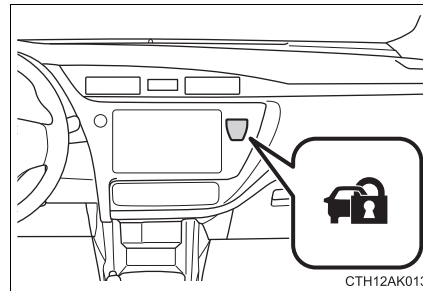

### Deactivating or stopping the alarm

Do one of the following to deactivate or stop the alarm:

- Unlock the doors or open the trunk.
- Vehicles without a smart key system:
  - Turn the engine switch to the "ACC" or "ON" position, or start the engine. (The alarm will be deactivated or stopped after a few seconds.)
- Vehicles with a smart key system:
  - Turn the engine switch to ACCESSORY or IGNITION ON mode, or start the engine. (The alarm will be deactivated or stopped after a few seconds.)

\*: If equipped

1

For safety and security

### ■ System maintenance

The vehicle has a maintenance-free type alarm system.

### ■ Items to check before locking the vehicle

To prevent unexpected triggering of the alarm and vehicle theft, make sure of the following:

- Nobody is in the vehicle.
- The windows and moon roof are closed before the alarm is set.
- No valuables or other personal items are left in the vehicle.

### ■ Triggering of the alarm

The alarm may be triggered in the following situations:  
(Stopping the alarm deactivates the alarm system.)

- A person inside the vehicle opens a door, the trunk or hood, or unlocks the vehicle using a door lock switch or inside lock button.



- The battery is recharged or replaced when the vehicle is locked. (→P. 529)

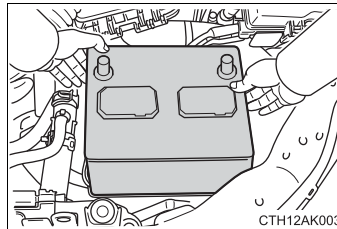

### ■ Alarm-operated door lock

In the following cases, depending on the situation, the door may automatically lock to prevent improper entry into the vehicle:

- The doors are unlocked manually without the mechanical key and the alarm is triggered.
- While the alarm is operating, the doors are unlocked manually without the mechanical key.
- When recharging or replacing the battery

#### ⚠ NOTICE

#### ■ To ensure the system operates correctly

Do not modify or remove the system. If modified or removed, the proper operation of the system cannot be guaranteed.

**Instrument cluster**

**2**

71

**2. Instrument cluster**

Warning lights and indicators .....	72
Gauges and meters (vehicles with a monochrome display) .....	77
Gauges and meters (vehicles with a color display).....	86
Fuel consumption information .....	96
Eco Driving Indicator .....	99

## Warning lights and indicators

The warning lights and indicators on the instrument cluster and center panel inform the driver of the status of the vehicle's various systems.

For the purpose of explanation, the following illustration displays all warning lights and indicators illuminated.

- Vehicles with a monochrome display

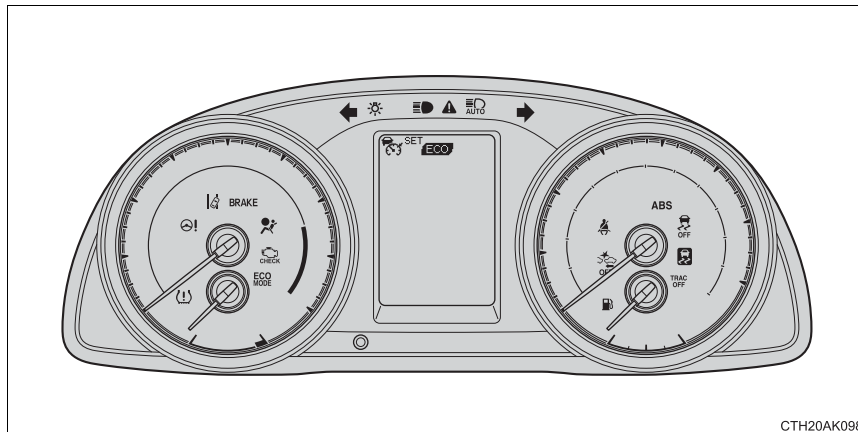

- Vehicles with a color display

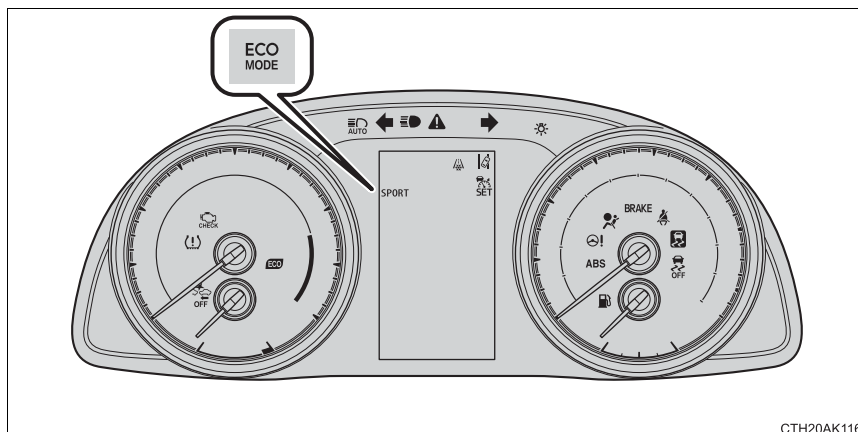

















The units used on the meters and some indicators may differ depending on the target region.



## Warning lights



















Warning lights inform the driver of malfunctions in the indicated vehicle's systems.

<p>*<sub>1</sub></p>  <p>(U.S.A.)</p>	<p>Brake system warning light (→P. 480)</p>	<p>*<sub>1</sub></p> 	<p>Slip indicator (→P. 481)</p>
<p>*<sub>1</sub></p>  <p>(Canada)</p>	<p>Brake system warning light (→P. 480)</p>		<p>Low fuel level warning light (→P. 481)</p>
<p>*<sub>1</sub></p>  <p>(U.S.A.)</p>	<p>Malfunction indicator lamp (→P. 480)</p>		<p>Driver's and front passenger's seat belt reminder light (→P. 481)</p>
<p>*<sub>1</sub></p>  <p>(Canada)</p>	<p>Malfunction indicator lamp (→P. 480)</p>	<p>*<sub>3</sub></p> 	<p>Rear passengers' seat belt reminder lights (→P. 481)</p>
<p>*<sub>1</sub></p> 	<p>SRS warning light (→P. 480)</p>	<p>*<sub>1, 4</sub></p> 	<p>PCS warning light (→P. 482)</p>
<p>*<sub>1</sub></p>  <p>(U.S.A.)</p>	<p>ABS warning light (→P. 481)</p>	<p>(Orange)</p> 	<p>LDA (Lane Departure Alert with steering control) indicator (→P. 482)</p>
<p>*<sub>1</sub></p>  <p>(Canada)</p>	<p>ABS warning light (→P. 481)</p>	<p>*<sub>1</sub></p> 	<p>Master warning light (→P. 481)</p>
<p>*<sub>1</sub></p> 	<p>Electric power steering system warning light (→P. 481)</p>	<p>*<sub>1, 2</sub></p> 	<p>Tire pressure warning light (→P. 482)</p>

- \*1: These lights turn on when the engine switch is turned to the “ON” position (vehicles without a smart key system) or the engine switch is turned to IGNITION ON mode (vehicles with a smart key system), to indicate that a system check is being performed. They will turn off after the engine is started, or after a few seconds. There may be a malfunction in a system if a light does not come on, or turn off. Have the vehicle inspected by your Toyota dealer.
- \*2: If equipped
- \*3: This light illuminates on the center panel.
- \*4: The light flashes to indicate a malfunction.

**Indicators**

The indicators inform the driver of the operating state of the vehicle's various systems.

	Turn signal indicator (→P. 191)		Dynamic radar cruise control (vehicle-to-vehicle distance control mode) indicator (→P. 239)
<sup>*2</sup> 	Headlight indicator (→P. 193) (U.S.A.)		Dynamic radar cruise control "SET" indicator (→P. 239, 243)
<sup>*2</sup> 	Tail light indicator (→P. 193) (Canada)	<sup>*1, 6</sup> 	PCS warning light (→P. 217)
	Headlight high beam indicator (→P. 195)		LDA (Lane Departure Alert with steering control) indicator (→P. 230)
<sup>*1</sup> 	Automatic High Beam indicator (→P. 198)	<sup>*2</sup> 	"ECO MODE" indicator (→P. 182)
<sup>*2</sup> 	Sport mode indicator (→P. 185)	<sup>*1, 3</sup> 	Slip indicator (→P. 258)
<sup>*1, 2, 4</sup> 	Eco Driving Indicator Light (→P. 99)	<sup>*1</sup> 	VSC OFF indicator (→P. 259)
<sup>*1, 2</sup> 	"TRAC OFF" indicator (→P. 258)	<sup>*1, 5</sup> 	"AIR BAG ON/OFF" indicator (→P. 47) (U.S.A.)
	Dynamic radar cruise control (constant speed control mode) indicator (→P. 243)	<sup>*1, 5</sup> 	"AIR BAG ON/OFF" indicator (→P. 47) (Canada)

2  
Instrument cluster



Security indicator  
(→P. 67, 69)



Low outside temperature indicator (→P. 86)

\*1: These lights, except those shown on the multi-information display, turn on when the engine switch is turned to the “ON” position (vehicles without a smart key system) or the engine switch is turned to IGNITION ON mode (vehicles with a smart key system) to indicate that a system check is being performed. They will turn off after the engine is started, or after a few seconds. There may be a malfunction in a system if a light does not come on, or turn off. Have the vehicle inspected by your Toyota dealer.

\*2: If equipped

\*3: The light flashes to indicate that the system is operating.

\*4: The light does not turn on when the system is disabled.

\*5: This light illuminates on the center panel.

\*6: The light turns on when the system is off.

\*7: When the outside temperature is approximately 37°F (3°C) or lower, the indicator will flash 10 times, then stay on.

 **WARNING**

**■ If a safety system warning light does not come on**

Should a safety system light such as the ABS and SRS warning lights not come on when you start the engine, this could mean that these systems are not available to help protect you in an accident, which could result in death or serious injury. Have the vehicle inspected by your Toyota dealer immediately if this occurs.

## Gauges and meters (vehicles with a mono-chrome display)

The displayed content may differ depending on the type of meter.

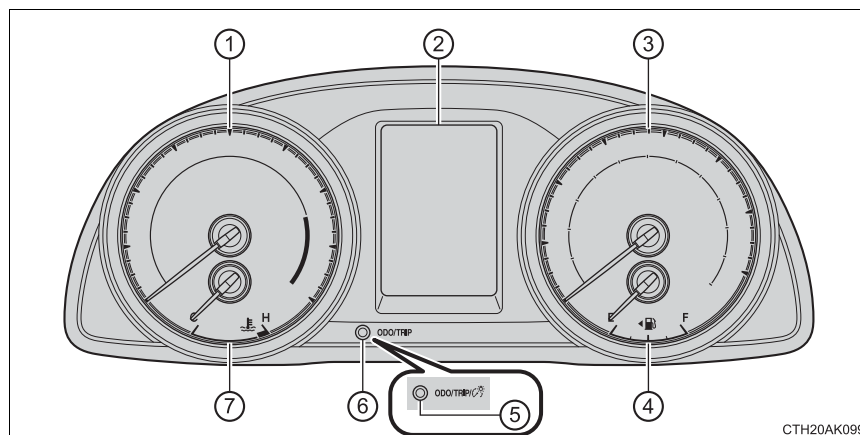

- ① Tachometer  
Displays the engine speed in revolutions per minute.
- ② Multi-information display  
The multi-information display presents the driver with a variety of driving-related data including the current outside air temperature.
- ③ Speedometer
- ④ Fuel gauge
- ⑤ Display change button (for Canada)  
Switches the trip information and instrument panel light control.
- ⑥ Display change button (for U.S.A.)  
Switches the trip information.
- ⑦ Engine coolant temperature gauge  
Displays the engine coolant temperature.

**Multi-information display**

- ① Driving assist information (→P. 99, 235)
- ② Driving monitor (→P. 81)
- ③ Warning messages (→P. 489)
- ④ Eco Driving Indicator Zone Display\* (→P. 100)
- ⑤ Outside temperature display (→P. 393)
- ⑥ Trip information (→P. 80)
- ⑦ Shift position and gear position indicator\* (→P. 181, 184)

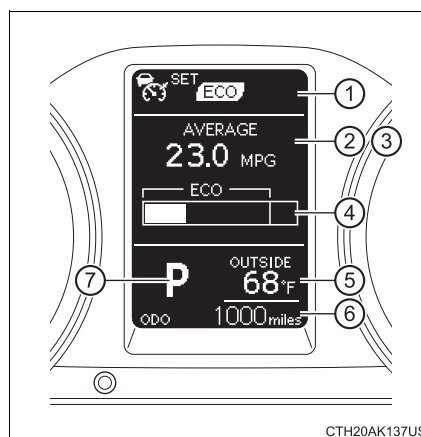

\*: Vehicles with a continuously variable transmission

### Instrument panel light control

When the tail lights are on, the brightness of the instrument panel lights can be adjusted. (On vehicles with an automatic light control system, the instrument panel lights can be adjusted when the surrounding area is dark and the tail lights are on.)

The brightness of the clock light can be adjusted regardless of whether the tail lights are on or off.

► For U.S.A.

- ① Brighter
- ② Darker

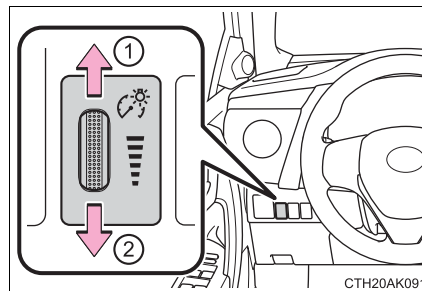

► For Canada

Press the display change button repeatedly to display the instrument panel lights control display. To adjust the brightness, press and hold the display change button.

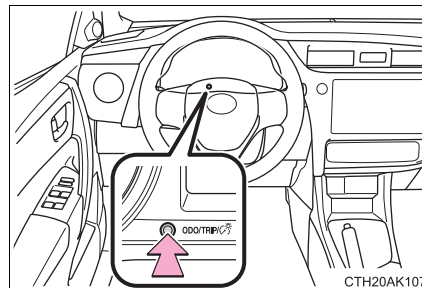

### Trip information

#### ■ Switching the display

Items displayed can be switched by pressing the display change button.

▶ For U.S.A.

▶ For Canada

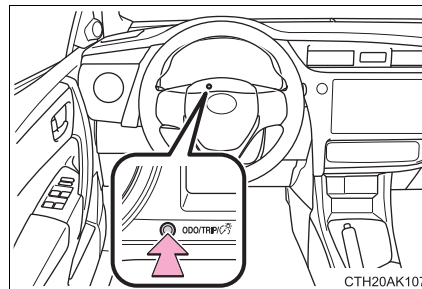
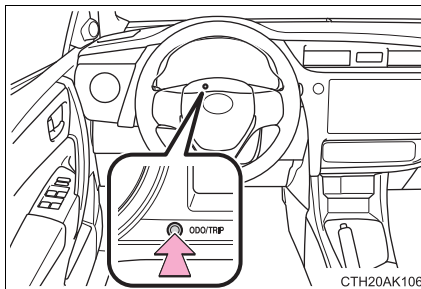

#### ■ Odometer

Displays the total distance the vehicle has been driven.

#### ■ Trip meter A/trip meter B

Displays the distance the vehicle has been driven since the meter was last reset. Trip meters A and B can be used to record and display different distances independently.

Press and hold the display change button to reset.



## Driving monitor

### ■ Switching the display

Items displayed can be switched by pressing the “DISP” switch.

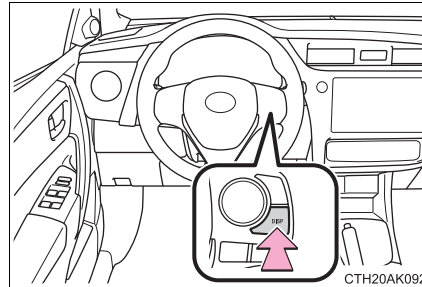

### ■ Average fuel consumption

Displays the average fuel consumption since the function was reset.

- Press and hold the “DISP” switch to reset when the average fuel consumption is displayed.
- Use the displayed average fuel consumption as a reference.

### ■ Current fuel consumption

Displays the current rate of fuel consumption.

Use the displayed current fuel consumption as a reference.

**■ Driving range**

Displays the estimated maximum distance that can be driven with the quantity of fuel remaining.

- This distance is computed based on your average fuel consumption. As a result, the actual distance that can be driven may differ from that displayed.
- When only a small amount of fuel is added to the tank, the display may not be updated.  
When refueling, turn the engine switch off. If the vehicle is refueled without turning the engine switch off, the display may not be updated.

**■ Average vehicle speed**

Displays the average vehicle speed since the engine was last started.

**■ Elapsed time**

Displays the elapsed time since the engine was started.

**■ Customization**

Some settings can be changed. (Customizable features: →P. 564)

**■ Eco Driving Indicator Zone Display (vehicles with a continuously variable transmission)**

→P. 100

### Customizing vehicle features

It is possible to customize the language and Eco Driving Indicator Light settings using the “DISP” switch.

When customizing vehicle features, ensure that the vehicle is parked in a safe place with the shift the shift lever to P (continuously variable transmission) or N (manual transmission) and the parking brake set.

- 1 Press the “DISP” switch to display the setting screen while the vehicle is stopped, and then press and hold the “DISP” switch to display the customize mode screen.

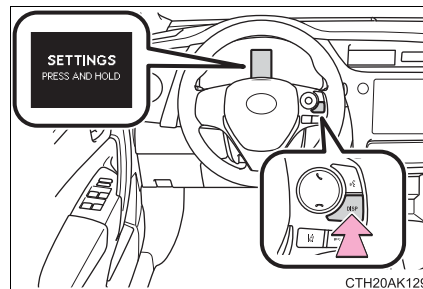

- 2 Press the “DISP” switch to select the item to be set, then press and hold the “DISP” switch.



- 3 Press the “DISP” switch to select the desired setting, and then press and hold the “DISP” switch.



To go back to the previous screen or exit the customize mode, press the “DISP” switch to select “EXIT”, and then press and hold the “DISP” switch.

2

Instrument cluster

**■ Customization**

Some settings can be changed. (Customizable features: →P. 564)

---

**■ The meters and display illuminate when**

- ▶ Vehicles without a smart key system  
The engine switch is in the "ON" position.
- ▶ Vehicles with a smart key system  
The engine switch is in IGNITION ON mode.

**■ When disconnecting and reconnecting battery terminals**

The following information data will be reset:

- Driving range
- Average vehicle speed
- Elapsed time
- Average fuel consumption

**■ Liquid crystal display**

Small spots or light spots may appear on the display. This phenomenon is characteristic of liquid crystal displays, and there is no problem continuing to use the display.

**■ Setting display automatic suspension**

In the following situations, the setting display will be suspended.

- When a message appears.
- When the vehicle begins to move.

 **WARNING****■ The display at low temperatures**

Allow the interior of the vehicle to warm up before using the display. At extremely low temperatures, the display monitor may respond slowly, and display changes may be delayed.

For example, there is a lag between the driver's shifting and the new gear number appearing on the display. This lag could cause the driver to downshift again, causing rapid and excessive engine braking and possibly an accident resulting in death or injury.

**■ Cautions during setting up the display**

As the engine needs to be running during setting up the display, ensure that the vehicle is parked in a place with adequate ventilation. In a closed area such as a garage, exhaust gases including harmful carbon monoxide (CO) may collect and enter the vehicle. This may lead to death or a serious health hazard.

 **NOTICE****■ To prevent damage to the engine and its components**

- Do not let the indicator needle of the tachometer enter the red zone, which indicates the maximum engine speed.
- The engine may be overheating if the engine coolant temperature gauge are in the red zone. In this case, immediately stop the vehicle in a safe place, and check the engine after it has cooled completely. (→P. 531)

## Gauges and meters (vehicles with a color display)

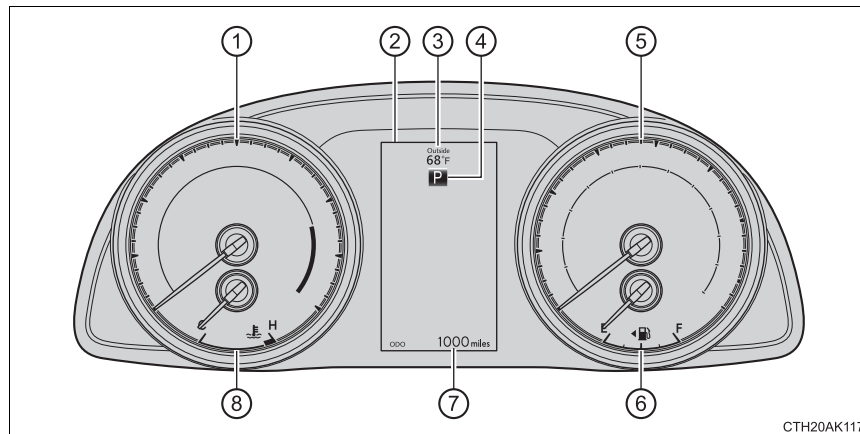

- ① Tachometer  
Displays the engine speed in revolutions per minute.
  - ② Multi-information display  
Presents the driver with a variety of driving-related data.  
Displays warning messages in case of a malfunction (→P. 489)
  - ③ Outside temperature display  
→P. 393
  - ④ Shift position/gear position display  
Displays the currently selected the shift position and gear position.  
→P. 181, 184
  - ⑤ Speedometer
  - ⑥ Fuel gauge
  - ⑦ Odometer and trip meter display/Instrument panel light control display\*  
→P. 87, 88
  - ⑧ Engine coolant temperature gauge  
Displays the engine coolant temperature.
- \*: Canada only

### Changing the odometer/trip meter display

Switches the items of the odometer and trip meter display by pressing the “TRIP” switch.

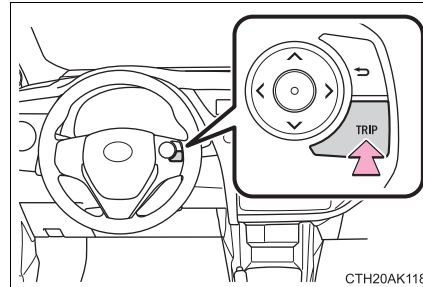

#### ■ Odometer

Displays the total distance the vehicle has been driven.

#### ■ Trip meter A\*/trip meter B\*

Displays the distance the vehicle has been driven since the meter was last reset. Trip meters A and B can be used to record and display different distances independently.

\*: Press and hold the “TRIP” switch to reset.

### Instrument panel light control

When the tail lights are on, the brightness of the instrument panel lights can be adjusted. (On vehicles with an automatic light control system, the instrument panel lights can be adjusted when the surrounding area is dark and the tail lights are on.)

The brightness of the clock light can be adjusted regardless of whether the tail lights are on or off.

► For U.S.A.

- ① Brighter
- ② Darker

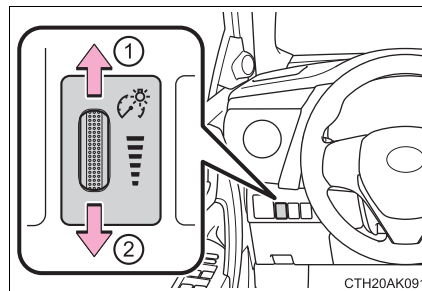

► For Canada

Press the "TRIP" switch repeatedly to display the instrument panel lights control display.

To adjust the brightness, press and hold the "TRIP" switch.

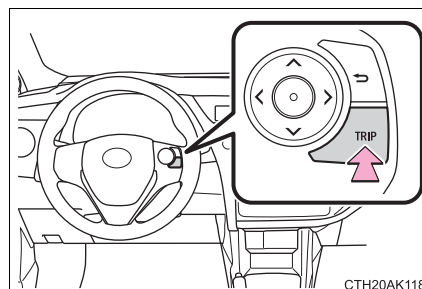



**■ The meters and display illuminate when**

- ▶ Vehicles without a smart key system

The engine switch is in the "ON" position.

- ▶ Vehicles with a smart key system

The engine switch is in IGNITION ON mode.

**NOTICE****■ To prevent damage to the engine and its components**

- Do not let the indicator needle of the tachometer enter the red zone, which indicates the maximum engine speed.
- The engine may be overheating if the engine coolant temperature gauge is in the red zone. In this case, immediately stop the vehicle in a safe place, and check the engine after it has cooled completely. (→P. 531)

## Multi-information display

### ■ Display contents

The multi-information display presents the driver with a variety of vehicle data.

#### ● Menu icons

Displays the following information when an icon is selected. (→P. 91)

Some of the information may be displayed automatically depending on the situation.

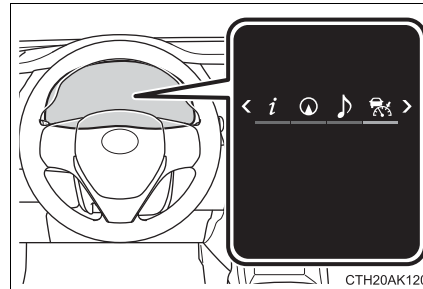

#### Drive information

Select to display various drive data. (→P. 92)



#### Navigation system-linked display (if equipped)

Select to display the following navigation system-linked information.

- Route guidance
- Compass display (north-up display/heading-up display)



#### Audio system-linked display (if equipped)

Select to enable selection of an audio source or track on the meter using the meter control switches.



#### Driving assist information

Select to display the dynamic radar cruise control or LDA (Lane Departure Alert with steering control) information, when the system is used. (→P. 226, 235)

The display icon changes depending on the system used.



### Warning message display

Select to display warning messages and measures to be taken if a malfunction is detected. (→P. 489)



### Settings display

Select to change the meter display settings. (→P. 93)

### ■ Operating the meter control switches

- ① Select an item/change pages
- ② Press: Enters/Sets  
Press and hold: Resets
- ③ Returns to the previous screen

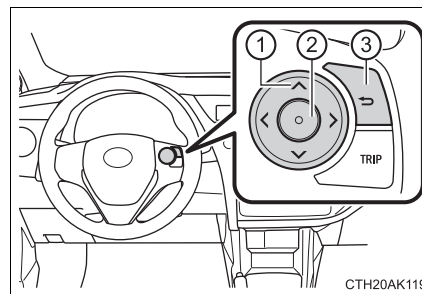

2

Instrument cluster

### Drive information

- Current fuel consumption\*<sup>1</sup>
- Average fuel consumption (after reset\*<sup>2</sup>/after start/after refuel)\*<sup>1</sup>

Displays the average fuel consumption since the function was reset, the engine was started, and the vehicle was refueled, respectively

Use the displayed average fuel consumption as a reference.
- Average speed (after reset\*<sup>2</sup>/after start)\*<sup>1</sup>

Displays the average vehicle speed since the function was reset and the engine was started, respectively
- Distance (driving range/after start)\*<sup>1</sup>

Displays the estimated maximum distance that can be driven with the quantity of fuel remaining and the distance driven after the engine was started, respectively.

  - This distance is computed based on your average fuel consumption. As a result, the actual distance that can be driven may differ from that displayed.
  - When only a small amount of fuel is added to the tank, the display may not be updated.

When refueling, turn the engine switch off. If the vehicle is refueled without turning the engine switch off, the display may not be updated.
- Elapsed time (after reset\*<sup>2</sup>/after start)\*<sup>1</sup>

Displays the elapsed time since the function was reset and the engine was started, respectively
- Eco Driving Indicator Zone Display (vehicles with a continuously variable transmission)
  - P. 100
- LDA (Lane Departure Alert with steering control) vehicle sway warning
  - P. 227
- Display off
 

A blank screen is displayed

\*<sup>1</sup>: Can be registered to Drive information 1 or 2. (→P. 93)

\*<sup>2</sup>: Resetting procedures:

- Select a function to be reset using the meter control switch and then press and hold to reset.
- If there is more than one function that can be reset, check boxes will be displayed next to those functions.

## Settings display

### ■ Changing the settings

- 1 Select  using the meter control switch.
- 2 Select an item and then set it with the center button.

### ■ Customizable items

- LDA (Lane Departure Alert with steering control)  
→P. 226
- LDA (Lane Departure Alert with steering control) vehicle sway warning  
→P. 227
- PCS (Pre-Collision System)  
→P. 214
- Language  
Select to change the language displayed on the multi-information display.
- Units  
Select to change the unit of measure displayed on the multi-information display.
- Drive information 1/Drive information 2  
Select to select up to 2 items that will be displayed on a Drive information screen.
- Eco driving indicator light  
Select to activate/deactivate the Eco Driving Indicator Light.  
(→P. 99)
- Pop-up display  
Select to set the following pop-up displays, which may appear in some situations, on/off.
  - Route guidance display of the navigation system-linked system (if equipped)
  - Incoming call display of the hands-free phone system
- Accent color  
Select to change the accent colors on the screen, such as the cursor color.

- **Maintenance system (U.S.A.)**

Select to reset the message after the required maintenance is performed. (→P. 415)

- **Initialization**

Registered or changed meter settings will be deleted or returned to their default setting.

---

- **Pop-up display**

In some situations, such as when a switch operation is performed, a pop-up display, such as the operating dynamic radar cruise control switch, will be temporarily displayed on the multi-information display.

The pop-up display function can be set on/off.

- **Setting display automatic cancelation**

In the following situations, a setting display in which the settings can be changed through the meter control switches will automatically be turned off.

- When a warning message appears while the setting display is displayed
- When the vehicle begins to move while the setting display is displayed

- **Liquid crystal display**

Small spots or light spots may appear on the display. This phenomenon is characteristic of liquid crystal displays, and there is no problem continuing to use the display.

 **WARNING****■ The information display at low temperatures**

Allow the interior of the vehicle to warm up before using the liquid crystal information display. At extremely low temperatures, the display monitor may respond slowly, and display changes may be delayed.

For example, there is a lag between the driver's shifting and the new gear number appearing on the display. This lag could cause the driver to down-shift again, causing rapid and excessive engine braking and possibly an accident resulting in death or injury.

**■ Cautions during setting up the display**

As the engine needs to be running during setting up the display, ensure that the vehicle is parked in a place with adequate ventilation. In a closed area such as a garage, exhaust gases including harmful carbon monoxide (CO) may collect and enter the vehicle. This may lead to death or a serious health hazard.

 **NOTICE****■ During setting up the display**

To prevent battery discharge, ensure that the engine is running while setting up the display features.

## Fuel consumption information

**Fuel consumption information can be displayed on Entune Audio, Entune Audio Plus and/or Entune Premium Audio.**

Entune Audio, Entune Audio Plus or Entune Premium Audio

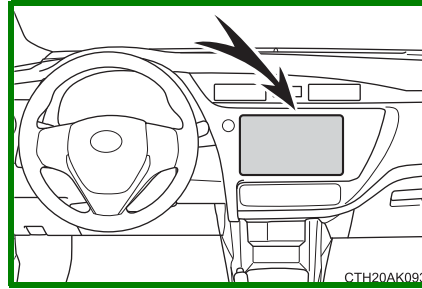

### Trip information

#### ► Entune Audio

Press the “CAR” button.

If the “Past Record” screen is displayed, select “Trip Information”.

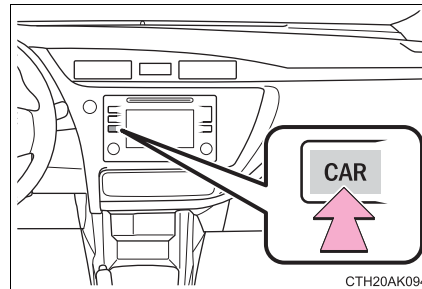

#### ► Entune Audio Plus or Entune Premium Audio

- 1 Press the “APPS” button.
- 2 Touch “Eco” on the “Apps” screen.

If the “Past Record” screen is displayed, select “Trip Information”.

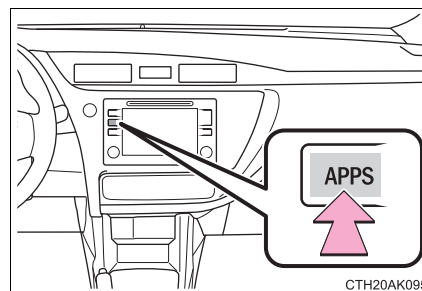



- ① Average vehicle speed
- ② Elapsed time
- ③ Range
- ④ Previous fuel consumption per minute
- ⑤ Current fuel consumption
- ⑥ Reset the trip information data
- ⑦ “Past Record” screen appears

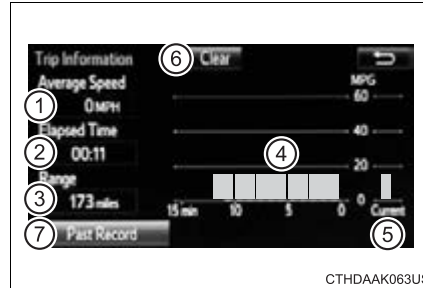

Vehicles without a smart key system:

Average fuel consumption for the past 15 minutes is divided by color into past averages and averages attained since the engine switch was last turned to the “ON” position. Use the displayed average fuel consumption as a reference.

Vehicles with a smart key system:

Average fuel consumption for the past 15 minutes is divided by color into past averages and averages attained since the engine switch was last turned to IGNITION ON mode. Use the displayed average fuel consumption as a reference.

This image is an example only.

### ■ Past record

- ▶ Entune Audio

Press the “CAR” button.

If the “Trip Information” screen is displayed, select “Past Record”.

- ▶ Entune Audio Plus or Entune Premium Audio

1 Press the “APPS” button.

2 Touch “Eco” on the “Apps” screen.

If the “Trip Information” screen is displayed, select “Past Record”.

1 Previous fuel economy record

2 Current fuel economy

3 Best recorded fuel economy

4 Update the past record data

5 Reset the past record data

6 “Trip Information” screen appears

7 Average recorded fuel economy

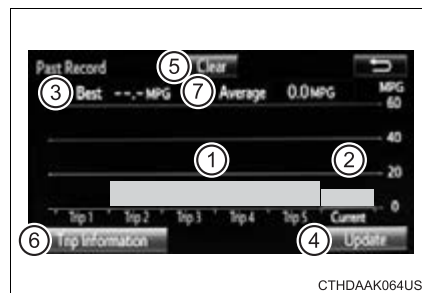

CTHDAAK064USa

These images are examples only, and may vary slightly from actual conditions.

### ■ Resetting the data

Selecting “Clear” on the “Trip Information” screen will reset the consumption data.

Selecting “Clear” on the “Past Record” screen will reset the past record data.

### ■ Updating the past record data

Selecting “Update” on the “Past Record” screen will update the past record data.

### ■ Cruising range

Displays the estimated maximum distance that can be driven with the quantity of fuel remaining.

This distance is computed based on your average fuel consumption.

As a result, the actual distance that can be driven may differ from that displayed.

## Eco Driving Indicator (vehicles with a continuously variable transmission)

### Eco Drive Indicator Light

During Eco-friendly acceleration operation (Eco driving), Eco Driving Indicator Light will turn on. When the acceleration exceeds Zone of Eco driving, and when the vehicle is stopped, the light turns off.

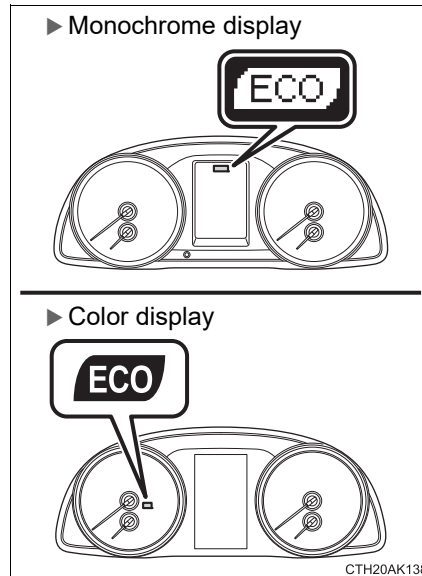

2

Instrument cluster

### Eco Drive Indicator Zone Display

Suggests Zone of Eco driving with current Eco driving ratio based on acceleration.

- ① Eco driving ratio based on acceleration  
If the acceleration exceeds Zone of Eco driving, the right side of Eco Driving Indicator Zone Display blinks.
- ② Zone of Eco driving

#### ► Monochrome display

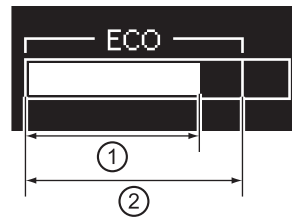

#### ► Color display

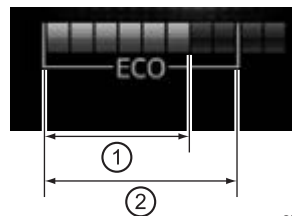

CTH20AK123

### Eco Driving Indicator Light customization

- Vehicles with a monochrome display  
→P. 83
- Vehicles with a color display  
→P. 93

#### ■ Operation of Eco Driving Indicator

Eco Driving Indicator will not operate in the following conditions:

- The shift lever is in any position other than D.
- Paddle shift switch\* is operated.
- Sport mode\* is selected.
- The vehicle speed is approximately 80 mph (130 km/h) or higher.

\*: If equipped

**Operation of  
each component****3****3-1. Key information**

Keys ..... 102

**3-2. Opening, closing and  
locking the doors**

Doors ..... 108

Trunk..... 117

Smart key system ..... 122

**3-3. Adjusting the seats**

Front seats ..... 130

Rear seats..... 132

Head restraints..... 134

**3-4. Adjusting the steering  
wheel and mirrors**

Steering wheel ..... 137

Inside rear view mirror ..... 139

Outside rear view  
mirrors..... 141**3-5. Opening and closing  
the windows**

Power windows ..... 143

Moon roof..... 147

## Keys

### The keys

The following keys are provided with the vehicle.

► Vehicles without a smart key system (type A)

- ① Keys
- ② Key number plate

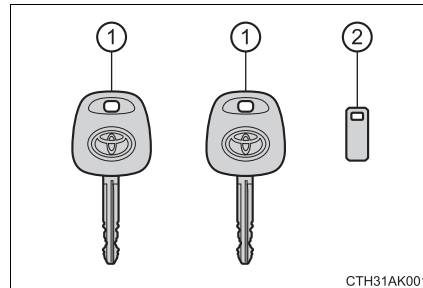

► Vehicles without a smart key system (type B)

- ① Keys
  - Operating the wireless remote control function
- ② Key number plate

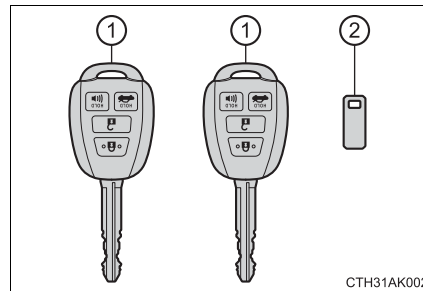

► Vehicles with a smart key system

- ① Electronic keys
  - Operating the smart key system (→P. 122)
  - Operating the wireless remote control function
- ② Mechanical keys
- ③ Key number plate

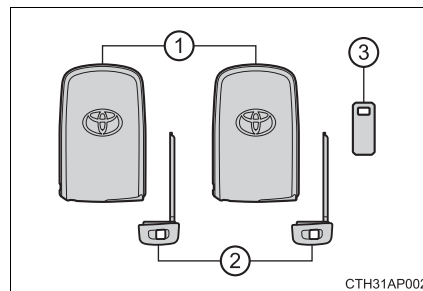

### Wireless remote control (if equipped)

#### ▶ Vehicles without a smart key system

- ① Locks all the doors (→P. 108)
- ② Unlocks all the doors (→P. 108)  
Pressing the button unlocks the driver's door. Pressing the button again within 5 seconds unlocks the other doors.
- ③ Sounds the alarm (→P. 104)
- ④ Opens the trunk (→P. 118)

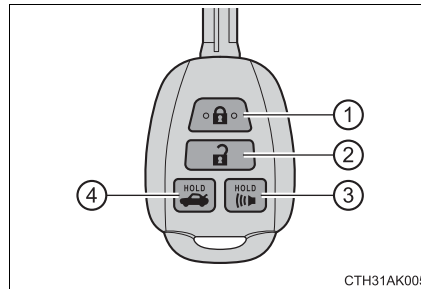

#### ▶ Vehicles with a smart key system

- ① Locks all the doors (→P. 109)
- ② Unlocks all the doors (→P. 109)  
Pressing the button unlocks the driver's door. Pressing the button again within 5 seconds unlocks the other doors.
- ③ Opens the trunk (→P. 118)
- ④ Sounds the alarm (→P. 104)

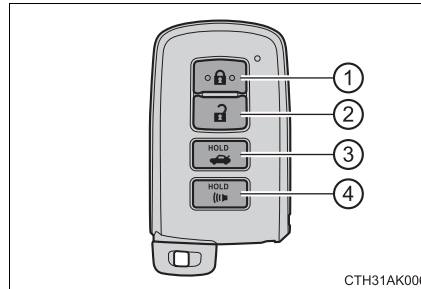

### Using the mechanical key

To take out the mechanical key, push the release button and take the key out.

The mechanical key can only be inserted in one direction, as the key only has grooves on one side. If the key cannot be inserted in a lock cylinder, turn it over and re-attempt to insert it.

After using the mechanical key, store it in the electronic key. Carry the mechanical key together with the electronic key. If the electronic key battery is depleted or the entry function does not operate properly, you will need the mechanical key. (→P. 523)

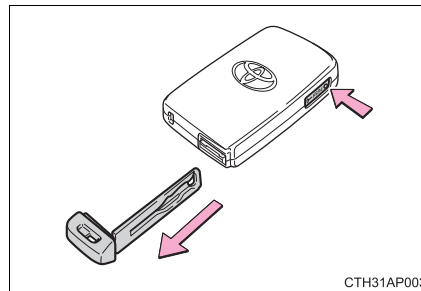

■ **Panic mode (with a wireless remote control function)**

▶ Vehicles without a smart key system

When  is pressed for longer than about one second, an alarm will sound intermittently and the vehicle lights will flash to deter any person from trying to break into or damage your vehicle.

To stop the alarm, press any button on the wireless remote control.



▶ Vehicles with a smart key system

When  is pressed for longer than about one second, an alarm will sound intermittently and the vehicle lights will flash to deter any person from trying to break into or damage your vehicle.

To stop the alarm, press any button on the electronic key.



■ **If you lose your keys**

New genuine keys can be made by your Toyota dealer using the other key (vehicles without a smart key system) or mechanical key (vehicles with a smart key system) and the key number stamped on your key number plate. Keep the plate in a safe place such as your wallet, not in the vehicle.

■ **When riding in an aircraft**

When bringing a key with wireless remote control function onto an aircraft, make sure you do not press any button on the key while inside the aircraft cabin. If you are carrying the key in your bag etc., ensure that the buttons are not likely to be pressed accidentally. Pressing a button may cause the key to emit radio waves that could interfere with the operation of the aircraft.



**■ Key battery depletion (vehicles with a wireless remote control function)****▶ Vehicles without a smart key system**

If the wireless remote control function does not operate, the battery may be depleted. Replace the battery when necessary. (→P. 455)

**▶ Vehicles with a smart key system**

- The standard battery life is 1 to 2 years.
- If the battery becomes low, an alarm will sound in the cabin when the engine stops. (→P. 503)
- As the electronic key always receives radio waves, the battery will become depleted even if the electronic key is not used. The following symptoms indicate that the electronic key battery may be depleted. Replace the battery when necessary. (→P. 455)
  - The smart key system or the wireless remote control does not operate.
  - The detection area becomes smaller.
  - The LED indicator on the key surface does not turn on.
- To avoid serious deterioration, do not leave the electronic key within 3 ft. (1 m) of the following electrical appliances that produce a magnetic field:
  - TVs
  - Personal computers
  - Cellular phones, cordless phones and battery chargers
  - Recharging cellular phones or cordless phones
  - Table lamps
  - Induction cookers

**■ Replacing the battery**

→P. 455

**■ Confirmation of the registered key number**

The number of keys already registered to the vehicle can be confirmed. Ask your Toyota dealer for details.

**■ If a wrong key is used (vehicles with a smart key system)**

The key cylinder rotates freely to isolate inside mechanism.

■ **Certification for the wireless remote control**

► For the U.S.A.

FCC ID: HYQ23AAH      FCC ID: HYQ12BEL

NOTE:

This device complies with part 15 of the FCC Rules. Operation is subject to the following two conditions: (1) This device may not cause harmful interference, and (2) this device must accept any interference received, including interference that may cause undesired operation.

FCC WARNING:

Changes or modifications not expressly approved by the party responsible for compliance could void the user's authority to operate the equipment.

For 12BEL

The FCC ID/IC Certification number is affixed inside the equipment. You can find the ID/number when replacing the battery.

► For Canada

NOTE:

This device complies with Industry Canada's licence-exempt RSSs. Operation is subject to the following two conditions: (1) This device may not cause interference; and (2) This device must accept any interference, including interference that may cause undesired operation of the device.

For 12BEL/12BDP

The FCC ID/IC Certification number is affixed inside the equipment. You can find the ID/number when replacing the battery.

NOTE:

Le présent appareil est conforme aux CNR d'Industrie Canada applicables aux appareils radio exempts de licence. L'exploitation est autorisée aux deux conditions suivantes: (1) l'appareil ne doit pas produire de brouillage; (2) l'utilisateur de l'appareil doit accepter tout brouillage radioélectrique subi, même si le brouillage est susceptible d'en compromettre le fonctionnement.

Pour 12BEL/12BDP

L'identification FCC/le numéro d'accréditation IC est apposé(e) à l'intérieur de l'appareil. Cette identification/ce numéro est visible au remplacement de la pile.

■ **Customization**

Settings (e.g. wireless remote control system) can be changed.

(Customizable features: →P. 564)

 NOTICE**■ To prevent key damage**

- Do not drop the keys, subject them to strong shocks or bend them.
- Do not expose the keys to high temperatures for long periods of time.
- Do not get the keys wet or wash them in an ultrasonic washer etc.
- Do not attach metallic or magnetic materials to the keys or place the keys close to such materials.
- Do not disassemble the keys.
- Do not attach a sticker or anything else to the surface of the electronic key and key (with a wireless remote control function).
- Vehicles with a smart key system: Do not place the keys near objects that produce magnetic fields, such as TVs, audio systems and induction cookers, or medical electrical equipment, such as low-frequency therapy equipment.

**■ Carrying the electronic key on your person (vehicles with a smart key system)**

Carry the electronic key 3.9 in. (10 cm) or more away from electric appliances that are turned on. Radio waves emitted from electric appliances within 3.9 in. (10 cm) of the electronic key may interfere with the key, causing the key to not function properly.

**■ In case of a smart key system malfunction or other key-related problems (vehicles with a smart key system)**

Take your vehicle with all the electronic keys provided with your vehicle to your Toyota dealer.

**■ When an electronic key is lost (vehicles with a smart key system)**

If the electronic key remains lost, the risk of vehicle theft increases significantly. Visit your Toyota dealer immediately with all remaining electronic keys that was provided with your vehicle.

## Doors

### Unlocking and locking the doors from the outside

#### ◆ Smart key system (if equipped)

Carry the electronic key to enable this function.

- ① Grip the driver's door handle to unlock the door. Grip the passenger's door handle to unlock all the doors.\*

Make sure to touch the sensor on the back of the handle.

The doors cannot be unlocked for 3 seconds after the doors are locked.

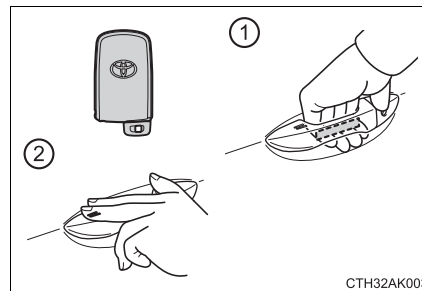

CTH32AK003

\*: The door unlock settings can be changed. (→P. 115)

- ② Touch the lock sensor (the indentation on the upper part of the door handle) to lock all the doors.

Check that the door is securely locked.

#### ◆ Wireless remote control (if equipped)

▶ Vehicles without a smart key system

- ① Locks all the doors

Check that the door is securely locked.

- ② Unlocks all the doors

Pressing the button unlocks the driver's door. Pressing the button again within 5 seconds unlocks the other doors.

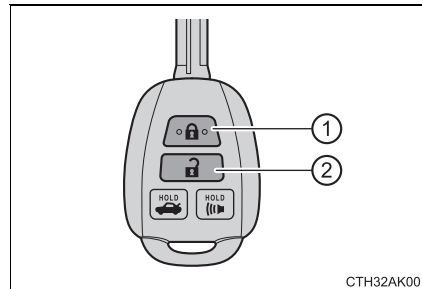

CTH32AK001

▶ Vehicles with a smart key system

① Locks all the doors

Check that the door is securely locked.

② Unlocks all the doors

Pressing the button unlocks the driver's door. Pressing the button again within 5 seconds unlocks the other doors.

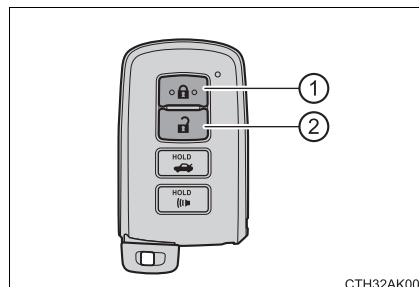

◆ **Key**

Turning the key operates the doors as follows:

▶ Vehicles without a smart key system

① Locks all the doors

② Unlocks all the doors

Driver's side only: Turning the key unlocks the driver's door. Turning the key again unlocks the other doors.

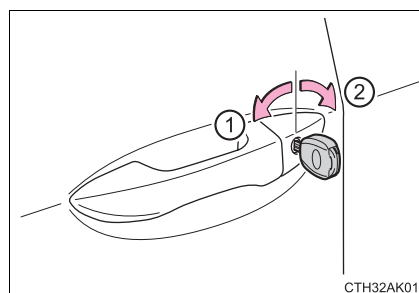

▶ Vehicles with a smart key system

The doors can also be locked and unlocked with the mechanical key. (→P. 523)

■ **Operation signals**

A buzzer sounds and the emergency flashers flash to indicate that the doors have been locked/unlocked. (Locked: once; Unlocked: twice)

■ **Security feature**

If a door is not opened within approximately 60 seconds after the vehicle is unlocked, the security feature automatically locks the vehicle again.

■ **When the door cannot be locked by the lock sensor on the upper part of the door handle**

If the door will not lock even when the top-side sensor area is touched, try using your palm to touch the lock sensor.

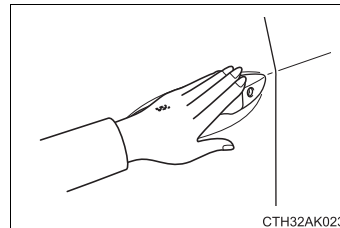

■ **Door lock buzzer**

If an attempt to lock the doors using the wireless remote control or smart key system is made when a door is not fully closed, a buzzer will sound for 5 seconds. Fully close the door, and lock the vehicle again.

■ **Setting the alarm (if equipped)**

Locking the doors will set the alarm system. (→P. 69)

■ **If the smart key system or the wireless remote control does not operate properly**

Use the mechanical key to lock and unlock the doors. (→P. 523)

Replace the battery with a new one if it is depleted. (→P. 455)

### Unlocking and locking the doors from the inside

#### ◆ Door lock switches

- ① Locks all the doors
- ② Unlocks all the doors

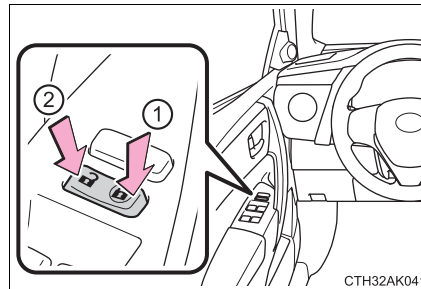

#### ◆ Inside lock buttons

- ① Locks the door
- ② Unlocks the door

The front doors can be opened by pulling the inside handle even if the lock buttons are in the lock position.

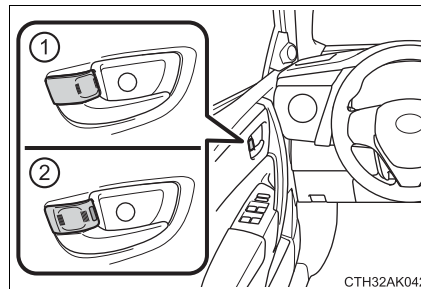

### Locking the doors from the outside without a key

- 1 Move the inside lock button to the lock position.
- 2 Close the door.

#### ▶ Vehicles without a smart key system

The door cannot be locked if either of the front doors is open and the key is in the engine switch.

#### ▶ Vehicles with a smart key system

The door cannot be locked if the engine switch is in ACCESSORY or IGNITION ON mode, or the electronic key is left inside the vehicle. However, the key may not be detected correctly and the door may be locked.

### Rear door child-protector lock

The door cannot be opened from inside the vehicle when the lock is set.

- ① Unlock
- ② Lock

These locks can be set to prevent children from opening the rear doors. Push down on each rear door switch to lock both rear doors.

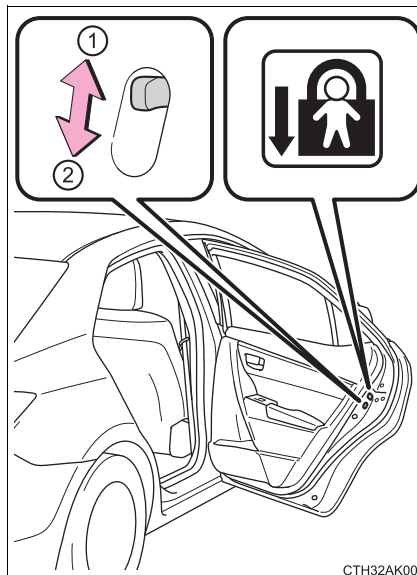

CTH32AK006



### Automatic door locking and unlocking systems

The following functions can be set or cancelled:

Function	Operation
Shift position linked door locking function <sup>*1</sup>	Shifting the shift lever out of P locks all doors.
Shift position linked door unlocking function <sup>*1</sup>	Shifting the shift lever to P unlocks all doors.
Speed linked door locking function <sup>*2</sup>	All doors are locked when the vehicle speed is approximately 12 mph (20 km/h) or higher.
Driver's door linked door unlocking function	<p>► Vehicles without a smart key system</p> <p>All doors are unlocked when the driver's door is opened within approximately 45 seconds of turning the engine switch to "ACC" or "LOCK".</p> <p>► Vehicles with a smart key system</p> <p>All doors are unlocked when the driver's door is opened within approximately 45 seconds of turning the engine switch to ACCESSORY mode or OFF.</p>

\*1: Vehicles with a continuously variable transmission



\*2: Vehicles with a smart key system

■ **Setting and canceling the functions**

To switch between set and canceled, follow the procedure below:

- 1 Vehicles without a smart key system: Close all the doors and switch the engine switch to the “ON” position. (Perform step 2 within 20 seconds.)



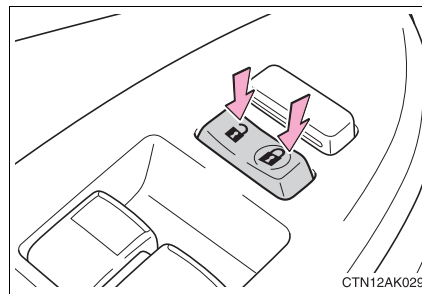

Vehicles with a smart key system: Close all the doors and switch the engine switch to IGNITION ON mode. (Perform step 2 within 20 seconds.)

- 2 Shift the shift lever to P or N, and press and hold the driver's door lock switch (  or  ) for approximately 5 seconds and then release.



The shift lever and switch positions corresponding to the desired function to be set are shown as follows.

Use the same procedure to cancel the function.

Function	Shift lever position	Driver's door lock switch position
Shift position linked door locking function*1	P	
Shift position linked door unlocking function*1		
Speed linked door locking function*2	N	
Driver's door linked door unlocking function		





\*1: Vehicles with a continuously variable transmission

\*2: Vehicles with a smart key system





When the setting or canceling operation is complete, all doors are locked and then unlocked.

■ **Switching the door unlock function (vehicles with a smart key system)**

It is possible to set which doors the entry function unlocks using the wireless remote control.

- 1 Turn the engine switch off.
- 2 When the indicator light on the key surface is not on, press and hold  ,  or  for approximately 5 seconds while pressing and holding  .

The setting changes each time an operation is performed, as shown below. (When changing the setting continuously, release the buttons, wait for at least 5 seconds, and repeat step 2.)

Multi-information display		Unlocking function	Beep
Monochrome display	Color display		
		Holding the driver's door handle unlocks only the driver's door.	Exterior: Beeps 3 times Interior: Pings once
		Holding the front passenger's door handle unlocks all the doors.	
		Holding either front door handle unlocks all the doors.	Exterior: Beeps twice Interior: Pings once

Vehicles with an alarm: To prevent unintended triggering of the alarm, unlock the doors using the wireless remote control and open and close a door once after the settings have been changed. (If a door is not opened within 60 seconds after  is pressed, the doors will be locked again and the alarm will automatically be set.)

In case that the alarm is triggered, immediately stop the alarm. (→P. 69)

3

Operation of each component

**■ Conditions affecting the operation of the smart key system or wireless remote control (with a wireless remote control function)****▶ Vehicles without a smart key system**

The wireless remote control function may not operate normally in the following situations:

- When the wireless key battery is depleted
- Near a TV tower, radio station, electric power plant, airport or other facility that generates strong radio waves
- When carrying a portable radio, cellular phone or other wireless communication devices
- When multiple wireless keys are in the vicinity
- When the wireless key is in contact with, or is covered by a metallic object
- When a wireless key (that emits radio waves) is being used nearby
- When the wireless key has been left near an electrical appliance such as a personal computer
- If window tint with a metallic content or metallic objects are attached to the rear window

**▶ Vehicles with a smart key system**

→P. 125

**■ Customization**

Settings (e.g. unlocking function using a key) can be changed.  
(Customizable features: →P. 564)

**⚠ WARNING****■ To prevent an accident**

Observe the following precautions while driving the vehicle.  
Failure to do so may result in a door opening and an occupant falling out, resulting in death or serious injury.

- Always use a seat belt.
- Always lock all the doors.
- Ensure that all doors are properly closed.
- Do not pull the inside handle of the doors while driving.  
The doors may be opened and the passengers are thrown out of the vehicle and it may result in serious injury or death.  
Be especially careful for the front doors, as the doors may be opened even if the inside lock buttons are in locked position.
- Set the rear door child-protector locks when children are seated in the rear seats.

## Trunk

The trunk can be opened using the trunk opener, entry function, wireless remote control or key.

### Opening the trunk from inside the vehicle

Pull up the lever to release the trunk lid.

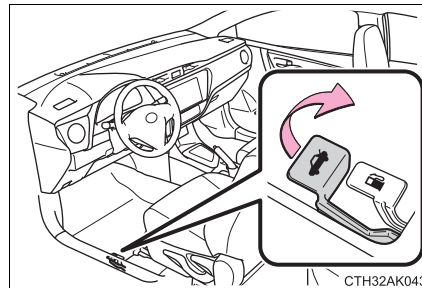

### Opening the trunk from outside the vehicle

#### ◆ Smart key system (if equipped)

While carrying the electronic key, press the button on the trunk lid.

When all the doors are unlocked with the power door lock system, the trunk can be opened without carrying the electronic key.

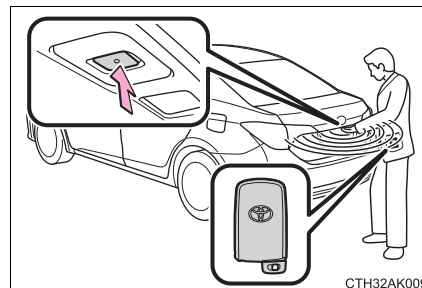

◆ **Wireless remote control (if equipped)**

▶ Vehicles without a smart key system

Press and hold the switch.

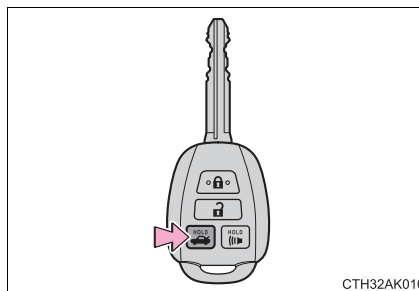

▶ Vehicles with a smart key system

Press and hold the switch.

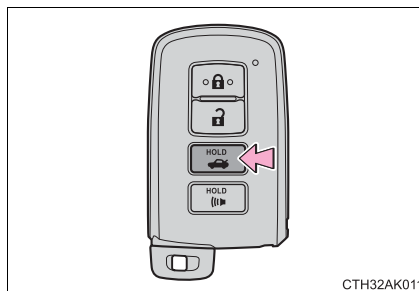

◆ **Key (vehicles with a key cylinder on the trunk lid)**

Turn the key clockwise to release the trunk lid.

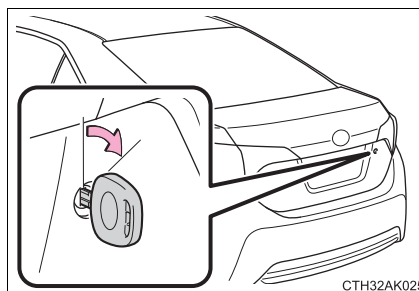

**■ Operation signal (with a wireless remote control function)**

A buzzer sounds to indicate that the trunk has been opened.

**■ Trunk light**

The trunk light turns on when the trunk is opened.

**■ Function to prevent the trunk being locked with the electronic key inside (vehicles with a smart key system)**

- When all doors are being locked, closing the trunk lid with the electronic key left inside the trunk will sound an alarm. In this case, the trunk lid can be opened by pressing the trunk release button on the trunk lid.
- Even when the spare electronic key is put in the trunk with all the doors locked, the key confinement prevention function can be activated so the trunk can be opened. In order to prevent theft, take all electronic keys with you when leaving the vehicle.
- Even when the electronic key is put in the trunk with all the doors are locked, the key may not be detected depending on the places and the surrounding radio wave conditions. In this case, the key confinement prevention function cannot be activated, causing the doors to lock when the trunk is closed. Make sure to check where the key is before closing the trunk.
- The key confinement prevention function cannot be activated if any one of the doors is unlocked. In this case, open the trunk using the trunk opener.

**■ Internal trunk release lever**

The trunk lid can be opened by pushing the glow-in-the-dark lever located on the inside of the trunk lid to the side.

The lever will continue to glow for some time after the trunk lid is closed.

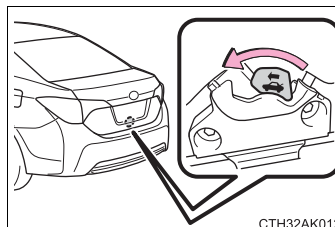
**■ Customization**

The trunk unlocking operation can be changed.  
(Customizable features: →P. 564)

 **WARNING****■ Caution while driving**

- Keep the trunk lid closed while driving.  
If the trunk lid is left open, it may hit near-by objects while driving or luggage in the trunk may be unexpectedly thrown out, causing an accident. In addition, exhaust gases may enter the vehicle, causing death or a serious health hazard. Make sure to close the trunk lid before driving.
- Before driving the vehicle, make sure that the trunk lid is fully closed. If the trunk lid is not fully closed, it may open unexpectedly while driving, causing an accident.
- Never let anyone sit in the trunk. In the event of sudden braking or a collision, they are susceptible to death or serious injury.

**■ When a child is in the vehicle**

Observe the following precautions.

Failure to do so may result in death or serious injury.

- Do not allow a child to play in the trunk.  
If a child is accidentally locked in the trunk, the child could suffer from heat exhaustion, suffocation or other injuries.
- Do not allow a child to open or close the trunk lid.  
Doing so may cause the trunk lid to operate unexpectedly, or cause the child's hands, head, or neck to be caught by the closing trunk lid.



**⚠ WARNING**

■ **Using the trunk**

Observe the following precautions.

Failure to do so may cause parts of the body to be caught, resulting in serious injury.

- Remove any heavy loads, such as snow and ice, from the trunk lid before opening it. Failure to do so may cause the trunk lid to suddenly shut again after it is opened.
- When opening or closing the trunk lid, thoroughly check to make sure the surrounding area is safe.
- If anyone is in the vicinity, make sure they are safe and let them know that the trunk is about to open or close.
- Use caution when opening or closing the trunk lid in windy weather as it may move abruptly in strong wind.
- The trunk lid may suddenly shut if it is not opened fully. It is more difficult to open or close the trunk lid on an incline than on a level surface, so beware of the trunk lid unexpectedly opening or closing by itself. Make sure that the trunk lid is fully open and secure before using the trunk.
- When closing the trunk lid, take extra care to prevent your fingers etc. from being caught.
- When closing the trunk lid, make sure to press it lightly on its outer surface. If the trunk handle is used to fully close the trunk lid, it may result in hands or arms being caught.
- Do not attach any accessories other than genuine Toyota parts to the trunk lid. Such additional weight on the trunk lid may cause the lid to suddenly shut again after it is opened.

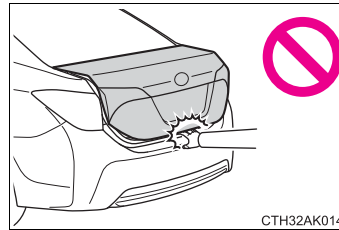
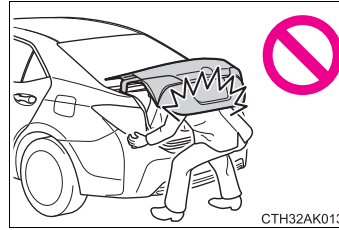

## Smart key system\*

The following operations can be performed simply by carrying the electronic key on your person, for example in your pocket. (The driver should always carry the electronic key.)

- Locks and unlocks the doors (→P. 108)
- Opens the trunk (→P. 117)
- Starts the engine (→P. 174)

### ■ Antenna location

- ① Antennas outside the cabin
- ② Antennas inside the cabin
- ③ Antenna inside the trunk
- ④ Antenna outside the trunk

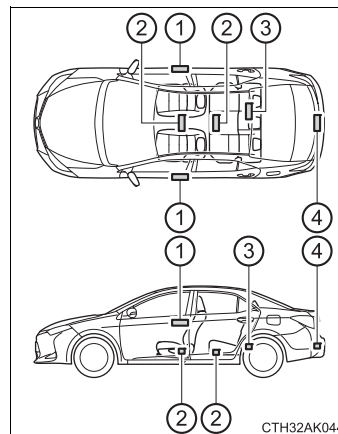

\*: If equipped

■ **Effective range (areas within which the electronic key is detected)**

- When locking or unlocking the doors

The system can be operated when the electronic key is within about 2.3 ft. (0.7 m) of either of the outside front door handles. (Only the doors detecting the key can be operated.)

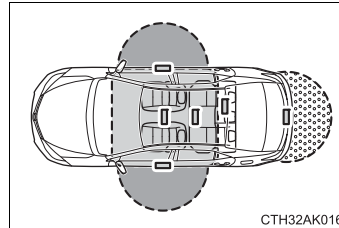

- When starting the engine or changing engine switch modes

The system can be operated when the electronic key is inside the vehicle.

- When opening the trunk

The system can be operated when the electronic key is within about 2.3 ft. (0.7 m) of the trunk release button.

■ **Alarms and warning indicators**

A combination of exterior and interior alarms as well as warning messages shown on the multi-information display are used to prevent theft of the vehicle and accidents resulting from erroneous operation. Take appropriate measures in response to any warning message on the multi-information display. (→P. 489)

The following table describes circumstances and correction procedures when only alarms are sounded.

Alarm	Situation	Correction procedure
Exterior alarm sounds once for 5 seconds	An attempt was made to lock the vehicle while a door was open.	Close all of the doors and lock the doors again.
	The trunk was closed while the electronic key was still inside the trunk and all the doors were locked.	Retrieve the electronic key from the trunk and close the trunk lid.
Interior alarm sounds continuously	The engine switch was turned to ACCESSORY mode while the driver's door was open (or the driver's door was opened while the engine switch was in ACCESSORY mode).	Turn the engine switch off and close the driver's door.



**Battery-saving function**

The battery-saving function will be activated in order to prevent the electronic key battery and the vehicle battery from being discharged while the vehicle is not in operation for a long time.

- In the following situations, the smart key system may take some time to unlock the doors.
  - The electronic key has been left in an area of approximately 6 ft. (2 m) of the outside of the vehicle for 10 minutes or longer.
  - The smart key system has not been used for 5 days or longer.
- If the smart key system has not been used for 14 days or longer, the doors cannot be unlocked at any doors except the driver's door. In this case, take hold of the driver's door handle, or use the wireless remote control or the mechanical key, to unlock the doors.

**Electronic Key Battery-Saving Function**

When battery-saving mode is set, battery depletion is minimized by stopping the electronic key from receiving radio waves.

Press  twice while pressing and holding . Confirm that the electronic key indicator flashes 4 times.

While the battery-saving mode is set, the smart key system cannot be used. To cancel the function, press any of the electronic key buttons.

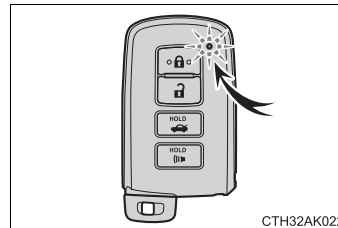

**■ Conditions affecting operation**

The smart key system uses weak radio waves. In the following situations, the communication between the electronic key and the vehicle may be affected, preventing the smart key system, wireless remote control and engine immobilizer system from operating properly. (Ways of coping: →P. 523)

- When the electronic key battery is depleted
- Near a TV tower, electric power plant, gas station, radio station, large display, airport or other facility that generates strong radio waves or electrical noise
- When carrying a portable radio, cellular phone, cordless phone or other wireless communication device
- When the electronic key is in contact with, or is covered by the following metallic objects
  - Cards to which aluminum foil is attached
  - Cigarette boxes that have aluminum foil inside
  - Metallic wallets or bags
  - Coins
  - Hand warmers made of metal
  - Media such as CDs and DVDs
- When other wireless keys (that emit radio waves) are being used nearby
- When carrying the electronic key together with the following devices that emit radio waves
  - Another vehicle's electronic key or a wireless key that emits radio waves
  - Personal computers or personal digital assistants (PDAs)
  - Digital audio players
  - Portable game systems
- If window tint with a metallic content or metallic objects are attached to the rear window
- When the electronic key is placed near a battery charger or electronic devices

**■ Note for the entry function**

- Even when the electronic key is within the effective range (detection areas), the system may not operate properly in the following cases:
  - The electronic key is too close to the window or outside door handle, near the ground, or in a high place when the doors are locked or unlocked.
  - The electronic key is near the ground or in a high place, or too close to the rear bumper center when the trunk is opened.
  - The electronic key is on the instrument panel, rear package tray or floor, or in the door pockets or glove box when the engine is started or engine switch modes are changed.
- Do not leave the electronic key on top of the instrument panel or near the door pockets when exiting the vehicle. Depending on the radio wave reception conditions, it may be detected by the antenna outside the cabin and the doors will become lockable from the outside, possibly trapping the electronic key inside the vehicle.
- As long as the electronic key is within the effective range, the doors may be locked or unlocked by anyone. However, only the doors detecting the electronic key can be used to unlock the vehicle.
- Even if the electronic key is not inside the vehicle, it may be possible to start the engine if the electronic key is near the window.
- The doors may unlock or lock if a large amount of water splashes on the door handle, such as in the rain or in a car wash, when the electronic key is within the effective range. (The doors will automatically be locked after approximately 60 seconds if the doors are not opened and closed.)
- If the wireless remote control is used to lock the doors when the electronic key is near the vehicle, there is a possibility that the door may not be unlocked by the entry function. (Use the wireless remote control to unlock the doors.)
- Touching the door lock or unlock sensor while wearing gloves may prevent lock or unlock operation.
- When the lock operation is performed using the lock sensor, recognition signals will be shown up to two consecutive times. After this, no recognition signals will be given.
- If the door handle becomes wet while the electronic key is within the effective range, the door may lock and unlock repeatedly. In this case, follow the following correction procedures to wash the vehicle:
  - Place the electronic key in a location 6 ft. (2 m) or more away from the vehicle. (Take care to ensure that the key is not stolen.)
  - Set the electronic key to battery-saving mode to disable the smart key system. (→P. 124)

- If the electronic key is inside the vehicle and a door handle becomes wet during a car wash, a message may be shown on the multi-information display and a buzzer will sound outside the vehicle. To turn off the alarm, lock all the doors.
  - The lock sensor may not work properly if it comes into contact with ice, snow, mud, etc. Clean the lock sensor and attempt to operate it again.
  - If there is another electronic key in the detection area, it may take slightly longer to unlock the doors after the door handle is gripped.
  - Fingernails may scrape against the door during operation of the door handle. Be careful not to injure fingernails or damage the surface of the door.
  - A sudden handle operation or a handle operation immediately after entering the effective range may prevent the doors from being unlocked. Touch the door unlock sensor and check that the doors are unlocked before pulling the door handle again.
  - Unlocking the vehicle may take more time if another electronic key is within the effective range.
- **When the vehicle is not driven for extended periods**
- To prevent theft of the vehicle, do not leave the electronic key within 6 ft. (2 m) of the vehicle.
  - The smart key system can be deactivated in advance. (→P. 564)
- **To operate the system properly**
- Make sure to carry the electronic key when operating the system. Do not get the electronic key too close to the vehicle when operating the system from the outside of the vehicle.
- Depending on the position and holding condition of the electronic key, the key may not be detected correctly and the system may not operate properly. (The alarm may go off accidentally, or the door lock prevention function may not operate.)
- **If the smart key system does not operate properly**
- Locking and unlocking the doors: Use the mechanical key. (→P. 523)
  - Starting the engine: →P. 524
- **Customization**
- Settings (e. g. smart key system) can be changed.  
(Customizable features: →P. 564)
- **If the smart key system has been deactivated in a customized setting**
- Locking and unlocking the doors and opening the trunk:  
Use the wireless remote control or mechanical key. (→P. 118, 523)
  - Starting the engine and changing engine switch modes: →P. 524
  - Stopping the engine: →P. 175

■ **Certification for the smart key system**

► For the U.S.A.

FCC ID: HYQ23AAB      FCC ID: HYQ14FBA

NOTE:

This device complies with part 15 of the FCC Rules. Operation is subject to the following two conditions: (1) This device may not cause harmful interference, and (2) this device must accept any interference received, including interference that may cause undesired operation.

FCC WARNING:

Changes or modifications not expressly approved by the party responsible for compliance could void the user's authority to operate the equipment.

► For Canada

NOTE:

This device complies with Industry Canada's licence-exempt RSSs. Operation is subject to the following two conditions: (1) This device may not cause interference; and (2) This device must accept any interference, including interference that may cause undesired operation of the device.

► For the U.S.A.

FCC ID: NI4TMLF10-51

This device complies with part 15 of the FCC Rules. Operation is subject to the following two conditions: (1) This device may not cause harmful interference, and (2) this device must accept any interference received, including interference that may cause undesired operation.

Changes or modifications not expressly approved by the party responsible for compliance could void the user's authority to operate the equipment.

► For Canada

This device complies with Industry Canada's licence-exempt RSSs. Operation is subject to the following two conditions: (1) This device may not cause interference; and (2) This device must accept any interference, including interference that may cause undesired operation of the device.

NOTE:

Le présent appareil est conforme aux CNR d'Industrie Canada applicables aux appareils radio exempts de licence. L'exploitation est autorisée aux deux conditions suivantes : (1) l'appareil ne doit pas produire de brouillage; (2) l'utilisateur de l'appareil doit accepter tout brouillage radioélectrique subi, même si le brouillage est susceptible d'en compromettre le fonctionnement.



 **WARNING****■ Caution regarding interference with electronic devices**

- People with implantable cardiac pacemakers, cardiac resynchronization therapy-pacemakers or implantable cardioverter defibrillators should keep away from the smart key system antennas. (→P. 122)

The radio waves may affect the operation of such devices. If necessary, the entry function can be disabled. Ask your Toyota dealer for details, such as the frequency of radio waves and timing of the emitted radio waves. Then, consult your doctor to see if you should disable the entry function.

- User of any electrical medical device other than implantable cardiac pacemakers, cardiac resynchronization therapy-pacemakers or implantable cardioverter defibrillators should consult the manufacturer of the device for information about its operation under the influence of radio waves.

Radio waves could have unexpected effects on the operation of such medical devices.

Ask your Toyota dealer for details for disabling the entry function.

## Front seats

### Adjustment procedure

► Manual seat

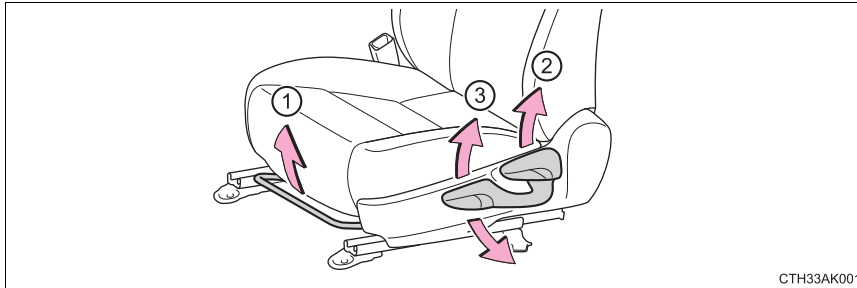

- ① Seat position adjustment lever
- ② Seatback angle adjustment lever
- ③ Vertical height adjustment lever (driver's side only)

► Power seat (driver's side only)

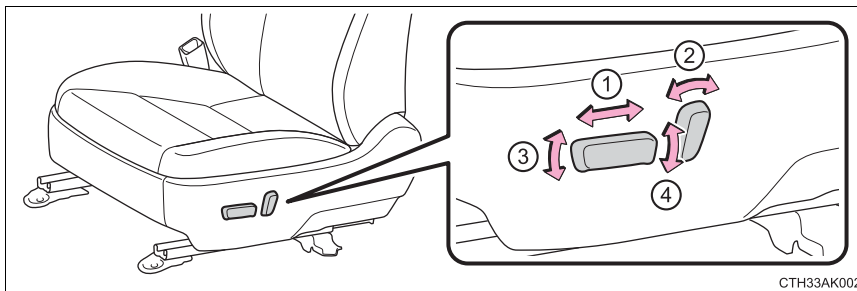

- ① Seat position adjustment switch
- ② Seatback angle adjustment switch
- ③ Seat cushion (front) angle adjustment switch
- ④ Vertical height adjustment switch

 **WARNING****■ Seat adjustment**

- Be careful that the seat does not hit passengers or luggage.
- Do not recline the seat more than necessary when the vehicle is in motion to reduce the risk of sliding under the lap belt.  
If the seat is too reclined, the lap belt may slide past the hips and apply restraint forces directly to the abdomen or your neck may contact the shoulder belt, increasing the risk of death or serious injury in the event of an accident.
- Manual seat only: After adjusting the seat, make sure that the seat is locked in position.

**■ When adjusting the seat positions**

Make sure to leave enough space around the feet so they do not get stuck.

3

Operation of each component

## Rear seats

The seatbacks of the rear seats can be folded down.

### Folding down the rear seatbacks

- 1 Stow the rear outside seat belt buckles and stow the rear center seat belt buckle as shown.

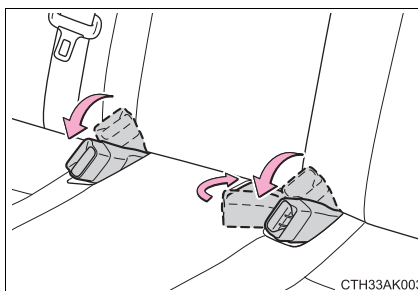

- 2 Pull the seatback lock release knob and fold the seatback down.

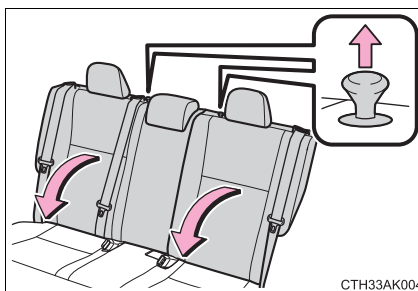

**⚠ WARNING****■ When folding the rear seatbacks down**

Observe the following precautions. Failure to do so may result in death or serious injury.

- Do not fold the seatbacks down while driving.
- Stop the vehicle on level ground, set the parking brake and shift the shift lever to P (continuously variable transmission) or N (manual transmission).
- Do not allow anyone to sit on a folded seatback or in the trunk while driving.
- Do not allow children to enter the trunk.
- Do not allow anyone to sit on the rear center seat if the rear right seat is folded down, as the seat belt buckle for the rear center seat belt is then concealed under the folded seat and cannot be used.
- Be careful not to catch your hand when folding the rear seatbacks.
- Adjust the position of the front seat before folding down the rear seatbacks so that the front seat does not interfere with the rear seatbacks when folding down the rear seatbacks.

**■ After returning the seatback to the upright position**

Observe the following precautions. Failure to do so may result in death or serious injury.

- Make sure that the seatback is securely locked in position by lightly rocking it back and forth.

If the seatback is not securely locked, the red marking will be visible on the seatback lock release knob. Make sure that the red marking is not visible.

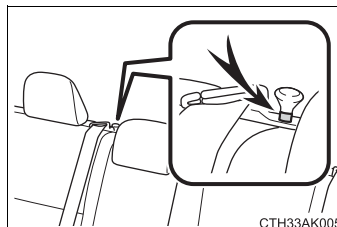

- Check that the seat belts are not twisted or caught under the seat.

**⚠ NOTICE****■ When the rear right seatback is folded down**

Make sure the luggage loaded in the enlarged trunk will not damage the webbing of the rear center seat belt.

## Head restraints

Head restraints are provided for all seats.

### Front seats

- ① Up  
Pull the head restraints up.
- ② Down  
Push the head restraint down while pressing the lock release button.

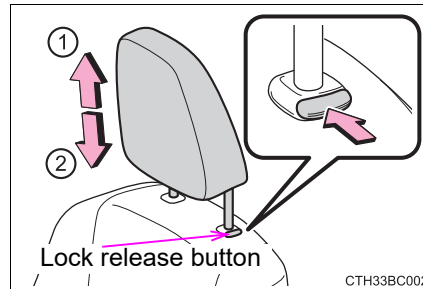

### Rear seats

#### ► Type A

- ① Up  
Pull the head restraints up.
- ② Down  
Push the head restraint down while pressing the lock release button.

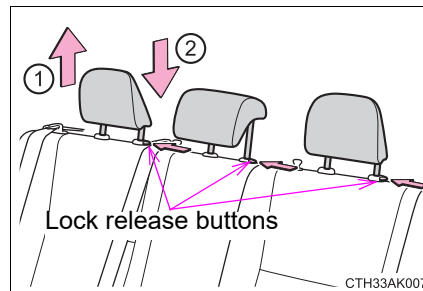

#### ► Type B

- ① Up  
Pull the head restraints up.
- ② Down  
Push the head restraint down while pressing the lock release button.

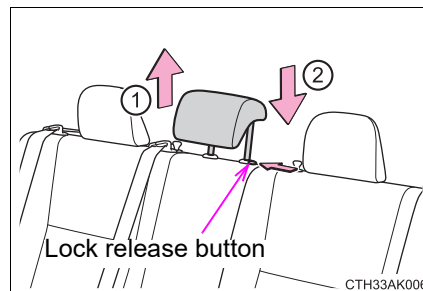

### ■ Removing the head restraints (except for fixed rear head restraints)

Pull the head restraint up while pressing the lock release button.

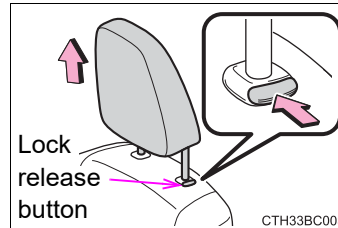

### ■ Installing the head restraints (except for fixed rear head restraints)

#### ▶ Front seats and rear outside seats

Align the head restraint with the installation holes and push it down to the lock position.

Press and hold the lock release button when lowering the head restraint.

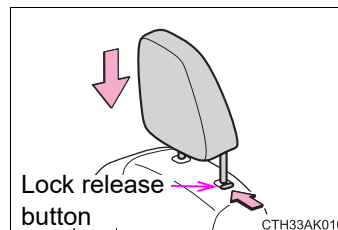

#### ▶ Rear center seat

Align the head restraint with the installation holes and push it down to the lowest lock position while pressing the lock release button.

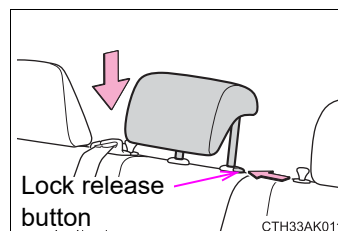

### ■ Adjusting the height of the head restraints (except for fixed rear head restraints)

Make sure that the head restraints are adjusted so that the center of the head restraint is closest to the top of your ears.

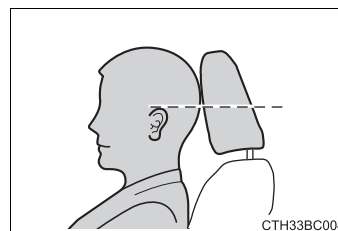

### ■ Adjusting the rear center seat head restraint

Always raise the head restraint one level from the stowed position when using.

**WARNING****■ Head restraint precautions**

Observe the following precautions regarding the head restraints. Failure to do so may result in death or serious injury.

- Use the head restraints designed for each respective seat.
- Adjust the head restraints to the correct position at all times.
- After adjusting the head restraints, push down on them and make sure they are locked in position.
- Do not drive with the head restraints removed.



## Steering wheel

### Adjustment procedure

- 1 Hold the steering wheel and push the lever down.

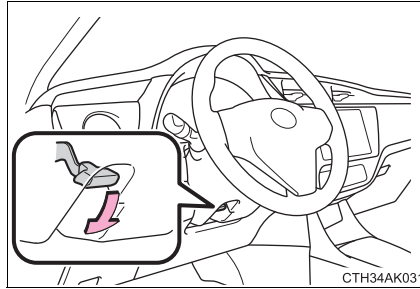

- 2 Adjust to the ideal position by moving the steering wheel horizontally and vertically. After adjustment, pull the lever up to secure the steering wheel.

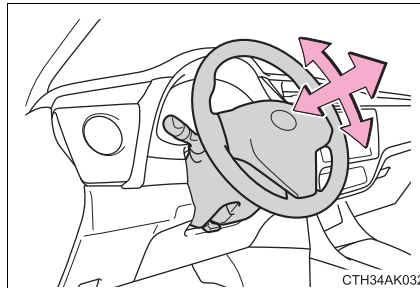

### Horn

To sound the horn, press on or close to the  mark.

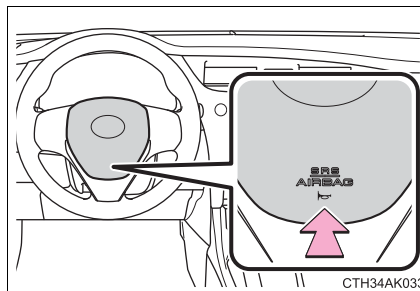

3

Operation of each component

 **WARNING****■ Caution while driving**

Do not adjust the steering wheel while driving.

Doing so may cause the driver to mishandle the vehicle and cause an accident, resulting in death or serious injury.

**■ After adjusting the steering wheel**

Make sure that the steering wheel is securely locked.

Otherwise, the steering wheel may move suddenly, possibly causing an accident, and resulting in death or serious injury. Also, the horn may not sound if the steering wheel is not securely locked.

## Inside rear view mirror

The rear view mirror's position can be adjusted to enable sufficient confirmation of the rear view.

### Adjusting the height of rear view mirror

The height of the rear view mirror can be adjusted to suit your driving posture.

Adjust the height of the rear view mirror by moving it up and down.

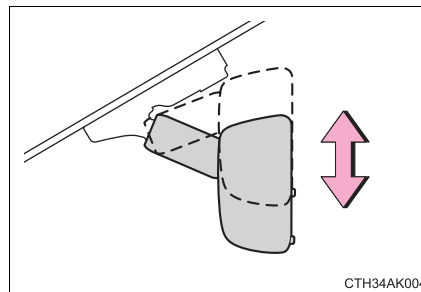

### Anti-glare function

#### ► Manual anti-glare inside rear view mirror

Reflected light from the headlights of vehicles behind can be reduced by operating the lever.

- ① Normal position
- ② Anti-glare position

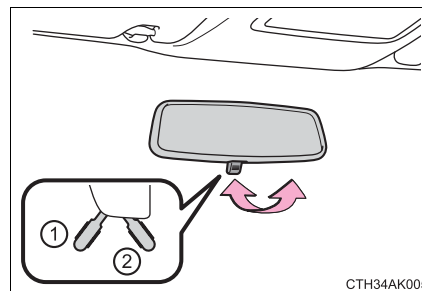

3

Operation of each component

▶ Auto anti-glare inside rear view mirror

Responding to the level of brightness of the headlights of vehicles behind, the reflected light is automatically reduced.

Changing automatic anti-glare function mode

On/off

When the automatic anti-glare function is in ON mode, the indicator illuminates.

Vehicles without a smart key system: The function will set to ON mode each time the engine switch is turned to the "ON" position.

Pressing the button turns the function to OFF mode. (The indicator also turns off.)

Vehicles with a smart key system: The function will set to ON mode each time the engine switch is turned to IGNITION ON mode.

Pressing the button turns the function to OFF mode. (The indicator also turns off.)

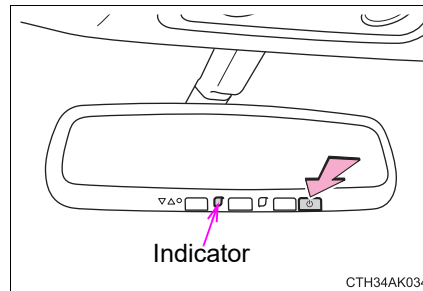

■ To prevent sensor error (vehicles with an auto anti-glare inside rear view mirror)

To ensure that the sensors operate properly, do not touch or cover them.

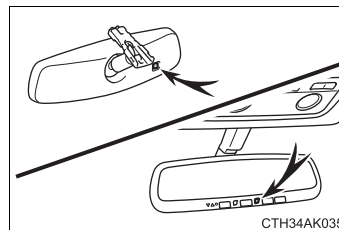

**⚠ WARNING**

Do not adjust the position of the mirror while driving. Doing so may lead to mishandling of the vehicle and cause an accident, resulting in death or serious injury.

## Outside rear view mirrors

### Adjustment procedure

- 1 To select a mirror to adjust, press the switch.

- ① Left
- ② Right

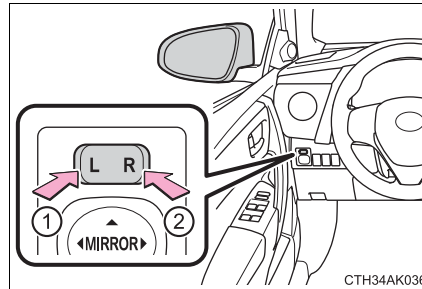

- 2 To adjust the mirror, press the switch.

- ① Up
- ② Right
- ③ Down
- ④ Left

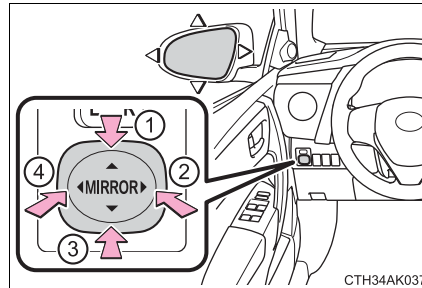

### Folding the mirrors

Push the mirror back in the direction of the vehicle's rear.

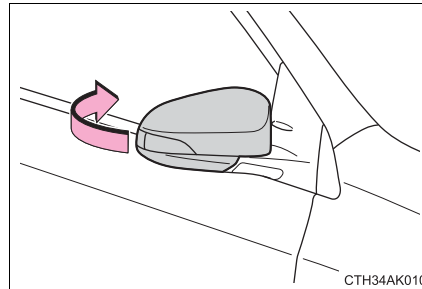

3

Operation of each component

**■ Mirror angle can be adjusted when**

- ▶ Vehicles without a smart key system

The engine switch is in the “ACC” or “ON” position.

- ▶ Vehicles with a smart key system

The engine switch is in ACCESSORY or IGNITION ON mode.

**■ When the mirrors are fogged up (if equipped)**

The outside rear view mirrors can be cleared using the mirror defoggers. Turn on the rear window defogger to turn on the outside rear view mirror defoggers. (→P. 368, 376)

**WARNING****■ Important points while driving**

Observe the following precautions while driving.

Failure to do so may result in loss of control of the vehicle and cause an accident, resulting in death or serious injury.

- Do not adjust the mirrors while driving.
- Do not drive with the mirrors folded.
- Both the driver and passenger side mirrors must be extended and properly adjusted before driving.

**■ When a mirror is moving**

To avoid personal injury and mirror malfunction, be careful not to get your hand caught by the moving mirror.

**■ When the mirror defoggers are operating (if equipped)**

Do not touch the rear view mirror surfaces, as they can become very hot and burn you.

## Power windows

### Opening and closing procedures

The power windows can be opened and closed using the switches. Operating the switch moves the windows as follows:

- ① Closing
- ② One-touch closing (driver's window only)\*
- ③ Opening
- ④ One-touch opening (driver's window only)\*

\*: To stop the window partway, operate the switch in the opposite direction.

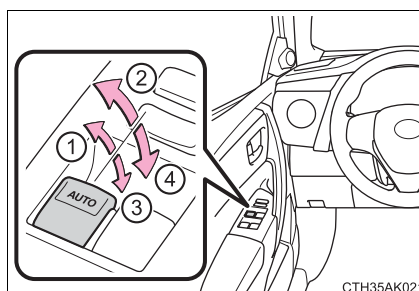

### Window lock switch

Press the switch to lock the passenger window switches.

Use this switch to prevent children from accidentally opening or closing a passenger window.

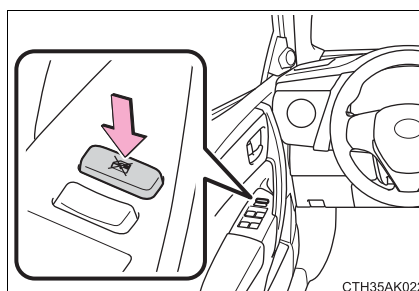

■ **The power windows can be operated when**

- ▶ Vehicles without a smart key system

The engine switch is in the “ON” position.

- ▶ Vehicles with a smart key system

The engine switch is in IGNITION ON mode.

■ **Operating the power windows after turning the engine off**

- ▶ Vehicles without a smart key system

The power windows can be operated for approximately 45 seconds even after the engine switch is turned to the “ACC” or “LOCK” position. They cannot, however, be operated once either front door is opened.

- ▶ Vehicles with a smart key system

The power windows can be operated for approximately 45 seconds even after the engine switch is turned to ACCESSORY mode or turned off. They cannot, however, be operated once either front door is opened.

■ **Jam protection function (driver’s window only)**

If an object becomes caught between the window and the window frame, window travel is stopped and the window is opened slightly.



**■ When the power window does not close normally (driver's window only)**

If the jam protection function is operating abnormally and a window cannot be closed, perform the following operations using the power window switch on the driver's door.

- Vehicles without a smart key system: After stopping the vehicle, the window can be closed by holding the power window switch in the one-touch closing position while the engine switch is turned to the "ON" position.

Vehicles with a smart key system: After stopping the vehicle, the window can be closed by holding the power window switch in the one-touch closing position while the engine switch is turned to IGNITION ON mode.

- If the window still cannot be closed even by carrying out the operation as explained above, initialize the function by performing the following procedure.

- 1 Hold the power window switch in the one-touch closing position. Continue holding the switch for a further 6 seconds after the window has closed.
- 2 Hold the power window switch in the one-touch opening position. Continue holding the switch for a further 2 seconds after the window has opened completely.
- 3 Hold the power window switch in the one-touch closing position once again. Continue holding the switch for a further 2 seconds after the window has closed.

If you release the switch while the window is moving, start again from the beginning.

If the window continues to close but then re-open slightly even after performing the above procedure correctly, have the vehicle inspected by your Toyota dealer.

 **WARNING**

Observe the following precautions.

Failure to do so may result in death or serious injury.

■ **Closing the windows**

- The driver is responsible for all the power window operations, including the operation for the passengers. In order to prevent accidental operation, especially by a child, do not let a child operate the power windows. It is possible for children and other passengers to have body parts caught in the power window. Also, when riding with a child, it is recommended to use the window lock switch.(→P. 143)
- Check to make sure that all passengers do not have any part of their body in a position where it could be caught when a window is being operated.
- When exiting the vehicle, turn the engine switch off, carry the key and exit the vehicle along with the child. There may be accidental operation, due to mischief, etc., that may possibly lead to an accident.

■ **Jam protection function (driver's window only)**

- Never use any part of your body to intentionally activate the jam protection function.
- The jam protection function may not work if something gets caught just before the window fully closes.

## Moon roof\*

Use the overhead switches to open and close the moon roof and tilt it up and down.

### ■ Opening and closing

- ① Opens the moon roof\*

The moon roof stops slightly before the fully open position to reduce wind noise.

Press the switch again to fully open the moon roof.

- ② Closes the moon roof\*

\*: Lightly press the switch in either direction to stop the moon roof partway.

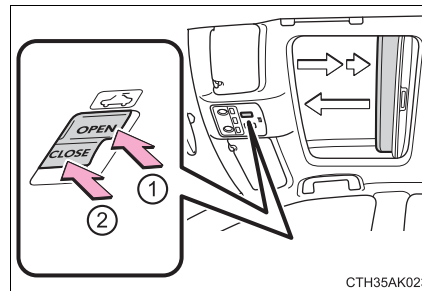

### ■ Tilt up and down

- ① Tilts the moon roof up\*

- ② Tilts the moon roof down\*

\*: Lightly press either of the moon roof switches to stop the moon roof partway.

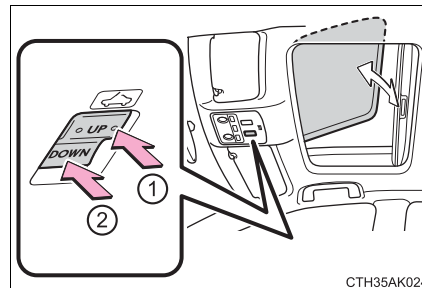

3

Operation of each component

\*: If equipped

■ **The moon roof can be operated when**

- ▶ Vehicles without a smart key system

The engine switch is in the “ON” position.

- ▶ Vehicles with a smart key system

The engine switch is in IGNITION ON mode.

■ **Operating the moon roof after turning the engine off**

- ▶ Vehicles without a smart key system

The moon roof can be operated for approximately 45 seconds after the engine switch is turned to the “ACC” or “LOCK” position. It cannot, however, be operated once either front door is opened.

- ▶ Vehicles with a smart key system

The moon roof can be operated for approximately 45 seconds after the engine switch is turned to ACCESSORY mode or turned off. It cannot, however, be operated once either front door is opened.

■ **Jam protection function**

If an object is detected between the moon roof and the frame while the moon roof is closing or tilting down, travel is stopped and the moon roof opens slightly.

■ **Sunshade**

The sunshade can be opened and closed manually. However, the sunshade will open automatically when the moon roof is opened.

### ■ When the moon roof does not close normally

Perform the following procedure:

- If the moon roof closes but then re-opens slightly

- 1 Stop the vehicle.
- 2 Press and hold the “CLOSE” switch.\*1  
The moon roof will close, reopen and pause for approximately 10 seconds.\*2 Then it will close again, tilt up and pause for approximately 1 second. Finally, it will tilt down, open and close.
- 3 Check to make sure that the moon roof is completely closed and then release the switch.

- If the moon roof tilts down but then tilts back up

- 1 Stop the vehicle.
- 2 Press and hold the “UP” switch\*1 until the moon roof moves into the tilt up position and stops.
- 3 Release the “UP” switch once and then press and hold the “UP” switch again.\*1  
The moon roof will pause for approximately 10 seconds in the tilt up position.\*2 Then it will adjust slightly and pause for approximately 1 second. Finally, it will tilt down, open and close.
- 4 Check to make sure that the moon roof is completely closed and then release the switch.

\*1: If the switch is released at the incorrect time, the procedure will have to be performed again from the beginning.

\*2: If the switch is released after the above mentioned 10 second pause, automatic operation will be disabled. In that case, press and hold the open/close switch in the close position or press and hold the “UP” switch. The moon roof will tilt up and pause for approximately 1 second. Then it will tilt down, open and close. Check to make sure that the moon roof is completely closed and then release the switch.

If the moon roof does not fully close even after performing the above procedure correctly, have the vehicle inspected by your Toyota dealer.

### ■ Moon roof open reminder function

An alarm will sound when the driver’s door is opened with the moon roof not fully closed and the engine switch off.

 **WARNING****■ Opening the moon roof**

Observe the following precautions.

Failure to do so may cause death or serious injury.

- Do not allow any passengers to put their hands or heads outside the vehicle while it is moving.
- Do not sit on top of the moon roof.

**■ Closing the moon roof**

Observe the following precautions.

Failure to do so may result in death or serious injury.

- The driver is responsible for moon roof opening and closing operations. In order to prevent accidental operation, especially by a child, do not let a child operate the moon roof. It is possible for children and other passengers to have body parts caught in the moon roof.
- Check to make sure that all passengers do not have any part of their bodies in a position where they could be caught when the moon roof is being operated.
- When exiting the vehicle, turn the engine switch off, carry the key and exit the vehicle along with the child. There may be accidental operation, due to mischief, etc., that may possibly lead to an accident.

**■ Jam protection function**

- Never use any part of your body to intentionally activate the jam protection function.
- The jam protection function may not work if something gets caught just before the moon roof fully closes.

## Driving

# 4

- |   |   |
|---|---|
| <p><b>4-1. Before driving</b></p> <ul style="list-style-type: none"> <li>Driving the vehicle..... 152</li> <li>Cargo and luggage ..... 163</li> <li>Vehicle load limits ..... 166</li> <li>Trailer towing..... 167</li> <li>Dinghy towing (vehicles with a continuously variable transmission) ..... 168</li> <li>Dinghy towing (vehicles with a manual transmission)..... 169</li> </ul> <p><b>4-2. Driving procedures</b></p> <ul style="list-style-type: none"> <li>Engine (ignition) switch (vehicles without a smart key system)..... 171</li> <li>Engine (ignition) switch (vehicles with a smart key system)..... 174</li> <li>Continuously variable transmission (vehicles without paddle shift switches) ..... 181</li> <li>Continuously variable transmission (vehicles with paddle shift switches) ..... 184</li> <li>Manual transmission ..... 189</li> <li>Turn signal lever..... 191</li> <li>Parking brake..... 192</li> </ul> | <p><b>4-3. Operating the lights and wipers</b></p> <ul style="list-style-type: none"> <li>Headlight switch..... 193</li> <li>Automatic High Beam ..... 198</li> <li>Windshield wipers and washer ..... 202</li> </ul> <p><b>4-4. Refueling</b></p> <ul style="list-style-type: none"> <li>Opening the fuel tank cap ..... 204</li> </ul> <p><b>4-5. Using the driving support systems</b></p> <ul style="list-style-type: none"> <li>Toyota Safety Sense P ..... 207</li> <li>PCS (Pre-Collision System) .... 214</li> <li>LDA (Lane Departure Alert with steering control)..... 226</li> <li>Dynamic radar cruise control ..... 235</li> <li>Rear view monitor system ..... 247</li> <li>Driving assist systems ..... 257</li> </ul> <p><b>4-6. Driving tips</b></p> <ul style="list-style-type: none"> <li>Winter driving tips ..... 263</li> </ul> |
|---|---|

## Driving the vehicle

**The following procedures should be observed to ensure safe driving:**

### Starting the engine

→P. 171, 174

### Driving

▶ Continuously variable transmission

- 1 With the brake pedal depressed, shift the shift lever to D.  
(→P. 181, 184)
- 2 Release the parking brake. (→P. 192)
- 3 Gradually release the brake pedal and gently depress the accelerator pedal to accelerate the vehicle.

▶ Manual transmission

- 1 While depressing the clutch pedal, shift the shift lever to 1.  
(→P. 189)
- 2 Release the parking brake. (→P. 192)
- 3 Gradually release the clutch pedal. At the same time, gently depress the accelerator pedal to accelerate the vehicle.

### Stopping

▶ Continuously variable transmission

- 1 With the shift lever in D, depress the brake pedal.
- 2 If necessary, set the parking brake.  
If the vehicle is to be stopped for an extended period of time, shift the shift lever to P or N. (→P. 181, 184)

▶ Manual transmission

- 1 While depressing the clutch pedal, depress the brake pedal.
- 2 If necessary, set the parking brake.  
If the vehicle is to be stopped for an extended period of time, shift the shift lever to N. (→P. 189)



### Parking the vehicle

▶ Continuously variable transmission

- 1 With the shift lever in D, depress the brake pedal.
- 2 Set the parking brake (→P. 192), and shift the shift lever to P. (→P. 181, 184)
- 3 Vehicles without a smart key system: Turn the engine switch to the “LOCK” position to stop the engine.  
Vehicles with a smart key system: Press the engine switch to stop the engine.
- 4 Lock the door, making sure that you have the key on your person.  
If parking on a hill, block the wheels as needed.

▶ Manual transmission

- 1 While depressing the clutch pedal, depress the brake pedal.
- 2 Shift the shift lever to N. (→P. 189)  
If parking on a hill, shift the shift lever to 1 or R.
- 3 Set the parking brake. (→P. 192)
- 4 Vehicles without a smart key system: Turn the engine switch to the “LOCK” position to stop the engine.  
Vehicles with a smart key system: Press the engine switch to stop the engine.
- 5 Lock the door, making sure that you have the key on your person.  
If parking on a hill, block the wheels as needed.

### **Starting off on a steep uphill**

▶ Continuously variable transmission

- 1 Make sure that the parking brake is set and shift the shift lever to D.
- 2 Gently depress the accelerator pedal.
- 3 Release the parking brake.

▶ Manual transmission

- 1 With the parking brake firmly set and the clutch pedal fully depressed, shift the shift lever to 1.
- 2 Lightly depress the accelerator pedal at the same time as gradually releasing the clutch pedal.
- 3 Release the parking brake.

---

### **When starting off on an uphill**

The hill-start assist control will activate. (→P. 257)

### **Driving in the rain**

- Drive carefully when it is raining, because visibility will be reduced, the windows may become fogged-up, and the road will be slippery.
- Drive carefully when it starts to rain, because the road surface will be especially slippery.
- Refrain from high speeds when driving on an expressway in the rain, because there may be a layer of water between the tires and the road surface, preventing the steering and brakes from operating properly.

### ■ Engine speed while driving (vehicles with a continuously variable transmission)

In the following conditions, the engine speed may become high while driving. This is due to automatic up-shifting control or down-shifting implementation to meet driving conditions. It does not indicate sudden acceleration.

- The vehicle is judged to be driving uphill or downhill
- When the accelerator pedal is released
- When the brake pedal is depressed while sport mode is selected (if equipped)
- When the brake pedal is depressed suddenly and vehicle speed is reduced sharply

### ■ Breaking in your new Toyota

To extend the life of the vehicle, observing the following precautions is recommended:

- For the first 186 miles (300 km):  
Avoid sudden stops.
- For the first 621 miles (1000 km):
  - Do not drive at extremely high speeds.
  - Avoid sudden acceleration.
  - Do not drive continuously in low gears.
  - Do not drive at a constant speed for extended periods.

### ■ Operating your vehicle in a foreign country

Comply with the relevant vehicle registration laws and confirm the availability of the correct fuel. (→P. 540)

#### WARNING

Observe the following precautions.

Failure to do so may result in death or serious injury.

#### ■ When starting the vehicle (vehicles with a continuously variable transmission)

Always keep your foot on the brake pedal while stopped with the engine running. This prevents the vehicle from creeping.

 **WARNING**

Observe the following precautions.

Failure to do so may result in death or serious injury.

■ **When driving the vehicle**

- Do not drive if you are unfamiliar with the location of the brake and accelerator pedals to avoid depressing the wrong pedal.
  - Accidentally depressing the accelerator pedal instead of the brake pedal will result in sudden acceleration that may lead to an accident.
  - When backing up, you may twist your body around, leading to a difficulty in operating the pedals. Make sure to operate the pedals properly.
  - Make sure to keep a correct driving posture even when moving the vehicle only slightly. This allows you to depress the brake and accelerator pedals properly.
  - Depress the brake pedal using your right foot. Depressing the brake pedal using your left foot may delay response in an emergency, resulting in an accident.
- Do not drive the vehicle over or stop the vehicle near flammable materials. The exhaust system and exhaust gases can be extremely hot. These hot parts may cause a fire if there is any flammable material nearby.
- During normal driving, do not turn off the engine. Turning the engine off while driving will not cause loss of steering or braking control, but the power assist to these systems will be lost. This will make it more difficult to steer and brake, so you should pull over and stop the vehicle as soon as it is safe to do so.

However, in the event of an emergency, such as if it becomes impossible to stop the vehicle in the normal way: →P. 471
- Use engine braking (downshift) to maintain a safe speed when driving down a steep hill.

Using the brakes continuously may cause the brakes to overheat and lose effectiveness. (→P. 181, 184, 189)
- Do not adjust the display, the positions of the steering wheel, the seat, or the inside or outside rear view mirrors while driving.

Doing so may result in a loss of vehicle control.
- Always check that all passengers' arms, heads or other parts of their body are not outside the vehicle.
- Do not drive in excess of the speed limit. Even if the legal speed limit permits it, do not drive over 85 mph (140 km/h) unless your vehicle has high-speed capability tires. Driving over 85 mph (140 km/h) may result in tire failure, loss of control and possible injury. Be sure to consult a tire dealer to determine whether the tires on your vehicle are high-speed capability tires or not before driving at such speeds.

 **WARNING**

Observe the following precautions.

Failure to do so may result in death or serious injury.

■ **When driving on slippery road surfaces**

- Sudden braking, acceleration and steering may cause tire slippage and reduce your ability to control the vehicle.
- Sudden acceleration, engine braking due to shifting, or changes in engine speed could cause the vehicle to skid.
- After driving through a puddle, lightly depress the brake pedal to make sure that the brakes are functioning properly. Wet brake pads may prevent the brakes from functioning properly. If the brakes on only one side are wet and not functioning properly, steering control may be affected.

■ **When shifting the shift lever**

- Vehicles with a continuously variable transmission: Do not let the vehicle roll backward while the shift lever is in a driving position, or roll forward while the shift lever is in R.  
Doing so may cause the engine to stall or lead to poor brake and steering performance, resulting in an accident or damage to the vehicle.
- Vehicles with a continuously variable transmission: Do not shift the shift lever to P while the vehicle is moving.  
Doing so can damage the transmission and may result in a loss of vehicle control.
- Do not shift the shift lever to R while the vehicle is moving forward.  
Doing so can damage the transmission and may result in a loss of vehicle control.
- Do not shift the shift lever to a driving position while the vehicle is moving backward.  
Doing so can damage the transmission and may result in a loss of vehicle control.
- Moving the shift lever to N while the vehicle is moving will disengage the engine from the transmission. Engine braking is not available when N is selected.
- Vehicles with a continuously variable transmission: Be careful not to shift the shift lever with the accelerator pedal depressed. Shifting the shift lever to a gear other than P or N may lead to unexpected rapid acceleration of the vehicle that may cause an accident and result in death or serious injury.

**⚠ WARNING**

Observe the following precautions.

Failure to do so may result in death or serious injury.

■ **If you hear a squealing or scraping noise (brake pad wear limit indicators)**

Have the brake pads checked and replaced by your Toyota dealer as soon as possible.

Rotor damage may result if the pads are not replaced when needed.

It is dangerous to drive the vehicle when the wear limits of the brake pads and/or those of the brake discs are exceeded.

■ **When the vehicle is stopped**

- Do not race the engine.

If the vehicle is in any gear other than P (continuously variable transmission) or N, the vehicle may accelerate suddenly and unexpectedly, causing an accident.

- Vehicles with a continuously variable transmission: In order to prevent accidents due to the vehicle rolling away, always keep depressing the brake pedal while the engine is running, and apply the parking brake as necessary.

- If the vehicle is stopped on an incline, in order to prevent accidents caused by the vehicle rolling forward or backward, always depress the brake pedal and securely apply the parking brake as needed.

- Avoid revving or racing the engine.

Running the engine at high speed while the vehicle is stopped may cause the exhaust system to overheat, which could result in a fire if combustible material is nearby.

■ **When the vehicle is parked**

- Do not leave glasses, cigarette lighters, spray cans, or soft drink cans in the vehicle when it is in the sun.

Doing so may result in the following:

- Gas may leak from a cigarette lighter or spray can, and may lead to a fire.
- The temperature inside the vehicle may cause the plastic lenses and plastic material of glasses to deform or crack.
- Soft drink cans may fracture, causing the contents to spray over the interior of the vehicle, and may also cause a short circuit in the vehicle's electrical components.

 **WARNING**

Observe the following precautions.

Failure to do so may result in death or serious injury.

■ **When the vehicle is parked**

- Do not leave cigarette lighters in the vehicle. If a cigarette lighter is in a place such as the glove box or on the floor, it may be lit accidentally when luggage is loaded or the seat is adjusted, causing a fire.
- Do not attach adhesive discs to the windshield or windows. Do not place containers such as air fresheners on the instrument panel or dashboard. Adhesive discs or containers may act as lenses, causing a fire in the vehicle.
- Do not leave a door or window open if the curved glass is coated with a metallized film such as a silver-colored one. Reflected sunlight may cause the glass to act as a lens, causing a fire.
- Vehicles with a continuously variable transmission: Always apply the parking brake, shift the shift lever to P, stop the engine and lock the vehicle. Do not leave the vehicle unattended while the engine is running. If the vehicle is parked with the shift lever in P but the parking brake is not set, the vehicle may start to move, possibly leading to an accident.  
Vehicles with a manual transmission: Always apply the parking brake, stop the engine and lock the vehicle. Do not leave the vehicle unattended while the engine is running.
- Do not touch the exhaust pipes while the engine is running or immediately after turning the engine off. Doing so may cause burns.

■ **When taking a nap in the vehicle**

Always turn the engine off. Otherwise, if you accidentally move the shift lever or depress the accelerator pedal, this could cause an accident or fire due to engine overheating. Additionally, if the vehicle is parked in a poorly ventilated area, exhaust gases may collect and enter the vehicle, leading to death or a serious health hazard.

 **WARNING**

Observe the following precautions.  
Failure to do so may result in death or serious injury.

■ **When braking**

- When the brakes are wet, drive more cautiously.  
Braking distance increases when the brakes are wet, and this may cause one side of the vehicle to brake differently than the other side. Also, the parking brake may not securely hold the vehicle.
- If the brake booster device does not operate, do not follow other vehicles closely and avoid hills or sharp turns that require braking.  
In this case, braking is still possible, but the brake pedal should be depressed more firmly than usual. Also, the braking distance will increase. Have your brakes fixed immediately.
- Do not pump the brake pedal if the engine stalls.  
Each push on the brake pedal uses up the reserve for the power-assisted brakes.
- The brake system consists of 2 individual hydraulic systems; if one of the systems fails, the other will still operate. In this case, the brake pedal should be depressed more firmly than usual and the braking distance will increase.  
Have your brakes fixed immediately.

 **NOTICE**

■ **When driving the vehicle (vehicles with a continuously variable transmission)**

- Do not depress the accelerator and brake pedals at the same time during driving, as this may restrain the engine output.
- Do not use the accelerator pedal or depress the accelerator and brake pedals at the same time to hold the vehicle on a hill.



 NOTICE**■ When driving the vehicle (vehicles with a manual transmission)**

- Do not depress the accelerator and brake pedals at the same time during driving, as this may restrain the engine output.
- Do not shift gears unless the clutch pedal is fully depressed. After shifting, do not release the clutch pedal abruptly. Doing so may damage the clutch, transmission and gears.
- Observe the following to prevent the clutch from being damaged.
  - Do not rest your foot on the clutch pedal while driving.  
Doing so may cause clutch trouble.
  - Do not use any gear other than the 1st gear when starting off and moving forward.  
Doing so may damage the clutch.
  - Do not use the clutch to hold the vehicle when stopping on an uphill grade.  
Doing so may damage the clutch.
- Do not shift the shift lever to R when the vehicle is still moving. Doing so may damage the clutch, transmission and gears.

**■ When parking the vehicle (vehicles with a continuously variable transmission)**

Always set the parking brake, and shift the shift lever to P. Failure to do so may cause the vehicle to move or the vehicle may accelerate suddenly if the accelerator pedal is accidentally depressed.

**■ Avoiding damage to vehicle parts**

- Do not turn the steering wheel fully in either direction and hold it there for an extended period of time.  
Doing so may damage the power steering motor.
- When driving over bumps in the road, drive as slowly as possible to avoid damaging the wheels, underside of the vehicle, etc.

 NOTICE**■ If you get a flat tire while driving**

A flat or damaged tire may cause the following situations. Hold the steering wheel firmly and gradually depress the brake pedal to slow down the vehicle.

- It may be difficult to control your vehicle.
- The vehicle will make abnormal sounds or vibrations.
- The vehicle will lean abnormally.

Information on what to do in case of a flat tire (→P. 509)

**■ When encountering flooded roads**

Do not drive on a road that has flooded after heavy rain etc. Doing so may cause the following serious damage to the vehicle:

- Engine stalling
- Short in electrical components
- Engine damage caused by water immersion

In the event that you drive on a flooded road and the vehicle is flooded, be sure to have your Toyota dealer check the following:

- Brake function
- Changes in quantity and quality of engine oil, transaxle fluid, etc.
- Lubricant condition for the bearings and suspension joints (where possible), and the function of all joints, bearings, etc.

## Cargo and luggage

**Take notice of the following information about storage precautions, cargo capacity and load:**

### Capacity and distribution

Cargo capacity depends on the total weight of the occupants.

(Cargo capacity) = (Total load capacity) — (Total weight of occupants)

#### Steps for Determining Correct Load Limit —

- (1) Locate the statement “The combined weight of occupants and cargo should never exceed XXX kg or XXX lbs.” on your vehicle’s placard.
- (2) Determine the combined weight of the driver and passengers that will be riding in your vehicle.
- (3) Subtract the combined weight of the driver and passengers from XXX kg or XXX lbs.
- (4) The resulting figure equals the available amount of cargo and luggage load capacity.  
For example, if the “XXX” amount equals 1400 lbs. and there will be five 150 lb passengers in your vehicle, the amount of available cargo and luggage load capacity is 650 lbs. (1400 – 750 (5 × 150) = 650 lbs.)
- (5) Determine the combined weight of luggage and cargo being loaded on the vehicle. That weight may not safely exceed the available cargo and luggage load capacity calculated in Step 4.
- (6) If your vehicle will be towing a trailer, load from your trailer will be transferred to your vehicle. Consult this manual to determine how this reduces the available cargo and luggage load capacity of your vehicle.

(→P. 166)

Toyota does not recommend towing a trailer with your vehicle. Your vehicle is not designed for trailer towing.

### Calculation formula for your vehicle

- ① Cargo capacity
- ② Total load capacity (vehicle capacity weight) (→P. 538)

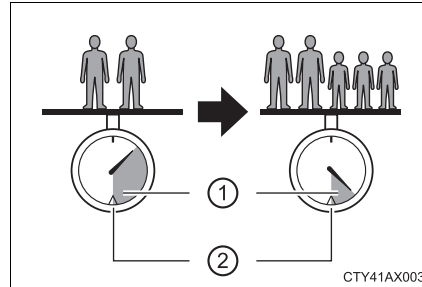

When 2 people with the combined weight of A lb. (kg) are riding in your vehicle, which has a total load capacity (vehicle capacity weight) of B lb. (kg), the available amount of cargo and luggage load capacity will be C lb. (kg) as follows:

$$B^{*2} \text{ lb. (kg)} - A^{*1} \text{ lb. (kg)} = C^{*3} \text{ lb. (kg)}$$

\*1: A =Weight of people

\*2: B =Total load capacity

\*3: C =Available cargo and luggage load

In this condition, if 3 more passengers with the combined weight of D lb. (kg) get on, the available cargo and luggage load will be reduced E lb. (kg) as follows:

$$C \text{ lb. (kg)} - D^{*4} \text{ lb. (kg)} = E^{*5} \text{ lb. (kg)}$$

\*4: D =Additional weight of people

\*5: E =Available cargo and luggage load

As shown in the example above, if the number of occupants increases, the cargo and luggage load will be reduced by an amount that equals the increased weight due to the additional occupants. In other words, if an increase in the number of occupants causes an excess of the total load capacity (combined weight of occupants plus cargo and luggage load), you must reduce the cargo and luggage on your vehicle.

 **WARNING****■ Things that must not be carried in the trunk**

The following things may cause a fire if loaded in the trunk:

- Receptacles containing gasoline
- Aerosol cans

**■ Storage precautions**

Observe the following precautions.

Failure to do so may prevent the pedals from being depressed properly, may block the driver's vision, or may result in items hitting the driver or passengers, possibly causing an accident.

- Stow cargo and luggage in the trunk whenever possible.
  - To prevent cargo and luggage from sliding forward during braking, do not stack anything in the enlarged trunk. Keep cargo and luggage low, as close to the floor as possible.
  - Do not place cargo or luggage in or on the following locations.
    - At the feet of the driver
    - On the front passenger or rear seats (when stacking items)
    - On the package tray
    - On the instrument panel
    - On the dashboard
    - Tray that has no lid
  - Secure all items in the occupant compartment.
  - When you fold down the rear seats, long items should not be placed directly behind the front seats.
  - Never allow anyone to ride in the enlarged trunk. It is not designed for passengers. They should ride in their seats with their seat belts properly fastened.
- Capacity and distribution**
- Do not exceed the maximum axle weight rating or the total vehicle weight rating.
  - Even if the total load of occupant's weight and the cargo load is less than the total load capacity, do not apply the load unevenly. Improper loading may cause deterioration of steering or braking control which may cause death or serious injury.

## Vehicle load limits

**Vehicle load limits include total load capacity, seating capacity, towing capacity and cargo capacity.**

◆ **Total load capacity (vehicle capacity weight): (→P. 538)**

Total load capacity means the combined weight of occupants, cargo and luggage.

◆ **Seating capacity: 5 occupants (Front 2, Rear 3)**

Seating capacity means the maximum number of occupants whose estimated average weight is 150 lb. (68 kg) per person.

◆ **Towing capacity**

Toyota does not recommend towing a trailer with your vehicle.

◆ **Cargo capacity**

Cargo capacity may increase or decrease depending on the weight and the number of occupants.

■ **Total load capacity and seating capacity**

These details are also described on the tire and loading information label. (→P. 448)

 **WARNING**

■ **Overloading the vehicle**

Do not overload the vehicle.  
It may not only cause damage to the tires, but also degrade steering and braking ability, resulting in an accident.

## Trailer towing

**Toyota does not recommend towing a trailer with your vehicle. Toyota also does not recommend the installation of a tow hitch or the use of a tow hitch carrier for a wheelchair, scooter, bicycle, etc. Your vehicle is not designed for trailer towing or for the use of tow hitch mounted carriers.**

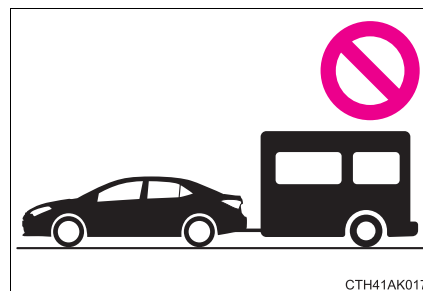

4

Driving

## Dinghy towing (vehicles with a continuously variable transmission)

**Your vehicle is not designed to be dinghy towed (with 4 wheels on the ground) behind a motor home.**

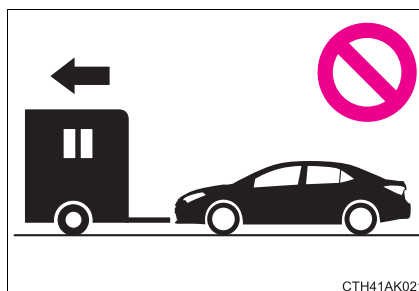

 **NOTICE**

**■ To avoid serious damage to your vehicle**

Do not tow your vehicle with four wheels on the ground.



## Dinghy towing (vehicles with a manual transmission)

**Your vehicle can be dinghy towed in a forward direction (with 4 wheels on the ground) behind a motor home.**

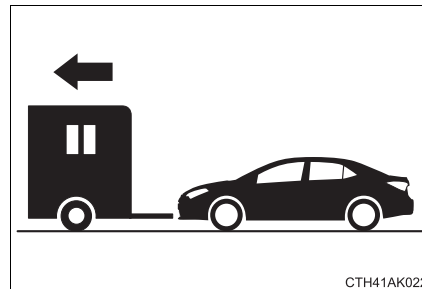

### Towing your vehicle with 4 wheels on the ground

To prevent damage to your vehicle, perform the following procedures before towing.

- 1 Shift the shift lever to N.
- 2 Turn the engine switch to the "ACC" position (without a smart key system) or ACCESSORY mode (with a smart key system).  
(→P. 171, 176)

Ensure that the audio system and other powered devices are turned off.

- 3 Release the parking brake.

After towing, leave the engine in idle for at least 3 minutes before driving the vehicle.

#### ■ Necessary equipment and accessories

Specialized equipment and accessories are required for dinghy towing. Contact the service branch of the motor home manufacturer regarding recommended equipment.

 NOTICE

■ **Dinghy towing direction**

Do not tow the vehicle backwards.  
Doing so may cause serious damage.

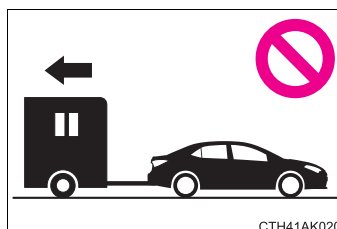

■ **To prevent the steering from locking**

Vehicles without a smart key system: Ensure the engine switch is in the “ACC” position.

Vehicles with a smart key system: Ensure the engine switch is in ACCESSORY mode.

## Engine (ignition) switch (vehicles without a smart key system)

### Starting the engine

▶ Continuously variable transmission

- 1 Check that the parking brake is set.
- 2 Check that the shift lever is set in P.
- 3 Firmly depress the brake pedal.
- 4 Turn the engine switch to the “START” position and start the engine.

▶ Manual transmission

- 1 Check that the parking brake is set.
- 2 Check that the shift lever is set in N.
- 3 Firmly depress the clutch pedal.
- 4 Turn the engine switch to the “START” position and start the engine.

### Changing the engine switch positions

- 1 “LOCK”  
The steering wheel is locked and the key can be removed. (Vehicles with a continuously variable transmission: The key can be removed only when the shift lever is in P.)
- 2 “ACC”  
Some electrical components such as the audio system can be used.
- 3 “ON”  
All electrical components can be used.
- 4 “START”  
For starting the engine.

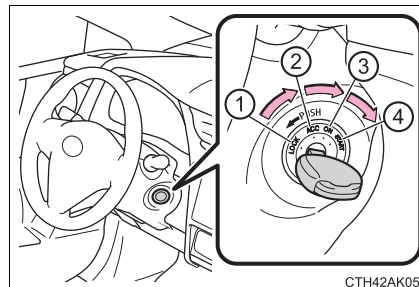

■ **Turning the key from “ACC” to “LOCK”**

- 1 Shift the shift lever to P (continuously variable transmission) or N (manual transmission). (→P. 181, 184, 189)
- 2 Push in the key and turn it to the “LOCK” position.

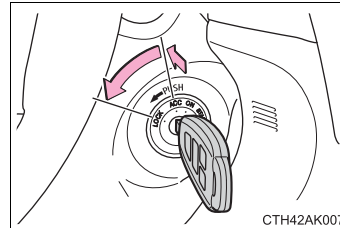

■ **If the engine does not start**

The engine immobilizer system may not have been deactivated. (→P. 67)  
Contact your Toyota dealer.

■ **When the steering lock cannot be released**

When starting the engine, the engine switch may seem stuck in the “LOCK” position. To free it, turn the key while turning the steering wheel slightly left and right.

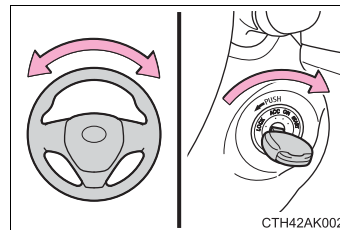

■ **Key reminder function**

A buzzer sounds if the driver’s door is opened while the engine switch is in the “LOCK” or “ACC” position to remind you to remove the key.

**⚠ WARNING**

■ **When starting the engine**  
Always start the engine while sitting in the driver’s seat. Do not depress the accelerator pedal while starting the engine under any circumstances. Doing so may cause an accident resulting in death or serious injury.

■ **Caution when driving**  
Do not turn the engine switch to the “LOCK” position while driving. If, in an emergency, you must turn the engine off while the vehicle is moving, turn the engine switch only to the “ACC” position to stop the engine. An accident may result if the engine is stopped while driving. (→P. 471)

 NOTICE**■ To prevent battery discharge**

Do not leave the engine switch in the “ACC” or “ON” position for long periods of time without the engine running.

**■ When starting the engine**

- Do not crank the engine for more than 30 seconds at a time. This may overheat the starter and wiring system.
- Do not race a cold engine.
- If the engine becomes difficult to start or stalls frequently, have your vehicle checked by your Toyota dealer immediately.

## Engine (ignition) switch (vehicles with a smart key system)

**Performing the following operations when carrying the electronic key on your person starts the engine or changes engine switch modes.**

### Starting the engine

- 1 Check that the parking brake is set.
- 2 Continuously variable transmission: Check that the shift lever is set in P. Firmly depress the brake pedal.

Manual transmission: Check that the shift lever is set in N. Firmly depress the clutch pedal.



will be displayed on the multi-information display.

If it is not displayed, the engine cannot be started.

- 3 Press the engine switch shortly and firmly.

When operating the engine switch, one short, firm press is enough. It is not necessary to press and hold the switch.

The engine will crank until it starts or for up to 30 seconds, whichever is less.

Continue depressing the brake pedal (continuously variable transmission) or clutch pedal (manual transmission) until the engine is completely started.

The engine can be started from any engine switch mode.

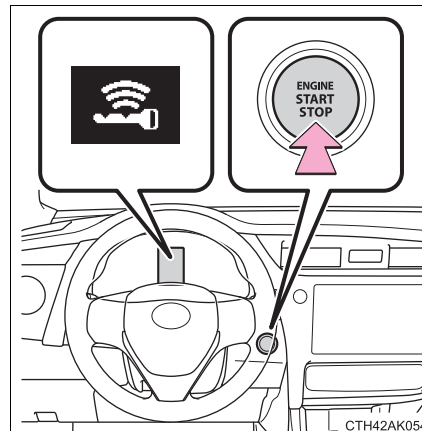

**Stopping the engine**

## ▶ Continuously variable transmission

- 1 Stop the vehicle.
- 2 Set the parking brake (→P. 192), and shift the shift lever to P.
- 3 Press the engine switch.
- 4 Release the brake pedal and check that “Power On” on the multi-information display is off.

## ▶ Manual transmission

- 1 Stop the vehicle.
- 2 Shift the shift lever to N.
- 3 Set the parking brake. (→P. 192)
- 4 Press the engine switch.
- 5 Release the clutch pedal and check that “Power On” on the multi-information display is off.

### Changing engine switch modes

Modes can be changed by pressing the engine switch with the brake pedal (continuously variable transmission) or clutch pedal (manual transmission) released. (The mode changes each time the switch is pressed.)

#### Off\*

The emergency flashers can be used.

The multi-information display will not be displayed.

#### ACCESSORY mode

Some electrical components such as the audio system can be used.

“Power On” will be displayed on the multi-information display.

#### IGNITION ON mode

All electrical components can be used.

“Power On” will be displayed on the multi-information display.

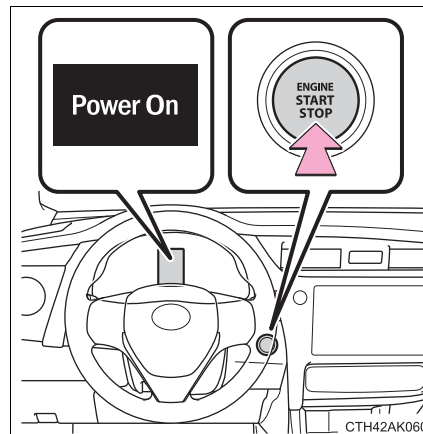

\*: Vehicles with a continuously variable transmission: If the shift lever is in a position other than P when turning off the engine, the engine switch will be turned to ACCESSORY mode, not to off.



**When stopping the engine with the shift lever in a position other than P (vehicles with a continuously variable transmission)**

If the engine is stopped with the shift lever in a position other than P, the engine switch will not be turned off but instead be turned to ACCESSORY mode. Perform the following procedure to turn the switch off:

- 1 Check that the parking brake is set.
- 2 Shift the shift lever to P.
- 3 Check that “Power On” and “Turn Off Vehicle”/“TURN POWER OFF” are displayed alternately on the multi-information display and then press the engine switch once.
- 4 Check that “Power On” and “Turn Off Vehicle”/“TURN POWER OFF” on the multi-information display are off.

**■ Message displays**

Message displays used in this section are intended as examples, and may differ from the image that is actually displayed on the multi-information display.

**■ Auto power off function****▶ Vehicles with a continuously variable transmission**

If the vehicle is left in ACCESSORY mode for more than 20 minutes or IGNITION ON mode (the engine is not running) for more than an hour with the shift lever in P, the engine switch will automatically turn off. However, this function cannot entirely prevent battery discharge. Do not leave the vehicle with the engine switch in ACCESSORY or IGNITION ON mode for long periods of time when the engine is not running.

**▶ Vehicles with a manual transmission**

If the vehicle is left in ACCESSORY mode for more than 20 minutes or IGNITION ON mode (the engine is not running) for more than an hour, the engine switch will automatically turn off. However, this function cannot entirely prevent battery discharge. Do not leave the vehicle with the engine switch in ACCESSORY or IGNITION ON mode for long periods of time when the engine is not running.

■ **Electronic key battery depletion**

→P. 105

■ **Conditions affecting operation**

→P. 125

■ **Notes for the entry function**

→P. 126

■ **If the engine does not start**

- The engine immobilizer system may not have been deactivated. (→P. 67)  
Contact your Toyota dealer.
- Vehicles with a continuously variable transmission: Check that the shift lever is securely set in P. The engine may not start if the shift lever is displaced out of P.  
“Shift to P position to Start” will be displayed on the multi-information display.

■ **Steering lock**

After turning the engine switch off and opening and closing the doors, the steering wheel will be locked due to the steering lock function. Operating the engine switch again automatically cancels the steering lock.

■ **When the steering lock cannot be released**

“Steering Lock Active” will be displayed on the multi-information display.

Vehicles with a continuously variable transmission: Check that the shift lever is set in P. Press the engine switch while turning the steering wheel left and right.

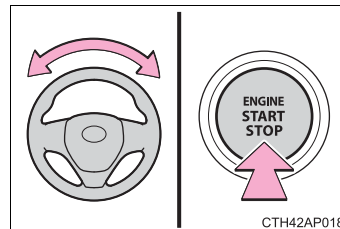

Vehicles with a manual transmission: Press the engine switch while turning the steering wheel left and right.

■ **Steering lock motor overheating prevention**

To prevent the steering lock motor from overheating, the motor may be suspended if the engine is turned on and off repeatedly in a short period of time. In this case, refrain from operating the engine. After about 10 seconds, the steering lock motor will resume functioning.

■ **When “Smart Key System Malfunction See Owner’s Manual”/“CHECK SMART KEY SYSTEM” will be displayed on the multi-information display**

The system may be malfunctioning. Have the vehicle inspected by your Toyota dealer immediately.

■ **If the electronic key battery is depleted**

→P. 455

■ **Operation of the engine switch**

- If the switch is not pressed shortly and firmly, the engine switch mode may not change or the engine may not start.
- If attempting to restart the engine immediately after turning the engine switch off, the engine may not start in some cases. After turning the engine switch off, please wait a few seconds before restarting the engine.

■ **If the smart key system has been deactivated in a customized setting**

→P. 523



**WARNING**

■ **When starting the engine**

Always start the engine while sitting in the driver’s seat. Do not depress the accelerator pedal while starting the engine under any circumstances. Doing so may cause an accident resulting in death or serious injury.

■ **Caution while driving**

If engine failure occurs while the vehicle is moving, do not lock or open the doors until the vehicle reaches a safe and complete stop. Activation of the steering lock in this circumstance may lead to an accident, resulting in death or serious injury.

■ **Stopping the engine in an emergency**

If you want to stop the engine in an emergency while driving the vehicle, press and hold the engine switch for more than 2 seconds, or press it briefly 3 times or more in succession. (→P. 471)

However, do not touch the engine switch while driving except in an emergency. Turning the engine off while driving will not cause loss of steering or braking control, but the power assist to these systems will be lost. This will make it more difficult to steer and brake, so you should pull over and stop the vehicle as soon as it is safe to do so.

**NOTICE****■ To prevent battery discharge**

- Do not leave the engine switch in ACCESSORY or IGNITION ON mode for long periods of time without the engine running.
- If “Power On” is displayed on the multi-information display, the engine switch is not off. When exiting the vehicle, always check that the engine switch is off.
- Vehicles with a continuously variable transmission:  
Do not stop the engine when the shift lever is in a position other than P. If the engine is stopped in another shift lever position, the engine switch will not be turned off but instead be turned to ACCESSORY mode. If the vehicle is left in ACCESSORY mode, battery discharge may occur.

**■ When starting the engine**

- Do not race a cold engine.
- If the engine becomes difficult to start or stalls frequently, have your vehicle checked by your Toyota dealer immediately.

**■ Symptoms indicating a malfunction with the engine switch**

If the engine switch seems to be operating somewhat differently than usual, such as the switch sticking slightly, there may be a malfunction. Contact your Toyota dealer immediately.

## Continuously variable transmission (vehicles without paddle shift switches)\*

### Shifting the shift lever

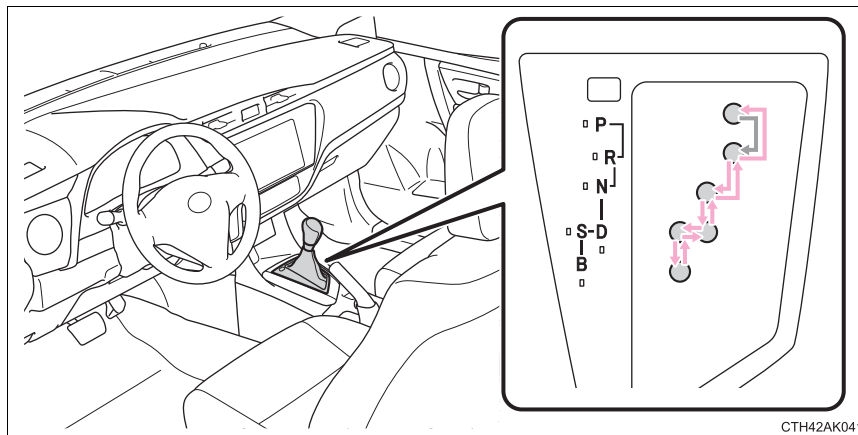

#### ← Vehicles without a smart key system:

While the engine switch is in the “ON” position, depress the brake pedal and move the shift lever.

#### Vehicles with a smart key system:

While the engine switch is in IGNITION ON mode, depress the brake pedal and move the shift lever.

When shifting the shift lever between P and D, make sure that the vehicle is completely stopped.

\*: If equipped

**Shift position purpose**

Shift position	Objective or function
P	Parking the vehicle/starting the engine
R	Reversing
N	Neutral
D	Normal driving*
S	Engine braking
B	Maximum engine braking

\*: To improve fuel efficiency and reduce noises, set the shift lever in D for normal driving.

**Eco drive mode (if equipped)**

Press the switch.

Suitable for enhancing the fuel economy, because the torque corresponding to the accelerator pedal depression amount can be generated more smoothly than it is in normal conditions and the operation of the air conditioning system (heating/cooling) will be minimized.

Press the switch again to return to normal mode.

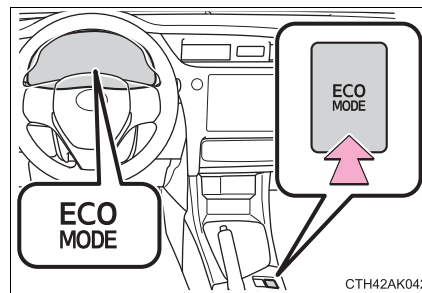

■ **When driving with the dynamic radar cruise control activated**

Even when performing the following actions with the intent of enabling engine braking, engine braking will not activate while downshifting to S because the dynamic radar cruise control will not be canceled. (→P. 235)

■ **Shift lock system**

The shift lock system is a system to prevent accidental operation of the shift lever in starting.

The shift lever can be shifted from P only when the engine switch is in the “ON” position (vehicles without a smart key system) or IGNITION ON mode (vehicles with a smart key system) and the brake pedal is being depressed.

### ■ If the shift lever cannot be shifted from P

First, check whether the brake pedal is being depressed.

If the shift lever cannot be shifted with your foot on the brake pedal, there may be a problem with the shift lock system. Have the vehicle inspected by your Toyota dealer immediately.

The following steps may be used as an emergency measure to ensure that the shift lever can be shifted.

Releasing the shift lock:

- 1 Set the parking brake.
- 2 Vehicles without a smart key system: Turn the engine switch to the “LOCK” position.

Vehicles with a smart key system: Turn the engine switch off.

- 3 Depress the brake pedal.
- 4 Pry the cover up with a flathead screwdriver or equivalent tool.

To prevent damage to the cover, cover the tip of the screwdriver with a rag.

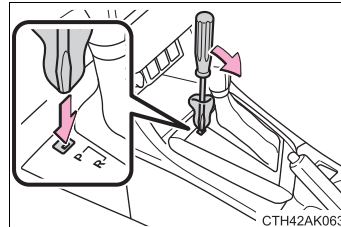

- 5 Press the shift lock override button.
- The shift lever can be shifted while the button is pressed.

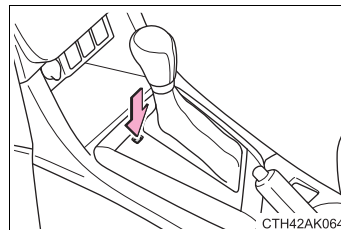

#### ⚠ WARNING

##### ■ When driving on slippery road surfaces

Be careful of downshifting and sudden acceleration, as this could result in the vehicle skidding to the side or spinning.

##### ■ To prevent an accident when releasing the shift lock

Before pressing the shift lock override button, make sure to set the parking brake and depress the brake pedal.

If the accelerator pedal is accidentally depressed instead of the brake pedal when the shift lock override button is pressed and the shift lever is shifted out of P, the vehicle may suddenly start, possibly leading to an accident resulting in death or serious injury.

## Continuously variable transmission (vehicles with paddle shift switches)\*

### Shifting the shift lever

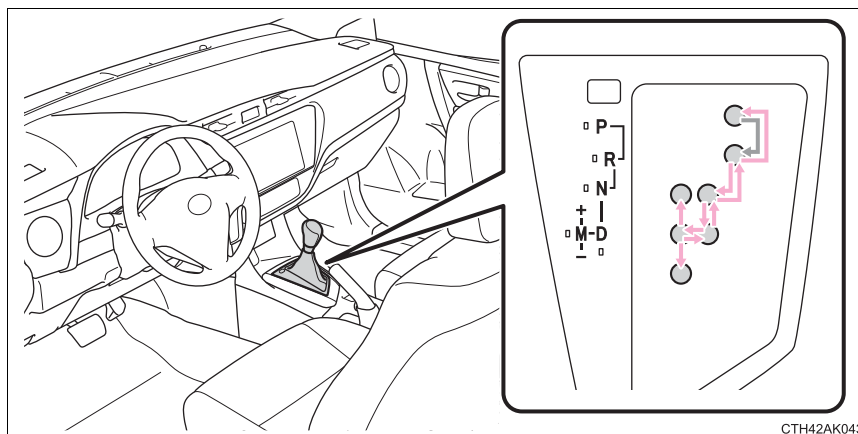

← Vehicles without a smart key system:

While the engine switch is in the “ON” position, depress the brake pedal and move the shift lever.

Vehicles with a smart key system:

While the engine switch is in IGNITION ON mode, depress the brake pedal and move the shift lever.

When shifting the shift lever between P and D, make sure that the vehicle is completely stopped.

\*: If equipped



### Shift position purpose

Shift position	Objective or function
P	Parking the vehicle/starting the engine
R	Reversing
N	Neutral
D	Normal driving <sup>*1</sup>
M	7-speed sport sequential shiftmatic mode driving <sup>*2</sup> (→P. 186)

<sup>\*1</sup>: To improve fuel efficiency and reduce noises, set the shift lever in D for normal driving.

<sup>\*2</sup>: Selecting gear step using the M position achieves suitable engine braking forces by operating the shift lever.

### Sport mode

Press the switch.

For powerful acceleration and driving in mountainous regions.

Press the switch again to return to normal mode.

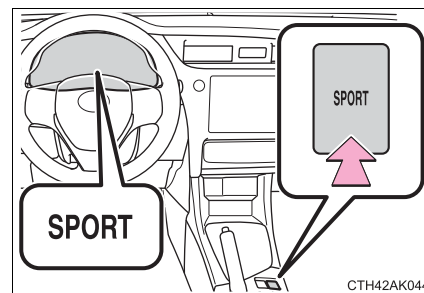

### Temporarily engaged gear steps selection mode in the D position

To drive in temporary gear steps selection mode, operate the “-” and “+” paddle shift switches. The gear steps can then be selected by operating the “-” and “+” paddle shift switches. By selecting gear step using paddle shift switches, you can control engine braking forces.

- ① Upshifting
- ② Downshifting

The selected gear step, from D1 to D7, will be displayed in the meter.

To return to normal D position driving, the “+” paddle shift switch must be held down for a period of time.

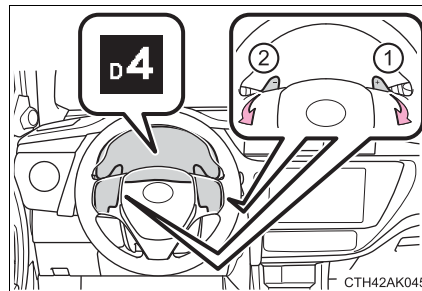

### Changing gear steps in the M position

To enter 7-speed sport sequential shiftmatic mode, shift the shift lever to M. Gear steps can then be selected by operating the shift lever or paddle shift switches, allowing you to drive in the gear step of your choosing.

- ① Upshifting
- ② Downshifting

The gear changes once every time the shift lever is operated.

The selected gear step, from M1 to M7, will be displayed in the meter.

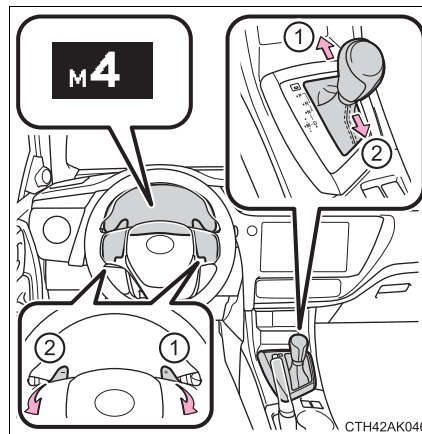

However, even when in the M position, the gear steps will be automatically changed if the engine speed is too high, or too low.

**■ Gear step functions**

- You can choose from 7 levels of engine braking force.
- A lower gear step will provide greater engine braking force than a higher gear step, and the engine speed will also increase.

**■ If the “M” indicator flashes or a buzzer beeps after shifting the shift lever to M**

This may indicate a malfunction in the continuously variable transmission system. Have the vehicle inspected by your Toyota dealer immediately. (In this situation, the transmission will operate in the same manner as when the shift lever is in D.)

**■ When the vehicle comes to a stop with the shift lever in the M position**

- The transmission will automatically downshift to M1 once the vehicle is stopped.
- After a stop, the vehicle will start off in M1.
- When the vehicle is stopped, the transmission is set at M1.

**■ When driving with the dynamic radar cruise control activated**

Even when performing the following actions with the intent of enabling engine braking, engine braking will not activate because the dynamic radar cruise control will not be canceled.

- While driving in D or 7-speed sport sequential shiftmatic mode, downshifting to 6, 5 or 4. (→P. 186)
- When switching the driving mode to sport mode while driving in D position. (→P. 185)

**■ Downshifting restrictions warning buzzer**

To help ensure safety and driving performance, downshifting operation may sometimes be restricted. In some circumstances, downshifting may not be possible even when the shift lever is operated. (A buzzer will sound twice.)

**■ Sport mode automatic deactivation**

Sport mode is automatically deactivated if the engine switch is turned off after driving in sport mode.

**■ Shift lock system**

The shift lock system is a system to prevent accidental operation of the shift lever in starting.

The shift lever can be shifted from P only when the engine switch is in the “ON” position (vehicles without a smart key system) or IGNITION ON mode (vehicles with a smart key system) and the brake pedal is being depressed.

### ■ If the shift lever cannot be shifted from P

First, check whether the brake pedal is being depressed.

If the shift lever cannot be shifted with your foot on the brake pedal, there may be a problem with the shift lock system. Have the vehicle inspected by your Toyota dealer immediately.

The following steps may be used as an emergency measure to ensure that the shift lever can be shifted.

Releasing the shift lock:

- 1 Set the parking brake.
- 2 Vehicles without a smart key system: Turn the engine switch to the "LOCK" position.

Vehicles with a smart key system: Turn the engine switch off.

- 3 Depress the brake pedal.
- 4 Pry the cover up with a flathead screwdriver or equivalent tool.

To prevent damage to the cover, cover the tip of the screwdriver with a rag.

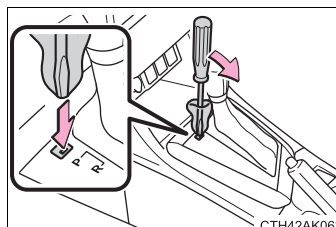

- 5 Press the shift lock override button.
- The shift lever can be shifted while the button is pressed.

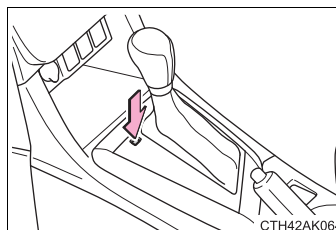

### ⚠ WARNING

#### ■ When driving on slippery road surfaces

Be careful of downshifting and sudden acceleration, as this could result in the vehicle skidding to the side or spinning.

#### ■ To prevent an accident when releasing the shift lock

Before pressing the shift lock override button, make sure to set the parking brake and depress the brake pedal.

If the accelerator pedal is accidentally depressed instead of the brake pedal when the shift lock override button is pressed and the shift lever is shifted out of P, the vehicle may suddenly start, possibly leading to an accident resulting in death or serious injury.

## Manual transmission\*

### Shifting the shift lever

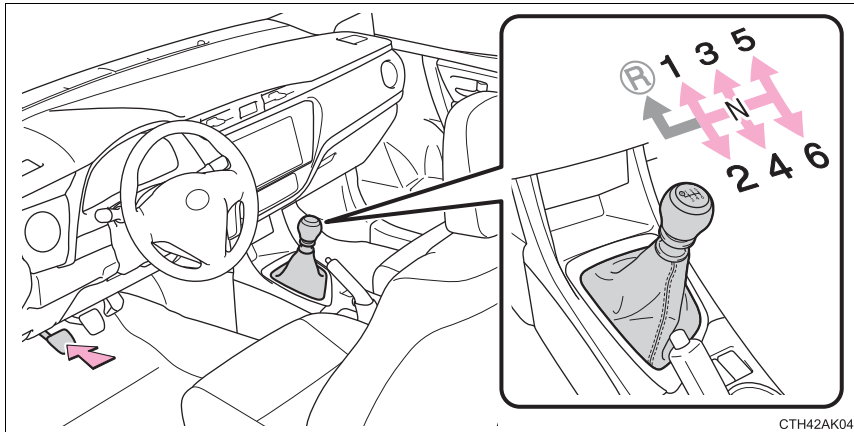

Fully depress the clutch pedal before operating the shift lever, and then release it slowly.

### Shifting the shift lever to R

Shift the shift lever to R while lifting up the ring section.

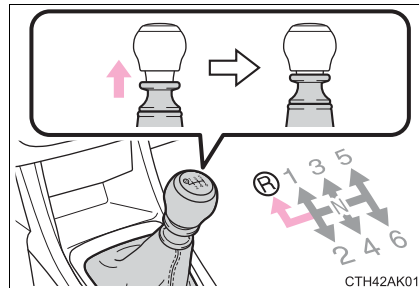

4

Driving

\*: If equipped

■ **Maximum allowable speeds**

Observe the following maximum allowable speeds in each gear when maximum acceleration is necessary.

mph (km/h)

Shift position	Maximum speed	
	Vehicles with 15-inch and 16-inch tires	Vehicles with 17-inch tires
1	30 (49)	30 (49)
2	56 (91)	56 (90)
3	82 (133)	82 (132)
4	111 (179)	111 (179)
5	—	—

 NOTICE

■ **To prevent damage to the transmission**

- Do not shift the shift lever to R without depressing the clutch pedal.

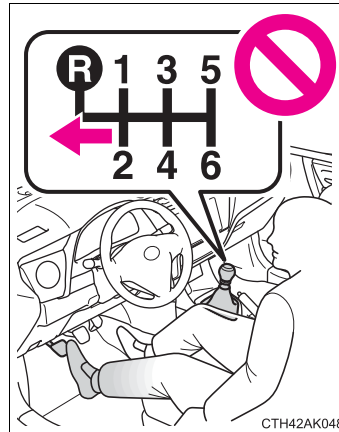

- Do not lift up the ring section except when shifting the lever to R.
- Shift the shift lever to R only when the vehicle is stationary.

## Turn signal lever

### Operating instructions

- ① Right turn
- ② Lane change to the right (move the lever partway and release it)  
The right hand signals will flash 3 times.
- ③ Lane change to the left (move the lever partway and release it)  
The left hand signals will flash 3 times.
- ④ Left turn

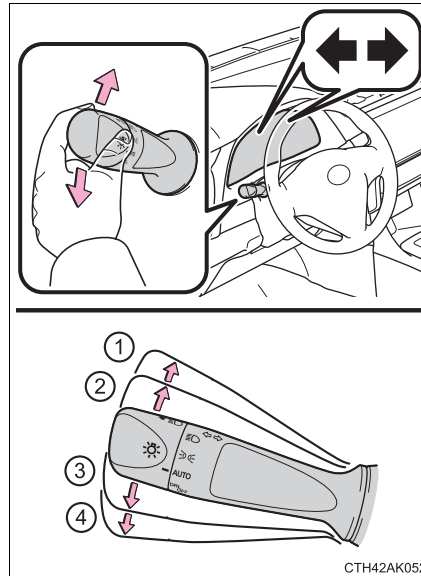

#### ■ Turn signals can be operated when

- ▶ Vehicles without a smart key system  
The engine switch is in the "ON" position.
- ▶ Vehicles with a smart key system  
The engine switch is in IGNITION ON mode.

#### ■ If the indicator flashes faster than usual

Check that a light bulb in the front or rear turn signal lights has not burned out.

#### ■ If the turn signals stop flashing before a lane change has been performed

Operate the lever again.

#### ■ To discontinue flashing of the turn signals during a lane change

Operate the lever in the opposite direction.

#### ■ When the lever is pushed and held partway

The turn signals will keep flashing until the lever is released.

#### ■ Customization

The number of times the turn signals flash during a lane change can be changed. (Customizable features →P. 564)

## Parking brake

### Operating instructions

- ① To set the parking brake, fully pull the parking brake lever while depressing the brake pedal.
- ② To release the parking brake, slightly raise the lever and lower it completely while pressing the button.

\*1: For U.S.A.

\*2: For Canada

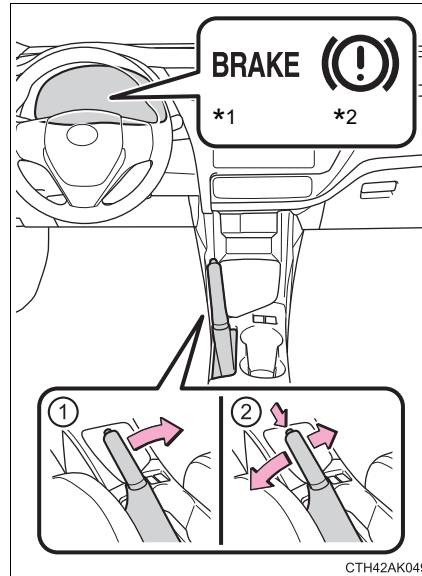

CTH42AK049

#### ■ Parking the vehicle

→P. 153

#### ■ Parking brake engaged warning buzzer

A buzzer will sound if the vehicle is driven at a speed of approximately 3 mph (5 km/h) or more with the parking brake engaged. (→P. 480, 490)

#### ■ Usage in winter time

→P. 263

#### ⚠ NOTICE

##### ■ Before driving

Fully release the parking brake.

Driving the vehicle with the parking brake set will lead to brake components overheating, which may affect braking performance and increase brake wear.





## Headlight switch

The headlights can be operated manually or automatically.

### Operating instructions



Turning the end of the lever turns on the lights as follows:

► Type A

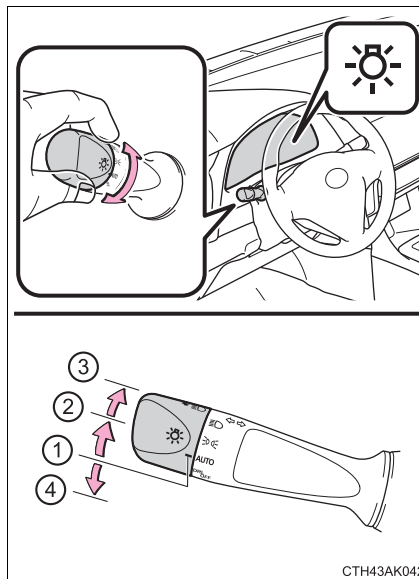
- ① **AUTO** The headlights, daytime running lights (→P. 195) and all the lights listed below turn on and off automatically. (Vehicles without a smart key system: When the engine switch is in the “ON” position)  
(Vehicles with a smart key system: When the engine switch is in IGNITION ON mode)
- ②  The side marker, parking, tail, license plate, instrument panel lights, and daytime running lights (→P. 195) turn on.
- ③  The headlights and all the lights listed above (except daytime running lights) turn on.
- ④ **DRL OFF** The daytime running lights turn off.



► Type B

- ① **AUTO** The headlights, daytime running lights (→P. 195) and all the lights listed below turn on and off automatically.  
(Vehicles without a smart key system: When the engine switch is in the “ON” position)  
(Vehicles with a smart key system: When the engine switch is in IGNITION ON mode)
- ②  The side marker, parking, tail, license plate, instrument panel lights, and daytime running lights (→P. 195) turn on.
- ③  The headlights and all the lights listed above (except daytime running lights) turn on.
- ④  The daytime running lights turn on. (→P. 195)

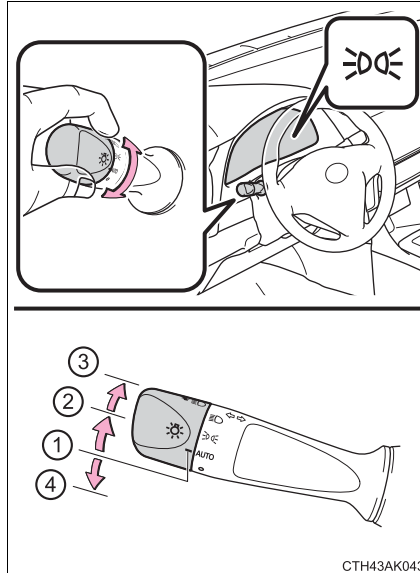

### Turning on the high beam headlights

- ① With the headlights on, push the lever away from you to turn on the high beams.

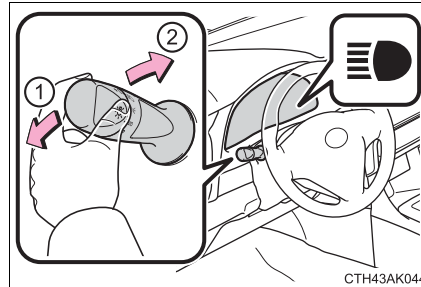

Pull the lever toward you to the center position to turn the high beams off.

- ② Pull the lever toward you and release it to flash the high beams once.



You can flash the high beams with the headlights on or off.

### Daytime running light system

- Vehicles with daytime running lights that are integrated into the headlights: The daytime running lights illuminate using the same lights as the headlight low beams and illuminate darker than the headlight low beams.
- To make your vehicle more visible to other drivers during daytime driving, the daytime running lights turn on automatically when all of the following conditions are met. (The daytime running lights are not designed for use at night.)
  - The engine is running
  - The parking brake is released
  - The headlight switch is in the  (type B only),  or "AUTO"\* position

\*: When the surroundings are bright

The daytime running lights remain on after they illuminate, even if the parking brake is set again.

- For the U.S.A.: Daytime running lights can be turned off by operating the switch.
- Compared to turning on the headlights, the daytime running light system offers greater durability and consumes less electricity, so it can help improve fuel economy.

### Headlight control sensor

The sensor may not function properly if an object is placed on the sensor, or anything that blocks the sensor is affixed to the windshield.

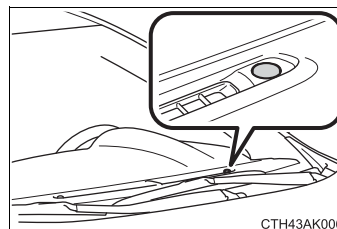

Doing so interferes with the sensor detecting the level of ambient light and may cause the automatic headlight system to malfunction.



■ **Automatic light off system**

▶ Vehicles without a smart key system



- When the headlights are on: The headlights and tail lights turn off 30 seconds after the engine switch is turned to the “ACC” or “LOCK” position and a door is opened and closed. (Vehicles with a wireless remote control: The lights turn off immediately if  on the key is pressed after all the doors are locked.)
- When only the tail lights are on: The tail lights turn off automatically if the engine switch is turned to the “ACC” or “LOCK” position and the driver’s door is opened.

To turn the lights on again, turn the engine switch to “ON” position, or turn the light switch off once and then back to the  or  position.

If any of the doors or trunk lid is kept open, the lights automatically turn off after 20 minutes.

▶ Vehicles with a smart key system

- When the headlights are on: The headlights and tail lights turn off 30 seconds after the engine switch is turned to ACCESSORY mode or turned off and a door is opened and closed. (The lights turn off immediately if  on the key is pressed after all the doors are locked.)
- When only the tail lights are on: The tail lights turn off automatically if the engine switch is turned to ACCESSORY mode or turned off and the driver’s door is opened.

To turn the lights on again, turn the engine switch to IGNITION ON mode, or turn the light switch off once and then back to the  or  position.

If any of the doors or trunk lid is kept open, the lights automatically turn off after 20 minutes.

■ **Light reminder buzzer**

▶ Vehicles without a smart key system

A buzzer sounds when the engine switch is turned to “LOCK” position and the driver’s door is opened while the lights are turned on.

▶ Vehicles with a smart key system

A buzzer sounds when the engine switch is turned off or turned to ACCESSORY mode and the driver’s door is opened while the lights are turned on.

### ■ Battery-saving function

In the following conditions, the headlights and the other remaining lights will go off automatically after 20 minutes in order to prevent the vehicle battery from being discharged:

- The headlights and/or tail lights are on.
- Vehicles without a smart key system: The engine switch is in the “ACC” or “LOCK” position.
- Vehicles with a smart key system: The engine switch is turned to ACCESSORY mode or turned off.

This function will be canceled in any of the following situations:

- Vehicles without a smart key system: When the engine switch is turned to the “ON” position.
- Vehicles with a smart key system: When the engine switch is turned to IGNITION ON mode.
- When the light switch is operated
- When the door or trunk is opened or closed

### ■ Customization

Settings (e.g. light sensor sensitivity) can be changed.  
(Customizable features: →P. 564)



#### NOTICE

#### ■ To prevent battery discharge

Do not leave the lights on longer than necessary when the engine is not running.

## Automatic High Beam

The Automatic High Beam uses a camera sensor located behind the upper portion of the windshield to assess the brightness of the lights of vehicles ahead, streetlights, etc., and automatically turns the high beams on or off as necessary.

### WARNING

#### ■ Limitations of the Automatic High Beam

Do not overly rely on the Automatic High Beam. Always drive safely, taking care to observe your surroundings and turning the high beams on or off manually if necessary.

#### ■ To prevent incorrect operation of the Automatic High Beam system

Do not overload the vehicle.

## Activating the Automatic High Beam

Push the lever away from you with the headlight switch in the **AUTO** position.

The Automatic High Beam indicator will come on when the system is operating.

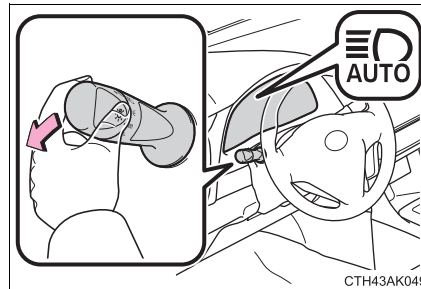

### Turning the high beams on/off manually

#### ■ Switching to the low beams

Pull the lever to its original position.

The Automatic High Beam indicator will turn off.

Push the lever away from you to activate the Automatic High Beam system again.

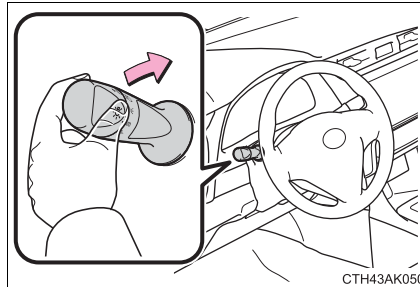

#### ■ Switching to the high beams

Turn the light switch to the  position.

The Automatic High Beam indicator will turn off and the high beam indicator will turn on.

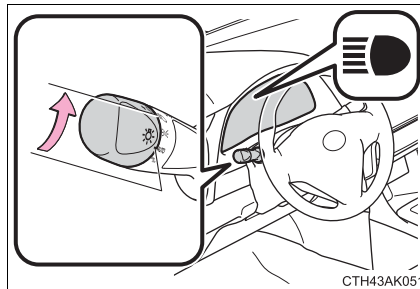

#### ■ Conditions to turn the high beams on/off automatically

- When all of the following conditions are met, the high beams will be turned on automatically (after approximately 1 second):
  - The vehicle speed is approximately 21 mph (34 km/h) or more.
  - The area ahead of the vehicle is dark.
  - There are no vehicles ahead with headlights or tail lights turned on.
  - There are few streetlights on the road ahead.
- If any of the following conditions is met, the high beams will turn off automatically:
  - The vehicle speed is below approximately 17 mph (27 km/h).
  - The area ahead of the vehicle is not dark.
  - Vehicles ahead have their headlights or tail lights turned on.
  - There are many streetlights on the road ahead.

**■ Camera sensor detection information**

- The high beams may not be automatically turned off in the following situations:
  - When a vehicle suddenly appears from around a curve
  - When the vehicle is cut in front of by another vehicle
  - When vehicles ahead cannot be detected due to repeated curves, road dividers or roadside trees
  - When vehicles ahead appear in a faraway lane on a wide road
  - When the lights of vehicles ahead are not on
- The high beams may be turned off if a vehicle ahead that is using fog lights without its headlights turned on is detected.
- House lights, street lights, traffic signals, and illuminated billboards or signs and other reflective objects may cause the high beams to change to the low beams, or the low beams to remain on.
- The following factors may affect the amount of time taken for the high beams to turn on or off:
  - The brightness of the headlights, fog lights, and tail lights of vehicles ahead
  - The movement and direction of vehicles ahead
  - When a vehicle ahead only has operational lights on one side
  - When a vehicle ahead is a two-wheeled vehicle
  - The condition of the road (gradient, curve, condition of the road surface, etc.)
  - The number of passengers and amount of luggage in the vehicle
- The high beams may turn on or off unexpectedly.
- Bicycles or similar vehicles may not be detected.
- In the following situations the system may not be able to correctly detect the surrounding brightness level. This may cause the low beams to remain on or the high beams to flash or dazzle pedestrians or vehicles ahead. In such a case, it is necessary to manually switch between the high and low beams.
  - When driving in inclement weather (heavy rain, snow, fog, sandstorms, etc.)
  - When the windshield is obscured by fog, mist, ice, dirt, etc.
  - When the windshield is cracked or damaged
  - When the camera sensor is deformed or dirty
  - When the temperature of the camera sensor is extremely high
  - When the surrounding brightness level is equal to that of headlights, tail lights or fog lights
  - When headlights or tail lights of vehicles ahead are turned off, dirty, changing color, or not aimed properly
  - When the vehicle is hit by water, snow, dust, etc. from a preceding vehicle



- When driving through an area of intermittently changing brightness and darkness
- When frequently and repeatedly driving ascending/descending roads, or roads with rough, bumpy or uneven surfaces (such as stone-paved roads, gravel roads, etc.)
- When frequently and repeatedly taking curves or driving on a winding road
- When there is a highly reflective object ahead of the vehicle, such as a sign or mirror
- When the back of a preceding vehicle is highly reflective, such as a container on a truck
- When the vehicle's headlights are damaged or dirty, or are not aimed properly
- When the vehicle is listing or titling due to a flat tire, a trailer being towed, etc.
- When the headlights are changed between the high beams and low beams repeatedly in an abnormal manner
- When the driver believes that the high beams may be flashing or dazzling pedestrians or other drivers

#### ■ Temporarily lowering sensor sensitivity

The sensitivity of the sensor can be temporarily lowered.





- 1 Turn the engine switch off while the following conditions are met.
  - The headlight switch is in **AUTO** .
  - The headlight switch lever is in the high beam position.
- 2 Turn the engine switch to the "ON" position (vehicles without a smart key system) or IGNITION ON mode (vehicles with a smart key system).
- 3 Within 30 seconds after 2, repeat pulling the headlight switch lever to the original position then pushing it to the high beam position quickly 10 times, then leave the lever in the high beam position.
- 4 If the sensitivity is changed, the Automatic High Beam indicator will turn on and off 3 times.

Automatic High Beam (headlights) may turn on even the vehicle is stopped.

## Windshield wipers and washer

### Operating the wiper lever

The wiper operation is selected by moving the lever as follows. When intermittent windshield wiper operation is selected, the wiper interval can be also adjusted.

- ① **INT** \*1 or  \*2  
Intermittent windshield wiper operation
- ② **LO** \*1 or  \*2  
Low speed windshield wiper operation
- ③ **HI** \*1 or  \*2  
High speed windshield wiper operation
- ④ **MIST** \*1 or  \*2  
Temporary operation

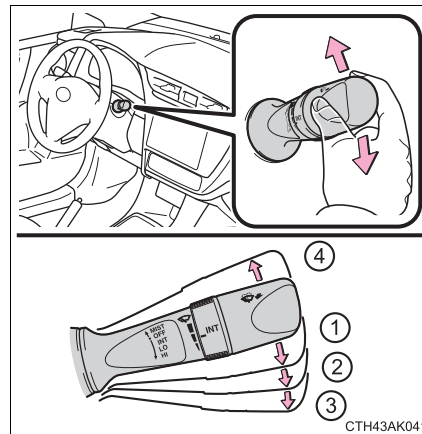

\*1: For the U.S.A.

\*2: For Canada

Wiper intervals can be adjusted when intermittent operation is selected.

- ⑤ Increases the intermittent windshield wiper frequency\*3
- ⑥ Decreases the intermittent windshield wiper frequency\*3

\*3: The interval adjuster may not be equipped depending on the grade.

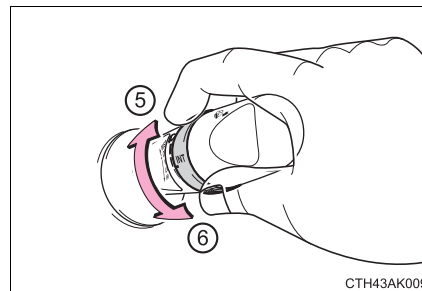

### ⑦ Washer/wiper dual operation

Wipers will automatically operate a couple of times after the washer squirts.

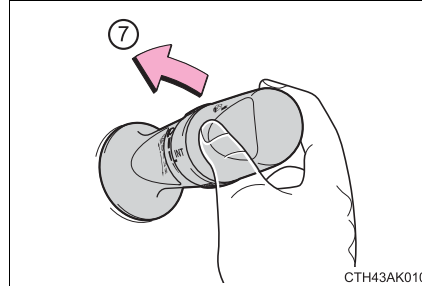

#### ■ The windshield wiper and washer can be operated when

- ▶ Vehicles without a smart key system  
The engine switch is in the “ON” position.
- ▶ Vehicles with a smart key system  
The engine switch is in IGNITION ON mode.

#### ■ If no windshield washer fluid sprays

Check that the washer nozzles are not blocked if there is washer fluid in the windshield washer fluid reservoir.

#### ⚠ WARNING

##### ■ Caution regarding the use of washer fluid

When it is cold, do not use the washer fluid until the windshield becomes warm. The fluid may freeze on the windshield and cause low visibility. This may lead to an accident, resulting in death or serious injury.

#### ⚠ NOTICE

##### ■ When the windshield is dry

Do not use the wipers, as they may damage the windshield.

##### ■ When the washer fluid tank is empty

Do not operate the switch continually as the washer fluid pump may over-heat.

##### ■ When a nozzle becomes blocked

In this case, contact your Toyota dealer.

Do not try to clear it with a pin or other object. The nozzle will be damaged.

## Opening the fuel tank cap

**Perform the following steps to open the fuel tank cap:**

### Before refueling the vehicle

- Close all the doors and windows, and turn the engine switch off.
- Confirm the type of fuel. (→P. 548)

### ■ Fuel types

→P. 548

### ■ Fuel tank opening for unleaded gasoline

To help prevent incorrect fueling, your vehicle has a fuel tank opening that only accommodates the special nozzle on unleaded fuel pumps.

### WARNING

#### ■ When refueling the vehicle

Observe the following precautions while refueling the vehicle. Failure to do so may result in death or serious injury.

- After exiting the vehicle and before opening the fuel door, touch an unpainted metal surface to discharge any static electricity. It is important to discharge static electricity before refueling because sparks resulting from static electricity can cause fuel vapors to ignite while refueling.
- Always hold the grips on the fuel tank cap and turn it slowly to remove it. A whooshing sound may be heard when the fuel tank cap is loosened. Wait until the sound cannot be heard before fully removing the cap. In hot weather, pressurized fuel may spray out the filler neck and cause injury.
- Do not allow anyone that has not discharged static electricity from their body to come close to an open fuel tank.
- Do not inhale vaporized fuel.  
Fuel contains substances that are harmful if inhaled.
- Do not smoke while refueling the vehicle.  
Doing so may cause the fuel to ignite and cause a fire.
- Do not return to the vehicle or touch any person or object that is statically charged.  
This may cause static electricity to build up, resulting in a possible ignition hazard.

**⚠ WARNING****■ When refueling**

Observe the following precautions to prevent fuel overflowing from the fuel tank:

- Securely insert the fuel nozzle into the fuel filler neck.
- Stop filling the tank after the fuel nozzle automatically clicks off.
- Do not top off the fuel tank.

**⚠ NOTICE****■ Refueling**

Do not spill fuel during refueling.

Doing so may damage the vehicle, such as causing the emission control system to operate abnormally or damaging fuel system components or the vehicle's painted surface.

**Opening the fuel tank cap**

- 1 Pull up the opener to open the fuel filler door.

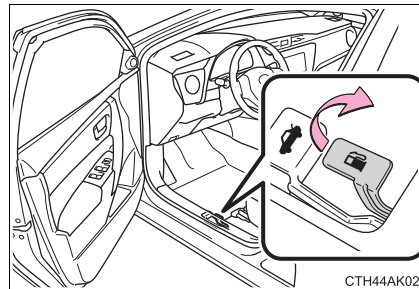

- 2 Turn the fuel tank cap slowly to remove it and hang it on the back of the fuel filler door.

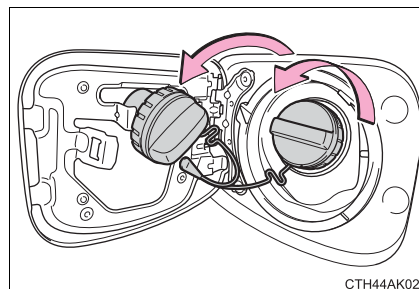

### Closing the fuel tank cap

After refueling, turn the fuel tank cap until you hear a click. Once the cap is released, it will turn slightly in the opposite direction.

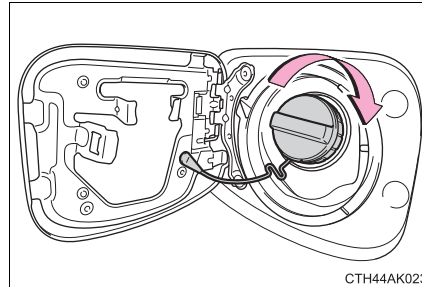

### WARNING

#### ■ When replacing the fuel tank cap

Do not use anything but a genuine Toyota fuel tank cap designed for your vehicle. Doing so may cause a fire or other incident which may result in death or serious injury.

## Toyota Safety Sense P

The Toyota Safety Sense P consists of the following drive assist systems and contributes to a safe and comfortable driving experience:

◆ **PCS (Pre-Collision System)**

→P. 214

◆ **LDA (Lane Departure Alert with steering control)**

→P. 226

◆ **Automatic High Beam**

→P. 198

◆ **Dynamic radar cruise control**

→P. 235

 **WARNING**

■ **Toyota Safety Sense P**

The Toyota Safety Sense P is designed to operate under the assumption that the driver will drive safely, and is designed to help reduce the impact to the occupants and the vehicle in the case of a collision or assist the driver in normal driving conditions.

As there is a limit to the degree of recognition accuracy and control performance that this system can provide, do not overly rely on this system. The driver is always responsible for paying attention to the vehicle's surroundings and driving safely.

### **Vehicle data recording**

The pre-collision system is equipped with a sophisticated computer that will record certain data, such as:

- Accelerator status
- Brake status
- Vehicle speed
- Operation status of the pre-collision system functions
- Information (such as the distance and relative speed between your vehicle and the vehicle ahead or other objects)
- Images from the camera sensor (available only when the pre-collision braking function or the pre-collision brake assist function was operating)

The pre-collision system does not record conversations, sounds or images of the inside of the vehicle.

#### ● Data usage

Toyota may use the data recorded in this computer to diagnose malfunctions, conduct research and development, and improve quality.

Toyota will not disclose the recorded data to a third party except:

- With the consent of the vehicle owner or with the consent of the lessee if the vehicle is leased
- In response to an official request by the police, a court of law or a government agency
- For use by Toyota in a lawsuit
- For research purposes where the data is not tied to a specific vehicle or vehicle owner

#### ● Recorded images can be erased using a specialized device.

The image recording function can be disabled. However, if the function is disabled, data from when the pre-collision system operates will not be available.



## Sensors

Two types of sensors, located behind the front grille and windshield, detect information necessary to operate the drive assist systems.

- ① Radar sensor
- ② Camera sensor

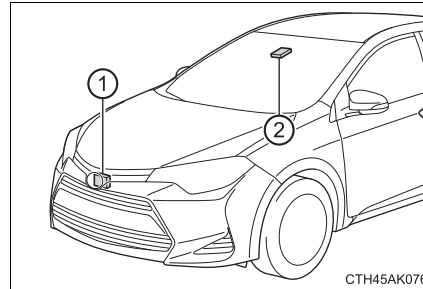

### ⚠ WARNING

#### ■ To avoid malfunction of the radar sensor

Observe the following precautions.

Otherwise, the radar sensor may not operate properly, possibly leading to an accident resulting in death or serious injury.

- Keep the radar sensor and front grille emblem clean at all times.

- ① Radar sensor
- ② Front grille emblem

If the front of the radar sensor or the front or back of the front grille emblem is dirty or covered with water droplets, snow, etc., clean it.

Clean the radar sensor and front grille emblem with a soft cloth so you do not mark or damage them.

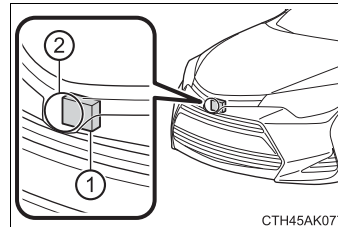

- Do not attach accessories, stickers (including transparent stickers) or other items to the radar sensor, front grille emblem or surrounding area.
- Do not subject the radar sensor or surrounding area to a strong impact. If the radar sensor, front grille, or front bumper has been subjected to a strong impact, have the vehicle inspected by your Toyota dealer.
- Do not disassemble the radar sensor.
- Do not modify or paint the radar sensor, front grille emblem or surrounding area.
- If the radar sensor, front grille, or front bumper needs to be removed and installed, or replaced, contact your Toyota dealer.

**⚠ WARNING****■ To avoid malfunction of the camera sensor**

Observe the following precautions.

Otherwise, the camera sensor may not operate properly, possibly leading to an accident resulting in death or serious injury.

- Keep the windshield clean at all times.
  - If the windshield is dirty or covered with an oily film, water droplets, snow, etc., clear the windshield.
  - If a glass coating agent is applied to the windshield, it will still be necessary to use the windshield wipers to remove water droplets, etc. from the area of the windshield in front of the camera sensor.
  - If the inner side of the windshield where the camera sensor is installed is dirty, contact your Toyota dealer.

- Do not attach objects, such as stickers, transparent stickers, and so forth, to the outer side of the windshield in front of the camera sensor (shaded area in the illustration).

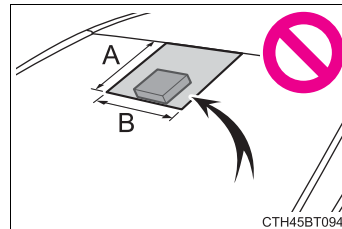

A: From the top of the windshield to approximately 0.4 in. (1 cm) below the bottom of the camera sensor

B: Approximately 7.9 in. (20 cm) (Approximately 4.0 in. [10 cm] to the right and left from the center of the camera sensor)

- If the part of the windshield in front of the camera sensor is fogged up or covered with condensation or ice, use the windshield defogger to remove the fog, condensation or ice. (→P. 368, 376)
- If water droplets cannot be properly removed from the area of the windshield in front of the camera sensor by the windshield wipers, replace the wiper insert or wiper blade.
 

If the wiper inserts or wiper blades need to be replaced, contact your Toyota dealer.
- Do not attach window tinting to the windshield.
- Replace the windshield if it is damaged or cracked.
 

If the windshield needs to be replaced, contact your Toyota dealer.
- Do not get the camera sensor wet.
- Do not allow bright lights to shine into the camera sensor.
- Do not dirty or damage the camera sensor.
 

When cleaning the inside of the windshield, do not allow glass cleaner to contact the lens. Also, do not touch the lens.

If the lens is dirty or damaged, contact your Toyota dealer.

 **WARNING**

- Do not subject the camera sensor to a strong impact.
- Do not change the installation position or direction of the camera sensor or remove it.
- Do not disassemble the camera sensor.
- Do not modify any components of the vehicle around the camera sensor (inside rear view mirror, etc.) or ceiling.
- Do not attach any accessories that may obstruct the camera sensor to the hood, front grille or front bumper. Contact your Toyota dealer for details.
- If a surfboard or other long object is to be mounted on the roof, make sure that it will not obstruct the camera sensor.
- Do not modify the headlights or other lights.

■ **Certification**

FCC ID: HYQDNMWR008

**NOTE:**

This device complies with part 15 of the FCC Rules. Operation is subject to the following two conditions: (1) This device may not cause harmful interference, and (2) this device must accept any interference received, including interference that may cause undesired operation.

**FCC WARNING:**

Changes or modifications not expressly approved by the party responsible for compliance could void the user's authority to operate the equipment.

**Radiofrequency radiation exposure Information:**

This equipment complies with FCC radiation exposure limits set forth for an uncontrolled environment. This equipment should be installed and operated with minimum distance of 20 cm between the radiator (antenna) and your body. This transmitter must not be co-located or operating in conjunction with any other antenna or transmitter.

**NOTE:**

This device complies with Industry Canada licence-exempt RSS standard(s). Operation is subject to the following two conditions: (1) this device may not cause interference, and (2) this device must accept any interference, including interference that may cause undesired operation of the device.

This equipment complies with IC radiation exposure limits set forth for an uncontrolled environment and meets RSS-102 of the IC radio frequency (RF) Exposure rules. This equipment should be installed and operated keeping the radiator at least 20 cm or more away from person's body.

**NOTE:**

Le présent appareil est conforme aux CNR d'Industrie Canada applicables aux appareils radio exempts de licence. L'exploitation est autorisée aux deux conditions suivantes: (1) l'appareil ne doit pas produire de brouillage, et (2) l'utilisateur de l'appareil doit accepter tout brouillage radioélectrique subi, même si le brouillage est susceptible d'en compromettre le fonctionnement.

Cet équipement est conforme aux limites d'exposition aux rayonnements énoncées pour un environnement non contrôlé et respecte les règles d'exposition aux fréquences radioélectriques (RF) CNR-102 de l'IC. Cet équipement doit être installé et utilisé en gardant une distance de 20 cm ou plus entre le dispositif rayonnant et le corps.

## PCS (Pre-Collision System)

The pre-collision system uses a radar sensor and camera sensor to detect vehicles and pedestrians in front of your vehicle. When the system determines that the possibility of a frontal collision with a vehicle or pedestrian is high, a warning operates to urge the driver to take evasive action and the potential brake pressure is increased to help the driver avoid the collision. If the system determines that the possibility of a frontal collision with a vehicle or pedestrian is extremely high, the brakes are automatically applied to help avoid the collision or help reduce the impact of the collision.

The pre-collision system can be disabled/enabled and the warning timing can be changed. (→P. 217)

### ◆ Pre-collision warning

When the system determines that the possibility of a frontal collision is high, a buzzer will sound and a warning message will be displayed on the multi-information display to urge the driver to take evasive action.

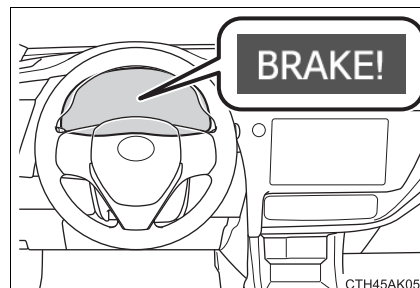

### ◆ Pre-collision brake assist

When the system determines that the possibility of a frontal collision is high, the system applies greater braking force in relation to how strongly the brake pedal is depressed.

### ◆ Pre-collision braking

When the system determines that the possibility of a frontal collision is high, the system warns the driver. If the system determines that the possibility of a collision is extremely high, the brakes are automatically applied to help avoid the collision or reduce the collision speed.

 **WARNING****■ Limitations of the pre-collision system**

- The driver is solely responsible for safe driving. Always drive safely, taking care to observe your surroundings.  
Do not use the pre-collision system instead of normal braking operations under any circumstances. This system will not prevent collisions or lessen collision damage or injury in every situation. Do not overly rely on this system. Failure to do so may lead to an accident, resulting in death or serious injury.
- Although this system is designed to help avoid a collision or help reduce the impact of the collision, its effectiveness may change according to various conditions, therefore the system may not always be able to achieve the same level of performance.  
Read the following conditions carefully. Do not overly rely on this system and always drive carefully.
  - Conditions under which the system may operate even if there is no possibility of a collision: →P. 219
  - Conditions under which the system may not operate properly: →P. 222
- Do not attempt to test the operation of the pre-collision system yourself, as the system may not operate properly, possibly leading to an accident.

**■ Pre-collision braking**

- When the pre-collision braking function is operating, a large amount of braking force will be applied.
- If the vehicle is stopped by the operation of the pre-collision braking function, the pre-collision braking function operation will be canceled after approximately 2 seconds. Depress the brake pedal as necessary.
- The pre-collision braking function may not operate if certain operations are performed by the driver. If the accelerator pedal is being depressed strongly or the steering wheel is being turned, the system may determine that the driver is taking evasive action and possibly prevent the pre-collision braking function from operating.
- In some situations, while the pre-collision braking function is operating, operation of the function may be canceled if the accelerator pedal is depressed strongly or the steering wheel is turned and the system determines that the driver is taking evasive action.
- If the brake pedal is being depressed, the system may determine that the driver is taking evasive action and possibly delay the operation timing of the pre-collision braking function.

 **WARNING****■ When to disable the pre-collision system**

In the following situations, disable the system, as it may not operate properly, possibly leading to an accident resulting in death or serious injury:

- When the vehicle is being towed
- When your vehicle is towing another vehicle
- When transporting the vehicle via truck, boat, train or similar means of transportation
- When the vehicle is raised on a lift with the engine running and the tires are allowed to rotate freely
- When inspecting the vehicle using a drum tester such as a chassis dynamometer or speedometer tester, or when using an on vehicle wheel balancer
- When a strong impact is applied to the front bumper or front grille, due to an accident or other reasons
- If the vehicle cannot be driven in a stable manner, such as when the vehicle has been in an accident or is malfunctioning
- When the vehicle is driven in a sporty manner or off-road
- When the tires are not properly inflated
- When the tires are very worn
- When tires of a size other than specified are installed
- When tire chains are installed
- When a compact spare tire or an emergency tire puncture repair kit is used
- If equipment (snow plow, etc.) that may obstruct the radar sensor or camera sensor is temporarily installed to the vehicle



## Changing settings of the pre-collision system

### ■ Enabling/disabling the pre-collision system

The pre-collision system can be enabled/disabled on the settings display (→P. 93) of the multi-information display.

The system is automatically enabled each time the engine switch is turned to the “ON” position (vehicles without a smart key system) or IGNITION ON mode (vehicles with a smart key system).

If the system is disabled, the PCS warning light will turn on and a message will be displayed on the multi-information display.

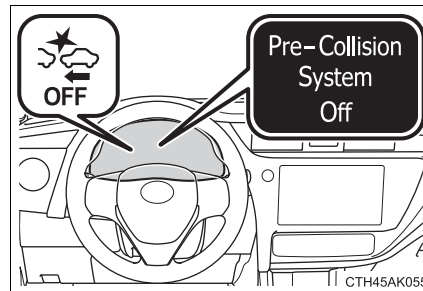

### ■ Changing the pre-collision warning timing

The pre-collision warning timing can be changed on the settings display (→P. 93) of the multi-information display.

The operation timing setting is retained when the engine switch is turned off.

- ① Far  
The warning will begin to operate earlier than with the default timing.
- ② Middle  
This is the default setting.
- ③ Near  
The warning will begin to operate later than with the default timing.

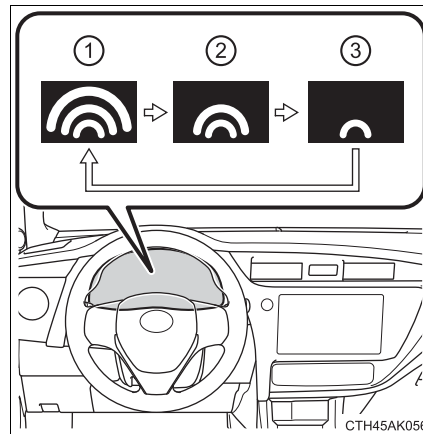

■ **Operational conditions**

The pre-collision system is enabled and the system determines that the possibility of a frontal collision with a vehicle or pedestrian is high.

Each function is operational at the following speeds:

- Pre-collision warning:
  - Vehicle speed is between approximately 7 and 110 mph (10 and 180 km/h). (For detecting a pedestrian, vehicle speed is between approximately 7 and 50 mph [10 and 80 km/h].)
  - The relative speed between your vehicle and the vehicle or pedestrian ahead is approximately 7 mph (10 km/h) or more.
- Pre-collision brake assist:
  - Vehicle speed is between approximately 20 and 110 mph (30 and 180 km/h). (For detecting a pedestrian, vehicle speed is between approximately 20 and 50 mph [30 and 80 km/h].)
  - The relative speed between your vehicle and the vehicle or pedestrian ahead is approximately 20 mph (30 km/h) or more.
- Pre-collision braking:
  - Vehicle speed is between approximately 7 and 110 mph (10 and 180 km/h). (For detecting a pedestrian, vehicle speed is between approximately 7 and 50 mph [10 and 80 km/h].)
  - The relative speed between your vehicle and the vehicle or pedestrian ahead is approximately 7 mph (10 km/h) or more.

The system may not operate in the following situations:

- If a battery terminal has been disconnected and reconnected and then the vehicle has not been driven for a certain amount of time
- If the shift lever is in R
- If VSC is disabled (only the pre-collision warning function will be operational)

### ■ Pedestrian detection function

The pre-collision system detects pedestrians based on the size, profile, and motion of a detected object. However, a pedestrian may not be detected depending on the surrounding brightness and the motion, posture, and angle of the detected object, preventing the system from operating properly. (→P. 222)

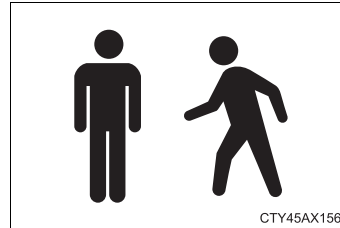

### ■ Cancellation of the pre-collision braking

If either of the following occurs while the pre-collision braking function is operating, it will be canceled:

- The accelerator pedal is depressed strongly.
- The steering wheel is turned sharply or abruptly.

### ■ Conditions under which the system may operate even if there is no possibility of a collision

- In some situations such as the following, the system may determine that there is a possibility of a frontal collision and operate.
  - When passing a vehicle or pedestrian
  - When changing lanes while overtaking a preceding vehicle
  - When overtaking a preceding vehicle that is changing lanes
  - When overtaking a preceding vehicle that is making a left/right turn

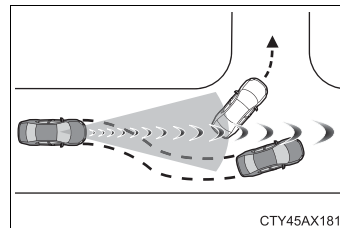

- When passing a vehicle in an oncoming lane that is stopped to make a right/left turn

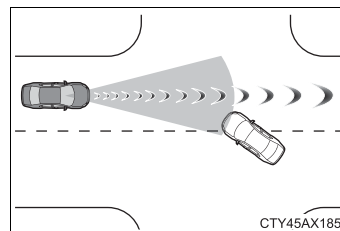

- When driving on a road where relative location to vehicle ahead in an adjacent lane may change, such as on a winding road

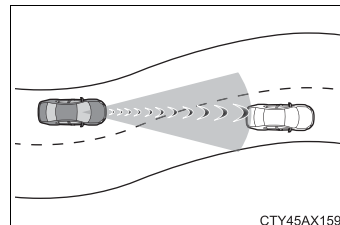

- When rapidly closing on a vehicle ahead
- If the front of the vehicle is raised or lowered, such as when the road surface is uneven or undulating
- When approaching objects on the roadside, such as guardrails, utility poles, trees, or walls
- When there is a vehicle, pedestrian, or object by the roadside at the entrance of a curve

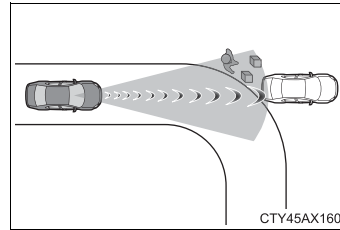

- When driving on a narrow path surrounded by a structure, such as in a tunnel or on an iron bridge
- When there is a metal object (manhole cover, steel plate, etc.), steps, or a protrusion on the road surface or roadside
- When a crossing pedestrian approaches very close to the vehicle

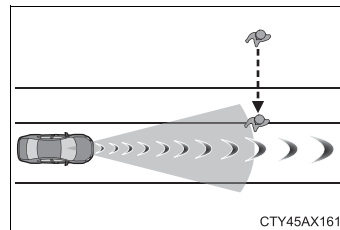

- When passing through a place with a low structure above the road (low ceiling, traffic sign, etc.)

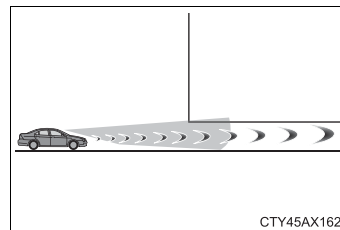

- When passing under an object (billboard, etc.) at the top of an uphill road

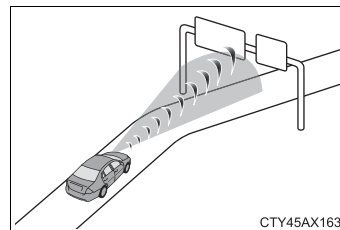

- When rapidly closing on an electric toll gate barrier, parking area barrier, or other barrier that opens and closes
- When using an automatic car wash

- When driving through or under objects that may contact the vehicle, such as thick grass, tree branches, or a banner

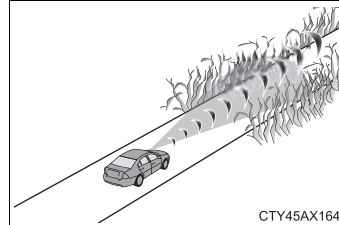

- When the vehicle is hit by water, snow, dust, etc. from a vehicle ahead
- When driving through steam or smoke
- When there are patterns or paint on the road or a wall that may be mistaken for a vehicle or pedestrian
- When driving near an object that reflects radio waves, such as a large truck or guardrail
- When driving near a TV tower, broadcasting station, electric power plant, or other location where strong radio waves or electrical noise may be present

■ **Situations in which the system may not operate properly**

● In some situations such as the following, a vehicle may not be detected by the radar sensor and camera sensor, preventing the system from operating properly:

- If an oncoming vehicle is approaching your vehicle
- If a vehicle ahead is a motorcycle or bicycle
- When approaching the side or front of a vehicle
- If a preceding vehicle has a small rear end, such as an unloaded truck
- If a preceding vehicle has a low rear end, such as a low bed trailer

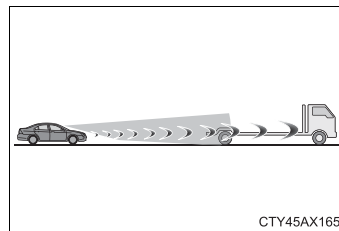

- If a vehicle ahead is carrying a load which protrudes past its rear bumper
- If a vehicle ahead has extremely high ground clearance

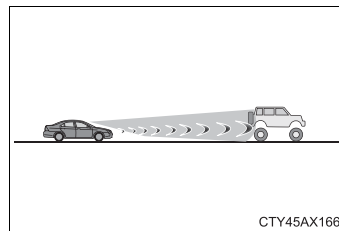

- If a vehicle ahead is irregularly shaped, such as a tractor or side car
- If the sun or other light is shining directly on a vehicle ahead
- If a vehicle cuts in front of your vehicle or emerges from beside a vehicle
- If a vehicle ahead makes an abrupt maneuver (such as sudden swerving, acceleration or deceleration)
- When suddenly cutting behind a preceding vehicle
- When a vehicle ahead is not directly in front of your vehicle

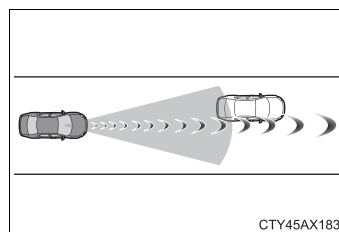

- When driving in inclement weather such as heavy rain, fog, snow or a sandstorm
- When the vehicle is hit by water, snow, dust, etc. from a vehicle ahead
- When driving through steam or smoke
- When driving in a place where the surrounding brightness changes suddenly, such as at the entrance or exit of a tunnel
- When a very bright light, such as the sun or the headlights of oncoming traffic, shines directly into the camera sensor
- When the surrounding area is dim, such as at dawn or dusk, or while at night or in a tunnel
- After the engine has started the vehicle has not been driven for a certain amount of time
- While making a left/right turn and for a few seconds after making a left/right turn
- While driving on a curve and for a few seconds after driving on a curve
- If your vehicle is skidding
- If the front of the vehicle is raised or lowered

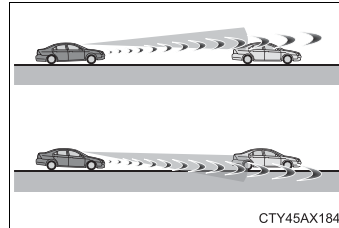

- If the wheels are misaligned
- If a wiper blade is blocking the camera sensor
- The vehicle is wobbling.
- The vehicle is being driven at extremely high speeds.
- When driving on a hill
- If the radar sensor or camera sensor is misaligned
- In some situations such as the following, sufficient braking force may not be obtained, preventing the system from performing properly:
  - If the braking functions cannot operate to their full extent, such as when the brake parts are extremely cold, extremely hot, or wet
  - If the vehicle is not properly maintained (brakes or tires are excessively worn, improper tire inflation pressure, etc.)
  - When the vehicle is being driven on a gravel road or other slippery surface

- Some pedestrians such as the following may not be detected by the radar sensor and camera sensor, preventing the system from operating properly:
  - Pedestrians shorter than approximately 3.2 ft. (1 m) or taller than approximately 6.5 ft. (2 m)
  - Pedestrians wearing oversized clothing (a rain coat, long skirt, etc.), making their silhouette obscure
  - Pedestrians who are carrying large baggage, holding an umbrella, etc., hiding part of their body
  - Pedestrians who are bending forward or squatting
  - Pedestrians who are pushing a stroller, wheelchair, bicycle or other vehicle
  - Groups of pedestrians which are close together
  - Pedestrians who are wearing white and look extremely bright
  - Pedestrians in the dark, such as at night or while in a tunnel
  - Pedestrians whose clothing appears to be nearly the same color or brightness as their surroundings
  - Pedestrians near walls, fences, guardrails, or large objects
  - Pedestrians who are on a metal object (manhole cover, steel plate, etc.) on the road
  - Pedestrians who are walking fast
  - Pedestrians who are changing speed abruptly
  - Pedestrians running out from behind a vehicle or a large object
  - Pedestrians who are extremely close to the side of the vehicle (outside rear view mirror, etc.)



**■ If the PCS warning light flashes or illuminates and a warning message is displayed on the multi-information display**

The pre-collision system may be temporarily unavailable or there may be a malfunction in the system.

- In the following situations, the warning light will turn off, the message will disappear and the system will become operational when normal operating conditions return:
    - When the radar sensor or camera sensor or the area around either sensor is hot, such as in the sun
    - When the radar sensor or camera sensor or the area around either sensor is cold, such as in an extremely cold environment
    - When a front sensor is dirty or covered with snow, etc.
    - When the part of the windshield in front of the camera sensor is fogged up or covered with condensation or ice  
(Defogging the windshield: →P. 368, 376)
    - If the camera sensor is obstructed, such as when the hood is open or a sticker is attached to the windshield near the camera sensor
  - If the PCS warning light continues to flash or remains illuminated or the warning message does not disappear even though the vehicle has returned to normal, the system may be malfunctioning. Have the vehicle inspected by your Toyota dealer immediately.
- If VSC is disabled**
- If VSC is disabled (→P. 259), the pre-collision brake assist and pre-collision braking functions are also disabled.
  - The PCS warning light will turn on and “VSC Turned Off Pre-Collision Brake System Unavailable” will be displayed on the multi-information display.

## LDA (Lane Departure Alert with steering control)

### Summary of functions

When driving on highways and freeways with white (yellow) lines, this function alerts the driver when the vehicle might depart from its lane and provides assistance by operating the steering wheel to keep the vehicle in its lane.

The LDA system recognizes visible white (yellow) lines with the camera sensor on the upper portion of the windshield.

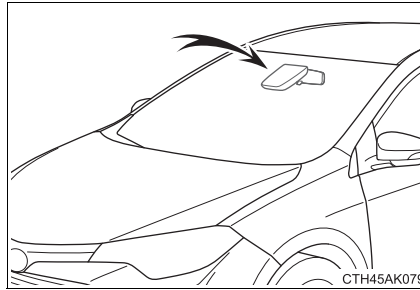

### Functions included in LDA system

#### ◆ Lane departure alert function

When the system determines that the vehicle might depart from its lane, a warning is displayed on the multi-information display and the warning buzzer sounds to alert the driver.

When the warning buzzer sounds, check the surrounding road situation and carefully operate the steering wheel to move the vehicle back to the center of the lane.

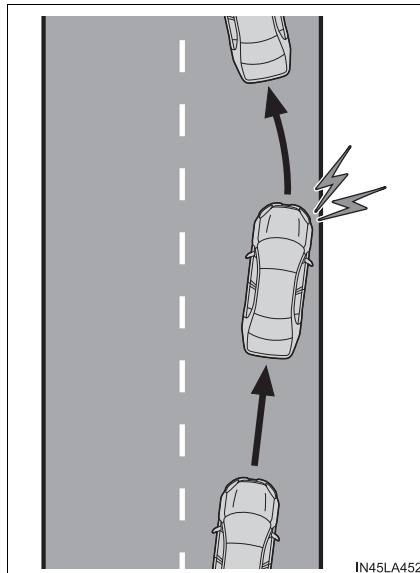

### ◆ Steering control function

When the system determines that the vehicle might depart from its lane, the system provides assistance as necessary by operating the steering wheel in small amounts for a short period of time to keep the vehicle in its lane.

If the system detects that the steering wheel has not been operated for a fixed amount of time or the steering wheel is not being firmly gripped, a warning is displayed on the multi-information display and the warning buzzer sounds.

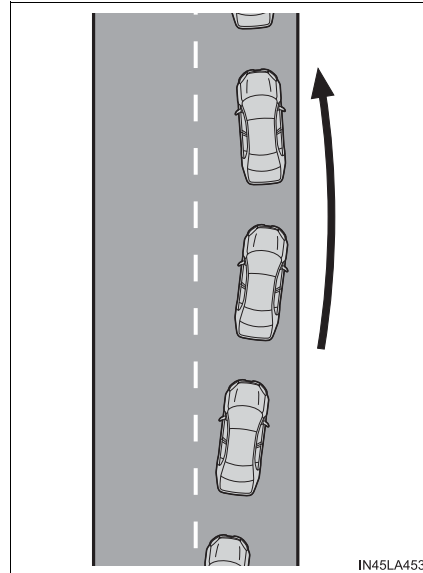

### ◆ Vehicle sway warning function

When the vehicle is swaying or appears as if it may depart from its lane multiple times, the warning buzzer sounds and a message is displayed on the multi-information display to alert the driver.

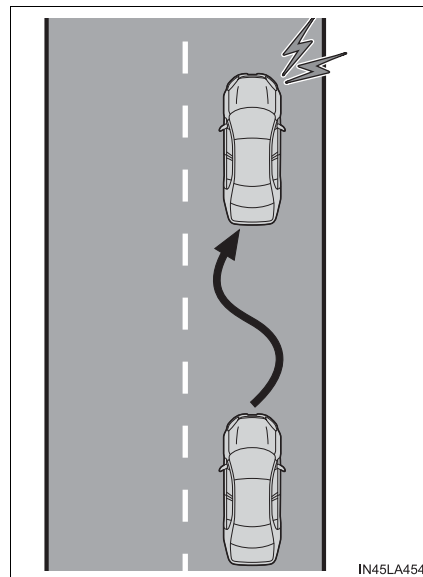

 **WARNING****■ Before using LDA system**

Do not rely solely upon the LDA system. The LDA system does not automatically drive the vehicle or reduce the amount of attention that must be paid to the area in front of the vehicle. The driver must always assume full responsibility for driving safely by paying careful attention to the surrounding conditions and operating the steering wheel to correct the path of the vehicle. Also, the driver must take adequate breaks when fatigued, such as from driving for a long period of time.

Failure to perform appropriate driving operations and pay careful attention may lead to an accident, resulting in death or serious injury.

**■ To avoid operating LDA by mistake**

When not using the LDA system, use the LDA switch to turn the system off.

**■ Situations unsuitable for LDA system**

Do not use the LDA system in the following situations.

The system may not operate properly and lead to an accident, resulting in death or serious injury.

- A spare tire, tire chains, etc. are equipped.
- When the tires have been excessively worn, or when the tire inflation pressure is low.
- Tires which differ by structure, manufacturer, brand or tread pattern are used.
- Objects or patterns that could be mistaken for white (yellow) lines are present on the side of the road (guardrails, curbs, reflective poles, etc.).
- Vehicle is driven on a snow-covered road.
- White (yellow) lines are difficult to see due to rain, snow, fog, dust, etc.
- Asphalt repair marks, white (yellow) line marks, etc. are present due to road repair.
- Vehicle is driven in a temporary lane or restricted lane due to construction work.
- Vehicle is driven on a road surface which is slippery due to rainy weather, fallen snow, freezing, etc.
- Vehicle is driven in traffic lanes other than on highways and freeways.
- Vehicle is driven in a construction zone.
- During emergency towing

**⚠ WARNING****■ Preventing LDA system malfunctions and operations performed by mistake**

- Do not modify the headlights or place stickers, etc. on the surface of the lights.
- Do not modify the suspension etc. If the suspension etc. needs to be replaced, contact your Toyota dealer.
- Do not install or place anything on the hood or grille. Also, do not install a grille guard (bull bars, kangaroo bar, etc.).
- If your windshield needs repairs, contact your Toyota dealer.

**Turning LDA system on**

Press the LDA switch to turn the LDA system on.

The LDA indicator illuminates and a message is displayed on the multi-information display.

Press the LDA switch again to turn the LDA system off.

When the LDA system is turned on or off, operation of the LDA system continues in the same condition the next time the engine is started.

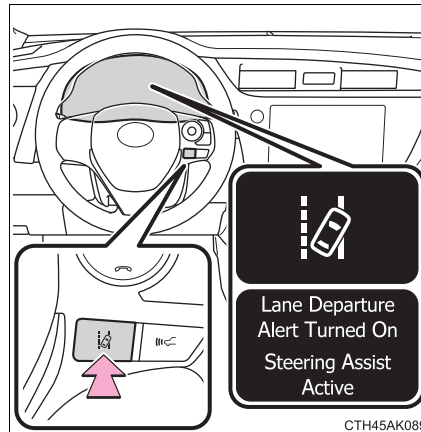

**Indications on multi-information display**

① LDA indicator

The illumination condition of the indicator informs the driver of the system operation status.

Illuminated in white:  
LDA system is operating.

Illuminated in green:  
Steering wheel assistance of the steering control function is operating.

Flashing in orange:  
Lane departure alert function is operating.

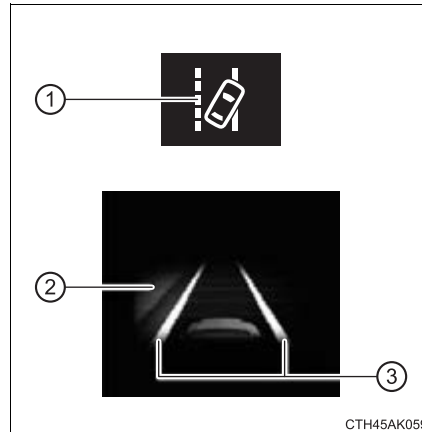

② Operation display of steering wheel operation support

Indicates that steering wheel assistance of the steering control function is operating.

③ Lane departure alert function display

Displayed when the multi-information display is switched to the driving assist system information screen.

▶ Inside of displayed white lines is white

▶ Inside of displayed white lines is black



Indicates that the system is recognizing white (yellow) lines. When the vehicle departs from its lane, the white line displayed on the side the vehicle departs from flashes orange.



Indicates that the system is not able to recognize white (yellow) lines or is temporarily canceled.

---

**■ Operation conditions of each function****● Lane departure alert function**

This function operates when all of the following conditions are met.

- LDA is turned on.
- Vehicle speed is approximately 32 mph (50 km/h) or more.
- System recognizes white (yellow) lines.
- Width of traffic lane is approximately 9.8 ft. (3 m) or more.
- Turn signal lever is not operated.
- Vehicle is driven on a straight road or around a gentle curve with a radius of more than approximately 492 ft. (150 m).
- No system malfunctions are detected. (→P. 480)

**● Steering control function**

This function operates when all of the following conditions are met in addition to the operation conditions for the lane departure alert function.

- Setting for the steering control function is set to on. (→P. 90)
- Vehicle is not accelerated or decelerated by a certain amount or more.
- Steering wheel is not operated with a steering force level suitable for changing lanes.
- ABS, VSC, TRAC and PCS are not operating.
- TRAC or VSC is not turned off.

**● Vehicle sway warning function**

This function operates when all of the following conditions are met.

- Setting for the vehicle sway warning function is set to on. (→P. 90)
- Vehicle speed is approximately 32 mph (50 km/h) or more.
- Width of traffic lane is approximately 9.8 ft. (3 m) or more.
- No system malfunctions are detected. (→P. 480)

**■ Temporary cancellation of functions**

When the operation conditions are no longer met, a function may be temporarily canceled. However, when the operation conditions are met again, operation of the function is automatically restored. (→P. 231)

**■ Steering control function**

Depending on the vehicle speed, lane departure situation, road conditions, etc., the driver may not feel the function is operating or the function may not operate at all.

**■ Lane departure alert function**

The warning buzzer may be difficult to hear due to external noise, audio playback, etc.

■ **Hands off steering wheel warning**

When the system determines that the driver has removed their hands from the steering wheel while the steering control function is operating, a warning message urging the driver to hold the steering wheel and the symbol shown in the illustration are displayed on the multi-information display.

If the driver continues to keep their hands off of the steering wheel, a buzzer sounds and a warning message and the symbol shown in the illustration are displayed on the multi-information display. This warning also operates in the same way when the driver continuously operates the steering wheel only a small amount. Always keep your hands on the steering wheel when using this system, regardless of warnings.

Depending on the vehicle and road conditions, the warning may not operate.

- ▶ Vehicles with a monochrome display



- ▶ Vehicles with a color display

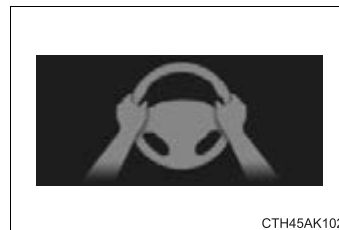

■ **Vehicle sway warning function**

When the system determines that the vehicle is swaying while the vehicle sway warning function is operating, a buzzer sounds and a warning message urging the driver to rest and the symbol shown in the illustration are simultaneously displayed on the multi-information display.

Depending on the vehicle and road conditions, the warning may not operate.

- ▶ Vehicles with a monochrome display



- ▶ Vehicles with a color display





**■ White (yellow) lines are only on one side of road**

The LDA system will not operate for the side on which white (yellow) lines could not be recognized.

**■ Conditions in which functions may not operate properly**

In the following situations, the camera sensor may not detect white (yellow) lines and various functions may not operate normally.

- There are shadows on the road that run parallel with, or cover, the white (yellow) lines.
- The vehicle is driven in an area without white (yellow) lines, such as in front of a tollgate or checkpoint, or at an intersection etc.
- The white (yellow) lines are cracked, “Botts’ dots”, “Raised pavement marker” or stones are present.
- The white (yellow) lines cannot be seen or are difficult to see due to sand, etc.
- The vehicle is driven on a road surface that is wet due to rain, puddles, etc.
- The traffic lines are yellow (which may be more difficult to recognize than lines that are white).
- The white (yellow) lines cross over a curb, etc.
- The vehicle is driven on a bright surface, such as concrete.
- The vehicle is driven on a surface that is bright due to reflected light, etc.
- The vehicle is driven in an area where the brightness changes suddenly, such as at the entrances and exits of tunnels, etc.
- Light from the headlights of an oncoming vehicle, the sun, etc. enters the camera.
- The vehicle is driven where the road diverges, merges, etc.
- The vehicle is driven on a slope.
- The vehicle is driven on a road which tilts left or right, or a winding road.
- The vehicle is driven on an unpaved or rough road.
- The vehicle is driven around a sharp curve.
- The traffic lane is excessively narrow or wide.
- The vehicle is extremely tilted due to carrying heavy luggage or having improper tire pressure.
- The distance to the preceding vehicle is extremely short.
- The vehicle is moving up and down a large amount due to road conditions during driving (poor roads or road seams).
- The headlight lenses are dirty and emit a faint amount of light at night, or the beam axis has deviated.
- The vehicle is struck by a crosswind.
- The vehicle has just changed lanes or crossed an intersection.
- Snow tires, etc. are equipped.

**■ Warning message**

Warning messages are used to indicate a system malfunction or to inform the driver of the need for caution while driving. (→P. 489)

**■ Customization**

The following settings can be changed.

Function	Setting details
Lane departure alert function	Adjust alert sensitivity
Steering control function	Turn steering wheel assistance on and off
Vehicle sway warning function	Turn function on and off
	Adjust alert sensitivity

For how to change settings, refer to P. 564

## Dynamic radar cruise control

### Summary of functions

In vehicle-to-vehicle distance control mode, the vehicle automatically accelerates and decelerates to match the speed changes of the preceding vehicle even if the accelerator pedal is not depressed. In constant speed control mode, the vehicle runs at a fixed speed.

Use the dynamic radar cruise control on freeways and highways.

- Vehicle-to-vehicle distance control mode (→P. 238)

- Constant speed control mode (→P. 243)

▶ Vehicles with a monochrome display ▶ Vehicles with a color display

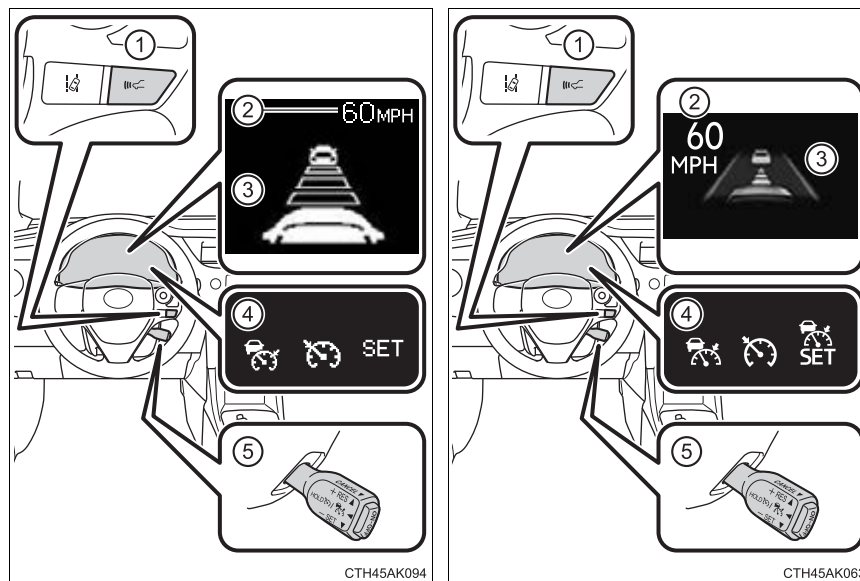

- ① Vehicle-to-vehicle distance switch
- ② Set speed
- ③ Display
- ④ Indicators
- ⑤ Cruise control switch

 **WARNING****■ Before using dynamic radar cruise control**

Driving safely is the sole responsibility of the driver. Do not rely solely on the system, and drive safely by always paying careful attention to your surroundings.

The dynamic radar cruise control provides driving assistance to reduce the driver's burden. However, there are limitations to the assistance provided.

Set the speed appropriately depending on the speed limit, traffic flow, road conditions, weather conditions, etc. The driver is responsible for checking the set speed.

Even when the system is functioning normally, the condition of the preceding vehicle as detected by the system may differ from the condition observed by the driver. Therefore, the driver must always remain alert, assess the danger of each situation and drive safely. Relying on this system or assuming the system ensures safety while driving can lead to an accident, resulting in death or serious injury.

**■ Cautions regarding the driving assist systems**

Observe the following precautions, as there are limitations to the assistance provided by the system.

Failure to do so may cause an accident resulting in death or serious injury.

**● Assisting the driver to measure following distance**

The dynamic radar cruise control is only intended to help the driver in determining the following distance between the driver's own vehicle and a designated vehicle traveling ahead. It is not a mechanism that allows careless or inattentive driving, and it is not a system that can assist the driver in low-visibility conditions. It is still necessary for driver to pay close attention to the vehicle's surroundings.

**● Assisting the driver to judge proper following distance**

The dynamic radar cruise control determines whether the following distance between the driver's own vehicle and a designated vehicle traveling ahead is within a set range. It is not capable of making any other type of judgement. Therefore, it is absolutely necessary for the driver to remain vigilant and to determine whether or not there is a possibility of danger in any given situation.

**● Assisting the driver to operate the vehicle**

The dynamic radar cruise control has limited capability to prevent or avoid a collision with a vehicle traveling ahead. Therefore, if there is ever any danger, the driver must take immediate and direct control of the vehicle and act appropriately in order to ensure the safety of all involved.

**■ To avoid inadvertent dynamic radar cruise control activation**

Switch the dynamic radar cruise control off using the "ON-OFF" button when not in use.

 **WARNING****■ Situations unsuitable for dynamic radar cruise control**

Do not use dynamic radar cruise control in any of the following situations. Doing so may result in inappropriate speed control and could cause an accident resulting in death or serious injury.

- Roads where there are pedestrians, cyclers, etc.
- In heavy traffic
- On roads with sharp bends
- On winding roads
- On slippery roads, such as those covered with rain, ice or snow
- On steep downhills, or where there are sudden changes between sharp up and down gradients  
Vehicle speed may exceed the set speed when driving down a steep hill.
- At entrances to freeways and highways
- When weather conditions are bad enough that they may prevent the sensors from detecting correctly (fog, snow, sandstorm, heavy rain, etc.)
- When there is rain, snow, etc. on the front surface of the radar sensor or camera sensor
- In traffic conditions that require frequent repeated acceleration and deceleration
- During emergency towing
- When an approach warning buzzer is heard often

### Driving in vehicle-to-vehicle distance control mode

This mode employs a radar sensor to detect the presence of vehicles up to approximately 328 ft. (100 m) ahead, determines the current vehicle-to-vehicle following distance, and operates to maintain a suitable following distance from the vehicle ahead.

Note that vehicle-to-vehicle distance will close in when traveling on long downhill slopes.

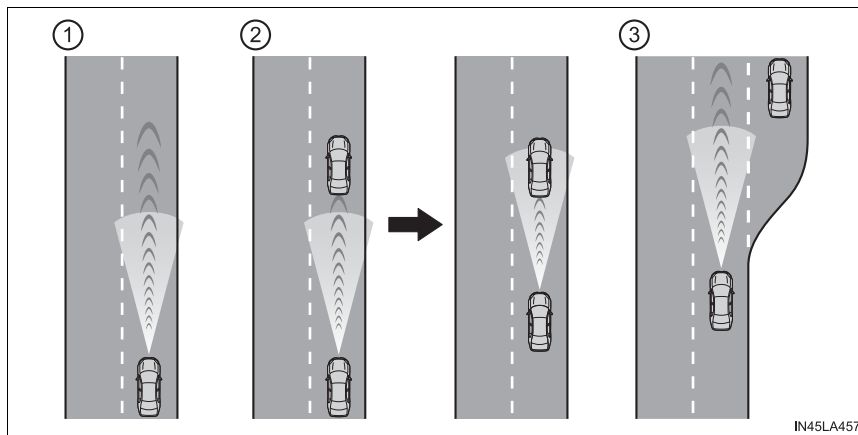

#### ① Example of constant speed cruising

When there are no vehicles ahead

The vehicle travels at the speed set by the driver. The desired vehicle-to-vehicle distance can also be set by operating the vehicle-to-vehicle distance switch.

#### ② Example of deceleration cruising and follow-up cruising

When a preceding vehicle driving slower than the set speed appears

When a vehicle is detected running ahead of you, the system automatically decelerates your vehicle. When a greater reduction in vehicle speed is necessary, the system applies the brakes (the stop lights will come on at this time). The system will respond to changes in the speed of the vehicle ahead in order to maintain the vehicle-to-vehicle distance set by the driver. Approach warning warns you when the system cannot decelerate sufficiently to prevent your vehicle from closing in on the vehicle ahead.

#### ③ Example of acceleration

When there are no longer any preceding vehicles driving slower than the set speed

The system accelerates until the set speed is reached. The system then returns to constant speed cruising.

**Setting the vehicle speed (vehicle-to-vehicle distance control mode)**

- 1 Press the “ON-OFF” button to activate the cruise control.

Radar cruise control indicator will come on and a message will be displayed on the multi-information display.

Press the button again to deactivate the cruise control.

If the “ON-OFF” button is pressed and held for 1.5 seconds or more, the system turns on in constant speed control mode. (→P. 243)

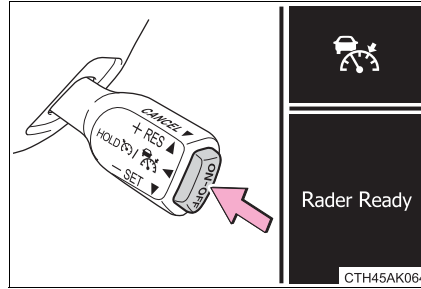

- 2 Accelerate or decelerate, with accelerator pedal operation, to the desired vehicle speed (at or above approximately 30 mph [50 km/h]) and push the lever down to set the speed.

Cruise control “SET” indicator will come on.

The vehicle speed at the moment the lever is released becomes the set speed.

- ▶ Vehicles with a monochrome display
- ▶ Vehicles with a color display

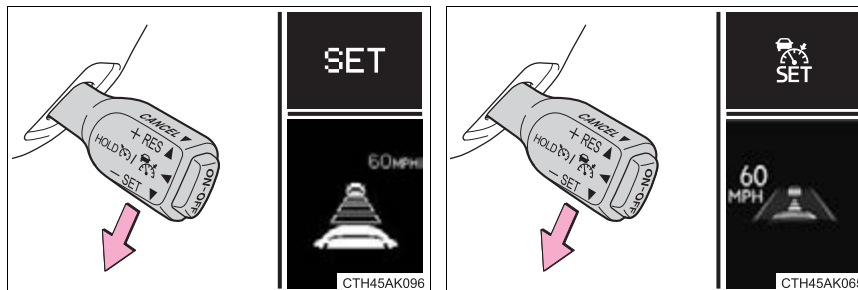

### Adjusting the set speed

To change the set speed, operate the lever until the desired set speed is displayed.

- ① Increases the speed
- ② Decreases the speed

**Fine adjustment:** Momentarily move the lever in the desired direction.

**Large adjustment:** Hold the lever up or down to change the speed, and release when the desired speed is reached.

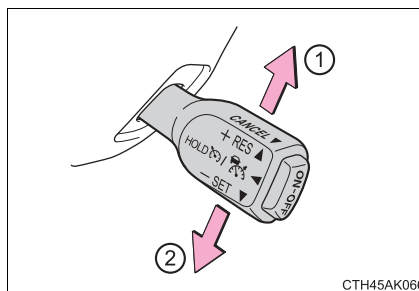

In the vehicle-to-vehicle distance control mode, the set speed will be increased or decreased as follows:

#### ► Type A

**Fine adjustment:** By 1 mph (1.6 km/h)<sup>\*1</sup> or 1 km/h (0.6 mph)<sup>\*2</sup> each time the lever is operated

**Large adjustment:** Increases or decreases in 1 mph (1.6 km/h)<sup>\*1</sup> or 1 km/h (0.6 mph)<sup>\*2</sup> increments for as long as the lever is held

#### ► Type B

**Fine adjustment:** By 1 mph (1.6 km/h)<sup>\*1</sup> or 1 km/h (0.6 mph)<sup>\*2</sup> each time the lever is operated

**Large adjustment:** Increases or decreases in 5 mph (8 km/h)<sup>\*1</sup> or 5 km/h (3.1 mph)<sup>\*2</sup> increments for as long as the lever is held

In the constant speed control mode (→P. 243), the set speed will be increased or decreased as follows:

**Fine adjustment:** By 1 mph (1.6 km/h)<sup>\*1</sup> or 1 km/h (0.6 mph)<sup>\*2</sup> each time the lever is operated

**Large adjustment:** The speed will continue to change while the lever is held.

\*1: When the set speed is shown in "MPH"

\*2: When the set speed is shown in "km/h"



### Changing the vehicle-to-vehicle distance (vehicle-to-vehicle distance control mode)

Pressing the switch changes the vehicle-to-vehicle distance as follows:

- ① Long
- ② Medium
- ③ Short

The vehicle-to-vehicle distance is set automatically to long mode when the engine switch is turned to the "ON" position (vehicles without a smart key system) or IGNITION ON mode (vehicles with a smart key system).

If a vehicle is running ahead of you, the preceding vehicle mark will also be displayed.

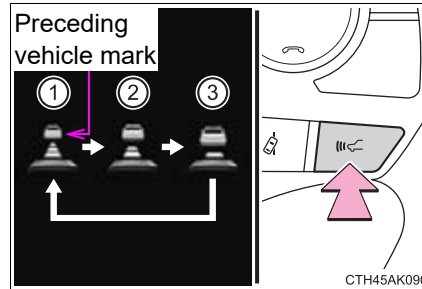

### Vehicle-to-vehicle distance settings (vehicle-to-vehicle distance control mode)

Select a distance from the table below. Note that the distances shown correspond to a vehicle speed of 50 mph (80 km/h). Vehicle-to-vehicle distance increases/decreases in accordance with vehicle speed.

Distance options	Vehicle-to-vehicle distance
Long	Approximately 160 ft. (50 m)
Medium	Approximately 130 ft. (40 m)
Short	Approximately 100 ft. (30 m)

### Canceling and resuming the speed control

- ① Pulling the lever toward you cancels the speed control.

The speed setting is also canceled when the brake pedal is depressed or the clutch pedal is depressed (vehicles with a manual transmission) for some seconds.

- ② Pushing the lever up resumes the cruise control and returns vehicle speed to the set speed.

However, cruise control does not resume when the vehicle speed is approximately 25 mph (40 km/h) or less.

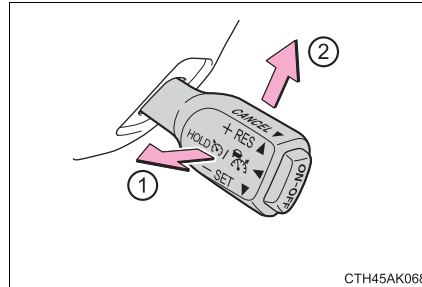

### Approach warning (vehicle-to-vehicle distance control mode)

When your vehicle is too close to a vehicle ahead, and sufficient automatic deceleration via the cruise control is not possible, the display will flash and the buzzer will sound to alert the driver. An example of this would be if another driver cuts in front of you while you are following a vehicle. Depress the brake pedal to ensure an appropriate vehicle-to-vehicle distance.

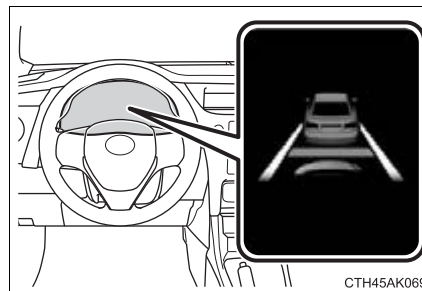

#### ■ Warnings may not occur when

In the following instances, warnings may not occur even when the vehicle-to-vehicle distance is small.

- When the speed of the preceding vehicle matches or exceeds your vehicle speed
- When the preceding vehicle is traveling at an extremely slow speed
- Immediately after the cruise control speed was set
- When depressing the accelerator pedal

**Selecting constant speed control mode**

When constant speed control mode is selected, your vehicle will maintain a set speed without controlling the vehicle-to-vehicle distance. Select this mode only when vehicle-to-vehicle distance control mode does not function correctly due to a dirty radar sensor, etc.

- 1 With the cruise control off, press and hold the “ON-OFF” button for 1.5 seconds or more.

Immediately after the “ON-OFF” button is pressed, the radar cruise control indicator will come on. Afterwards, it switches to the cruise control indicator.

Switching to constant speed control mode is only possible when operating the lever with the cruise control off.

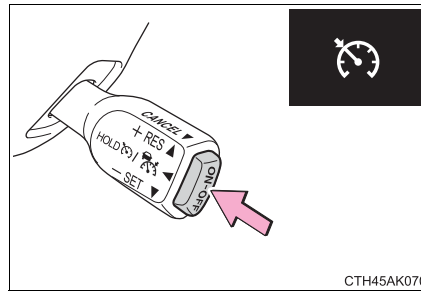

CTH45AK070

- 2 Accelerate or decelerate, with accelerator pedal operation, to the desired vehicle speed (at or above approximately 25 mph [40 km/h]) and push the lever down to set the speed.

Cruise control “SET” indicator will come on.

The vehicle speed at the moment the lever is released becomes the set speed.

Adjusting the speed setting: →P. 240

Canceling and resuming the speed setting: →P. 242

- ▶ Vehicles with a monochrome display
- ▶ Vehicles with a color display

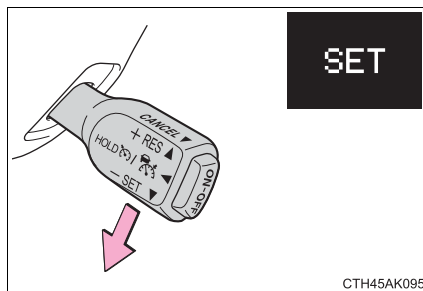

CTH45AK095

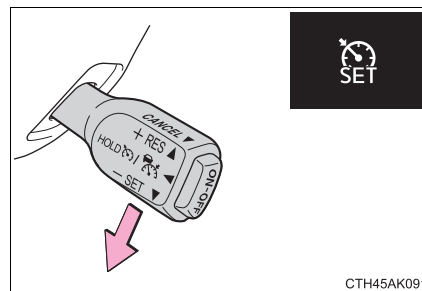

CTH45AK091

**■ Dynamic radar cruise control can be set when**

- ▶ Vehicles with a continuously variable transmission
  - The shift lever is in D or range 4 or higher of S has been selected. (vehicles without paddle shift switches)
  - The shift lever is in D. (vehicles with paddle shift switches)
  - Range 4 or higher of D has been selected by using the paddle shift switch. (vehicles with paddle shift switches)
  - Vehicle speed is at or above approximately 30 mph (50 km/h).
- ▶ Vehicles with a manual transmission
  - The shift lever is in the position 2 or higher.
  - Vehicle speed is at or above approximately 30 mph (50 km/h).

**■ Accelerating after setting the vehicle speed**

The vehicle can accelerate by operating the accelerator pedal. After accelerating, the set speed resumes. However, during vehicle-to-vehicle distance control mode, the vehicle speed may decrease below the set speed in order to maintain the distance to the preceding vehicle.

**■ Automatic cancelation of vehicle-to-vehicle distance control mode**

Vehicle-to-vehicle distance control mode is automatically canceled in the following situations:

- Actual vehicle speed falls at or below approximately 25 mph (40 km/h).
- VSC is activated.
- TRAC is activated for a period of time.
- When the VSC or TRAC system is turned off.
- The sensor cannot detect correctly because it is covered in some way.
- Pre-collision braking is activated.
- The engine speed is too high, or too low. (vehicles with a manual transmission)

If vehicle-to-vehicle distance control mode is automatically canceled for any other reason, there may be a malfunction in the system. Contact your Toyota dealer.

### ■ Automatic cancelation of constant speed control mode

Constant speed control mode is automatically canceled in the following situations:

- Actual vehicle speed is more than approximately 10 mph (16 km/h) below the set vehicle speed.
- Actual vehicle speed falls below approximately 25 mph (40 km/h).
- VSC is activated.
- TRAC is activated for a period of time.
- When the VSC or TRAC system is turned off.
- Pre-collision braking is activated.
- The engine speed is too high, or too low. (vehicles with a manual transmission)

If constant speed control mode is automatically canceled for any other reason, there may be a malfunction in the system. Contact your Toyota dealer.

### ■ Brake system operation sound

If the brakes are applied automatically while the vehicle is in vehicle-to-vehicle distance control mode, a brake system operation sound may be heard. This does not indicate a malfunction.

### ■ Warning messages and buzzers for dynamic radar cruise control

Warning messages and buzzers are used to indicate a system malfunction or to inform the driver of the need for caution while driving. If a warning message is shown on the multi-information display, read the message and follow the instructions. (→P. 489)

### ■ When the sensor may not be correctly detecting the vehicle ahead

In the case of the following and depending on the conditions, operate the brake pedal when deceleration of the system is insufficient or operate the accelerator pedal when acceleration is required.

As the sensor may not be able to correctly detect these types of vehicles, the approach warning (→P. 242) may not be activated.

- Vehicles that cut in suddenly
- Vehicles traveling at low speeds
- Vehicles that are not moving in the same lane
- Vehicles with small rear ends (trailers with no load on board, etc.)

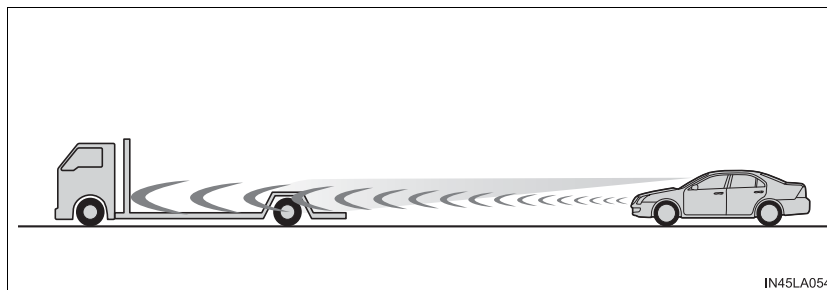

- Motorcycles traveling in the same lane

- When water or snow thrown up by the surrounding vehicles hinders the detecting of the sensor
- When your vehicle is pointing upwards (caused by a heavy load in the luggage compartment, etc.)

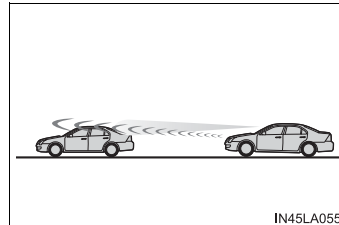

- Preceding vehicle has an extremely high ground clearance

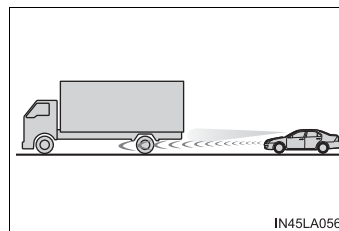

■ **Conditions under which the vehicle-to-vehicle distance control mode may not function correctly**

In the case of the following conditions, operate the brake pedal (or accelerator pedal, depending on the situation) as necessary.

As the sensor may not be able to correctly detect vehicles ahead, the system may not operate properly.

- When the road curves or when the lanes are narrow

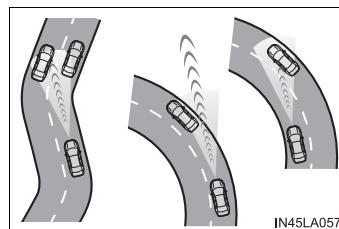

- When steering wheel operation or your position in the lane is unstable

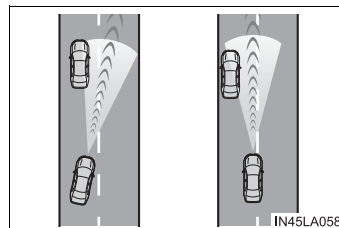

- When the vehicle ahead of you decelerates suddenly
- When driving on a road surrounded by a structure, such as in a tunnel or on a bridge
- While the vehicle speed is decreasing to the set speed after the vehicle accelerates by depressing the accelerator pedal

## Rear view monitor system

**The rear view monitor system assists the driver by displaying guide lines and an image of the view behind the vehicle while backing up, for example while parking.**

The screen illustrations used in this text are intended as examples, and may differ from the image that is actually displayed on the screen.

Vehicles without a smart key system: The rear view image is displayed when the shift position is in R and the engine switch is in the "ON" position.

Vehicles with a smart key system: The rear view image is displayed when the shift position is in R and the engine switch is in IGNITION ON mode.

The rear view monitor system will be deactivated when the shift lever is in any position other than R.

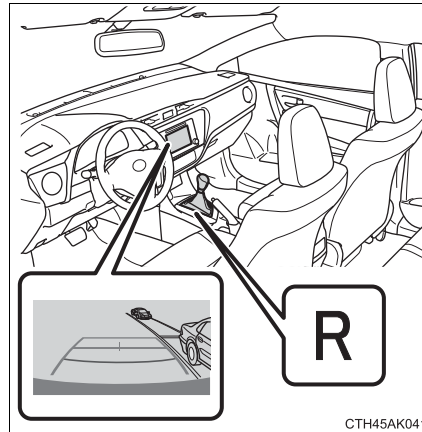

## Using the rear view monitor system

### ■ Screen description

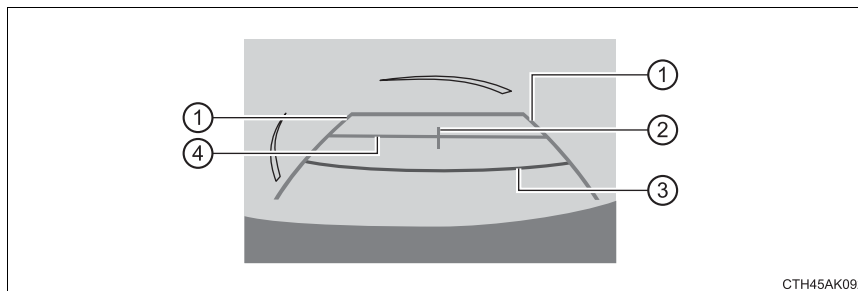

① Vehicle width guide lines

The line indicates a guide path when the vehicle is being backed straight up.  
The displayed width is wider than the actual vehicle width.

② Vehicle center guide line

The line indicates the estimated vehicle center on the ground.

③ Distance guide line

The line shows points approximately 1.5 ft. (0.5 m) (red) from the edge of the bumper.

④ Distance guide line

The line shows distance behind the vehicle, a point approximately 3 ft. (1 m) (blue) from the edge of the bumper.



### Rear view monitor system precautions

#### ■ Area displayed on screen

The rear view monitor system displays an image of the view from the bumper of the rear area of the vehicle.

To adjust the image on the rear view monitor system screen.  
(→P. 282)

- The area displayed on the screen may vary according to vehicle orientation conditions.
- Objects which are close to either corner of the bumper or under the bumper cannot be displayed.
- The camera uses a special lens. The distance of the image that appears on the screen differs from the actual distance.
- Items which are located higher than the camera may not be displayed on the monitor.

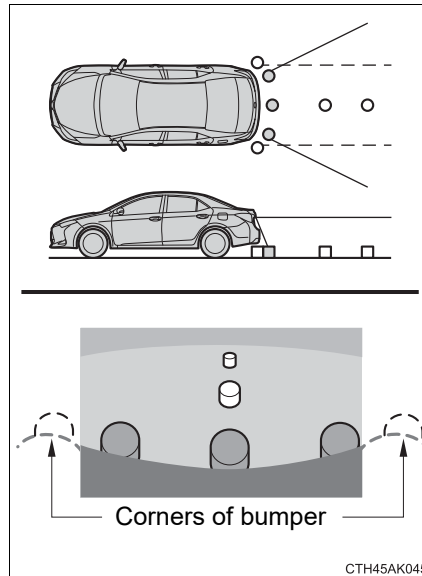

■ **Rear view monitor system camera**

The camera for the rear view monitor system is located above the license plate.

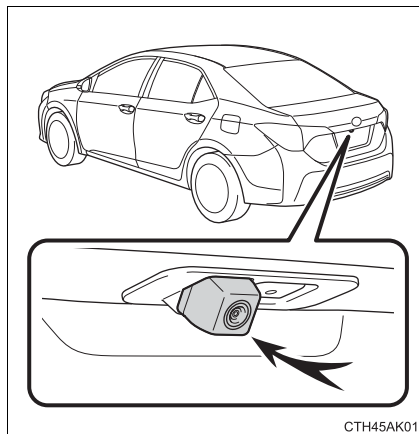

● **Using the camera**

If dirt or foreign matter (such as water droplets, snow, mud etc.) is adhering to the camera, it cannot transmit a clear image. In this case, flush it with a large quantity of water and wipe the camera lens clean with a soft and wet cloth.

■ **Differences between the screen and the actual road**

The distance guide lines and the vehicle width guide lines may not actually be parallel with the dividing lines of the parking space, even when they appear to be so. Be sure to check visually.

The distances between the vehicle width guide lines and the left and right dividing lines of the parking space may not be equal, even when they appear to be so. Be sure to check visually.

The distance guide lines give a distance guide for flat road surfaces. In any of the following situations, there is a margin of error between the fixed guide lines on the screen and the actual distance/course on the road.

- When the ground behind the vehicle slopes up sharply

The distance guide lines will appear to be closer to the vehicle than the actual distance. Because of this, objects will appear to be farther away than they actually are. In the same way, there will be a margin of error between the guidelines and the actual distance/course on the road.

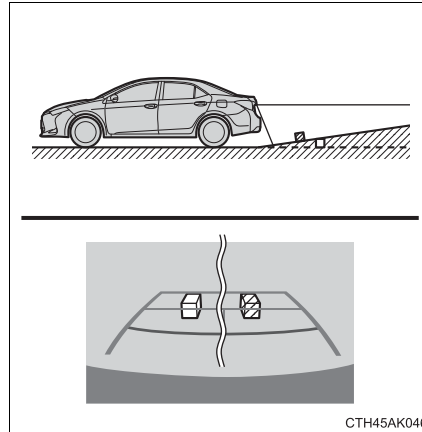

- When the ground behind the vehicle slopes down sharply

The distance guide lines will appear to be farther from the vehicle than the actual distance. Because of this, objects will appear to be closer than they actually are. In the same way, there will be a margin of error between the guidelines and the actual distance/course on the road.

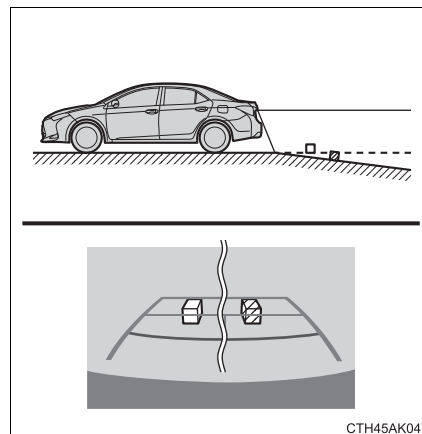

● When any part of the vehicle sags

When any part of the vehicle sags due to the number of passengers or the distribution of the load, there is a margin of error between the fixed guide lines on the screen and the actual distance/course on the road.

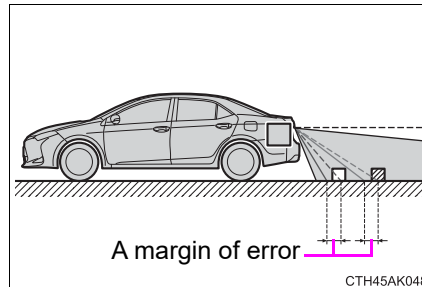

■ When approaching three-dimensional objects

The distance guide lines are displayed according to flat surfaced objects (such as the road). It is not possible to determine the position of three-dimensional objects (such as vehicles) using the vehicle width guide lines and distance guide lines. When approaching a three-dimensional object that extends outward (such as the flatbed of a truck), be careful of the following.

● Distance guide lines

Visually check the surroundings and the area behind the vehicle. On the screen, it appears that a truck is parked at point ②. However, in reality if you back up to point ①, you will hit the truck. On the screen, it appears that ① is closest and ③ is farthest away. However, in reality, the distance to ① and ③ is the same, and ② is farther than ① and ③.

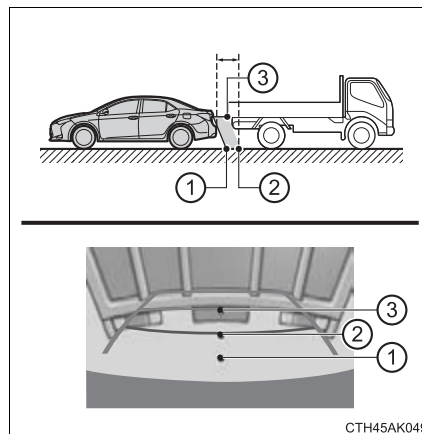

**■ Vehicle width guide lines**

Visually check the surroundings and the area behind the vehicle. In the case shown below, the truck appears to be outside of the vehicle width guide lines and the vehicle does not look as if it hits the truck. However, the rear body of the truck may actually cross over the vehicle width guide lines. In reality if you back up as guided by the vehicle width guide lines, the vehicle may hit the truck.

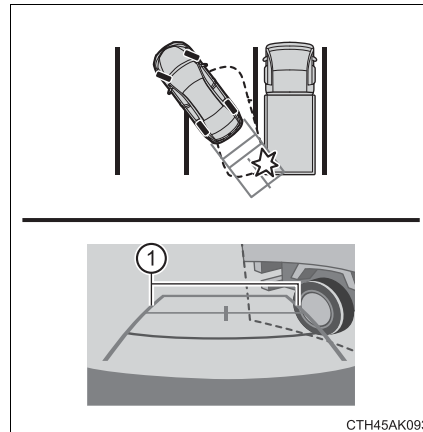
**① Vehicle width guide lines**

### Things you should know

#### ■ If you notice any symptoms

If you notice any of the following symptoms, refer to the likely cause and the solution, and re-check.

If the symptom is not resolved by the solution, have the vehicle inspected by your Toyota dealer.

Likely cause	Solution
<input type="checkbox"/> The image is difficult to see	
<ul style="list-style-type: none"> <li>• The vehicle is in a dark area</li> <li>• The temperature around the lens is either high or low</li> <li>• The outside temperature is low</li> <li>• There are water droplets on the camera</li> <li>• It is raining or humid</li> <li>• Foreign matter (mud etc.) is adhering to the camera</li> <li>• Sunlight or headlights are shining directly into the camera</li> <li>• The vehicle is under fluorescent lights, sodium lights, mercury lights etc.</li> </ul>	<p>If this happens due to these causes, it does not indicate a malfunction. Back up while visually checking the vehicle's surroundings. (Use the monitor again once conditions have been improved.)</p> <p>To adjust the image on the rear view monitor system screen. (→P. 282)</p>
<input type="checkbox"/> The image is blurry	
Dirt or foreign matter (such as water droplets, snow, mud etc.) is adhering to the camera.	Flush the camera with a large quantity of water and wipe the camera lens clean with a soft and wet cloth.
<input type="checkbox"/> The image is out of alignment	
The camera or surrounding area has received a strong impact.	Have the vehicle inspected by your Toyota dealer.
<input type="checkbox"/> The fixed guide lines are very far out of alignment	
<ul style="list-style-type: none"> <li>• The vehicle is tilted (there is a heavy load on the vehicle, tire pressure is low due to a tire puncture, etc.)</li> <li>• The vehicle is used on an incline.</li> </ul>	<p>If this happens due to these causes, it does not indicate a malfunction. Back up while visually checking the vehicle's surroundings.</p>
The camera position is out of alignment.	Have the vehicle inspected by your Toyota dealer.

 **WARNING****■ When using the rear view monitor system**

The rear view monitor system is a supplemental device intended to assist the driver when backing up. When backing up, be sure to visually check all around the vehicle both directly and using the mirrors before proceeding. If you do not, you may hit another vehicle, and could possibly cause an accident.

Pay attention to the following precautions when using the rear view monitor system.

- Never depend on the rear view monitor system entirely when backing up. The image and the position of the guide lines displayed on the screen may differ from the actual state. Use caution, just as you would when backing up any vehicle.
- Be sure to back up slowly, depressing the brake pedal to control vehicle speed.
- The instructions given are only guidelines. When and how much to turn the steering wheel will vary according to traffic conditions, road surface conditions, vehicle condition, etc. when parking. It is necessary to be fully aware of this before using the rear view monitor system.
- When parking, be sure to check that the parking space will accommodate your vehicle before maneuvering into it.
- Do not use the rear view monitor system in the following cases:
  - On icy or slick road surfaces, or in snow
  - When using tire chains or the compact spare tire
  - When the trunk lid is not closed completely
  - On roads that are not flat or straight, such as curves or slopes.
- In low temperatures, the screen may darken or the image may become faint. The image could distort when the vehicle is moving, or you may become unable to see the image on the screen. Be sure to visually check all around the vehicle both directly and using the mirrors before proceeding.
- If the tire sizes are changed, the position of the fixed guide lines displayed on the screen may change.
- The camera uses a special lens. The distances between objects and pedestrians that appear in the image displayed on the screen will differ from the actual distances. (→P. 250)

 NOTICE

■ **How to use the camera**

- The rear view monitor system may not operate properly in the following cases.
  - If the back of the vehicle is hit, the position and mounting angle of the camera may change.
  - As the camera has a water proof construction, do not detach, disassemble or modify it. This may cause incorrect operation.
  - When cleaning the camera lens, flush the camera with a large quantity of water and wipe it with a soft and wet cloth. Strongly rubbing the camera lens may cause the camera lens to be scratched and unable to transmit a clear image.
  - Do not allow organic solvent, car wax, window cleaner or glass coating to adhere to the camera. If this happens, wipe it off as soon as possible.
  - If the temperature changes rapidly, such as when hot water is poured on the vehicle in cold weather, the system may not operate normally.
  - When washing the vehicle, do not apply intensive bursts of water to the camera or camera area. Doing so may result in the camera malfunctioning.
- Do not expose the camera to strong impact as this could cause a malfunction. If this happens, have the vehicle inspected by your Toyota dealer as soon as possible.



## Driving assist systems

**To keep driving safety and performance, the following systems operate automatically in response to various driving situations. Be aware, however, that these systems are supplementary and should not be relied upon too heavily when operating the vehicle.**

### ◆ **ABS (Anti-lock Brake System)**

Helps to prevent wheel lock when the brakes are applied suddenly, or if the brakes are applied while driving on a slippery road surface

### ◆ **Brake assist**

Generates an increased level of braking force after the brake pedal is depressed when the system detects a panic stop situation

### ◆ **VSC (Vehicle Stability Control)**

Helps the driver to control skidding when swerving suddenly or turning on slippery road surfaces

### ◆ **TRAC (Traction Control)**

Helps to maintain drive power and prevent the drive wheels from spinning when starting the vehicle or accelerating on slippery roads

### ◆ **Hill-start assist control**

Helps to reduce the backward movement of the vehicle when starting on an uphill

### ◆ **EPS (Electric Power Steering)**

Employs an electric motor to reduce the amount of effort needed to turn the steering wheel

**When the TRAC/VSC systems are operating**

The slip indicator light will flash while the TRAC/VSC systems are operating.

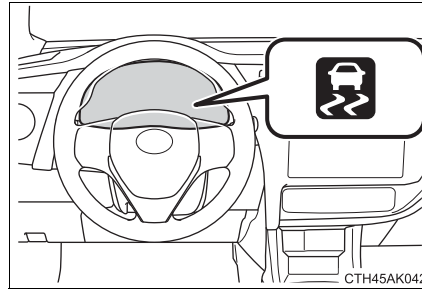

**Disabling the TRAC system**

If the vehicle gets stuck in mud, dirt or snow, the TRAC system may reduce power from the engine to the wheels. Pressing  to turn the system off may make it easier for you to rock the vehicle in order to free it.

To turn the TRAC system off, quickly press and release .

Press  again to turn the system back on.

- ▶ Vehicles with a monochrome display
- ▶ Vehicles with a color display

The "TRAC OFF" indicator light will come on.

"Traction Control Turned Off" will be shown.

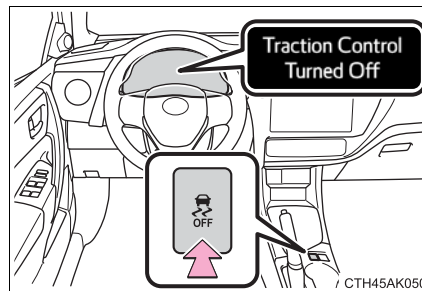
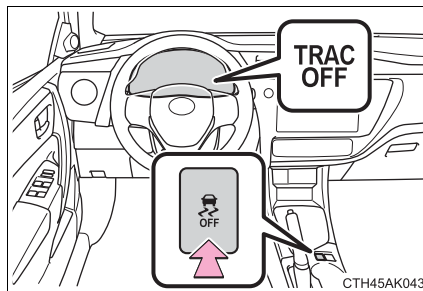

### ■ Turning off both TRAC and VSC systems

To turn the TRAC and VSC systems off, press and hold  for more than 3 seconds while the vehicle is stopped.

The “TRAC OFF” indicator light and VSC OFF indicator light will come on.\* (vehicles with a monochrome display)

“Traction Control Turned Off” will be shown and VSC OFF indicator light will come on.\* (vehicles with a color display)

Press  again to turn the systems back on.

\*: Pre-collision brake assist and pre-collision braking will also be disabled. The pre-collision system warning light will come on and the message will be shown on the multi-information display. (→P. 225)

### ■ When the “TRAC OFF” indicator light comes on even if has not been pressed (vehicles with a monochrome display)

TRAC cannot be operated. Contact your Toyota dealer.

### ■ When “Traction Control Turned Off” is shown even if has not been pressed (vehicles with a color display)

TRAC cannot be operated. Contact your Toyota dealer.

### ■ Sounds and vibrations caused by the ABS, brake assist, VSC, TRAC and hill-start assist control systems

- A sound may be heard from the engine compartment when the brake pedal is depressed repeatedly, when the engine is started or just after the vehicle begins to move. This sound does not indicate that a malfunction has occurred in any of these systems.

- Any of the following conditions may occur when the above systems are operating. None of these indicates that a malfunction has occurred.

- Vibrations may be felt through the vehicle body and steering.
- A motor sound may be heard also after the vehicle comes to a stop.
- The brake pedal may pulsate slightly after the ABS is activated.
- The brake pedal may move down slightly after the ABS is activated.

### ■ EPS operation sound

When the steering wheel is operated, a motor sound (whirring sound) may be heard. This does not indicate a malfunction.

### ■ Automatic reactivation of TRAC and VSC systems

After turning the TRAC and VSC systems off, the systems will be automatically re-enabled in the following situations:

- Vehicles without a smart key system: When the engine switch is turned to the “LOCK” position

Vehicles with a smart key system: When the engine switch is turned off

- If only the TRAC system is turned off, the TRAC will turn on when vehicle speed increases

If both the TRAC and VSC systems are turned off, automatic re-enabling will not occur when vehicle speed increases.

■ **Reduced effectiveness of the EPS system**

The effectiveness of the EPS system is reduced to prevent the system from overheating when there is frequent steering input over an extended period of time. The steering wheel may feel heavy as a result. Should this occur, refrain from excessive steering input or stop the vehicle and turn the engine off. The EPS system should return to normal within 10 minutes.

■ **Operating conditions of hill-start assist control**

When the following four conditions are met, the hill-start assist control will operate:

- Vehicles with a continuously variable transmission: The shift lever is in a position other than P or N (when starting off forward/backward on an upward incline)
- Vehicles with a manual transmission: The shift lever is in a position other than R when starting off forward on an upward incline, or the shift lever is in R when starting off backward on an upward incline.
- The vehicle is stopped
- The accelerator pedal is not depressed
- The parking brake is not engaged

■ **Automatic system cancelation of hill-start assist control**

The hill-start assist control will turn off in any of the following situations:

- Vehicles with a continuously variable transmission: The shift lever is shifted to P or N
- Vehicles with a manual transmission: The shift lever is shifted to R when starting off forward on an upward incline, or the shift lever is shifted to other than R when starting off backward on an upward incline.
- The accelerator pedal is depressed
- The parking brake is engaged
- 2 seconds at maximum elapsed after the brake pedal is released

 **WARNING****■ The ABS does not operate effectively when**

- The limits of tire gripping performance have been exceeded (such as excessively worn tires on a snow covered road).
- The vehicle hydroplanes while driving at high speed on wet or slick roads.

**■ Stopping distance when the ABS is operating may exceed that of normal conditions**

The ABS is not designed to shorten the vehicle's stopping distance. Always maintain a safe distance from the vehicle in front of you, especially in the following situations:

- When driving on dirt, gravel or snow-covered roads
- When driving with tire chains
- When driving over bumps in the road
- When driving over roads with potholes or uneven surfaces

**■ TRAC/VSC may not operate effectively when**

Directional control and power may not be achievable while driving on slippery road surfaces, even if the TRAC/VSC system is operating.

Drive the vehicle carefully in conditions where stability and power may be lost.

**■ Hill-start assist control does not operate effectively when**

- Do not overly rely on hill-start assist control. Hill-start assist control may not operate effectively on steep inclines and roads covered with ice.
- Unlike the parking brake, hill-start assist control is not intended to hold the vehicle stationary for an extended period of time. Do not attempt to use hill-start assist control to hold the vehicle on an incline, as doing so may lead to an accident.

**■ When the TRAC/VSC is activated**

The slip indicator light flashes. Always drive carefully. Reckless driving may cause an accident. Exercise particular care when the indicator light flashes.

**■ When the TRAC/VSC systems are turned off**

Be especially careful and drive at a speed appropriate to the road conditions. As these are the systems to help ensure vehicle stability and driving force, do not turn the TRAC/VSC systems off unless necessary.

 **WARNING****■ Replacing tires**

Make sure that all tires are of the specified size, brand, tread pattern and total load capacity. In addition, make sure that the tires are inflated to the recommended tire inflation pressure level.

The ABS, TRAC and VSC systems will not function correctly if different tires are installed on the vehicle.

Contact your Toyota dealer for further information when replacing tires or wheels.

**■ Handling of tires and the suspension**

Using tires with any kind of problem or modifying the suspension will affect the driving assist systems, and may cause a system to malfunction.

## Winter driving tips

**Carry out the necessary preparations and inspections before driving the vehicle in winter. Always drive the vehicle in a manner appropriate to the prevailing weather conditions.**

### Preparation for winter

- Use fluids that are appropriate to the prevailing outside temperatures.
  - Engine oil
  - Engine coolant
  - Washer fluid
- Have a service technician inspect the condition of the battery.
- Have the vehicle fitted with four snow tires or purchase a set of tire chains for the front tires.

Ensure that all tires are the same size and brand, and that chains match the size of the tires.

### Before driving the vehicle

Perform the following according to the driving conditions:

- Do not try to forcibly open a window or move a wiper that is frozen. Pour warm water over the frozen area to melt the ice. Wipe away the water immediately to prevent it from freezing.
- To ensure proper operation of the climate control system fan, remove any snow that has accumulated on the air inlet vents in front of the windshield.
- Check for and remove any excess ice or snow that may have accumulated on the exterior lights, vehicle's roof, chassis, around the tires or on the brakes.
- Remove any snow or mud from the bottom of your shoes before getting in the vehicle.

### **When driving the vehicle**

Accelerate the vehicle slowly, keep a safe distance between you and the vehicle ahead, and drive at a reduced speed suitable to road conditions.

### **When parking the vehicle**

- Park the vehicle and move the shift lever to P (continuously variable transmission), 1 or R (manual transmission) without setting the parking brake. The parking brake may freeze up, preventing it from being released. If the vehicle is parked without setting the parking brake, make sure to block the wheels.

Failure to do so may be dangerous because it may cause the vehicle to move unexpectedly, possibly leading to an accident.

- Vehicles with a continuously variable transmission: If the vehicle is parked without setting the parking brake, confirm that the shift lever cannot be moved out of P\*.

\*: The shift lever will be locked if it is attempted to be shifted from P to any other position without depressing the brake pedal. If the shift lever can be shifted from P, there may be a problem with the shift lock system. Have the vehicle inspected by your Toyota dealer immediately



### Selecting tire chains

- ▶ Vehicles with 15-inch tires

Use the tire chains of correct size and type.

Use SAE Class "S" type radial tire chains except radial cable chains or V-bar type chains.

- ▶ Vehicles with 16-inch and 17-inch tires

Use the correct tire chain size when mounting the snow chains.

Chain size is regulated for each tire size.

Side chain:

- ① 0.12 in. (3 mm) in diameter
- ② 0.39 in. (10 mm) in width
- ③ 1.18 in. (30 mm) in length

Cross chain:

- ④ 0.16 in. (4 mm) in diameter
- ⑤ 0.55 in. (14 mm) in width
- ⑥ 0.98 in. (25 mm) in length

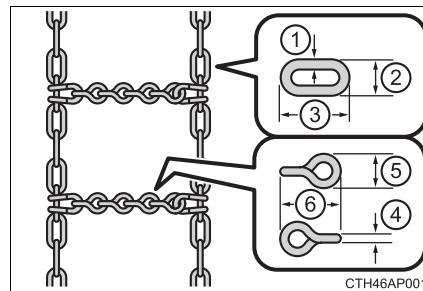

4

Driving

### Regulations on the use of tire chains

Regulations regarding the use of tire chains vary depending on location and type of road. Always check local regulations before installing chains.

#### ■ Tire chain installation

Observe the following precautions when installing and removing chains:

- Install and remove tire chains in a safe location.
- Install tire chains on the front tires. Do not install tire chains on the rear tires.
- Install tire chains on front tires as tightly as possible. Retighten chains after driving 1/4 — 1/2 mile (0.5 — 1.0 km).
- Install tire chains following the instructions provided with the tire chains.

 **WARNING****■ Driving with snow tires**

Observe the following precautions to reduce the risk of accidents. Failure to do so may result in a loss of vehicle control and cause death or serious injury.

- Use tires of the size specified.
- Maintain the recommended level of air pressure.
- Do not drive in excess of 75 mph (120 km/h), regardless of the type of snow tires being used.
- Use snow tires on all, not just some wheels.

**■ Driving with tire chains**

Observe the following precautions to reduce the risk of accidents. Failure to do so may result in the vehicle being unable to be driven safely, and may cause death or serious injury.

- Do not drive in excess of the speed limit specified for the tire chains being used, or 30 mph (50 km/h), whichever is lower.
- Avoid driving on bumpy road surfaces or over potholes.
- Avoid sudden acceleration, abrupt steering, sudden braking and shifting operations that cause sudden engine braking.
- Slow down sufficiently before entering a curve to ensure that vehicle control is maintained.
- Do not use LDA (Lane Departure Alert with steering control) system.

 **NOTICE****■ Repairing or replacing snow tires (vehicles with a tire pressure warning system)**

Request repairs or replacement of snow tires from Toyota dealers or legitimate tire retailers.

This is because the removal and attachment of snow tires affects the operation of the tire pressure warning valves and transmitters.

**■ Fitting tire chains (vehicles with a tire pressure warning system)**

The tire pressure warning valves and transmitters may not function correctly when tire chains are fitted.



<b>5-1. Basic Operations</b>	
Audio system types.....	270
Steering wheel audio switches .....	271
AUX port/USB port.....	272
Entune Audio .....	273
Basic audio operations.....	276
<b>5-2. Setup</b>	
Setup menu.....	278
General settings.....	279
Audio settings .....	281
Display settings.....	282
Voice settings.....	283
<b>5-3. Using Entune Audio</b>	
Selecting the audio source .....	284
List screen operation.....	285
Optimal use of Entune Audio .....	287
<b>5-4. Using the radio</b>	
Radio operation.....	288
<b>5-5. Playing an audio CD and MP3/WMA/AAC discs</b>	
CD player operation .....	290

## Audio system

# 5

- 5-6. Using an external device**
  - Listening to an iPod ..... 296
  - Listening to a USB memory device..... 301
  - Using the AUX port ..... 305
- 5-7. Connecting Bluetooth®**
  - Preparations to use wireless communication..... 306
  - Registering a Bluetooth® audio player for the first time ..... 310
  - Registering a Bluetooth® phone for the first time .... 311
  - Registering a Bluetooth® device..... 312
  - Connecting a Bluetooth® device..... 315
  - Displaying a Bluetooth® device details ..... 318
  - Detailed Bluetooth® system settings ..... 319
- 5-8. Bluetooth® Audio**
  - Listening to Bluetooth® Audio..... 320
- 5-9. Bluetooth® phone**
  - Using a Bluetooth® Phone ..... 322
  - Making a call ..... 325
  - Receiving a call ..... 328
  - Speaking on the phone .... 329
  - Bluetooth® phone message function..... 333
  - Using the steering wheel switches ..... 338
  - Bluetooth® phone settings ..... 339
  - Contact/Call History Settings ..... 341
  - What to do if... (Troubleshooting)..... 351
- 5-10. Bluetooth®**
  - Bluetooth® ..... 355
- 5-11. Using the voice command system**
  - Voice command system.... 359

## Audio system types

- ▶ Entune Audio

→P. 273

- ▶ Entune Audio Plus or Entune Premium Audio

Refer to the “NAVIGATION AND MULTIMEDIA SYSTEM OWNER’S MANUAL”.

## Steering wheel audio switches

Some audio features can be controlled using the switches on the steering wheel.

Operation may differ depending on the type of audio system or navigation system. For details, refer to the manual provided with the audio system or navigation system.

### Operating the audio system using the steering wheel switches

#### ► Type A

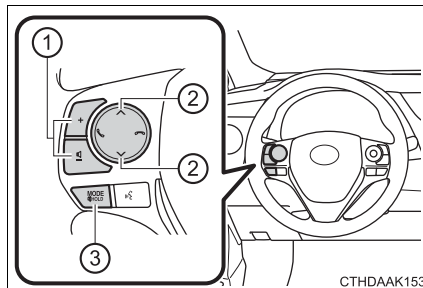

#### ► Type B

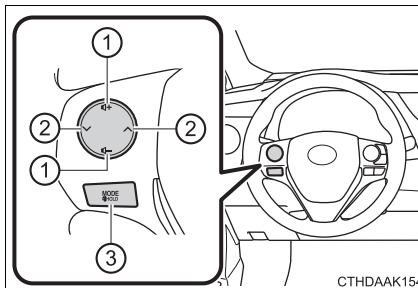

- ① Volume switch
  - Increases/decreases volume
  - Press and hold: Continuously increases/decreases volume
- ② Cursor switch
  - Selects (radio stations/radio presets/tracks/files/songs)
  - Moves cursor
  - Press and hold: Seeks up/down (radio stations)
  - Fast up/down (tracks/files)
- ③ “MODE/HOLD” switch:
  - Changes audio source
  - Press and hold: Mutes or pauses the current operation.  
To cancel the mute or pause, press and hold again.

#### WARNING

#### To reduce the risk of an accident

Exercise care when operating the audio switches on the steering wheel.

## AUX port/USB port

Connect an iPod, USB memory device or portable audio player to the AUX port/USB port as indicated below. Select “iPod”, “USB” or “AUX” on the audio source selection screen and the device can be operated via audio system.

### Connecting using the AUX port/USB port

#### ■ iPod

Open the cover and connect an iPod using an iPod cable.

Turn on the power of the iPod if it is not turned on.

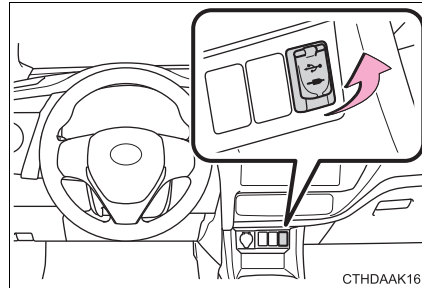

#### ■ USB memory

Open the cover and connect a USB memory device.

Turn on the power of the USB memory device if it is not turned on.

#### ■ Portable audio player

Open the cover and connect a portable audio player.

Turn on the power of the portable audio player if it is not turned on.

#### ■ AUX port

The AUX port only supports audio input.

#### ⚠ WARNING

#### ■ While driving

Do not connect a device or operate the device controls.



## Entune Audio\*

- ▶ With an Entune Audio

**Operations such as listening to audio, using the hands-free phone and changing Entune Audio settings are started by using the following buttons.**

- ▶ With an Entune Audio Plus

**Owners of this system should refer to the “NAVIGATION AND MULTIMEDIA SYSTEM OWNER'S MANUAL”.**

### Entune Audio operation buttons

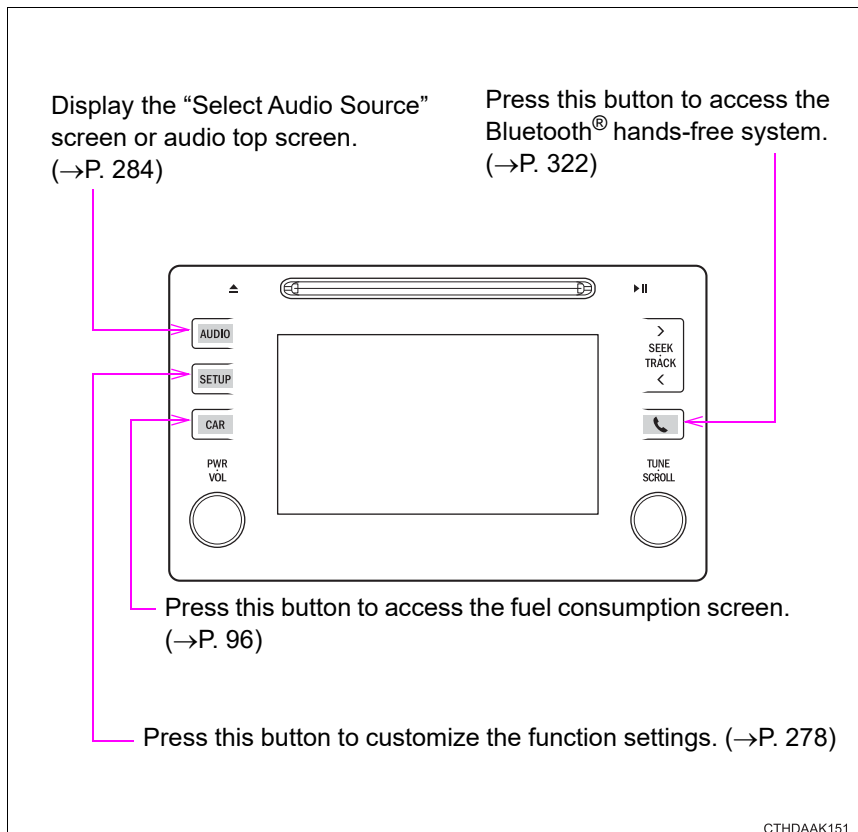

5

Audio system

\*: If equipped

### Operating the touch screen

By touching the screen with your finger, you can control Entune Audio, etc.

#### ■ Drag\*

Touch the screen with your finger, and move the screen to the desired position.

- Scrolling the lists

#### ■ Flick\*

Touch the screen with your finger and quickly move the screen by flicking your finger.

- Scrolling the main screen page

\*: The above operations may not be performed on all screens.

### ■ Capacitive touch switches

The control panel uses capacitive touch sensors.

- In the following cases, incorrect operation or non-response may occur.
  - If the operating section is dirty or has liquid attached to it, incorrect operation or non-response may occur.
  - If the operating section receives electromagnetic waves, incorrect operation or non-response may occur.
  - If wearing gloves during operation, non-response may occur.
  - If fingernails are used to operate the system, non-response may occur.
  - If a touch pen is used to operate the system, non-response may occur.
  - If the palm of your hand touches the operating section during operation, incorrect operation may occur.
  - If the palm of your hand touches the operating section, incorrect operation may occur.
  - If operations are performed quickly, non-response may occur.
- Please do not reach your hand to the part of button when Entune Audio turn on. Because the button may become unresponsive for a while. But it will be back to normal for a given time even if Entune Audio turned on under the condition.

### ■ When using the touch screen

- If the screen is cold, the display may be dark, or the system may seem to be operating slightly slower than normal.
- The screen may seem dark and hard to see when viewed through sunglasses. Change your angle of viewing, adjust the display on the "Display Settings" screen (→P. 282) or remove your sunglasses.
- Flick operations may not be performed smoothly in high altitudes.

 NOTICE**■ To avoid damaging the touch screen**

- To prevent damaging the screen, lightly touch the screen buttons with your finger.
- Do not use objects other than your finger to touch the screen.
- Wipe off fingerprints using a glass cleaning cloth. Do not use chemical cleaners to clean the screen, as they may damage the touch screen.

## Basic audio operations

Basic audio operations and functions common to each mode are explained in this section.

### Operating Entune Audio

Press this button to eject a disc

Insert a disc into the disc slot

Press the ">" or "<" button to seek up or down for a radio station, or to access a desired track or file.

Press to pause or resume playing music.

Press this knob to turn Entune Audio on and off, and turn it to adjust the volume.

Turn this knob to select radio station bands, tracks and files. Also the knob can be used to select items in the list display.

|| :Select to pause music.

▶ :Select to resume playing music.

CTHDAAK152US

The diagram shows a car's audio control panel. At the top left is an eject button. Below it are buttons for AUDIO, SETUP, and CAR. A volume knob is on the left. The central display shows 'CD' and 'Track 1' with a progress bar. To the right of the display are 'SEEK TRACK' buttons with '>' and '<' symbols, and a 'TUNE SCROLL' knob. A power button is also visible on the right side of the panel.

### Random playback

Select **RAND** to change on/off.

### Repeat play

Select **RPT** to change on/off.

### Using cellular phones

Interference may be heard through Entune Audio's speakers if a cellular phone is being used inside or close to the vehicle while Entune Audio is operating.

### WARNING

#### ■ Laser product

This product is a class 1 laser product.

Do not open the cover of the player or attempt to repair the unit yourself. Refer servicing to qualified personnel.

#### ● Laser products

- Do not take this unit apart or attempt to make any changes yourself. This is an intricate unit that uses a laser pickup to retrieve information from the surface of compact discs. The laser is carefully shielded so that its rays remain inside the cabinet. Therefore, never try to disassemble the player or alter any of its parts since you may be exposed to laser rays and dangerous voltages.
- This product utilizes a laser. Use of controls or adjustments or performance of procedures other than those specified herein may result in hazardous radiation exposure. **THE USE OF OPTICAL INSTRUMENTS WITH THIS PRODUCT WILL INCREASE EYE HAZARD.**

### NOTICE

#### ■ To prevent battery discharge

Do not leave Entune Audio on longer than necessary when the engine is off.

#### ■ To avoid damaging Entune Audio

Take care not to spill drinks or other fluids on Entune Audio.

## Setup menu

You can adjust Entune Audio to your desired settings.

### Display “Setup” screen

Press the “SETUP” button to display the “Setup” screen.

- ① Select to adjust the settings for operation sounds, screen animation, etc. (→P. 279)
- ② Select to set the voice settings. (→P. 283)
- ③ Select to adjust the settings for contrast and brightness of the screen. (→P. 282)
- ④ Select to adjust the settings for registering, removing, connecting and disconnecting Bluetooth® devices. (→P. 319)
- ⑤ Select to adjust the settings for phone sound, contact, etc. (→P. 341)
- ⑥ Select to set audio settings. (→P. 281)
- ⑦ Select to turn the screen off.
- ⑧ Select to set the vehicle customization (→P. 564).

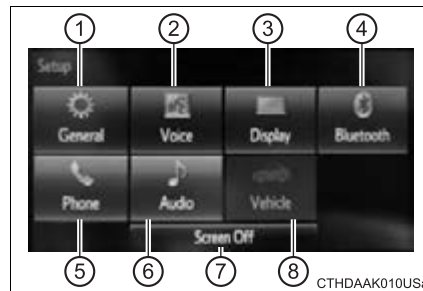

## General settings

Settings are available for adjusting the operation sounds, screen animation, etc.

### Screen for general settings

- 1 Press the “SETUP” button.
- 2 Select “General” on the “Setup” screen.
  - ① “English”, “Français” or “Español” can be selected.
  - ② On/off can be selected to sound beeps.
  - ③ Select to change the screen color.
  - ④ Select to change the keyboard layout.
  - ⑤ Select to change the capacitive touch button sensor sensitivity.
  - ⑥ The animation effect for the screen can be set to on/off.
  - ⑦ Select to delete personal data (→P. 280)
  - ⑧ Select to update program versions. For details, contact your Toyota dealer.
  - ⑨ Select to display the software information. Notices related to third party software used in this product are enlisted. (This includes instructions for obtaining such software, where applicable.)

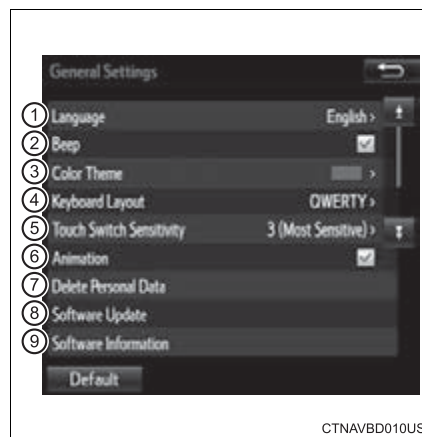

5

Audio system

#### ■ To return to the default volume settings

Select “Default”, and then “Yes”.

### **Delete personal data**

1 Select "Delete Personal Data" on the "General Settings" screen.

2 Select "Delete".

Check carefully beforehand, as data cannot be retrieved once deleted.

3 A confirmation screen will be displayed. Select "Yes".

The following personal data will be deleted or changed to its default settings.

- General settings
- Audio settings
- Phone settings



## Audio settings

Settings are available for adjusting the radio operation, cover art, etc.

### Screen for audio settings

- 1 Press the "SETUP" button.
- 2 Select "Audio" on the "Setup" screen.
  - ① Number of Radio Presets  
Select the number of radio preset stations.
  - ② Display Cover Art on/off
  - ③ Automatic Sound Levelizer



### Automatic sound leveliser (ASL)

- 1 Select "Automatic Sound Levelizer".
- 2 Select "High", "Mid", "Low" or "Off".

#### ■ About Automatic Sound Leveliser (ASL)

ASL automatically adjusts the volume and tone quality according to the vehicle speed.

## Display settings

**Settings are available for adjusting the contrast and brightness of the screen.**

### Screen for display settings

- 1 Press the “SETUP” button.
- 2 Select “Display” on the “Setup” screen.
  - ① Adjust screen contrast/brightness
  - ② Adjust screen contrast/brightness of the rear view monitor camera
  - ③ Changes to day mode.

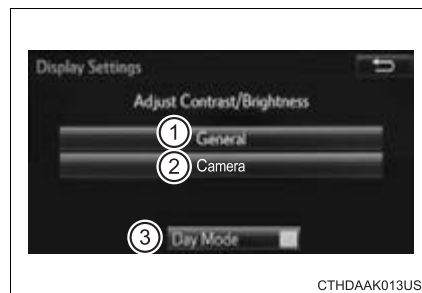

### Adjusting the screen contrast/brightness

- 1 Select “General” on the “Display Settings” screen.
- 2 Adjust the display as desired by selecting “+” or “-”.

### Day mode

When the headlights are turned on, the screen dims. However, the screen can be switched to day mode by selecting “Day Mode”.

The screen will stay in day mode when the headlights are turned on until “Day Mode” is selected again.

## Voice settings

**This screen is used for guidance for voice command systems setting.**

- ① Adjust the voice guidance volume setting.
- ② Set the voice recognition prompts “High”, “Low” or “Off”.
- ③ Set the train voice recognition.
- ④ Set the voice prompt interrupt on/off.
- ⑤ Set the voice recognition tutorial.



### ■ To return to the default volume settings

Select “Default”, and then “Yes”.

## Selecting the audio source



Switching between audio sources such as radio and CD are explained in this section.

### Changing audio source

- 1 Press the “AUDIO” button to display the audio source selection screen.

If the audio source selection screen is not displayed, press the “AUDIO” button again.

- 2 Select the desired audio source.

- 1 Select the desired audio source then  or  to reorder.





### Using the steering wheel switches to change audio source



The audio source changes as follows each time the “MODE/HOLD” switch is pressed.

## List screen operation

**When a list screen is displayed, use the appropriate buttons to scroll through the list.**

### How to scroll

 : Select to scroll to the next or previous page.

: If  appears to the right of titles, the complete titles are too long for the display. Select this button to scroll the title.

Turn the “TUNE·SCROLL” knob to move the cursor box to select a desired item from the list, and press the “TUNE·SCROLL” knob to play it. The track that is being played is highlighted.

To return to the top screen, select “Now Playing” on the list screen.



**Selecting, fast-forwarding and reversing tracks/files/songs**

■ **Selecting a track/file/song**

Press the “>” or “<” button on “SEEK·TRACK” or turn the “TUNE·SCROLL” knob to select the desired track/file/song number.

To fast-forward or reverse, press and hold the “>” or “<” button on “SEEK·TRACK”.

■ **Selecting a track/file/song from the track/file/song list**

- 1 Select “Browse” or cover art.
- 2 Select the desired track/file/song.



When an MP3/WMA/AAC disc or USB memory device is being used, the folder can be selected. When a Bluetooth® device or iPod is being used, the album can be selected.

According to the audio device, the following is displayed.

Audio source	List name
Audio CD	Track
MP3/WMA/AAC disc	Folder, File
Bluetooth®	Album, Track
USB	Artists, Albums, Songs, Genres, Composers
iPod	Artists, Albums, Songs, Genres, Composers, Audiobooks, Videos

## Optimal use of Entune Audio

On the “Sound Settings” screen, sound quality (Treble/Mid/Bass), volume balance can be adjusted.

### How to adjust the sound settings and sound quality

- ① ② ③ Select “-” or “+” to adjust the treble, mid or bass to a level between -5 and 5.
- ④ ⑤ Select “Front” or “Rear” to adjust the front/rear audio balance.
- ⑥ ⑦ Select “L” or “R” to adjust the left/right audio balance.

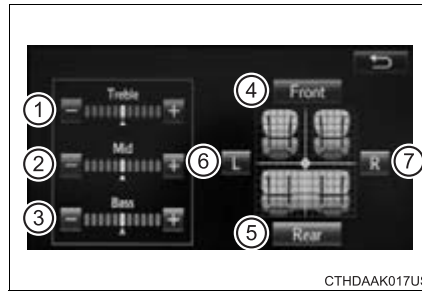

#### ■ The sound quality level is adjusted individually

The treble, mid and bass levels can be adjusted for each audio mode separately.

## Radio operation

Select “AM” or “FM” on the audio source selection screen to begin listening to the radio.

### Audio control screen

Pressing the “AUDIO” button displays the audio control screen from any screens of the selected source.

- ① Audio source selection screen appears
- ② Preset stations
- ③ Select to display RBDS text messages\*
- ④ Scanning for receivable station
- ⑤ Select to display a list of receivable stations
- ⑥ Setting the sound (→P. 287)

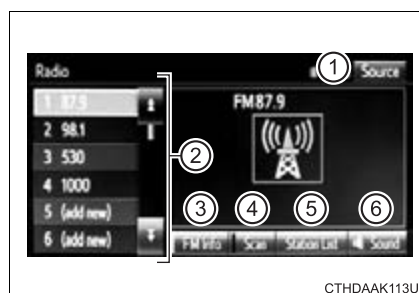

CTHDAAK113US

\*: FM only

### Selecting a station

Tune in to the desired station using one of the following methods.

#### ■ Seek tuning

Press the “>” or “<” button on “SEEK·TRACK”.

The radio will begin seeking up or down for a station of the nearest frequency and will stop when a station is found.

#### ■ Manual tuning

Turn the “TUNE·SCROLL” knob.

#### ■ Preset stations

Select the desired preset station.



---

**Setting station presets**

- 1 Search for desired stations by turning the “TUNE·SCROLL” knob or pressing the “>” or “<” button on “SEEK·TRACK”.
- 2 Select “(add new)”.  
To change the preset station to a different one, select and hold the preset station.
- 3 Select “Yes”.
- 4 Select “OK” after setting the new preset station.

**■ Refreshing the station list**

- 1 Select “Refresh” on the “Station List” screen.  
To cancel the refresh, select “Cancel Refresh”.

---

**■ Reception sensitivity**

- Maintaining perfect radio reception at all times is difficult due to the continually changing position of the antenna, differences in signal strength and surrounding objects, such as trains, transmitters, etc.
- The radio antenna is mounted inside the rear window. To maintain clear radio reception, do not attach metallic window tinting or other metallic objects to the antenna wire mounted inside the rear window.

## CD player operation

**Insert disc or select “CD” on the audio source selection screen with a disc inserted to begin listening to a CD.**

### Audio control screen

Pressing the “AUDIO” button displays the audio control screen from any screens of the selected source.

- ① Audio source selection screen appears
- ② Displaying the track/file list  
MP3/WMA/AAC: Displaying the folder list
- ③ Random playback (→P. 277)
- ④ Repeat play (→P. 277)
- ⑤ Pause  
Select  to resume play
- ⑥ Setting the sound (→P. 287)



CTHDAAK019US

### ■ Displaying the title and artist name

If a CD-TEXT disc is inserted, the title of the disc and track will be displayed.

### ■ Error messages

If an error message is displayed, refer to the following table and take the appropriate measures. If the problem is not rectified, take the vehicle to your Toyota dealer.

Message	Cause	Correction procedures
"Check DISC"	<ul style="list-style-type: none"> <li>• The disc is dirty or damaged.</li> <li>• The disc is inserted upside down.</li> <li>• The disc is not playable with the player.</li> </ul>	<ul style="list-style-type: none"> <li>• Clean the disc.</li> <li>• Insert the disc correctly.</li> <li>• Confirm the disc is playable with the player.</li> </ul>
"Disc Error"	There is a malfunction within the system.	Eject the disc.
"No music files found."	No playable data is included on the disc.	Eject the disc.

### ■ Discs that can be used

Discs with the marks shown below can be used.

Playback may not be possible depending on recording format or disc features, or due to scratches, dirt or deterioration.



CDs with copy-protection features may not play correctly.

### ■ CD player protection feature

To protect the internal components, playback is automatically stopped when a problem is detected.

### ■ If a disc is left inside the CD player or in the ejected position for extended periods

Disc may be damaged and may not play properly.

### ■ Lens cleaners

Do not use lens cleaners. Doing so may damage the CD player.

**■ MP3, WMA and AAC files**

MP3 (MPEG Audio LAYER3) is a standard audio compression format.

Files can be compressed to approximately 1/10 of their original size by using MP3 compression.

WMA (Windows Media Audio) is a Microsoft audio compression format.

This format compresses audio data to a size smaller than that of the MP3 format.

AAC is short for Advanced Audio Coding and refers to an audio compression technology standard used with MPEG2 and MPEG4.

MP3, WMA and AAC file and media/formats compatibility are limited.

**● MP3 file compatibility**

- Compatible standards  
MP3 (MPEG1 LAYER3, MPEG2 LSF LAYER3)
- Compatible sampling frequencies  
MPEG1 LAYER3: 32, 44.1, 48 (kHz)  
MPEG2 LSF LAYER3: 16, 22.05, 24 (kHz)
- Compatible bit rates (compatible with VBR)  
MPEG1 LAYER3: 32-320 (kbps)  
MPEG2 LSF LAYER3: 8-160 (kbps)
- Compatible channel modes: stereo, joint stereo, dual channel and monaural

**● WMA file compatibility**

- Compatible standards  
WMA Ver. 7, 8, 9
- Compatible sampling frequencies  
32, 44.1, 48 (kHz)
- Compatible bit rates (only compatible with 2-channel playback)  
Ver. 7, 8: CBR 48-192 (kbps)  
Ver. 9: CBR 48-320 (kbps)

- AAC file compatibility
  - Compatible standards  
MPEG4/AAC-LC
  - Compatible sampling frequencies  
11.025/12/16/22.05/24/32/44.1/48 (kHz)
  - Compatible bit rates  
16-320 (kbps)Compatible channel modes: 1ch and 2ch
- Compatible media

Media that can be used for MP3, WMA and AAC playback are CD-Rs and CD-RWs.

Playback in some instances may not be possible if the CD-R or CD-RW is not finalized. Playback may not be possible or the audio may jump if the disc is scratched or marked with fingerprints.
- Compatible disc formats

The following disc formats can be used.

  - Disc formats: CD-ROM Mode 1 and Mode 2  
CD-ROM XA Mode 2, Form 1 and Form 2
  - File formats: ISO9660 Level 1, Level 2, (Romeo, Joliet)  
UDF (2.01 or lower)

MP3, WMA and AAC files written in any format other than those listed above may not play correctly, and their file names and folder names may not be displayed correctly.

Items related to standards and limitations are as follows.

  - Maximum directory hierarchy: 8 levels (including the root)
  - Maximum length of folder names/file names: 32 characters
  - Maximum number of folders: 192 (including the root)
  - Maximum number of files per disc: 255
- File names

The only files that can be recognized as MP3/WMA/AAC and played are those with the extension .mp3, .wma or .m4a.
- Discs containing multi-session recordings

As Entune Audio is compatible with multi session discs, it is possible to play discs that contain MP3, WMA and AAC files. However, only the first session can be played.

- ID3, WMA and AAC tags

ID3 tags can be added to MP3 files, making it possible to record the track title, artist name, etc.

The system is compatible with ID3 Ver. 1.0, 1.1, and Ver. 2.2, 2.3 ID3 tags. (The number of characters is based on ID3 Ver. 1.0 and 1.1.)

WMA tags can be added to WMA files, making it possible to record the track title and artist name in the same way as with ID3 tags.

AAC tags can be added to AAC files, making it possible to record the track title and artist name in the same way as with ID3 tags.

- MP3, WMA and AAC playback

When a disc containing MP3, WMA or AAC files is inserted, all files on the disc are first checked. Once the file check is finished, the first MP3, WMA or AAC file is played. To make the file check finish more quickly, we recommend you do not write any files to the disc other than MP3, WMA or AAC files or create any unnecessary folders.

Discs that contain a mixture of music data and MP3, WMA or AAC format data cannot be played.

- Extensions

If the file extensions .mp3, .wma and .m4a are used for files other than MP3, WMA and AAC files, they may be mistakenly recognized and played as MP3, WMA and AAC files. This may result in large amounts of interference and damage to the speakers.

- Playback

- To play MP3 files with steady sound quality, we recommend a fixed bit rate of at least 128 kbps and a sampling frequency of 44.1 kHz.
- CD-R or CD-RW playback may not be possible in some instances, depending on the characteristics of the disc.
- There is a wide variety of freeware and other encoding software for MP3, WMA and AAC files on the market, and depending on the status of the encoding and the file format, poor sound quality or noise at the start of playback may result. In some cases, playback may not be possible at all.
- When files other than MP3, WMA or AAC files are recorded on a disc, it may take more time to recognize the disc and in some cases, playback may not be possible at all.
- Microsoft, Windows, and Windows Media are the registered trademarks of Microsoft Corporation in the U.S.A. and other countries.

 NOTICE

■ **Discs and adapters that cannot be used**

Do not use the following types of CDs.

Also, do not use 3 in. (8 cm) CD adapters, Dual Discs or printable discs.

Doing so may damage the CD player and/or the CD insert/eject function.

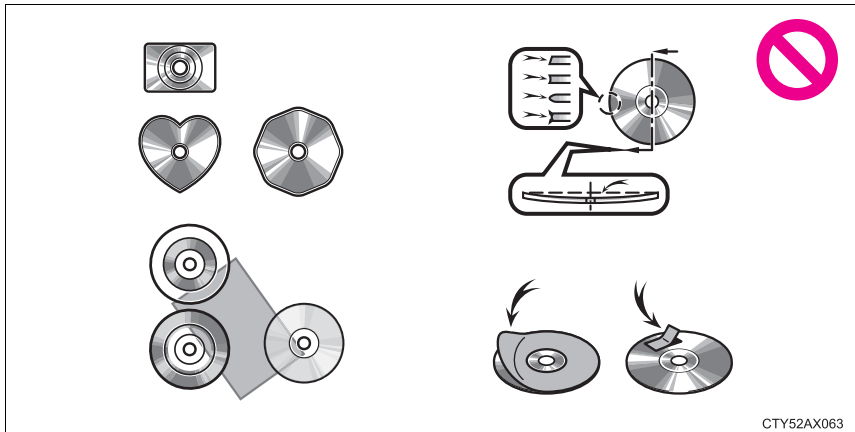

- Discs that have a diameter that is not 4.7 in. (12 cm).
- Low-quality or deformed discs.
- Discs with a transparent or translucent recording area.
- Discs that have tape, stickers or CD-R labels attached to them, or that have had the label peeled off.

■ **Player precautions**

Failure to follow the precautions below may result in damage to the discs or the player itself.

- Do not insert anything other than discs into the disc slot.
- Do not apply oil to the player.
- Store discs away from direct sunlight.
- Never try to disassemble any part of the player.

## Listening to an iPod

**Connecting an iPod enables you to enjoy music from the vehicle speakers.**

**Select “iPod” on the audio source selection screen.**

**When the iPod connected to the system includes iPod video, the system can only output the sound by selecting the browse screen.**

### Connecting an iPod

→P. 272

### Audio control screen

Pressing the “AUDIO” button displays the audio control screen from any screens of the selected source.

- ① Audio source selection screen appears
- ② Displays cover art
- ③ Selecting the play mode
- ④ Shuffle play
- ⑤ Repeat play
- ⑥ Pause  
Select  to resume playback
- ⑦ Setting the sound (→P. 287)

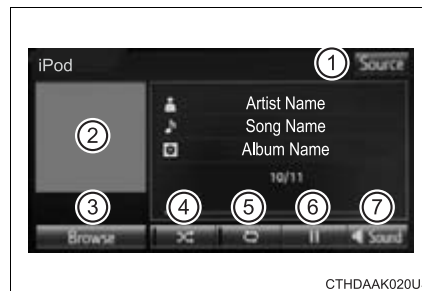

CTHDAAK020US



**Selecting a play mode**

- 1 Select "Browse" on the screen.
- 2 Select the desired play mode. Then select a song to begin using the selected play mode.

**Shuffle play**

Select  to change on/off.

**Repeat play**

Select  to change on/off.

---

**■ About iPod**

- "Made for iPod", "Made for iPhone" and "Made for iPad" mean that an electronic accessory has been designed to connect specifically to iPod or iPhone, or iPad, respectively, and has been certified by the developer to meet Apple performance standards.
- Apple is not responsible for the operation of this device or its compliance with safety and regulatory standards. Please note that the use of this accessory with iPod, iPhone or iPad may affect wireless performance.
- iPad, iPhone, iPod, iPod classic, iPod nano, and iPod touch are trademarks of Apple Inc., registered in the U.S. and other countries. Lightning is a trademark of Apple Inc.

**■ iPod cover art**

- Depending on the iPod and songs in the iPod, iPod cover art may be displayed.
- This function can be changed to on/off. (→P. 281)
- It may take time to display iPod cover art, and the iPod may not be operated while the cover art display is in process.
- Only iPod cover art that is saved in JPEG format can be displayed.

**■ iPod functions**

- When an iPod is connected and the audio source is changed to iPod mode, the iPod will resume play from the same point in which it was last used.
- Depending on the iPod that is connected to the system, certain functions may not be available. If a function is unavailable due to a malfunction (as opposed to a system specification), disconnecting the device and reconnecting it may resolve the problem.
- While connected to the system, the iPod cannot be operated with its own controls. It is necessary to use the controls of the vehicle's Entune Audio instead.
- When the battery level of an iPod is very low, the iPod may not operate. If so, charge the iPod before use.
- Compatible models (→P. 300)

### ■ iPod problems

To resolve most problems encountered when using your iPod, disconnect your iPod from the vehicle iPod connection and reset it. For instructions on how to reset your iPod, refer to your iPod Owner's Manual.

### ■ Error messages

Message	Cause/Correction procedures
"Connection error. Please consult your Owner's Manual for instructions on how to connect the iPod."	This indicates a problem in the iPod or its connection.
"No music files found."	This indicates that there is no music data in the iPod.
"No videos found."	This indicates that no video files are included in the iPod.
"There are no songs available for playback. Please add compatible files to your iPod."	This indicates that songs are not found in a selected playlist.
"iPod authorization unsuccessful."	This indicates that the display Entune Audio failed to authorize the iPod. Please check your iPod.

**Compatible models**

The following iPod®, iPod nano®, iPod classic®, iPod touch® and iPhone® devices can be used with this system.

**Made for**

- iPod touch (5th generation)
- iPod touch (4th generation)
- iPod touch (3rd generation)
- iPod touch (2nd generation)
- iPod touch (1st generation)
- iPod classic
- iPod with video
- iPod nano (7th generation)
- iPod nano (6th generation)
- iPod nano (5th generation)
- iPod nano (4th generation)
- iPod nano (3rd generation)
- iPod nano (2nd generation)
- iPod nano (1st generation)
- iPhone 5s
- iPhone 5c
- iPhone 5
- iPhone 4S
- iPhone 4
- iPhone 3GS
- iPhone 3G
- iPhone

This system only supports audio playback.

Depending on differences between models or software versions etc., some models might be incompatible with this system.

**⚠ WARNING****■ While driving**

Do not connect an iPod or operate the controls.

**⚠ NOTICE****■ To prevent damage to the iPod or its terminals**

- Do not leave the iPod in the vehicle. The temperature inside the vehicle may become high, resulting in damage to the iPod.
- Do not push down on or apply unnecessary pressure to the iPod while it is connected.
- Do not insert foreign objects into the port.

## Listening to a USB memory device

Connecting a USB memory device enables you to enjoy music from the vehicle speakers.

Touch “USB” on the audio source selection screen.

### Connecting a USB memory device

→P. 272

### Audio control screen

Pressing the “AUDIO” button displays the audio control screen from any screens of the selected source.

- ① Audio source selection screen appears
- ② Displaying the folder list
- ③ Random playback (→P. 277)
- ④ Repeat play (→P. 277)
- ⑤ Pause  
Select  to resume playback
- ⑥ Setting the sound (→P. 287)

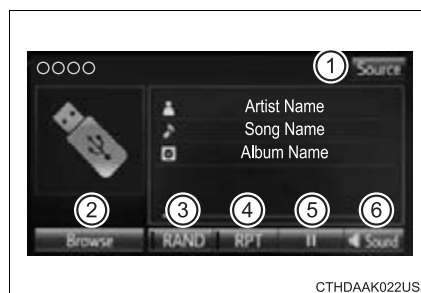

5

Audio system

### Selecting a play mode

- 1 Select “Browse” on the screen.
- 2 Select the desired play mode. Then select a song to begin using the selected play mode.

#### ■ Displaying the now playing list

Touch the cover art display.

■ **USB memory functions**

- Depending on the USB memory device that is connected to the system, the device itself may not be operable and certain functions may not be available. If the device is inoperable or a function is unavailable due to a malfunction (as opposed to a system specification), disconnecting the device and reconnecting it may resolve the problem.
- If the USB memory device still does not begin operation after being disconnected and reconnected, format the memory.

■ **Error messages for USB memory**

Message	Cause/Correction procedures
“Connection error. Please consult your Owner’s Manual for instructions on how to connect the USB device.”	This indicates a problem with the USB memory device or its connection.
“No music files found.”	This indicates that no MP3/WMA/AAC files are included on the USB memory device.

■ **USB memory**

- **Compatible devices**  
USB memory device that can be used for MP3, WMA and AAC playback.
- **Compatible device formats**  
The following device format can be used:
  - USB communication format: USB2.0 HS (Mbps) and FS (12 Mbps)
  - File system format: FAT16/32 (Windows)
  - Correspondence class: Mass storage class
 MP3, WMA and AAC files written to a device with any format other than those listed above may not play correctly, and their file names and folder names may not be displayed correctly.  
 Items related to standards and limitations are as follows:
  - Maximum directory hierarchy: 8 levels
  - Maximum number of folders in a device: 3000 (including the root)
  - Maximum number of files in a device: 9999
  - Maximum number of files per folder: 255
- **MP3, WMA and AAC files**  
 MP3 (MPEG Audio LAYER 3) is a standard audio compression format. Files can be compressed to approximately 1/10 of their original size using MP3 compression.  
 WMA (Windows Media Audio) is a Microsoft audio compression format. This format compresses audio data to a size smaller than that of the MP3 format.  
 AAC is short for Advanced Audio Coding and refers to an audio compression technology standard used with MPEG2 and MPEG4.  
 MP3, WMA and AAC file and media/formats compatibility are limited.

- MP3 file compatibility
  - Compatible standards  
MP3 (MPEG1 AUDIO LAYERII, III, MPEG2 AUDIO LAYERII, III)
  - Compatible sampling frequencies  
MPEG1 AUDIO LAYERII, III: 32, 44.1, 48 (kHz)  
MPEG2 AUDIO LAYERII, III: 16, 22.05, 24 (kHz)
  - Compatible bit rates (compatible with VBR)  
MPEG1 AUDIO LAYERII, III: 32-320 (kbps)  
MPEG2 AUDIO LAYERII, III: 8-160 (kbps)
  - Compatible channel modes: stereo, joint stereo, dual channel and monaural
- WMA file compatibility
  - Compatible standards  
WMA Ver. 7, 8, 9
  - Compatible sampling frequencies  
HIGH PROFILE 32, 44.1, 48 (kHz)
  - Compatible bit rates  
HIGH PROFILE 48-320 (kbps, VBR)
- AAC file compatibility
  - Compatible standards  
MPEG4/AAC-LC
  - Compatible sampling frequencies  
11.025/12/16/22.05/24/32/44.1/48 (kHz)
  - Compatible bit rates  
16-320 (kbps)
  - Compatible channel modes: 1 ch and 2 ch
- File names

The only files that can be recognized as MP3/WMA/AAC and played are those with the extension .mp3, .wma or .m4a.
- ID3, WMA and AAC tags

ID3 tags can be added to MP3 files, making it possible to record the track title, artist name, etc.

The system is compatible with ID3 Ver. 1.0, 1.1, and Ver. 2.2, 2.3 ID3 tags. (The number of characters is based on ID3 Ver. 1.0 and 1.1.)

WMA tags can be added to WMA files, making it possible to record the track title and artist name in the same way as with ID3 tags.

AAC tags can be added to AAC files, making it possible to record the track title and artist name in the same way as with ID3 tags.

- MP3, WMA and AAC playback

- When a device containing MP3, WMA and AAC files is connected, all files in the USB memory device are checked. Once the file check is finished, the first MP3, WMA and AAC file is played. To make the file check finish more quickly, we recommend that you do not include any files other than MP3, WMA and AAC files or create any unnecessary folders.
- When a USB memory device is connected and the audio source is changed to USB memory mode, the USB memory device will start playing the first file in the first folder. If the same device is removed and reconnected (and the contents have not been changed), the USB memory device will resume play from the same point in which it was last used.

- Extensions

If the file extensions .mp3, .wma and .m4a are used for files other than MP3, WMA and AAC files, they will be skipped (not played).

- Playback

- To play MP3 files with steady sound quality, we recommend a fixed bit rate of at least 128 kbps and a sampling frequency of 44.1 kHz.
- There is a wide variety of freeware and other encoding software for MP3, WMA and AAC files on the market, and depending on the status of the encoding and the file format, poor sound quality or noise at the start of playback may result. In some cases, playback may not be possible at all.
- Microsoft, Windows, and Windows Media are the registered trademarks of Microsoft Corporation in the U.S.A. and other countries.

**WARNING****■ While driving**

Do not connect a USB memory device or operate the device controls.

**NOTICE****■ To prevent damage to the USB memory device or its terminals**

- Do not leave the USB memory device in the vehicle. The temperature inside the vehicle may become high, resulting in damage to the USB memory device.
- Do not push down on or apply unnecessary pressure to the USB memory device while it is connected.
- Do not insert foreign objects into the port.



## Using the AUX port

To use the AUX port, connect a portable player, press the “AUDIO” button, then select “AUX” to display the audio control screen.

### Connecting a portable audio player

→P. 272

#### ■ Operating portable audio players connected to Entune Audio

The volume can be adjusted using the vehicle's audio controls. All other adjustments must be made on the portable audio player itself.

#### ■ When using a portable audio player connected to the power outlet

Noise may occur during playback. Use the power source of the portable audio player.

#### WARNING

##### ■ While driving

Do not connect a portable audio player or operate the device controls.

## Preparations to use wireless communication

The following can be performed using Bluetooth® wireless communication:

- A portable audio player can be operated and listened to via Entune Audio
- Hands-free phone calls can be made via a cellular phone

In order to use wireless communication, register and connect a Bluetooth® device by performing the following procedures.

### ■ About Bluetooth®

The Bluetooth® word mark and logos are registered trademarks owned Bluetooth SIG, Inc. and any use of such marks by Fujitsu Ten Limited is under license. Other trademarks and trade names are those of their respective owners.



### ⚠ WARNING

#### ■ Certifications for the Bluetooth®

FCC ID: BABFT0077A

#### ● CAUTION: Radio Frequency Radiation Exposure

This equipment complies with FCC radiation exposure limits set forth for uncontrolled equipment and meets the FCC radio frequency (RF) Exposure Guidelines.

This equipment has very low levels of RF energy that it deemed to comply without maximum permissive exposure evaluation (MPE). But it is desirable that it should be installed and operated with at least 20cm and more between the radiator and person's body in normal use position.

- Co-location: This transmitter must not be co-located or operated in conjunction with any other antenna or transmitter.
- This device complies with part 15 of the FCC Rules. Operation is subject to the following two conditions: (1) This device may not cause harmful interference, and (2) this device must accept any interference received, including interference that may cause undesired operation.

**⚠ WARNING****● FCC WARNING:**

Changes or modifications not expressly approved by the party responsible for compliance could void the user's authority to operate the equipment.

**● IC: 2024B-FT0077A**

- This device complies with Industry Canada's licence-exempt RSSs. Operation is subject to the following two conditions: (1) This device may not cause interference; and (2) This device must accept any interference, including interference that may cause undesired operation of the device.

**● CAUTION: Radio Frequency Radiation Exposure**

This equipment complies with IC radiation exposure limits set forth for uncontrolled equipment and meets RSS-102 of the IC radio frequency (RF) Exposure rules.

This equipment has very low levels of RF energy that it deemed to comply without maximum permissive exposure evaluation (MPE).

But it is desirable that it should be installed and operated with at least 20cm and more between the radiator and person's body (excluding extremities: hands, wrists, feet and ankles).

**● IC: 2024B-FT0077A**

- Le présent appareil est conforme aux CNR d'Industrie Canada applicables aux appareils radio exempts de licence. L'exploitation est autorisée aux deux conditions suivantes : (1) l'appareil ne doit pas produire de brouillage; (2) l'utilisateur de l'appareil doit accepter tout brouillage radioélectrique subi, même si le brouillage est susceptible d'en compromettre le fonctionnement.

**● ATTENTION: l'exposition aux rayonnements radiofréquence**

- Cet équipement se conforme aux limites d'exposition aux radiations établies par Industrie Canada pour un environnement non contrôlé ainsi qu'aux directives d'exposition aux fréquences radioélectriques (RF) émises par Industrie Canada dans la norme CNR-102. Cet équipement émet un niveau d'énergie RF faible à un point tel qu'il se conforme sans devoir effectuer d'évaluation d'exposition maximum admissible (EMA).

Lorsque l'équipement est utilisé, il est toutefois souhaitable de laisser au moins 20cm entre l'antenne et le corps (à l'exception des extrémités : mains, poignets, pieds et chevilles).

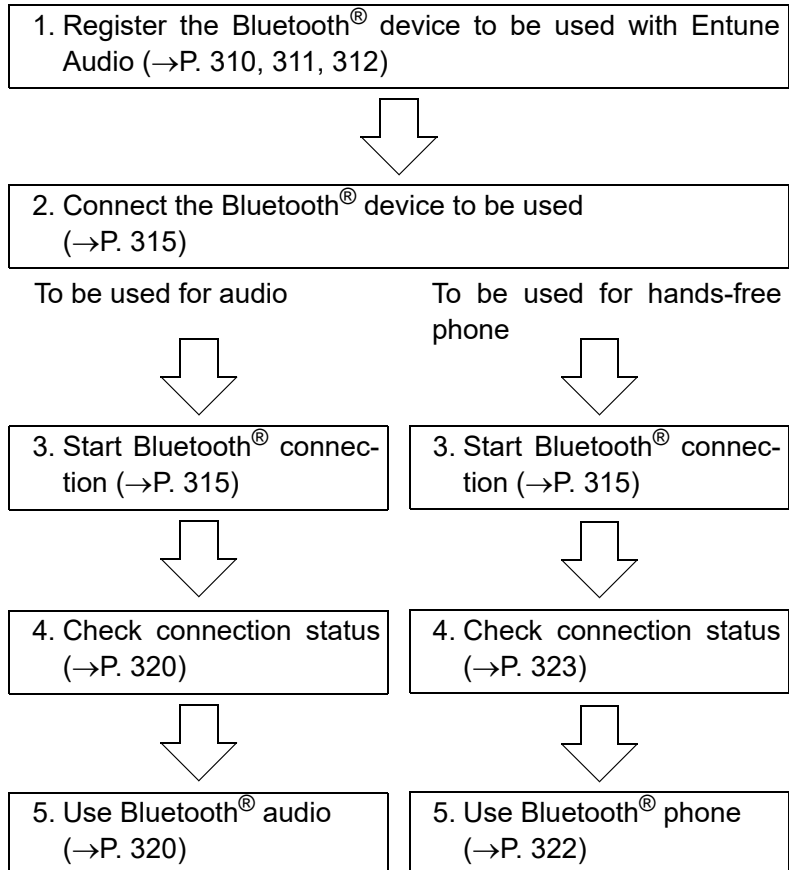
**Device registration/connection flow**

**Registering and connecting from the “Bluetooth\* Setup” screen**

To display the screen shown below, press the “SETUP” button and select “Bluetooth\*” on the “Setup” screen.

- ① Select to connect the device to be used with Entune Audio. (→P. 315)
- ② Select to register a Bluetooth® device to be used with Entune Audio. (→P. 312)
- ③ Select to set detailed Bluetooth® system settings. (→P. 319)
- ④ Select to delete registered devices. (→P. 314)

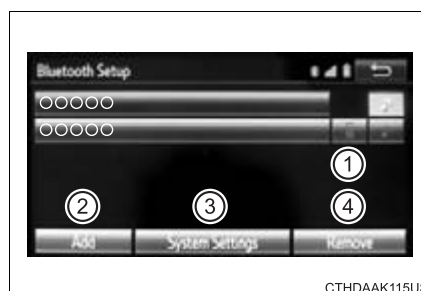

\*: Bluetooth is a registered trademark of Bluetooth SIG, Inc.

## Registering a Bluetooth® audio player for the first time

**To use the Bluetooth® Audio, it is necessary to register an audio player with the system.**

**Once the player has been registered, it is possible to use the Bluetooth® Audio.**

**For details about registering a Bluetooth® device (→P. 312)**

- 1 Turn the Bluetooth® connection setting of your audio player on.
- 2 Press the “AUDIO” button.
- 3 Select “ Audio”.
- 4 Select “Select Device”.
- 5 Follow the steps in “How to registering a Bluetooth® device” from step 2. (→P. 312)

## Registering a Bluetooth® phone for the first time

**To use the hands-free system, it is necessary to register a Bluetooth® phone with the system.**

**Once the phone has been registered, it is possible to use the hands-free system.**

**For details about registering a Bluetooth® device (→P. 312)**

- 1 Turn the Bluetooth® connection setting of your cellular phone on.
- 2 Press the “” button.
- 3 Select “OK” to register a phone.
- 4 Follow the steps in “How to registering a Bluetooth® device” from step 3. (→P. 312)

## Registering a Bluetooth® device

**Bluetooth® compatible phones (HFP) and portable audio players (AVP) can be registered simultaneously. You can register up to 5 Bluetooth® devices.**

### How to registering a Bluetooth® device

- 1 Display the “Bluetooth\* Setup” screen. (→P. 309)
- 2 Select “Add”.
- 3 When this screen is displayed, search for the device name displayed on this screen on the screen of your Bluetooth® device.

For details about operating the Bluetooth® device, see the manual that comes with it.

To cancel the registration, select “Cancel”.

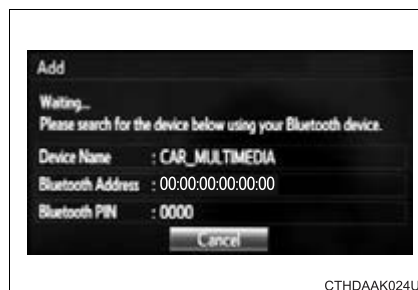

CTHDAAK024US

- 4 Register the Bluetooth® device using your Bluetooth® device.

A PIN-code is not required for SSP (Secure Simple Pairing) compatible Bluetooth® devices. Depending on the type of Bluetooth® device being connected, a message confirming registration may be displayed on the Bluetooth® device's screen. Respond and operate the Bluetooth® device according to the confirmation message.

\*: Bluetooth is a registered trademark of Bluetooth SIG, Inc.



- 5 Check that this screen is displayed when registration is complete.

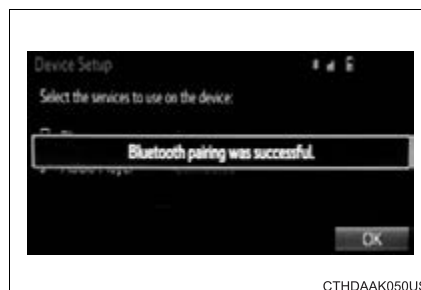

- 6 Select "OK" when the connection status changes from "Connecting..." to "Connected".

If an error message is displayed, follow the guidance on the screen to try again.

Registration can be performed from screens other than the "Bluetooth\* Setup" screen.

■ **When registering from the "Bluetooth\* Audio" screen**

- 1 Display the "Bluetooth\* Audio" screen. (→P. 284)
- 2 Select "Select Device".
- 3 Follow the steps in "How to registering a Bluetooth® device" from step 2. (→P. 312)

\*: Bluetooth is a registered trademark of Bluetooth SIG, Inc.

### **Deleting a Bluetooth® device**

- 1 Display the “Bluetooth\* Setup” screen. (→P. 309)
- 2 Select “Remove”.
- 3 Select the desired device.
- 4 A confirmation message will be displayed, select “Yes” to delete the device.
- 5 Check that a confirmation screen is displayed when the operation is complete.

\*: Bluetooth is a registered trademark of Bluetooth SIG, Inc.

## Connecting a Bluetooth® device

**Up to 5 Bluetooth® devices (Phones (HFP) and audio players (AVP)) can be registered.**

**If more than 1 Bluetooth® device has been registered, select which device to connect to.**

- 1 Press the “SETUP” button.
- 2 Select “Bluetooth\*”.
- 3 Select the device to be connected.

Supported profile icons will be displayed.

- ① Phone
- ② Audio player

Supported profile icons for currently connected devices will illuminate.

Dimmed icons can be selected to connect to the function directly.

\*: Bluetooth is a registered trademark of Bluetooth SIG, Inc.

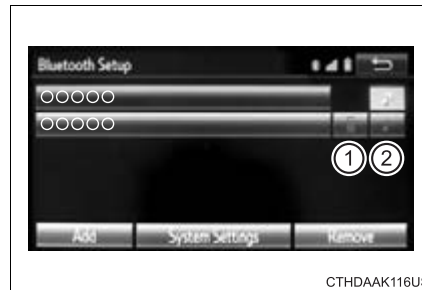

### Auto connection

To turn auto connection mode on, set “Bluetooth\* Power” to on.  
(→P. 319)

When you register a phone, auto connection will be activated. Always set it to this mode and leave the Bluetooth® phone in a place where a connection can be established.

When the engine switch is turned to the “ACC” or “ON” position (vehicles without a smart key system) or ACCESSORY or IGNITION ON mode (vehicles with a smart key system), the system will search for a nearby cellular phone you have registered.

Next, the system automatically connects with the most recent of the phones connected to in the past. Then, the connection result is displayed.

\*: Bluetooth is a registered trademark of Bluetooth SIG, Inc.

### Manual connection

When auto connection has failed or “Bluetooth\* Power” is turned off, you must connect the Bluetooth® device manually.

- 1 Follow the steps in “Connecting a Bluetooth® device” from step 1.  
(→P. 315)

\*: Bluetooth is a registered trademark of Bluetooth SIG, Inc.

### Connecting a Bluetooth® audio player

▶ Registering an additional device

- 1 Select “Select Device” on the Bluetooth® audio control screen.
- 2 For more information: →P. 312

▶ Selecting a registered device

- 1 Select “Select Device” on the Bluetooth® audio control screen.
- 2 For more information: →P. 315

---

**■ Reconnecting a Bluetooth® phone**

If the system cannot connect due to poor signal strength with the engine switch in the “ACC” or “ON” position (vehicles without a smart key system) or ACCESSORY or IGNITION ON mode (vehicles with a smart key system), the system will automatically attempt to reconnect.

If the system is attempting to connect to a Bluetooth® phone and the Bluetooth® phone is turned off and then back on, the system will attempt to reconnect.

## Displaying a Bluetooth® device details

You can confirm and change the registered device details.

### Bluetooth® device registration status

- 1 Display the “Bluetooth\* Setup” screen. (→P. 309)
- 2 Select the device.
- 3 Select “Device Info”.
- 4 Following screen is displayed:

- ① Device Name
- ② Change connection method
- ③ Bluetooth® Address
- ④ Display your telephone number  
The number may not be displayed depending on the model of phone.
- ⑤ Compatibility profile of the device
- ⑥ Restore default settings

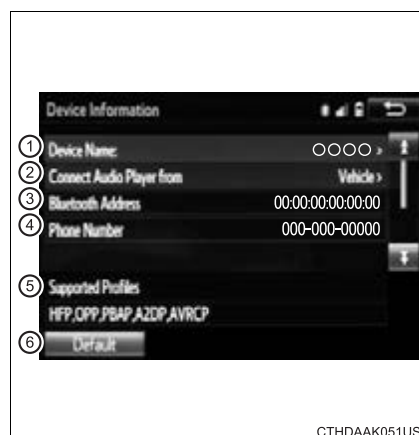

\*: Bluetooth is a registered trademark of Bluetooth SIG, Inc.

### Changing connection method

- 1 Select “Connect Audio Player from”.
- 2 Select “Vehicle” or “Device”.  
“Vehicle”: Connect Entune Audio to the portable audio player.  
“Device”: Connect the portable audio player to Entune Audio

## Detailed Bluetooth® system settings

You can confirm and change the detailed Bluetooth® settings.

### How to check and change detailed Bluetooth® settings

- 1 Display the “Bluetooth\* Setup” screen. (→P. 309)
- 2 Select “System Settings”.
- 3 The following screen is displayed:

- ① Bluetooth\* Power on/off  
You can change Bluetooth\* function on/off
- ② Bluetooth\* Name
- ③ Change PIN-code
- ④ Bluetooth\* Address
- ⑤ Display Phone Status

You can set the system to show the status confirmation display when connecting a telephone

- ⑥ Display Audio Player Status  
You can set the system to show the status confirmation display when connecting an audio player

- ⑦ Compatibility profile of the system
- ⑧ Restore default settings

\*: Bluetooth is a registered trademark of Bluetooth SIG, Inc.

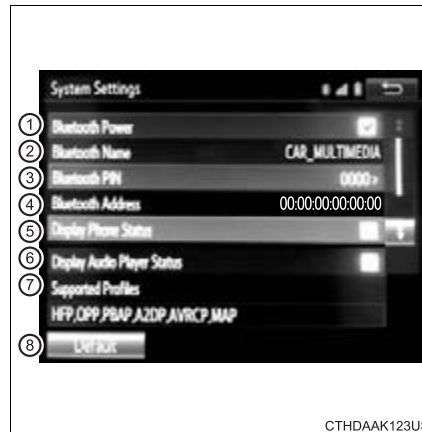

CTHDAAK123US

5

Audio system

### Editing the Bluetooth\* PIN

You can change the PIN-code that is used to register your Bluetooth® devices in the system.

- 1 Select “Bluetooth\* PIN”.
- 2 Input a PIN-code, and select “OK”.

\*: Bluetooth is a registered trademark of Bluetooth SIG, Inc.

## Listening to Bluetooth® Audio

**The Bluetooth® audio system enables the user to enjoy music played on a portable player from the vehicle speakers via wireless communication.**

When a Bluetooth® device cannot be connected, check the connection status on the “Bluetooth\* Audio” screen. If the device is not connected, either register or reconnect the device. (→P. 315)





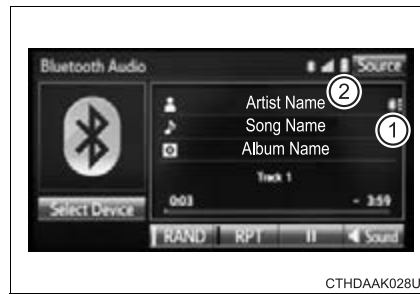

\*: Bluetooth is a registered trademark of Bluetooth SIG, Inc.

### Status display

You can check such indicators as signal strength and battery charge on the screen.

- ① Connection status
- ② Battery charge



Indicators	Conditions
Connection status	Good ← → Not connected   
Battery charge	Full ← → Empty   

CTHDAAK028US



**Playing Bluetooth® audio**

Select  or  to Play/Pause.

For details on “Bluetooth\* Audio” screen operation methods, refer to Basic Audio Operations. (→P. 276)

For details on how to select a track or album, refer to selecting, fast-forwarding and reversing tracks/files/songs. (→P. 286)

\*: Bluetooth is a registered trademark of Bluetooth SIG, Inc.

## Using a Bluetooth® Phone

**The hands-free system is a function that allows you to use your cellular phone without touching it.**

**This system supports Bluetooth®. Bluetooth® is a wireless data system that allows the cellular phone to wirelessly connect to the hands-free system and make/receive calls.**

Before making a phone call, check the connection status, battery charge, call area and signal strength. (→P. 323)

If a Bluetooth® device cannot be connected, check the connection status on the phone screen. If the device is not connected, either register or reconnect it. (→P. 315)

### Phone screen

To display the screen shown below, press the off-hook switch on the steering wheel or the  button.

Several functions are available to operate on each screen that is displayed by selecting the 4 tabs.

- ① Device name
- ② Bluetooth® connection status



CTHDAAK032USc

■ Telephone switch (→P. 338)

■ Microphone

▶ Type A

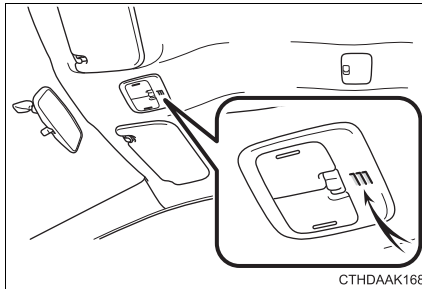

CTHDAAK168

▶ Type B

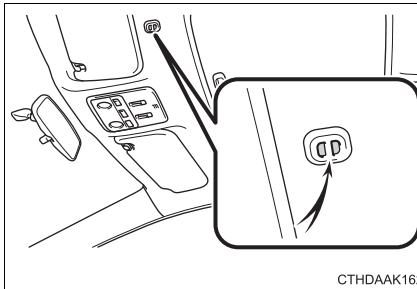

CTHDAAK162

The vehicle's built in microphone is used when talking on the phone.

The person you are speaking to can be heard from the front speakers.

To use the hands-free system, you must register your Bluetooth® phone in the system. (→P. 312)







### Status display

You can check indicators such as signal strength and battery charge on the phone screen.

- ① Connection status
- ② Signal strength
- ③ Battery charge





CTHDAAK033USa

Indicators	Conditions
Connection status	Good  ↔  Not connected
Battery charge	Full  ↔  Empty
Call area	"Rm": Roaming area
Signal strength	Excellent  ↔  Poor

## Making a call

**Once a Bluetooth® phone is registered, you can make a call using the following procedure:**

### Dialing

- 1 Display the phone screen. (→P. 322)
- 2 Select the “Dial Pad” tab and enter a phone number.  
To delete the input phone number, select .  
For the first digit, you can enter “+” by selecting “\*” for a while.
- 3 Press the off-hook switch on the steering wheel or select .

### Dialing from the contacts list

You can dial a number from the contact data imported from your cellular phone. The system has one contact for each registered phone. Up to 2500 contacts may be stored in each contact.

- 1 Display the phone screen. (→P. 322)
- 2 Select “Contacts” tab.
- 3 Choose the desired contact to call from the list.
- 4 Choose the number and then press the off-hook switch on the steering wheel or select .

### When the contact is empty

You can transfer the phone numbers in a Bluetooth® phone to the system.

Operation methods differ between PBAP (Phone Book Access Profile) compatible and PBAP incompatible Bluetooth® phones. If the cellular phone does not support either PBAP or OPP (Object Push Profile) service, you cannot transfer contacts.

- 1 Press the off-hook switch on the steering wheel.  
If the phonebook is empty, a message will be displayed.  
▶ For a PBAP compatible Bluetooth® phone and “Automatic Transfer” is off

2 Select the desired item.

- 1 Select to transfer new contacts from a cellular phone, select “Always” and then enable “Automatic Transfer”.
- 2 Select to transfer all the contacts from a connected cellular phone only once.
- 3 Select to cancel transferring.

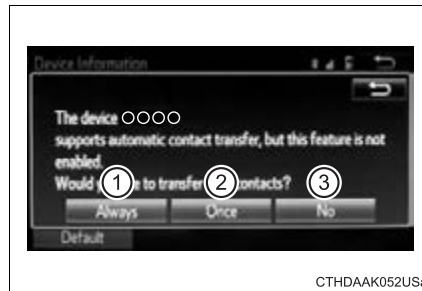

- ▶ For PBAP incompatible but OPP compatible Bluetooth® phones

2 Select the desired item.

- 1 Select to transfer the contacts from the connected cellular phone.  
Follow the steps in “Update contacts from phone” from step 2. (→P. 342)
- 2 Select to add a new contact manually.  
Follow the steps in “Registering a new contact to the contacts list” from step 2. (→P. 344)
- 3 Select to cancel transferring.



### Calling using favorites list

You can make a call using numbers registered in the contact.

- 1 Display the phone screen. (→P. 322)
- 2 Select “Favorites” tab.
- 3 Select the desired number to make a call.



### Dialing from call history

You can make a call using the call history, which has the 3 functions below.

 : calls which you missed

 : calls which you received

 : calls which you made

- 1 Display the phone screen. (→P. 322)
- 2 Select “Call History” tab.
- 3 Select  or the desired entry from the list.
  - ▶ When  is selected
- 4 Check that the “Call” screen is displayed.
  - ▶ When the desired contact is selected
- 4 Select the desired number.
- 5 Check that the “Call” screen is displayed.

#### Call history list

- If you make a call to or receive a call from a number registered in the contact, the name is displayed in the call history.
- If you make multiple calls to the same number, only the last call made is displayed in the call history.

#### International calls

You may not be able to make international calls, depending on the mobile phone in use.

## Receiving a call

**When a call is received, the following screen is displayed together with a sound.**

### To answer the phone

Press the off-hook switch on the steering wheel or select .

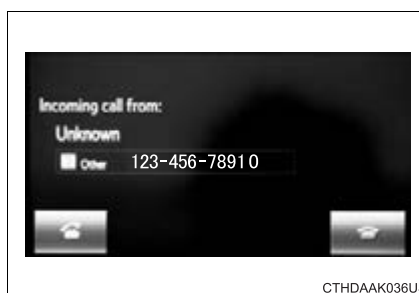

### To refuse a call

Press the on-hook switch on the steering wheel or select .

### To adjust the incoming call volume

Turn the “PWR·VOL” knob. You can also adjust the volume using the steering switches.

### ■ International calls

Received international calls may not be displayed correctly depending on the cellular phone in use.



## Speaking on the phone

The following screen is displayed when speaking on the phone.



### To adjust the call volume

Select “-” or “+”. You can also adjust the volume using the steering switches or the volume knob.

### To prevent the other party from hearing your voice

Select “Mute”.

### Inputting tones

When using phone services such as an answering service or a bank, you can store phone numbers and code numbers in the contact.

- 1 Select “0-9”.
- 2 Input the number.

#### ■ Release Tones

“Release Tones” appear when a continuous tone signal(s) containing a (w) is registered in the contact list.

- 1 Select “Release Tones”.

■ **Release Tones**

- A continuous tone signal is a character string that consists of numbers and the characters p or w. (e.g.056133w0123p#1\*)
- When the “p” pause tone is used, the tone data up until the next pause tone will be automatically sent after 2 seconds have elapsed. When the “w” pause tone is used, the tone data up until the next pause tone will be automatically sent after a user operation is performed.
- Release tones can be used when automated operation of a phone based service such as an answering machine or bank phone service is desired. A phone number with continuous tone signals can be registered in the contact list.
- Tone data after a “w” pause tone can be operated on voice command during a call.

### To transfer a call

Select “Handset Mode” to on from a hands-free call to a cellular phone call.

Select “Handset Mode” to off from a cellular phone call to a hands-free call.

### Transmit volume setting

- 1 Select “Transmit Volume”.
- 2 Select the desired level for the transmit volume.
- 3 Select “OK”.

### To hang up

Press the on-hook switch on the steering wheel or select .

### Call waiting

When a call is interrupted by a third party while talking, an incoming call message will be displayed.

To talk with the other party:

- Press the off-hook switch on the steering wheel.
- Select .

To refuse the call:

- Press the on-hook switch on the steering wheel.
- Select .

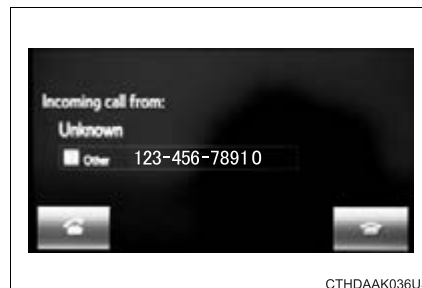

Every time you press the off-hook switch on the steering wheel or select  during call waiting, you will be switched to the other party.

■ **Transferring calls**

- If you transfer from the cellular phone to hands-free, the hands-free screen will be displayed, and you can operate the system using the screen.
- Transfer method and operation may vary according to the cellular phone used.
- For operation of the cellular phone in use, see the phone's manual.

■ **Call waiting operation**

Call waiting operation may differ depending on your phone company and cellular phone.

## Bluetooth® phone message function

Received messages can be forwarded from the connected Bluetooth® phone, enabling checking and replying using Entune Audio.

Depending on the type of Bluetooth® phone connected, received messages may not be transferred to the message inbox.

If the phone does not support the message function, this function cannot be used.

### Displaying message inbox screen

- 1 Press the “☎” button.
- 2 Select .

### Receiving a message

When an e-mail/SMS/MMS is received, the incoming message screen pops up with sound and is ready to be operated on the screen.

- ① Select to check the message.
- ② Select to refuse the message.
- ③ Select to call the message sender.



■ **Receiving a message**

- Depending on the cellular phone used for receiving messages, or its registration status with the system, some information may not be displayed.
- The pop up screen is separately available for incoming e-mail and SMS/MMS messages under the following conditions:

E-mail:

- “Incoming E-mail Display” is set to “Full Screen”. (→P. 349)
- “E-mail Notification Popup” is set to on. (→P. 349)

SMS/MMS:

- “Incoming SMS/MMS Display” is set to “Full screen”. (→P. 349)
- “SMS/MMS Notification Popup” is set to on. (→P. 349)

### Checking the messages

- 1 Display the message inbox screen. (→P. 333)
- 2 Select the desired message from the list.
- 3 Check that the message is displayed.

- ① E-mails: Select “Mark Unread” or “Mark Read” to mark mail unread or read on the message inbox screen.

This function is available when “Update Read Status on Phone” is set to on (→P. 349)

- ② Select to make a call to the sender.
- ③ Select to have messages read out. To cancel this function, select “Stop”.
- ④ Select to display the previous or next message.
- ⑤ Select to reply the message.

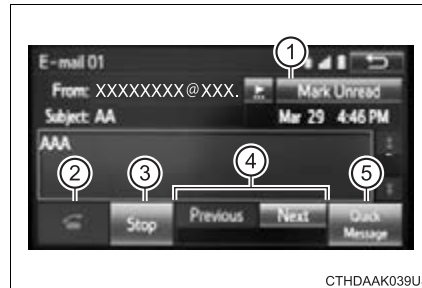

CTHDAAK039US

**■ Check the messages**

- Depending on the type of Bluetooth® phone being connected, it may be necessary to perform additional steps on the phone.
- Messages are displayed in the appropriate connected Bluetooth® phone's registered mail address folder.  
Select the tab of the desired folder to be displayed.
- Only received messages on the connected Bluetooth® phone can be displayed.
- The text of the message is not displayed while driving.
- When "Automatic Message Readout" is set to on, messages will be automatically read out. (→P. 349)
- Turn the "PWR·VOL" knob, or use the volume switch on the steering wheel to adjust the message read out volume.
- The message read out function is available even while driving.

**Replying to a message**

- 1 Display the message inbox screen. (→P. 333)
- 2 Select the desired message from the list.
- 3 Select "Quick Message".
- 4 Select the desired message.
- 5 Select "Send".

**■ Editing quick reply message**

- 1 Select "Quick Message".
- 2 Select  corresponding to the desired message to edit.
- 3 Select "OK" when editing is completed.



### Calling the message sender

Calls can be made to an e-mail/SMS/MMS message sender's phone number.

- 1 Display the message inbox screen. (→P. 333)
- 2 Select the desired message.
- 3 Select .
- 4 Check that the "Call" screen is displayed.

#### ■ Calling from a number within a message

Calls can be made to a number identified in a message's text area.

- 1 Display the message inbox screen. (→P. 333)
- 2 Select the desired message.
- 3 Select the text area.
- 4 Select  corresponding to the desired number.
- 5 Check that the "Call" screen is displayed.

#### ■ Calling from the incoming message screen

→P. 331

## Using the steering wheel switches

The steering wheel switches can be used to operate a connected cellular phone.

### Operating a telephone using the steering wheel switches

► Type A

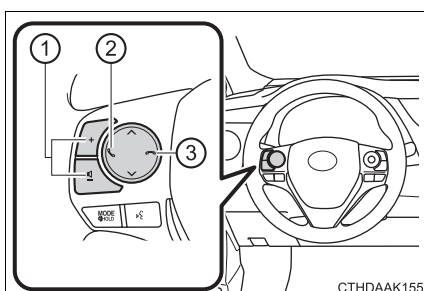

► Type B

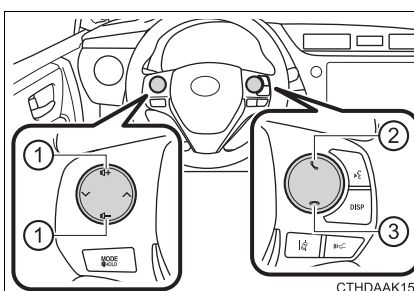

- ① Volume switch
  - Increase/Decrease the volume
  - Press and hold:  
Continuously increase/decrease the volume
- ② Off-hook switch
  - Make a call
  - Receive a call
  - Display "Phone" screen
- ③ On-hook switch
  - End a call
  - Refuse a call

## Bluetooth® phone settings

You can adjust the hands-free system to your desired settings.

### “Phone/Message Settings” screen

To display the screen shown below, press the “SETUP” button, and select “Phone” on the “Setup” screen.

- ① Set the phone connection  
(→P. 312)
- ② Setting the sound (→P. 340)
- ③ Contact/Call History Settings  
(→P. 341)
- ④ Set the message settings  
(→P. 349)
- ⑤ Set the phone display  
(→P. 350)



### Sound setting

- 1 Display the “Phone/Message Settings” screen. (→P. 339)
- 2 Select “Sound Settings” on the “Phone/Message Settings” screen.
  - ① Set the desired ringtone.
  - ② Adjust the ringtone volume.
  - ③ Adjust the message readout volume.
  - ④ Set the desired incoming SMS/MMS tone.
  - ⑤ Adjust the incoming SMS/MMS tone volume.
  - ⑥ Set the incoming e-mail tone.
  - ⑦ Adjust the incoming e-mail tone volume.
  - ⑧ Adjust the default volume of the other party's voice.



#### ■ To return to the default volume settings

Select “Default”, and then “Yes”.

## Contact/Call History Settings

The contact can be transferred from a Bluetooth® phone to the system. The contact also can be added, edited and deleted.

The call history can be deleted and contact and favorites can be changed.

- 1 Display the “Phone/Message Settings” screen. (→P. 339)
- 2 Select “Contact/Call History Settings”.
- 3 Select the desired item to be set.

- ① For PBAP compatible Bluetooth® phones, select to set “Automatic Transfer” on/off. When set to on, the phone’s contact data and history are automatically transferred.

- ② Select to update contacts from the connected phone. (→P. 342)

- ③ Select to sort contacts by the first name or last name field.

- ④ Select to add contacts to the favorites list. (→P. 346)

- ⑤ Select to delete contacts from the favorites list. (→P. 348)

- ⑥ Select to display contact images.

- ⑦ Select to clear contacts from the call history.\*

- ⑧ Select to add new contacts to the contact list.\* (→P. 344)

- ⑨ Select to edit contacts in the contact list.\* (→P. 345)

- ⑩ Select to delete contacts from the contact list.\* (→P. 346)

- ⑪ Select to reset all setup items.

\*: For PBAP compatible Bluetooth® phones only, this function is available when “Automatic Transfer” is set to off.



**Update contacts from phone**

Operation methods differ between PBAP compatible and PBAP incompatible but OPP compatible Bluetooth® phones.

If your cellular phone is neither PBAP nor OPP compatible, the contacts cannot be transferred.

**■ For PBAP Compatible Bluetooth® Phones**

- 1 Select "Update Contacts from Phone".
- 2 Check that a confirmation screen is displayed when the operation is complete.

This operation may be unnecessary depending on the type of cellular phone.

Depending on the type of cellular phone, OBEX authentication may be required when transferring contact data. Enter "1234" into the Bluetooth® phone.

If another Bluetooth® device is connected when transferring contact data, depending on the phone, the connected Bluetooth® device may need to be disconnected.

Depending on the type of Bluetooth® phone being connected, it may be necessary to perform additional steps on the phone.

---

**■ For PBAP Incompatible but OPP compatible Bluetooth® Phones**

- 1 Select “Update Contacts from Phone”.
- 2 Transfer the contact data to the system using a Bluetooth® phone.

This operation may be unnecessary depending on the type of cellular phone.

Depending on the type of cellular phone, OBEX authentication may be required when transferring contact data. Enter “1234” into the Bluetooth® phone.

To cancel this function, select “Cancel”.

- 3 Select “Done” when it appears on the screen.
- 4 Check that a confirmation screen is displayed when the operation is complete.

**■ Updating the contacts in a different way (From the “Call History” screen)**

For PBAP compatible Bluetooth® phones, this function is available when “Automatic Transfer” is set to off. (→P. 341)

- 1 Display the phone screen. (→P. 322)
- 2 Select the “Call History” tab and select a contact not yet registered in the contact list.
- 3 Select “Update Contact”.
- 4 Select the desired contact.
- 5 Select a phone type for the phone number.

**Registering a new contact to the contact list**

New contact data can be registered. Up to 4 numbers per person can be registered. For PBAP compatible Bluetooth® phones, this function is available when “Automatic Transfer” is set to off. (→P. 341)

- 1 Select “New Contact”.
- 2 Enter the name and select “OK”.
- 3 Enter the phone number and select “OK”.
- 4 Select the phone type for the phone number.
- 5 To add another number to this contact, select “Yes”.

**■ Registering a new contact in a different way (From the “Call History” screen)**

- 1 Display the phone screen. (→P. 322)
- 2 Select the “Call History” tab and select a contact not yet registered in the contact list.
- 3 Select “Add to Contacts”.
- 4 Follow the steps in “Registering a new contact to the contacts list” from step 3.



### Editing the contact data

For PBAP compatible Bluetooth® phones, this function is available when “Automatic Transfer” is set to off. (→P. 341)

- 1 Select “Edit Contact”.
- 2 Select the desired contact.
- 3 Select  corresponding to the desired name or number.
  - ▶ For editing the name
- 4 Follow the steps in “Registering a new contact to the contacts list” from step [3](#). (→P. 344)
  - ▶ For editing the number
- 4 Follow the steps in “Registering a new contact to the contacts list” from step [4](#). (→P. 344)

#### ■ Editing the contacts in a different way (From the “Contact Details” screen)

- 1 Display the phone screen. (→P. 322)
- 2 Select the “Contacts”, “Call History” tab or the “Favorites” tab and select the desired contact.
- 3 Select “Edit Contact”.
  - “E-mail Addresses”: Select to display all registered e-mail addresses for the contact.
- 4 Follow the steps in “Editing the contact data” from step [4](#).

### Deleting the contact data

For PBAP compatible Bluetooth® phones, this function is available when “Automatic Transfer” is set to off. (→P. 341)

- 1 Select “Delete Contacts”.
- 2 Select the desired contact and select “Delete”.
- 3 Select “Yes” when the confirmation screen appears.

#### ■ Deleting the contact in a different way (From the “Contact Details” screen)

- 1 Display the phone screen. (→P. 322)
- 2 Select the “Contacts”, “Call History” tab or the “Favorites” tab and select the desired contact.
- 3 Select “Edit Contact”.
- 4 Select “Yes” when the confirmation screen appears.

### Favorites list setting

Up to 15 contacts (maximum of 4 numbers per contact) can be registered in the favorites list.

#### ■ Registering the contacts in the favorites list

- 1 Select “Add Favorite”.
- 2 Select the desired contact to add to the favorites list.  
Dimmed contacts are already stored as a favorite.
- 3 Check that a confirmation screen is displayed when the operation is complete.

- ▶ When 15 contacts have already been registered to the favorites list

- 1 When 15 contacts have already been registered to the favorites list, a registered contact needs to be replaced. Select “Yes” when the confirmation screen appears to replace a contact.

- 2 Select the contact to be replaced.

- 3 Check that a confirmation screen is displayed when the operation is complete.

- ▶ Registering contacts in the favorites list in a different way (from the “Contacts” screen)

- 1 Display the phone screen. (→P. 322)

- 2 Select the “Contacts” tab.

- 3 Select ☆ at the beginning of the desired contact list name to be registered in the favorites list.

When selected, ☆ is changed to ★, and the contact is registered in the favorites list.

- ▶ Registering contacts in the favorites list in a different way (from the “Contact Details” screen)

- 1 Display the phone screen. (→P. 322)

- 2 Select the “Contacts” tab or the “Call History” tab and select the desired contact.

- 3 Select “Add Favorite”.

- 4 Check that a confirmation screen is displayed when the operation is complete.

**■ Deleting the contacts in the favorites list**

- 1 Select "Remove Favorite".
- 2 Select the desired contacts and select "Remove".
- 3 Select "Yes" when the confirmation screen appears.
- 4 Check that a confirmation screen is displayed when the operation is complete.
  - ▶ Deleting contacts in the favorites list in a different way (from the "Contacts" screen)
- 1 Display the phone screen. (→P. 322)
- 2 Select the "Contacts" tab.
- 3 Select ★ at the beginning of the contact list name to be deleted from the favorites. list.

When selected, ★ is changed to ☆, and the data is deleted from the list.

  - ▶ Deleting contacts in the favorites list in a different way (from the "Contact Details" screen)
- 1 Display the phone screen. (→P. 322)
- 2 Select the "Contacts", "Call History" tab or the "Favorites" tab and select the desired contact to delete.
- 3 Select "Remove Favorite".
- 4 Select "Yes" when the confirmation screen appears.
- 5 Check that a confirmation screen is displayed when the operation is complete.

### Message Settings

- 1 Display the “Phone/Message Settings” screen. (→P. 339)
- 2 Select “Messaging Settings”.
- 3 Select the desired item to be set.

- ① Set automatic message transfer on/off.
- ② Set automatic message readout on/off.
- ③ Set the SMS/MMS notification popup on/off.
- ④ Set the e-mail notification popup on/off.
- ⑤ Set adding the vehicle signature to outgoing messages on/off.

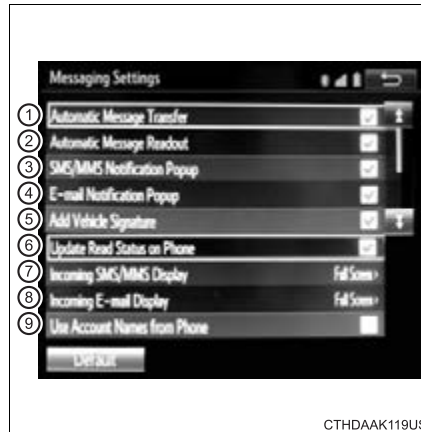

- ⑥ Set updating message read status on phone on/off.
- ⑦ Change the incoming SMS/MMS display.

“Full Screen”: When an SMS/MMS message is received, the incoming SMS/MMS display screen is displayed and can be operated on the screen.

“Drop-Down”: When an SMS/MMS message is received, a message is displayed on the upper side of the screen.

- ⑧ Change the incoming e-mail display.

“Full Screen”: When an e-mail is received, the incoming e-mail display screen is the displayed and can be operated on the screen.

“Drop-Down”: When an e-mail is received, a message is displayed on the upper side of the screen.

- ⑨ Set display of messaging account names on the inbox tab on/off.

When set to on, messaging account names used on the cellular phone will be displayed.

#### ■ To return to the default volume settings

Select “Default”, and then “Yes”.

### ■ Displaying the “Messaging Settings” screen in a different way

- 1 Display the phone screen. (→P. 322)
- 2 Select .
- 3 Select “Settings”.

### Phone Display Settings

- 1 Display the “Phone/Message Settings” screen. (→P. 339)
- 2 Select “Phone Display Settings”.
- 3 Select the desired item to be set.

- ① Change the incoming call display.

“Full Screen”: When a call is received, the hands-free screen is displayed and can be operated on the screen.

“Drop-Down”: A message is displayed on the upper side of the screen.

- ② Set display of the contact/history transfer completion message on/off.

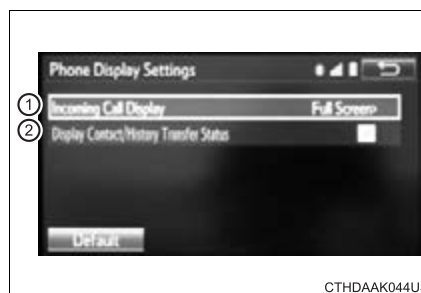

## What to do if... (Troubleshooting)

If there is a problem with the hands-free system or a Bluetooth® device, first check the table below.

- ▶ When using the hands-free system with a Bluetooth® device

The hands-free system or Bluetooth® device does not work.
The connected device may not be a compatible Bluetooth® cellular phone. → <b>For a list of specific devices which operation has been confirmed on this system, check with your Toyota dealer or the following website: <a href="http://www.toyota.com/entune.html">http://www.toyota.com/entune.html</a></b>
The Bluetooth version of the connected cellular phone may be older than the specified version. → <b>Use a cellular phone with Bluetooth version 2.0 or higher (recommended: Ver. 3.0 with EDR or higher). (→P. 355)</b>

## ▶ When registering/connecting a cellular phone

A cellular phone cannot be registered.
An incorrect passcode was entered on the cellular phone. → <b>Enter the correct passcode on the cellular phone.</b>
The registration operation has not been completed on the cellular phone side. → <b>Complete the registration operation on the cellular phone (approve registration on the phone).</b>
Old registration information remains on either this system or the cellular phone. → <b>Delete the existing registration information from both this system and the cellular phone, then register the cellular phone you wish to connect to this system. (→P. 314)</b>
A Bluetooth® connection cannot be made.
Another Bluetooth® device is already connected. → <b>Manually connect the cellular phone you wish to use to this system. (→P. 316)</b>
Bluetooth® function is not enabled on the cellular phone. → <b>Enable the Bluetooth® function on the cellular phone.</b>
“Please check your device settings.” message is displayed.
Bluetooth® function is not enabled on the cellular phone. → <b>Enable the Bluetooth® function on the cellular phone.</b>
Old registration information remains on either this system or the cellular phone. → <b>Delete the existing registration information from both this system and the cellular phone, then register the cellular phone you wish to connect to this system. (→P. 314)</b>

## ▶ When making/receiving a call

A call cannot be made/received.
Your vehicle is in a “Out of cellular service area. Please try again later.” area. → <b>Move to where “Out of cellular service area. Please try again later.” no longer appears on the display.</b>



► When using the phonebook

Phonebook data cannot be transferred manually/automatically.
The profile version of the connected cellular phone may not be compatible with transferring phonebook data. → <b>For a list of specific devices which operation has been confirmed on this system, check with your Toyota dealer or the following website: <a href="http://www.toyota.com/entune.html">http://www.toyota.com/entune.html</a></b>
Automatic phonebook transfer function on this system is set to off. → <b>Set automatic phonebook transfer function on this system to on. (→P. 341)</b>
Passcode has not been entered on the cellular phone. → <b>Enter the passcode on the cellular phone if requested (default passcode: 1234).</b>
Transfer operation on the cellular phone has not completed. → <b>Complete transfer operation on the cellular phone (approve transfer operation on the phone).</b>
Phonebook data cannot be edited.
Automatic phonebook transfer function on this system is set to on. → <b>Set automatic phonebook transfer function on this system to off. (→P. 341)</b>

► When using the Bluetooth® message function

Messages cannot be viewed.
Message transfer is not enabled on the cellular phone. → <b>Enable message transfer on the cellular phone (approve message transfer on the phone).</b>
Automatic transfer function on this system is set to off. → <b>Set automatic transfer function on this system to on. (→P. 349)</b>
New message notifications are not displayed.
Notification of SMS/MMS/E-mail reception on this system is set to off. → <b>Set notification of SMS/MMS/E-mail reception on this system to on. (→P. 349)</b>
Automatic message transfer function is not enabled on the cellular phone. → <b>Enable automatic transfer function on the cellular phone.</b>

► In other situations

Even though all conceivable measures have been taken, the symptom status does not change.

The cellular phone is not close enough to this system.  
→ **Bring the cellular phone closer to this system.**

The cellular phone is the most likely cause of the symptom.  
→ **Turn the cellular phone off, remove and reinstall the battery pack, and then restart the cellular phone.**  
→ **Enable the cellular phone's Bluetooth® connection.**  
→ **Stop the cellular phone's security software and close all applications.**  
→ **Before using an application installed on the cellular phone, carefully check its source and how its operation might affect this system.**

## Bluetooth®

### ■ When using the Bluetooth® audio system

- In the following conditions, the system may not function.
  - If the portable audio player is turned off
  - If the portable audio player is not connected
  - If the portable audio player's battery is low
- There may be a delay if a cellular phone connection is made during Bluetooth® audio play.
- Depending on the type of portable audio player that is connected to the system, operation may differ slightly and certain functions may not be available.

### ■ When using the hands-free system

- Entune Audio is muted when making a call.
- If both parties speak at the same time, it may be difficult to hear.
- If the received call volume is overly loud, an echo may be heard. If the Bluetooth® phone is too close to the system, quality of the sound may deteriorate and connection status may deteriorate.
- In the following circumstances, it may be difficult to hear the other party:
  - When driving on unpaved roads
  - When driving at high speeds
  - If a roof or window is open
  - If the air conditioning is blowing directly on the microphone
  - If there is interference from the network of the cellular phone

### ■ Conditions under which the system will not operate

- If using a cellular phone that does not support Bluetooth®
- If the cellular phone is turned off
- If you are outside of cellular phone service coverage
- If the cellular phone is not connected
- If the cellular phone's battery is low
- When outgoing calls are controlled, due to heavy traffic on telephone lines, etc.
- When the cellular phone itself cannot be used
- When transferring contact data from the cellular phone

**■ Bluetooth® antenna**

The antenna is built into the display.

If the portable audio player is behind the seat or in the glove box or console box, or is touching or covered by metal objects, the connection status may deteriorate.

If the cellular phone is behind the seat or in the console box, or touching or covered by metal objects, the connection status may deteriorate.

**■ Battery charge/signal status**

- This display may not correspond exactly with the portable audio player or cellular phone itself.
- This system does not have a charging function.
- The portable audio player or cellular phone battery will be depleted quickly when the device is connected to Bluetooth®.

**■ When using the Bluetooth® audio and hands-free system at the same time**

The following problems may occur.

- The Bluetooth® audio connection may be interrupted.
- Noise may be heard during Bluetooth® audio playback.

**■ About the contact in this system**

The following data is stored for every registered cellular phone. When another phone is connecting, you cannot read the registered data.

- Contact data
- Call history
- Favorite
- Message

When removing a Bluetooth® phone from the system, the above-mentioned data is also deleted.

### ■ Compatible models

The Bluetooth® audio system supports portable audio players with the following specifications

- Bluetooth® specifications:

- Ver. 2.0, or higher (Recommended: Ver. 3.0+EDR or higher)

- Profiles:

- A2DP (Advanced Audio Distribution Profile) Ver. 1.0, or higher (Recommended: Ver. 1.2 or higher)  
This is a profile to transmit stereo audio or high quality sound to Entune Audio.
- AVRCP (Audio/Video Remote Control Profile) Ver. 1.0 or higher (Recommended: Ver. 1.4 or higher)  
This is a profile to allow remote control the A/V equipment.

However, please note that some functions may be limited depending on the type of portable audio player connected.

The hands-free system supports cellular phones with the following specifications.

- Bluetooth® specification:

- Ver. 2.0 or higher (Recommended: Ver. 3.0+EDR or higher)

- Profiles:

- HFP (Hands Free Profile) Ver. 1.0 or higher (Recommended: Ver. 1.6 or higher)  
This is a profile to allow hands-free phone calls using a cellular phone or head set. It has outgoing and incoming call functions.
- OPP (Object Push Profile) Ver. 1.1 or higher (Recommended: Ver. 1.2)  
This is a profile to transfer contact data. When a Bluetooth® compatible cellular phone has both PBAP and OPP, OPP cannot be used.
- PBAP (Phone Book Access Profile) Ver. 1.0 or higher (Recommended: Ver. 1.1)  
This is a profile to transfer contact data.
- MAP (Message Access Profile) Ver.1.0 or higher  
This is a profile to using phone message.

If the cellular phone does not support HFP, you cannot register it with the hands-free system. OPP, PBAP or MAP services must be selected individually.

**■ Reconnecting the portable audio player**

If the portable audio player is disconnected due to poor reception when the engine switch is in the "ACC" or "ON" position (vehicles without a smart key system) or ACCESSORY or IGNITION ON mode (vehicles with a smart key system), the system automatically reconnects the portable audio player.

If you have switched off the portable audio player yourself, follow the instructions below to reconnect:

- Select the portable audio player again
- Enter the portable audio player

**■ When you sell your car**

Be sure to delete your personal data. (→P. 280)

**⚠ WARNING****■ While driving**

Do not use the portable audio player, cellular phone or connect a device to the Bluetooth® system.

**■ Caution regarding interference with electronic devices**

- Your audio unit is fitted with Bluetooth® antennas. People with implantable cardiac pacemakers, cardiac resynchronization therapy-pacemakers or implantable cardioverter defibrillators should maintain a reasonable distance between themselves and the Bluetooth® antennas. The radio waves may affect the operation of such devices.
- Before using Bluetooth® devices, users of any electrical medical device other than implantable cardiac pacemakers, cardiac resynchronization therapy-pacemakers or implantable cardioverter defibrillators should consult the manufacturer of the device for information about its operation under the influence of radio waves. Radio waves could have unexpected effects on the operation of such medical devices.

**⚠ NOTICE****■ When leaving the vehicle**

Do not leave your portable audio player or cellular phone in the vehicle. The inside of the vehicle may become hot, causing damage to the portable audio player or cellular phone.

## Voice command system

The voice command system enables the hands-free system to be operated using voice commands.

Operations of the voice command system can be performed by selecting the menu corresponding to each function on the screen. Even if any menu is selected, commands displayed on all menus can be operated.

### Using the voice command system

- 1 Press the talk switch.

▶ Type A

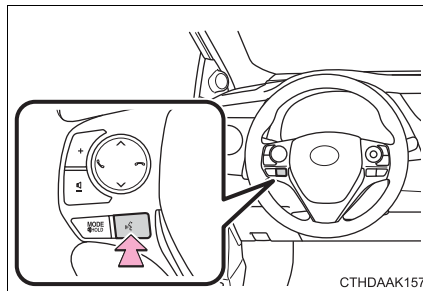

▶ Type B

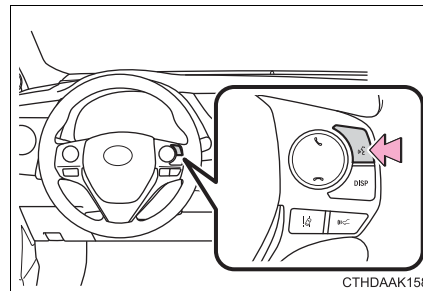

- 1 Select to train voice recognition.
- 2 Select to start the voice recognition tutorial.

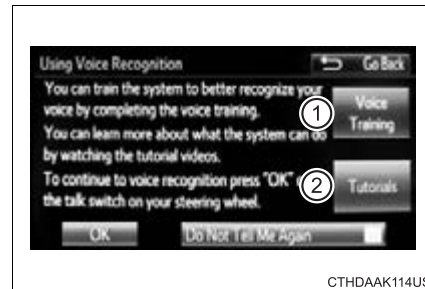

- 2 Select "OK" and say the desired command.

On the list screen, you can select the desired command.

To cancel the voice command system, press and hold the talk switch.

**■ Microphone**

→P. 323

**■ When using the microphone**

- It is unnecessary to speak directly into the microphone when giving a command.
- When “Voice Prompt Interrupt” set to on, it is not necessary to wait for the confirmation beep before speaking a command. (→P. 283)
- Voice commands may not be recognized if:
  - Spoken too quickly.
  - Spoken at a low or high volume.
  - The roof or windows are open.
  - Passengers are talking while voice commands are spoken.
  - The air conditioning speed is set high.
  - The air conditioning vents are turned towards the microphone.
- In the following conditions, the system may not recognize the command properly and using voice commands may not be possible:
  - The command is incorrect or unclear. Note that certain words, accents or speech patterns may be difficult for the system to recognize.
  - There is excessive background noise, such as wind noise.

**Casual speech recognition**

Due to natural language speech recognition technology, this system enables recognition of a command when spoken naturally. However, the system cannot recognize every variation of each command.

In some situations, it is possible to omit the command for the procedure and directly state the desired operation.

Not all voice commands are displayed in the short cut menu.

This function is available in English, Spanish and French.

**■ Expression examples for each function**

Command	Expression examples
“Call (name) (type)”	Get me (Robert Brown). I need to call (Robert Brown) at (Work) right away.
“Dial (number)”	Please dial the number (3334445555). Ring (3334445555).



### Command list

Some recognizable voice commands and their actions are shown below as examples.

#### ► Basic

Command	Action
"Help"	Prompts voice guidance to offer examples of commands or operation methods
"Go Back"	Returns to the previous screen

#### ► Phone

Command	Action
"Redial"	Places a call to the phone number of the latest outgoing call
"Call Back"	Places a call to the phone number of latest incoming call
"Show Recent Calls"	Displays the call history screen
"Dial (phone number)"	Places a call to the said phone number
"Call (contacts) (phonetypes)"	Place a call to the said phone type of the contact from the phone book

### Mobile Assistant

The Mobile Assistant feature will activate Apple's Siri® Eyes Free mode via the steering wheel switches. To operate the Mobile Assistant, a compatible cellular phone must be registered and connected to this system via Bluetooth®. (→P. 312)

- 1 Press and hold the off-hook on the steering wheel until you hear the beeps.

▶ Type A

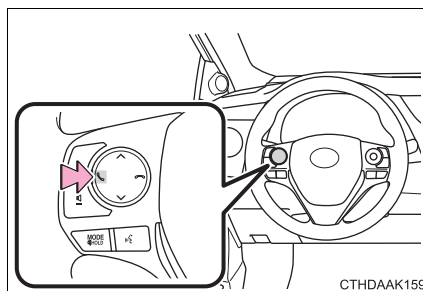

▶ Type B

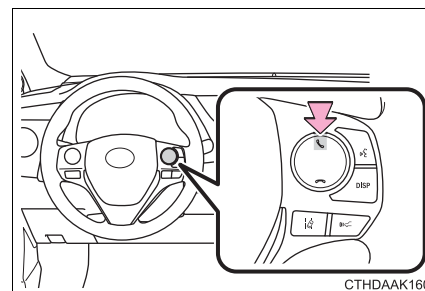

- 2 The Mobile Assistant can be used only when the following screen is displayed.

To cancel the Mobile Assistant, select "Cancel", or press and hold the off-hook on the steering wheel.

To restart the Mobile Assistant for additional commands, press the off-hook on the steering wheel.

- Mobile Assistant can only be restarted after the system responds to a voice command.
- After some phone and music commands, the Mobile Assistant feature will automatically end to complete the requested action.

#### ■ Adjusting the Mobile Assistant volume

The volume of the Mobile Assistant can be adjusted using the "PWR·VOL" knob or steering wheel volume switches. The Mobile Assistant and phone call volumes are synchronized.

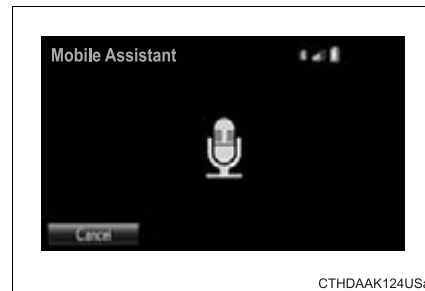

---

**■ Notes about Mobile Assistant**

- The available features and functions may vary based on the iOS version installed on the connected device.
- Some Siri features are limited in Eyes Free mode. If you attempt to use an unavailable function, Siri will inform you that the function is not available.
- If Siri is not enabled on the cellular phone connected via Bluetooth<sup>®</sup>, an error message will be displayed on the screen.
- While a phone call is active, the Mobile Assistant cannot be used.
- If using the navigation feature of the cellular phone, ensure the active audio source is Bluetooth<sup>®</sup> audio or iPod in order to hear turn by turn direction prompts.



**Interior features****6****6-1. Using the air conditioning system and defogger**

- Manual air conditioning system..... 366
- Automatic air conditioning system..... 373
- Heated steering wheel/ seat heaters ..... 382

**6-2. Using the interior lights**

- Interior lights list ..... 384
  - Front interior light/ personal lights..... 385
  - Rear interior light ..... 386

**6-3. Using the storage features**

- List of storage features ..... 387
  - Glove box..... 388
  - Console box..... 388
  - Bottle holders..... 389
  - Cup holders ..... 390

**6-4. Other interior features**

- Other interior features ..... 392
  - Sun visors ..... 392
  - Vanity mirrors..... 392
  - Clock..... 392
  - Outside temperature display..... 393
  - Power outlet..... 394
  - Assist grips ..... 395
- Garage door opener..... 396
- Compass ..... 403

## Manual air conditioning system\*

### Air conditioning controls

#### ► Heater

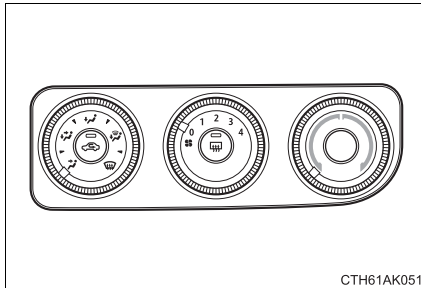

#### ► Air conditioning system

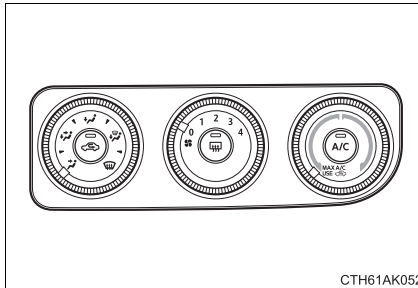



### ■ Adjusting the temperature setting

#### ► Heater

To adjust the temperature setting, turn the  dial clockwise to increase the temperature.

#### ► Air conditioning system

To adjust the temperature setting, turn the  dial clockwise (warm) or counterclockwise (cool).

If  is not pressed, the system will blow ambient temperature air or heated air.

### ■ Fan speed setting

To adjust the fan speed, turn the  dial clockwise (increase) or counterclockwise (decrease).

Turning the dial to "0" turns off the fan.

\*: If equipped

**■ Changing airflow modes**

To change the airflow mode, set the  dial to the desired position.

- ① Air flows to the upper body.
- ② Air flows to the upper body and feet.
- ③ Air flows to the feet.
- ④ Air flows to the feet and the windshield defogger operates.
- ⑤ Air flows to the windshield.

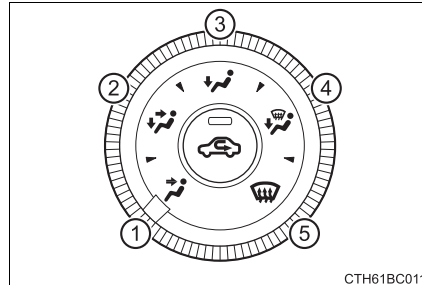

### Other functions

#### ■ Switching between outside air and recirculated air modes

Press  .

The mode switches between outside air mode (indicator off) and recirculated air mode (indicator on) each time  is pressed.

#### ■ Defogging the windshield

Defoggers are used to defog the windshield and front side windows.

Set the air outlet selector dial to the  position.

Set the outside/recirculated air mode button to outside air mode if the recirculated air mode is used. (It may switch automatically.)

To defog the windshield and the side windows early, turn the air flow and temperature up.

Vehicles with the air conditioning system: If the dehumidification function is not operating, press  to operate the dehumidification function.

#### ■ Defogging the rear window and outside rear view mirrors

▶ Vehicles without outside rear view mirror defoggers

Defoggers are used to defog the rear window.

Press  .

The defoggers will automatically turn off after a period of time.

▶ Vehicles with outside rear view mirror defoggers

Defoggers are used to defog the rear window, and to remove raindrops, dew and frost from the outside rear view mirrors.

Press  .

The defoggers will automatically turn off after a period of time.



## Air outlets

### ■ Location of air outlets

The air outlets and air volume changes according to the selected airflow mode.

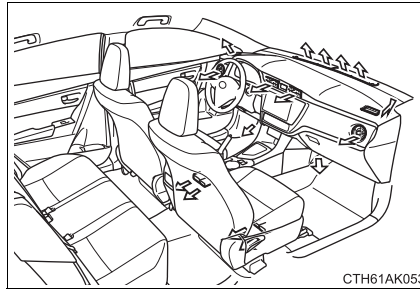

### ■ Adjusting the position of and opening and closing the air outlets

#### ► Front center outlets

Direct air flow to the left or right, up or down.

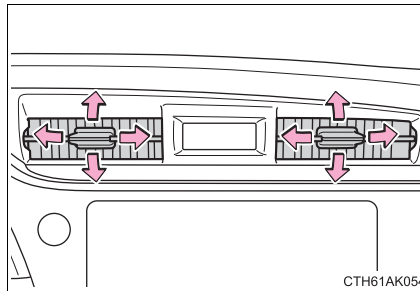

► Front side outlets

Direct air flow to the left or right,  
up or down.

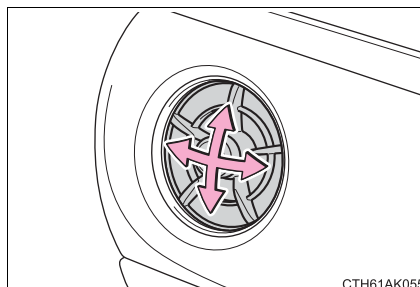

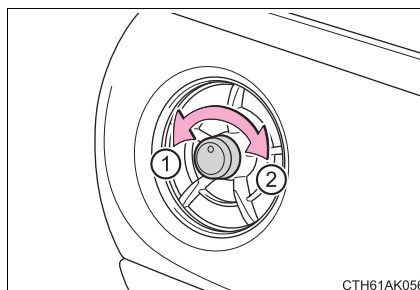

- ① Open the vent
- ② Close the vent





**■ For quick cooling (vehicles with an air conditioning system)**

Turn the  dial to the "MAX A/C" position and select the recirculated air mode.

**■ Fogging up of the windows**

● Vehicles with the  button: The windows will easily fog up when the humidity in the vehicle is high. Turning  on will dehumidify the air from the outlets and defog the windshield effectively.

● Vehicles with the  button: If you turn  off, the windows may fog up more easily.

● The windows may fog up if the recirculated air mode is used.

**■ Outside/recirculated air mode**

When driving on dusty roads such as tunnels or in heavy traffic, set the outside/recirculated air mode button to the recirculated air mode. This is effective in preventing outside air from entering the vehicle interior. During cooling operation, setting the recirculated air mode will also cool the vehicle interior effectively.

**■ When the outside temperature is low (vehicles with the  button)**

The air conditioning system may not operate even when  is pressed.

**■ Ventilation and air conditioning odors**

● To let fresh air in, set the air conditioning system to the outside air mode.

● During use, various odors from inside and outside the vehicle may enter into and accumulate in the air conditioning system. This may then cause odor to be emitted from the vents.

● To reduce potential odors from occurring:

It is recommended that the air conditioning system be set to outside air mode prior to turning the vehicle off.

**■ Air conditioning filter**

→P. 453

**⚠ WARNING****■ To prevent the windshield from fogging up**

- Do not set the air outlet selector dial to  during cool air operation in extremely humid weather. The difference between the temperature of the outside air and that of the windshield can cause the outer surface of the windshield to fog up, blocking your vision.
- Do not place anything on the instrument panel which may cover the air outlets. Otherwise, air flow may be obstructed, preventing the windshield defoggers from defogging.

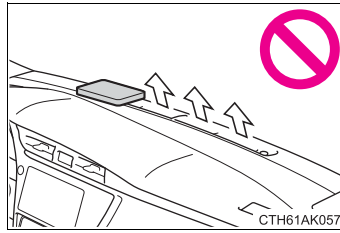
**■ To prevent burns (vehicles with outside rear view mirror defoggers)**

Do not touch the rear view mirror surfaces when the outside rear view mirror defoggers are on.

**⚠ NOTICE****■ To prevent battery discharge**

Do not leave the air conditioning system on longer than necessary when the engine is stopped.

## Automatic air conditioning system\*

**Air outlets and fan speed are automatically adjusted according to the temperature setting.**

### Air conditioning controls

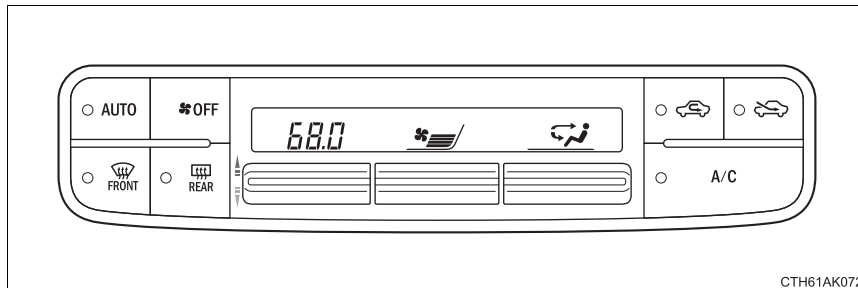

CTH61AK072

#### ■ Adjusting the temperature setting

- ① Increases the temperature
- ② Decreases the temperature

If  is not pressed, the system will blow ambient temperature air or heated air.

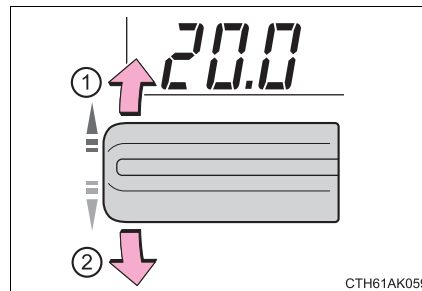

CTH61AK059

6

Interior features

\*: If equipped

### ■ Fan speed setting

- ① Increases the fan speed
- ② Decreases the fan speed

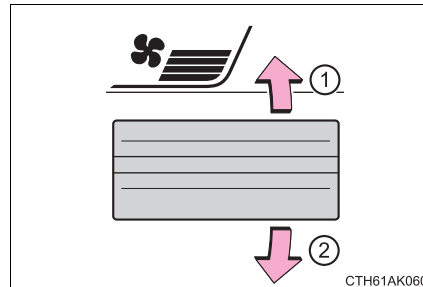

### ■ Change the airflow mode

To change the airflow mode, move the airflow change knob upward or downward.

The air outlets used are changed each time the knob is operated.

- ① Air flows to the upper body.
- ② Air flows to the upper body and feet.
- ③ Air flows to the feet.
- ④ Air flows to the feet and the windshield defogger operates.

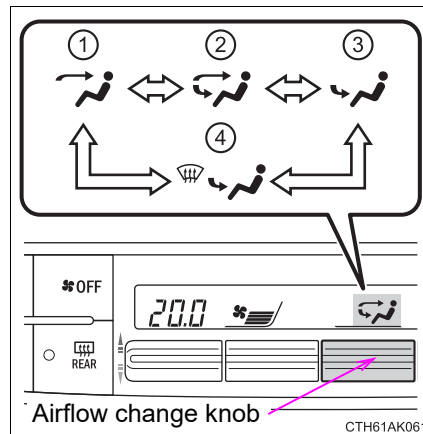

### ■ Other functions

- Switching between outside air and recirculated air modes (→P. 375)
- Defogging the windshield (→P. 376)
- Defogging the rear window and outside rear view mirrors (→P. 376)

### Using automatic mode

- 1 Press .

The dehumidification function begins to operate. Air outlets and fan speed are automatically adjusted according to the temperature setting.

- 2 Adjust the temperature setting.

- 3 To stop the operation, press .

#### ■ Automatic mode indicator

If the fan speed setting or air flow modes are operated, the automatic mode indicator goes off. However, automatic mode for functions other than that operated is maintained.

### Other functions

#### ■ Switching between outside air and recirculated air modes

Press  to change to recirculated air mode.

Press  to change to outside air mode.

When recirculated air mode is selected, the indicator on  illuminates.

When outside air mode is selected, the indicator on  illuminates.

### ■ Defogging the windshield

Defoggers are used to defog the windshield and front side windows.

Press  .

The dehumidification function operates and fan speed increases.

Set the outside/recirculated air mode button to the outside air mode if the recirculated air mode is used. (It may switch automatically.)

To defog the windshield and the front side windows early, turn the air flow and temperature up.

To return to the previous mode, press  again when the windshield is defogged.

### ■ Defogging the rear window and outside rear view mirrors

Defoggers are used to defog the rear window, and to remove rain-drops, dew and frost from the outside rear view mirrors.

Press  .

The defoggers will automatically turn off after a period of time.

### ■ Windshield wiper de-icer (if equipped)

This feature is used to prevent ice from building up on the windshield and wiper blades.

Press the switch to turn the system on/off.

The indicator comes on when the windshield wiper de-icer is on.

The windshield de-icer will automatically turn off after a period of time.

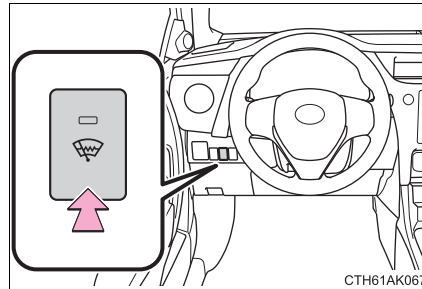



## Air outlets

### ■ Location of air outlets

The air outlets and air volume changes according to the selected airflow mode.

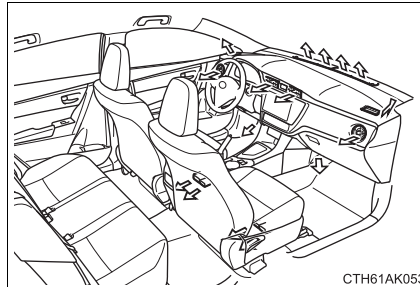

### ■ Adjusting the position of and opening and closing the air outlets

#### ▶ Front center outlets

Direct air flow to the left or right, up or down.

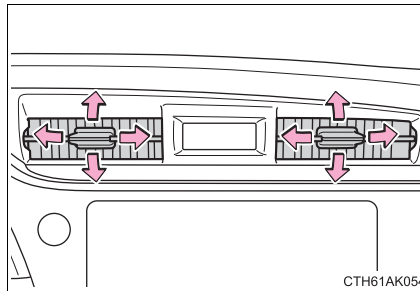

► Front side outlets

Direct air flow to the left or right, up or down.

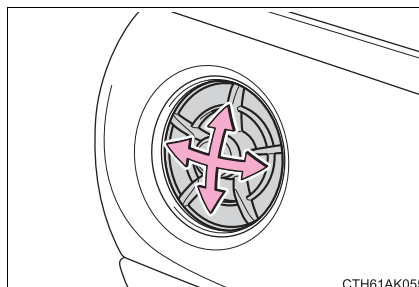

- ① Open the vent
- ② Close the vent

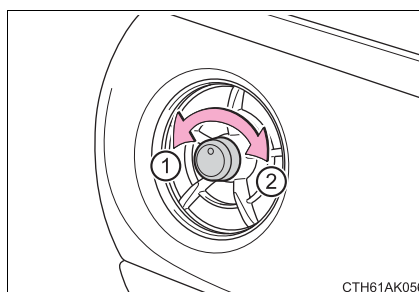

■ **Operation of the air conditioning system in Eco drive mode (if equipped)**

In Eco drive mode, the air conditioning system is controlled as follows to prioritize fuel efficiency:

- Engine speed controlled to restrict heating/cooling capacity.
- Outside/recirculated air mode may automatically switch depending on the temperature setting or the inside temperature.
- Fan speed restricted when automatic mode is selected

To improve air conditioning performance, perform the following operations:

- Adjust the fan speed.
- Turn off Eco drive mode. (→P. 182)

■ **Using automatic mode**

Fan speed is adjusted automatically according to the temperature setting and the ambient conditions.

Therefore, the fan may stop for a while until warm or cool air is ready to flow

immediately after  is pressed.

**■ Fogging up of the windows**

- The windows will easily fog up when the humidity in the vehicle is high.

Turning  on will dehumidify the air from the outlets and defog the windshield effectively.

- If you turn  off, the windows may fog up more easily.
- The windows may fog up if the recirculated air mode is used.

**■ Outside/recirculated air mode**

- When driving on dusty roads such as tunnels or in heavy traffic, set the outside/recirculated air mode button to recirculated air mode. This is effective in preventing outside air from entering the vehicle interior. During cooling operation, setting the recirculated air mode will also cool the vehicle interior effectively.
- Outside/recirculated air mode may automatically switch depending on the temperature setting or the inside temperature.

**■ When the outside temperature exceeds 75°F (24°C) and the air conditioning system is on**

- In order to reduce the air conditioning power consumption, the air conditioning system may switch to recirculated air mode automatically. This may also reduce fuel consumption.
  - ▶ Vehicles without a smart key system
- Recirculated air mode is selected as a default mode when the engine switch is turned to the “ON” position.
  - ▶ Vehicles with a smart key system
- Recirculated air mode is selected as a default mode when the engine switch is turned to IGNITION ON mode.
- It is possible to switch to outside air mode at any time by pressing  .

**■ When the outside temperature is low**

The dehumidification function may not operate even when  is pressed.

**■ Ventilation and air conditioning odors**

- To let fresh air in, set the air conditioning system to the outside air mode.
- During use, various odors from inside and outside the vehicle may enter into and accumulate in the air conditioning system. This may then cause odor to be emitted from the vents.
- To reduce potential odors from occurring:
  - It is recommended that the air conditioning system be set to outside air mode prior to turning the vehicle off.
  - The start timing of the blower may be delayed for a short period of time immediately after the air conditioning system is started in automatic mode.

**■ Air conditioning filter**

→P. 453

**■ Customization that can be configured at Toyota dealer**

Settings (e.g. air conditioning setting) can be changed.  
(Customizable features →P. 564)

**⚠ WARNING****■ To prevent the windshield from fogging up**

- Do not use  during cool air operation in extremely humid weather.

The difference between the temperature of the outside air and that of the windshield can cause the outer surface of the windshield to fog up, blocking your vision.

- Do not place anything on the instrument panel which may cover the air outlets. Otherwise, air flow may be obstructed, preventing the windshield defoggers from defogging.

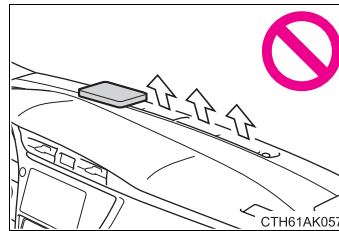
**■ To prevent burns**

- Do not touch the rear view mirror surfaces when the outside rear view mirror defoggers are on.
- Do not touch the glass at lower part of the windshield or to the side of the front pillars when the windshield wiper de-icer is on. (if equipped)

**⚠ NOTICE****■ To prevent battery discharge**

Do not leave the air conditioning system on longer than necessary when the engine is stopped.

## Heated steering wheel\*/seat heaters\*

**The heated steering wheel and seat heaters heat the side grips of the steering wheel and seats, respectively.**

### WARNING

- Care should be taken to prevent injury if anyone in the following categories comes in contact with the steering wheel or seats when the heater is on:
  - Babies, small children, the elderly, the sick and the physically challenged
  - Persons with sensitive skin
  - Persons who are fatigued
  - Persons who have taken alcohol or drugs that induce sleep (sleeping drugs, cold remedies, etc.)
- Observe the following precautions to prevent the minor burns or overheating
  - Do not cover the seat with a blanket or cushion when using the seat heater.
  - Do not use the seat heaters more than necessary.

### NOTICE

- Do not put heavy objects that have an uneven surface on the seat and do not stick sharp objects (needles, nails, etc.) into the seat.
- To prevent battery discharge, do not use the functions when the engine is stopped.

\*: If equipped

### Heated steering wheel

Turn the heated steering wheel on/off

The indicator light comes on when the heated steering wheel is operating.

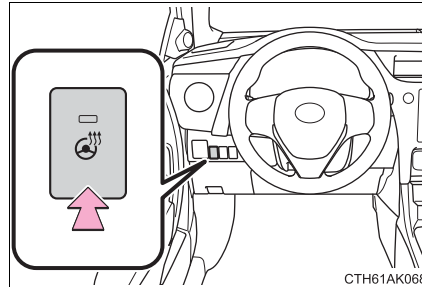

CTH61AK068

#### ■ The heated steering wheel can be used when

- ▶ Vehicles without a smart key system  
The engine switch is in the "ON" position.
- ▶ Vehicles with a smart key system  
The engine switch is in IGNITION ON mode.

### Seat heaters

Press the switch.

- ① High temperature
- ② Low temperature

The indicator light comes on when the switch is on.

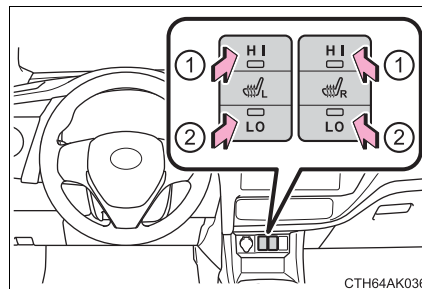

CTH64AK036

#### ■ The seat heaters can be used when

- ▶ Vehicles without a smart key system  
The engine switch is in the "ON" position.
- ▶ Vehicles with a smart key system  
The engine switch is in IGNITION ON mode.

#### ■ When not in use

Put the switch in the neutral position. The indicator will turn off.

## Interior lights list

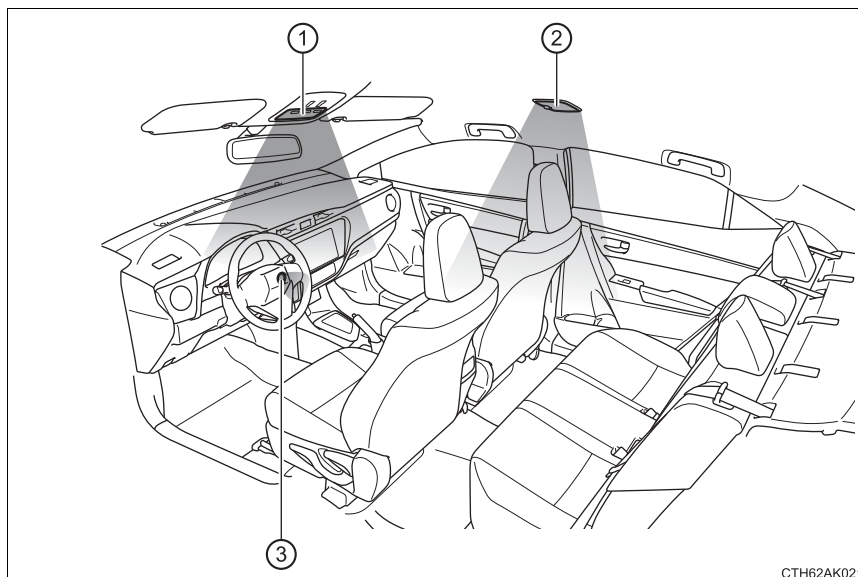

- ① Front interior light/personal lights (→P. 385)
- ② Rear interior light (→P. 386)
- ③ Engine switch light (vehicles with a smart key system)



**Front interior light/personal lights**

■ **Front interior light**

▶ **Type A**

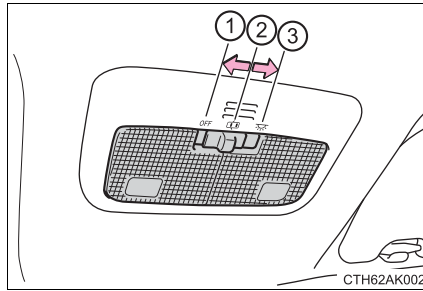

- ① Off
- ② Door position
- ③ On

▶ **Type B**

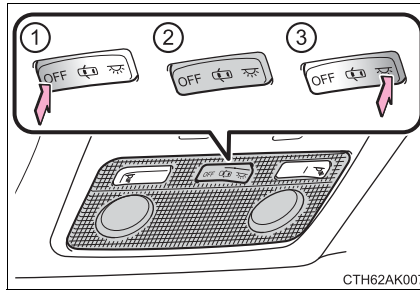

■ **Personal lights**

▶ **Type A**

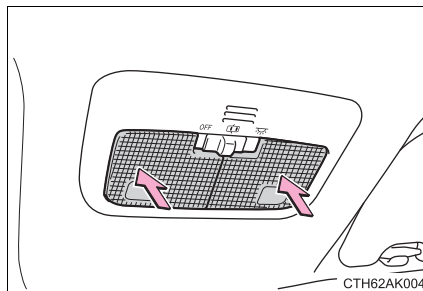

On/off

▶ **Type B**

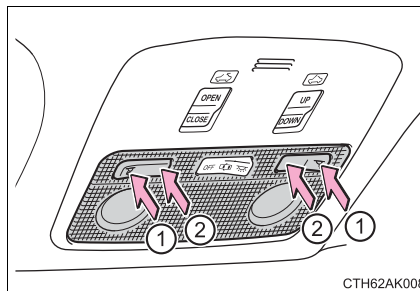

- ① On
- ② Off

When a light is on due to its door link switch, the light will not turn off even if the lens or switch is pressed.

### Rear interior light

- ① On
- ② Door position
- ③ Off

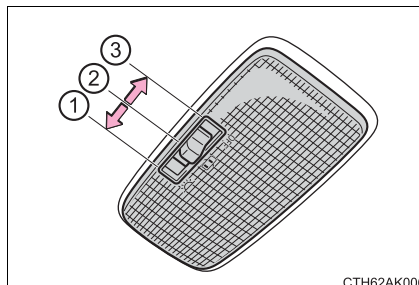

### ■ Illuminated entry system

- ▶ Vehicles without a smart key system

When the interior light switch is in the door position, the interior light automatically turns on/off according to the engine switch position, whether the doors are locked/unlocked and whether the doors are open/closed.

- ▶ Vehicles with a smart key system

When the interior light switch is in the door position, the interior light and engine switch light automatically turn on/off according to engine switch mode, the presence of the electronic key, whether the doors are locked/unlocked and whether the doors are open/closed.

### ■ To prevent battery discharge

The following lights will go off automatically after 20 minutes:

- Front interior light/personal lights
- Rear interior light
- Trunk light

### ■ Customization

Setting (e.g. the time elapsed before lights turn off) can be changed.  
(Customizable features: →P. 564)

## List of storage features

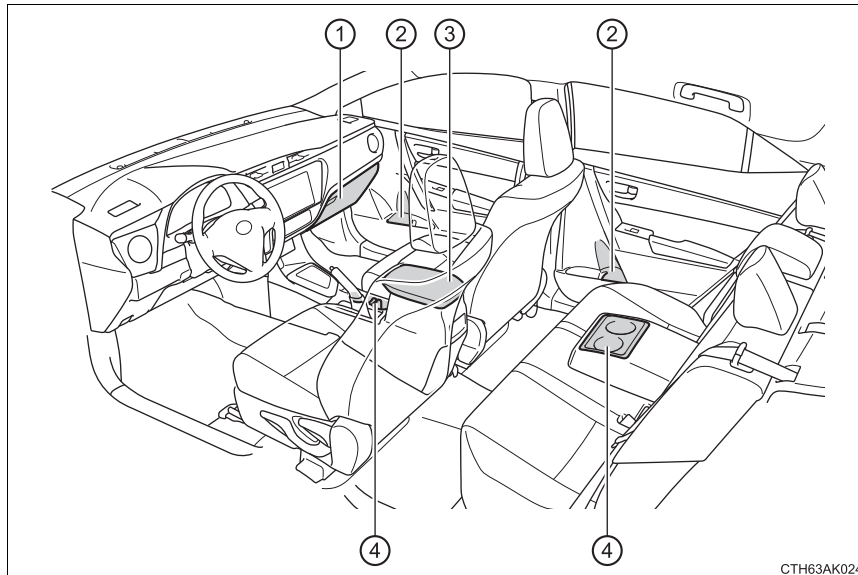

- |                  |           |               |           |
|------------------|-----------|---------------|-----------|
| ① Glove box      | (→P. 388) | ③ Console box | (→P. 388) |
| ② Bottle holders | (→P. 389) | ④ Cup holders | (→P. 390) |

### **⚠ WARNING**

#### ■ Items that should not be left in the storage spaces

Do not leave glasses, lighters or spray cans in the storage spaces, as this may cause the following when cabin temperature becomes high:

- Glasses may be deformed by heat or cracked if they come into contact with other stored items.
- Lighters or spray cans may explode. If they come into contact with other stored items, the lighter may catch fire or the spray can may release gas, causing a fire hazard.

#### ■ When driving or when the storage compartments are not in use

Keep the lids closed.

In the event of sudden braking or sudden swerving, an accident may occur due to an occupant being struck by an open lid or the items stored inside.

### Glove box

Pull up the lever to open the glove box.

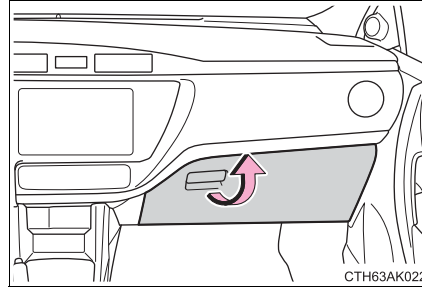

### Console box

#### ► Console box

Lift the lid while pulling up the knob on the right side.

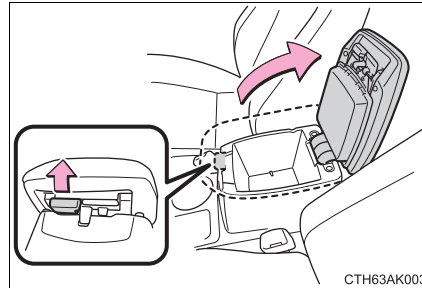

#### ► Upper level box

Lift the lid while pulling up the knob on the left side.

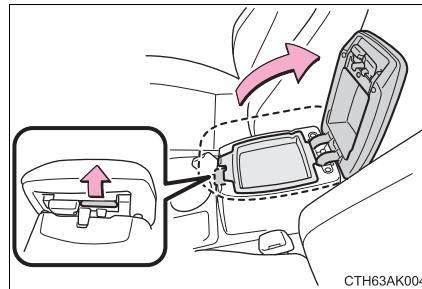

## Bottle holders

### ■ Front

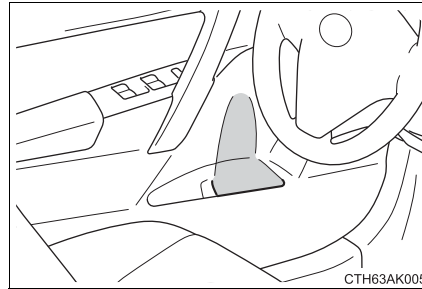

### ■ Rear

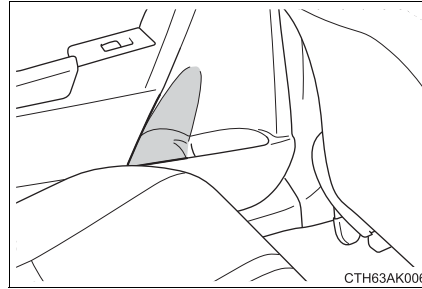

### ■ When using the holder as a bottle holder

- When storing a bottle, close the cap.
- The bottle may not be stored depending on its size or shape.

### ⚠ WARNING

#### ■ Items unsuitable for the bottle holder

Do not place anything other than a bottle in the bottle holders. Other items may be thrown out of the holders in the event of an accident or sudden braking and cause injury.

### ⚠ NOTICE

#### ■ Items that should not be stowed in the bottle holders

Put the cap on before stowing a bottle. Do not place open bottles in the bottle holders, or glass or paper cups containing liquid. The contents may spill and glass cups may break.

### Cup holders

#### ■ Front

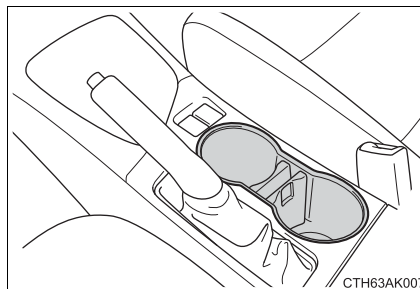

#### ■ Rear (if equipped)

Pull the armrest down.

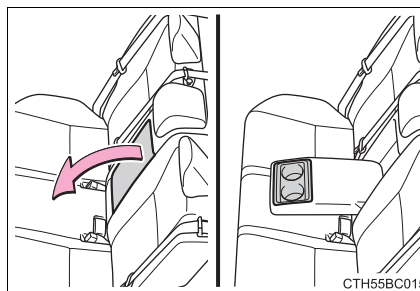

### ■ Adjusting the size of the cup holder (front)

- 1 Remove the cup holder insert.

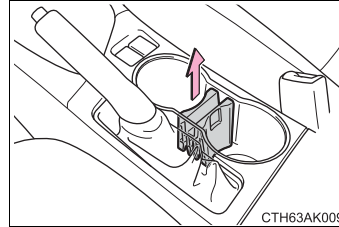

- 2 Change the cup holder insert position.

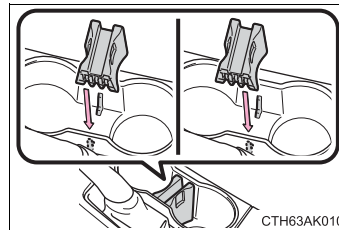

### ■ Removing the cup holder insert (front)

The cup holder insert may be removed for cleaning.

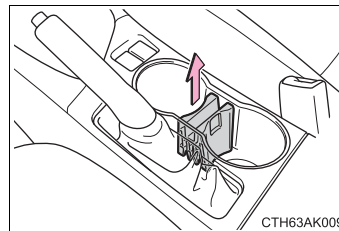

#### ⚠ WARNING

##### ■ Items unsuitable for the cup holders

Do not place anything other than cups or aluminum cans in the cup holders. Other items may be thrown out of the holders in the event of an accident or sudden braking, causing injury. If possible, cover hot drinks to prevent burns.

## Other interior features

### Sun visors

- ① To set the visor in the forward position, flip it down.
- ② To set the visor in the side position, flip down, unhook, and swing it to the side.
- ③ To use the side extender, place the visor in the side position, then slide it backward. (if equipped)

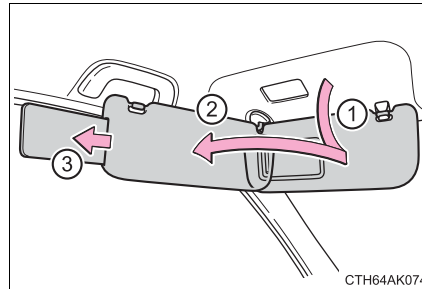

CTH64AK074

### Vanity mirrors

Slide the cover to open.

The vanity light turns on when the cover is opened.

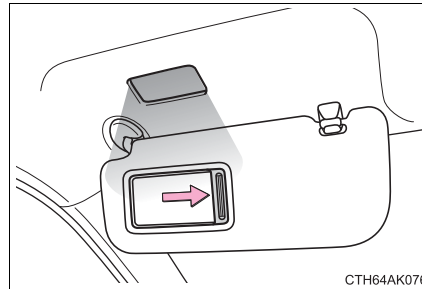

CTH64AK076

If the vanity lights remain on for 20 minutes while the engine is off, the lights will turn off automatically.

### Clock

The clock can be adjusted.

- ① Adjusts the hours
- ② Adjusts the minutes
- ③ Rounds to the nearest hour\*

\*: e.g. 1:00 to 1:29 → 1:00  
1:30 to 1:59 → 2:00

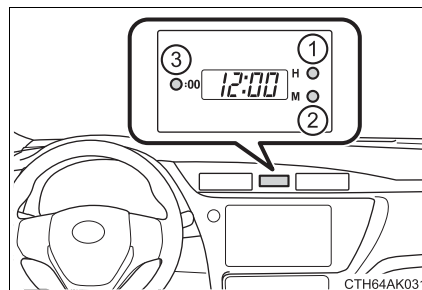

CTH64AK031



### Outside temperature display

The temperature display shows temperatures within the range of  $-40^{\circ}\text{F}$  ( $-40^{\circ}\text{C}$ ) to  $122^{\circ}\text{F}$  ( $50^{\circ}\text{C}$ ).

#### ► Type A

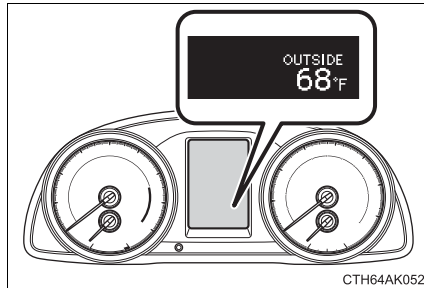

#### ► Type B

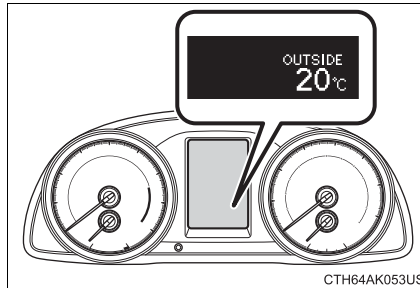

#### ► Type C

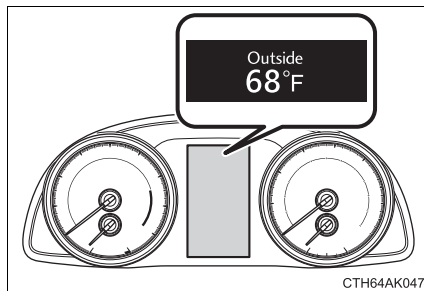

#### ► Type D

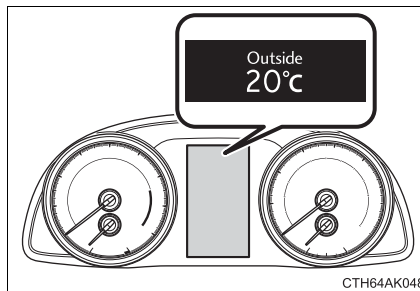

#### ■ The outside temperature is displayed when

- Vehicles without a smart key system  
The engine switch is in the “ON” position.
- Vehicles with a smart key system  
The engine switch is in IGNITION ON mode.

#### ■ Display

In the following situations, the correct outside temperature may not be displayed, or the display may take longer than normal to change.

- When the vehicle is stopped, or moving at low speeds (less than 9 mph [15 km/h]).
- When the outside temperature has changed suddenly (at the entrance/exit of a garage, tunnel, etc.)

#### ■ When “--°F” or “--°C” is displayed

The system may be malfunctioning. Take your vehicle to your Toyota dealer.

### Power outlet

Please use as a power supply for electronic goods that use less than 12 VDC/10 A (power consumption of 120 W).

Open the lid.

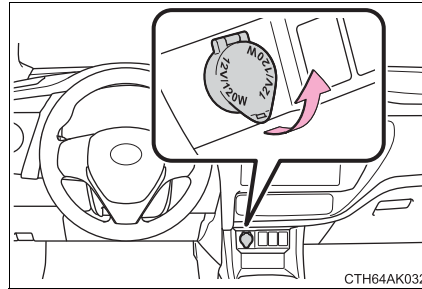

#### ■ The power outlet can be used when

- ▶ Vehicles without a smart key system

The engine switch is in the “ACC” or “ON” position.

- ▶ Vehicles with a smart key system

The engine switch is in ACCESSORY or IGNITION ON mode.

#### ⚠ NOTICE

- To avoid damaging the power outlet, close the power outlet lid when the power outlet is not in use. Foreign objects or liquids that enter the power outlet may cause a short circuit.
- To prevent battery discharge, do not use the power outlet longer than necessary when the engine is off.

### Assist grips

An assist grip installed on the ceiling can be used to support your body while sitting on the seat.

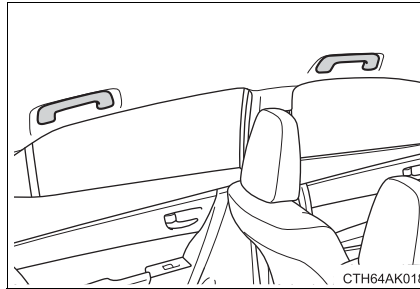

#### WARNING

Do not use the assist grip when getting in or out of the vehicle or rising from your seat.

#### NOTICE

To prevent damage to the assist grip, do not put a heavy load on the assist grip.

## Garage door opener\*

The garage door opener can be programmed to operate garage doors, gates, entry doors, door locks, home lighting systems, security systems, and other devices.

### HomeLink®

The HomeLink® wireless control system in your vehicle has 3 buttons which can be programmed to operate 3 different devices. Refer to the programming methods on the following pages to determine the method which is appropriate for the device.

- ① HomeLink® indicator light
- ② Garage door operation indicators
- ③ Buttons

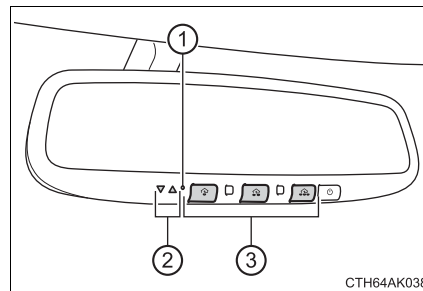

#### ■ Before programming the HomeLink®

- During programming, it is possible that garage doors, gates, or other devices may operate. For this reason, make sure that people and objects are clear of the garage door or other devices to prevent injury or other potential harm.
- It is recommended that a new battery be placed in the remote control transmitter for more accurate programming.
- Garage door opener motors manufactured after 1995 may be equipped with rolling code protection. If this is the case, you may need a stepladder or other sturdy, safe device to reach the “learn” or “smart” button on the garage door opener motor.

\*: If equipped

### ■ Programming the HomeLink®

Steps **1** through **3** must be performed within 60 seconds, otherwise the indicator light will stop flashing and programming will not be able to be completed.

- 1** Press and release the HomeLink® button you want to program and check that the HomeLink® indicator light flashes orange.

- 2** Point the remote control transmitter for the device at the rear view mirror, 1 to 3 in. (25 to 75 mm) from the HomeLink® buttons.

Keep the HomeLink® indicator light in view while programming.

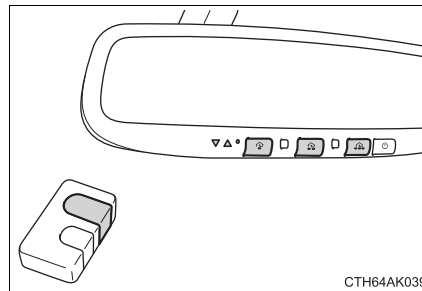

- 3** Program a device.

- ▶ Programming a device other than an entry gate (for U.S.A. owners)

Press and hold the remote control transmitter button until the HomeLink® indicator light changes from slowly flashing orange to rapidly flashing green (rolling code) or continuously lit green (fixed code), then release the button.

- ▶ Programming an entry gate (for U.S.A. owners)/Programming a device in the Canadian market

Press and release the remote control transmitter button at 2 second intervals, repeatedly, until the HomeLink® indicator light changes from slowly flashing orange to rapidly flashing green (rolling code) or continuously lit green (fixed code).

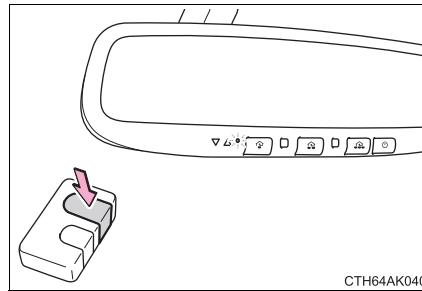

- 4 Test the HomeLink<sup>®</sup> operation by pressing the newly programmed button and observing the indicator light:
  - Indicator light illuminates: Programming of a fixed code device has completed. The garage door or other device should operate when a HomeLink<sup>®</sup> button is pressed and released.
  - Indicator light flashes rapidly: The garage door opener motor or other device is equipped with a rolling code. To complete programming, firmly press and hold the HomeLink<sup>®</sup> button for 2 seconds then release it.
  - If the garage door or other device does not operate, proceed to “Programming a rolling code system”.
- 5 Repeat the steps above to program another device for any of the remaining HomeLink<sup>®</sup> buttons.

#### ■ Programming a rolling code system

2 or more people may be necessary to complete rolling code programming.

- 1 Locate the “Learn” or “Smart” button on the garage door opener motor in the garage.

This button can usually be found where the hanging antenna wire is attached to the unit. The name and color of the button may vary by manufacturer. Refer to the Owner’s manual supplied with the garage door opener motor for details.

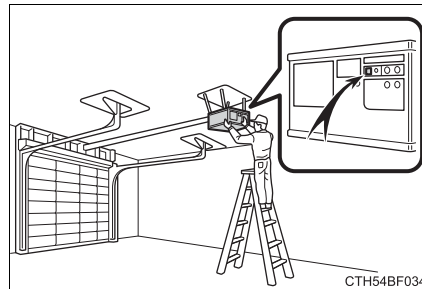

- 2 Press and release the “Learn” or “Smart” button. Perform 3 within 30 seconds after performing 2.

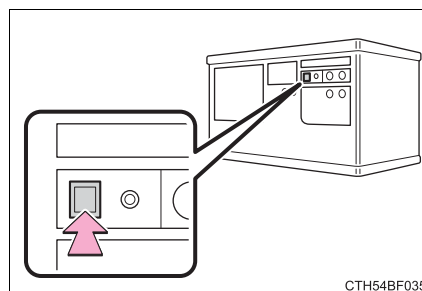

- 3 Press and hold the desired HomeLink<sup>®</sup> button (inside the vehicle) for 2 seconds and release it. Repeat this sequence (press/hold/release) up to 3 times to complete programming.

If the garage door opener motor operates when the HomeLink<sup>®</sup> button is pressed, the garage door opener motor recognizes the HomeLink<sup>®</sup> signal.

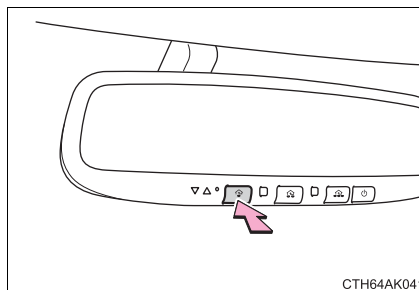

#### ■ Enabling 2-way communication with a garage door (only available for compatible devices)

When enabled, 2-way communication allows you to check the status of the opening and closing of a garage door through indicators in your vehicle.

2-way communication is only available if the garage door opener motor used is a compatible device. (To check device compatibility, refer to [www.HomeLink.com](http://www.HomeLink.com).)

- 1 Within 5 seconds after programming the garage door opener has been completed, if the garage door opener motor is trained to HomeLink<sup>®</sup>, both garage door operation indicators will flash rapidly green and the light on the garage door opener motor will blink twice, indicating that 2-way communication is enabled.

If the indicators do not flash, perform 2 and 3 within the first 10 presses of the HomeLink<sup>®</sup> button after programming has been completed.

- 2 Press a programmed HomeLink<sup>®</sup> button to operate a garage door.
- 3 Within 1 minute of pressing the HomeLink<sup>®</sup> button, after the garage door operation has stopped, press the “Learn” or “Smart” button on the garage door opener motor. Within 5 seconds of the establishment of 2-way communication with the garage door opener, both garage door operation indicators in the vehicle will flash rapidly green and the light on the garage door opener motor will blink twice, indicating that 2-way communication is enabled.

**■ Reprogramming a single HomeLink® button**

When the following procedure is performed, buttons which already have devices registered to them can be overwritten:

- 1 With one hand, press and hold the desired HomeLink® button.
- 2 When the HomeLink® indicator starts flashing orange, continue to hold the HomeLink® button and perform “Programming HomeLink®” 1 (it takes 20 seconds for the HomeLink® indicator to start flashing).

**Operating the HomeLink®**

Press the appropriate HomeLink® button. The HomeLink® indicator light should turn on.

**Garage door operation indicators**

The status of the opening and closing of a garage door is shown by the indicators.



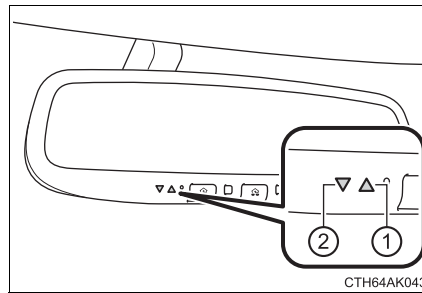

- 1 Opening
- 2 Closing

This function is only available if the garage door opener motor used is a compatible device. (To check device compatibility, refer to [www.HomeLink.com](http://www.HomeLink.com).)



Color	Status
Orange (flashing)	Currently opening/closing
Green	Opening/closing has completed
Red (flashing)	Feedback signals cannot be received

The indicators can operate within approximately 820 ft. (250 m) of the garage door. However, if there are obstructions between the garage door and the vehicle, such as houses and trees, feedback signals from the garage door may not be received. To recall the previous door operation status, press and release either HomeLink®

buttons  and  or  and  simultaneously. The last recorded status will be displayed for 3 seconds.



### Erasing the entire HomeLink® memory (all three codes)

Press and hold the 2 outside buttons for 10 seconds until the HomeLink® indicator light changes from continuously lit orange to rapidly flashing green.

If you sell your vehicle, be sure to erase the programs stored in the HomeLink® memory.

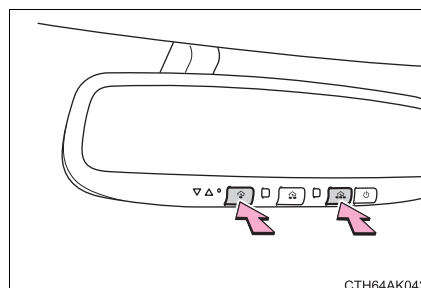

#### Codes stored in the HomeLink® memory

- The registered codes are not erased even if the battery cable is disconnected.
- If learning failed when registering a different code to a HomeLink® button that already has a code registered to it, the already registered code will not be erased.

#### Before programming

- Install a new battery in the transmitter.
- The battery side of the transmitter must be pointed away from the HomeLink®.

#### Certification for the garage door opener

- ▶ For the U.S.A.

FCC ID: NZLAECHL5

NOTE:

This device complies with part 15 of the FCC Rules. Operation is subject to the following two conditions: (1) This device may not cause harmful interference, and (2) this device must accept any interference received, including interference that may cause undesired operation.

FCC WARNING:

Changes or modifications not expressly approved by the party responsible for compliance could void the user's authority to operate the equipment.

- ▶ For Canada

NOTE:

This device complies with Industry Canada licence-exempt RSS standard(s). Operation is subject to the following two conditions: (1) this device may not cause interference, and (2) this device must accept any interference, including interference that may cause undesired operation of the device.

REMARQUE:

Le présent appareil est conforme aux CNR d'Industrie Canada applicables aux appareils radio exempts de licence. L'exploitation est autorisée aux deux conditions suivantes: (1) l'appareil ne doit pas produire de brouillage, et (2) l'utilisateur de l'appareil doit accepter tout brouillage radioélectrique subi, même si le brouillage est susceptible d'en compromettre le fonctionnement.

■ **When support is necessary**

Visit on the web at [www.homelink.com/toyota](http://www.homelink.com/toyota) or call 1-800-355-3515.

 **WARNING**

■ **When programming a garage door or other remote control device**

The garage door or other device may operate, so ensure people and objects are out of danger to prevent potential harm.

■ **Conforming to federal safety standards**

Do not use the HomeLink® compatible transceiver with any garage door opener or device that lacks safety stop and reverse features as required by federal safety standards. This includes any garage door that cannot detect an interfering object. A door or device without these features increases the risk of death or serious injury.

■ **When operating or programming HomeLink®**

Never allow a child to operate or play with the HomeLink® buttons.

## Compass\*

The compass on the inside rear view mirror indicates the direction in which the vehicle is heading.

### Operation

To turn the compass on or off, press the button for more than 3 seconds.

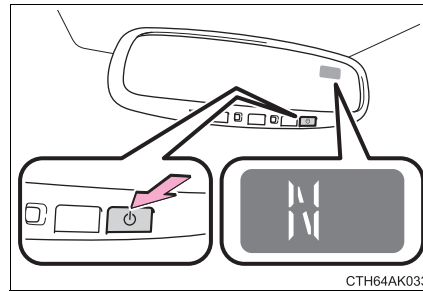

### Displays and directions

Display	Direction
N	North
NE	Northeast
E	East
SE	Southeast
S	South
SW	Southwest
W	West
NW	Northwest

\*: If equipped

**Calibrating the compass**

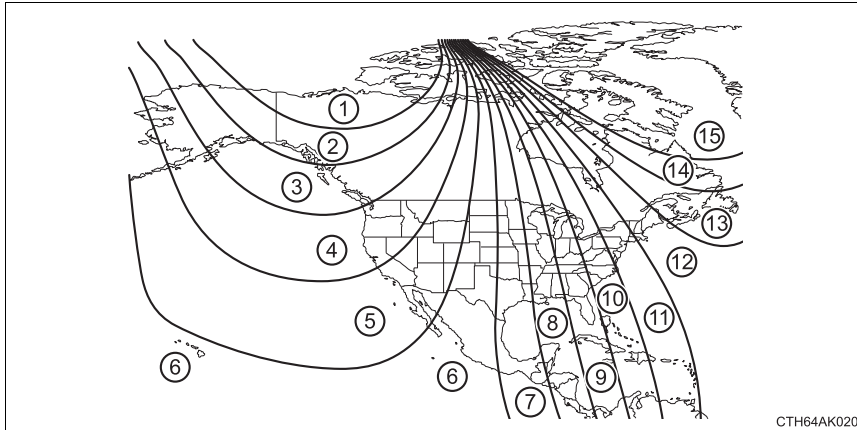

The direction display deviates from the true direction determined by the earth's magnetic field. The amount of deviation varies according to the geographic position of the vehicle.

If you cross over a map boundary shown in illustration, the compass will deviate.

To obtain higher precision or perfect calibration, refer to the following.

■ **Deviation calibration**

- 1 Stop the vehicle.
- 2 Press and hold the button for 6 seconds.  
A number (1 to 15) appears on the compass display.

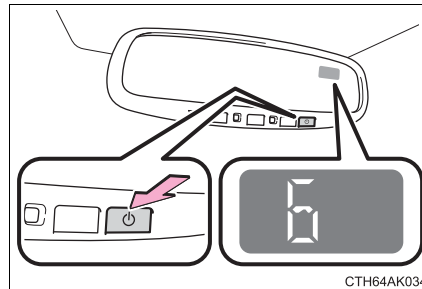

- 3 Press the switch and referring to the map above, select the number of the zone where you are.

If the direction is displayed several seconds after adjustment, the calibration is complete.

**■ Circling calibration**

- 1 Stop the vehicle in a place where it is safe to drive in a circle.
- 2 Press and hold the button for 9 seconds.  
C appears on the compass display.

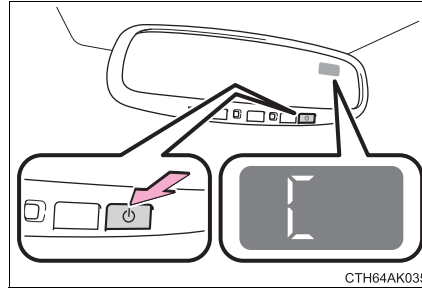

- 3 Drive the vehicle at 5 mph (8 km/h) or less in a circle until a direction is displayed.  
If there is not enough space to drive in a circle, drive around the block until the direction is displayed.

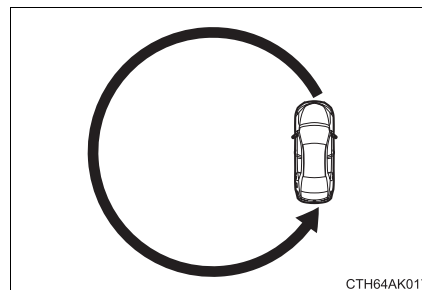

### ■ Conditions unfavorable to correct operation

The compass may not show the correct direction in the following conditions:

- The vehicle is stopped immediately after turning.
- The vehicle is on an inclined surface.
- The vehicle is in a place where the earth's magnetic field is subject to interference by artificial magnetic fields (underground car park/parking lot, under a steel tower, between buildings, roof car park/parking lot, near an intersection, near a large vehicle, etc.).
- The vehicle has become magnetized.  
(There is a magnet or metal object near the inside rear view mirror.)
- The battery has been disconnected.
- A door is open.



### WARNING

#### ■ While driving the vehicle

Do not adjust the display. Adjust the display only when the vehicle is stopped.

#### ■ When doing the circling calibration

Secure a wide space, and watch out for people and vehicles in the neighborhood. Do not violate any local traffic rules while performing circling calibration.



### NOTICE

#### ■ To avoid compass malfunctions

Do not place magnets or any metal objects near the inside rear view mirror. Doing this may cause the compass sensor to malfunction.

#### ■ To ensure normal operation of the compass

- Do not perform circling calibration of the compass in a place where the earth's magnetic field is subject to interference by artificial magnetic fields.
- During calibration, do not operate electric systems (moon roof, power windows, etc.) as they may interfere with the calibration.

**Maintenance and care****7**

- 7-1. Maintenance and care**
  - Cleaning and protecting the vehicle exterior..... 408
  - Cleaning and protecting the vehicle interior..... 411
- 7-2. Maintenance**
  - Maintenance requirements..... 414
  - General maintenance..... 417
  - Emission inspection and maintenance (I/M) programs..... 421
- 7-3. Do-it-yourself maintenance**
  - Do-it-yourself service precautions ..... 422
  - Hood ..... 425
  - Positioning a floor jack ..... 427
  - Engine compartment..... 429
  - Tires ..... 440
  - Tire inflation pressure ..... 448
  - Wheels ..... 451
  - Air conditioning filter..... 453
  - Wireless remote control/ electronic key battery ..... 455
  - Checking and replacing fuses ..... 458
  - Light bulbs..... 461

## Cleaning and protecting the vehicle exterior

### Perform the following to protect the vehicle and maintain it in prime condition:

- Working from top to bottom, liberally apply water to the vehicle body, wheel wells and underside of the vehicle to remove any dirt and dust.
- Wash the vehicle body using a sponge or soft cloth, such as a chamois.
- For hard-to-remove marks, use car wash soap and rinse thoroughly with water.
- Wipe away any water.
- Wax the vehicle when the waterproof coating deteriorates.  
If water does not bead on a clean surface, apply wax when the vehicle body is cool.

#### ■ Automatic car washes

- Fold the mirrors before washing the vehicle. Start washing from the front of the vehicle. Make sure to extend the mirrors before driving.
- Brushes used in automatic car washes may scratch the vehicle surface and harm your vehicle's paint.
- Vehicles with a rear spoiler: In certain automatic car washes, the rear spoiler may interfere with machine operation. This may prevent the vehicle from being cleaned properly or result in damage to the rear spoiler.

#### ■ High pressure car washes

- Do not allow the nozzles of the car wash to come within close proximity of the windows.
- Before using the car wash, check that the fuel filler door on your vehicle is closed properly.



### ■ When using a car wash (vehicles with a smart key system)

If the door handle becomes wet while the electronic key is within the effective range, the door may lock and unlock repeatedly. In that case, follow the following correction procedures to wash the vehicle:

- Place the key in a position 6 ft. (2 m) or more separate from the vehicle while the vehicle is being washed. (Take care to ensure that the key is not stolen.)
- Set the electronic key to battery-saving mode to disable the smart key system. (→P. 124)

### ■ Aluminum wheels (if equipped)

- Remove any dirt immediately by using a neutral detergent.
- Wash detergent off with water immediately after use.
- To protect the paint from damage, make sure to observe the following precautions.
  - Do not use acidic, alkaline or abrasive detergent
  - Do not use hard brushes
  - Do not use detergent on the wheels when they are hot, such as after driving or parking in hot weather

### ■ Bumpers

Do not scrub with abrasive cleaners.



### WARNING

#### ■ When washing the vehicle

Do not apply water to the inside of the engine compartment. Doing so may cause the electrical components etc. to catch fire.

#### ■ Precautions regarding the exhaust pipe

Exhaust gasses cause the exhaust pipe to become quite hot.

When washing the vehicle, be careful not to touch the pipe until it has cooled sufficiently, as touching a hot exhaust pipe can cause burns.

 NOTICE**■ To prevent paint deterioration and corrosion on the body and components (aluminum wheels etc.)**

- Wash the vehicle immediately in the following cases:
  - After driving near the sea coast
  - After driving on salted roads
  - If coal tar or tree sap is present on the paint surface
  - If dead insects, insect droppings or bird droppings are present on the paint surface
  - After driving in an area contaminated with soot, oily smoke, mine dust, iron powder or chemical substances
  - If the vehicle becomes heavily soiled with dust or mud
  - If liquids such as benzene and gasoline are spilled on the paint surface
- If the paint is chipped or scratched, have it repaired immediately.
- To prevent the wheels from corroding, remove any dirt and store in a place with low humidity when storing the wheels.

**■ Cleaning the exterior lights**

- Wash carefully. Do not use organic substances or scrub with a hard brush. This may damage the surfaces of the lights.
- Do not apply wax to the surfaces of the lights. Wax may cause damage to the lenses.

**■ To prevent damage to the windshield wiper arms**

When lifting the wiper arms away from the windshield, pull the driver side wiper arm upward first, and then the passenger side. When returning the wipers to their original position, do so from the passenger side first.

**■ When using a high pressure car wash**

Do not bring the nozzle tip close to boots (rubber or resin manufactured cover), connectors or the following parts. The parts may be damaged if they come into contact with high-pressure water.

- Traction related parts
- Steering parts
- Suspension parts
- Brake parts

## Cleaning and protecting the vehicle interior

**The following procedures will help protect your vehicle's interior and keep it in top condition:**

### Protecting the vehicle interior

- Remove dirt and dust using a vacuum cleaner. Wipe dirty surfaces with a cloth dampened with lukewarm water.
- If dirt cannot be removed, wipe it off with a soft cloth dampened with neutral detergent diluted to approximately 1%.  
Wring out any excess water from the cloth and thoroughly wipe off remaining traces of detergent and water.

### Cleaning the synthetic leather areas

- Remove dirt and dust using a vacuum cleaner.
- Wipe it off with a soft cloth dampened with neutral detergent diluted to approximately 1%.
- Wring out any excess water from the cloth and thoroughly wipe off remaining traces of detergent and water.

**■ Shampooing the carpets**

There are several commercial foaming-type cleaners available. Use a sponge or brush to apply the foam. Rub in overlapping circles. Do not use water. Wipe dirty surfaces and let them dry. Excellent results are obtained by keeping the carpet as dry as possible.

**■ Seat belts**

Clean with mild soap and lukewarm water using a cloth or sponge. Also check the belts periodically for excessive wear, fraying or cuts.

**⚠ WARNING****■ Water in the vehicle**

- Do not splash or spill liquid in the vehicle.  
Doing so may cause electrical components etc. to malfunction or catch fire.
- Do not get any of the SRS components or wiring in the vehicle interior wet.  
(→P. 36)  
An electrical malfunction may cause the airbags to deploy or not function properly, resulting in death or serious injury.

**■ Cleaning the interior (especially instrument panel)**

Do not use polish wax or polish cleaner. The instrument panel may reflect off the windshield, obstructing the driver's view and leading to an accident, resulting in death or serious injury.

 NOTICE**■ Cleaning detergents**

- Do not use the following types of detergent, as they may discolor the vehicle interior or cause streaks or damage to painted surfaces:
  - Non-seat portions: Organic substances such as benzene or gasoline, alkaline or acidic solutions, dye, and bleach
  - Seats: Alkaline or acidic solutions, such as thinner, benzene, and alcohol
- Do not use polish wax or polish cleaner. The instrument panel's or other interior part's painted surface may be damaged.

**■ Preventing damage to leather surfaces**

Observe the following precautions to avoid damage to and deterioration of leather surfaces:

- Remove any dust or dirt from leather surfaces immediately.
- Do not expose the vehicle to direct sunlight for extended periods of time. Park the vehicle in the shade, especially during summer.
- Do not place items made of vinyl, plastic, or containing wax on the upholstery, as they may stick to the leather surface if the vehicle interior heats up significantly.

**■ Water on the floor**

Do not wash the vehicle floor with water.

Vehicle systems such as the audio system may be damaged if water comes into contact with electrical components such as the audio system above or under the floor of the vehicle. Water may also cause the body to rust.

**■ When cleaning the inside of the windshield**

Do not allow glass cleaner to contact the lens. Also, do not touch the lens. (→P. 226).

**■ Cleaning the inside of the rear window**

- Do not use glass cleaner to clean the rear window, as this may cause damage to the rear window defogger heater wires or antenna. Use a cloth dampened with lukewarm water to gently wipe the window clean. Wipe the window in strokes running parallel to the heater wires or antenna.
- Be careful not to scratch or damage the heater wires or antenna.

## Maintenance requirements

**To ensure safe and economical driving, day-to-day care and regular maintenance are essential. It is the owner's responsibility to perform regular checks. Toyota recommends the following maintenance:**

### General maintenance

General maintenance should be performed on a daily basis. This can be done by yourself or by a Toyota dealer.

### Scheduled maintenance

Scheduled maintenance should be performed at specified intervals according to the maintenance schedule.

For details about maintenance items and schedules, refer to the "Scheduled Maintenance Guide" or "Owner's Manual Supplement".

### Do-it-yourself maintenance

You can perform some maintenance procedures by yourself.

Please be aware that do-it-yourself maintenance may affect warranty coverage.

The use of Toyota Repair Manuals is recommended.

For details about warranty coverage, refer to the separate "Owner's Warranty Information Booklet" or "Owner's Manual Supplement".

### ■ Repair and replacement

It is recommended that genuine Toyota parts be used for repairs to ensure performance of each system. If non-Toyota parts are used in replacement or if a repair shop other than a Toyota dealer performs repairs, confirm the warranty coverage.

### ■ Resetting the message indicating maintenance is required (U.S.A. only)

After the required maintenance is performed according to the maintenance schedule, please reset the message.

To reset the message, follow the procedure described below:

#### ▶ Vehicles with a monochrome display

- 1 Vehicles without a smart key system: Turn the engine switch to the "LOCK" position with the trip meter A reading shown. (→P. 77)

Vehicles with a smart key system: Turn the engine switch off with the trip meter A reading shown. (→P. 77)

- 2 Vehicles without a smart key system:

While pressing the display change button (→P. 77), turn the engine switch to the "ON" position (do not start the engine because reset mode will be canceled).

Vehicles with a smart key system:

While pressing the display change button (→P. 77), turn the engine switch to the IGNITION ON mode (do not start the engine because otherwise the reset mode will be canceled).

- 3 Continue to press and hold the button until the trip meter displays "000000".

#### ▶ Vehicles with a color display

- 1 While the engine is running, switch the multi-information display to the "Settings" screen. (→P. 93)
- 2 Select "Reset Scheduled Maint. Data" on the "Settings" screen.
- 3 Select "Yes" when "Reset Data?" is displayed on the multi-information display.  
"The Data Has Been Reset" will be displayed when the reset procedure has been completed.

### ■ Allow inspection and repairs to be performed by a Toyota dealer

- Toyota technicians are well-trained specialists and are kept up to date with the latest service information. They are well informed about the operations of all systems on your vehicle.
- Keep a copy of the repair order. It proves that the maintenance that has been performed is under warranty coverage. If any problem should arise while your vehicle is under warranty, your Toyota dealer will promptly take care of it.

 **WARNING**

■ **If your vehicle is not properly maintained**

Improper maintenance could result in serious damage to the vehicle and possible death or serious injury.

■ **Handling of the battery**

- Engine exhaust, some of its constituents, and a wide variety of automobile components contain or emit chemicals known to the State of California to cause cancer and birth defects and other reproductive harm. Work in a well ventilated area.
- Oils, fuels and fluids contained in vehicles as well as waste produced by component wear contain or emit chemicals known to the State of California to cause cancer and birth defects or other reproductive harm. Avoid exposure and wash any affected area immediately.
- Battery posts, terminals and related accessories contain lead and lead compounds which are known to cause brain damage. Wash your hands after handling. (→P. 437)



## General maintenance

Listed below are the general maintenance items that should be performed at the intervals specified in the “Owner’s Warranty Information Booklet” or “Owner’s Manual Supplement/Scheduled Maintenance Guide”. It is recommended that any problem you notice should be brought to the attention of your Toyota dealer or qualified service shop for advice.

### Engine compartment

Items	Check points
Battery	Check the battery fluid level and connections. (→P. 437)
Brake fluid	Is the brake fluid at the correct level? (→P. 435)
Engine coolant	Is the engine coolant at the correct level? (→P. 433)
Engine oil	Is the engine oil at the correct level? (→P. 430)
Exhaust system	There should not be any fumes or strange sounds.
Radiator/condenser	The radiator and condenser should be free from foreign objects. (→P. 435)
Washer fluid	Is there sufficient washer fluid? (→P. 439)

**Vehicle interior**

Items	Check points
Accelerator pedal	<ul style="list-style-type: none"> <li>The accelerator pedal should move smoothly (without uneven pedal effort or catching).</li> </ul>
Continuously variable transmission "Park" mechanism	<ul style="list-style-type: none"> <li>When parked on a slope and the shift lever is in P, is the vehicle securely stopped?</li> </ul>
Brake pedal	<ul style="list-style-type: none"> <li>Does the brake pedal move smoothly?</li> <li>Does the brake pedal have appropriate clearance from the floor? (→P. 545)</li> <li>Does the brake pedal have the correct amount of free play? (→P. 545)</li> </ul>
Brakes	<ul style="list-style-type: none"> <li>The vehicle should not pull to one side when the brakes are applied.</li> <li>The brakes should work effectively.</li> <li>The brake pedal should not feel spongy.</li> <li>The brake pedal should not get too close to the floor when the brakes are applied.</li> </ul>
Clutch pedal	<ul style="list-style-type: none"> <li>Does the clutch pedal move smoothly?</li> <li>Does the clutch pedal have appropriate clearance from the floor?</li> <li>Does the clutch pedal have the correct amount of free play? (→P. 544)</li> </ul>

Items	Check points
Head restraints	<ul style="list-style-type: none"> <li>• Do the head restraints move smoothly and lock securely?</li> </ul>
Indicators/buzzers	<ul style="list-style-type: none"> <li>• Do the indicators and buzzers function properly?</li> </ul>
Lights	<ul style="list-style-type: none"> <li>• Do all the lights come on?</li> </ul>
Parking brake	<ul style="list-style-type: none"> <li>• Moves smoothly?</li> <li>• When parked on a slope and the parking brake is on, is the vehicle securely stopped?</li> </ul>
Seat belts	<ul style="list-style-type: none"> <li>• Do the seat belts operate smoothly?</li> <li>• The seat belts should not be damaged.</li> </ul>
Seats	<ul style="list-style-type: none"> <li>• Do the seat controls operate properly?</li> </ul>
Steering wheel	<ul style="list-style-type: none"> <li>• Does the steering wheel rotate smoothly?</li> <li>• Does the steering wheel have the correct amount of free play?</li> <li>• There should not be any strange sounds coming from the steering wheel.</li> </ul>

**Vehicle exterior**

Items	Check points
Doors/trunk	<ul style="list-style-type: none"> <li>• Do the doors/trunk operate smoothly?</li> </ul>
Engine hood	<ul style="list-style-type: none"> <li>• Does the engine hood lock system work properly?</li> </ul>
Fluid leaks	<ul style="list-style-type: none"> <li>• There should not be any signs of fluid leakage after the vehicle has been parked.</li> </ul>
Tires	<ul style="list-style-type: none"> <li>• Is the tire inflation pressure correct?</li> <li>• The tires should not be damaged or excessively worn.</li> <li>• Have the tires been rotated according to the maintenance schedule?</li> <li>• The wheel nuts should not be loose.</li> </ul>
Windshield wipers	<ul style="list-style-type: none"> <li>• The wiper blades should not show any signs of cracking, splitting, wear, contamination or deformation.</li> <li>• The wiper blades should clear the windshield without streaking or skipping.</li> </ul>

** WARNING****■ If the engine is running**

Turn the engine off and ensure that there is adequate ventilation before performing maintenance checks.

## Emission inspection and maintenance (I/M) programs

**Some states have vehicle emission inspection programs which include OBD (On Board Diagnostics) checks. The OBD system monitors the operation of the emission control system.**

### **If the malfunction indicator lamp comes on**

The OBD system determines that a problem exists somewhere in the emission control system. Your vehicle may not pass the I/M test and may need to be repaired. Contact your Toyota dealer to service the vehicle.

### **Your vehicle may not pass the I/M test in the following situations:**

- When the battery is disconnected or discharged  
Readiness codes that are set during ordinary driving are erased. Also, depending on your driving habits, the readiness codes may not be completely set.
- When the fuel tank cap is loose  
The malfunction indicator lamp comes on indicating a temporary malfunction and your vehicle may not pass the I/M test.

### **When the malfunction indicator lamp still remains on after several driving trips**

The error code in the OBD system will not be cleared unless the vehicle is driven 40 or more times.

### **If your vehicle does not pass the I/M test**

Contact your Toyota dealer to prepare the vehicle for re-testing.

## Do-it-yourself service precautions

**If you perform maintenance by yourself, be sure to follow the correct procedure as given in these sections.**

Items	Parts and tools
Battery condition (→P. 437)	<ul style="list-style-type: none"> <li>• Warm water</li> <li>• Baking soda</li> <li>• Grease</li> <li>• Conventional wrench (for terminal clamp bolts)</li> </ul>
Brake fluid level (→P. 435)	<ul style="list-style-type: none"> <li>• FMVSS No.116 DOT 3 or SAE J1703 brake fluid</li> <li>• Rag or paper towel</li> <li>• Funnel (used only for adding brake fluid)</li> </ul>
Engine coolant level (→P. 433)	<ul style="list-style-type: none"> <li>• “Toyota Super Long Life Coolant” or a similar high quality ethylene glycol-based non-silicate, non-amine, non-nitrite and non-borate coolant with long-life hybrid organic acid technology</li> <li>For the U.S.A.: “Toyota Super Long Life Coolant” is pre-mixed with 50% coolant and 50% deionized water.</li> <li>For Canada: “Toyota Super Long Life Coolant” is pre-mixed with 55% coolant and 45% deionized water.</li> <li>• Funnel (used only for adding engine coolant)</li> </ul>
Engine oil level (→P. 430)	<ul style="list-style-type: none"> <li>• “Toyota Genuine Motor Oil” or equivalent</li> <li>• Rag or paper towel</li> <li>• Funnel (used only for adding engine oil)</li> </ul>
Fuses (→P. 458)	<ul style="list-style-type: none"> <li>• Fuse with same amperage rating as original</li> </ul>

Items	Parts and tools
Light bulbs (→P. 461)	<ul style="list-style-type: none"> <li>• Bulb with same number and wattage rating as original</li> <li>• Phillips-head screwdriver</li> <li>• Flathead screwdriver</li> <li>• Wrench</li> </ul>
Radiator/condenser (→P. 435)	—
Tire inflation pressure (→P. 448)	<ul style="list-style-type: none"> <li>• Tire pressure gauge</li> <li>• Compressed air source</li> </ul>
Washer fluid (→P. 439)	<ul style="list-style-type: none"> <li>• Water or washer fluid containing antifreeze (for winter use)</li> <li>• Funnel (used only for adding water or washer fluid)</li> </ul>

 **WARNING**

The engine compartment contains many mechanisms and fluids that may move suddenly, become hot, or become electrically energized. To avoid death or serious injury, observe the following precautions.

**■ When working on the engine compartment**

- Keep hands, clothing and tools away from the moving fan and engine drive belt.
- Be careful not to touch the engine, radiator, exhaust manifold, etc. right after driving as they may be hot. Oil and other fluids may also be hot.
- Do not leave anything that may burn easily, such as paper and rags, in the engine compartment.
- Do not smoke, cause sparks or expose an open flame to fuel or the battery. Fuel and battery fumes are flammable.
- Be extremely cautious when working on the battery. It contains poisonous and corrosive sulfuric acid.

 **WARNING****■ When working near the electric cooling fan or radiator grille**

Vehicles without a smart key system: Be sure the engine switch is off. With the engine switch in the "ON" position, the electric cooling fan may automatically start to run if the air conditioning is on and/or the coolant temperature is high. (→P. 435)

Vehicles with a smart key system: Be sure the engine switch is off. With the engine switch in IGNITION ON mode, the electric cooling fan may automatically start to run if the air conditioning is on and/or the coolant temperature is high. (→P. 435)

**■ Safety glasses**

Wear safety glasses to prevent flying or falling material, fluid spray, etc. from getting in your eyes.

 **NOTICE****■ If you remove the air cleaner filter**

Driving with the air cleaner filter removed may cause excessive engine wear due to dirt in the air.



## Hood

### Release the lock from the inside of the vehicle to open the hood.

- 1 Pull the hood lock release lever.  
The hood will pop up slightly.

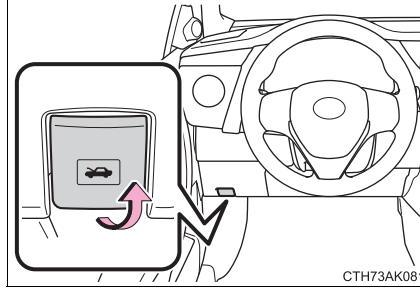

- 2 Pull up the auxiliary catch lever and lift the hood.

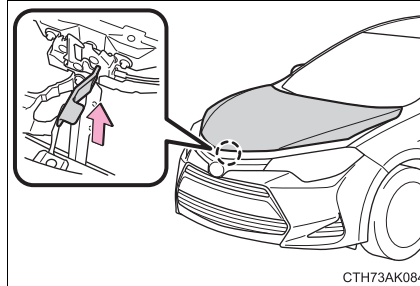

- 3 Hold the hood open by inserting the support rod into the slot.

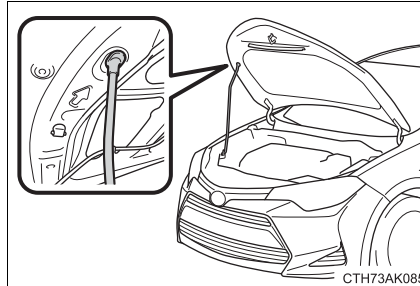

 **WARNING****■ Pre-driving check**

Check that the hood is fully closed and locked.

If the hood is not locked properly, it may open while the vehicle is in motion and cause an accident, which may result in death or serious injury.

**■ After installing the support rod into the slot**

Make sure the rod supports the hood securely preventing it from falling down onto your head or body.

 **NOTICE****■ When closing the hood**

Be sure to return the support rod to its clip before closing the hood. Closing the hood with the support rod not clipped could cause the hood to bend.

## Positioning a floor jack

When using a floor jack, follow the instructions in the manual provided with the jack and perform the operation safely.

When raising your vehicle with a floor jack, position the jack correctly. Improper placement may damage your vehicle or cause injury.

### ◆ Front

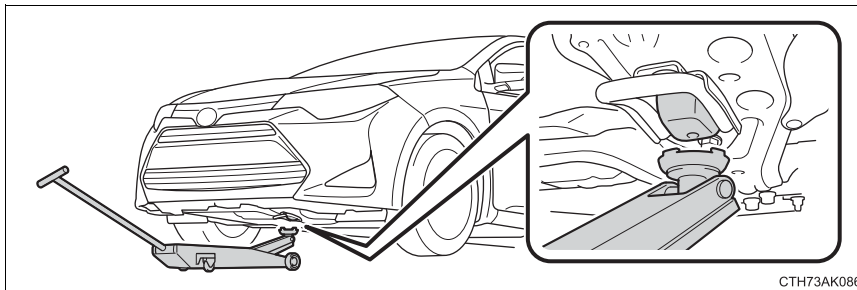

### ◆ Rear

- 1 Take out the jack attachment.

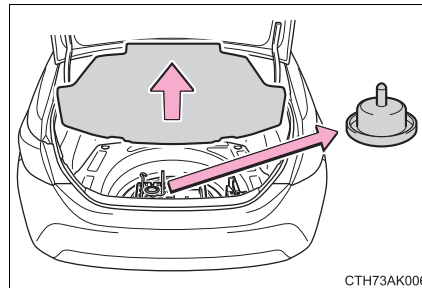

- 2 Set the jack attachment on the floor jack and position the jack.

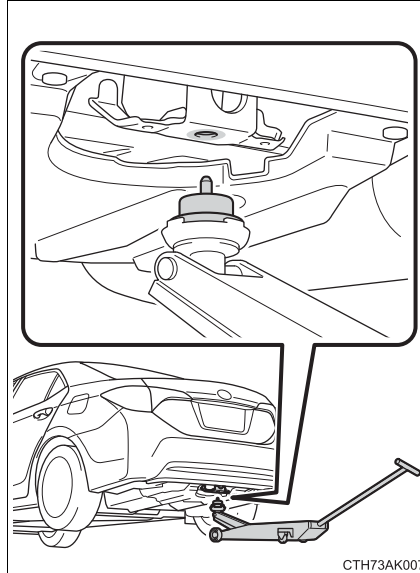

- 3 Before raising the vehicle, make sure that the floor jack is positioned so that the protrusion on the jack attachment fits securely into the hole of the jack point.

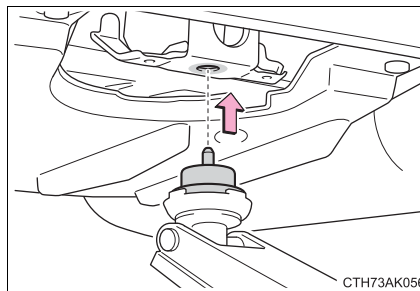

**⚠ WARNING**

Make sure to set the protrusion on the jack attachment properly into the hole of the jack point. Raising the vehicle with an improperly positioned floor jack will damage the vehicle and may cause the vehicle to fall off the floor jack.

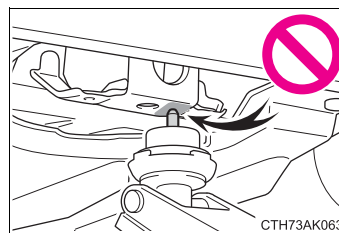

## Engine compartment

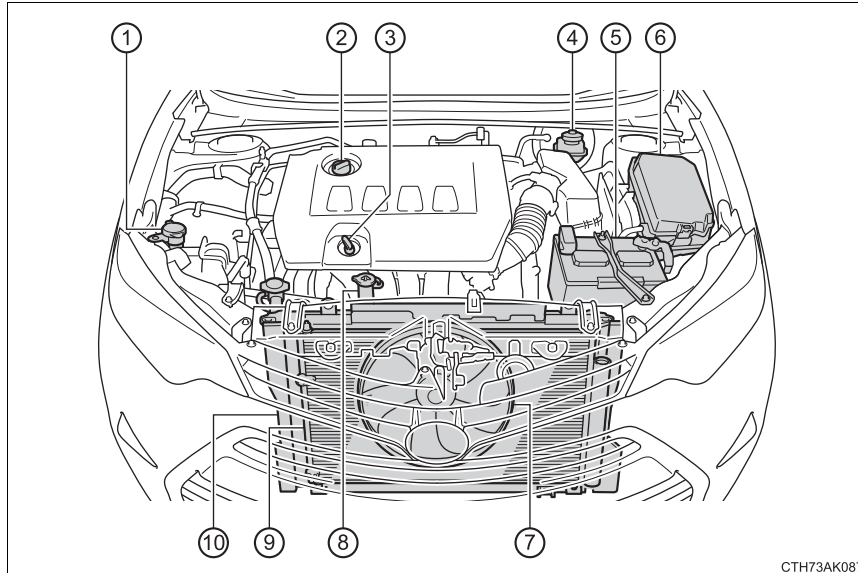

- |                                       |                                      |
|---------------------------------------|--------------------------------------|
| ① Washer fluid tank (→P. 439)         | ⑤ Battery (→P. 437)                  |
| ② Engine oil filler cap (→P. 431)     | ⑥ Fuse box (→P. 458)                 |
| ③ Engine oil level dipstick (→P. 430) | ⑦ Electric cooling fan               |
| ④ Brake fluid reservoir (→P. 435)     | ⑧ Engine coolant reservoir (→P. 433) |
|                                       | ⑨ Condenser (→P. 435)                |
|                                       | ⑩ Radiator (→P. 435)                 |

### Engine oil

With the engine at operating temperature and turned off, check the oil level on the dipstick.

#### ■ Checking the engine oil

- 1 Park the vehicle on level ground. After warming up the engine and turning it off, wait more than 5 minutes for the oil to drain back into the bottom of the engine.
- 2 Holding a rag under the end, pull the dipstick out.

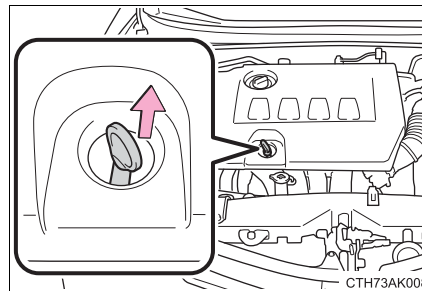

- 3 Wipe the dipstick clean.
- 4 Reinsert the dipstick fully.
- 5 Holding a rag under the end, pull the dipstick out and check the oil level.

- ① Low
- ② Normal
- ③ Excessive

The shape of the dipstick may differ depending on the type of vehicle or engine.

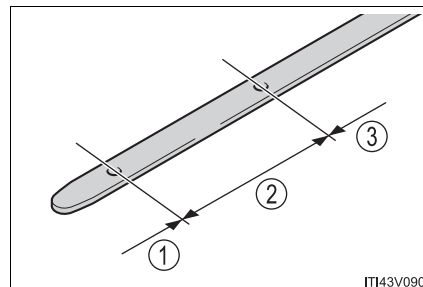

- 6 Wipe the dipstick and reinsert it fully.

### ■ Adding engine oil

If the oil level is below or near the low level mark, add engine oil of the same type as that already in the engine.

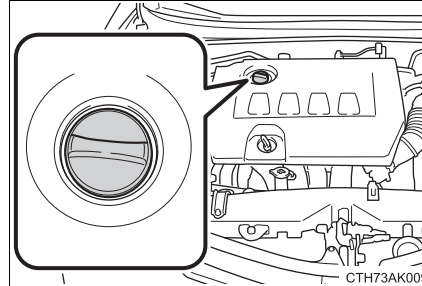

Make sure to check the oil type and prepare the items needed before adding oil.

Engine oil selection	→P. 541
Oil quantity (Low → Full)	1.6 qt. (1.5 L, 1.3 Imp. qt.)
Items	Clean funnel

- 1 Remove the oil filler cap by turning it counterclockwise.
- 2 Add engine oil slowly, checking the dipstick.
- 3 Install the oil filler cap by turning it clockwise.

**■ Engine oil consumption**

A certain amount of engine oil will be consumed while driving. In the following situations, oil consumption may increase, and engine oil may need to be refilled in between oil maintenance intervals.

- When the engine is new, for example directly after purchasing the vehicle or after replacing the engine
- If low quality oil or oil of an inappropriate viscosity is used
- When driving at high engine speeds or with a heavy load, or when driving while accelerating or decelerating frequently
- When leaving the engine idling for a long time, or when driving frequently through heavy traffic

**⚠ WARNING****■ Used engine oil**

- Used engine oil contains potentially harmful contaminants which may cause skin disorders such as inflammation and skin cancer, so care should be taken to avoid prolonged and repeated contact. To remove used engine oil from your skin, wash thoroughly with soap and water.
- Dispose of used oil and filters only in a safe and acceptable manner. Do not dispose of used oil and filters in household trash, in sewers or onto the ground.  
Call your Toyota dealer, service station or auto parts store for information concerning recycling or disposal.
- Do not leave used engine oil within the reach of children.

**⚠ NOTICE****■ To prevent serious engine damage**

Check the oil level on a regular basis.

**■ When replacing the engine oil**

- Be careful not to spill engine oil on the vehicle components.
- Avoid overfilling, or the engine could be damaged.
- Check the oil level on the dipstick every time you refill the vehicle.
- Be sure the engine oil filler cap is properly tightened.



### Engine coolant

The coolant level is satisfactory if it is between the “F” and “L” lines on the reservoir when the engine is cold.

- ① Reservoir cap
- ② “F” line
- ③ “L” line

If the level is on or below the “L” line, add coolant up to the “F” line.  
(→P. 531)

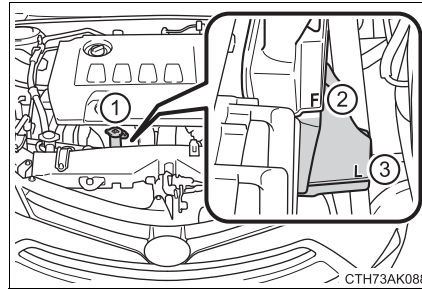

### ■ Coolant selection

Only use “Toyota Super Long Life Coolant” or a similar high quality ethylene glycol based non-silicate, non-amine, non-nitrite, and non-borate coolant with long-life hybrid organic acid technology.

For the U.S.A.: “Toyota Super Long Life Coolant” is a mixture of 50% coolant and 50% deionized water. (Minimum temperature: -31°F [-35°C])

For Canada: “Toyota Super Long Life Coolant” is a mixture of 55% coolant and 45% deionized water. (Minimum temperature: -44°F [-42°C])

For more details about engine coolant, contact your Toyota dealer.

### ■ If the coolant level drops within a short time of replenishing

Visually check the radiator, hoses, engine coolant reservoir caps, drain cock and water pump.

If you cannot find a leak, have your Toyota dealer test the cap and check for leaks in the cooling system.

 **WARNING**

■ **When the engine is hot**

Do not remove the engine coolant reservoir cap or the radiator cap.  
(→P. 533)

The cooling system may be under pressure and may spray hot coolant if the cap is removed, causing serious injuries, such as burns.

 **NOTICE**

■ **When adding coolant**

Coolant is neither plain water nor straight antifreeze. The correct mixture of water and antifreeze must be used to provide proper lubrication, corrosion protection and cooling. Be sure to read the antifreeze or coolant label.

■ **If you spill coolant**

Be sure to wash it off with water to prevent it from damaging parts or paint.

**Radiator and condenser**

Check the radiator and condenser and clear away any foreign objects. If either of the above parts is extremely dirty or you are not sure of their condition, have your vehicle inspected by your Toyota dealer.

**⚠ WARNING**

**■ When the engine is hot**

Do not touch the radiator or condenser as they may be hot and cause serious injuries, such as burns.

**Brake fluid**

**■ Checking fluid level**

The brake fluid level should be between the “MAX” and “MIN” lines on the tank.

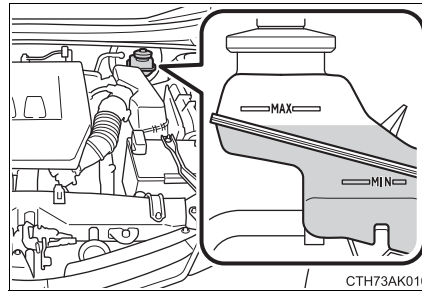

**■ Adding fluid**

Make sure to check the fluid type and prepare the necessary item.

Fluid type	FMVSS No.116 DOT 3 or SAE J1703 brake fluid
Item	Clean funnel

- 1 Slide and lift up the rubber strip to partially remove it as shown.

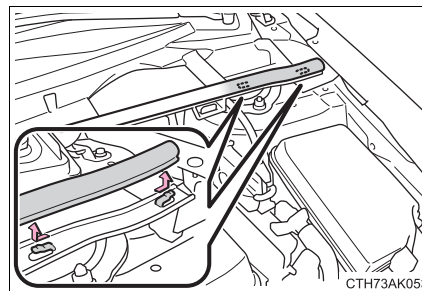

- 2 Disconnect the claws and remove the service cover.

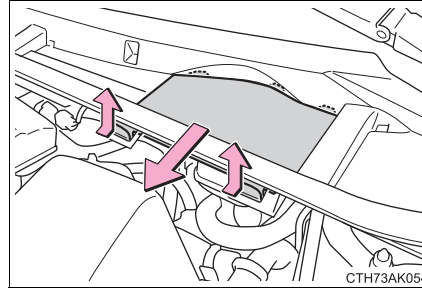

- 3 Remove the reservoir cap.

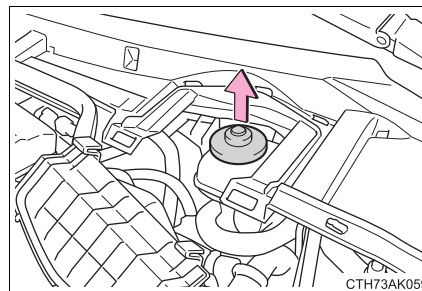

- 4 Add brake fluid slowly while checking the fluid level.

■ **Brake fluid can absorb moisture from the air**

Excess moisture in the brake fluid can cause a dangerous loss of braking efficiency. Use only newly opened brake fluid.

 **WARNING**

■ **When filling the reservoir**

Take care as brake fluid can harm your hands and eyes and damage painted surfaces.

If fluid gets on your hands or in your eyes, flush the affected area with clean water immediately.

If you still experience discomfort, see a doctor.

 **NOTICE**

■ **If the fluid level is low or high**

It is normal for the brake fluid level to go down slightly as the brake pads wear out or when the fluid level in the accumulator is high.

However, if the reservoir needs frequent refilling, there may be a serious problem. Have the vehicle inspected at your Toyota dealer as soon as possible.

## Battery

Check the battery as follows.

### ■ Battery exterior

Make sure that the battery terminals are not corroded and that there are no loose connections, cracks, or loose clamps.

- ① Terminals
- ② Hold-down clamp

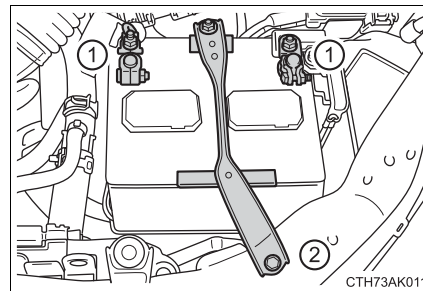

### ■ Before recharging

When recharging, the battery produces hydrogen gas which is flammable and explosive. Therefore, observe the following before recharging:

- If recharging with the battery installed on the vehicle, be sure to disconnect the ground cable.
- Make sure the power switch on the charger is off when connecting and disconnecting the charger cables to the battery.

### ■ After recharging/reconnecting the battery (vehicles with a smart key system)

- Unlocking the doors using the smart key system may not be possible immediately after reconnecting the battery. If this happens, use the wireless remote control or the mechanical key to lock/unlock the doors.
- Start the engine with the engine switch in ACCESSORY mode. The engine may not start with the engine switch turned off. However, the engine will operate normally from the second attempt.
- The engine switch mode is recorded by the vehicle. If the battery is reconnected, the vehicle will return the engine switch mode to the status it was in before the battery was disconnected. Make sure to turn off the engine before disconnect the battery. Take extra care when connecting the battery if the engine switch mode prior to discharge is unknown.

If the system will not start even after multiple attempts, contact your Toyota dealer.

 **WARNING****■ Chemicals in the battery**

Batteries contain poisonous and corrosive sulfuric acid and may produce hydrogen gas which is flammable and explosive. To reduce the risk of death or serious injury, take the following precautions while working on or near the battery:

- Do not cause sparks by touching the battery terminals with tools.
- Do not smoke or light a match near the battery.
- Avoid contact with eyes, skin and clothes.
- Never inhale or swallow electrolyte.
- Wear protective safety glasses when working near the battery.
- Keep children away from the battery.

**■ Where to safely charge the battery**

Always charge the battery in an open area. Do not charge the battery in a garage or closed room where there is insufficient ventilation.

**■ How to recharge the battery**

Only perform a slow charge (5 A or less). The battery may explode if charged at a quicker rate.

**■ Emergency measures regarding electrolyte**

- If electrolyte gets in your eyes  
Flush your eyes with clean water for at least 15 minutes and get immediate medical attention. If possible, continue to apply water with a sponge or cloth while traveling to the nearest medical facility.
- If electrolyte gets on your skin  
Wash the affected area thoroughly. If you feel pain or burning, get medical attention immediately.
- If electrolyte gets on your clothes  
It can soak through clothing on to your skin. Immediately take off the clothing and follow the procedure above if necessary.
- If you accidentally swallow electrolyte  
Drink a large quantity of water or milk. Get emergency medical attention immediately.

 **NOTICE****■ When recharging the battery**

Never recharge the battery while the engine is running. Also, be sure all accessories are turned off.

### Washer fluid

Add washer fluid in the following situations:

- A washer does not work.
- The warning message (if equipped) appears on the multi-information display. (→P. 497)

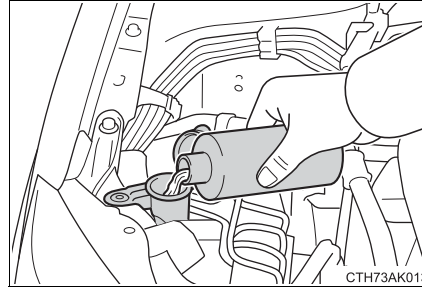

#### WARNING

##### ■ When adding washer fluid

Do not add washer fluid when the engine is hot or running as washer fluid contains alcohol and may catch fire if spilled on the engine etc.

#### NOTICE

##### ■ Do not use any fluid other than washer fluid

Do not use soapy water or engine antifreeze instead of washer fluid. Doing so may cause streaking on the vehicle's painted surfaces, as well as damaging the pump leading to problems of the washer fluid not spraying.

##### ■ Diluting washer fluid

Dilute washer fluid with water as necessary. Refer to the freezing temperatures listed on the label of the washer fluid bottle.

## Tires

**Replace or rotate tires in accordance with maintenance schedules and treadwear.**

### Checking tires

Check if the treadwear indicators are showing on the tires. Also check the tires for uneven wear, such as excessive wear on one side of the tread.

Check the spare tire condition and pressure if not rotated.

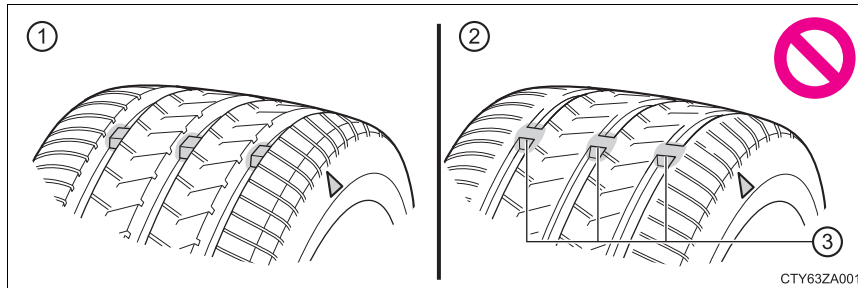

- ① New tread
- ② Worn tread
- ③ Treadwear indicator

The location of treadwear indicators is shown by a “TWI” or “Δ” mark, etc., molded into the sidewall of each tire.

Replace the tires if the treadwear indicators are showing on a tire.

### Tire rotation

Rotate the tires in the order shown.

To equalize tire wear and extend tire life, Toyota recommends that tire rotation is carried out at the same interval as tire inspection.

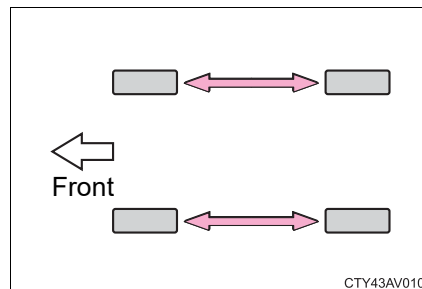



**Tire pressure warning system (if equipped)**

Your vehicle is equipped with a tire pressure warning system that uses tire pressure warning valves and transmitters to detect low tire inflation pressure before serious problems arise. (→P. 480)

**◆ Installing tire pressure warning valves and transmitters**

When replacing tires or wheels, tire pressure warning valves and transmitters must also be installed.

When new tire pressure warning valves and transmitters are installed, new ID codes must be registered in the tire pressure warning computer and the tire pressure warning system must be initialized. Have tire pressure warning valves and transmitter ID codes registered by your Toyota dealer. (→P. 443)

**◆ Initializing the tire pressure warning system****■ The tire pressure warning system must be initialized in the following circumstances:**

- When changing the tire size.
- When the tire inflation pressure is changed such as when changing traveling speed or load weight.

When the tire pressure warning system is initialized, the current tire inflation pressure is set as the benchmark pressure.

■ **How to initialize the tire pressure warning system**

- 1 Park the vehicle in a safe place and turn the engine switch off.

Initialization cannot be performed while the vehicle is moving.

- 2 Adjust the tire inflation pressure to the specified cold tire inflation pressure level. (→P. 546)

Make sure to adjust the tire pressure to the specified cold tire inflation pressure level. The tire pressure warning system will operate based on this pressure level.

- 3 Turn the engine switch to the “ON” position (vehicles without a smart key system) or IGNITION ON mode (vehicles with a smart key system).

- 4 Open the glove box. Press and hold the tire pressure warning reset switch until the tire pressure warning light blinks slowly 3 times.

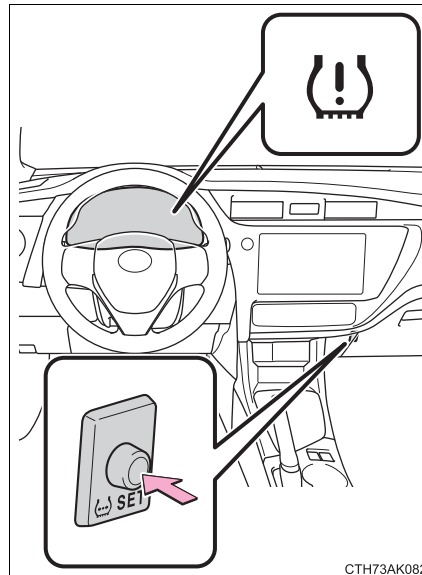

- 5 Vehicles without a smart key system: Wait for a few minutes with the engine switch in the “ON” position and then turn the engine switch to the “ACC” or “LOCK” position.

Vehicles with a smart key system: Wait for a few minutes with the engine switch in IGNITION ON mode and then turn the engine switch off.

---

**◆ Registering ID codes**

---

The tire pressure warning valve and transmitter is equipped with a unique ID code. When replacing a tire pressure warning valve and transmitter, it is necessary to register the ID code. Have the ID code registered by your Toyota dealer.

---

**■ When to replace your vehicle's tires**

Tires should be replaced if:

- The treadwear indicators are showing on a tire.
- You have tire damage such as cuts, splits, cracks deep enough to expose the fabric, and bulges indicating internal damage
- A tire goes flat repeatedly or cannot be properly repaired due to the size or location of a cut or other damage

If you are not sure, consult with your Toyota dealer.

**■ Replacing tires and wheels (vehicles with a tire pressure warning system)**

If the ID code of the tire pressure warning valve and transmitter is not registered, the tire pressure warning system will not work properly. After driving for about 20 minutes, the tire pressure warning light blinks for 1 minute and stays on to indicate a system malfunction.

**■ Tire life**

Any tire over 6 years old must be checked by a qualified technician even if it has seldom or never been used or damage is not obvious.

**■ Routine tire inflation pressure checks (vehicles with a tire pressure warning system)**

The tire pressure warning system does not replace routine tire inflation pressure checks. Make sure to check tire inflation pressure as part of your routine of daily vehicle checks.

**■ Low profile tires (17-inch tires)**

Generally, low profile tires will wear more rapidly and tire grip performance will be reduced on snowy and/or icy roads when compared to standard tires. Be sure to use snow tires or tire chains on snowy and/or icy roads and drive carefully at a speed appropriate for road and weather conditions.

**■ Maximum load of tire**

Check that the maximum load of the replacement tire is greater than 1/2 of the Gross Axle Weight Ratings (GAWR) of either the front axle or the rear axle, whichever is greater.

For the GAWR, see the Certification Label. For the maximum load of the tire, see the load limit at maximum cold tire inflation pressure mentioned on the sidewall of the tire. (→P. 551)

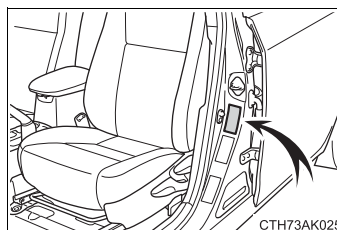
**■ Tire types****● Summer tires**

Summer tires are high-speed performance tires best suited to highway driving under dry conditions. Since summer tires do not have the same traction performance as snow tires, summer tires are inadequate for driving on snow-covered or icy roads. For driving on snow-covered roads or icy roads, the use of snow tires is recommended. When installing snow tires, be sure to replace all four tires.

**● All season tires**

All season tires are designed to provide better traction in snow and to be adequate for driving in most winter conditions as well as for use year-round. All season tires, however, do not have adequate traction performance compared with snow tires in heavy or loose snow. Also, all season tires fall short in acceleration and handling performance compared with summer tires in highway driving.

**● Snow tires**

For driving on snow-covered roads or icy roads, we recommend using snow tires. If you need snow tires, select tires of the same size, construction and load capacity as the originally installed tires. Since your vehicle has radial tires as original equipment, make sure your snow tires also have radial construction. Do not install studded tires without first checking local regulations for possible restrictions. Snow tires should be installed on all wheels. (→P. 263)

**■ Initializing the tire pressure warning system (vehicles with a tire pressure warning system)**

Initialize the system with the tire inflation pressure adjusted to the specified level.

**■ If the tread on snow tires wears down below 0.16 in. (4 mm)**

The effectiveness of the tires as snow tires is lost.

■ **If you press the tire pressure warning reset switch accidentally (vehicles with a tire pressure warning system)**

If initialization is performed, adjust the tire inflation pressure to the specified level and initialize the tire pressure warning system again.

■ **When initialization of the tire pressure warning system has failed (vehicles with a tire pressure warning system)**

Initialization can be completed in a few minutes. However, in the following cases, the settings have not been recorded and the system will not operate properly. If repeated attempts to record tire inflation pressure settings are unsuccessful, have the vehicle inspected by your Toyota dealer.

- When operating the tire pressure warning reset switch, the tire pressure warning light does not blink 3 times.
- After driving for a certain period of time since the initialization has been completed, the warning light comes on after blinking for 1 minute.

■ **Tire pressure warning system certification**

- ▶ For the U.S.A.

FCC ID: HYQ23AAK    FCC ID: PAXPMVC010

NOTE:

This device complies with part 15 of the FCC Rules. Operation is subject to the following two conditions: (1) This device may not cause harmful interference, and (2) this device must accept any interference received, including interference that may cause undesired operation.

FCC WARNING:

Changes or modifications not expressly approved by the party responsible for compliance could void the user's authority to operate the equipment.

- ▶ For Canada

NOTE:

Operation is subject to the following two conditions: (1) this device may not cause interference, and (2) this device must accept any interference, including interference that may cause undesired operation of the device.

NOTE:

L'utilisation de ce dispositif est autorisée seulement aux deux conditions suivantes : (1) il ne doit pas produire de brouillage, et (2) l'utilisateur du dispositif doit être prêt à accepter tout brouillage radioélectrique reçu, même si ce brouillage est susceptible de compromettre le fonctionnement du dispositif.

 **WARNING****■ When inspecting or replacing tires**

Observe the following precautions to prevent accidents.

Failure to do so may cause damage to parts of the drive train as well as dangerous handling characteristics, which may lead to an accident resulting in death or serious injury.

- Do not mix tires of different makes, models or tread patterns.  
Also, do not mix tires of remarkably different treadwear.
- Do not use tire sizes other than those recommended by Toyota.
- Do not mix differently constructed tires (radial, bias-belted or bias-ply tires).
- Do not mix summer, all season and snow tires.
- Do not use tires that have been used on another vehicle.  
Do not use tires if you do not know how they were used previously.

**■ When initializing the tire pressure warning system (vehicles with a tire pressure warning system)**

Do not operate the tire pressure warning reset switch without first adjusting the tire inflation pressure to the specified level. Otherwise, the tire pressure warning light may not come on even if the tire inflation pressure is low, or it may come on when the tire inflation pressure is actually normal.

 NOTICE

■ **Repairing or replacing tires, wheels, tire pressure warning valves, transmitters and tire valve caps (vehicles with a tire pressure warning system)**

- When removing or fitting the wheels, tires or the tire pressure warning valves and transmitters, contact your Toyota dealer as the tire pressure warning valves and transmitters may be damaged if not handled correctly.
- When replacing tire valve caps, do not use tire valve caps other than those specified. The cap may become stuck.

■ **To avoid damage to the tire pressure warning valves and transmitters (vehicles with a tire pressure warning system)**

When a tire is repaired with liquid sealants, the tire pressure warning valve and transmitter may not operate properly. If a liquid sealant is used, contact your Toyota dealer or other qualified service shop as soon as possible. Make sure to replace the tire pressure warning valve and transmitter when replacing the tire. (→P. 441)

■ **Driving on rough roads**

Take particular care when driving on roads with loose surfaces or potholes.

These conditions may cause losses in tire inflation pressure, reducing the cushioning ability of the tires. In addition, driving on rough roads may cause damage to the tires themselves, as well as the vehicle's wheels and body.

■ **Low profile tires (17-inch tires)**

Low profile tires may cause greater damage than usual to the tire wheel when sustaining impact from the road surface. Therefore, pay attention to the following:

- Be sure to use proper tire inflation pressure. If tires are under-inflated, they may be damaged more severely.
- Avoid potholes, uneven pavement, curbs and other road hazards. Failure to do so may lead to severe tire and wheel damage.

■ **If tire inflation pressure of each tire becomes low while driving**

Do not continue driving, or your tires and/or wheels may be ruined.

## Tire inflation pressure

### Tire inflation pressure

The recommended cold tire inflation pressure and tire size are displayed on the tire and loading information label. (→P. 546)

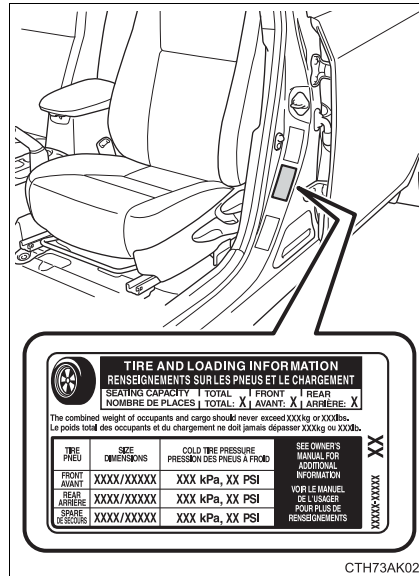



### Inspection and adjustment procedure

- ① Tire valve
- ② Tire pressure gauge

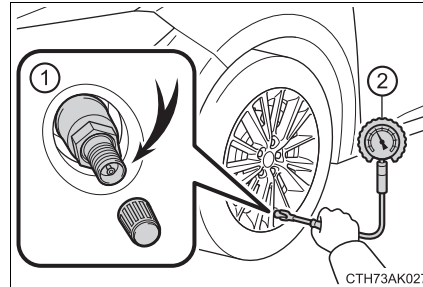

- 1 Remove the tire valve cap.
- 2 Press the tip of the tire pressure gauge onto the tire valve.
- 3 Read the pressure using the gauge gradations.
- 4 If the tire inflation pressure is not at the recommended level, adjust the pressure.  
If you add too much air, press the center of the valve to deflate.
- 5 After completing the tire inflation pressure measurement and adjustment, apply soapy water to the valve and check for leakage.
- 6 Put the tire valve cap back on.

#### ■ Tire inflation pressure check interval

You should check tire inflation pressure every two weeks, or at least once a month.

Do not forget to check the spare.

#### ■ Effects of incorrect tire inflation pressure

Driving with incorrect tire inflation pressure may result in the following:

- Reduced fuel economy
- Reduced driving comfort and poor handling
- Reduced tire life due to wear
- Reduced safety
- Damage to the drive train

If a tire needs frequent inflating, have it checked by your Toyota dealer.

**■ Instructions for checking tire inflation pressure**

When checking tire inflation pressure, observe the following:

- Check only when the tires are cold.  
If your vehicle has been parked for at least 3 hours or has not been driven for more than 1 mile or 1.5 km, you will get an accurate cold tire inflation pressure reading.
- Always use a tire pressure gauge.  
It is difficult to judge if a tire is properly inflated based only on its appearance.
- It is normal for the tire inflation pressure to be higher after driving as heat is generated in the tire. Do not reduce tire inflation pressure after driving.
- Never exceed the vehicle capacity weight.  
Passengers and luggage weight should be placed so that the vehicle is balanced.

**⚠ WARNING****■ Proper inflation is critical to save tire performance**

Keep your tires properly inflated.

If the tires are not properly inflated, the following conditions may occur which could lead to an accident resulting in death or serious injury:

- Excessive wear
- Uneven wear
- Poor handling
- Possibility of blowouts resulting from overheated tires
- Air leaking from between tire and wheel
- Wheel deformation and/or tire damage
- Greater possibility of tire damage while driving (due to road hazards, expansion joints, sharp edges in the road, etc.)

**⚠ NOTICE****■ When inspecting and adjusting tire inflation pressure**

Be sure to put the tire valve caps back on.

If a valve cap is not installed, dirt or moisture may get into the valve and cause an air leak, resulting in decreased tire inflation pressure.

## Wheels

**If a wheel is bent, cracked or heavily corroded, it should be replaced. Otherwise, the tire may separate from the wheel or cause a loss of handling control.**

### Wheel selection

When replacing wheels, care should be taken to ensure that they are equivalent to those removed in load capacity, diameter, rim width and inset\*.

Replacement wheels are available at your Toyota dealer.

\*: Conventionally referred to as "offset".

Toyota does not recommend using the following:

- Wheels of different sizes or types
- Used wheels
- Bent wheels that have been straightened

### Aluminum wheel precautions (if equipped)

- Use only Toyota wheel nuts and wrenches designed for use with your aluminum wheels.
- When rotating, repairing or changing your tires, check that the wheel nuts are still tight after driving 1000 miles (1600 km).
- Be careful not to damage the aluminum wheels when using tire chains.
- Use only Toyota genuine balance weights or equivalent and a plastic or rubber hammer when balancing your wheels.

### ■ When replacing wheels (vehicles with a tire pressure warning system)

The wheels of your vehicle are equipped with tire pressure warning valves and transmitters that allow the tire pressure warning system to provide advance warning in the event of a loss in tire inflation pressure. Whenever wheels are replaced, tire pressure warning valves and transmitters must be installed. (→P. 441)

**⚠ WARNING****■ When replacing wheels**

- Do not use wheels that are a different size from those recommended in the Owner's Manual, as this may result in a loss of handling control.
- Never use an inner tube in a leaking wheel which is designed for a tubeless tire. Doing so may result in an accident, causing death or serious injury.

**■ When installing the wheel nuts**

- Be sure to install the wheel nuts with the tapered ends facing inward. Installing the nuts with the tapered ends facing outward can cause the wheel to break and eventually cause the wheel to come off while driving, which could lead to an accident resulting in death or serious injury.

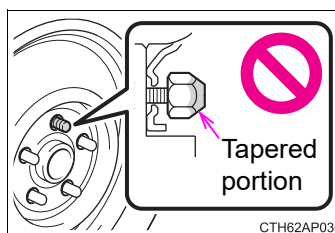

- Never use oil or grease on the wheel bolts or wheel nuts. Oil and grease may cause the wheel nuts to be excessively tightened, leading to bolt or disc wheel damage. In addition, the oil or grease can cause the wheel nuts to loosen and the wheel may fall off, causing an accident and resulting in death or serious injury. Remove any oil or grease from the wheel bolts or wheel nuts.

**■ Use of defective wheels prohibited**

Do not use cracked or deformed wheels. Doing so could cause the tire to leak air during driving, possibly causing an accident.

**⚠ NOTICE****■ Replacing tire pressure warning valves and transmitters (vehicles with a tire pressure warning system)**

- Because tire repair or replacement may affect the tire pressure warning valves and transmitters, make sure to have tires serviced by your Toyota dealer or other qualified service shop. In addition, make sure to purchase your tire pressure warning valves and transmitters at your Toyota dealer.
- Ensure that only genuine Toyota wheels are used on your vehicle. Tire pressure warning valves and transmitters may not work properly with non-genuine wheels.

## Air conditioning filter

The air conditioning filter must be changed regularly to maintain air conditioning efficiency.

### Removal method

- 1 Turn the engine switch off.
- 2 Open the glove box. Slide off the damper.

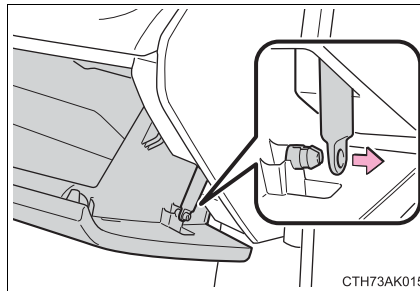

- 3 Push in the glove box on the vehicle's outer side to disconnect the claws. Then pull out the glove box and disconnect the lower claws.

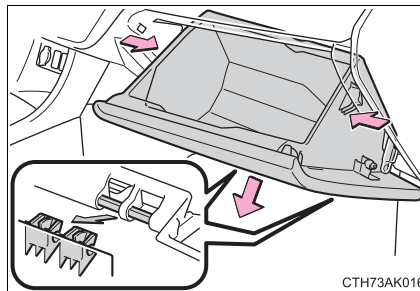

- 4 Remove the filter cover.

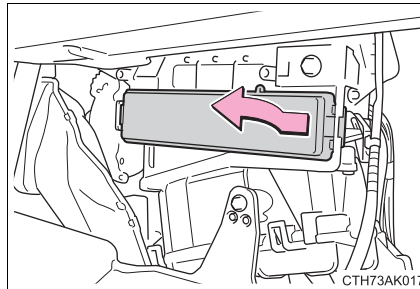

■ **Replacement method**

Remove the air conditioning filter and replace it with a new one.

The “↑UP” marks shown on the filter should be pointing up.

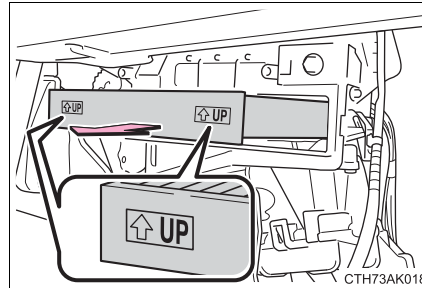

■ **Checking interval**

Inspect and replace the air conditioning filter according to the maintenance schedule. In dusty areas or areas with heavy traffic flow, early replacement may be required. (For scheduled maintenance information, please refer to the “Schedule maintenance guide” or “Owner’s Manual Supplement”.)

■ **If air flow from the vents decreases dramatically**

The filter may be clogged. Check the filter and replace if necessary.

 **NOTICE**

■ **When using the air conditioning system**

Make sure that a filter is always installed.

Using the air conditioning system without a filter may cause damage to the system.

## Wireless remote control/electronic key battery\*

Replace the battery with a new one if it is depleted.

### You will need the following items:

- Flathead screwdriver
- Small flathead screwdriver
- Lithium battery CR2016 (vehicles without a smart key system), or CR2032 (vehicles with a smart key system)

### Replacing the battery

#### ► Vehicles without a smart key system

#### 1 Remove the cover.

To prevent damage to the key, cover the tip of the screwdriver with a rag.

To prevent the buttons from being disassembled, face the button surface downward.

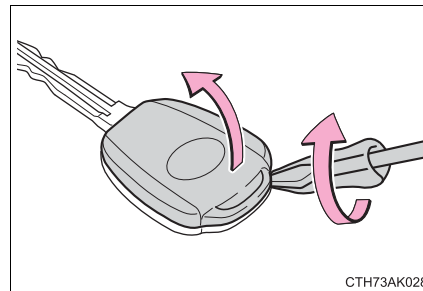

#### 2 Remove the module.

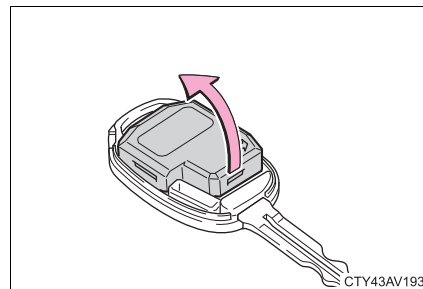

7

Maintenance and care

\*: If equipped

- 3 Open the case cover using a coin protected with tape etc. and remove the depleted battery using a small flathead screwdriver.

Insert a new battery with the “+” terminal facing up.

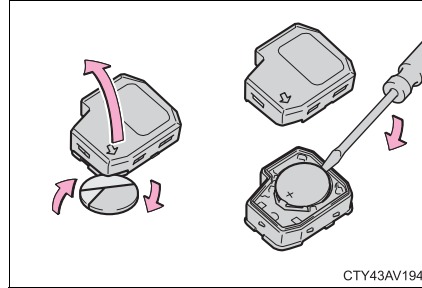

► Vehicles with a smart key system

- 1 Take out the mechanical key.

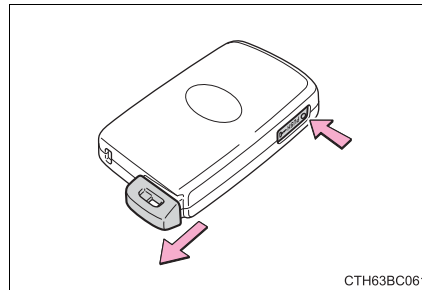

- 2 Remove the cover.

To prevent damage to the key, cover the tip of the screwdriver with a rag.

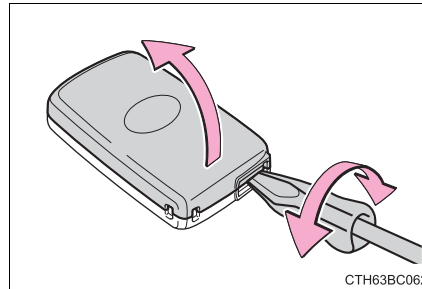

- 3 Remove the depleted battery.

Insert a new battery with the “+” terminal facing up.

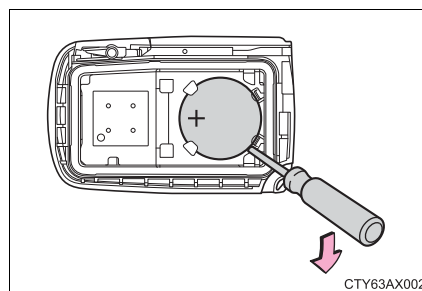



■ **Use a CR2016 (vehicles without a smart key system) or CR2032 (vehicles with a smart key system) lithium battery**

- Batteries can be purchased at your Toyota dealer, local electrical appliance shops or camera stores.
- Replace only with the same or equivalent type recommended by the manufacturer.
- Dispose of used batteries according to local laws.

■ **If the key battery is depleted**

The following symptoms may occur:

- The smart key system (if equipped) and wireless remote control will not function properly.
- The operational range will be reduced.



**WARNING**

■ **Removed battery and other parts**

These parts are small and if swallowed by a child, they can cause choking. Keep away from children. Failure to do so could result in death or serious injury.



**NOTICE**

■ **For normal operation after replacing the battery**

Observe the following precautions to prevent accidents:

- Always work with dry hands.  
Moisture may cause the battery to rust.
- Do not touch or move any other component inside the remote control.
- Do not bend either of the battery terminals.

## Checking and replacing fuses

**If any of the electrical components do not operate, a fuse may have blown. If this happens, check and replace the fuses as necessary.**

- 1 Turn the engine switch off.
- 2 Open the fuse box cover.

► Engine compartment

Push the tab in and lift the lid off.

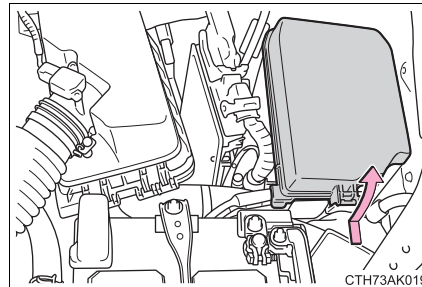

► Under the driver's side instrument panel

Remove the lid.

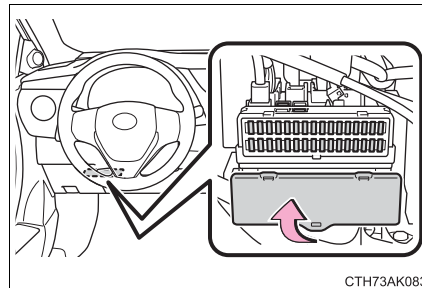

- 3 Remove the fuse with the pull-out tool.

Only type A fuses can be removed using the pullout tool.

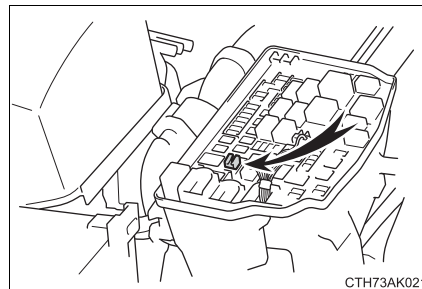

**4** Check if the fuse is blown.

- ① Normal fuse
- ② Blown fuse

Replace the blown fuse with a new fuse of an appropriate amperage rating. The amperage rating can be found on the fuse box lid.

## ▶ Type A

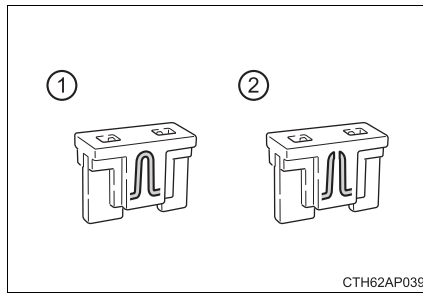

## ▶ Type B

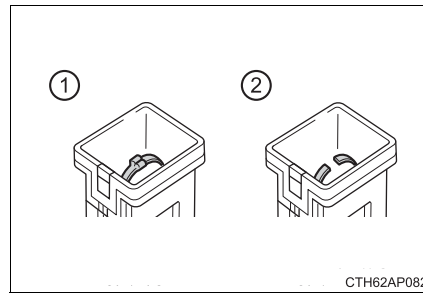

## ▶ Type C

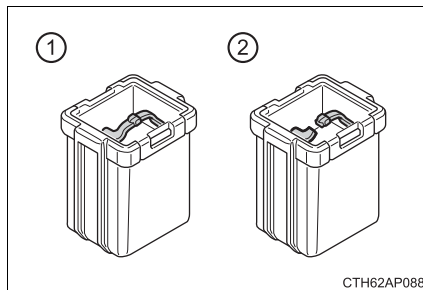

■ **After a fuse is replaced**

- If the lights do not turn on even after the fuse has been replaced, a bulb may need replacement. (→P. 461)
- If the replaced fuse blows again, have the vehicle inspected by your Toyota dealer.

■ **If there is an overload in a circuit**

The fuses are designed to blow, protecting the wiring harness from damage.

 **WARNING**

■ **To prevent system breakdowns and vehicle fire**

Observe the following precautions.

Failure to do so may cause damage to the vehicle, and possibly a fire or injury.

- Never use a fuse of a higher amperage rating than that indicated, or use any other object in place of a fuse.
- Always use a genuine Toyota fuse or equivalent.  
Never replace a fuse with a wire, even as a temporary fix.
- Do not modify the fuses or fuse boxes.

 **NOTICE**

■ **Before replacing fuses**

Have the cause of electrical overload determined and repaired by your Toyota dealer as soon as possible.

## Light bulbs

You may replace the following bulbs yourself. The difficulty level of replacement varies depending on the bulb. If necessary bulb replacement seems difficult to perform, contact your Toyota dealer.

For more information about replacing other light bulbs, contact your Toyota dealer.

### Preparing for light bulb replacement

Check the wattage of the light bulb to be replaced. (→P. 547)

### Bulb locations

#### ■ Front

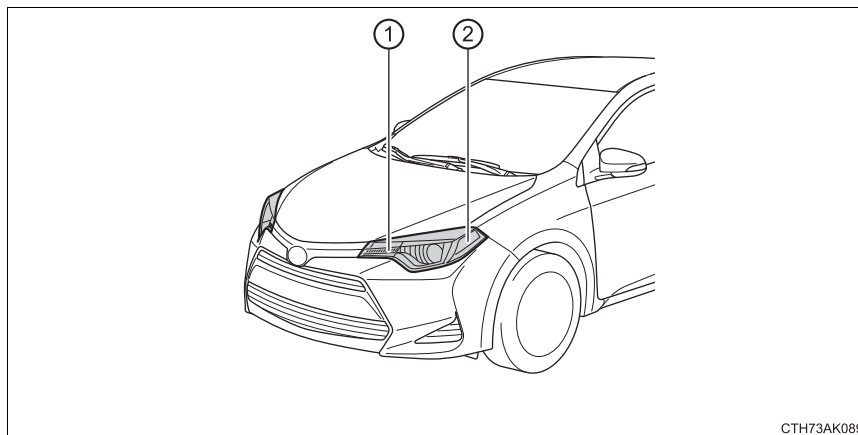

- ① Front turn signal/parking lights
- ② Front side marker lights

■ Rear

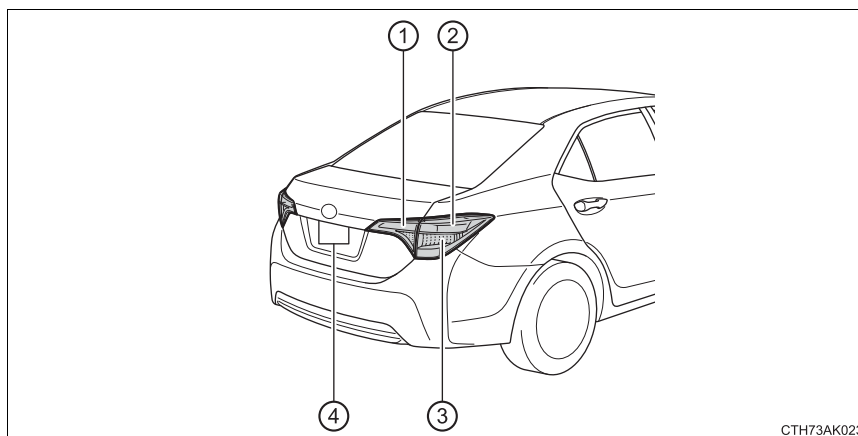

CTH73AK023

- ① Back-up lights (bulb type)
- ② Rear turn signal lights
- ③ Stop/tail/rear side marker lights
- ④ License plate lights

**Replacing light bulbs****■ Front side marker lights**

- 1 Turn the bulb base counter-clockwise.

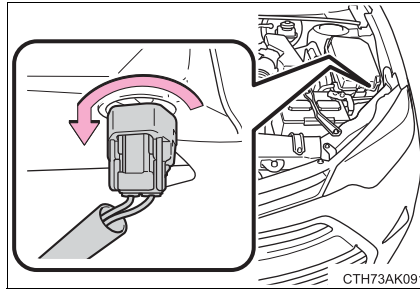

- 2 Remove the light bulb.

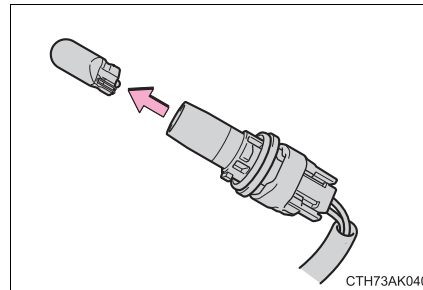

- 3 When installing, reverse the steps listed.

■ **Front turn signal/parking lights**

- 1 Turn the bulb base counter-clockwise.

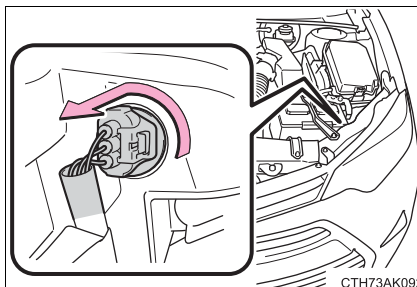

- 2 Remove the light bulb.

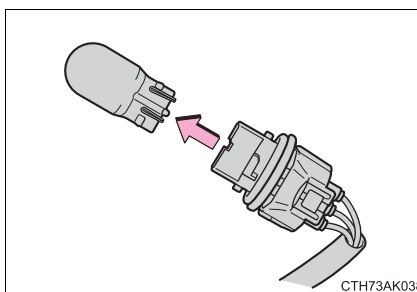

- 3 When installing, reverse the steps listed.



### ■ Stop/tail/rear side marker lights and rear turn signal lights

- 1 Open the trunk lid and remove the clips.

To prevent damage to the vehicle, cover the tip of the screwdriver with a rag.

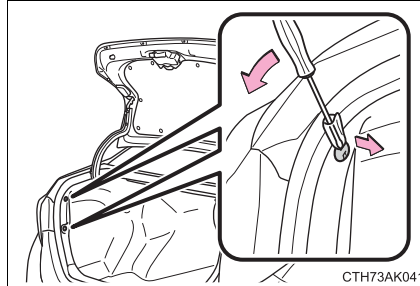

- 2 Partly remove the luggage trim cover.

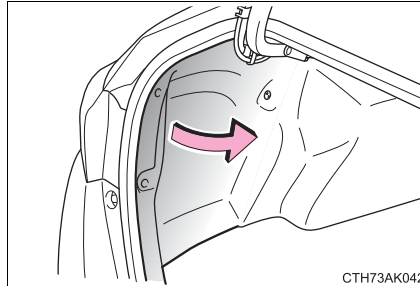

- 3 Turn the bulb base counter-clockwise.

- ① Rear turn signal light
- ② Stop/tail/rear side marker light

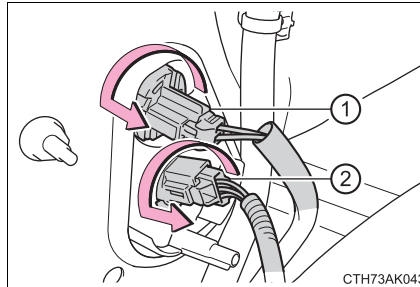

- 4 Remove the light bulb.

- ① Rear turn signal light
- ② Stop/tail/rear side marker light

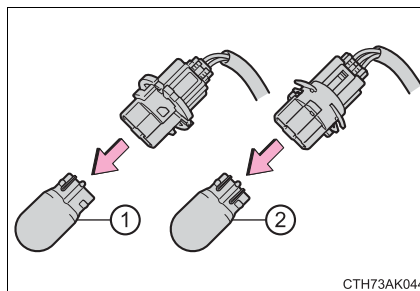

- 5 When installing, reverse the steps listed.

■ **Back-up lights (bulb type)**

- 1 Open the trunk lid and remove the cover.

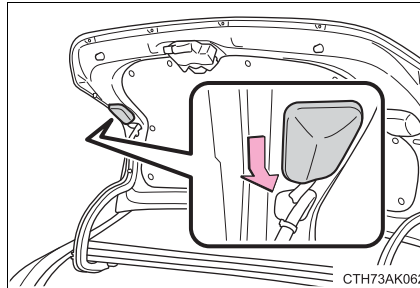

- 2 Turn the bulb base counter-clockwise.

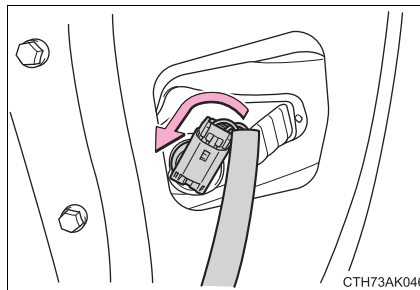

- 3 Remove the light bulb.

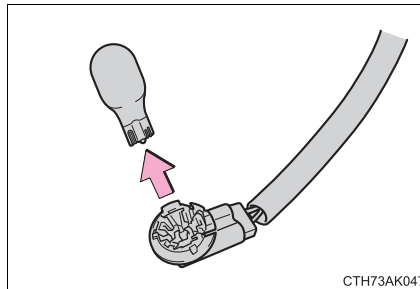

- 4 When installing, reverse the steps listed.

**■ License plate lights**

- 1 Open the trunk lid and remove the trunk panel cover clips.

To prevent damage to the vehicle, cover the tip of the screwdriver with a rag.

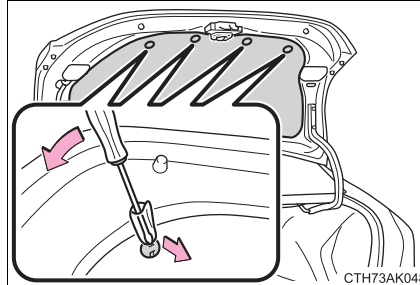

- 2 Partly remove the trunk panel cover and turn the bulb base counterclockwise.

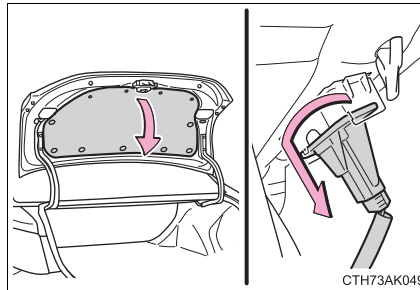

- 3 Remove the light bulb.

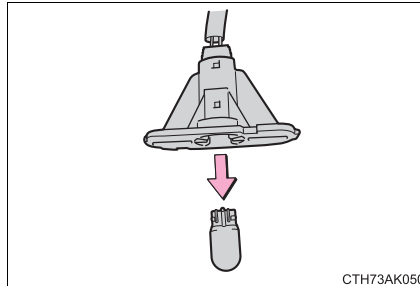

- 4 When installing, reverse the steps listed.

**■ Replacing the following bulbs**

If any of the lights listed below has burnt out, have it replaced by your Toyota dealer.

- Headlights/daytime running lights (if equipped)
- Daytime running lights (if equipped)
- High mounted stoplight
- Side turn signal lights (if equipped)
- Back-up lights (LED type)

**■ LED light bulbs**

The headlights, daytime running lights, high mounted stoplight, and back-up lights (LED type) consist of a number of LEDs. If any of the LEDs burns out, take your vehicle to your Toyota dealer to have the light replaced.

**■ Condensation build-up on the inside of the lens**

Temporary condensation build-up on the inside of the headlight lens does not indicate a malfunction.

Contact your Toyota dealer for more information in the following situations:

- Large drops of water have built up on the inside of the lens.
- Water has built up inside the headlight.

**⚠ WARNING****■ Replacing light bulbs**

- Turn off the lights. Do not attempt to replace the bulb immediately after turning off the lights.

The bulbs become very hot and may cause burns.

- Do not touch the glass portion of the light bulb with bare hands. When it is unavoidable to hold the glass portion, use and hold with a clean dry cloth to avoid getting moisture and oils on the bulb.

Also, if the bulb is scratched or dropped, it may blow out or crack.

- Fully install light bulbs and any parts used to secure them. Failure to do so may result in heat damage, fire, or water entering the headlight unit. This may damage the headlights or cause condensation to build up on the lens.

**■ To prevent damage or fire**

Make sure bulbs are fully seated and locked.

**When trouble arises****8****8-1. Essential information**

- Emergency flashers ..... 470
- If your vehicle has to be stopped in an emergency ..... 471

**8-2. Steps to take in an emergency**

- If your vehicle needs to be towed ..... 473
- If you think something is wrong ..... 478
- Fuel pump shut off system ..... 479
- If a warning light turns on or a warning buzzer sounds ..... 480
- If a warning message or indicator is displayed ..... 489
- If you have a flat tire..... 509
- If the engine will not start..... 521
- If the electronic key does not operate properly..... 523
- If the vehicle battery is discharged ..... 526
- If your vehicle overheats ... 531
- If the vehicle becomes stuck ..... 534

## Emergency flashers

**The emergency flashers are used to warn other drivers when the vehicle has to be stopped in the road due to a breakdown, etc.**

Press the switch.

All the turn signal lights will flash.  
To turn them off, press the switch  
once again.

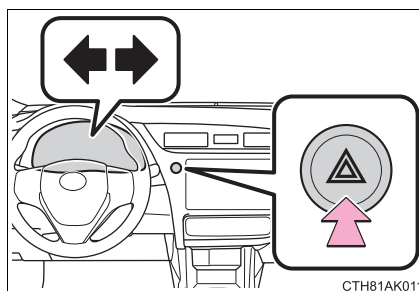

### ■ Emergency flashers

If the emergency flashers are used for a long time while the engine is not operating, the battery may discharge.

## If your vehicle has to be stopped in an emergency

**Only in an emergency, such as if it becomes impossible to stop the vehicle in the normal way, stop the vehicle using the following procedure:**

- 1 Steadily step on the brake pedal with both feet and firmly depress it.  
Do not pump the brake pedal repeatedly as this will increase the effort required to slow the vehicle.
- 2 Shift the shift lever to N.
  - ▶ If the shift lever is shifted to N
- 3 After slowing down, stop the vehicle in a safe place by the road.
- 4 Stop the engine.
  - ▶ If the shift lever cannot be shifted to N
- 3 Keep depressing the brake pedal with both feet to reduce vehicle speed as much as possible.
- 4 Vehicles without a smart key system: Stop the engine by turning the engine switch to the "ACC" position.
 

Diagram showing a hand turning the engine start/stop switch to the 'ACC' position. The dial has markings for 'LOCK', 'ACC ON', 'STOP', and 'START'. A red arrow points to the 'ACC ON' position.

CTH81AK002
- 4 Vehicles with a smart key system: To stop the engine, press and hold the engine switch for 2 consecutive seconds or more, or press it briefly 3 times or more in succession.
 

Diagram showing a smart key engine start/stop button. The button is circular with 'ENGINE START STOP' written on it. A red arrow points to the button.

Press and hold for 2 seconds or more, or press briefly 3 times or more

CTH71AP004
- 5 Stop the vehicle in a safe place by the road.

 **WARNING****■ If the engine has to be turned off while driving**

- Power assist for the brakes and steering wheel will be lost, making the brake pedal harder to depress and the steering wheel heavier to turn. Decelerate as much as possible before turning off the engine.
- Vehicles without a smart key system: Never attempt to remove the key, as doing so will lock the steering wheel.



## If your vehicle needs to be towed

**If towing is necessary, we recommend having your vehicle towed by your Toyota dealer or commercial towing service, using a wheel-lift type truck or flatbed truck.**

**Use a safety chain system for all towing, and abide by all state/provincial and local laws.**

### Situations when it is necessary to contact dealers before towing

The following may indicate a problem with your transmission. Contact your Toyota dealer or commercial towing service before towing.

- The engine is running but the vehicle does not move.
- The vehicle makes an abnormal sound.

### Towing with a sling-type truck

Do not tow with a sling-type truck to prevent body damage.

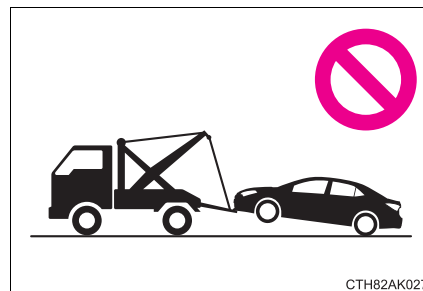

### Towing with a wheel-lift type truck

► From the front

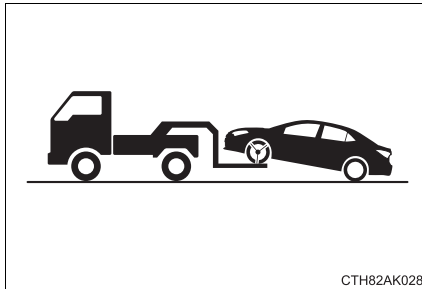

Release the parking brake.

► From the rear

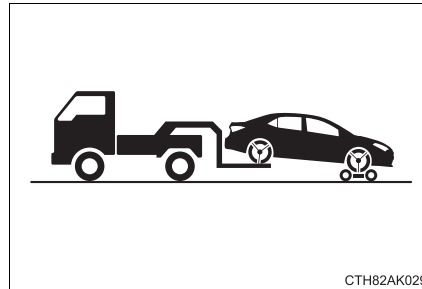

Use a towing dolly under the front wheels.

### Using a flatbed truck

If your vehicle is transported by a flatbed truck, it should be tied down at the locations shown in the illustration.

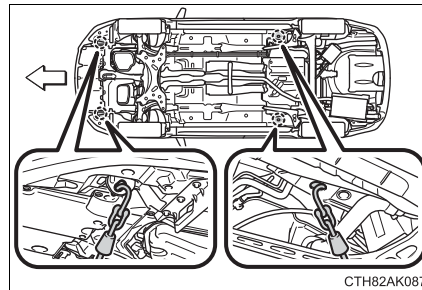

If you use chains or cables to tie down your vehicle, the angles shaded in black must be 45°.

Do not overly tighten the tie downs or the vehicle may be damaged.

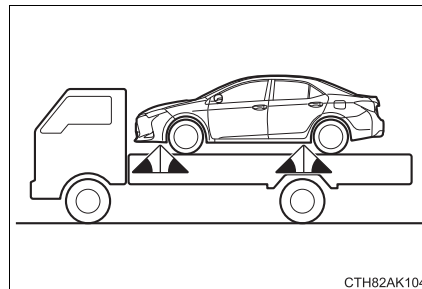

### Emergency towing

If a tow truck is not available in an emergency, your vehicle may be temporarily towed using cables or chains secured to the emergency towing eyelet. This should only be attempted on hard surfaced roads for at most 50 miles (80 km) at under 18 mph (30 km/h).

A driver must be in the vehicle to steer and operate the brakes. The vehicle's wheels, drive train, axles, steering and brakes must be in good condition.

### Emergency towing procedure

- 1 Securely attach cables or chains to the towing eyelet.

Take care not to damage the vehicle body.

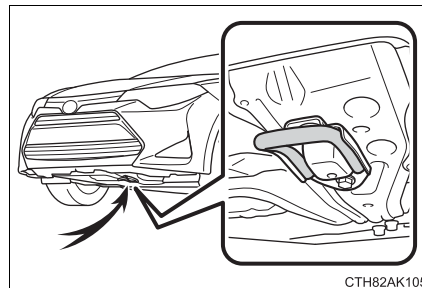

CTH82AK105

- 2 Vehicles without a smart key system: Enter the vehicle being towed and start the engine.

If the engine does not start, turn the engine switch to the "ON" position.

Vehicles with a smart key system: Enter the vehicle being towed and start the engine.

If the engine does not start, turn the engine switch to IGNITION ON mode.

- 3 Shift the shift lever to N and release the parking brake.

Vehicles with a continuously variable transmission: When the shift lever cannot be shifted: →P. 183, 188

#### ■ While towing

If the engine is not running, the power assist for the brakes and steering will not function, making steering and braking more difficult.

#### ■ Wheel nut wrench

Wheel nut wrench is stored in the trunk. (→P. 509)

**⚠ WARNING**

Observe the following precautions.  
Failure to do so may result in death or serious injury.

■ **When towing the vehicle**

Be sure to transport the vehicle with the front wheels raised or with all four wheels raised off the ground. If the vehicle is towed with the front wheels contacting the ground, the drivetrain and related parts may be damaged.

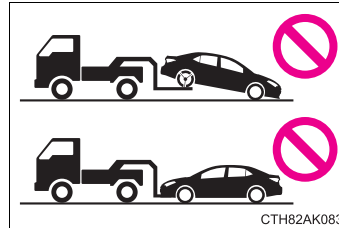

■ **While towing**

- When towing using cables or chains, avoid sudden starts, etc. which place excessive stress on the towing eyelet, cables or chains. The towing eyelet, cables or chains may become damaged, broken debris may hit people, and cause serious damage.
- Vehicles without a smart key system: Do not turn the engine switch to the "LOCK" position.  
There is a possibility that the steering wheel is locked and cannot be operated.
- Vehicles with a smart key system: Do not turn the engine switch off.  
There is a possibility that the steering wheel is locked and cannot be operated.

 NOTICE**■ To prevent damage to the vehicle when towing using a wheel-lift type truck**

- Vehicles without a smart key system: Do not tow the vehicle from the rear when the engine switch is in the “LOCK” position or the key is removed. The steering lock mechanism is not strong enough to hold the front wheels straight.
- Vehicles with a smart key system: Do not tow the vehicle from the rear when the engine switch is off. The steering lock mechanism is not strong enough to hold the front wheels straight.
- When raising the vehicle, ensure adequate ground clearance for towing at the opposite end of the raised vehicle. Without adequate clearance, the vehicle could be damaged while being towed.

**■ To prevent damage to the vehicle when towing with a sling-type truck**

Do not tow with a sling-type truck, either from the front or rear.

**■ To prevent damage to the vehicle during emergency towing**

Do not secure cables or chains to the suspension components.

## If you think something is wrong

**If you notice any of the following symptoms, your vehicle probably needs adjustment or repair. Contact your Toyota dealer as soon as possible.**

### Visible symptoms

- Fluid leaks under the vehicle.  
(Water dripping from the air conditioning after use is normal.)
- Flat-looking tires or uneven tire wear
- Engine coolant temperature gauge needle continually points higher than normal.

### Audible symptoms

- Changes in exhaust sound
- Excessive tire squeal when cornering
- Strange noises related to the suspension system
- Pinging or other noises related to the engine

### Operational symptoms

- Engine missing, stumbling or running roughly
- Appreciable loss of power
- Vehicle pulls heavily to one side when braking
- Vehicle pulls heavily to one side when driving on a level road
- Loss of brake effectiveness, spongy feeling, pedal almost touches the floor

## Fuel pump shut off system

**To minimize the risk of fuel leakage when the engine stalls or when an airbag inflates upon collision, the fuel pump shut off system stops the supply of fuel to the engine.**

Follow the procedure below to restart the engine after the system is activated.

▶ Vehicles without a smart key system

- 1 Turn the engine switch to the “ACC” or “LOCK” position.
- 2 Restart the engine.

▶ Vehicles with a smart key system

- 1 Turn the engine switch to ACCESSORY mode or turn it off.
- 2 Restart the engine.



### NOTICE

■ **Before starting the engine**







Inspect the ground under the vehicle.

If you find that fuel has leaked onto the ground, the fuel system has been damaged and is in need of repair. Do not restart the engine.



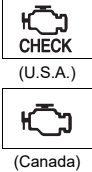





## If a warning light turns on or a warning buzzer sounds



**Calmly perform the following actions if any of the warning lights comes on or flashes. If a light comes on or flashes, but then goes off, this does not necessarily indicate a malfunction in the system. However, if this continues to occur, have the vehicle inspected by your Toyota dealer.**

### Warning light and warning buzzer list

Warning light	Warning light/Details/Actions
 <p><b>BRAKE</b> (U.S.A.)  (Canada)</p>	<p><b>Brake system warning light (warning buzzer)*1</b> Indicates that:</p> <ul style="list-style-type: none"> <li>• The brake fluid level is low; or</li> <li>• The brake system is malfunctioning</li> </ul> <p>This light also comes on when the parking brake is not released. If the light turns off after the parking brake is fully released the system is operating normally.</p> <p>→ <b>Immediately stop the vehicle in a safe place and contact your Toyota dealer. Continuing to drive the vehicle may be dangerous.</b></p>
 <p> <b>CHECK</b> (U.S.A.)  (Canada)</p>	<p><b>Malfunction indicator lamp</b> Indicates a malfunction in:</p> <ul style="list-style-type: none"> <li>• The electronic engine control system;</li> <li>• The electronic throttle control system; or</li> <li>• The electronic continuously variable transmission control system.</li> </ul> <p>→ <b>Have the vehicle inspected by your Toyota dealer immediately.</b></p>
 <p></p>	<p><b>SRS warning light</b> Indicates a malfunction in:</p> <ul style="list-style-type: none"> <li>• The SRS airbag system;</li> <li>• The front passenger occupant classification system; or</li> <li>• The seat belt pretensioner system</li> </ul> <p>→ <b>Have the vehicle inspected by your Toyota dealer immediately.</b></p>



Warning light	Warning light/Details/Actions
 <p>(U.S.A.)</p>  <p>(Canada)</p>	<p><b>ABS warning light</b> Indicates a malfunction in:</p> <ul style="list-style-type: none"> <li>• The ABS; or</li> <li>• The brake assist system</li> </ul> <p>→ <b>Have the vehicle inspected by your Toyota dealer immediately.</b></p>
	<p><b>Electric power steering system warning light (warning buzzer)</b> Indicates a malfunction in the EPS (Electric Power Steering) system</p> <p>→ <b>Have the vehicle inspected by your Toyota dealer immediately.</b></p>
 <p>(Comes on)</p>	<p><b>Slip indicator</b> Indicates a malfunction in:</p> <ul style="list-style-type: none"> <li>• The VSC (Vehicle Stability Control) system;</li> <li>• The TRAC (Traction Control) system; or</li> <li>• The hill-start assist control system</li> </ul> <p>The light will flash when the VSC or the TRAC system is operating.</p> <p>→ <b>Have the vehicle inspected by your Toyota dealer immediately.</b></p>
	<p><b>Low fuel level warning light</b> Indicates that remaining fuel is approximately 2.0 gal. (7.5 L, 1.7 Imp. gal.) or less</p> <p>→ <b>Refuel the vehicle.</b></p>
	<p><b>Driver's and front passenger's seat belt reminder light (warning buzzer)*2</b> Warns the driver and/or front passenger to fasten their seat belts</p> <p>→ <b>Fasten the seat belt.</b></p> <p><b>If the front passenger's seat is occupied, the front passenger's seat belt also needs to be fastened to make the warning light (warning buzzer) turn off.</b></p>
	<p><b>Rear passengers' seat belt reminder lights (warning buzzer)*2</b> Warns the rear passengers to fasten their seat belts.</p> <p>→ <b>Fasten the seat belt.</b></p>
	<p><b>Master warning light</b> A buzzer sounds and the warning light comes on and flashes to indicate that the master warning system has detected a malfunction.</p> <p>→ <b>P. 489</b></p>

Warning light	Warning light/Details/Actions
 <p>(Flashes or illuminates)</p>	<p><b>PCS warning light</b></p> <p>Indicates a malfunction in the PCS (Pre-Collision System) or that the system is temporarily unavailable due to the vehicle being extremely hot/cold, or dirt around a front sensor, etc. (→P. 225, 489)</p> <p>→ <b>Follow the instructions displayed on the multi-information display. (→P. 225, 489)</b></p> <p>If the PCS (Pre-Collision System) or VSC (Vehicle Stability Control) system is disabled, the PCS warning light will illuminate.</p> <p>→ <b>P. 225</b></p>
 <p>(Orange)</p>	<p><b>LDA (Lane Departure Alert with steering control) indicator</b></p> <p>The warning light comes on and a warning message is displayed to indicate that the LDA (Lane Departure Alert with steering control) system is not available temporarily or has detected a malfunction.</p> <p>→ <b>P. 491, 492</b></p>
	<p><b>Tire pressure warning light*<sup>3</sup></b></p> <p>When the light comes on:</p> <p>Low tire inflation pressure such as</p> <ul style="list-style-type: none"> <li>• Natural causes (→P. 484)</li> <li>• Flat tire (→P. 509)</li> </ul> <p>→ <b>Adjust the tire inflation pressure to the specified level.</b></p> <p><b>The light will turn off after a few minutes. In case the light does not turn off even if the tire inflation pressure is adjusted, have the system checked by your Toyota dealer.</b></p> <p>When the light comes on after blinking for 1 minute:</p> <p>Malfunction in the tire pressure warning system</p> <p>→ <b>Have the system checked by your Toyota dealer.</b></p>

\*1: Parking brake engaged warning buzzer:

→P. 490

\*2: Driver's seat belt buzzer:

Vehicles without a smart key system: The driver's seat belt buzzer sounds to alert the driver that his or her seat belt is not fastened. Once the engine switch is turned to the "ON" position, the buzzer sounds for 6 seconds. If the vehicle reaches a speed of 12 mph (20 km/h), the buzzer sounds once. If the seat belt is still unfastened after 24 seconds, the buzzer will sound intermittently for 6 seconds. Then, if the seat belt is still unfastened, the buzzer will sound in a different tone for 90 more seconds.

Vehicles with a smart key system: The driver's seat belt buzzer sounds to alert the driver that his or her seat belt is not fastened. Once the engine switch is turned to IGNITION ON mode, the buzzer sounds for 6 seconds. If the vehicle reaches a speed of 12 mph (20 km/h), the buzzer sounds once. If the seat belt is still unfastened after 24 seconds, the buzzer will sound intermittently for 6 seconds. Then, if the seat belt is still unfastened, the buzzer will sound in a different tone for 90 more seconds.

Front passenger's seat belt buzzer:

The front passenger's seat belt buzzer sounds to alert the front passenger that his or her seat belt is not fastened. The buzzer sounds once if the vehicle reaches a speed of 12 mph (20 km/h). If the seat belt is still unfastened after 24 seconds, the buzzer will sound intermittently for 6 seconds. Then, if the seat belt is still unfastened, the buzzer will sound in a different tone for 90 more seconds.

Rear passenger's seat belt buzzer:

The rear passenger's seat belt buzzer sounds to alert the rear passengers that his or her seat belt is not fastened. The buzzer sounds for 6 seconds after the vehicle reaches a speed of 12 mph (20 km/h). Then, if the seat belt is still unfastened, the buzzer will sound in a different tone for 24 more seconds.

\*3: If equipped

**■ SRS warning light**

This warning light system monitors the airbag sensor assembly, front impact sensors, side impact sensors (front door), side impact sensors (front), side impact sensors (rear), driver's seat belt buckle switch, front passenger occupant classification system, "AIR BAG ON" indicator light, "AIR BAG OFF" indicator light, front passenger's seat belt buckle switch, seat belt pretensioners (front), airbags, interconnecting wiring and power sources. (→P. 36)

**■ Front passenger detection sensor, seat belt reminder and warning buzzer**

If luggage is placed on the front passenger seat, the front passenger detection sensor may cause the warning light to flash and the warning buzzer to sound even if a passenger is not sitting in the seat.

**■ If the malfunction indicator lamp comes on while driving**

First check the following:

- Is the fuel tank empty?  
If it is, fill the fuel tank immediately.
- Is the fuel tank cap loose?  
If it is, tighten it securely.

The light will go off after several driving trips.

If the light does not go off even after several trips, contact your Toyota dealer as soon as possible.

**■ When the tire pressure warning light comes on (vehicles with a tire pressure warning system)**

Check the tire inflation pressure and adjust to the appropriate level. Pushing the tire pressure warning reset switch will not turn off the tire pressure warning light.

**■ The tire pressure warning light may come on due to natural causes (vehicles with a tire pressure warning system)**

The tire pressure warning light may come on due to natural causes such as natural air leaks and tire inflation pressure changes caused by temperature. In this case, adjusting the tire inflation pressure will turn off the warning light (after a few minutes).

**■ When a tire is replaced with a spare tire (vehicles with a tire pressure warning system)**

The compact spare tire is not equipped with a tire pressure warning valve and transmitter. If a tire goes flat, the tire pressure warning light will not turn off even though the flat tire has been replaced with the spare tire. Replace the spare tire with the repaired tire and adjust the tire inflation pressure. The tire pressure warning light will go off after a few minutes.

**■ Conditions that the tire pressure warning system may not function properly (vehicles with a tire pressure warning system)**

The tire pressure warning system will be disabled in the following conditions:

(When the condition becomes normal, the system will work properly.)

- If tires not equipped with tire pressure warning valves and transmitters are used
- If the ID code on the tire pressure warning valves and transmitters is not registered in the tire pressure warning computer
- If the tire inflation pressure is 73 psi (500 kPa, 5.1 kgf/cm<sup>2</sup> or bar) or higher

The tire pressure warning system may be disabled in the following conditions:

(When the condition becomes normal, the system will work properly.)

- If electronic devices or facilities using similar radio wave frequencies are nearby
- If a radio set at similar frequency is in use in the vehicle
- If a window tint that affects the radio wave signals is installed
- If there is a lot of snow or ice on the vehicle, in particular around the wheels or wheel housings
- If non-genuine Toyota wheels are used (Even if you use Toyota wheels, the tire pressure warning system may not work properly with some types of tires.)
- If tire chains are used

**■ If the tire pressure warning light frequently comes on after blinking for 1 minute (vehicles with a tire pressure warning system)**

If the tire pressure warning light frequently comes on after blinking for 1 minute when the engine switch is turned on, have it checked by your Toyota dealer.

**■ Warning buzzer**

In some cases, the buzzer may not be heard because of noisy place or an audio sound.

**■ Electric power steering system warning light (warning buzzer)**

When the battery charge becomes insufficient or the voltage temporarily drops, the electric power steering system warning light may come on and the warning buzzer may sound.

 **WARNING****■ If both the ABS and the brake system warning lights remain on**

Stop your vehicle in a safe place immediately and contact your Toyota dealer. The vehicle will become extremely unstable during braking, and the ABS system may fail, which could cause an accident resulting in death or serious injury.

**■ When the electric power steering system warning light comes on**

The steering wheel may become extremely heavy.

When steering wheel operations are heavier than usual, grip the steering wheel firmly and operate it using more force than usual.

**■ If the tire pressure warning light comes on (vehicles with a tire pressure warning system)**

Be sure to observe the following precautions. Failure to do so could cause a loss of vehicle control and result in death or serious injury.

- Stop your vehicle in a safe place as soon as possible. Adjust the tire inflation pressure immediately.
- If the tire pressure warning light comes on even after tire inflation pressure adjustment, it is probable that you have a flat tire. Check the tires. If a tire is flat, change it with the spare tire and have the flat tire repaired by the nearest Toyota dealer.
- Avoid abrupt maneuvering and braking. If the vehicle tires deteriorate, you could lose control of the steering wheel or the brakes.

**■ If a blowout or sudden air leakage should occur (vehicles with a tire pressure warning system)**

The tire pressure warning system may not activate immediately.

 **WARNING****■ Maintenance of the tires**

Each tire, including the spare (if provided), should be checked monthly when cold and inflated to the inflation pressure recommended by the vehicle manufacturer on the vehicle placard or tire inflation pressure label (tire and load information label). (If your vehicle has tires of a different size than the size indicated on the vehicle placard or tire inflation pressure label [tire and load information label], you should determine the proper tire inflation pressure for those tires.)

As an added safety feature, your vehicle has been equipped with a tire pressure monitoring system (TPMS-tire pressure warning system) that illuminates a low tire pressure telltale (tire pressure warning light) when one or more of your tires is significantly under-inflated. Accordingly, when the low tire pressure telltale (tire pressure warning light) illuminates, you should stop and check your tires as soon as possible, and inflate them to the proper pressure. Driving on a significantly under-inflated tire causes the tire to overheat and can lead to tire failure. Under-inflation also reduces fuel efficiency and tire tread life, and may affect the vehicle's handling and stopping ability.

Please note that the TPMS (tire pressure warning system) is not a substitute for proper tire maintenance, and it is the driver's responsibility to maintain correct tire pressure, even if under-inflation has not reached the level to trigger illumination of the TPMS low tire pressure telltale (tire pressure warning light).

Your vehicle has also been equipped with a TPMS (tire pressure warning system) malfunction indicator to indicate when the system is not operating properly. The TPMS (tire pressure warning system) malfunction indicator is combined with the low tire pressure telltale (tire pressure warning light). When the system detects a malfunction, the telltale will flash for approximately one minute and then remain continuously illuminated. This sequence will continue upon subsequent vehicle start-ups as long as the malfunction exists. When the malfunction indicator is illuminated, the system may not be able to detect or signal low tire pressure as intended.

TPMS (tire pressure warning system) malfunctions may occur for a variety of reasons, including the installation of replacement or alternate tires or wheels on the vehicle that prevent the TPMS (tire pressure warning system) from functioning properly. Always check the TPMS (tire pressure warning system) malfunction telltale after replacing one or more tires or wheels on your vehicle to ensure that the replacement or alternate tires and wheels allow the TPMS (tire pressure warning system) to continue to function properly.

 NOTICE

■ **To ensure the tire pressure warning system operates properly (vehicles with a tire pressure warning system)**

Do not install tires with different specifications or makers, as the tire pressure warning system may not operate properly.



If a warning message or indicator is displayed

If a warning is shown on the multi-information display, stay calm and perform the following actions:

① Master warning light



The master warning light also comes on or flashes in order to indicate that a message is currently being displayed on the multi-information display.

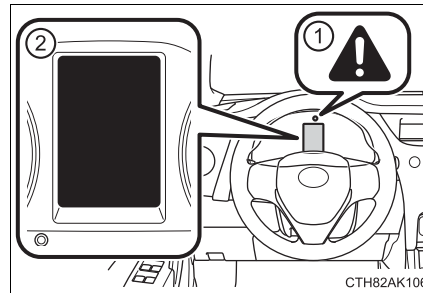





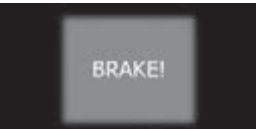



② Multi-information display













If any of the warning message or indicator comes on again after the following actions have been performed, contact your Toyota dealer.







Warning message and warning buzzer list



Warning message	Details/Actions
	Indicates that: <ul style="list-style-type: none"> <li>• There is a high possibility of a frontal collision; or</li> <li>• The pre-collision braking function is operating</li> </ul> A buzzer also sounds. → <b>Slow the vehicle by applying the brakes.</b>
<p>▶ Monochrome display</p>  <p>▶ Color display</p> 	Indicates that your vehicle is nearing the vehicle ahead (in vehicle-to-vehicle distance control mode) A buzzer also sounds. → <b>Slow the vehicle by applying the brakes.</b>





Warning message	Details/Actions
<p>► Monochrome display</p>  <p>► Color display</p> 	<p>Indicates that one or more of the doors is not fully closed.</p> <p>The system also indicates which doors are not fully closed.</p> <p>If the vehicle reaches a speed of 3 mph (5 km/h),  flashes and a buzzer sounds to indicate that the door(s) are not yet fully closed.</p> <p>→ <b>Make sure that all the doors are closed.</b></p>
<p>► Monochrome display</p>  <p>► Color display</p> 	<p>Indicates that the trunk is not fully closed.</p> <p>If the vehicle reaches a speed of 3 mph (5 km/h),  flashes and a buzzer sounds to indicate that the trunk is not yet fully closed.</p> <p>→ <b>Close the trunk.</b></p>
   	<p>Indicates that the vehicle is being driven at 3 mph (5 km/h) or more with the parking brake still engaged.</p> <p>A buzzer also sounds.</p> <p>→ <b>Release the parking brake.</b></p>







Warning message	Details/Actions
<p>▶ Monochrome display</p>  <p>▶ Color display</p>   <p>(Orange) (Flashes)</p>	<p>Indicates that the vehicle has deviated from the lane (while the LDA [Lane Departure Alert with steering control] system is operating)</p> <ul style="list-style-type: none"> <li>• Vehicles with a monochrome display: The lane line on the side the vehicle has deviated from flashes.</li> <li>• Vehicles with a color display: The lane line on the side the vehicle has deviated from flashes in amber.</li> <li>• A buzzer also sounds.</li> </ul> <p>→ <b>Check around the vehicle and back to inside of the lane lines.</b></p>
 <p>LDA Hold Steering Wheel</p>	<p>Indicates that the LDA (Lane Departure Alert with steering control) system has determined that the driver does not have their hands on the steering wheel while the steering control function is on</p> <p>If the system continues to determine that the driver does not have his hands on the steering wheel, a buzzer will sound.</p> <p>→ <b>Firmly hold the steering wheel.</b></p>
<p>Lane Departure Alert Malfunction</p> <p>Visit Your Dealer</p>  <p>(Orange)</p>	<p>Indicates a malfunction in the LDA (Lane Departure Alert with steering control) system</p> <p>A buzzer also sounds.</p> <p>→ <b>Have the vehicle inspected by your Toyota dealer.</b></p>

Warning message	Details/Actions
<div style="background-color: black; color: white; padding: 5px; text-align: center;"> <b>Front Camera Unavailable</b> </div> <div style="display: flex; justify-content: space-around; margin-top: 10px;"> <div style="text-align: center;">   <small>(Flashes)</small> </div> <div style="text-align: center;">   <small>(Orange)</small> </div> </div>	<p>Indicates that the LDA (Lane Departure Alert with steering control) and pre-collision system are temporarily canceled due to high temperatures around the camera sensor</p> <p>→ <b>Turn the LDA (Lane Departure Alert with steering control) system off, wait for the area around the camera sensor to cool, and then turn the LDA (Lane Departure Alert with steering control) system back on.</b></p>
<div style="background-color: black; color: white; padding: 5px; text-align: center;"> <b>Lane Departure Alert Unavailable</b> </div> <div style="display: flex; justify-content: space-around; margin-top: 10px;"> <div style="text-align: center;">   <small>(Orange)</small> </div> <div style="text-align: center;">   <small>(Orange)</small> </div> </div>	<p>The LDA (Lane Departure Alert with steering control) system is temporarily canceled due to a malfunction in a sensor other than the camera sensor.</p> <p>A buzzer also sounds.</p> <p>→ <b>Turn the LDA (Lane Departure Alert with steering control) system off and follow the appropriate troubleshooting procedures for warning message. Afterward, drive the vehicle for a short time, and then turn the LDA (Lane Departure Alert with steering control) system back on.</b></p>
<div style="background-color: black; color: white; padding: 5px; text-align: center;"> <b>Front Camera Unavailable Remove Debris On Windshield</b> </div> <div style="display: flex; justify-content: space-around; margin-top: 10px;"> <div style="text-align: center;">   <small>(Flashes)</small> </div> <div style="text-align: center;">   <small>(Orange)</small> </div> </div>	<p>Indicates that the LDA (Lane Departure Alert with steering control) and pre-collision system are temporarily canceled because dirt, rain, condensation, ice, snow, etc., are present on the windshield in front of the camera sensor</p> <p>→ <b>Turn the LDA (Lane Departure Alert with steering control) system off, remove any dirt, rain, condensation, ice, snow, etc., from the windshield, and then turn the LDA (Lane Departure Alert with steering control) system back on.</b></p>
<div style="background-color: black; color: white; padding: 5px; text-align: center;"> <b>Lane Departure Alert Unavailable Below Approx 32MPH</b> </div>	<p>Indicates that the LDA (Lane Departure Alert with steering control) system cannot be used because the vehicle speed is lower than approximately 32 mph (50 km/h)</p> <p>→ <b>Drive the vehicle at 32 mph (50 km/h) or higher.</b></p>

Warning message	Details/Actions
	<p>Indicates that LDA (Lane Departure Alert with steering control) cannot be used due to the vehicle speed being too high → <b>Slow down.</b></p>
<p>▶ Monochrome display</p>  <p>▶ Color display</p> 	<p>Indicates a malfunction in the vehicle's charging system. → <b>Immediately stop the vehicle in a safe place and contact your Toyota dealer. Continuing to drive the vehicle may be dangerous.</b></p>
<p>▶ Monochrome display</p>  <p>▶ Color display</p>   <p>(Flashes)</p>	<p>Indicates a malfunction in the smart key system (if equipped). A buzzer also sounds. → <b>Have the vehicle inspected by your Toyota dealer.</b></p>



Warning message	Details/Actions
<div data-bbox="400 495 643 678" style="background-color: black; color: white; padding: 5px; text-align: center;">           Radar Cruise Control Unavailable  Clean Sensor         </div> <div data-bbox="400 701 475 757" style="text-align: center;">  </div>	<p>Indicates that the radar sensor is dirty or covered with ice</p> <p>A buzzer also sounds.</p> <p>→ <b>Clean the sensor.</b></p>
<div data-bbox="400 808 643 920" style="background-color: black; color: white; padding: 5px; text-align: center;">           Radar Cruise Control Unavailable         </div> <div data-bbox="400 943 475 999" style="text-align: center;">  </div>	<p>Indicates that the dynamic radar cruise control system cannot be used temporarily due to bad weather</p> <p>A buzzer also sounds.</p> <p>→ <b>Use the dynamic radar cruise control system when it becomes available again.</b></p>
<div data-bbox="400 1050 643 1256" style="background-color: black; color: white; padding: 5px; text-align: center;">           Radar Cruise Control Unavailable  Depress Brake to Resume Driving         </div>	<p>Indicates that the dynamic radar cruise control system brake control function is temporarily unavailable</p> <p>A buzzer also sounds.</p> <p>→ <b>Depress the brake.</b></p>
<p>▶ Monochrome display</p> <div data-bbox="392 1341 651 1469" style="background-color: black; color: white; padding: 5px; text-align: center;">           CHECK CRUISE CONTROL SYSTEM         </div> <p>▶ Color display</p> <div data-bbox="400 1536 643 1671" style="background-color: black; color: white; padding: 5px; text-align: center;">           Cruise Control Malfunction  Visit Your Dealer         </div> <div data-bbox="400 1682 475 1738" style="text-align: center;">  </div>	<p>Indicates a malfunction in the dynamic radar cruise control system.</p> <ul style="list-style-type: none"> <li>• Press the “ON-OFF” button once to deactivate the system, and then press the button again to reactivate the system.</li> <li>• A buzzer also sounds.</li> </ul> <p>→ <b>Have the vehicle inspected by your Toyota dealer.</b></p>

Warning message	Details/Actions
<p data-bbox="403 488 643 734">Cruise Control Fault</p> <p data-bbox="403 600 643 667">Press Brake to Deactivate</p> <p data-bbox="403 689 643 734">Visit Your Dealer</p> 	<p data-bbox="675 555 1235 611">Indicates a malfunction in the dynamic radar cruise control</p> <ul data-bbox="699 611 1010 667" style="list-style-type: none"> <li>• Depress the brake pedal.</li> <li>• A buzzer also sounds.</li> </ul> <p data-bbox="675 678 1235 734">→ <b>Have the vehicle inspected by your Toyota dealer.</b></p>
<p data-bbox="403 869 643 981">Pre-Collision System Malfunction</p> <p data-bbox="403 1003 643 1048">Visit Your Dealer</p>   <p data-bbox="483 1126 563 1149">(Flashes)</p>	<p data-bbox="675 925 1235 981">Indicates a malfunction in the pre-collision system</p> <p data-bbox="699 981 946 1014">A buzzer also sounds.</p> <p data-bbox="675 1014 1235 1070">→ <b>Have the vehicle inspected by your Toyota dealer.</b></p>
<p data-bbox="403 1227 643 1361">VSC Turned Off Pre-Collision Brake System Unavailable</p> 	<p data-bbox="675 1261 1235 1350">Indicates that, since the VSC (Vehicle Stability Control) system was turned off, the pre-collision brake system operation is stopped</p> <p data-bbox="675 1350 1034 1384">→ <b>Turn the VSC on. (→P. 259)</b></p>
<p data-bbox="403 1541 643 1608">Pre-Collision System Unavailable</p>  <p data-bbox="403 1709 475 1731">(Flashes)</p>	<p data-bbox="675 1507 1235 1563">Indicates that the pre-collision system is temporarily unavailable</p> <p data-bbox="675 1563 1235 1709">→ <b>Please wait until the system returns. If the message does not disappear, the system may be malfunctioning. Have the vehicle inspected by your Toyota dealer immediately.</b></p>

Warning message	Details/Actions
<p>Pre-Collision System Unavailable</p> <p>Clean Sensor</p>  <p>OFF (Flashes)</p>	<p>Indicates that the pre-collision system sensor is dirty, covered with ice, etc. → <b>Remove any dirt, ice, etc.</b></p>
<p>► Monochrome display</p>  <p>► Color display</p>  <p>Stop in a Safe Place See Owner's Manual</p> 	<p>Indicates abnormal engine oil pressure.</p> <ul style="list-style-type: none"> <li>• The warning message is shown if the engine oil pressure is too low.</li> <li>• A buzzer also sounds.</li> </ul> <p>→ <b>Immediately stop the vehicle in a safe place and contact your Toyota dealer. Continuing to drive the vehicle may be dangerous.</b></p>
<p>Turn Lights Off</p>  <p>(Flashes)</p>	<p>Vehicles without a smart key system: Indicates that the engine switch is turned off or turned to the "ACC" position mode and the driver's door is opened while the lights are turned on. A buzzer also sounds. → <b>Turn the lights off.</b></p> <p>Vehicles with a smart key system: Indicates that the engine switch is turned off or turned to ACCESSORY mode and the driver's door is opened while the lights are turned on. A buzzer also sounds. → <b>Turn the lights off.</b></p>
<p>Moon Roof Open</p>  <p>(Flashes) (If equipped)</p>	<p>Indicates that the moon roof is not fully closed (with the engine switch off, and the driver's door open) A buzzer also sounds. → <b>Close the moon roof.</b></p>



Warning message	Details/Actions
<div data-bbox="400 510 643 656" style="background-color: black; color: white; padding: 5px; text-align: center;">           Headlight System Malfunction  Visit Your Dealer         </div> <div data-bbox="400 701 475 757" style="text-align: center;">  </div>	<p>Indicates a malfunction in:</p> <ul style="list-style-type: none"> <li>• The automatic headlight leveling system;</li> <li>• The Automatic High Beam system; or</li> <li>• The LED headlight system</li> </ul> <p>A buzzer also sounds.</p> <p>→ <b>Have the vehicle inspected by your Toyota dealer.</b></p>
<p>▶ Monochrome display</p> <div data-bbox="395 824 651 954" style="background-color: black; color: white; padding: 5px; text-align: center;">           LOW WASHER FLUID         </div> <p>▶ Color display</p> <div data-bbox="400 1014 651 1144" style="background-color: black; color: white; padding: 5px; text-align: center;">           Windshield Washer Fluid Low         </div> <p style="text-align: center; font-size: small;">(If equipped)</p>	<p>Indicates that the washer fluid level is low.</p> <p>→ <b>Add washer fluid.</b></p>
<p>▶ Color display only</p> <div data-bbox="400 1238 643 1301" style="background-color: black; color: white; padding: 5px; text-align: center;">           Fuel Low         </div>	<p>Indicates that remaining fuel is approximately 2.0 gal. (7.5L, 1.7 Imp. gal.) or less</p> <p>→ <b>Refuel the vehicle.</b></p>
<p>▶ Color display only</p> <div data-bbox="400 1373 651 1491" style="background-color: black; color: white; padding: 5px; text-align: center;">           Traction Control Turned Off         </div>	<p>Indicates that the TRAC (Traction Control) system is turned off</p> <p>→ <b>Turn the TRAC on. (→P. 259)</b></p>
<div data-bbox="400 1563 643 1659" style="background-color: black; color: white; padding: 5px; text-align: center;">           Maintenance Required Soon         </div> <p style="text-align: center; font-size: small;">(U.S.A. only)</p>	<p>Indicates that all maintenance according to the driven distance on the maintenance schedule* should be performed soon.</p> <p>Comes on approximately 4500 miles (7200 km) after the message has been reset.</p> <p>→ <b>If necessary, perform maintenance.</b></p>

Warning message	Details/Actions
<p>▶ Monochrome display</p>  <p>▶ Color display</p>  <p>(U.S.A. only)</p>	<p>Indicates that all maintenance is required to correspond to the driven distance on the maintenance schedule*.</p> <p>Comes on approximately 5000 miles (8000 km) after the message has been reset. (The indicator will not work properly unless the message has been reset.)</p> <p>→ <b>Perform the necessary maintenance. Please reset the message after the maintenance is performed (→P. 415)</b></p>

\*: Refer to the separate “Scheduled Maintenance Guide” or “Owner’s Manual Supplement” for the maintenance interval applicable to your vehicle.

■ **Message displays**



Message displays used in this section are intended as examples, and may differ from the image that is actually displayed on the multi-information display.

■ **Warning buzzer**







→P. 485

**Have the malfunction repaired immediately. (vehicles with a smart key system)**

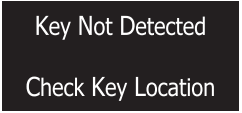

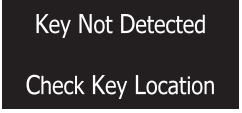

After taking the specified steps to correct the suspected problem, check that the warning message and light go off.





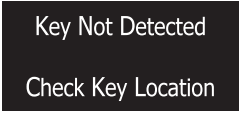

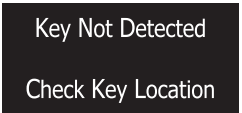

Interior buzzer	Exterior buzzer	Warning message	Details/Actions
Continuous	—	<p>▶ Monochrome display</p>  <p>▶ Color display</p>  <p> (Flashes) (Vehicles with a continuously variable transmission)</p>	<p>The driver's door was opened while any shift lever other than P was selected without turning off the engine switch. → <b>Shift the shift lever to P.</b></p>



Interior buzzer	Exterior buzzer	Warning message	Details/Actions
Continuous	Continuous	<p>▶ Monochrome display</p> <div data-bbox="592 539 847 667" style="background-color: black; color: white; padding: 5px; text-align: center;"> <b>SHIFT TO P POSITION</b> </div> <div data-bbox="592 689 847 817" style="background-color: black; color: white; padding: 5px; text-align: center;"> <b>KEY NOT DETECTED</b> </div> <p style="text-align: center; font-size: small;">(Displayed alternately)</p> <p>▶ Color display</p> <div data-bbox="603 913 836 1025" style="background-color: black; color: white; padding: 5px; text-align: center;"> <b>Shift to P Before Exiting Vehicle</b> </div> <div data-bbox="603 1059 836 1171" style="background-color: black; color: white; padding: 5px; text-align: center;"> <b>Key Not Detected Check Key Location</b> </div> <p style="text-align: center; font-size: small;">(Displayed alternately)</p> <div data-bbox="595 1211 675 1272" style="border: 1px solid black; padding: 2px; text-align: center;">  </div> <p style="text-align: center; font-size: x-small;">(Flashes)</p> <p style="text-align: center; font-size: x-small;">(Vehicles with a continuously variable transmission)</p>	<p>The driver's door was opened and closed while the electronic key was not in the vehicle, the shift lever was not in P and the engine switch was not turned off.</p> <p>→ <b>Shift the shift lever to P.</b></p> <p>→ <b>Bring the electronic key back into the vehicle.</b></p>

Interior buzzer	Exterior buzzer	Warning message	Details/Actions
Once	3 times	<p>► Monochrome display</p>  <p>► Color display</p>   <p>(Flashes)</p>	<p>The electronic key was carried outside the vehicle and a door other than the driver's door was opened and closed while the engine switch was in a mode other than off. → <b>Bring the electronic key back into the vehicle.</b></p> <hr/> <p>The driver's door was opened and closed while the electronic key was not in the vehicle, the shift lever was in P (vehicles with a continuously variable transmission) and the engine switch was not turned off. → <b>Turn the engine switch off.</b> → <b>Bring the electronic key back into the vehicle.</b></p>
Once	Continuous (5 seconds)	<p>► Monochrome display</p>   <p>(Displayed alternately)</p> <p>► Color display</p>   <p>(Displayed alternately)</p>  <p>(Flashes) (Vehicles with a continuously variable transmission)</p>	<p>An attempt was made to exit the vehicle with the electronic key and lock the doors without first turning the engine switch off when the shift lever was in P. → <b>Turn the engine switch off and lock the doors again.</b></p>







8  
When trouble arises



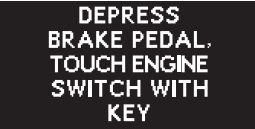

Interior buzzer	Exterior buzzer	Warning message	Details/Actions
Once	—	<p>▶ Monochrome display</p>  <p>▶ Color display</p>  	<p>The electronic key is not detected when an attempt is made to start the engine.                      → <b>Start the engine with the electronic key present.</b></p>
9 times	—	<p>▶ Monochrome display</p>  <p>▶ Color display</p>  	<p>An attempt was made to drive when the regular key was not inside the vehicle.                      → <b>Confirm that the electronic key is inside the vehicle.</b></p>





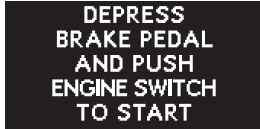
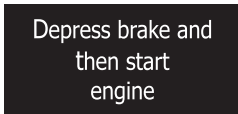

Interior buzzer	Exterior buzzer	Warning message	Details/Actions
—	Continuous (5 seconds)	<p>▶ Monochrome display</p>  <p>▶ Color display</p>  	<p>An attempt was made to lock the doors using the smart key system while the electronic key was still inside the vehicle.</p> <p>→ <b>Retrieve the electronic key from the vehicle and lock the doors again.</b></p>
Once	Continuous (5 seconds)	<p>▶ Monochrome display</p>  <p>▶ Color display</p>  	<p>An attempt was made to lock either front door by opening a door and putting the inside lock button into the lock position, then closing the door by pulling on the outside door handle with the electronic key still inside the vehicle.</p> <p>→ <b>Retrieve the electronic key from the vehicle and lock the doors again.</b></p>
Once	—	 	<p>The electronic key has a low battery.</p> <p>→ <b>Replace the electronic key battery. (→P. 455)</b></p>



Interior buzzer	Exterior buzzer	Warning message	Details/Actions
Once	—	<div data-bbox="600 539 839 591" style="background-color: black; color: white; padding: 2px; text-align: center;">Steering Lock active</div> <div data-bbox="595 613 675 674" style="text-align: center;">  </div> <div data-bbox="595 674 675 694" style="text-align: center;">(Flashes)</div> <div data-bbox="584 698 855 739" style="text-align: center;">(Vehicles with a continuously variable transmission)</div>	<p>The steering lock could not be released within 3 seconds of the engine switch being pressed.</p> <p>→ <b>Press the engine switch while depressing the brake pedal and moving the steering wheel left and right.</b></p>
		<div data-bbox="600 831 839 882" style="background-color: black; color: white; padding: 2px; text-align: center;">Steering Lock active</div> <div data-bbox="595 904 675 965" style="text-align: center;">  </div> <div data-bbox="595 965 675 985" style="text-align: center;">(Flashes)</div> <div data-bbox="584 990 855 1010" style="text-align: center;">(Vehicles with a manual transmission)</div>	<p>The steering lock could not be released within 3 seconds of the engine switch being pressed.</p> <p>→ <b>Press the engine switch while depressing the clutch pedal and moving the steering wheel left and right.</b></p>

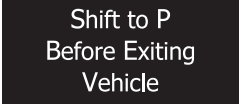

Interior buzzer	Exterior buzzer	Warning message	Details/Actions
Once	—	<p>▶ Monochrome display</p>  <p>▶ Color display</p>   <p>(Flashes) (Vehicles with a continuously variable transmission)</p>	<ul style="list-style-type: none"> <li>• When the doors were unlocked with the mechanical key and then the engine switch was pressed, the electronic key could not be detected in the vehicle.</li> <li>• The electronic key could not be detected in the vehicle even after the engine switch was pressed two consecutive times.</li> </ul> <p>→ <b>Touch the electronic key to the engine switch while depressing the brake pedal.</b></p>
		<p>▶ Monochrome display</p>  <p>▶ Color display</p>   <p>(Flashes) (Vehicles with a manual transmission)</p>	<ul style="list-style-type: none"> <li>• When the doors were unlocked with the mechanical key and then the engine switch was pressed, the electronic key could not be detected in the vehicle.</li> <li>• The electronic key could not be detected in the vehicle even after the engine switch was pressed two consecutive times.</li> </ul> <p>→ <b>Touch the electronic key to the engine switch while depressing the clutch pedal.</b></p>

Interior buzzer	Exterior buzzer	Warning message	Details/Actions
Once	—	<p>► Monochrome display</p>  <p>► Color display</p>   <p>(Flashes) (Vehicles with a continuously variable transmission)</p>	<p>The driver's door was opened and closed with the engine switch turned off and then the engine switch was put in ACCESSORY or IGNITION ON mode twice without the engine being started. → <b>Press the engine switch while depressing the brake pedal.</b></p> <p>During an engine starting procedure in the event that the electronic key was not functioning properly (→P. 523), the engine switch was touched with the electronic key. → <b>Press the engine switch while depressing the brake pedal within 10 seconds of the buzzer sounding.</b></p>
		<p>► Monochrome display</p>  <p>► Color display</p>   <p>(Flashes) (Vehicles with a manual transmission)</p>	<p>The driver's door was opened and closed with the engine switch turned off and then the engine switch was put in ACCESSORY or IGNITION ON mode twice without the engine being started. → <b>Press the engine switch while depressing the clutch pedal.</b></p> <p>During an engine starting procedure in the event that the electronic key was not functioning properly (→P. 523), the engine switch was touched with the electronic key. → <b>Press the engine switch while depressing the clutch pedal within 10 seconds of the buzzer sounding.</b></p>

Interior buzzer	Exterior buzzer	Warning message	Details/Actions
Once	—	<p>Shift to P position to Start</p>  <p>(Flashes) (Vehicles with a continuously variable transmission)</p>	<p>An attempt was made to start the engine with the shift lever in an incorrect position. → <b>Shift the shift lever to P and start the engine.</b></p>
Once	—	<p>► Monochrome display</p>  <p>► Color display</p>   <p>(Flashes) (Vehicles with a continuously variable transmission)</p>	<p>The engine switch has been turned off with the shift lever in a position other than P or N. → <b>Shift the shift lever to P.</b></p>
Once	—	<p>► Monochrome display</p>  <p>► Color display</p>   <p>(Flashes) (Vehicles with a continuously variable transmission)</p>	<p>After the engine switch has been turned off with the shift lever in a position other than P, the shift lever has been shifted to P. → <b>Turn the engine switch off.</b></p>

Interior buzzer	Exterior buzzer	Warning message	Details/Actions
—	—	<p>▶ Monochrome display</p>  <p>▶ Color display</p>  <p>(Vehicles with a continuously variable transmission)</p>	<p>Power was turned off due to the automatic power off function.            → <b>Next time when starting the engine, increase the engine speed slightly and maintain that level for approximately 5 minutes to recharge the battery.</b></p>

■ **Message displays**

Message displays used in this section are intended as examples, and may differ from the image that is actually displayed on the multi-information display.

■ **Warning buzzer**

→P. 485

## If you have a flat tire

**Your vehicle is equipped with a spare tire. The flat tire can be replaced with the spare tire.**

**For details about tires: →P. 440**

### WARNING

#### ■ If you have a flat tire

Do not continue driving with a flat tire.

Driving even a short distance with a flat tire can damage the tire and the wheel beyond repair, which could result in an accident.

### Before jacking up the vehicle

- Stop the vehicle in a safe place on a hard, flat surface.
- Set the parking brake.
- Shift the shift lever to P (continuously variable transmission) or R (manual transmission).
- Stop the engine.
- Turn on the emergency flashers. (→P. 470)

### Location of the spare tire, jack and tools

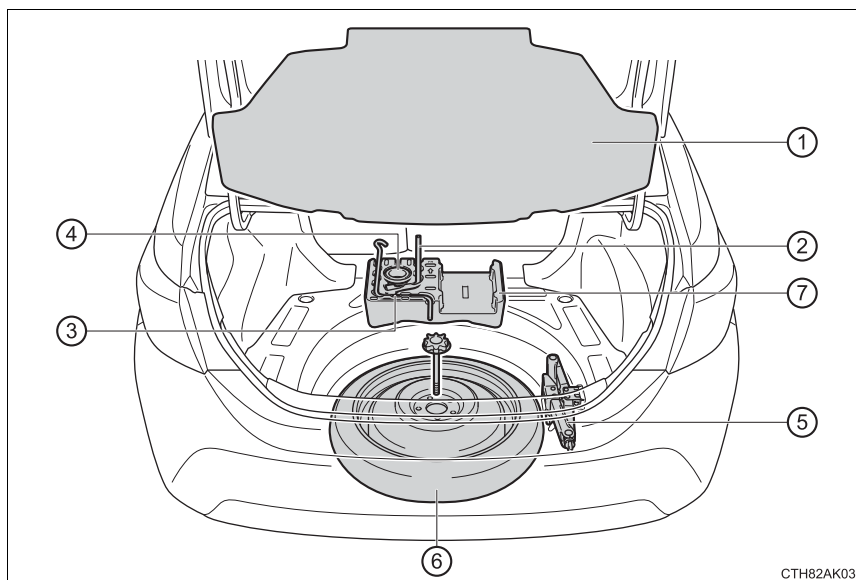

- ① Luggage floor cover
- ② Wheel nut wrench
- ③ Jack handle
- ④ Jack attachment\*
- ⑤ Jack
- ⑥ Spare tire
- ⑦ Tool tray

\*: The jack attachment is used when raising your vehicle with a floor jack.  
(→P. 427)

**⚠ WARNING****■ Using the tire jack**

Observe the following precautions.

Improper use of the tire jack may cause the vehicle to suddenly fall off the jack, leading to death or serious injury.

- Do not use the tire jack for any purpose other than replacing tires or installing and removing tire chains.
- Only use the tire jack that comes with this vehicle for replacing a flat tire.  
Do not use it on other vehicles, and do not use other tire jacks for replacing tires on this vehicle.
- Put the jack properly in its jack point.
- Do not put any part of your body under the vehicle while it is supported by the jack.
- Do not start the engine or drive the vehicle while the vehicle is supported by the jack.
- Do not raise the vehicle while someone is inside.
- When raising the vehicle, do not put an object on or under the jack.
- Do not raise the vehicle to a height greater than that required to replace the tire.
- Use a jack stand if it is necessary to get under the vehicle.
- When lowering the vehicle, make sure that there is no-one near the vehicle. If there are people nearby, warn them vocally before lowering.

**Taking out the jack**

- 1 Remove the luggage floor cover.

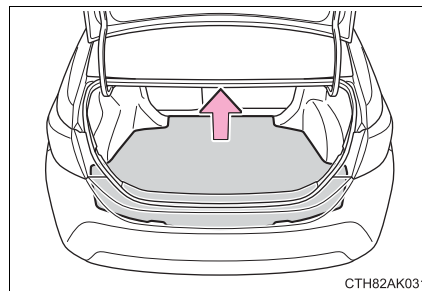

CTH82AK031

**2** Take out the jack.

- ① For tightening
- ② For loosening

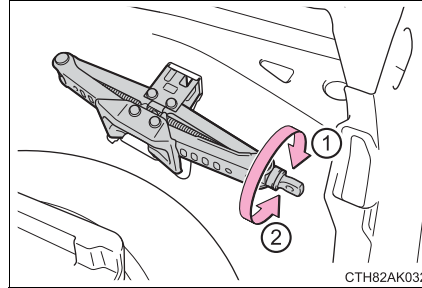

**Taking out the spare tire**

**1** Remove the luggage floor cover. (→P. 511)

**2** Remove the tool tray.

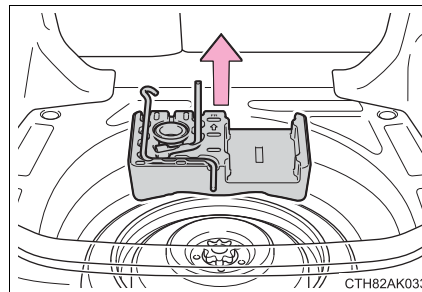

**3** Loosen the center fastener that secures the spare tire.

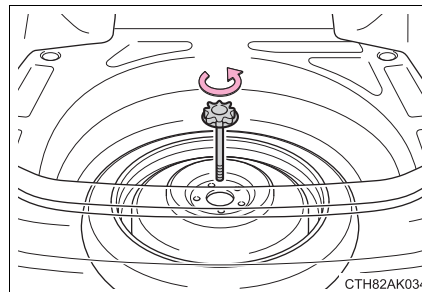

**⚠ WARNING**

**■ When storing the spare tire**

Be careful not to catch fingers or other body parts between the spare tire and the body of the vehicle.



**Replacing a flat tire**

- 1 Check the tires.

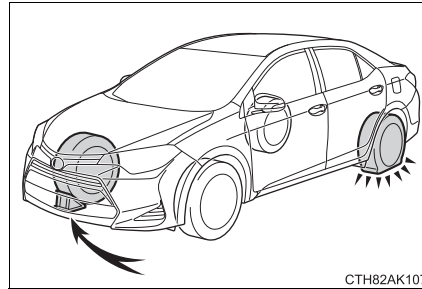

Flat tire		Wheel chock positions
Front	Left-hand side	Behind the rear right-hand side tire
	Right-hand side	Behind the rear left-hand side tire
Rear	Left-hand side	In front of the front right-hand side tire
	Right-hand side	In front of the front left-hand side tire

- 2 For vehicles with steel wheels, remove the wheel ornament using the wrench.

To protect the wheel ornament, place a rag between the wrench and the wheel ornament, as shown in the illustration.

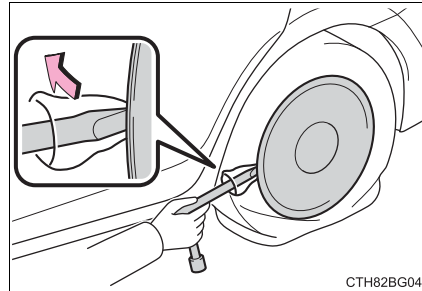

- 3 Slightly loosen the wheel nuts (one turn).

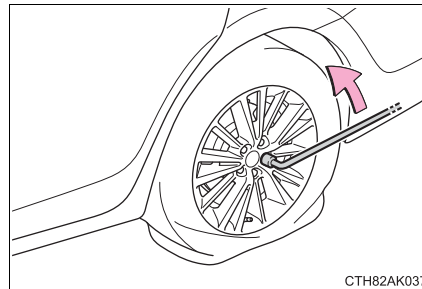

- 4** Turn the tire jack portion “A” by hand until the notch of the jack is in contact with the jack point. The jack point guides are located under the rocker panel. They indicate the jack point positions.

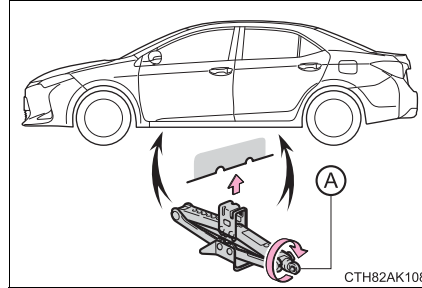

- 5** Raise the vehicle until the tire is slightly raised off the ground.

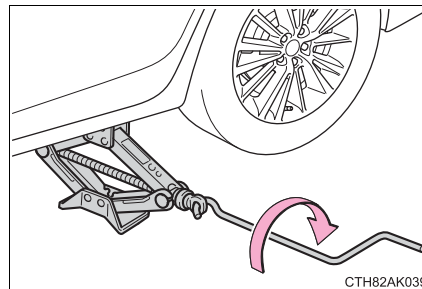

- 6** Remove all the wheel nuts and the tire. When resting the tire on the ground, place the tire so that the wheel design faces up to avoid scratching the wheel surface.

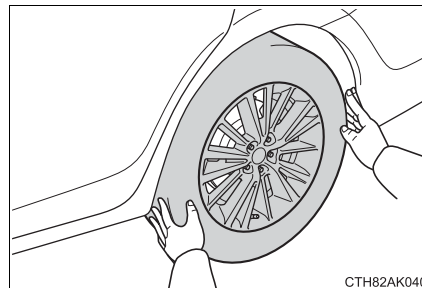

 **WARNING****■ Replacing a flat tire**

- Do not touch the disc wheels or the area around the brakes immediately after the vehicle has been driven.  
After the vehicle has been driven the disc wheels and the area around the brakes will be extremely hot. Touching these areas with hands, feet or other body parts while changing a tire, etc. may result in burns.
- Failure to follow these precautions could cause the wheel nuts to loosen and the tire to fall off, resulting in death or serious injury.
  - Have the wheel nuts tightened with a torque wrench to 76 ft•lbf (103 N•m, 10.5 kgf•m) as soon as possible after changing wheels.
  - Do not attach a heavily damaged wheel ornament, as it may fly off the wheel while the vehicle is moving.
  - When installing a tire, only use wheel nuts that have been specifically designed for that wheel.
  - If there are any cracks or deformations in the bolt screws, nut threads or bolt holes of the wheel, have the vehicle inspected by your Toyota dealer.
  - When installing the wheel nuts, be sure to install them with the tapered ends facing inward. (→P. 452)

### Installing the spare tire

- 1 Remove any dirt or foreign matter from the wheel contact surface.

If foreign matter is on the wheel contact surface, the wheel nuts may loosen while the vehicle is in motion, causing the tire to come off.

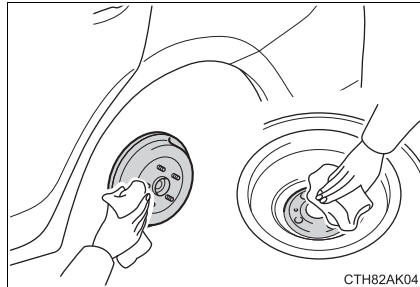

- 2 Install the tire and loosely tighten each wheel nut by hand by approximately the same amount.

When replacing a steel wheel with a compact spare tire, tighten the wheel nuts until the tapered portion comes into loose contact with the disc wheel seat.

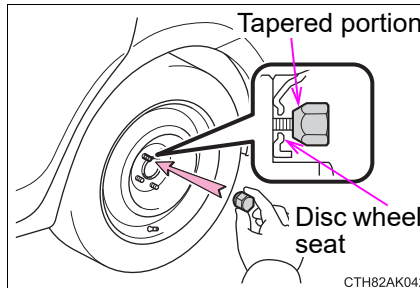

When replacing an aluminum wheel with a compact spare tire, tighten the wheel nuts until the tapered portion comes into loose contact with the disc wheel seat.

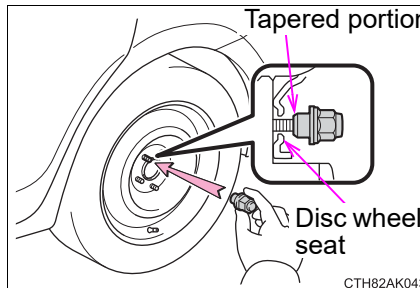

- 3 Lower the vehicle.

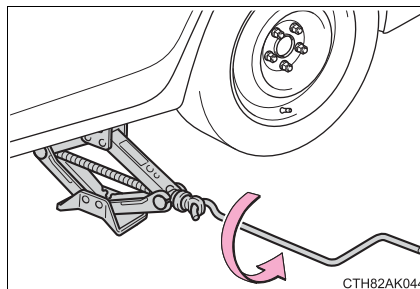

- 4 Firmly tighten each wheel nut two or three times in the order shown in the illustration.

Tightening torque:  
76 ft•lbf (103 N•m, 10.5 kgf•m)

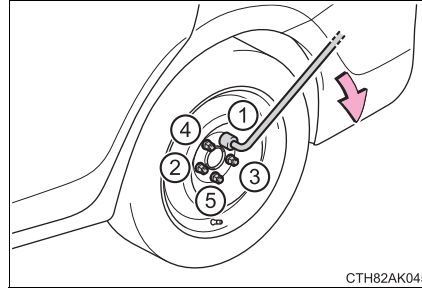

- 5 Stow the flat tire, tire jack and all tools.

■ **The compact spare tire**

- The compact spare tire is identified by the label “TEMPORARY USE ONLY” on the tire sidewall. Use the compact spare tire temporarily, and only in an emergency.
- Make sure to check the tire inflation pressure of the compact spare tire. (→P. 546)

■ **When the compact spare tire is equipped**

The vehicle becomes lower when driving with the compact spare tire compared to when driving with standard tires.

■ **After completing the tire change (vehicles with a tire pressure warning system)**

The tire pressure warning system must be reset. (→P. 442)

■ **When using the compact spare tire (vehicles with a tire pressure warning system)**

As the compact spare tire is not equipped with a tire pressure warning valve and transmitter, low inflation pressure of the spare tire will not be indicated by the tire pressure warning system. Also, if you replace the compact spare tire after the tire pressure warning light comes on, the light remains on.

■ **If you have a flat front tire on a road covered with snow or ice**

Install the compact spare tire on one of the rear wheels of the vehicle. Perform the following steps and fit tire chains to the front tires:

- 1 Replace a rear tire with the compact spare tire.
- 2 Replace the flat front tire with the tire removed from the rear of the vehicle.
- 3 Fit tire chains to the front tires.

■ **When reinstalling the wheel ornament (vehicles with steel wheels)**

Align the cutout of the wheel ornament with the valve stem as shown the illustration.

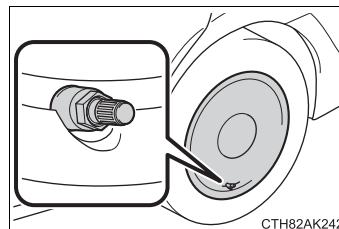

**⚠ WARNING****■ When using the compact spare tire**

- Remember that the compact spare tire provided is specifically designed for use with your vehicle. Do not use your compact spare tire on another vehicle.
- Do not use more than one compact spare tires simultaneously.
- Replace the compact spare tire with a standard tire as soon as possible.
- Avoid sudden acceleration, abrupt steering, sudden braking and shifting operations that cause sudden engine braking.

**■ When the compact spare tire is attached**

The vehicle speed may not be correctly detected, and the following systems may not operate correctly:

- ABS & Brake assist
- VSC
- TRAC
- Dynamic radar cruise control
- EPS
- LDA (Lane Departure Alert with steering control)
- PCS (Pre-Collision System)
- Rear view monitor system
- Navigation system (if equipped)

**■ Speed limit when using the compact spare tire**

Do not drive at speeds in excess of 50 mph (80 km/h) when a compact spare tire is installed on the vehicle.

The compact spare tire is not designed for driving at high speeds. Failure to observe this precaution may lead to an accident causing death or serious injury.

**■ After using the tools and jack**

Before driving, make sure all the tools and jack are securely in place in their storage location to reduce the possibility of personal injury during a collision or sudden braking.

 NOTICE

■ **Be careful when driving over bumps with the compact spare tire installed on the vehicle.**

The vehicle becomes lower when driving with the compact spare tire compared to when driving with standard tires. Be careful when driving over uneven road surfaces.

■ **Driving with tire chains and the compact spare tire**

Do not fit tire chains to the compact spare tire.

Tire chains may damage the vehicle body and adversely affect driving performance.

■ **When replacing the tires (vehicles with a tire pressure warning system)**

When removing or fitting the wheels, tires or the tire pressure warning valve and transmitter, contact your Toyota dealer as the tire pressure warning valve and transmitter may be damaged if not handled correctly.

■ **To avoid damage to the tire pressure warning valves and transmitters (vehicles with a tire pressure warning system)**

When a tire is repaired with liquid sealants, the tire pressure warning valve and transmitter may not operate properly. If a liquid sealant is used, contact your Toyota dealer or other qualified service shop as soon as possible. Make sure to replace the tire pressure warning valve and transmitter when replacing the tire. (→P. 441)



## If the engine will not start

**If the engine will not start even though correct starting procedures are being followed (→P. 171, 174), consider each of the following points:**

### **The engine will not start even though the starter motor operates normally.**

One of the following may be the cause of the problem:

- There may not be sufficient fuel in the vehicle's tank.  
Refuel the vehicle.
- The engine may be flooded.  
Try to restart the engine again following correct starting procedures.  
(→P. 171, 174)
- There may be a malfunction in the engine immobilizer system.  
(→P. 67)

### **The starter motor turns over slowly, the interior lights and headlights are dim, or the horn does not sound or sounds at a low volume.**

One of the following may be the cause of the problem:

- The battery may be discharged. (→P. 526)
- The battery terminal connections may be loose or corroded.

### **The starter motor does not turn over (vehicles with a smart key system)**

The engine starting system may be malfunctioning due to an electrical problem such as electronic key battery depletion or a blown fuse. However, an interim measure is available to start the engine.  
(→P. 522)

**The starter motor does not turn over, the interior lights and headlights do not turn on, or the horn does not sound.**

One of the following may be the cause of the problem:

- One or both of the battery terminals may be disconnected.
- The battery may be discharged. (→P. 526)
- There may be a malfunction in the steering lock system (vehicles with a smart key system).

Contact your Toyota dealer if the problem cannot be repaired, or if repair procedures are unknown.

**Emergency start function (vehicles with a smart key system)**

When the engine does not start, the following steps can be used as an interim measure to start the engine if the engine switch is functioning normally:

- 1 Set the parking brake.
- 2 Shift the shift lever to P (continuously variable transmission) or N (manual transmission).
- 3 Turn the engine switch to ACCESSORY mode.
- 4 Press and hold the engine switch for about 15 seconds while depressing the brake pedal and clutch pedal (manual transmission) firmly.

Even if the engine can be started using the above steps, the system may be malfunctioning. Have the vehicle inspected by your Toyota dealer.

## If the electronic key does not operate properly (vehicles with a smart key system)

If communication between the electronic key and vehicle is interrupted (→P. 125) or the electronic key cannot be used because the battery is depleted, the smart key system and wireless remote control cannot be used. In such cases, the doors can be opened and the engine can be started by following the procedure below.

### Locking and unlocking the doors

Use the mechanical key (→P. 103) in order to perform the following operations:

- ① Locks all the doors
- ② Unlocks the door

Turning the key rearward unlocks the driver's door. Turning the key once again within 5 seconds unlocks the other doors.

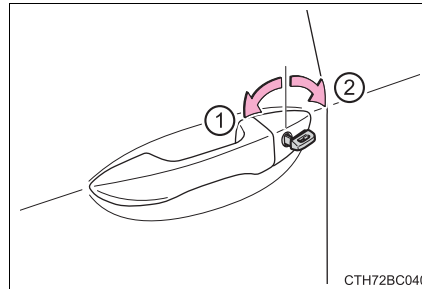

### Starting the engine

- 1 Continuously variable transmission: Ensure that the shift lever is in P and depress the brake pedal.  
Manual transmission: Shift the shift lever to N and depress the clutch pedal.

- 2 Touch the Toyota emblem side of the electronic key to the engine switch.

When the electronic key is detected, a buzzer sounds and the engine switch will turn to IGNITION ON mode.

When the smart key system is deactivated in customization setting, the engine switch will turn to ACCESSORY mode.

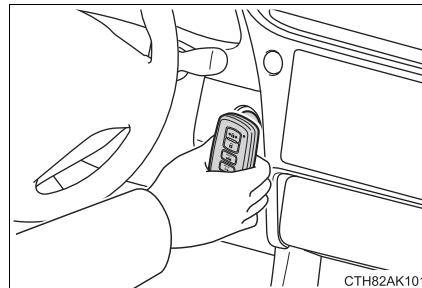

- 3 Firmly depress the brake pedal (continuously variable transmission) or clutch pedal (manual transmission) and check that  is shown on the multi-information display.

- 4 Press the engine switch.

In the event that the engine still cannot be started, contact your Toyota dealer.

---

**■ Stopping the engine**

Shift the shift lever to P (continuously variable transmission) or N (manual transmission) and press the engine switch as you normally do when stopping the engine.

**■ Replacing the key battery**

As the above procedure is a temporary measure, it is recommended that the electronic key battery be replaced immediately when the battery is depleted. (→P. 455)

**■ Changing engine switch modes**

Release the brake pedal (continuously variable transmission) or clutch pedal (manual transmission) and press the engine switch in step **3** above.

The engine does not start and modes will be changed each time the switch is pressed. (→P. 176)

**■ When the electronic key does not work properly**

- Make sure that the smart key system has not been deactivated in the customization setting. If it is off, turn the function on. (Customizable features →P. 564)
- Check if battery-saving mode is set. If it is set, cancel the function. (→P. 124)

## If the vehicle battery is discharged

**The following procedures may be used to start the engine if the vehicle's battery is discharged.**

**You can also call your Toyota dealer or a qualified repair shop.**

If you have a set of jumper (or booster) cables and a second vehicle with a 12-volt battery, you can jump start your vehicle by following the steps below.

- 1 Vehicles with an alarm: Confirm that the electronic key (vehicles with a smart key system) or key (vehicles without a smart key system) is being carried.

When connecting the jumper (or booster) cables, depending on the situation, the alarm may activate and doors locked. (→P. 70)

- 2 Open the hood. (→P. 425)
- 3 Remove the engine cover.

Raise the rear of the engine cover to remove the two rear clips, and then raise the front of the engine cover to remove the two front clips.

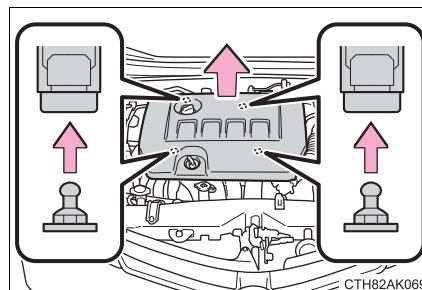
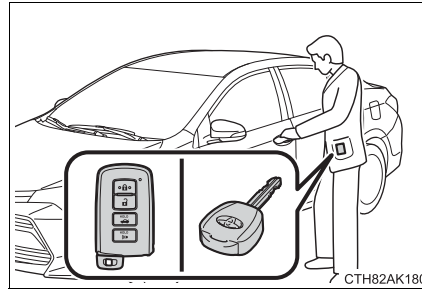

- 4 Connect the jumper cables according to the following procedure:

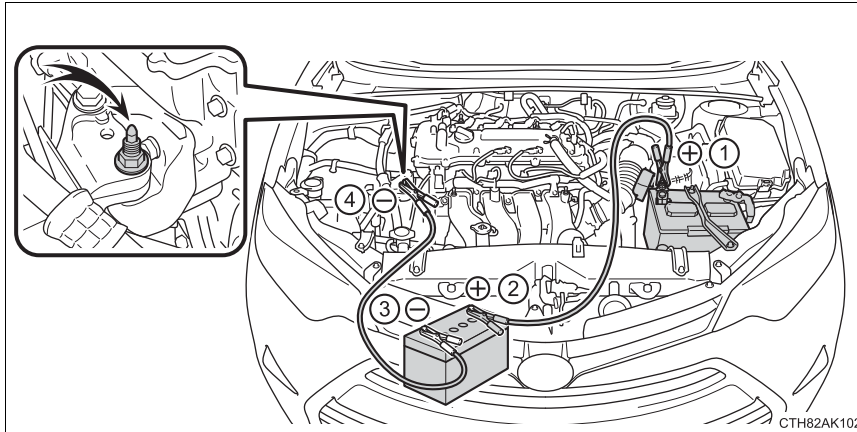

- ① Connect a positive jumper cable clamp to the positive (+) battery terminal on your vehicle.
- ② Connect the clamp on the other end of the positive cable to the positive (+) battery terminal on the second vehicle.
- ③ Connect a negative cable clamp to the negative (-) battery terminal on the second vehicle.
- ④ Connect the clamp at the other end of the negative cable to a solid, stationary, unpainted metallic point away from the battery and any moving parts, as shown in the illustration.

- 5 Start the engine of the second vehicle. Increase the engine speed slightly and maintain at that level for approximately 5 minutes to recharge the battery of your vehicle.
- 6 Vehicles with a smart key system: Open and close any of the doors of your vehicle with the engine switch off.
- 7 Vehicles without a smart key system:  
Maintain the engine speed of the second vehicle and turn the engine switch to the "ON" position, then start the vehicle's engine.  
Vehicles with a smart key system:  
Maintain the engine speed of the second vehicle and turn the engine switch to IGNITION ON mode, then start the vehicle's engine.
- 8 Once the vehicle's engine has started, remove the jumper cables in the exact reverse order from which they were connected.  
Once the engine starts, have the vehicle inspected at your Toyota dealer as soon as possible.



---

**■ Starting the engine when the battery is discharged**

The engine cannot be started by push-starting.

**■ To prevent battery discharge**

- Turn off the headlights and the audio system while the engine is off.
- Turn off any unnecessary electrical components when the vehicle is running at a low speed for an extended period, such as in heavy traffic.

**■ Charging the battery**

The electricity stored in the battery will discharge gradually even when the vehicle is not in use, due to natural discharge and the draining effects of certain electrical appliances. If the vehicle is left for a long time, the battery may discharge, and the engine may be unable to start. (The battery recharges automatically during driving.)

**■ When recharging or replacing the battery**

- Vehicles with a smart key system: In some cases, it may not be possible to unlock the doors using the smart key system when the battery is discharged. Use the wireless remote control or the mechanical key to lock or unlock the doors.
- The engine may not start on the first attempt after the battery has recharged but will start normally after the second attempt. This is not a malfunction.
- Vehicles with a smart key system: The engine switch mode is memorized by the vehicle. When the battery is reconnected, the system will return to the mode it was in before the battery was discharged. Before disconnecting the battery, turn the engine switch off.  
If you are unsure what mode the engine switch was in before the battery discharged, be especially careful when reconnecting the battery.

 **WARNING****■ Avoiding battery fires or explosions**

Observe the following precautions to prevent accidentally igniting the flammable gas that may be emitted from the battery:

- Make sure each jumper cable is connected to the correct terminal and that it is not unintentionally in contact with any other than the intended terminal.
- Do not allow the other end of the jumper cable connected to the “+” terminal to come into contact with any other parts or metal surfaces in the area, such as brackets or unpainted metal.
- Do not allow the + and - clamps of the jumper cables to come into contact with each other.
- Do not smoke, use matches, cigarette lighters or allow open flame near the battery.

**■ Battery precautions**

The battery contains poisonous and corrosive acidic electrolyte, while related parts contain lead and lead compounds. Observe the following precautions when handling the battery:

- When working with the battery, always wear safety glasses and take care not to allow any battery fluids (acid) to come into contact with skin, clothing or the vehicle body.
- Do not lean over the battery.
- In the event that battery fluid comes into contact with the skin or eyes, immediately wash the affected area with water and seek medical attention. Place a wet sponge or cloth over the affected area until medical attention can be received.
- Always wash your hands after handling the battery support, terminals, and other battery-related parts.
- Do not allow children near the battery.

 **NOTICE****■ When handling jumper cables**

When connecting the jumper cables, ensure that they do not become entangled in the cooling fan or engine drive belt.

## If your vehicle overheats

### The following may indicate that your vehicle is overheating.

- The engine coolant temperature gauge (→P. 77, 86) enters the red zone or a loss of power is experienced.
- Steam comes out from under the hood.

### Correction procedures

- 1 Stop the vehicle in a safe place and turn off the air conditioning system, and then stop the engine.
- 2 If you see steam:  
Carefully lift the hood after the steam subsides.  
If you do not see steam:  
Carefully lift the hood.
- 3 After the engine has cooled down sufficiently, inspect the hoses and radiator core (radiator) for any leaks.
  - 1 Radiator
  - 2 Cooling fanIf a large amount of coolant leaks, immediately contact your Toyota dealer.

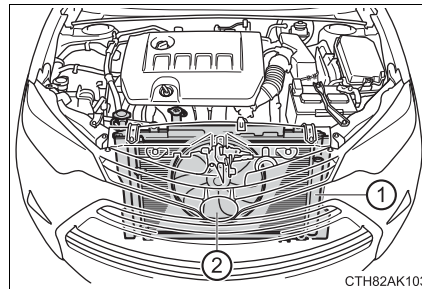

- 4 The coolant level is satisfactory if it is between the “F” and “L” lines on the reservoir.

- ① Reservoir
- ② “F” line
- ③ “L” line
- ④ Radiator cap

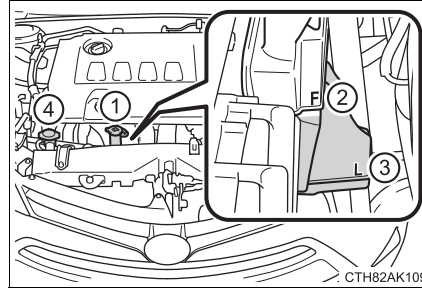

- 5 Add engine coolant if necessary.

Water can be used in an emergency if engine coolant is unavailable.

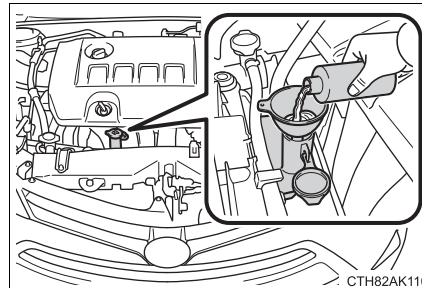

- 6 Start the engine to check that the radiator cooling fan operate and to check for coolant leaks from the radiator or hoses.

- 7 If the fan is not operating:

Stop the engine immediately and contact your Toyota dealer.

If the fan is operating:

Have the vehicle inspected at the nearest Toyota dealer.

**⚠ WARNING****■ When inspecting under the hood of your vehicle**

Observe the following precautions.

Failure to do so may result in serious injury such as burns.

- If steam is seen coming from under the hood, do not open the hood until the steam has subsided. The engine compartment may be very hot.
- Keep hands and clothing (especially a tie, a scarf or a muffler) away from the fan and belts.
- Do not loosen the radiator cap and the coolant reservoir cap while the engine and radiator are hot.  
High temperature steam or coolant could spray out.

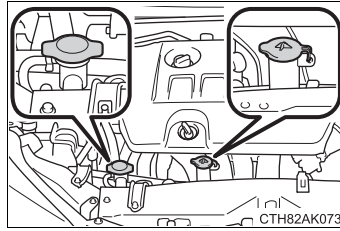
**⚠ NOTICE****■ When adding engine coolant**

Add coolant slowly after the engine has cooled down sufficiently. Adding cool coolant to a hot engine too quickly can cause damage to the engine.

**■ To prevent damage to the cooling system**

Observe the following precautions:

- Avoid contaminating the coolant with foreign matter (such as sand or dust etc.).
- Do not use any coolant additives.

## If the vehicle becomes stuck

**Carry out the following procedures if the tires spin or the vehicle becomes stuck in mud, dirt or snow:**

- 1 Stop the engine. Set the parking brake and shift the shift lever to P (continuously variable transmission) or N (manual transmission).
- 2 Remove the mud, snow or sand from around the front wheels.
- 3 Place wood, stones or some other material under the front wheels to help provide traction.
- 4 Restart the engine.
- 5 Shift the shift lever to D or R (continuously variable transmission) or 1 or R (manual transmission) and release the parking brake. Then, while exercising caution, depress the accelerator pedal.

■ **When it is difficult to free the vehicle (vehicles with a TRAC system)**

Press  to turn off TRAC.

► Vehicles with a monochrome display

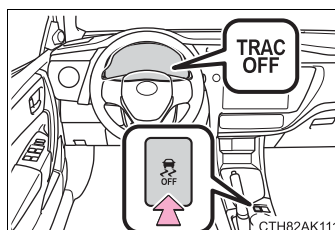

► Vehicles with a color display

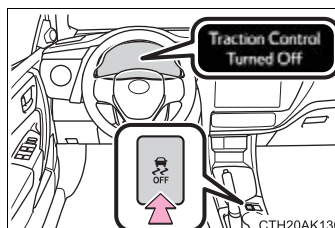

 **WARNING****■ When attempting to free a stuck vehicle**

If you choose to push the vehicle back and forth to free it, make sure the surrounding area is clear to avoid striking other vehicles, objects or people. The vehicle may also lunge forward or lunge back suddenly as it becomes free. Use extreme caution.

**■ When shifting the shift lever**

Be careful not to shift the shift lever with the accelerator pedal depressed. This may lead to unexpected rapid acceleration of the vehicle that may cause an accident resulting in death or serious injury.

 **NOTICE****■ To avoid damaging the transmission and other components**

- Avoid spinning the front wheels and depressing the accelerator pedal more than necessary.
- If the vehicle remains stuck even after these procedures are performed, the vehicle may require towing to be freed.





**Vehicle specifications**

**9**

**9-1. Specifications**

- Maintenance data  
(fuel, oil level, etc.)..... 538
- Fuel information ..... 548
- Tire information ..... 551

**9-2. Customization**

- Customizable features ..... 564

**9-3. Items to initialize**

- Items to initialize ..... 573

## Maintenance data (fuel, oil level, etc.)

### Dimensions and weights

Overall length		183.1 in. (4650 mm)
Overall width		69.9 in. (1776 mm)
Overall height* <sup>1</sup>		57.3 in. (1455 mm)
Wheelbase		106.3 in. (2700 mm)
Tread	Front	60.3 in. (1531 mm) <sup>*2</sup> 59.8 in. (1519 mm) <sup>*3</sup>
	Rear	60.4 in. (1534 mm) <sup>*2</sup> 59.9 in. (1522 mm) <sup>*3</sup>
Vehicle capacity weight (occupants + luggage)		865 lb. (390 kg)

\*1: Unladen vehicles

\*2: 195/65R15 tires

\*3: P205/55R16 and P215/45R17 tires

### Vehicle identification

#### ■ Vehicle identification number

The vehicle identification number (VIN) is the legal identifier for your vehicle. This is the primary identification number for your Toyota. It is used in registering the ownership of your vehicle.

This number is stamped on the top left of the instrument panel.

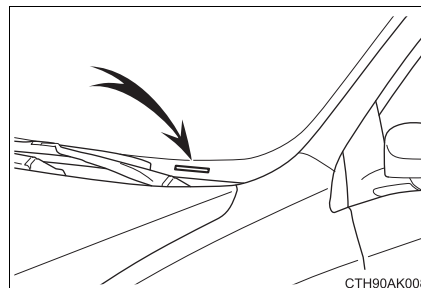

CTH90AK008

This number is also on the Certification Label on the driver's side center pillar.

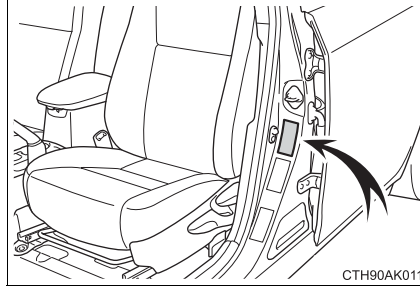

■ **Engine number**

The engine number is stamped on the engine block as shown.

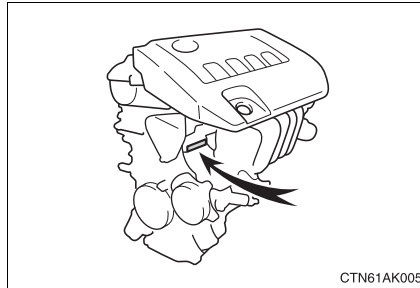

**Engine**

Model	1.8 L 4-cylinder (2ZR-FE and 2ZR-FAE) engines
Type	4 cylinder in line, 4 cycle, gasoline
Bore and stroke	3.17 × 3.48 in. (80.5 × 88.3 mm)
Displacement	109.7 cu. in. (1798 cm <sup>3</sup> )
Drive belt tension	▶ 2ZR-FE* 143 ± 22 lbf (650 ± 100 N, 65 ± 10 kgf) ▶ 2ZR-FAE Automatic adjustment
Valve clearance	Automatic adjustment

\*: Drive belt tension measured with Borroughs drive belt tension gauge No. BT-33-73F (used belt), lbf

**Fuel**

Fuel type	Unleaded gasoline only
Octane rating	87 (Research Octane Number 91) or higher
Fuel tank capacity (Reference)	13.2 gal. (50 L, 10.9 Imp. gal.)

**Lubrication system**

Oil capacity (Drain and refill — reference*)	
With filter	4.4 qt. (4.2 L, 3.7 Imp. qt.)
Without filter	4.1 qt. (3.9 L, 3.4 Imp. qt.)

\*: The engine oil capacity is a reference quantity to be used when changing the engine oil. Warm up and turn off the engine, wait more than 5 minutes, and check the oil level on the dipstick.

### ■ Engine oil selection

“Toyota Genuine Motor Oil” is used in your Toyota vehicle. Use Toyota approved “Toyota Genuine Motor Oil” or equivalent to satisfy the following grade and viscosity.

Oil grade: ILSAC GF-5 multigrade engine oil

Recommended viscosity:

SAE 0W-20

SAE 0W-20 is the best choice for good fuel economy and good starting in cold weather.

If SAE 0W-20 is not available, SAE 5W-20 oil may be used. However, it must be replaced with SAE 0W-20 at the next oil change.

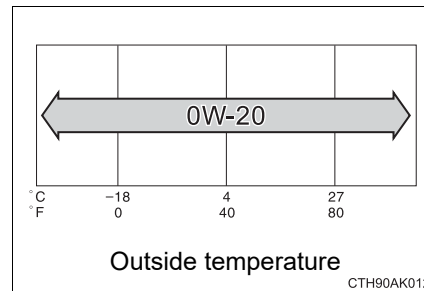

Oil viscosity (0W-20 is explained here as an example):

- The 0W in 0W-20 indicates the characteristic of the oil which allows cold startability. Oils with a lower value before the W allow for easier starting of the engine in cold weather.
- The 20 in 0W-20 indicates the viscosity characteristic of the oil when the oil is at high temperature. An oil with a higher viscosity (one with a higher value) may be better suited if the vehicle is operated at high speeds, or under extreme load conditions.

How to read oil container label

The International Lubricant Specification Advisory Committee (ILSAC) Certification Mark is added to some oil containers to help you select the oil you should use.



**Cooling system**

Capacity (Reference)	5.8 qt. (5.5 L, 4.8 Imp. qt.)
Coolant type	<p>Use either of the following.</p> <ul style="list-style-type: none"> <li>• “Toyota Super Long Life Coolant”</li> <li>• Similar high-quality ethylene glycol-based non-silicate, non-amine, non-nitrite, and non-borate coolant with long-life hybrid organic acid technology</li> </ul> <p>Do not use plain water</p>

**Ignition system**

Spark plug	
Make	DENSO SC20HR11 DENSO SC16HR11
Gap	0.043 in. (1.1 mm)

 NOTICE

 **Iridium-tipped spark plugs**

Use only iridium-tipped spark plugs. Do not adjust spark plug gap.

**Electrical system**

Battery	12.3 V or More If the voltage is lower than the standard value, charge the battery. (Voltage checked 20 minutes after the engine and all the lights turned off)
Open voltage at 68°F (20°C):	
Charging rates	5 A max.

**Manual transaxle**

Gear oil capacity (Reference)	2.5 qt. (2.4 L, 2.1 Imp. qt.)
Gear oil type	“TOYOTA Genuine Manual Transmission Gear Oil LV GL-4 75W” or equivalent

 NOTICE**Manual transmission gear oil type**

- Please be aware that depending on the particular characteristics of the gear oil used or the operating conditions, idle sound, shift feeling and/or fuel efficiency may be different or affected and, in the worst case, damage to the vehicle's transmission. Toyota recommends to use “TOYOTA Genuine Manual Transmission Gear Oil LV GL-4 75W” to achieve optimal performance.
- Your Toyota vehicle is filled with “TOYOTA Genuine Manual Transmission Gear Oil LV GL-4 75W” at the factory. Use Toyota approved “TOYOTA Genuine Manual Transmission Gear Oil LV GL-4 75W” or an equivalent oil of matching quality that satisfies the above specifications. Please contact your Toyota dealer for further details.

**Continuously variable transaxle**

Fluid capacity*	7.9 qt. (7.5 L, 6.6 Imp. qt.)
Fluid type	Toyota Genuine CVTF FE

\*: The fluid capacity is a reference quantity.  
If replacement is necessary, contact your Toyota dealer.

 NOTICE**Continuously variable transaxle fluid type**

Using continuously variable transaxle fluid other than “Toyota Genuine CVTF FE” may cause deterioration in shift quality, locking up of the transmission accompanied by vibration and, ultimately, damage to the vehicle’s transmission.

**Clutch**

Pedal free play	0.2 — 0.6 in. (5 — 15 mm)
Fluid type	SAE J1703 or FMVSS No.116 DOT 3



**Brakes**

Pedal clearance*1	<ul style="list-style-type: none"> <li>▶ 1.8 L 4-cylinder (2ZR-FE) engine 2.9 in. (74 mm)</li> <li>▶ 1.8 L 4-cylinder (2ZR-FAE) engine 2.8 in. (71 mm)</li> </ul>
Pedal free play	0.04 — 0.24 in. (1 — 6 mm)
Brake pad wear limit	0.04 in. (1.0 mm)
Parking brake lining wear limit	0.04 in. (1.0 mm)
Parking brake lever travel*2	6 — 9 clicks
Fluid type	SAE J1703 or FMVSS No.116 DOT 3

\*1: Minimum pedal clearance when depressed with a force of 66 lbf (294 N, 30 kgf) while the engine is running

\*2: Parking brake lever travel when pulled up with a force of 44 lbf (200 N, 20 kgf)

**Steering**

Free play	Less than 1.2 in. (30 mm)
-----------	---------------------------

**Tires and wheels**

## ▶ Type A

Tire size	195/65R15 91S, T135/80R16 101M
Tire inflation pressure (Recommended cold tire inflation pressure)	Front: 35 psi (240 kPa, 2.4 kgf/cm <sup>2</sup> or bar) Rear: 35 psi (240 kPa, 2.4 kgf/cm <sup>2</sup> or bar) Spare: 60 psi (420 kPa, 4.2 kgf/cm <sup>2</sup> or bar)
Wheel size	15 × 6 J, 16 × 4T (compact spare)
Wheel nut torque	76 ft•lbf (103 N•m, 10.5 kgf•m)

## ▶ Type B

Tire size	P205/55R16 89H, T135/80R16 101M
Tire inflation pressure (Recommended cold tire inflation pressure)	Front: 32 psi (220 kPa, 2.2 kgf/cm <sup>2</sup> or bar) Rear: 32 psi (220 kPa, 2.2 kgf/cm <sup>2</sup> or bar) Spare: 60 psi (420 kPa, 4.2 kgf/cm <sup>2</sup> or bar)
Wheel size	16 × 6 1/2 J, 16 × 4T (compact spare)
Wheel nut torque	76 ft•lbf (103 N•m, 10.5 kgf•m)

## ▶ Type C

Tire size	P215/45R17 87W, T135/80R16 101M
Tire inflation pressure (Recommended cold tire inflation pressure)	Front: 32 psi (220 kPa, 2.2 kgf/cm <sup>2</sup> or bar) Rear: 32 psi (220 kPa, 2.2 kgf/cm <sup>2</sup> or bar) Spare: 60 psi (420 kPa, 4.2 kgf/cm <sup>2</sup> or bar)
Wheel size	17 × 7 J, 16 × 4T (compact spare)
Wheel nut torque	76 ft•lbf (103 N•m, 10.5 kgf•m)

**Light bulbs\*1**

	Light bulbs	Bulb No.	W	Type
Exterior	Front side marker lights	W5W	5	B
	Front turn signal/parking lights Type A Type B	7444NA WY21W	28/8 21	B
	Side turn signal lights*2	—	5	B
	Rear turn signal lights	—	21	B
	Stop/tail and rear side marker lights	7443	21/5	A
	License plate lights	—	5	A
	Back-up lights (bulb type)*2	921	16	A
Interior	Vanity lights	—	8	A
	Front personal/interior lights (vehicles without a moon roof)	—	8	A
	Front personal/interior lights (vehicles with a moon roof)	—	5	A
	Rear interior light	—	8	C
	Trunk light	—	3.8	A

A: Wedge base bulbs (clear)

B: Wedge base bulbs (amber)

C: Double end bulbs

\*1: Light bulbs not listed in this table are LED bulbs.

\*2: If equipped

## Fuel information

**You must only use unleaded gasoline.**

**Select octane rating 87 (Research Octane Number 91) or higher. Use of unleaded gasoline with an octane rating lower than 87 may result in engine knocking. Persistent knocking can lead to engine damage.**

At minimum, the gasoline you use should meet the specifications of ASTM D4814 in the U.S.A..

---

### ■ Gasoline quality

In very few cases, driveability problems may be caused by the brand of gasoline you are using. If driveability problems persist, try changing the brand of gasoline. If this does not correct the problem, consult your Toyota dealer.

### ■ Recommendation of the use of gasoline containing detergent additives

- Toyota recommends the use of gasoline that contains detergent additives to avoid the build-up of engine deposits.
- All gasoline sold in the U.S.A. contains minimum detergent additives to clean and/or keep clean intake systems, per EPA's lowest additives concentration program.
- Toyota strongly recommends the use of Top Tier Detergent Gasoline. For more information on Top Tier Detergent Gasoline and a list of marketers, please go to the official website [www.toptiergas.com](http://www.toptiergas.com).

### ■ Recommendation of the use of low emissions gasoline

Gasolines containing oxygenates such as ethers and ethanol, as well as reformulated gasolines, are available in some cities. These fuels are typically acceptable for use, providing they meet other fuel requirements.

Toyota recommends these fuels, since the formulations allow for reduced vehicle emissions.

### ■ Non-recommendation of the use of blended gasoline

- Use only gasoline containing up to 15% ethanol.

DO NOT use any flex-fuel or gasoline that could contain more than 15% ethanol, including from any pump labeled E30, E50, E85 (which are only some examples of fuel containing more than 15% ethanol).

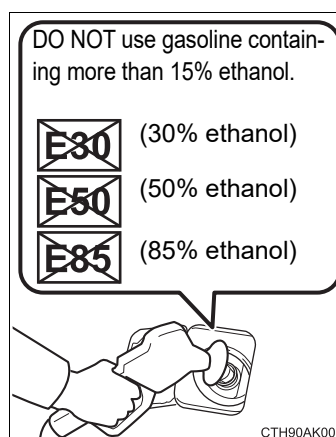

- If you use gasohol in your vehicle, be sure that it has an octane rating no lower than 87.
- Toyota does not recommend the use of gasoline containing methanol.

### ■ Non-recommendation of the use of gasoline containing MMT

Some gasoline contains an octane enhancing additive called MMT (Methylcyclopentadienyl Manganese Tricarbonyl).

Toyota does not recommend the use of gasoline that contains MMT. If fuel containing MMT is used, your emission control system may be adversely affected.

The malfunction indicator lamp on the instrument cluster may come on. If this happens, contact your Toyota dealer for service.

### ■ If your engine knocks

- Consult your Toyota dealer.
- You may occasionally notice light knocking for a short time while accelerating or driving uphill. This is normal and there is no need for concern.

 NOTICE

■ **Notice on fuel quality**

- Do not use improper fuels. If improper fuels are used, the engine will be damaged.
- Do not use leaded gasoline.  
Leaded gasoline can cause damage to your vehicle's three-way catalytic converters causing the emission control system to malfunction.
- Do not use gasohol other than the type previously stated.  
Other gasohol may cause fuel system damage or vehicle performance problems.
- Using unleaded gasoline with an octane number or rating lower than the level previously stated will cause persistent heavy knocking.  
At worst, this will lead to engine damage.

■ **Fuel-related poor driveability**

If poor driveability (poor hot starting, vaporization, engine knocking, etc.) is encountered after using a different type of fuel, discontinue the use of that type of fuel.

■ **When refueling with gasohol**

Take care not to spill gasohol. It can damage your vehicle's paint.

## Tire information

### Typical tire symbols

► Full-size tire

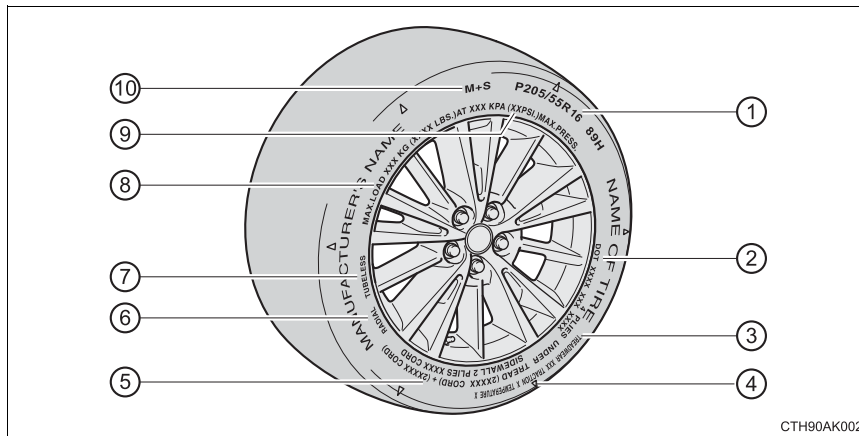

CTH90AK002

► Compact spare tire

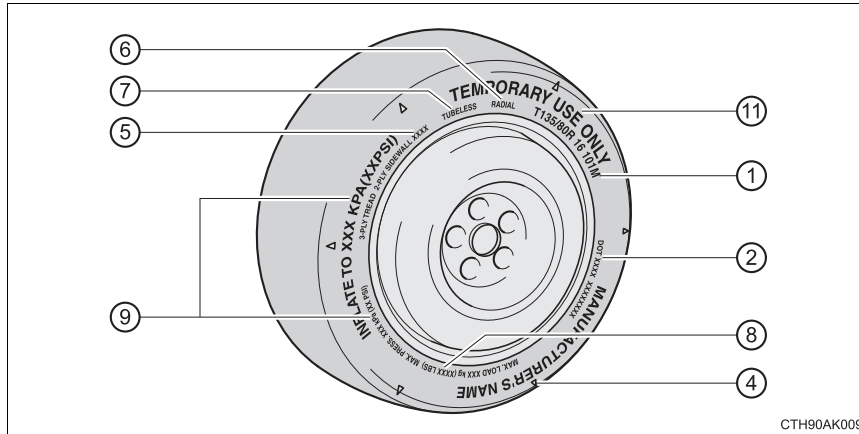

CTH90AK009

9

Vehicle specifications

- ① Tire size (→P. 554)
- ② DOT and Tire Identification Number (TIN) (→P. 553)
- ③ Uniform tire quality grading  
For details, see “Uniform Tire Quality Grading” that follows.
- ④ Location of treadwear indicators (→P. 440)
- ⑤ Tire ply composition and materials  
Plies are layers of rubber-coated parallel cords. Cords are the strands which form the plies in a tire.
- ⑥ Radial tires or bias-ply tires  
A radial tire has “RADIAL” on the sidewall. A tire not marked “RADIAL” is a bias-ply tire.
- ⑦ TUBELESS or TUBE TYPE  
A tubeless tire does not have a tube and air is directly put into the tire. A tube type tire has a tube inside the tire and the tube maintains the air pressure.
- ⑧ Load limit at maximum cold tire inflation pressure (→P. 558)
- ⑨ Maximum cold tire inflation pressure (→P. 558)  
This means the pressure to which a tire may be inflated.
- ⑩ Summer tires or all season tires (→P. 444)  
An all season tire has “M+S” on the sidewall. A tire not marked “M+S” is a summer tire.
- ⑪ “TEMPORARY USE ONLY”  
A compact spare tire is identified by the phrase “TEMPORARY USE ONLY” molded on its sidewall. This tire is designed for temporary emergency use only.



### Typical DOT and Tire Identification Number (TIN)

#### ► Type A

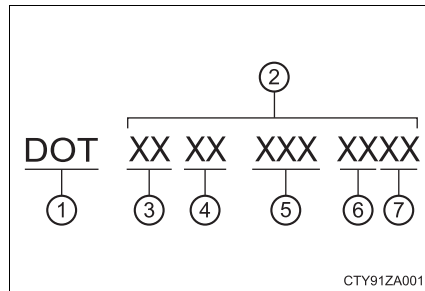

#### ► Type B

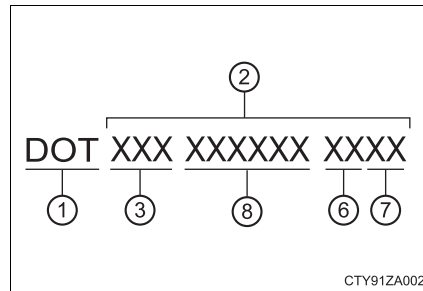

- ① DOT symbol\*
- ② Tire Identification Number (TIN)
- ③ Tire manufacturer's identification mark
- ④ Tire size code
- ⑤ Manufacturer's optional tire type code (3 or 4 letters)
- ⑥ Manufacturing week
- ⑦ Manufacturing year
- ⑧ Manufacturer's code

\*: The DOT symbol certifies that the tire conforms to applicable Federal Motor Vehicle Safety Standards.

## Tire size

### ■ Typical tire size information

The illustration indicates typical tire size.

- ① Tire use (P = Passenger car, T = Temporary use)
- ② Section width (millimeters)
- ③ Aspect ratio (tire height to section width)
- ④ Tire construction code (R = Radial, D = Diagonal)
- ⑤ Wheel diameter (inches)
- ⑥ Load index (2 digits or 3 digits)
- ⑦ Speed symbol (alphabet with one letter)

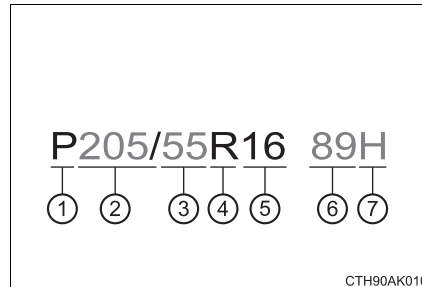

### ■ Tire dimensions

- ① Section width
- ② Tire height
- ③ Wheel diameter

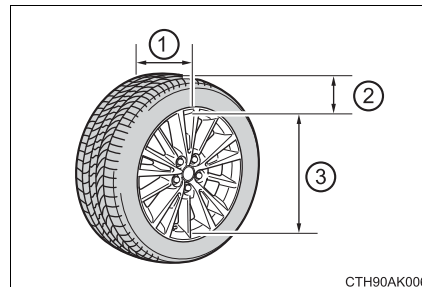

**Tire section names**

- ① Bead
- ② Sidewall
- ③ Shoulder
- ④ Tread
- ⑤ Belt
- ⑥ Inner liner
- ⑦ Reinforcing rubber
- ⑧ Carcass
- ⑨ Rim lines
- ⑩ Bead wires
- ⑪ Chafer

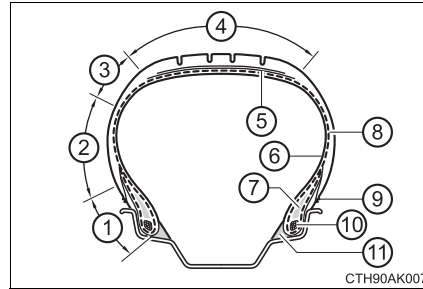

## Uniform Tire Quality Grading

This information has been prepared in accordance with regulations issued by the National Highway Traffic Safety Administration of the U.S. Department of Transportation.

It provides the purchasers and/or prospective purchasers of Toyota vehicles with information on uniform tire quality grading.

Your Toyota dealer will help answer any questions you may have as you read this information.

### ■ DOT quality grades

All passenger vehicle tires must conform to Federal Safety Requirements in addition to these grades. Quality grades can be found where applicable on the tire sidewall between tread shoulder and maximum section width.

For example: Treadwear 200 Traction AA Temperature A

### ■ Treadwear

The treadwear grade is a comparative rating based on the wear rate of the tire when tested under controlled conditions on a specified government test course.

For example, a tire graded 150 would wear one and a half (1 - 1/2) times as well on the government course as a tire graded 100.

The relative performance of tires depends upon the actual conditions of their use. Performance may differ significantly from the norm due to variations in driving habits, service practices and differences in road characteristics and climate.

### ■ Traction AA, A, B, C

The traction grades, from highest to lowest, are AA, A, B and C, and they represent the tire's ability to stop on wet pavement as measured under controlled conditions on specified government test surfaces of asphalt and concrete.

A tire marked C may have poor traction performance.

Warning: The traction grade assigned to this tire is based on braking (straight ahead) traction tests and does not include cornering (turning) traction.

---

**■ Temperature A, B, C**

The temperature grades are A (the highest), B, and C, representing the tire's resistance to the generation of heat and its ability to dissipate heat when tested under controlled conditions on a specified indoor laboratory test wheel.

Sustained high temperature can cause the material of the tire to degenerate and reduce tire life, and excessive temperature can lead to sudden tire failure.

Grade C corresponds to a level of performance which all passenger car tires must meet under the Federal Motor Vehicle Safety Standard No. 109.

Grades B and A represent higher levels of performance on the laboratory test wheel than the minimum required by law.

**Warning:** The temperature grades of a tire assume that it is properly inflated and not overloaded.

Excessive speed, underinflation, or excessive loading, either separately or in combination, can cause heat buildup and possible tire failure.

**Glossary of tire terminology**

Tire related term	Meaning
Cold tire inflation pressure	Tire pressure when the vehicle has been parked for three hours or more, or has not been driven more than 1 mile or 1.5 km under that condition
Maximum inflation pressure	The maximum cold inflated pressure to which a tire may be inflated, shown on the sidewall of the tire
Recommended inflation pressure	Cold tire inflation pressure recommended by a manufacturer
Accessory weight	The combined weight (in excess of those standard items which may be replaced) of automatic transmission, power steering, power brakes, power windows, power seats, radio and heater, to the extent that these items are available as factory-installed equipment (whether installed or not)
Curb weight	The weight of a motor vehicle with standard equipment, including the maximum capacity of fuel, oil and coolant, and if so equipped, air conditioning and additional weight optional engine
Maximum loaded vehicle weight	The sum of: (a) Curb weight (b) Accessory weight (c) Vehicle capacity weight (d) Production options weight
Normal occupant weight	150 lb. (68 kg) times the number of occupants specified in the second column of Table 1* that follows
Occupant distribution	Distribution of occupants in a vehicle as specified in the third column of Table 1* below

Tire related term	Meaning
Production options weight	The combined weight of installed regular production options weighing over 5 lb. (2.3 kg) in excess of the standard items which they replace, not previously considered in curb weight or accessory weight, including heavy duty brakes, ride levelers, roof rack, heavy duty battery, and special trim
Rim	A metal support for a tire or a tire and tube assembly upon which the tire beads are seated
Rim diameter (Wheel diameter)	Nominal diameter of the bead seat
Rim size designation	Rim diameter and width
Rim type designation	The industry manufacturer's designation for a rim by style or code
Rim width	Nominal distance between rim flanges
Vehicle capacity weight (Total load capacity)	The rated cargo and luggage load plus 150 lb. (68 kg) times the vehicle's designated seating capacity
Vehicle maximum load on the tire	The load on an individual tire that is determined by distributing to each axle its share of the maximum loaded vehicle weight, and dividing by two
Vehicle normal load on the tire	The load on an individual tire that is determined by distributing to each axle its share of curb weight, accessory weight, and normal occupant weight (distributed in accordance with Table 1* below), and dividing by two
Weather side	The surface area of the rim not covered by the inflated tire
Bead	The part of the tire that is made of steel wires, wrapped or reinforced by ply cords and that is shaped to fit the rim
Bead separation	A breakdown of the bond between components in the bead

Tire related term	Meaning
Bias ply tire	A pneumatic tire in which the ply cords that extend to the beads are laid at alternate angles substantially less than 90 degrees to the centerline of the tread
Carcass	The tire structure, except tread and sidewall rubber which, when inflated, bears the load
Chunking	The breaking away of pieces of the tread or sidewall
Cord	The strands forming the plies in the tire
Cord separation	The parting of cords from adjacent rubber compounds
Cracking	Any parting within the tread, sidewall, or innerliner of the tire extending to cord material
CT	A pneumatic tire with an inverted flange tire and rim system in which the rim is designed with rim flanges pointed radially inward and the tire is designed to fit on the underside of the rim in a manner that encloses the rim flanges inside the air cavity of the tire
Extra load tire	A tire designed to operate at higher loads and at higher inflation pressures than the corresponding standard tire
Groove	The space between two adjacent tread ribs
Innerliner	The layer(s) forming the inside surface of a tubeless tire that contains the inflating medium within the tire
Innerliner separation	The parting of the innerliner from cord material in the carcass
Intended outboard sidewall	<p>(a) The sidewall that contains a whitewall, bears white lettering, or bears manufacturer, brand, and/or model name molding that is higher or deeper than the same molding on the other sidewall of the tire, or</p> <p>(b) The outward facing sidewall of an asymmetrical tire that has a particular side that must always face outward when mounted on a vehicle</p>



Tire related term	Meaning
Light truck (LT) tire	A tire designated by its manufacturer as primarily intended for use on lightweight trucks or multipurpose passenger vehicles
Load rating	The maximum load that a tire is rated to carry for a given inflation pressure
Maximum load rating	The load rating for a tire at the maximum permissible inflation pressure for that tire
Maximum permissible inflation pressure	The maximum cold inflation pressure to which a tire may be inflated
Measuring rim	The rim on which a tire is fitted for physical dimension requirements
Open splice	Any parting at any junction of tread, sidewall, or innerliner that extends to cord material
Outer diameter	The overall diameter of an inflated new tire
Overall width	The linear distance between the exteriors of the sidewalls of an inflated tire, including elevations due to labeling, decorations, or protective bands or ribs
Passenger car tire	A tire intended for use on passenger cars, multipurpose passenger vehicles, and trucks, that have a gross vehicle weight rating (GVWR) of 10,000 lb. or less.
Ply	A layer of rubber-coated parallel cords
Ply separation	A parting of rubber compound between adjacent plies
Pneumatic tire	A mechanical device made of rubber, chemicals, fabric and steel or other materials, that, when mounted on an automotive wheel, provides the traction and contains the gas or fluid that sustains the load
Radial ply tire	A pneumatic tire in which the ply cords that extend to the beads are laid at substantially 90 degrees to the centerline of the tread
Reinforced tire	A tire designed to operate at higher loads and at higher inflation pressures than the corresponding standard tire

Tire related term	Meaning
Section width	The linear distance between the exteriors of the sidewalls of an inflated tire, excluding elevations due to labeling, decoration, or protective bands
Sidewall	That portion of a tire between the tread and bead
Sidewall separation	The parting of the rubber compound from the cord material in the sidewall
Snow tire	A tire that attains a traction index equal to or greater than 110, compared to the ASTM E-1136 Standard Reference Test Tire, when using the snow traction test as described in ASTM F-1805-00, Standard Test Method for Single Wheel Driving Traction in a Straight Line on Snow-and Ice-Covered Surfaces, and which is marked with an Alpine Symbol (  ) on at least one sidewall
Test rim	The rim on which a tire is fitted for testing, and may be any rim listed as appropriate for use with that tire
Tread	That portion of a tire that comes into contact with the road
Tread rib	A tread section running circumferentially around a tire
Tread separation	Pulling away of the tread from the tire carcass
Treadwear indicators (TWI)	The projections within the principal grooves designed to give a visual indication of the degrees of wear of the tread
Wheel-holding fixture	The fixture used to hold the wheel and tire assembly securely during testing

\*: Table 1 — Occupant loading and distribution for vehicle normal load for various designated seating capacities

---

Designated seating capacity, Number of occupants	Vehicle normal load, Number of occupants	Occupant distribution in a normally loaded vehicle
2 through 4	2	2 in front
5 through 10	3	2 in front, 1 in second seat
11 through 15	5	2 in front, 1 in second seat, 1 in third seat, 1 in fourth seat
16 through 20	7	2 in front, 2 in second seat, 2 in third seat, 1 in fourth seat

## Customizable features

**Your vehicle includes a variety of electronic features that can be personalized to suit your preferences. Programming these preferences requires specialized equipment and may be performed by your Toyota dealer.**

### Customizing vehicle features

#### ■ Changing by using Entune Audio

- 1 Press the "SETUP" button.
- 2 Select "Vehicle" on the "Setup" screen.

Various setting can be changed. Refer to the list of settings that can be changed for details.

#### ■ Changing by using Entune Audio Plus or Entune Premium Audio

- 1 Press the "APPS" button.
- 2 Select "Setup" on the "Apps" screen and select "Vehicle".

Various setting can be changed. Refer to the list of settings that can be changed for details.

#### ■ Changing by using multi-information display

→P. 83, 93

#### ■ Changing by using the door lock switch

→P. 114

### Customizable features

Some function settings are changed simultaneously with other functions being customized. Contact your Toyota dealer for further details.

- ① Settings that can be changed using the audio system
- ② Settings that can be changed using the multi-information display
- ③ Settings that can be changed by your Toyota dealer

Definition of symbols: O = Available, — = Not available

#### ■ Gauges, meters and multi-information display (→P. 77, 86, 99)

##### ▶ Vehicles with a monochrome display

Function <sup>*1</sup>	Default setting	Customized setting	①	②	③
Language <sup>*2</sup>	English	French	O	O	—
Eco Driving Indicator Light <sup>*3</sup>	On (Self-lighting)	Off	—	O	—

##### ▶ Vehicles with a color display

Function <sup>*1</sup>	Default setting	Customized setting	①	②	③
Language <sup>*2</sup>	English	French	O	O	—
Units <sup>*2</sup>	miles (MPG US)	km (km/L)	O	O	—
		km (L/100 km)	—	—	—
Maintenance system initialization <sup>*4</sup>	Off	On	—	O	—
Eco Driving Indicator Light <sup>*3</sup>	On (Self-lighting)	Off	—	O	—
Drive information 1	Current fuel consumption	*5	—	O	—
	Average fuel consumption (after reset)		—	O	—
Drive information 2	Distance (driving range)	*5	—	O	—
	Average vehicle speed (after reset)		—	O	—
Pop-up display <sup>*6</sup>	On	Off	—	O	—



Function*1	Default setting	Customized setting	①	②	③
Accent color	Light blue	Blue	O	O	—
		Orange			
		Yellow			

- \*1: For details about each function: →P. 83, 93
- \*2: The default setting varies according to country.
- \*3: If equipped
- \*4: U.S.A. only
- \*5: 4 of the following items: current fuel consumption, average fuel consumption (after reset), average fuel consumption (after start), average fuel consumption (after refuel), average vehicle speed (after reset), average vehicle speed (after start), distance (driving range), distance (after start), elapsed time (after reset), elapsed time (after start), blank.
- \*6: Intersection guidance, incoming calls

■ **LDA (Lane Departure Alert with steering control) (→P. 226)**

Function	Default setting	Customized setting	①	②	③
Steering Assist	On	Off	—	O	—
Alert sensitivity	Standard	High	—	O	—
Vehicle sway warning function	On	Off	—	O	—
Vehicle sway warning sensitivity	Standard	Low	—	O	—
		High			

■ **PCS (Pre-Collision System) (→P. 214)**

Function	Default setting	Customized setting	①	②	③
PCS (Pre-Collision System)	On	Off	—	O	—
Alert timing	 (Middle)	 (Far)	—	O	—
		 (Near)			

■ **Door lock (→P. 108, 117, 523)**

Function	Default setting	Customized setting	①	②	③
Unlocking using a key	Driver's door unlocked in one step, all doors unlocked in two steps	All doors unlocked in one step	—	—	○
Speed-detecting automatic door lock function (vehicles with a smart key system)	Off	On	○	—	○
Opening driver's door unlocks all doors	Off	On			
Shifting gears to P unlocks all doors. (vehicles with a continuously variable transmission)	On	Off	○	—	○
Shifting gears to position other than P locks all doors. (vehicles with a continuously variable transmission)	On	Off			
Locking/unlocking of the trunk when all doors are locked/unlocked	On	Off	—	—	○

■ **Smart key system\* and wireless remote control\* (→P. 108, 117)**

Function	Default setting	Customized setting	①	②	③
Operation buzzer volume	5	Off	○	—	○
		1 to 7			
Operation signal (emergency flashers)	On	Off	○	—	○
Time elapsed before automatic door lock function is activated if door is not opened after being unlocked	60 seconds	Off			
		30 seconds	○	—	○
		120 seconds			
Open door warning buzzer (when locking the vehicle)	On	Off	—	—	○

\*: If equipped



■ **Smart key system\*** (→P. 108, 117, 122)

Function	Default setting	Customized setting	①	②	③
Smart key system	On	Off	—	—	○
Number of permissible times of continuous smart lock	Twice	Unlimited	—	—	○

\*: If equipped

■ **Wireless remote control\*** (→P. 102, 108, 117)

Function	Default setting	Customized setting	①	②	③
Wireless remote control	On	Off	—	—	○
Unlocking operation	Driver's door unlocked in one step, all doors unlocked in two steps	All doors unlocked in one step	○	—	○
Trunk unlocking operation	Press and hold (short)	One short press	—	—	○
		Push twice			
		Press and hold (long)			
		Off			
Alarm (panic mode)	On	Off	—	—	○

\*: If equipped

### ■ Turn signal lever (→P. 191)

Function	Default setting	Customized setting	①	②	③
The number of times the turn signal lights flash automatically when the turn signal lever is moved to the first position during a lane change*1	3	5			
		7	—	—	○
		Off*2			

\*1: After flashing the turn signal lights when turning left or right while this function is off and the turn signal lever is moved to the first position in the direction of the flashing light, the turn signal lights can be selected to be flashing or off.

\*2: The turn signal lights will be off if the turn signal lever is moved to the first position in the direction of flashing light.

### ■ Automatic light control system (→P. 193)

Function	Default setting	Customized setting	①	②	③
Light sensor sensitivity	Level 3	Level 1 to 5	○	—	○
Sensitivity of the ambient light sensor used for dimming the indicator on the air conditioning control buttons.	Standard	-2 to 2	—	—	○
Sensitivity of the ambient light sensor used for brightening the indicator on the air conditioning control buttons.	Standard	-2 to 2	—	—	○
Time elapsed before headlights automatically turn off after doors are closed	30 seconds	Off			
		60 seconds	○	—	○
		90 seconds			

### ■ Lights (→P. 193)

Function	Default setting	Customized setting	①	②	③
Daytime running light system	On	Off	0	—	0

### ■ Automatic air conditioning system\* (→P. 373)

Function	Default setting	Customized setting	①	②	③
Air conditioning auto switch operation	On	Off	0	—	0

\*: If equipped

### ■ Illumination (→P. 384)

Function	Default setting	Customized setting	①	②	③
Time elapsed before the interior lights turn off	15 seconds	7.5 seconds	0*	—	0
		30 seconds			
Operation after the engine switch is turned off	On	Off	—	—	0
Operation when the doors are unlocked	On	Off	—	—	0
Operation when you approach the vehicle with the electronic key on your person*	On	Off	—	—	0

\*: If equipped

**■ Vehicle customization**

When the doors remain closed after unlocking the doors and the timer activated automatic door lock function activates, signals will be generated in accordance with the operational signal (emergency flashers) function settings.

**■ When customizing using audio system**

Stop the vehicle in a safe place, apply the parking brake, and shift the shift lever to P (continuously variable transmission) or N (manual transmission). Also, to prevent battery discharge, leave the engine running while customizing the features.

 **WARNING****■ During customization**

As the engine needs to be running during customization, ensure that the vehicle is parked in a place with adequate ventilation. In a closed area such as a garage, exhaust gases including harmful carbon monoxide (CO) may collect and enter the vehicle. This may lead to death or a serious health hazard.

 **NOTICE****■ During customization**

To prevent battery discharge, ensure that the engine is running while customizing features.

## Items to initialize

**The following items must be initialized for normal system operation after such cases as maintenance being performed on the vehicle:**

Item	When to initialize	Reference
Message indicating maintenance is required (U.S.A. only)	<ul style="list-style-type: none"> <li>• After the maintenance is performed</li> </ul>	P. 415
Tire pressure warning system (if equipped)	<ul style="list-style-type: none"> <li>• When changing the tire size</li> <li>• When changing the tire inflation pressure by changing traveling speed or load weight, etc.</li> </ul>	P. 442



**For owners**

**10**

Reporting safety defects for  
U.S. owners ..... 576

Seat belt instructions for  
Canadian owners  
(in French) ..... 577

SRS airbag instructions for  
Canadian owners  
(in French) ..... 579

## Reporting safety defects for U.S. owners

If you believe that your vehicle has a defect which could cause a crash or could cause injury or death, you should immediately inform the National Highway Traffic Safety Administration (NHTSA) in addition to notifying Toyota Motor Sales, U.S.A., Inc. (Toll-free: 1-800-331-4331).

If NHTSA receives similar complaints, it may open an investigation, and if it finds that a safety defect exists in a group of vehicles, it may order a recall and remedy campaign. However, NHTSA cannot become involved in individual problems between you, your dealer, or Toyota Motor Sales, U.S.A., Inc.

To contact NHTSA, you may call the Vehicle Safety Hotline toll-free at 1-888-327-4236 (TTY: 1-800-424-9153); go to <http://www.safercar.gov>; or write to: Administrator, NHTSA, 1200 New Jersey Ave, S.E., Washington, DC 20590. You can also obtain other information about motor vehicle safety from <http://www.safercar.gov>.



## Seat belt instructions for Canadian owners (in French)

**The following is a French explanation of seat belt instructions extracted from the seat belt section in this manual.**

See the seat belt section for more detailed seat belt instructions in English.

### Utilisation correcte des ceintures de sécurité

- Déroulez la sangle diagonale de telle sorte qu'elle passe entièrement sur l'épaule, sans pour autant être en contact avec le cou ou glisser de l'épaule.
- Placez la sangle abdominale aussi bas que possible sur les hanches.
- Réglez la position du dossier de siège. Asseyez-vous le dos le plus droit possible et calez-vous bien dans le siège.
- Ne vrillez pas la ceinture de sécurité.

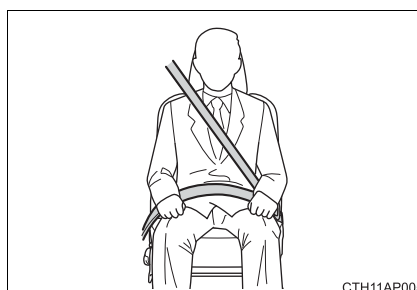

### Entretien et soin

#### ■ Ceintures de sécurité

Nettoyez avec un chiffon ou une éponge humectée d'eau savonneuse tiède. Vérifiez régulièrement que les ceintures ne sont pas effilochées, entaillées ou exagérément usées.

 **AVERTISSEMENT****■ Dommage et usure de la ceinture de sécurité**

Inspectez la ceinture de sécurité périodiquement. Vérifiez si elles ne sont pas entaillées, effilochées et que leurs ancrages ne sont pas desserrés. N'utilisez pas une ceinture de sécurité défectueuse avant qu'elle ne soit remplacée. Une ceinture de sécurité défectueuse n'apporte aucune garantie de protection de l'occupant en cas de blessures graves, voire mortelles.

## SRS airbag instructions for Canadian owners (in French)

The following is a French explanation of SRS airbag instructions extracted from the SRS airbag section in this manual.

See the SRS airbag section for more detailed SRS airbag instructions in English.

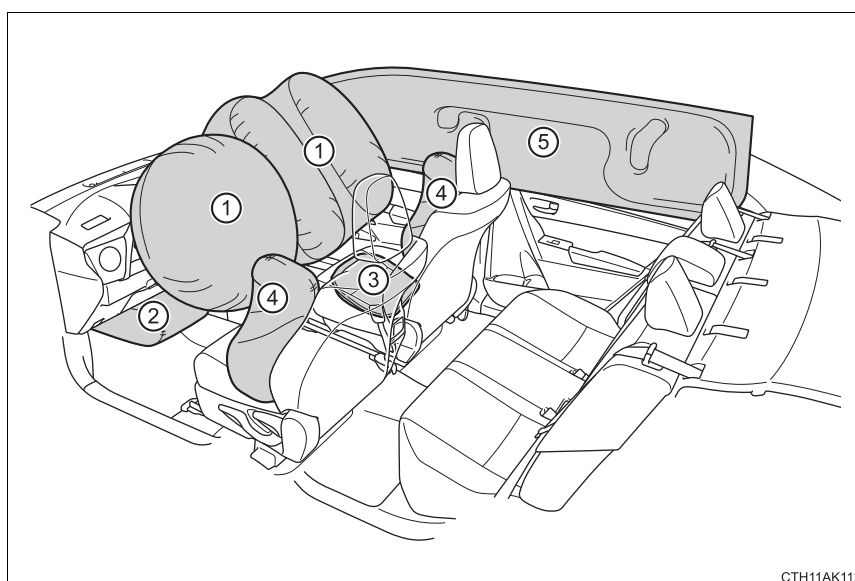

CTH11AK112

### ◆ Coussins gonflables avant SRS

- ① Coussin gonflable conducteur SRS/coussin gonflable passager avant  
Participent à la protection de la tête et du thorax du conducteur et du passager avant contre les chocs avec les éléments intérieurs
- ② Coussin gonflable de genoux du conducteur SRS  
Participe à la protection du conducteur
- ③ Coussin gonflable d'assise SRS  
Contribue à retenir le passager avant

---

**◆ Coussins gonflables latéraux et rideaux SRS**

---

- ④ Coussins gonflables latéraux avant SRS  
Participent à la protection du thorax des occupants du siège avant
- ⑤ Coussins gonflables rideaux SRS
  - Participent principalement à la protection de la tête des occupants des sièges latéraux
  - Peut contribuer à empêcher les occupants d'être éjectés du véhicule en cas de tonneau

### Compositions du système de coussin gonflable SRS

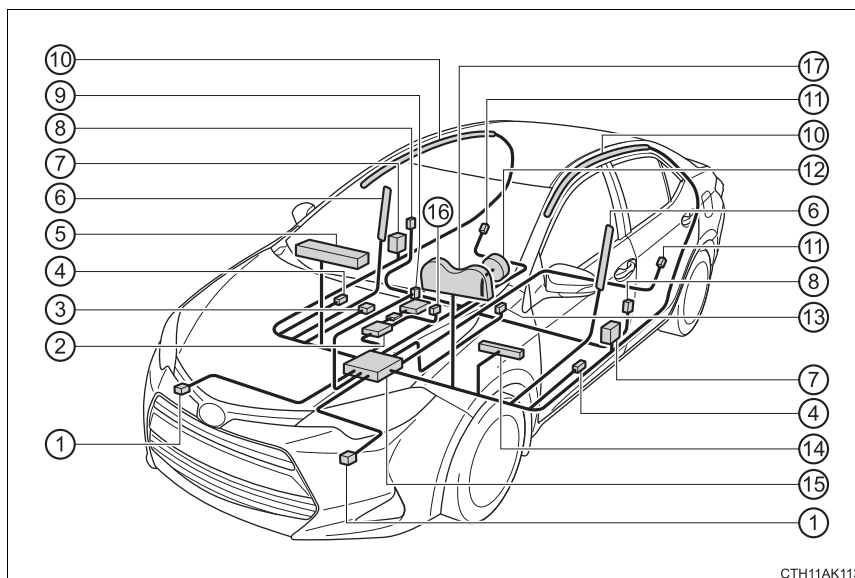

CTH11AK113

- |   |  |
|---|--|
| ① Capteurs d'impact avant   | ⑩ Coussins gonflables rideaux  |
| ② Système de classification de l'occupant du passager avant (ECU et capteurs) | ⑪ Capteurs d'impact latéral (arrière)                                    |
| ③ Coussin gonflable d'assise  | ⑫ Coussin gonflable conducteur   |
| ④ Capteurs d'impact latéral (porte avant)                                     | ⑬ Bouton de la boucle de ceinture de sécurité du conducteur              |
| ⑤ Coussin gonflable passager avant  | ⑭ Coussin gonflable de genoux du conducteur                              |
| ⑥ Coussins gonflables latéraux  | ⑮ Ensemble de capteurs du coussin gonflable                              |
| ⑦ Prétensionneurs de ceintures de sécurité et limiteurs de force              | ⑯ Bouton de la boucle de ceinture de sécurité du siège du passager avant |
| ⑧ Capteurs d'impact latéral (avant)   | ⑰ Témoin d'avertissement SRS   |
| ⑨ Témoins indicateurs "AIR BAG ON" et "AIR BAG OFF"                           |  |

Votre véhicule est équipé de COUSSINS GONFLABLES INTELLIGENTS conçus selon les normes de sécurité américaines applicables aux véhicules à moteur (FMVSS208). Le boîtier électronique (ECU) des coussins gonflables régule le déploiement de ces derniers sur la base des informations qu'il reçoit des capteurs, etc., indiqués ci-dessus dans le schéma illustrant les composants du système. Parmi ces informations figurent la gravité du choc et les informations de l'occupant. Le déploiement rapide des coussins gonflables est obtenu au moyen d'une réaction chimique dans les dispositifs pyrotechniques, qui produit un gaz inoffensif permettant d'amortir le mouvement des occupants.

## AVERTISSEMENT

### ■ Précautions concernant le coussin gonflable SRS

Respectez les précautions suivantes concernant les coussins gonflables SRS.

Autrement, des blessures graves, voire mortelles, pourraient s'ensuivre.

- Le conducteur et les passagers du véhicule doivent porter correctement leur ceinture de sécurité.

Les coussins gonflables SRS sont des dispositifs supplémentaires à utiliser avec les ceintures de sécurité.

- Le coussin gonflable conducteur SRS se déploie avec une force considérable, et peut provoquer des blessures graves, voire mortelles, si le conducteur se trouve très près du coussin gonflable. L'autorité fédérale chargée de la sécurité routière aux États-Unis (NHTSA) conseille:

Sachant que la zone de danger pour le coussin gonflable conducteur se trouve dans les premiers 2 à 3 in. (50 - 75 mm) de déploiement, placez-vous à 10 in. (250 mm) de votre coussin gonflable conducteur vous garantit une marge de sécurité suffisante. Cette distance est mesurée entre l'axe du volant et votre sternum. Si vous êtes assis à moins de 10 in. (250 mm), vous pouvez changer votre position de conduite de plusieurs façons:

- Reculez votre siège le plus possible, de manière à pouvoir encore atteindre confortablement les pédales.
- Inclinez légèrement le dossier du siège.  
Bien que les véhicules puissent être différents les uns des autres, la plupart des conducteurs peuvent s'asseoir à une distance de 10 in. (250 mm), même avec le siège conducteur complètement avancé, simplement en inclinant un peu le dossier de siège. Si vous avez des difficultés à voir la route après avoir incliné votre siège, utilisez un coussin ferme et antidérapant pour vous rehausser ou, si votre véhicule est équipé du réglage en hauteur du siège, remontez-le.
- Si votre volant est réglable, inclinez-le vers le bas. Cela a pour effet d'orienter le coussin gonflable en direction de votre poitrine plutôt que de votre tête et de votre cou.

Réglez votre siège selon les recommandations de la NHTSA ci-dessus, tout en conservant le contrôle des pédales, du volant et de l'affichage des commandes du tableau de bord.

## ⚠ AVERTISSEMENT

### ■ Précautions concernant le coussin gonflable SRS

● Si vous attachez une rallonge de ceinture de sécurité aux boucles de ceinture de sécurité du siège avant, mais pas au pêne de la ceinture de sécurité, les coussins gonflables avant SRS détectent que le conducteur et le passager avant ont attaché leur ceinture de sécurité, alors même que ce n'est pas le cas. Dans ce cas, il se peut que les coussins gonflables avant SRS ne se déploient pas correctement en cas de collision, ce qui peut provoquer des blessures graves, voire mortelles en cas de collision. Veillez à porter la ceinture de sécurité avec la rallonge de ceinture de sécurité.

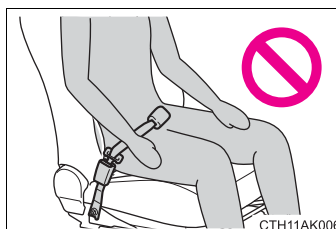

- Le coussin gonflable passager avant SRS se déploie également avec une force considérable, ce qui peut provoquer des blessures graves, voire mortelles, si le passager avant se trouve très près du coussin gonflable. Éloignez le siège du passager avant aussi loin que possible du coussin gonflable et réglez le dossier de siège de façon à ce que le passager avant soit assis bien droit dans le siège.
- Les nourrissons et les enfants qui ne sont pas correctement assis et/ou protégés peuvent être grièvement blessés ou tués par le déploiement du coussin gonflable. Installez dans un siège de sécurité enfant les enfants trop jeunes pour pouvoir utiliser la ceinture de sécurité. Toyota recommande vivement que les nourrissons et les enfants soient installés sur le siège arrière du véhicule et convenablement attachés. Les sièges arrière sont plus sûrs pour les nourrissons et les enfants que le siège du passager avant.
- N'installez jamais un siège de sécurité enfant type dos à la route sur le siège du passager avant, même si le témoin indicateur "AIR BAG OFF" est allumé. En cas d'accident, par la violence et la vitesse de son déploiement, le coussin gonflable du passager avant peut blesser grièvement, voire tuer l'enfant si le siège de sécurité enfant type dos à la route est installé sur le siège du passager avant.



**⚠ AVERTISSEMENT**

**■ Précautions concernant le coussin gonflable SRS**

- Ne vous asseyez pas sur le bord du siège et ne vous appuyez pas contre le tableau de bord.

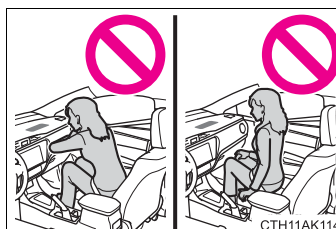

- Ne laissez pas un enfant se tenir debout devant le coussin gonflable passager avant SRS ou bien s'asseoir sur les genoux du passager avant.

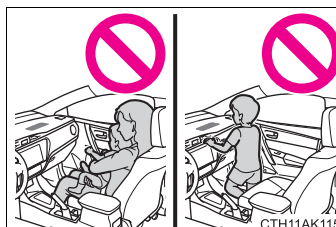

- Ne laissez pas les occupants du siège avant voyager avec un objet sur les genoux.

- Ne vous appuyez pas contre la porte, le rail latéral de toit ou contre les montants avant, latéraux et arrière.



- Ne laissez personne s'agenouiller sur les sièges passagers en appui contre la porte ou sortir la tête ou les mains à l'extérieur du véhicule.

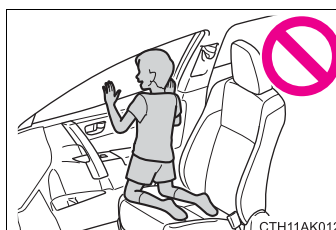

## ⚠ AVERTISSEMENT

### ■ Précautions concernant le coussin gonflable SRS

- Ne fixez ni ne posez aucun objet sur des emplacements tels que le tableau de bord, la garniture du volant de direction et la partie inférieure du tableau de bord.

Ces objets risquent de se transformer en projectile lorsque les coussins gonflables du conducteur, passager avant et genoux conducteur SRS se déclenchent.

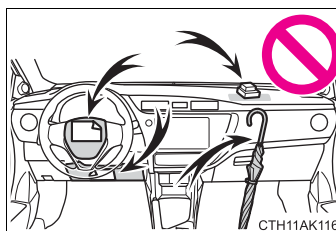

- Ne rien fixer aux emplacements tels que la porte, la vitre du pare-brise, la vitre latérale, au montant avant et arrière, au rail latéral de toit et à la poignée d'assistance.

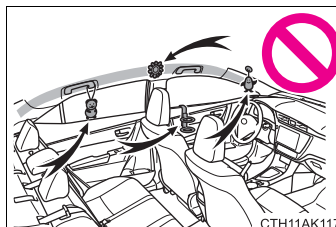

- Véhicules dépourvus du système d'accès et de démarrage "mains libres": Ne fixez pas d'objets lourds, pointus ou très durs, tels que des clés et des accessoires aux clés. Ces objets risquent d'entraver le déploiement du coussin gonflable de genoux du conducteur SRS ou d'être projetés vers l'emplacement du siège conducteur par la force de déploiement du coussin gonflable, constituant ainsi un danger potentiel.

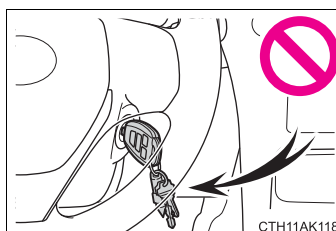

**⚠ AVERTISSEMENT****■ Précautions concernant le coussin gonflable SRS**

- Si un cache en plastique recouvre la partie où le coussin gonflable de genoux du conducteur SRS se déploie, veillez à le retirer.
- N'utilisez pas d'accessoires de siège venant recouvrir les zones de déploiement des coussins gonflables latéraux SRS et du coussin gonflable d'assise SRS, car ils risqueraient de gêner le déploiement des coussins gonflables SRS. De tels accessoires peuvent empêcher les coussins gonflables latéraux et le coussin gonflable d'assise de fonctionner correctement, désactiver le dispositif ou entraîner le déploiement accidentel des coussins gonflables latéraux et du coussin gonflable d'assise, entraînant la mort ou des blessures graves.
- Évitez de faire subir des chocs ou des pressions excessives aux zones renfermant les composants du coussin gonflable SRS.  
En effet, cela pourrait entraîner un dysfonctionnement des coussins gonflables SRS.
- Ne touchez aucun composant du système immédiatement après le déploiement (gonflage) des coussins gonflables SRS, car ils peuvent être très chauds.
- Si vous avez des difficultés à respirer après le déploiement des coussins gonflables SRS, ouvrez une porte ou une vitre pour faire entrer de l'air frais, ou bien descendez du véhicule si cela ne présente pas de danger. Essayez tout résidu dès que possible afin d'éviter d'éventuelles irritations cutanées.
- Si les parties renfermant les coussins gonflables SRS, telles que la garniture du moyeu de volant et les garnitures de montants avant et arrière, apparaissent abîmées ou craquelées, faites-les remplacer par votre concessionnaire Toyota.
- Ne placez rien sur le siège du passager avant, comme un coussin par exemple. Cela a pour conséquence de répartir le poids du passager, ce qui empêche le capteur de détecter correctement le poids du passager. En conséquence, les coussins gonflables avant SRS du passager avant risquent de ne pas se déployer en cas de collision.

 **AVERTISSEMENT****■ Modification et mise au rebut des éléments du système du coussin gonflables SRS**

Ne mettez pas votre véhicule au rebut et n'effectuez pas les modifications suivantes sans consulter votre concessionnaire Toyota. Les coussins gonflables SRS peuvent être défaillants ou se déployer (se gonfler) accidentellement, provoquant la mort ou de graves blessures.

- Installation, retrait, démontage et réparation des coussins gonflables SRS
- Réparations, modifications, retrait ou remplacement du volant, du tableau de bord, de la planche de bord, des sièges ou de leur garniture, des montants avant, latéraux et arrière ou des rails latéraux de toit
- Réparations ou modifications de l'aile avant, du pare-choc avant, ou des flancs de l'habitacle
- Installation d'un protège-calandre (pare-buffles, pare-kangourou, etc.), de chasse-neige, de treuils
- Modifications du système de suspension du véhicule
- Installation d'appareils électroniques, tels qu'une radio émetteur/récepteur et d'un lecteur CD
- Aménagements de votre véhicule pour une personne ayant un handicap physique

		589
<b>Index</b>		

What to do if... (Troubleshooting) .....	590
Alphabetical index .....	595

Vehicles with an Entune Premium Audio or Entune Audio Plus:  
 For details of equipment related to Entune Premium Audio or Entune Audio Plus, such as the audio system, refer to the “NAVIGATION AND MULTIMEDIA SYSTEM OWNER'S MANUAL”.

## What to do if... (Troubleshooting)

**If you have a problem, check the following before contacting your Toyota dealer.**

### The doors cannot be locked, unlocked, opened or closed



#### **You lose your keys**

- If you lose your keys or mechanical keys, new genuine keys or mechanical keys can be made by your Toyota dealer. (→P. 104)
- If you lose your keys or electronic keys, the risk of vehicle theft increases significantly. Contact your Toyota dealer immediately. (→P. 107)



#### **The doors cannot be locked or unlocked**

- Is the key battery weak or depleted? (→P. 455)
- Vehicles with a smart key system:  
Is the engine switch in IGNITION ON mode?  
When locking the doors, turn the engine switch off. (→P. 176)
- Vehicles with a smart key system:  
Is the electronic key left inside the vehicle?  
When locking the doors, make sure that you have the electronic key on your person.
- The function may not operate properly due to the condition of the radio wave. (→P. 125)



#### **The rear door cannot be opened**

- Is the child-protector lock set?  
The rear door cannot be opened from inside the vehicle when the lock is set. Open the rear door from outside and then unlock the child-protector lock. (→P. 112)



#### **The trunk lid is closed with the electronic key left inside (vehicles with a smart key system)**

- The function to prevent the electronic key from being left inside the trunk will operate and you can open the trunk as usual. Take the key out from the trunk. (→P. 119)

**If you think something is wrong****The engine does not start  
(vehicles without a smart key system)**

- Vehicles with a continuously variable transmission:  
Is the shift lever in P? (→P. 171)
- Vehicles with a manual transmission:  
Do you turn the key with the clutch pedal depressed firmly?  
(→P. 171)
- Is the steering wheel unlocked? (→P. 171)
- Is the battery discharged? (→P. 526)

**The engine does not start  
(vehicles with a smart key system)**

- Vehicles with a continuously variable transmission:  
Did you press the engine switch while firmly depressing the brake pedal?  
(→P. 174)
- Vehicles with a manual transmission:  
Did you press the engine switch while firmly depressing the clutch pedal?  
(→P. 174)
- Vehicles with a continuously variable transmission:  
Is the shift lever in P? (→P. 178)
- Is the electronic key anywhere detectable inside the vehicle?  
(→P. 123)
- Is the steering wheel unlocked? (→P. 178)
- Is the electronic key battery weak or depleted?  
In this case, the engine can be started in a temporary way.  
(→P. 524)
- Is the battery discharged? (→P. 526)



**The shift lever cannot be shifted from P even if you depress the brake pedal (vehicles with a continuously variable transmission)**

- Vehicles without a smart key system:  
Is the engine switch in the "ON" position?  
If you cannot release the shift lever by depressing the brake pedal with the engine switch in the "ON" position. (→P. 183, 188)
- Vehicles with a smart key system:  
Is the engine switch in IGNITION ON mode?  
If you cannot release the shift lever by depressing the brake pedal with the engine switch in IGNITION ON mode. (→P. 183, 188)



**The steering wheel cannot be turned after the engine is stopped**

- Vehicles without a smart key system:  
It is locked to prevent theft of the vehicle if the key is pulled from the engine switch. (→P. 172)
- Vehicles with a smart key system:  
It is locked automatically to prevent theft of the vehicle. (→P. 178)



**The windows do not open or close by operating the power window switches**

- Is the window lock switch pressed?  
The power window except for the one at the driver's seat cannot be operated if the window lock switch is pressed. (→P. 143)





### **The engine switch is turned off automatically (vehicles with a smart key system)**

- The auto power off function will be operated if the vehicle is left in ACCESSORY or IGNITION ON mode (the engine is not running) for a period of time. (→P. 177)



### **A warning buzzer sounds during driving**

- The seat belt reminder light is flashing  
Are the driver and the passenger wearing the seat belts? (→P. 481)
- The brake system warning light is on  
Is the parking brake released? (→P. 192)

Depending on the situation, other types of warning buzzer may also sound. (→P. 480, 489)



### **A warning buzzer sounds when leaving the vehicle (vehicles with a smart key system)**

- Is the electronic key left inside the vehicle?  
Check the message on the multi-information display. (→P. 489)



### **An alarm is activated and the horn sounds (vehicles with an alarm)**

- Did anyone inside the vehicle open a door during setting the alarm?  
The sensor detects it and the alarm sounds. (→P. 69)
  - ▶ Vehicles without a smart key system  
To stop the alarm, turn the engine switch to the "ON" position or start the engine.
  - ▶ Vehicles with a smart key system  
To stop the alarm, turn the engine switch to IGNITION ON mode or start the engine.



### **A warning light turns on or a warning message or indicator is displayed**

- When a warning light turns on or a warning message or indicator is displayed, refer to P. 480, 489.

### When a problem has occurred



#### **If you have a flat tire**

- Stop the vehicle in a safe place and replace the flat tire with the spare tire. (→P. 509)



#### **The vehicle becomes stuck**

- Try the procedure for when the vehicle becomes stuck in mud, dirt, or snow. (→P. 534)

## Alphabetical index

**A**

<b>A/C</b> .....	<b>366, 373</b>
Air conditioning filter .....	453
<b>ABS</b>	
<b>(Anti-lock Brake System)</b> .....	<b>257</b>
Function .....	257
Warning light.....	481
<b>Air conditioning filter</b> .....	<b>453</b>
<b>Air conditioning system</b> .....	<b>366, 373</b>
Air conditioning filter .....	453
<b>Airbags</b> .....	<b>34</b>
Airbag operating conditions ....	42
Airbag precautions for	
your child .....	37
Airbag warning light .....	480
Correct driving posture .....	26
Curtain shield airbag operating	
conditions .....	42
Curtain shield airbag	
precautions.....	40
General airbag precautions ....	37
Locations of airbags.....	34
Modification and	
disposal of airbags .....	41
Side airbag operating	
conditions .....	42
Side airbag precautions.....	37
Side and curtain shield airbags	
operating conditions .....	42
Side and curtain shield airbags	
precautions.....	37
SRS airbags.....	34
<b>Alarm</b> .....	<b>69</b>
<b>Anchor brackets</b> .....	<b>58</b>
<b>Antennas</b>	
<b>(smart key system)</b> .....	<b>122</b>

**Anti-lock Brake System**

<b>(ABS)</b> .....	<b>257</b>
Function.....	257
Warning light.....	481
<b>Assist grips</b> .....	<b>395</b>
<b>Audio input *</b> .....	<b>272</b>
<b>Automatic High Beam</b> .....	<b>198</b>
<b>Automatic light control system</b> .....	<b>193</b>
<b>AUX port*</b> .....	<b>272, 305</b>

**B**

<b>Back-up lights</b>	
Replacing light bulb .....	466
Wattage .....	547
<b>Battery</b> .....	<b>437</b>
Battery checking .....	437
If the vehicle has discharged	
battery .....	526
Preparing and checking	
before winter .....	263
Warning light.....	489
<b>Bluetooth®*</b>	
Entune Audio .....	320, 322
<b>Bottle holders</b> .....	<b>389</b>
<b>Brake</b>	
Fluid.....	545
Parking brake .....	192
Warning light.....	480
<b>Brake assist</b> .....	<b>257</b>
<b>Break-in tips</b> .....	<b>155</b>
<b>Brightness control</b>	
Instrument panel light	
control .....	79, 88

\*: For vehicles with an Entune Premium Audio or Entune Audio Plus, refer to the "NAVIGATION AND MULTIMEDIA SYSTEM OWNER'S MANUAL".

**C**

<b>Care</b> .....	<b>408, 411</b>
Aluminum wheels.....	409
Exterior .....	408
Interior.....	411
Seat belts.....	412
<b>Cargo capacity</b> .....	<b>166</b>
<b>CD player*</b> .....	<b>290</b>
<b>Chains</b> .....	<b>265</b>
<b>Child restraint system</b> .....	<b>54</b>
Booster seats, definition .....	55
Booster seats, installation.....	62
Convertible seats, definition .....	55
Convertible seats, installation .....	61
Infant seats, definition.....	55
Infant seats, installation .....	60
Installing CRS with LATCH anchors.....	59
Installing CRS with seat belts.....	60
Installing CRS with top tether strap .....	63

<b>Child safety</b> .....	<b>53</b>
Airbag precautions.....	37
Battery precautions.....	438, 530
Child restraint system .....	54
How your child should wear the seat belt.....	30
Installing child restraints .....	58
Moon roof precautions.....	150
Power window lock switch ....	143
Power window precautions... ..	146
Rear door child-protectors ....	112
Removed electronic key battery precautions.....	457
Seat belt extender precautions.....	33
Seat belt precautions.....	32
Seat heater precautions .....	383
Trunk precautions.....	120
<b>Child-protectors</b> .....	<b>112</b>
<b>Cleaning</b> .....	<b>408, 411</b>
Aluminum wheels .....	409
Exterior .....	408
Interior .....	411
Seat belts.....	412
<b>Clock</b> .....	<b>392</b>
<b>Compass</b> .....	<b>403</b>
<b>Condenser</b> .....	<b>435</b>
<b>Console box</b> .....	<b>388</b>
<b>Continuously variable transmission</b> .....	<b>181, 184</b>
If the shift lever cannot be shifted from P.....	183, 188
M mode.....	186
<b>Cooling system</b> .....	<b>433</b>
Engine overheating.....	531
<b>Cup holders</b> .....	<b>390</b>
<b>Curtain shield airbags</b> .....	<b>35</b>
<b>Customizable features</b> .....	<b>564</b>

**D**

<b>Daytime running light system</b> .....	<b>195</b>
<b>Defogger</b>	
Outside rear view mirrors .....	368, 376
Rear window .....	368, 376
<b>Dimensions</b> .....	<b>538</b>
<b>Dinghy towing</b> .....	<b>168, 169</b>
<b>Display</b>	
Multi-information display ...	77, 86
Trip information.....	80, 87
Warning message .....	489
<b>Do-it-yourself maintenance</b> ....	<b>422</b>
<b>Door lock</b>	
Doors .....	108
Key.....	109
Smart key system .....	108
Wireless remote control .....	108
<b>Doors</b> .....	<b>108</b>
Automatic door locking and unlocking systems .....	113
Door lock.....	111
Door windows .....	143
Open door warning buzzer ...	123
Outside rear view mirrors.....	141
Rear door child-protector .....	112
Warning message.....	489
<b>Driving</b> .....	<b>152</b>
Break-in tips .....	155
Correct posture .....	26
Procedures .....	152
Winter drive tips .....	263
<b>Dynamic radar cruise control</b> .....	<b>235</b>
Constant speed control mode .....	243
Vehicle-to-vehicle distance control mode.....	239

**E**

<b>Eco drive mode</b> .....	<b>182</b>
<b>Eco Driving Indicator</b> .....	<b>99</b>
<b>Electric Power Steering (EPS)</b> .....	<b>257</b>
Function.....	257
Warning light.....	481
<b>Electronic key</b> .....	<b>102</b>
Battery-saving function .....	124
If the electronic key does not operate properly .....	523
Replacing the battery.....	455
<b>Emergency, in case of</b>	
If a warning buzzer sounds.....	480
If a warning light turns on .....	480
If a warning message or indicator is displayed.....	489
If the battery is discharged ...	526
If the electronic key does not operate properly .....	523
If the engine will not start.....	521
If you have a flat tire .....	509
If you think something is wrong .....	478
If your vehicle becomes stuck.....	534
If your vehicle has to be stopped in an emergency... ..	471
If your vehicle needs to be towed.....	473
If your vehicle overheats.....	531

\*: For vehicles with an Entune Premium Audio or Entune Audio Plus, refer to the "NAVIGATION AND MULTIMEDIA SYSTEM OWNER'S MANUAL".

**Emergency flashers ..... 470**

**Engine..... 540**  
 ACCESSORY mode ..... 176  
 Compartment ..... 429  
 Engine switch..... 171, 174  
 Hood ..... 425  
 How to start the  
 engine..... 171, 174  
 Identification number ..... 539  
 If the engine will not start ..... 521  
 Ignition switch  
 (engine switch) ..... 171, 174  
 Overheating ..... 531

**Engine coolant..... 433**  
 Capacity..... 542  
 Checking..... 433  
 Preparing and checking  
 before winter..... 263

**Engine coolant temperature  
 gauge..... 77, 86**

**Engine immobilizer system ..... 67**

**Engine oil ..... 430**  
 Capacity..... 540  
 Checking..... 430  
 Preparing and checking  
 before winter..... 263

**Engine switch ..... 171, 174**

**Entune Audio ..... 273**  
 Audio input..... 272  
 AUX port/USB  
 port ..... 272  
 Bluetooth® audio..... 320  
 CD player..... 290  
 iPod..... 296  
 MP3/WMA disc ..... 290  
 Optimal use..... 287  
 Portable music player ..... 272  
 Radio ..... 288  
 Steering wheel audio  
 switch ..... 338  
 USB memory ..... 301

**Entune Audio Plus\***  
**Entune Premium Audio\***

**EPS**

**(Electric Power Steering) ..... 257**  
 Function..... 257  
 Warning light..... 481

**F****Flat tire**

Vehicles with a spare tire..... 509

**Floor mats ..... 24****Fluid**

Brake ..... 545  
 Continuously variable  
 transmission ..... 544  
 Washer ..... 439

**Front interior light ..... 385****Front passenger occupant  
classification system..... 47****Front seats ..... 130**

Adjustment..... 130  
 Cleaning ..... 411  
 Correct driving posture ..... 26  
 Head restraints ..... 134  
 Seat heaters ..... 383

**Front turn signal lights ..... 191**

Replacing light bulbs ..... 464  
 Turn signal lever ..... 191  
 Wattage ..... 547

**Fuel ..... 204**

Capacity..... 540  
 Fuel gauge..... 77, 86  
 Fuel pump shut off system ... 479  
 Information..... 548  
 Refueling ..... 204  
 Type..... 540, 548  
 Warning light..... 481

**Fuel filler door ..... 204**

Refueling ..... 204

**Fuel pump shut off system..... 479****Fuses ..... 458**

**G**

- Garage door opener ..... 396
- Gauges ..... 77, 86
- Glove box ..... 388

**H**

- Hands-free system  
(for cellular phone)\* ..... 306
- Head restraints ..... 134
- Headlights ..... 193
  - Light switch ..... 193
  - Wattage ..... 547
- Heaters
  - Heated steering wheel ..... 383
  - Outside rear view  
mirrors ..... 368, 376
  - Seat heaters ..... 383
- Hood ..... 425
- Hooks
  - Retaining hooks (floor mat).... 24
- Horn ..... 137

**I**

- I/M test ..... 421
- Identification ..... 538
  - Engine ..... 539
  - Vehicle ..... 538
- Ignition switch  
(engine switch)..... 171, 174
- Illuminated entry system ..... 386
- Immobilizer system ..... 67
- Indicators ..... 75
- Initialization
  - Moon roof ..... 149
  - Power windows..... 145
  - Tire pressure  
warning system ..... 441
- Inside rear view mirror..... 139
- Instrument panel light  
control..... 79, 88
- Interior lights ..... 384

\*: For vehicles with an Entune Premium Audio or Entune Audio Plus, refer to the "NAVIGATION AND MULTIMEDIA SYSTEM OWNER'S MANUAL".

**J**

**Jack**  
 Positioning the jack..... 427  
 Vehicle-equipped jack..... 510  
**Jack handle**..... **510**  
**Jam protection function**  
 Moon roof..... 148  
 Power window..... 144

**K**

**Keyless entry**  
 Smart key system ..... 108, 117  
 Wireless remote  
 control..... 108, 118  
**Keys**..... **102**  
 Battery-saving function ..... 124  
 Electronic key ..... 102  
 Engine switch..... 171, 174  
 If the electronic key does  
 not operate properly ..... 523  
 Key number plate..... 102  
 Keyless entry ..... 103  
 Mechanical key ..... 103  
 Replacing the battery..... 455  
 Warning buzzer..... 123  
 Wireless remote control ..... 103  
**Knee airbags**..... **34**

**L**

**LATCH anchors** ..... **59**  
**LDA (Lane Departure Alert with steering control)**..... **226**  
 Lane departure alert  
 function..... 226  
 Steering control function..... 227  
 Vehicle sway warning ..... 227  
**Lever**  
 Auxiliary catch lever..... 425  
 Hood lock  
 release lever..... 425  
 Shift lever..... 181, 184, 189  
 Turn signal lever ..... 191  
 Wiper lever ..... 202  
**License plate lights** ..... **193**  
 Light switch..... 193  
 Replacing light bulbs ..... 467  
 Wattage ..... 547  
**Light bulbs**  
 Replacing..... 461  
 Wattage ..... 547  
**Lights**  
 Front interior light ..... 385  
 Headlight switch ..... 193  
 Illuminated entry system..... 386  
 Interior lights list..... 384  
 Personal lights ..... 385  
 Rear interior light ..... 386  
 Replacing light bulbs ..... 461  
 Trunk light..... 119  
 Turn signal lever ..... 191  
 Vanity lights ..... 392  
 Wattage ..... 547  
**Lock steering column** ..... **172, 178**



**M**

<b>Maintenance</b>	
Do-it-yourself maintenance...	422
General maintenance .....	417
Maintenance data .....	538
Maintenance requirements .....	414
Resetting the reminder light or message indicating maintenance is required .....	415
<b>Malfunction indicator lamp</b> .....	<b>480</b>
<b>Manual air conditioning system</b> .....	<b>366</b>
<b>Manual transmission</b> .....	<b>189</b>
<b>Master warning light</b> .....	<b>481</b>
<b>Meter</b> .....	<b>77, 86</b>
Indicators .....	75
Meters.....	77, 86
Multi-information display ...	77, 86
Warning lights .....	73
<b>Mirrors</b>	
Inside rear view mirror .....	139
Outside rear view mirror defoggers .....	368, 376
Outside rear view mirrors.....	141
Vanity mirrors.....	392
<b>Mobile Assistant*</b> .....	<b>362</b>
<b>Moon roof</b> .....	<b>147</b>
Jam protection function.....	148
Operation .....	147
<b>MP3 disc *</b> .....	<b>290</b>
<b>Multi-information display</b> ....	<b>77, 86</b>
Customizing vehicle features .....	83, 93
Drive monitor .....	81, 92
Switching the display .....	77, 87
Trip information.....	80, 87
Warning message.....	489

**N**

<b>Noise from under vehicle</b> .....	<b>8</b>
---------------------------------------	----------

**O**

<b>Odometer</b> .....	<b>77, 86</b>
<b>Oil</b>	
Engine oil.....	540
<b>Opener</b>	
Hood .....	425
Trunk .....	117
<b>Outside rear view mirrors</b> .....	<b>141</b>
Adjusting and folding .....	141
Outside rear view mirror defoggers .....	368, 376
<b>Outside temperature display</b> .....	<b>393</b>
<b>Overheating, Engine</b> .....	<b>531</b>

\*: For vehicles with an Entune Premium Audio or Entune Audio Plus, refer to the "NAVIGATION AND MULTIMEDIA SYSTEM OWNER'S MANUAL".

**P**

**Paddle shift switches** ..... 186  
**Parking brake** ..... 192  
     Operation ..... 192  
     Parking brake engaged  
         warning buzzer ..... 490  
     Parking brake engaged  
         warning message ..... 490  
**Parking lights** ..... 193  
     Light switch ..... 193  
     Replacing light bulbs ..... 464  
     Wattage ..... 547  
**PCS (Pre-Collision System)** ..... 214  
     Pre-collision brake assist ..... 214  
     Pre-collision braking ..... 214  
     Pre-collision warning ..... 214  
**Personal lights** ..... 385  
**Power outlet** ..... 394  
**Power steering** ..... 257  
     Warning light ..... 481  
**Power windows** ..... 143  
     Jam protection function ..... 144  
     Operation ..... 143  
     Window lock switch ..... 143

**R**

**Radiator** ..... 435  
**Radio\*** ..... 288  
**Rear interior light** ..... 386  
**Rear seat**  
     Folding down ..... 132  
**Rear turn signal lights** ..... 191  
     Replacing light bulbs ..... 465  
     Turn signal lever ..... 191  
     Wattage ..... 547  
**Rear view mirror**  
     Inside rear view mirror ..... 139  
     Outside rear view mirrors ..... 141  
**Rear view monitor system** ..... 247  
**Rear window defogger** .... 368, 376  
**Refueling** ..... 204  
     Capacity ..... 540  
     Fuel types ..... 540, 548  
     Opening the fuel tank cap ..... 205  
**Replacing**  
     Electronic key battery ..... 455  
     Fuses ..... 458  
     Light bulbs ..... 461  
     Tires ..... 509  
**Reporting safety defects for U.S. owners** ..... 576  
**Resetting the reminder light or message indicating maintenance is required** ..... 415

**S**

<b>Seat belt reminder light</b> .....	<b>481</b>
<b>Seat belts</b> .....	<b>28</b>
Adjusting the seat belt .....	29
Automatic Locking	
Retractor (ALR) .....	30
Child restraint system	
installation .....	60
Cleaning and maintaining	
the seat belt .....	412
Emergency Locking Retractor	
(ELR) .....	30
How to wear your seat belt .....	28
How your child should wear	
the seat belt .....	30
Pregnant women, proper	
seat belt use .....	31
Reminder light and buzzer .....	481
Seat belt extender .....	30
Seat belt pretensioners .....	29
SRS warning light .....	480
<b>Seat heaters</b> .....	<b>383</b>
<b>Seats</b> .....	<b>130</b>
Adjustment .....	130
Adjustment precautions .....	131
Child seats/child restraint	
system installation .....	58
Cleaning .....	411
Head restraints .....	134
Properly sitting in the seat .....	26
Seat heaters .....	383

**Sensor**

Automatic headlight	
system .....	195
Camera sensor .....	209
Inside rear view mirror .....	140
Radar sensor .....	209
<b>Shift lever</b> .....	<b>181, 184, 189</b>
Continuously variable	
transmission .....	181, 184
If the shift lever cannot	
be shifted from P .....	183, 188
Manual transmission .....	189
<b>Shift lock system</b> .....	<b>182, 187</b>
<b>Side airbags</b> .....	<b>35</b>
<b>Side marker lights</b> .....	<b>193</b>
Light switch .....	193
Replacing light bulbs .....	463, 465
Wattage .....	547
<b>Side mirrors</b> .....	<b>141</b>
Adjusting and folding .....	141
<b>Side turn signal lights</b> .....	<b>191</b>
Replacing light bulbs .....	468
Turn signal lever .....	191
Wattage .....	547
<b>Smart key system</b> .....	<b>122</b>
Antenna location .....	122
Entry functions .....	108, 117
Starting the engine .....	174
<b>Snow tires</b> .....	<b>266</b>
<b>Spare tire</b> .....	<b>509</b>
Inflation pressure .....	546
Storage location .....	510
<b>Spark plug</b> .....	<b>542</b>
<b>Specifications</b> .....	<b>538</b>

\*: For vehicles with an Entune Premium Audio or Entune Audio Plus, refer to the "NAVIGATION AND MULTIMEDIA SYSTEM OWNER'S MANUAL".

- Speedometer**..... 77, 86
- Steering lock**  
 Column lock release ..... 172, 178  
 Steering lock system warning  
 message..... 504
- Steering wheel** ..... 137  
 Adjustment..... 137  
 Audio switches\* ..... 271  
 Heated steering wheel ..... 383
- Stop lights**  
 Replacing light bulbs..... 465
- Storage feature** ..... 387
- Stuck**  
 If the vehicle becomes  
 stuck..... 534
- Sun shade**  
 Roof ..... 148
- Sun visors** ..... 392
- Switches**  
 Audio remote control  
 switches\* ..... 271  
 Compass switch..... 403  
 "DISP" switch..... 81  
 Door lock switches..... 111  
 Dynamic radar cruise  
 control switch..... 235  
 "ECO MODE" switch..... 182  
 Emergency flashers  
 switch ..... 470  
 Engine switch..... 171, 174
- Garage door opener  
 switches ..... 396
- Heated steering  
 wheel switch..... 383
- Ignition switch..... 171, 174
- LDA (Lane Departure  
 Alert with steering  
 control) switch ..... 229
- Light switches ..... 193
- Meter control switches..... 91
- Moon roof switches..... 147
- Outside rear view mirror  
 switches ..... 141
- Paddle shift switches ..... 186
- Power door lock switch..... 111
- Power window switches..... 143
- Rear window and outside  
 rear view mirror  
 defoggers switch ..... 368, 376
- Seat heater switches ..... 383
- Sport mode switch ..... 185
- Talk switch\* ..... 359
- Telephone switches\* ..... 338
- Tire pressure warning reset  
 switch ..... 442
- "TRIP" switch ..... 87
- Vehicle-to-vehicle  
 distance switch..... 235
- VSC OFF switch ..... 258
- Window lock switch ..... 143
- Windshield wiper and  
 washer switch..... 202

**T**

<b>Tachometer</b> .....	<b>77, 86</b>
<b>Tail lights</b> .....	<b>193</b>
Light switch .....	193
Replacing light bulbs .....	465
Wattage .....	547
<b>Talk switch*</b> .....	<b>359</b>
<b>Telephone switches*</b> .....	<b>338</b>
<b>Theft deterrent system</b>	
Alarm .....	69
Engine immobilizer system .....	67
<b>Tire inflation pressure</b> .....	<b>448</b>
Maintenance data .....	546
Warning light .....	482
<b>Tire information</b> .....	<b>551</b>
Glossary .....	558
Size .....	554
Tire identification number .....	553
Uniform Tire Quality Grading .....	556
<b>Tire pressure warning system</b> .....	<b>441</b>
Function .....	441
Initializing .....	441
Installing tire pressure warning valves and transmitters .....	441
Registering ID codes .....	443
Tire pressure warning reset switch .....	442
Warning light .....	482

<b>Tires</b> .....	<b>440</b>
Chains .....	265
Checking .....	440
If you have a flat tire .....	509
Inflation pressure .....	546
Replacing .....	509
Rotating tires .....	440
Size .....	546
Snow tires .....	266
Spare tire .....	509
Tire pressure warning system .....	441
Warning light .....	482
<b>Tools</b> .....	<b>510</b>
<b>Top tether strap</b> .....	<b>63</b>
<b>Total load capacity</b> .....	<b>166</b>
<b>Towing</b>	
Dinghy towing .....	168, 169
Emergency towing .....	473
Towing eyelet .....	473
Trailer towing .....	167
<b>Toyota Safety Sense P</b> .....	<b>207</b>
Automatic High Beam .....	198
Dynamic radar cruise control .....	235
LDA (Lane Departure Alert with steering control) .....	226
PCS (Pre-Collision System) .....	214

\*: For vehicles with an Entune Premium Audio or Entune Audio Plus, refer to the "NAVIGATION AND MULTIMEDIA SYSTEM OWNER'S MANUAL".

**TRAC (Traction Control) ..... 257**  
**Traction Control**  
 (TRAC)..... 257  
**Transmission ..... 181, 184, 189**  
**Trip information ..... 80, 87**  
**Trip meters ..... 77, 86**  
**Trunk..... 117**  
 Internal trunk release lever ... 119  
 Smart key system ..... 117  
 Trunk light ..... 119  
 Trunk opener ..... 117  
 Wireless remote control ..... 118  
**Trunk light**  
 Trunk light ..... 119  
 Wattage ..... 547  
**Turn signal lights..... 191**  
 Replacing light bulbs.... 464, 465  
 Turn signal lever ..... 191  
 Wattage ..... 547

**U**

**USB port\* ..... 272**

**V**

**Vanity lights ..... 392**  
 Wattage ..... 547  
**Vanity mirrors ..... 392**  
**Vehicle data recording ..... 9**  
**Vehicle identification**  
 number ..... 538  
**Vehicle Stability Control**  
 (VSC) ..... 257  
**Voice command system\* ..... 359**  
**VSC**  
 (Vehicle Stability Control) .... 257

**W**

**Warning buzzers**  
 Brake system..... 480  
 Downshifting ..... 187  
 Electric power steering ..... 481  
 Key reminder ..... 172, 499  
 Open door..... 490  
 Open moon roof..... 496  
 Open trunk..... 490  
 Seat belt reminder ..... 481  
**Warning lights ..... 73**  
 ABS ..... 481  
 Brake system..... 480  
 Electric power steering ..... 481  
 LDA (Lane Departure Alert  
 with steering control)  
 indicator..... 482  
 Low fuel level..... 481  
 Malfunction indicator lamp .... 480  
 Master warning light ..... 481  
 PCS ..... 482  
 Seat belt reminder light..... 481  
 Slip indicator ..... 481  
 SRS ..... 480  
 Tire pressure ..... 482

<b>Warning messages</b> .....	<b>489</b>
<b>Washer</b> .....	<b>202</b>
Checking.....	439
Preparing and checking	
before winter.....	263
Switch .....	202
<b>Washing and waxing</b> .....	<b>408</b>
<b>Weight</b> .....	<b>538</b>
<b>Wheels</b> .....	<b>451</b>
Replacing.....	451
Size.....	546
<b>Window glasses</b> .....	<b>143</b>
<b>Window lock switch</b> .....	<b>143</b>
<b>Windows</b> .....	<b>143</b>
Power windows.....	143
Rear window	
defogger .....	368, 376
<b>Windshield wiper</b>	
<b>de-icer</b> .....	<b>376</b>
<b>Windshield wipers</b> .....	<b>202</b>
Intermittent wiper .....	202
<b>Winter driving tips</b> .....	<b>263</b>
<b>Wireless remote control</b> .....	<b>103</b>
Battery-Saving Function .....	124
Locking/Unlocking.....	108, 118
Replacing the battery.....	455
<b>WMA disc*</b> .....	<b>290</b>

\*: For vehicles with an Entune Premium Audio or Entune Audio Plus, refer to the "NAVIGATION AND MULTIMEDIA SYSTEM OWNER'S MANUAL".

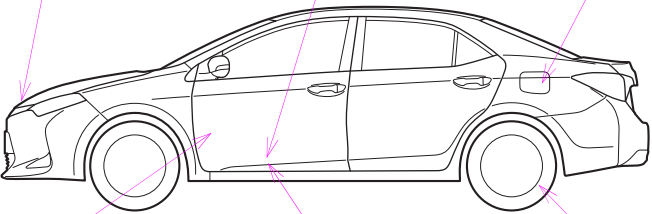
GAS STATION INFORMATION		
Auxiliary catch lever	Trunk opener	Fuel filler door
P. 425	P. 117	P. 204
		
Hood lock release lever	Fuel filler door opener	Tire inflation pressure
P. 425	P. 204	P. 546
Fuel tank capacity (Reference)	13.2 gal. (50 L, 10.9 Imp. gal.)	
Fuel type	P. 540, 548	
Cold tire inflation pressure	P. 546	
Engine oil capacity (Drain and refill — reference)	P. 540	
Engine oil type	"Toyota Genuine Motor Oil" or equivalent P. 540	