

## Pictorial index

Search by illustration

1

### For safety and security

Make sure to read through them

2

### Instrument cluster

How to read the gauges and meters, the variety of warning lights and indicators, etc.

3

### Operation of each component

Opening and closing the doors and windows, adjustment before driving, etc.

4

### Driving

Operations and advice which are necessary for driving

5

### Interior features

Usage of the interior features, etc.

6

### Maintenance and care

Caring for your vehicle and maintenance procedures

7

### When trouble arises

What to do in case of malfunction or emergency

8

### Vehicle specifications

Vehicle specifications, customizable features, etc.

9

### For owners

Reporting safety defects for U.S. owners

## Index

Search by symptom

Search alphabetically

For your information.....	8
Reading this manual .....	14
How to search.....	15
Pictorial index .....	16

## 1 For safety and security

### 1-1. For safe use

Before driving .....	26
For safety drive .....	28
Seat belts .....	30
SRS airbags .....	36
Front passenger occupant classification system .....	48
Safety information for children .....	54
Child restraint systems.....	55
Installing child restraints.....	59
Exhaust gas precautions .....	69

### 1-2. Hybrid system

Hybrid system features .....	70
Hybrid system precautions .....	74

### 1-3. Theft deterrent system

Immobilizer system .....	79
Alarm.....	81
Theft prevention labels.....	83

## 2 Instrument cluster

### 2. Instrument cluster

Warning lights and indicators .....	86
Gauges and meters .....	90
Multi-information display.....	94
Energy monitor/ consumption screen .....	100

## 3 Operation of each component

### 3-1. Key information

Keys.....	106
-----------	-----

### 3-2. Opening, closing and locking the doors and trunk

Doors .....	110
Trunk .....	116
Smart key system .....	121

### 3-3. Adjusting the seats

Front seats.....	131
Driving position memory .....	133
Head restraints .....	138

### 3-4. Adjusting the steering wheel and mirrors

Steering wheel.....	141
Inside rear view mirror .....	143
Outside rear view mirrors .....	145

### 3-5. Opening, closing the windows and moon roof

Power windows.....	148
Moon roof .....	151

## 4 Driving

### 4-1. Before driving

Driving the vehicle .....	156
Cargo and luggage .....	166
Vehicle load limits .....	169
Trailer towing .....	170
Dinghy towing .....	171

### 4-2. Driving procedures

Power (ignition) switch .....	172
EV drive mode .....	178
Hybrid transmission .....	180
Turn signal lever .....	184
Parking brake .....	185

### 4-3. Operating the lights and wipers

Headlight switch .....	186
Automatic High Beam .....	189
Windshield wipers and washer .....	193

### 4-4. Refueling

Opening the fuel tank cap .....	198
---------------------------------	-----

### 4-5. Using the driving support systems

Toyota Safety Sense P .....	202
PCS (Pre-Collision System) .....	209
LDA (Lane Departure Alert with steering control) .....	222
Dynamic radar cruise control .....	233
Cruise control .....	246
BSM (Blind Spot Monitor) .....	250
• The Blind Spot Monitor function .....	252
• The Rear Cross Traffic Alert function detection areas .....	257
Driving mode select switch .....	259
Driving assist systems .....	261

### 4-6. Driving tips

Hybrid vehicle driving tips .....	266
Winter driving tips .....	269

1

2

3

4

5

6

7

8

9

## 5 Interior features

### 5-1. Using the air conditioning system and defogger

Automatic air conditioning system.....	274
Seat heaters/seat ventilators.....	283

### 5-2. Using the interior lights

Interior lights list .....	286
• Personal/interior light main switch .....	287
• Personal/interior lights .....	287
• Ambient lights .....	288

### 5-3. Using the storage features

List of storage features.....	289
• Glove box.....	290
• Console box.....	291
• Cup holders .....	292
• Auxiliary boxes.....	293
Trunk features .....	297

### 5-4. Other interior features

Other interior features.....	299
• Sun visors .....	299
• Vanity mirrors .....	299
• Clock .....	300
• Outside temperature display .....	301
• Power outlets .....	302
• Armrest.....	304
• Rear sunshade.....	304
• Coat hooks .....	306
• Assist grips .....	306
Garage door opener .....	307
Safety Connect.....	314
Compass .....	320

## 6 Maintenance and care

### 6-1. Maintenance and care

- Cleaning and protecting the vehicle exterior ..... 326
- Cleaning and protecting the vehicle interior ..... 329

### 6-2. Maintenance

- Maintenance requirements ..... 332
- General maintenance ..... 334
- Emission inspection and maintenance (I/M) programs ..... 338

### 6-3. Do-it-yourself maintenance

- Do-it-yourself service precautions ..... 339
- Hood ..... 341
- Positioning a floor jack ..... 342
- Engine compartment ..... 343
- 12-volt battery ..... 352
- Tires ..... 356
- Tire inflation pressure ..... 365
- Wheels ..... 368
- Air conditioning filter ..... 371
- Electronic key battery ..... 373
- Checking and replacing fuses ..... 375
- Light bulbs ..... 378

## 7 When trouble arises

### 7-1. Essential information

- Emergency flashers ..... 392
- If your vehicle has to be stopped in an emergency ..... 393

### 7-2. Steps to take in an emergency

- If your vehicle needs to be towed ..... 394
- If you think something is wrong ..... 397
- If a warning light turns on or a warning buzzer sounds ..... 398
- If a warning message is displayed ..... 407
- If you have a flat tire ..... 408
- If the hybrid system will not start ..... 420
- If the electronic key does not operate properly ..... 422
- If the 12-volt battery is discharged ..... 424
- If your vehicle overheats ..... 429
- If the vehicle becomes stuck ..... 433

1

2

3

4

5

6

7

8

9

## 8 Vehicle specifications

### 8-1. Specifications

Maintenance data (fuel, oil level, etc.) .....	436
Fuel information .....	445
Tire information .....	448

### 8-2. Customization

Customizable features .....	461
-----------------------------	-----

### 8-3. Items to initialize

Items to initialize.....	468
--------------------------	-----

## 9 For owners

Reporting safety defects for U.S. owners.....	470
--	-----

## Index

What to do if... (Troubleshooting).....	472
Alphabetical index.....	476

For vehicles with a audio/navigation system, refer to the “NAVIGATION AND MULTIMEDIA SYSTEM OWNER’S MANUAL” for information regarding the audio/navigation system.



## For your information

### **Main Owner's Manual**

Please note that this manual applies to all models and explains all equipment, including options. Therefore, you may find some explanations for equipment not installed on your vehicle.

All specifications provided in this manual are current at the time of printing. However, because of the Toyota policy of continual product improvement, we reserve the right to make changes at any time without notice.

Depending on specifications, the vehicle shown in the illustrations may differ from your vehicle in terms of color and equipment.

### **Noise from under vehicle after turning off the hybrid system**

Approximately five hours after the hybrid system is turned off, you may hear sound coming from under the vehicle for several minutes. This is the sound of a fuel evaporation leakage check and, it does not indicate a malfunction.

### **Accessories, spare parts and modification of your Toyota**

A wide variety of non-genuine spare parts and accessories for Toyota vehicles are currently available in the market. You should know that Toyota does not warrant these products and is not responsible for their performance, repair, or replacement, or for any damage they may cause to, or adverse effect they may have on, your Toyota vehicle.

This vehicle should not be modified with non-genuine Toyota products. Modification with non-genuine Toyota products could affect its performance, safety or durability, and may even violate governmental regulations. In addition, damage or performance problems resulting from the modification may not be covered under warranty.



## Installation of a mobile two-way radio system

The installation of a mobile two-way radio system in your vehicle could affect electronic systems such as:

- Multiport fuel injection system/sequential multiport fuel injection system
- Dynamic radar cruise control system (if equipped)
- Cruise control system (if equipped)
- Anti-lock brake system
- SRS airbag system
- Seat belt pretensioner system

Be sure to check with your Toyota dealer for precautionary measures or special instructions regarding installation of a mobile two-way radio system.

High voltage parts and cables on the hybrid vehicles emit approximately the same amount of electromagnetic waves as the conventional gasoline powered vehicles or home electronic appliances despite of their electromagnetic shielding.

Unwanted noise may occur in the reception of the mobile two-way radio.

## Vehicle data recordings

Your Toyota is equipped with several sophisticated computers that will record certain data, such as:

- Engine speed
- Electric motor speed (traction motor speed)
- Accelerator status
- Brake status
- Vehicle speed
- Shift position
- Hybrid battery (traction battery) status

The recorded data varies according to the vehicle grade level and options with which it is equipped. These computers do not record conversations or sounds, and only record images outside of the vehicle in certain situations.

### ● Data Transmission

Your vehicle may transmit the data recorded in these computers to Toyota without notification to you.

### ● Data usage

Toyota may use the data recorded in these computers to diagnose malfunctions, conduct research and development, and improve quality.

Toyota will not disclose the recorded data to a third party except:

- With the consent of the vehicle owner or with the consent of the lessee if the vehicle is leased
- In response to an official request by the police, a court of law or a government agency
- For use by Toyota in a law suit
- For research purposes where the data is not tied to a specific vehicle or vehicle owner

### ● Usage of data collected through Safety Connect (U.S. mainland only)

If your Toyota has Safety Connect and if you have subscribed to those services, please refer to the Safety Connect Telematics Subscription Service Agreement for information on data collected and its usage.

- To learn more about the vehicle data collected, used and shared by Toyota, please visit [www.toyota.com/privacyvts/](http://www.toyota.com/privacyvts/).

## Event data recorder

This vehicle is equipped with an event data recorder (EDR). The main purpose of an EDR is to record, in certain crash or near crash-like situations, such as an air bag deployment or hitting a road obstacle, data that will assist in understanding how a vehicle's systems performed. The EDR is designed to record data related to vehicle dynamics and safety systems for a short period of time, typically 30 seconds or less.

The EDR in this vehicle is designed to record such data as:

- How various systems in your vehicle were operating;
- Whether or not the driver and passenger safety belts were buckled/fastened;
- How far (if at all) the driver was depressing the accelerator and/or brake pedal; and,
- How fast the vehicle was traveling.

These data can help provide a better understanding of the circumstances in which crashes and injuries occur.

NOTE: EDR data are recorded by your vehicle only if a non-trivial crash situation occurs; no data are recorded by the EDR under normal driving conditions and no personal data (e.g., name, gender, age, and crash location) are recorded. However, other parties, such as law enforcement, could combine the EDR data with the type of personally identifying data routinely acquired during a crash investigation.

To read data recorded by an EDR, special equipment is required, and access to the vehicle or the EDR is needed. In addition to the vehicle manufacturer, other parties, such as law enforcement, that have the special equipment, can read the information if they have access to the vehicle or the EDR.

### ● Disclosure of the EDR data

Toyota will not disclose the data recorded in an EDR to a third party except when:

- An agreement from the vehicle's owner (or the lessee for a leased vehicle) is obtained
- In response to an official request by the police, a court of law or a government agency
- For use by Toyota in a lawsuit

However, if necessary, Toyota may:

- Use the data for research on vehicle safety performance
- Disclose the data to a third party for research purposes without disclosing information about the specific vehicle or vehicle owner

## Scrapping of your Toyota

The SRS airbag and seat belt pretensioner devices in your Toyota contain explosive chemicals. If the vehicle is scrapped with the airbags and seat belt pretensioners left as they are, this may cause an accident such as fire. Be sure to have the systems of the SRS airbag and seat belt pretensioner removed and disposed of by a qualified service shop or by your Toyota dealer before you scrap your vehicle.

## Perchlorate Material

Special handling may apply, See [www.dtsc.ca.gov/hazardouswaste/perchlorate](http://www.dtsc.ca.gov/hazardouswaste/perchlorate). Your vehicle has components that may contain perchlorate. These components may include airbag, seat belt pretensioners, and wireless remote control batteries.

### WARNING

#### ■ General precautions while driving

**Driving under the influence:** Never drive your vehicle when under the influence of alcohol or drugs that have impaired your ability to operate your vehicle. Alcohol and certain drugs delay reaction time, impair judgment and reduce coordination, which could lead to an accident that could result in death or serious injury.

**Defensive driving:** Always drive defensively. Anticipate mistakes that other drivers or pedestrians might make and be ready to avoid accidents.

**Driver distraction:** Always give your full attention to driving. Anything that distracts the driver, such as adjusting controls, talking on a cellular phone or reading can result in a collision with resulting death or serious injury to you, your occupants or others.

#### ■ General precaution regarding children's safety

Never leave children unattended in the vehicle, and never allow children to have or use the key.

Children may be able to start the vehicle or shift the vehicle into neutral. There is also a danger that children may injure themselves by playing with the windows, the moon roof, or other features of the vehicle. In addition, heat build-up or extremely cold temperatures inside the vehicle can be fatal to children.

**WARNING****■ Hybrid battery (traction battery)**

Never resell, hand over or modify the hybrid battery. To prevent accidents, hybrid batteries that have been removed from a disposed vehicle are collected through Toyota dealers. Do not dispose of the battery yourself.

Unless the battery is properly collected, the following may occur, resulting in death or serious injury:

- The hybrid battery may be illegally disposed of or dumped, and someone may touch a high voltage part, resulting in an electric shock.
- The hybrid battery is intended to be used exclusively with your hybrid vehicle. If the hybrid battery is used outside of your vehicle or modified in any way, accidents such as electric shock, heat generation, smoke generation, an explosion and electrolyte leakage may occur.

When reselling or handing over your vehicle, the possibility of an accident is extremely high because the person receiving the vehicle may not be aware of these dangers.

**■ Disposal of the hybrid battery (traction battery)**

If your vehicle is disposed of without the hybrid battery having been removed, there is a danger of serious electric shock if high voltage parts, cables and their connectors are touched. In the event that your vehicle must be disposed of, the hybrid battery must be disposed of by your Toyota dealer or a qualified service shop. If the hybrid battery is not disposed of properly, it may cause electric shock that can result in death or serious injury.

## Reading this manual



### WARNING:

Explains something that, if not obeyed, could cause death or serious injury to people.



### NOTICE:

Explains something that, if not obeyed, could cause damage to or a malfunction in the vehicle or its equipment.



Indicates operating or working procedures. Follow the steps in numerical order.



Indicates the action (pushing, turning, etc.) used to operate switches and other devices.



Indicates the outcome of an operation (e.g. a lid opens).

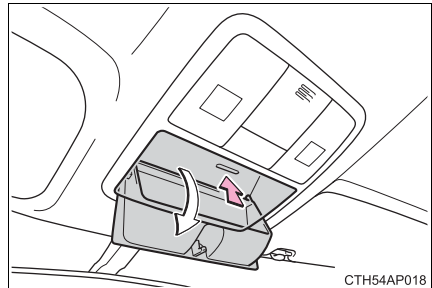

Indicates the component or position being explained.



Means “Do not”, “Do not do this”, or “Do not let this happen”.

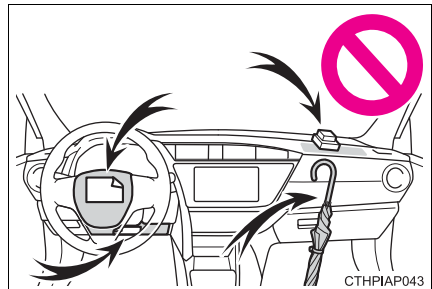

## How to search

### ■ Searching by name

- Alphabetical index.....P. 476

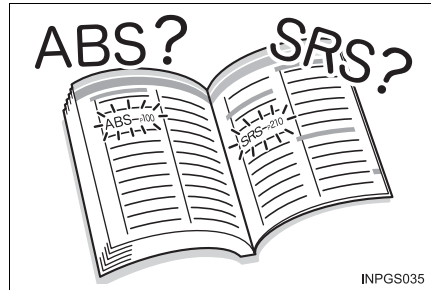

### ■ Searching by installation position

- Pictorial index.....P. 16



### ■ Searching by symptom or sound

- What to do if...  
(Troubleshooting).....P. 472



### ■ Searching by title

- Table of contents.....P. 2

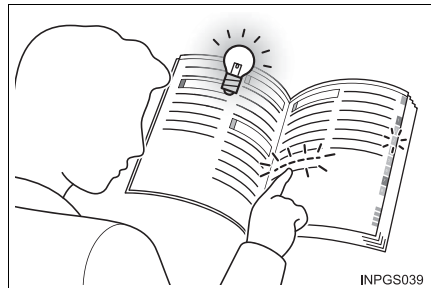

# Pictorial index

## Exterior

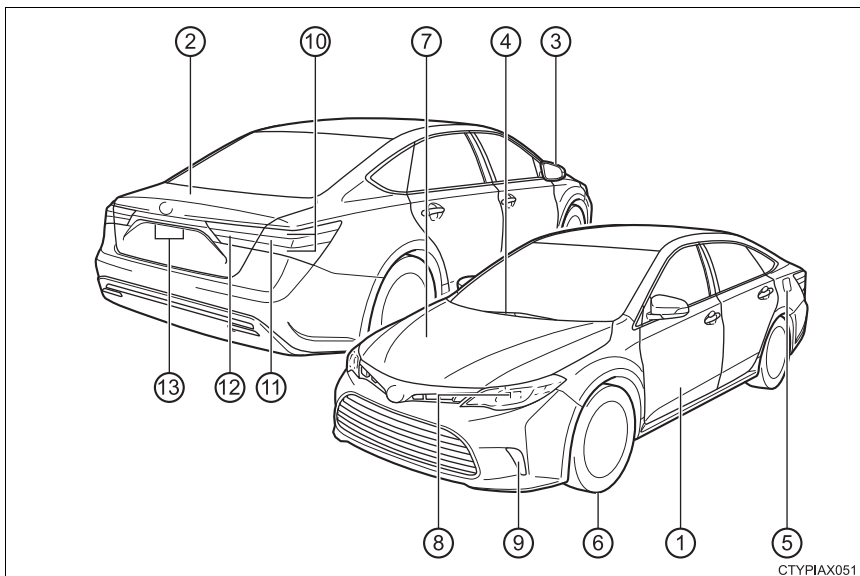

CTYPIAX051

- ① **Doors** ..... **P. 110**
  - Locking/unlocking ..... P. 110
  - Opening/closing the door glasses ..... P. 148
  - Locking/unlocking by using the mechanical key ..... P. 422
  - Warning lights/warning messages ..... P. 401, 407
- ② **Trunk** ..... **P. 116**
  - Opening from inside the cabin ..... P. 116
  - Opening from outside ..... P. 116
  - Warning lights/warning messages ..... P. 401, 407
- ③ **Outside rear view mirrors** ..... **P. 145**
  - Adjusting the mirror angle ..... P. 145
  - Folding the mirrors ..... P. 145
  - Driving position memory ..... P. 133
  - Defogging the mirrors ..... P. 278



- ④ **Windshield wipers** . . . . . **P. 193**  
     Precautions against winter season . . . . . P. 269  
     Precautions against car wash . . . . . P. 327
- ⑤ **Fuel filler door** . . . . . **P. 198**  
     Refueling method . . . . . P. 198  
     Fuel type/fuel tank capacity . . . . . P. 438
- ⑥ **Tires** . . . . . **P. 356**  
     Tire size/inflation pressure . . . . . P. 443  
     Winter tires/tire chain . . . . . P. 269  
     Checking/rotation/tire pressure warning system . . . . . P. 356  
     Coping with flat tires . . . . . P. 408
- ⑦ **Hood** . . . . . **P. 341**  
     Opening . . . . . P. 341  
     Engine oil . . . . . P. 439  
     Coping with overheat . . . . . P. 429

### Light bulbs of the exterior lights for driving

(Replacing method: P. 378, Wattages: P. 444)

- ⑧ **Headlights/side marker lights/  
daytime running lights** . . . . . **P. 186**
- ⑨ **Front turn signal/parking lights** . . . . . **P. 184**
- ⑩ **Stop/tail lights** . . . . . **P. 186**
- ⑪ **Rear turn signal lights** . . . . . **P. 184**
- ⑫ **Back-up lights**  
     Shifting the shift lever to R. . . . . P. 180
- ⑬ **License plate lights** . . . . . **P. 186**

## Instrument panel

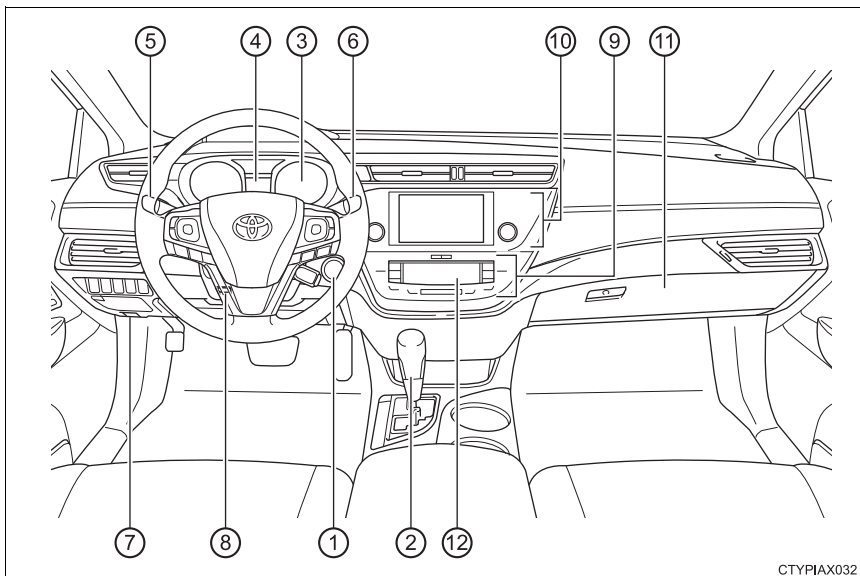

CTYPIAX032

- |   |  |               |
|---|--|---------------|
| ① | <b>Power switch</b> .....                                    | <b>P. 172</b> |
|   | Starting the hybrid system/changing the modes .....          | P. 172        |
|   | Emergency stop of the hybrid system .....                    | P. 393        |
|   | When the hybrid system will not start .....                  | P. 420        |
| ② | <b>Shift lever</b> .....                                     | <b>P. 180</b> |
|   | Changing the shift position .....                            | P. 180        |
|   | When the shift lever does not move .....                     | P. 182        |
| ③ | <b>Meters</b> .....  | <b>P. 90</b>  |
|   | Reading the meters/adjusting the instrument panel light..... | P. 90         |
|   | Warning lights/indicator lights .....                        | P. 86         |
|   | When the warning lights come on .....                        | P. 398        |

④	<b>Multi-information display</b> .....	<b>P. 94</b>
	Display .....	P. 94
	Energy monitor .....	P. 100
	When the warning messages are displayed .....	P. 407
⑤	<b>Turn signal lever</b> .....	<b>P. 184</b>
	Headlight switch .....	P. 186
	Headlights/parking lights/tail lights/daytime running lights. . . .	P. 186
⑥	<b>Windshield wiper and washer switch</b> .....	<b>P. 193</b>
	Usage .....	P. 193
	Adding washer fluid .....	P. 351
⑦	<b>Hood lock release lever</b> .....	<b>P. 341</b>
⑧	<b>Tilt and telescopic steering lock release lever</b> .....	<b>P. 141</b>
⑨	<b>Air conditioning system</b> .....	<b>P. 274</b>
	Usage .....	P. 274
	Rear window defogger .....	P. 278
⑩	<b>Audio/Navigation system*</b>	
⑪	<b>Glove box</b> .....	<b>P. 290</b>
⑫	<b>Clock</b> .....	<b>P. 300</b>

\*: Refer to "NAVIGATION AND MULTIMEDIA SYSTEM OWNER'S MANUAL".

**Switches**

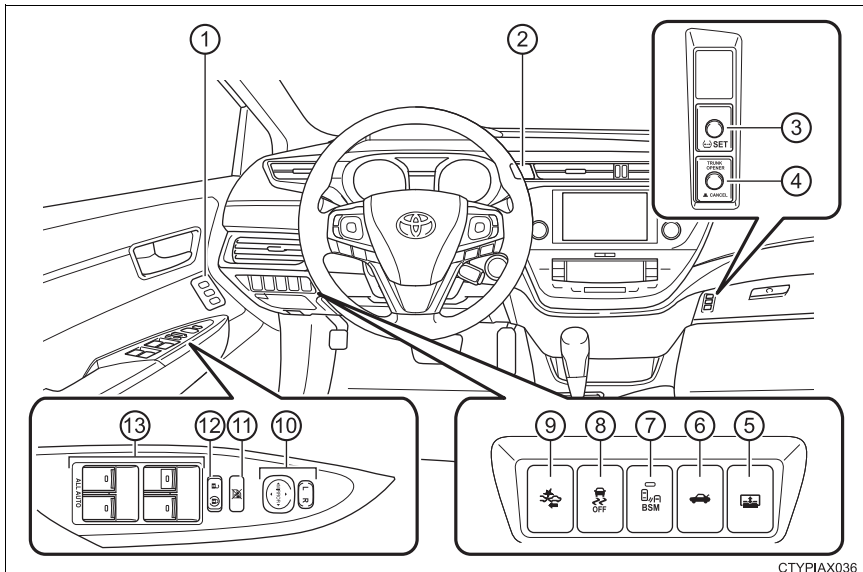

CTYPIAX036

- ① **Driving position memory switches\*1** ..... P. 133
- ② **Emergency flasher switch** ..... P. 392
- ③ **Tire pressure warning reset switch**..... P. 358
- ④ **Trunk opener main switch** ..... P. 117
- ⑤ **Rear sunshade switch\*1** ..... P. 304
- ⑥ **Trunk opener** ..... P. 116
- ⑦ **BSM (Blind Spot Monitor) main switch\*1** ..... P. 250
- ⑧ **VSC OFF switch** ..... P. 262
- ⑨ **PCS (Pre-Collision System) switch\*1** ..... P. 209
- ⑩ **Outside rear view mirror switches**..... P. 145
- ⑪ **Window lock switch**..... P. 148
- ⑫ **Door lock switches** ..... P. 112
- ⑬ **Power window switches** ..... P. 148

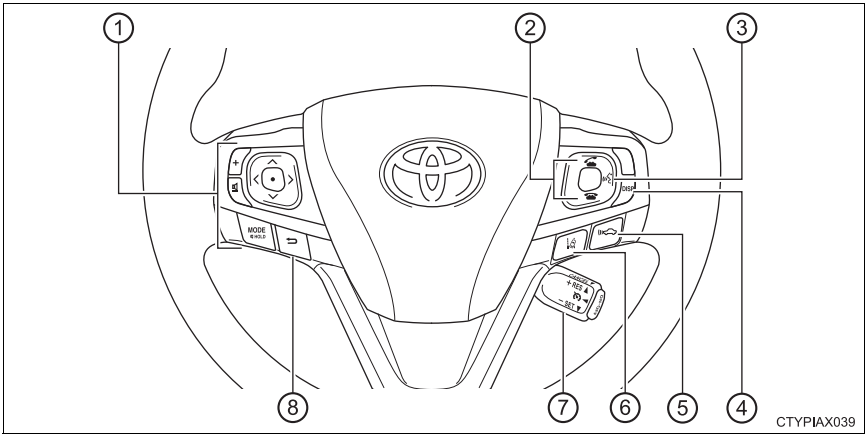

CTYPIAX039

- ① **Audio remote control switches\*2**
- ② **Telephone switches\*2**
- ③ **Talk switch\*2**
- ④ **“DISP” button** ..... P. 95
- ⑤ **Vehicle-to-vehicle distance button\*1** ..... P. 233
- ⑥ **LDA (Lane Departure Alert with steering control) switch\*1** ..... P. 222
- ⑦ **Cruise control switch**  
 Cruise control\*1 ..... P. 246  
 Dynamic radar cruise control\*1 ..... P. 233
- ⑧ **Back switch\*2**

\*1: If equipped

\*2: Refer to “NAVIGATION AND MULTIMEDIA SYSTEM OWNER’S MANUAL”.

## Interior

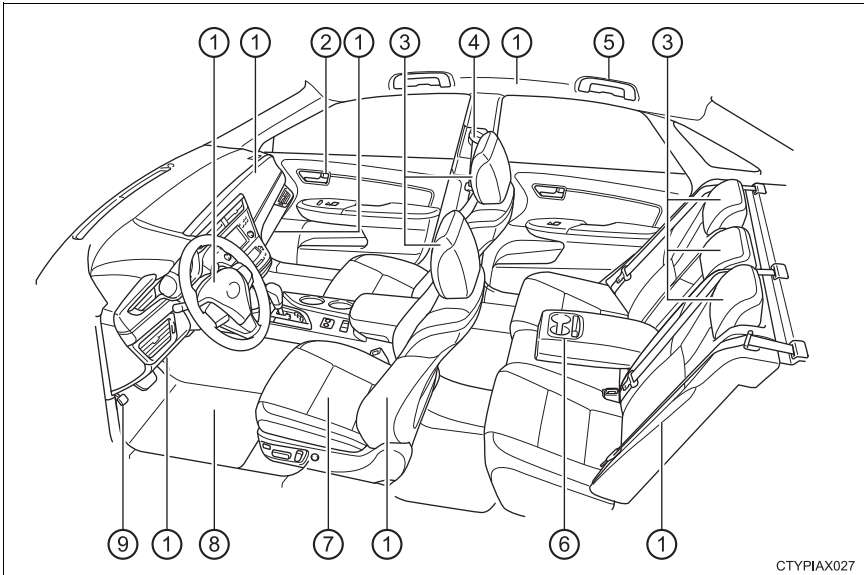

CTYPIAX027

- |   |   |                    |
|---|---|--------------------|
| ① | <b>SRS airbags</b> .....                | <b>P. 36</b>       |
| ② | <b>Inside lock buttons</b> .....        | <b>P. 112</b>      |
| ③ | <b>Head restraints</b> .....            | <b>P. 138</b>      |
| ④ | <b>Seat belts</b> .....                 | <b>P. 30</b>       |
| ⑤ | <b>Assist grips</b> .....               | <b>P. 306</b>      |
| ⑥ | <b>Armrest</b> .....                    | <b>P. 304</b>      |
|   | <b>Cup holders</b> .....                | <b>P. 292</b>      |
|   | <b>Power outlet*1</b> .....             | <b>P. 302</b>      |
| ⑦ | <b>Front seats</b> .....                | <b>P. 131</b>      |
| ⑧ | <b>Floor mat</b> .....                  | <b>P. 26</b>       |
| ⑨ | <b>Parking brake</b> .....              | <b>P. 185</b>      |
|   | Applying/releasing .....                | <b>P. 185</b>      |
|   | Precautions against winter season ..... | <b>P. 270</b>      |
|   | Warning buzzer/message .....            | <b>P. 398, 407</b> |

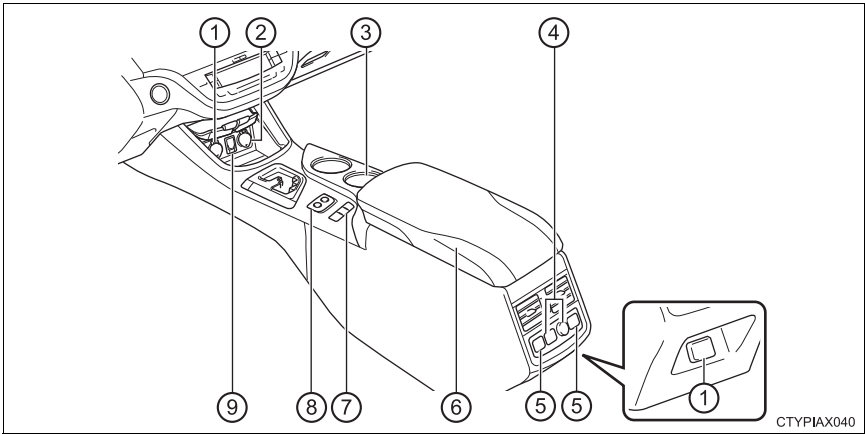

- ① **Power outlets** ..... P. 302
- ② **Power outlet\*1** ..... P. 302  
**Wireless charger switch\*1** ..... P. 294
- ③ **Cup holders** ..... P. 292
- ④ **Air conditioning controls\*1** ..... P. 274
- ⑤ **Rear seat heater switches\*1** ..... P. 283
- ⑥ **Console box** ..... P. 291
- ⑦ **Driving mode select switch** ..... P. 259
- ⑧ **Seat heater/ventilator switches\*1** ..... P. 283
- ⑨ **AUX/USB port\*2**

\*1: If equipped

\*2: Refer to "NAVIGATION AND MULTIMEDIA SYSTEM OWNER'S MANUAL".

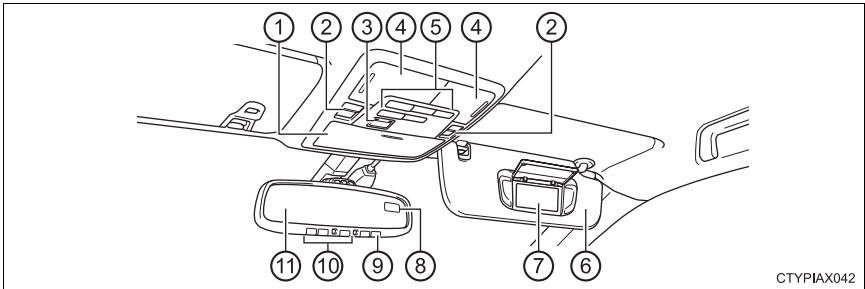

CTYPIAX042

- |   |  |               |
|---|--|---------------|
| ① | <b>Auxiliary box</b> .....                             | <b>P. 293</b> |
| ② | <b>Moon roof switches</b> *1 .....                     | <b>P. 151</b> |
| ③ | <b>“SOS” button</b> *1 .....                           | <b>P. 314</b> |
| ④ | <b>Interior lights/personal lights</b> *2 .....        | <b>P. 287</b> |
| ⑤ | <b>Interior light/ambient lights</b> *1 switches ..... | <b>P. 287</b> |
| ⑥ | <b>Sun visors</b> .....                                | <b>P. 299</b> |
| ⑦ | <b>Vanity mirrors</b> .....                            | <b>P. 299</b> |
| ⑧ | <b>Compass display</b> *1 .....                        | <b>P. 320</b> |
| ⑨ | <b>Compass switch</b> *1 .....                         | <b>P. 320</b> |
| ⑩ | <b>Garage door opener switches</b> *1 .....            | <b>P. 307</b> |
| ⑪ | <b>Inside rear view mirror</b> .....                   | <b>P. 143</b> |

\*1: If equipped

\*2: The illustration shows the front, but they are also equipped in the rear.



<b>1-1. For safe use</b>	
Before driving .....	26
For safety drive .....	28
Seat belts .....	30
SRS airbags.....	36
Front passenger occupant classification system .....	48
Safety information for children .....	54
Child restraint systems.....	55
Installing child restraints.....	59
Exhaust gas precautions .....	69
<b>1-2. Hybrid system</b>	
Hybrid system features .....	70
Hybrid system precautions .....	74
<b>1-3. Theft deterrent system</b>	
Immobilizer system .....	79
Alarm.....	81
Theft prevention labels.....	83

## Before driving

### Floor mat

Use only floor mats designed specifically for vehicles of the same model and model year as your vehicle. Fix them securely in place onto the carpet.

- 1 Insert the retaining hooks (clips) into the floor mat eyelets.

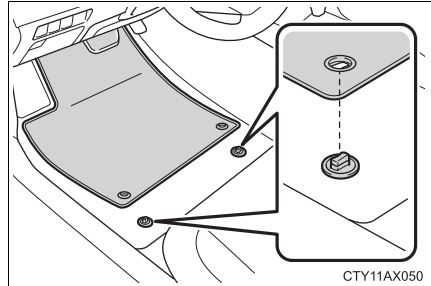

- 2 Turn the upper knob of each retaining hook (clip) to secure the floor mats in place.

\*: Always align the  $\triangle$  marks.

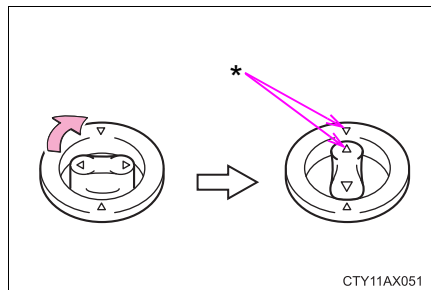

The shape of the retaining hooks (clips) may differ from that shown in the illustration.

**! WARNING**

Observe the following precautions.

Failure to do so may cause the driver's floor mat to slip, possibly interfering with the pedals while driving. An unexpectedly high speed may result or it may become difficult to stop the vehicle. This could lead to an accident, resulting in death or serious injury.

**■ When installing the driver's floor mat**

- Do not use floor mats designed for other models or different model year vehicles, even if they are Toyota Genuine floor mats.
- Only use floor mats designed for the driver's seat.
- Always install the floor mat securely using the retaining hooks (clips) provided.
- Do not use two or more floor mats on top of each other.
- Do not place the floor mat bottom-side up or upside-down.

**■ Before driving**

- Check that the floor mat is securely fixed in the correct place with all the provided retaining hooks (clips). Be especially careful to perform this check after cleaning the floor.
- With the hybrid system stopped and the shift lever in P, fully depress each pedal to the floor to make sure it does not interfere with the floor mat.

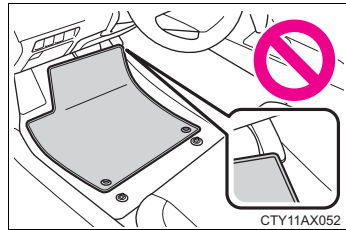

## For safety drive

**For safe driving, adjust the seat and mirror to an appropriate position before driving.**

### Correct driving posture

- ① Adjust the angle of the seat-back so that you are sitting straight up and so that you do not have to lean forward to steer. (→P. 131)
- ② Adjust the seat so that you can depress the pedals fully and so that your arms bend slightly at the elbow when gripping the steering wheel. (→P. 131)
- ③ Adjust the tilt and telescopic positions of the steering wheel downward so the airbag is facing your chest. (→P. 141)
- ④ Lock the head restraint in place with the center of the head restraint closest to the top of your ears. (→P. 138)
- ⑤ Wear the seat belt correctly. (→P. 30)

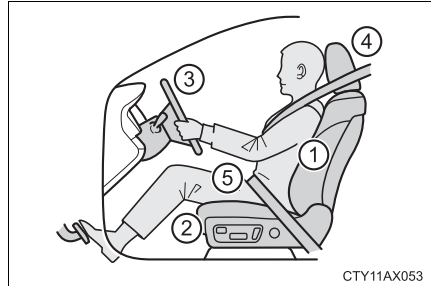

### Correct use of the seat belts

Make sure that all occupants are wearing their seat belts before driving the vehicle. (→P. 30)

Use a child restraint system appropriate for the child until the child becomes large enough to properly wear the vehicle's seat belt. (→P. 55)

## Adjusting the mirrors

Make sure that you can see backward clearly by adjusting the inside and outside rear view mirrors properly. (→P. 143, 145)

### WARNING

Observe the following precautions.

Failure to do so may result in death or serious injury.

- Do not adjust the position of the driver's seat while driving.  
Doing so could cause the driver to lose control of the vehicle.
- Do not place a cushion between the driver or passenger and the seatback.  
A cushion may prevent correct posture from being achieved, and reduce the effectiveness of the seat belt and head restraint.
- Do not place anything under the front seats.  
Objects placed under the front seats may become jammed in the seat tracks and stop the seat from locking in place. This may lead to an accident and the adjustment mechanism may also be damaged.
- Always observe the legal speed limit when driving on public roads.
- When driving over long distances, take regular breaks before you start to feel tired.  
Also, if you feel tired or sleepy while driving, do not force yourself to continue driving and take a break immediately.

## Seat belts

**Make sure that all occupants are wearing their seat belts before driving the vehicle.**

### Correct use of the seat belts

- Extend the shoulder belt so that it comes fully over the shoulder, but does not come into contact with the neck or slide off the shoulder.
- Position the lap belt as low as possible over the hips.
- Adjust the position of the seat-back. Sit up straight and well back in the seat.
- Do not twist the seat belt.

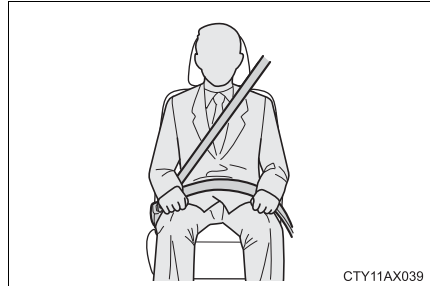

### Fastening and releasing the seat belt

- ① To fasten the seat belt, push the plate into the buckle until a click sound is heard.
- ② To release the seat belt, press the release button.

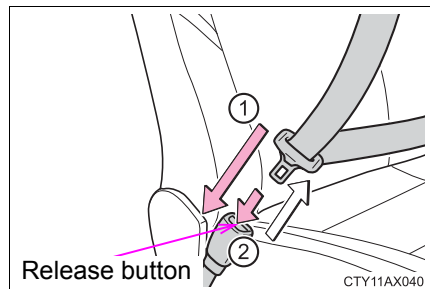

## Adjusting the seat belt shoulder anchor height (front seats)

- ① Push the seat belt shoulder anchor down while pressing the release button.
- ② Push the seat belt shoulder anchor up.

Move the height adjuster up and down as needed until you hear a click.

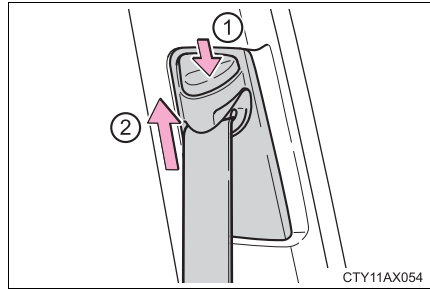

## Seat belt pretensioners (front seats)

The pretensioners help the seat belts to quickly restrain the occupants by retracting the seat belts when the vehicle is subjected to certain types of severe frontal or side collision or a vehicle rollover.

The pretensioners do not activate in the event of a minor frontal impact, a minor side impact or a rear impact.

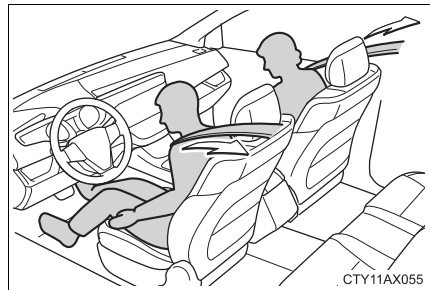

### ■ Emergency locking retractor (ELR)

The retractor will lock the belt during a sudden stop or on impact. It may also lock if you lean forward too quickly. A slow, easy motion will allow the belt to extend so that you can move around fully.

### ■ Automatic locking retractor (ALR)

When a passenger's shoulder belt is completely extended and then retracted even slightly, the belt is locked in that position and cannot be extended. This feature is used to hold the child restraint system (CRS) firmly. To free the belt again, fully retract the belt and then pull the belt out once more. (→P. 59)

### ■ Child seat belt usage

The seat belts of your vehicle were principally designed for persons of adult size.

- Use a child restraint system appropriate for the child, until the child becomes large enough to properly wear the vehicle's seat belt. (→P. 55)
- When the child becomes large enough to properly wear the vehicle's seat belt, follow the instructions regarding seat belt usage. (→P. 30)

### ■ Replacing the belt after the pretensioner has been activated

If the vehicle is involved in multiple collisions, the pretensioner will activate for the first collision, but will not activate for the second or subsequent collisions.

### ■ Seat belt extender

If your seat belts cannot be fastened securely because they are not long enough, a personalized seat belt extender is available from your Toyota dealer free of charge.

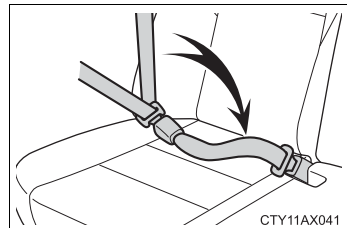



## WARNING

Observe the following precautions to reduce the risk of injury in the event of sudden braking, sudden swerving or an accident. Failure to do so may cause death or serious injury.

### ■ Wearing a seat belt

- Ensure that all passengers wear a seat belt.
- Always wear a seat belt properly.
- Each seat belt should be used by one person only. Do not use a seat belt for more than one person at once, including children.
- Toyota recommends that children be seated in the rear seat and always use a seat belt and/or an appropriate child restraint system.
- To achieve a proper seating position, do not recline the seat more than necessary. The seat belt is most effective when the occupants are sitting up straight and well back in the seats.
- Do not wear the shoulder belt under your arm.
- Always wear your seat belt low and snug across your hips.

### ■ Pregnant women

Obtain medical advice and wear the seat belt in the proper way. (→P. 30)

Women who are pregnant should position the lap belt as low as possible over the hips in the same manner as other occupants, extending the shoulder belt completely over the shoulder and avoiding belt contact with the rounding of the abdominal area.

If the seat belt is not worn properly, not only the pregnant woman, but also the fetus could suffer death or serious injury as a result of sudden braking or a collision.

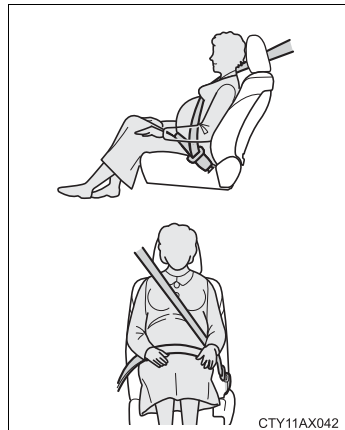

CTY11AX042

**WARNING****■ People suffering illness**

Obtain medical advice and wear the seat belt in the proper way. (→P. 30)

**■ When children are in the vehicle**

Do not allow children to play with the seat belt. If the seat belt becomes twisted around a child's neck, it may lead to choking or other serious injuries that could result in death.

If this occurs and the buckle cannot be unfastened, scissors should be used to cut the belt.

**■ Seat belt pretensioners (front seats)**

● Do not place anything, such as a cushion, on the front passenger's seat. Doing so will disperse the passenger's weight, which prevents the sensor from detecting the passenger's weight properly. As a result, the seat belt pretensioner for the front passenger's seat may not activate in the event of a collision.

● If the pretensioner has activated, the SRS warning light will come on. In that case, the seat belt cannot be used again and must be replaced at your Toyota dealer.

**■ Adjustable shoulder anchor (front seats)**

Always make sure the shoulder belt is positioned across the center of your shoulder. The belt should be kept away from your neck, but not falling off your shoulder. Failure to do so could reduce the amount of protection in an accident and cause death or serious injuries in the event of a sudden stop, sudden swerve or accident. (→P. 31)

**WARNING****■ Seat belt damage and wear**

- Do not damage the seat belts by allowing the belt, plate, or buckle to be jammed in the door.
- Inspect the seat belt system periodically. Check for cuts, fraying, and loose parts. Do not use a damaged seat belt until it is replaced. Damaged seat belts cannot protect an occupant from death or serious injury.
- Ensure that the belt and plate are locked and the belt is not twisted. If the seat belt does not function correctly, immediately contact your Toyota dealer.
- Replace the seat assembly, including the belts, if your vehicle has been involved in a serious accident, even if there is no obvious damage.
- Do not attempt to install, remove, modify, disassemble or dispose of the seat belts. Have any necessary repairs carried out by your Toyota dealer. Inappropriate handling may lead to incorrect operation.

**■ Using a seat belt extender**

- Do not wear the seat belt extender if you can fasten the seat belt without the extender.
- Do not use the seat belt extender when installing a child restraint system because the belt will not securely hold the child restraint system, increasing the risk of death or serious injury in the event of an accident.
- The personalized extender may not be safe on another vehicle, when used by another person, or at a different seating position other than the one originally intended.

**NOTICE****■ When using a seat belt extender**

When releasing the seat belt, press on the buckle release button on the extender, not on the seat belt.

This helps prevent damage to the vehicle interior and the extender itself.

## SRS airbags

The SRS airbags inflate when the vehicle is subjected to certain types of severe impacts that may cause significant injury to the occupants. They work together with the seat belts to help reduce the risk of death or serious injury.

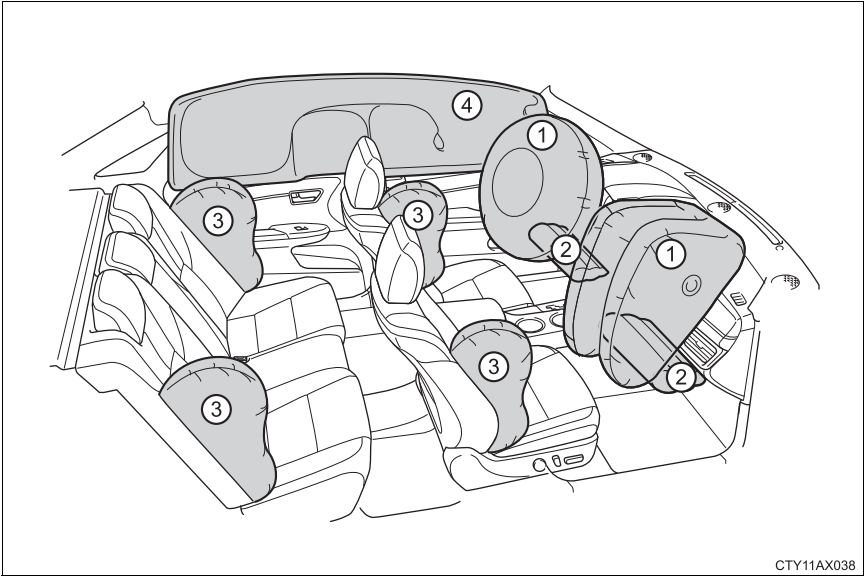

CTY11AX038

### ◆ SRS front airbags

---

- ① SRS driver airbag/front passenger airbag  
Can help protect the head and chest of the driver and front passenger from impact with interior components
- ② SRS knee airbags  
Can help provide driver and front passenger protection

### ◆ SRS side and curtain shield airbags

---

- ③ SRS front side airbags  
Can help protect the torso of the front seat occupants  
SRS rear side airbags  
Can help protect the torso of occupants in the rear outer seats
- ④ SRS curtain shield airbags
  - Can help protect primarily the head of occupants in the outer seats
  - Can help prevent the occupants from being thrown from the vehicle in the event of vehicle rollover

## SRS airbag system components

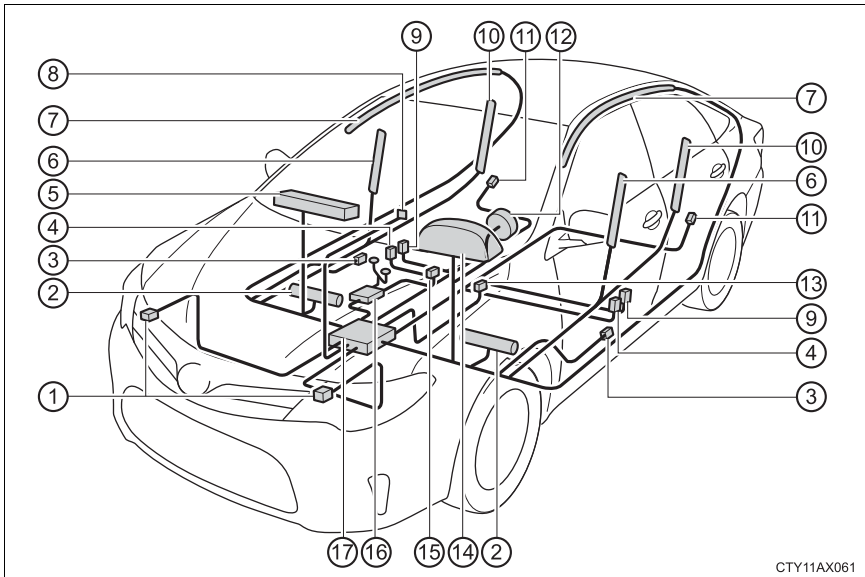

CTY11AX061

- |   |  |
|---|--|
| ① Front impact sensors                            | ⑩ Rear side airbags  |
| ② Knee airbags                                    | ⑪ Side impact sensors (rear)                                       |
| ③ Side impact sensors (front doors)               | ⑫ Driver airbag  |
| ④ Seat belt pretensioners and force limiters      | ⑬ Driver's seat belt buckle switch                                 |
| ⑤ Front passenger airbag                          | ⑭ SRS warning light  |
| ⑥ Front side airbags                              | ⑮ Front passenger's seat belt buckle switch                        |
| ⑦ Curtain shield airbags                          | ⑯ Front passenger occupant classification system (ECU and sensors) |
| ⑧ "AIR BAG ON" and "AIR BAG OFF" indicator lights | ⑰ Airbag sensor assembly   |
| ⑨ Side impact sensors (front)                     |  |

Your vehicle is equipped with ADVANCED AIRBAGS designed based on the US motor vehicle safety standards (FMVSS208). The airbag sensor assembly (ECU) controls airbag deployment based on information obtained from the sensors etc. shown in the system components diagram above. This information includes crash severity and occupant information. As the airbags deploy, a chemical reaction in the inflators quickly fills the airbags with non-toxic gas to help restrain the motion of the occupants.

 **WARNING**

■ **SRS airbag precautions**

Observe the following precautions regarding the SRS airbags. Failure to do so may cause death or serious injury.

- The driver and all passengers in the vehicle must wear their seat belts properly.

The SRS airbags are supplemental devices to be used with the seat belts.

- The SRS driver airbag deploys with considerable force, and can cause death or serious injury especially if the driver is very close to the airbag. The National Highway Traffic Safety Administration (NHTSA) advises:

Since the risk zone for the driver's airbag is the first 2 - 3 in. (50 - 75 mm) of inflation, placing yourself 10 in. (250 mm) from your driver airbag provides you with a clear margin of safety. This distance is measured from the center of the steering wheel to your breastbone. If you sit less than 10 in. (250 mm) away now, you can change your driving position in several ways:

- Move your seat to the rear as far as you can while still reaching the pedals comfortably.
- Slightly recline the back of the seat.  
Although vehicle designs vary, many drivers can achieve the 10 in. (250 mm) distance, even with the driver seat all the way forward, simply by reclining the back of the seat somewhat. If reclining the back of your seat makes it hard to see the road, raise yourself by using a firm, non-slippery cushion, or raise the seat if your vehicle has that feature.
- If your steering wheel is adjustable, tilt it downward. This points the airbag toward your chest instead of your head and neck.

The seat should be adjusted as recommended by NHTSA above, while still maintaining control of the foot pedals, steering wheel, and your view of the instrument panel controls.

**⚠ WARNING****■ SRS airbag precautions**

● If the seat belt extender has been connected to the front seat belt buckles but the seat belt extender has not also been fastened to the latch plate of the seat belt, the SRS front airbags will judge that the driver and front passenger are wearing the seat belt even though the seat belt has not been connected. In this case, the SRS front airbags may not activate correctly in a collision, resulting in death or serious injury in the event of a collision. Be sure to wear the seat belt with the seat belt extender.

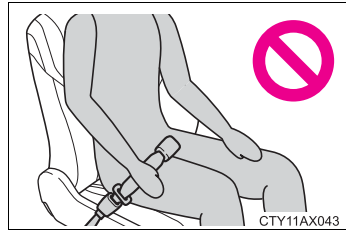

● The SRS front passenger airbag also deploys with considerable force, and can cause death or serious injury especially if the front passenger is very close to the airbag. The front passenger seat should be as far from the airbag as possible with the seatback adjusted, so the front passenger sits upright.

● Improperly seated and/or restrained infants and children can be killed or seriously injured by a deploying airbag. An infant or child who is too small to use a seat belt should be properly secured using a child restraint system. Toyota strongly recommends that all infants and children be placed in the rear seats of the vehicle and properly restrained. The rear seats are safer for infants and children than the front passenger seat. (→P. 55)

● Do not sit on the edge of the seat or lean against the dashboard.

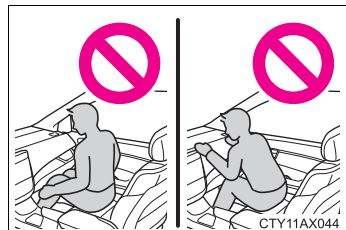



**! WARNING**

**■ SRS airbag precautions**

- Do not allow a child to stand in front of the SRS front passenger airbag unit or sit on the knees of a front passenger.
- Do not allow the front seat occupants to hold items on their knees.

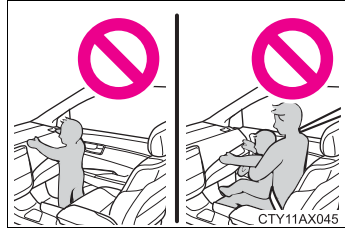

- Do not lean against the door, the roof side rail or the front, side and rear pillars.



- Do not allow anyone to kneel on the passenger seats toward the door or put their head or hands outside the vehicle.



- Do not attach anything to or lean anything against areas such as the dashboard, steering wheel pad and lower portion of the instrument panel. These items can become projectiles when the SRS driver, front passenger and knee airbags deploy.

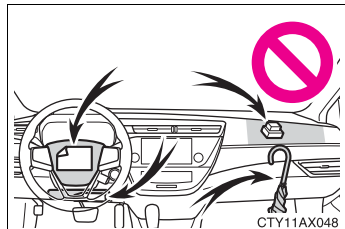

**! WARNING****■ SRS airbag precautions**

- Do not attach anything to areas such as a door, windshield glass, side door glass, front or rear pillar, roof side rail and assist grip.

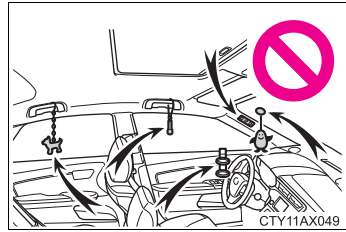

- Do not hang coat hangers or hard objects on the coat hooks. All of these items could become projectiles and may cause death or serious injury, should the SRS curtain shield airbags deploy.
- If a vinyl cover is put on the area where the SRS knee airbag will deploy, be sure to remove it.
- Do not use seat accessories which cover the parts where the SRS side airbags inflate as they may interfere with inflation of the airbags. Such accessories may prevent the side airbags from activating correctly, disable the system or cause the side airbags to inflate accidentally, resulting in death or serious injury.
- Do not strike or apply significant levels of force to the area of the SRS airbag components.  
Doing so can cause the SRS airbags to malfunction.
- Do not touch any of the component parts immediately after the SRS airbags have deployed (inflated) as they may be hot.
- If breathing becomes difficult after the SRS airbags have deployed, open a door or window to allow fresh air in, or leave the vehicle if it is safe to do so. Wash off any residue as soon as possible to prevent skin irritation.
- If the areas where the SRS airbags are stored, such as the steering wheel pad, and front and rear pillar garnishes are damaged or cracked, have them replaced by your Toyota dealer.
- Do not place anything, such as a cushion, on the front passenger's seat. Doing so will disperse the passenger's weight, which prevents the sensor from detecting the passenger's weight properly. As a result, the SRS front airbags for the front passenger may not deploy in the event of a collision.

**WARNING****■ Modification and disposal of SRS airbag system components**

Do not dispose of your vehicle or perform any of the following modifications without consulting your Toyota dealer. The SRS airbags may malfunction or deploy (inflate) accidentally, causing death or serious injury.

- Installation, removal, disassembly and repair of the SRS airbags
- Repairs, modifications, removal or replacement of the steering wheel, instrument panel, dashboard, seats or seat upholstery, front, side and rear pillars or roof side rails
- Repairs or modifications of the front fender, front bumper, or side of the occupant compartment
- Installation of a grille guard (bull bars, kangaroo bar, etc.), snow plows, winches, or roof luggage carrier
- Modifications to the vehicle's suspension system
- Installation of electronic devices such as mobile two-way radios and CD players
- Modifications to your vehicle for a person with a physical disability

**■ If the SRS airbags deploy (inflate)**

- Slight abrasions, burns, bruising etc., may be sustained from SRS airbags, due to the extremely high speed deployment (inflation) by hot gases.
- A loud noise and white powder will be emitted.
- Parts of the airbag module (steering wheel hub, airbag cover and inflator) as well as the seats, parts of the front and rear pillars, and roof side rails may be hot for several minutes. The airbag itself may also be hot.
- The windshield may crack.
- For Safety Connect subscribers, if the SRS airbags deploy or in the event of a severe rear-end collision, the system is designed to send an emergency call to the response center, notifying them of the vehicle's location (without needing to push the "SOS" button) and an agent will attempt to speak with the occupants to ascertain the level of emergency and assistance required. If the occupants are unable to communicate, the agent automatically treats the call as an emergency and helps to dispatch the necessary emergency services. (→P. 314)

**■ SRS airbag deployment conditions (SRS front airbags)**

- The SRS front airbags will deploy in the event of an impact that exceeds the set threshold level (the level of force corresponding to an approximately 12 - 18 mph [20 - 30 km/h] frontal collision with a fixed wall that does not move or deform).

However, this threshold velocity will be considerably higher in the following situations:

- If the vehicle strikes an object, such as a parked vehicle or sign pole, which can move or deform on impact
  - If the vehicle is involved in an underride collision, such as a collision in which the front of the vehicle “underrides”, or goes under, the bed of a truck
- Depending on the type of collision, it is possible that only the seat belt pretensioners will activate.
  - The SRS front airbags for the front passenger will not activate if there is no passenger sitting in the front passenger seat. However, the SRS front airbags for the front passenger may deploy if luggage is put in the seat, even if the seat is unoccupied. (→P. 48)

**■ SRS airbag deployment conditions (SRS side and curtain shield airbags)**

- The SRS side and curtain shield airbags will deploy in the event of an impact that exceeds the set threshold level (the level of force corresponding to the impact force produced by an approximately 3300 lb. [1500 kg] vehicle colliding with the vehicle cabin from a direction perpendicular to the vehicle orientation at an approximate speed of 12 - 18 mph [20 - 30 km/h]).
- The SRS curtain shield airbags will deploy in the event of vehicle rollover.
- The SRS side and curtain shield airbags will deploy in the event of a severe frontal collision.

## ■ Conditions under which the SRS airbags may deploy (inflate), other than a collision

The SRS front airbags and SRS side and curtain shield airbags may also deploy if a serious impact occurs to the underside of your vehicle. Some examples are shown in the illustration.

- Hitting a curb, edge of pavement or hard surface
- Falling into or jumping over a deep hole
- Landing hard or falling

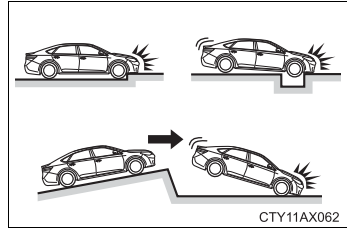

The SRS curtain shield airbags may also deploy under the situations shown in the illustration.

- The angle of vehicle tip-up is marginal.
- The vehicle skids and hits a curb stone.

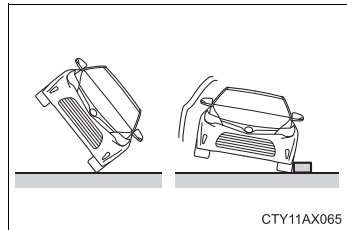

## ■ Types of collisions that may not deploy the SRS airbags (SRS front airbags)

The SRS front airbags do not generally inflate if the vehicle is involved in a side or rear collision, if it rolls over, or if it is involved in a low-speed frontal collision. But, whenever a collision of any type causes sufficient forward deceleration of the vehicle, deployment of the SRS front airbags may occur.

- Collision from the side
- Collision from the rear
- Vehicle rollover

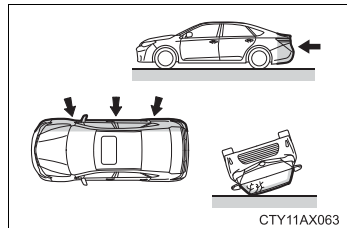

### ■ Types of collisions that may not deploy the SRS airbags (SRS side and curtain shield airbags)

The SRS side and curtain shield airbags may not activate if the vehicle is subjected to a collision from the side at certain angles, or a collision to the side of the vehicle body other than the passenger compartment.

- Collision from the side to the vehicle body other than the passenger compartment
- Collision from the side at an angle

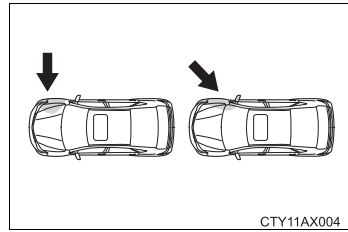

The SRS side airbags do not generally inflate if the vehicle is involved in a rear collision, if it rolls over, or if it is involved in a low-speed side or low-speed frontal collision.

- Collision from the rear
- Vehicle rollover

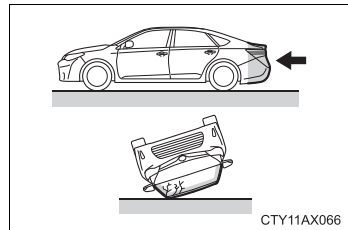

The SRS curtain shield airbags do not generally inflate if the vehicle is involved in a rear collision, if it pitches end over end, or if it is involved in a low-speed side or low-speed frontal collision.

- Collision from the rear
- Pitching end over end

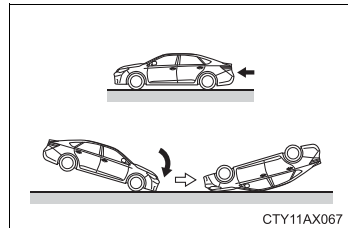

## ■ When to contact your Toyota dealer

In the following cases, the vehicle will require inspection and/or repair. Contact your Toyota dealer as soon as possible.

- Any of the SRS airbags have been inflated.
- The front of the vehicle is damaged or deformed, or was involved in an accident that was not severe enough to cause the SRS front airbags to inflate.

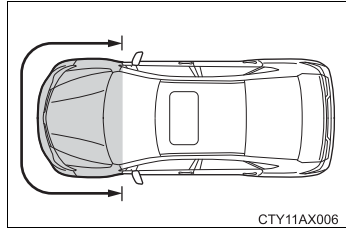

- A portion of a door or its surrounding area is damaged or deformed, or the vehicle was involved in an accident that was not severe enough to cause the SRS side and curtain shield airbags to inflate.

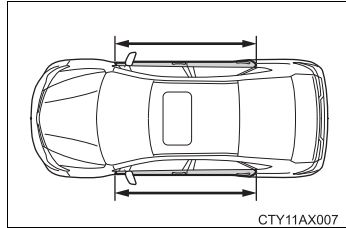

- The pad section of the steering wheel, dashboard near the front passenger airbag or lower portion of the instrument panel is scratched, cracked, or otherwise damaged.

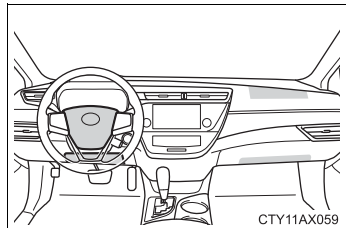

- The surface of the seats with the side airbag is scratched, cracked, or otherwise damaged.

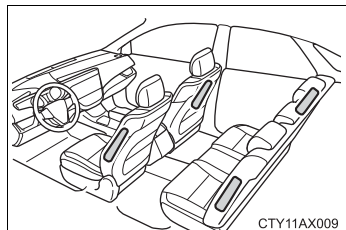

- The portion of the front pillars, rear pillars or roof side rail garnishes (padding) containing the curtain shield airbags inside is scratched, cracked, or otherwise damaged.

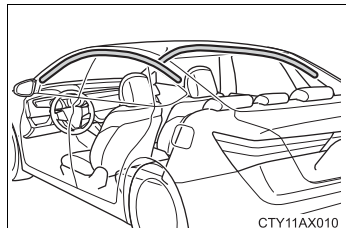

## Front passenger occupant classification system

Your vehicle is equipped with a front passenger occupant classification system. This system detects the conditions of the front passenger seat and activates or deactivates the devices for the front passenger.

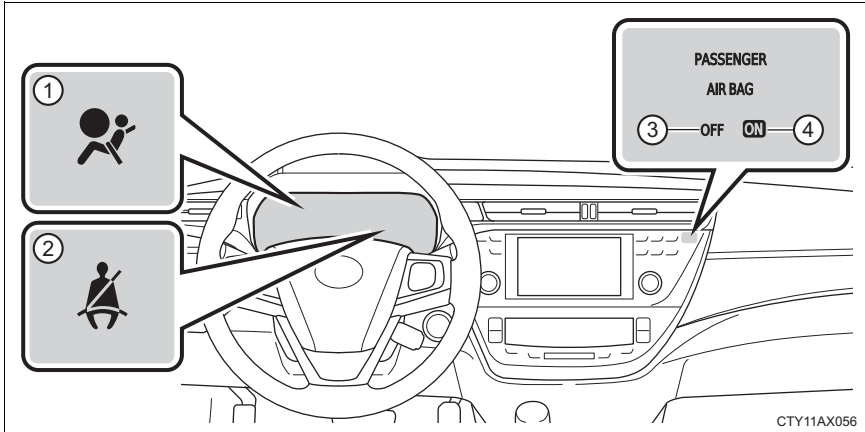

- ① SRS warning light
- ② Seat belt reminder light
- ③ "AIR BAG OFF" indicator light
- ④ "AIR BAG ON" indicator light



## Condition and operation in the front passenger occupant classification system

### ■ Adult\*1

Indicator/ warning light	“AIR BAG ON” and “AIR BAG OFF” indicator lights	“AIR BAG ON”
	SRS warning light	Off
	Seat belt reminder light	Off*2 or flashing*3
Devices	Front passenger airbag	Activated
	Side airbag on the front passenger seat	
	Curtain shield airbag in the front passenger side	
	Front passenger knee airbag	
	Front passenger’s seat belt pretensioner	

### ■ Child\*4

Indicator/ warning light	“AIR BAG ON” and “AIR BAG OFF” indicator lights	“AIR BAG OFF” or “AIR BAG ON”*4
	SRS warning light	Off
	Seat belt reminder light	Off*2 or flashing*3
Devices	Front passenger airbag	Deactivated or activated*4
	Side airbag on the front passenger seat	Activated
	Curtain shield airbag in the front passenger side	
	Front passenger knee airbag	Deactivated or activated*4
	Front passenger’s seat belt pretensioner	Activated

### ■ Child restraint system with infant\*5

Indicator/ warning light	“AIR BAG ON” and “AIR BAG OFF” indicator lights	“AIR BAG OFF”*6
	SRS warning light	Off
	Seat belt reminder light	Off*2 or flashing*3
Devices	Front passenger airbag	Deactivated
	Side airbag on the front passenger seat	Activated
	Curtain shield airbag in the front passenger side	
	Front passenger knee airbag	Deactivated
	Front passenger’s seat belt pretensioner	Activated

### ■ Unoccupied

Indicator/ warning light	“AIR BAG ON” and “AIR BAG OFF” indicator lights	“AIR BAG OFF”
	SRS warning light	Off
	Seat belt reminder light	
Devices	Front passenger airbag	Deactivated
	Side airbag on the front passenger seat	Activated
	Curtain shield airbag in the front passenger side	
	Front passenger knee airbag	Deactivated
	Front passenger’s seat belt pretensioner	Activated

## ■ There is a malfunction in the system

Indicator/ warning light	“AIR BAG ON” and “AIR BAG OFF” indicator lights	“AIR BAG OFF”
	SRS warning light	On
	Seat belt reminder light	
Devices	Front passenger airbag	Deactivated
	Side airbag on the front passenger seat	Activated
	Curtain shield airbag in the front passenger side	
	Front passenger knee airbag	Deactivated
	Front passenger’s seat belt pretensioner	Activated

\*1: The system judges a person of adult size as an adult. When a smaller adult sits in the front passenger seat, the system may not recognize him/her as an adult depending on his/her physique and posture.

\*2: In the event the front passenger is wearing a seat belt.

\*3: In the event the front passenger does not wear a seat belt.

\*4: For some children, child in seat, child in booster seat or child in convertible seat, the system may not recognize him/her as a child. Factors which may affect this can be the physique or posture.

\*5: Never install a rear-facing child restraint system on the front passenger seat. A forward-facing child restraint system should only be installed on the front passenger seat when it is unavoidable. (→P. 55)

\*6: In case the indicator light is not illuminated, consult this manual on how to install the child restraint system properly. (→P. 59)

**WARNING****■ Front passenger occupant classification system precautions**

Observe the following precautions regarding the front passenger occupant classification system.

Failure to do so may cause death or serious injury.

- Wear the seat belt properly.
- Make sure the front passenger's seat belt plate has not been left inserted into the buckle before someone sits in the front passenger seat.
- Make sure the "AIR BAG OFF" indicator light is not illuminated when using the seat belt extender for the front passenger seat. If the "AIR BAG OFF" indicator light is illuminated, disconnect the extender tongue from the seat belt buckle, and reconnect the seat belt. Reconnect the seat belt extender after making sure the "AIR BAG ON" indicator light is illuminated. If you use the seat belt extender while the "AIR BAG OFF" indicator light is illuminated, the SRS airbags for the front passenger will not activate correctly, which could cause death or serious injury in the event of a collision.
- Do not apply a heavy load to the front passenger seat or equipment (e.g. seatback pockets).
- Do not put weight on the front passenger seat by putting your hands or feet on the front passenger seat seatback from the rear passenger seat.
- Do not let a rear passenger lift the front passenger seat with their feet or press on the seatback with their legs.
- Do not put objects under the front passenger seat.

**WARNING****■ Front passenger occupant classification system precautions**

- Do not recline the front passenger seatback so far that it touches a rear seat. This may cause the “AIR BAG OFF” indicator light to be illuminated, which indicates that the SRS airbags for the front passenger will not deploy in the event of a severe accident. If the seatback touches the rear seat, return the seatback to a position where it does not touch the rear seat. Keep the front passenger seatback as upright as possible when the vehicle is moving. Reclining the seatback excessively may lessen the effectiveness of the seat belt system.
- If an adult sits in the front passenger seat, the “AIR BAG ON” indicator light is illuminated. If the “AIR BAG OFF” indicator is illuminated, ask the passenger to sit up straight, well back in the seat, feet on the floor, and with the seat belt worn correctly. If the “AIR BAG OFF” indicator still remains illuminated, either ask the passenger to move to the rear seat, or if that is not possible, move the front passenger seat fully rearward.
- When it is unavoidable to install a forward-facing child restraint system on the front passenger seat, install the child restraint system on the front passenger seat in the proper order. (→P. 59)
- Do not modify or remove the front seats.
- Do not kick the front passenger seat or subject it to severe impact. Otherwise, the SRS warning light may come on to indicate a malfunction of the detection system. In this case, contact your Toyota dealer immediately.
- Child restraint systems installed on the rear seat should not contact the front seatbacks.
- Do not use a seat accessory, such as a cushion and seat cover, that covers the seat cushion surface.
- Do not modify or replace the upholstery of the front seat.

## Safety information for children

**Observe the following precautions when children are in the vehicle.**

**Use a child restraint system appropriate for the child, until the child becomes large enough to properly wear the vehicle's seat belt.**

- It is recommended that children sit in the rear seats to avoid accidental contact with the shift lever, wiper switch etc.
- Use the rear door child-protector lock or the window lock switch to avoid children opening the door while driving or operating the power window accidentally.
- Do not let small children operate equipment which may catch or pinch body parts, such as the power window, hood, trunk, seats etc.



### WARNING

Never leave children unattended in the vehicle, and never allow children to have or use the key.

Children may be able to start the vehicle or shift the vehicle into neutral. There is also a danger that children may injure themselves by playing with the windows, the moon roof or other features of the vehicle. In addition, heat build-up or extremely cold temperatures inside the vehicle can be fatal to children.

## Child restraint systems

**A child restraint system for a small child or baby must itself be properly restrained on the seat with the LATCH anchors or the lap portion of the lap/shoulder belt.**

**The laws of all 50 states of the U.S.A. and Canada now require the use of child restraint systems.**

### Points to remember

Studies have shown that installing a child restraint on a rear seat is much safer than installing one on the front passenger seat.

- Choose a child restraint system that suits your vehicle and is appropriate to the age and size of the child.
- For installation details, follow the instructions provided with the child restraint system.

General installation instructions are provided in this manual.

(→P. 59)

## Types of child restraints

Child restraint systems are classified into the following 3 types according to the age and size of the child:

- ▶ Rear facing — Infant seat/convertible seat
- ▶ Forward facing — Convertible seat

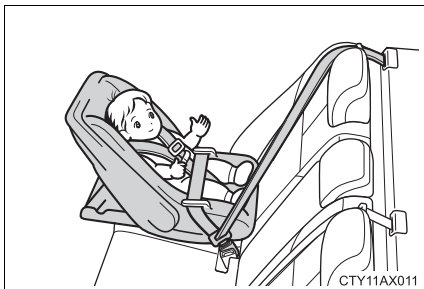

- ▶ Booster seat



### ■ Selecting an appropriate child restraint system

- Use a child restraint system appropriate for the child until the child becomes large enough to properly wear the vehicle's seat belt.
- If the child is too large for a child restraint system, sit the child on a rear seat and use the vehicle's seat belt. (→P. 30)



**WARNING****■ Child restraint precautions**

- For effective protection in automobile accidents and sudden stops, a child must be properly restrained, using a seat belt or child restraint system depending on the age and size of the child. Holding a child in your arms is not a substitute for a child restraint system. In an accident, the child can be crushed against the windshield, or between you and the vehicle's interior.
- Toyota strongly urges the use of a proper child restraint system that conforms to the size of the child, installed on the rear seat. According to accident statistics, the child is safer when properly restrained in the rear seat than in the front seat.
- Never install a rear-facing child restraint system on the front passenger seat even if the "AIR BAG OFF" indicator light is illuminated. In the event of an accident, the force of the rapid inflation of the front passenger airbag can cause death or serious injury to the child if the rear-facing child restraint system is installed on the front passenger seat.
- A forward-facing child restraint system may be installed on the front passenger seat only when it is unavoidable. A child restraint system that requires a top tether strap should not be used in the front passenger seat since there is no top tether strap anchor for the front passenger seat. Adjust the seatback as upright as possible and always move the seat as far back as possible even if the "AIR BAG OFF" indicator light is illuminated, because the front passenger airbag could inflate with considerable speed and force. Otherwise, the child may be killed or seriously injured.
- Do not use the seat belt extender when installing a child restraint system on the front or rear passenger seat. If installing a child restraint system with the seat belt extender connected to the seat belt, the seat belt will not securely hold the child restraint system, which could cause death or serious injury to the child or other passengers in the event of an accident.
- Do not allow the child to lean his/her head or any part of his/her body against the door or the area of the seat, front and rear pillars or roof side rails from which the SRS side airbags or SRS curtain shield airbags deploy even if the child is seated in the child restraint system. It is dangerous if the SRS side airbags and curtain shield airbags inflate, and the impact could cause death or serious injury to the child.
- Make sure you have complied with all installation instructions provided by the child restraint manufacturer and that the system is properly secured. If it is not secured properly, it may cause death or serious injury to the child in the event of a sudden stop, sudden swerve or accident.

**WARNING****■ When children are in the vehicle**

Do not allow children to play with the seat belt. If the seat belt becomes twisted around a child's neck, it may lead to choking or other serious injuries that could result in death.

If this occurs and the buckle cannot be unfastened, scissors should be used to cut the belt.

**■ When the child restraint system is not in use**

- Keep the child restraint system properly secured on the seat even if it is not in use. Do not store the child restraint system unsecured in the passenger compartment.
- If it is necessary to detach the child restraint system, remove it from the vehicle or store it securely in the trunk. This will prevent it from injuring passengers in the event of a sudden stop, sudden swerve or accident.

## Installing child restraints

**Follow the child restraint system manufacturer's instructions. Firmly secure child restraints to the seats using the LATCH anchors or a seat belt. Attach the top tether strap when installing a child restraint.**

**The lap/shoulder belt can be used if your child restraint system is not compatible with the LATCH (Lower Anchors and Tethers for Children) system.**

### Child restraint LATCH anchors

LATCH anchors are provided for the outboard rear seats. (Buttons displaying the location of the anchors are attached to the seats.)

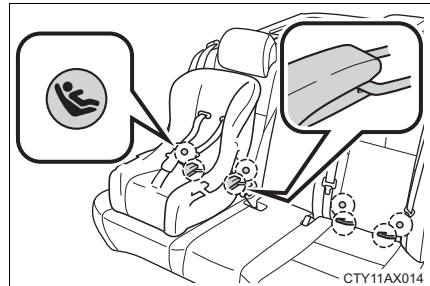

Seat belts equipped with a child restraint locking mechanism (ALR/ELR belts except driver's seat belt) (→P. 32)

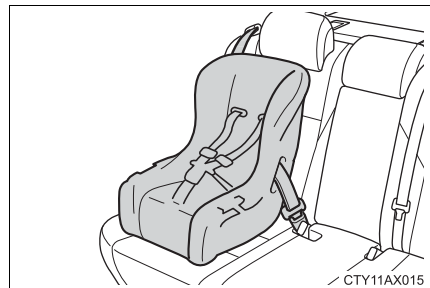

Anchor brackets (for top tether strap)

An anchor bracket is provided for each rear seat.

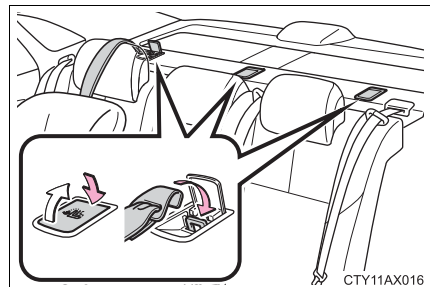

## Installation with LATCH system

- 1 Adjust the head restraint to the downmost position. (→P. 138)
- 2 Widen the gap between the seat cushion and seatback slightly.
- 3 Rear left seat only: Slide the rear center seat belt to the side to prevent it from getting pinched in the lower anchorage.

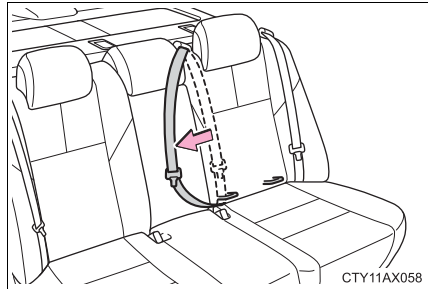

### ► Type A

- 4 Latch the hooks of the lower straps onto the LATCH anchors. If the child restraint has a top tether strap, the top tether strap should be latched onto the top tether strap anchor.

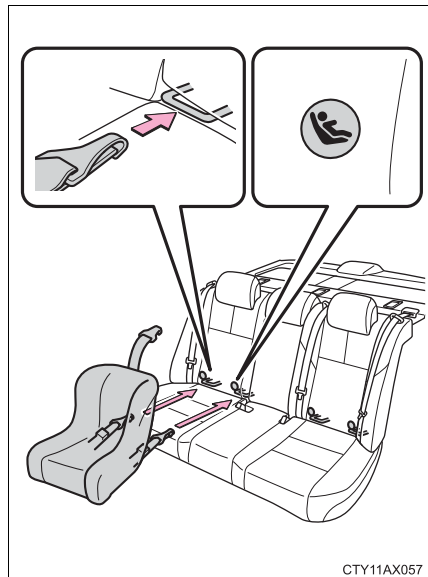

► Type B

- 4 Latch the buckles onto the LATCH anchors. If the child restraint has a top tether strap, the top tether strap should be latched onto the top tether strap anchor.

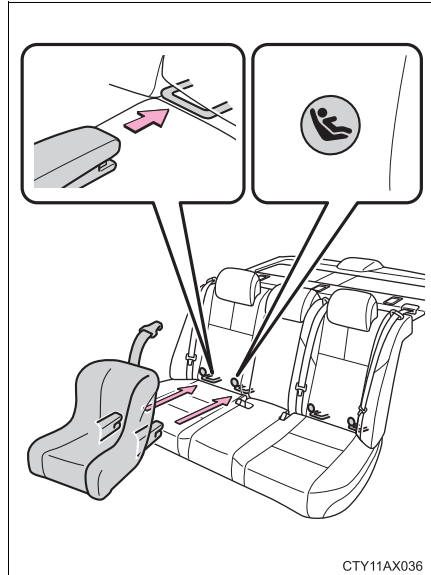

## Installing child restraints using a seat belt (child restraint lock function belt)

### ■ Rear-facing — Infant seat/convertible seat

- 1 Place the child restraint system on the rear seat facing the rear of the vehicle.

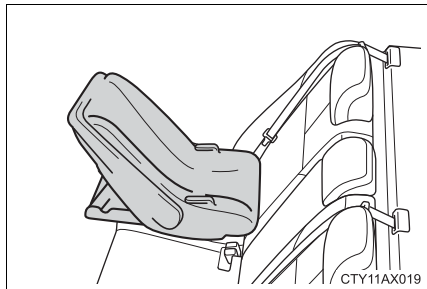

- 2 Run the seat belt through the child restraint system and insert the plate into the buckle. Make sure that the belt is not twisted.

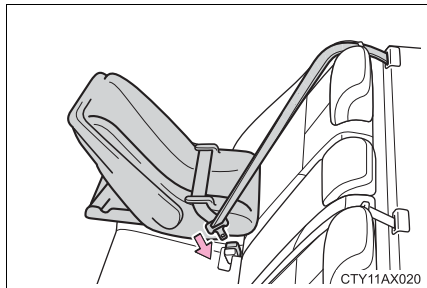

- 3 Fully extend the shoulder belt and allow it to retract to put it in lock mode. In lock mode, the belt cannot be extended.

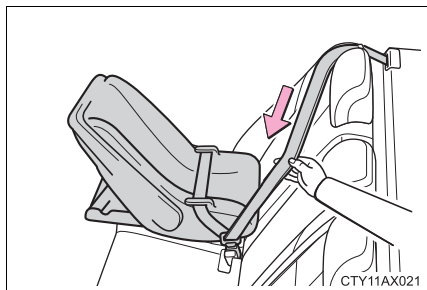

- 4 While pushing the child restraint system down into the rear seat, allow the shoulder belt to retract until the child restraint system is securely in place.

After the shoulder belt has retracted to a point where there is no slack in the belt, pull the belt to check that it cannot be extended.

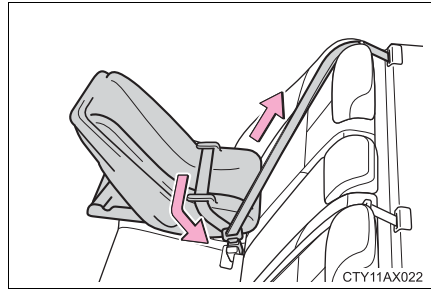

#### ■ Forward-facing — Convertible seat

- 1 Adjust the head restraint to the downmost position. (→P. 138)
- 2 Place the child restraint system on the seat facing the front of the vehicle.

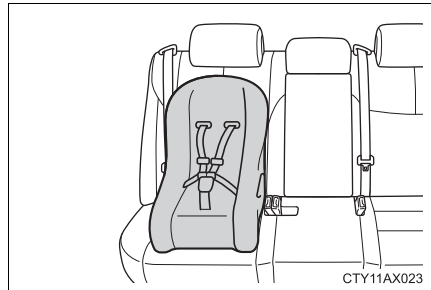

- 3 Run the seat belt through the child restraint system and insert the plate into the buckle. Make sure that the belt is not twisted.

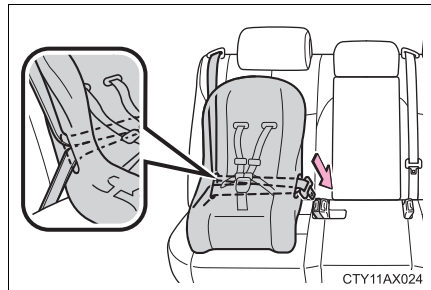

- 4 Fully extend the shoulder belt and allow it to retract to put it in lock mode. In lock mode, the belt cannot be extended.

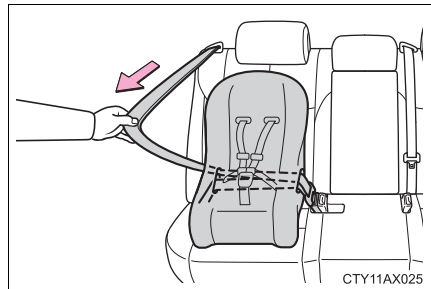

- 5 While pushing the child restraint system into the rear seat, allow the shoulder belt to retract until the child restraint system is securely in place.

After the shoulder belt has retracted to a point where there is no slack in the belt, pull the belt to check that it cannot be extended.

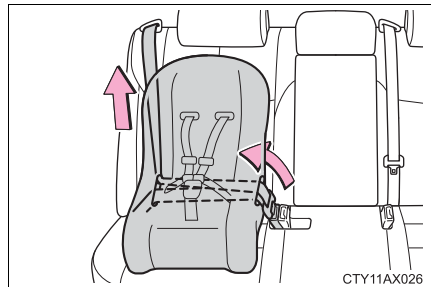

- 6 If the child restraint has a top tether strap, the top tether strap should be latched onto the top tether strap anchor. (→P. 66)



## ■ Booster seat

- 1 Place the child restraint system on the seat facing the front of the vehicle.

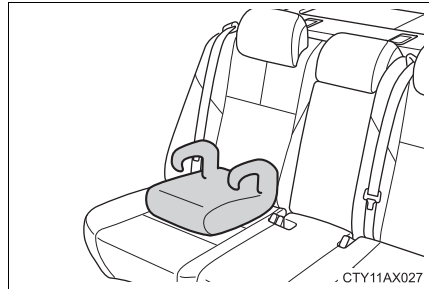

- 2 Sit the child in the child restraint system. Fit the seat belt to the child restraint system according to the manufacturer's instructions and insert the plate into the buckle. Make sure that the belt is not twisted.



Check that the shoulder belt is correctly positioned over the child's shoulder and that the lap belt is as low as possible. (→P. 30)

## Removing a child restraint installed with a seat belt

Push the buckle release button and fully retract the seat belt.

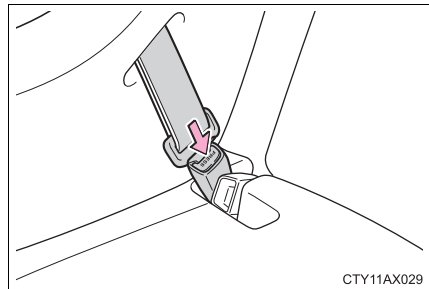

## Child restraint systems with a top tether strap

- 1 Adjust the head restraint to the downmost position. (→P. 138)
- 2 Secure the child restraint system using the seat belt or LATCH anchors.

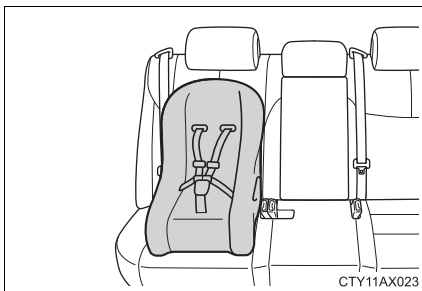

- 3 Open the anchor bracket cover, latch the hook onto the anchor bracket and tighten the top tether strap.

Make sure the top tether strap is securely latched.

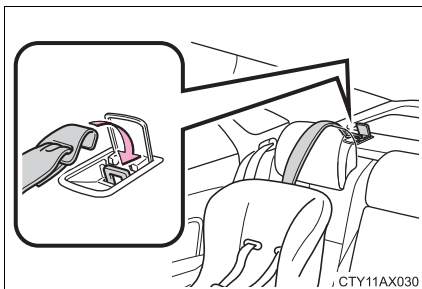

### ■ Laws and regulations pertaining to anchorages

The LATCH system conforms to FMVSS225 or CMVSS210.2.

Child restraint systems conforming to FMVSS213 or CMVSS213 specifications can be used.

This vehicle is designed to conform to the SAE J1819.

**! WARNING**

**■ When installing a booster seat**

To prevent the belt from going into ALR lock mode, do not fully extend the shoulder belt. ALR mode causes the belt to tighten only. This could cause injury or discomfort to the child. (→P. 32)

**■ When installing a child restraint system**

Follow the directions given in the child restraint system installation manual and fix the child restraint system securely in place.

If the child restraint system is not correctly fixed in place, the child or other passengers may be seriously injured or even killed in the event of a sudden braking or an accident.

- If the driver's seat interferes with the child restraint system and prevents it from being attached correctly, attach the child restraint system to the right-hand rear seat.
- Adjust the front passenger seat so that it does not interfere with the child restraint system.
- Only put a forward-facing child restraint system on the front seat when unavoidable. When installing a forward-facing child restraint system on the front passenger seat, move the seat as far back as possible even if the "AIR BAG OFF" indicator light is illuminated. Failure to do so may result in death or serious injury if the airbags deploy (inflate).

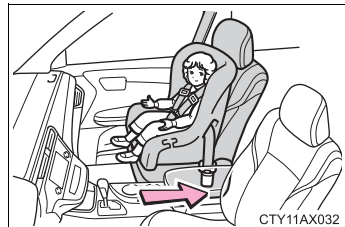
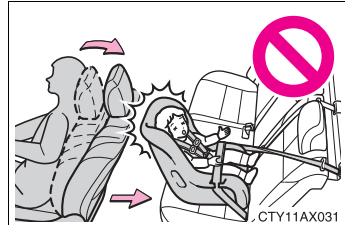

**WARNING****■ When installing a child restraint system**

- When a booster seat is installed, always ensure that the shoulder belt is positioned across the center of the child's shoulder. The belt should be kept away from the child's neck, but not so that it could fall off the child's shoulder. Failing to do so may result in death or serious injury in the event of an accident or a sudden braking.
- Ensure that the belt and plate are securely locked and the seat belt is not twisted.
- Shake the child restraint system left and right, and forward and backward to ensure that it has been securely installed.
- After securing a child restraint system, never adjust the seat.
- Follow all installation instructions provided by the child restraint system manufacturer.
- When securing some types of child restraint systems in rear seats, it may not be possible to properly use the seat belts in positions next to the child restraint without interfering with it or affecting seat belt effectiveness. Be sure your seat belt fits snugly across your shoulder and low on your hips. If it does not, or if it interferes with the child restraint, move to a different position. Failure to do so may result in death or serious injury.

**■ Do not use a seat belt extender**

If a seat belt extender is used when installing a child restraint system, the seat belt will not securely hold the child restraint system, which could cause death or serious injury to the child or other passengers in the event of a sudden braking, sudden swerving or an accident.

**■ To correctly attach a child restraint system to the anchors**

When using the LATCH anchors, be sure that there are no foreign objects around the anchors and that the seat belt is not caught behind the child restraint system. Make sure the child restraint system is securely attached, or it may cause death or serious injury to the child or other passengers in the event of a sudden braking or an accident.

## Exhaust gas precautions

**Harmful substance to the human body is included in exhaust gases if inhaled.**

### WARNING

Exhaust gases include harmful carbon monoxide (CO), which is colorless and odorless. Observe the following precautions.

Failure to do so may cause exhaust gases to enter the vehicle and may lead to an accident caused by light-headedness, or may lead to death or a serious health hazard.

#### ■ Important points while driving

- Keep the trunk lid closed.
- If you smell exhaust gases in the vehicle even when the trunk lid is closed, open the windows and have the vehicle inspected at your Toyota dealer as soon as possible.

#### ■ When parking

- If the vehicle is in a poorly ventilated area or a closed area, such as a garage, stop the hybrid system.
- Do not leave the vehicle with the hybrid system on for a long time. If such a situation cannot be avoided, park the vehicle in an open space and ensure that exhaust fumes do not enter the vehicle interior.
- Do not leave the hybrid system operating in an area with snow build-up, or where it is snowing. If snowbanks build up around the vehicle while the hybrid system is operating, exhaust gases may collect and enter the vehicle.

#### ■ Exhaust pipe

The exhaust system needs to be checked periodically. If there is a hole or crack caused by corrosion, damage to a joint or abnormal exhaust noise, be sure to have the vehicle inspected and repaired by your Toyota dealer.

## Hybrid system features

**Your vehicle is a hybrid vehicle. It has characteristics different from conventional vehicles. Be sure you are closely familiar with the characteristics of your vehicle, and operate it with care.**

**The hybrid system combines the use of a gasoline engine and an electric motor (traction motor) according to driving conditions, improving fuel efficiency and reducing exhaust emissions.**

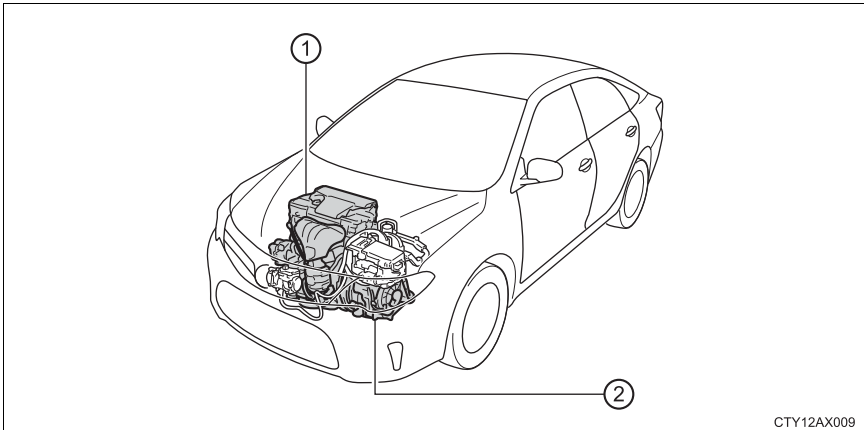

The illustration is an example for explanation and may differ from the actual item.

- ① Gasoline engine
- ② Electric motor (traction motor)

### ◆ When stopped/during start off

The gasoline engine stops\* when the vehicle is stopped. During start off, the electric motor (traction motor) drives the vehicle. At slow speeds or when traveling down a gentle slope, the engine is stopped\* and the electric motor (traction motor) is used.

When the shift lever is in N, the hybrid battery (traction battery) is not being charged.

\*: When the hybrid battery (traction battery) requires charging or the engine is warming up, etc., the gasoline engine will not automatically stop.  
(→P. 72)

### ◆ During normal driving

The gasoline engine is predominantly used. The electric motor (traction motor) charges the hybrid battery (traction battery) as necessary.

### ◆ When accelerating sharply

When the accelerator pedal is depressed heavily, the power of the hybrid battery (traction battery) is added to that of the gasoline engine via the electric motor (traction motor).

### ◆ When braking (regenerative braking)

The wheel operates the electric motor (traction motor) as a power generator, and the hybrid battery (traction battery) is charged.

## Vehicle proximity notification system

When driving with the gasoline engine stopped, a sound, which changes in accordance with the driving speed, will be played in order to warn people nearby of the vehicle's approach. The sound will stop when the vehicle speed exceeds approximately 15 mph (25 km/h).

### ■ Regenerative braking

In the following situations, kinetic energy is converted to electric energy and deceleration force can be obtained in conjunction with the recharging of the hybrid battery (traction battery).

- The accelerator pedal is released while driving with the shift lever in D or S.
- The brake pedal is depressed while driving with the shift lever in D or S.

### ■ EV indicator

The EV indicator comes on when the vehicle is driven using only the electric motor (traction motor) or the gasoline engine is stopped.

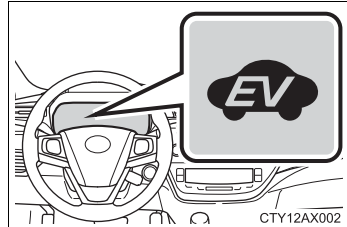

### ■ Conditions in which the gasoline engine may not stop

The gasoline engine starts and stops automatically. However, it may not stop automatically in the following conditions:

- During gasoline engine warm-up
- During hybrid battery (traction battery) charging
- When the temperature of the hybrid battery (traction battery) is high or low
- When the heater is switched on

### ■ Charging the hybrid battery (traction battery)

As the gasoline engine charges the hybrid battery (traction battery), the battery does not need to be charged from an outside source. However, if the vehicle is left parked for a long time the hybrid battery will slowly discharge. For this reason, be sure to drive the vehicle at least once every few months for at least 30 minutes or 10 miles (16 km). If the hybrid battery becomes fully discharged and you are unable to start the hybrid system, contact your Toyota dealer.

### ■ Charging the 12-volt battery

→P. 426

### ■ After the 12-volt battery has discharged or when the terminal has been removed and installed during exchange, etc.

The gasoline engine may not stop even if the vehicle is being driven by the hybrid battery (traction battery). If this continues for a few days, contact your Toyota dealer.



## ■ Sounds and vibrations specific to a hybrid vehicle

There may be no engine sound or vibration even though the vehicle is able to move with the “READY” indicator is illuminated. For safety, apply the parking brake and make sure to shift the shift lever to P when parked.

The following sounds or vibrations may occur when the hybrid system is operating and are not a malfunction:

- Motor sounds may be heard from under the vehicle.
- Sounds may be heard from the hybrid battery (traction battery) behind the rear seats when the hybrid system starts or stops.
- Relay operating sounds such as a snap or soft clank will be emitted from the hybrid battery (traction battery), behind the rear seats, when the hybrid system is started or stopped.
- Sounds from the hybrid system may be heard when the trunk lid is open.
- Sounds may be heard from the transmission when the gasoline engine starts or stops, when driving at low speeds, or during idling.
- Engine sounds may be heard when accelerating sharply.
- Sounds may be heard due to regenerative braking when the brake pedal is depressed or as the accelerator pedal is released.
- Operating sounds or motor sounds that occur when the brake pedal is operated.
- Vibration may be felt when the gasoline engine starts or stops.
- Cooling fan sounds may be heard from the air intake vents on the left side of the rear seatback.

## ■ Vehicle proximity notification system

In the following cases, the vehicle proximity notification system may be difficult for surrounding people to hear.

- In very noisy areas
- In the wind or the rain

Also, as the vehicle proximity notification system is installed on the front of the vehicle, it may be more difficult to hear from the rear of the vehicle compared to the front.

## ■ Maintenance, repair, recycling, and disposal

Contact your Toyota dealer regarding maintenance, repair, recycling and disposal. Do not dispose of the vehicle yourself.

## Hybrid system precautions

Take care when handling the hybrid system, as it is a high voltage system (about 650 V at maximum) as well as contains parts that become extremely hot when the hybrid system is operating. Obey the warning labels attached to the vehicle.

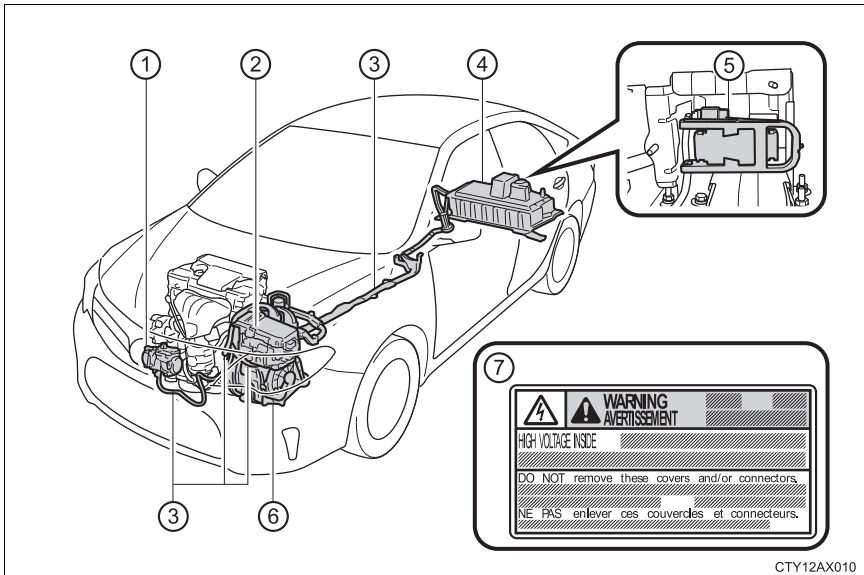

The illustration is an example for explanation and may differ from the actual item.

- ① Air conditioning compressor
- ② Power control unit with DC/DC converter
- ③ High voltage cables (orange)
- ④ Hybrid battery (traction battery)
- ⑤ Service plug
- ⑥ Electric motor (traction motor)
- ⑦ Caution label

### Hybrid battery (traction battery) air intake vent

There is an air intake vent on the left side of the rear seatback for the purpose of cooling the hybrid battery (traction battery). If the vent becomes blocked, the hybrid battery may overheat, leading to a reduction in hybrid battery output.

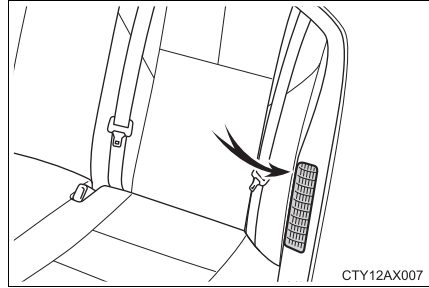

### Emergency shut off system

When a certain level of impact is detected by the impact sensor, the emergency shut off system blocks the high voltage current and stops the fuel pump to minimize the risk of electrocution and fuel leakage. If the emergency shut off system activates, your vehicle will not restart. To restart the hybrid system, contact your Toyota dealer.

### Hybrid warning message

A message is automatically displayed when a malfunction occurs in the hybrid system or an improper operation is attempted.

If a warning message is shown on the multi-information display, read the message and follow the instructions. (→P. 407)

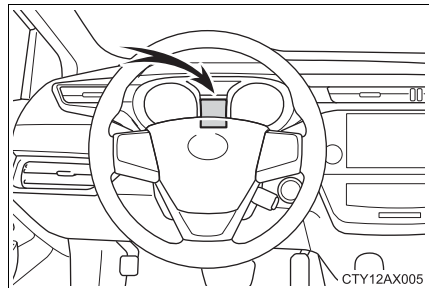

■ **If a warning light comes on, a warning message is displayed, or the 12-volt battery is disconnected**

The hybrid system may not start. In this case, try to start the system again. If the "READY" indicator does not come on, contact your Toyota dealer.

■ **Running out of fuel**

When the vehicle has run out of fuel and the hybrid system cannot be started, refuel the vehicle with at least enough gasoline to make the low fuel level warning light (→P. 401) go off. If there is only a small amount of fuel, the hybrid system may not be able to start. (The standard amount of fuel about 3.0 gal. [11.3 L, 2.5 Imp. gal.], when the vehicle is on a level surface. This value may vary when the vehicle is on a slope. Add extra fuel when the vehicle is inclined.)

■ **Electromagnetic waves**

- High voltage parts and cables on hybrid vehicles incorporate electromagnetic shielding, and therefore emit approximately the same amount of electromagnetic waves as conventional gasoline powered vehicles or home electronic appliances.
- Your vehicle may cause sound interference in some third party-produced radio parts.

■ **Hybrid battery (traction battery)**

The hybrid battery (traction battery) has a limited service life. The lifespan of the hybrid battery (traction battery) can change in accordance with driving style and driving conditions.

**! WARNING**

**High voltage precautions**

This vehicle has high voltage DC and AC systems as well as a 12-volt system. DC and AC high voltage is very dangerous and can cause severe burns and electric shock that may result in death or serious injury.

- Never touch, disassemble, remove or replace the high voltage parts, cables or their connectors.
- The hybrid system will become hot after starting as the system uses high voltage. Be careful of both the high voltage and the high temperature, and always obey the caution labels attached to the vehicle.
- Never try to open the service plug access hole located behind the rear seats. The service plug is used only when the vehicle is serviced and is subject to high voltage.

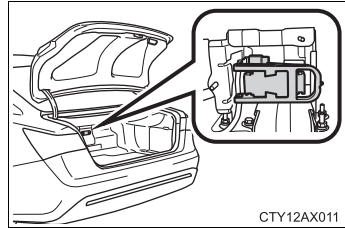

**Road accident cautions**

Observe the following precautions to reduce the risk of death or serious injury:

- Pull your vehicle off the road, apply the parking brake, shift the shift lever to P, and turn the hybrid system off.
- Do not touch the high voltage parts, cables and connectors.
- If electric wires are exposed inside or outside your vehicle, an electric shock may occur. Never touch exposed electric wires.
- If a fluid leak occurs, do not touch the fluid as it may be strong alkaline electrolyte from the hybrid battery (traction battery). If it comes into contact with your skin or eyes, wash it off immediately with a large amount of water or, if possible, boric acid solution. Seek immediate medical attention.
- If a fire occurs in the hybrid vehicle, leave the vehicle as soon as possible. Never use a fire extinguisher that is not meant for electric fires. Using even a small amount of water may be dangerous.
- If your vehicle needs to be towed, do so with front wheels raised. If the wheels connected to the electric motor (traction motor) are on the ground when towing, the motor may continue to generate electricity. This may cause a fire. (→P. 394)
- Carefully inspect the ground under the vehicle. If you find that liquid has leaked onto the ground, the fuel system may have been damaged. Leave the vehicle as soon as possible.

**WARNING****Hybrid battery (traction battery)**

- Never resell, hand over or modify the hybrid battery. To prevent accidents, hybrid batteries that have been removed from a disposed vehicle are collected through Toyota dealer. Do not dispose of the battery yourself.

Unless the battery is properly collected, the following may occur, resulting in death or serious injury:

- The hybrid battery may be illegally disposed of or dumped, and it is hazardous to the environment or someone may touch a high voltage part, resulting in an electric shock.
- The hybrid battery is intended to be used exclusively with your hybrid vehicle. If the hybrid battery is used outside of your vehicle or modified in any way, accidents such as electric shock, heat generation, smoke generation, an explosion and electrolyte leakage may occur.

When reselling or handing over your vehicle, the possibility of an accident is extremely high because the person receiving the vehicle may not be aware of these dangers.

- If your vehicle is disposed of without the hybrid battery having been removed, there is a danger of serious electric shock if high voltage parts, cables and their connectors are touched. In the event that your vehicle must be disposed of, the hybrid battery must be disposed of by your Toyota dealer or a qualified service shop. If the hybrid battery is not disposed of properly, it may cause electric shock that can result in death or serious injury.

**NOTICE****Hybrid battery air intake vent**

- Do not place objects that will block the air intake vent. The hybrid battery (traction battery) may overheat and be damaged.
- Clean the air intake vent regularly to prevent the hybrid battery (traction battery) from overheating.
- Do not wet or allow foreign substances to enter the air intake vent as this may cause a short circuit and damage the hybrid battery (traction battery).
- Do not carry large amounts of water such as water cooler bottles in the vehicle. If water spills onto the hybrid battery (traction battery), the battery may be damaged. Have the vehicle inspected by your Toyota dealer.

## Immobilizer system

The vehicle's keys have built-in transponder chips that prevent the hybrid system from starting if a key has not been previously registered in the vehicle's on-board computer.

Never leave the keys inside the vehicle when you leave the vehicle.

This system is designed to help prevent vehicle theft but does not guarantee absolute security against all vehicle thefts.

The indicator light flashes after the power switch has been turned off to indicate that the system is operating.

The indicator light stops flashing after the power switch has been turned to ACCESSORY or ON mode to indicate that the system has been canceled.

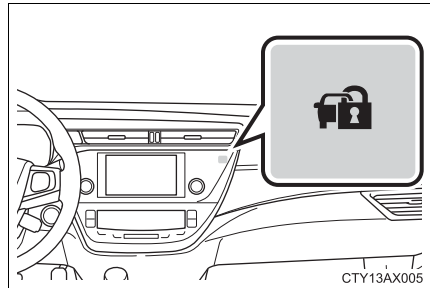

### ■ System maintenance

The vehicle has a maintenance-free type immobilizer system.

### ■ Conditions that may cause the system to malfunction

- If the grip portion of the key is in contact with a metallic object
- If the key is in close proximity to or touching a key to the security system (key with a built-in transponder chip) of another vehicle

**■ Certifications for the immobilizer system**

FCC ID: NI4TMIMB-3

This device complies with part 15 of the FCC Rules. Operation is subject to the following two conditions: (1) This device may not cause harmful interference, and (2) this device must accept any interference received, including interference that may cause undesired operation.

**WARNING****■ Certifications for the immobilizer system**

Changes or modifications not expressly approved by the party responsible for compliance could void the user's authority to operate the equipment.

**NOTICE****■ To ensure the system operates correctly**

Do not modify or remove the system. If modified or removed, the proper operation of the system cannot be guaranteed.



## Alarm

### The alarm

The alarm uses light and sound to give an alert when an intrusion is detected.

The alarm is triggered in the following situations when the alarm is set:

- A locked door or trunk is unlocked or opened in any way other than using the entry function, wireless remote control or mechanical key.
- The hood is opened.
- Some models: The window is tapped or broken.

### Setting the alarm system

Close the doors, trunk and hood, and lock all the doors. The system will be set automatically after 30 seconds.

The indicator light changes from being on to flashing when the system is set.

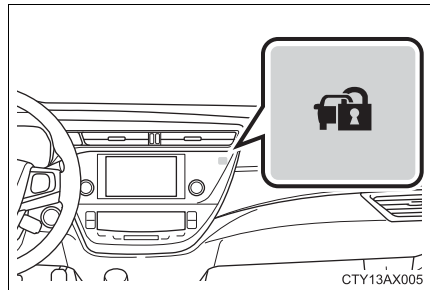

### Deactivating or stopping the alarm

Do one of the following to deactivate or stop the alarms:

- Unlock the doors or open the trunk.
- Turn the power switch to ACCESSORY or ON mode, or start the hybrid system. (The alarm will be deactivated or stopped after a few seconds.)

### ■ System maintenance

The vehicle has a maintenance-free type alarm system.

### ■ Items to check before locking the vehicle

To prevent unexpected triggering of the alarm and vehicle theft, make sure of the following:

- Nobody is in the vehicle.
- The windows and moon roof are closed before the alarm is set.
- No valuables or other personal items are left in the vehicle.

### ■ Triggering of the alarm

The alarm may be triggered in the following situations:

(Stopping the alarm deactivates the alarm system.)

- A person inside the vehicle opens a door, the trunk or hood.



CTY13AX001

- The 12-volt battery is recharged or replaced when the vehicle is locked.

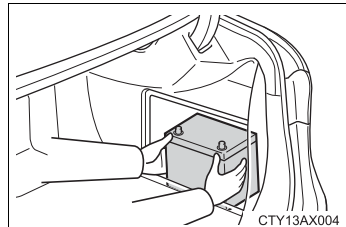

CTY13AX004

### ■ Alarm-operated door lock

- When the alarm is operating, the doors are locked automatically to prevent intruders.
- Do not leave the key inside the vehicle when the alarm is operating, and make sure the key is not inside the vehicle when recharging or replacing the battery.



NOTICE

### ■ To ensure the system operates correctly

Do not modify or remove the system. If modified or removed, the proper operation of the system cannot be guaranteed.

## Theft prevention labels

These labels are attached to the vehicle to reduce vehicle theft by facilitating the tracing and recovery of parts from stolen vehicles. Do not remove under penalty of law.

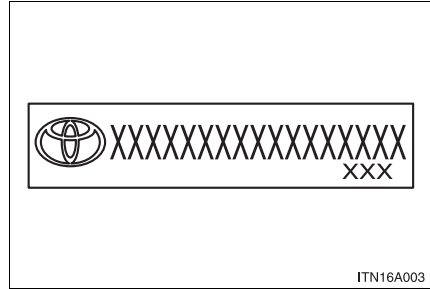



**2. Instrument cluster**

Warning lights and indicators .....	86
Gauges and meters .....	90
Multi-information display.....	94
Energy monitor/ consumption screen.....	100

## Warning lights and indicators





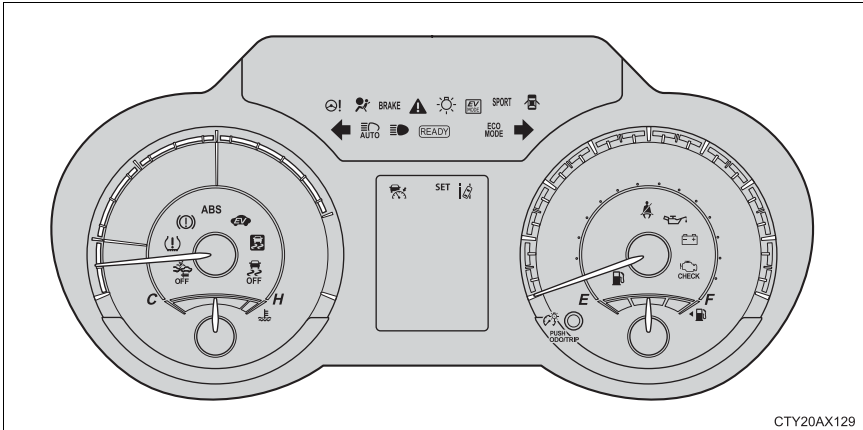











The warning lights and indicators on the instrument cluster and center panel inform the driver of the status of the vehicle's various systems.

For the purpose of explanation, the following illustration displays all warning lights and indicators illuminated.



## Warning lights

Warning lights inform the driver of malfunctions in the indicated vehicle's systems.

<p>*1</p> 	<p>Brake system warning light (→P. 398)</p>	<p>*1</p> 	<p>Slip indicator (→P. 399)</p>
<p>*1</p> 	<p>Charging system warning light (→P. 398)</p>	<p>*1</p> 	<p>Brake system warning light (→P. 401)</p>
<p>*1</p> 	<p>Malfunction indicator lamp (→P. 398)</p>	<p>*1</p> 	<p>Open door warning light (→P. 401)</p>
<p>*1</p> 	<p>SRS warning light (→P. 399)</p>	<p>*1</p> 	<p>Low fuel level warning light (→P. 401)</p>
<p>*1</p> 	<p>ABS warning light (→P. 399)</p>	<p>*1</p> 	<p>Seat belt reminder light (→P. 401)</p>
<p>*1</p> 	<p>Electric power steering system warning light (→P. 399)</p>	<p>*1</p> 	<p>Master warning light (→P. 401)</p>
<p>*1</p> 	<p>Low engine oil pressure warning light (→P. 398)</p>	<p>*1</p> 	<p>Tire pressure warning light (→P. 401)</p>
<p>*1, 2, 3</p> 	<p>PCS warning light (→P. 400)</p>	<p>*2, 4</p> 	<p>LDA (Lane Departure Alert with steering control) indicator (→P. 400)</p>

\*1: These lights turn on when the power switch is turned to ON mode to indicate that a system check is being performed. They will turn off after the hybrid system is on, or after a few seconds. There may be a malfunction in a system if a light does not come on, or turn off. Have the vehicle inspected by your Toyota dealer.

\*2: If equipped

\*3: The light flashes to indicate a malfunction.

\*4: This light illuminates on the multi-information display.

## Indicators

The indicators inform the driver of the operating state of the vehicle's various systems.



Turn signal indicator  
(→P. 184)



EV drive mode indicator  
(→P. 178)



Headlight indicator  
(→P. 186)



Eco drive mode indicator  
(→P. 259)



Headlight high beam indicator (→P. 186)



Sport mode indicator  
(→P. 259)



"READY" indicator  
(→P. 172)



<sup>\*2</sup> Automatic high beam indicator (→P. 189)



EV indicator (→P. 72)



<sup>\*1, 3</sup> Slip indicator (→P. 262)



<sup>\*4</sup> Security indicator  
(→P. 79, 81)



<sup>\*1</sup> VSC OFF indicator  
(→P. 263)



<sup>\*2, 5</sup> Cruise control indicator  
(→P. 246)



<sup>\*1, 2, 6</sup> PCS warning light  
(→P. 209)



<sup>\*2, 5</sup> Dynamic radar cruise control indicator  
(→P. 233)



<sup>\*2, 5</sup> LDA (Lane Departure Alert with steering control) indicator  
(→P. 222)



<sup>\*5</sup> Cruise control "SET" indicator (→P. 233, 246)



<sup>\*1, 4</sup> "AIR BAG ON/OFF" indicator (→P. 48)



- \*1: These lights turn on when the power switch is turned to ON mode to indicate that a system check is being performed. They will turn off after the hybrid system is on, or after a few seconds. There may be a malfunction in a system if a light does not come on, or turn off. Have the vehicle inspected by your Toyota dealer.
- \*2: If equipped
- \*3: The light flashes to indicate that the system is operating.
- \*4: This light illuminates on the center panel.
- \*5: This light illuminates on the multi-information display.
- \*6: The light turns on when the system is off.

**WARNING****■ If a safety system warning light does not come on**

Should a safety system light such as the ABS and SRS warning light not come on when you start the hybrid system, this could mean that these systems are not available to help protect you in an accident, which could result in death or serious injury. Have the vehicle inspected by your Toyota dealer immediately if this occurs.

## Gauges and meters

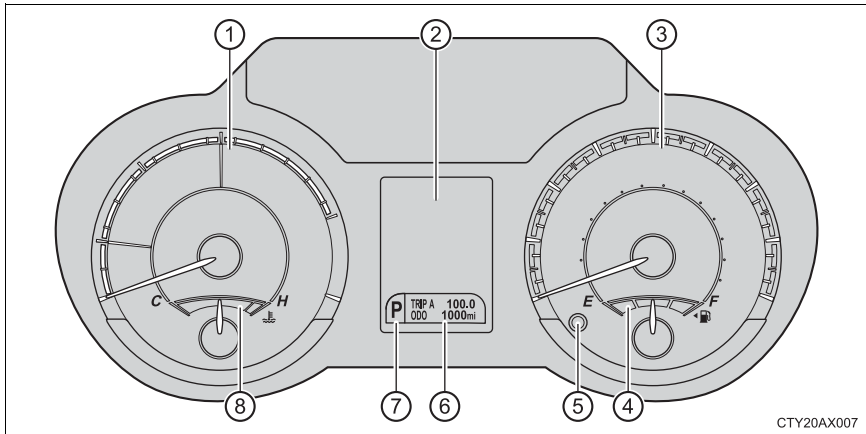

CTY20AX007

- ① **Hybrid System Indicator**  
Displays hybrid system output or regeneration level (→P. 92)
- ② **Multi-information display**  
Presents the driver with a variety of driving-related data (→P. 94)
- ③ **Speedometer**  
Displays the vehicle speed
- ④ **Fuel gauge**  
Displays the quantity of fuel remaining in the tank
- ⑤ **Trip meter reset knob/instrument panel light control knob**  
→P. 91
- ⑥ **Odometer and trip meter display**  
Odometer:  
Displays the total distance the vehicle has been driven  
Trip meter:  
Displays the distance the vehicle has been driven since the meter was last reset. Trip meters “A” and “B” can be used to record and display different distances independently.
- ⑦ **Shift position and shift range**  
Displays the selected shift position or selected shift range (→P. 180)
- ⑧ **Engine coolant temperature gauge**  
Displays the engine coolant temperature

### Changing the trip meter display

Switches between trip meter “A” and “B” displays. When the trip meter is displayed, pressing and holding the knob will reset the trip meter.

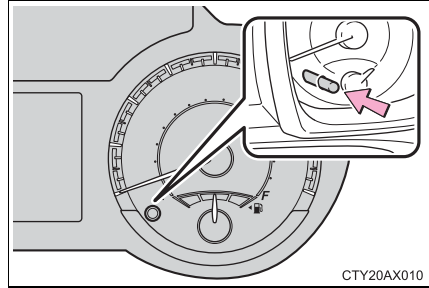

### Instrument panel light control

The brightness of the instrument panel lights can be adjusted.

- ① Darker
- ② Brighter

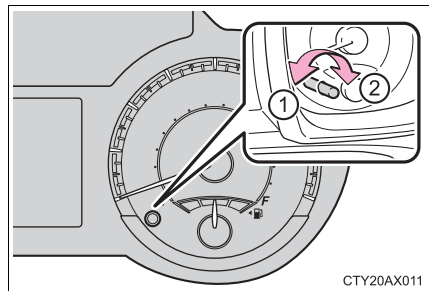

### ■ The meters and display illuminate when

The power switch is in ON mode.

### ■ The brightness of the instrument panel lights

- When the headlight switch is turned to on, the brightness will be reduced slightly unless the control knob is turned fully clockwise.
- When the knob is turned fully clockwise, the display audio/navigation system screen will always be in day mode regardless of the headlight switch position.

### ■ Hybrid System Indicator

#### ① Charge area

Shows regenerative charging.

#### ② Hybrid Eco area

Shows that gasoline engine power is not being used very often.

The gasoline engine will automatically stop and restart under various conditions.

#### ③ Eco area

Shows that the vehicle is being driven in an Eco-friendly manner.

#### ④ Power area

Shows that an Eco-friendly driving range is being exceeded (during full power driving etc.)

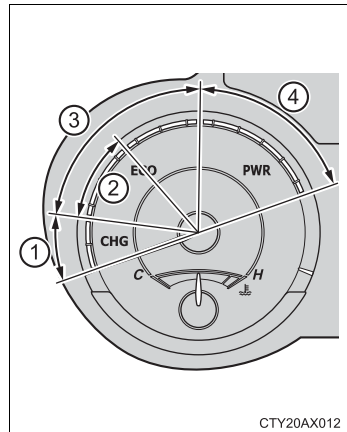

- Hybrid System Indicator is displayed when the driving mode is other than the sport mode.
- By keeping the indicator needle within Eco area, more Eco-friendly driving can be achieved.
- Charge area indicates regeneration\* status. Regenerated energy will be used to charge the battery.

\*: When used in this manual, “regeneration” refers to the conversion of energy created by the movement of the vehicle into electrical energy.

### ■ Engine speed

On hybrid vehicles, engine speed is precisely controlled in order to help improve fuel efficiency and reduce exhaust emissions etc.

There are times when the engine speed that is displayed may differ even when vehicle operation and driving conditions are the same.

## ■ Customization

The instrument panel light auto dimmer control can be changed.  
(Customizable feature: →P. 461)



### NOTICE

#### ■ To prevent damage to the engine and its components

- When indicating the tachometer (Using the S mode driving): Do not let the indicator of the tachometer enter the red zone, which indicates the maximum engine speed. (→P. 181)
- The engine may be overheating if the engine coolant temperature gauge is in the red zone (H). In this case, immediately stop the vehicle in a safe place, and check the engine after it has cooled completely. (→P. 429)

## Multi-information display

### Display contents

The multi-information display presents the driver with a variety of driving-related data.

- Trip information (→P. 95)

Displays the following items:

- Distance to empty
- Average fuel economy
- Current fuel economy
- Turn-by-turn navigation (vehicles with a navigation system)

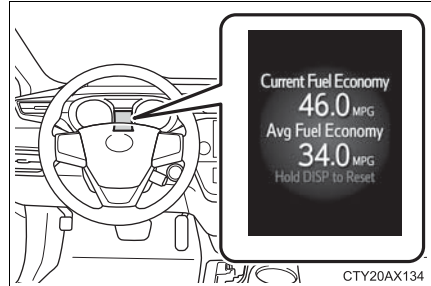

- Settings (→P. 96)

- Energy Flow (→P. 100)

- Warning messages and reminder messages (→P. 407)

- Automatically displayed when a malfunction occurs in one of the vehicle's systems or when a reminder message is required. The display returns to the previous screen by pressing the "DISP" button. (→P. 95)

- Cruise control display (if equipped) (→P. 246)

- Dynamic radar cruise control display (if equipped) (→P. 233)

- LDA (Lane Departure Alert with steering control) display (if equipped) (→P. 222)

- PCS (Pre-Collision System) display (if equipped) (→P. 209)

- Tachometer (→P. 181)

- Tire pressure warning system display (→P. 357)

## Trip information

### ■ Switching the display

Items displayed can be switched by pressing the “DISP” button.

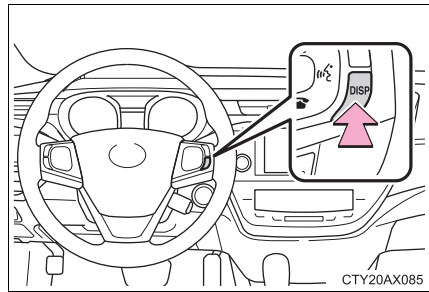

### ■ Distance to empty

Displays the estimated maximum distance that can be driven with the quantity of fuel remaining.

- This distance is computed based on your average fuel consumption. As a result, the actual distance that can be driven may differ from that displayed.
- When only a small amount of fuel is added to the tank, the display may not be updated.  
When refueling, turn the power switch off. If the vehicle is refueled without turning the power switch off, the display may not be updated.

### ■ Digital speedometer

Displays the current vehicle speed.

### ■ Average fuel economy

Displays the average fuel consumption since the function was reset.

- The function can be reset by pressing and holding the “DISP” button when the average fuel consumption is displayed.
- Use the displayed average fuel consumption as a reference.

### ■ Current fuel economy

Displays the current rate of fuel consumption.

### ■ Sway warning (if equipped)

Detects the sway of the vehicle within a lane, which is often associated with a decrease in the driver’s attention level, and displays the decrease in attention using a segment display.

The fewer segments lit, the more the driver may need to rest.

This display is a part of the LDA (Lane Departure Alert with steering control) system. The display is enabled when the operating conditions of the vehicle sway warning are met. (→P. 222)

### ■ Turn-by-turn navigation (vehicles with a navigation system)

Displays information from the navigation system about the next turn on the guidance route.

## Setting up the displays





### ◆ Customizable items

#### ■ Meter settings

Item	Settings	Details
Digital Speed	ON	Select to enable/disable the digital speedometer.
	OFF	
Units (vehicles without a navigation system)	English	Select to change the units of measure displayed.
	Metric	
Turn-by-Turn (vehicles with a navigation system)	ON	Select to enable/disable the Turn-by-turn navigation.
	OFF	
EV Indicator	OFF	Select to enable/disable the EV indicator.
	ON	

### ■ LDA (Lane Departure Alert with steering control) (if equipped) (→P. 222)

The following LDA system settings can be changed:

Item	Settings	Details
 Steering Assist	ON	Select to enable/disable steering wheel assistance.
	OFF	
 Sensitivity	Standard	Select to set the warning sensitivity.
	High	
 Alert	ON	Select to enable/disable the vehicle sway warning.
	OFF	
 Sensitivity	Standard	Select to set the vehicle sway warning sensitivity.
	Low	
	High	



## ◆ Changing the settings

- 1 While the vehicle is stopped, press the “DISP” button until the “Settings” screen appears.



- 2 Press and hold the “DISP” button while the “Settings” screen is displayed.

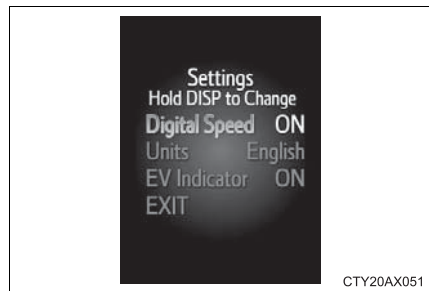

- 3 Press the “DISP” button to highlight the desired item.

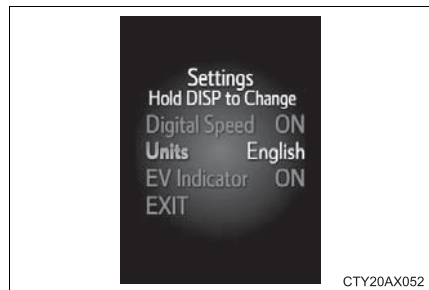

- 4 Press and hold the “DISP” button to change the setting.

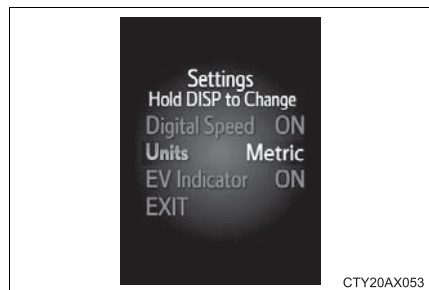

- 5 To exit the “Settings” screen, press the “DISP” button repeatedly until “EXIT” is highlighted and then press and hold the “DISP” button.

If the Lane Departure settings screen is displayed, press the “DISP” button repeatedly until “RETURN” is highlighted, then press and hold the “DISP” switch to return to the “Settings” screen.

The display goes back to step

1.



CTY20AX054

### ■ System check display

After turning the power switch to ON mode, “SYSTEM CHECK” is displayed while system operation is checked.

### ■ Trip summary display

When the hybrid system is turned off, drive information data since the hybrid system was started is displayed for 3 seconds.

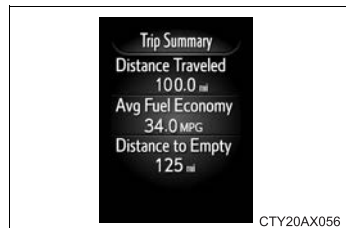

CTY20AX056

### ■ Setting display automatic cancelation

In the following situations, setting display in which the settings can be changed through the “DISP” button will automatically be turned off.

- When a warning message appears while the setting display is displayed
- When the vehicle begins to move while the setting display is displayed

### ■ Tire inflation pressure

- It may take a few minutes to display the tire inflation pressure after the power switch is turned to ON mode. It may also take a few minutes to display the tire inflation pressure after inflation pressure has been adjusted
- “---” may be displayed if the tire information cannot be determined due to unfavorable radio wave conditions.
- Tire inflation pressure changes with temperature. The displayed values may also be different from the values measured using a tire pressure gauge.

### ■ Liquid crystal display

Small spots or light spots may appear on the display. This phenomenon is characteristic of liquid crystal displays, and there is no problem continuing to use the display.



#### WARNING

#### ■ The information display at low temperatures

Allow the interior of the vehicle to warm up before using the liquid crystal information display. At extremely low temperatures, the information display monitor may respond slowly, and display changes may be delayed.

For example, there is a lag between the driver’s shifting and the new gear number appearing on the display. This lag could cause the driver to down-shift again, causing rapid and excessive engine braking and possibly an accident resulting in death or injury.

#### ■ Cautions during setting up the display

As the hybrid system needs to be operating during setting up the display, ensure that the vehicle is parked in a place with adequate ventilation. In a closed area such as a garage, exhaust gases including harmful carbon monoxide (CO) may collect and enter the vehicle. This may lead to death or a serious health hazard.



#### NOTICE

#### ■ During setting up the display

To prevent 12-volt battery discharge, ensure that the hybrid system is operating while setting up the display features.

## Energy monitor/consumption screen

You can view the status of your hybrid system on the multi-information display and the audio system.

- ① Audio system
- ② Multi-information display

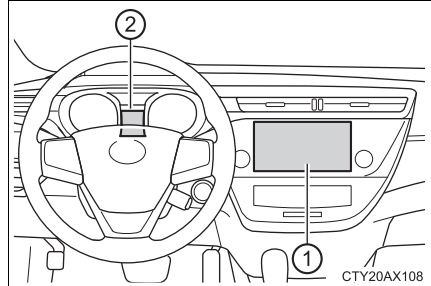

### Energy monitor

#### ■ Audio system

- 1 Press "APPS".

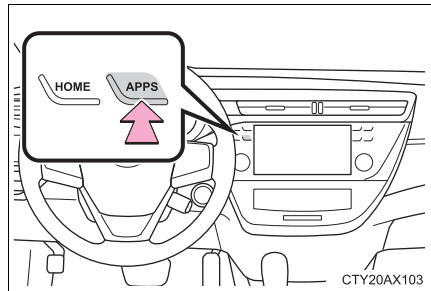

- 2 Select "Eco".



If the "Trip Information" or "Past Record" screen is displayed, touch "Energy".

## ■ Multi-information display

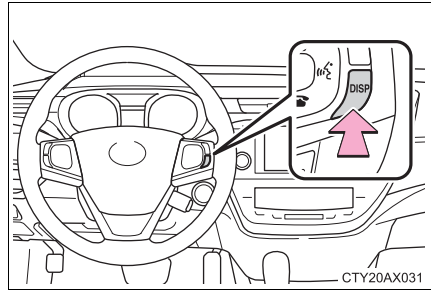
Press the “DISP” button on the steering wheel several times to select the energy monitor display.

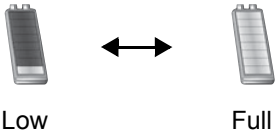
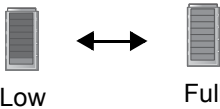

	Audio system	Multi-information display
When the vehicle is powered by the electric motor (traction motor)		
When the vehicle is powered by the gasoline engine		
When the vehicle is powered by both the gasoline engine and the electric motor (traction motor)		
When the vehicle is charging the hybrid battery (traction battery)		

	Audio system	Multi-information display
When there is no energy flow		
Hybrid battery (traction battery) status		

## Trip Information

### ■ Audio system

- 1 Press "APPS". (→P. 100)
- 2 Select "Eco".

If "Energy Monitor" screen is displayed, touch "Fuel Consumption".

If "Past Record" screen is displayed, touch "Trip Information".

- 1 Fuel consumption in the past 15 minutes
- 2 Displays the average vehicle speed since the hybrid system was started.
- 3 Displays the elapsed time since the hybrid system was started.

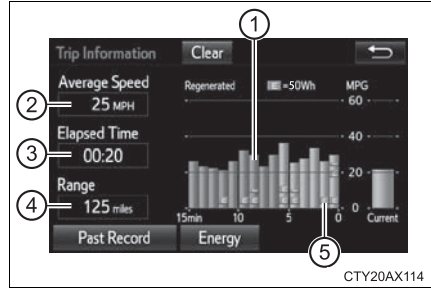

- 4 Cruising range
- 5 Regenerated energy in the past 15 minutes

One symbol indicates 50 Wh. Up to 5 symbols are shown.

The image is example only, and may vary slightly from actual conditions.

## Past record screen

### ■ Audio system

- 1 Press "APPS". (→P. 100)
- 2 Select "Eco".

If "Energy Monitor" screen is displayed, touch "Fuel Consumption".

If "Trip Information" screen is displayed, touch "Past Record".

- 1 Best past fuel consumption

- 2 Update

The average fuel consumption and graph are updated, and a new average fuel consumption record begins.

- 3 Average fuel consumption

Displays a maximum of five past record of the average fuel consumption.

- 4 Previous fuel consumption record

The image is example only, and may vary slightly from actual conditions.

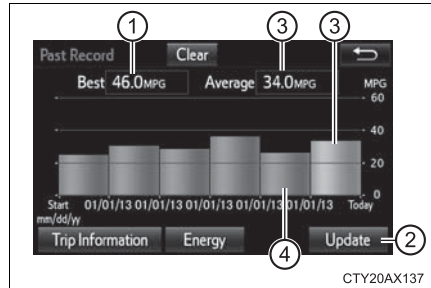

CTY20AX137

### ■ Resetting the consumption data

Selecting "Clear" on the "Trip Information" screen will reset the fuel consumption and the regenerated energy for the past 15 minutes. Selecting "Clear" on the "Past Record" screen will reset the past records and best past fuel consumption. Selecting "Yes" on the following screen will confirm resetting of all the data.

### ■ Customization

The touch button sensitivity can be changed.  
(Customizable features →P. 461)



<b>3-1. Key information</b>	
Keys .....	106
<b>3-2. Opening, closing and locking the doors and trunk</b>	
Doors .....	110
Trunk.....	116
Smart key system .....	121
<b>3-3. Adjusting the seats</b>	
Front seats .....	131
Driving position memory .....	133
Head restraints.....	138
<b>3-4. Adjusting the steering wheel and mirrors</b>	
Steering wheel .....	141
Inside rear view mirror .....	143
Outside rear view mirrors.....	145
<b>3-5. Opening, closing the windows and moon roof</b>	
Power windows .....	148
Moon roof.....	151

# Keys

## The keys

The following keys are provided with the vehicle.

- ① Electronic keys
  - Operating the smart key system (→P. 121)
  - Operating the wireless remote control function
- ② Mechanical keys
- ③ Key number plate

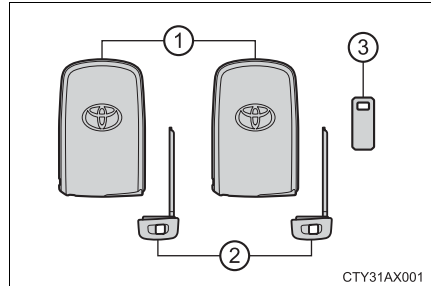

CTY31AX001

## Wireless remote control

- ① Locks all the doors (→P. 110)
- ② Unlocks all the doors (→P. 110)
 

Pressing the button unlocks the driver's door. Pressing the button again within 5 seconds unlocks the other doors.
- ③ Unlocks the trunk (press and hold) (→P. 116)
- ④ Sounds the alarm (press and hold) (→P. 107)

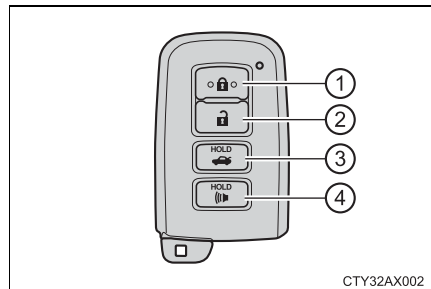

CTY32AX002

## Using the mechanical key

To take out the mechanical key, push the release button and take the key out.

The mechanical key can only be inserted in one direction, as the key only has grooves on one side. If the key cannot be inserted in a lock cylinder, turn it over and re-attempt to insert it.

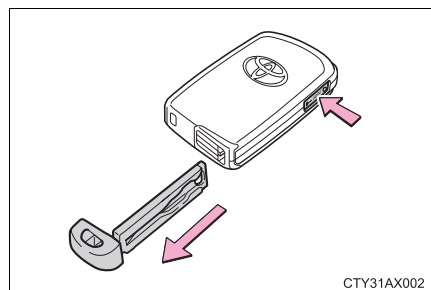

CTY31AX002

After using the mechanical key, store it in the electronic key. Carry the mechanical key together with the electronic key. If the electronic key battery is depleted or the entry function does not operate properly, you will need the mechanical key. (→P. 422)

### ■ Panic mode

When  is pressed for longer than about one second, an alarm will sound intermittently and the vehicle lights will flash to deter any person from trying to break into or damage your vehicle.

To stop the alarm, press any button on the electronic key.



### ■ When required to leave the vehicle's key with a parking attendant

Turn the trunk opener main switch off and lock the glove box as circumstances demand. (→P. 117, 290)

Remove the mechanical key for your own use and provide the attendant with the electronic key only.

### ■ If you lose your mechanical keys

New genuine mechanical keys can be made by your Toyota dealer using the other mechanical key and the key number stamped on your key number plate. Keep the plate in a safe place such as your wallet, not in the vehicle.

### ■ When riding in an aircraft

When bringing an electronic key onto an aircraft, make sure you do not press any buttons on the electronic key while inside the aircraft cabin. If you are carrying an electronic key in your bag etc., ensure that the buttons are not likely to be pressed accidentally. Pressing a button may cause the electronic key to emit radio waves that could interfere with the operation of the aircraft.

### ■ Conditions affecting operation

→P. 126

### ■ Electronic key battery depletion

- The standard battery life is 1 to 2 years.
- If the battery becomes low, an alarm will sound in the cabin when the hybrid system stops.
- As the electronic key always receives radio waves, the battery will become depleted even if the electronic key is not used. The following symptoms indicate that the electronic key battery may be depleted. Replace the battery when necessary. (→P. 373)
  - The smart key system or the wireless remote control does not operate.
  - The detection area becomes smaller.
  - The LED indicator on the key surface does not turn on.
- To avoid serious deterioration, do not leave the electronic key within 3 ft. (1 m) of the following electrical appliances that produce a magnetic field:
  - TVs
  - Personal computers
  - Cellular phones, cordless phones and battery chargers
  - Recharging cellular phones or cordless phones
  - Table lamps
  - Induction cookers

### ■ Replacing the battery

→P. 424

### ■ Confirmation of the registered key number

The number of keys already registered to the vehicle can be confirmed. Ask your Toyota dealer for details.

### ■ If a wrong key is used

The key cylinder rotates freely to isolate inside mechanism.

### ■ Customization

Settings (e.g. wireless remote control system) can be changed.  
(Customizable features: →P. 461)

### ■ Certification for wireless remote control

FCC ID: HYQ23AAP

FCC ID: HYQ14FBA

NOTE:

This device complies with part 15 of the FCC Rules. Operation is subject to the following two conditions: (1) This device may not cause harmful interference, and (2) this device must accept any interference received, including interference that may cause undesired operation.

FCC WARNING:

Changes or modifications not expressly approved by the party responsible for compliance could void the user's authority to operate the equipment.

**NOTICE****■ To prevent key damage**

- Do not drop the keys, subject them to strong shocks or bend them.
- Do not expose the keys to high temperatures for long periods of time.
- Do not get the keys wet or wash them in an ultrasonic washer etc.
- Do not attach metallic or magnetic materials to the keys or place the keys close to such materials.
- Do not disassemble the keys.
- Do not attach a sticker or anything else to the surface of the electronic key.
- Do not place the keys near objects that produce magnetic fields, such as TVs, audio systems and induction cookers, or medical electrical equipment, such as low-frequency therapy equipment.

**■ Carrying the electronic key on your person**

Carry the electronic key 3.9 in. (10 cm) or more away from electric appliances that are turned on. Radio waves emitted from electric appliances within 3.9 in. (10 cm) of the electronic key may interfere with the key, causing the key to not function properly.

**■ In case of a smart key system malfunction or other key-related problems**

Take your vehicle with all the electronic keys provided with your vehicle to your Toyota dealer.

**■ When an electronic key is lost**

If the electronic key remains lost, the risk of vehicle theft increases significantly. Visit your Toyota dealer immediately with all remaining electronic keys that was provided with your vehicle.

## Doors

### Unlocking and locking the doors from the outside

#### ◆ Smart key system

Carry the electronic key to enable this function.

- ① Grip the driver's door handle to unlock the door. Some models, grip the passenger's door handle to unlock all the doors.\*

Make sure to touch the sensor on the back of the handle.

The doors cannot be unlocked for 3 seconds after the doors are locked.

\*: The door unlock settings can be changed. (→P. 114)

- ② Touch the lock sensor (the indentation on the upper part of the door handle) to lock all the doors.

Check that the door is securely locked.

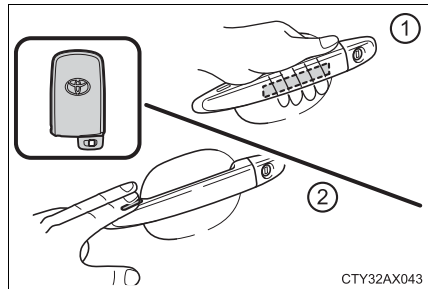

CTY32AX043

#### ◆ Wireless remote control

- ① Locks all the doors

Check that the door is securely locked.

- ② Unlocks all the doors

Pressing the button unlocks the driver's door. Pressing the button again within 5 seconds unlocks the other doors.

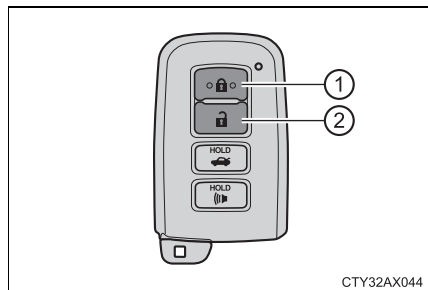

CTY32AX044

### ■ Operation signals

A buzzer sounds and the emergency flashers flash to indicate that the doors have been locked/unlocked. (Locked: once; Unlocked: twice)

### ■ Security feature

If a door is not opened within approximately 60 seconds after the vehicle is unlocked, the security feature automatically locks the vehicle again.

### ■ When the door cannot be locked by the lock sensor on the upper part of the door handle

If the door will not lock even when the top-side sensor area is touched, try touching both the topside and underside sensor areas at the same time.

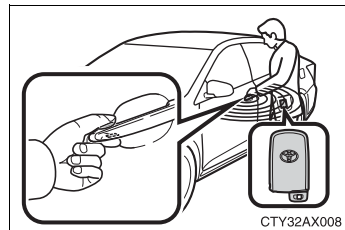

### ■ Door lock buzzer

If an attempt to lock the doors is made when a door is not fully closed, a buzzer sounds continuously for 5 seconds. Fully close the door to stop the buzzer, and lock the vehicle once more.

### ■ Alarm

Locking the doors will set the alarm system. (→P. 81)

### ■ If the smart key system or the wireless remote control does not operate properly

Use the mechanical key to lock and unlock the doors. (→P. 422)

Replace the battery with a new one if it is depleted. (→P. 373)

## Unlocking and locking the doors from the inside

### ◆ Door lock switches

- ① Locks all the doors
- ② Unlocks all the doors

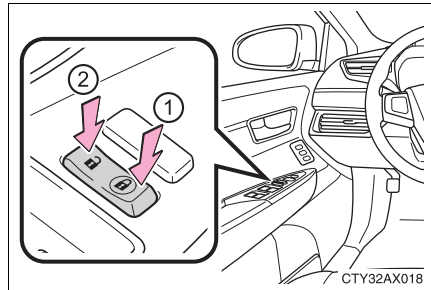

### ◆ Inside lock buttons

- ① Unlocks the door
- ② Locks the door

The front doors can be opened by pulling the inside handle even if the lock buttons are in the lock position.

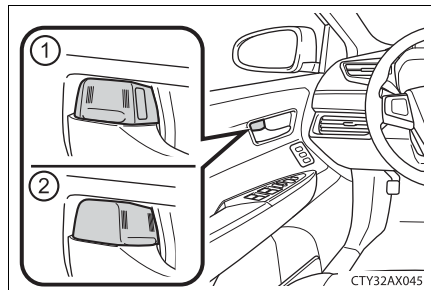

## Locking the front doors from the outside without a key

- 1 Move the inside lock button to the lock position.
- 2 Close the door.

The door cannot be locked if the power switch is in ACCESSORY or ON mode, or the electronic key is left inside the vehicle.

The key may not be detected correctly and the door may be locked.



### Rear door child-protector lock

The door cannot be opened from inside the vehicle when the lock is set.

- ① Unlock
- ② Lock

These locks can be set to prevent children from opening the rear doors. Push down on each rear door switch to lock both rear doors.

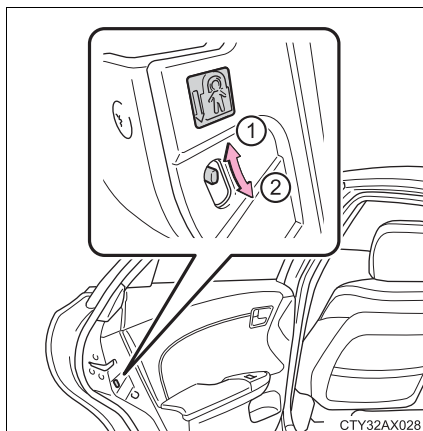

### Automatic door locking and unlocking systems





The following functions can be set or canceled:

For instructions on customizing, refer to P. 461.



Function	Operation
Speed linked door locking function	All doors are automatically locked when vehicle speed is approximately 12 mph (20 km/h) or higher.
Shift position linked door locking function	All doors are automatically locked when shifting the shift lever to position other than P.
Shift position linked door unlocking function	All doors are automatically unlocked when shifting the shift lever to P.
Driver's door linked door unlocking function	All doors are automatically unlocked when driver's door is opened.

### ■ Switching the door unlock function (some models)

It is possible to set which doors the entry function unlocks using the wireless remote control.

- 1 Turn the power switch off.
- 2 When the indicator light on the key surface is not on, press and hold  ,  or  for approximately 5 seconds while pressing and holding  .

The setting changes each time an operation is performed, as shown below. (When changing the setting continuously, release the buttons, wait for at least 5 seconds, and repeat step 2.)

Multi-information display	Unlocking function	Beep
	Holding the driver's door handle unlocks only the driver's door.	Exterior: Beeps 3 times Interior: Pings once
	Holding a passenger's door handle unlocks all the doors.	
	Holding either front door handle unlocks all the doors.	Exterior: Beeps twice Interior: Pings once

To prevent unintended triggering of the alarm, unlock the doors using the wireless remote control and open and close a door once after the settings have been changed. (If a door is not opened within 60 seconds after  is pressed, the doors will be locked again and the alarm will automatically be set.)

In case that the alarm is triggered, immediately stop the alarm. (→P. 81)

### ■ Using the mechanical key

The doors can also be locked and unlocked with the mechanical key. (→P. 422)

### ■ Conditions affecting the operation of the smart key system or wireless remote control

→P. 126

### ■ Customization

Settings (e.g. unlocking function using a key) can be changed. (Customizable features: →P. 461)

**WARNING****■ To prevent an accident**

Observe the following precautions while driving the vehicle.

Failure to do so may result in a door opening and an occupant throwing out of the vehicle, resulting in death or serious injury.

- Ensure that all doors are properly closed and locked.
- Do not pull the inside handle of the doors while driving.  
Be especially careful for the front doors, as the doors may be opened even if the inside lock buttons are in locked position.
- Set the rear door child-protector locks when children are seated in the rear seats.

## Trunk

The trunk can be opened using the trunk opener, entry function or wireless remote control.

### Opening the trunk from inside the vehicle

Press the opener switch.

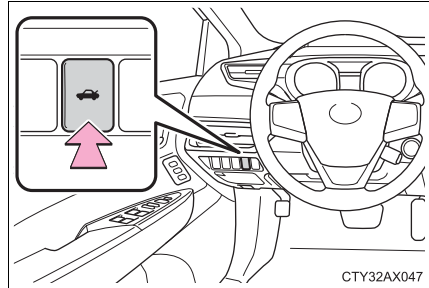

### Opening the trunk from outside the vehicle

#### ◆ Smart key system

While carrying the electronic key, press the button on the trunk lid.

When all the doors are unlocked with the power door lock system, the trunk can be opened without carrying the electronic key.

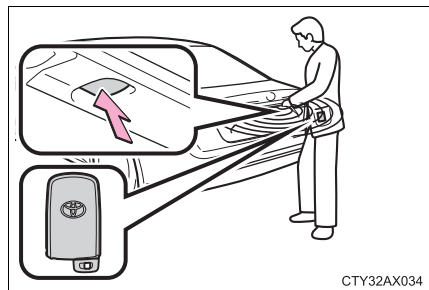

#### ◆ Wireless remote control

Press and hold the switch.

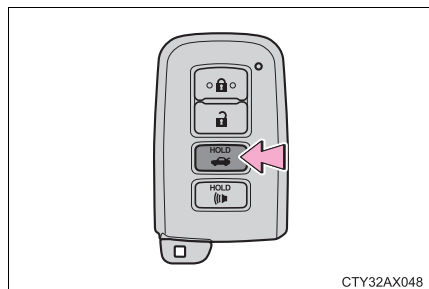

### When closing the trunk

Using the trunk grip, lower the trunk without applying force to the side and push the trunk down from the outside to close it.

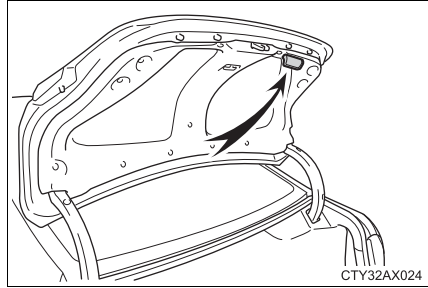

### Luggage security system

The trunk opener switch can be temporarily disabled to protect luggage stored in the trunk against theft.

Turn the main switch in the glove box off to disable the trunk opener.

- ① On
- ② Off

The trunk lid cannot be opened even with the wireless remote control or the entry function.

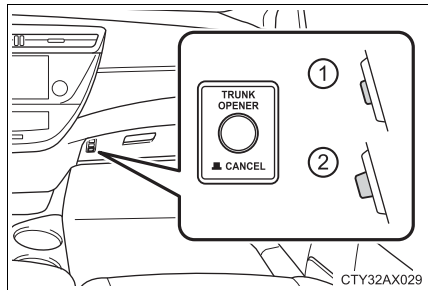

### ■ Operation signal

A buzzer sounds to indicate that the trunk has been opened.

### ■ Trunk light

The trunk light turns on when the trunk is opened.

### ■ Function to prevent the trunk being locked with the electronic key inside

- When all doors are being locked, closing the trunk lid with the electronic key left inside the trunk will sound an alarm.  
In this case, the trunk lid can be opened pressing the trunk release button on the trunk lid.
- Even when the spare electronic key is put in the trunk with all the doors locked, the key confinement prevention function can be activated so the trunk can be opened. In order to prevent theft, take all electronic keys with you when leaving the vehicle.
- Even when the electronic key is put in the trunk with all the doors are locked, the key may not be detected depending on the places and the surrounding radio wave conditions. In this case, the key confinement prevention function cannot be activated, causing the doors to lock when the trunk is closed. Make sure to check where the key is before closing the trunk.
- The key confinement prevention function cannot be activated if any one of the doors is unlocked. In this case, open the trunk using the trunk opener.

### ■ Internal trunk release lever

The trunk lid can be opened by pulling the glow-in-the-dark lever located on the inside of the trunk lid.

The lever will continue to glow for some time after the trunk lid is closed.

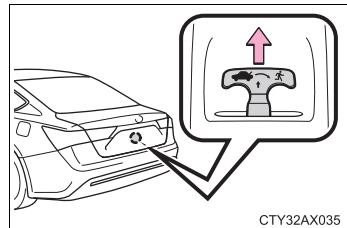

### ■ In case the trunk opener is not actuated

- 1 Pull down the rear armrest and open the door behind it.

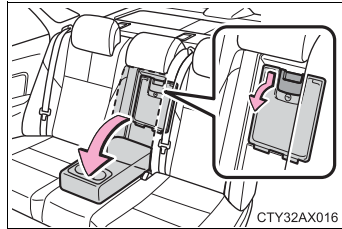

- 2 Pull the loop of wire to unlock the trunk lid.

This is used in case the trunk lid cannot be unlocked due to a discharged battery or other trouble.

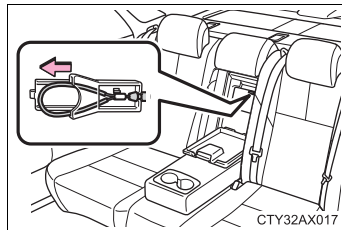

### ■ When leaving a key to the vehicle with a parking attendant

→P. 107

### ■ Customization

The trunk opener main switch can be deactivated.  
(Customizable feature: →P. 461)

### ⚠ WARNING

Observe the following precautions.  
Failure to do so may result in death or serious injury.

#### ■ Before driving

- Make sure that the trunk lid is fully closed. If the trunk lid is not fully closed, it may open unexpectedly while driving and hit near-by objects or luggage in the trunk may be thrown out, causing an accident.
- Do not allow children to play in the trunk.  
If a child is accidentally locked in the trunk, they could suffer from heat exhaustion, suffocation or other injuries.
- Do not allow a child to open or close the trunk lid.  
Doing so may cause the trunk lid to open unexpectedly, or cause the child's hands, head, or neck to be caught by the closing trunk lid.

#### ■ Important points while driving

Never let anyone sit in the trunk. In the event of sudden braking or a collision, they are susceptible to death or serious injury.

**⚠ WARNING****■ Using the trunk**

Observe the following precautions.

Failure to do so may cause parts of the body to be caught, resulting in serious injury.

- Remove any heavy loads, such as snow and ice, from the trunk lid before opening it. Failure to do so may cause the trunk lid to suddenly shut again after it is opened.
- When opening or closing the trunk lid, thoroughly check to make sure the surrounding area is safe.
- If anyone is in the vicinity, make sure they are safe and let them know that the trunk is about to open or close.
- Use caution when opening or closing the trunk lid in windy weather as it may move abruptly in strong wind.

- The trunk lid may suddenly shut if it is not opened fully. It is more difficult to open or close the trunk lid on an incline than on a level surface, so beware of the trunk lid unexpectedly opening or closing by itself. Make sure that the trunk lid is fully open and secure before using the trunk.

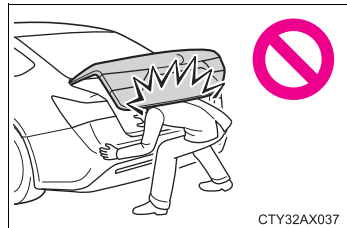

- When closing the trunk lid, take extra care to prevent your fingers etc. from being caught.
- When closing the trunk lid, make sure to press it lightly on its outer surface. If the trunk handle is used to fully close the trunk lid, it may result in hands or arms being caught.

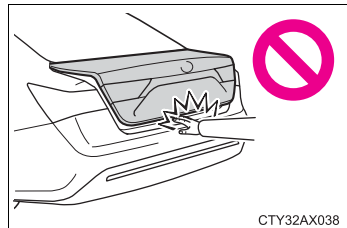

- Do not attach any accessories other than genuine Toyota parts to the trunk lid. Such additional weight on the trunk lid may cause the lid to suddenly shut again after it is opened.



## Smart key system

The following operations can be performed simply by carrying the electronic key on your person, for example in your pocket. (The driver should always carry the electronic key.)

- Locks and unlocks the doors (→P. 110)
- Opens the trunk (→P. 116)
- Starts the hybrid system (→P. 172)

### ■ Antenna location

- ① Antennas outside the cabin
- ② Antennas inside the cabin
- ③ Antenna inside the trunk
- ④ Antenna outside the trunk

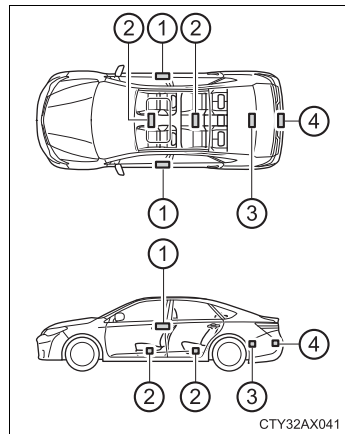

### ■ Effective range (areas within which the electronic key is detected)

- When locking or unlocking the doors

The system can be operated when the electronic key is within about 2.3 ft. (0.7 m) of an outside door handle. (Only the doors detecting the key can be operated.)

- When unlocking the trunk

The system can be operated when the electronic key is within about 2.3 ft. (0.7 m) of the trunk release button.

- When starting the hybrid system or changing power switch modes

The system can be operated when the electronic key is inside the vehicle.

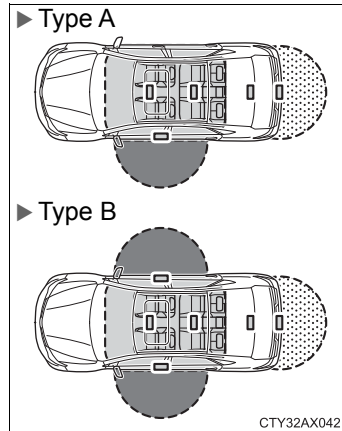

### ■ Alarms and warning indicators

An alarm sounds and warning message displays shown on the multi-information display are used to protect against unexpected accidents or theft of the vehicle resulting from erroneous operation. When a warning message is displayed, take appropriate measures based on the displayed message. (→P. 407)

When only an alarm sounds, circumstances and correction procedures are as follows.

Alarm	Situation	Correction procedure
Exterior alarm sounds once for 5 seconds	An attempt was made to lock the doors using the smart key system while the electronic key was still inside the vehicle.	Retrieve the electronic key from the passenger compartment and lock the doors again.
	The trunk was closed while the electronic key was still inside the trunk and all the doors were locked.	Retrieve the electronic key from the trunk and close the trunk lid.
	An attempt was made to lock the vehicle while a door was open.	Close all of the doors and lock the doors again.

Alarm	Situation	Correction procedure
Interior alarm pings once and exterior alarm sounds once for 5 seconds	An attempt was made to lock either front door by opening a door and putting the inside lock button into the lock position, then closing the door with the electronic key still inside the vehicle.	Retrieve the electronic key from the vehicle and lock the doors again.
Interior alarm sounds continuously	The power switch was turned to ACCESSORY mode while the driver's door was open (The driver's door was opened when the power switch was in ACCESSORY mode.)	Turn the power switch off and close the driver's door.
	The driver's door was opened while any shift position other than P was selected without turning off the power switch.	Shift the shift lever to P.

The following table describes circumstances and correction procedures when alarms are sounded and a message or key icon is displayed.

Interior buzzer	Exterior buzzer	Situation	Correction procedure
Continuous	Continuous	The electronic key was carried outside the vehicle and the driver's door was opened and closed while any shift position other than P was selected without turning off the power switch.	<ul style="list-style-type: none"> <li>• Change the shift position to P.</li> <li>• Bring the electronic key back into the vehicle.</li> </ul>
Once	3 times	The electronic key was carried outside the vehicle and the driver's door was opened and closed while the shift position P was selected without turning off the power switch.	Turn the power switch off or bring the electronic key back into the vehicle.
Once	3 times	Indicates that a door other than the driver's door has been opened and closed with the power switch in any mode other than off and the electronic key outside of the detection area.	Confirm the location of the electronic key.
Once	Continuous (5 seconds)	An attempt was made to exit the vehicle with the electronic key and lock the doors without first turning the power switch off.	Turn the power switch off and lock the doors again.
Once	—	Indicates that the electronic key is not present when attempting to start the hybrid system.	Confirm the location of the electronic key.
9 times	—	An attempt was made to drive when the regular key was not inside the vehicle.	Confirm that the electronic key is inside the vehicle.
Once	—	Indicates that the electronic key battery is low.	Replace the battery. (→P. 373)
Once	—	Indicates that the steering lock has not been released.	Release the steering lock. (→P. 175)

Interior buzzer	Exterior buzzer	Situation	Correction procedure
Once	—	<ul style="list-style-type: none"> <li>When the doors were unlocked with the mechanical key and then the power switch was pressed, the electronic key could not be detected in the vehicle.</li> <li>The electronic key could not be detected in the vehicle even after the power switch was pressed two consecutive times.</li> </ul>	Touch the electronic key to the power switch while depressing the brake pedal.



### ■ Battery-saving function

The battery-saving function will be activated in order to prevent the electronic key battery and the 12-volt battery from being discharged while the vehicle is not in operation for a long time.

- In the following situations, the smart key system may take some time to unlock the doors.
  - The electronic key has been left in an area of approximately 6 ft. (2 m) of the outside of the vehicle for 10 minutes or longer.
  - The smart key system has not been used for 5 days or longer.
- If the smart key system has not been used for 14 days or longer, the doors cannot be unlocked at any doors except the driver's door. In this case, take hold of the driver's door handle, or use the wireless remote control or the mechanical key, to unlock the doors.

### ■ Electronic Key battery-Saving Function

When battery-saving mode is set, battery depletion is minimized by stopping the electronic key from receiving radio waves.

Press  twice while pressing and holding . Confirm that the electronic key indicator flashes 4 times.

While the battery-saving mode is set, the smart key system cannot be used. To cancel the function, press any of the electronic key buttons.

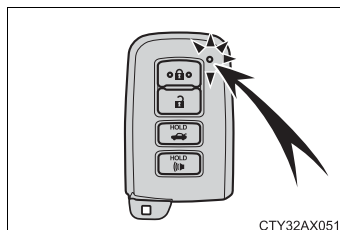

### ■ Conditions affecting operation

The smart key system uses weak radio waves. In the following situations, the communication between the electronic key and the vehicle may be affected, preventing the smart key system, wireless remote control and immobilizer system from operating properly. (Ways of coping: →P. 422)

- When the electronic key battery is depleted
- Near a TV tower, electric power plant, gas station, radio station, large display, airport or other facility that generates strong radio waves or electrical noise
- When carrying a portable radio, cellular phone, cordless phone or other wireless communication device
- When the electronic key is in contact with, or is covered by the following metallic objects
  - Cards to which aluminum foil is attached
  - Cigarette boxes that have aluminum foil inside
  - Metallic wallets or bags
  - Coins
  - Hand warmers made of metal
  - Media such as CDs and DVDs
- When other wireless keys (that emit radio waves) are being used nearby
- When carrying the electronic key together with the following devices that emit radio waves
  - Another vehicle's electronic key or a wireless key that emits radio waves
  - Personal computers or personal digital assistants (PDAs)
  - Digital audio players
  - Portable game systems
- If window tint with a metallic content or metallic objects are attached to the rear window

**■ Note for the entry function**

- Even when the electronic key is within the effective range (detection areas), the system may not operate properly in the following cases:
  - The electronic key is too close to the window or outside door handle, near the ground, or in a high place when the doors are locked or unlocked.
  - The electronic key is near the ground or in a high place, or too close to the rear bumper center when the trunk is opened.
  - The electronic key is on the instrument panel, rear package tray or floor, or in the door pockets or glove box when the hybrid system is started or power switch modes are changed.
- Do not leave the electronic key on top of the instrument panel or near the door pockets when exiting the vehicle. Depending on the radio wave reception conditions, it may be detected by the antenna outside the cabin and the door will become lockable from the outside, possibly trapping the electronic key inside the vehicle.
- As long as the electronic key is within the effective range, the doors may be locked or unlocked by anyone. However, only the doors detecting the electronic key can be used to unlock the vehicle.
- Even if the electronic key is not inside the vehicle, it may be possible to start the hybrid system if the electronic key is near the window.
- The doors may unlock or lock if a large amount of water splashes on the door handle, such as in the rain or in a car wash when the electronic key is within the effective range. (The doors will automatically be locked after approximately 60 seconds if the doors are not opened and closed.)
- If the wireless remote control is used to lock the doors when the electronic key is near the vehicle, there is a possibility that the door may not be unlocked by the entry function. (Use the wireless remote control to unlock the doors.)

**■ Note for locking the doors**

- Touching the door lock sensor while wearing gloves may delay or prevent lock operation. Remove the gloves and touch the lock sensor again.
- If the door handle becomes wet while the electronic key is within the effective range, the door may lock and unlock repeatedly. In that case, follow the following correction procedures to wash the vehicle:
  - Place the electronic key in a location 6 ft. (2 m) or more away from the vehicle. (Take care to ensure that the key is not stolen.)
  - Set the electronic key to battery-saving mode to disable the smart key system. (→P. 125)
- If the electronic key is inside the vehicle and a door handle becomes wet during a car wash, a message may be shown on the multi-information display and a buzzer will sound outside the vehicle. To turn off the alarm, lock all the doors.
- The lock sensor may not work properly if it comes into contact with ice, snow, mud, etc. Clean the lock sensor and attempt to operate it again, or use the lock sensor on the lower part of the door handle.
- Fingernails may scrape against the door during operation of the door handle. Be careful not to injure fingernails or damage the surface of the door.

**■ Note for the unlocking function**

- A sudden approach to the effective range or door handle may prevent the doors from being unlocked. In this case, return the door handle to the original position and check that the doors unlock before pulling the door handle again.
- Gripping the door handle when wearing a glove may not unlock the door.
- If the door handle becomes wet while the electronic key is within the effective range, the door may lock and unlock repeatedly. In that case, follow the following correction procedures to wash the vehicle:
  - Place the electronic key in a location 6 ft. (2 m) or more away from the vehicle. (Take care to ensure that the key is not stolen.)
  - Set the electronic key to battery-saving mode to disable the smart key system. (→P. 125)
- If there is another electronic key in the detection area, it may take slightly longer to unlock the doors after the door handle is gripped.
- Fingernails may scrape against the door during operation of the door handle. Be careful not to injure fingernails or damage the surface of the door.



### ■ When the vehicle is not driven for extended periods

- To prevent theft of the vehicle, do not leave the electronic key within 6 ft. (2 m) of the vehicle.
- The smart key system can be deactivated in advance. (→P. 461)

### ■ To operate the system properly

- Make sure to carry the electronic key when operating the system. Do not get the electronic key too close to the vehicle when operating the system from the outside of the vehicle.

Depending on the position and holding condition of the electronic key, the key may not be detected correctly and the system may not operate properly. (The alarm may go off accidentally, or the door lock prevention function may not operate.)

- Do not leave the electronic key inside the luggage compartment. The key confinement prevention function may not operate, depending on the location of the key (close to a spare tire, the inside edge of the luggage compartment), conditions (inside a metal bag, close to metallic objects) and the radio waves in the surrounding area. (→P. 118)

### ■ If the smart key system does not operate properly

- Locking and unlocking the doors: Use the mechanical key. (→P. 422)
- Unlocking the trunk: →P. 119
- Starting the hybrid system: →P. 423

### ■ When the electronic key battery is fully depleted

→P. 373

### ■ Customization

Settings (e. g. operation signal) can be changed.  
(Customizable features: →P. 461)

### ■ If the smart key system has been deactivated in a customized setting

- Locking and unlocking the doors: →P. 110, 422
- Unlocking the trunk: →P. 119
- Starting the hybrid system and changing power switch modes: →P. 423
- Stopping the hybrid system: →P. 173

### ■ Certification for the smart key system

FCC ID: NI4TMLF10-51

FCC ID: NI4TMLF10-54

#### NOTE:

This device complies with part 15 of the FCC Rules. Operation is subject to the following two conditions: (1) This device may not cause harmful interference, and (2) this device must accept any interference received, including interference that may cause undesired operation.

#### FCC WARNING:

Changes or modifications not expressly approved by the party responsible for compliance could void the user's authority to operate the equipment.

**WARNING****■ Caution regarding interference with electronic devices**

- People with implantable cardiac pacemakers, cardiac resynchronization therapy-pacemakers or implantable cardioverter defibrillators should keep away from the smart key system antennas. (→P. 121)

The radio waves may affect the operation of such devices. If necessary, the entry function can be disabled. Ask your Toyota dealer for details, such as the frequency of radio waves and timing of the emitted radio waves. Then, consult your doctor to see if you should disable the entry function.

- Users of any electrical medical device other than implantable cardiac pacemakers, cardiac resynchronization therapy-pacemakers or implantable cardioverter defibrillators should consult the manufacturer of the device for information about its operation under the influence of radio waves.

Radio waves could have unexpected effects on the operation of such medical devices.

Ask your Toyota dealer for details on disabling the entry function.

## Front seats

### Adjustment procedure

#### ► Driver's seat

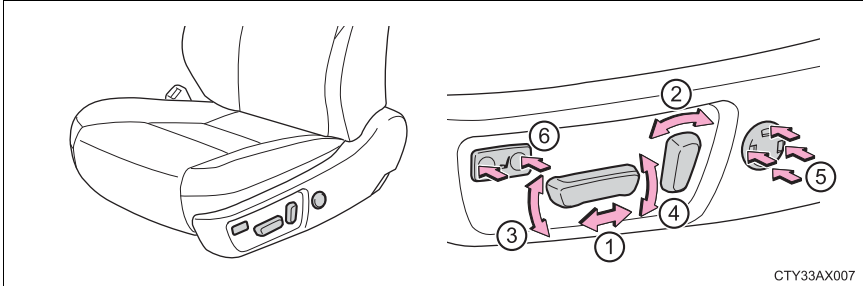

#### ► Passenger's seat

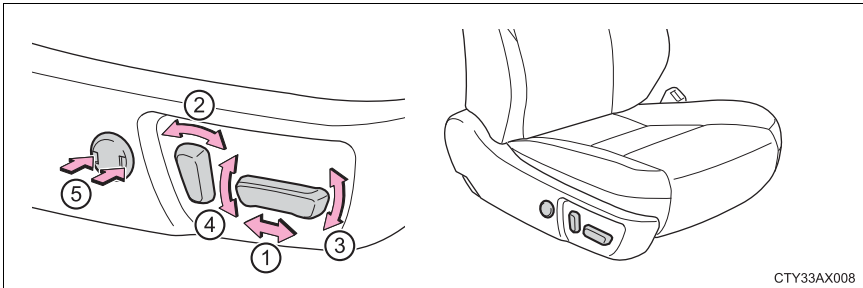

- |   |  |
|---|--|
| ① Seat position adjustment switch   | ④ Vertical height adjustment switch (if equipped for passenger's seat) |
| ② Seatback angle adjustment switch  | ⑤ Lumbar support adjustment switch (if equipped for passenger's seat)  |
| ③ Seat cushion (front) angle adjustment switch (if equipped for passenger's seat) | ⑥ Seat cushion length adjustment switch (if equipped)                  |

**■ Power easy access system (vehicles with driving position memory)**

The auto away/return function enables easy access by activating when the driver attempts to enter or exit the vehicle.

- When the power switch has been turned to ON mode or the driver's seat belt has been fastened, the driver's seat will move forward.
- When the power switch has been turned off and the driver's seat belt has been unfastened, the driver's seat will move backward.

**■ Customization**

Settings (e.g. driver's seat movement when exiting the vehicle) can be changed. (Customizable features: →P. 461)

**WARNING****■ When adjusting the seat position**

- Take care when adjusting the seat position to ensure that other passengers are not injured by the moving seat.
- Do not put your hands under the seat or near the moving parts to avoid injury.  
Fingers or hands may become jammed in the seat mechanism.

**■ Seat adjustment**

To reduce the risk of sliding under the lap belt during a collision, do not recline the seat more than necessary.

If the seat is too reclined, the lap belt may slide past the hips and apply restraint forces directly to the abdomen, or your neck may contact the shoulder belt, increasing the risk of death or serious injury in the event of an accident.

Adjustments should not be made while driving as the seat may unexpectedly move and cause the driver to lose control of the vehicle.

**■ When adjusting the seat positions**

Make sure to leave enough space around the feet so they do not get stuck.

## Driving position memory\*

**This feature automatically adjusts the driver's seat and outside rear view mirrors to make entering and exiting the vehicle easier or to suit your preferences.**

### Power easy access system

The seat is automatically adjusted to allow the driver to enter and exit the vehicle easily.

When all of the following have been performed, the driver's seat is automatically adjusted to a position that allows driver to enter and exit the vehicle easily.

- The shift lever has been shifted to P.
- The power switch has been turned off.
- The driver's seat belt has been unfastened.

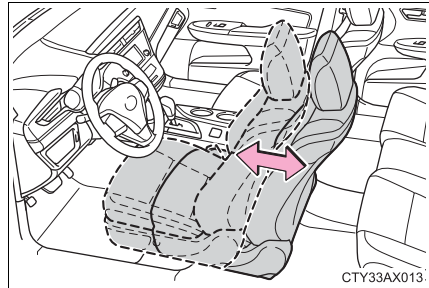

When any of the following is performed, the driver's seat automatically returns to its original position.

- The power switch has been turned to ACCESSORY or ON mode.
- The driver's seat belt has been fastened.

#### ■ Operation of the power easy access system

When exiting the vehicle, the power easy access system may not operate if the seat is already close to the rearmost position, etc.

#### ■ Customization

The seat movement amount settings of the power easy access system can be customized. (Customizable features: →P. 461)

## Driving position memory

Your preferred driving position (the position of the driver's seat and outside rear view mirrors) can be recorded and recalled by pressing a button.

Two different driving positions can be recorded into memory.

### ■ Recording procedure

- 1 Check that the shift lever is in P.
- 2 Turn the power switch to ON mode.
- 3 Adjust the driver's seat and outside rear view mirrors to the desired positions.
- 4 While pressing the "SET" button, or within 3 seconds after the "SET" button is pressed, press button "1" or "2" until the signal beeps.

If the selected button has already been preset, the previously recorded position will be overwritten.

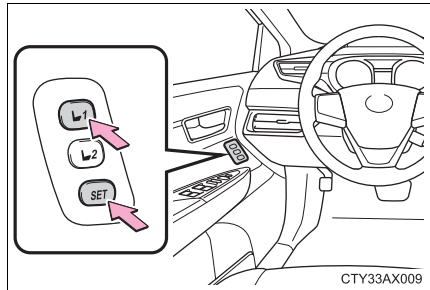

### ■ Recall procedure

- 1 Check that the shift lever is in P.
- 2 Turn the power switch to ON mode.
- 3 Press button "1" or "2" to recall the desired position.

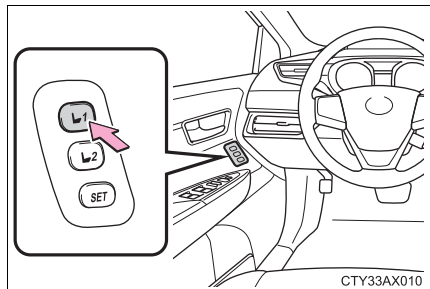

---

**■ To stop the position recall operation part-way through**

Perform any of the following:

- Press the “SET” button.
- Press button “1” or “2”.
- Adjust the seat using the switches (only cancels seat position recall).

**■ Seat positions that can be memorized (→P. 131)**

The seat position, with the exception of the portions adjusted by the seat cushion length switch and lumbar support switch, can be recorded.

**■ Operating the driving position memory after turning the power switch off**

Recorded seat positions can be activated up to 180 seconds after the driver’s door is opened and another 60 seconds after it is closed again.

**■ In order to correctly use the driving position memory function**

If a seat position is already in the furthest possible position and the seat is operated in the same direction, the recorded position may be slightly different when it is recalled.

## Memory recall function

Each electronic key can be registered to recall your preferred driving position.

### ■ Registering procedure

Record your driving position to button “1” or “2” before performing the following:

Carrying only the key to which you want to link the driving position, shift the shift lever to P and then close the driver’s door.

If 2 or more keys are in the vehicle, the driving position cannot be linked properly.

- 1 Turn the power switch to ON mode and recall the position which you want to link.
- 2 While pressing the button to recall the position, press the driver’s door lock switch (either lock or unlock) until the signal beeps.

The driving position is recalled when the driver’s door is unlocked using the entry function or wireless remote control and the driver’s door is opened.

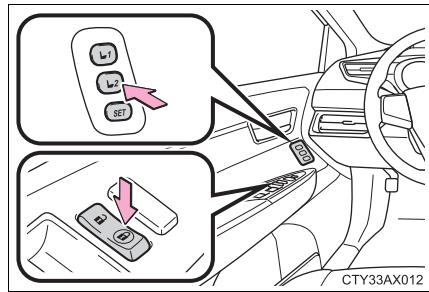

### ■ Recall procedure

- 1 Carry the electronic key that has been registered to the driving position, and then unlock and open the driver’s door using the smart key system or wireless remote control.

The driving position will move to the recorded position. However, the seat will move to a position slightly behind the recorded position in order to make entering the vehicle easier.

If the driving position is in a position that has already been recorded, the seat and outside rear view mirrors will not move.

- 2 Turn the power switch to ACCESSORY or ON mode, or fasten a seat belt.

The seat will move to the recorded position.



### ■ Cancellation procedure

Carry only the key to which you want to cancel the linked door unlock operation.

If 2 or more keys are in the vehicle, the driving position cannot be canceled properly.

- 1 Turn the power switch to ON mode.
- 2 While pressing the “SET” button, press the driver’s door lock switch (either lock or unlock) until the signal beeps.

---

### ■ Recalling the driving position using the memory recall function

- Different driving positions can be registered for each electronic key. Therefore, the driving position that is recalled may be different depending on the key being carried.
- If a door other than the driver’s door is unlocked with the smart key system, the driving position cannot be recalled. In this case, press the driving position button which has been set.

### ■ Customization

The unlock door settings of the memory recall function can be customized. (Customizable features: →P. 461)

#### WARNING

#### ■ Seat adjustment caution

Take care during seat adjustment so that the seat does not strike the rear passenger or squeeze your body against the steering wheel.

## Head restraints

Head restraints are provided for all seats.

### Front seats

#### Vertical adjustment

- ① Up  
Pull the head restraints up.
- ② Down  
Push the head restraint down while pressing the lock release button.

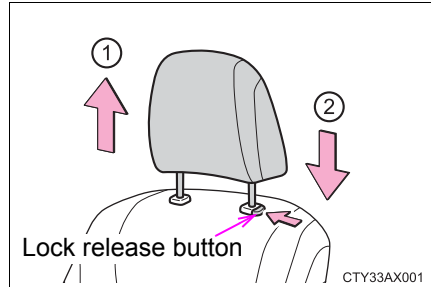

### Rear seats (except center seat)

- ① Up  
Pull the head restraints up.
- ② Down  
Push the head restraint down while pressing the lock release button.

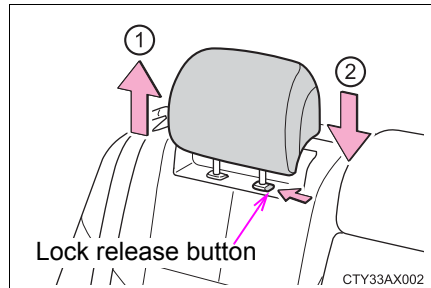

### ■ Removing the head restraints (except rear center seat)

Pull the head restraint up while pressing the lock release button.

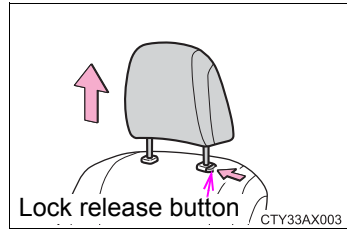

### ■ Installing the head restraints

#### ▶ Front seats

Align the head restraint with the installation holes and push it down to the lock position.

Press and hold the lock release button when lowering the head restraint.

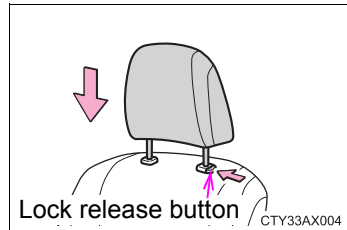

#### ▶ Rear seats (except center seat)

Align the head restraint with the installation holes and push it down to the lowest lock position while pressing the lock release button.

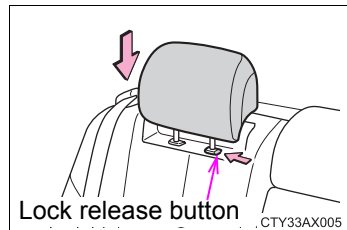

### ■ Adjusting the height of the head restraints (except rear center seat)

Make sure that the head restraints are adjusted so that the center of the head restraint is closest to the top of your ears.

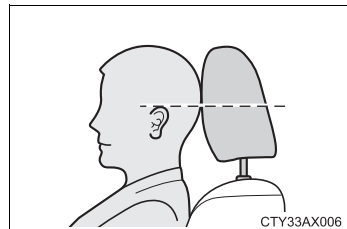

### ■ Adjusting the rear seat head restraint (except center seat)

Always raise the head restraint one level from the stowed position when using.

**WARNING****■ Head restraint precautions**

Observe the following precautions regarding the head restraints. Failure to do so may result in death or serious injury.

- Use the head restraints designed for each respective seat.
- Adjust the head restraints to the correct position at all times.
- After adjusting the head restraints, push down on them and make sure they are locked in position.
- Do not drive with the head restraints removed.

## Steering wheel

The steering wheel can be adjusted to a comfortable position.

### Adjustment procedure

- 1 Hold the steering wheel and push the lever down.

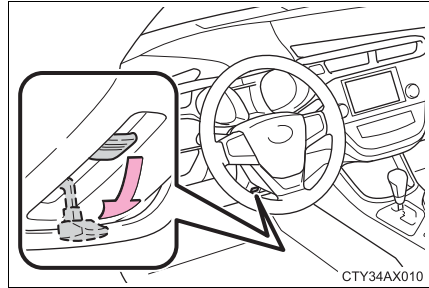

- 2 Adjust to the ideal position by moving the steering wheel horizontally and vertically.  
After adjustment, pull the lever up to secure the steering wheel.

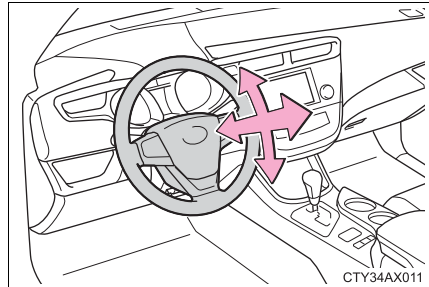

### Horn

To sound the horn, press on or close to the  mark.

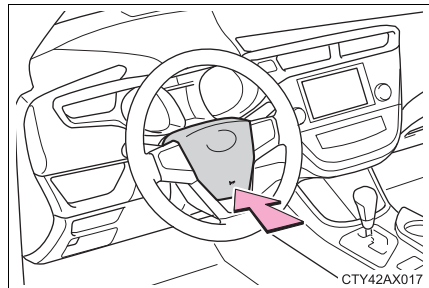

**WARNING****■ Caution while driving**

Do not adjust the steering wheel while driving.

Doing so may cause the driver to mishandle the vehicle and cause an accident, resulting in death or serious injury.

**■ After adjusting the steering wheel**

Make sure that the steering wheel is securely locked.

Otherwise, the steering wheel may move suddenly, possibly causing an accident, and resulting in death or serious injury. Also, the horn may not sound if the steering wheel is not securely locked.

## Inside rear view mirror

The rear view mirror's position can be adjusted to enable sufficient confirmation of the rear view.

### Adjusting the height of rear view mirror

The height of the rear view mirror can be adjusted to suit your driving posture.

Adjust the height of the rear view mirror by moving it up and down.

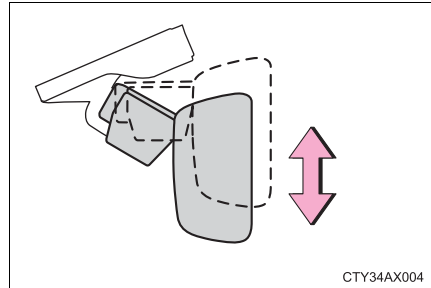

### Anti-glare function

► Manual anti-glare inside rear view mirror

Reflected light from the headlights of vehicles behind can be reduced by operating the lever.

- ① Normal position
- ② Anti-glare position

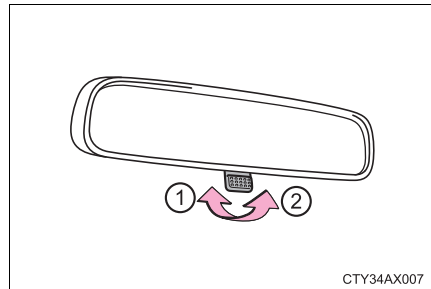

► Auto anti-glare inside rear view mirror

Responding to the level of brightness of the headlights of vehicles behind, the reflected light is automatically reduced.

Changing automatic anti-glare function mode

ON/OFF

When the automatic anti-glare function is in ON mode, the indicator illuminates.

The function will set to ON mode each time the power switch is turned to ON mode.

Pressing the button turns the function to OFF mode. (The indicator also turns off.)

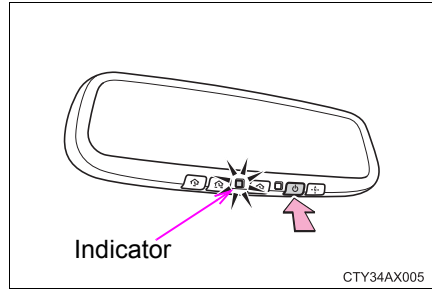

■ To prevent sensor error (vehicles with an auto anti-glare inside rear view mirror)

To ensure that the sensors operate properly, do not touch or cover them.

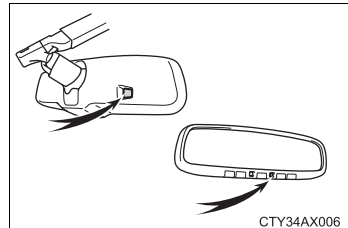

**! WARNING**

Do not adjust the position of the mirror while driving. Doing so may lead to mishandling of the vehicle and cause an accident, resulting in death or serious injury.



## Outside rear view mirrors

### Adjustment procedure

- 1 To select a mirror to adjust, press the switch.

- ① Left
- ② Right

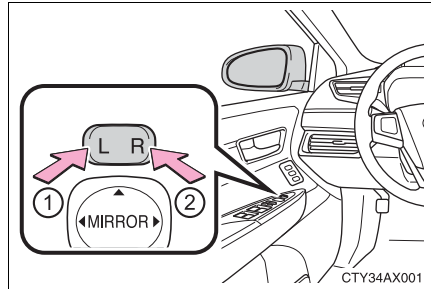

- 2 To adjust the mirror, press the switch.

- ① Up
- ② Right
- ③ Down
- ④ Left

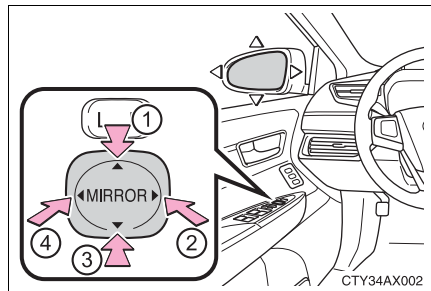

### Folding the mirrors

Push the mirror back in the direction of the vehicle's rear.

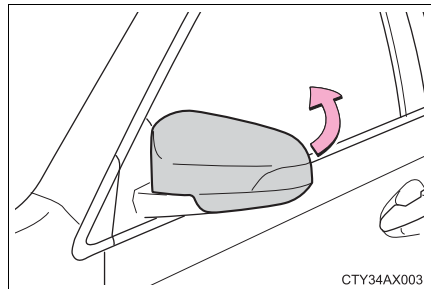

### **Linked mirror function when reversing (vehicles with driving position memory)**

When the mirror select switch is in the L or R position, the outside rear view mirrors will automatically angle downwards when the vehicle is reversing in order to give a better view of the ground.

To disable this function, move the mirror select switch to the neutral position (between L and R).

#### **■ Adjusting the mirror angle when the vehicle is reversing**

With the shift lever in R, adjust the mirror angle at a desired position. The adjusted angle will be memorized and the mirror will automatically tilt to the memorized angle whenever the shift lever is shifted to R from next time.

The memorized downward tilt position of the mirror is linked to the normal position (angle adjusted with the shift lever in other than R). Therefore, if the normal position is changed after adjustment, the tilt position will also change.

If the normal position is changed, readjust the tilt down angle.

---

#### **■ Mirror angle can be adjusted when**

The power switch is in ACCESSORY or ON mode.

#### **■ When the mirrors are fogged up**

The outside rear view mirrors can be cleared using the mirror defoggers. Turn on the rear window defogger to turn on the outside rear view mirror defoggers. (→P. 278)

#### **■ Automatic adjustment of the mirror angle (vehicles with driving position memory)**

A desired mirror face angle can be entered to memory and recalled automatically by the driving position memory. (→P. 133)

#### **■ Auto anti-glare function (vehicles with outer foot lights)**

When the anti-glare inside rear view mirror is set to automatic mode, the outside rear view mirrors will activate in conjunction with the anti-glare inside rear view mirror to reduce reflected light. (→P. 143)

**WARNING****■ Important points while driving**

Observe the following precautions while driving.

Failure to do so may result in loss of control of the vehicle and cause an accident, resulting in death or serious injury.

- Do not adjust the mirrors while driving.
- Do not drive with the mirrors folded.
- Both the driver and passenger side mirrors must be extended and properly adjusted before driving.

**■ When a mirror is moving**

To avoid personal injury and mirror malfunction, be careful not to get your hand caught by the moving mirror.

**■ When the mirror defoggers are operating**

Do not touch the rear view mirror surfaces, as they can become very hot and burn you.

## Power windows

### Opening and closing procedures

The power windows can be opened and closed using the switches.

Operating the switch moves the windows as follows:

- ① Closing
- ② One-touch closing\*
- ③ Opening
- ④ One-touch opening\*

\*: To stop the window partway, operate the switch in the opposite direction.

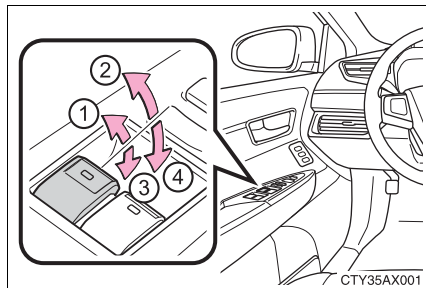

### Window lock switch

Press the switch to lock the passenger window switches.

Use this switch to prevent children from accidentally opening or closing a passenger window.

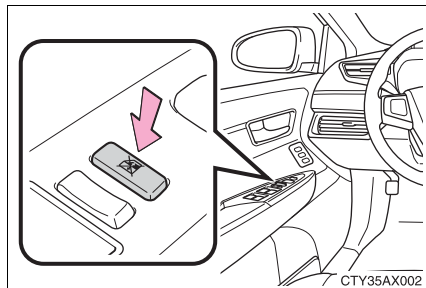

**■ The power windows can be operated when**

The power switch is in ON mode.

**■ Operating the power windows after turning the hybrid system off**

The power windows can be operated for approximately 45 seconds even after the power switch is turned to ACCESSORY mode or turned off. They cannot, however, be operated once either front door is opened.

**■ Jam protection function**

If an object becomes caught between the window and the window frame, window travel is stopped and the window is opened slightly.

**■ When the power window does not close normally**

If the jam protection function is operating abnormally and a window cannot be closed, perform the following operations using the power window switch on the relevant door.

- After stopping the vehicle, the window can be closed by holding the power window switch in the one-touch closing position while the power switch is turned to ON mode.
- If the window still cannot be closed even by carrying out the operation as explained above, initialize the function by performing the following procedure.
  - 1 Hold the power window switch in the one-touch closing position. Continue holding the switch for a further 6 seconds after the window has closed.
  - 2 Hold the power window switch in the one-touch opening position. Continue holding the switch for a further 2 seconds after the window has opened completely.
  - 3 Hold the power window switch in the one-touch closing position once again. Continue holding the switch for a further 2 seconds after the window has closed.

If you release the switch while the window is moving, start again from the beginning.

If the window continues to close but then re-open slightly even after performing the above procedure correctly, have the vehicle inspected by your Toyota dealer.

**■ When the 12-volt battery is disconnected**

The window lock switch is disabled. If necessary, press the window lock switch after reconnecting the 12-volt battery.

**WARNING**

Observe the following precautions.

Failure to do so may result in death or serious injury.

**■ Closing the windows**

- The driver is responsible for all the power window operations, including the operation for the passengers. In order to prevent accidental operation, especially by a child, do not let a child operate the power windows. It is possible for children and other passengers to have body parts caught in the power window. Also, when riding with a child, it is recommended to use the window lock switch. (→P. 148)
- Check to make sure that all passengers do not have any part of their body in a position where it could be caught when a window is being operated.
- When exiting the vehicle, turn the power switch off, carry the key and exit the vehicle along with the child. There may be accidental operation, due to mischief, etc., that may possibly lead to an accident.

**■ Jam protection function**

- Never use any part of your body to intentionally activate the jam protection function.
- The jam protection function may not work if something gets caught just before the window fully closes.

## Moon roof\*

Use the overhead switches to open and close the moon roof and tilt it up and down.

### Opening and closing

① Opens the moon roof\*

The moon roof stops slightly before the fully open position to reduce wind noise.

Press the switch again to fully open the moon roof.

② Closes the moon roof\*

\*: Lightly press either way of the moon roof switch to stop the moon roof partway.

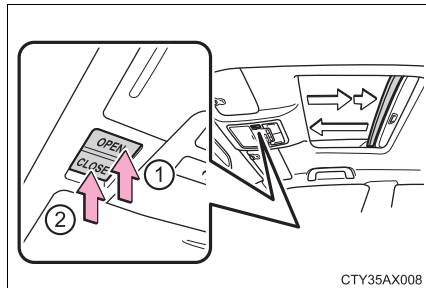

CTY35AX008

### Tilting up and down

① Tilts the moon roof up\*

② Tilts the moon roof down\*

\*: Lightly press either way of the moon roof switch to stop the moon roof partway.

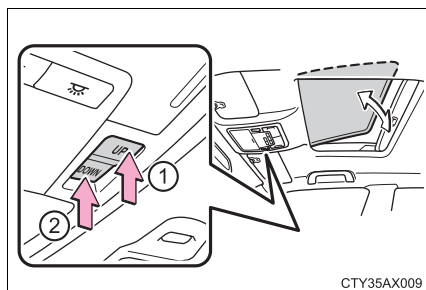

CTY35AX009

**■ The moon roof can be operated when**

The power switch is in ON mode.

**■ Operating the moon roof after turning the hybrid system off**

The moon roof can be operated for approximately 45 seconds after the power switch is turned to ACCESSORY mode or turned off. It cannot, however, be operated once either front door is opened.

**■ Jam protection function**

If an object is detected between the moon roof and the frame while the moon roof is closing or tilting down, travel is stopped and the moon roof opens slightly.

**■ Sunshade**

The sunshade can be opened and closed manually. However, the sunshade will open automatically when the moon roof is opened.



**■ When the moon roof does not close normally**

Perform the following procedure:

- If the moon roof closes but then re-opens slightly

- 1 Stop the vehicle.
- 2 Press and hold the “CLOSE” switch.\*1  
The moon roof will close, reopen and pause for approximately 10 seconds.\*2 Then it will close again, tilt up and pause for approximately 1 second. Finally, it will tilt down, open and close.
- 3 Check to make sure that the moon roof is completely closed and then release the switch.

- If the moon roof tilts down but then tilts back up

- 1 Stop the vehicle.
- 2 Press and hold the “UP” switch\*1 until the moon roof moves into the tilt up position and stops.
- 3 Release the “UP” switch once and then press and hold the “UP” switch again.\*1  
The moon roof will pause for approximately 10 seconds in the tilt up position.\*2 Then it will adjust slightly and pause for approximately 1 second. Finally, it will tilt down, open and close.
- 4 Check to make sure that the moon roof is completely closed and then release the switch.

\*1: If the switch is released at the incorrect time, the procedure will have to be performed again from the beginning.

\*2: If the switch is released after the above mentioned 10 second pause, automatic operation will be disabled. In that case, press and hold the “CLOSE” or “UP” switch, and the moon roof will tilt up and pause for approximately 1 second. Then it will tilt down, open and close. Check to make sure that the moon roof is completely closed and then release the switch.

If the moon roof does not fully close even after performing the above procedure correctly, have the vehicle inspected by your Toyota dealer.

**■ Moon roof open warning buzzer**

The buzzer sounds and a message is shown on the multi-information display when the power switch is turned off and the driver’s door is opened with the moon roof open.

**WARNING**

Observe the following precautions.

Failure to do so may cause death or serious injury.

**■ Opening the moon roof**

- Do not allow any passengers to put their hands or heads outside the vehicle while it is moving.
- Do not sit on top of the moon roof.

**■ Closing the moon roof**

- The driver is responsible for moon roof opening and closing operations. In order to prevent accidental operation, especially by a child, do not let a child operate the moon roof. It is possible for children and other passengers to have body parts caught in the moon roof.
- Check to make sure that all passengers do not have any part of their body in a position where it could be caught when the moon roof is being operated.
- When exiting the vehicle, turn the power switch off, carry the key and exit the vehicle along with the child. There may be accidental operation, due to mischief, etc., that may possibly lead to an accident.

**■ Jam protection function**

- Never use any part of your body to intentionally activate the jam protection function.
- The jam protection function may not work if something gets caught just before the moon roof fully closes.

- 4-1. Before driving**
- Driving the vehicle..... 156
  - Cargo and luggage ..... 166
  - Vehicle load limits ..... 169
  - Trailer towing..... 170
  - Dinghy towing ..... 171
- 4-2. Driving procedures**
- Power (ignition) switch ..... 172
  - EV drive mode ..... 178
  - Hybrid transmission..... 180
  - Turn signal lever..... 184
  - Parking brake ..... 185
- 4-3. Operating the lights and wipers**
- Headlight switch ..... 186
  - Automatic High Beam ..... 189
  - Windshield wipers and washer ..... 193
- 4-4. Refueling**
- Opening the fuel tank cap ..... 198
- 4-5. Using the driving support systems**
- Toyota Safety Sense P ..... 202
  - PCS (Pre-Collision System)..... 209
  - LDA (Lane Departure Alert with steering control)..... 222
  - Dynamic radar cruise control ..... 233
  - Cruise control..... 246
  - BSM (Blind Spot Monitor) ..... 250
    - The Blind Spot Monitor function ..... 252
    - The Rear Cross Traffic Alert function detection areas..... 257
  - Driving mode select switch ..... 259
  - Driving assist systems ..... 261
- 4-6. Driving tips**
- Hybrid vehicle driving tips ..... 266
  - Winter driving tips ..... 269

## Driving the vehicle

**The following procedures should be observed to ensure safe driving:**

### Starting the hybrid system

→P. 172

### Driving

- 1 With the brake pedal depressed, shift the shift lever to D. (→P. 180)
- 2 Release the parking brake. (→P. 185)
- 3 Gradually release the brake pedal and gently depress the accelerator pedal to accelerate the vehicle.

### Stopping

- 1 With the shift lever in D, depress the brake pedal until the vehicle comes to a stop.
- 2 If necessary, set the parking brake.

If the vehicle is to be stopped for an extended period of time, shift the shift lever to P. (→P. 180)

### Parking the vehicle

- 1 With the shift lever in D, depress the brake pedal.
- 2 Set the parking brake (→P. 185), and shift the shift lever to P (→P. 180).
- 3 Press the power switch to stop the hybrid system.
- 4 Lock the door, making sure that you have the electronic key on your person.

If parking on a hill, block the wheels as needed.

## Starting off on a steep uphill

- 1 Make sure that the parking brake is set and shift the shift lever to D.
- 2 Gently depress the accelerator pedal.
- 3 Release the parking brake.

### ■ When starting off on a uphill

The hill-start assist control is available. (→P. 261)

### ■ For fuel-efficient driving

Keep in mind that hybrid vehicles are similar to conventional vehicles, and it is necessary to refrain from activities such as sudden acceleration. (→P. 266)

### ■ Driving in the rain

- Drive carefully when it is raining, because visibility will be reduced, the windows may become fogged-up, and the road will be slippery.
- Drive carefully when it starts to rain, because the road surface will be especially slippery.
- Refrain from driving at high speeds in the rain, as there may be a layer of water between the tires and the road surface, preventing the steering and brakes from operating properly.

### ■ Breaking in your new Toyota

To extend the life of the vehicle, observing the following precautions is recommended:

- For the first 186 miles (300 km):  
Avoid sudden stops.
- For the first 621 miles (1000 km):
  - Do not drive at extremely high speeds.
  - Avoid sudden acceleration.
  - Do not drive continuously in low gears.
  - Do not drive at a constant speed for extended periods.

### ■ Drum-in-disc type parking brake system

Your vehicle has a drum-in-disc type parking brake system. This type of brake system needs bedding-down of the brake shoes periodically or whenever the parking brake shoes and/or drum are replaced. Have your Toyota dealer perform the bedding down operation.

### ■ Operating your vehicle in a foreign country

Comply with the relevant vehicle registration laws and confirm the availability of the correct fuel. (→P. 445)

**WARNING**

Observe the following precautions.

Failure to do so may result in death or serious injury.

**■ When starting the vehicle**

Always keep your foot on the brake pedal while stopped with the “READY” indicator is illuminated. This prevents the vehicle from creeping.

**■ When driving the vehicle**

- Do not drive if you are unfamiliar with the location of the brake and accelerator pedals to avoid depressing the wrong pedal.
  - Accidentally depressing the accelerator pedal instead of the brake pedal will result in sudden acceleration that may lead to an accident.
  - When backing up, you may twist your body around, leading to a difficulty in operating the pedals. Make sure to operate the pedals properly.
  - Make sure to keep a correct driving posture even when moving the vehicle only slightly. This allows you to depress the brake and accelerator pedals properly.
  - Depress the brake pedal using your right foot. Depressing the brake pedal using your left foot may delay response in an emergency, resulting in an accident.
- The driver should pay extra attention to pedestrians when the vehicle is powered only by the electric motor (traction motor). As there is no engine noise, the pedestrians may misjudge the vehicle’s movement.
- Do not drive the vehicle over or stop the vehicle near flammable materials. The exhaust system and exhaust gases can be extremely hot. These hot parts may cause a fire if there is any flammable material nearby.

 **WARNING**

Observe the following precautions.

Failure to do so may result in death or serious injury.

■ **When driving the vehicle**

- During normal driving, do not turn off the hybrid system. Turning the hybrid system off while driving will not cause loss of steering or braking control, however, power assist to the steering will be lost. This will make it more difficult to steer smoothly, so you should pull over and stop the vehicle as soon as it is safe to do so.  
In the event of an emergency, such as if it becomes impossible to stop the vehicle in the normal way: →P. 393
- Use engine braking (downshift) to maintain a safe speed when driving down a steep hill.  
Using the brakes continuously may cause the brakes to overheat and lose effectiveness. (→P. 180)
- Do not adjust the positions of the steering wheel, the seat, or the inside or outside rear view mirrors while driving.  
Doing so may result in a loss of vehicle control.
- Always check that all passengers' arms, heads or other parts of their body are not outside the vehicle.
- Do not drive in excess of the speed limit. Even if the legal speed limit permits it, do not drive over 85 mph (140 km/h) unless your vehicle has high-speed capability tires. Driving over 85 mph (140 km/h) may result in tire failure, loss of control and possible injury. Be sure to consult a tire dealer to determine whether the tires on your vehicle are high-speed capability tires or not before driving at such speeds.

**WARNING**

Observe the following precautions.

Failure to do so may result in death or serious injury.

**■ When driving on slippery road surfaces**

- Sudden braking, acceleration and steering may cause tire slippage and reduce your ability to control the vehicle.
- Sudden acceleration, engine braking due to shifting, or changes in engine speed could cause the vehicle to skid.
- After driving through a puddle, depress the brake pedal to make sure that the brakes are functioning properly. Wet brake pads may prevent the brakes from functioning properly. If the brakes on only one side are wet and not functioning properly, steering control may be affected.

**■ When shifting the shift lever**

- Do not let the vehicle roll backward while the shift lever is in a driving position, or roll forward while the shift lever is in R.  
Doing so may result in an accident or damage to the vehicle.
- Do not shift the shift lever to P while the vehicle is moving.  
Doing so can damage the transmission and may result in a loss of vehicle control.
- Do not shift the shift lever to R while the vehicle is moving forward.  
Doing so can damage the transmission and may result in a loss of vehicle control.
- Do not shift the shift lever to a driving position while the vehicle is moving backward.  
Doing so can damage the transmission and may result in a loss of vehicle control.
- Shifting the shift lever to N while the vehicle is moving will disengage the hybrid system. Engine braking is not available when N is selected.
- Be careful not to shift the shift lever with the accelerator pedal depressed. Shifting the shift lever to a gear other than P or N may lead to unexpected rapid acceleration of the vehicle that may cause an accident and result in death or serious injury.



**WARNING**

Observe the following precautions.

Failure to do so may result in death or serious injury.

■ **If you hear a squealing or scraping noise (brake pad wear limit indicators)**

Have the brake pads checked and replaced by your Toyota dealer as soon as possible.

Rotor damage may result if the pads are not replaced when needed.

It is dangerous to drive the vehicle when the wear limits of the brake pads and/or those of the brake discs are exceeded.

■ **When the vehicle is stopped**

- Do not depress the accelerator pedal unnecessarily.

If the shift lever is in any position other than P or N, the vehicle may accelerate suddenly and unexpectedly, causing an accident.

- In order to prevent accidents due to the vehicle rolling away, always keep depressing the brake pedal while stopped with the "READY" indicator is illuminated, and apply the parking brake as necessary.

- If the vehicle is stopped on an incline, in order to prevent accidents caused by the vehicle rolling forward or backward, always depress the brake pedal and securely apply the parking brake as needed.

- Avoid revving or racing the engine.

Running the engine at high speed while the vehicle is stopped may cause the exhaust system to overheat, which could result in a fire if combustible material is nearby.

**WARNING**

Observe the following precautions.

Failure to do so may result in death or serious injury.

**■ When the vehicle is parked**

- Do not leave glasses, cigarette lighters, spray cans, or soft drink cans in the vehicle when it is in the sun.

Doing so may result in the following:

- Gas may leak from a cigarette lighter or spray can, and may lead to a fire.
  - The temperature inside the vehicle may cause the plastic lenses and plastic material of glasses to deform or crack.
  - Soft drink cans may fracture, causing the contents to spray over the interior of the vehicle, and may also cause a short circuit in the vehicle's electrical components.
- Do not leave cigarette lighters in the vehicle. If a cigarette lighter is in a place such as the glove box or on the floor, it may be lit accidentally when luggage is loaded or the seat is adjusted, causing a fire.
  - Do not attach adhesive discs to the windshield or windows. Do not place containers such as air fresheners on the instrument panel or dashboard. Adhesive discs or containers may act as lenses, causing a fire in the vehicle.
  - Do not leave a door or window open if the curved glass is coated with a metallized film such as a silver-colored one. Reflected sunlight may cause the glass to act as a lens, causing a fire.
  - Always apply the parking brake, shift the shift lever to P, stop the hybrid system and lock the vehicle.  
Do not leave the vehicle unattended while the "READY" indicator is illuminated.  
If the vehicle is parked with the shift lever in P but the parking brake is not set, the vehicle may start to move, possibly leading to an accident.
  - Do not touch the exhaust pipes while the "READY" indicator is illuminated or immediately after turning the hybrid system off.  
Doing so may cause burns.

**WARNING**

Observe the following precautions.

Failure to do so may result in death or serious injury.

**■ When taking a nap in the vehicle**

Always turn the hybrid system off. Otherwise, if you accidentally move the shift lever or depress the accelerator pedal, this could cause an accident or fire due to hybrid system overheating. Additionally, if the vehicle is parked in a poorly ventilated area, exhaust gases may collect and enter the vehicle, leading to death or a serious health hazard.

**■ When braking**

- When the brakes are wet, drive more cautiously.

Braking distance increases when the brakes are wet, and this may cause one side of the vehicle to brake differently than the other side. Also, the parking brake may not securely hold the vehicle.

- If the electronically controlled brake system does not operate, do not follow other vehicles closely and avoid hills or sharp turns that require braking.

In this case, braking is still possible, but the brake pedal should be depressed more firmly than usual. Also, the braking distance will increase. Have your brakes fixed immediately.

- The brake system consists of 2 or more individual hydraulic systems; if one of the systems fails, the other(s) will still operate. In this case, the brake pedal should be depressed more firmly than usual and the braking distance will increase. Have your brakes fixed immediately.

**NOTICE****■ When driving the vehicle**

- Do not depress the accelerator and brake pedals at the same time during driving, as this may restrain driving torque.
- Do not use the accelerator pedal or depress the accelerator and brake pedals at the same time to hold the vehicle on a hill.

**■ When parking the vehicle**

Always set the parking brake, and shift the shift lever to P. Failure to do so may cause the vehicle to move or the vehicle may accelerate suddenly if the accelerator pedal is accidentally depressed.

**■ Avoiding damage to vehicle parts**

- Do not turn the steering wheel fully in either direction and hold it there for an extended period of time.  
Doing so may damage the power steering motor.
- When driving over bumps in the road, drive as slowly as possible to avoid damaging the wheels, underside of the vehicle, etc.

**■ If you get a flat tire while driving**

A flat or damaged tire may cause the following situations. Hold the steering wheel firmly and gradually depress the brake pedal to slow down the vehicle.

- It may be difficult to control your vehicle.
- The vehicle will make abnormal sounds or vibrations.
- The vehicle will behave abnormally.

Information on what to do in case of a flat tire (→P. 408)

**NOTICE****■ When encountering flooded roads**

Do not drive on a road that has flooded after heavy rain etc. Doing so may cause the following serious damage to the vehicle:

- Engine stalling
- Short in electrical components
- Engine damage caused by water immersion

In the event that you drive on a flooded road and the vehicle is flooded, be sure to have your Toyota dealer check the following:

- Brake function
- Changes in quantity and quality of oil and fluid used for the engine, hybrid transmission, etc.
- Lubricant condition for the bearings and suspension joints (where possible), and the function of all joints, bearings, etc.

## Cargo and luggage

**Take notice of the following information about storage precautions, cargo capacity and load:**

### Capacity and distribution

Cargo capacity depends on the total weight of the occupants.

(Cargo capacity) = (Total load capacity) — (Total weight of occupants)

#### **Steps for Determining Correct Load Limit —**

- (1) Locate the statement “The combined weight of occupants and cargo should never exceed XXX kg or XXX lbs.” on your vehicle’s placard.
- (2) Determine the combined weight of the driver and passengers that will be riding in your vehicle.
- (3) Subtract the combined weight of the driver and passengers from XXX kg or XXX lbs.
- (4) The resulting figure equals the available amount of cargo and luggage load capacity.  
For example, if the “XXX” amount equals 1400 lbs. and there will be five 150 lb passengers in your vehicle, the amount of available cargo and luggage load capacity is 650 lbs. (1400 – 750 (5 × 150) = 650 lbs.)
- (5) Determine the combined weight of luggage and cargo being loaded on the vehicle. That weight may not safely exceed the available cargo and luggage load capacity calculated in Step 4.
- (6) If your vehicle will be towing a trailer, load from your trailer will be transferred to your vehicle. Consult this manual to determine how this reduces the available cargo and luggage load capacity of your vehicle.

(→P. 169)

Toyota does not recommend towing a trailer with your vehicle. Your vehicle is not designed for trailer towing.

## Calculation formula for on your vehicle

- ① Cargo capacity
- ② Total load capacity  
(vehicle capacity weight)  
(→P. 436)

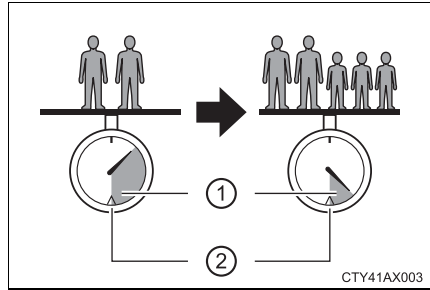

When 2 people with the combined weight of A lb. (kg) are riding in your vehicle, which has a total load capacity (vehicle capacity weight) of B lb. (kg), the available amount of cargo and luggage load capacity will be C lb. (kg) as follows:

$$B^{*2} \text{ lb. (kg)} - A^{*1} \text{ lb. (kg)} = C^{*3} \text{ lb. (kg)}$$

\*1: A = Weight of people

\*2: B = Total load capacity

\*3: C = Available cargo and luggage load

In this condition, if 3 more passengers with the combined weight of D lb. (kg) get on, the available cargo and luggage load will be reduced E lb. (kg) as follows:

$$C \text{ lb. (kg)} - D^{*4} \text{ lb. (kg)} = E^{*5} \text{ lb. (kg)}$$

\*4: D = Additional weight of people

\*5: E = Available cargo and luggage load

As shown in the example above, if the number of occupants increases, the cargo and luggage load will be reduced by an amount that equals the increased weight due to the additional occupants. In other words, if an increase in the number of occupants causes an excess of the total load capacity (combined weight of occupants plus cargo and luggage load), you must reduce the cargo and luggage on your vehicle.

**WARNING****■ Things that must not be carried in the trunk**

The following things may cause a fire if loaded in the trunk:

- Receptacles containing gasoline
- Aerosol cans

**■ Storage precautions**

Observe the following precautions.

Failure to do so may prevent the pedals from being depressed properly, may block the driver's vision, or may result in items hitting the driver or passengers, possibly causing an accident.

- Stow cargo and luggage in the trunk whenever possible.
- Do not place cargo or luggage in or on the following locations.
  - At the feet of the driver
  - On the front passenger or rear seats (when stacking items)
  - On the package tray
  - On the instrument panel
  - On the dashboard
- Secure all items in the occupant compartment.

**■ Capacity and distribution**

- Do not exceed the maximum axle weight rating or the total vehicle weight rating.
- Even if the total load of occupant's weight and the cargo load is less than the total load capacity, do not apply the load unevenly. Improper loading may cause deterioration of steering or braking control which may cause death or serious injury.



## Vehicle load limits

**Vehicle load limits include total load capacity, seating capacity, towing capacity and cargo capacity.**

◆ **Total load capacity (vehicle capacity weight): (→P. 436)**

Total load capacity means the combined weight of occupants, cargo and luggage.

◆ **Seating capacity: 5 occupants (Front 2, Rear 3)**

Seating capacity means the maximum number of occupants whose estimated average weight is 150 lb. (68 kg) per person.

◆ **Towing capacity**

Toyota does not recommend towing a trailer with your vehicle.

◆ **Cargo capacity**

Cargo capacity may increase or decrease depending on the weight and the number of occupants.

■ **Total load capacity and seating capacity**

These details are also described on the tire and loading information label. (→P. 365)

 **WARNING**

■ **Overloading the vehicle**

Do not overload the vehicle.

It may not only cause damage to the tires, but also degrade steering and braking ability, resulting in an accident.

## Trailer towing

**Toyota does not recommend towing a trailer with your vehicle. Toyota also does not recommend the installation of a tow hitch or the use of a tow hitch carrier for a wheelchair, scooter, bicycle, etc. Your vehicle is not designed for trailer towing or for the use of tow hitch mounted carriers.**

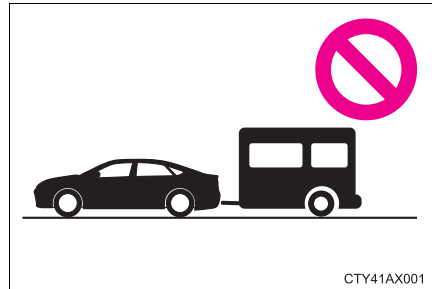

## Dinghy towing

**Your vehicle is not designed to be dinghy towed (with 4 wheels on the ground) behind a motor home.**

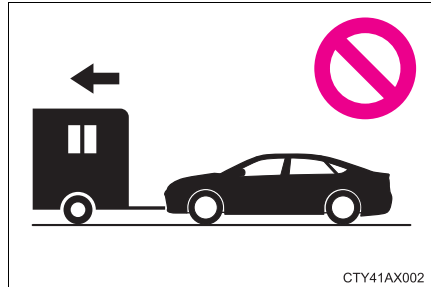

### NOTICE

**■ To avoid serious damage to your vehicle**

Do not tow your vehicle with the four wheels on the ground.

## Power (ignition) switch

Performing the following operations when carrying the electronic key on your person starts the hybrid system or changes power switch modes.

### Starting the hybrid system

- 1 Check that the parking brake is set.
- 2 Check that the shift lever is in P.
- 3 Firmly depress the brake pedal.

Messages indicating how to start the hybrid system and how to turn to ACCESSORY mode will be displayed alternately on the multi-information display.

- 4 Press the engine switch shortly and firmly.

When operating the power switch, one short, firm press is enough. It is not necessary to press and hold the switch.

If the “READY” indicator turns on, the hybrid system will operate normally.

Continue depressing the brake pedal until the “READY” indicator is illuminated.

The hybrid system can be started from any power switch mode.

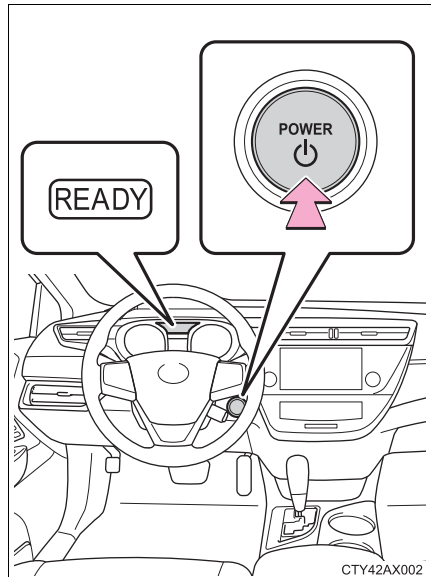

- 5 Check that the “READY” indicator is illuminated.

The vehicle will not move when the “READY” indicator is off.

## Stopping the hybrid system

- 1 Stop the vehicle.
- 2 Set the parking brake (→P. 185), and shift the shift lever to P.
- 3 Press the power switch.

Driving-related data will be displayed on the multi-information display.  
(→P. 98)

## Changing power switch modes

Modes can be changed by pressing the power switch with brake pedal released. (The mode changes each time the switch is pressed.)

### Off\*

The emergency flashers can be used.

### ACCESSORY mode

Some electrical components such as the audio system can be used.

A message indicating how to start the hybrid system will be displayed on the multi-information display.

### ON mode

All electrical components can be used.

\*: If the shift lever is in a position other than P when turning off the hybrid system, the power switch will be turned to ACCESSORY mode, not to off.

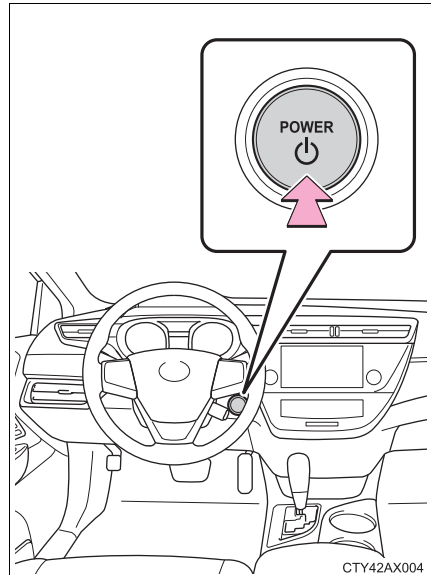

## When stopping the hybrid system with the shift lever in a position other than P

If the hybrid system is stopped with the shift lever in a position other than P, a message indicating to shift the shift lever to P will be displayed on the multi-information display. At this time, the power switch will not be turned off but instead be turned to ACCESSORY mode. Perform the following procedure to turn the switch off:

- 1 Check that the parking brake is set.
- 2 Shift the shift lever to P.
- 3 Check that “Turn Power OFF” is displayed on the multi-information display and then press the power switch once.
- 4 Check that “Turn Power OFF” on the multi-information display is turned off.

---

### ■ Auto power off function

If the vehicle is left in ACCESSORY mode for more than 20 minutes or ON mode (the hybrid system is not operating) for more than an hour with the shift lever in P, the power switch will automatically turn off. However, this function cannot entirely prevent 12-volt battery discharge. Do not leave the vehicle with the power switch in ACCESSORY or ON mode for long periods of time when the hybrid system is not operating.

### ■ Sounds and vibrations specific to a hybrid vehicle

→P. 73

### ■ Electronic key battery depletion

→P. 108

### ■ When the ambient temperature is low, such as during winter driving conditions

When starting the hybrid system, the flashing time of the “READY” indicator may be long. Leave the vehicle as it is until the “READY” indicator is steady on, as steady means the vehicle is able to move.

### ■ Conditions affecting operation

→P. 126

### ■ Notes for the entry function

→P. 127

### ■ If the hybrid system does not start

- The immobilizer system may not have been deactivated. (→P. 79)  
Contact your Toyota dealer.
- Check that the shift lever is securely set in P. The hybrid system may not start if the shift lever is displaced out of P.

### ■ Steering lock

After turning the power switch off and opening and closing the doors, the steering wheel will be locked due to the steering lock function. Operating the power switch again automatically cancels the steering lock.

### ■ When the steering lock cannot be released

A message informing the driver that the steering wheel is locked will be displayed on the multi-information display.

Check that the shift lever is set in P. Press the power switch while turning the steering wheel left and right.

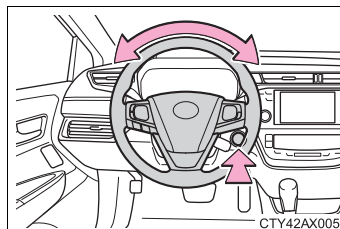

### ■ Steering lock motor overheating prevention

To prevent the steering lock motor from overheating, the motor may be suspended if the hybrid system is turned on and off repeatedly in a short period of time. In this case, refrain from operating the hybrid system. After about 10 seconds, the steering lock motor will resume functioning.

### ■ When a message requesting the smart key system be inspected is displayed on the multi-information display

The system may be malfunctioning. Have the vehicle inspected by your Toyota dealer immediately.

### ■ If the “READY” indicator does not come on

In the event that the “READY” indicator does not come on even after performing the proper procedures for starting the vehicle, contact your Toyota dealer immediately.

### ■ If the hybrid system is malfunctioning

→P. 75

### ■ If the electronic key battery is depleted

→P. 373

**■ Operation of the power switch**

- If the switch is not pressed shortly and firmly, the power switch mode may not change or the hybrid system may not start.
- If attempting to restart the hybrid system immediately after turning the power switch off, the hybrid system may not start in some cases. After turning the power switch off, please wait a few seconds before restarting the hybrid system.

**■ If the smart key system has been deactivated in a customized setting**

→P. 422

**■ Customization**

The time elapsed before the power switch related messages on the multi-information display turn off can be changed.

(Customizable features: →P. 461)

**WARNING****■ When starting the hybrid system**

Always start the hybrid system while sitting in the driver's seat. Do not depress the accelerator pedal while starting the hybrid system under any circumstances.

Doing so may cause an accident resulting in death or serious injury.

**■ Caution while driving**

If hybrid system failure occurs while the vehicle is moving, do not lock or open the doors until the vehicle reaches a safe and complete stop. Activation of the steering lock in this circumstance may lead to an accident, resulting in death or serious injury.

**■ Stopping the hybrid system in an emergency**

If you want to stop the hybrid system in an emergency while driving the vehicle, press and hold the power switch for more than 2 seconds, or press it briefly 3 times or more in succession. (→P. 393)

However, do not touch the power switch while driving except in an emergency. Turning the hybrid system off while driving will not cause loss of steering or braking control, however, power assist to the steering will be lost. This will make it more difficult to steer smoothly, so you should pull over and stop the vehicle as soon as it is safe to do so.



**NOTICE****■ To prevent 12-volt battery discharge**

- Do not leave the power switch in ACCESSORY or ON mode for long periods of time without the hybrid system on.
- Do not stop the hybrid system when the shift lever is in a position other than P. If the hybrid system is stopped in another shift lever position, the power switch will not be turned off but instead be turned to ACCESSORY mode. If the vehicle is left in ACCESSORY mode, 12-volt battery discharge may occur.

**■ When starting the hybrid system**

- Do not depress the accelerator pedal unnecessarily.
- If the hybrid system becomes difficult to start, have your vehicle checked by your Toyota dealer immediately.

**■ Symptoms indicating a malfunction with the power switch**

If the power switch seems to be operating somewhat differently than usual, such as the switch sticking slightly, there may be a malfunction. Contact your Toyota dealer immediately.

## EV drive mode

**In EV drive mode the electric motor (traction motor), powered by the hybrid battery (traction battery), is used to drive the vehicle.**

**This mode allows you to drive in residential areas early in the morning and late at night, or in indoor parking lots etc. without concern for noises and gas emissions.**

**However, when the vehicle proximity notification system is active, the vehicle may produce sound.**

### Turns EV drive mode on/off

When EV drive mode is turned on, a message indicating the vehicle is in EV drive mode will be shown on the multi-information display. Pressing the switch when in EV drive mode will return the vehicle to normal driving (using the gasoline engine and electric motor [traction motor]).

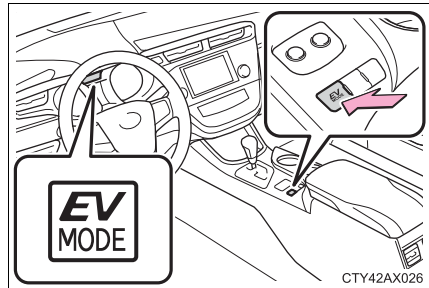

### ■ Situations in which EV drive mode cannot be turned on

It may not be possible to turn EV drive mode on in the following situations. If it cannot be turned on, a buzzer will sound and a message will be shown on the multi-information display.

- The temperature of the hybrid system is high.  
The vehicle has been left in the sun, driven on a hill, driven at high speeds, etc.
- The temperature of the hybrid system is low.  
The vehicle has been left in temperatures lower than about 68°F (20°C) for a long period of time etc.
- The gasoline engine is warming up.
- The hybrid battery (traction battery) is low.  
The remaining battery level indicated in the energy monitor on the multi-information display is low. (→P. 100)
- Vehicle speed is high.
- The accelerator pedal is depressed firmly or the vehicle is on a hill etc.
- The windshield defogger is in use.

### ■ Switching to EV drive mode when the gasoline engine is cold

If the hybrid system is started while the gasoline engine is cold, the gasoline engine will start automatically after a short period of time in order to warm up. In this case, you will become unable to switch to EV drive mode.

After the hybrid system has started and the “READY” indicator has illuminated, press the EV drive mode switch before the gasoline engine starts to switch to EV drive mode.

### ■ Automatic cancelation of EV drive mode

When driving in EV drive mode, the gasoline engine may automatically restart in the following situations. When EV drive mode is canceled, a buzzer will sound and the EV drive mode indicator will flash and go off.

- The hybrid battery (traction battery) becomes low.

The remaining battery level indicated in the energy monitor on the multi-information display is low. (→P. 100)

- Vehicle speed is high.
- The accelerator pedal is depressed firmly.

### ■ Possible driving distance when driving in EV drive mode

EV drive mode's possible driving distance ranges from a few hundred meters to approximately 1.3 miles (2 km). However, depending on vehicle conditions, there are situations when EV drive mode cannot be used.

(The distance that is possible depends on the hybrid battery [traction battery] level and driving conditions.)

### ■ Fuel economy

The hybrid system is designed to achieve the best possible fuel economy during normal driving (using the gasoline engine and electric motor [traction motor]). Driving in EV drive mode more than necessary may lower fuel economy.



#### WARNING

#### ■ Caution while driving

When driving in EV drive mode no engine noise is made. As such, pedestrians, people riding bicycles or other people and vehicles in the surrounding area may not be aware of the vehicle starting off or approaching them. Therefore, take extra care while driving even if the vehicle proximity notification system is active.

## Hybrid transmission

### Shifting the shift lever

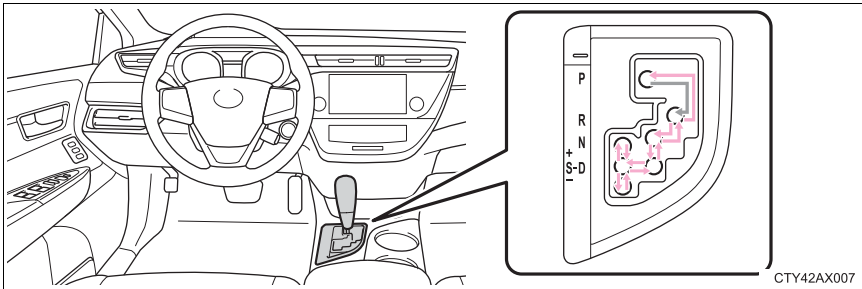

CTY42AX007

- ← While the power switch is in ON mode, move the shift lever with the brake pedal depressed.

When shifting the shift lever between P and D, make sure that the vehicle is completely stopped.

### Shift position purpose

Shift position	Objective or function
P	Parking the vehicle/starting the hybrid system
R	Reversing
N	Neutral
D	Normal driving <sup>*1</sup>
S	S mode driving <sup>*2</sup> (→P. 181)

\*1: To improve fuel efficiency and reduce noises, set the shift lever in the D position for normal driving.

\*2: By selecting shift ranges using S mode, you can control engine braking force.

## Selecting shift ranges in the S position

To enter S mode, shift the shift lever to S. Shift ranges can then be selected by operating the shift lever, allowing you to drive in the shift range of your choosing.

- ① Upshifting
- ② Downshifting

The selected shift range, from S1 to S6, will be displayed in the meter.

The initial shift range in S mode is automatically set to S4 or S5 according to vehicle speed.

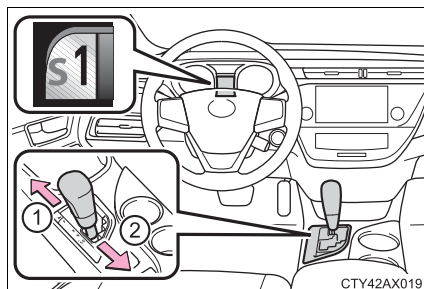

### ■ Shift ranges and their functions

- You can choose from 6 levels of engine braking force.
- A lower shift range will provide greater engine braking force than a higher shift range. The engine speed will also increase.
- If you accelerate while in ranges S1 to S4, the shift range may automatically range up in accordance with the vehicle's speed.

### ■ S mode

- When the shift range is S4 or lower, holding the shift lever toward “+” sets the shift range to S6.
- To prevent the engine from over-revving, upshifting may automatically occur.

### ■ Tachometer

When the S mode driving is selected, the tachometer will be displayed on the multi-information display. The tachometer displays the engine speed in revolutions per minute.



### ■ Downshifting restrictions warning buzzer

To help ensure safety and driving performance, downshifting operation may sometimes be restricted. In some circumstances, downshifting may not be possible even when the shift lever is operated. (A buzzer will sound twice.)

### ■ When driving with cruise control or radar cruise control activated

Even if switching the driving mode to power mode with the intent of enabling engine braking, engine braking will not activate because cruise control or radar cruise control will not be canceled. (→P. 233, 246)

■ **If the S indicator does not come on or the D indicator is displayed even after shifting the shift lever to S**

This may indicate a malfunction in the automatic transmission system. Have the vehicle inspected by your Toyota dealer immediately.

(In this situation, the transmission will operate in the same manner as when the shift lever is in D.)

■ **Shift lock system**

The shift lock system is a system to prevent accidental operation of the shift lever in starting.

The shift lever can be shifted from P only when the engine switch is in ON mode and the brake pedal is being depressed.

■ **If the shift lever cannot be shifted from P**

First, check whether the brake pedal is being depressed.

If the shift lever cannot be shifted with your foot on the brake pedal, there may be a problem with the shift lock system. Have the vehicle inspected by your Toyota dealer immediately.

The following steps may be used as an emergency measure to ensure that the shift lever can be shifted.

Releasing the shift lock:

- 1 Set the parking brake.
- 2 Turn the engine switch is off.
- 3 Depress the brake pedal.
- 4 Pry the cover up with a flathead screwdriver or equivalent tool.

To prevent damage to the cover, cover the tip of the screwdriver with a rag.

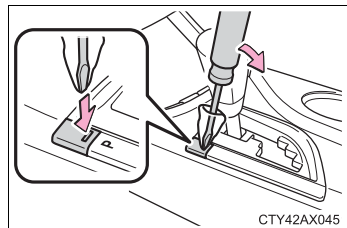

- 5 Press the shift lock override button.

The shift lever can be shifted while the button is pressed.

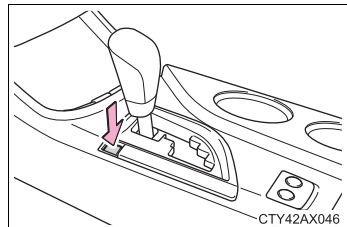

## ■ AI-SHIFT

AI-SHIFT automatically selects the suitable gear according to driver performance and driving conditions.

AI-SHIFT automatically operates when the shift lever is in the D position. (Shifting the shift lever to the S position cancels the function.)

### WARNING

#### ■ When driving on slippery road surfaces

Do not accelerate or shift gears suddenly.

Sudden changes in engine braking may cause the vehicle to spin or skid, resulting in an accident.

#### ■ To prevent an accident when releasing the shift lock

Before pressing the shift lock override button, make sure to set the parking brake and depress the brake pedal.

If the accelerator pedal is accidentally depressed instead of the brake pedal when the shift lock override button is pressed and the shift lever is shifted out of P, the vehicle may suddenly start, possibly leading to an accident resulting in death or serious injury.

### NOTICE

#### ■ Hybrid battery (traction battery) charge precaution

If the shift lever is in N, the hybrid battery (traction battery) will not be charged even when the engine is running. Therefore, if the vehicle is left with the shift lever in N for a long period of time, the hybrid battery (traction battery) will discharge, and this may result in the vehicle not being able to start.

## Turn signal lever

### Operating instructions

The lever will return to its original position after operation.

- ① Right turn
- ② Lane change to the right (move the lever partway and release it)  
The right hand signals will flash 3 times.
- ③ Lane change to the left (move the lever partway and release it)  
The left hand signals will flash 3 times.
- ④ Left turn

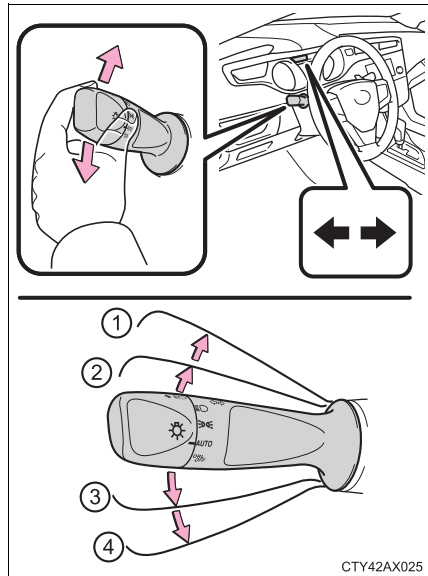

#### ■ Turn signals can be operated when

The power switch is in ON mode.

#### ■ If the indicator flashes faster than usual

Check that a light bulb in the front or rear turn signal lights has not burned out.

#### ■ If the turn signals stop flashing before a lane change has been performed

Operate the lever again.

#### ■ To discontinue flashing of the turn signals during a lane change

Operate the lever in the opposite direction.

#### ■ When the lever is pushed and held partway

The turn signals will keep flashing until the lever is released.

#### ■ Customization

The number of times the turn signals flash during a lane change can be changed. (Customizable feature →P. 461)



## Parking brake

To set the parking brake, fully depress the parking brake pedal with your left foot while depressing the brake pedal with your right foot.

(Depressing the pedal again releases the parking brake.)

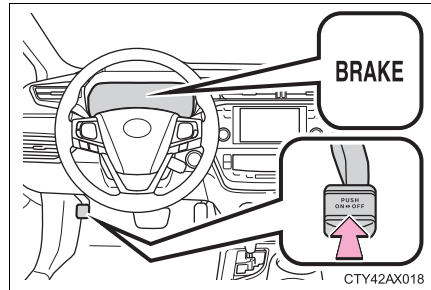

### ■ Parking the vehicle

→P. 156

### ■ Usage in winter time

→P. 270



### NOTICE

#### ■ Before driving

Fully release the parking brake.

Driving the vehicle with the parking brake set will lead to brake components overheating, which may affect braking performance and increase brake wear.

## Headlight switch

The headlights can be operated manually or automatically.

### Operating instructions

Turning the end of the lever turns on the lights as follows:

- ① **AUTO** The headlights, parking lights, daytime running lights (→P. 187) and so on turn on and off automatically (when the power switch is in ON mode).
- ② **☰☷☷** The side marker, parking, tail, license plate, daytime running lights (→P. 187) and instrument panel lights turn on.
- ③ **☰☷** The headlights and all the lights listed above (except daytime running lights) turn on.
- ④ **DRL OFF** The daytime running lights turn off.

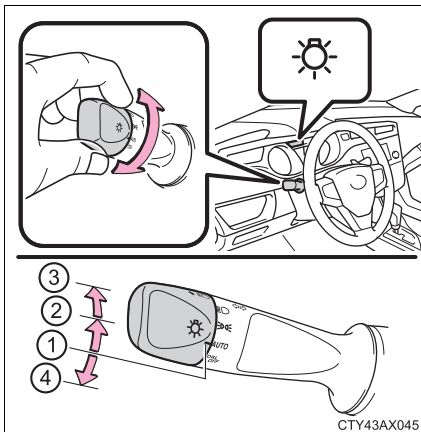

### Turning on the high beam headlights

- ① With the headlights on, push the lever away from you to turn on the high beams.  
Pull the lever toward you to the center position to turn the high beams off.
- ② Pull the lever toward you and release it to flash the high beams once.

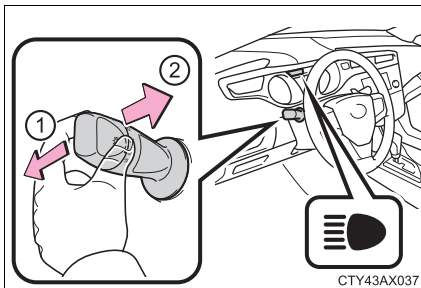

You can flash the high beams with the headlights on or off.

### ■ Daytime running light system (vehicles with halogen headlights)

- To make your vehicle more visible to other drivers during daytime driving, the daytime running lights turn on automatically whenever the hybrid system is started and the parking brake is released with the headlight switch off or in the "AUTO" position. (Illuminate dimmer than the headlight high beam.) Daytime running lights are not designed for use at night. Daytime running lights can be turned off by operating the switch.
- Compared to turning on the headlights, the daytime running light system offers greater durability and consumes less electricity, so it can help improve fuel economy.

### ■ Headlight control sensor

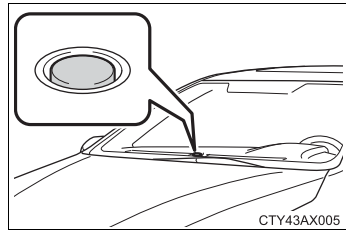

The sensor may not function properly if an object is placed on the sensor, or anything that blocks the sensor is affixed to the windshield.

Doing so interferes with the sensor detecting the level of ambient light and may cause the automatic headlight system to malfunction.



### ■ Automatic light off system

- When the headlights are on: The headlights and tail lights turn off 30 seconds after the power switch is turned off and a door is opened and all of the doors and trunk are closed. (The lights turn off immediately if  on the key is pressed twice after all the doors are closed.)
- When only the tail lights are on: The tail lights turn off automatically if the power switch is turned off and the driver's door is opened.

To turn the lights on again, turn the power switch to ON mode, or turn the light switch off once and then back to  or .

If any of the doors or trunk lid is kept open, the lights automatically turn off after 20 minutes.

### ■ Light reminder buzzer

A buzzer sounds when the power switch is turned off or turned to ACCESSORY mode and the driver's door is opened while the lights are turned on.

**■ Automatic headlight leveling system (if equipped)**

The level of the headlights is automatically adjusted according to the number of passengers and the loading condition of the vehicle to ensure that the headlights do not interfere with other road users.

**■ Customization**

Settings (e.g. light sensor sensitivity) can be changed.  
(Customizable features: →P. 461)

**NOTICE****■ To prevent 12-volt battery discharge**

Do not leave the lights on longer than necessary when the hybrid system is off.

## Automatic High Beam\*

The Automatic High Beam uses an in-vehicle camera sensor to assess the brightness of streetlights, the lights of vehicles ahead etc., and automatically turns the high beam on or off as necessary.

### WARNING

#### ■ Limitations of the Automatic High Beam

Do not rely on the Automatic High Beam. Always drive safely, taking care to observe your surroundings and turning the high beam on or off manually if necessary.

#### ■ To prevent incorrect operation of the Automatic High Beam system

Do not overload the vehicle.

### Activating the Automatic High Beam system

- 1 Put the headlight switch in the "AUTO" position.

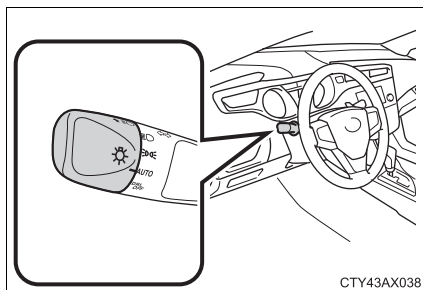

- 2 Push the lever away from you.

The Automatic High Beam indicator will come on when the headlights are turned on automatically to indicate that the system is active.

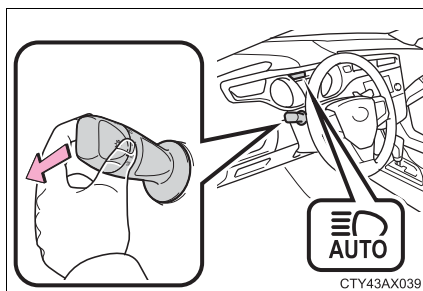

## Turning the high beam on/off manually

### ■ Switching to low beam

Pull the lever to the original position.

The Automatic High Beam indicator will turn off.

Push the lever away from you to activate the Automatic High Beam system again.

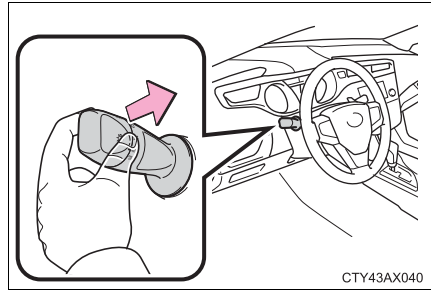

### ■ Switching to high beam

Turn the light switch to  position.

The Automatic High Beam indicator will turn off and the high beam indicator will turn on.

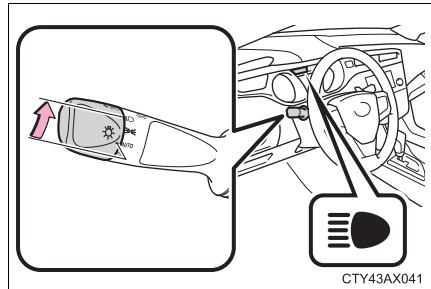

**■ High beam automatic turning on or off conditions**

- When all of the following conditions are fulfilled, the high beam will be automatically turned on (after approximately 1 second):
  - Vehicle speed is above approximately 25 mph (40 km/h).
  - The area ahead of the vehicle is dark.
  - There are no vehicles ahead with headlights or tail lights turned on.
  - There are few streetlights on the road ahead.
- If any of the following conditions are fulfilled, the high beam will be automatically turned off:
  - Vehicle speed drops below approximately 19 mph (30 km/h).
  - The area ahead of the vehicle is not dark.
  - Vehicles ahead have headlights or tail lights turned on.
  - There are many streetlights on the road ahead.

**■ Camera sensor detection information**

- The high beam may not be automatically turned off in the following situations:
  - When oncoming vehicles suddenly appear from a curve
  - When the vehicle is cut in front of by another vehicle
  - When vehicles ahead are hidden from sight due to repeated curves, road dividers or roadside trees
  - When vehicles ahead appear from the faraway lane on wide road
  - When vehicles ahead have no lights
- The high beam may be turned off if a vehicle ahead that is using fog lights without using the headlights is detected.
- House lights, street lights, traffic signals, and illuminated billboards or signs may cause the high beam to switch to the low beams, or the low beams to remain on.
- The following factors may affect the amount of time taken to turn the high beam on or off:
  - The brightness of headlights, fog lights, and tail lights of vehicles ahead
  - The movement and direction of vehicles ahead
  - When a vehicle ahead only has operational lights on one side
  - When a vehicle ahead is a two-wheeled vehicle
  - The condition of the road (gradient, curve, condition of the road surface etc.)
  - The number of passengers and amount of luggage
- The high beam may be turned on or off when the driver does not expect it.
- Bicycles or similar objects may not be detected.

- In the situations shown below, the system may not be able to accurately detect surrounding brightness levels. This may cause the low beams to remain on or the high beams to cause problems for pedestrians, vehicles ahead or other parties. In these cases, manually switch between the high and low beams.
  - In bad weather (rain, snow, fog, sandstorms etc.)
  - The windshield is obscured by fog, mist, ice, dirt etc.
  - The windshield is cracked or damaged.
  - The inside rear view mirror or camera sensor is deformed or dirty.
  - The camera sensor temperature is extremely high.
  - Surrounding brightness levels are equal to those of headlights, tail lights or fog lights.
  - Vehicles ahead have headlights that are either switched off, dirty, are changing color, or have are not aimed properly.
  - When driving through an area of intermittently changing brightness and darkness.
  - When frequently and repeatedly driving ascending/descending roads, or roads with rough, bumpy or uneven surfaces (such as stone-paved roads, gravel tracks etc.).
  - When frequently and repeatedly taking curves or driving on a winding road.
  - There is a highly reflective object ahead of the vehicle, such as a sign or a mirror.
  - The back of a vehicle ahead is highly reflective, such as a container on a truck.
  - The vehicle's headlights are damaged or dirty.
  - The vehicle is listing or tilting, due to a flat tire, a trailer being towed etc.
  - The high beam and low beam are repeatedly being switched between in an abnormal manner.
  - The driver believes that the high beam may be causing problems or distress to other drivers or pedestrians nearby.

■ **If the Automatic High Beam indicator flashes**

It may indicate a malfunction in the system. Contact your Toyota dealer.

■ **Customization**

The automatic high beam can be deactivated.  
(Customizable feature: →P. 461)



## Windshield wipers and washer

### Intermittent wiper with interval adjuster (if equipped)

Wiper intervals can be adjusted for intermittent operation (when INT is selected).

- ① INT Intermittent windshield wiper operation
- ② LO Low speed windshield wiper operation
- ③ HI High speed windshield wiper operation
- ④ MIST Temporary operation

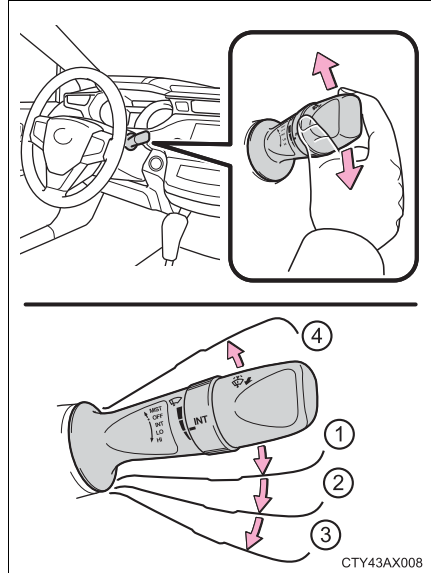

Wiper intervals can be adjusted when intermittent operation is selected.

- ⑤ Increases the intermittent windshield wiper frequency
- ⑥ Decreases the intermittent windshield wiper frequency

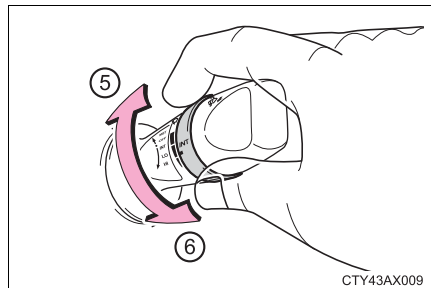

**⑦ Washer/wiper dual operation**

Wipers will automatically operate a couple of times after the washer squirts.

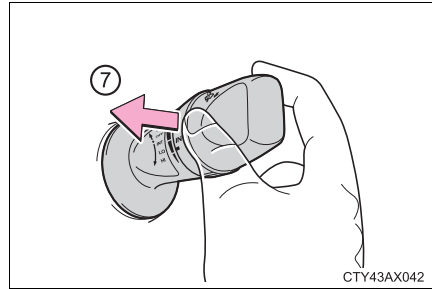

### Rain-sensing windshield wipers (if equipped)

With “AUTO” selected, the wipers will operate automatically when the sensor detects falling rain. The system automatically adjusts wiper timing in accordance with rain volume and vehicle speed.

- ① **AUTO** Rain-sensing windshield wiper operation
- ② **LO** Low speed windshield wiper operation
- ③ **HI** High speed windshield wiper operation
- ④ **MIST** Temporary operation

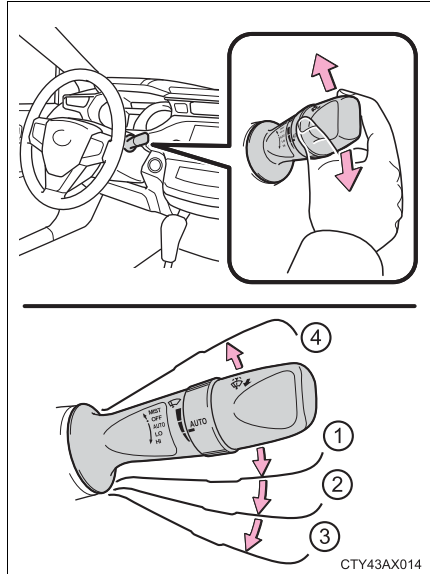

When “AUTO” is selected, the sensor sensitivity can be adjusted as follows by turning the switch ring.

- ⑤ Increases the sensitivity
- ⑥ Decreases the sensitivity

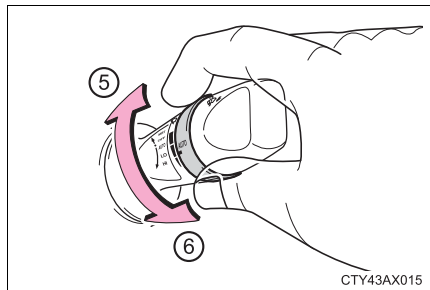

- ⑦ **Washer/wiper dual operation**

Wipers will automatically operate a couple of times after the washer squirts.

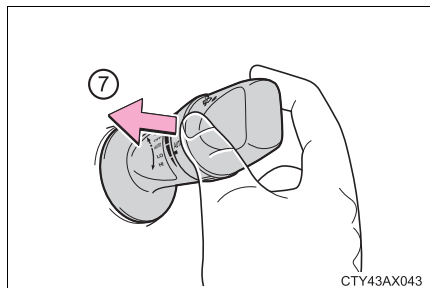

CTY43AX014

CTY43AX015

CTY43AX043

### ■ The windshield wiper and washer can be operated when

The power switch is in ON mode.

### ■ Effects of vehicle speed on wiper operation (vehicles with rain-sensing windshield wipers)

With low speed windshield wiper operation selected, wiper operation will be switched from low speed to intermittent wiper operation only when the vehicle is stationary.

### ■ Raindrop sensor (vehicles with rain-sensing windshield wipers)

- The raindrop sensor judges the amount of raindrops.

An optical sensor is adopted. It may not operate properly when sunlight from the rising or setting of the sun intermittently strikes the windshield, or if bugs etc. are present on the windshield.

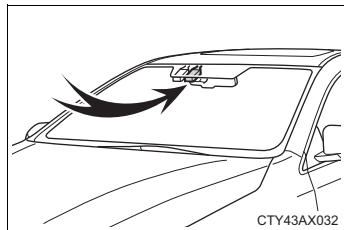

- If the wiper is turned to AUTO mode while the power switch is in ON mode, the wipers will operate once to show that AUTO mode is activated.
- If the temperature of the raindrop sensor is 194°F (90°C) or higher, or 14°F (-10°C) or lower, automatic operation may not occur. In this case, operate the wipers in any mode other than AUTO mode.

### ■ If no windshield washer fluid sprays

Check that the washer nozzles are not blocked if there is washer fluid in the windshield washer fluid reservoir.

### ⚠ WARNING

#### ■ Caution regarding the use of windshield wipers in AUTO mode (vehicles with rain-sensing windshield wipers)

The windshield wipers may operate unexpectedly if the sensor is touched or the windshield is subject to vibration in AUTO mode. Take care that your fingers or anything else do not become caught in the windshield wipers.

#### ■ Caution regarding the use of washer fluid

When it is cold, do not use the washer fluid until the windshield becomes warm. The fluid may freeze on the windshield and cause low visibility. This may lead to an accident, resulting in death or serious injury.

**NOTICE****■ When the windshield is dry**

Do not use the wipers, as they may damage the windshield.

**■ When there is no washer fluid spray from the nozzle**

Damage to the washer fluid pump may be caused if the lever is pulled toward you and held continually.

**■ When a nozzle becomes blocked**

In this case, contact your Toyota dealer.

Do not try to clear it with a pin or other object. The nozzle will be damaged.

## Opening the fuel tank cap

**Perform the following steps to open the fuel tank cap:**

### **Before refueling the vehicle**

- Close all the doors and windows, and turn the power switch off.
- Confirm the type of fuel.

---

### ■ **Fuel types**

→P. 445

### ■ **Fuel tank opening for unleaded gasoline**

To help prevent incorrect fueling, your vehicle has a fuel tank opening that only accommodates the special nozzle on unleaded fuel pumps.

**WARNING****■ When refueling the vehicle**

Observe the following precautions while refueling the vehicle. Failure to do so may result in death or serious injury.

- After exiting the vehicle and before opening the fuel door, touch an unpainted metal surface to discharge any static electricity. It is important to discharge static electricity before refueling because sparks resulting from static electricity can cause fuel vapors to ignite while refueling.
- Always hold the grips on the fuel tank cap and turn it slowly to remove it. A whooshing sound may be heard when the fuel tank cap is loosened. Wait until the sound cannot be heard before fully removing the cap. In hot weather, pressurized fuel may spray out the filler neck and cause injury.
- Do not allow anyone that has not discharged static electricity from their body to come close to an open fuel tank.
- Do not inhale vaporized fuel.  
Fuel contains substances that are harmful if inhaled.
- Do not smoke while refueling the vehicle.  
Doing so may cause the fuel to ignite and cause a fire.
- Do not return to the vehicle or touch any person or object that is statically charged.  
This may cause static electricity to build up, resulting in a possible ignition hazard.

**■ When refueling**

Observe the following precautions to prevent fuel overflowing from the fuel tank:

- Securely insert the fuel nozzle into the fuel filler neck.
- Stop filling the tank after the fuel nozzle automatically clicks off.
- Do not top off the fuel tank.

**NOTICE****■ Refueling**

Do not spill fuel during refueling.

Doing so may damage the vehicle, such as causing the emission control system to operate abnormally or damaging fuel system components or the vehicle's painted surface.

## Opening the fuel tank cap

- 1 With the doors unlocked, press the center of the rear edge of the fuel filler door.

Push until you hear a click and take your hand away to slightly open the fuel filler door. Then open the door fully by hand.

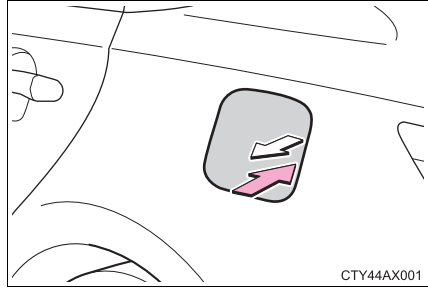

- 2 Turn the fuel tank cap slowly to remove it and hang it on the back of the fuel filler door.

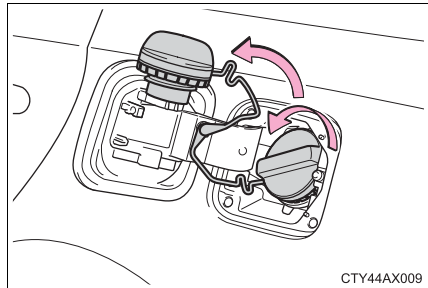

### ■ If the fuel filler door cannot be opened

Remove the cover inside the trunk and pull the lever to unlock the fuel filler door. Then press the center of the rear edge of the fuel filler door to open it.

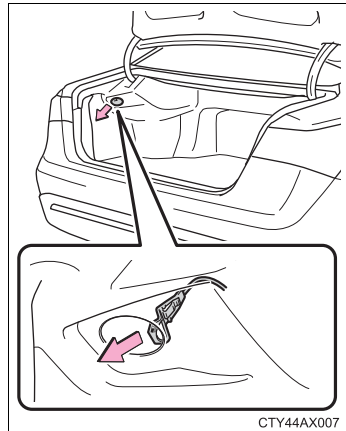



## Closing the fuel tank cap

- 1 After refueling, turn the fuel tank cap until you hear a click. Once the cap is released, it will turn slightly in the opposite direction.

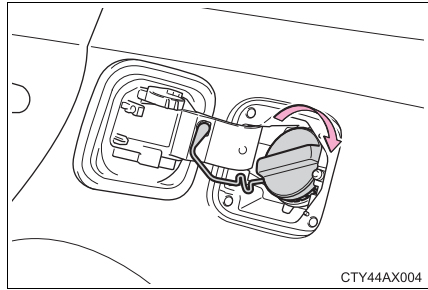

- 2 Close the fuel filler door, and press the center of the rear edge of the fuel filler door until you hear a click.

When you lock the doors, the fuel filler door will lock also.

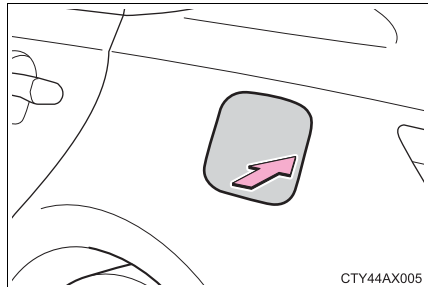

### Fuel filler door lock condition

The fuel filler door may not be locked even when the vehicle's doors are locked in the following conditions:

- When operating the door lock button inside the vehicle
- When the automatic door locking system is operated (→P. 113)
- When the fuel filler door is closed after the vehicle's doors are locked

### WARNING

#### ■ When replacing the fuel tank cap

Do not use anything but a genuine Toyota fuel tank cap designed for your vehicle. Doing so may cause a fire or other incident which may result in death or serious injury.

## Toyota Safety Sense P\*

The Toyota Safety Sense P consists of the following drive assist systems and contributes to a safe and comfortable driving experience:

◆ **PCS (Pre-Collision System)**

→P. 209

◆ **LDA (Lane Departure Alert with steering control)**

→P. 222

◆ **Automatic High Beam**

→P. 189

◆ **Dynamic radar cruise control**

→P. 233



### WARNING

■ **Toyota Safety Sense P**

The Toyota Safety Sense P is designed to operate under the assumption that the driver will drive safely, and is designed to help reduce the impact to the occupants and the vehicle in the case of a collision or assist the driver in normal driving conditions.

As there is a limit to the degree of recognition accuracy and control performance that this system can provide, do not overly rely on this system. The driver is always responsible for paying attention to the vehicle's surroundings and driving safely.

## Vehicle data recordings

The pre-collision system is equipped with a sophisticated computer that will record certain data, such as:

- How far (if at all) the driver was depressing the accelerator and/or brake pedal
- How fast the vehicle was traveling
- Operation status of the pre-collision system functions
- Information (such as the distance and relative speed between your vehicle and the vehicle ahead or other objects)
- Images from the camera sensor (available only when the pre-collision braking function or the pre-collision brake assist function was operating)

The pre-collision system does not record conversations, sounds or images of the inside of the vehicle.

### ● Data usage

Toyota may use the data recorded in this computer to diagnose malfunctions, conduct research and development, and improve quality.

Toyota will not disclose the recorded data to a third party except:

- With the consent of the vehicle owner or with the consent of the lessee if the vehicle is leased
  - In response to an official request by the police, a court of law or a government agency
  - For use by Toyota in a lawsuit
  - For research purposes where the data is not tied to a specific vehicle or vehicle owner
- Recorded images can be erased using a specialized device.

The image recording function can be disabled. However, if the function is disabled, data from when the pre-collision system operates will not be available.

## Sensors

Two types of sensors, located behind the front grille and windshield, detect information necessary to operate the drive assist systems.

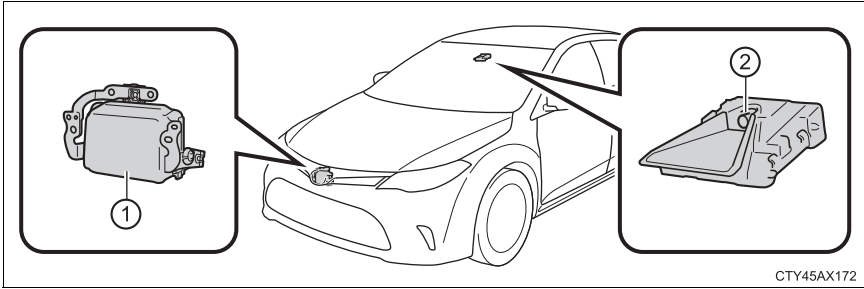

① Radar sensor

② Camera sensor

**! WARNING**

**■ To avoid malfunction of the radar sensor**

Observe the following precautions.

Otherwise, the radar sensor may not operate properly, possibly leading to an accident resulting in death or serious injury.

● Keep the radar sensor and front grille emblem clean at all times.

- ① Front grille emblem
- ② Radar sensor

If the front of the radar sensor or the front or back of the front grille emblem is dirty or covered with water droplets, snow, etc., clean it.

Clean the radar sensor and front grille emblem with a soft cloth so you do not mark or damage them.

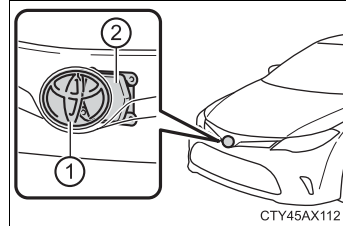

- Do not attach accessories, stickers (including transparent stickers) or other items to the radar sensor, front grille emblem or surrounding area.
- Do not subject the radar sensor or surrounding area to a strong impact. If the radar sensor, front grille, or front bumper has been subjected to a strong impact, have the vehicle inspected by your Toyota dealer.
- Do not disassemble the radar sensor.
- Do not modify or paint the radar sensor, front grille emblem or surrounding area.
- If the radar sensor, front grille, or front bumper needs to be removed and installed, or replaced, contact your Toyota dealer.



## WARNING

### ■ To avoid malfunction of the camera sensor

Observe the following precautions.

Otherwise, the camera sensor may not operate properly, possibly leading to an accident resulting in death or serious injury.

- Keep the windshield clean at all times.
  - If the windshield is dirty or covered with an oily film, water droplets, snow, etc., clear the windshield.
  - If a glass coating agent is applied to the windshield, it will still be necessary to use the windshield wipers to remove water droplets, etc. from the area of the windshield in front of the camera sensor.
  - If the inner side of the windshield where the camera sensor is installed is dirty, contact your Toyota dealer.
- Do not install an antenna or attach stickers (including transparent stickers) or other items to the area of the windshield in front of the camera sensor (shaded area in the illustration).

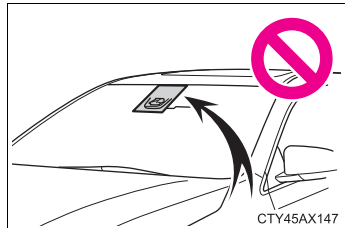

- If the part of the windshield in front of the camera sensor is fogged up or covered with condensation or ice, use the windshield defogger to remove the fog, condensation or ice. (→P. 278)
- If water droplets cannot be properly removed from the area of the windshield in front of the camera sensor by the windshield wipers, replace the wiper insert or wiper blade.
 

If the wiper inserts or wiper blades need to be replaced, contact your Toyota dealer.
- Do not attach window tinting to the windshield.
- Replace the windshield if it is damaged or cracked.
 

If the windshield needs to be replaced, contact your Toyota dealer.
- Do not get the camera sensor wet.
- Do not allow bright lights to shine into the camera sensor.
- Do not dirty or damage the camera sensor.
 

When cleaning the inside of the windshield, do not allow glass cleaner to contact the lens. Also, do not touch the lens.

If the lens is dirty or damaged, contact your Toyota dealer.

**WARNING**

- Do not subject the camera sensor to a strong impact.
- Do not change the installation position or direction of the camera sensor or remove it.
- Do not disassemble the camera sensor.
- Do not install an electronic device or device that emits strong electric waves near the camera sensor.
- Do not modify any components of the vehicle around the camera sensor (inside rear view mirror, etc.) or ceiling.
- Do not attach any accessories that may obstruct the camera sensor to the hood, front grille or front bumper. Contact your Toyota dealer for details.
- If a surfboard or other long object is to be mounted on the roof, make sure that it will not obstruct the camera sensor.
- Do not modify the headlights or other lights.

**■ Certification**

FCC ID: HYQDNMWR008

**NOTE:**

This device complies with part 15 of the FCC Rules. Operation is subject to the following two conditions: (1) This device may not cause harmful interference, and (2) this device must accept any interference received, including interference that may cause undesired operation.

**FCC WARNING:**

Changes or modifications not expressly approved by the party responsible for compliance could void the user's authority to operate the equipment.

**Radiofrequency radiation exposure Information:**

This equipment complies with FCC radiation exposure limits set forth for an uncontrolled environment. This equipment should be installed and operated with minimum distance of 20 cm between the radiator (antenna) and your body. This transmitter must not be co-located or operating in conjunction with any other antenna or transmitter.



## PCS (Pre-Collision System)\*

The pre-collision system uses a radar sensor and camera sensor to detect vehicles and pedestrians\*<sup>1</sup> in front of your vehicle. When the system determines that the possibility of a frontal collision with a vehicle or pedestrian is high, a warning operates to urge the driver to take evasive action and the potential brake pressure is increased to help the driver avoid the collision. If the system determines that the possibility of a frontal collision with a vehicle or pedestrian is extremely high, the brakes are automatically applied to help avoid the collision or help reduce the impact of the collision.

The pre-collision system can be disabled/enabled and the warning timing can be changed. (→P. 213)

\*1: Depending on the region in which the vehicle was sold, the pedestrian detection function may not be available. See the following table for details.

Countries/areas	Function availability	Regions
U.S. mainland, Canada, Hawaii	The pedestrian detection function is available	Region A
Guam, Saipan, Puerto Rico	The pedestrian detection function is not available	Region B

---

**◆ Pre-collision warning**

---

When the system determines that the possibility of a frontal collision is high, a buzzer will sound and a warning message will be displayed on the multi-information display to urge the driver to take evasive action.

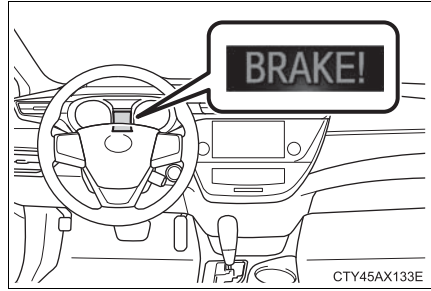

---

**◆ Pre-collision brake assist**

---

When the system determines that the possibility of a frontal collision is high, the system applies greater braking force in relation to how strongly the brake pedal is depressed.

---

**◆ Pre-collision braking**

---

When the system determines that the possibility of a frontal collision is high, the system warns the driver. If the system determines that the possibility of a frontal collision is extremely high, the brakes are automatically applied to help avoid the collision or reduce the collision speed.

 **WARNING****■ Limitations of the pre-collision system**

- The driver is solely responsible for safe driving. Always drive safely, taking care to observe your surroundings.  
Do not use the pre-collision system instead of normal braking operations under any circumstances. This system will not prevent collisions or lessen collision damage or injury in every situation. Do not overly rely on this system. Failure to do so may lead to an accident, resulting in death or serious injury.
- Although this system is designed to help avoid a collision or help reduce the impact of the collision, its effectiveness may change according to various conditions, therefore the system may not always be able to achieve the same level of performance.  
Read the following conditions carefully. Do not overly rely on this system and always drive carefully.
  - Conditions under which the system may operate even if there is no possibility of a collision: →P. 216
  - Conditions under which the system may not operate properly: →P. 218
- Do not attempt to test the operation of the pre-collision system yourself, as the system may not operate properly, possibly leading to an accident.

**■ Pre-collision braking**

- When the pre-collision braking function is operating, a large amount of braking force will be applied.
- If the vehicle is stopped by the operation of the pre-collision braking function, the pre-collision braking function operation will be canceled after approximately 2 seconds. Depress the brake pedal as necessary.
- The pre-collision braking function may not operate if certain operations are performed by the driver. If the accelerator pedal is being depressed strongly or the steering wheel is being turned, the system may determine that the driver is taking evasive action and possibly prevent the pre-collision braking function from operating.
- In some situations, while the pre-collision braking function is operating, operation of the function may be canceled if the accelerator pedal is depressed strongly or the steering wheel is turned and the system determines that the driver is taking evasive action.
- If the brake pedal is being depressed, the system may determine that the driver is taking evasive action and possibly delay the operation timing of the pre-collision braking function.

**WARNING****■ When to disable the pre-collision system**

In the following situations, disable the system, as it may not operate properly, possibly leading to an accident resulting in death or serious injury:

- When the vehicle is being towed
- When your vehicle is towing another vehicle
- When transporting the vehicle via truck, boat, train or similar means of transportation
- When the vehicle is raised on a lift with the hybrid system on and the tires are allowed to rotate freely
- When inspecting the vehicle using a drum tester such as a chassis dynamometer or speedometer tester, or when using an on vehicle wheel balancer
- When a strong impact is applied to the front bumper or front grille, due to an accident or other reasons
- If the vehicle cannot be driven in a stable manner, such as when the vehicle has been in an accident or is malfunctioning
- When the vehicle is driven in a sporty manner or off-road
- When the tires are not properly inflated
- When the tires are very worn
- When tires of a size other than specified are installed
- When tire chains are installed
- When a compact spare tire or an emergency tire puncture repair kit is used
- If equipment (snow plow, etc.) that may obstruct the radar sensor or camera sensor is temporarily installed to the vehicle

## Changing settings of the pre-collision system

### ■ Disabling the pre-collision system

Press the PCS switch for 3 seconds or more.

The PCS warning light will turn on and a message will be displayed on the multi-information display.

To enable the system, press the PCS switch again.

The system is enabled each time the power switch is turned to ON mode.

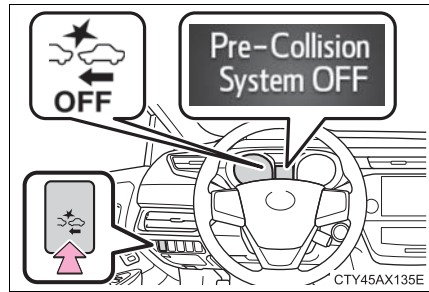

### ■ Changing the pre-collision warning timing

Press the PCS switch to display the current warning timing on the multi-information display. Each time the PCS switch is pressed with the warning timing displayed, the warning timing will change as follows.

The operation timing setting is retained when the power switch is turned off.

#### ① Far

The warning will begin to operate earlier than with the default timing.

#### ② Middle

This is the default setting.

#### ③ Near

The warning will begin to operate later than with the default timing.

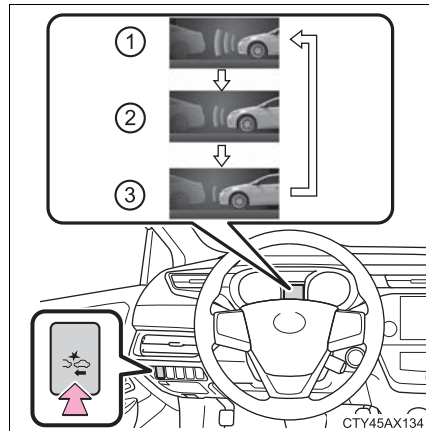

### ■ Operational conditions

Availability of the pedestrian detection function depends on the region in which the vehicle was sold. (For specific countries/areas: →P. 209)

Read the following for details:

#### ▶ Region A

(The pedestrian detection function is available)

The pre-collision system is enabled and the system determines that the possibility of a frontal collision with a vehicle or pedestrian is high.

Each function is operational at the following speeds:

#### ● Pre-collision warning:

- Vehicle speed is between approximately 7 and 110 mph (10 and 180 km/h). (For detecting a pedestrian, vehicle speed is between approximately 7 and 50 mph [10 and 80 km/h].)
- The relative speed between your vehicle and the vehicle or pedestrian ahead is approximately 7 mph (10 km/h) or more.

#### ● Pre-collision brake assist:

- Vehicle speed is between approximately 19 and 110 mph (30 and 180 km/h). (For detecting a pedestrian, vehicle speed is between approximately 19 and 50 mph [30 and 80 km/h].)
- The relative speed between your vehicle and the vehicle or pedestrian ahead is approximately 19 mph (30 km/h) or more.

#### ● Pre-collision braking:

- Vehicle speed is between approximately 7 and 110 mph (10 and 180 km/h). (For detecting a pedestrian, vehicle speed is between approximately 7 and 50 mph [10 and 80 km/h].)
- The relative speed between your vehicle and the vehicle or pedestrian ahead is approximately 7 mph (10 km/h) or more.

The system may not operate in the following situations:

- If a 12-volt battery terminal has been disconnected and reconnected and then the vehicle has not been driven for a certain amount of time
- If the shift lever is in R
- If VSC is disabled (only the pre-collision warning function will be operational)
- If the PCS warning light is flashing or illuminated

► Region B

(The pedestrian detection function is not available)

The pre-collision system is enabled and the system determines that the possibility of a frontal collision with a vehicle is high.

Each function is operational at the following speeds:

● Pre-collision warning:

- Vehicle speed is between approximately 10 and 110 mph (15 and 180 km/h).
- The relative speed between your vehicle and the vehicle ahead is approximately 7 mph (10 km/h) or more.

● Pre-collision brake assist:

- Vehicle speed is between approximately 19 and 110 mph (30 and 180 km/h).
- The relative speed between your vehicle and the vehicle ahead is approximately 19 mph (30 km/h) or more.

● Pre-collision braking:

- Vehicle speed is between approximately 10 and 110 mph (15 and 180 km/h).
- The relative speed between your vehicle and the vehicle ahead is approximately 7 mph (10 km/h) or more.

The system may not operate in the following situations:

- If a 12-volt battery terminal has been disconnected and reconnected and then the vehicle has not been driven for a certain amount of time
- If the shift lever is in R
- If VSC is disabled (only the pre-collision warning function will be operational)
- If the PCS warning light is flashing or illuminated

### ■ Pedestrian detection function\*2

The pre-collision system detects pedestrians based on the size, profile, and motion of a detected object. However, a pedestrian may not be detected depending on the surrounding brightness and the motion, posture, and angle of the detected object, preventing the system from operating properly. (→P. 220)

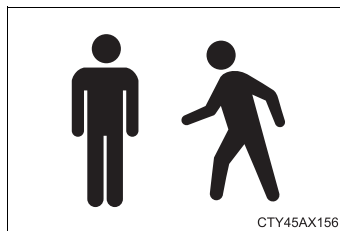

\*2: For countries/areas specified as Region B (→P. 209), the pedestrian detection function may not be available.

### ■ Cancellation of the pre-collision braking

If either of the following occur while the pre-collision braking function is operating, it will be canceled:

- The accelerator pedal is depressed strongly.
- The steering wheel is turned sharply or abruptly.

### ■ Conditions under which the system may operate even if there is no possibility of a collision

● In some situations such as the following, the system may determine that there is a possibility of a frontal collision and operate.

- When passing a vehicle or pedestrian\*2
- When changing lanes while overtaking a preceding vehicle
- When overtaking a preceding vehicle that is changing lanes
- When overtaking a preceding vehicle that is making a left/right turn

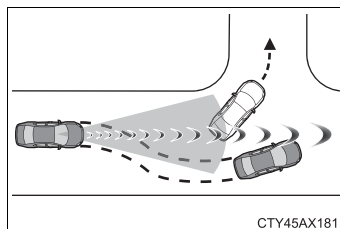

- When passing a vehicle in an oncoming lane that is stopped to make a right/left turn

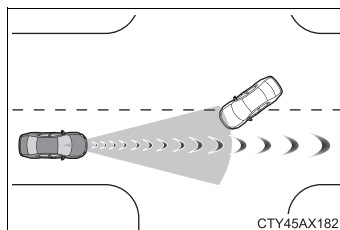



- When driving on a road where relative location to vehicle ahead in an adjacent lane may change, such as on a winding road

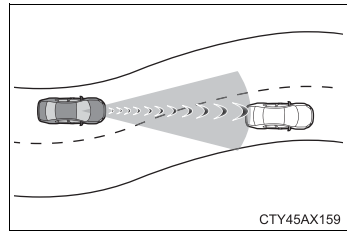

- When rapidly closing on a vehicle ahead
- If the front of the vehicle is raised or lowered, such as when the road surface is uneven or undulating
- When approaching objects on the roadside, such as guardrails, utility poles, trees, or walls
- When there is a vehicle, pedestrian<sup>\*2</sup>, or object by the roadside at the entrance of a curve

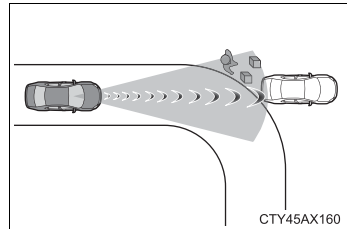

- When driving on a narrow path surrounded by a structure, such as in a tunnel or on an iron bridge
- When there is a metal object (manhole cover, steel plate, etc.), steps, or a protrusion on the road surface or roadside
- When a crossing pedestrian approaches very close to the vehicle<sup>\*2</sup>

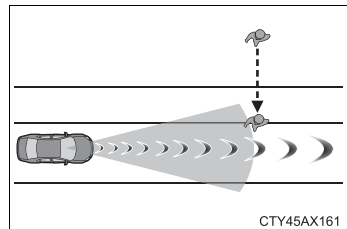

- When passing through a place with a low structure above the road (low ceiling, traffic sign, etc.)

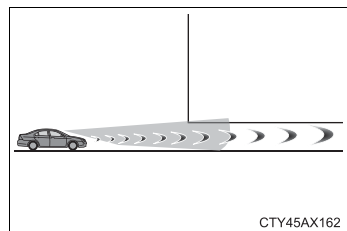

- When passing under an object (billboard, etc.) at the top of an uphill road

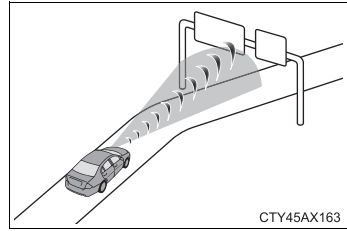

- When rapidly closing on an electric toll gate barrier, parking area barrier, or other barrier that opens and closes
- When using an automatic car wash
- When driving through or under objects that may contact the vehicle, such as thick grass, tree branches, or a banner

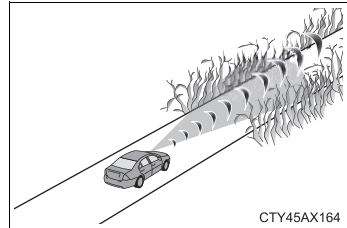

- When the vehicle is hit by water, snow, dust, etc. from a vehicle ahead
- When driving through steam or smoke
- When there are patterns or paint on the road or a wall that may be mistaken for a vehicle or pedestrian\*2
- When driving near an object that reflects radio waves, such as a large truck or guardrail
- When driving near a TV tower, broadcasting station, electric power plant, or other location where strong radio waves or electrical noise may be present

\*2: For countries/areas specified as Region B (→P. 209), the pedestrian detection function may not be available.

### ■ Situations in which the system may not operate properly

- In some situations such as the following, a vehicle may not be detected by the radar sensor and camera sensor, preventing the system from operating properly:
  - If an oncoming vehicle is approaching your vehicle
  - If a vehicle ahead is a motorcycle or bicycle
  - When approaching the side or front of a vehicle
  - If a preceding vehicle has a small rear end, such as an unloaded truck
  - If a preceding vehicle has a low rear end, such as a low bed trailer

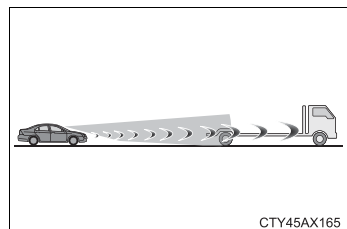

- If a vehicle ahead is carrying a load which protrudes past its rear bumper
- If a vehicle ahead has extremely high ground clearance

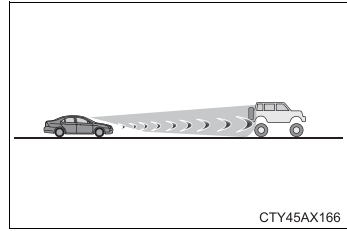

- If a vehicle ahead is irregularly shaped, such as a tractor or side car
- If the sun or other light is shining directly on a vehicle ahead
- If a vehicle cuts in front of your vehicle or emerges from beside a vehicle
- If a vehicle ahead makes an abrupt maneuver (such as sudden swerving, acceleration or deceleration)
- When suddenly cutting behind a preceding vehicle
- When a vehicle ahead is not directly in front of your vehicle

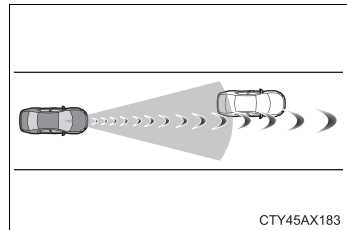

- When driving in inclement weather such as heavy rain, fog, snow or a sandstorm
- When the vehicle is hit by water, snow, dust, etc. from a vehicle ahead
- When driving through steam or smoke
- When driving in a place where the surrounding brightness changes suddenly, such as at the entrance or exit of a tunnel
- When a very bright light, such as the sun or the headlights of oncoming traffic, shines directly into the camera sensor
- When the surrounding area is dim, such as at dawn or dusk, or while at night or in a tunnel
- After the hybrid system has started the vehicle has not been driven for a certain amount of time
- While making a left/right turn and for a few seconds after making a left/right turn
- While driving on a curve and for a few seconds after driving on a curve
- If your vehicle is skidding

- If the front of the vehicle is raised or lowered

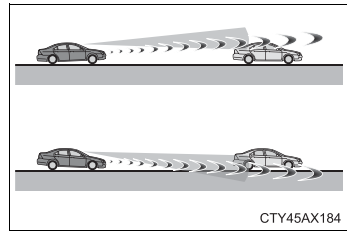

- If the wheels are misaligned
  - If a wiper blade is blocking the camera sensor
  - The vehicle is wobbling.
  - The vehicle is being driven at extremely high speeds.
  - When driving on a hill
  - If the radar sensor or camera sensor is misaligned
- In some situations such as the following, sufficient braking force may not be obtained, preventing the system from performing properly:
    - If the braking functions cannot operate to their full extent, such as when the brake parts are extremely cold, extremely hot, or wet
    - If the vehicle is not properly maintained (brakes or tires are excessively worn, improper tire inflation pressure, etc.)
    - When the vehicle is being driven on a gravel road or other slippery surface
  - Some pedestrians such as the following may not be detected by the radar sensor and camera sensor, preventing the system from operating properly\*2:
    - Pedestrians shorter than approximately 3.2 ft. (1 m) or taller than approximately 6.5 ft. (2 m)
    - Pedestrians wearing oversized clothing (a rain coat, long skirt, etc.), making their silhouette obscure
    - Pedestrians who are carrying large baggage, holding an umbrella, etc., hiding part of their body
    - Pedestrians who are bending forward or squatting
    - Pedestrians who are pushing a stroller, wheelchair, bicycle or other vehicle
    - Groups of pedestrians which are close together
    - Pedestrians who are wearing white and look extremely bright
    - Pedestrians in the dark, such as at night or while in a tunnel
    - Pedestrians whose clothing appears to be nearly the same color or brightness as their surroundings
    - Pedestrians near walls, fences, guardrails, or large objects
    - Pedestrians who are on a metal object (manhole cover, steel plate, etc.) on the road

- Pedestrians who are walking fast
- Pedestrians who are changing speed abruptly
- Pedestrians running out from behind a vehicle or a large object
- Pedestrians who are extremely close to the side of the vehicle (outside rear view mirror, etc.)

\*2: For countries/areas specified as Region B (→P. 209), the pedestrian detection function may not be available.

### ■ If the PCS warning light flashes and a warning message is displayed on the multi-information display

The pre-collision system may be temporarily unavailable or there may be a malfunction in the system.

- In the following situations, the warning light will turn off, the message will disappear and the system will become operational when normal operating conditions return:
  - When the radar sensor or camera sensor or the area around either sensor is hot, such as in the sun
  - When the radar sensor or camera sensor or the area around either sensor is cold, such as in an extremely cold environment
  - When the radar sensor or front grille emblem is dirty or covered with snow, etc.
  - If the camera sensor is obstructed, such as when the hood is open or a sticker is attached to the windshield near the camera sensor
- If the PCS warning light continues to flash or the warning message does not disappear, the system may be malfunctioning. Have the vehicle inspected by your Toyota dealer immediately.

### ■ If VSC is disabled

- If VSC is disabled (→P. 263), the pre-collision brake assist and pre-collision braking functions are also disabled.
- The PCS warning light will turn on and “Pre-Collision Brake is Disabled Due to VSC OFF” will be displayed on the multi-information display.

## LDA (Lane Departure Alert with steering control)\*

### Summary of functions

When driving on highways and freeways with white (yellow) lines, this function alerts the driver when the vehicle might depart from its lane and provides assistance by operating the steering wheel to keep the vehicle in its lane.

The LDA system recognizes visible white (yellow) lines with the camera sensor on the upper portion of the front windshield.

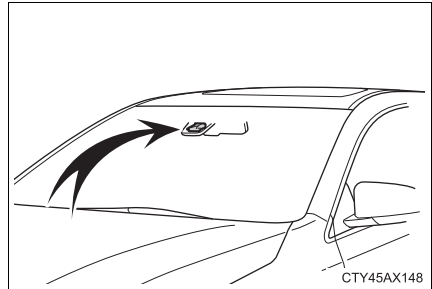

## Functions included in LDA system

### ◆ Lane departure alert function

When the system determines that the vehicle might depart from its lane, a warning is displayed on the multi-information display and the warning buzzer sounds to alert the driver.

When the warning buzzer sounds, check the surrounding road situation and carefully operate the steering wheel to move the vehicle back to the center within the white (yellow) lines.

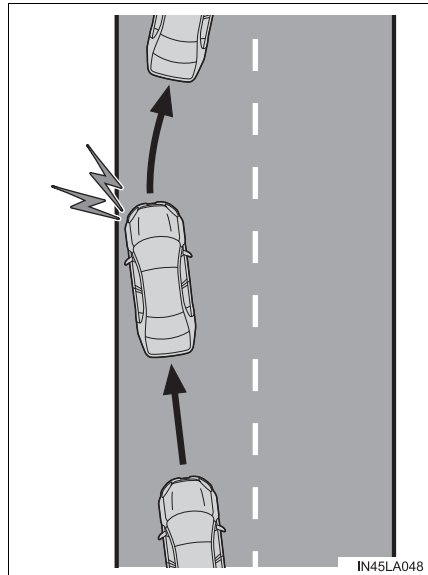

### ◆ Steering control function

When the system determines that the vehicle might depart from its lane, the system provides assistance as necessary by operating the steering wheel in small amounts for a short period of time to keep the vehicle in its lane.

If the system detects that the steering wheel has not been operated for a fixed amount of time or the steering wheel is not being firmly gripped, a warning is displayed on the multi-information display and the warning buzzer sounds.

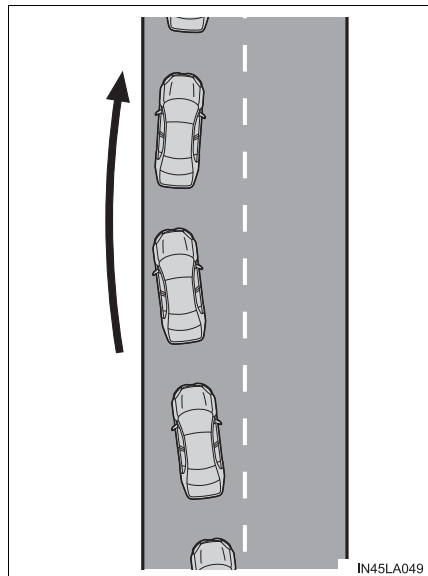

### ◆ Vehicle sway warning

When the vehicle is swaying or appears as if it may depart from its lane multiple times, the warning buzzer sounds and a message is displayed on the multi-information display to alert the driver.

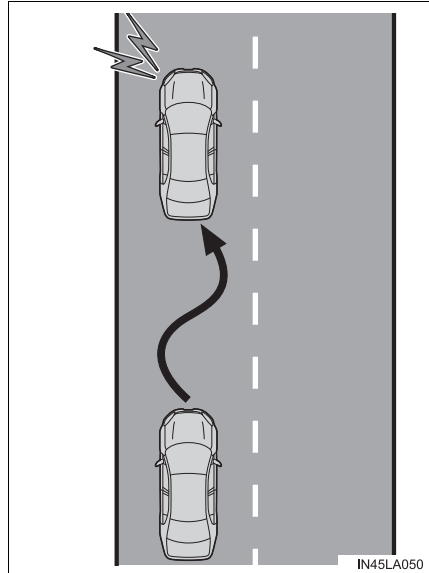

### ⚠ WARNING

#### ■ Before using LDA system

Do not rely solely upon the LDA system. LDA is not a system which automatically drives the vehicle or reduces the amount of attention that must be paid to the area in front of the vehicle. The driver must always assume full responsibility for driving safely by always paying careful attention to the surrounding conditions and operate the steering wheel to correct the path of the vehicle. Also, make sure to take adequate breaks when fatigued, such as from driving for a long period of time. Failure to perform appropriate driving operations and pay careful attention may lead to an accident, resulting in death or serious injury.

#### ■ To avoid operating LDA by mistake

When not using the LDA system, use the LDA switch to turn the system off.



**WARNING****■ Situations unsuitable for LDA**

Do not use the LDA system in the following situations.

The system may not operate properly and lead to an accident, resulting in death or serious injury.

- A spare tire, tire chains, etc., are equipped.
- When the tires have been excessively worn, or when the tire inflation pressure is low.
- Tires which differ by structure, manufacturer, brand or tread pattern are used.
- Objects or patterns that could be mistaken for white (yellow) lines are present on the side of the road (guardrails, curbs, reflective poles, etc.).
- Vehicle is driven on a snow-covered road.
- White (yellow) lines are difficult to see due to rain, snow, fog, dust, etc.
- Asphalt repair marks, white (yellow) line marks, etc., are present due to road repair.
- Vehicle is driven in a temporary lane or restricted lane due to construction work.
- Vehicle is driven on a road surface which is slippery due to rainy weather, fallen snow, freezing, etc.
- Vehicle is driven in traffic lanes other than on highways and freeways.
- Vehicle is driven in a construction zone.
- Vehicle is towing a trailer or another vehicle.

**■ Preventing LDA system malfunctions and operations performed by mistake**

- Do not modify the headlights or place stickers, etc., on the surface of the lights.
- Do not modify the suspension etc. If the suspension etc. needs to be replaced, contact your Toyota dealer.
- Do not install or place anything on the hood or grille. Also, do not install a grille guard (bull bars, kangaroo bar, etc.).
- If your windshield needs repairs, contact your Toyota dealer.

## Turning LDA system on

Press the LDA switch to turn the LDA system on.

The LDA indicator illuminates and a message is displayed on the multi-information display.

Press the LDA switch again to turn the LDA system off.

When the LDA system is turned on or off, operation of the LDA system continues in the same condition the next time the hybrid system is started.



## Indications on multi-information display

### ① LDA indicator

The illumination condition of the indicator informs the driver of the system operation status.

Illuminated in white:  
LDA system is operating.

Illuminated in green:  
Steering wheel assistance of the steering control function is operating.

Flashing in amber:  
Lane departure alert function is operating.

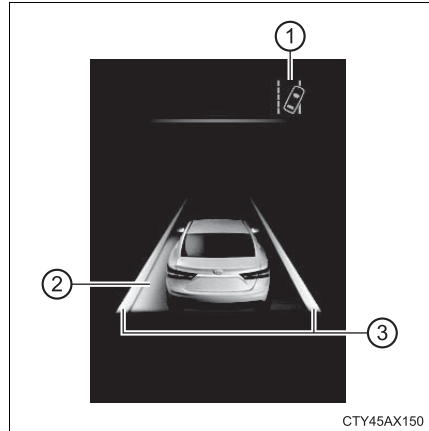

### ② Operation display of steering wheel operation support

Indicates that steering wheel assistance of the steering control function is operating.

### ③ Lane departure alert function display

Displayed when the multi-information display is switched to the driving assist system information screen.

▶ Inside of displayed white lines is white

▶ Inside of displayed white lines is black



Indicates that the system is recognizing white (yellow) lines. When the vehicle departs from its lane, the white line displayed on the side the vehicle departs from flashes amber.

Indicates that the system is not able to recognize white (yellow) lines or is temporarily canceled.

## ■ Operation conditions of each function

### ● Lane departure alert function

This function operates when all of the following conditions are met.

- LDA is turned on.
- Vehicle speed is approximately 32 mph (50 km/h) or more.
- System recognizes white (yellow) lines.
- Width of traffic lane is approximately 9.8 ft. (3 m) or more.
- Turn signal lever is not operated.
- Vehicle is driven on a straight road or around a gentle curve with a radius of more than approximately 492 ft. (150 m).
- No system malfunctions are detected. (→P. 231)

### ● Steering control function

This function operates when all of the following conditions are met in addition to the operation conditions for the lane departure alert function.

- Setting for “ Steering Assist” in “Settings” of the multi-information display is set to “On”. (→P. 96)
- Vehicle is not accelerated or decelerated by a fixed amount or more.
- Steering wheel is not operated with a steering force level suitable for changing lanes.
- ABS, VSC, TRAC and PCS are not operating.
- When the VSC or TRAC system is turned off by pressing the VSC OFF switch.

### ● Vehicle sway warning

This function operates when all of the following conditions are met.

- Setting for “ Alert” in “Settings” of the multi-information display is set to “On”. (→P. 96)
- Vehicle speed is approximately 32 mph (50 km/h) or more.
- Width of traffic lane is approximately 9.8 ft. (3 m) or more.
- No system malfunctions are detected. (→P. 231)

**■ Temporary cancellation of functions**

When operation conditions are no longer met, a function may be temporarily canceled. However, when the operation conditions are met again, operation of the function is automatically restored. (→P. 228)

**■ Steering control function**

Depending on the vehicle speed, lane departure situation, road conditions, etc., the operation of the functions may not be recognized or the functions may not operate.

**■ Lane departure alert function**

The warning buzzer may be difficult to hear due to external noise, audio playback, etc.

**■ Hands off steering wheel alert**

When the system determines that the driver has removed their hands from the steering wheel while the steering control function is operating, a warning message is displayed on the multi-information display and the buzzer sounds.

**■ White (yellow) lines are only on one side of road**

The LDA system will not operate for the side on which white (yellow) lines could not be recognized.

**■ Conditions in which functions may not operate properly**

In the following situations, the camera sensor may not detect white (yellow) lines and various functions may not operate normally.

- There are shadows on the road that run parallel with, or cover, the white (yellow) lines.
- The vehicle is driven in an area without white (yellow) lines, such as in front of a tollgate or checkpoint, or at an intersection, etc.
- The white (yellow) lines are cracked, “Botts’ dots”, “Raised pavement marker” or stones are present.
- The white (yellow) lines cannot be seen or are difficult to see due to sand, etc.
- The vehicle is driven on a road surface that is wet due to rain, puddles, etc.
- The traffic lines are yellow (which may be more difficult to recognize than lines that are white).
- The white (yellow) lines cross over a curb, etc.
- The vehicle is driven on a bright surface, such as concrete.
- The vehicle is driven on a surface that is bright due to reflected light, etc.
- The vehicle is driven in an area where the brightness changes suddenly, such as at the entrances and exits of tunnels, etc.
- Light from the headlights of an oncoming vehicle, the sun, etc., enters the camera.
- The vehicle is driven where the road diverges, merges, etc.
- The vehicle is driven on a slope.
- The vehicle is driven on a road which tilts left or right, or a winding road.
- The vehicle is driven on an unpaved or rough road.
- The vehicle is driven around a sharp curve.
- The traffic lane is excessively narrow or wide.
- The vehicle is extremely tilted due to carrying heavy luggage or having improper tire pressure.
- The distance to the preceding vehicle is extremely short.
- The vehicle is moving up and down a large amount due to road conditions during driving (poor roads or road seams).
- The headlight lenses are dirty and emit a faint amount of light at night, or the beam axis has deviated.
- The vehicle is struck by a crosswind.
- The vehicle has just changed lanes or crossed an intersection.
- Snow tires, etc., are equipped.

### ■ Warning message

If the following warning message is displayed on the multi-information display and the LDA indicator illuminates in amber, follow the appropriate troubleshooting procedure.

Warning message	Details/Actions
"Check LDA System"	<p>The system may not be operating properly.</p> <p>→ Have the vehicle inspected at your Toyota dealer.</p>
<p>"Forward Camera System Unavailable Clean Windshield"</p>	<p>Dirt, rain, condensation, ice, snow, etc., are present on the windshield in front of the camera sensor.</p> <p>→ Turn the LDA system off, remove any dirt, rain, condensation, ice, snow, etc., from the windshield, and then turn the LDA system back on.</p>
<p>"Forward Camera System Unavailable"</p>	<p>The LDA system is temporarily canceled because the operating conditions of the camera sensor (temperature, etc.) are not met.</p> <p>→ The LDA system can be operated when the operating conditions of the camera sensor (temperature, etc.) are met. Turn the LDA system off, wait for a while, and then turn the LDA system back on.</p>
<p>"LDA Not Available"</p>	<p>The LDA system is temporarily canceled due to a malfunction in a sensor other than the camera sensor.</p> <p>→ Turn the LDA system off and follow the appropriate troubleshooting procedures for other warning messages. Afterward, drive the vehicle for a short time, and then turn the LDA system back on.</p>
<p>"LDA Unavailable Below Approx. 32 MPH"</p>	<p>The LDA system cannot be used as the vehicle speed is approximately 32 mph (50 km/h) or less.</p> <p>→ Drive the vehicle at approximately 32 mph (50 km/h) or more.</p>

If a different warning message is displayed, follow the instructions displayed on the screen.

**■ Customization**

The following settings can be changed.

Function	Setting details
Lane departure alert	Adjust alert sensitivity
Steering control function	Turn steering wheel assistance on and off
Vehicle sway warning	Turn function on and off
	Adjust alert sensitivity

For how to change settings, refer to P. 96.



## Dynamic radar cruise control\*

### Summary of functions

In vehicle-to-vehicle distance control mode, the vehicle automatically accelerates and decelerates to match the speed changes of the preceding vehicle even if the accelerator pedal is not depressed. In constant speed control mode, the vehicle runs at a fixed speed.

Use the dynamic radar cruise control on freeways and highways.

- Vehicle-to-vehicle distance control mode (→P. 236)
- Constant speed control mode (→P. 241)

- ① Vehicle-to-vehicle distance button
- ② Display
- ③ Indicators
- ④ Set speed
- ⑤ Cruise control switch

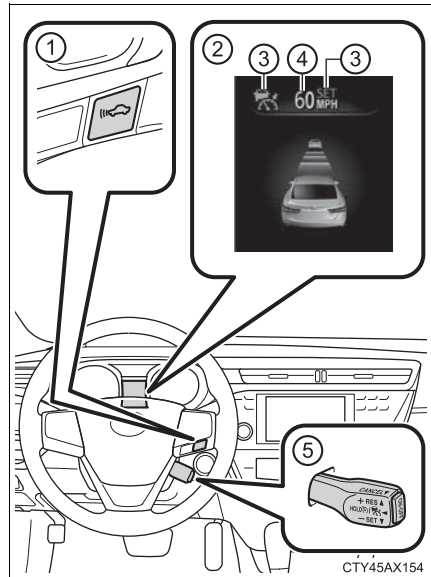

 **WARNING****■ Before using dynamic radar cruise control**

Driving safely is the sole responsibility of the driver. Do not rely solely on the system, and drive safely by always paying careful attention to your surroundings.

The dynamic radar cruise control provides driving assistance to reduce the driver's burden. However, there are limitations to the assistance provided. Even when the system is functioning normally, the condition of the preceding vehicle as detected by the system may differ from the condition observed by the driver. Therefore, the driver must always remain alert, assess the danger of each situation and drive safely. Relying on this system or assuming the system ensures safety while driving can lead to an accident, resulting in death or serious injury.

**■ Cautions regarding the driving assist systems**

Observe the following precautions, as there are limitations to the assistance provided by the system.

Failure to do so may cause an accident resulting in death or serious injury.

**● Assisting the driver to measure following distance**

The dynamic radar cruise control is only intended to help the driver in determining the following distance between the driver's own vehicle and a designated vehicle traveling ahead. It is not a mechanism that allows careless or inattentive driving, and it is not a system that can assist the driver in low-visibility conditions. It is still necessary for driver to pay close attention to the vehicle's surroundings.

**● Assisting the driver to judge proper following distance**

The dynamic radar cruise control determines whether the following distance between the driver's own vehicle and a designated vehicle traveling ahead is within a set range. It is not capable of making any other type of judgement. Therefore, it is absolutely necessary for the driver to remain vigilant and to determine whether or not there is a possibility of danger in any given situation.

**● Assisting the driver to operate the vehicle**

The dynamic radar cruise control has limited capability to prevent or avoid a collision with a vehicle traveling ahead. Therefore, if there is ever any danger, the driver must take immediate and direct control of the vehicle and act appropriately in order to ensure the safety of all involved.

**■ To avoid inadvertent dynamic radar cruise control activation**

Switch the dynamic radar cruise control off using the "ON-OFF" button when not in use.

**WARNING****■ Situations unsuitable for dynamic radar cruise control**

Do not use dynamic radar cruise control in any of the following situations. Doing so may result in inappropriate speed control and could cause an accident resulting in death or serious injury.

- Roads where there are pedestrians, cyclists, etc.
- In heavy traffic
- On roads with sharp bends
- On winding roads
- On slippery roads, such as those covered with rain, ice or snow
- On steep downhill, or where there are sudden changes between sharp up and down gradients  
Vehicle speed may exceed the set speed when driving down a steep hill.
- At entrances to freeways and highways
- When weather conditions are bad enough that they may prevent the sensors from detecting correctly (fog, snow, sandstorm, heavy rain, etc.)
- When there is rain, snow, etc. on the front surface of the radar sensor or camera sensor
- In traffic conditions that require frequent repeated acceleration and deceleration
- When an approach warning buzzer is heard often

### Driving in vehicle-to-vehicle distance control mode

This mode employs a radar sensor to detect the presence of vehicles up to approximately 400 ft. (120 m) ahead, determines the current vehicle-to-vehicle following distance, and operates to maintain a suitable following distance from the vehicle ahead.

Note that vehicle-to-vehicle distance will close in when traveling on long downhill slopes.

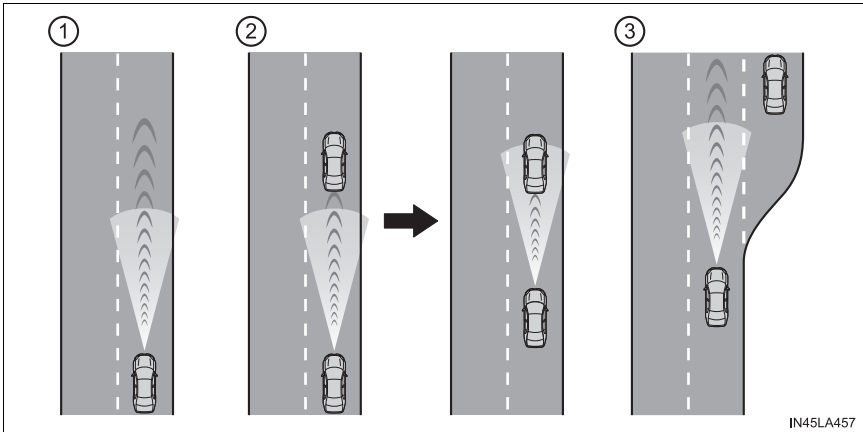

#### ① Example of constant speed cruising

When there are no vehicles ahead

The vehicle travels at the speed set by the driver. The desired vehicle-to-vehicle distance can also be set by operating the vehicle-to-vehicle distance button.

#### ② Example of deceleration cruising and follow-up cruising

When a preceding vehicle driving slower than the set speed appears

When a vehicle is detected running ahead of you, the system automatically decelerates your vehicle. When a greater reduction in vehicle speed is necessary, the system applies the brakes (the stop lights will come on at this time). The system will respond to changes in the speed of the vehicle ahead in order to maintain the vehicle-to-vehicle distance set by the driver. Approach warning warns you when the system cannot decelerate sufficiently to prevent your vehicle from closing in on the vehicle ahead.

#### ③ Example of acceleration

When there are no longer any preceding vehicles driving slower than the set speed

The system accelerates until the set speed is reached. The system then returns to constant speed cruising.

## Setting the vehicle speed (vehicle-to-vehicle distance control mode)

- 1 Press the “ON-OFF” button to activate the cruise control.

Radar cruise control indicator will come on and a message will be displayed on the multi-information display.

Press the button again to deactivate the cruise control.

If the “ON-OFF” button is pressed and held for 1.5 seconds or more, the system turns on in constant speed control mode. (→P. 241)



- 2 Accelerate or decelerate, with accelerator pedal operation, to the desired vehicle speed (above approximately 30 mph [50 km/h]) and push the lever down to set the speed.

Cruise control “SET” indicator will come on.

The vehicle speed at the moment the lever is released becomes the set speed.

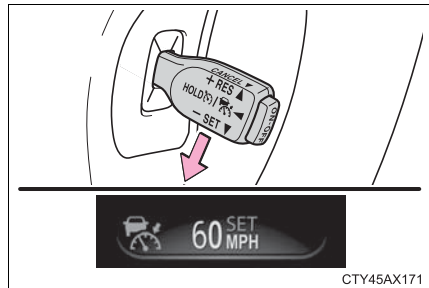

## Adjusting the set speed

To change the set speed, operate the lever until the desired set speed is displayed.

- ① Increases the speed
- ② Decreases the speed

**Fine adjustment:** Momentarily move the lever in the desired direction.

**Large adjustment:** Hold the lever up or down to change the speed, and release when the desired speed is reached.

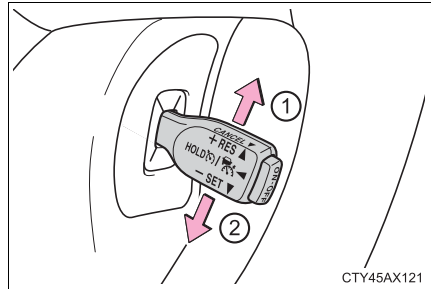

In the vehicle-to-vehicle distance control mode, the set speed will be increased or decreased as follows:

**Fine adjustment:** By 1 mph (1.6 km/h)<sup>\*1</sup> or 1 km/h (0.6 mph)<sup>\*2</sup> each time the lever is operated

**Large adjustment:** Increases or decreases in 1 mph (1.6 km/h)<sup>\*1</sup> or 1 km/h (0.6 mph)<sup>\*2</sup> increments for as long as the lever is held

In the constant speed control mode (→P. 241), the set speed will be increased or decreased as follows:

**Fine adjustment:** By 1 mph (1.6 km/h)<sup>\*1</sup> or 1 km/h (0.6 mph)<sup>\*2</sup> each time the lever is operated

**Large adjustment:** The speed will continue to change while the lever is held.

\*1: When the set speed is shown in "MPH"

\*2: When the set speed is shown in "km/h"

### Changing the vehicle-to-vehicle distance (vehicle-to-vehicle distance control mode)

Pressing the button changes the vehicle-to-vehicle distance as follows:

- ① Long
- ② Medium
- ③ Short

The vehicle-to-vehicle distance is set automatically to long mode when the power switch is turned to ON mode.

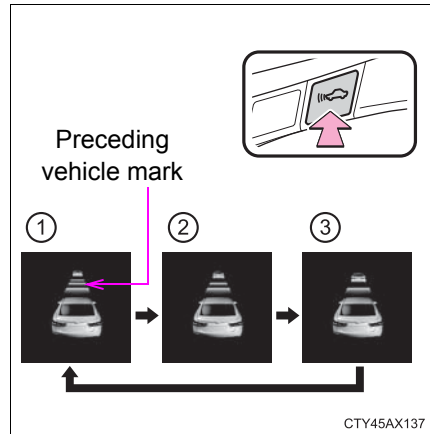

If a vehicle is running ahead of you, the preceding vehicle mark will also be displayed.

### Vehicle-to-vehicle distance settings (vehicle-to-vehicle distance control mode)

Select a distance from the table below. Note that the distances shown correspond to a vehicle speed of 50 mph (80 km/h). Vehicle-to-vehicle distance increases/decreases in accordance with vehicle speed.

Distance options	Vehicle-to-vehicle distance
Long	Approximately 160 ft. (50 m)
Medium	Approximately 130 ft. (40 m)
Short	Approximately 100 ft. (30 m)

## Canceling and resuming the speed control

- ① Pulling the lever toward you cancels the speed control.

The speed control is also canceled when the brake pedal is depressed.

- ② Pushing the lever up resumes the cruise control and returns vehicle speed to the set speed.

However, cruise control does not resume when the vehicle speed is approximately 25 mph (40 km/h) or less.

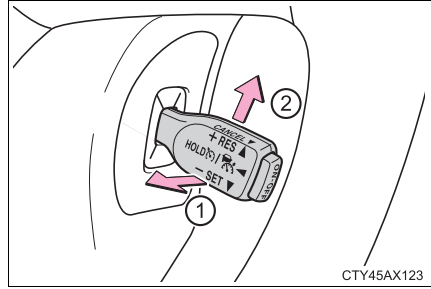

## Approach warning (vehicle-to-vehicle distance control mode)

When your vehicle is too close to a vehicle ahead, and sufficient automatic deceleration via the cruise control is not possible, the display will flash and the buzzer will sound to alert the driver. An example of this would be if another driver cuts in front of you while you are following a vehicle. Depress the brake pedal to ensure an appropriate vehicle-to-vehicle distance.

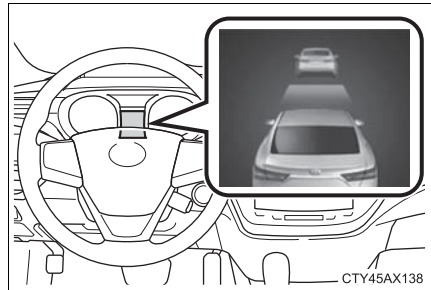

### ■ Warnings may not occur when

In the following instances, warnings may not occur even when the vehicle-to-vehicle distance is small.

- When the speed of the preceding vehicle matches or exceeds your vehicle speed
- When the preceding vehicle is traveling at an extremely slow speed
- Immediately after the cruise control speed was set
- When depressing the accelerator pedal



## Selecting constant speed control mode

When constant speed control mode is selected, your vehicle will maintain a set speed without controlling the vehicle-to-vehicle distance. Select this mode only when vehicle-to-vehicle distance control mode does not function correctly due to a dirty radar sensor, etc.

- 1 With the cruise control off, press and hold the “ON-OFF” button for 1.5 seconds or more.

Immediately after the “ON-OFF” button is pressed, the radar cruise control indicator will come on. Afterwards, it switches to the cruise control indicator.

Switching to constant speed control mode is only possible when operating the lever with the cruise control off.

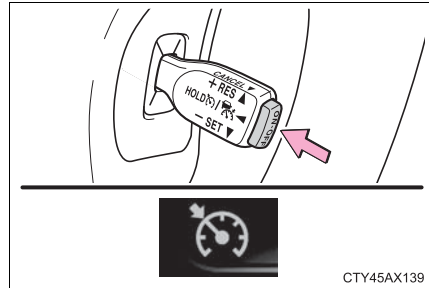

CTY45AX139

- 2 Accelerate or decelerate, with accelerator pedal operation, to the desired vehicle speed (above approximately 30 mph [50 km/h]) and push the lever down to set the speed.

Cruise control “SET” indicator will come on.

The vehicle speed at the moment the lever is released becomes the set speed.

Adjusting the speed setting: →P. 238

Canceling and resuming the speed setting: →P. 240

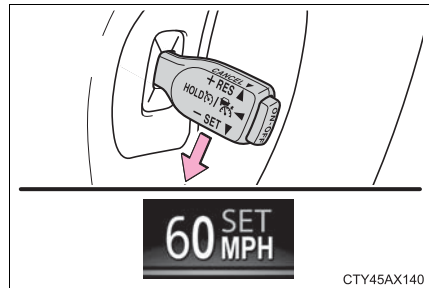

CTY45AX140

**■ Dynamic radar cruise control can be set when**

- The shift lever is in D or range 4 or higher of S has been selected.
- Vehicle speed is above approximately 30 mph (50 km/h).

**■ Accelerating after setting the vehicle speed**

The vehicle can accelerate by operating the accelerator pedal. After accelerating, the set speed resumes. However, during vehicle-to-vehicle distance control mode, the vehicle speed may decrease below the set speed in order to maintain the distance to the preceding vehicle.

**■ Automatic cancelation of vehicle-to-vehicle distance control mode**

Vehicle-to-vehicle distance control mode is automatically canceled in the following situations.

- Actual vehicle speed falls below approximately 25 mph (40 km/h).
- VSC is activated.
- TRAC is activated for a period of time.
- When the VSC or TRAC system is turned off by pressing the VSC OFF switch.
- The sensor cannot detect correctly because it is covered in some way.
- Pre-collision braking is activated.

If vehicle-to-vehicle distance control mode is automatically canceled for any other reason, there may be a malfunction in the system. Contact your Toyota dealer.

**■ Automatic cancelation of constant speed control mode**

Constant speed control mode is automatically canceled in the following situations:

- Actual vehicle speed is more than approximately 10 mph (16 km/h) below the set vehicle speed.
- Actual vehicle speed falls below approximately 25 mph (40 km/h).
- VSC is activated.
- TRAC is activated for a period of time.
- When the VSC or TRAC system is turned off by pressing the VSC OFF switch.
- Pre-collision braking is activated.

If constant speed control mode is automatically canceled for any other reason, there may be a malfunction in the system. Contact your Toyota dealer.

**■ Warning messages and buzzers for dynamic radar cruise control**

Warning messages and buzzers are used to indicate a system malfunction or to inform the driver of the need for caution while driving. If a warning message is shown on the multi-information display, read the message and follow the instructions.

### ■ When the sensor may not be correctly detecting the vehicle ahead

In the case of the following and depending on the conditions, operate the brake pedal when deceleration of the system is insufficient or operate the accelerator pedal when acceleration is required.

As the sensor may not be able to correctly detect these types of vehicles, the approach warning (→P. 240) may not be activated.

- Vehicles that cut in suddenly
- Vehicles traveling at low speeds
- Vehicles that are not moving in the same lane
- Vehicles with small rear ends (trailers with no load on board, etc.)

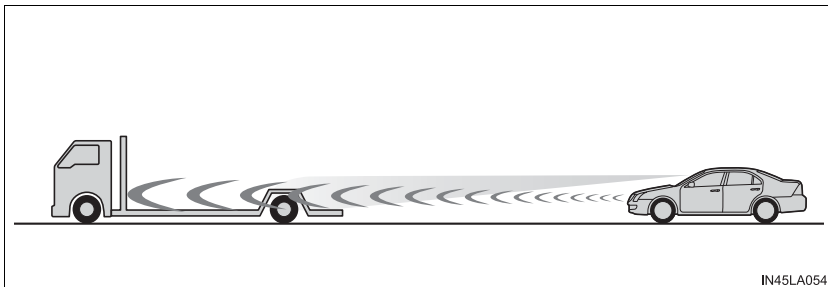

- Motorcycles traveling in the same lane
- When water or snow thrown up by the surrounding vehicles hinders the detecting of the sensor
- When your vehicle is pointing upwards (caused by a heavy load in the luggage compartment, etc.)

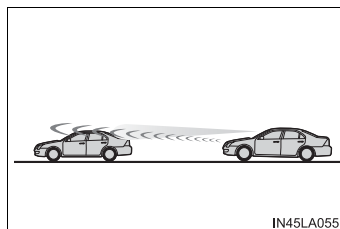

- Preceding vehicle has an extremely high ground clearance

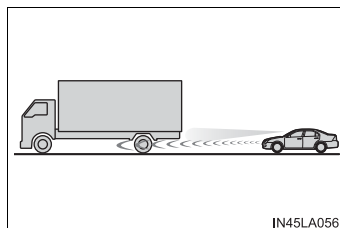

**■ Conditions under which the vehicle-to-vehicle distance control mode may not function correctly**

In the case of the following conditions, operate the brake pedal (or accelerator pedal, depending on the situation) as necessary.

As the sensor may not be able to correctly detect vehicles ahead, the system may not operate properly.

- When the road curves or when the lanes are narrow

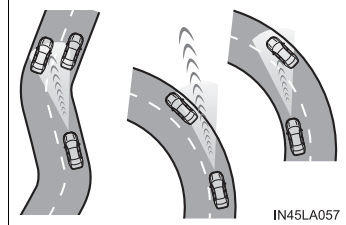

- When steering wheel operation or your position in the lane is unstable

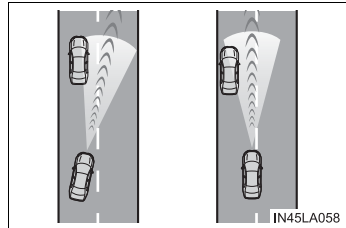

- When the vehicle ahead of you decelerates suddenly

## Cruise control\*

### Summary of functions

Use the cruise control to maintain a set speed without depressing the accelerator pedal.

- ① Display
- ② Indicators
- ③ Set speed
- ④ Cruise control switch

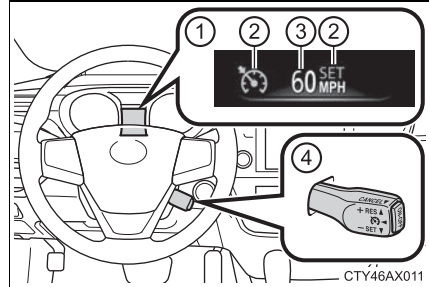

### Setting the vehicle speed

- 1 Press the "ON/OFF" button to activate the cruise control.

Cruise control indicator will be displayed.

Press the button again to deactivate the cruise control.

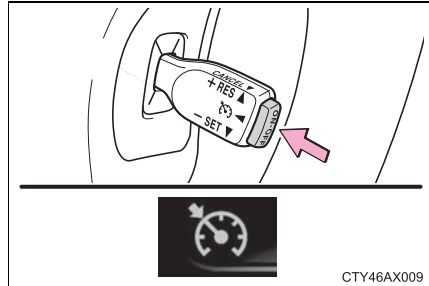

- 2 Accelerate or decelerate the vehicle to the desired speed, and push the lever down to set the speed.

Cruise control "SET" indicator will be displayed.

The vehicle speed at the moment the lever is released becomes the set speed.

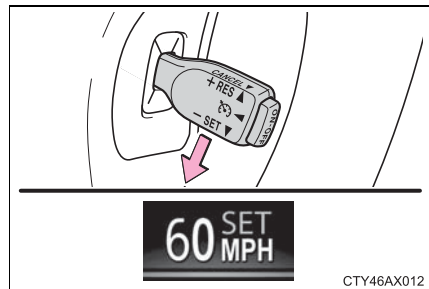

## Adjusting the set speed

To change the set speed, operate the lever until the desired set speed is obtained.

- ① Increases the speed
- ② Decreases the speed

**Fine adjustment:** Momentarily move the lever in the desired direction.

**Large adjustment:** Hold the lever in the desired direction.

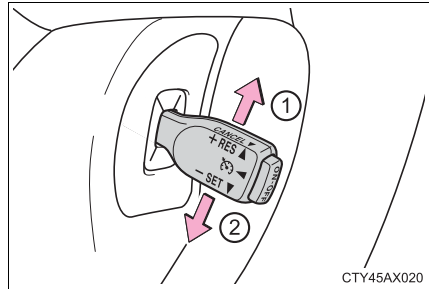

The set speed will be increased or decreased as follows:

- When the set speed is shown in "MPH"

**Fine adjustment:** By approximately 1 mph (1.6 km/h) each time the lever is operated.

**Large adjustment:** The set speed can be increased or decreased continually until the lever is released.

- When the set speed is shown in "km/h"

**Fine adjustment:** By approximately 1 km/h (0.6 mph) each time the lever is operated

**Large adjustment:** The set speed can be increased or decreased continually until the lever is released.

## Canceling and resuming the constant speed control

- ① Pulling the lever toward you cancels the constant speed control.

The speed setting is also canceled when the brakes are applied.

- ② Pushing the lever up resumes the constant speed control.

Resuming is available when the vehicle speed is more than approximately 25 mph (40 km/h).

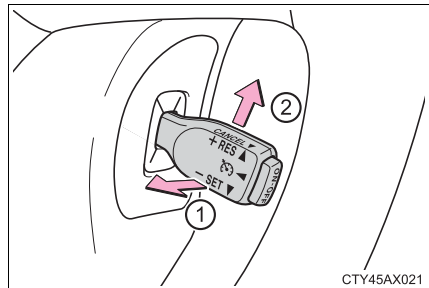

**■ Cruise control can be set when**

- The shift lever is in D or range 4 or higher of S has been selected.
- Vehicle speed is above approximately 25 mph (40 km/h).

**■ Accelerating after setting the vehicle speed**

- The vehicle can be accelerated normally. After acceleration, the set speed resumes.
- Even without canceling the cruise control, the set speed can be increased by first accelerating the vehicle to the desired speed and then pushing the lever down to set the new speed.

**■ Automatic cruise control cancelation**

Cruise control will stop maintaining the vehicle speed in any of the following situations.

- Actual vehicle speed falls more than approximately 10 mph (16 km/h) below the preset vehicle speed.  
At this time, the memorized set speed is not retained.
- Actual vehicle speed is below approximately 25 mph (40 km/h).
- VSC is activated.

**■ If the warning message for the cruise control is shown on the multi-information display**

Press the "ON/OFF" button once to deactivate the system, and then press the button again to reactivate the system.

If the cruise control speed cannot be set or if the cruise control cancels immediately after being activated, there may be a malfunction in the cruise control system. Have the vehicle inspected by your Toyota dealer.



**WARNING****■ To avoid operating the cruise control by mistake**

Switch the cruise control off using the “ON/OFF” button when not in use.

**■ Situations unsuitable for cruise control**

Do not use cruise control in any of the following situations.

Doing so may result in loss of control and could cause an accident resulting in death or serious injury.

- In heavy traffic
- On roads with sharp bends
- On winding roads
- On slippery roads, such as those covered with rain, ice or snow
- On steep hills  
Vehicle speed may exceed the set speed when driving down a steep hill.
- During emergency towing

## BSM (Blind Spot Monitor)\*

### Summary of the Blind Spot Monitor

The Blind Spot Monitor is a system that has 2 functions;

- The Blind Spot Monitor function
  - Assists the driver in making the decision when changing lanes
- The Rear Cross Traffic Alert function
  - Assists the driver when backing up

These functions use same sensors.

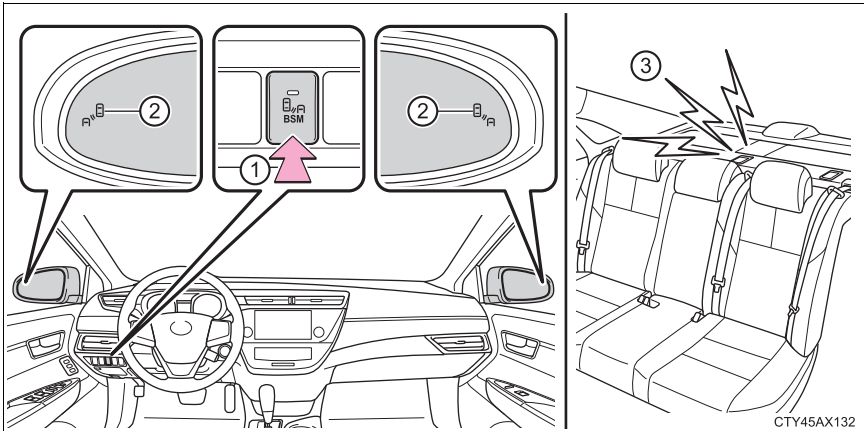

#### ① BSM main switch

Pressing the switch turns the system on or off. When the switch is set to on, the switch's indicator illuminates. Common switch for Blind Spot Monitor function and Rear Cross Traffic Alert function.

#### ② Outside rear view mirror indicator

**Blind Spot Monitor function:**

When a vehicle is detected in the blind spot, the outside rear view mirror indicator comes on while the turn signal lever is not operated and the outside rear view mirror indicator flashes while the turn signal lever is operated.

**Rear Cross Traffic Alert function:**

When a vehicle approaching from the right or left rear of the vehicle is detected, the outside rear view mirror indicators flash.

### ③ Rear Cross Traffic Alert buzzer (Rear Cross Traffic Alert function only)

When a vehicle approaching from the right or left rear of the vehicle is detected, a buzzer sounds from behind the rear seat.

---

#### ■ The outside rear view mirror indicators visibility

When under strong sunlight, the outside rear view mirror indicator may be difficult to see.

#### ■ Rear Cross Traffic Alert buzzer hearing

Rear Cross Traffic Alert function may be difficult to hear over loud noises such as high audio volume.

#### ■ When there is a malfunction in the Blind Spot Monitor system

If a system malfunction is detected due to any of the following reasons, warning messages will be displayed:

- There is a malfunction with the sensors
- The sensors have become dirty  
Clean the sensor and its surrounding area on the bumper.
- The outside temperature is extremely high or low
- The sensor voltage has become abnormal

If a message continues to be displayed, have the vehicle inspected by your Toyota dealer.

#### ■ Certification for the Blind Spot Monitor system

FCC ID: OAYSRR2A

This device complies with part 15 of the FCC Rules. Operation is subject to the following two conditions:

- (1) This device may not cause harmful interference, and
- (2) this device must accept any interference received, including interference that may cause undesired operation.

#### FCC WARNING

Changes or modifications not expressly approved by the party responsible for compliance could void the user's authority to operate the equipment.

**⚠ WARNING****■ Handling the radar sensor**

One Blind Spot Monitor sensor is installed inside the left and right side of the vehicle rear bumper respectively. Observe the following to ensure the Blind Spot Monitor system can function correctly.

- Keep the sensor and its surrounding area on the bumper clean at all times.

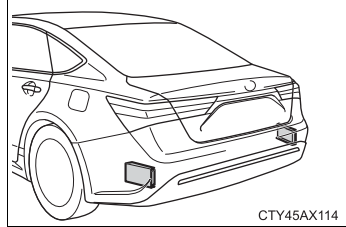

- Do not subject the sensor or surrounding area on the bumper to a strong impact. If the sensor moves even slightly off position, the system may malfunction and vehicles that enter the detection area may not be detected. If the sensor or surrounding area is subject to a strong impact, always have the area inspected by your Toyota dealer.
- Do not disassemble the sensor.
- Do not attach accessories or stickers to the sensor or surrounding area on the bumper.
- Do not modify the sensor or surrounding area on the bumper.
- Do not paint the rear bumper any color other than an official Toyota color.

**The Blind Spot Monitor function**

The Blind Spot Monitor function uses radar sensors to detect vehicles that are traveling in an adjacent lane in the area that is not reflected in the outside rear view mirror (the blind spot), and advises the driver of the vehicles existence via the outside rear view mirror indicator.

## The Blind Spot Monitor function detection areas

The areas that vehicles can be detected in are outlined below.

The range of the detection area extends to:

- ① Approximately 11.5 ft. (3.5 m) from the side of the vehicle  
The first 1.6 ft. (0.5 m) from the side of the vehicle is not in the detection area
- ② Approximately 9.8 ft. (3 m) from the rear bumper
- ③ Approximately 3.3 ft. (1 m) forward of the rear bumper

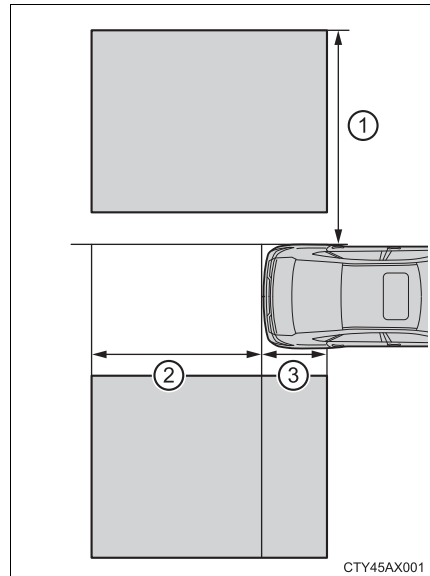

### WARNING

#### ■ Cautions regarding the use of the system

The driver is solely responsible for safe driving. Always drive safely, taking care to observe your surroundings.

The Blind Spot Monitor function is a supplementary function which alerts the driver that a vehicle is present in the blind spot. Do not overly rely on the Blind Spot Monitor function. The function cannot judge if it is safe to change lanes, therefore over reliance could cause an accident resulting in death or serious injury.

According to conditions, the system may not function correctly. Therefore the driver's own visual confirmation of safety is necessary.

**■ The Blind Spot Monitor function is operational when**

- The BSM main switch is set to on
- Vehicle speed is greater than approximately 10 mph (16 km/h).

**■ The Blind Spot Monitor function will detect a vehicle when**

- A vehicle in an adjacent lane overtakes your vehicle.
- Another vehicle enters the detection area when it changes lanes.

**■ Conditions under which the Blind Spot Monitor function will not detect a vehicle**

The Blind Spot Monitor function is not designed to detect the following types of vehicles and/or objects:

- Small motorcycles, bicycles, pedestrians etc.\*
- Vehicles traveling in the opposite direction
- Guardrails, walls, signs, parked vehicles and similar stationary objects\*
- Following vehicles that are in the same lane\*
- Vehicles driving 2 lanes across from your vehicle\*

\*: Depending on conditions, detection of a vehicle and/or object may occur.

**■ Conditions under which the Blind Spot Monitor function may not function correctly**

- The Blind Spot Monitor function may not detect vehicles correctly in the following conditions:
  - During bad weather such as heavy rain, fog, snow etc.
  - When ice or mud etc. is attached to the rear bumper
  - When driving on a road surface that is wet due to rain, standing water etc.
  - When there is a significant difference in speed between your vehicle and the vehicle that enters the detection area
  - When a vehicle is in the detection area from a stop and remains in the detection area as your vehicle accelerates
  - When driving up or down consecutive steep inclines, such as hills, a dip in the road etc.
  - When multiple vehicles approach with only a small gap between each vehicle
  - When vehicle lanes are wide, and the vehicle in the next lane is too far away from your vehicle
  - When the vehicle that enters the detection area is traveling at about the same speed as your vehicle
  - When there is a significant difference in height between your vehicle and the vehicle that enters the detection area
  - Directly after the BSM main switch is set to on
- Instances of the Blind Spot Monitor function unnecessarily detecting a vehicle and/or object may increase under the following conditions:
  - When there is only a short distance between your vehicle and a guardrail, wall etc.
  - When there is only a short distance between your vehicle and a following vehicle
  - When vehicle lanes are narrow and a vehicle driving 2 lanes across from your vehicle enters the detection area
  - When items such as a bicycle carrier are installed on the rear of the vehicle

## The Rear Cross Traffic Alert function

The Rear Cross Traffic Alert functions when your vehicle is in reverse. It can detect other vehicles approaching from the right or left rear of the vehicle. It uses radar sensors to alert the driver of the other vehicle's existence through flashing the outside rear view mirror indicators and sounding a buzzer.

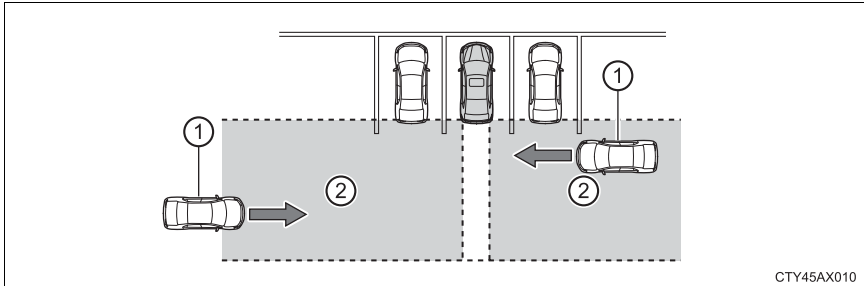

CTY45AX010

① Approaching vehicles

② Detection areas

### WARNING

#### ■ Cautions regarding the use of the system

The driver is solely responsible for safe driving. Always drive safely, taking care to observe your surroundings.

The Rear Cross Traffic Alert function is only an assist and is not a replacement for careful driving. Driver must be careful when backing up, even when using Rear Cross Traffic Alert function. The driver's own visual confirmation of behind you and your vehicle is necessary and be sure there are no pedestrians, other vehicles etc. before backing up. Failure to do so could cause death or serious injury.

According to conditions, the system may not function correctly. Therefore the driver's own visual confirmation of safety is necessary.



## The Rear Cross Traffic Alert function detection areas

The areas that vehicles can be detected in are outlined below.

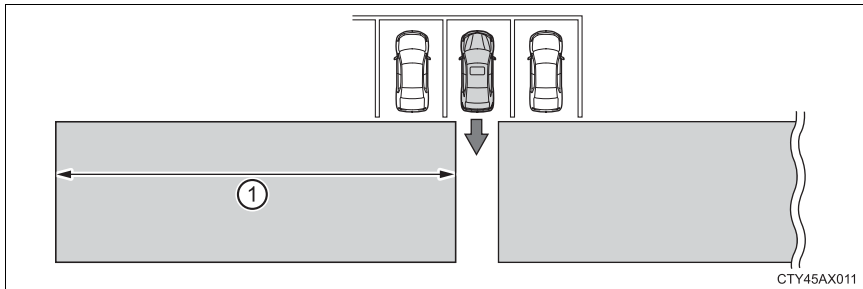

To give the driver a more consistent time to react, the buzzer can alert for faster vehicles from farther away.

Example:

Approaching vehicle	Speed	① Approximate alert distance
Fast	18 mph (28 km/h)	65 ft. (20 m)
Slow	5 mph (8 km/h)	18 ft. (5.5 m)

### ■ The Rear Cross Traffic Alert function is operational when

- The BSM main switch is set to on.
- The shift lever is in R.
- Vehicle speed is less than approximately 5 mph (8 km/h).
- Approaching vehicle speed is between approximately 5 mph (8 km/h) and 18 mph (28 km/h).

### ■ Conditions under which the Rear Cross Traffic Alert function will not detect a vehicle

The Rear Cross Traffic Alert function is not designed to detect the following types of vehicles and/or objects.

- Small motorcycles, bicycles, pedestrians etc.\*
- Vehicles approaching from directly behind
- Guardrails, walls, signs, parked vehicles and similar stationary objects\*
- Vehicles moving away from your vehicle
- Vehicles approaching from the parking spaces next to your vehicle\*
- Vehicles backing up in the parking space next to your vehicle\*

\*: Depending on conditions, detection of a vehicle and/or object may occur.

### ■ Conditions under which the Rear Cross Traffic Alert function may not function correctly

The Rear Cross Traffic Alert function may not detect vehicles correctly in the following conditions:

- When ice or mud etc. is attached to the rear bumper
- During bad weather such as heavy rain, fog, snow etc.
- When ice or mud etc. is attached to the rear bumper
- When multiple vehicles approach continuously
- Shallow angle parking
- When a vehicle is approaching at high speed
- When parking on a steep incline, such as hills, a dip in the road etc.
- Directly after the BSM main switch is set to on
- Vehicles that the sensors cannot detect because of obstacles

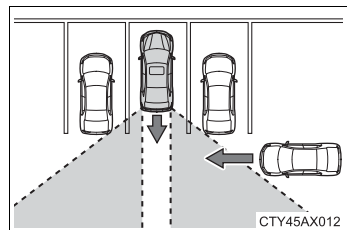

## Driving mode select switch

The driving modes can be selected to suit driving condition.

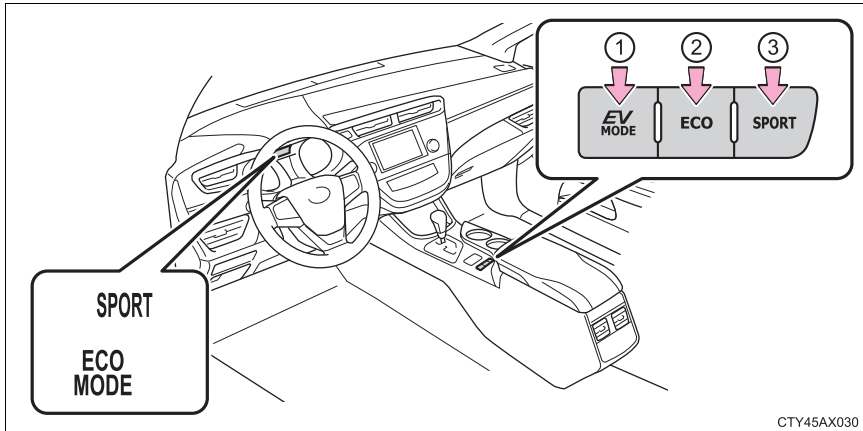

① EV drive mode →P. 178

② Eco drive mode

Use Eco drive mode to help achieve low fuel consumption during trips that involve frequent accelerating.

When the “ECO” switch is pressed, the “ECO MODE” indicator comes on in the instrument cluster and message is shown on the multi-information display. To turn off Eco drive mode, press the “ECO” switch again.

③ Sport mode

Assists acceleration response by controlling the hybrid system. Suitable for when precise handling is desirable, for example when driving on mountain roads.

When the “SPORT” switch is pressed, the “SPORT” indicator comes on in the instrument cluster. To turn off the sport mode, press the “SPORT” switch again.

**■ Operation of the air conditioning system in Eco drive mode**

Eco drive mode controls the heating/cooling operations and fan speed of the air conditioning system to enhance fuel efficiency (→P. 274). To improve air conditioning performance, adjust the fan speed or turn off Eco drive mode.

**■ Sport mode automatic deactivation**

Sport mode is automatically deactivated if the power switch is turned off after driving in sport mode.

## Driving assist systems

To help enhance driving safety and performance, the following systems operate automatically in response to various driving situations. Be aware, however, that these systems are supplementary and should not be relied upon too heavily when operating the vehicle.

### ◆ ECB (Electronically Controlled Brake System)

---

The electronically controlled system generates braking force corresponding to the brake operation

### ◆ ABS (Anti-lock Brake System)

---

Helps to prevent wheel lock when the brakes are applied suddenly, or if the brakes are applied while driving on a slippery road surface

### ◆ Brake assist

---

Generates an increased level of braking force after the brake pedal is depressed when the system detects a panic stop situation

### ◆ VSC (Vehicle Stability Control)

---

Helps the driver to control skidding when swerving suddenly or turning on slippery road surfaces

### ◆ Enhanced VSC (Enhanced Vehicle Stability Control)

---

Provides cooperative control of the ABS, TRAC, VSC and EPS. Helps to maintain directional stability when swerving on slippery road surfaces by controlling steering performance.

### ◆ TRAC (Traction Control)

---

Helps to maintain drive power and prevent the drive wheels from spinning when starting the vehicle or accelerating on slippery roads

### ◆ Hill-start assist control

---

Helps to reduce the backward movement of the vehicle when starting on an uphill

### ◆ EPS (Electric Power Steering)

Employs an electric motor to reduce the amount of effort needed to turn the steering wheel

### ◆ BSM (Blind Spot Monitor) (if equipped)

→P. 250

### When the TRAC/VSC/ABS systems are operating

The slip indicator light will flash while the TRAC/VSC/ABS systems are operating.

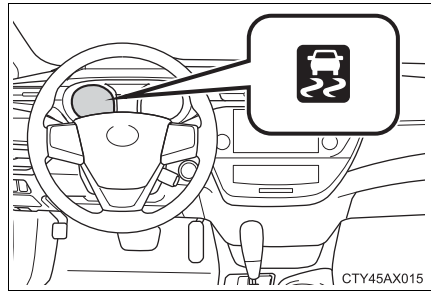

### Disabling the TRAC system

If the vehicle gets stuck in mud, dirt or snow, the TRAC systems may reduce power from the hybrid system to the wheels. Pressing the switch to turn the system off may make it easier for you to rock the vehicle in order to free it.

To turn the TRAC system off, quickly press and release the switch.

The "TRAC OFF" and a message will be shown on the multi-information display.

Press the switch again to turn the system back on.

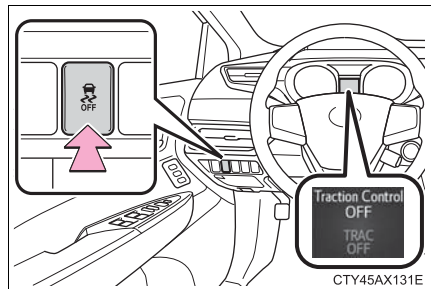

### ■ Turning off both TRAC and VSC systems

To turn the TRAC and VSC systems off, press and hold the switch for more than 3 seconds while the vehicle is stopped.

The VSC OFF and “TRAC OFF” and a message will be shown on the multi-information display\*.

Press the switch again to turn the systems back on.

\*: On vehicles with pre-collision system, pre-collision brake assist and pre-collision braking will also be disabled. The pre-collision system warning light will come on and the message will be shown on the multi-information display. (→P. 221)

### ■ When the message is displayed on the multi-information display showing that TRAC has been disabled even if the TRAC/VSC OFF switch has not been pressed

TRAC and hill-start assist control cannot be operated. Contact your Toyota dealer.

### ■ Sounds and vibrations caused by the ABS, brake assist, TRAC, VSC systems

Any of the following conditions may occur when the above systems are operating. None of these indicates that a malfunction has occurred.

- Vibrations may be felt through the vehicle body and steering.
- A motor sound may be heard after the vehicle comes to a stop.
- The brake pedal may pulsate slightly after the ABS is activated.
- The brake pedal may move down slightly after the ABS is activated.

### ■ ECB operating sound

ECB operating sound may be heard in the following cases, but it does not indicate that a malfunction has occurred.

- Operating sound heard from engine compartment when the brake pedal is operated.
- Motor sound of the brake system heard from the front part of the vehicle when the driver's door is opened.
- Operating sound heard from the engine compartment when one or two minutes passed after the stop of the hybrid system.

### ■ EPS operation sound

When the steering wheel is operated, a motor sound (whirring sound) may be heard. This does not indicate a malfunction.

### ■ Automatic reactivation of TRAC and VSC systems

After turning the TRAC and VSC systems off, the systems will be automatically re-enabled in the following situations:

- When the power switch is turned off
- If only the TRAC system is turned off, the TRAC will turn on when vehicle speed increases
- If both the TRAC and VSC systems are turned off, automatic re-enabling will not occur when vehicle speed increases.

### ■ Reduced effectiveness of the EPS system

The effectiveness of the EPS system is reduced to prevent the system from overheating when there is frequent steering input over an extended period of time. The steering wheel may feel heavy as a result. Should this occur, refrain from excessive steering input or stop the vehicle and turn the hybrid system off. The EPS system should return to normal within 10 minutes.

### ■ Hill-start assist control operating conditions

- The system operates in the following situations:
  - The shift lever is in a position other than P or N.
  - The parking brake is not applied.
  - The accelerator pedal is not depressed.
- Hill-start assist control cannot be operated while the slip indicator light is illuminated.

### ■ Hill-start assist control

- While hill-start assist control is operating, the brakes remain automatically applied after the driver releases the brake pedal. The stop lights and the high mounted stoplight turn on.
- Hill-start assist control operates for about 2 seconds after the brake pedal is released.

### ■ If the slip indicator comes on

It may indicate a malfunction in the system. Contact your Toyota dealer.



### WARNING

#### ■ The ABS does not operate effectively when

- The limits of tire gripping performance have been exceeded (such as excessively worn tires on a snow covered road).
- The vehicle hydroplanes while driving at high speed on wet or slick roads.



 **WARNING****■ Stopping distance when the ABS is operating may exceed that of normal conditions**

The ABS is not designed to shorten the vehicle's stopping distance. Always maintain a safe distance from the vehicle in front of you, especially in the following situations:

- When driving on dirt, gravel or snow-covered roads
- When driving with tire chains
- When driving over bumps in the road
- When driving over roads with potholes or uneven surfaces

**■ TRAC may not operate effectively when**

Directional control and power may not be achievable while driving on slippery road surfaces, even if the TRAC system is operating.

Drive the vehicle carefully in conditions where stability and power may be lost.

**■ When the VSC is activated**

The slip indicator light flashes. Always drive carefully. Reckless driving may cause an accident. Exercise particular care when the indicator light flashes.

**■ When the TRAC/VSC systems are turned off**

Be especially careful and drive at a speed appropriate to the road conditions. As these are the systems to help ensure vehicle stability and driving force, do not turn the TRAC/VSC systems off unless necessary.

**■ Hill-start assist control**

- Do not overly rely on hill-start assist control. Hill-start assist control may not operate effectively on extremely steep inclines and roads covered with ice.
- Unlike the parking brake, hill-start assist control is not intended to hold the vehicle stationary for an extended period of time. Do not attempt to use hill-start assist control to hold the vehicle on an incline for an extended period of time, as doing so may lead to an accident.

**■ Replacing tires**

Make sure that all tires are of the specified size, brand, tread pattern and total load capacity. In addition, make sure that the tires are inflated to the recommended tire inflation pressure level.

The ABS, TRAC and VSC systems will not function correctly if different tires are installed on the vehicle.

Contact your Toyota dealer for further information when replacing tires or wheels.

**■ Handling of tires and the suspension**

Using tires with any kind of problem or modifying the suspension will affect the driving assist systems, and may cause a system to malfunction.

## Hybrid vehicle driving tips

**For economical and ecological driving, pay attention to the following points:**

### ◆ **Using Eco drive mode**

---

When using Eco drive mode, the torque corresponding to the accelerator pedal depression amount can be generated more smoothly than it is in normal conditions. In addition, the operation of the air conditioning system (heating/cooling) will be minimized, improving the fuel economy. (→P. 259)

### ◆ **Use of Hybrid System Indicator**

---

The Eco-friendly driving is possible by keeping the Hybrid System Indicator within Eco area. (→P. 92)

### ◆ **Shift lever operation**

---

Shift the shift lever to D when stopped at a traffic light, or driving in heavy traffic etc. Shift the shift lever to P when parking. When using the N, there is no positive effect on fuel consumption. In the N, the gasoline engine operates but electricity cannot be generated. Also, when using the air conditioning system, etc., the hybrid battery (traction battery) power is consumed.

### ◆ **Accelerator pedal/brake pedal operation**

---

- Drive your vehicle smoothly. Avoid abrupt acceleration and deceleration. Gradual acceleration and deceleration will make more effective use of the electric motor (traction motor) without having to use gasoline engine power.
- Avoid repeated acceleration. Repeated acceleration consumes hybrid battery (traction battery) power, resulting in poor fuel consumption. Battery power can be restored by driving with the accelerator pedal slightly released.

---

### ◆ When braking

---

Make sure to operate the brakes gently and in a timely manner. A greater amount of electrical energy can be regenerated when slowing down.

### ◆ Delays

---

Repeated acceleration and deceleration, as well as long waits at traffic lights, will lead to bad fuel economy. Check traffic reports before leaving and avoid delays as much as possible. When driving in a traffic jam, gently release the brake pedal to allow the vehicle to move forward slightly while avoiding overuse of the accelerator pedal. Doing so can help control excessive gasoline consumption.

### ◆ Highway driving

---

Control and maintain the vehicle at a constant speed. Before stopping at a toll booth or similar, allow plenty of time to release the accelerator and gently apply the brakes. A greater amount of electrical energy can be regenerated when slowing down.

### ◆ Air conditioning

---

Use the air conditioning only when necessary. Doing so can help reduce excessive gasoline consumption.

In summer: When the ambient temperature is high, use the recirculated air mode. Doing so will help to reduce the burden on the air conditioning system and reduce fuel consumption as well.

In winter: Because the gasoline engine will not automatically cut out until it and the interior of the vehicle are warm, it will consume fuel. Also, fuel consumption can be improved by avoiding overuse of the heater.

### ◆ Checking tire inflation pressure

---

Make sure to check the tire inflation pressure frequently. Improper tire inflation pressure can cause poor fuel economy.

Also, as snow tires can cause large amounts of friction, their use on dry roads can lead to poor fuel economy. Use tires that are appropriate for the season.

**◆ Luggage**

---

Carrying heavy luggage will lead to poor fuel economy. Avoid carrying unnecessary luggage. Installing a large roof rack will also cause poor fuel economy.

**◆ Warming up before driving**

---

Since the gasoline engine starts up and cuts out automatically when cold, warming up the engine is unnecessary. Moreover, frequently driving short distances will cause the engine to repeatedly warm up, which can lead to excess fuel consumption.

## Winter driving tips

**Carry out the necessary preparations and inspections before driving the vehicle in winter. Always drive the vehicle in a manner appropriate to the prevailing weather conditions.**

### Preparation for winter

- Use fluids that are appropriate to the prevailing outside temperatures.
  - Engine oil
  - Engine/power control unit coolant
  - Washer fluid
- Have a service technician inspect the condition of the 12-volt battery.
- Have the vehicle fitted with four snow tires or purchase a set of tire chains for the front tires.

Ensure that all tires are the specified size and brand, and that chains match the size of the tires.

### Before driving the vehicle

Perform the following according to the driving conditions:

- Do not try to forcibly open a window or move a wiper that is frozen. Pour warm water over the frozen area to melt the ice. Wipe away the water immediately to prevent it from freezing.
- To ensure proper operation of the climate control system fan, remove any snow that has accumulated on the air inlet vents in front of the windshield.
- Check for and remove any excess ice or snow that may have accumulated on the exterior lights, vehicle's roof, chassis, around the tires or on the brakes.
- Remove any snow or mud from the bottom of your shoes before getting in the vehicle.

### When driving the vehicle

Accelerate the vehicle slowly, keep a safe distance between you and the vehicle ahead, and drive at a reduced speed suitable to road conditions.

### When parking the vehicle

- Park the vehicle and move the shift lever to P without setting the parking brake. The parking brake may freeze up, preventing it from being released. If the vehicle is parked without setting the parking brake, make sure to block the wheels.

Failure to do so may be dangerous because it may cause the vehicle to move unexpectedly, possibly leading to an accident.

- If the vehicle is parked without setting the parking brake, confirm that the shift lever cannot be moved out of P\*.

\*: The shift lever will be locked if it is attempted to be shifted from P to any other position without depressing the brake pedal. If the shift lever can be shifted from P, there may be a problem with the shift lock system. Have the vehicle inspected by your Toyota dealer immediately.

### Selecting tire chains

Use the correct tire chain size when mounting the tire chains. Chain size is regulated for each tire size.

Side chain:

- ① 0.12 in. (3 mm) in diameter
- ② 0.39 in. (10 mm) in width
- ③ 1.18 in. (30 mm) in length

Cross chain:

- ④ 0.16 in. (4 mm) in diameter
- ⑤ 0.55 in. (14 mm) in width
- ⑥ 0.98 in. (25 mm) in length

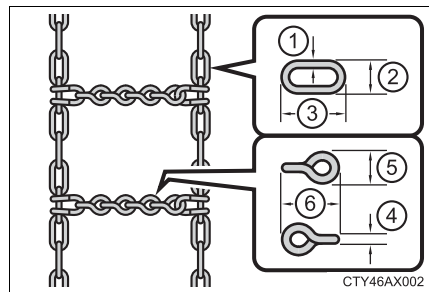

### Regulations on the use of tire chains

Regulations regarding the use of tire chains vary depending on location and type of road. Always check local regulations before installing chains.

### ■ Tire chain installation

Observe the following precautions when installing and removing chains:

- Install and remove tire chains in a safe location.
- Install tire chains on the front tires. Do not install tire chains on the rear tires.
- Install tire chains on front tires as tightly as possible. Retighten chains after driving 1/4 — 1/2 mile (0.5 — 1.0 km).
- Install tire chains following the instructions provided with the tire chains.



### WARNING

#### ■ Driving with snow tires

Observe the following precautions to reduce the risk of accidents.

Failure to do so may result in a loss of vehicle control and cause death or serious injury.

- Use tires of the specified size.
- Maintain the recommended level of air pressure.
- Do not drive in excess of 75 mph (120 km/h), regardless of the type of snow tires being used.
- Use snow tires on all, not just some wheels.

#### ■ Driving with tire chains

Observe the following precautions to reduce the risk of accidents.

Failure to do so may result in the vehicle being unable to be driven safely, and may cause death or serious injury.

- Do not drive in excess of the speed limit specified for the tire chains being used, or 30 mph (50 km/h), whichever is lower.
- Avoid driving on bumpy road surfaces or over potholes.
- Avoid sudden acceleration, abrupt steering, sudden braking and shifting operations that cause sudden engine braking.
- Slow down sufficiently before entering a curve to ensure that vehicle control is maintained.
- Vehicles with LDA (Lane Departure Alert with steering control) system: Do not use LDA (Lane Departure Alert with steering control) system.

**NOTICE****■ Repairing or replacing snow tires**

Request repairs or replacement of snow tires from Toyota dealers or legitimate tire retailers.

This is because the removal and attachment of snow tires affects the operation of the tire pressure warning valves and transmitters.

**■ Fitting tire chains**

The tire pressure warning valves and transmitters may not function correctly when tire chains are fitted.



## Interior features

# 5

- 5-1. Using the air conditioning system and defogger**
- Automatic air conditioning system..... 274
  - Seat heaters/seat ventilators..... 283
- 5-2. Using the interior lights**
- Interior lights list ..... 286
    - Personal/interior light main switch ..... 287
    - Personal/interior lights ..... 287
    - Ambient lights ..... 288
- 5-3. Using the storage features**
- List of storage features ..... 289
    - Glove box..... 290
    - Console box..... 291
    - Cup holders ..... 292
    - Auxiliary boxes..... 293
  - Trunk features ..... 297
- 5-4. Other interior features**
- Other interior features ..... 299
    - Sun visors ..... 299
    - Vanity mirrors..... 299
    - Clock..... 300
    - Outside temperature display..... 301
    - Power outlets ..... 302
    - Armrest ..... 304
    - Rear sunshade ..... 304
    - Coat hooks..... 306
    - Assist grips ..... 306
  - Garage door opener..... 307
  - Safety Connect ..... 314
  - Compass..... 320

## Automatic air conditioning system

**Air outlets and fan speed are automatically adjusted according to the temperature setting.**

### Air conditioning controls

- ▶ Front control panel (type A)

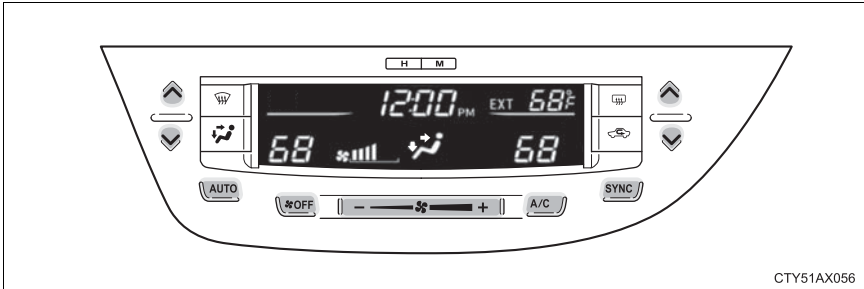

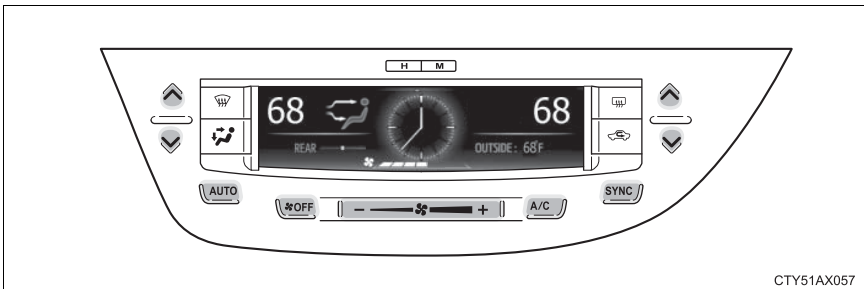

- ▶ Front control panel (type B)



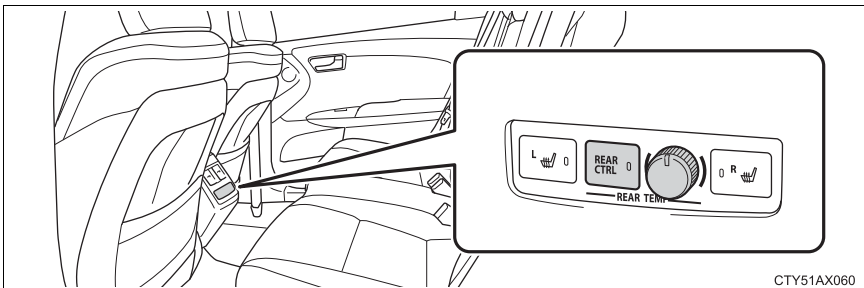



- ▶ Rear control panel (if equipped)



## ■ Adjusting the temperature setting

To adjust the temperature setting, touch  (driver's side) to increase the temperature and touch  (driver's side) to decrease the temperature.

The temperature for the driver's, front passenger's and rear seats (vehicles with a rear control switch) can be adjusted separately when:

-  is pressed (the "SYNC" display disappears).
- The front passenger's side temperature control switch is touched (the front passenger's side temperature setting is shown).
- Vehicles with a rear control switch:  is pressed ( indicator is on and the rear passenger's temperature setting is shown).
- Vehicles with a rear control switch:  is turned ( indicator is on and the rear passenger's temperature setting is shown).

The air conditioning system switches between individual and synchronized modes each time  is touched.

Vehicles with a rear control switch: The rear passenger's temperature setting switches between individual and synchronized modes each time

 is pressed.

### ■ Fan speed setting

To adjust the fan speed, touch  and slide your finger toward “+” to increase the fan speed or “-” to decrease the fan speed.

The fan speed can also be adjusted by touching “+” or “-” on .

Touch  to turn the fan off.

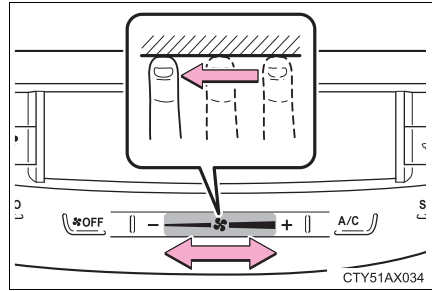

### ■ Change the airflow mode

To change the airflow mode, press .

The air outlets used are switched each time  is pressed.

#### ▶ Type A

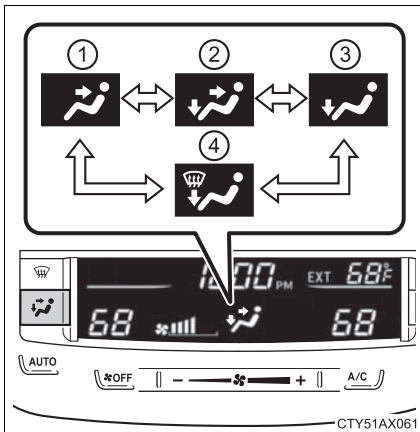

- ① Air flows to the upper body.
- ② Air flows to the upper body and feet.

#### ▶ Type B

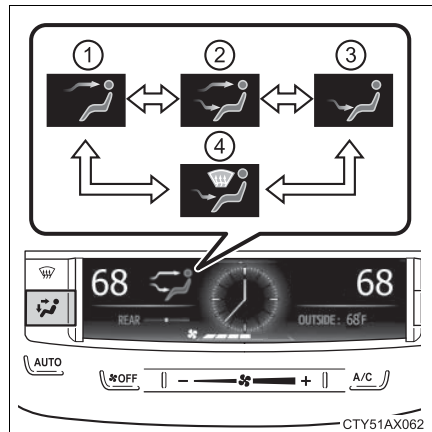

- ③ Air flows to the feet.
- ④ Air flows to the feet and the windshield defogger operates.

### ■ Changing the rear seat temperature settings (vehicles with a rear control switch)

→P. 277

## Using the automatic air conditioning system

### ■ Using automatic operation



1 Touch .

The air conditioning system begins to operate. Air outlets and fan speed are automatically adjusted according to the temperature setting.

2 Adjust the temperature setting.

3 To stop the operation, touch .

### ■ Changing the rear seat temperature settings (vehicles with a rear control switch)

Turn  clockwise to increase the temperature and turn  counterclockwise to decrease the temperature.

### ■ Confirming automatic operation status

During automatic operation, the operation status of fan speed, air outlet mode, outside/recirculated air mode and whether the A/C is on or off can be confirmed on the display by touching .

The display will return to its previous state after a few seconds.

### ■ Automatic mode indicator

If the fan speed setting or air flow modes are operated, the automatic mode indicator goes off. However, automatic mode for functions other than that operated is maintained.

## Other functions

### ■ Switching between outside air and recirculated air modes

Press  .

The mode switches between outside air mode and recirculated air mode each time the button is pressed.

### ■ Defogging the windshield

Defoggers are used to defog the windshield and front side windows.

Press  .

The dehumidification function operates and fan speed increases.

Set the outside/recirculated air mode button to the outside air mode if the recirculated air mode is used. (It may switch automatically.)

To defog the windshield and the side windows early, turn the air flow and temperature up.

To return to the previous mode, press  again when the windshield is defogged.

### ■ Defogging the rear window and outside rear view mirrors

Defoggers are used to defog the rear window, and to remove rain-drops, dew and frost from the outside rear view mirrors.

Press  .

The defoggers will automatically turn off after a period of time.

## Air outlets

### ■ Location of air outlets

The air outlets and air volume change according to the selected airflow mode.

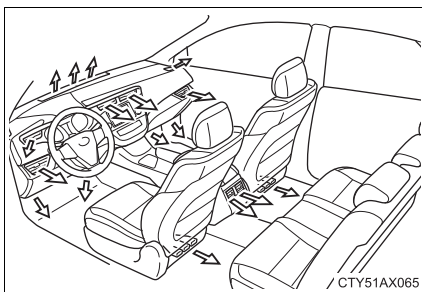

### ■ Adjusting the position of and opening and closing the air outlets

#### ▶ Front center outlets

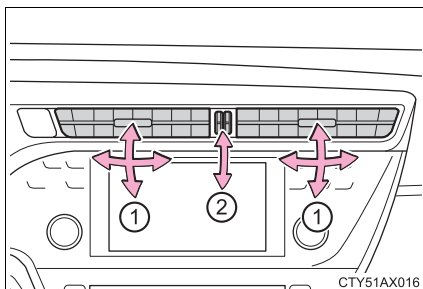

#### ▶ Front side outlets

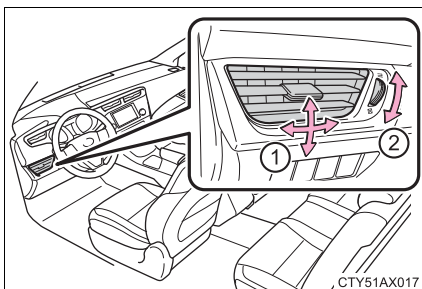

#### ▶ Rear outlets

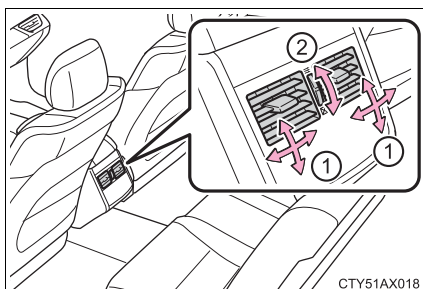

- ① Direct air flow to the left or right, up or down.
- ② Turn the knob to open or close the vent.

### ■ Operation of the air conditioning system in Eco drive mode

In Eco drive mode, the air conditioning system is controlled as follows to prioritize fuel efficiency:

- When the outside temperature exceeds 68°F (20°C), the air conditioning system may switch to recirculated air mode automatically. This may also reduce fuel consumption.
- It is possible to switch to outside air mode at any time by pressing  .
- Engine speed and compressor operation controlled to restrict heating/cooling capacity
- Fan speed restricted when automatic mode is selected

To improve air conditioning performance, perform the following operations:



- Adjust the fan speed
- Turn off Eco drive mode

### ■ Using automatic mode

Fan speed is adjusted automatically according to the temperature setting and the ambient conditions.

Therefore, the fan may stop for a while until warm or cool air is ready to flow immediately after  is touched.

### ■ Fogging up of the windows

- The windows will easily fog up when the humidity in the vehicle is high. Turning  on will dehumidify the air from the outlets and defog the windshield effectively.
- If you turn  off, the windows may fog up more easily.
- The windows may fog up if the recirculated air mode is used.

### ■ Windshield fog detection function

When automatic mode is set, the humidity sensor (→P. 282) detects fog on the windshield and controls the air conditioning system to prevent fog.

### ■ Outside/recirculated air mode

- When driving on dusty roads such as tunnels or in heavy traffic, set the outside/recirculated air mode to the recirculated air mode. This is effective in preventing outside air from entering the vehicle interior. During cooling operation, setting the recirculated air mode will also cool the vehicle interior effectively.
- Outside/recirculated air mode may automatically switch depending on the temperature setting, outside temperature, pressure, engine coolant temperature or inside temperature.



### ■ When the outside temperature exceeds 75°F (24°C) and the air conditioning system is on

- In order to reduce the air conditioning power consumption, the air conditioning system may switch to recirculated air mode automatically. This may also reduce fuel consumption.
- Recirculated air mode is selected as a default mode when the power switch is turned to ON mode.
- It is possible to switch to outside air mode at any time by pressing  .

### ■ When the outside temperature falls to nearly 32°F (0°C)

The dehumidification function may not operate even when  is touched.

### ■ Ventilation and air conditioning odors

- To let fresh air in, set the air conditioning system to the outside air mode.
- During use, various odors from inside and outside the vehicle may enter into and accumulate in the air conditioning system. This may then cause odor to be emitted from the vents.
- To reduce potential odors from occurring:
  - This vehicle is equipped with a deodorizing charcoal air filter. This filter should be inspected and replaced according to the maintenance schedule. (Air conditioning filter: →P. 371)
  - It is recommended that the air conditioning system be set to outside air mode prior to turning the vehicle off.
  - The start timing of the blower may be delayed for a short period of time immediately after the air conditioning system is started in automatic mode.

### ■ Air conditioning filter

→P. 371

### ■ Handling of the air conditioning panel

The operating section of the air conditioning panel uses touch switch sensors. In the following cases, incorrect operation or non-response may occur.

- If the surface of the touch switch is dirty or has liquid attached to it, incorrect operation or non-response may occur.
- If the surface of the touch switch receives electromagnetic waves, incorrect operation or non-response may occur.
- If wearing gloves during operation, non-response may occur.
- If fingernails are used to operate the system, non-response may occur.
- If a touch pen is used to operate the system, non-response may occur.
- If the palm of your hand touches the surface of the touch switch during operation, incorrect operation may occur.
- If the palm of your hand touches the surface of the touch switch, incorrect operation may occur.
- If operations are performed quickly, non-response may occur.

### ■ Customization

Settings (e.g. air conditioning setting, touch switch sensitivity) can be changed.

(Customizable features →P. 461)

### ⚠ WARNING

#### ■ To prevent the windshield from fogging up

- Do not use  during cool air operation in extremely humid weather. The difference between the temperature of the outside air and that of the windshield can cause the outer surface of the windshield to fog up, blocking your vision.
- Do not place anything on the instrument panel which may cover the air outlets. Otherwise, air flow may be obstructed, preventing the windshield defoggers from defogging.

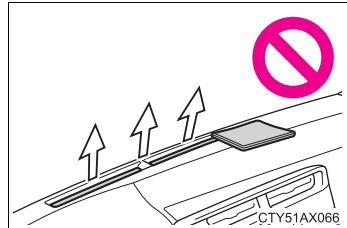

#### ■ To prevent burns

Do not touch the rear view mirror surfaces when the outside rear view mirror defoggers are on.

### ⚠ NOTICE

#### ■ Humidity sensor

In order to detect fog on the windshield, a sensor which monitors the temperature of the windshield, the surround humidity, etc. is installed.

Follow these points to avoid damaging the sensor:

- Do not disassemble the sensor
- Do not spray the glass cleaner on the sensor or subject it to strong impacts
- Do not stick anything on the sensor

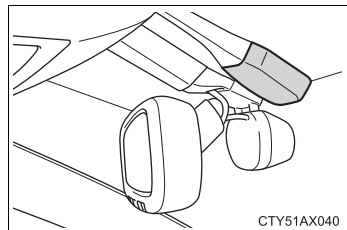

#### ■ To prevent 12-volt battery discharge

Do not leave the air conditioning system on longer than necessary when the hybrid system is off.

## Seat heaters\*/seat ventilators\*

**The seat heaters warm the seats and the seat ventilators maintain good airflow by blowing air through the seats.**

### WARNING

- Care should be taken to prevent injury if anyone in the following categories comes in contact with the seats when the heater is on:
  - Babies, small children, the elderly, the sick and the physically challenged
  - Persons with sensitive skin
  - Persons who are fatigued
  - Persons who have taken alcohol or drugs that induce sleep (sleeping drugs, cold remedies, etc.)
- Observe the following precautions to prevent the minor burns or overheating
  - Do not cover the seat with a blanket or cushion when using the seat heater.
  - Do not use seat heater more than necessary.

### NOTICE

- Do not put heavy objects that have an uneven surface on the seat and do not stick sharp objects (needles, nails, etc.) into the seat.
- To prevent 12-volt battery discharge, do not use the functions when the power is off.

## ■ Front seats

### ▶ Vehicles with ventilator

- ① Press the knob to release it, and turn the knob to the desired temperature setting.
- ② OFF  
Press the knob to lock it when not in use.
- ③ Ventilation
- ④ Heat

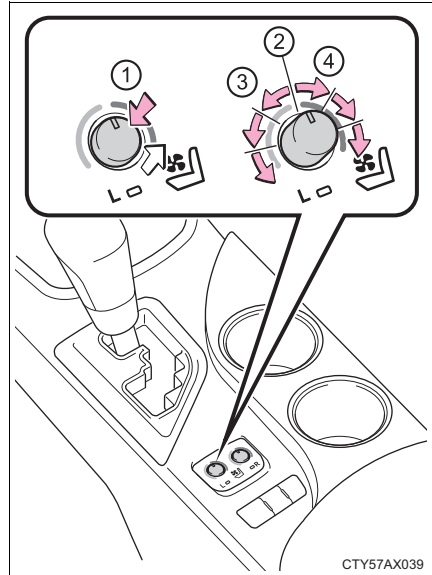

### ▶ Vehicles without ventilator

Press the knob to release it, and turn the knob to the desired temperature setting.

The further you turn the knob clockwise, the warmer the seat temperature becomes. Turn the knob counterclockwise all the way to turn the system off. Press the knob again to lock it when not in use.

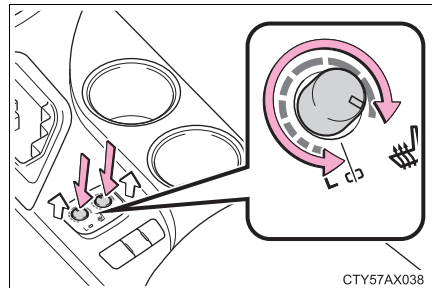

## ■ Rear seats

### ON/OFF

The indicator illuminates when the seat heater is turned on.

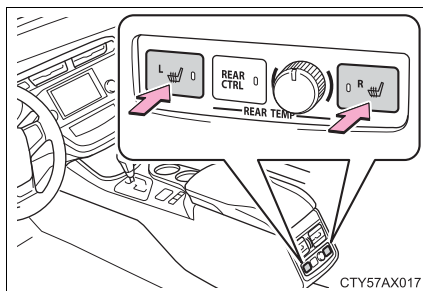

## ■ The seat heaters/seat ventilators can be used when

The power switch is in ON mode.

## ■ Automatic operation of the seat ventilator for the passenger's seat

If a passenger leaves the passenger seat with the seat ventilator on, the seat ventilator will automatically turn off after approximately 10 minutes. If the passenger returns to the seat, it will automatically turn on again.

## ■ Operation display illumination (if equipped)

- ① Illuminates when the ventilator is operating.
- ② Illuminates when the front seat heater is operating.

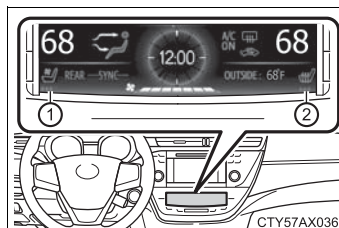

## Interior lights list

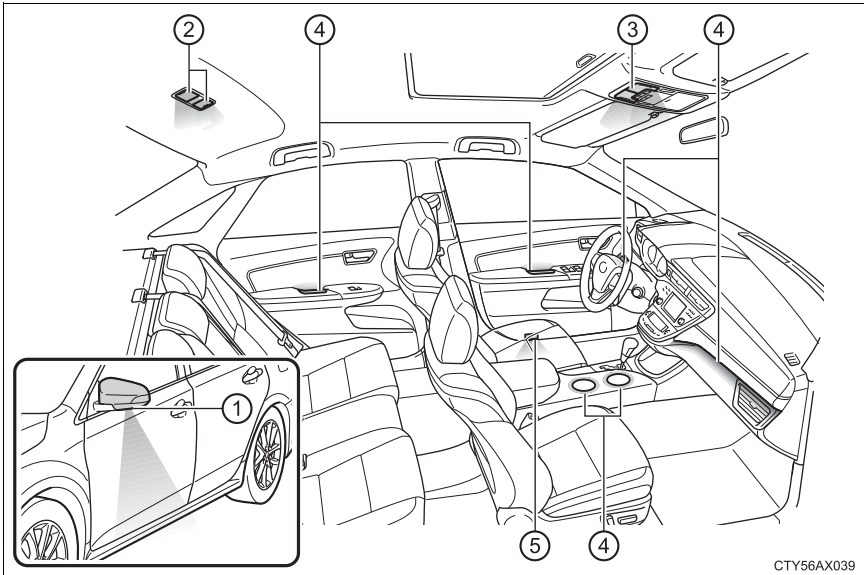

- ① Outer foot lights (if equipped)
- ② Rear personal/interior lights (→P. 287)
- ③ Front personal/interior lights (→P. 287)
- ④ Ambient lights (if equipped) (→P. 288)
- ⑤ Front door courtesy lights

### Personal/interior light main switch

- ① Turns the lights on/off
- ② Turns the lights on/off linked to door position

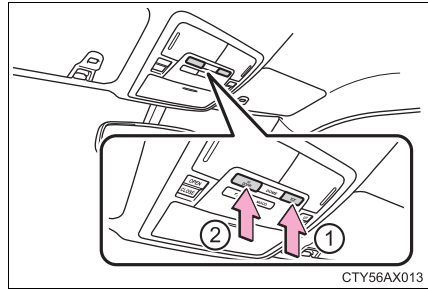

### Personal/interior lights

#### ■ Front

Turns the light on/off

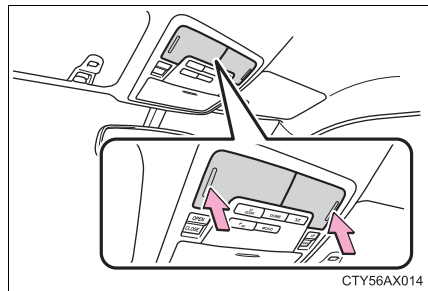

#### ■ Rear

Turns the light on/off

If the lights are turned on by the personal/interior light main switch, the lights cannot turn off by pressing the switch.

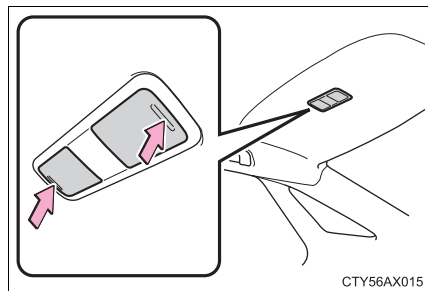

### Ambient lights (if equipped)

Each time the “MOOD” switch is pressed, the brightness level changes.

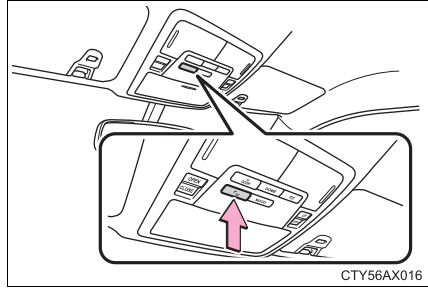

#### ■ Illuminated entry system

The lights automatically turn on/off according to power switch mode, the presence of the electronic key, whether the doors are locked/unlocked, and whether the doors are opened/closed.

#### ■ To prevent 12-volt battery discharge

If the personal/interior lights remain on when the power switch is turned off, the lights will go off automatically after 20 minutes.

#### ■ Customization

Setting (e.g. the time elapsed before lights turn off) can be changed.  
(Customizable features: →P. 461)



#### NOTICE

To prevent 12-volt battery discharge, do not leave the lights on longer than necessary when the hybrid system is off.



## List of storage features

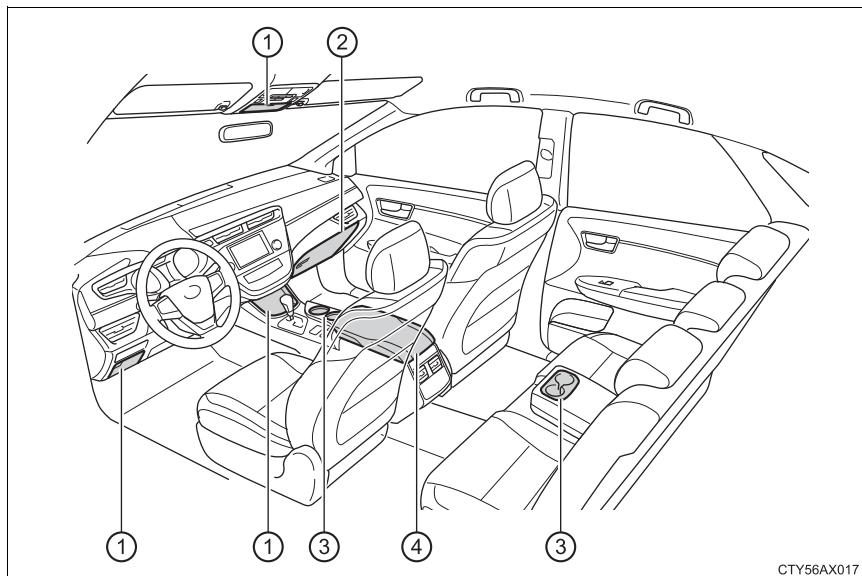

- |                   |           |               |           |
|-------------------|-----------|---------------|-----------|
| ① Auxiliary boxes | (→P. 293) | ③ Cup holders | (→P. 292) |
| ② Glove box       | (→P. 290) | ④ Console box | (→P. 291) |

### WARNING

- Do not leave glasses, lighters or spray cans in the storage spaces, as this may cause the following when cabin temperature becomes high:
  - Glasses may be deformed by heat or cracked if they come into contact with other stored items.
  - Lighters or spray cans may explode. If they come into contact with other stored items, the lighter may catch fire or the spray can may release gas, causing a fire hazard.
- When driving or when the storage compartments are not in use, keep the lids closed.  
In the event of sudden braking or sudden swerving, an accident may occur due to an occupant being struck by an open lid or the items stored inside.

**Glove box**

- ① Open (pull up the lever)
- ② Lock with the mechanical key
- ③ Unlock with the mechanical key

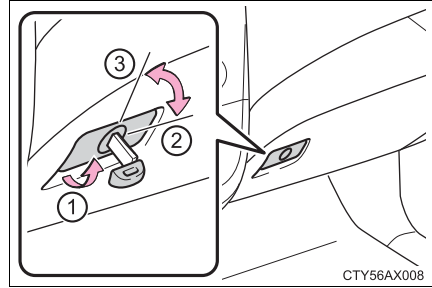

The trunk opener main switch is located in the glove box. (→P. 117)

## Console box

Lift the lid while pulling up the lever to release the lock.

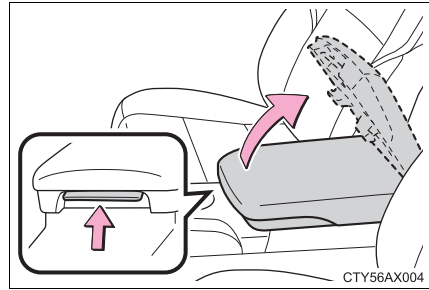

### ■ When using the console box lid as an armrest

Slide the console box lid forward as needed. Slide the lid forward while pulling up the lever.

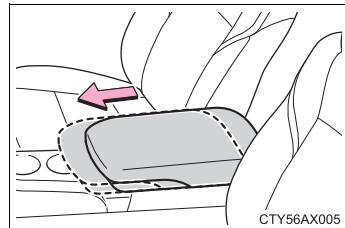

The lid can also be opened from the forwardmost position.

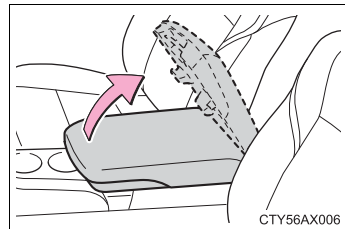

### ■ Tray in the console box

The tray slides forward/backward. To remove the tray slide it forward and lift it.

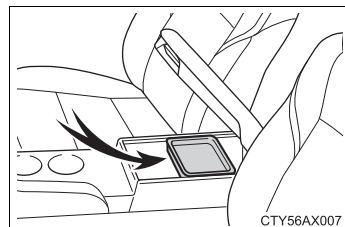

**Cup holders**

## ► Front

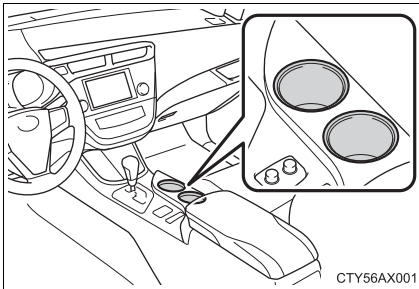

## ► Rear (type A)

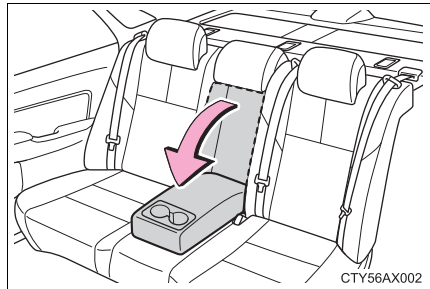

Pull down the armrest.

## ► Rear (type B)

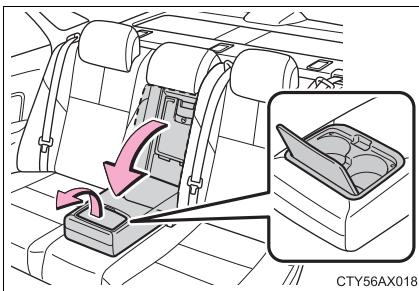

Pull down the armrest and open the lid.

**⚠ WARNING**

Do not place anything other than cups or aluminum cans in the cup holders. Other items may be thrown out of the holders in the event of an accident or sudden braking, causing injury. If possible, cover hot drinks to prevent burns.

## Auxiliary boxes

### ► Type A

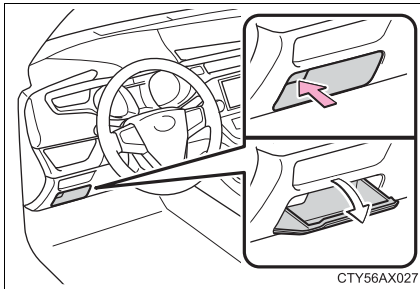

Press in the button.

### ► Type B

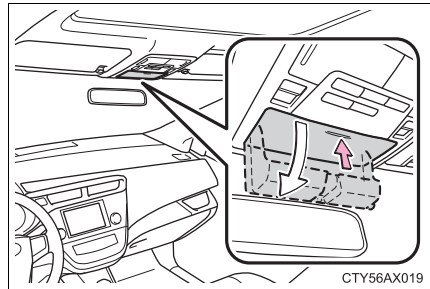

Push the lid.

### ► Type C

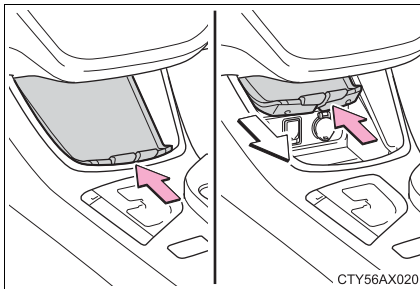

#### Opening

Push the tray forward until it locks.

#### Closing

Push the tray forward to release the lock and the tray will automatically close.

### ■ When placing small items on top of the tray

The tray can be opened while small items are placed on it.

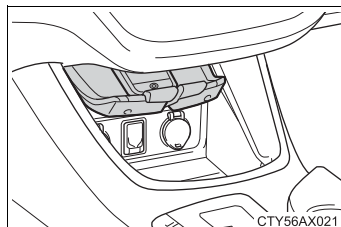

An electronic device on the tray can be recharged by running a charging cable through the clearance of the tray and connecting it to the AUX/USB port or power outlet underneath the tray.

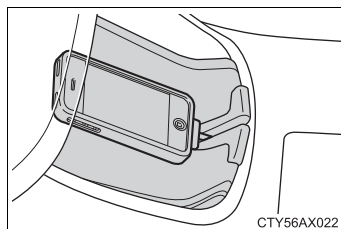

### ■ When using wireless charger (if equipped)

A mobile device can be charged wirelessly on the tray.

Charging can only be performed with the power switch in ACCESSORY or ON mode and only on mobile devices with the “ $\Phi$ ” logo.

- ① Push the tray forward until it locks and press the wireless charger switch.
- ② Push the tray forward to release the lock to close the tray and place a mobile device on the tray as shown in the illustration.

An amber indicator is illuminated while charging is in progress. When charging is complete, a green indicator will also be illuminated.

Some phones, cases or cover type wireless chargers may not cause the green indicator to illuminate even though it is fully charged.

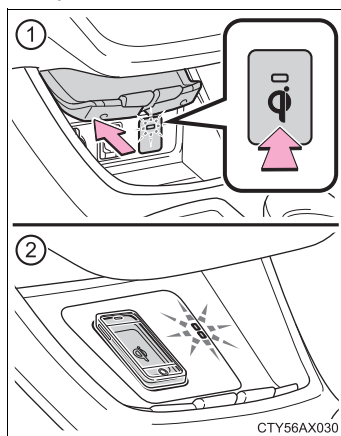

When placing the mobile device on the wireless charging surface of the tray, make sure that there are no objects in-between the mobile device and the tray. They may interfere with charging.

### ■ If the wireless charger LED indicators flash

If the wireless charging surface of the tray becomes too hot, the LED indicators will flash and charging is canceled. The LED indicators will be illuminated if the surface of the tray cools down.

If the LED indicators flash even though the surface of the tray is not hot, the wireless charger may be malfunctioning. Consult your Toyota dealer.

### ■ When charging of the wireless charger stops temporarily

If any of the following operations are performed with the electronic key present, charging may stop temporarily. Charging will start again after a while.

- Locking/unlocking the doors by touching the door handle
- Opening/closing the doors
- Pressing the trunk opener switch
- Closing the trunk lid
- Starting the hybrid system
- Locking the doors by pressing the lock button on the electronic key
- When the electronic key is out of the detection area

### ■ Certification for the wireless charger

This device complies with Part 18 of the FCC Rules.

Toyota Motor Sales, U.S.A., Inc.  
19001 S. Western Avenue  
Torrance, CA 90501



### WARNING

#### ■ Items unsuitable for storing (type B)

Do not store items heavier than 0.4 lb. (0.2 kg).

Doing so may cause the auxiliary box to open and the items inside may fall out, resulting in an accident.

#### ■ Caution regarding interference with electronic devices (vehicles with a wireless charger)

- People with implantable cardiac pacemakers, cardiac resynchronization therapy-pacemakers or implantable cardioverter defibrillators should maintain a reasonable distance between themselves and the wireless charger. The radio waves may affect the operation of such devices.
- Before using the wireless charger, users of any electrical medical device other than implantable cardiac pacemakers, cardiac resynchronization therapy-pacemakers or implantable cardioverter defibrillators should consult the manufacturer of the device for information about its operation under the influence of radio waves. Radio waves could have unexpected effects on the operation of such medical devices.
- To avoid interference with other electrical devices, turn the wireless charger off by turning off the wireless charger switch.

**WARNING****■ When using wireless charger**

Avoid placing metal objects between the wireless charger and the mobile device when charging is active. Doing so may cause metal objects to become hot and could cause burns.

**NOTICE**

- To prevent damaging small items, when opening the tray while small items are placed on it, make sure the items will not get caught.
- To prevent damaging the tray, do not pull down the tray to close it. Doing so may damage the tray.
- When on a steep downward incline, the tray can be closed slowly. In this case, the tray can be pulled down to close it. However, make sure the lock has been released before doing so.



# Trunk features

## Grocery bag hooks

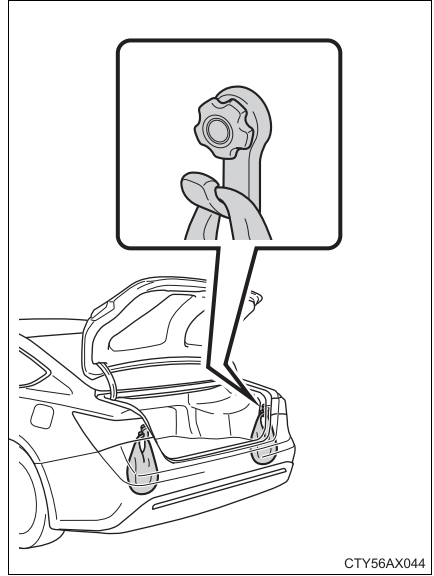

## Cargo net (if equipped)

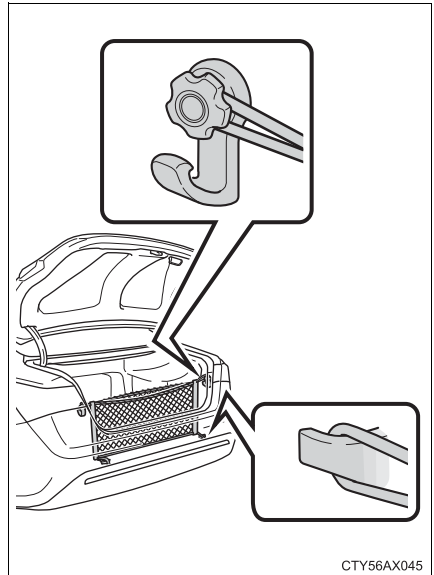

**NOTICE**

To prevent damage to the hooks, do not apply too much load to the hooks.

## Other interior features

### Sun visors

- ① To set the visor in the forward position, flip it down.
- ② To set the visor in the side position, flip down, unhook, and swing it to the side.
- ③ To use the side extender, place the visor in the side position, then slide it backward.

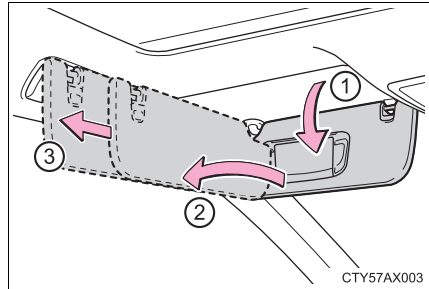

### Vanity mirrors

Open the cover to use.

The light turns on when the cover is opened.

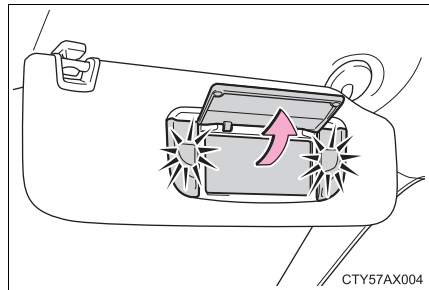

#### NOTICE

To prevent 12-volt battery discharge, do not leave the vanity lights on for extended periods while the hybrid system is off.

## Clock

The clock can be adjusted by pressing the buttons.

### ▶ Type A

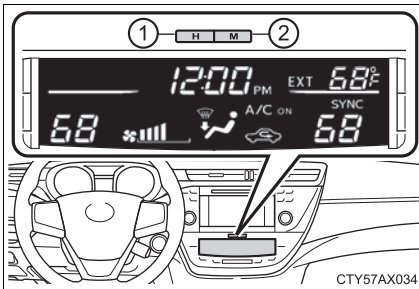

### ▶ Type B

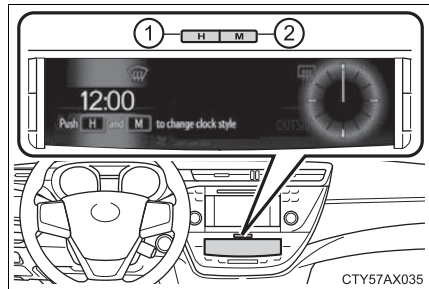

#### ① Adjusts the hours

Pressing and holding the button adjusts the hours forward quickly 1 hour at a time.

#### ② Adjusts the minutes

Pressing and holding the button adjusts the minutes forward quickly by 1 minute at a time. If the button is pressed and held for 5 seconds or more, the minutes move forward by 5 minutes at a time.

### ■ The clock is displayed when

The power switch is in ACCESSORY or ON mode.

### ■ When disconnecting and reconnecting 12-volt battery terminals

#### ▶ Type A

The time display will automatically be set to 12:00 AM.

#### ▶ Type B

The time display will automatically be set to 12:00.

### ■ Time display (Type B)

After pressing “H” or “M” to show the setting screen, press “H” and “M” at the same time to change between the analog and digital displays.

## Outside temperature display

The temperature display shows temperatures within the range of  $-40^{\circ}\text{F}$  ( $-40^{\circ}\text{C}$ ) to  $122^{\circ}\text{F}$  ( $50^{\circ}\text{C}$ ).

### ▶ Type A

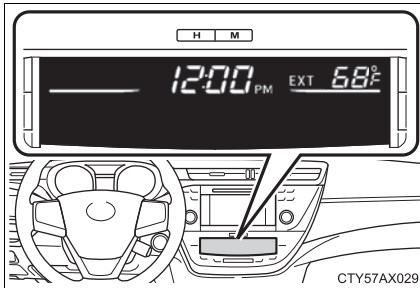

### ▶ Type B

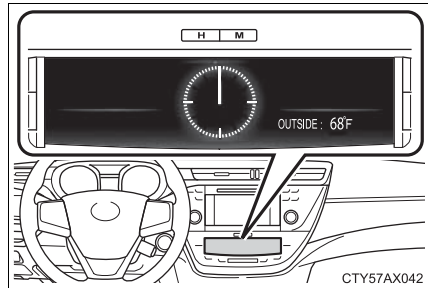

### ■ The outside temperature is displayed when

The power switch is in ON mode.

### ■ Display

In the following situations, the correct outside temperature may not be displayed, or the display may take longer than normal to change.

- When the vehicle is stopped, or moving at low speeds (less than 9 mph [15 km/h]).
- When the outside temperature has changed suddenly (at the entrance/exit of a garage, tunnel, etc.)

### ■ When “---°F” is displayed

The system may be malfunctioning. Take your vehicle to your Toyota dealer.

## Power outlets

The power outlets can be used for 12 V accessories that run on less than 10 A.

### ■ Console box

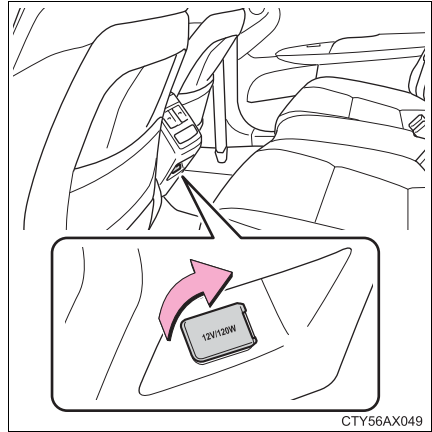

### ■ Instrument panel

#### ► Type A

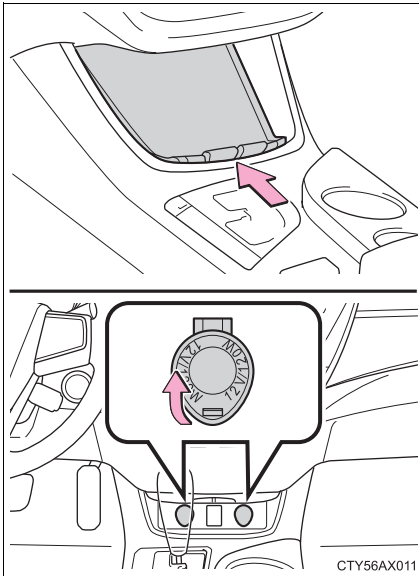

#### ► Type B

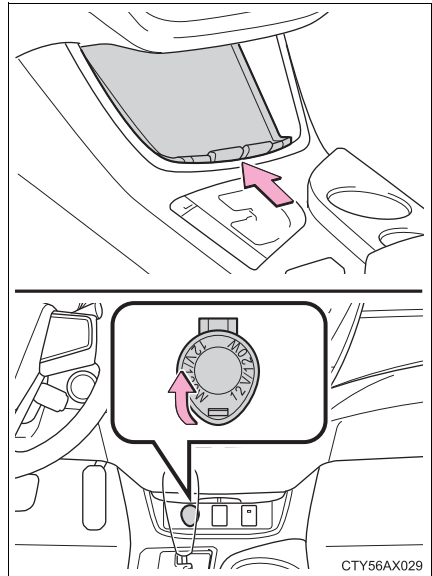

## ■ Rear armrest (if equipped)

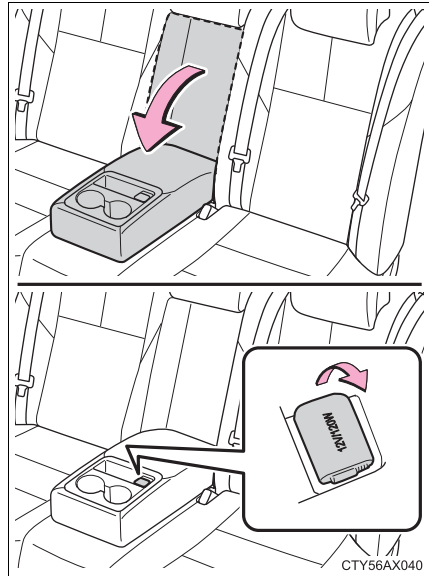

## ■ The power outlets can be used when

The power switch is in ACCESSORY or ON mode.



### NOTICE

- To avoid damaging the power outlets, close the power outlet lids when the power outlets are not in use. Foreign objects or liquids that enter the power outlets may cause a short circuit.
- To prevent blown fuse, do not use an accessory that uses more than 12 V 10 A.
- To prevent 12-volt battery discharge, do not use the power outlets longer than necessary when the hybrid system is off.

## Armrest

Fold down the armrest for use.

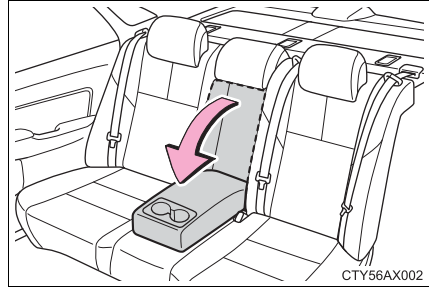

### NOTICE

To prevent damage to the armrest, do not apply too much load on the armrest.

## Rear sunshade (if equipped)

The rear sunshade can be raised and lowered by pressing the switch shown below.

Extends/retracts the rear sunshade

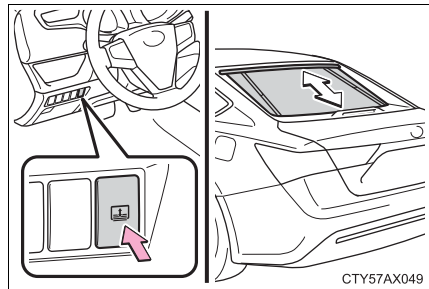



### ■ The rear sunshade can be used when

The power switch is in ON mode.

### ■ Reverse operation feature

To ensure adequate rear visibility, the rear sunshade automatically lowers when the shift lever is shifted to R.

However, the rear sunshade is raised again if either of the following occurs:

- The button is pressed again.
- The shift lever is shifted out of R, and the vehicle reaches a speed of 9 mph (15 km/h).

If the hybrid system is turned off when the rear sunshade has been lowered due to the reverse operation feature, it will not be raised even when the hybrid system is turned on again and the vehicle reaches a speed of 9 mph (15 km/h). To raise the sunshade again, press the button.

### ■ Customization

Settings (e.g. time elapsed before the reverse operation feature activates) can be changed.

(Customizable features: →P. 461)



### WARNING

When the rear sunshade is being raised or lowered, do not place fingers or other objects in the fastener section or in the opening. They may get caught, causing injury.



### NOTICE

To prevent 12-volt battery discharge, do not operate the rear sunshade when the hybrid system is off.

To ensure normal operation of the sunshade, observe the following precautions.

- Do not place excessive load on the motor or other components.
- Do not place objects where they may hinder opening and closing operations.
- Do not attach items to the rear sunshade.
- Keep the opening clean and clear of obstructions.
- Do not operate the rear sunshade continuously for long periods of time.

### Coat hooks

The coat hooks are provided with the rear assist grips.

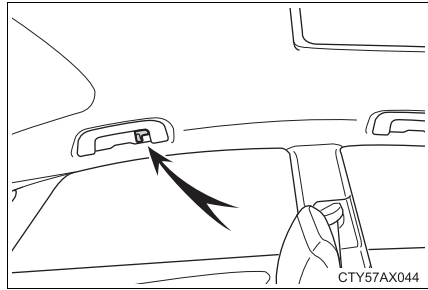

### ⚠ WARNING

Do not hang coat hangers or other hard or sharp objects on the hook. If the SRS curtain shield airbags deploy, these items may become projectiles, causing death or serious injury.

### Assist grips

An assist grip installed on the ceiling can be used to support your body while sitting on the seat.

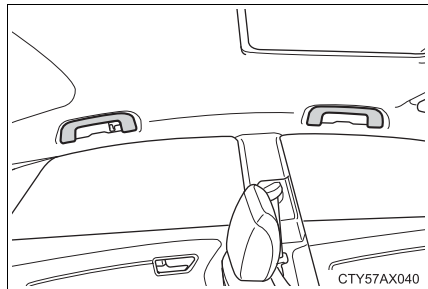

### ⚠ WARNING

Do not use the assist grip when getting in or out of the vehicle or rising from your seat.

### ⚠ NOTICE

To prevent damage to the assist grip, do not hang any heavy object or put a heavy load on the assist grip.

## Garage door opener\*

**The garage door opener can be programmed to operate garage doors, gates, entry doors, door locks, home lighting systems, security systems, and other devices.**

The garage door opener (HomeLink® Universal Transceiver) is manufactured under license from HomeLink®.

### Programming the HomeLink® (for U.S.A. owners)

The HomeLink® compatible transceiver in your vehicle has 3 buttons which can be programmed to operate 3 different devices. Refer to the programming method below appropriate for the device.

- ① Indicator light
- ② Buttons

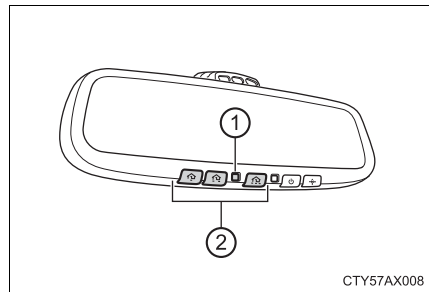

## ■ Programming the HomeLink®

- 1 Point the remote control for the device 1 to 3 in. (25 to 75 mm) from the HomeLink® control buttons.

Keep the indicator light on the HomeLink® in view while programming.

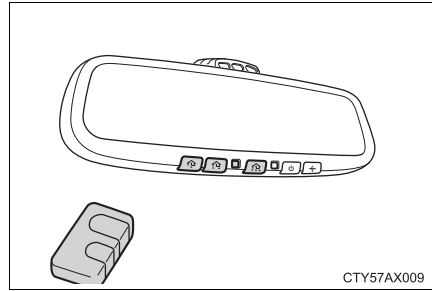

- 2 Press and hold one of the HomeLink® buttons and the transmitter button. When the HomeLink® indicator light changes from a slow to a rapid flash, you can release both buttons.

If the HomeLink® indicator light comes on but does not flash, or flashes rapidly for 2 seconds and remains lit, the HomeLink® button is already programmed. Use the other buttons or follow the “Reprogramming a HomeLink® button” instructions. (→P. 312)

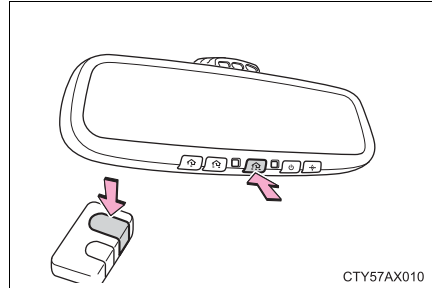

- 3 Test the operation of the HomeLink<sup>®</sup> by pressing the newly programmed button.

If programming a garage door opener, check to see if the garage door opens and closes. If the garage door does not operate, see if your garage transmitter is of the Rolling Code type. Press and hold the programmed HomeLink<sup>®</sup> button. The garage door has the rolling code feature if the indicator light (on the HomeLink<sup>®</sup>) flashes rapidly for 2 seconds and then remains lit. If your transmitter is the Rolling Code type, proceed to the heading "Programming a rolling code system".

- 4 Repeat the steps above to program another device for each of the remaining HomeLink<sup>®</sup> buttons.

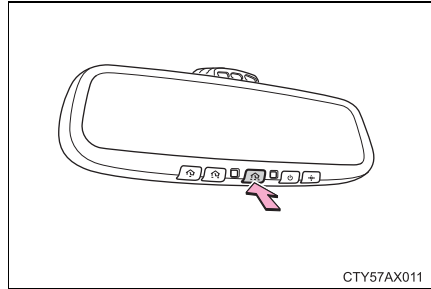

### ■ Programming a Rolling Code system (for U.S.A. owners)

If your device is Rolling Code equipped, follow the steps under the heading “Programming the HomeLink<sup>®</sup>” before proceeding with the steps listed below.

- 1 Locate the training button on the ceiling mounted garage door opener motor. The exact location and color of the button may vary by brand of garage door opener.

Refer to the operation manual supplied with the garage door opener for the location of the training button.

- 2 Press the training button.

Following this step, you have 30 seconds in which to initiate step 3 below.

- 3 Press and hold the vehicle’s programmed HomeLink<sup>®</sup> button for 2 seconds and release it. Repeat this step once again. The garage door may open.

If the garage door opens, the programming process is complete. If the door does not open, press and release the button a third time. This third press and release will complete the programming process by opening the garage door.

The ceiling mounted garage door opener motor should now recognize the HomeLink<sup>®</sup> transceiver and operate the garage door.

- 4 Repeat the steps above to program another rolling code system for any of the remaining HomeLink<sup>®</sup> buttons.

### ■ **Programming an entry gate (for U.S.A. owners)/Programming all devices in the Canadian market**

- 1 Place your transmitter 1 to 3 in. (25 to 75 mm) away from the surface of the HomeLink®.

Keep the indicator light on the HomeLink® in view while programming.

- 2 Press and hold the selected HomeLink® button.
- 3 Repeatedly press and release (cycle) the device's remote control button for two seconds each until step 4 is completed.
- 4 When the indicator light on the HomeLink® compatible transceiver starts to flash rapidly, release the buttons.
- 5 Test the operation of the HomeLink® by pressing the newly programmed button. Check to see if the gate/device operates correctly.
- 6 Repeat the steps above to program another device for each of the remaining HomeLink® buttons.

### ■ **Programming other devices**

To program other devices such as home security systems, home door locks or lighting, contact your authorized Toyota dealer for assistance.

### ■ **Reprogramming a button**

The individual HomeLink® buttons cannot be erased but can be reprogrammed. To reprogram a button, follow the "Basic programming" instructions.

### Operating the HomeLink®

Press the appropriate HomeLink® button. The HomeLink® indicator light on the HomeLink® transceiver should turn on.

The HomeLink® continues to send a signal for up to 20 seconds as long as the button is pressed.

### Reprogramming a HomeLink® button

Press and hold the desired HomeLink® button. After 20 seconds, the HomeLink® indicator light will start flashing slowly. Keep pressing the HomeLink® button and press and hold the transmitter button until the HomeLink® indicator light changes from a slow to a rapid flash. Release the buttons.

### Erasing the entire HomeLink® memory (all three programs)

Press and hold down the 2 outside buttons for 10 seconds until the indicator light flashes.

If you sell your vehicle, be sure to erase the programs stored in the HomeLink® memory.

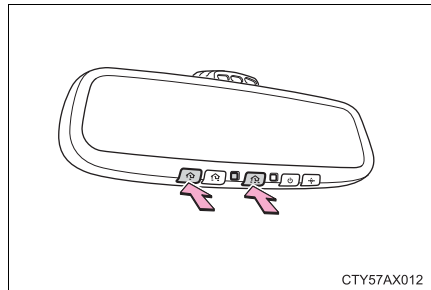



**■ Before programming**

- Install a new battery in the transmitter.
- The battery side of the transmitter must be pointed away from the HomeLink®.

**■ Certification for the garage door opener**

FCC ID: NZLWZLHL4

**NOTE:**

This device complies with Part 15 of the FCC Rules.

Operation is subject to the following two conditions: (1) this device may not cause harmful interference, and (2) this device must accept any interference received, including interference that may cause undesired operation.

**FCC WARNING:**

Changes or modifications not expressly approved by the party responsible for compliance could void the user's authority to operate the equipment.

**■ For additional programming assistance with your HomeLink® Universal Transceiver**

Visit on the web at [www.homelink.com](http://www.homelink.com) or call 1-800-355-3515.

**WARNING****■ When programming a garage door or other remote control device**

The garage door may operate, so ensure people and objects are out of danger to prevent potential harm.

**■ Conforming to federal safety standards**

Do not use the HomeLink® Compatible Transceiver with any garage door opener or device that lacks safety stop and reverse features as required by federal safety standards.

This includes any garage door that cannot detect an obstruction object. A door or device without these features increases the risk of death or serious injury.

## Safety Connect\*

**Safety Connect is a subscription-based telematics service that uses Global Positioning System (GPS) data and embedded cellular technology to provide safety and security features to subscribers. Safety Connect is supported by Toyota's designated response center, which operates 24 hours per day, 7 days per week.**

**Safety Connect service is available by subscription on select, telematics hardware-equipped vehicles.**

**By using the Safety Connect service, you are agreeing to be bound by the Telematics Subscription Service Agreement and its Terms and Conditions, as in effect and amended from time to time, a current copy of which is available at Toyota.com. All use of the Safety Connect service is subject to such then-applicable Terms and Conditions.**

### ■ System components

- ① Microphone
- ② LED light indicators
- ③ "SOS" button

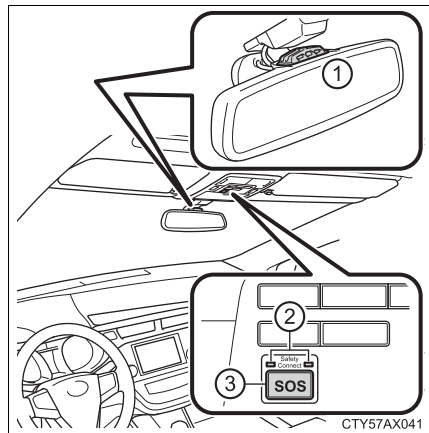

\*: If equipped

## ■ Services

Subscribers have the following Safety Connect services available:

- Automatic Collision Notification\*  
Helps drivers receive necessary response from emergency service providers. (→P. 317)  
\*: U.S. Patent No. 7,508,298 B2
- Stolen Vehicle Location  
Helps drivers in the event of vehicle theft. (→P. 318)
- Emergency Assistance Button (SOS)  
Connects drivers to response-center support. (→P. 318)
- Enhanced Roadside Assistance  
Provides drivers various on-road assistance. (→P. 318)

## ■ Subscription

After you have signed the Telematics Subscription Service Agreement and are enrolled, you can begin receiving services.

A variety of subscription terms is available for purchase. Contact your Toyota dealer, call 1-800-331-4331, or push the “SOS” button in your vehicle for further subscription details.

**■ Safety Connect Services Information**

- Phone calls using the vehicles Bluetooth® technology will not be possible during Safety Connect.
- Safety Connect is available beginning Fall 2009 on select Toyota models. Contact with the Safety Connect response center is dependent upon the telematics device being in operative condition, cellular connection availability, and GPS satellite signal reception, which can limit the ability to reach the response center or receive emergency service support. Enrollment and Telematics Subscription Service Agreement required. A variety of subscription terms is available; charges vary by subscription term selected.
- Automatic Collision Notification, Emergency Assistance, Stolen Vehicle Location, and Enhanced Roadside Assistance will function in the United States, including Hawaii and Alaska, and in Canada. No Safety Connect services will function outside of the United States in countries other than Canada.
- Safety Connect services are not subject to section 255 of the Telecommunications Act and the device is not TTY compatible.

**■ Languages**

The Safety Connect response center will offer support in multiple languages. The Safety Connect system will offer voice prompts in English and Spanish. Please indicate your language of choice when enrolling.

**■ When contacting the response center**

You may be unable to contact the response center if the network is busy.

## Safety Connect LED light Indicators

When the power switch is turned to ON mode, the red indicator light comes on for 2 seconds then turns off. Afterward, the green indicator light comes on, indicating that the service is active.

The following indicator light patterns indicate specific system usage conditions:

- Green indicator light on = Active service
- Green indicator light flashing = Safety Connect call in process
- Red indicator light (except at vehicle start-up) = System malfunction (contact your Toyota dealer)
- No indicator light (off) = Safety Connect service not active

## Safety Connect services

### ■ Automatic Collision Notification

In case of either airbag deployment or severe rear-end collision, the system is designed to automatically call the response center. The responding agent receives the vehicle's location and attempts to speak with the vehicle occupants to assess the level of emergency. If the occupants are unable to communicate, the agent automatically treats the call as an emergency, contacts the nearest emergency services provider to describe the situation, and requests that assistance be sent to the location.

### ■ **Stolen Vehicle Location**

If your vehicle is stolen, Safety Connect can work with local authorities to assist them in locating and recovering the vehicle. After filing a police report, call the Safety Connect response center at 1-800-331-4331 and follow the prompts for Safety Connect to initiate this service.

In addition to assisting law enforcement with recovery of a stolen vehicle, Safety-Connect-equipped vehicle location data may, under certain circumstances, be shared with third parties to locate your vehicle. Further information is available at [Toyota.com](http://Toyota.com).

### ■ **Emergency Assistance Button (“SOS”)**

In the event of an emergency on the road, push the “SOS” button to reach the Safety Connect response center. The answering agent will determine your vehicle’s location, assess the emergency, and dispatch the necessary assistance required.

If you accidentally press the “SOS” button, tell the response-center agent that you are not experiencing an emergency.

### ■ **Enhanced Roadside Assistance**

Enhanced Roadside Assistance adds GPS data to the already included warranty-based Toyota roadside service.

Subscribers can press the “SOS” button to reach a Safety Connect response-center agent, who can help with a wide range of needs, such as: towing, flat tire, fuel delivery, etc. For a description of the Enhanced Roadside Assistance services and their limitations, please see the Safety Connect Terms and Conditions, which are available at [Toyota.com](http://Toyota.com).

## Safety information for Safety Connect

Important! Read this information before using Safety Connect.

### ■ Exposure to radio frequency signals

The Safety Connect system installed in your vehicle is a low-power radio transmitter and receiver. It receives and also sends out radio frequency (RF) signals.

In August 1996, the Federal Communications Commission (FCC) adopted RF exposure guidelines with safety levels for mobile wireless phones. Those guidelines are consistent with the safety standards previously set by the following U.S. and international standards bodies.

- ANSI (American National Standards Institute) C95.1 [1992]
- NCRP (National Council on Radiation Protection and Measurement) Report 86 [1986]
- ICNIRP (International Commission on Non-Ionizing Radiation Protection) [1996]

Those standards were based on comprehensive and periodic evaluations of the relevant scientific literature. Over 120 scientists, engineers, and physicians from universities, and government health agencies and industries reviewed the available body of research to develop the ANSI Standard (C95.1).

The design of Safety Connect complies with the FCC guidelines in addition to those standards.

---

### ■ Certification for Safety Connect

FCC ID: O6Y-CDMRF101

FCC ID: XOECDMRF101B

FCC ID: N7NGTM2

#### NOTE:

This device complies with Part 15 of the FCC Rules. Operation is subject to the following two conditions: (1) This device may not cause harmful interference, and (2) this device must accept any interference received, including interference that may cause undesired operation.

#### FCC WARNING:

Changes or modifications not expressly approved by the party responsible for compliance could void the user's authority to operate the equipment.

## Compass\*

The compass on the inside rear view mirror indicates the direction in which the vehicle is heading.

### ■ Operation

To turn the compass on or off, press the switch for more than 3 seconds.

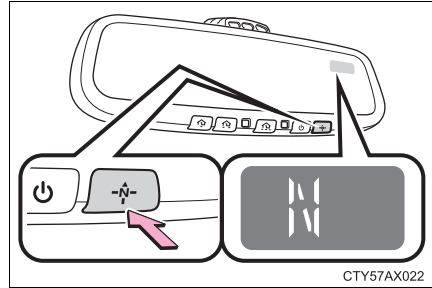



## ■ Displays and directions

Display	Direction
N	North
NE	Northeast
E	East
SE	Southeast
S	South
SW	Southwest
W	West
NW	Northwest

## Calibrating the compass

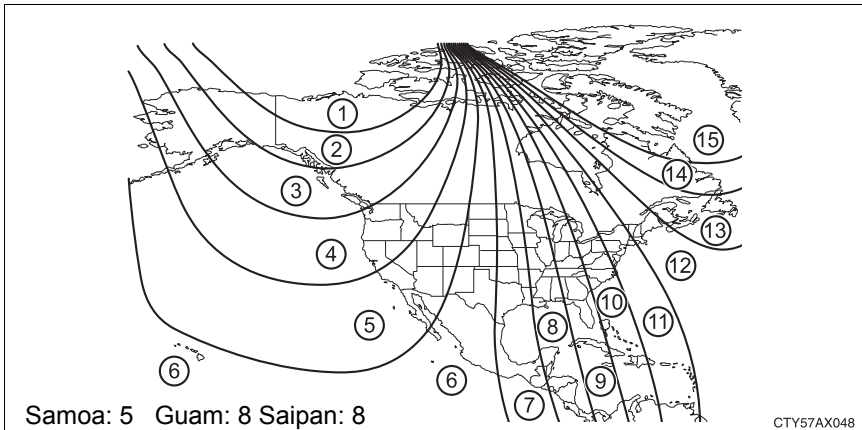

The direction display deviates from the true direction determined by the earth's magnetic field. The amount of deviation varies according to the geographic position of the vehicle.

If you cross over a map boundary shown in illustration, the compass will deviate.

To obtain higher precision or perfect calibration, refer to the following.

### ■ Deviation calibration

- 1 Stop the vehicle.
- 2 Press and hold the switch.  
A number (1 to 15) appears on the compass display.

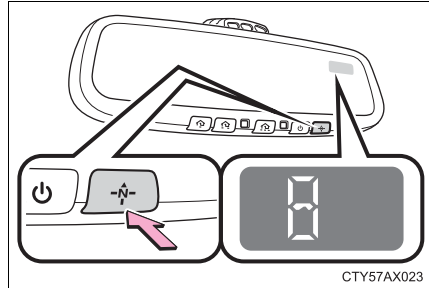

- 3 Referring to the map above, press the switch to select the number of the zone you are in.

If the direction is displayed several seconds after adjustment, the calibration is complete.

### ■ Circling calibration

When “C” appears on the display, drive the vehicle at 5 mph (8 km/h) or less in a circle until a direction is displayed.

If there is not enough space to drive in a circle, drive around the block until the direction is displayed.

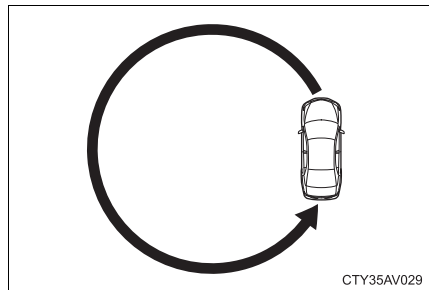

### ■ **Conditions unfavorable to correct operation**

The compass may not show the correct direction in the following conditions:

- The vehicle is stopped immediately after turning.
- The vehicle is on an inclined surface.
- The vehicle is in a place where the earth's magnetic field is subject to interference by artificial magnetic fields (underground car park/parking lot, under a steel tower, between buildings, roof car park/parking lot, near an intersection, near a large vehicle, etc.).
- The vehicle has become magnetized.  
(There is a magnet or metal object near the inside rear view mirror.)
- The 12-volt battery has been disconnected.
- A door is open.



### **WARNING**

#### ■ **While driving**

Do not adjust the display.

Be sure to adjust the display only when the vehicle is stopped.

#### ■ **When doing the circling calibration**

Be sure to secure a wide space, and watch out for people and vehicles in the neighborhood. Do not violate any local traffic rules while performing circling calibration.



### **NOTICE**

#### ■ **To avoid the compass malfunctions**

Do not place magnets or any metal objects near the inside rear view mirror. Doing this may cause a malfunction of the compass sensor.

#### ■ **To ensure normal operation of the compass**

- Do not perform circling calibration of the compass in a place where the earth's magnetic field is subject to interference by artificial magnetic fields.
- During calibration, do not operate electric systems (moon roof, power windows, etc.) as they may interfere with the calibration.



<b>6-1. Maintenance and care</b>	
Cleaning and protecting the vehicle exterior.....	326
Cleaning and protecting the vehicle interior.....	329
<b>6-2. Maintenance</b>	
Maintenance requirements .....	332
General maintenance.....	334
Emission inspection and maintenance (I/M) programs.....	338
<b>6-3. Do-it-yourself maintenance</b>	
Do-it-yourself service precautions .....	339
Hood .....	341
Positioning a floor jack .....	342
Engine compartment.....	343
12-volt battery .....	352
Tires .....	356
Tire inflation pressure .....	365
Wheels .....	368
Air conditioning filter.....	371
Electronic key battery.....	373
Checking and replacing fuses .....	375
Light bulbs.....	378

## Cleaning and protecting the vehicle exterior

### Perform the following to protect the vehicle and maintain it in prime condition:

- Working from top to bottom, liberally apply water to the vehicle body, wheel wells and underside of the vehicle to remove any dirt and dust.
- Wash the vehicle body using a sponge or soft cloth, such as a chamois.
- For hard-to-remove marks, use car wash soap and rinse thoroughly with water.
- Wipe away any water.
- Wax the vehicle when the waterproof coating deteriorates.  
If water does not bead on a clean surface, apply wax when the vehicle body is cool.

---

#### ■ Automatic car washes

- Fold the mirrors before washing the vehicle. Start washing from the front of the vehicle. Make sure to extend the mirrors before driving.
- Brushes used in automatic car washes may scratch the vehicle surface and harm your vehicle's paint.

#### ■ High pressure car washes

- Do not allow the nozzles of the car wash to come within close proximity of the windows.
- Before using the car wash, check that the fuel filler door on your vehicle is closed properly.

#### ■ When using a car wash

If the door handle becomes wet while the electronic key is within the effective range, the door may lock and unlock repeatedly. In that case, follow the following correction procedures to wash the vehicle:

- Place the key in a position 6 ft. (2 m) or more separate from the vehicle while the vehicle is being washed. (Take care to ensure that the key is not stolen.)
- Set the electronic key to battery-saving mode to disable the smart key system. (→P. 125)

### ■ Aluminum wheels

- Remove any dirt immediately by using a neutral detergent. Do not use hard brushes or abrasive cleaners. Do not use strong or harsh chemical cleaners.  
Use the same mild detergent and wax as used on the paint.
- Do not use detergent on the wheels when they are hot, for example after driving for long distance in the hot weather.
- Wash detergent from the wheels immediately after use.

### ■ Bumpers

Do not scrub with abrasive cleaners.

### ⚠ WARNING

#### ■ When washing the vehicle

Do not apply water to the inside of the engine compartment. Doing so may cause the electrical components etc. to catch fire.

#### ■ When cleaning the windshield (vehicles with rain-sensing windshield wipers)

Set the wiper switch to off.

If the wiper switch is in "AUTO", the wipers may operate unexpectedly in the following situations, and may result in hands being caught or other serious injuries and cause damage to the wiper blades.

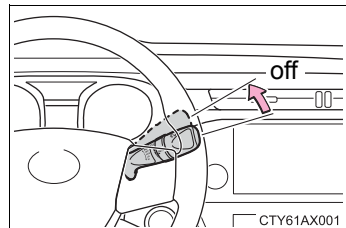

- When the upper part of the windshield where the raindrop sensor is located is touched by hand
- When a wet rag or similar is held close to the raindrop sensor
- If something bumps against the windshield
- If you directly touch the raindrop sensor body or if something bumps into the raindrop sensor

#### ■ Precautions regarding the exhaust pipes

Exhaust gases cause the exhaust pipes to become quite hot.

When washing the vehicle, be careful not to touch the pipes until they have cooled sufficiently, as touching hot exhaust pipes can cause burns.

#### ■ Precaution regarding the Blind Spot Monitor (if equipped)

If the paint of the rear bumper is chipped or scratched, the system may malfunction. If this occurs, consult your Toyota dealer.

**NOTICE****■ To prevent paint deterioration and corrosion on the body and components (aluminum wheels etc.)**

- Wash the vehicle immediately in the following cases:
  - After driving near the sea coast
  - After driving on salted roads
  - If coal tar or tree sap is present on the paint surface
  - If dead insects, insect droppings or bird droppings are present on the paint surface
  - After driving in an area contaminated with soot, oily smoke, mine dust, iron powder or chemical substances
  - If the vehicle becomes heavily soiled with dust or mud
  - If liquids such as benzene and gasoline are spilled on the paint surface
- If the paint is chipped or scratched, have it repaired immediately.
- To prevent the wheels from corroding, remove any dirt and store in a place with low humidity when storing the wheels.

**■ Cleaning the exterior lights**

- Wash carefully. Do not use organic substances or scrub with a hard brush. This may damage the surfaces of the lights.
- Do not apply wax to the surfaces of the lights. Wax may cause damage to the lenses.

**■ To prevent damage to the windshield wiper arms**

When lifting the wiper arms away from the windshield, pull the driver side wiper arm upward first, and repeat for the passenger side. When returning the wipers to their original position, do so from the passenger side first.

**■ When using an automatic car wash (vehicles with rain-sensing windshield wipers)**

Set the wiper switch to off.

If AUTO mode is selected, the wipers may operate and the wiper blades may be damaged.

**■ When using a high pressure car wash**

Do not bring the nozzle tip close to boots (rubber or resin manufactured cover), connectors or the following parts. The parts may be damaged if they come into contact with high-pressure water.

- Traction related parts
- Steering parts
- Suspension parts
- Brake parts



## Cleaning and protecting the vehicle interior

**The following procedures will help protect your vehicle's interior and keep it in top condition:**

### Protecting the vehicle interior

- Remove dirt and dust using a vacuum cleaner. Wipe dirty surfaces with a cloth dampened with lukewarm water.
- If dirt cannot be removed, wipe it off with a soft cloth dampened with neutral detergent diluted to approximately 1%.  
Wring out any excess water from the cloth and thoroughly wipe off remaining traces of detergent and water.

### Cleaning the leather areas

- Remove dirt and dust using a vacuum cleaner.
- Wipe off any excess dirt and dust with a soft cloth dampened with diluted detergent.  
Use a diluted water solution of approximately 5% neutral wool detergent.
- Wring out any excess water from the cloth and thoroughly wipe off all remaining traces of detergent.
- Wipe the surface with a dry, soft cloth to remove any remaining moisture. Allow the leather to dry in a shaded and ventilated area.

### Cleaning the synthetic leather areas

- Remove dirt and dust using a vacuum cleaner.
- Wipe it off with a soft cloth dampened with neutral detergent diluted to approximately 1%.
- Wring out any excess water from the cloth and thoroughly wipe off remaining traces of detergent and water.

**■ Caring for leather areas**

Toyota recommends cleaning the interior of the vehicle at least twice a year to maintain the quality of the vehicle's interior.

**■ Shampooing the carpets**

There are several commercial foaming-type cleaners available. Use a sponge or brush to apply the foam. Rub in overlapping circles. Do not use water. Wipe dirty surfaces and let them dry. Excellent results are obtained by keeping the carpet as dry as possible.

**■ Seat belts**

Clean with mild soap and lukewarm water using a cloth or sponge. Also check the belts periodically for excessive wear, fraying or cuts.

**■ When cleaning the carpeted portions of the glove box, console box, etc.**

If a strong adhesive tape is used, there is a possibility that the surface of the carpet could be damaged.

**WARNING****■ Water in the vehicle**

- Do not splash or spill liquid in the vehicle, such as on the floor, in the hybrid battery (traction battery) air vents, and in the trunk.

Doing so may cause the hybrid battery, electrical components, etc. to malfunction or catch fire.

- Do not get any of the SRS components or wiring in the vehicle interior wet. (→P. 38)

An electrical malfunction may cause the airbags to deploy or not function properly, resulting in death or serious injury.

**■ Cleaning the interior (especially instrument panel)**

Do not use polish wax or polish cleaner. The instrument panel may reflect off the windshield, obstructing the driver's view and leading to an accident, resulting in death or serious injury.

 NOTICE**■ Cleaning detergents**

- Do not use the following types of detergent, as they may discolor the vehicle interior or cause streaks or damage to painted surfaces:
  - Non-seat portions: Organic substances such as benzene or gasoline, alkaline or acidic solutions, dye, and bleach
  - Seats: Alkaline or acidic solutions, such as thinner, benzene, and alcohol
- Do not use polish wax or polish cleaner. The instrument panel's or other interior part's painted surface may be damaged.

**■ Preventing damage to leather surfaces**

Observe the following precautions to avoid damage to and deterioration of leather surfaces:

- Remove any dust or dirt from leather surfaces immediately.
- Do not expose the vehicle to direct sunlight for extended periods of time. Park the vehicle in the shade, especially during summer.
- Do not place items made of vinyl, plastic, or containing wax on the upholstery, as they may stick to the leather surface if the vehicle interior heats up significantly.

**■ Water on the floor**

Do not wash the vehicle floor with water.

Vehicle systems such as the audio system may be damaged if water comes into contact with electrical components such as the audio system above or under the floor of the vehicle. Water may also cause the body to rust.

**■ When cleaning the inside of the windshield (vehicles with Toyota Safety Sense P)**

Do not allow glass cleaner to contact the lens. Also, do not touch the lens. (→P. 204)

**■ Cleaning the inside of the rear window**

- Do not use glass cleaner to clean the rear window, as this may cause damage to the rear window defogger heater wires or antenna. Use a cloth dampened with lukewarm water to gently wipe the window clean. Wipe the window in strokes running parallel to the heater wires or antenna.
- Be careful not to scratch or damage the heater wires or antenna.

## Maintenance requirements

**To ensure safe and economical driving, day-to-day care and regular maintenance are essential. It is the owner's responsibility to perform regular checks. Toyota recommends the following maintenance:**

### General maintenance

General maintenance should be performed on a daily basis. This can be done by yourself or by a Toyota dealer.

### Scheduled maintenance

Scheduled maintenance should be performed at specified intervals according to the maintenance schedule.

For details about maintenance items and schedules, refer to the "Scheduled Maintenance Guide" or "Owner's Manual Supplement".

### Do-it-yourself maintenance

You can perform some maintenance procedures by yourself. Please be aware that do-it-yourself maintenance may affect warranty coverage.

The use of Toyota Repair Manuals is recommended.

For details about warranty coverage, refer to the separate "Owner's Warranty Information Booklet" or "Owner's Manual Supplement".

## ■ Repair and replacement

It is recommended that genuine Toyota parts be used for repairs to ensure performance of each system. If non-Toyota parts are used in replacement or if a repair shop other than a Toyota dealer performs repairs, confirm the warranty coverage.

## ■ Resetting the message indicating maintenance is required

After the required maintenance is performed according to the maintenance schedule, please reset the message.

To reset the message, follow the procedure described below:

- 1 Turn the power switch off with the trip meter A reading shown. (→P. 91)
- 2 While pressing the trip meter reset knob (→P. 91), turn the power switch to ON mode
- 3 Continue to press and hold the knob until the trip meter displays "000000".

## ■ Allow inspection and repairs to be performed by a Toyota dealer

- Toyota technicians are well-trained specialists and are kept up to date with the latest service information. They are well informed about the operations of all systems on your vehicle.
- Keep a copy of the repair order. It proves that the maintenance that has been performed is under warranty coverage. If any problem should arise while your vehicle is under warranty, your Toyota dealer will promptly take care of it.



### WARNING

#### ■ If your vehicle is not properly maintained

Improper maintenance could result in serious damage to the vehicle and possible death or serious injury.

#### ■ Handling of the 12-volt battery

- Engine exhaust, some of its constituents, and a wide variety of automobile components contain or emit chemicals known to the State of California to cause cancer and birth defects and other reproductive harm. Work in a well ventilated area.
- Oils, fuels and fluids contained in vehicles as well as waste produced by component wear contain or emit chemicals known to the State of California to cause cancer and birth defects or other reproductive harm. Avoid exposure and wash any affected area immediately.
- 12-volt battery posts, terminals and related accessories contain lead and lead compounds which are known to cause brain damage. Wash your hands after handling. (→P. 352)

## General maintenance

Listed below are the general maintenance items that should be performed at the intervals specified in the “Owner’s Warranty Information Booklet” or “Owner’s Manual Supplement/Scheduled Maintenance Guide”. It is recommended that any problem you notice should be brought to the attention of your Toyota dealer or qualified service shop for advice.

### Engine compartment

Items	Check points
Brake fluid	Is the brake fluid at the correct level? (→P. 350)
Engine/power control unit coolant	Is the engine/power control unit coolant at the correct level? (→P. 347)
Engine oil	Is the engine oil at the correct level? (→P. 344)
Exhaust system	There should not be any fumes or strange sounds.
Radiator/condenser	The radiator and condenser should be free from foreign objects. (→P. 349)
Washer fluid	Is there sufficient washer fluid? (→P. 351)

### Luggage compartment

Items	Check points
12-volt battery	Check the connections. (→P. 352)

## Vehicle interior

Items	Check points
Accelerator pedal	<ul style="list-style-type: none"> <li>The accelerator pedal should move smoothly (without uneven pedal effort or catching).</li> </ul>
Hybrid transmission "Park" mechanism	<ul style="list-style-type: none"> <li>When parked on a slope and the shift lever is in P, is the vehicle securely stopped?</li> </ul>
Brake pedal	<ul style="list-style-type: none"> <li>Does the brake pedal move smoothly?</li> <li>Does the brake pedal have appropriate clearance from the floor? (→P. 443)</li> <li>Does the brake pedal have the correct amount of free play? (→P. 443)</li> </ul>
Brakes	<ul style="list-style-type: none"> <li>The vehicle should not pull to one side when the brakes are applied.</li> <li>The brakes should work effectively.</li> <li>The brake pedal should not feel spongy.</li> <li>The brake pedal should not get too close to the floor when the brakes are applied.</li> </ul>

Items	Check points
Head restraints	<ul style="list-style-type: none"><li>• Do the head restraints move smoothly and lock securely?</li></ul>
Indicators/buzzers	<ul style="list-style-type: none"><li>• Do the indicators and buzzers function properly?</li></ul>
Lights	<ul style="list-style-type: none"><li>• Do all the lights come on?</li></ul>
Parking brake	<ul style="list-style-type: none"><li>• Moves smoothly?</li><li>• When parked on a slope and the parking brake is on, is the vehicle securely stopped?</li></ul>
Seat belts	<ul style="list-style-type: none"><li>• Do the seat belts operate smoothly?</li><li>• The seat belts should not be damaged.</li></ul>
Seats	<ul style="list-style-type: none"><li>• Do the seat controls operate properly?</li></ul>
Steering wheel	<ul style="list-style-type: none"><li>• Does the steering wheel rotate smoothly?</li><li>• Does the steering wheel have the correct amount of free play?</li><li>• There should not be any strange sounds coming from the steering wheel.</li></ul>



## Vehicle exterior

Items	Check points
Doors/trunk	<ul style="list-style-type: none"> <li>• Do the doors/trunk operate smoothly?</li> </ul>
Engine hood	<ul style="list-style-type: none"> <li>• Does the engine hood lock system work properly?</li> </ul>
Fluid leaks	<ul style="list-style-type: none"> <li>• There should not be any signs of fluid leakage after the vehicle has been parked.</li> </ul>
Tires	<ul style="list-style-type: none"> <li>• Is the tire inflation pressure correct?</li> <li>• The tires should not be damaged or excessively worn.</li> <li>• Have the tires been rotated according to the maintenance schedule?</li> <li>• The wheel nuts should not be loose.</li> </ul>
Windshield wipers	<ul style="list-style-type: none"> <li>• The wiper blades should not show any signs of cracking, splitting, wear, contamination or deformation.</li> <li>• The wiper blades should clear the windshield without streaking or skipping.</li> </ul>



### WARNING

#### ■ If the hybrid system is operating

Turn the hybrid system off and ensure that there is adequate ventilation before performing maintenance checks.

## Emission inspection and maintenance (I/M) programs

**Some states have vehicle emission inspection programs which include OBD (On Board Diagnostics) checks. The OBD system monitors the operation of the emission control system.**

### **If the malfunction indicator lamp comes on**

The OBD system determines that a problem exists somewhere in the emission control system. Your vehicle may not pass the I/M test and may need to be repaired. Contact your Toyota dealer to service the vehicle.

### **Your vehicle may not pass the I/M test in the following situations:**

- When the 12-volt battery is disconnected or discharged  
Readiness codes that are set during ordinary driving are erased. Also, depending on your driving habits, the readiness codes may not be completely set.
- When the fuel tank cap is loose  
The malfunction indicator lamp comes on indicating a temporary malfunction and your vehicle may not pass the I/M test.

### **When the malfunction indicator lamp still remains on after several driving trips**

The error code in the OBD system will not be cleared unless the vehicle is driven 40 or more times.

### **If your vehicle does not pass the I/M test**

Contact your Toyota dealer to prepare the vehicle for re-testing.

## Do-it-yourself service precautions

**If you perform maintenance by yourself, be sure to follow the correct procedure as given in these sections.**

Items	Parts and tools
12-volt battery condition (→P. 352)	<ul style="list-style-type: none"> <li>• Grease</li> <li>• Conventional wrench (for terminal clamp bolts)</li> </ul>
Brake fluid level (→P. 350)	<ul style="list-style-type: none"> <li>• FMVSS No.116 DOT 3 or SAE J1703 brake fluid</li> <li>• Rag or paper towel</li> <li>• Funnel (used only for adding brake fluid)</li> </ul>
Engine/power control unit coolant level (→P. 347)	<ul style="list-style-type: none"> <li>• “Toyota Super Long Life Coolant” or a similar high quality ethylene glycol-based non-silicate, non-amine, non-nitrite and non-borate coolant with long-life hybrid organic acid technology. “Toyota Super Long Life Coolant” is pre-mixed with 50% coolant and 50% deionized water.</li> <li>• Funnel (used only for adding coolant)</li> </ul>
Engine oil level (→P. 344)	<ul style="list-style-type: none"> <li>• “Toyota Genuine Motor Oil” or equivalent</li> <li>• Rag or paper towel</li> <li>• Funnel (used only for adding engine oil)</li> </ul>
Fuses (→P. 375)	<ul style="list-style-type: none"> <li>• Fuse with same amperage rating as original</li> </ul>
Light bulbs (→P. 378)	<ul style="list-style-type: none"> <li>• Bulb with same number and wattage rating as original</li> <li>• Phillips-head screwdriver</li> <li>• Flathead screwdriver</li> <li>• Wrench</li> </ul>
Radiator and condenser (→P. 349)	—
Tire inflation pressure (→P. 365)	<ul style="list-style-type: none"> <li>• Tire pressure gauge</li> <li>• Compressed air source</li> </ul>
Washer fluid (→P. 351)	<ul style="list-style-type: none"> <li>• Water or washer fluid containing antifreeze (for winter use)</li> <li>• Funnel (used only for adding water or washer fluid)</li> </ul>

**WARNING**

The engine compartment contains many mechanisms and fluids that may move suddenly, become hot, or become electrically energized. To avoid death or serious injury, observe the following precautions.

**■ When working on the engine compartment**

- Make sure that the “READY” indicator is off.
- Keep hands, clothing and tools away from the moving fan and engine drive belt.
- Be careful not to touch the engine, power control unit, radiator, exhaust manifold, etc. right after driving as they may be hot. Oil and other fluids may also be hot.
- Do not leave anything that may burn easily, such as paper and rags, in the engine compartment.
- Do not smoke, cause sparks or expose an open flame to fuel. Fuel fumes are flammable.

**■ When working near the electric cooling fans or radiator grille**

Be sure the power switch is off.

With the power switch in ON mode, the electric cooling fans may automatically start to run if the air conditioning is on and/or the coolant temperature is high. (→P. 349)

**■ Safety glasses**

Wear safety glasses to prevent flying or falling material, fluid spray, etc. from getting in your eyes.

**NOTICE****■ If you remove the air cleaner filter**

Driving with the air cleaner filter removed may cause excessive engine wear due to dirt in the air.

## Hood

### Release the lock from the inside of the vehicle to open the hood.

- 1 Pull the hood lock release lever.  
The hood will pop up slightly.

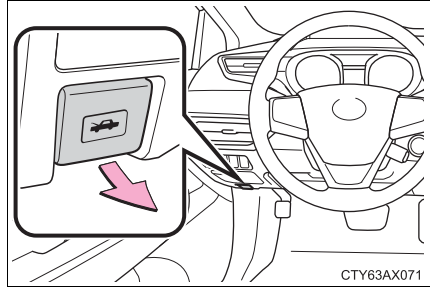

- 2 Pull up the auxiliary catch lever and lift the hood.

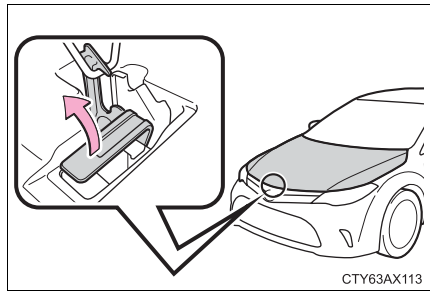

### WARNING

#### ■ Pre-driving check

Check that the hood is fully closed and locked.  
If the hood is not locked properly, it may open while the vehicle is in motion and cause an accident, which may result in death or serious injury.

## Positioning a floor jack

When using a floor jack, follow the instructions in the manual provided with the jack and perform the operation safely.

When raising your vehicle with a floor jack, position the jack correctly. Improper placement may damage your vehicle or cause injury.

### ◆ Front

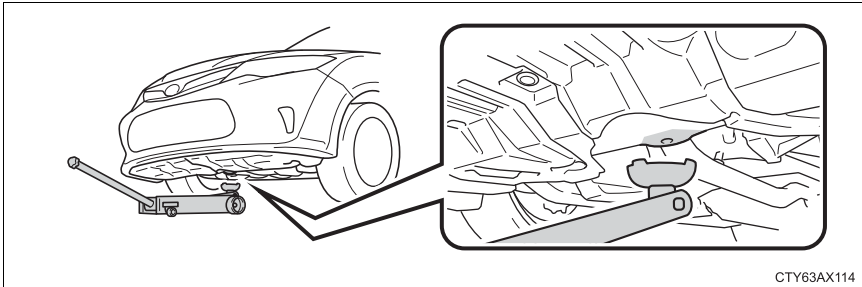

### ◆ Rear

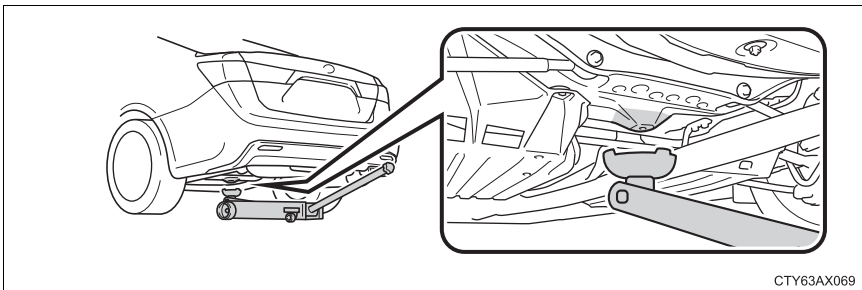

## Engine compartment

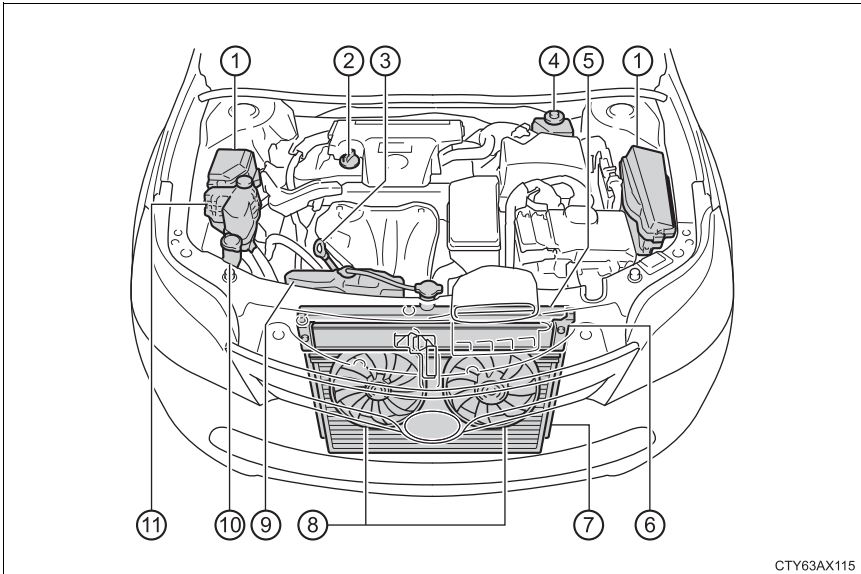

- |                                       |  |
|---------------------------------------|--|
| ① Fuse boxes (→P. 375)                | ⑥ Power control unit coolant radiator (→P. 349)  |
| ② Engine oil filler cap (→P. 345)     | ⑦ Condenser (→P. 349)                            |
| ③ Engine oil level dipstick (→P. 344) | ⑧ Electric cooling fans                          |
| ④ Brake fluid reservoir (→P. 350)     | ⑨ Engine coolant reservoir (→P. 347)             |
| ⑤ Engine coolant radiator (→P. 349)   | ⑩ Washer fluid tank (→P. 351)                    |
|                                       | ⑪ Power control unit coolant reservoir (→P. 347) |

### ■ 12-volt battery

→P. 352

## Engine oil

With the engine at operating temperature and turned off, check the oil level on the dipstick.

### ■ Checking the engine oil

- 1 Park the vehicle on level ground. After warming up the engine and turning off the hybrid system, wait more than 5 minutes for the oil to drain back into the bottom of the engine.
- 2 Holding a rag under the end, pull the dipstick out.

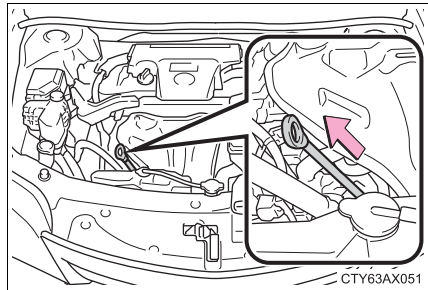

- 3 Wipe the dipstick clean.
- 4 Reinsert the dipstick fully.
- 5 Holding a rag under the end, pull the dipstick out and check the oil level.

- ① Low
- ② Normal
- ③ Excessive

The shape of the dipstick may differ depending on the type of vehicle or engine.

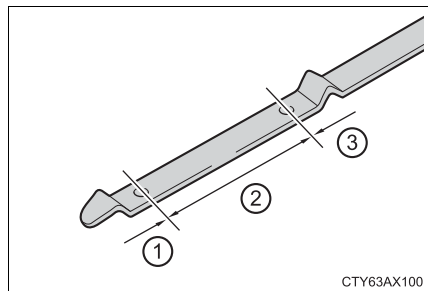

- 6 Wipe the dipstick and reinsert it fully.



## ■ Adding engine oil

If the oil level is below or near the low level mark, add engine oil of the same type as that already in the engine.

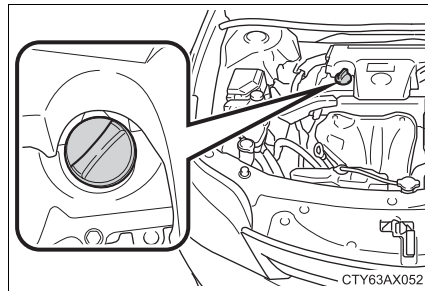

Make sure to check the oil type and prepare the items needed before adding oil.

Engine oil selection	→P. 440
Oil quantity (Low → Full)	1.6 qt. (1.5 L, 1.3 Imp. qt.)
Items	Clean funnel

- 1 Remove the oil filler cap by turning it counterclockwise.
- 2 Add engine oil slowly, checking the dipstick.
- 3 Install the oil filler cap by turning it clockwise.

## ■ Engine oil consumption

A certain amount of engine oil will be consumed while driving. In the following situations, oil consumption may increase, and engine oil may need to be refilled in between oil maintenance intervals.

- When the engine is new, for example directly after purchasing the vehicle or after replacing the engine
- If low quality oil or oil of an inappropriate viscosity is used
- When driving at high engine speeds or with a heavy load, or when driving while accelerating or decelerating frequently
- When leaving the engine idling for a long time, or when driving frequently through heavy traffic

**WARNING****■ Used engine oil**

- Used engine oil contains potentially harmful contaminants which may cause skin disorders such as inflammation and skin cancer, so care should be taken to avoid prolonged and repeated contact. To remove used engine oil from your skin, wash thoroughly with soap and water.
- Dispose of used oil and filters only in a safe and acceptable manner. Do not dispose of used oil and filters in household trash, in sewers or onto the ground.  
Call your Toyota dealer, service station or auto parts store for information concerning recycling or disposal.
- Do not leave used engine oil within the reach of children.

**NOTICE****■ To prevent serious engine damage**

Check the oil level on a regular basis.

**■ When replacing the engine oil**

- Be careful not to spill engine oil on the vehicle components.
- Avoid overfilling, or the engine could be damaged.
- Check the oil level on the dipstick every time you refill the vehicle.
- Be sure the engine oil filler cap is properly tightened.

## Coolant

The coolant level is satisfactory if it is between the full and low lines on the reservoir when the hybrid system is cold.

### ■ Engine coolant reservoir

- ① Reservoir cap
- ② “F” line
- ③ “L” line

If the level is on or below the “L” line, add coolant up to the “F” line. (→P. 429)

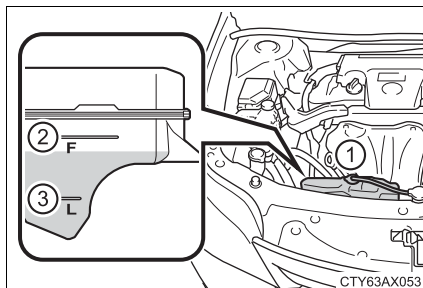

### ■ Power control unit coolant reservoir

- ① Reservoir cap
- ② “FULL” line
- ③ “LOW” line

If the level is on or below the “LOW” line, add coolant up to the “FULL” line. (→P. 429)

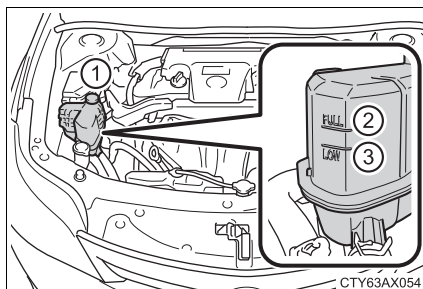

### ■ Coolant selection

Only use “Toyota Super Long Life Coolant” or a similar high quality ethylene glycol based non-silicate, non-amine, non-nitrite, and non-borate coolant with long-life hybrid organic acid technology.

“Toyota Super Long Life Coolant” is a mixture of 50% coolant and 50% deionized water. (Minimum temperature: -31°F [-35°C])

For more details about coolant, contact your Toyota dealer.

### ■ If the coolant level drops within a short time of replenishing

Visually check the radiator, hoses, engine/power control unit coolant reservoir caps, drain cock and water pump.

If you cannot find a leak, have your Toyota dealer test the cap and check for leaks in the cooling system.



### WARNING

#### ■ When the hybrid system is hot

Do not remove the engine/power control unit coolant reservoir caps or the radiator cap.(→P. 432)

The cooling system may be under pressure and may spray hot coolant if the cap is removed, causing serious injuries, such as burns.



### NOTICE

#### ■ When adding coolant

Coolant is neither plain water nor straight antifreeze. The correct mixture of water and antifreeze must be used to provide proper lubrication, corrosion protection and cooling. Be sure to read the antifreeze or coolant label.

#### ■ If you spill coolant

Be sure to wash it off with water to prevent it from damaging parts or paint.

## Radiators and condenser

Check the radiators and condenser and clear away any foreign objects.

If either of the above parts is extremely dirty or you are not sure of their condition, have your vehicle inspected by your Toyota dealer.

### WARNING

#### ■ When the hybrid system is hot

Do not touch the radiators or condenser as they may be hot and cause serious injuries, such as burns.

## Brake fluid

### ■ Checking fluid level

The brake fluid level should be between the “MAX” and “MIN” lines on the tank.

- ① “MAX” line
- ② “MIN” line

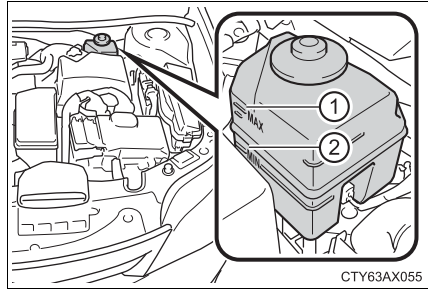

### ■ Adding fluid

Make sure to check the fluid type and prepare the necessary item.

Fluid type	FMVSS No.116 DOT 3 or SAE J1703 brake fluid
Items	Clean funnel

### ■ Brake fluid can absorb moisture from the air

Excess moisture in the brake fluid can cause a dangerous loss of braking efficiency. Use only newly opened brake fluid.

#### WARNING

##### ■ When filling the reservoir

Take care as brake fluid can harm your hands and eyes and damage painted surfaces.

If fluid gets on your hands or in your eyes, flush the affected area with clean water immediately.

If you still experience discomfort, see a doctor.

#### NOTICE

##### ■ If the fluid level is low or high

It is normal for the brake fluid level to go down slightly as the brake pads wear out or when the fluid level in the accumulator is high.

If the reservoir needs frequent refilling, there may be a serious problem.

## Washer fluid

If any washer does not work or the warning message appears on the multi-information display, the washer tank may be empty. Add washer fluid.

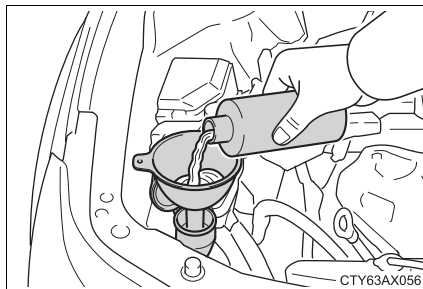

### WARNING

#### ■ When adding washer fluid

Do not add washer fluid when the hybrid system is hot or operating as washer fluid contains alcohol and may catch fire if spilled on the engine etc.

### NOTICE

#### ■ Do not use any fluid other than washer fluid

Do not use soapy water or engine antifreeze instead of washer fluid. Doing so may cause streaking on the vehicle's painted surfaces.

#### ■ Diluting washer fluid

Dilute washer fluid with water as necessary.

Refer to the freezing temperatures listed on the label of the washer fluid bottle.

## 12-volt battery

### Location

The 12-volt battery is located on the right-hand side of luggage compartment.

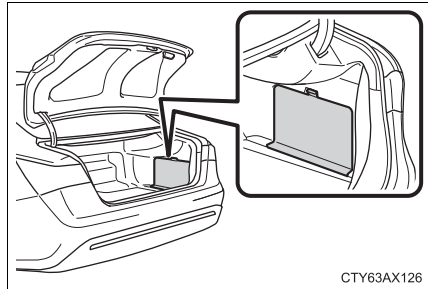

### Removing the 12-volt battery cover

Pull the 12-volt battery cover while pressing down on the tab.

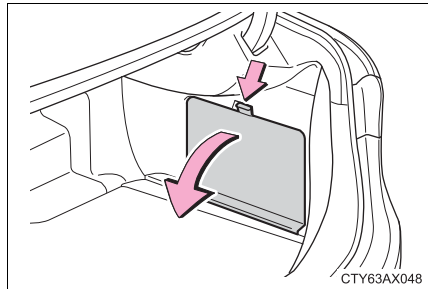

### Exterior

Make sure that the 12-volt battery terminals are not corroded and that there are no loose connections, cracks, or loose clamps.

- ① Terminals
- ② Hold-down clamp

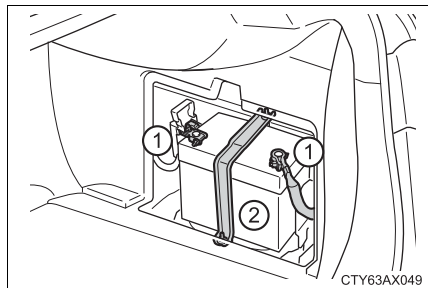



### ■ Before recharging

When recharging, the 12-volt battery produces hydrogen gas which is flammable and explosive. Therefore, observe the following precautions before recharging:

- If recharging with the 12-volt battery installed on the vehicle, be sure to disconnect the ground cable.
- Make sure the power switch on the charger is off when connecting and disconnecting the charger cables to the 12-volt battery.

### ■ After recharging/reconnecting the 12-volt battery

- The hybrid system may not start. Follow the procedure below to initialize the system.

- 1 Shift the shift lever to P.
- 2 Open and close any of the doors.
- 3 Restart the hybrid system.

- Unlocking the doors using the smart key system may not be possible immediately after reconnecting the 12-volt battery. If this happens, use the wireless remote control or the mechanical key to lock/unlock the doors.
- Start the hybrid system with the power switch in ACCESSORY mode. The hybrid system may not start when the power switch turned from off. However, the hybrid system will operate normally from the second attempt.
- The power switch mode is recorded by the vehicle. If the 12-volt battery is reconnected, the vehicle will return the power switch mode to the status it was in before the 12-volt battery was disconnected. Make sure to turn off the power switch before disconnect the 12-volt battery. Take extra care when connecting the 12-volt battery if the power switch mode prior to discharge is unknown.

If the system will not start even after multiple attempts at all methods above, contact your Toyota dealer.

**WARNING****■ Chemicals in the 12-volt battery**

The 12-volt battery contains poisonous and corrosive sulfuric acid and may produce hydrogen gas which is flammable and explosive. To reduce the risk of death or serious injury, take the following precautions while working on or near the 12-volt battery:

- Do not cause sparks by touching the 12-volt battery terminals with tools.
- Do not smoke or light a match near the 12-volt battery.
- Avoid contact with eyes, skin and clothes.
- Never inhale or swallow electrolyte.
- Wear protective safety glasses when working near the 12-volt battery.
- Keep children away from the 12-volt battery.

**■ Where to safely charge the 12-volt battery**

Always charge the 12-volt battery in an open area. Do not charge the 12-volt battery in a garage or closed room where there is insufficient ventilation.

**■ How to recharge the 12-volt battery**

Only perform a slow charge (5 A or less). The 12-volt battery may explode if charged at a quicker rate.

 **WARNING****■ Emergency measures regarding electrolyte**

- If electrolyte gets in your eyes  
Flush your eyes with clean water for at least 15 minutes and get immediate medical attention. If possible, continue to apply water with a sponge or cloth while traveling to the nearest medical facility.
- If electrolyte gets on your skin  
Wash the affected area thoroughly. If you feel pain or burning, get medical attention immediately.
- If electrolyte gets on your clothes  
It can soak through clothing on to your skin. Immediately take off the clothing and follow the procedure above if necessary.
- If you accidentally swallow electrolyte  
Drink a large quantity of water or milk. Get emergency medical attention immediately.

**■ When replacing the 12-volt battery**

Use a 12-volt battery designed for this vehicle. Failure to do so may cause gas (hydrogen) to enter the passenger compartment, causing a fire or explosion.

For replacement of the 12-volt battery, contact your Toyota dealer.

 **NOTICE****■ When recharging the 12-volt battery**

Never recharge the 12-volt battery while the hybrid system is operating. Also, be sure all accessories are turned off.

## Tires

**Replace or rotate tires in accordance with maintenance schedules and treadwear.**

### Checking tires

Check if the treadwear indicators are showing on the tires. Also check the tires for uneven wear, such as excessive wear on one side of the tread.

Check the spare tire condition and pressure if not rotated.

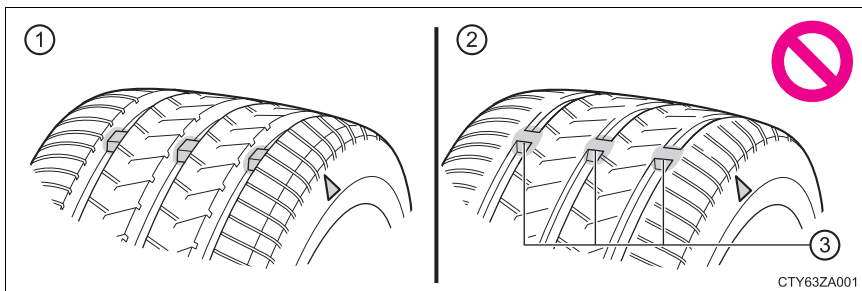

- ① New tread
- ② Worn tread
- ③ Treadwear indicator

The location of treadwear indicators is shown by a “TWI” or “Δ” mark, etc., molded into the sidewall of each tire.

Replace the tires if the treadwear indicators are showing on a tire.

### Tire rotation

Rotate the tires in the order shown.

To equalize tire wear and extend tire life, Toyota recommends that tire rotation is carried out at the same interval as tire inspection.

Do not fail to initialize the tire pressure warning system after tire rotation.

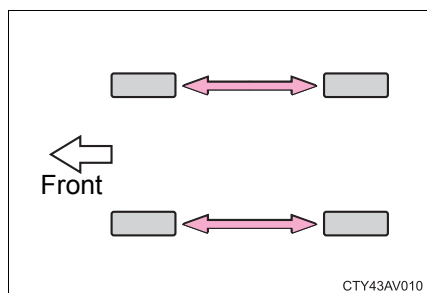

## Tire pressure warning system

Your vehicle is equipped with a tire pressure warning system that uses tire pressure warning valves and transmitters to detect low tire inflation pressure before serious problems arise.

- If the tire pressure drops below a predetermined level, the driver is warned by a screen display and a warning light. (→P. 401)
- The tire pressure detected by the tire pressure warning system can be displayed on the multi-information display.

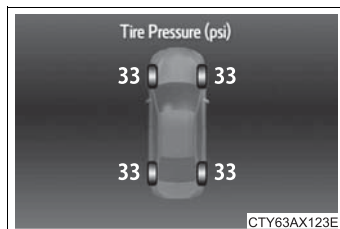

### ◆ Installing tire pressure warning valves and transmitters

When replacing tires or wheels, tire pressure warning valves and transmitters must also be installed.

When new tire pressure warning valves and transmitters are installed, new ID codes must be registered in the tire pressure warning computer and the tire pressure warning system must be initialized. Have tire pressure warning valve and transmitter ID codes registered by your Toyota dealer. (→P. 359)

### ◆ Initializing the tire pressure warning system

#### ■ The tire pressure warning system must be initialized in the following circumstances:

- When changing the tire size.
- When the tire inflation pressure is changed such as when changing traveling speed or load weight.
- When rotating the tires.

When the tire pressure warning system is initialized, the current tire inflation pressure is set as the benchmark pressure.

### ■ How to initialize the tire pressure warning system

- 1 Park the vehicle in a safe place and turn the power switch off.

Initialization cannot be performed while the vehicle is moving.

- 2 Adjust the tire inflation pressure to the specified cold tire inflation pressure level. (→P. 443)

Make sure to adjust the tire pressure to the specified cold tire inflation pressure level. The tire pressure warning system will operate based on this pressure level.

- 3 Turn the power switch to ON mode.

- 4 Press and hold the tire pressure warning reset switch until the tire pressure warning light blinks slowly 3 times.

“- -” will be displayed for inflation pressure of each tire on the multi-information display while the tire pressure warning system determines the position of each tire.

When position of each tire is determined, the inflation pressure of each tire will be displayed on the multi-information display.

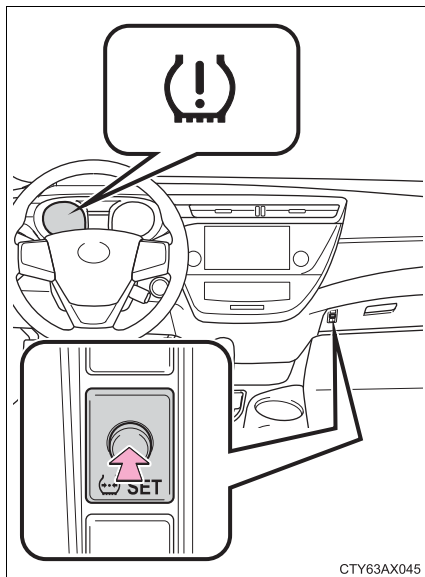

- 5 Wait for a few minutes with the power switch in ON mode and then turn the power switch off.

## ◆ Registering ID codes

The tire pressure warning valve and transmitter is equipped with a unique ID code. When replacing a tire pressure warning valve and transmitter, it is necessary to register the ID code. Have the ID code registered by your Toyota dealer.

### ■ When to replace your vehicle's tires

Tires should be replaced if:

- The treadwear indicators are showing on a tire.
- You have tire damage such as cuts, splits, cracks deep enough to expose the fabric, and bulges indicating internal damage
- A tire goes flat repeatedly or cannot be properly repaired due to the size or location of a cut or other damage

If you are not sure, consult with your Toyota dealer.

### ■ Replacing tires and wheels

If the ID code of the tire pressure warning valve and transmitter is not registered, the tire pressure warning system will not work properly. After driving for about 20 minutes, the tire pressure warning light blinks for 1 minute and stays on to indicate a system malfunction.

### ■ Tire life

Any tire over 6 years old must be checked by a qualified technician even if it has seldom or never been used or damage is not obvious.

### ■ Routine tire inflation pressure checks

The tire pressure warning system does not replace routine tire inflation pressure checks. Make sure to check tire inflation pressure as part of your routine of daily vehicle checks.

### ■ Maximum load of tire

Check that the maximum load of the replacement tire is greater than 1/2 of the Gross Axle Weight Ratings (GAWR) of either the front axle or the rear axle, whichever is greater.

For the GAWR, see the Certification Label. For the maximum load of the tire, see the load limit at maximum cold tire inflation pressure mentioned on the sidewall of the tire. (→P. 448)

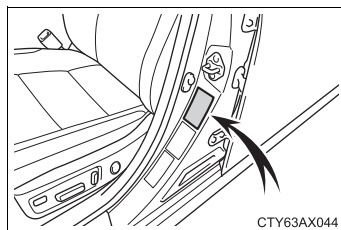

## ■ Tire types

### ● Summer tires

Summer tires are high-speed performance tires best suited to highway driving under dry conditions. Since summer tires do not have the same traction performance as snow tires, summer tires are inadequate for driving on snow-covered or icy roads. For driving on snow-covered roads or icy roads, the use of snow tires is recommended. When installing snow tires, be sure to replace all four tires.

### ● All season tires

All season tires are designed to provide better traction in snow and to be adequate for driving in most winter conditions as well as for use year-round. All season tires, however, do not have adequate traction performance compared with snow tires in heavy or loose snow. Also, all season tires fall short in acceleration and handling performance compared with summer tires in highway driving.

### ● Snow tires

For driving on snow-covered roads or icy roads, we recommend using snow tires. If you need snow tires, select tires of the same size, construction and load capacity as the originally installed tires. Since your vehicle has radial tires as original equipment, make sure your snow tires also have radial construction. Do not install studded tires without first checking local regulations for possible restrictions. Snow tires should be installed on all wheels. (→P. 269)

## ■ Initializing the tire pressure warning system

Initialize the system with the tire inflation pressure adjusted to the specified level.

### ■ If the tread on snow tires wears down below 0.16 in. (4 mm)

The effectiveness of the tires as snow tires is lost.

### ■ If you press the tire pressure warning reset switch accidentally

If initialization is performed, adjust the tire inflation pressure to the specified level and initialize the tire pressure warning system again.



**■ Situations in which the tire pressure warning system may not operate properly (vehicles with a tire pressure warning system)**

- In the following cases, the tire pressure warning system may not operate properly.
    - If non-genuine Toyota wheels are used.
    - A tire has been replaced with a tire that is not an OE (Original Equipment) tire.
    - A tire has been replaced with a tire that is not of the specified size.
    - Tire chains etc. are equipped.
    - If a window tint that affects the radio wave signals is installed.
    - If there is a lot of snow or ice on the vehicle, particularly around the wheels or wheel housings.
    - If the tire inflation pressure is extremely higher than the specified level.
    - If tires not equipped with tire pressure warning valves and transmitters are used.
    - If the ID code on the tire pressure warning valves and transmitters is not registered in the tire pressure warning computer.
  - Performance may be affected in the following situations.
    - Near a TV tower, electric power plant, gas station, radio station, large display, airport or other facility that generates strong radio waves or electrical noise
    - When carrying a portable radio, cellular phone, cordless phone or other wireless communication device
- Vehicles with a tire inflation pressure display function: If tire position information is not correctly displayed due to the radio wave conditions, the display may be corrected by driving and changing the radio wave conditions.
- When the vehicle is parked, the time taken for the warning to start or go off could be extended.
  - When tire inflation pressure declines rapidly for example when a tire has burst, the warning may not function.

### ■ The initialization operation

- Make sure to carry out initialization after adjusting the tire inflation pressure.  
Also, make sure the tires are cold before carrying out initialization or tire inflation pressure adjustment.
- If you have accidentally turned the power switch off during initialization, it is not necessary to press the reset switch again as initialization will restart automatically when the power switch has been turned to ON mode for the next time.
- If you accidentally press the reset switch when initialization is not necessary, adjust the tire inflation pressure to the specified level when the tires are cold, and conduct initialization again.
- While the position of each tire is being determined and the inflation pressures are not being displayed on the multi-information display, if the inflation pressure of a tire drops, the tire pressure warning light will come on.

### ■ Warning performance of the tire pressure warning system

The warning of the tire pressure warning system will change in accordance with the conditions under which it was initialized. For this reason, the system may give a warning even if the tire pressure does not reach a low enough level, or if the pressure is higher than the pressure that was adjusted to when the system was initialized.

### ■ When initialization of the tire pressure warning system has failed

Initialization may take longer to complete if the vehicle is driven on an unpaved road. When performing initialization, drive on a paved road if possible. Depending on the driving environment and condition of the tires, initialization will be completed in approximately 10 minutes. If initialization is not complete after driving approximately 10 minutes, continue driving for a while.

If the inflation pressure of each tire is not displayed after driving for approximately 1 hour, perform the following procedure.

- Park the vehicle in a safe place for approximately 20 minutes. Then drive straight (with occasional left and right turns) at approximately 25mph (40 km/h) or more for approximately 10 to 20 minutes.

However, in the following situations, the tire inflation pressure will not be recorded and the system will not operate properly. Perform initialization again.

- When operating the tire pressure warning reset switch, the tire pressure warning light does not blink 3 times.
- After performing initialization, the tire pressure warning light blinks for 1 minute then stays on while driving.

If the inflation pressure of each tire is still not displayed, have the vehicle inspected by your Toyota dealer.

## ■ Tire pressure warning system certification

FCC ID: HYQ23AAP

FCC ID: HYQ23AAN

FCC ID: HYQ23AAC

FCC ID: PAXPMVC015

FCC ID: PAXPMVC010

### NOTE:

This device complies with part 15 of the FCC Rules. Operation is subject to the following two conditions: (1) This device may not cause harmful interference, and (2) this device must accept any interference received, including interference that may cause undesired operation.

### FCC WARNING:

Changes or modifications not expressly approved by the party responsible for compliance could void the user's authority to operate the equipment.

## WARNING

### ■ When inspecting or replacing tires

Observe the following precautions to prevent accidents.

Failure to do so may cause damage to parts of the drive train as well as dangerous handling characteristics, which may lead to an accident resulting in death or serious injury.

- Do not mix tires of different makes, models or tread patterns.  
Also, do not mix tires of remarkably different treadwear.
- Do not use tire sizes other than those recommended by Toyota.
- Do not mix differently constructed tires (radial, bias-belted or bias-ply tires).
- Do not mix summer, all season and snow tires.
- Do not use tires that have been used on another vehicle.  
Do not use tires if you do not know how they were used previously.

### ■ When initializing the tire pressure warning system

Do not operate the tire pressure warning reset switch without first adjusting the tire inflation pressure to the specified level. Otherwise, the tire pressure warning light may not come on even if the tire inflation pressure is low, or it may come on when the tire inflation pressure is actually normal.

**NOTICE****■ Repairing or replacing tires, wheels, tire pressure warning valves, transmitters and tire valve caps**

- When removing or fitting the wheels, tires or the tire pressure warning valves and transmitters, contact your Toyota dealer as the tire pressure warning valves and transmitters may be damaged if not handled correctly.
- When replacing tire valve caps, do not use tire valve caps other than those specified. The cap may become stuck.

**■ To avoid damage to the tire pressure warning valves and transmitters**

When a tire is repaired with liquid sealants, the tire pressure warning valve and transmitter may not operate properly. If a liquid sealant is used, contact your Toyota dealer or other qualified service shop as soon as possible. Make sure to replace the tire pressure warning valve and transmitter when replacing the tire. (→P. 357)

**■ Driving on rough roads**

Take particular care when driving on roads with loose surfaces or potholes. These conditions may cause losses in tire inflation pressure, reducing the cushioning ability of the tires. In addition, driving on rough roads may cause damage to the tires themselves, as well as the vehicle's wheels and body.

**■ If tire inflation pressure of each tire becomes low while driving**

Do not continue driving, or your tires and/or wheels may be ruined.

## Tire inflation pressure

### Tire inflation pressure

The recommended cold tire inflation pressure and tire size are displayed on the tire and loading information label. (→P. 443)

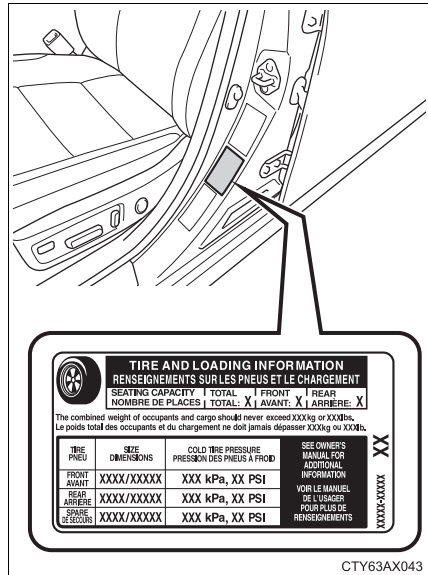

CTY63AX043

## Inspection and adjustment procedure

- ① Tire valve
- ② Tire pressure gauge

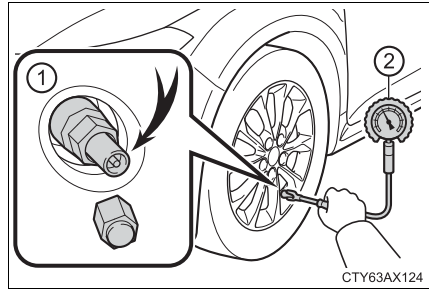

- 1 Remove the tire valve cap.
- 2 Press the tip of the tire pressure gauge onto the tire valve.
- 3 Read the pressure using the gauge gradations.
- 4 If the tire inflation pressure is not at the recommended level, adjust the pressure.  
If you add too much air, press the center of the valve to deflate.
- 5 After completing the tire inflation pressure measurement and adjustment, apply soapy water to the valve and check for leakage.
- 6 Put the tire valve cap back on.

### ■ Tire inflation pressure check interval

You should check tire inflation pressure every two weeks, or at least once a month.

Do not forget to check the spare.

### ■ Effects of incorrect tire inflation pressure

Driving with incorrect tire inflation pressure may result in the following:

- Reduced fuel economy
- Reduced driving comfort and poor handling
- Reduced tire life due to wear
- Reduced safety
- Damage to the drive train

If a tire needs frequent inflating, have it checked by your Toyota dealer.

## ■ Instructions for checking tire inflation pressure

When checking tire inflation pressure, observe the following:

- Check only when the tires are cold.  
If your vehicle has been parked for at least 3 hours or has not been driven for more than 1 mile or 1.5 km, you will get an accurate cold tire inflation pressure reading.
- Always use a tire pressure gauge.  
It is difficult to judge if a tire is properly inflated based only on its appearance.
- It is normal for the tire inflation pressure to be higher after driving as heat is generated in the tire. Do not reduce tire inflation pressure after driving.
- Never exceed the vehicle capacity weight.  
Passengers and luggage weight should be placed so that the vehicle is balanced.



### WARNING

#### ■ Proper inflation is critical to save tire performance

Keep your tires properly inflated.

If the tires are not properly inflated, the following conditions may occur which could lead to an accident resulting in death or serious injury:

- Excessive wear
- Uneven wear
- Poor handling
- Possibility of blowouts resulting from overheated tires
- Air leaking from between tire and wheel
- Wheel deformation and/or tire damage
- Greater possibility of tire damage while driving (due to road hazards, expansion joints, sharp edges in the road, etc.)



### NOTICE

#### ■ When inspecting and adjusting tire inflation pressure

Be sure to put the tire valve caps back on.

If a valve cap is not installed, dirt or moisture may get into the valve and cause an air leak, resulting in decreased tire inflation pressure.

## Wheels

**If a wheel is bent, cracked or heavily corroded, it should be replaced. Otherwise, the tire may separate from the wheel or cause a loss of handling control.**

### Wheel selection

When replacing wheels, care should be taken to ensure that they are equivalent to those removed in load capacity, diameter, rim width and inset\*.

Replacement wheels are available at your Toyota dealer.

\*: Conventionally referred to as “offset”.

Toyota does not recommend using the following:

- Wheels of different sizes or types
- Used wheels
- Bent wheels that have been straightened

### Aluminum wheel precautions

- Use only Toyota wheel nuts and wrenches designed for use with your aluminum wheels.
- When rotating, repairing or changing your tires, check that the wheel nuts are still tight after driving 1000 miles (1600 km).
- Be careful not to damage the aluminum wheels when using tire chains.
- Use only Toyota genuine balance weights or equivalent and a plastic or rubber hammer when balancing your wheels.



## ■ When replacing wheels

The wheels of your vehicle are equipped with tire pressure warning valves and transmitters that allow the tire pressure warning system to provide advance warning in the event of a loss in tire inflation pressure. Whenever wheels are replaced, tire pressure warning valves and transmitters must be installed. (→P. 357)

### ⚠ WARNING

#### ■ When replacing wheels

- Do not use wheels that are a different size from those recommended in the Owner's Manual, as this may result in a loss of handling control.
- Never use an inner tube in a leaking wheel which is designed for a tubeless tire. Doing so may result in an accident, causing death or serious injury.

#### ■ When installing the wheel nuts

- Be sure to install the wheel nuts with the tapered ends facing inward. Installing the nuts with the tapered ends facing outward can cause the wheel to break and eventually cause the wheel to come off while driving, which could lead to an accident resulting in death or serious injury.

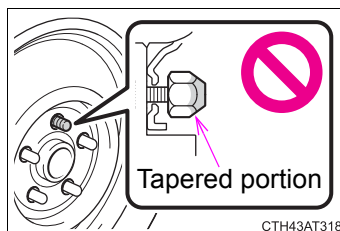

- Never use oil or grease on the wheel bolts or wheel nuts. Oil and grease may cause the wheel nuts to be excessively tightened, leading to bolt or disc wheel damage. In addition, the oil or grease can cause the wheel nuts to loosen and the wheel may fall off, causing an accident and resulting in death or serious injury. Remove any oil or grease from the wheel bolts or wheel nuts.

**NOTICE****■ Replacing tire pressure warning valves and transmitters**

- Because tire repair or replacement may affect the tire pressure warning valves and transmitters, make sure to have tires serviced by your Toyota dealer or other qualified service shop. In addition, make sure to purchase your tire pressure warning valves and transmitters at your Toyota dealer.
- Ensure that only genuine Toyota wheels are used on your vehicle. Tire pressure warning valves and transmitters may not work properly with non-genuine wheels.

## Air conditioning filter

**The air conditioning filter must be changed regularly to maintain air conditioning efficiency.**

### Removal method

- 1 Turn the power switch off.
- 2 Open the glove box. (→P. 290)
- 3 Remove the glove box cover.

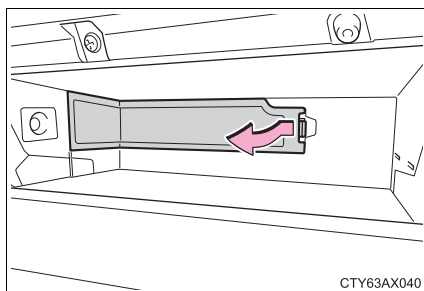

- 4 Press the tabs and remove the filter cover.

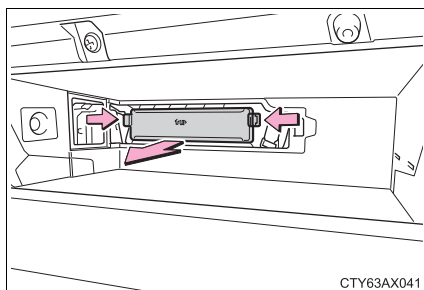

- 5 Remove the air conditioning filter and replace it with a new one.

The “↑UP” marks shown on the filter should be pointing up.

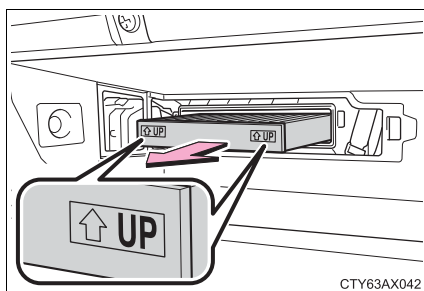

---

**■ Checking interval**

Inspect and replace the air conditioning filter according to the maintenance schedule. In dusty areas or areas with heavy traffic flow, early replacement may be required. (For scheduled maintenance information, please refer to the "Schedule maintenance guide" or "Owner's Manual Supplement".)

**■ If air flow from the vents decreases dramatically**

The filter may be clogged. Check the filter and replace if necessary.

**■ Air conditioning filter deodorizing function**

This vehicle is equipped with a deodorizing charcoal air filter to reduce odor from the air conditioning system.

When items or products which emit fragrances or odors are placed in your vehicle, the deodorizing effect may be significantly weakened in a short period of time.

If frequent or strong odor comes from your air conditioning system, replace the air conditioning filter.

**NOTICE****■ When using the air conditioning system**

Make sure that a filter is always installed.

Using the air conditioning system without a filter may cause damage to the system.

## Electronic key battery

Replace the battery with a new one if it is depleted.

You will need the following items:

- Flathead screwdriver
- Small flathead screwdriver
- Lithium battery CR2032

### Replacing the battery

1 Take out the mechanical key.

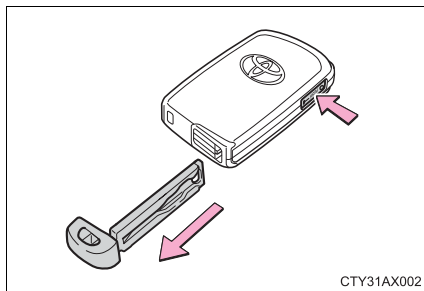

2 Remove the cover.

To prevent damage to the key, cover the tip of the screwdriver with a rag.

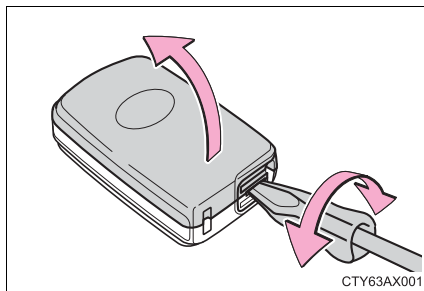

3 Remove the depleted battery.

Insert a new battery with the “+” terminal facing up.

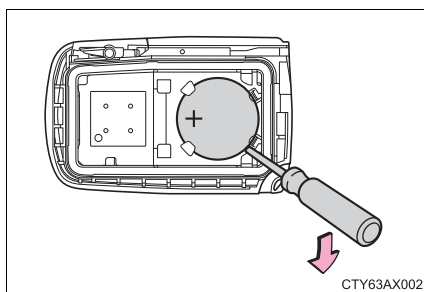

**■ Use a CR2032 lithium battery**

- Batteries can be purchased at your Toyota dealer, local electrical appliance shops or camera stores.
- Replace only with the same or equivalent type recommended by the manufacturer.
- Dispose of used batteries according to local laws.

**■ If the electronic key battery is depleted**

The following symptoms may occur:

- The smart key system and wireless remote control will not function properly.
- The operational range will be reduced.

**WARNING****■ Removed battery and other parts**

These parts are small and if swallowed by a child, they can cause choking. Keep away from children. Failure to do so could result in death or serious injury.

**NOTICE****■ For normal operation after replacing the battery**

Observe the following precautions to prevent accidents:

- Always work with dry hands.  
Moisture may cause the battery to rust.
- Do not touch or move any other component inside the remote control.
- Do not bend either of the battery terminals.

## Checking and replacing fuses

If any of the electrical components do not operate, a fuse may have blown. If this happens, check and replace the fuses as necessary.

- 1 Turn the power switch off.
- 2 Open the Fuse box cover.

► Engine compartment (type A)

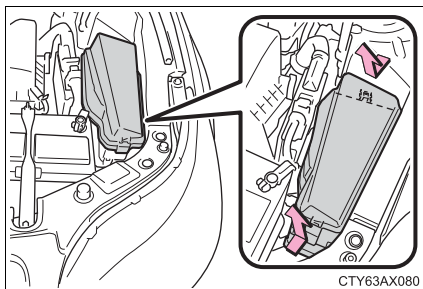

Push the tabs in and lift the lid off.

► Engine compartment (type B)

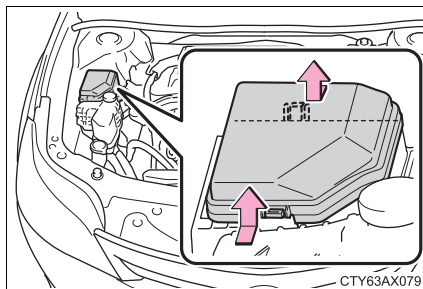

Push the tabs in and lift the lid off.

► Under the driver's side instrument panel

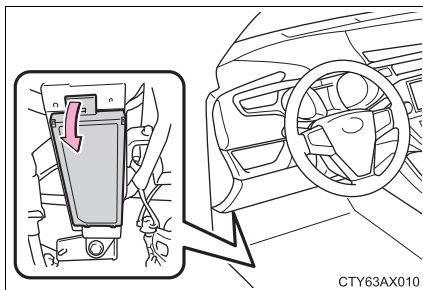

Remove the lid.

- 3** Remove the fuse with the pull-out tool.

Only type A fuse can be removed using the pullout tool.

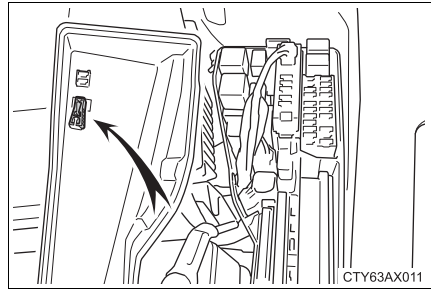

- 4** Check if the fuse is blown.

► Type A

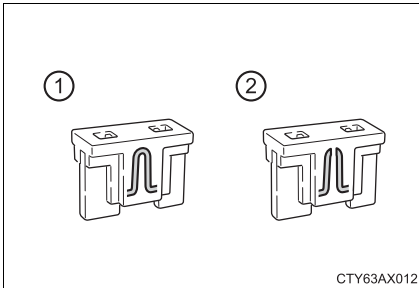

► Type B

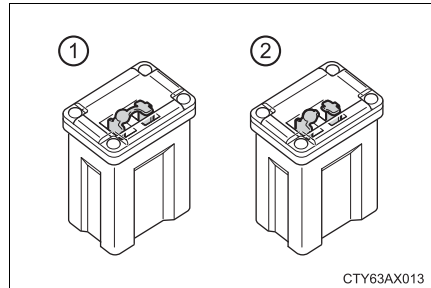

► Type C

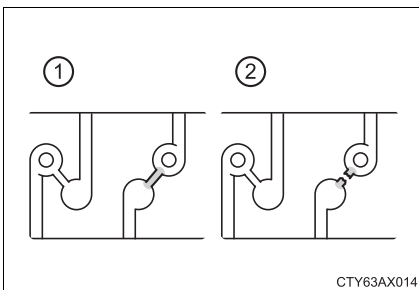

- ① Normal fuse  
② Blown fuse

Type A and B:

Replace the blown fuse with a new fuse of an appropriate amperage rating. The amperage rating can be found on the fuse box lid.

Type C:

Contact your Toyota dealer.



**■ After a fuse is replaced**

- If the lights do not turn on even after the fuse has been replaced, a bulb may need replacement. (→P. 378)
- If the replaced fuse blows again, have the vehicle inspected by your Toyota dealer.

**■ If there is an overload in a circuit**

The fuses are designed to blow, protecting the wiring harness from damage.

**■ When replacing light bulbs**

Toyota recommends that you use genuine Toyota products designed for this vehicle. Because certain bulbs are connected to circuits designed to prevent overload, non-genuine parts or parts not designed for this vehicle may be unusable.

**WARNING****■ To prevent system breakdowns and vehicle fire**

Observe the following precautions.

Failure to do so may cause damage to the vehicle, and possibly a fire or injury.

- Never use a fuse of a higher amperage rating than that indicated, or use any other object in place of a fuse.
- Always use a genuine Toyota fuse or equivalent.  
Never replace a fuse with a wire, even as a temporary fix.
- Do not modify the fuses or fuse boxes.

**NOTICE****■ Before replacing fuses**

Have the cause of electrical overload determined and repaired by your Toyota dealer as soon as possible.

## Light bulbs

You may replace the following bulbs by yourself. The difficulty level of replacement varies depending on the bulb. If necessary bulb replacement seems difficult to perform, contact your Toyota dealer.

For more information about replacing other light bulbs, contact your Toyota dealer.

### Preparing for light bulb replacement

Check the wattage of the light bulb to be replaced. (→P. 444)

### Bulb locations

#### ■ Front

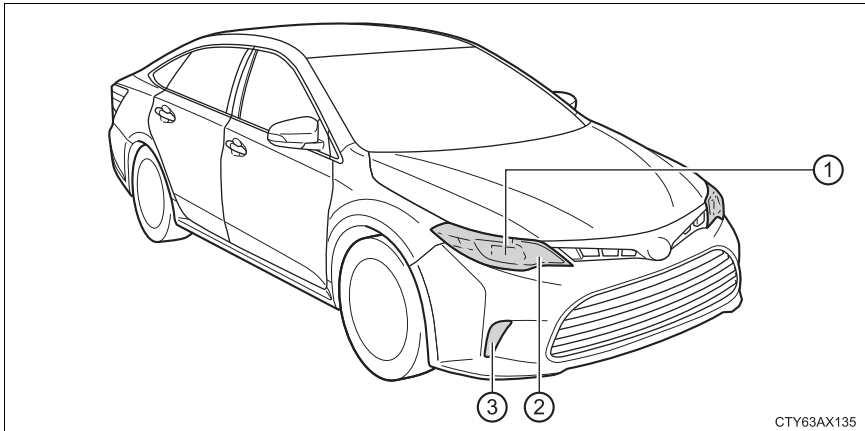

- ① Headlight low beam (halogen bulb)
- ② Headlight high beam and daytime running light (vehicles with halogen bulbs for low beams)  
Headlight high beam (vehicles with discharge bulbs for low beams)
- ③ Front turn signal/parking light

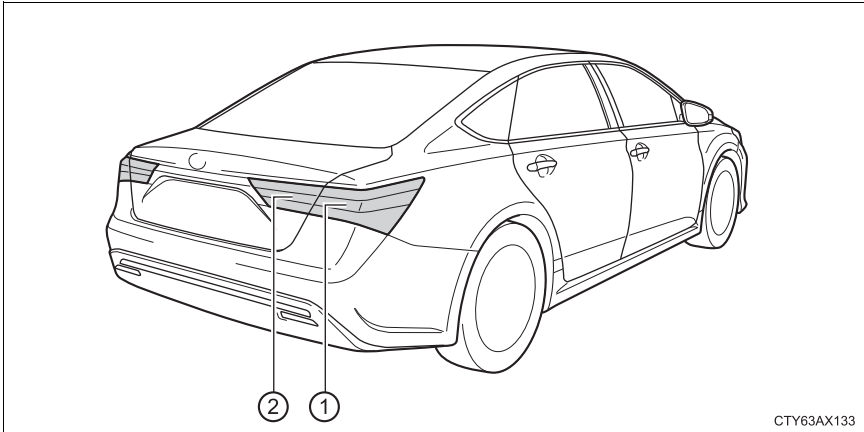
**■ Rear**

① Rear turn signal light

② Back-up light

## Replacing light bulbs

### ■ Headlight low beam (halogen bulb)

- 1 Unplug the connector while pressing the lock release.

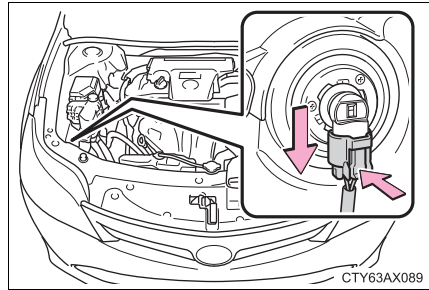

- 2 Turn the bulb base counter-clockwise.

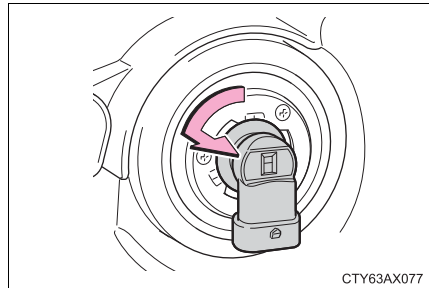

- 3 Set the new light bulb.  
Align the 3 tabs on the light bulb with the mounting, and insert. Turn it clockwise to set.

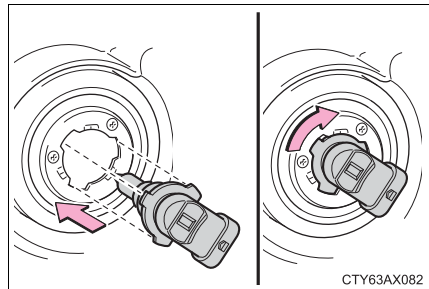

- 4 Set the connector.

After installing the connector, shake the bulb base gently to check that it is not loose, turn the headlights on once and visually confirm that no light is leaking through the mounting.

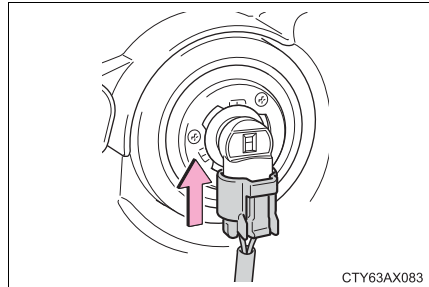

■ **Headlight high beam and daytime running light (vehicles with halogen bulbs for low beams)/Headlight high beam (vehicles with discharge bulbs for low beams)**

- 1 Unplug the connector while pressing the lock release.

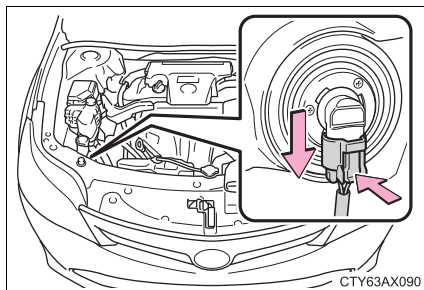

- 2 Turn the bulb base counter-clockwise.

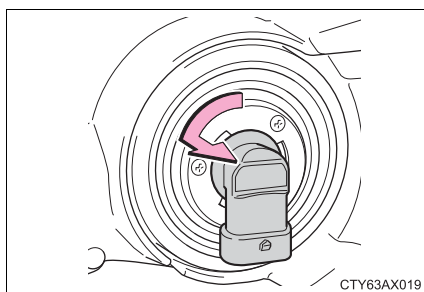

- 3 Set the new light bulb.  
Align the 3 tabs on the light bulb with the mounting, and insert. Turn it clockwise to set.

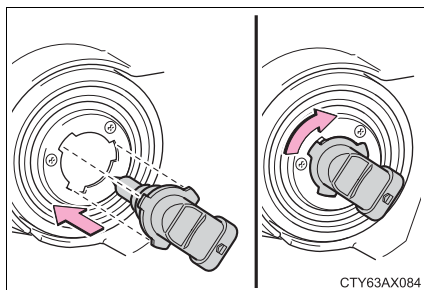

- 4 Set the connector.

After installing the connector, shake the bulb base gently to check that it is not loose, turn the headlights on once and visually confirm that no light is leaking through the mounting.

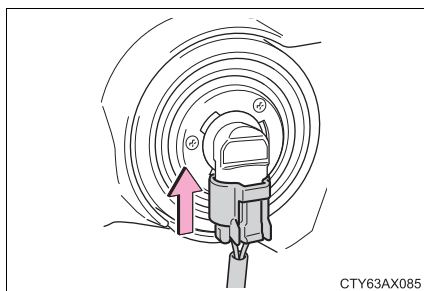

## ■ Front turn signal/parking light

- 1 To allow enough working space, turn the steering wheel to the opposite side of the bulb to be replaced. Remove the 3 fender liner clips.

Turn the steering wheel to the left when replacing the right side light bulb, and turn the steering wheel to the right when replacing the left side light bulb.

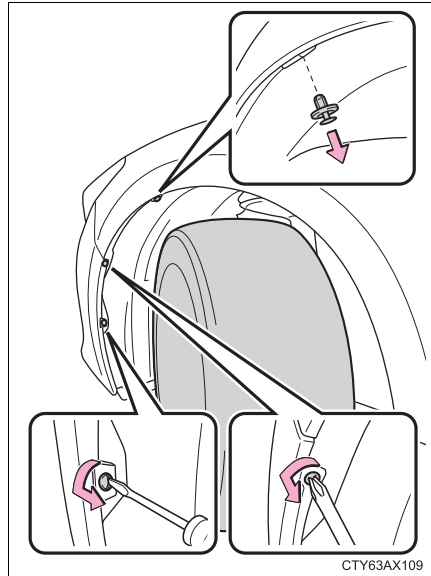

- 2 Remove the fender liner bolt and partly remove the fender liner.

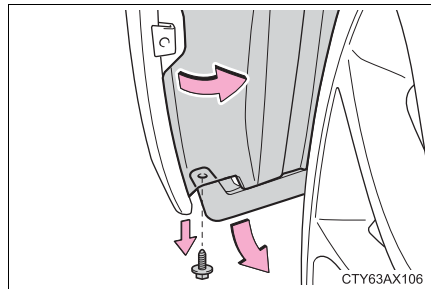

- 3 Unplug the connector while pressing the lock release.

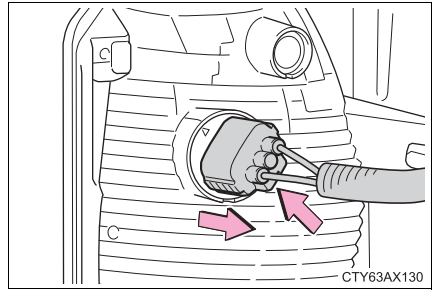

- 4 Turn the bulb base counter-clockwise.

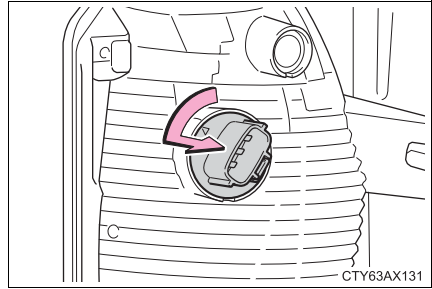

- 5 Remove the light bulb.

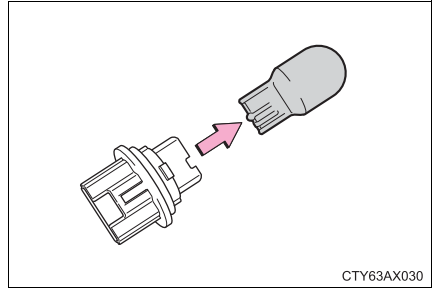

- 6 When installing, reverse the steps listed.

### ■ Rear turn signal light

- 1 Open the trunk lid and remove the luggage trim cover clip.

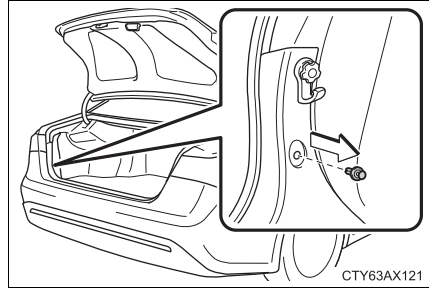

- 2 Pull the hook while depressing the button.

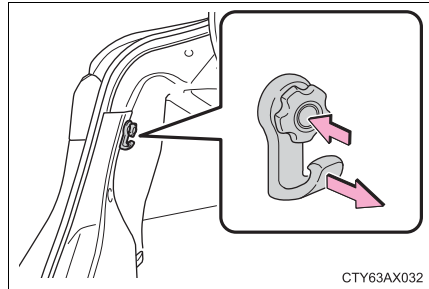

- 3 Partly remove the luggage trim cover.

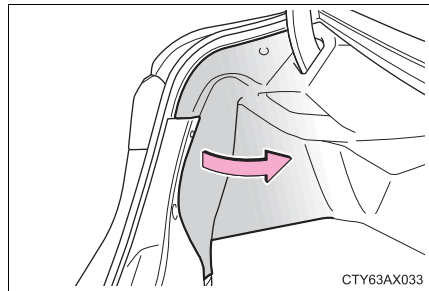



- 4 Turn the bulb base counter-clockwise.

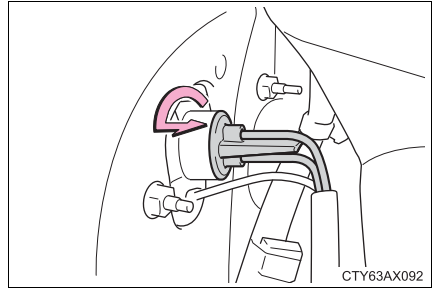

- 5 Remove the light bulb.

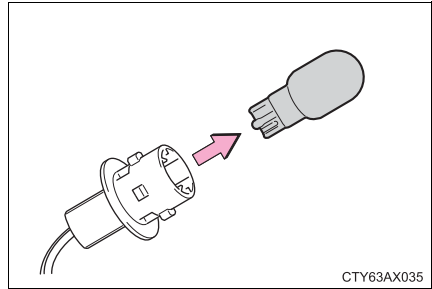

- 6 When installing, reverse the steps listed.

### ■ Back-up light

- 1 Open the trunk lid and remove the clips. Then partly remove the trunk panel cover.

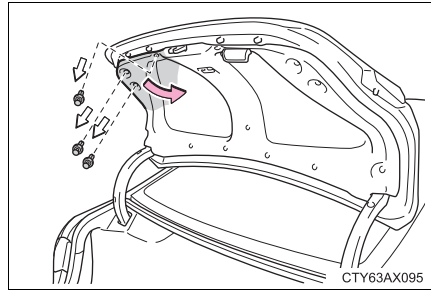

- 2 Turn the bulb base counter-clockwise.

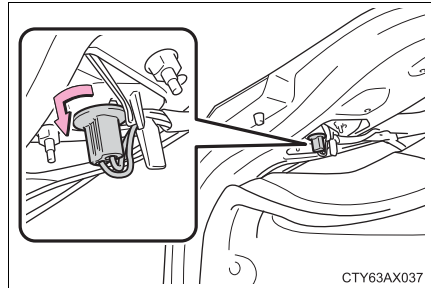

- 3 Remove the light bulb.

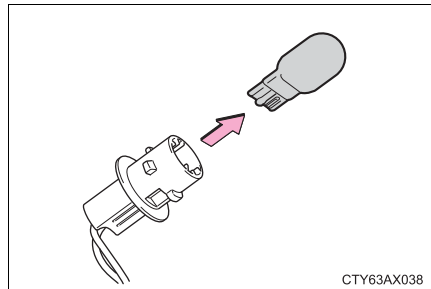

- 4 When installing, reverse the steps listed.

## ■ Replacing the following bulbs

If any of the lights listed below has burnt out, have it replaced by your Toyota dealer.

- Headlight low/high beams (LED type)
- Headlight low beams (discharge bulb)
- Daytime running lights (vehicles with discharge or LED headlights)
- Side marker lights
- Side turn signal lights
- Stop/tail lights
- High mounted stoplight
- Outer foot lights (if equipped)
- License plate light

## ■ Discharge headlights (if equipped)

If voltage to the discharge bulbs is insufficient, the bulbs may not come on, or may go out temporarily. The discharge bulbs will come on when normal power is restored.

## ■ LED light bulbs

The headlight low/high beams (LED type), parking lights/daytime running lights (vehicles with discharge or LED headlights), side marker lights (vehicles with LED headlights), stop/tail lights, high mounted stoplight, outer foot lights and license plate light each consist of a number of LEDs. If any of the LEDs burn out, take your vehicle to your Toyota dealer to have the light replaced.

## ■ Condensation build-up on the inside of the lens

Temporary condensation build-up on the inside of the lens does not indicate a malfunction. Contact your Toyota dealer for more information in the following situations:

- Large drops of water have built up on the inside of the lens.
- Water has built up inside the lens.

## ■ Removing and installing the clips

The fender liner, luggage trim cover and trunk panel cover clip

- ① Removing
- ② Installing

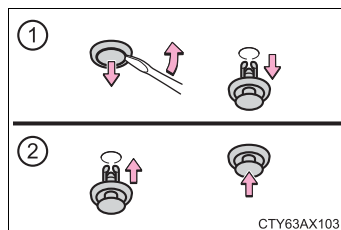

**■ When replacing light bulbs**

→P. 377

**⚠ WARNING****■ Replacing light bulbs**

- Turn off the lights. Do not attempt to replace the bulb immediately after turning off the lights.  
The bulbs become very hot and may cause burns.
- Do not touch the glass portion of the light bulb with bare hands. When it is unavoidable to hold the glass portion, use and hold with a clean dry cloth to avoid getting moisture and oils on the bulb.  
Also, if the bulb is scratched or dropped, it may blow out or crack.
- Fully install light bulbs and any parts used to secure them. Failure to do so may result in heat damage, fire, or water entering the headlight unit. This may damage the headlights or cause condensation to build up on the lens.

**● Vehicles with discharge headlights:**

While the low beam headlights are turned on, and for a short time after they have been turned off, metal components at the rear of the headlight assembly will be extremely hot. To prevent burns, do not touch these metal components until you are certain they have cooled down.

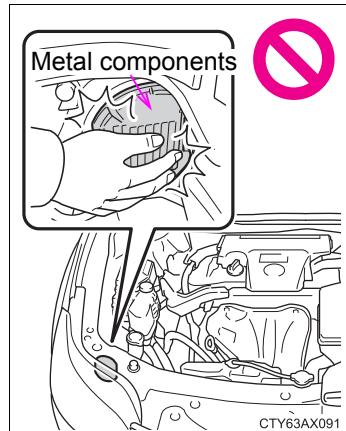

**WARNING****■ Discharge headlights (if equipped)**

- Contact your Toyota dealer before replacing the discharge headlights (including light bulbs).
- Do not touch the discharge headlight's high voltage socket when the headlights are turned on.  
An extremely high voltage of 30000 V will be discharged and could result in death or serious injury by electric shock.
- Do not attempt to take apart or repair the headlight bulbs, connectors, power supply circuits, or related components.  
Doing so could result in electric shock and death or serious injury.

**■ To prevent damage or fire**

- Make sure bulbs are fully seated and locked.
- Check the wattage of the bulb before installing to prevent heat damage.



<b>7-1. Essential information</b>	
Emergency flashers .....	392
If your vehicle has to be stopped in an emergency .....	393
<b>7-2. Steps to take in an emergency</b>	
If your vehicle needs to be towed .....	394
If you think something is wrong .....	397
If a warning light turns on or a warning buzzer sounds .....	398
If a warning message is displayed .....	407
If you have a flat tire .....	408
If the hybrid system will not start .....	420
If the electronic key does not operate properly .....	422
If the 12-volt battery is discharged .....	424
If your vehicle overheats .....	429
If the vehicle becomes stuck .....	433

## Emergency flashers

**The emergency flashers are used to warn other drivers when the vehicle has to be stopped in the road due to a breakdown, etc.**

Press the switch.

All the turn signal lights will flash.  
To turn them off, press the switch once again.

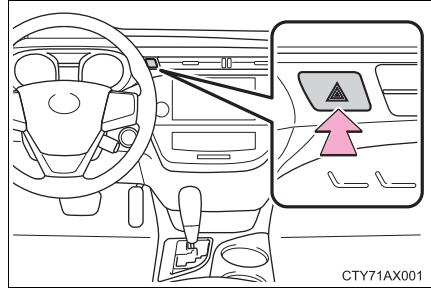

### ■ Emergency flashers

If the emergency flashers are used for a long time while the hybrid system is not operating (while the "READY" indicator is not illuminated), the 12-volt battery may discharge.



## If your vehicle has to be stopped in an emergency

**Only in an emergency, such as if it becomes impossible to stop the vehicle in the normal way, stop the vehicle using the following procedure:**

- 1 Steadily step on the brake pedal with both feet and firmly depress it.  
Do not pump the brake pedal repeatedly as this will increase the effort required to slow the vehicle.
- 2 Shift the shift lever to N.
  - ▶ If the shift lever is shifted to N
- 3 After slowing down, stop the vehicle in a safe place by the road.
- 4 Stop the hybrid system.
  - ▶ If the shift lever cannot be shifted to N
- 3 Keep depressing the brake pedal with both feet to reduce vehicle speed as much as possible.
- 4 To stop the hybrid system, press and hold the power switch for 2 consecutive seconds or more, or press it briefly 3 times or more in succession.

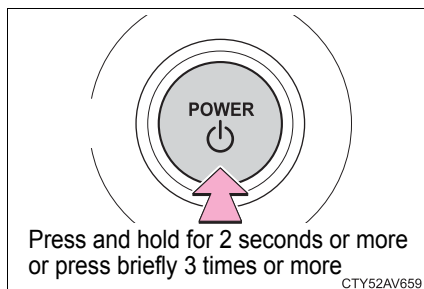

- 5 Stop the vehicle in a safe place by the road.

### WARNING

#### ■ If the hybrid system has to be turned off while driving

Power assist for the steering wheel will be lost, making the steering wheel heavier to turn. Decelerate as much as possible before turning off the hybrid system.

## If your vehicle needs to be towed

If towing is necessary, we recommend having your vehicle towed by your Toyota dealer or commercial towing service, using a wheel-lift type truck or flatbed truck.

Use a safety chain system for all towing, and abide by all state/provincial and local laws.

### Situations when it is necessary to contact dealers before towing

The following may indicate a problem with your transmission. Contact your Toyota dealer or commercial towing service before towing.

- A warning message for the hybrid system is shown on the multi-information display and the vehicle does not move.
- The vehicle makes an abnormal sound.

### Towing with a sling-type truck

Do not tow with a sling-type truck to prevent body damage.

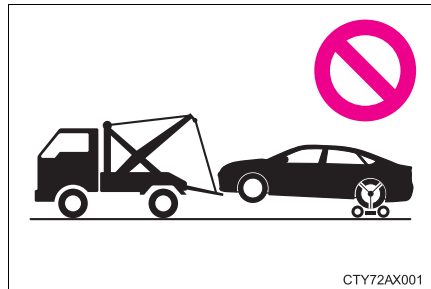

CTY72AX001

## Towing with a wheel-lift type truck

► From the front

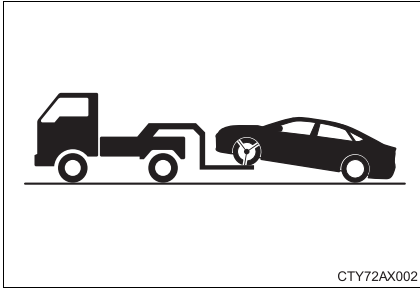

Release the parking brake.

► From the rear

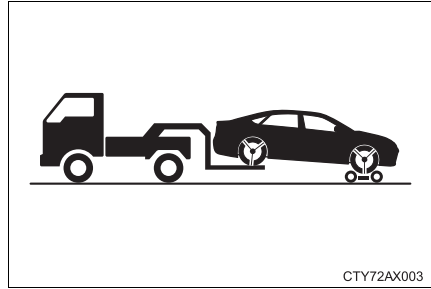

Use a towing dolly under the front wheels.

## Using a flatbed truck

If your vehicle is transported by a flatbed truck, it should be tied down at the locations shown in the illustration.

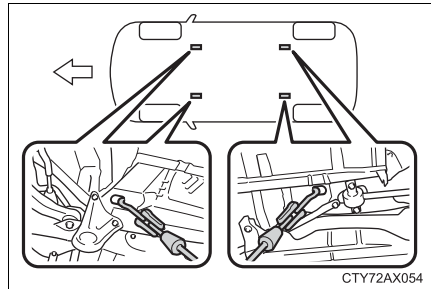

If you use chains or cables to tie down your vehicle, the angles shaded in black must be 45°.

Do not overly tighten the tie downs or the vehicle may be damaged.

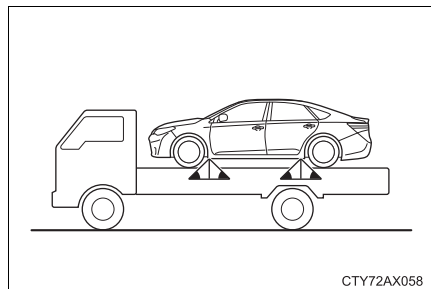

**⚠ WARNING**

Observe the following precaution.  
Failure to do so may result in death or serious injury.

**■ When towing the vehicle**

Be sure to transport the vehicle with the front wheels raised or with all four wheels raised off the ground. If the vehicle is towed with the front wheels contacting the ground, the drivetrain and related parts may be damaged or electricity generated by the operation of the motor may cause a fire to occur depending on the nature of the damage or malfunction.

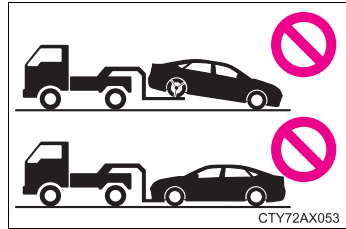
**■ While towing**

- When towing using cables or chains, avoid sudden starts, etc. which place excessive stress on the towing eyelets, cables or chains. The towing eyelets, cables or chains may become damaged, broken debris may hit people, and cause serious damage.
- Do not turn the power switch off.  
There is a possibility that the steering wheel is locked and cannot be operated.

**⚠ NOTICE****■ To prevent damage to the vehicle when towing using a wheel-lift type truck**

- Do not tow the vehicle from the rear when the power switch is off. The steering lock mechanism is not strong enough to hold the front wheels straight.
- When raising the vehicle, ensure adequate ground clearance for towing at the opposite end of the raised vehicle. Without adequate clearance, the vehicle could be damaged while being towed.

**■ To prevent damage to the vehicle when towing with a sling-type truck**

Do not tow with a sling-type truck, either from the front or rear.

## If you think something is wrong

**If you notice any of the following symptoms, your vehicle probably needs adjustment or repair. Contact your Toyota dealer as soon as possible.**

### Visible symptoms

- Fluid leaks under the vehicle.  
(Water dripping from the air conditioning after use is normal.)
- Flat-looking tires or uneven tire wear
- Engine coolant temperature gauge needle continually points higher than normal.

### Audible symptoms

- Changes in exhaust sound
- Excessive tire squeal when cornering
- Strange noises related to the suspension system
- Pinging or other noises related to the hybrid system





### Operational symptoms





- Engine missing, stumbling or running roughly
- Appreciable loss of power
- Vehicle pulls heavily to one side when braking
- Vehicle pulls heavily to one side when driving on a level road
- Loss of brake effectiveness, spongy feeling, pedal almost touches the floor



## If a warning light turns on or a warning buzzer sounds

Calmly perform the following actions if any of the warning lights comes on or flashes. If a light comes on or flashes, but then goes off, this does not necessarily indicate a malfunction in the system. However, if this continues to occur, have the vehicle inspected by your Toyota dealer.







### Warning light and warning buzzer list

Warning light	Warning light/Details/Actions
	<p><b>Brake system warning light (warning buzzer)*1</b></p> <ul style="list-style-type: none"> <li>• Low brake fluid</li> <li>• Malfunction in the brake system</li> </ul> <p>This light also comes on when the parking brake is not released. If the light turns off after the parking brake is fully released the system is operating normally.</p> <p>→ <b>Immediately stop the vehicle in a safe place and contact your Toyota dealer. Continuing to drive the vehicle may be dangerous.</b></p>
	<p><b>Charging system warning light</b></p> <p>Indicates a malfunction in the vehicle's charging system</p> <p>→ <b>Immediately stop the vehicle in a safe place and contact your Toyota dealer.</b></p>
	<p><b>Low engine oil pressure warning light</b></p> <p>Indicates that the engine oil pressure is too low.</p> <p>→ <b>Immediately stop the vehicle in a safe place and contact your Toyota dealer.</b></p>
	<p><b>Malfunction indicator lamp</b></p> <p>Indicates a malfunction in:</p> <ul style="list-style-type: none"> <li>• The hybrid system;</li> <li>• The electronic engine control system;</li> <li>• The electronic throttle control system; or</li> <li>• The hybrid transmission control system</li> </ul> <p>→ <b>Have the vehicle inspected by your Toyota dealer immediately.</b></p>

Warning light	Warning light/Details/Actions
	<p><b>SRS warning light</b> Indicates a malfunction in:</p> <ul style="list-style-type: none"> <li>• The SRS airbag system;</li> <li>• The front passenger occupant classification system; or</li> <li>• The seat belt pretensioner system</li> </ul> <p>→ <b>Have the vehicle inspected by your Toyota dealer immediately.</b></p>
	<p><b>ABS warning light</b> Indicates a malfunction in:</p> <ul style="list-style-type: none"> <li>• The ABS; or</li> <li>• The brake assist system</li> </ul> <p>→ <b>Have the vehicle inspected by your Toyota dealer immediately.</b></p>
	<p><b>Electric power steering system warning light (warning buzzer)</b> Indicates a malfunction in the EPS (Electric Power Steering) system</p> <p>→ <b>Have the vehicle inspected by your Toyota dealer immediately.</b></p>
	<p><b>Slip indicator</b> Indicates a malfunction in:</p> <ul style="list-style-type: none"> <li>• The VSC (Vehicle Stability Control) system;</li> <li>• The TRAC (Traction Control) system; or</li> <li>• The hill-start assist control system</li> </ul> <p>The light will flash when the ABS, the VSC, the TRAC or the hill-start assist control system is operating.</p> <p>→ <b>Have the vehicle inspected by your Toyota dealer immediately.</b></p>

Warning light	Warning light/Details/Actions
 <p>(Flashes) (If equipped)</p>	<p><b>PCS warning light</b></p> <ul style="list-style-type: none"> <li>• When the warning light flashes (and a buzzer sounds): Indicates a malfunction in the PCS (Pre-Collision System) → <b>Have the vehicle inspected by your Toyota dealer immediately.</b></li> <li>• When the warning light flashes (and a buzzer does not sound): Indicates that the PCS (Pre-Collision System) is temporarily unavailable, possibly due to either of the following: <ul style="list-style-type: none"> <li>• An area around the radar sensor or camera sensor being dirty or covered with condensation, ice, stickers, etc.</li> </ul> </li> </ul> <p>→ <b>Clear the dirt, condensation, ice, stickers, etc. (→P. 205, 206)</b></p> <ul style="list-style-type: none"> <li>• Radar sensor or camera sensor operational conditions (such as temperature etc.) being not met</li> </ul> <p>→ <b>Driving is possible in this case. The PCS (Pre-Collision System) will be enabled if the operational conditions (such as temperature etc.) are met again.</b></p> <ul style="list-style-type: none"> <li>• When the warning light is illuminated: Either the VSC (Vehicle Stability Control) system or PCS (Pre-Collision System) is disabled or both are disabled.</li> </ul> <p>→ <b>To enable the PCS, enable both the VSC system and PCS. (→P. 213, 263)</b></p>
 <p>(Amber) (If equipped)</p>	<p><b>LDA (Lane Departure Alert with steering control) indicator</b></p> <p>Indicates a malfunction in the LDA (Lane Departure Alert with steering control) The light will flash when the LDA system is operating.</p> <p>→ <b>P. 231</b></p>



Warning light	Warning light/Details/Actions
	<p><b>Brake system warning light</b> Indicates a malfunction in:</p> <ul style="list-style-type: none"> <li>• The electronically controlled brake system; or</li> <li>• The regenerative braking system</li> </ul> <p>→ <b>Have the vehicle inspected by your Toyota dealer immediately.</b></p>
	<p><b>Open door warning light (warning buzzer)*2</b> Indicates that a door or the trunk is not fully closed</p> <p>→ <b>Check that all the doors and the trunk are closed.</b></p>
	<p><b>Low fuel level warning light</b> Indicates remaining fuel is approximately 2.6 gal. (9.7 L, 2.1 Imp. gal.) or less</p> <p>→ <b>Refuel the vehicle.</b></p>
	<p><b>Seat belt reminder light (warning buzzer)*3</b> Warns the driver and/or front passenger to fasten their seat belts</p> <p>→ <b>Fasten the seat belt.</b> <b>If the front passenger's seat is occupied, the front passenger's seat belt also needs to be fastened to make the warning light (warning buzzer) off.</b></p>
	<p><b>Master warning light</b> A buzzer sounds and the warning light comes on and flashes to indicate that the master warning system has detected a malfunction.</p> <p>→ <b>P. 407</b></p>
	<p><b>Tire pressure warning light</b> When the light comes on:</p> <p>Low tire inflation pressure such as</p> <ul style="list-style-type: none"> <li>• Natural causes (→P. 403)</li> <li>• Flat tire (→P. 408)</li> </ul> <p>→ <b>Adjust the tire inflation pressure to the specified level.</b> <b>The light will turn off after a few minutes. In case the light does not turn off even if the tire inflation pressure is adjusted, have the system checked by your Toyota dealer.</b></p> <p>When the light comes on after blinking for 1 minute: Malfunction in the tire pressure warning system</p> <p>→ <b>Have the system checked by your Toyota dealer.</b></p>

**\*1: Brake system warning buzzer:**

When there is a possible problem that could affect braking performance, the warning light will come on and a warning buzzer will sound.

**Parking brake engaged warning buzzer:**

Parking brake engaged warning buzzer: The buzzer sounds to indicate that the parking brake is still engaged (with the vehicle having reached a speed of 3 mph [5 km/h]).

**\*2: Open door warning buzzer:**

A buzzer will sound if the vehicle reaches a speed of 3 mph (5 km/h) or more with any door open.

**\*3: Driver's seat belt buzzer:**

The driver's seat belt buzzer sounds to alert the driver that his or her seat belt is not fastened. Once the power switch is turned to ON mode, the buzzer sounds for 6 seconds. If the vehicle reaches a speed of 12 mph (20 km/h), the buzzer sounds once. If the seat belt is still unfastened after 30 seconds, the buzzer will sound intermittently for 10 seconds. Then, if the seat belt is still unfastened, the buzzer will sound in a different tone for 20 more seconds.

Front passenger's seat belt buzzer:

The front passenger's seat belt buzzer sounds to alert the front passenger that his or her seat belt is not fastened. The buzzer sounds once if the vehicle reaches a speed of 12 mph (20 km/h). If the seat belt is still unfastened after 30 seconds, the buzzer will sound intermittently for 10 seconds. Then, if the seat belt is still unfastened, the buzzer will sound in a different tone for 20 more seconds.

---

**■ SRS warning light**

This warning light system monitors the airbag sensor assembly, front impact sensors, side impact sensors (front door), side impact sensors (front), side impact sensors (rear), driver's seat belt buckle switch, front passenger occupant classification system (ECU and sensors), "AIR BAG ON" indicator light, "AIR BAG OFF" indicator light, front passenger's seat belt buckle switch, seat belt pretensioners (front), airbags, interconnecting wiring and power sources. (→P. 38)

**■ Front passenger detection sensor, seat belt reminder and warning buzzer**

If luggage is placed on the front passenger seat, the front passenger detection sensor may cause the warning light to flash and the warning buzzer to sound even if a passenger is not sitting in the seat.

**■ If the malfunction indicator lamp comes on while driving**

First check the following:

- Is the fuel tank empty?  
If it is, fill the fuel tank immediately.
- Is the fuel tank cap loose?  
If it is, tighten it securely.

The light will go off after several driving trips.

If the light does not go off even after several trips, contact your Toyota dealer as soon as possible.

**■ Electric power steering system warning light (warning buzzer)**

When the 12-volt battery charge becomes insufficient or the voltage temporarily drops, the electric power steering system warning light may come on and the warning buzzer may sound.

**■ When the tire pressure warning light comes on**

Check the tire inflation pressure and adjust to the appropriate level. Pushing the tire pressure warning reset switch will not turn off the tire pressure warning light.

**■ The tire pressure warning light may come on due to natural causes**

The tire pressure warning light may come on due to natural causes such as natural air leaks and tire inflation pressure changes caused by temperature. In this case, adjusting the tire inflation pressure will turn off the warning light (after a few minutes).

**■ When a tire is replaced with a spare tire**

The compact spare tire is not equipped with a tire pressure warning valve and transmitter. If a tire goes flat, the tire pressure warning light will not turn off even though the flat tire has been replaced with the spare tire. Replace the spare tire with the repaired tire and adjust the tire inflation pressure. The tire pressure warning light will go off after a few minutes.

**■ Conditions that the tire pressure warning system may not function properly**

→P. 361

**■ If the tire pressure warning light frequently comes on after blinking for 1 minute**

If the tire pressure warning light frequently comes on after blinking for 1 minute when the power switch is turned to ON mode, have it checked by your Toyota dealer.

**■ Warning buzzer**

In some cases, the buzzer may not be heard because of a noisy place or an audio sound.

**WARNING****■ If both the ABS and the brake system warning lights remain on**

Stop your vehicle in a safe place immediately and contact your Toyota dealer. The vehicle will become extremely unstable during braking, and the ABS system may fail, which could cause an accident resulting in death or serious injury.

**■ When the electric power steering system warning light comes on**

The steering wheel may become extremely heavy.

When steering wheel operations are heavier than usual, grip the steering wheel firmly and operate it using more force than usual.

**■ If the tire pressure warning light comes on**

Be sure to observe the following precautions. Failure to do so could cause a loss of vehicle control and result in death or serious injury.

- Stop your vehicle in a safe place as soon as possible. Adjust the tire inflation pressure immediately.
- If the tire pressure warning light comes on even after tire inflation pressure adjustment, it is probable that you have a flat tire. Check the tires. If a tire is flat, change it with the spare tire and have the flat tire repaired by the nearest Toyota dealer.
- Avoid abrupt maneuvering and braking. If the vehicle tires deteriorate, you could lose control of the steering wheel or the brakes.

**■ If a blowout or sudden air leakage should occur**

The tire pressure warning system may not activate immediately.

 **WARNING****■ Maintenance of the tires**

Each tire, including the spare (if provided), should be checked monthly when cold and inflated to the inflation pressure recommended by the vehicle manufacturer on the vehicle placard or tire inflation pressure label (tire and load information label). (If your vehicle has tires of a different size than the size indicated on the vehicle placard or tire inflation pressure label [tire and load information label], you should determine the proper tire inflation pressure for those tires.)

As an added safety feature, your vehicle has been equipped with a tire pressure monitoring system (TPMS-tire pressure warning system) that illuminates a low tire pressure telltale (tire pressure warning light) when one or more of your tires is significantly under-inflated. Accordingly, when the low tire pressure telltale (tire pressure warning light) illuminates, you should stop and check your tires as soon as possible, and inflate them to the proper pressure. Driving on a significantly under-inflated tire causes the tire to overheat and can lead to tire failure. Under-inflation also reduces fuel efficiency and tire tread life, and may affect the vehicle's handling and stopping ability.

Please note that the TPMS (tire pressure warning system) is not a substitute for proper tire maintenance, and it is the driver's responsibility to maintain correct tire pressure, even if under-inflation has not reached the level to trigger illumination of the TPMS low tire pressure telltale (tire pressure warning light).

Your vehicle has also been equipped with a TPMS (tire pressure warning system) malfunction indicator to indicate when the system is not operating properly. The TPMS (tire pressure warning system) malfunction indicator is combined with the low tire pressure telltale (tire pressure warning light). When the system detects a malfunction, the telltale will flash for approximately one minute and then remain continuously illuminated. This sequence will continue upon subsequent vehicle start-ups as long as the malfunction exists. When the malfunction indicator is illuminated, the system may not be able to detect or signal low tire pressure as intended.

**WARNING**

TPMS (tire pressure warning system) malfunctions may occur for a variety of reasons, including the installation of replacement or alternate tires or wheels on the vehicle that prevent the TPMS (tire pressure warning system) from functioning properly. Always check the TPMS (tire pressure warning system) malfunction telltale after replacing one or more tires or wheels on your vehicle to ensure that the replacement or alternate tires and wheels allow the TPMS (tire pressure warning system) to continue to function properly.

**NOTICE****■ To ensure the tire pressure warning system operates properly**

Do not install tires with different specifications or makers, as the tire pressure warning system may not operate properly.

## If a warning message is displayed

The multi-information display shows warnings of system malfunctions, incorrectly performed operations, messages that indicate a need for maintenance and reminder messages. When a message is shown, perform the correction procedure appropriate to the message.

### ① Master warning light

The master warning light also comes on or flashes in order to indicate that a message is currently being displayed on the multi-information display.

### ② Multi-information display

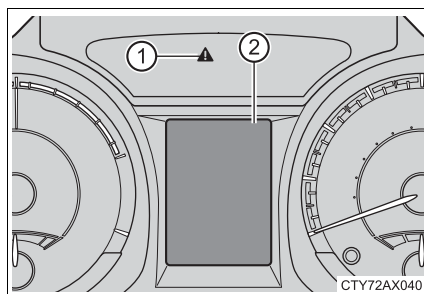

If any of the warning messages is shown again after its correction procedure has been performed, contact your Toyota dealer.

### ■ Warning buzzer

In some cases, the buzzer may not be heard because of noisy place or an audio sound.

### ■ If “Hybrid System Overheat/Stop the Vehicle in a Safe Place” is shown

Coping method:→P. 429

This message may be displayed when driving under severe operating conditions. (For example, when driving up a long steep hill.)

### ■ If “Maintenance Required for Hybrid Battery Cooling Parts at Your Dealer” is shown.

The filter may be clogged, the air intake vent may be blocked or there may be a gap in the duct. Have maintenance performed on the hybrid battery (traction battery) cooling component at your Toyota dealer.

## If you have a flat tire

**Your vehicle is equipped with a spare tire. The flat tire can be replaced with the spare tire.**

**For details about tires: →P. 356**



### WARNING

#### ■ If you have a flat tire

Do not continue driving with a flat tire.

Driving even a short distance with a flat tire can damage the tire and the wheel beyond repair, which could result in an accident.

## Before jacking up the vehicle

- Stop the vehicle in a safe place on a hard, flat surface.
- Set the parking brake.
- Shift the shift lever to P.
- Stop the hybrid system.
- Turn on the emergency flashers. (→P. 392)

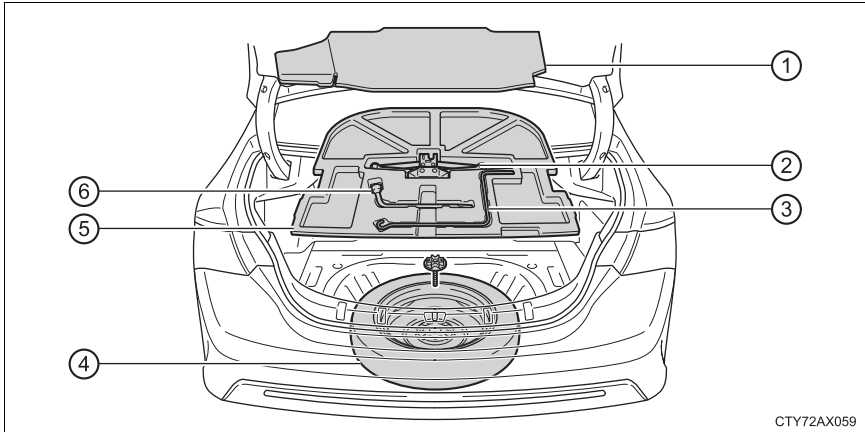

**Location of the spare tire, jack and tools**

① Luggage floor cover

② Jack

③ Jack handle

④ Spare tire

⑤ Tool tray

⑥ Wheel nut wrench

**WARNING****■ Using the tire jack**

Observe the following precautions.

Improper use of the tire jack may cause the vehicle to suddenly fall off the jack, leading to death or serious injury.

- Do not use the tire jack for any purpose other than replacing tires or installing and removing tire chains.
- Only use the tire jack that comes with this vehicle for replacing a flat tire.  
Do not use it on other vehicles, and do not use other tire jacks for replacing tires on this vehicle.
- Put the jack properly in its jack point.
- Do not put any part of your body under the vehicle while it is supported by the jack.
- Do not start the hybrid system or drive the vehicle while the vehicle is supported by the jack.
- Do not raise the vehicle while someone is inside.
- When raising the vehicle, do not put an object on or under the jack.
- Do not raise the vehicle to a height greater than that required to replace the tire.
- Use a jack stand if it is necessary to get under the vehicle.
- When lowering the vehicle, make sure that there is no-one near the vehicle. If there are people nearby, warn them vocally before lowering.

## Taking out the jack and jack handle

- 1 Remove the luggage floor cover.

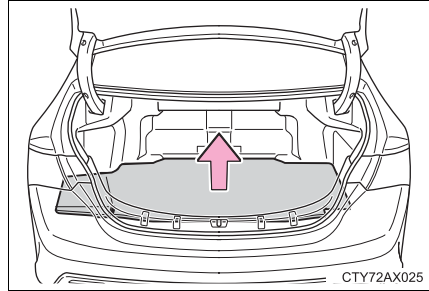

- 2 Remove the jack.

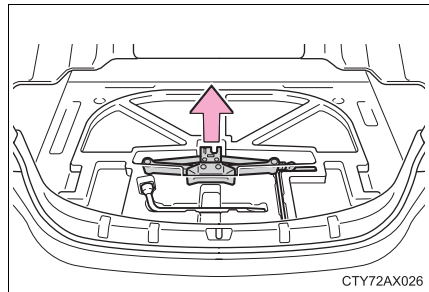

### Taking out the spare tire

- 1 Remove the luggage floor cover. (→P. 411)
- 2 Remove the tool tray.

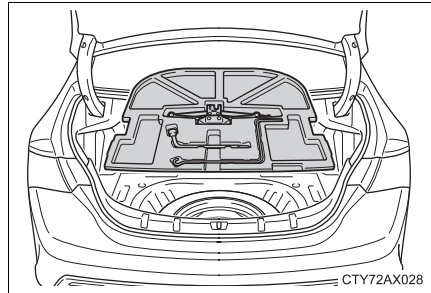

- 3 Loosen the center fastener that secures the spare tire.

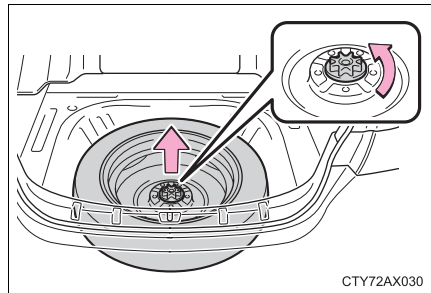

#### WARNING

#### ■ When storing the spare tire

Be careful not to catch fingers or other body parts between the spare tire and the body of the vehicle.

## Replacing a flat tire

- 1 Check the tires.

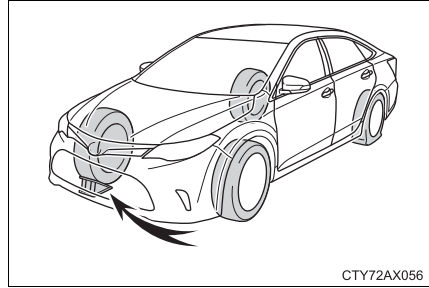

Flat tire		Wheel chock positions
Front	Left-hand side	Behind the rear right-hand side tire
	Right-hand side	Behind the rear left-hand side tire
Rear	Left-hand side	In front of the front right-hand side tire
	Right-hand side	In front of the front left-hand side tire

- 2 Slightly loosen the wheel nuts (one turn).

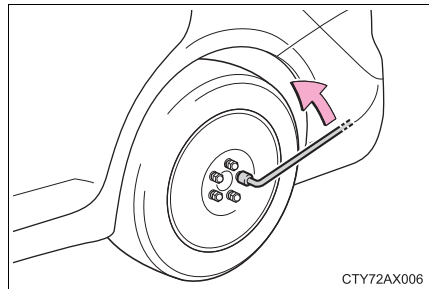

- 3 Turn the tire jack portion "A" by hand until the notch of the jack is in contact with the jack point. The jack point guides are located under the rocker panel. They indicate the jack point positions.

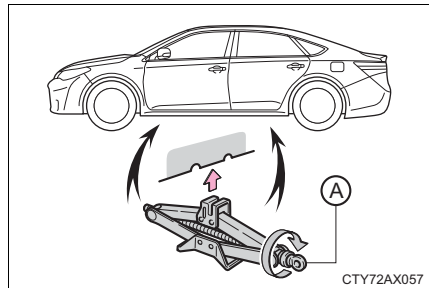

- 4 Raise the vehicle until the tire is slightly raised off the ground.

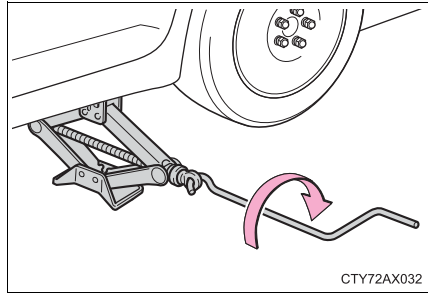

- 5 Remove all the wheel nuts and the tire.

When resting the tire on the ground, place the tire so that the wheel design faces up to avoid scratching the wheel surface.

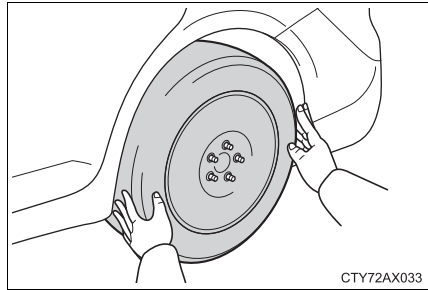

**WARNING****■ Replacing a flat tire**

- Do not touch the disc wheels or the area around the brakes immediately after the vehicle has been driven.  
After the vehicle has been driven the disc wheels and the area around the brakes will be extremely hot. Touching these areas with hands, feet or other body parts while changing a tire, etc. may result in burns.
- Failure to follow these precautions could cause the wheel nuts to loosen and the tire to fall off, resulting in death or serious injury.
  - Have the wheel nuts tightened with a torque wrench to 76 ft•lbf (103 N•m, 10.5 kgf•m) as soon as possible after changing wheels.
  - When installing a tire, only use wheel nuts that have been specifically designed for that wheel.
  - If there are any cracks or deformations in the bolt screws, nut threads or bolt holes of the wheel, have the vehicle inspected by your Toyota dealer.
  - When installing the wheel nuts, be sure to install them with the tapered ends facing inward. (→P. 369)

## Installing the spare tire

- 1 Remove any dirt or foreign matter from the wheel contact surface.

If foreign matter is on the wheel contact surface, the wheel nuts may loosen while the vehicle is in motion, causing the tire to come off.

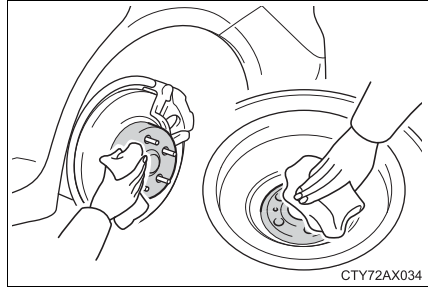

- 2 Install the spare tire and loosely tighten each wheel nut by hand by approximately the same amount.

Tighten the wheel nuts until the tapered portion comes into loose contact with the disc wheel seat.

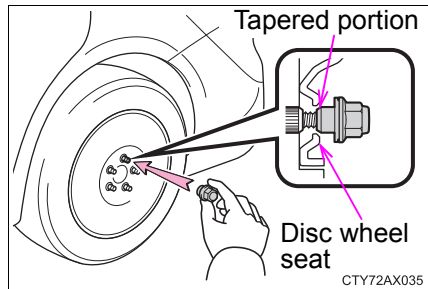

- 3 Lower the vehicle.

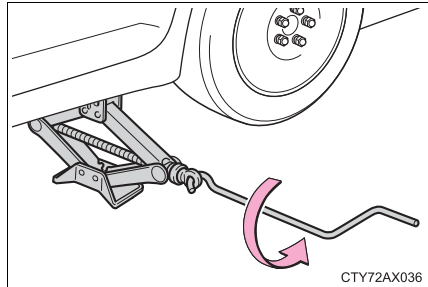

- 4 Firmly tighten each wheel nut two or three times in the order shown in the illustration.

Tightening torque:  
76 ft•lbf (103 N•m, 10.5 kgf•m)

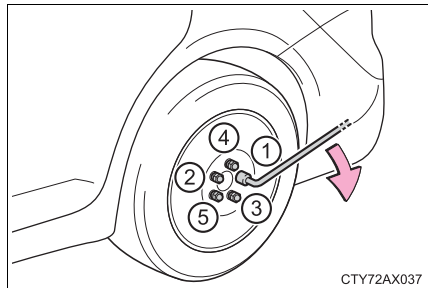

- 5 Stow the flat tire, tire jack and all tools.



---

**■ The compact spare tire**

- The compact spare tire is identified by the label “TEMPORARY USE ONLY” on the tire sidewall.  
Use the compact spare tire temporarily, and only in an emergency.
- Make sure to check the tire inflation pressure of the compact spare tire.  
(→P. 443)

**■ After completing the tire change**

The tire pressure warning system must be reset. (→P. 358)

**■ When using the compact spare tire**

As the compact spare tire is not equipped with a tire pressure warning valve and transmitter, low inflation pressure of the spare tire will not be indicated by the tire pressure warning system. Also, if you replace the compact spare tire after the tire pressure warning light comes on, the light remains on.

**■ When the compact spare tire is equipped**

The vehicle becomes lower when driving with the compact spare tire compared to when driving with standard tires.

**■ If you have a flat front tire on a road covered with snow or ice**

Install the compact spare tire on one of the rear wheels of the vehicle. Perform the following steps and fit tire chains to the front tires:

- 1 Replace a rear tire with the compact spare tire.
- 2 Replace the flat front tire with the tire removed from the rear of the vehicle.
- 3 Fit tire chains to the front tires.

**WARNING****■ When using the compact spare tire**

- Remember that the compact spare tire provided is specifically designed for use with your vehicle. Do not use your compact spare tire on another vehicle.
- Do not use more than one compact spare tires simultaneously.
- Replace the compact spare tire with a standard tire as soon as possible.
- Avoid sudden acceleration, abrupt steering, sudden braking and shifting operations that cause sudden engine braking.

**■ When the compact spare tire is attached**

The vehicle speed may not be correctly detected, and the following systems may not operate correctly:

- ABS & Brake assist
- VSC
- TRAC
- Cruise control (if equipped)
- Dynamic radar cruise control (if equipped)
- PCS (if equipped)
- EPS
- LDA (Lane Departure Alert with steering control) (if equipped)
- Automatic High Beam (if equipped)
- Tire pressure warning system
- Rear view monitor system
- Navigation system (if equipped)

 **WARNING****■ Speed limit when using the compact spare tire**

Do not drive at speeds in excess of 50 mph (80 km/h) when a compact spare tire is installed on the vehicle.

The compact spare tire is not designed for driving at high speeds. Failure to observe this precaution may lead to an accident causing death or serious injury.

**■ After using the tools and jack**

Before driving, make sure all the tools and jack are securely in place in their storage location to reduce the possibility of personal injury during a collision or sudden braking.

 **NOTICE****■ Be careful when driving over bumps with the compact spare tire installed on the vehicle.**

The vehicle becomes lower when driving with the compact spare tire compared to when driving with standard tires. Be careful when driving over uneven road surfaces.

**■ Driving with tire chains and the compact spare tire**

Do not fit tire chains to the compact spare tire.

Tire chains may damage the vehicle body and adversely affect driving performance.

**■ When replacing the tires**

When removing or fitting the wheels, tires or the tire pressure warning valve and transmitter, contact your Toyota dealer as the tire pressure warning valve and transmitter may be damaged if not handled correctly.

**■ To avoid damage to the tire pressure warning valves and transmitters**

When a tire is repaired with liquid sealants, the tire pressure warning valve and transmitter may not operate properly. If a liquid sealant is used, contact your Toyota dealer or other qualified service shop as soon as possible. Make sure to replace the tire pressure warning valve and transmitter when replacing the tire. (→P. 357)

## If the hybrid system will not start

**Reasons for the hybrid system not starting vary depending on the situation. Check the following and perform the appropriate procedure:**

### **The hybrid system will not start even though the correct starting procedure is being followed. (→P. 172)**

One of the following may be the cause of the problem:

- The electronic key may not be functioning properly. (→P. 423)
- There may not be sufficient fuel in the vehicle's tank.  
Refuel the vehicle.
- There may be a malfunction in the immobilizer system. (→P. 79)
- There may be a malfunction in the steering lock system.
- The hybrid system may be malfunctioning due to an electrical problem such as electronic key battery depletion or a blown fuse. However, depending on the type of malfunction, an interim measure is available to start the hybrid system. (→P. 421)

### **The interior lights and headlights are dim, or the horn does not sound or sounds at a low volume.**

One of the following may be the cause of the problem:

- The 12-volt battery may be discharged. (→P. 424)
- The 12-volt battery terminal connections may be loose or corroded.  
(→P. 352)

**The interior lights and headlights do not turn on, or the horn does not sound.**

One of the following may be the cause of the problem:

- The 12-volt battery may be discharged. (→P. 424)
- One or both of the 12-volt battery terminals may be disconnected. (→P. 352)

Contact your Toyota dealer if the problem cannot be repaired, or if repair procedures are unknown.

**Emergency start function**

When the hybrid system does not start, the following steps can be used as an interim measure to start the hybrid system if the power switch is functioning normally:

Do not use this starting procedure except in case of emergency.

- 1 Set the parking brake.
- 2 Shift the shift lever to P.
- 3 Turn the power switch to ACCESSORY mode.
- 4 Press and hold the power switch for about 15 seconds while depressing the brake pedal firmly.

Even if the hybrid system can be started using the above steps, the system may be malfunctioning. Have the vehicle inspected by your Toyota dealer.

## If the electronic key does not operate properly

If communication between the electronic key and vehicle is interrupted (→P. 126) or the electronic key cannot be used because the battery is depleted, the smart key system and wireless remote control cannot be used. In such cases, the doors and trunk can be opened and the hybrid system can be started by following the procedure below.

### Locking and unlocking the doors and unlocking the trunk

#### ■ Doors

Use the mechanical key (→P. 106) in order to perform the following operations:

- ① Locks all the doors
- ② Unlocks the door

Turning the key rearward unlocks the driver's door. Turning the key once again within 5 seconds unlocks the other doors.

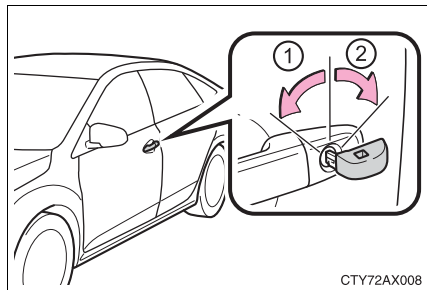

#### ■ Trunk

→P. 119

## Starting the hybrid system

1 Ensure that the shift lever is in P and depress the brake pedal.

2 Touch the Toyota emblem side of the electronic key to the power switch.

The power switch will turn to ON mode.

When the smart key system is deactivated in customization setting, the power switch will turn to ACCESSORY mode.

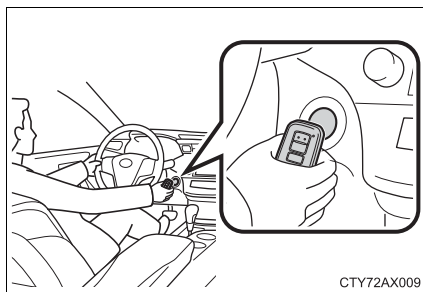

3 Firmly depress the brake pedal.

A message indicating how to start the hybrid system will be displayed on the multi-information display.

4 Press the power switch.

In the event that the hybrid system still cannot be started, contact your Toyota dealer.

### Stopping the hybrid system

Shift the shift lever to P and press the power switch as you normally do when stopping the hybrid system.

### Replacing the key battery

As the above procedure is a temporary measure, it is recommended that the electronic key battery be replaced immediately when the battery is depleted. (→P. 373)

### Changing power switch modes

Release the brake pedal and press the power switch in step 3 above. The hybrid system does not start and modes will be changed each time the switch is pressed.(→P. 173)

### When the electronic key does not work properly

- Make sure that the smart key system has not been deactivated in the customization setting. If it is off, turn the function on. (Customizable features →P. 461)
- Check if battery-saving mode is set. If it is set, cancel the function. (→P. 125)

## If the 12-volt battery is discharged

**The following procedures may be used to start the hybrid system if the 12-volt battery is discharged.**

**You can also call your Toyota dealer or a qualified repair shop.**

If you have a set of jumper (or booster) cables and a second vehicle with a 12-volt battery, you can jump start your vehicle by following the steps below.

- 1 Confirm that the electronic key is being carried.

When connecting the jumper (or booster) cables, depending on the situation, the alarm may activate and doors locked. (→P. 82)

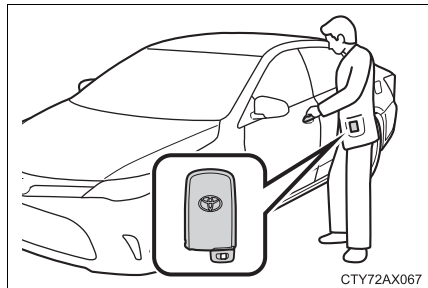

- 2 Open the trunk lid and remove the 12-volt battery cover.

In the event that the trunk opener cannot be used, use the loop of wire to unlock the trunk. (→P. 119)

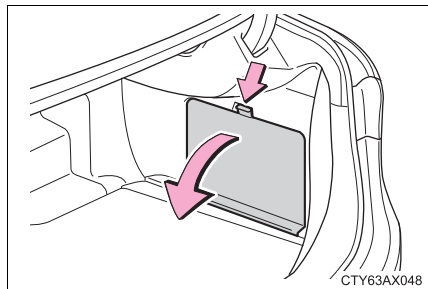



- 3 Connect the jumper cables according to the following procedure:

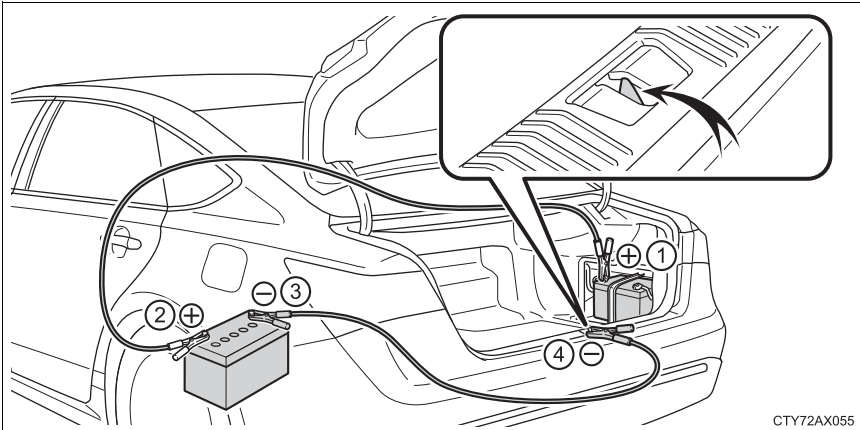

- 1 Connect a positive jumper cable clamp to the positive (+) battery terminal on your vehicle.
- 2 Connect the clamp on the other end of the positive cable to the positive (+) battery terminal on the second vehicle.
- 3 Connect a negative cable clamp to the negative (-) battery terminal on the second vehicle.
- 4 Connect the clamp at the other end of the negative cable to a solid, stationary, unpainted metallic point away from the 12-volt battery and any moving parts, as shown in the illustration.

- 4 Start the engine of the second vehicle. Increase the engine speed slightly and maintain at that level for approximately 5 minutes to recharge the 12-volt battery of your vehicle.
- 5 Open and close any of the doors of your vehicle with the power switch off.
- 6 Maintain the engine speed of the second vehicle and start the hybrid system of your vehicle by turning the power switch to ON mode.
- 7 Make sure the “READY” indicator comes on. If the indicator does not come on, contact your Toyota dealer.
- 8 Once the hybrid system has started, remove the jumper cables in the exact reverse order from which they were connected.

Once the hybrid system starts, have the vehicle inspected at your Toyota dealer as soon as possible.

---

**■ Starting the hybrid system when the 12-volt battery is discharged**

The hybrid system cannot be started by push-starting.

**■ To prevent 12-volt battery discharge**

- Turn off the headlights and the audio system while the hybrid system is off.
- Turn off any unnecessary electrical components when the vehicle is running at a low speed for an extended period, such as in heavy traffic.

**■ Charging the 12-volt battery**

The electricity stored in the 12-volt battery will discharge gradually even when the vehicle is not in use, due to natural discharge and the draining effects of certain electrical appliances. If the vehicle is left for a long time, the 12-volt battery may discharge, and the hybrid system may be unable to start. (The 12-volt battery recharges automatically while the hybrid system is operating.)

**■ When recharging or replacing the 12-volt battery**

- In some cases, it may not be possible to unlock the doors using the smart key system when the 12-volt battery is discharged. Use the wireless remote control or the mechanical key to lock or unlock the doors.
- The hybrid system may not start on the first attempt after the 12-volt battery has recharged but will start normally after the second attempt. This is not a malfunction.
- The power switch mode is memorized by the vehicle. When the 12-volt battery is reconnected, the system will return to the mode it was in before the 12-volt battery was discharged. Before disconnecting the 12-volt battery, turn the power switch off.

If you are unsure what mode the power switch was in before the 12-volt battery discharged, be especially careful when reconnecting the 12-volt battery.

**⚠ WARNING****■ Avoiding 12-volt battery fires or explosions**

Observe the following precautions to prevent accidentally igniting the flammable gas that may be emitted from the 12-volt battery:

- Make sure each jumper cable is connected to the correct terminal and that it is not unintentionally in contact with any other than the intended terminal.
- Do not allow the other end of the jumper cable connected to the “+” terminal to come into contact with any other parts or metal surfaces in the area, such as brackets or unpainted metal.
- Do not allow the + and - clamps of the jumper cables to come into contact with each other.
- Do not smoke, use matches, cigarette lighters or allow open flame near the 12-volt battery.

**WARNING****■ 12-volt battery precautions**

The 12-volt battery contains poisonous and corrosive acidic electrolyte, while related parts contain lead and lead compounds. Observe the following precautions when handling the 12-volt battery:

- When working with the 12-volt battery, always wear safety glasses and take care not to allow any 12-volt battery fluids (acid) to come into contact with skin, clothing or the vehicle body.
- Do not lean over the 12-volt battery.
- In the event that 12-volt battery fluid comes into contact with the skin or eyes, immediately wash the affected area with water and seek medical attention.  
Place a wet sponge or cloth over the affected area until medical attention can be received.
- Always wash your hands after handling the 12-volt battery support, terminals, and other battery-related parts.
- Do not allow children near the 12-volt battery.

**■ After recharging the 12-volt battery**

Have the 12-volt battery inspected at your Toyota dealer as soon as possible.

If the 12-volt battery is deteriorating, continued use may cause the 12-volt battery to emit a malodorous gas, which may be detrimental to the health of passengers.

**■ When replacing the 12-volt battery**

→P. 355

## If your vehicle overheats

### The following may indicate that your vehicle is overheating:

- The engine coolant temperature gauge enters the red zone or a loss of power is experienced. (For example, the vehicle speed does not increase.)
- “Hybrid System Overheat/Stop the Vehicle in a Safe Place” is shown on the multi-information display.
- Steam comes out from under the hood.

### Correction procedures

#### ■ If the needle of the engine coolant temperature gauge enters the red zone

1 Stop the vehicle in a safe place and turn off the air conditioning system, and then stop the hybrid system.

2 If you see steam:  
Carefully lift the hood after the steam subsides.

If you do not see steam:  
Carefully lift the hood.

3 After the hybrid system has cooled down sufficiently, inspect the hoses and radiator core (radiator) for any leaks.

- ① Radiator
- ② Cooling fan

If a large amount of coolant leaks, immediately contact your Toyota dealer.

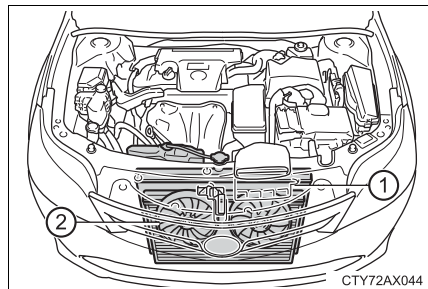

- 4 The coolant level is satisfactory if it is between the “F” and “L” lines on the reservoir.

- ① Reservoir
- ② “F” line
- ③ “L” line
- ④ Radiator cap

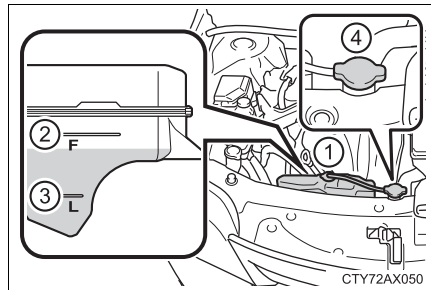

- 5 Add coolant if necessary.

Water can be used in an emergency if coolant is unavailable.

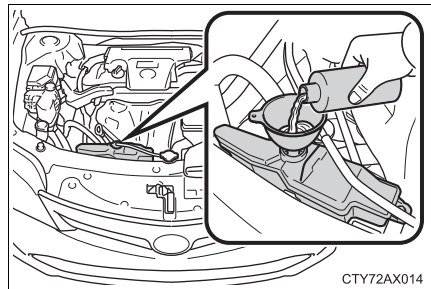

- 6 Start the hybrid system and turn the air conditioning system on to check that the radiator cooling fan operates and to check for coolant leaks from the radiator or hoses.

The fan operates when the air conditioning system is turned on immediately after a cold start. Confirm that the fan is operating by checking the fan sound and air flow. If it is difficult to check these, turn the air conditioning system on and off repeatedly.

(The fan may not operate in freezing temperatures.)

- 7 If the fan is not operating:

Stop the hybrid system immediately and contact your Toyota dealer.

If the fan is operating:

Have the vehicle inspected at the nearest Toyota dealer.

■ If “Hybrid System Overheat/Stop the Vehicle in a Safe Place” is shown on the multi-information display

- 1 Stop the vehicle in a safe place.
- 2 Stop the hybrid system and carefully lift the hood.
- 3 After the hybrid system has cooled down, inspect the hoses and radiator core (radiator) for any leaks.

- ① Radiator
- ② Cooling fan

If a large amount of coolant leaks, immediately contact your Toyota dealer

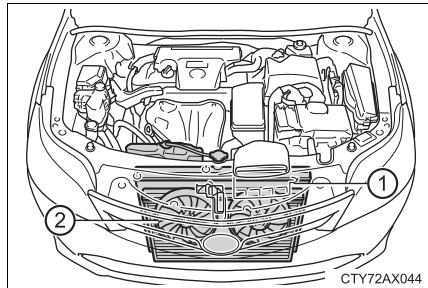

- 4 The coolant level is satisfactory if it is between the “FULL” and “LOW” lines on the reservoir.

- ① Reservoir
- ② “FULL” line
- ③ “LOW” line

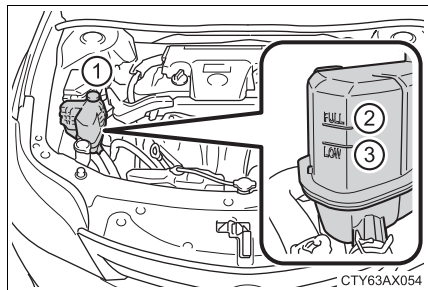

- 5 Add coolant if necessary.

Water can be used in an emergency if coolant is unavailable.

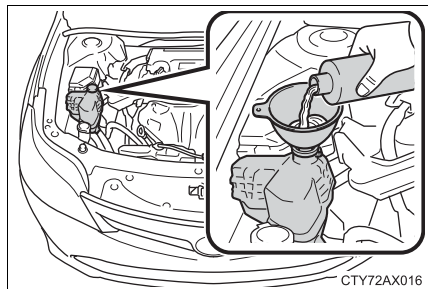

- 6 Start the hybrid system and check for the multi-information display.

If the message does not disappear:

Stop the hybrid system and contact your Toyota dealer.

If the message is not displayed:

Have the vehicle inspected at the nearest Toyota dealer.

 **WARNING**

**■ When inspecting under the hood of your vehicle**

Observe the following precautions.

Failure to do so may result in serious injury such as burns.

- If steam is seen coming from under the hood, do not open the hood until the steam has subsided. The engine compartment may be very hot.

- After the hybrid system has been turned off, check that the indicator on the “POWER” switch and the “READY” indicator are off.

When the hybrid system is operating, the gasoline engine may automatically start, or the cooling fan may suddenly operate even if the gasoline engine stops. Do not touch or approach rotating parts such as the fan, which may lead to fingers or clothing (especially a tie, a scarf or a muffler) getting caught, resulting in serious injury.

- Do not loosen the radiator cap or the coolant reservoir caps while the hybrid system and radiator are hot. Serious injury, such as burns, may result from hot coolant and steam released under pressure.

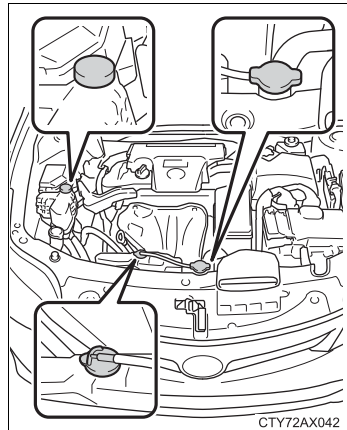

 **NOTICE**

**■ When adding engine/power control unit coolant**

Add coolant slowly after the hybrid system has cooled down sufficiently. Adding cool coolant to a hot hybrid system too quickly can cause damage to the hybrid system.

**■ To prevent damage to the cooling system**

Observe the following precautions:

- Avoid contaminating the coolant with foreign matter (such as sand or dust etc.).
- Do not use any coolant additives.



## If the vehicle becomes stuck

**Carry out the following procedures if the tires spin or the vehicle becomes stuck in mud, dirt or snow:**

- 1 Stop the hybrid system. Set the parking brake and shift the shift lever to P.
- 2 Remove the mud, snow or sand from around the front wheels.
- 3 Place wood, stones or some other material under the front wheels to help provide traction.
- 4 Restart the hybrid system.
- 5 Shift the shift lever to D or R and release the parking brake. Then, while exercising caution, depress the accelerator pedal.

### ■ When it is difficult to free the vehicle

Press  to turn off TRAC.

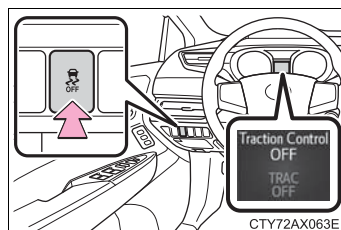

### WARNING

#### ■ When attempting to free a stuck vehicle

If you choose to push the vehicle back and forth to free it, make sure the surrounding area is clear to avoid striking other vehicles, objects or people. The vehicle may also lunge forward or lunge back suddenly as it becomes free. Use extreme caution.

#### ■ When shifting the shift lever

Be careful not to shift the shift lever with the accelerator pedal depressed. This may lead to unexpected rapid acceleration of the vehicle that may cause an accident resulting in death or serious injury.

**NOTICE****■ To avoid damaging the transmission and other components**

- Avoid spinning the front wheels and depressing the accelerator pedal more than necessary.
- If the vehicle remains stuck even after these procedures are performed, the vehicle may require towing to be freed.

**8-1. Specifications**

Maintenance data (fuel, oil level, etc.).....	436
Fuel information .....	445
Tire information .....	448

**8-2. Customization**

Customizable features .....	461
-----------------------------	-----

**8-3. Items to initialize**

Items to initialize .....	468
---------------------------	-----

## Maintenance data (fuel, oil level, etc.)

### Dimensions and weight

Overall length		195.3 in. (4960 mm)
Overall width		72.2 in. (1835 mm)
Overall height*		57.5 in. (1460 mm)
Wheelbase		111.0 in. (2820 mm)
Tread*	Front	62.6 in. (1590 mm)
	Rear	62.2 in. (1580 mm)
Vehicle capacity weight (Occupants + luggage)		930 lb. (420 kg)

\*: Unladen vehicle

## Vehicle identification

### ■ Vehicle identification number

The vehicle identification number (VIN) is the legal identifier for your vehicle. This is the primary identification number for your Toyota. It is used in registering the ownership of your vehicle.

This number is located on the top left of the instrument panel.

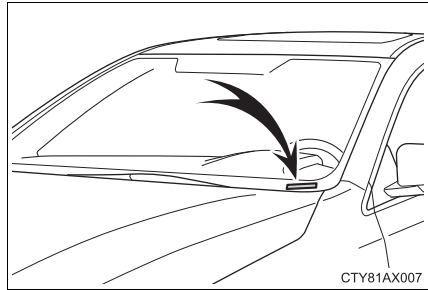

This number is also on the Certification Label.

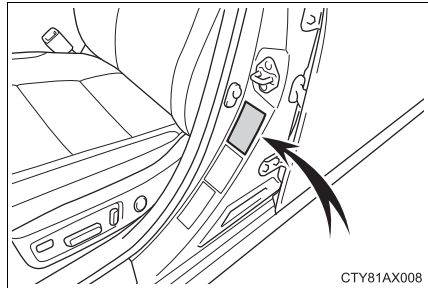

### ■ Engine number

The engine number is stamped on the engine block as shown.

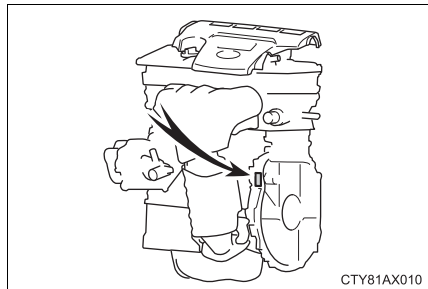

**Engine**

Model	2.5 L 4-cylinder (2AR-FXE)
Type	4-cylinder in line, 4-cycle, gasoline
Bore and stroke	3.54 × 3.86 in. (90.0 × 98.0 mm)
Displacement	152.2 cu. in. (2494 cm <sup>3</sup> )
Valve clearance	Automatic adjustment

**Fuel**

Fuel type	Unleaded gasoline only
Octane Rating	87 (Research Octane Number 91) or higher
Fuel tank capacity (Reference)	17.0 gal. (64.35 L, 14.2 Imp. gal.)

**Electric motor (traction motor)**

Type	Permanent magnet synchronous motor
Maximum output	105 kW
Maximum torque	199 ft•lbf (270 N•m, 27.5 kgf•m)

**Hybrid battery (traction battery)**

Type	Nickel-Metal hydride battery
Voltage	7.2 V/module
Capacity	6.5 Ah (3HR)
Quantity	34 modules
Overall voltage	244.8 V

## Lubrication system

Oil capacity Drain and refill (Reference*)	
With filter	4.6 qt. (4.4 L, 3.9 Imp. qt.)
Without filter	4.2 qt. (4.0 L, 3.5 Imp. qt.)

\*: The engine oil capacity is a reference quantity to be used when changing the engine oil. Warm up the engine and turn off the hybrid system, wait more than 5 minutes, and check the oil level on the dipstick.

## ■ Engine oil selection

“Toyota Genuine Motor Oil” is used in your Toyota vehicle. Use Toyota approved “Toyota Genuine Motor Oil” or equivalent to satisfy the following grade and viscosity.

Oil grade: ILSAC GF-5 multigrade engine oil

Recommended viscosity: SAE 0W-20

SAE 0W-20 is the best choice for good fuel economy and good starting in cold weather.

If SAE 0W-20 is not available, SAE 5W-20 oil may be used. However, it must be replaced with SAE 0W-20 at the next oil change.

How to read oil container label

The International Lubricant Specification Advisory Committee (ILSAC) Certification Mark is added to some oil containers to help you select the oil you should use.

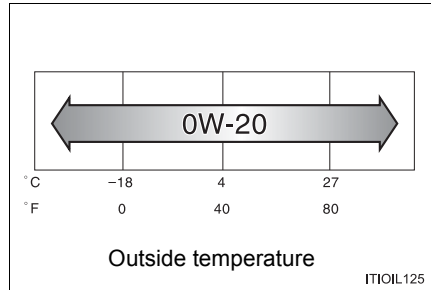



## Cooling system

Capacity	Gasoline engine	7.6 qt. (7.2 L, 6.3 Imp. qt.)
	Power control unit	3.4 qt. (3.2 L, 2.8 Imp. qt.)
Coolant type		<p>Use either of the following:</p> <ul style="list-style-type: none"> <li>• “Toyota Super Long Life Coolant”</li> <li>• Similar high-quality ethylene glycol-based non-silicate, non-amine, non-nitrite, and non-borate coolant with long-life hybrid organic acid technology</li> </ul> <p>Do not use plain water alone.</p>

## Ignition system

Spark plug	
Make	DENSO FK16HR-A8
Gap	0.031 in. (0.8 mm)

 NOTICE

**■ Iridium-tipped spark plugs**

Use only iridium-tipped spark plugs. Do not adjust the spark plug gap.

## Electrical system

12-volt battery Open voltage at 68°F (20°C):	12.6 — 12.8 V Fully charged 12.2 — 12.4 V Half charged 11.8 — 12.0 V Discharged (Voltage is checked 20 minutes after the hybrid system and all lights are turned off.)
Charging rates	5 A max.

## Hybrid transaxle

Fluid capacity*	3.9 qt. (3.7 L, 3.3 Imp. qt.)
Fluid type	Toyota Genuine ATF WS

\*: The fluid capacity is the quantity of reference.  
If replacement is necessary, contact your Toyota dealer.



### NOTICE

#### ■ Hybrid transmission fluid type

Using transmission fluid other than “Toyota Genuine ATF WS” may cause deterioration in shift quality, locking up of your transmission accompanied by vibration, and ultimately damage the transmission of your vehicle.

## Brakes

Pedal clearance* <sup>1</sup>	3.62 in. (92 mm) Min.
Pedal free play	0.04 — 0.24 in. (1.0 — 6.0 mm)
Brake pad wear limit	0.04 in. (1.0 mm)
Parking brake lining wear limit	0.04 in. (1.0 mm)
Parking brake pedal travel* <sup>2</sup>	7 — 10 clicks
Fluid type	SAE J1703 or FMVSS No.116 DOT 3

\*1: Minimum pedal clearance when depressed with a force of 112 lbf (500 N, 51 kgf) while the hybrid system is operating

\*2: Parking brake pedal travel when depressed with a force of 67 lbf (300 N, 30.6 kgf).

## Steering

Free play	Less than 1.2 in. (30 mm)
-----------	---------------------------

## Tires and wheels

Tire size	P215/55R17 93V, T155/70D17 110M
Tire inflation pressure (Recommended cold tire inflation pressure)	Front 33 psi (230 kPa, 2.3 kgf/cm <sup>2</sup> or bar) Rear 33 psi (230 kPa, 2.3 kgf/cm <sup>2</sup> or bar) Spare 60 psi (420 kPa, 4.2 kgf/cm <sup>2</sup> or bar)
Wheel size	17 × 7 J, 17 × 4 T (compact spare)
Wheel nut torque	76 ft•lbf (103 N•m, 10.5 kgf•m)

**Light bulbs\*1**

	Light bulbs	Bulb No.	W	Type
Exterior	Headlights			
	Low beam (discharge bulbs)*2	—	35	A
	Low beam (halogen bulbs)*2	9005	60	B
	High beam	9005	60	C
	Front turn signal/parking lights	7444NA	28/8	D
	Side marker lights (bulb type)*2	W5W	5	E
	Side turn signal lights	WY5W	5	D
Interior	Rear turn signal lights	921	16	E
	Back-up lights	921	16	E
	Interior/front personal lights	W6W	6	E
	Interior/rear personal lights	—	8	E
	Vanity lights	7065	1.4	F
Door courtesy lights	168	5	E	
Trunk light	194	3.8	E	

A: D4S discharge bulbs

B: HB3L+ halogen bulbs

C: HB3 halogen bulbs

D: Wedge base bulbs (amber)

E: Wedge base bulbs (clear)

F: Double end bulbs

\*1: Light bulbs not listed in this table are LED bulbs.

\*2: If equipped

## Fuel information

**You must only use unleaded gasoline.**

**Select octane rating 87 (Research Octane Number 91) or higher. Use of unleaded gasoline with an octane rating lower than 87 may result in engine knocking. Persistent knocking can lead to engine damage.**

At minimum, the gasoline you use should meet the specifications of ASTM D4814 in the U.S.A.

---

### ■ Gasoline quality

In very few cases, driveability problems may be caused by the brand of gasoline you are using. If driveability problems persist, try changing the brand of gasoline. If this does not correct the problem, consult your Toyota dealer.

### ■ Gasoline quality standards

- Automotive manufacturers in the U.S.A., Europe and Japan have developed a specification for fuel quality called the World-Wide Fuel Charter (WWFC), which is expected to be applied worldwide.
- The WWFC consists of four categories that are based on required emission levels. In the U.S., category 4 has been adopted.
- The WWFC improves air quality by lowering emissions in vehicle fleets, and improves customer satisfaction through better performance.

**■ Recommendation of the use of gasoline containing detergent additives**

- Toyota recommends the use of gasoline that contains detergent additives to avoid the build-up of engine deposits.
- All gasoline sold in the U.S.A. contains minimum detergent additives to clean and/or keep clean intake systems, per EPA's lowest additives concentration program.
- Toyota strongly recommends the use of Top Tier Detergent Gasoline. For more information on Top Tier Detergent Gasoline and a list of marketers, please go to the official website [www.toptiergas.com](http://www.toptiergas.com).

**■ Recommendation of the use of low emissions gasoline**

Gasolines containing oxygenates such as ethers and ethanol, as well as reformulated gasolines, are available in some cities. These fuels are typically acceptable for use, providing they meet other fuel requirements.

Toyota recommends these fuels, since the formulations allow for reduced vehicle emissions.

**■ Non-recommendation of the use of blended gasoline**

- Use only gasoline containing up to 15% ethanol.

DO NOT use any flex-fuel or gasoline that could contain more than 15% ethanol, including from any pump labeled E30, E50, E85 (which are only some examples of fuel containing more than 15% ethanol).

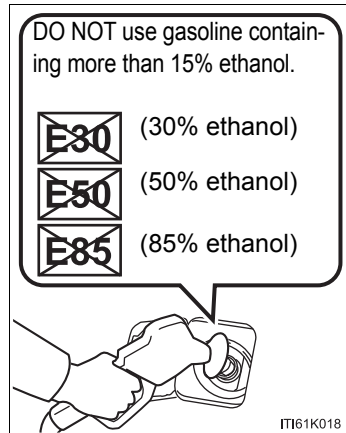

- If you use gasohol in your vehicle, be sure that it has an octane rating no lower than 87.
- Toyota does not recommend the use of gasoline containing methanol.

### ■ Non-recommendation of the use of gasoline containing MMT

Some gasoline contains an octane enhancing additive called MMT (Methylcyclopentadienyl Manganese Tricarbonyl).

Toyota does not recommend the use of gasoline that contains MMT. If fuel containing MMT is used, your emission control system may be adversely affected.

The malfunction indicator lamp on the instrument cluster may come on. If this happens, contact your Toyota dealer for service.

### ■ If your engine knocks

- Consult your Toyota dealer.
- You may occasionally notice light knocking for a short time while accelerating or driving uphill. This is normal and there is no need for concern.



#### NOTICE

#### ■ Notice on fuel quality

- Do not use improper fuels. If improper fuels are used, the engine will be damaged.
- Do not use leaded gasoline.  
Leaded gasoline can cause damage to your vehicle's three-way catalytic converters causing the emission control system to malfunction.
- Do not use gasohol other than the type previously stated.  
Other gasohol may cause fuel system damage or vehicle performance problems.
- Using unleaded gasoline with an octane number or rating lower than the level previously stated will cause persistent heavy knocking.  
At worst, this will lead to engine damage.

#### ■ Fuel-related poor driveability

If poor driveability (poor hot starting, vaporization, engine knocking, etc.) is encountered after using a different type of fuel, discontinue the use of that type of fuel.

#### ■ When refueling with gasohol

Take care not to spill gasohol. It can damage your vehicle's paint.





- ① Tire size (→P. 451)
- ② DOT and Tire Identification Number (TIN) (→P. 450)
- ③ Uniform tire quality grading  
For details, see “Uniform Tire Quality Grading” that follows.
- ④ Location of treadwear indicators (→P. 356)
- ⑤ Tire ply composition and materials  
Plies are layers of rubber-coated parallel cords. Cords are the strands which form the plies in a tire.
- ⑥ Radial tires or bias-ply tires  
A radial tire has “RADIAL” on the sidewall. A tire not marked “RADIAL” is a bias-ply tire.
- ⑦ TUBELESS or TUBE TYPE  
A tubeless tire does not have a tube and air is directly put into the tire. A tube type tire has a tube inside the tire and the tube maintains the air pressure.
- ⑧ Load limit at maximum cold tire inflation pressure (→P. 455)
- ⑨ Maximum cold tire inflation pressure (→P. 455)  
This means the pressure to which a tire may be inflated.
- ⑩ Summer tires or all season tires (→P. 360)  
An all season tire has “M+S” on the sidewall. A tire not marked “M+S” is a summer tire.
- ⑪ “TEMPORARY USE ONLY”  
A compact spare tire is identified by the phrase “TEMPORARY USE ONLY” molded on its sidewall. This tire is designed for temporary emergency use only.

## Typical DOT and Tire Identification Number (TIN)

### ► Type A

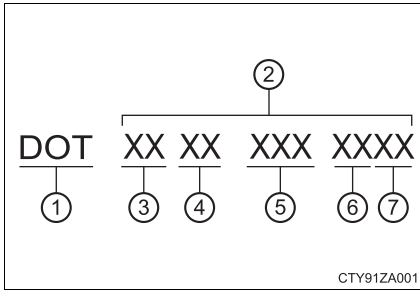

### ► Type B

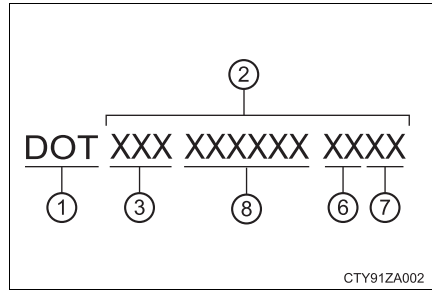

- ① DOT symbol\*
- ② Tire Identification Number (TIN)
- ③ Tire manufacturer's identification mark
- ④ Tire size code
- ⑤ Manufacturer's optional tire type code (3 or 4 letters)
- ⑥ Manufacturing week
- ⑦ Manufacturing year
- ⑧ Manufacturer's code

\*: The DOT symbol certifies that the tire conforms to applicable Federal Motor Vehicle Safety Standards.

## Tire size

### ■ Typical tire size information

The illustration indicates typical tire size.

- ① Tire use  
(P = Passenger car,  
T = Temporary use)
- ② Section width (millimeters)
- ③ Aspect ratio  
(tire height to section width)
- ④ Tire construction code (R = Radial, D = Diagonal)
- ⑤ Wheel diameter (inches)
- ⑥ Load index (2 digits or 3 digits)
- ⑦ Speed symbol (alphabet with one letter)

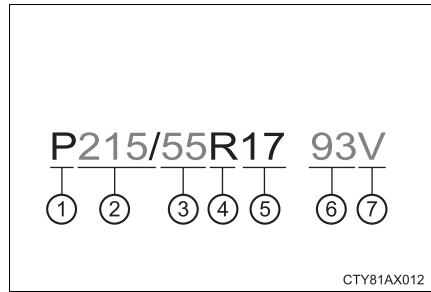

### ■ Tire dimensions

- ① Section width
- ② Tire height
- ③ Wheel diameter

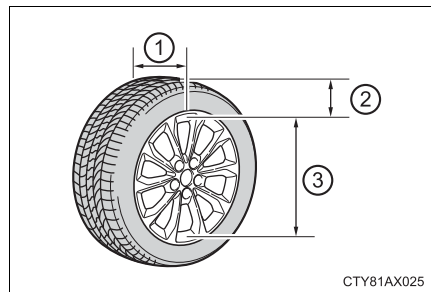

**Tire section names**

- ① Bead
- ② Sidewall
- ③ Shoulder
- ④ Tread
- ⑤ Belt
- ⑥ Inner liner
- ⑦ Reinforcing rubber
- ⑧ Carcass
- ⑨ Rim lines
- ⑩ Bead wires
- ⑪ Chafer

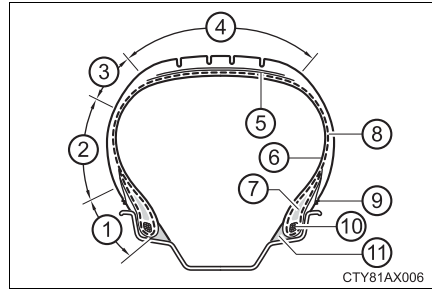

## Uniform Tire Quality Grading

This information has been prepared in accordance with regulations issued by the National Highway Traffic Safety Administration of the U.S. Department of Transportation.

It provides the purchasers and/or prospective purchasers of Toyota vehicles with information on uniform tire quality grading.

Your Toyota dealer will help answer any questions you may have as you read this information.

### ■ DOT quality grades

All passenger vehicle tires must conform to Federal Safety Requirements in addition to these grades. Quality grades can be found where applicable on the tire sidewall between tread shoulder and maximum section width.

For example: Treadwear 200 Traction AA Temperature A

### ■ Treadwear

The treadwear grade is a comparative rating based on the wear rate of the tire when tested under controlled conditions on a specified government test course.

For example, a tire graded 150 would wear one and a half (1 - 1/2) times as well on the government course as a tire graded 100.

The relative performance of tires depends upon the actual conditions of their use. Performance may differ significantly from the norm due to variations in driving habits, service practices and differences in road characteristics and climate.

### ■ Traction AA, A, B, C

The traction grades, from highest to lowest, are AA, A, B and C, and they represent the tire's ability to stop on wet pavement as measured under controlled conditions on specified government test surfaces of asphalt and concrete.

A tire marked C may have poor traction performance.

Warning: The traction grade assigned to this tire is based on braking (straight ahead) traction tests and does not include cornering (turning) traction.

### ■ Temperature A, B, C

The temperature grades are A (the highest), B, and C, representing the tire's resistance to the generation of heat and its ability to dissipate heat when tested under controlled conditions on a specified indoor laboratory test wheel.

Sustained high temperature can cause the material of the tire to degenerate and reduce tire life, and excessive temperature can lead to sudden tire failure.

Grade C corresponds to a level of performance which all passenger car tires must meet under the Federal Motor Vehicle Safety Standard No. 109.

Grades B and A represent higher levels of performance on the laboratory test wheel than the minimum required by law.

Warning: The temperature grades of a tire assume that it is properly inflated and not overloaded.

Excessive speed, underinflation, or excessive loading, either separately or in combination, can cause heat buildup and possible tire failure.

## Glossary of tire terminology

Tire related term	Meaning
Cold tire inflation pressure	Tire pressure when the vehicle has been parked for three hours or more, or has not been driven more than 1 mile or 1.5 km under that condition
Maximum inflation pressure	The maximum cold inflated pressure to which a tire may be inflated, shown on the sidewall of the tire
Recommended inflation pressure	Cold tire inflation pressure recommended by a manufacturer
Accessory weight	The combined weight (in excess of those standard items which may be replaced) of hybrid transmission, power steering, power brakes, power windows, power seats, radio and heater, to the extent that these items are available as factory-installed equipment (whether installed or not)
Curb weight	The weight of a motor vehicle with standard equipment, including the maximum capacity of fuel, oil and coolant, and if so equipped, air conditioning and additional weight optional engine
Maximum loaded vehicle weight	The sum of: (a) Curb weight (b) Accessory weight (c) Vehicle capacity weight (d) Production options weight
Normal occupant weight	150 lb. (68 kg) times the number of occupants specified in the second column of Table 1* that follows
Occupant distribution	Distribution of occupants in a vehicle as specified in the third column of Table 1* below

Tire related term	Meaning
Production options weight	The combined weight of installed regular production options weighing over 5 lb. (2.3 kg) in excess of the standard items which they replace, not previously considered in curb weight or accessory weight, including heavy duty brakes, ride levelers, roof rack, heavy duty 12-volt battery, and special trim
Rim	A metal support for a tire or a tire and tube assembly upon which the tire beads are seated
Rim diameter (Wheel diameter)	Nominal diameter of the bead seat
Rim size designation	Rim diameter and width
Rim type designation	The industry manufacturer's designation for a rim by style or code
Rim width	Nominal distance between rim flanges
Vehicle capacity weight (Total load capacity)	The rated cargo and luggage load plus 150 lb. (68 kg) times the vehicle's designated seating capacity
Vehicle maximum load on the tire	The load on an individual tire that is determined by distributing to each axle its share of the maximum loaded vehicle weight, and dividing by two
Vehicle normal load on the tire	The load on an individual tire that is determined by distributing to each axle its share of curb weight, accessory weight, and normal occupant weight (distributed in accordance with Table 1* below), and dividing by two
Weather side	The surface area of the rim not covered by the inflated tire
Bead	The part of the tire that is made of steel wires, wrapped or reinforced by ply cords and that is shaped to fit the rim
Bead separation	A breakdown of the bond between components in the bead



Tire related term	Meaning
Bias ply tire	A pneumatic tire in which the ply cords that extend to the beads are laid at alternate angles substantially less than 90 degrees to the centerline of the tread
Carcass	The tire structure, except tread and sidewall rubber which, when inflated, bears the load
Chunking	The breaking away of pieces of the tread or sidewall
Cord	The strands forming the plies in the tire
Cord separation	The parting of cords from adjacent rubber compounds
Cracking	Any parting within the tread, sidewall, or innerliner of the tire extending to cord material
CT	A pneumatic tire with an inverted flange tire and rim system in which the rim is designed with rim flanges pointed radially inward and the tire is designed to fit on the underside of the rim in a manner that encloses the rim flanges inside the air cavity of the tire
Extra load tire	A tire designed to operate at higher loads and at higher inflation pressures than the corresponding standard tire
Groove	The space between two adjacent tread ribs
Innerliner	The layer(s) forming the inside surface of a tubeless tire that contains the inflating medium within the tire
Innerliner separation	The parting of the innerliner from cord material in the carcass
Intended sidewall outboard	<p>(a) The sidewall that contains a whitewall, bears white lettering, or bears manufacturer, brand, and/or model name molding that is higher or deeper than the same molding on the other sidewall of the tire, or</p> <p>(b) The outward facing sidewall of an asymmetrical tire that has a particular side that must always face outward when mounted on a vehicle</p>

Tire related term	Meaning
Light truck (LT) tire	A tire designated by its manufacturer as primarily intended for use on lightweight trucks or multipurpose passenger vehicles
Load rating	The maximum load that a tire is rated to carry for a given inflation pressure
Maximum load rating	The load rating for a tire at the maximum permissible inflation pressure for that tire
Maximum permissible inflation pressure	The maximum cold inflation pressure to which a tire may be inflated
Measuring rim	The rim on which a tire is fitted for physical dimension requirements
Open splice	Any parting at any junction of tread, sidewall, or innerliner that extends to cord material
Outer diameter	The overall diameter of an inflated new tire
Overall width	The linear distance between the exteriors of the sidewalls of an inflated tire, including elevations due to labeling, decorations, or protective bands or ribs
Passenger car tire	A tire intended for use on passenger cars, multipurpose passenger vehicles, and trucks, that have a gross vehicle weight rating (GVWR) of 10,000 lb. or less.
Ply	A layer of rubber-coated parallel cords
Ply separation	A parting of rubber compound between adjacent plies
Pneumatic tire	A mechanical device made of rubber, chemicals, fabric and steel or other materials, that, when mounted on an automotive wheel, provides the traction and contains the gas or fluid that sustains the load
Radial ply tire	A pneumatic tire in which the ply cords that extend to the beads are laid at substantially 90 degrees to the centerline of the tread
Reinforced tire	A tire designed to operate at higher loads and at higher inflation pressures than the corresponding standard tire

Tire related term	Meaning
Section width	The linear distance between the exteriors of the sidewalls of an inflated tire, excluding elevations due to labeling, decoration, or protective bands
Sidewall	That portion of a tire between the tread and bead
Sidewall separation	The parting of the rubber compound from the cord material in the sidewall
Snow tire	A tire that attains a traction index equal to or greater than 110, compared to the ASTM E-1136 Standard Reference Test Tire, when using the snow traction test as described in ASTM F-1805-00, Standard Test Method for Single Wheel Driving Traction in a Straight Line on Snow-and Ice-Covered Surfaces, and which is marked with an Alpine Symbol (  ) on at least one sidewall
Test rim	The rim on which a tire is fitted for testing, and may be any rim listed as appropriate for use with that tire
Tread	That portion of a tire that comes into contact with the road
Tread rib	A tread section running circumferentially around a tire
Tread separation	Pulling away of the tread from the tire carcass
Treadwear indicators (TWI)	The projections within the principal grooves designed to give a visual indication of the degrees of wear of the tread
Wheel-holding fixture	The fixture used to hold the wheel and tire assembly securely during testing

\*: Table 1 — Occupant loading and distribution for vehicle normal load for various designated seating capacities

Designated seating capacity, Number of occupants	Vehicle normal load, Number of occupants	Occupant distribution in a normally loaded vehicle
2 through 4	2	2 in front
5 through 10	3	2 in front, 1 in second seat
11 through 15	5	2 in front, 1 in second seat, 1 in third seat, 1 in fourth seat
16 through 20	7	2 in front, 2 in second seat, 2 in third seat, 1 in fourth seat

## Customizable features

**Your vehicle includes a variety of electronic features that can be personalized to suit your preferences. The settings of these features can be changed on the audio system screen or at your Toyota dealer.**

Some function settings are changed simultaneously with other functions being customized. Contact your Toyota dealer for further details.

### Customizing vehicle features

It is possible to customize certain vehicle features using the audio system.

- 1 Press the “APPS” button.
- 2 Select “Setup” on the “Apps” screen and select “Vehicle”.

Various setting can be changed. Refer to the list of settings that can be changed for details.

### Customizable Features

- ① Vehicles with an audio system: Settings that can be changed using the audio system
- ② Settings that can be changed by your Toyota dealer

Definition of symbols: O = Available, — = Not available

### ■ Smart key system and wireless remote control (→P. 110, 121)

Function	Default setting	Customized setting	①	②
Operation signal (Emergency flashers)	On	Off	○	○
Operation signal (Buzzer)	On	Off	—	○
Operation buzzer volume	Level 5	Off to level 7	○	○
Time elapsed before automatic door lock function is activated if door is not opened after being unlocked	60 seconds	Off	○	○
		30 seconds		
		120 seconds		
Open door warning buzzer	On	Off	—	○

### ■ Smart key system (→P. 121)

Function	Default setting	Customized setting	①	②
Smart key system	On	Off	—	○
Number of permissible times of continuous smart lock	Twice	Unlimited	—	○

### ■ Wireless remote control (→P. 106, 110, 116)

Function	Default setting	Customized setting	①	②
Wireless remote control	On	Off	—	○
Unlocking operation	Driver's door unlocked in one step, all doors unlocked in two steps	All doors unlocked in one step.	○	○
Panic function	On	Off	—	○
Trunk unlocking operation	Press and hold (short)	Off	—	○
		Press twice		
		One short press		
		Press and hold (long)		

### ■ Door lock (→P. 110)

Function	Default setting	Customized setting	①	②
Unlocking using a key	Driver's door unlocked in one step, all doors unlocked in two steps	All doors unlocked in one step.	—	○
Speed-detecting automatic door lock function	Off	On	○	○
Opening driver's door unlocks all doors	Off	On	○	○
Shifting gears to P unlocks all doors.	On	Off	○	○
Shifting gears to position other than P locks all doors.	On	Off	○	○
Locking/unlocking of the trunk when all doors are locked/unlocked	On	Off	—	○

### ■ Trunk (→P. 116)

Function	Default setting	Customized setting	①	②
Trunk opener main switch	Activated	Deactivated	—	○

### ■ Driving position memory\* (→P. 132, 136)

Function	Default setting	Customized setting	①	②
Driver's seat movement when exiting the vehicle	Full	Off	○	○
		Partial		
Doors linked to the driving position memory recall function	Driver's door	All doors	—	○

\*: If equipped

### ■ Power switch (→P. 172)

Function	Default setting	Customized setting	①	②
Time elapsed before the power switch related messages on the multi-information display turn off	60 seconds	30 seconds	—	○
		600 seconds		

### ■ Turn signal lever (→P. 184)

Function	Default setting	Customized setting	①	②
Times of flashing of the lane change signal flashers	3	4	—	○
		5		
		6		
		7		
		Off		



### ■ Automatic light control system (→P. 186)

Function	Default setting	Customized setting	①	②
Light sensor sensitivity	Level 3	Level 1 to 5	○	○
Time elapsed before headlights automatically turn off after doors are closed	30 seconds	0 seconds	○	○
		60 seconds		
		90 seconds		

### ■ Lights (→P. 186, 189)

Function	Default setting	Customized setting	①	②
Daytime running light system	On	Off	○	○
Automatic high beam*	On	Off	—	○

\*: If equipped

### ■ Illumination (→P. 286)

Function	Default setting	Customized setting	①	②
Interior lights illumination control	On	Off	—	○
Time elapsed before interior lights turn off	15 seconds	Off	○	○
		7.5 seconds		
		30 seconds		
Center console spot light	On	Off	—	○
Operation when the doors are unlocked	On	Off	—	○
Operation after the power switch turned off	On	Off	—	○
Operation when you approach the vehicle with the electronic key on your person	On	Off	—	○
Ambient lights*	On	Off	—	○
Outer foot lights*	On	Off	—	○

Function	Default setting	Customized setting	①	②
Time elapsed before the outer foot lights turn off*	15 seconds	Off	0	0
		7.5 seconds		
		30 seconds		
Enable/disable operation of the outer foot lights when you approach the vehicle with the electronic key on your person*	On	Off	—	0
Enable/disable operation of the outer foot lights when the doors are unlocked with the power door lock switch*	On	Off	—	0

\*: If equipped

### ■ Instrument panel (→P. 92)

Function	Default setting	Customized setting	①	②
Instrument panel light auto dimmer control	Level 3	Level 1 to 5	—	0

### ■ Automatic air conditioning system (→P. 274)

Function	Default setting	Customized setting	①	②
A/C auto switch operation	Auto	Manual	0	0

### ■ Touch switch (on the audio panel) (→P. 100)

Function	Default setting	Customized setting	①	②
Touch switch sensitivity	Level 3	Level 1 to 3	0	—

### ■ Touch switch (on the air conditioning panel) (→P. 274)

Function	Default setting	Customized setting	①	②
Touch switch sensitivity	Level 1	Level 1 to 3	—	0

### ■ Rear sunshade\* (→P. 304)

Function	Default setting	Customized setting	①	②
Reverse operation	On	Off	—	○
Time elapsed before the reverse operation feature activates	0.7 seconds	0 second	—	○
		0.9 seconds		
		1.2 seconds		

\*: If equipped

#### WARNING

##### ■ During customization

As the hybrid system needs to be operating during customization, ensure that the vehicle is parked in a place with adequate ventilation. In a closed area such as a garage, exhaust gases including harmful carbon monoxide (CO) may collect and enter the vehicle. This may lead to death or a serious health hazard.

#### NOTICE

##### ■ During customization

To prevent 12-volt battery discharge, ensure that the hybrid system is operating while customizing features.

## Items to initialize

**The following items must be initialized for normal system operation after such cases as the maintenance being performed on the vehicle:**

Item	When to initialize	Reference
Message indicating maintenance is required	<ul style="list-style-type: none"><li>• After the maintenance is performed</li></ul>	P. 333
Tire pressure warning system	<ul style="list-style-type: none"><li>• When changing the tire size</li><li>• When changing the tire inflation pressure by changing traveling speed or load weight, etc.</li></ul>	P. 358

Reporting safety defects for U.S. owners.....	470
--	-----

## Reporting safety defects for U.S. owners

If you believe that your vehicle has a defect which could cause a crash or could cause injury or death, you should immediately inform the National Highway Traffic Safety Administration (NHTSA) in addition to notifying Toyota Motor Sales, U.S.A., Inc. (Toll-free: 1-800-331-4331).

If NHTSA receives similar complaints, it may open an investigation, and if it finds that a safety defect exists in a group of vehicles, it may order a recall and remedy campaign. However, NHTSA cannot become involved in individual problems between you, your dealer, or Toyota Motor Sales, U.S.A., Inc.

To contact NHTSA, you may call the Vehicle Safety Hotline toll-free at 1-888-327-4236 (TTY: 1-800-424-9153); go to <http://www.safercar.gov>; or write to: Administrator, NHTSA, 1200 New Jersey Ave, S.E., Washington, DC 20590. You can also obtain other information about motor vehicle safety from <http://www.safercar.gov>.

## Index

What to do if... (Troubleshooting) .....	472
Alphabetical index .....	476

For details of equipment related to the audio/navigation system, refer to the “NAVIGATION AND MULTIMEDIA SYSTEM OWNER'S MANUAL”.

## What to do if... (Troubleshooting)

**If you have a problem, check the following before contacting your Toyota dealer.**

### **The doors cannot be locked, unlocked, opened or closed**



#### **You lose your keys**

- If you lose your mechanical keys, new genuine mechanical keys can be made by your Toyota dealer. (→P. 107)
- If you lose your electronic keys, the risk of vehicle theft increases significantly. Contact your Toyota dealer immediately. (→P. 109)



#### **The doors cannot be locked or unlocked**

- Is the electronic key battery weak or depleted? (→P. 373)
- Is the power switch in ON mode?  
When locking the doors, turn the power switch off. (→P. 173)
- Is the electronic key left inside the vehicle?  
When locking the doors, make sure that you have the electronic key on your person.
- The function may not operate properly due to the condition of the radio wave. (→P. 126)



#### **The rear door cannot be opened**

- Is the child-protector lock set?  
The rear door cannot be opened from inside the vehicle when the lock is set. Open the rear door from outside and then unlock the child-protector lock. (→P. 113)



#### **The trunk lid is closed with the electronic key left inside**

- The function to prevent the electronic key from being left inside the trunk will operate and you can open the trunk as usual. Take the key out from the trunk. (→P. 118)



## If you think something is wrong



### The hybrid system does not start

- Did you press the power switch while firmly depressing the brake pedal? (→P. 172)
- Is the shift lever in P? (→P. 175)
- Is the electronic key anywhere detectable inside the vehicle? (→P. 122)
- Is the steering wheel unlocked? (→P. 175)
- Is the electronic key battery weak or depleted?  
In this case, the hybrid system can be started in a temporary way.  
(→P. 423)
- Is the 12-volt battery discharged? (→P. 424)



### The shift lever cannot be shifted from P even if you depress the brake pedal

- Is the power switch in ON mode?  
If you cannot release the shift lever by depressing the brake pedal with the power switch in ON mode (→P. 182)



### The steering wheel cannot be turned after the hybrid system is stopped

- It is locked automatically to prevent theft of the vehicle. (→P. 175)



### The windows do not open or close by operating the power window switches

- Is the window lock switch pressed?  
The power window except for the one at the driver's seat cannot be operated if the window lock switch is pressed. (→P. 148)



### The power switch is turned off automatically

- The auto power off function will be operated if the vehicle is left in ACCESSORY or ON mode (the hybrid system is not operating) for a period of time. (→P. 174)



### **A warning buzzer sounds during driving**

- The seat belt reminder light is flashing  
Are the driver and the front passenger wearing the seat belts?  
(→P. 401)
- The brake system warning light is on  
Is the parking brake released? (→P. 185)

Depending on the situation, other types of warning buzzer may also sound. (→P. 398, 407)



### **An alarm is activated and the horn sounds**

- Did anyone inside the vehicle open a door during setting the alarm?  
The sensor detects it and the alarm sounds. (→P. 81)

To stop the alarm, turn the power switch to ON mode or start the hybrid system.



### **A warning buzzer sounds when leaving the vehicle**

- Is the message displayed on the multi-information display?  
Check the message on the multi-information display.



### **A warning light turns on or a warning message is displayed**

- When a warning light turns on, refer to P. 398.
- When a warning message is displayed, perform the correction procedure appropriate to the message.

## When a problem has occurred



### **If you have a flat tire**

- Stop the vehicle in a safe place and replace the flat tire with the spare tire. (→P. 408)



### **The vehicle becomes stuck**

- Try the procedure for when the vehicle becomes stuck in mud, dirt, or snow. (→P. 433)

## Alphabetical index

## A

<b>A/C</b> .....	<b>274</b>
Air conditioning filter .....	371
Automatic air conditioning system .....	274
<b>ABS (Anti-lock Brake System)</b> .....	<b>261</b>
Function .....	261
Warning light .....	399
<b>Air conditioning filter</b> .....	<b>371</b>
<b>Air conditioning system</b> .....	<b>274</b>
Air conditioning filter .....	371
Automatic air conditioning system .....	274
<b>Airbags</b> .....	<b>36</b>
Airbag operating conditions ....	44
Airbag precautions for your child .....	39
Airbag warning light .....	399
Correct driving posture .....	28
Curtain shield airbag operating conditions .....	44
Curtain shield airbag precautions .....	42
Front passenger occupant classification system .....	48
General airbag precautions ....	39
Locations of airbags .....	36
Modification and disposal of airbags .....	43
Side airbag operating conditions .....	44
Side airbag precautions .....	39
Side and curtain shield airbags operating conditions .....	44
Side and curtain shield airbags precautions .....	39
SRS airbags .....	36

<b>Alarm</b> .....	<b>81</b>
Alarm .....	81
Warning buzzer .....	398
<b>Anchor brackets</b> .....	<b>59</b>
<b>Antennas (smart key system)</b> .....	<b>121</b>
<b>Anti-lock Brake System (ABS)</b> .....	<b>261</b>
Function .....	261
Warning light .....	399
<b>Approach warning (dynamic radar cruise control)</b> .....	<b>240</b>
<b>Armrest</b> .....	<b>304</b>
<b>Assist grips</b> .....	<b>306</b>
<b>Audio system</b> *	
<b>Automatic headlight leveling system</b> .....	<b>188</b>
<b>Automatic high beam</b> .....	<b>189</b>
<b>Automatic light control system</b> .....	<b>186</b>
<b>AUX port</b> *	
<b>Auxiliary boxes</b> .....	<b>293</b>

**B**

<b>Back-up lights</b>	
Replacing light bulbs.....	386
Wattage .....	444
<b>Battery (12-volt battery) .....</b>	<b>352</b>
If the 12-volt battery is	
discharged.....	424
Preparing and checking before	
winter.....	269
Warning light.....	398
<b>Battery (traction battery).....</b>	<b>74</b>
<b>Blind Spot Monitor (BSM).....</b>	<b>250</b>
<b>Brake</b>	
Fluid .....	350
Parking brake.....	185
Regenerative braking.....	72
Warning light.....	398, 401
<b>Brake assist .....</b>	<b>261</b>
<b>Break-in tips.....</b>	<b>157</b>
<b>Brightness control</b>	
Instrument panel light	
control.....	91
<b>BSM (Blind Spot Monitor).....</b>	<b>250</b>

**C**

<b>Care .....</b>	<b>326, 329</b>
Aluminum wheels .....	327
Exterior .....	326
Interior .....	329
Seat belts.....	330
<b>Cargo capacity.....</b>	<b>169</b>
<b>Cargo net.....</b>	<b>297</b>
<b>Caution label.....</b>	<b>74</b>
<b>Chains .....</b>	<b>270</b>
<b>Child restraint system.....</b>	<b>55</b>
Booster seats, definition .....	56
Booster seats, installation.....	65
Convertible seats, definition ...	56
Convertible seats,	
installation .....	62
Front passenger occupant	
classification system .....	48
Infant seats, definition.....	56
Infant seats, installation .....	62
Installing CRS	
with LATCH anchors .....	60
Installing CRS with	
seat belts.....	62
Installing CRS	
with top tether strap.....	66

\*: Refer to the “NAVIGATION AND MULTIMEDIA SYSTEM OWNER’S MANUAL”.

- Child safety ..... 54**
  - 12-volt battery
    - precautions ..... 354, 428
  - Airbag precautions ..... 39
  - Child restraint system ..... 55
  - How your child should wear
    - the seat belt ..... 32
  - Installing child restraints ..... 59
  - Moon roof precautions ..... 154
  - Power window lock switch .... 148
  - Power window precautions ... 150
  - Rear door child-protectors .... 113
  - Removed electronic
    - key battery precautions ..... 374
  - Seat belt extender
    - precautions ..... 35
  - Seat belt precautions ..... 58
  - Seat heater precautions ..... 283
  - Trunk precautions ..... 119
- Child-protectors ..... 113**
- Cleaning ..... 326, 329**
  - Aluminum wheels ..... 327
  - Exterior ..... 326
  - Interior ..... 329
  - Seat belts ..... 330
- Clock ..... 300**
- Coat hooks ..... 306**
- Compass ..... 320**
- Condenser ..... 349**
- Console box ..... 291**
- Consumption screen ..... 100**
- Coolant ..... 347**
  - Capacity ..... 441
  - Checking ..... 347
  - Preparing and checking
    - before winter ..... 269
- Cooling system ..... 347**
  - Engine overheating ..... 429
  - Hybrid system overheating ... 429
- Cruise control**
  - Cruise control ..... 246
  - Dynamic radar cruise
    - control ..... 233
- Cup holders ..... 292**
- Curtain shield airbags ..... 37**
- Customizable features ..... 461**

**D**

<b>Daytime running light system</b> .....	<b>187</b>
<b>Defogger</b>	
Front windshield.....	278
Outside rear view mirrors.....	278
Rear window.....	278
<b>Dimensions</b> .....	<b>436</b>
<b>Dinghy towing</b> .....	<b>171</b>
<b>Display</b>	
Cruise control.....	246
Dynamic radar	
cruise control.....	233
LDA (Lane Departure Alert with steering control).....	222
Multi-information display.....	94
Trip information.....	95
Warning message.....	407
<b>Do-it-yourself maintenance</b> .....	<b>339</b>
<b>Door courtesy lights</b>	
Wattage.....	444
<b>Door lock</b>	
Doors.....	110
Smart key system.....	121
Wireless remote control.....	110

<b>Doors</b> .....	<b>110</b>
Automatic door locking and unlocking system.....	113
Door glasses.....	148
Door lock.....	112
Open door warning buzzer ...	122
Open door warning light.....	401
Outside rear view mirrors.....	145
Rear door child-protector.....	113
<b>Driver's seat position memory</b> .....	<b>133</b>
<b>Driving</b> .....	<b>156</b>
Break-in tips.....	157
Correct driving posture.....	28
Driving mode select switch ...	259
Hybrid vehicle driving tips.....	266
Procedures.....	156
Winter drive tips.....	269
<b>Dynamic radar cruise control</b> .....	<b>233</b>

## E

<b>Eco drive mode</b> .....	259
<b>EDR (Event data recorder)</b> .....	11
<b>Electric motor</b>	
<b>(traction motor)</b> .....	70
<b>Electric Power</b>	
<b>Steering (EPS)</b> .....	262
Function .....	262
Warning light.....	399
<b>Electronic key</b> .....	106
Battery-saving function .....	125
If the electronic key does not operate properly .....	422
Replacing the battery.....	373
<b>Emergency flashers</b> .....	392
<b>Emergency, in case of</b>	
If the 12-volt battery is discharged.....	424
If the electronic key does not operate properly .....	422
If the hybrid system will not start .....	420
If the trunk opener is not actuated.....	119
If the warning buzzer sounds.....	398
If the warning light turns on .....	398
If the warning message is displayed.....	407
If you have a flat tire .....	408
If you think something is wrong.....	397
If your vehicle becomes stuck.....	433
If your vehicle has to be stopped in an emergency...	393
If your vehicle needs to be towed.....	394
If your vehicle overheats.....	429

<b>Energy monitor</b> .....	100
<b>Engine</b>	
ACCESSORY mode .....	173
Compartment.....	343
Engine switch .....	172
Hood .....	341
How to start the hybrid system .....	172
Identification number .....	437
Ignition switch (power switch).....	172
Overheating.....	429
Power switch .....	172
<b>Engine coolant</b> .....	347
Capacity.....	441
Checking.....	347
Preparing and checking before winter .....	269
<b>Engine coolant temperature     gauge</b> .....	90
<b>Engine oil</b> .....	344
Capacity.....	439
Checking.....	344
Preparing and checking before winter .....	269
<b>Engine switch</b> .....	172
<b>EPS (Electronic     Power Steering)</b> .....	262
Function .....	262
Warning light.....	399
<b>EV drive mode</b> .....	178
<b>Event data recorder (EDR)</b> .....	11



**F**

<b>Flat tire</b> .....	<b>408</b>
<b>Floor mats</b> .....	<b>26</b>
<b>Fluid</b>	
Brake .....	443
Hybrid transmission .....	442
Washer .....	351
<b>Front passenger occupant classification system</b> .....	<b>48</b>
<b>Front personal lights</b> .....	<b>287</b>
<b>Front seats</b> .....	<b>131</b>
Adjustment.....	131
Cleaning.....	329
Correct driving posture .....	28
Driving position memory .....	133
Head restraints .....	138
Power easy access system .....	133
Seat heaters .....	283
Seat position memory .....	133
Seat ventilators .....	283
<b>Front side marker lights</b> .....	<b>186</b>
Light switch .....	186
Replacing light bulbs.....	387
<b>Front turn signal lights</b> .....	<b>184</b>
Replacing light bulbs.....	382
Turn signal lever .....	184
Wattage .....	444
<b>Fuel</b> .....	<b>438</b>
Capacity.....	438
Fuel gauge.....	90
Information.....	445
Refueling.....	198
Type.....	438
Warning light.....	401
<b>Fuel consumption</b> .....	<b>95</b>
<b>Fuel filler door</b> .....	<b>198</b>
If the fuel filler door cannot be opened.....	200
Refueling.....	198
<b>Fuses</b> .....	<b>375</b>

**G**

<b>Garage door opener</b> .....	<b>307</b>
<b>Gauges</b> .....	<b>90</b>
<b>Glove box</b> .....	<b>290</b>
<b>Grocery bag hooks</b> .....	<b>297</b>

**H**

<b>Head restraints</b> .....	<b>138</b>
<b>Headlights</b> .....	<b>186</b>
Automatic high beam.....	189
Discharge headlights precautions.....	389
Light switch.....	186
Replacing light bulbs .....	387
Wattage .....	444
<b>Heaters</b>	
Air conditioning system.....	274
Outside rear view mirrors .....	278
Seat heaters .....	283
<b>High-voltage components</b> .....	<b>74</b>
<b>Hill-start assist control</b> .....	<b>261</b>
<b>Hood</b> .....	<b>341</b>
<b>Hooks</b>	
Coat hooks .....	306
Grocery bag hooks .....	297
Retaining hooks (floor mat) ....	26

<b>Horn</b> .....	<b>141</b>
<b>Hybrid battery</b>	
<b>(traction battery)</b> .....	<b>74</b>
<b>Hybrid battery</b>	
<b>(traction battery)</b>	
<b>air vents</b> .....	<b>75</b>
<b>Hybrid system</b> .....	<b>70</b>
Emergency shut off system ....	75
Energy monitor/	
consumption screen .....	100
EV drive mode .....	178
High voltage components .....	74
Hybrid System Indicator.....	92
Hybrid system precautions .....	74
Hybrid vehicle driving tips .....	266
If the hybrid system	
will not start .....	420
Overheating .....	429
Power (ignition) switch.....	172
Starting the hybrid system ....	172
Vehicle proximity notification	
system .....	71
<b>Hybrid System Indicator</b> .....	<b>92</b>
<b>Hybrid transmission</b> .....	<b>180</b>
If the shift lever	
cannot be shifted from P ....	182
S mode .....	181

<b>I</b>	
<b>I/M test</b> .....	<b>338</b>
<b>Identification</b>	
Engine .....	437
Vehicle.....	437
<b>Ignition switch</b>	
<b>(power switch)</b> .....	<b>172</b>
<b>Illuminated entry system</b> .....	<b>288</b>
<b>Immobilizer system</b> .....	<b>79</b>
<b>Indicators</b> .....	<b>88</b>
<b>Initialization</b>	
Maintenance .....	333
Tire pressure	
warning system .....	357
<b>Inside rear view mirror</b> .....	<b>143</b>
<b>Instrument panel</b>	
<b>light control</b> .....	<b>91</b>
<b>Interior lights</b> .....	<b>286</b>

**J****Jack**

- Positioning a floor jack..... 342
- Vehicle-equipped jack..... 409

**Jack handle..... 409****Jam protection function**

- Moon roof..... 152
- Power windows..... 149

**K****Keyless entry**

- Smart key system ..... 110, 116
- Wireless remote control..... 110, 116

**Keys..... 106**

- Battery-Saving Function ..... 125
- Electronic key ..... 106
- If the electronic key does not operate properly ..... 422
- Key number plate..... 106
- Keyless entry ..... 106
- Mechanical key ..... 106
- Power switch..... 172
- Replacing the battery..... 373
- Warning buzzer..... 122
- Wireless remote control key..... 106

**Knee airbags..... 37****L****Lane Departure Alert with steering control (LDA)..... 222****LATCH anchors ..... 60****LDA (Lane Departure Alert with steering control)..... 222****Lever**

- Auxiliary catch lever..... 341
- Hood lock release lever..... 341
- Internal trunk release lever... 118
- Shift lever..... 180
- Turn signal lever ..... 184
- Wiper lever ..... 193

**License plate lights..... 186**

- Light switch..... 186

**Light bulbs**

- Replacing..... 380
- Wattage ..... 444

**Lights**

- Automatic high beam..... 189
- Headlight switch ..... 186
- Illuminated entry system..... 288
- Interior light..... 287
- Interior lights list..... 286
- Personal lights ..... 287
- Replacing light bulbs ..... 380
- Trunk light..... 118
- Turn signal lever ..... 184
- Vanity lights ..... 299
- Wattage ..... 444

**Load capacity ..... 169****Lock steering column ..... 175****Luggage net..... 297****Luggage security system ..... 117**

**M****Maintenance**

- Do-it-yourself maintenance... 339
- General maintenance ..... 334
- Maintenance requirements ... 332
- Resetting the message
  - indicating maintenance
  - is required..... 332

**Malfunction indicator lamp..... 398****Master warning light..... 401****Meter ..... 90**

- Indicators ..... 88
- Instrument panel
  - light control ..... 91
- Meters..... 90
- Multi-information display ..... 94
- Warning lights ..... 87

**Mirrors**

- Inside rear view mirror ..... 143
- Outside rear view mirror
  - defoggers ..... 278
- Outside rear view mirrors..... 145
- Vanity mirrors..... 299

**Moon roof ..... 151**

- Jam protection function..... 152
- Operation ..... 151

**Multi-information display ..... 94**

- Cruise control..... 246
- Dynamic radar cruise
  - control..... 233
- Energy monitor ..... 100
- Switching the display ..... 95
- Tachometer..... 181
- Trip information..... 95
- Warning message..... 407

**N****Navigation system\*****Noise from under vehicle ..... 8****O****Odometer ..... 90****Oil**

- Engine oil..... 439

**Opener**

- Hood ..... 341
- Trunk ..... 116

**Outer foot lights ..... 286****Outside rear view mirrors..... 145**

- Adjusting and folding ..... 145
- Blind spot monitor..... 250
- Linked mirror function
  - when reversing..... 146
- Mirror position memory..... 133
- Outside rear view
  - mirror defoggers..... 278

**Overheating ..... 429**

## P

<b>Parking brake</b> .....	<b>185</b>
Operation .....	185
Parking brake engaged warning buzzer .....	398
<b>Parking lights</b> .....	<b>186</b>
Light switch .....	186
Replacing light bulbs.....	387
<b>PCS (Pre-Collision System)</b> .....	<b>209</b>
Function.....	209
PCS (Pre-Collision System) switch .....	213
Warning light.....	400
<b>Personal lights</b> .....	<b>287</b>
<b>Power control unit</b> .....	<b>74</b>
<b>Power control unit coolant</b> ....	<b>347</b>
Capacity .....	441
Checking.....	347
Preparing and checking before winter.....	269
<b>Power easy access system</b> .....	<b>133</b>
<b>Power outlets</b> .....	<b>302</b>
<b>Power steering (Electric Power Steering system)</b> .....	<b>262</b>
Warning light.....	399
<b>Power switch</b> .....	<b>172</b>
<b>Power windows</b> .....	<b>148</b>
Jam protection function.....	149
Operation .....	148
Window lock switch.....	148
<b>Pre-Collision System (PCS)</b> ....	<b>209</b>
Function .....	209
PCS (Pre-Collision System) switch .....	213
Warning light.....	400

## R

<b>Radar cruise control (dynamic radar cruise control)</b> .....	<b>233</b>
<b>Radiator</b> .....	<b>349</b>
<b>Rear personal lights</b> .....	<b>287</b>
<b>Rear seat heaters</b> .....	<b>283</b>
<b>Rear sunshade</b> .....	<b>304</b>
<b>Rear turn signal lights</b> .....	<b>184</b>
Replacing light bulbs .....	384
Turn signal lever.....	184
Wattage .....	444
<b>Rear view mirror</b>	
Inside rear view mirror .....	143
Outside rear view mirrors .....	145
<b>Rear view monitor system*</b>	
<b>Rear window defoggers</b> .....	<b>278</b>
<b>Refueling</b> .....	<b>198</b>
Capacity.....	438
Fuel types .....	438
If the fuel filler door cannot be opened .....	200
Opening the fuel tank cap.....	200
<b>Regenerative braking</b> .....	<b>72</b>
<b>Replacing</b>	
Electronic key battery .....	373
Fuses.....	375
Light bulbs .....	378
Tires.....	408
<b>Reporting safety defects for U.S. owners</b> .....	<b>470</b>
<b>Resetting the message indicating maintenance is required</b> .....	<b>333</b>
<b>Road accident cautions</b> .....	<b>77</b>

\*: Refer to the “NAVIGATION AND MULTIMEDIA SYSTEM OWNER’S MANUAL”.

## S

<b>Safety Connect .....</b>	<b>314</b>
<b>Seat belts.....</b>	<b>30</b>
Adjusting the seat belt .....	31
Automatic Locking	
Retractor.....	32
Child restraint system	
installation .....	62
Cleaning and maintaining	
the seat belt.....	330
Emergency Locking	
Retractor.....	32
How to wear your seat belt .....	30
How your child should wear	
the seat belt.....	32
Pregnant women, proper	
seat belt use .....	33
Reminder light and buzzer....	401
Seat belt extender.....	32
Seat belt pretensioners.....	31
SRS warning light .....	399
<b>Seat heaters .....</b>	<b>283</b>
<b>Seat position memory .....</b>	<b>133</b>
<b>Seat ventilators.....</b>	<b>283</b>
<b>Seating capacity .....</b>	<b>169</b>

<b>Seats.....</b>	<b>131</b>
Adjustment.....	131
Adjustment precautions .....	132
Child seats/child restraint	
system installation.....	59
Cleaning .....	329
Driving position memory .....	133
Head restraints .....	138
Power easy access	
system.....	132
Properly sitting in the seat .....	28
Seat heaters .....	283
Seat position memory.....	133
Seat ventilators.....	283
<b>Sensor</b>	
Automatic headlight	
system.....	187
Automatic high beam.....	189
Camera sensor .....	204, 206
Humidity sensor.....	282
Inside rear view mirror.....	144
Radar sensor.....	204, 205, 252
Rain-sensing windshield	
wipers.....	196
<b>Service plug .....</b>	<b>74</b>
<b>Service reminder</b>	
<b>indicators.....</b>	<b>86</b>

- Shift lever ..... 180**
  - Hybrid transmission ..... 180
  - If the shift lever  
cannot be shifted from P .... 182
- Shift lock system ..... 182**
- Side airbags ..... 37**
- Side marker lights ..... 186**
  - Light switch ..... 186
  - Replacing light bulbs ..... 387
- Side mirrors ..... 145**
  - Adjusting and folding ..... 145
  - BSM (Blind spot monitor) ..... 250
  - Linked mirror function  
when reversing ..... 146
  - Mirror position memory ..... 133
- Side turn signal lights ..... 184**
  - Replacing light bulbs ..... 387
  - Turn signal lever ..... 184
- Smart key system ..... 121**
  - Antenna location ..... 121
  - Entry functions ..... 110, 116
  - Starting the hybrid system .... 172
- Snow tires ..... 271**
- Spare tire ..... 408**
  - Inflation pressure ..... 443
  - Storage location ..... 409
- Spark plug ..... 441**
- Specifications ..... 436**
- Speedometer ..... 90**
- Sport mode ..... 259**
- Steering lock ..... 175**
  - Column lock release ..... 175
- Steering wheel ..... 141**
- Stop lights**
  - Replacing light bulbs ..... 387
- Storage feature ..... 289**
- Stuck**
  - If the vehicle becomes  
stuck ..... 433
- Sun shade**
  - Rear ..... 304
  - Roof ..... 152
- Sun visors ..... 299**

**Switches**

- BSM (Blind spot monitor)
  - switch ..... 250
- Compass switch..... 320
- Cruise control switch..... 233, 246
- “DISP” button ..... 95
- Door lock switches..... 112
- Driving mode select switch ... 259
- Driving position memory
  - switches..... 133
- Emergency flashers switch ... 392
- EV drive mode switch ..... 178
- Garage door opener
  - switches..... 307
- Ignition switch ..... 172
- LDA (Lane Departure Alert
  - with steering control)
    - switch ..... 222
- Light switch..... 186
- Moon roof switches..... 151
- Outside rear view mirror
  - switches..... 145
- PCS (Pre-Collision
  - System) switch ..... 213
- Power door lock switch..... 112
- Power switch ..... 172
- Power window switches..... 148
- Rear sunshade switch ..... 304
- Rear window and outside
  - rear view mirror defoggers
    - switch ..... 278
- Seat heater switches ..... 283
- Seat ventilator switches..... 283
- “SOS” button..... 314
- Tire pressure warning reset
  - switch ..... 358
- Trunk opener main switch .... 117
- Trunk opener switch ..... 116
- Vehicle-to-vehicle distance
  - button ..... 233
- VSC OFF switch ..... 262
- Window lock switch ..... 148
- Windshield wipers
  - and washer switch..... 193



**T**

**Tachometer** ..... 181

**Tail lights**..... 186

    Light switch ..... 186

    Replacing light bulbs..... 387

**Theft deterrent system**

    Alarm ..... 81

    Immobilizer system ..... 79

**Tire inflation pressure**..... 443

    Maintenance data ..... 443

    Warning light..... 401

**Tire information** ..... 448

    Glossary..... 455

    Size..... 451

    Tire identification number ..... 450

    Uniform Tire Quality Grading..... 453

**Tire pressure warning system**..... 357

    Function ..... 357

    Initializing ..... 357

    Installing tire pressure warning valves and transmitters..... 357

    Registering ID codes ..... 359

    Tire pressure warning reset switch ..... 358

    Warning light..... 401

**Tires**..... 356

    Chains ..... 270

    Checking..... 356

    If you have a flat tire ..... 408

    Inflation pressure ..... 443

    Information..... 448

    Replacing..... 408

    Rotating tires ..... 356

    Size..... 443

    Snow tires ..... 271

    Spare tire ..... 408

    Tire pressure warning system..... 357

    Warning light..... 401

**Tools**..... 409

**Top tether strap** ..... 66

**Total load capacity** ..... 169

**Towing**

    Dinghy towing ..... 171

    Emergency towing ..... 394

    Trailer towing ..... 170

**TOYOTA PARKING ASSIST MONITOR\***

**Toyota Safety Sense P**..... 202

    Automatic High Beam..... 189

    Dynamic radar cruise control ..... 233

    LDA (Lane Departure Alert with steering control)..... 222

    PCS (Pre-Collision System)..... 209

\*: Refer to the “NAVIGATION AND MULTIMEDIA SYSTEM OWNER’S MANUAL”.

<b>TRAC (Traction Control) .....</b>	<b>261</b>
<b>Traction battery</b>	
<b>(hybrid battery).....</b>	<b>74</b>
<b>Traction motor</b>	
<b>(electric motor).....</b>	<b>70</b>
<b>Transmission .....</b>	<b>180</b>
Driving mode select switch ...	259
Hybrid transmission .....	180
If the shift lever cannot be	
shifted from P .....	182
S mode .....	181
<b>Trip information .....</b>	<b>95</b>
<b>Trip meters .....</b>	<b>90</b>
<b>Trunk.....</b>	<b>116</b>
Internal trunk release lever ...	118
Luggage security system .....	117
Smart key system .....	116
Trunk features.....	297
Trunk grip.....	117
Trunk light.....	118
Trunk opener main switch.....	117
Trunk opener switch .....	116
Wireless remote control .....	116
<b>Trunk light</b>	
Trunk light .....	118
Wattage .....	444
<b>Turn signal lights.....</b>	<b>184</b>
Replacing light bulbs.....	382, 384
Turn signal lever .....	184
Wattage .....	444

## U

USB port\*

## V

### Vanity lights

  Vanity lights .....

    Wattage .....

**Vanity mirrors .....**

**Vehicle data recordings.....**

### Vehicle identification

  number .....

### Vehicle proximity notification

  system.....

### Vehicle Stability Control

**(VSC) .....**

### Ventilators

**(seat ventilators) .....**

### VSC

**(Vehicle Stability Control) ....**

## W

### Warning buzzers

Approach warning.....	240
Brake system.....	398
Downshifting.....	181
Seat belt reminder.....	401

### Warning lights..... 87

ABS.....	399
Brake system.....	398
Charging system.....	398
Electric power steering.....	399
Low engine oil pressure.....	398
Low fuel level.....	401
Malfunction indicator lamp.....	398
Master warning light.....	401
Open door.....	401
Parking brake indicator.....	398
Pre-collision system.....	400
Seat belt reminder light.....	401
Slip indicator.....	399
SRS.....	399
Tire pressure.....	401

### Warning messages..... 407

### Washer ..... 193

Checking.....	351
Preparing and checking before winter.....	269
Switch.....	193

### Washing and waxing..... 326

### Weight

Cargo capacity.....	169
Load limits.....	169
Weight.....	436

### Wheels

Replacing wheels.....	368
Size.....	443

### Window glasses ..... 148

### Window lock switch ..... 148

### Windows..... 148

Power windows.....	148
Rear window defogger.....	278

### Windshield wipers..... 193

Intermittent windshield wipers with interval adjuster.....	193
Rain-sensing windshield wipers.....	195

### Winter driving tips..... 269

### Wireless remote

#### control key..... 106

Battery-Saving Function.....	125
Locking/Unlocking.....	110, 116
Replacing the battery.....	373

\*: Refer to the “NAVIGATION AND MULTIMEDIA SYSTEM OWNER’S MANUAL”.

## GAS STATION INFORMATION

Auxiliary catch lever

P. 341

Trunk opener

P. 116

Fuel filler door

P. 200

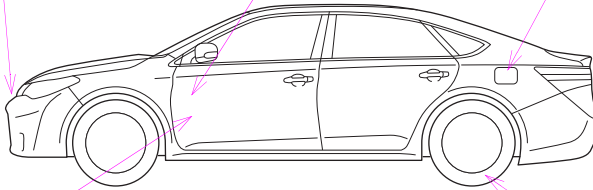

CTYPIAX043

Hood lock release  
lever

P. 341

Tire inflation  
pressure

P. 443

Fuel tank capacity (Reference)	17.0 gal. (64.35 L, 14.2 Imp. gal.)	
Fuel type	Unleaded gasoline only	P. 198, 438
Cold tire inflation pressure		P. 443
Engine oil capacity (Drain and refill — reference)		P. 439
Engine oil type		P. 439