

# **2013 Scion FR-S Quick Reference Guide**

# 2013 Scion FR-S

## INDEX

This *Quick Reference Guide* is a summary of basic vehicle operations. It contains brief descriptions of fundamental operations so you can locate and use the vehicle's main equipment quickly and easily.

The *Quick Reference Guide* is not intended as a substitute for the *Owner's Manual* located in the vehicle's glove box. We strongly encourage you to review the *Owner's Manual* and supplementary manuals so you will have a better understanding of the vehicle's capabilities and limitations.

Your dealership and the entire staff of Scion, a marque of Toyota Motor Sales, U.S.A., Inc., wish you many years of satisfied driving in your new SCION FR-S.

### A word about safe vehicle operation

This *Quick Reference Guide* is not a full description of SCION FR-S operations. Every SCION FR-S owner should review the *Owner's Manual* that accompanies this vehicle.

Pay special attention to the boxed information highlighted in color throughout the *Owner's Manual*. Each box contains safe operating instructions to help you avoid injury or equipment malfunction.

All information in this *Quick Reference Guide* is current at the time of printing. Toyota reserves the right to make changes at any time without notice.

### OVERVIEW

Engine maintenance	8
Fuel tank door release and cap	6
Hood release	8
Indicator symbols	4-5
Instrument cluster	4
Instrument panel	2-3
Keyless entry	6
Light control-instrument panel	7
Trunk release	7

### FEATURES/OPERATIONS

Air Conditioning/Heating	14
Automatic Transmission	9
AUX port/USB port	14
Bottle holder	15
Clock	13
Cruise control	11
Cup holders	15
Lights & turn signals	11
Multi-Information Display	12
Parking brake	9
Power outlets	15
Seat adjustments-Front	10
Seats-Fold down rear seats	10
Seats-Head restraints	10
Tilt steering wheel	9
Windows	13
Windshield wipers & washers	12

### SAFETY AND

### EMERGENCY FEATURES

Door locks	16
Floor mat installation	19
Seat belts	16
Spare tire & tools	17
Star Safety System™	18
Tire Pressure Monitoring (warning) System	16

# OVERVIEW

## Instrument panel

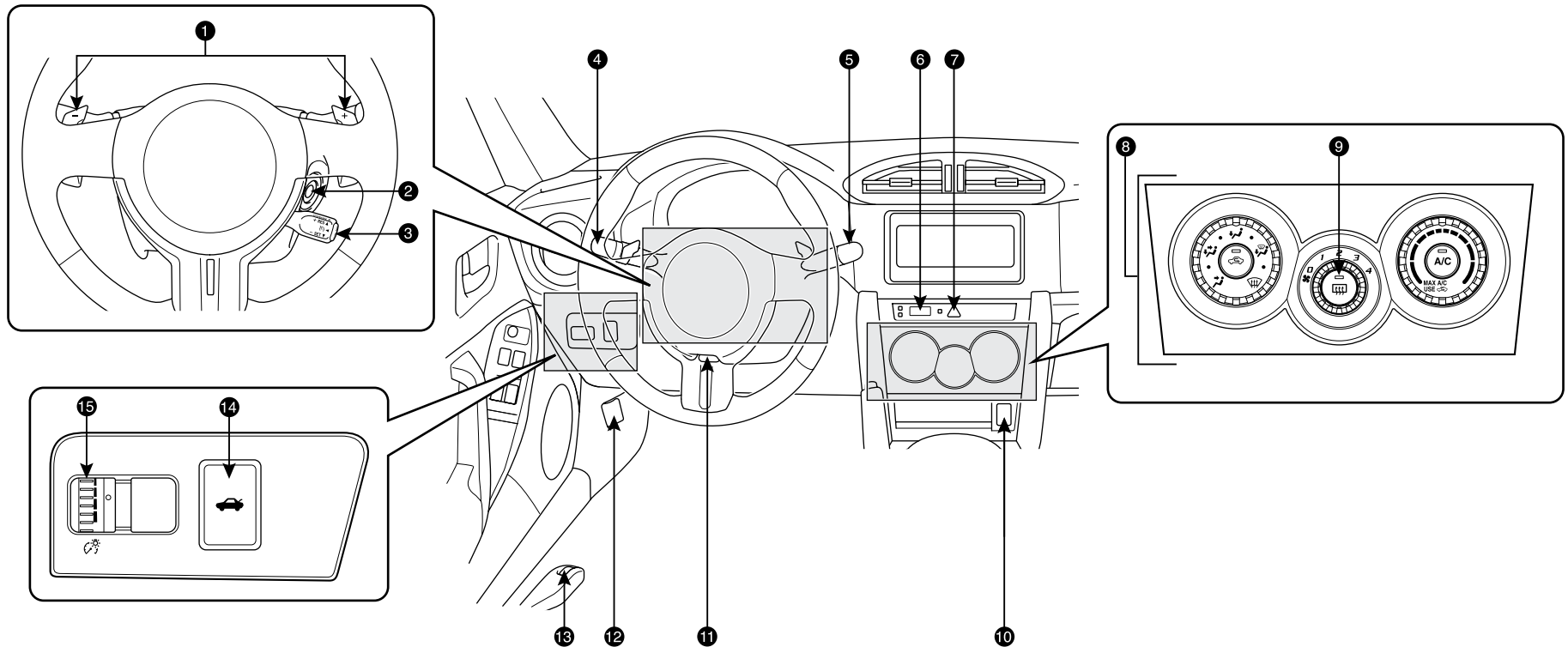

- ❶ Paddle shift switches\*
- ❷ Ignition switch
- ❸ Cruise control
- ❹ Headlight and turn signal controls
- ❺ Wiper and washer controls
- ❻ Clock
- ❼ Emergency flasher switch
- ❽ Air Conditioning controls
- ❾ Rear window defogger switch

- ❿ AUX port/USB port
- ⓫ Tilt and telescopic steering lock release
- ⓬ Hood release
- ⓭ Fuel filler door opener
- ⓮ Trunk opener
- ⓯ Instrument panel light control

\* If equipped

**Instrument cluster**

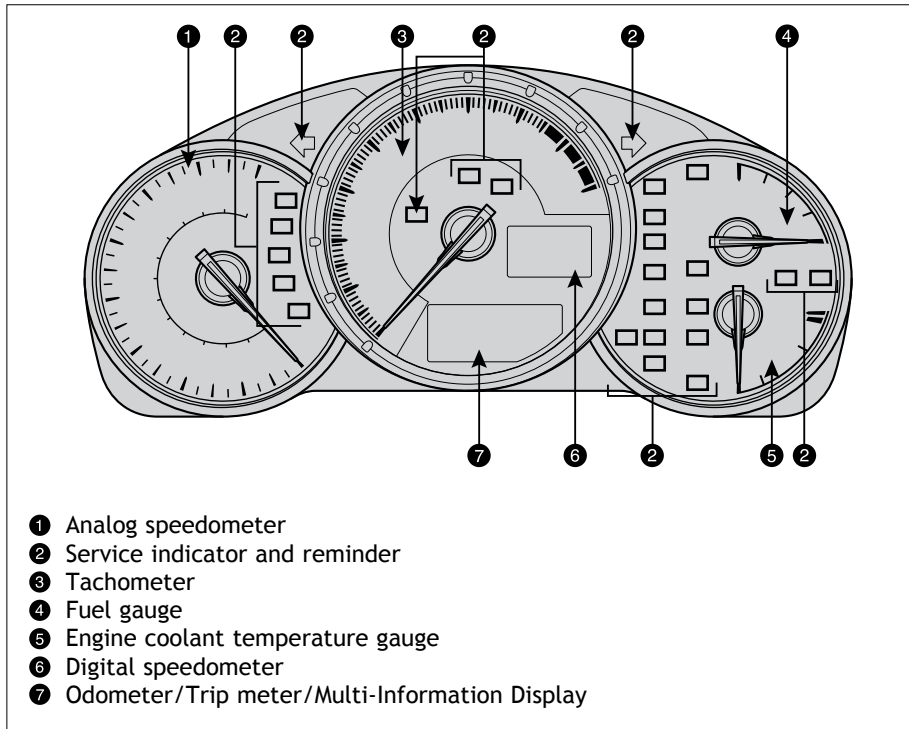

**Indicator symbols**

For details, refer to “Indicators and warning lights,” Section 2-2, 2013 Owner’s Manual.

- BRAKE Brake system warning<sup>1</sup>
- Seat belt reminder (alarm will sound if speed is over 12 mph)
- Charging system warning<sup>1</sup>
- Malfunction/Check Engine indicator<sup>1</sup>
- Low engine oil pressure warning<sup>1</sup>
- Open door warning
- AIR BAG ON and AIR BAG OFF indicator

- Airbag SRS warning<sup>1</sup>
- Low Tire Pressure Warning<sup>1</sup>
- Turn signal indicators
- Headlight high beam indicator
- Cruise control indicator<sup>2</sup>
- SET Cruise control SET indicator
- ABS Anti-lock Brake System warning<sup>1</sup>
- Electric power steering system warning<sup>1</sup>
- Slip indicator<sup>1</sup>
- Low fuel level warning<sup>1</sup>
- A/T OIL TEMP Automatic Transmission fluid temperature warning<sup>1</sup>
- VSC SPORT Vehicle Stability Control SPORT indicator<sup>1</sup>
- OFF Vehicle Stability Control OFF indicator<sup>1</sup>
- TRAC OFF Traction Control OFF indicator<sup>1</sup>
- Security indicator
- Shift position and shift range indicator
- Upshift/downshift indicator
- Shift position indicator
- Shift-up indicator
- SPORT SPORT indicator
- SNOW SNOW indicator
- REV (engine RPM) indicator

<sup>1</sup> If indicator does not turn off within a few seconds of starting engine, there may be a malfunction. Have vehicle inspected by your Scion or Toyota dealer.

<sup>2</sup> If this light come on in yellow, refer to “Cruise control” Section 2-4, 2013 Owner’s Manual.

Keyless entry

Locking operation (side door)

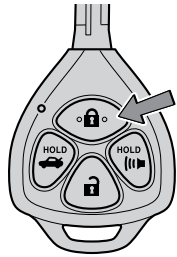

Push 

Unlocking operation (side door)

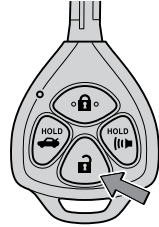

Push ONCE: Driver door   
TWICE: All doors

**NOTE:** If a door is not opened within 60 seconds of unlocking, all doors will relock for safety.

Unlocking operation (trunk)

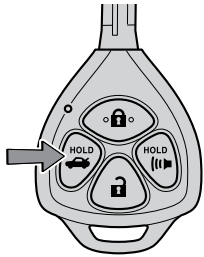

Push and hold 

Panic button

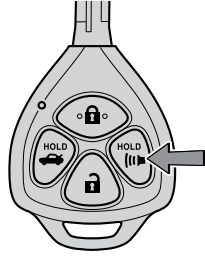

Push and hold 

Fuel tank door release and cap

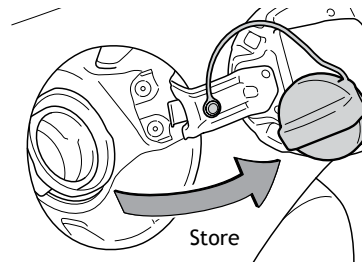
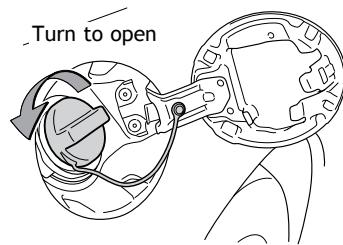
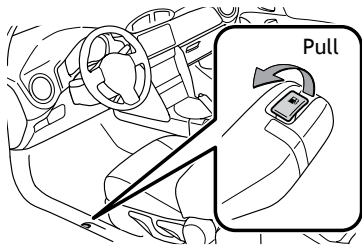

**NOTE:** Tighten until one click is heard. If the cap is not tightened enough, Check Engine "CHECK" indicator may illuminate.

Trunk release

Trunk opener

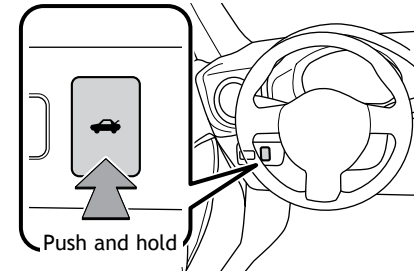

Light control-Instrument panel

Brightness control

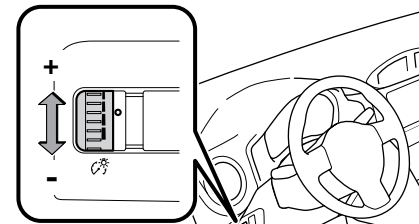

Hood release

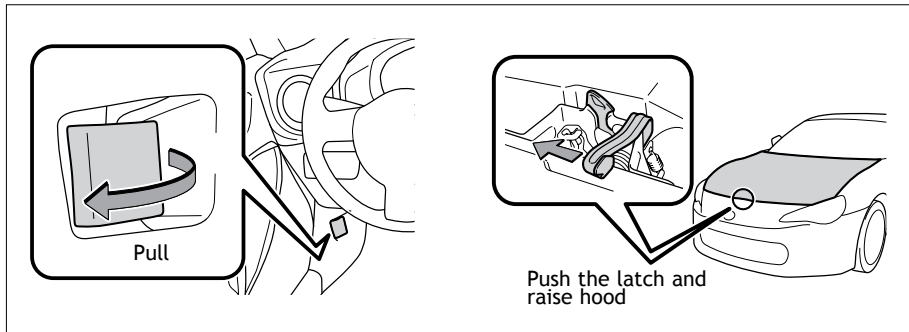

Engine maintenance

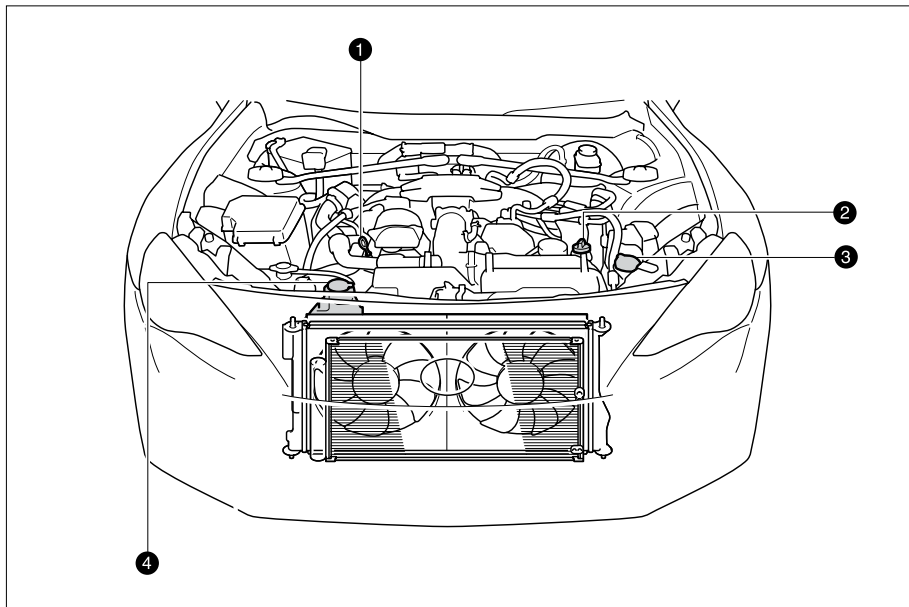

- ❶ Engine oil level dipstick
- ❷ Engine oil filler cap
- ❸ Windshield washer fluid tank
- ❹ Engine coolant reservoir

**NOTE:** Regularly scheduled maintenance, including oil changes, will help extend the life of your vehicle and maintain performance. Please refer to the “Warranty Maintenance Guide.”

Automatic Transmission (if equipped)

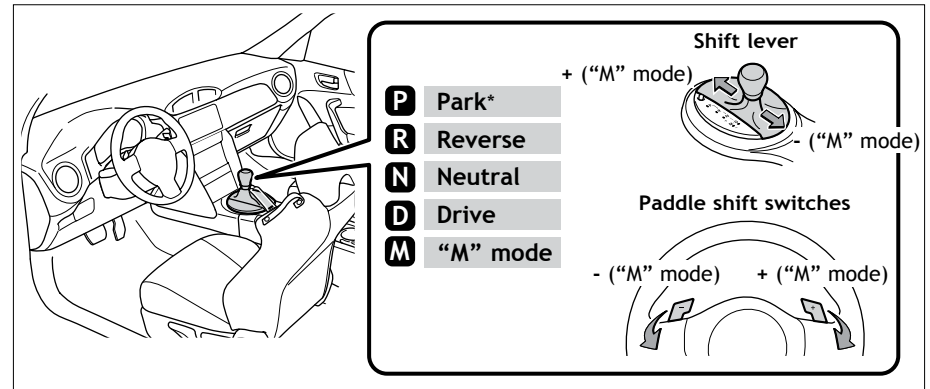

\* The ignition switch must be “ON” and the brake pedal depressed to shift from Park.

“M” (Manual) mode

Shift the shift lever to “M” position from “D” position.

- +: Upshifting
- : Downshifting

Refer to the *Owner’s Manual* for more details.

Tilt steering wheel

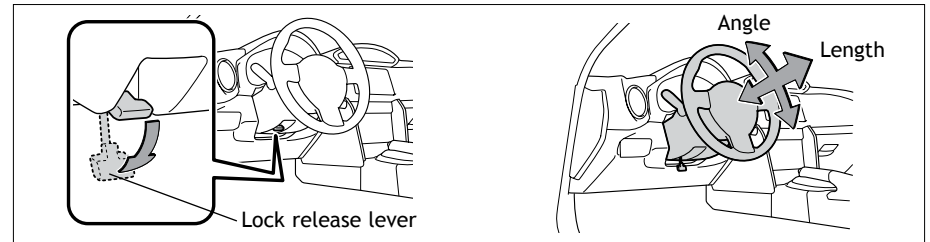

Hold wheel, push lever down, set angle and length, and return lever.

**NOTE:** Do not attempt to adjust while the vehicle is in motion.

Parking brake

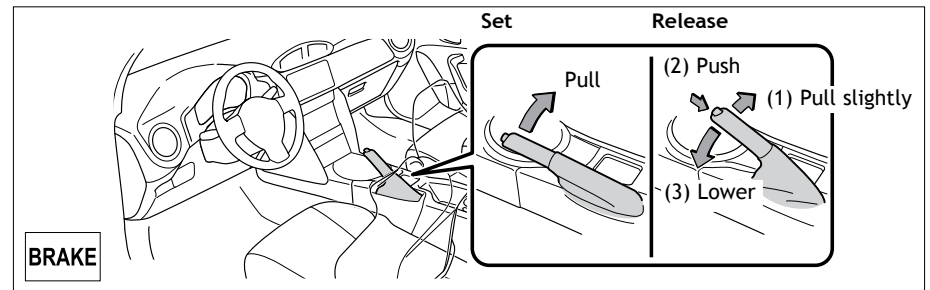

### Seat adjustments-Front

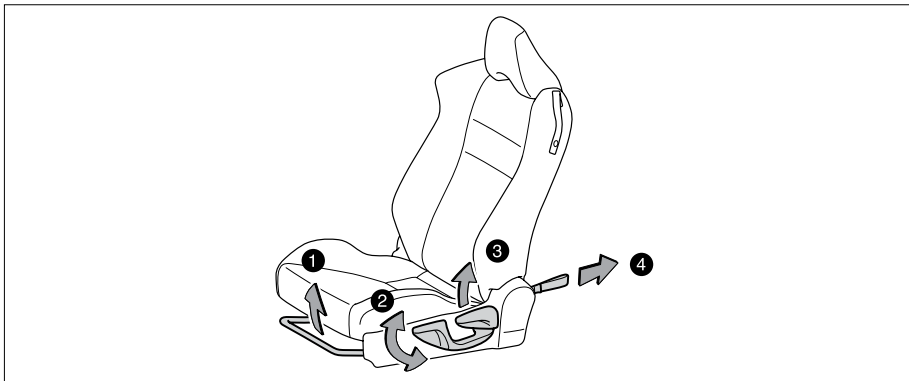

- 1 Seat position (forward/backward)
- 2 Height crank (driver side only)
- 3 Seatback angle
- 4 Seatback lock release

### Seats-Fold down rear seats

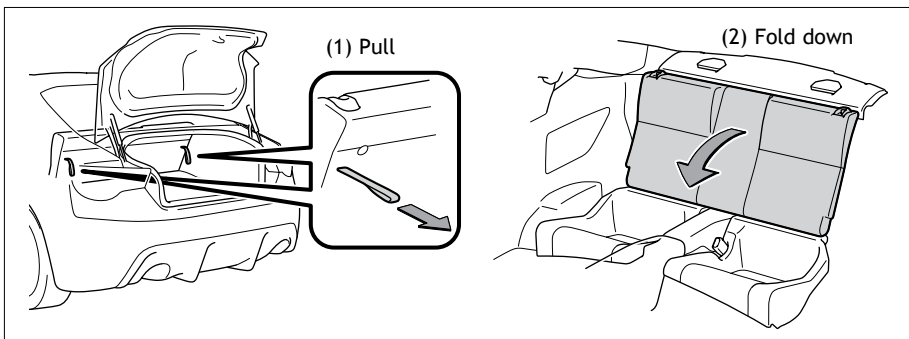

### Seats-Head restraints

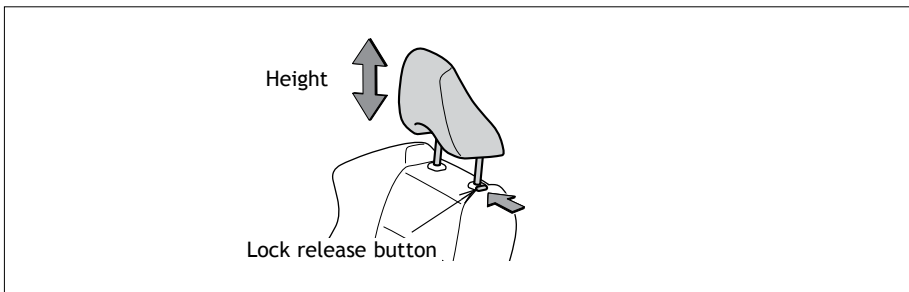

### Cruise control

#### Turning system ON/OFF

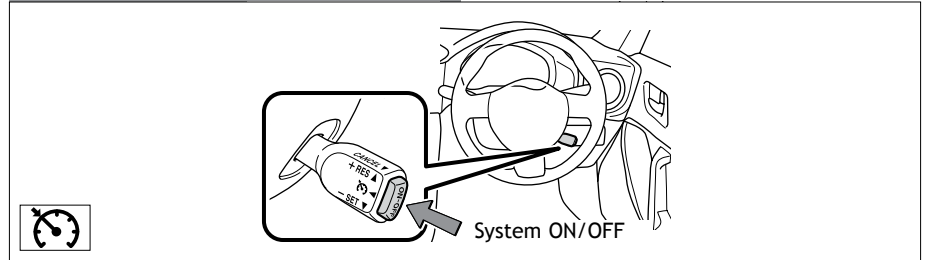

#### Functions

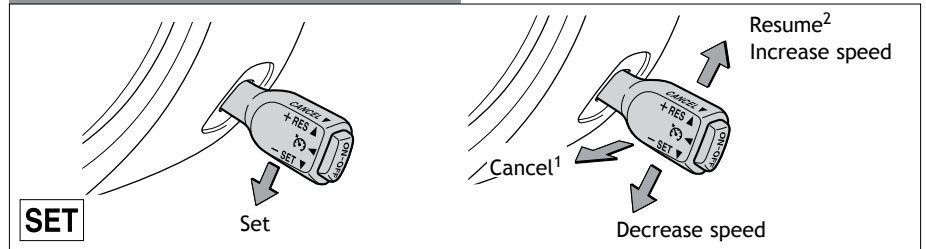

- <sup>1</sup> The set speed may also be cancelled by depressing the brake pedal.
- <sup>2</sup> The set speed may be resumed once vehicle speed exceeds 20 mph.

### Lights & turn signals

#### Headlights

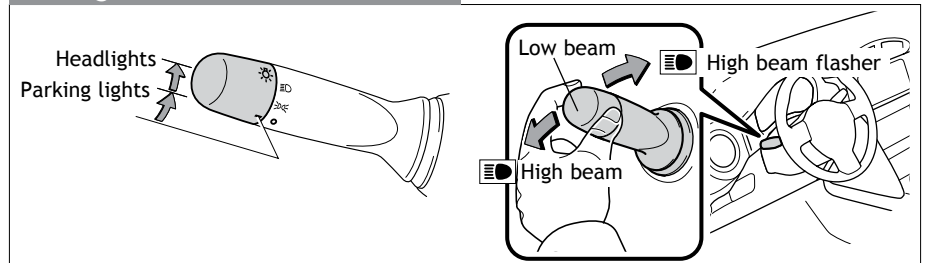

#### Turn signals

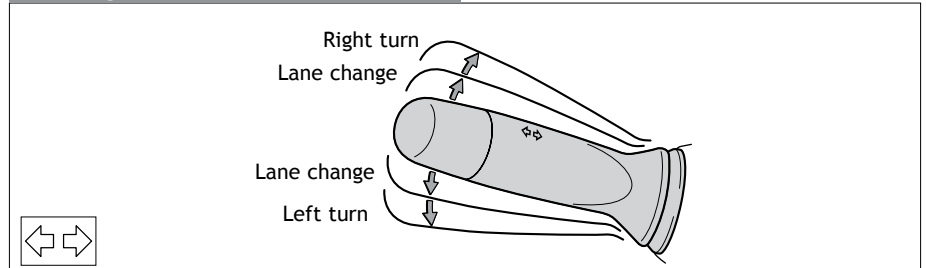

### Multi-Information Display

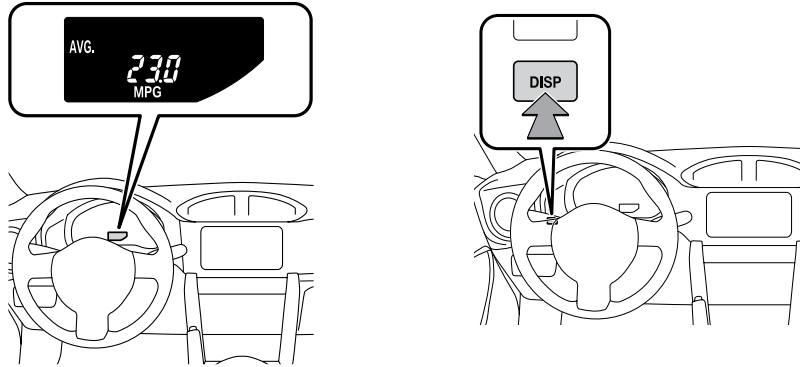

Push “DISP” to change information in the following:

- (1) Outside temperature
- (2) Current fuel consumption
- (3) Average fuel consumption
- (4) Setting screen for the REV (engine RPM) indicator

### Windshield wipers & washers

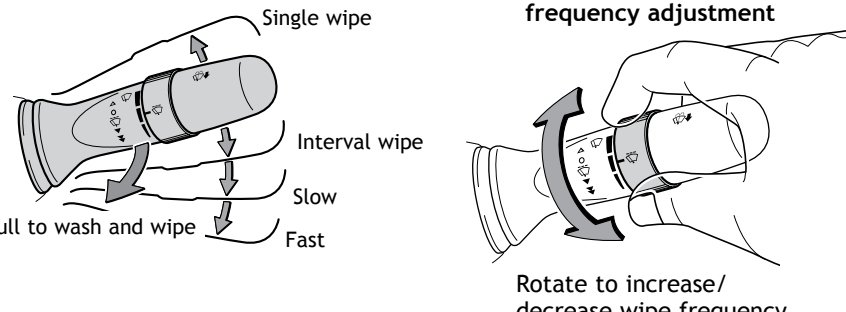

Intermittent windshield wiper frequency adjustment

Rotate to increase/ decrease wipe frequency

Pull to wash and wipe

### Windows

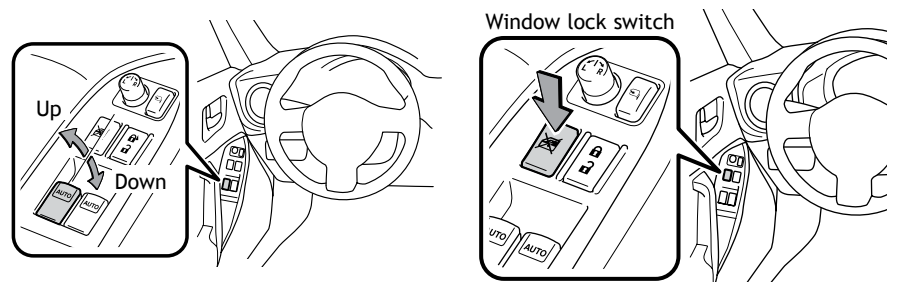

Driver door window controls

Window lock switch

**Automatic operation** Push the switch completely down or pull it completely up and release to fully open. To stop window midway, lightly push the switch in the opposite direction.

**Window lock switch** Deactivates all passenger windows. Driver’s window remains operable.

### Clock

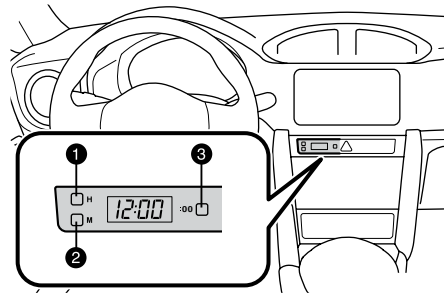

- ① Hour set
- ② Minute set
- ③ Round off minutes



### Air Conditioning/Heating

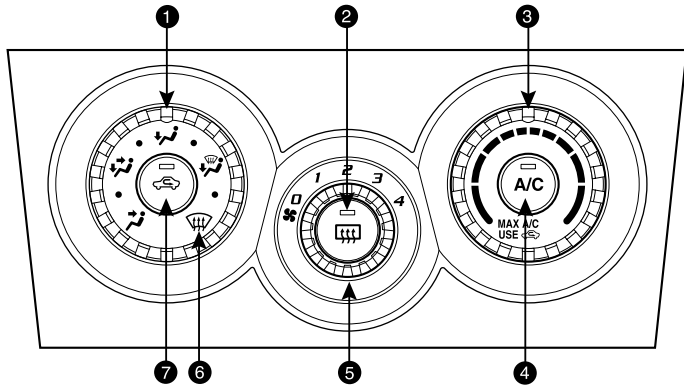

- ❶ Airflow vent  
“” and “” mode uses fresh air only
- ❷ Rear window defogger
- ❸ Temperature selector
- ❹ Air Conditioning ON/OFF
- ❺ Fan speed
- ❻ Windshield airflow
- ❼ Recirculate cabin air (fresh air when OFF)

### AUX port/USB port

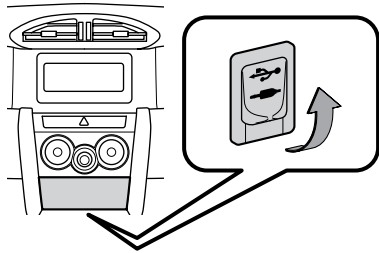

#### AUX port

By inserting a mini plug (not included) into the AUX port, you can listen to music from a portable audio device through the vehicle’s speaker system while in AUX mode.

#### USB port

By connecting a USB memory or USB-compatible portable audio device to the USB port, you can listen to music from the portable audio device or USB memory through the vehicle’s speaker system.

Refer to the *SCION Audio System Owner’s Manual* or the *SCION Navigation System Owner’s Manual* for more details.

### Power outlets

#### Console tray

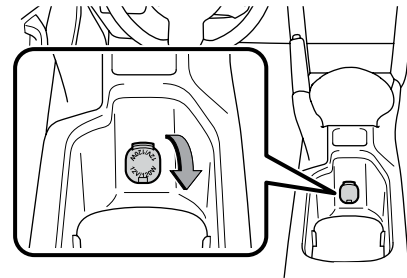

#### Glove box

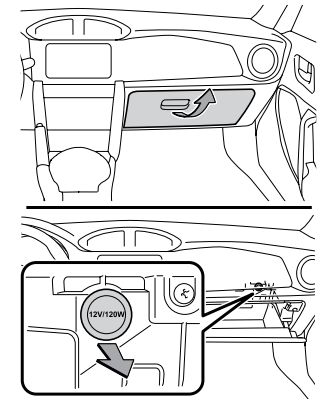

Designed for car accessories. Ignition switch must be in the “ACC” or “ON” position to be used.

### Cup holders

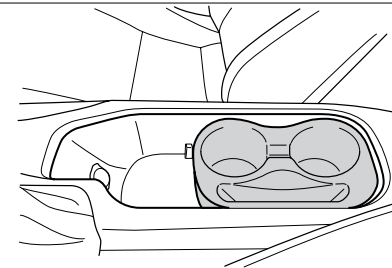

### Bottle holder

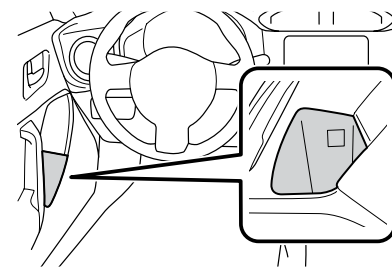

# SAFETY AND EMERGENCY FEATURES

## Door locks

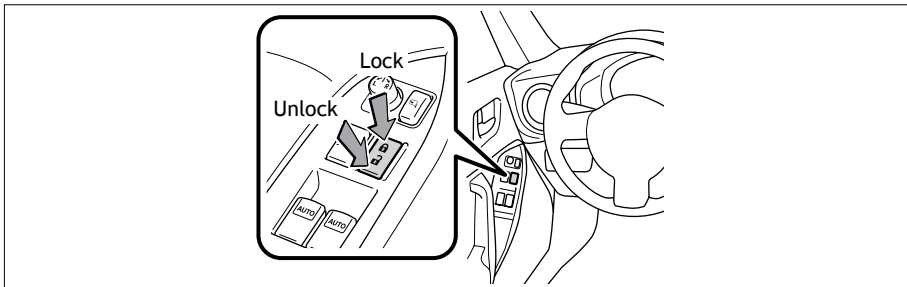

## Seat belts

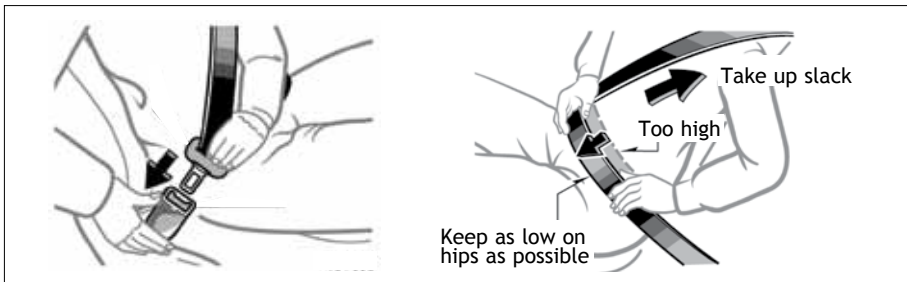

If belt is fully extended, then retracted even slightly, it cannot be re-extended beyond that point, unless fully retracted again. This feature is used to help hold child restraint systems securely.

To find more information about seat belts, and how to install a child restraint system, refer to the *Owner's Manual*.

## Tire Pressure Monitoring (warning) System

If tire pressure becomes critically low on any of the tires (excluding the spare), “” indicator will illuminate. Correctly adjusting tire inflation will turn off the light after a few minutes. If the light does not turn off, have the system checked by your Scion or Toyota dealer.

Refer to the *Owner's Manual* for more details.

## Spare tire & tools

### Tool location

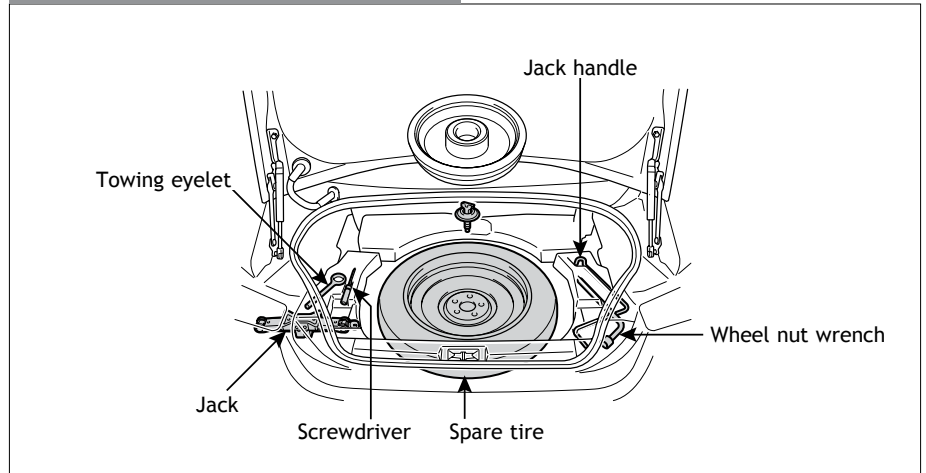

### Removing the spare tire

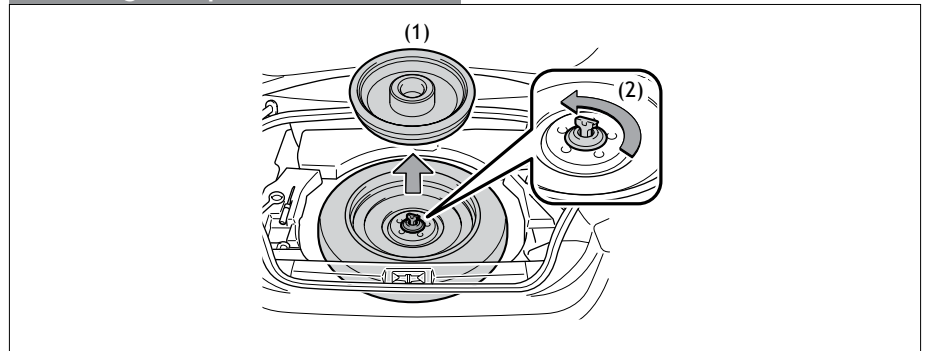

(1) Remove the spare tire cover.

(2) Loosen and remove the bolt.

Refer to the *Owner's Manual* for jack positioning and tire changing procedures.

## Star Safety System™

All new Scion vehicles come standard with the Star Safety System™, which combines Traction Control (TRAC), Electronic Brake-force Distribution (EBD), Vehicle Stability Control (VSC), Brake Assist (BA) and an Anti-lock Braking System (ABS).

### Vehicle Stability Control (VSC)

VSC helps prevent loss of traction during cornering by reducing engine power and applying brake force to selected wheels.

Toyota's VSC monitors steering angle and the direction your vehicle is traveling. When it senses that the front or rear wheels begin to lose traction, VSC reduces engine power and applies braking to selected wheels. This helps restore traction and vehicle control.

### Traction Control (TRAC)

VSC helps prevent loss of traction during cornering by reducing engine power, and Traction Control helps maintain traction on loose gravel and wet, icy, or uneven surfaces by applying brake force to the spinning wheel(s).

Toyota's TRAC sensors are activated when one of the drive wheels starts to slip. TRAC limits engine output and applies the brakes to the spinning wheel. This transfers power to the wheels that still have traction to help keep you on track.

### Brake Assist (BA)

Brake Assist is designed to detect sudden or "panic" braking, and then add braking pressure to help decrease the vehicle's stopping distance. When there's only a split second to react, Brake Assist can add additional brake pressure more quickly than just the driver alone can.

### Electronic Brake Force Distribution (EBD)

Toyota's ABS technology has Electronic Brake-force Distribution (EBD) to help maintain control and balance when braking. Abrupt stops can cause a vehicle to tilt forward, reducing the braking power of the rear wheels. EBD responds to sudden stops by redistributing brake force to enhance the braking effectiveness of all four wheels.

### Anti-Lock Brake System (ABS)

ABS helps prevent brakes from locking up by "pulsing" brake pressure to each wheel. This limits brake lockup and helps provide directional control for the current road conditions.

Toyota's ABS sensors detect which wheels are locking up and limits wheel lockup by "pulsing" each wheel's brakes independently. Pulsing releases brake pressure repeatedly for fractions of a second. This helps the tires attain the traction that current road conditions will allow, helping you to stay in directional control.

### Smart Stop Technology (SST)

Smart Stop Technology automatically reduces engine power when the accelerator and brake pedals are pressed simultaneously under certain conditions.

SST engages when the accelerator is depressed first and the brakes are applied firmly for longer than one-half second at speeds greater than five miles per hour.

SST doesn't engage if the brake pedal is depressed before the accelerator pedal, allowing vehicles to start on a steep hill and safely accelerate without rolling backward.

## Floor mat installation

Each vehicle has model-specific floor mats. Installation is easy.

To keep your floor mat properly positioned, follow these steps:

- Only use floor mats designed for your specific model.
- Use only one floor mat at a time, using the retaining hooks to keep the mat in place.
- Install floor mats right side up.

