

<b>Pictorial index</b>	Search by illustration
<b>1 For safety and security</b>	Make sure to read through them
<b>2 Instrument cluster</b>	How to read the gauges and meters, the variety of warning lights and indicators, etc.
<b>3 Operation of each component</b>	Opening and closing the doors and windows, adjustment before driving, etc.
<b>4 Driving</b>	Operations and advice which are necessary for driving
<b>5 Lexus Display Audio system</b>	Operating the Lexus Display Audio system
<b>6 Interior features</b>	Usage of the interior features, etc.
<b>7 Maintenance and care</b>	Caring for your vehicle and maintenance procedures
<b>8 When trouble arises</b>	What to do in case of malfunction or emergency
<b>9 Vehicle specifications</b>	Vehicle specifications, customizable features, etc.
<b>10 For owners</b>	Reporting safety defects for U.S. owners, and seat belt, SRS airbag and headlight aim instructions for Canadian owners
<b>Index</b>	Search by symptom
	Search alphabetically

## 2 TABLE OF CONTENTS

---

For your information.....	8
Reading this manual.....	12
How to search.....	13
Pictorial index.....	14

### 1 For safety and security

<b>1-1. For safe use</b>	
Before driving .....	28
For safe driving .....	30
Seat belts .....	32
SRS airbags .....	36
Front passenger occupant classification system .....	47
Exhaust gas precautions.....	53
<b>1-2. Child safety</b>	
Riding with children .....	54
Child restraint systems .....	55
<b>1-3. Theft deterrent system</b>	
Engine immobilizer system.....	74
Alarm .....	77

### 2 Instrument cluster

<b>2. Instrument cluster</b>	
Warning lights and indicators.....	80
Gauges and meters .....	86
Multi-information display .....	90
Head-up display .....	108
Fuel consumption information .....	114

### 3 Operation of each component

<b>3-1. Key information</b>	
Keys.....	120
<b>3-2. Opening, closing and locking the doors</b>	
Side doors.....	124
Power back door .....	130
Smart access system with push-button start.....	146
<b>3-3. Adjusting the seats</b>	
Front seats .....	156
Rear seats .....	157
Driving position memory.....	172
Head restraints .....	177
<b>3-4. Adjusting the steering wheel and mirrors</b>	
Steering wheel.....	180
Inside rear view mirror .....	182
Outside rear view mirrors .....	184
<b>3-5. Opening, closing the windows and moon roof</b>	
Power windows .....	187
Moon roof.....	191
Panoramic moon roof.....	195

## 4 Driving

### 4-1. Before driving

Driving the vehicle .....	202
Cargo and luggage .....	210
Vehicle load limits .....	213
Trailer towing (vehicles with towing package).....	215
Trailer towing (vehicles without towing package).....	229
Dinghy towing.....	230

### 4-2. Driving procedures

Engine (ignition) switch.....	231
Automatic transmission (vehicles without paddle shift switches) .....	236
Automatic transmission (vehicles with paddle shift switches) .....	240
Turn signal lever .....	246
Parking brake.....	247
Brake Hold .....	250

### 4-3. Operating the lights and wipers

Headlight switch .....	252
Automatic High Beam.....	256
Fog light switch .....	260
Windshield wipers and washer .....	261
Rear window wiper and washer .....	267

### 4-4. Refueling

Opening the fuel tank cap .....	269
------------------------------------	-----

### 4-5. Using the driving support systems

Lexus Safety System+ .....	274
PCS (Pre-Collision System).....	281
LKA (Lane-Keeping Assist).....	291
Dynamic radar cruise control with full-speed range.....	300
BSM (Blind Spot Monitor).....	313
• BSM function.....	317
• RCTA function.....	321
Intuitive parking assist.....	326
Intelligent Clearance Sonar (ICS).....	336
Lexus parking assist monitor.....	357
Driving mode select switch.....	373
All-wheel drive lock switch.....	377
Driving assist systems .....	378

### 4-6. Driving tips

Winter driving tips.....	384
Utility vehicle precautions .....	388

**5** **Lexus Display Audio system**

**5-1. Basic Operations**  
 Lexus Display Audio system..... 394  
 Steering wheel audio switches ..... 400  
 Mobile Assistant ..... 401  
 USB/AUX ports..... 403

**5-2. Setup**  
 Setup menu ..... 406  
 General settings..... 407  
 Voice settings..... 410  
 Display settings..... 411

**5-3. Using the audio system**  
 Selecting the audio source..... 412  
 Optimal use of the audio system..... 413  
 Audio settings ..... 414  
 Audio menu screen operation..... 417

**5-4. Using the radio**  
 Radio operation..... 420

**5-5. Playing an audio CD and MP3/WMA/AAC discs**  
 CD player operation..... 427

**5-6. Using an external device**  
 Listening to an iPod ..... 434  
 Using USB memory device ..... 438  
 Using the AUX port..... 442

**5-7. Connecting Bluetooth®**  
 Steps for using Bluetooth® devices ..... 443  
 Registering a Bluetooth® device ..... 445  
 Selecting a Bluetooth® device ..... 446  
 Connecting a Bluetooth® audio player ..... 447  
 Connecting a Bluetooth® phone..... 448  
 Displaying a Bluetooth® device details..... 449  
 Detailed Bluetooth® settings ..... 450

**5-8. Bluetooth® Audio**  
 Listening to Bluetooth® Audio ..... 453

**5-9. Bluetooth® Phone**  
 Using a Bluetooth® Phone..... 455  
 Making a call..... 457  
 Receiving a call..... 460  
 Speaking on the phone ..... 461  
 Using a Bluetooth® phone message..... 463  
 Using the steering wheel switches ..... 465  
 Bluetooth® phone settings ..... 466

**5-10. Phonebook**  
 Contact settings ..... 468  
 Messaging setting ..... 471

**5-11. Bluetooth®**

- What to do if...  
(Troubleshooting).....472
- Bluetooth® ..... 476

**5-12. Other function**

- “Information” screen .....482
- USB photo .....484
- Weather information.....486
- Voice command system .....487

**6 Interior features****6-1. Basic operation of the Remote Touch screen**

- Remote Touch .....496
- 12.3-inch display .....500

**6-2. Using the air conditioning system and defogger**

- Lexus Climate Concierge .....502
- Front automatic air conditioning system.....503
- Rear automatic air conditioning system.....518
- Heated steering wheel/ seat heaters/ seat ventilators .....521

**6-3. Using the interior lights**

- Interior lights list .....524
  - Interior lights.....525
  - Personal lights.....526

**6-4. Using the storage features**

- List of storage features .....528
  - Glove box.....530
  - Console box .....530
  - Cup holders .....531
  - Door pockets .....533
  - Bottle holders .....533
  - Coin box.....534
  - Auxiliary boxes .....535
- Luggage compartment features .....536

**6-5. Using the other interior features**

- Other interior features .....543
  - Sun visors .....543
  - Vanity mirrors .....543
  - Clock .....544
  - Wireless charger .....544
  - Power outlets .....551
  - USB charging ports.....553
  - Front passenger footwell hooks.....554
  - Rear door sunshades .....554
  - Armrest.....555
  - Assist grips .....556
  - Coat hooks.....556
- Garage door opener .....557
- Compass .....564
- LEXUS Enform Safety Connect.....568
- LEXUS Enform Remote.....573
- LEXUS Enform Service Connect.....574

**7 Maintenance and care**

**7-1. Maintenance and care**  
 Cleaning and protecting  
 the vehicle exterior ..... 576  
 Cleaning and protecting  
 the vehicle interior ..... 581

**7-2. Maintenance**  
 Maintenance  
 requirements ..... 584  
 General maintenance ..... 586  
 Emission inspection and  
 maintenance (I/M)  
 programs ..... 589

**7-3. Do-it-yourself  
 maintenance**  
 Do-it-yourself service  
 precautions ..... 590  
 Hood ..... 592  
 Positioning a floor jack ..... 593  
 Engine compartment ..... 594  
 Tires ..... 604  
 Tire inflation pressure ..... 613  
 Wheels ..... 616  
 Air conditioning filter ..... 618  
 Windshield wiper inserts ..... 621  
 Electronic key battery ..... 623  
 Checking and replacing  
 fuses ..... 625  
 Headlight aim ..... 628  
 Light bulbs ..... 630

**8 When trouble arises**

**8-1. Essential information**  
 Emergency flashers ..... 644  
 If your vehicle has  
 to be stopped in  
 an emergency ..... 645

**8-2. Steps to take in  
 an emergency**  
 If your vehicle needs  
 to be towed ..... 646  
 If you think something is  
 wrong ..... 652  
 Fuel pump shut off system ..... 653  
 If a warning light turns  
 on or a warning buzzer  
 sounds ..... 654  
 If a warning message is  
 displayed ..... 661  
 If you have a flat tire ..... 666  
 If the engine will not start ..... 682  
 If the electronic key does  
 not operate properly ..... 684  
 If the vehicle battery is  
 discharged ..... 687  
 If your vehicle overheats ..... 692  
 If the vehicle becomes  
 stuck ..... 695

## 9 Vehicle specifications

### 9-1. Specifications

Maintenance data (fuel, oil level, etc.) .....	698
Fuel information .....	706
Tire information .....	709

### 9-2. Customization

Customizable features .....	722
-----------------------------	-----

### 9-3. Initialization

Items to initialize .....	735
---------------------------	-----

## 10 For owners

Reporting safety defects for U.S. owners .....	738
Seat belt instructions for Canadian owners (in French) .....	739
SRS airbag instructions for Canadian owners (in French) .....	740
Headlight aim instructions for Canadian owners (in French) .....	748

## Index

What to do if... (Troubleshooting) .....	752
Alphabetical index .....	756

1

2

3

4

5

6

7

8

9

10

For vehicles with a navigation system, refer to the “NAVIGATION SYSTEM OWNER’S MANUAL” for information regarding the equipment listed below.

- Navigation system
- Audio/visual system
- Rear seat entertainment system
- Panoramic view monitor
- Lexus Enform

## For your information

### Main Owner's Manual

Please note that this manual applies to all models and explains all equipment, including options. Therefore, you may find some explanations for equipment not installed on your vehicle.

All specifications provided in this manual are current at the time of printing. However, because of the Lexus policy of continual product improvement, we reserve the right to make changes at any time without notice.

Depending on specifications, the vehicle shown in the illustrations may differ from your vehicle in terms of color and equipment.

### Noise from under vehicle after turning off the engine

Approximately five hours after the engine is turned off, you may hear sound coming from under the vehicle for several minutes. This is the sound of a fuel evaporation leakage check and, it does not indicate a malfunction.

### Accessories, spare parts and modification of your Lexus

A wide variety of non-genuine spare parts and accessories for Lexus vehicles are currently available in the market. You should know that Toyota does not warrant these products and is not responsible for their performance, repair, or replacement, or for any damage they may cause to, or adverse effect they may have on, your Lexus vehicle.

This vehicle should not be modified with non-genuine Lexus products. Modification with non-genuine Lexus products could affect its performance, safety or durability, and may even violate governmental regulations. In addition, damage or performance problems resulting from the modification may not be covered under warranty.

### Installation of a mobile two-way radio system

The installation of a mobile two-way radio system in your vehicle could affect electronic systems such as:

- Multiport fuel injection system/sequential multiport fuel injection system
- Lexus Safety System+
- Anti-lock brake system
- Vehicle dynamics integrated management
- SRS airbag system
- Seat belt pretensioner system

Be sure to check with your Lexus dealer for precautionary measures or special instructions regarding installation of a mobile two-way radio system.



## Vehicle data recordings

Your Lexus is equipped with several sophisticated computers that will record certain data, such as:

- Engine speed
- Accelerator status
- Brake status
- Vehicle speed
- Shift position

The recorded data varies according to the vehicle grade level and options with which it is equipped. These computers do not record conversations or sounds, and only record images outside of the vehicle in certain situations.

### ● Data Transmission

Your vehicle may transmit the data recorded in these computers to Lexus without notification to you.

### ● Data usage

Lexus may use the data recorded in these computers to diagnose malfunctions, conduct research and development, and improve quality.

Lexus will not disclose the recorded data to a third party except:

- With the consent of the vehicle owner or with the consent of the lessee if the vehicle is leased
- In response to an official request by the police, a court of law or a government agency
- For use by Lexus in a lawsuit
- For research purposes where the data is not tied to a specific vehicle or vehicle owner

### ● Usage of data collected through Lexus Enform (U.S. mainland only)

If your Lexus has Lexus Enform and if you have subscribed to those services, please refer to the Lexus Enform Telematics Subscription Service Agreement for information on data collected and its usage.

- To learn more about the vehicle data collected, used and shared by Lexus, please visit [www.lexus.com/privacyvts/](http://www.lexus.com/privacyvts/).

## Event data recorder

This vehicle is equipped with an event data recorder (EDR). The main purpose of an EDR is to record, in certain crash or near crash-like situations, such as an air bag deployment or hitting a road obstacle, data that will assist in understanding how a vehicle's systems performed. The EDR is designed to record data related to vehicle dynamics and safety systems for a short period of time, typically 30 seconds or less.

The EDR in this vehicle is designed to record such data as:

- How various systems in your vehicle were operating;
- Whether or not the driver and passenger safety belts were buckled/fastened;
- How far (if at all) the driver was depressing the accelerator and/or brake pedal; and,
- How fast the vehicle was traveling.

These data can help provide a better understanding of the circumstances in which crashes and injuries occur.

NOTE: EDR data are recorded by your vehicle only if a non-trivial crash situation occurs; no data are recorded by the EDR under normal driving conditions and no personal data (e.g., name, gender, age, and crash location) are recorded. However, other parties, such as law enforcement, could combine the EDR data with the type of personally identifying data routinely acquired during a crash investigation.

To read data recorded by an EDR, special equipment is required, and access to the vehicle or the EDR is needed. In addition to the vehicle manufacturer, other parties, such as law enforcement, that have the special equipment, can read the information if they have access to the vehicle or the EDR.

### ● Disclosure of the EDR data

Lexus will not disclose the data recorded in an EDR to a third party except when:

- An agreement from the vehicle's owner (or the lessee for a leased vehicle) is obtained
- In response to an official request by the police, a court of law or a government agency
- For use by Lexus in a lawsuit

However, if necessary, Lexus may:

- Use the data for research on vehicle safety performance
- Disclose the data to a third party for research purposes without disclosing information about the specific vehicle or vehicle owner

## Scrapping of your Lexus

The SRS airbag and seat belt pretensioner devices in your Lexus contain explosive chemicals. If the vehicle is scrapped with the airbags and seat belt pretensioners left as they are, this may cause an accident such as fire. Be sure to have the systems of the SRS airbag and seat belt pretensioner removed and disposed of by a qualified service shop or by your Lexus dealer before you scrap your vehicle.

## Perchlorate Material

Special handling may apply, See [www.dtsc.ca.gov/hazardouswaste/perchlorate](http://www.dtsc.ca.gov/hazardouswaste/perchlorate).

Your vehicle has components that may contain perchlorate. These components may include airbag, seat belt pretensioners, and wireless remote control batteries.

### WARNING

#### ■ General precautions while driving

**Driving under the influence:** Never drive your vehicle when under the influence of alcohol or drugs that have impaired your ability to operate your vehicle. Alcohol and certain drugs delay reaction time, impair judgment and reduce coordination, which could lead to an accident that could result in death or serious injury.

**Defensive driving:** Always drive defensively. Anticipate mistakes that other drivers or pedestrians might make and be ready to avoid accidents.

**Driver distraction:** Always give your full attention to driving. Anything that distracts the driver, such as adjusting controls, talking on a cellular phone or reading can result in a collision with resulting death or serious injury to you, your occupants or others.

#### ■ General precaution regarding children's safety

Never leave children unattended in the vehicle, and never allow children to have or use the key.

Children may be able to start the vehicle or shift the vehicle into neutral. There is also a danger that children may injure themselves by playing with the windows, the moon roof or panoramic moon roof, or other features of the vehicle. In addition, heat build-up or extremely cold temperatures inside the vehicle can be fatal to children.

## Reading this manual

 **WARNING:**  
Explains something that, if not obeyed, could cause death or serious injury to people.

 **NOTICE:**  
Explains something that, if not obeyed, could cause damage to or a malfunction in the vehicle or its equipment.

**1 2 3**... Indicates operating or working procedures. Follow the steps in numerical order.

 Indicates the action (pushing, turning, etc.) used to operate switches and other devices.

 Indicates the outcome of an operation (e.g. a lid opens).

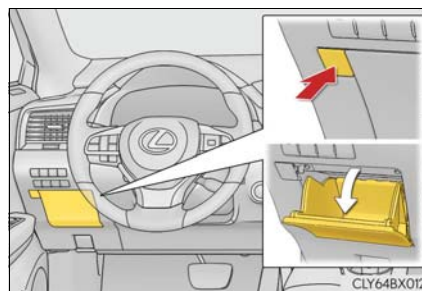

 Indicates the component or position being explained.

 Means "Do not", "Do not do this", or "Do not let this happen".

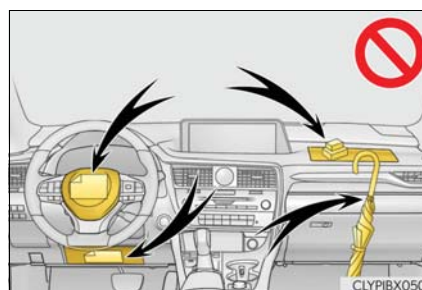

## How to search

### ■ Searching by name

- Alphabetical index.....P. 756

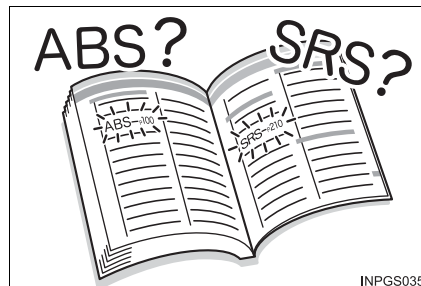

### ■ Searching by installation position

- Pictorial index..... P. 14

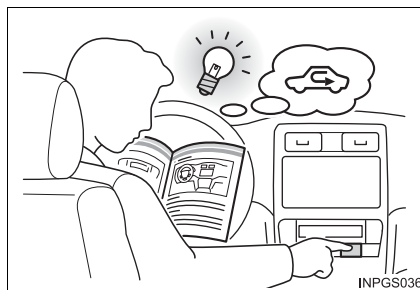

### ■ Searching by symptom or sound

- What to do if...  
(Troubleshooting).....P. 752



### ■ Searching by title

- Table of contents.....P. 2

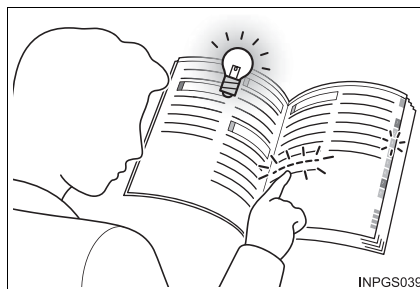

## Pictorial index

### Exterior

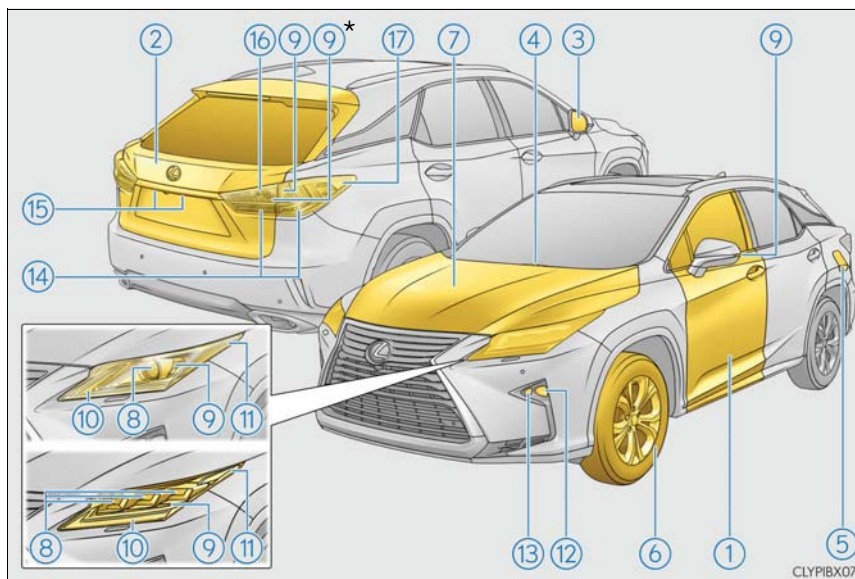

The shape of the lights may differ depending on the grade, etc.

- ① **Side doors** ..... P. 124
  - Locking/unlocking ..... P. 124
  - Opening/closing the side windows ..... P. 187
  - Locking/unlocking by using the mechanical key ..... P. 684
- ② **Back door** ..... P. 130
  - Opening from inside the cabin ..... P. 131
  - Opening from outside ..... P. 131
- ③ **Outside rear view mirrors** ..... P. 184
  - Adjusting the mirror angle ..... P. 184
  - Folding the mirrors ..... P. 184, 185
  - Driving position memory\* ..... P. 172
  - Defogging the mirrors ..... P. 513

④	<b>Windshield wipers</b> .....	<b>P. 261</b>
	Precautions for winter season.....	P. 384
	To prevent freezing (windshield wiper de-icer)* .....	P. 513
	Precautions against car wash .....	P. 578
⑤	<b>Fuel filler door</b> .....	<b>P. 269</b>
	Refueling method.....	P. 271
	Fuel type/fuel tank capacity.....	P. 700
⑥	<b>Tires</b> .....	<b>P. 604</b>
	Tire size/inflation pressure.....	P. 704
	Winter tires/tire chain .....	P. 384
	Checking/rotation/tire pressure warning system .....	P. 604
	Coping with flat tires.....	P. 666
⑦	<b>Hood</b> .....	<b>P. 592</b>
	Opening.....	P. 592
	Engine oil.....	P. 700
	Coping with overheat.....	P. 692

**Light bulbs of the exterior lights for driving**  
(Replacing method: P. 630, Watts: P. 705)

⑧	<b>Headlights</b> .....	<b>P. 252</b>
⑨	<b>Turn signal lights</b> .....	<b>P. 246</b>
⑩	<b>Parking lights/daytime running lights</b> .....	<b>P. 252</b>
⑪	<b>Front side marker lights</b> .....	<b>P. 252</b>
⑫	<b>Fog lights</b> .....	<b>P. 260</b>
⑬	<b>Cornering lights*</b> .....	<b>P. 253</b>
⑭	<b>Stop/tail lights</b> .....	<b>P. 252</b>
⑮	<b>License plate lights</b> .....	<b>P. 252</b>
⑯	<b>Back-up lights</b>	
	Shifting the shift lever to R .....	P. 240
⑰	<b>Rear side marker lights</b> .....	<b>P. 252</b>

\*: If equipped

■ Instrument panel

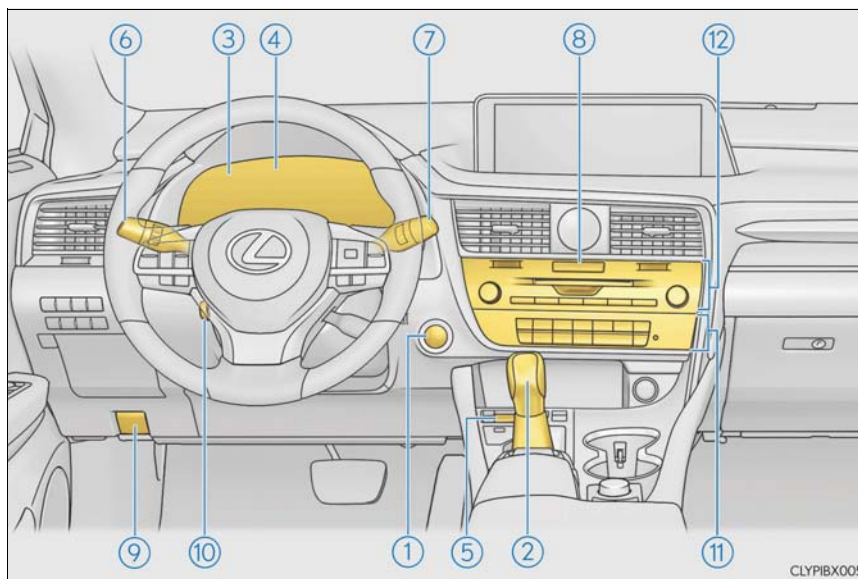

- ① **Engine switch** ..... P. 231
  - Starting the engine/changing the modes..... P. 231
  - Emergency stop of the engine ..... P. 645
  - When the engine will not start ..... P. 682
- ② **Shift lever** ..... P. 240
  - Changing the shift position..... P. 240
  - Precautions for towing..... P. 646
  - When the shift lever does not move.....P. 239, 244
- ③ **Meters** ..... P. 86
  - Reading the meters/adjusting the instrument panel light ..... P. 86, 88
  - Warning lights/indicator lights.....P. 80
  - When a warning light comes on..... P. 654



④	<b>Multi-information display</b> .....	<b>P. 90</b>
	Display .....	P. 90
	When the warning messages are displayed .....	P. 661
⑤	<b>Parking brake switch</b> .....	<b>P. 247</b>
	Applying/releasing .....	P. 247, 248
	Precautions for winter season .....	P. 385
	Warning buzzer/message .....	P. 249, 661
⑥	<b>Turn signal lever</b> .....	<b>P. 246</b>
	<b>Headlight switch</b> .....	<b>P. 252</b>
	Headlights/side marker lights/parking lights/tail lights/ license plate lights/daytime running lights .....	P. 252
	Fog lights .....	P. 260
⑦	<b>Windshield wiper and washer switch</b> .....	<b>P. 261, 267</b>
	Usage .....	P. 261, 267
	Adding washer fluid .....	P. 603
⑧	<b>Emergency flasher switch</b> .....	<b>P. 644</b>
⑨	<b>Hood lock release lever</b> .....	<b>P. 592</b>
⑩	<b>Tilt and telescopic steering control switch</b> .....	<b>P. 180</b>
	Adjustment .....	P. 180
	Driving position memory *1 .....	P. 172
⑪	<b>Air conditioning system</b> .....	<b>P. 503</b>
	Usage .....	P. 503
	Rear window defogger .....	P. 513
⑫	<b>Audio system</b> *2	
	Audio system .....	P. 394
	Hands-free system .....	P. 455

\*1: If equipped

\*2: For vehicles with a navigation system, refer to "NAVIGATION SYSTEM OWNER'S MANUAL".

■ Switches

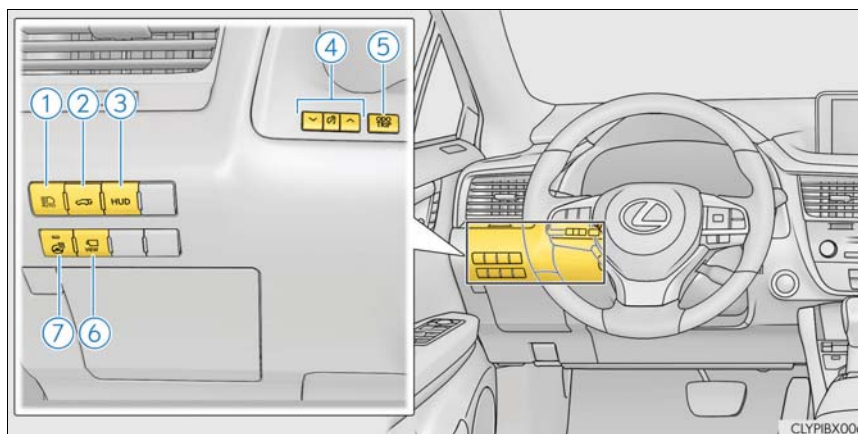

- ① Automatic High Beam switch .....P. 256
- ② Power back door switch.....P. 131
- ③ HUD (Head-up display) switch\*<sup>1</sup> ..... P. 108
- ④ Instrument panel light control switches..... P. 88
- ⑤ "ODO/TRIP" switch ..... P. 93
- ⑥ Camera switch \*<sup>1,2</sup>
- ⑦ Heated steering wheel switch \*<sup>1</sup> .....P. 522

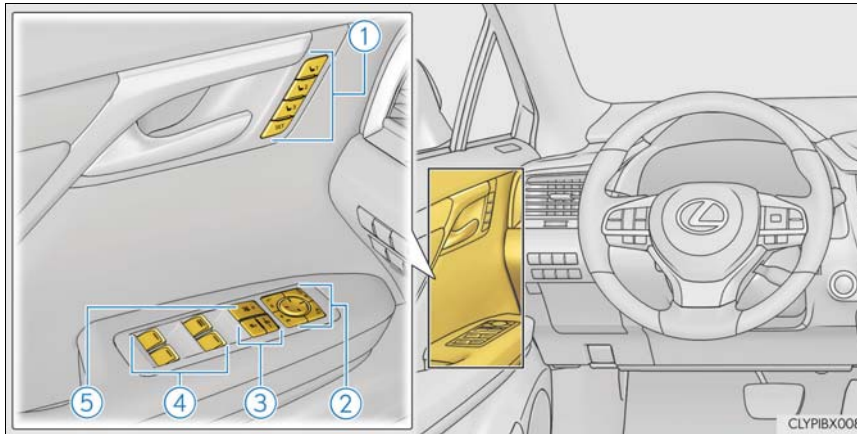

- ① Driving position memory switches <sup>\*1</sup> ..... P. 172
- ② Outside rear view mirror switches ..... P. 184
- ③ Door lock switches ..... P. 126
- ④ Power window switches ..... P. 187
- ⑤ Window lock switch ..... P. 187

<sup>\*1</sup>: If equipped

<sup>\*2</sup>: Refer to "NAVIGATION SYSTEM OWNER'S MANUAL".

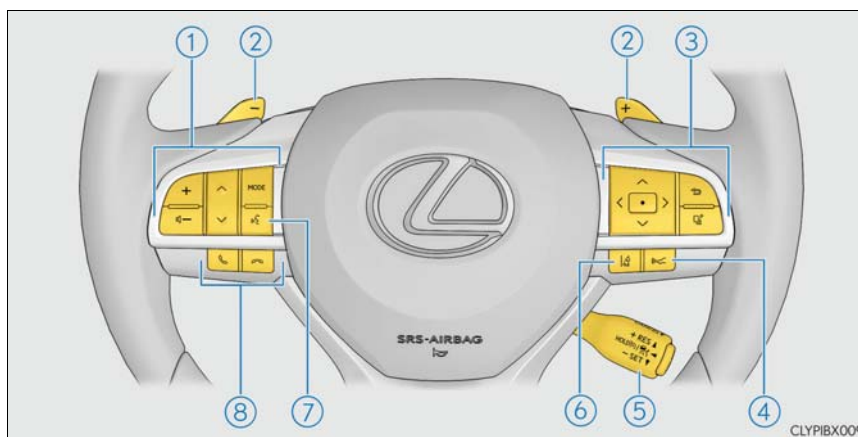

- ① Audio remote control switches\*<sup>1</sup> ..... P. 400, 465
- ② Paddle shift switches\*<sup>2</sup> ..... P. 241, 242
- ③ Meter control switches ..... P. 92
- ④ Vehicle-to-vehicle distance switch ..... P. 306
- ⑤ Cruise control switch  
Dynamic radar cruise control with full-speed range ..... P. 300
- ⑥ LKA (Lane-Keeping Assist) switch ..... P. 291
- ⑦ Talk switch\*<sup>1</sup> ..... P. 487
- ⑧ Telephone switches\*<sup>1</sup> ..... P. 401, 465

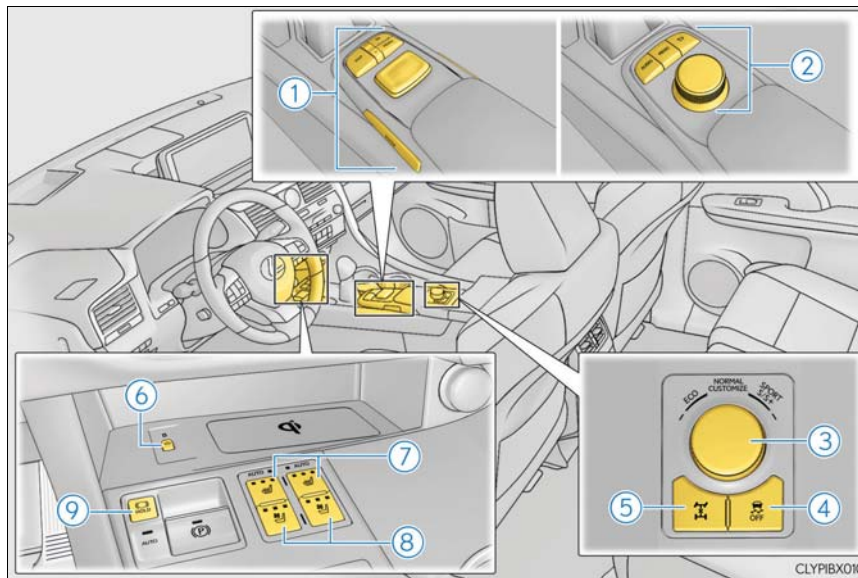

① Remote Touch <sup>*1,2</sup> .....	P. 496
② Lexus Display Audio controller <sup>*2</sup> .....	P. 396
③ Driving mode select switch .....	P. 373
④ VSC OFF switch .....	P. 380
⑤ All-wheel drive lock switch <sup>*2</sup> .....	P. 377
⑥ Wireless charger switch <sup>*2</sup> .....	P. 544
⑦ Front seat heater switches <sup>*2</sup> .....	P. 522
⑧ Seat ventilator switches <sup>*2</sup> .....	P. 523
⑨ Brake hold switch .....	P. 250

<sup>\*1</sup>: For vehicles with a navigation system, refer to "NAVIGATION SYSTEM OWNER'S MANUAL".  
<sup>\*2</sup>: If equipped

■ Interior

► RX350

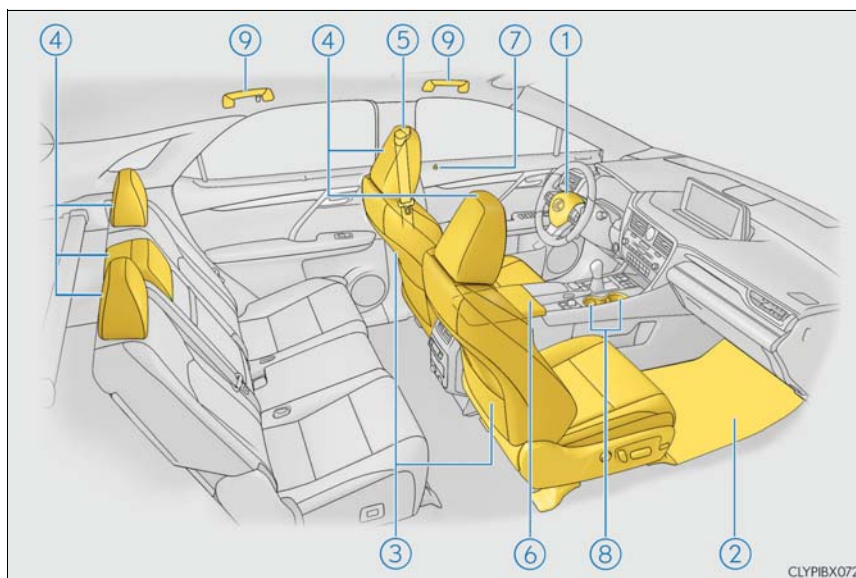

① SRS airbags.....	P. 36
② Floor mats.....	P. 28
③ Front seats.....	P. 156
④ Head restraints.....	P. 177
⑤ Seat belts.....	P. 32
⑥ Console box.....	P. 530
⑦ Inside lock buttons.....	P. 126
⑧ Cup holders.....	P. 531
⑨ Assist grips.....	P. 556

► RX350L (Vehicles with separate-type second-row seats)

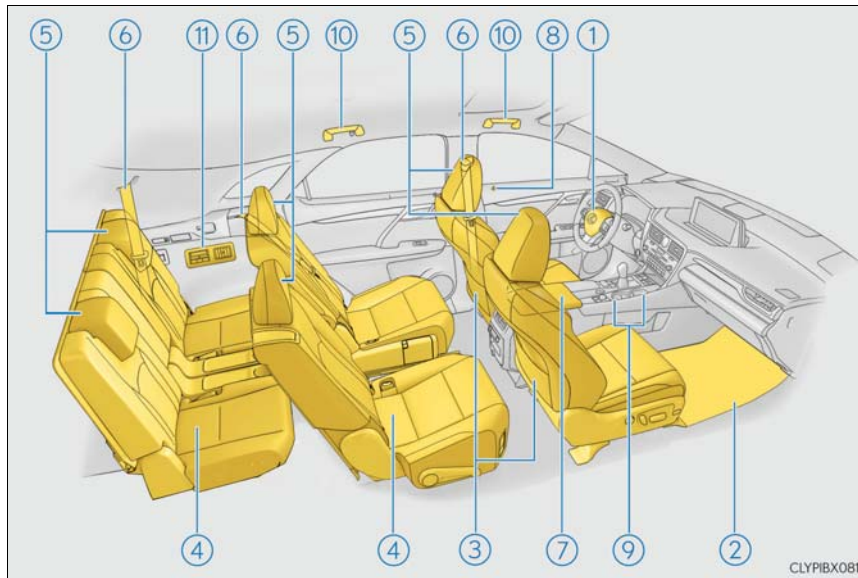

① SRS airbags .....	P. 36
② Floor mats .....	P. 28
③ Front seats .....	P. 156
④ Rear seats .....	P. 157
⑤ Head restraints .....	P. 177
⑥ Seat belts .....	P. 32
⑦ Console box .....	P. 530
⑧ Inside lock buttons .....	P. 126
⑨ Cup holders .....	P. 531
⑩ Assist grips .....	P. 556
⑪ Rear automatic air conditioning system .....	P. 518

► RX350L (Vehicles with bench-type second-row seats)

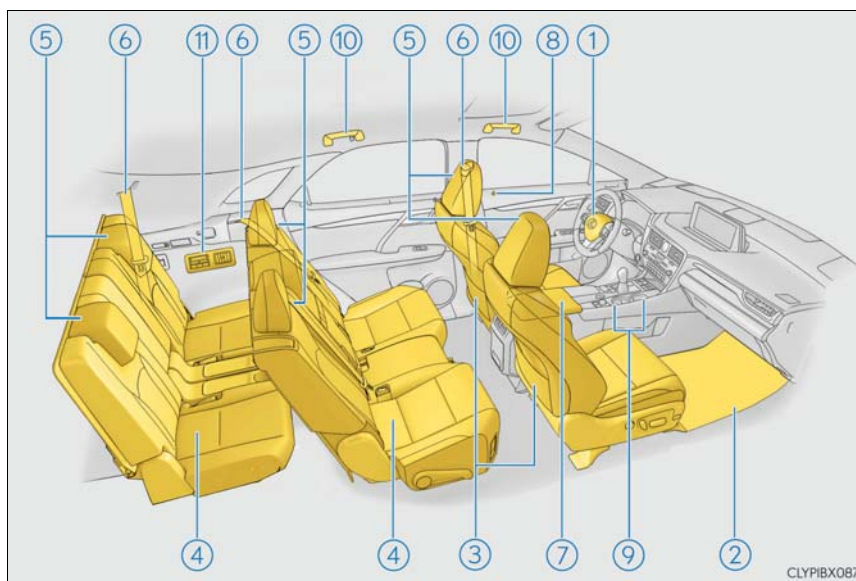

① SRS airbags .....	P. 36
② Floor mats .....	P. 28
③ Front seats .....	P. 156
④ Rear seats .....	P. 157
⑤ Head restraints .....	P. 177
⑥ Seat belts .....	P. 32
⑦ Console box .....	P. 530
⑧ Inside lock buttons .....	P. 126
⑨ Cup holders .....	P. 531
⑩ Assist grips .....	P. 556
⑪ Rear automatic air conditioning system .....	P. 518



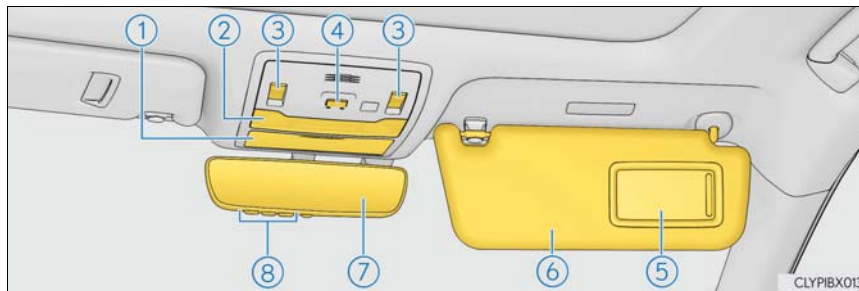

①	Auxiliary box	P. 535
②	Interior light <sup>*2</sup>	P. 525
	Personal lights <sup>*2</sup>	P. 526
③	Moon roof switches <sup>*1</sup>	P. 191
	Panoramic moon roof switches <sup>*1</sup>	P. 195
④	"SOS" button <sup>*1</sup>	P. 568
⑤	Vanity mirrors	P. 543
⑥	Sun visors	P. 543
⑦	Inside rear view mirror	P. 182
⑧	Garage door opener switches	P. 557

<sup>\*1</sup>: If equipped

<sup>\*2</sup>: The illustration shows the front, but they are also equipped in the rear.



**For safety and security****1**

- 1-1. For safe use**
  - Before driving.....28
  - For safe driving .....30
  - Seat belts ..... 32
  - SRS airbags .....36
  - Front passenger occupant  
classification system..... 47
  - Exhaust gas precautions .....53
- 1-2. Child safety**
  - Riding with children .....54
  - Child restraint systems .....55
- 1-3. Theft deterrent system**
  - Engine immobilizer  
system..... 74
  - Alarm .....77

## Before driving

### Floor mat

Use only floor mats designed specifically for vehicles of the same model and model year as your vehicle. Fix them securely in place onto the carpet.

- 1 Insert the retaining hooks (clips) into the floor mat eyelets.

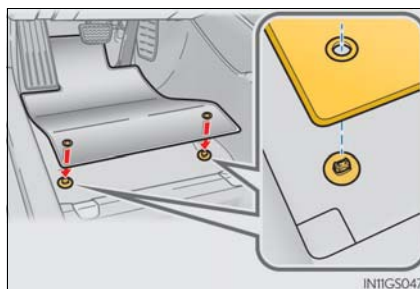

- 2 Turn the upper knob of each retaining hook (clip) to secure the floor mats in place.

\*: Always align the  $\Delta$  marks.

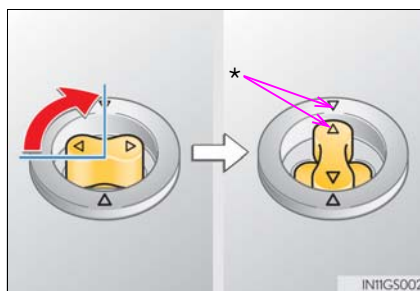

The shape of the retaining hooks (clips) may differ from that shown in the illustration.

**⚠ WARNING**

Observe the following precautions.

Failure to do so may cause the driver's floor mat to slip, possibly interfering with the pedals while driving. An unexpectedly high speed may result or it may become difficult to stop the vehicle. This could lead to an accident, resulting in death or serious injury.

**■ When installing the driver's floor mat**

- Do not use floor mats designed for other models or different model year vehicles, even if they are Lexus Genuine floor mats.
- Only use floor mats designed for the driver's seat.
- Always install the floor mat securely using the retaining hooks (clips) provided.
- Do not use two or more floor mats on top of each other.
- Do not place the floor mat bottom-side up or upside-down.

**■ Before driving**

- Check that the floor mat is securely fixed in the correct place with all the provided retaining hooks (clips). Be especially careful to perform this check after cleaning the floor.
- With the engine stopped and the shift lever in P, fully depress each pedal to the floor to make sure it does not interfere with the floor mat.



## For safe driving

For safe driving, adjust the seat and mirror to an appropriate position before driving.

### Correct driving posture

- ① Adjust the angle of the seatback so that you are sitting straight up and so that you do not have to lean forward to steer. (→P. 156)
- ② Adjust the seat so that you can depress the pedals fully and so that your arms bend slightly at the elbow when gripping the steering wheel. (→P. 156)
- ③ Lock the head restraint in place with the center of the head restraint closest to the top of your ears. (→P. 177)
- ④ Wear the seat belt correctly. (→P. 32)



### Correct use of the seat belts

Make sure that all occupants are wearing their seat belts before driving the vehicle. (→P. 32)

Use a child restraint system appropriate for the child until the child becomes large enough to properly wear the vehicle's seat belt. (→P. 55)

### Adjusting the mirrors

Make sure that you can see backward clearly by adjusting the inside and outside rear view mirrors properly. (→P. 182, 184)

 **WARNING**

Observe the following precautions.

Failure to do so may result in death or serious injury.

- Do not adjust the position of the driver's seat while driving.  
Doing so could cause the driver to lose control of the vehicle.
- Do not place a cushion between the driver or passenger and the seatback.  
A cushion may prevent correct posture from being achieved, and reduce the effectiveness of the seat belt and head restraint.
- Do not place anything under the front seats.  
Objects placed under the front seats may become jammed in the seat tracks and stop the seat from locking in place. This may lead to an accident and the adjustment mechanism may also be damaged.
- Always observe the legal speed limit when driving on public roads.
- When driving over long distances, take regular breaks before you start to feel tired.  
Also, if you feel tired or sleepy while driving, do not force yourself to continue driving and take a break immediately.

## Seat belts

Make sure that all occupants are wearing their seat belts before driving the vehicle.

### Correct use of the seat belts

- Extend the shoulder belt so that it comes fully over the shoulder, but does not come into contact with the neck or slide off the shoulder.
- Position the lap belt as low as possible over the hips.
- Adjust the position of the seatback. Sit up straight and well back in the seat.
- Do not twist the seat belt.



### Fastening and releasing the seat belt

- ① To fasten the seat belt, push the plate into the buckle until a click sound is heard.
- ② To release the seat belt, press the release button.

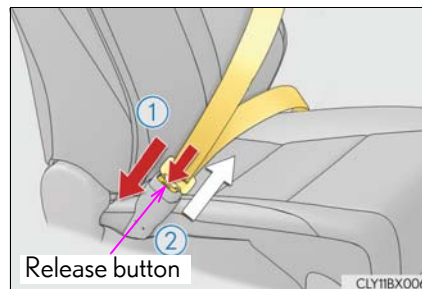

### Adjusting the seat belt shoulder anchor height (front seats)

- ① Push the seat belt shoulder anchor down while pressing the release button.
  - ② Push the seat belt shoulder anchor up.
- Move the height adjuster up and down as needed until you hear a click.





### Seat belt pretensioners (front seats and outboard second-row seats)

The pretensioners help the seat belts to quickly restrain the occupants by retracting the seat belts when the vehicle is subjected to certain types of severe frontal or side collision or a vehicle rollover.

The pretensioners do not activate in the event of a minor frontal impact, a minor side impact or a rear impact.



#### ■ Emergency locking retractor (ELR)

The retractor will lock the belt during a sudden stop or on impact. It may also lock if you lean forward too quickly. A slow, easy motion will allow the belt to extend so that you can move around fully.

#### ■ Automatic locking retractor (ALR)

When a passenger's shoulder belt is completely extended and then retracted even slightly, the belt is locked in that position and cannot be extended. This feature is used to hold the child restraint system (CRS) firmly. To free the belt again, fully retract the belt and then pull the belt out once more. (→P. 57)

#### ■ Child seat belt usage

The seat belts of your vehicle were principally designed for persons of adult size.

- Use a child restraint system appropriate for the child, until the child becomes large enough to properly wear the vehicle's seat belt. (→P. 55)
- When the child becomes large enough to properly wear the vehicle's seat belt, follow the instructions regarding seat belt usage. (→P. 32)

#### ■ Replacing the belt after the pretensioner has been activated

If the vehicle is involved in multiple collisions, the pretensioner will activate for the first collision, but will not activate for the second or subsequent collisions.

#### ■ Seat belt extender

If your seat belts cannot be fastened securely because they are not long enough, a personalized seat belt extender is available from your Lexus dealer free of charge.

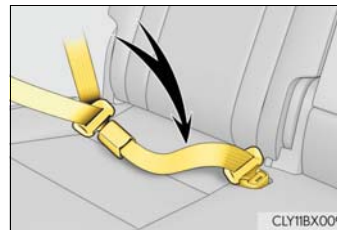

### WARNING

Observe the following precautions to reduce the risk of injury in the event of sudden braking, sudden swerving or an accident. Failing to do so may cause death or serious injury.

#### ■ Wearing a seat belt

- Ensure that all passengers wear a seat belt.
- Always wear a seat belt properly.
- Each seat belt should be used by one person only. Do not use a seat belt for more than one person at once, including children.
- Lexus recommends that children be seated in the rear seat and always use a seat belt and/or an appropriate child restraint system.
- To achieve a proper seating position, do not recline the seat more than necessary. The seat belt is most effective when the occupants are sitting up straight and well back in the seats.
- Do not wear the shoulder belt under your arm.
- Always wear your seat belt low and snug across your hips.
- RX350L: Do not let third-row seat passengers to use second-row seat seat belts.





#### ■ Pregnant women

Obtain medical advice and wear the seat belt in the proper way. (→P. 32)

Women who are pregnant should position the lap belt as low as possible over the hips in the same manner as other occupants, extending the shoulder belt completely over the shoulder and avoiding belt contact with the rounding of the abdominal area.

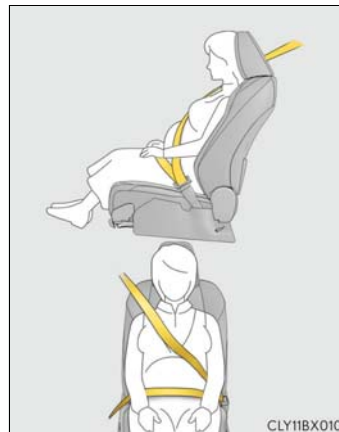
If the seat belt is not worn properly, not only the pregnant woman, but also the fetus could suffer death or serious injury as a result of sudden braking or a collision.



 **WARNING****■ People suffering illness**

Obtain medical advice and wear the seat belt in the proper way. (→P. 32)

**■ When children are in the vehicle**

→P. 66

**■ Seat belt pretensioners**

- Do not place anything, such as a cushion, on the front passenger's seat. Doing so will disperse the passenger's weight, which prevents the sensor from detecting the passenger's weight properly. As a result, the seat belt pretensioner for the front passenger's seat may not activate in the event of a collision.
- If the pretensioner has activated, the SRS warning light will come on. In that case, the seat belt cannot be used again and must be replaced at your Lexus dealer.

**■ Adjustable shoulder anchor**

Always make sure the shoulder belt is positioned across the center of your shoulder. The belt should be kept away from your neck, but not falling off your shoulder. Failure to do so could reduce the amount of protection in an accident and cause death or serious injuries in the event of a sudden stop, sudden swerve or accident. (→P. 32)

**■ Seat belt damage and wear**

- Do not damage the seat belts by allowing the belt, plate, or buckle to be jammed in the door.
- Inspect the seat belt system periodically. Check for cuts, fraying, and loose parts. Do not use a damaged seat belt until it is replaced. Damaged seat belts cannot protect an occupant from death or serious injury.
- Ensure that the belt and plate are locked and the belt is not twisted.  
If the seat belt does not function correctly, immediately contact your Lexus dealer.
- Replace the seat assembly, including the belts, if your vehicle has been involved in a serious accident, even if there's no obvious damage.
- Do not attempt to install, remove, modify, disassemble or dispose of the seat belts. Have any necessary repairs carried out by your Lexus dealer. Inappropriate handling may lead to incorrect operation.

**■ Using a seat belt extender**

- Do not wear the seat belt extender if you can fasten the seat belt without the extender.
- Do not use the seat belt extender when installing a child restraint system because the belt will not securely hold the child restraint system, increasing the risk of death or serious injury in the event of an accident.
- The personalized extender may not be safe on another vehicle, when used by another person, or at a different seating position other than the one originally intended.

 **NOTICE****■ When releasing a seat belt extender**

When releasing the seat belt, press on the buckle release button on the extender, not on the seat belt.  
This helps prevent damage to the vehicle interior and the extender itself.

## SRS airbags

The SRS airbags inflate when the vehicle is subjected to certain types of severe impacts that may cause significant injury to the occupants. They work together with the seat belts to help reduce the risk of death or serious injury.

► RX350

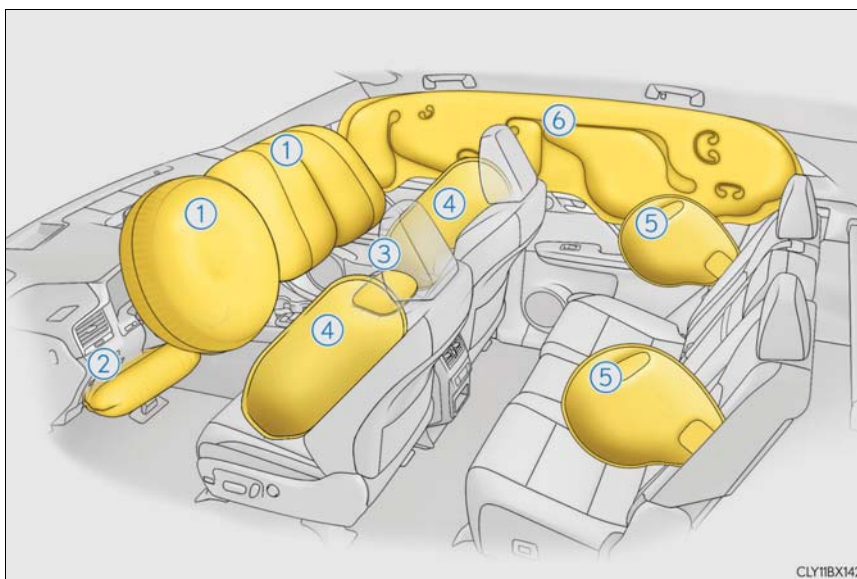

## ▶ RX350L

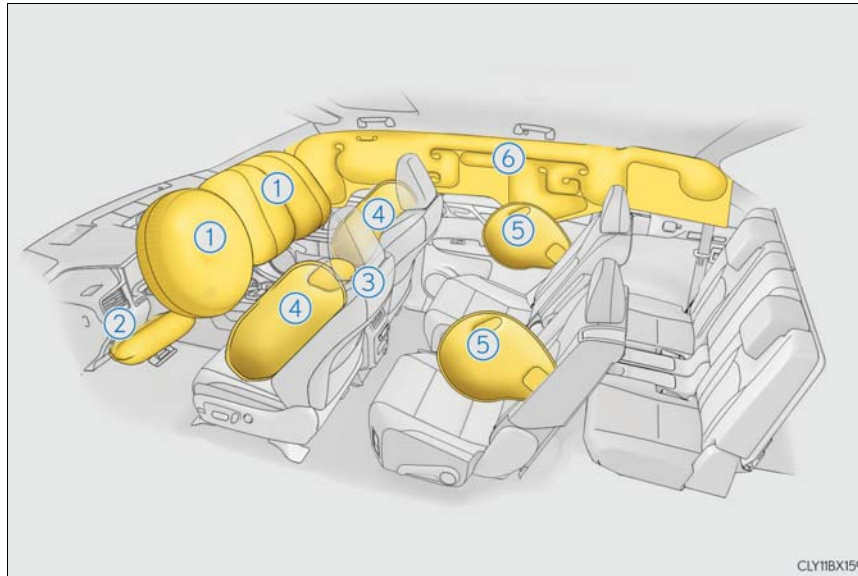

## ◆ SRS front airbags

- ① SRS driver airbag/front passenger airbag  
Can help protect the head and chest of the driver and front passenger from impact with interior components
- ② SRS knee airbag  
Can help provide driver protection
- ③ SRS seat cushion airbag  
Can help restrain the front passenger.

## ◆ SRS side and curtain shield airbags

- ④ SRS front side airbags  
Can help protect the torso of the front seat occupants
- ⑤ SRS rear side airbags  
Can help protect the torso of occupants in the rear outer seats
- ⑥ SRS curtain shield airbags
  - Can help protect primarily the head of occupants in the outer seats
  - Can help prevent the occupants from being thrown from the vehicle in the event of vehicle rollover

### SRS airbag system components

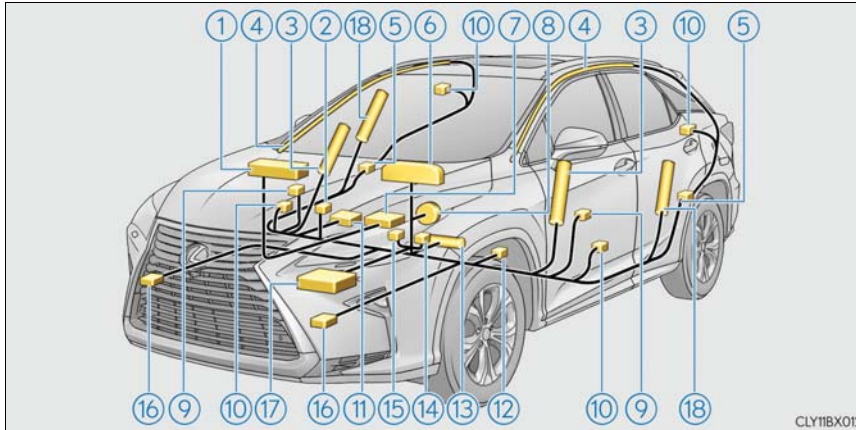

- |  |  |
|--|--|
| ① Front passenger airbag   | ⑩ Seat belt pretensioners and force limiters |
| ② “AIR BAG ON” and “AIR BAG OFF” indicator lights                  | ⑪ Passenger seat cushion airbag              |
| ③ Front side airbags   | ⑫ Driver’s seat position sensor              |
| ④ Curtain shield airbags   | ⑬ Driver’s knee airbag                       |
| ⑤ Side impact sensors (rear)                                       | ⑭ Driver’s seat belt buckle switch           |
| ⑥ SRS warning light  | ⑮ Front passenger’s seat belt buckle switch  |
| ⑦ Front passenger occupant classification system (ECU and sensors) | ⑯ Front impact sensors                       |
| ⑧ Driver airbag  | ⑰ Airbag sensor assembly                     |
| ⑨ Side impact sensors (front door)                                 | ⑱ Rear side airbags                          |

Your vehicle is equipped with ADVANCED AIRBAGS designed based on the US motor vehicle safety standards (FMVSS208). The airbag sensor assembly (ECU) controls airbag deployment based on information obtained from the sensors etc. shown in the system components diagram above. This information includes crash severity and occupant information. As the airbags deploy, a chemical reaction in the inflators quickly fills the airbags with non-toxic gas to help restrain the motion of the occupants.

**⚠ WARNING**

■ **SRS airbag precautions**

Observe the following precautions regarding the SRS airbags. Failure to do so may cause death or serious injury.

- The driver and all passengers in the vehicle must wear their seat belts properly. The SRS airbags are supplemental devices to be used with the seat belts.
- The SRS driver airbag deploys with considerable force, and can cause death or serious injury especially if the driver is very close to the airbag. The National Highway Traffic Safety Administration (NHTSA) advises:

Since the risk zone for the driver's airbag is the first 2 - 3 in. (50 - 75 mm) of inflation, placing yourself 10 in. (250 mm) from your driver airbag provides you with a clear margin of safety. This distance is measured from the center of the steering wheel to your breastbone. If you sit less than 10 in. (250 mm) away now, you can change your driving position in several ways:

- Move your seat to the rear as far as you can while still reaching the pedals comfortably.
- Slightly recline the back of the seat. Although vehicle designs vary, many drivers can achieve the 10 in. (250 mm) distance, even with the driver seat all the way forward, simply by reclining the back of the seat somewhat. If reclining the back of your seat makes it hard to see the road, raise yourself by using a firm, non-slippery cushion, or raise the seat if your vehicle has that feature.
- If your steering wheel is adjustable, tilt it downward. This points the airbag toward your chest instead of your head and neck.

The seat should be adjusted as recommended by NHTSA above, while still maintaining control of the foot pedals, steering wheel, and your view of the instrument panel controls.

- If the seat belt extender has been connected to the front seat belt buckles but the seat belt extender has not also been fastened to the latch plate of the seat belt, the SRS front airbags will judge that the driver and front passenger are wearing the seat belt even though the seat belt has not been connected. In this case, the SRS front airbags may not activate correctly in a collision, resulting in death or serious injury in the event of a collision. Be sure to wear the seat belt with the seat belt extender.



- The SRS front passenger airbag also deploys with considerable force, and can cause death or serious injury especially if the front passenger is very close to the airbag. The front passenger seat should be as far from the airbag as possible with the seatback adjusted, so the front passenger sits upright.

**⚠ WARNING**

■ **SRS airbag precautions**

● Improperly seated and/or restrained infants and children can be killed or seriously injured by a deploying airbag. An infant or child who is too small to use a seat belt should be properly secured using a child restraint system. Lexus strongly recommends that all infants and children be placed in the rear seats of the vehicle and properly restrained. The rear seats are safer for infants and children than the front passenger seat. (→P. 55)

● Do not sit on the edge of the seat or lean against the dashboard.

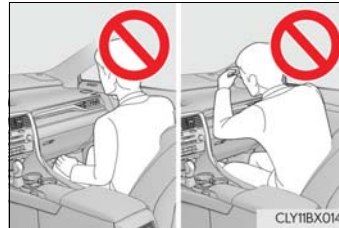

● Do not allow a child to stand in front of the SRS front passenger airbag unit or sit on the knees of a front passenger.

● Do not allow the front seat occupants to hold items on their knees.



● Do not lean against the door, the roof side rail or the front, side and rear pillars.



● Do not allow anyone to kneel on the passenger seats toward the door or put their head or hands outside the vehicle.





**⚠ WARNING**

■ **SRS airbag precautions**

- Do not attach anything to or lean anything against areas such as the dashboard, steering wheel pad and lower portion of the instrument panel. These items can become projectiles when the SRS driver, front passenger and knee airbags deploy.

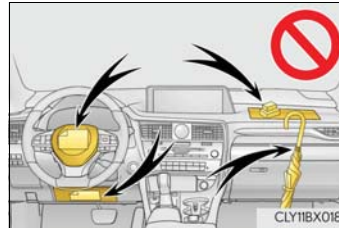

- Do not attach anything to areas such as a door, windshield, side windows, front or rear pillar, roof side rail and assist grip.



- Do not hang coat hangers or other hard objects on the coat hooks. All of these items could become projectiles and may cause death or serious injury, should the SRS curtain shield airbags deploy.
- If a vinyl cover is put on the area where the SRS knee airbag will deploy, be sure to remove it.
- Do not use seat accessories which cover the parts where the SRS side airbags and SRS seat cushion airbag inflate as they may interfere with inflation of the SRS airbags. Such accessories may prevent the side airbags and SRS seat cushion airbag from activating correctly, disable the system or cause the side airbags and SRS seat cushion airbag to inflate accidentally, resulting in death or serious injury.
- Do not strike or apply significant levels of force to the areas around the SRS airbag components or the front doors. Doing so can cause the SRS airbags to malfunction.
- Do not touch any of the component parts immediately after the SRS airbags have deployed (inflated) as they may be hot.
- If breathing becomes difficult after the SRS airbags have deployed, open a door or window to allow fresh air in, or leave the vehicle if it is safe to do so. Wash off any residue as soon as possible to prevent skin irritation.
- If the areas where the SRS airbags are stored, such as the steering wheel pad and front and rear pillar garnishes, are damaged or cracked, have them replaced by your Lexus dealer.
- Do not place anything, such as a cushion, on the front passenger's seat. Doing so will disperse the passenger's weight, which prevents the sensor from detecting the passenger's weight properly. As a result, the SRS front airbags for the front passenger may not deploy in the event of a collision.

**⚠ WARNING****■ Modification and disposal of SRS airbag system components**

Do not dispose of your vehicle or perform any of the following modifications without consulting your Lexus dealer. The SRS airbags may malfunction or deploy (inflate) accidentally, causing death or serious injury.

- Installation, removal, disassembly and repair of the SRS airbags
- Repairs, modifications, removal or replacement of the steering wheel, instrument panel, dashboard, seats or seat upholstery, front, side and rear pillars, roof side rails, front door panels, front door trims, or front door speakers
- Modifications to the front door panel (such as making a hole in it)
- Repairs or modifications of the front fender, front bumper, or side of the occupant compartment
- Installation of a grille guard (bull bars, kangaroo bar, etc.), snow plows, winches or roof luggage carrier
- Modifications to the vehicle's suspension system
- Installation of electronic devices such as mobile two-way radios and CD players
- Modifications to your vehicle for a person with a physical disability

**■ If the SRS airbags deploy (inflate)**

- Slight abrasions, burns, bruising etc., may be sustained from SRS airbags, due to the extremely high speed deployment (inflation) by hot gases.
- A loud noise and white powder will be emitted.
- Parts of the airbag module (steering wheel hub, airbag cover and inflator) as well as the front seats, parts of the front and rear pillars, and roof side rails, may be hot for several minutes. The airbag itself may also be hot.
- The windshield may crack.
- For Lexus Enform Safety Connect subscribers, if any of the following situations occur, the system is designed to send an emergency call to the response center, notifying them of the vehicle's location (without needing to push the "SOS" button) and an agent will attempt to speak with the occupants to ascertain the level of emergency and assistance required. If the occupants are unable to communicate, the agent automatically treats the call as an emergency and helps to dispatch the necessary emergency services. (→P. 568)
  - An SRS airbag is deployed.
  - A seat belt pretensioner is activated.
  - The vehicle is involved in a severe rear-end collision.

### ■ SRS airbag deployment conditions (SRS front airbags)

- The SRS front airbags will deploy in the event of an impact that exceeds the set threshold level (the level of force corresponding to an approximately 12-18 mph [20-30 km/h] frontal collision with a fixed wall that does not move or deform).

However, this threshold velocity will be considerably higher in the following situations:

- If the vehicle strikes an object, such as a parked vehicle or sign pole, which can move or deform on impact
- If the vehicle is involved in an underride collision, such as a collision in which the front of the vehicle "underrides", or goes under, the bed of a truck
- Depending on the type of collision, it is possible that only the seat belt pretensioners will activate.
- The SRS front airbags for the front passenger will not activate if there is no passenger sitting in the front passenger seat. However, the SRS front airbags for the front passenger may deploy if luggage is put in the seat, even if the seat is unoccupied. (→P. 47)
- The SRS seat cushion airbag on the front passenger seat will not operate if the occupant is not wearing a seat belt.

### ■ SRS airbag deployment conditions (SRS side and curtain shield airbags)

- The SRS side and curtain shield airbags will deploy in the event of an impact that exceeds the set threshold level (the level of force corresponding to the impact force produced by an approximately 3300 lb. [1500 kg] vehicle colliding with the vehicle cabin from a direction perpendicular to the vehicle orientation at an approximate speed of 12 -18 mph [20 -30 km/h]).
- Both SRS curtain shield airbags will deploy in the event of vehicle rollover.
- All SRS side and curtain shield airbags will deploy in the event of a severe frontal collision.

### ■ Conditions under which the SRS airbags may deploy (inflate), other than a collision

The SRS front airbags and SRS side and curtain shield airbags may also deploy if a serious impact occurs to the underside of your vehicle. Some examples are shown in the illustration.

- Hitting a curb, edge of pavement or hard surface
- Falling into or jumping over a deep hole
- Landing hard or falling

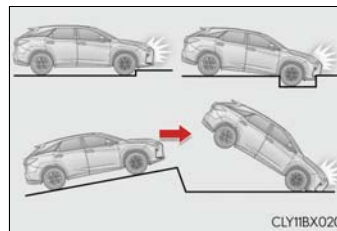

The SRS curtain shield airbags may also deploy under the situations shown in the illustration.

- The angle of vehicle tip-up is marginal.
- The vehicle skids and hits a curb stone.

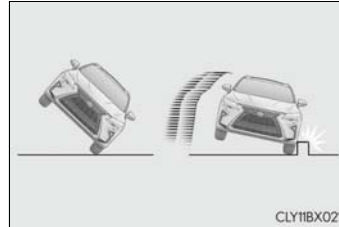

#### ■ Types of collisions that may not deploy the SRS airbags (SRS front airbags)

The SRS front airbags do not generally inflate if the vehicle is involved in a side or rear collision, if it rolls over, or if it is involved in a low-speed frontal collision. But, whenever a collision of any type causes sufficient forward deceleration of the vehicle, deployment of the SRS front airbags may occur.

- Collision from the side
- Collision from the rear
- Vehicle rollover



#### ■ Types of collisions that may not deploy the SRS airbags (SRS side and curtain shield airbags)

The SRS side and curtain shield airbags may not activate if the vehicle is subjected to a collision from the side at certain angles, or a collision to the side of the vehicle body other than the passenger compartment.

- Collision from the side to the vehicle body other than the passenger compartment
- Collision from the side at an angle



The SRS side airbags do not generally inflate if the vehicle is involved in a rear collision, if it rolls over, or if it is involved in a low-speed side or low-speed frontal collision.

- Collision from the rear
- Vehicle rollover

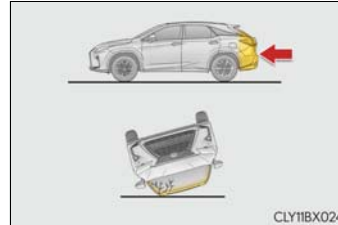

The SRS curtain shield airbags do not generally inflate if the vehicle is involved in a rear collision, if it pitches end over end, or if it is involved in a low-speed side or low-speed frontal collision.

- Collision from the rear
- Pitching end over end

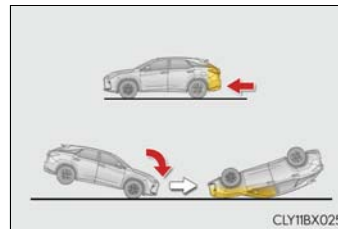

#### ■ When to contact your Lexus dealer

In the following cases, the vehicle will require inspection and/or repair. Contact your Lexus dealer as soon as possible.

- Any of the SRS airbags have been inflated.
- The front of the vehicle is damaged or deformed, or was involved in an accident that was not severe enough to cause the SRS front airbags to inflate.

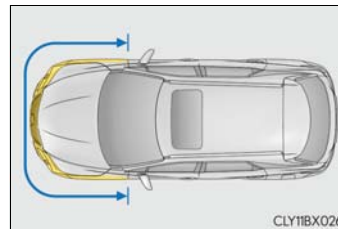

- A portion of a door or its surrounding area is damaged, deformed or has had a hole made in it, or the vehicle was involved in an accident that was not severe enough to cause the SRS side and curtain shield airbags to inflate.

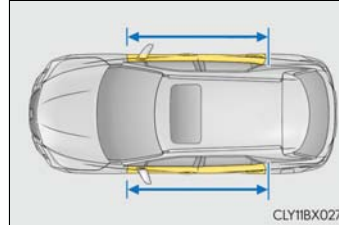

- The pad section of the steering wheel, dashboard near the front passenger airbag or lower portion of the instrument panel is scratched, cracked, or otherwise damaged.

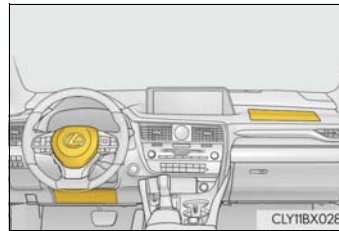

- The front passenger's seat cushion surface is scratched, cracked, or otherwise damaged.



- The surface of the seats with the SRS side airbag is scratched, cracked, or otherwise damaged.

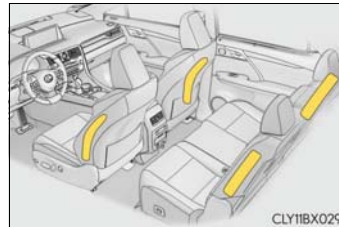

- The portion of the front pillars, rear pillars or roof side rail garnishes (padding) containing the SRS curtain shield airbags inside is scratched, cracked, or otherwise damaged.

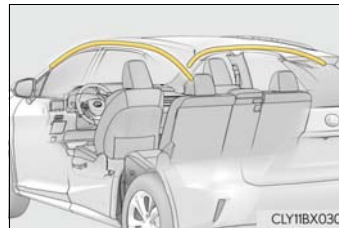

## Front passenger occupant classification system

Your vehicle is equipped with a front passenger occupant classification system. This system detects the conditions of the front passenger seat and activates or deactivates the devices for the front passenger.

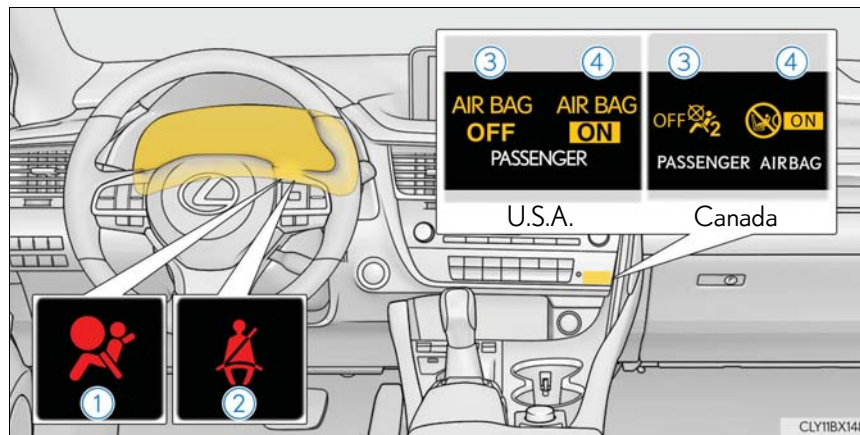

- ① SRS warning light
- ② Seat belt reminder light
- ③ "AIR BAG OFF" indicator light
- ④ "AIR BAG ON" indicator light

1

For safety and security

### Condition and operation in the front passenger occupant classification system

#### ■ Adult\*<sup>1</sup>

Indicator/ warning light	"AIR BAG ON" and "AIR BAG OFF" indicator lights	"AIR BAG ON"
	SRS warning light	Off
	Seat belt reminder light	Off* <sup>2</sup> or flashing* <sup>3</sup>
Devices	Front passenger airbag	Activated
	Side airbag on the front passenger seat	
	Curtain shield airbag in the front passenger side	
	Seat cushion airbag in the front passenger side	Activated* <sup>2</sup> or deactivated* <sup>3</sup>
	Front passenger's seat belt pretensioner and force limiter	Activated

#### ■ Child\*<sup>4</sup>

Indicator/ warning light	"AIR BAG ON" and "AIR BAG OFF" indicator lights	"AIR BAG OFF" or "AIR BAG ON"* <sup>4</sup>
	SRS warning light	Off
	Seat belt reminder light	Off* <sup>2</sup> or flashing* <sup>3</sup>
Devices	Front passenger airbag	Deactivated or activated* <sup>4</sup>
	Side airbag on the front passenger seat	Activated
	Curtain shield airbag in the front passenger side	
	Seat cushion airbag in the front passenger side	Deactivated or activated* <sup>4,2</sup>
	Front passenger's seat belt pretensioner and force limiter	Activated



### ■ Child restraint system with infant<sup>\*5</sup>

Indicator/ warning light	"AIR BAG ON" and "AIR BAG OFF" indicator lights	"AIR BAG OFF" <sup>*6</sup>
	SRS warning light	Off
	Seat belt reminder light	Off <sup>*2</sup> or flashing <sup>*3</sup>
Devices	Front passenger airbag	Deactivated
	Side airbag on the front passenger seat	Activated
	Curtain shield airbag in the front passenger side	
	Seat cushion airbag in the front passenger side	Deactivated
	Front passenger's seat belt pretensioner and force limiter	Activated

### ■ Unoccupied

Indicator/ warning light	"AIR BAG ON" and "AIR BAG OFF" indicator lights	"AIR BAG OFF"
	SRS warning light	Off
	Seat belt reminder light	
Devices	Front passenger airbag	Deactivated
	Side airbag on the front passenger seat	Activated
	Curtain shield airbag in the front passenger side	
	Seat cushion airbag in the front passenger side	Deactivated
	Front passenger's seat belt pretensioner and force limiter	Activated

■ There is a malfunction in the system

Indicator/ warning light	"AIR BAG ON" and "AIR BAG OFF" indicator lights	"AIR BAG OFF"
	SRS warning light	On
	Seat belt reminder light	
Devices	Front passenger airbag	Deactivated
	Side airbag on the front passenger seat	Activated
	Curtain shield airbag in the front passenger side	
	Seat cushion airbag in the front passenger side	Deactivated
	Front passenger's seat belt pretensioner and force limiter	Activated

\*1: The system judges a person of adult size as an adult. When a smaller adult sits in the front passenger seat, the system may not recognize him/her as an adult depending on his/her physique and posture.

\*2: In the event the front passenger is wearing a seat belt.

\*3: In the event the front passenger does not wear a seat belt.

\*4: For some children, child in seat, child in booster seat or child in convertible seat, the system may not recognize him/her as a child. Factors which may affect this can be the physique or posture.

\*5: Never install a rear-facing child restraint system on the front passenger seat. A forward-facing child restraint system should only be installed on the front passenger seat when it is unavoidable. (→P. 55)

\*6: In case the indicator light is not illuminated, consult this manual on how to install the child restraint system properly. (→P. 57)

 **WARNING****■ Front passenger occupant classification system precautions**

Observe the following precautions regarding the front passenger occupant classification system.

Failure to do so may cause death or serious injury.

- Wear the seat belt properly.
- Make sure the front passenger's seat belt plate has not been left inserted into the buckle before someone sits in the front passenger seat.
- Make sure the "AIR BAG OFF" indicator light is not illuminated when using the seat belt extender for the front passenger seat. If the "AIR BAG OFF" indicator light is illuminated, disconnect the extender tongue from the seat belt buckle, and reconnect the seat belt. Reconnect the seat belt extender after making sure the "AIR BAG ON" indicator light is illuminated. If you use the seat belt extender while the "AIR BAG OFF" indicator light is illuminated, the SRS airbags for the front passenger will not activate, which could cause death or serious injury in the event of a collision.
- Do not apply a heavy load to the front passenger seat or equipment (e.g. seatback pocket).
- Do not put weight on the front passenger seat by putting your hands or feet on the front passenger seat seatback from the rear passenger seat.
- Do not let a rear passenger lift the front passenger seat with their feet or press on the seatback with their legs.
- Do not put objects under the front passenger seat.

 **WARNING****■ Front passenger occupant classification system precautions**

- Do not recline the front passenger seatback so far that it touches a rear seat. This may cause the "AIR BAG OFF" indicator light to be illuminated, which indicates that the SRS airbags for the front passenger will not activate in the event of a severe accident. If the seatback touches the rear seat, return the seatback to a position where it does not touch the rear seat. Keep the front passenger seatback as upright as possible when the vehicle is moving. Reclining the seatback excessively may lessen the effectiveness of the seat belt system.
- If an adult sits in the front passenger seat, the "AIR BAG ON" indicator light is illuminated. If the "AIR BAG OFF" indicator is illuminated, ask the passenger to sit up straight, well back in the seat, feet on the floor, and with the seat belt worn correctly. If the "AIR BAG OFF" indicator still remains illuminated, either ask the passenger to move to the rear seat, or if that is not possible, move the front passenger seat fully rearward.
- When it is unavoidable to install a forward-facing child restraint system on the front passenger seat, install the child restraint system on the front passenger seat in the proper order. (→P. 57)
- Do not modify or remove the front seats.
- Do not kick the front passenger seat or subject it to severe impact. Otherwise, the SRS warning light may come on to indicate a malfunction of the front passenger occupant classification system. In this case, contact your Lexus dealer immediately.
- Child restraint systems installed on the rear seat should not contact the front seatbacks.
- Do not use a seat accessory, such as a cushion and seat cover, that covers the seat cushion surface.
- Do not modify or replace the upholstery of the front seat.
- Adjust the front passenger seat so that the head restraint does not touch the ceiling. If the head restraint is left in contact with the ceiling, the system may not detect the front passenger properly, leading to improper operation of the airbags.

## Exhaust gas precautions

Harmful substance to the human body is contained in exhaust gases if inhaled.

### WARNING

Exhaust gases contain harmful carbon monoxide (CO), which is colorless and odorless. Observe the following precautions. Failure to do so may cause exhaust gases enter the vehicle and may lead to an accident caused by light-deadness, or may lead to death or a serious health hazard.

#### ■ Important points while driving

- Keep the back door closed.
- If you smell exhaust gases in the vehicle even when the back door is closed, open the windows and have the vehicle inspected at your Lexus dealer as soon as possible.

#### ■ When parking

- If the vehicle is in a poorly ventilated area or a closed area, such as a garage, stop the engine.
- Do not leave the vehicle with the engine running for a long time. If such a situation cannot be avoided, park the vehicle in an open space and ensure that exhaust fumes do not enter the vehicle interior.
- Do not leave the engine running in an area with snow build-up, or where it is snowing. If snowbanks build up around the vehicle while the engine is running, exhaust gases may collect and enter the vehicle.

#### ■ Exhaust pipe

The exhaust system needs to be checked periodically. If there is a hole or crack caused by corrosion, damage to a joint or abnormal exhaust noise, be sure to have the vehicle inspected and repaired by your Lexus dealer.



## Riding with children

Observe the following precautions when children are in the vehicle.

Use a child restraint system appropriate for the child, until the child becomes large enough to properly wear the vehicle's seat belt.

- It is recommended that children sit in the rear seats to avoid accidental contact with the shift lever, wiper switch, etc.
- Use the rear door child-protector lock or the window lock switch to avoid children opening the door while driving or operating the power window accidentally.
- Do not let small children operate equipment which may catch or pinch body parts, such as the power window, hood, back door, seats etc.

### WARNING

Never leave children unattended in the vehicle, and never allow children to have or use the key.

Children may be able to start the vehicle or shift the vehicle into neutral. There is also a danger that children may injure themselves by playing with the windows, the moon roof or panoramic moon roof, or other features of the vehicle. In addition, heat build-up or extremely cold temperatures inside the vehicle can be fatal to children.

## Child restraint systems

**Before installing a child restraint system in the vehicle, there are precautions that need to be observed, different types of child restraint systems, as well as installation methods, etc., written in this manual.**

Use a child restraint system when riding with a small child that cannot properly use a seat belt. For the child's safety, install the child restraint system to a rear seat. Be sure to follow the installation method that is in the operation manual enclosed with the restraint system.

### Table of contents

Points to remember .....	P. 55
Child restraint system .....	P. 57
When using a child restraint system .....	P. 59
Child restraint system installation method	
• Fixed with a seat belt .....	P. 61
• Fixed with a child restraint LATCH anchor .....	P. 67
• Using an anchor bracket (for top tether strap) .....	P. 70

### Points to remember

The laws of all 50 states of the U.S.A. as well as Canada now require the use of child restraint systems.

- Prioritize and observe the warnings, as well as the laws and regulations for child restraint systems.
- Use a child restraint system until the child becomes large enough to properly wear the vehicle's seat belt.
- Choose a child restraint system that suits your vehicle and is appropriate to the age and size of the child.



 **WARNING****■ When a child is riding**

Observe the following precautions.

Failure to do so may result in death or serious injury.

- For effective protection in automobile accidents and sudden stops, a child must be properly restrained, using a seat belt or child restraint system which is correctly installed. For installation details, refer to the operation manual enclosed with the child restraint system. General installation instruction is provided in this manual.
- Lexus strongly urges the use of a proper child restraint system that conforms to the weight and size of the child, installed on the rear seat. According to accident statistics, the child is safer when properly restrained in the rear seat than in the front seat.
- Holding a child in your or someone else's arms is not a substitute for a child restraint system. In an accident, the child can be crushed against the windshield or between the holder and the interior of the vehicle.

**■ Handling the child restraint system**

If the child restraint system is not properly fixed in place, the child or other passengers may be seriously injured or even killed in the event of sudden braking, sudden swerving, or an accident.

- If the vehicle were to receive a strong impact from an accident, etc., it is possible that the child restraint system has damage that is not readily visible. In such cases, do not reuse the restraint system.
- Make sure you have complied with all installation instructions provided with the child restraint system manufacturer and that the system is properly secured.
- Keep the child restraint system properly secured on the seat even if it is not in use. Do not store the child restraint system unsecured in the passenger compartment.
- If it is necessary to detach the child restraint system, remove it from the vehicle or store it securely in the luggage compartment.

## Child restraint system

### ■ Types of child restraint system installation methods

Confirm with the operation manual enclosed with the child restraint system about the installation of the child restraint system.

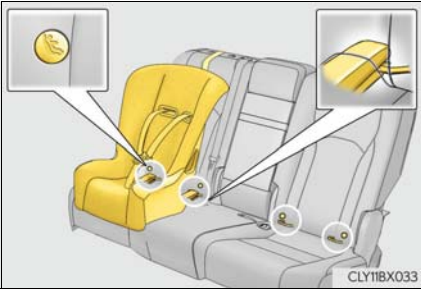
Installation method		Page
Seat belt attachment		P. 61
Child restraint LATCH anchors attachment		P. 67

1

For safety and security

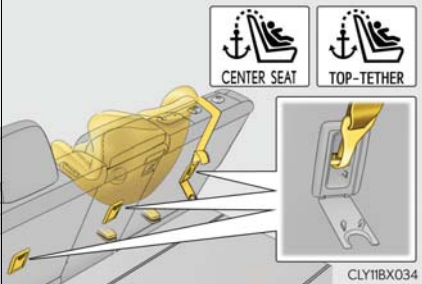
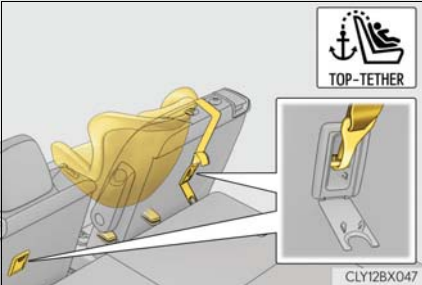
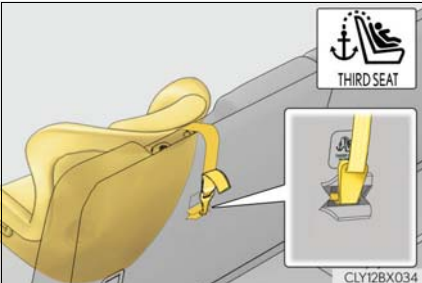
	Installation method	Page
<p>Anchor brackets (for top tether strap) attachment</p>	<p>▶ Bench-type second-row seats</p> 	
	<p>▶ Separate-type second-row seats</p> 	
	<p>▶ Third-row seats</p> 	

### When using a child restraint system

#### ■ When installing a child restraint system to a front passenger seat

For the safety of a child, install child restraint systems to second-row seats. When installing child restraint system to a front passenger seat is unavoidable, adjust the seat as follows and install the child restraint system.

- Raise the seatback as much as possible
- Move the seat to the rearmost position
- Raise the seat to the highest position
- If the head restraint interferes with the installation of the child restraint system, and the head restraint can be removed, remove the head restraint



If the head restraint cannot be removed, raise it to the uppermost position.

#### WARNING

#### ■ When using a child restraint system

Observe the following precautions.  
Failure to do so may result in death or serious injury.

- Never install a rear-facing child restraint system on the front passenger seat even if the "AIR BAG OFF" indicator light is illuminated. In the event of an accident, the force of the rapid inflation of the front passenger airbag can cause death or serious injury to the child if the rear-facing child restraint system is installed on the front passenger seat.
- A forward-facing child restraint system may be installed on the front passenger seat only when it is unavoidable. A child restraint system that requires a top tether strap should not be used in the front passenger seat since there is no top tether strap anchor for the front passenger seat.

**⚠ WARNING**

■ **When using a child restraint system**

- A forward-facing child restraint system may be installed on the front passenger seat only when it is unavoidable. When installing a forward-facing child restraint system on the front passenger seat, raise the seatback as much as possible, move the seat to the rearmost position, and raise the seat to the highest position, even if the "AIR BAG OFF" indicator light is illuminated.



If the head restraint interferes with the installation of the child restraint system, and the head restraint can be removed, remove the head restraint.

If the head restraint cannot be removed, raise it to the uppermost position.

- Do not allow the child to lean his/her head or any part of his/her body against the door or the area of the seat, front or rear pillars, or roof side rails from which the SRS side airbags or SRS curtain shield airbags deploy even if the child is seated in the child restraint system. It is dangerous if the SRS side airbags and curtain shield airbags inflate, and the impact could cause death or serious injury to the child.



- When a booster seat is installed, always ensure that the shoulder belt is positioned across the center of the child's shoulder. The belt should be kept away from the child's neck, but not so that it could fall off the child's shoulder.
- Use child restraint system suitable to the age and size of the child and install it to the rear seat.
- If the driver's seat interferes with the child restraint system and prevents it from being attached correctly, attach the child restraint system to the right-hand rear seat.
- Adjust the front passenger seat so that it does not interfere with the child restraint system.



### Child restraint system fixed with a seat belt

A child restraint system for a small child or baby must itself be properly restrained on the seat with the lap/shoulder belt.

#### ◆ Installing child restraint system using a seat belt (child restraint lock function belt)

Install the child restraint system in accordance to the operation manual enclosed with the child restraint system.

#### ■ Rear-facing – Infant seat/convertible seat

##### 1 Adjust the rear seat

If there is a gap between the child seat and the seatback, adjust the seatback angle until good contact is achieved.

##### 2 Place the child restraint system on the rear seat facing the rear of the vehicle.

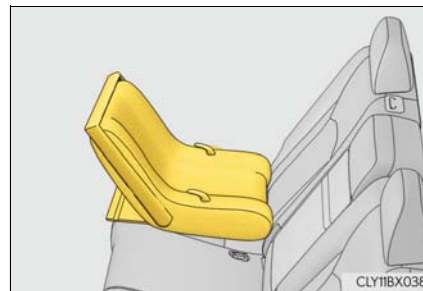

##### 3 Run the seat belt through the child restraint system and insert the plate into the buckle. Make sure that the belt is not twisted.

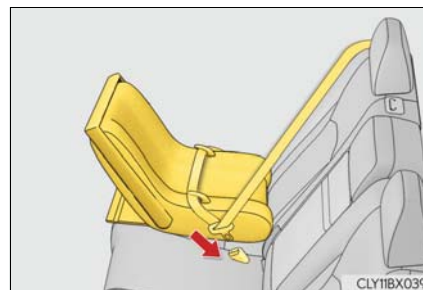

##### 4 Fully extend the shoulder belt and allow it to retract to put it in lock mode. In lock mode, the belt cannot be extended.

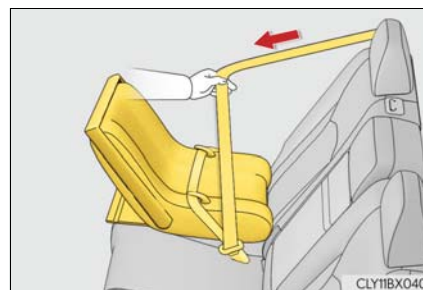

- 5 While pushing the child restraint system down into the rear seat, allow the shoulder belt to retract until the child restraint system is securely in place.

After the shoulder belt has retracted to a point where there is no slack in the belt, pull the belt to check that it cannot be extended.

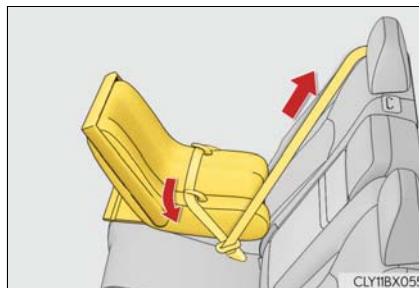

- 6 After installing the child restraint system, rock it back and forth to ensure that it is installed securely. (→P. 66)

■ Forward-facing – Convertible seat

- 1 Adjust the seat

- ▶ When using the front passenger seat

If installing the child restraint system to the front passenger seat is unavoidable, refer to P. 59 for the front passenger seat adjustment.

- ▶ When using the rear seat

If there is a gap between the child seat and the seatback, adjust the seat-back angle until good contact is achieved.

- 2 Remove the head restraint if it interferes with your child restraint system. (→P. 177)

If the head restraint cannot be removed, raise it to the uppermost position.

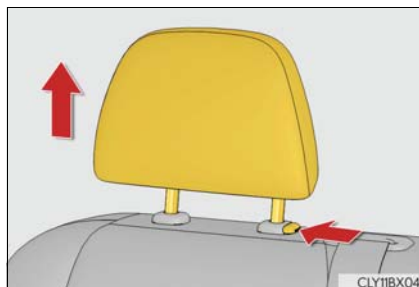

- 3 Place the child restraint system on the seat facing the front of the vehicle.



- 4** Run the seat belt through the child restraint system and insert the plate into the buckle. Make sure that the belt is not twisted.



- 5** Fully extend the shoulder belt and allow it to retract to put it in lock mode. In lock mode, the belt cannot be extended.

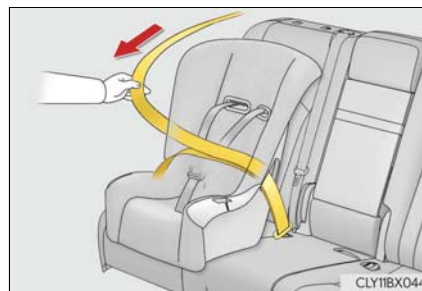

- 6** While pushing the child restraint system into the rear seat, allow the shoulder belt to retract until the child restraint system is securely in place.

After the shoulder belt has retracted to a point where there is no slack in the belt, pull the belt to check that it cannot be extended.



- 7** If the child restraint has a top tether strap, follow the child restraint manufacturer's operation manual regarding the installation, using the top tether strap to latch onto the top tether strap anchor. (→P. 70)
- 8** After installing the child restraint system, rock it back and forth to ensure that it is installed securely. (→P. 66)



■ **Booster seat**

1 If installing the child restraint system to the front passenger seat is unavoidable, refer to P. 59 for the front passenger seat adjustment.

2 High back type: Remove the head restraint if it interferes with your child restraint system. (→P. 177)

If the head restraint cannot be removed, raise it to the uppermost position.

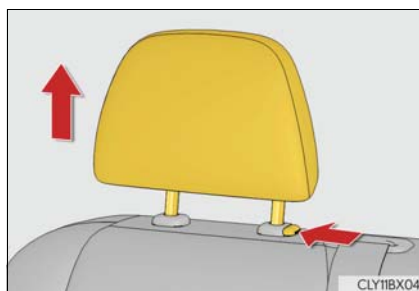

3 Place the child restraint system on the seat facing the front of the vehicle.

▶ **Booster type**



▶ **High back type**



4 Sit the child in the child restraint system. Fit the seat belt to the child restraint system according to the manufacturer's instructions and insert the plate into the buckle. Make sure that the belt is not twisted.

Check that the shoulder belt is correctly positioned over the child's shoulder and that the lap belt is as low as possible. (→P. 32)



**◆ Removing a child restraint system installed with a seat belt**

Press the buckle release button and fully retract the seat belt.

When releasing the buckle, the child restraint system may spring up due to the rebound of the seat cushion. Release the buckle while holding down the child restraint system.

Since the seat belt automatically reels itself, slowly return it to the stowing position.

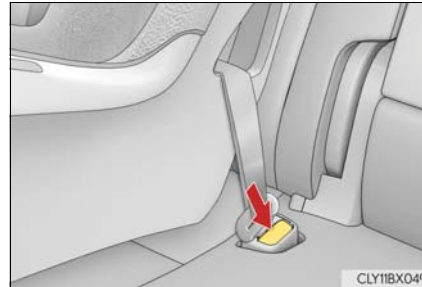

1

For safety and security

 **WARNING****■ When installing a child restraint system**

Observe the following precautions.

Failure to do so may result in death or serious injury.

- Do not allow children to play with the seat belt. If the seat belt becomes twisted around a child's neck, it may lead to choking or other serious injuries that could result in death.  
If this occurs and the buckle cannot be unfastened, scissors should be used to cut the belt.
- Ensure that the belt and plate are securely locked and the seat belt is not twisted.
- Shake the child restraint system left and right, and forward and backward to ensure that it has been securely installed.
- After securing a child restraint system, never adjust the seat.
- When a booster seat is installed, always ensure that the shoulder belt is positioned across the center of the child's shoulder. The belt should be kept away from the child's neck, but not so that it could fall off the child's shoulder.
- Follow all installation instructions provided by the child restraint system manufacturer.
- When securing some types of child restraint systems in rear seats, it may not be possible to properly use the seat belts in positions next to the child restraint without interfering with it or affecting seat belt effectiveness. Be sure your seat belt fits snugly across your shoulder and low on your hips. If it does not, or if it interferes with the child restraint, move to a different position. Failure to do so may result in death or serious injury.
- When installing a child restraint system in the rear center seat, adjust both seat cushions to the same position and align both seatbacks at the same angle. The seatbacks must be adjusted to the same angle. Otherwise, the child restraint system cannot be securely restrained and this may cause death or serious injuries in the event of sudden braking, sudden swerving or an accident.

**■ When installing a booster seat**

To prevent the belt from going into ALR lock mode, do not fully extend the shoulder belt. ALR mode causes the belt to tighten only. This could cause injury or discomfort to the child. (→P. 33)

**■ Do not use a seat belt extender**

If a seat belt extender is used when installing a child restraint system, the seat belt will not securely hold the child restraint system, which could cause death or serious injury to the child or other passengers in the event of sudden braking, sudden swerving or an accident.

### Child restraint system fixed with a child restraint LATCH anchor

#### ■ Child restraint LATCH anchors

LATCH anchors are provided for the outboard rear seats. (Buttons displaying the location of the anchors are attached to the seats.)

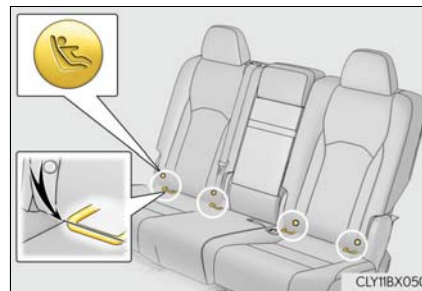

#### ■ When installing in the rear outboard seats

Install the child restraint system in accordance to the operation manual enclosed with the child restraint system.

##### 1 Adjust the seat

If there is a gap between the child seat and the seatback, adjust the seat-back angle until good contact is achieved.

##### 2 Remove the head restraint if it interferes with your child restraint system. (→P. 177)

If the head restraint cannot be removed, raise it to the uppermost position.

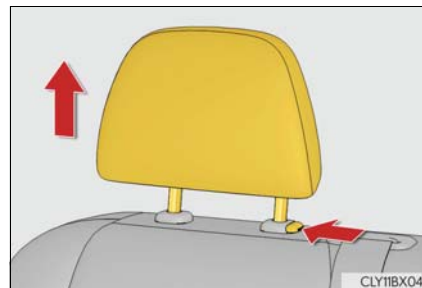

##### 3 Widen the gap between the seat cushion and seatback slightly.

► With flexible lower attachments

- 4** Latch the hooks of the lower straps onto the LATCH anchors.

For owners in Canada:  
The symbol on a child restraint system indicates the presence of a lower connector system.

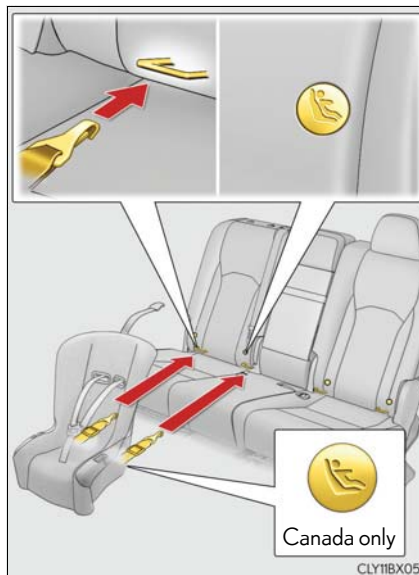

► With rigid lower attachments

- 4** Latch the buckles onto the LATCH anchors.

For owners in Canada:  
The symbol on a child restraint system indicates the presence of a lower connector system.

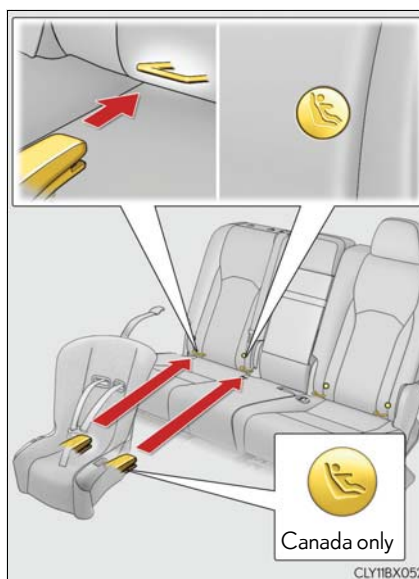

- 5** If the child restraint has a top tether strap, follow the child restraint manufacturer's operation manual regarding the installation, using the top tether strap to latch onto the top tether strap anchor. (→P. 70)

- 6 After installing the child restraint system, rock it back and forth to ensure that it is installed securely. (→P. 66)

■ **When installing in the rear center seat**

There are no LATCH anchors behind the rear center seat. However, the inboard LATCH anchors of the outboard seats, which are 18.1 in. (460 mm) apart, can be used if the child restraint system manufacturer's instructions permit use of those anchors with the anchor spacing stated.

Child restraint systems with rigid lower attachments cannot be installed in the center seat. This type of child restraint system can only be installed in the outboard seat.

■ **Laws and regulations pertaining to anchors**

The LATCH system conforms to FMVSS225 or CMVSS210.2.

Child restraint systems conforming to FMVSS213 or CMVSS213 specifications can be used.

This vehicle is designed to conform to SAE J1819.

 **WARNING**

■ **When installing a child restraint system**

Observe the following precautions.

Failure to do so may result in death or serious injury.

- When using the LATCH anchors, be sure that there are no foreign objects around the anchors and that the seat belt is not caught behind the child restraint system.
- Follow all installation instructions provided by the child restraint system manufacturer.
- Never attach two child restraint system attachments to the same anchor. In a collision, one anchor may not be strong enough to hold two child restraint system attachments and may break.  
If the LATCH anchors are already in use, use the seat belt to install a child restraint system in the center seat.
- When securing some types of child restraint systems in rear seats, it may not be possible to properly use the seat belts in positions next to the child restraint without interfering with it or affecting seat belt effectiveness. Be sure your seat belt fits snugly across your shoulder and low on your hips. If it does not, or if it interferes with the child restraint, move to a different position. Failure to do so may result in death or serious injury.
- When installing a child restraint system in the rear center seat, adjust both seat cushions to the same position and align both seatbacks at the same angle. The seatbacks must be adjusted to the same angle. Otherwise, the child restraint system cannot be securely restrained and this may cause death or serious injuries in the event of sudden braking, sudden swerving or an accident.
- If the seat is adjusted, reconfirm the security of the child restraint system.

### Using an anchor bracket (for top tether strap)

#### ■ Anchor brackets (for top tether strap)

Anchor brackets are provided for the following seats:

- ▶ Bench-type second-row seats
- ▶ Separate-type second-row seats

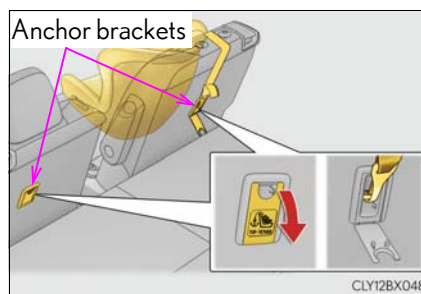
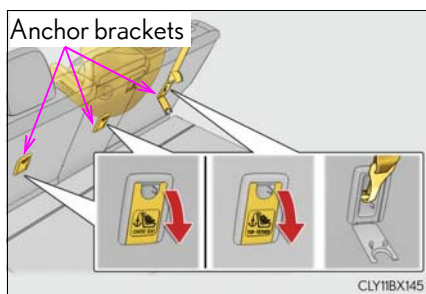

- ▶ Third-row left side seat

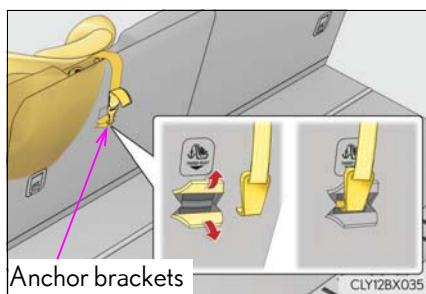

### ■ Fixing the top tether strap to the anchor bracket (second-row seats)

Install the child restraint system in accordance to the operation manual enclosed with the child restraint system.

- 1 Remove the head restraint if it interferes with your child restraint system. (→P. 177)

If the head restraint cannot be removed, raise it to the uppermost position.

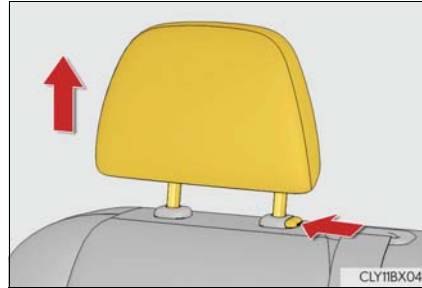

- 2 Open the anchor bracket cover, latch the hook onto the anchor bracket and tighten the top tether strap.

Make sure the top tether strap is securely latched. (→P. 66)

When installing the child restraint system with the head restraint being raised, be sure to have the top tether strap pass underneath the head restraint.

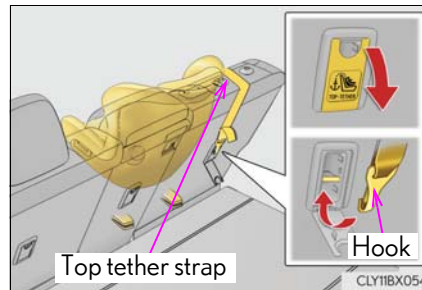



### ■ Fixing the top tether strap to the anchor bracket (third-row left side seat)

Install the child restraint system in accordance to the operation manual enclosed with the child restraint system.

- 1 Remove the head restraint if it interferes with your child restraint system. (→P. 177)

If the head restraint cannot be removed, raise it to the uppermost position.

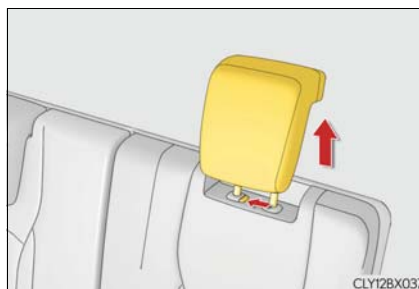

- 2 Latch the hook onto the anchor bracket and tighten the top tether strap.

Make sure the top tether strap is securely latched. (→P. 66)

When installing the child restraint system with the head restraint being raised, be sure to have the top tether strap pass underneath the head restraint.

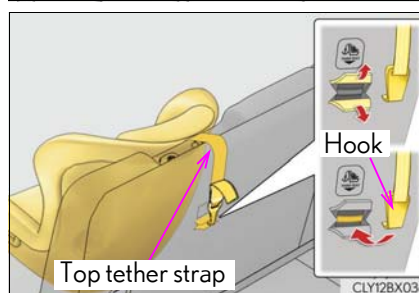

### ■ Laws and regulations pertaining to anchors

The LATCH system conforms to FMVSS225 or CMVSS210.2.

Child restraint systems conforming to FMVSS213 or CMVSS213 specifications can be used.

This vehicle is designed to conform to SAE J1819.

 **WARNING****■ When installing a child restraint system**

Observe the following precautions.

Failure to do so may result in death or serious injury.

- Firmly attach the top tether strap and make sure that the belt is not twisted.
- Do not attach the top strap to anything other than the anchor bracket of the seat the child restraint system is installed to.
- Follow all installation instructions provided by the child restraint system manufacturer.
- When installing the child restraint system with the head restraint being raised, after the head restraint has been raised and then the anchor bracket has been fixed, do not lower the head restraint.
- When installing a child restraint system in the rear center seat, adjust both seat cushions to the same position and align both seatbacks at the same angle. The seatbacks must be adjusted to the same angle. Otherwise, the child restraint system cannot be securely restrained and this may cause death or serious injuries in the event of sudden braking, sudden swerving or an accident.
- If the seat is adjusted, reconfirm the security of the child restraint system.

 **NOTICE****■ Anchor brackets (for top tether strap)**

When not in use, make certain to close the lid. If it remains open, the lid may be damaged.

## Engine immobilizer system

The vehicle's keys have built-in transponder chips that prevent the engine from starting if a key has not been previously registered in the vehicle's on-board computer.

Never leave the keys inside the vehicle when you leave the vehicle.

This system is designed to help prevent vehicle theft but does not guarantee absolute security against all vehicle thefts.

The indicator light flashes after the engine switch has been turned off to indicate that the system is operating.

The indicator light stops flashing after the engine switch has been turned to ACCESSORY or IGNITION ON mode to indicate that the system has been canceled.

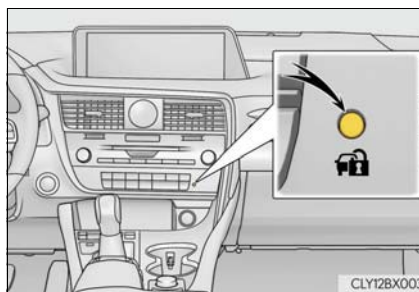

### ■ System maintenance

The vehicle has a maintenance-free type engine immobilizer system.

### ■ Conditions that may cause the system to malfunction

- If the grip portion of the key is in contact with a metallic object
- If the key is in close proximity to or touching a key registered to the security system (key with a built-in transponder chip) of another vehicle

**■ Certification for the engine immobilizer system**

- ▶ For vehicles sold in the U.S.A.

FCC ID: NI4TMIMB-3

This device complies with part 15 of the FCC Rules. Operation is subject to the following two conditions: (1) This device may not cause harmful interference, and (2) this device must accept any interference received, including interference that may cause undesired operation.

Changes or modifications not expressly approved by the party responsible for compliance could void the user's authority to operate the equipment.

FCC ID: NI4TMIMB-3

This device complies with part 15 of the FCC Rules. Operation is subject to the following two conditions: (1) This device may not cause harmful interference, and (2) this device must accept any interference received, including interference that may cause undesired operation.

Changes or modifications not expressly approved by the party responsible for compliance could void the user's authority to operate the equipment.

FCC ID: NI4TMIMB-3

This device complies with part 15 of the FCC Rules. Operation is subject to the following two conditions: (1) This device may not cause harmful interference, and (2) this device must accept any interference received, including interference that may cause undesired operation.

Changes or modifications not expressly approved by the party responsible for compliance could void the user's authority to operate the equipment.

- ▶ For vehicles sold in Canada

This device complies with Industry Canada's licence-exempt RSSs. Operation is subject to the following two conditions: (1) This device may not cause interference; and (2) This device must accept any interference, including interference that may cause undesired operation of the device.

Le présent appareil est conforme aux CNR d'Industrie Canada applicables aux appareils radio exempts de licence. L'exploitation est autorisée aux deux conditions suivantes : (1) l'appareil ne doit pas produire de brouillage; (2) l'utilisateur de l'appareil doit accepter tout brouillage radioélectrique subi, même si le brouillage est susceptible d'en compromettre le fonctionnement.

This device complies with Industry Canada's licence-exempt RSSs. Operation is subject to the following two conditions: (1) This device may not cause interference; and (2) This device must accept any interference, including interference that may cause undesired operation of the device.

Le présent appareil est conforme aux CNR d'Industrie Canada applicables aux appareils radio exempts de licence. L'exploitation est autorisée aux deux conditions suivantes : (1) l'appareil ne doit pas produire de brouillage; (2) l'utilisateur de l'appareil doit accepter tout brouillage radioélectrique subi, même si le brouillage est susceptible d'en compromettre le fonctionnement.

#### WARNING

##### ■ Certifications for the engine immobilizer system

Changes or modifications not expressly approved by the party responsible for compliance could void the user's authority to operate the equipment.

#### NOTICE

##### ■ To ensure the system operates correctly

Do not modify or remove the system. If modified or removed, the proper operation of the system cannot be guaranteed.

## Alarm

### The alarm

The alarm uses light and sound to give an alert when an intrusion is detected.

The alarm is triggered in the following situations when the alarm is set:

- A locked door is unlocked or opened in any way other than using the entry function, wireless remote control or mechanical key. (The doors will lock again automatically.)
- The hood is opened.

### Setting the alarm system

Close the doors and hood, and lock all the doors. The system will be set automatically after 30 seconds.

The indicator light changes from being on to flashing when the system is set.

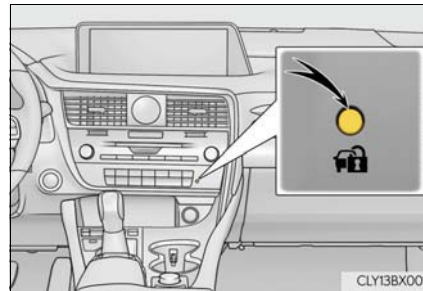

### Deactivating or stopping the alarm

Do one of the following to deactivate or stop the alarms:

- Unlock the doors.
- Turn the engine switch to ACCESSORY or IGNITION ON mode, or start the engine. (The alarm will be deactivated or stopped after a few seconds.)

#### ■ System maintenance

The vehicle has a maintenance-free type alarm system.

#### ■ Items to check before locking the vehicle

To prevent unexpected triggering of the alarm and vehicle theft, make sure of the following:

- Nobody is in the vehicle.
- The windows and moon roof or panoramic moon roof are closed before the alarm is set.
- No valuables or other personal items are left in the vehicle.

■ **Triggering of the alarm**

The alarm may be triggered in the following situations:  
(Stopping the alarm deactivates the alarm system.)

- A person inside the vehicle opens a door or hood, or unlocks the vehicle.



- The battery is recharged or replaced when the vehicle is locked. (→P. 689)

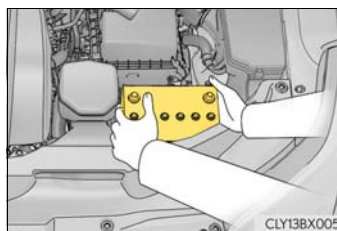

■ **Alarm-operated door lock**

In the following cases, depending on the situation, the door may automatically lock to prevent improper entry into the vehicle:

- When a person remaining in the vehicle unlocks the door and the alarm is activated.
- While the alarm is activated, a person remaining in the vehicle unlocks the door.
- When recharging or replacing the battery

 **NOTICE**

■ **To ensure the system operates correctly**

Do not modify or remove the system. If modified or removed, the proper operation of the system cannot be guaranteed.

## Instrument cluster

## 2

**2. Instrument cluster**

Warning lights and indicators .....	80
Gauges and meters .....	86
Multi-information display .....	90
Head-up display .....	108
Fuel consumption information .....	114



## Warning lights and indicators

The warning lights and indicators on the instrument cluster, center panel and outside rear view mirrors inform the driver of the status of the vehicle's various systems.

For the purpose of explanation, the following illustrations display all warning lights and indicators illuminated.

- ▶ Except F SPORT models



- ▶ F SPORT models









The units used on the meter and some indicators may differ depending on the target region.

**Warning lights**

Warning lights inform the driver of malfunctions in any of the vehicle's systems.

<sup>*1</sup>  (U.S.A.)	Brake system warning light (→P. 654)	<sup>*1</sup>  (U.S.A.)	Parking brake indicator (→P. 655)
<sup>*1</sup>  (Canada)	Brake system warning light (→P. 654)	<sup>*1</sup>  (Canada)	Parking brake indicator (→P. 655)
<sup>*1</sup>  (if equipped)	Brake system warning light (→P. 654)	<sup>*1,2</sup> 	Brake hold operated indicator (→P. 655)
<sup>*1</sup>  (if equipped)	Charging system warning light (→P. 654)	<sup>*1</sup> 	Electric power steering system warning light (→P. 655)
<sup>*1</sup>  (U.S.A.)	Malfunction indicator lamp (→P. 654)	<sup>*1</sup> 	Electric power steering system warning light (→P. 655)
<sup>*1</sup>  (Canada)	Malfunction indicator lamp (→P. 654)		LKA indicator (→P. 655)
<sup>*1</sup> 	SRS warning light (→P. 654)	<sup>*1</sup> 	Slip indicator (→P. 655)
<sup>*1</sup>  (U.S.A.)	ABS warning light (→P. 654)	<sup>*1,3</sup> 	PCS warning light (→P. 656)
<sup>*1</sup>  (Canada)	ABS warning light (→P. 654)	<sup>*1,2</sup>  (if equipped)	ICS OFF indicator (→P. 656)

	Low fuel level warning light (→P. 656)		Rear passengers' seat belt reminder light (→P. 656)
	Driver's and front passenger's seat belt reminder light (→P. 656)		Tire pressure warning light (→P. 656)
	Rear passengers' seat belt reminder light (→P. 656)		Master warning light (→P. 657)

\*1: These lights turn on when the engine switch is turned to IGNITION ON mode to indicate that a system check is being performed. They will turn off after the engine is started, or after a few seconds. There may be a malfunction in a system if a light does not come on, or turn off. Have the vehicle inspected by your Lexus dealer.

\*2: This light flashes to indicate a malfunction.

\*3: This light flashes or illuminates to indicate a malfunction.











\*4: This light illuminates on the center panel.





















\*5: RX350

\*6: RX350L

### Indicators

The indicators inform the driver of the operating state of the vehicle's various systems.

	Turn signal indicator (→P. 246)		Fog light indicator (→P. 260)
	Headlight indicator (→P. 252) (U.S.A.)		Cruise control indicator (→P. 300)
	Tail light indicator (→P. 252) (Canada)		Radar cruise control indicator (→P. 300)
	Headlight high beam indicator (→P. 253)		Cruise control "SET" indicator (→P. 300)
	Automatic High Beam indicator (→P. 256)		LKA indicator (→P. 291)

	LKA indicator (→P. 291)		Parking brake indicator (→P. 247, 248) (U.S.A.)
<sup>*4</sup> 	LKA indicator (→P. 291)		Parking brake indicator (→P. 247, 248) (Canada)
	Intuitive parking assist indicator (→P. 326) (if equipped)	<sup>*1</sup> 	Brake hold standby indicator (→P. 250)
<sup>*1,5</sup> 	ICS OFF indicator (→P. 339) (if equipped)	<sup>*1</sup> 	Brake hold operated indicator (→P. 250)
	"BSM" indicator (→P. 313) (if equipped)	<sup>*1</sup> 	Eco Driving Indicator Light (→P. 105)
	"RCTA" indicator (→P. 313) (if equipped)	<sup>*6</sup> 	Security indicator (→P. 74, 77)
<sup>*2,3</sup> 	BSM outside rear view mirror indicators (→P. 313) (if equipped)	<sup>*1</sup> 	All-wheel drive lock indicator (→P. 377) (AWD models only)
<sup>*1,4</sup> 	Slip indicator (→P. 380)	<sup>*7</sup> 	Low outside temperature indicator (→P. 86)
<sup>*1,5</sup> 	VSC OFF indicator (→P. 381)	<sup>*1,6</sup> 	"AIR BAG ON/OFF" indicator (→P. 47) (U.S.A.)
<sup>*1,5</sup> 	PCS warning light (→P. 284)	<sup>*1,6</sup> 	"AIR BAG ON/OFF" indicator (→P. 47) (Canada)

● Drive mode indicators

▶ Except F SPORT models



Eco drive mode indicator  
(→P. 373)



“SPORT” indicator  
(→P. 373)

▶ F SPORT models



Eco drive mode indicator  
(→P. 373)



“SPORT S” indicator  
(→P. 373)



“SPORT S+” indicator  
(→P. 373)



“CUSTOMIZE” indicator  
(→P. 373)

\*1: These lights turn on when the engine switch is turned to the IGNITION ON mode to indicate that a system check is being performed. They will turn off after the engine is started, or after a few seconds. There may be a malfunction in a system if a light does not come on, or turn off. Have the vehicle inspected by your Lexus dealer.

\*2: In order to confirm operation, the BSM outside rear view mirror indicators illuminate in the following situations:

- When the BSM function is enabled on  of the multi-information display, the engine switch is turned to IGNITION ON mode.
- When the engine switch is in IGNITION ON mode, the BSM function is enabled on  of the multi-information display.

If the system is functioning correctly, the BSM outside rear view mirror indicators will turn off after a few seconds.

If the BSM outside rear view mirror indicators do not illuminate or do not turn off, there may be a malfunction in the system.

If this occurs, have the vehicle inspected by your Lexus dealer.

\*3: This light illuminates on the outside rear view mirrors.

\*4: This light flashes to indicate that the system is operating.

\*5: The light comes on when the system is turned off.

\*6: This light illuminates on the center panel.

\*7: When the outside temperature is approximately 37°F (3°C) or lower, this indicator will flash for approximately 10 seconds, then stay on.

 **WARNING****■ If a safety system warning light does not come on**

Should a safety system light such as the ABS and SRS warning lights not come on when you start the engine, this could mean that these systems are not available to help protect you in an accident, which could result in death or serious injury. Have the vehicle inspected by your Lexus dealer immediately if this occurs.

## Gauges and meters

► Except F SPORT models

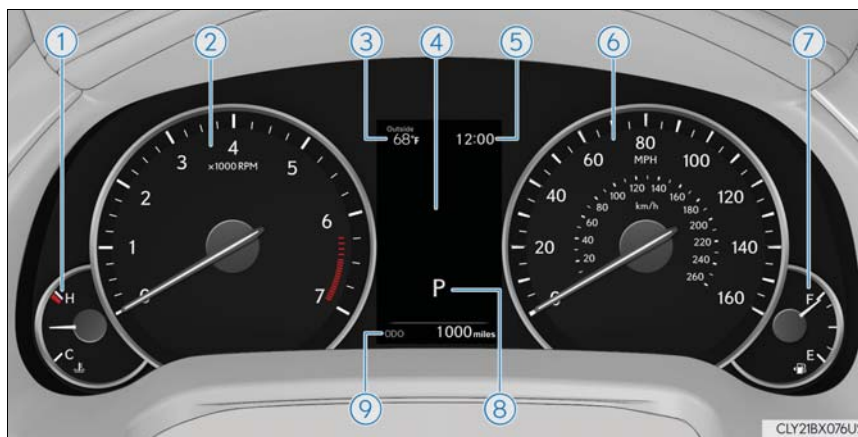

► F SPORT models

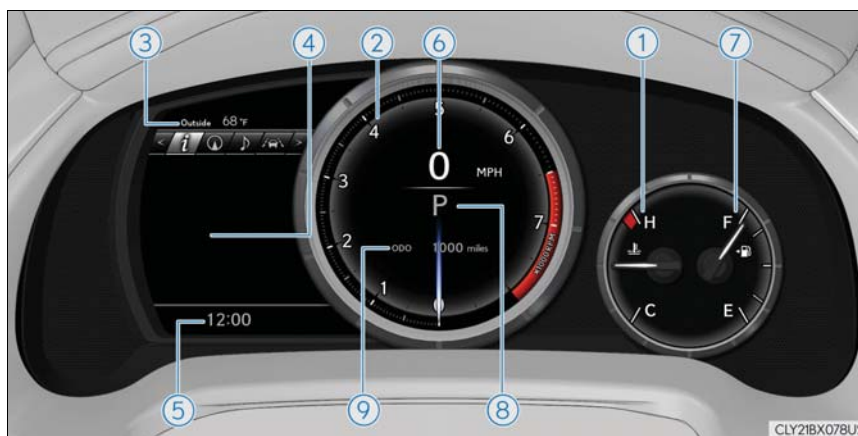

The units used on the meters may differ depending on the target region.

- ① Engine coolant temperature gauge  
Displays the engine coolant temperature
- ② Tachometer  
Displays the engine speed in revolutions per minute  
F SPORT models: When sport mode is selected for the driving mode, the periphery of the tachometer will change color and the scale of the tachometer will be emphasized.
- ③ Outside temperature  
Displays the outside temperature within the range of -40°F (-40°C) to 122°F (50°C). Low outside temperature indicator comes on when the ambient temperature is 37°F (3°C) or lower.
- ④ Multi-information display  
Presents the driver with a variety of vehicle data (→P. 90)  
Displays warning messages in case of a malfunction (→P. 661)
- ⑤ Clock  
Vehicles with a navigation system:  
Time displayed is linked to the analog clock on the instrument panel. (→P. 544)  
Vehicles with a Lexus Display Audio system:  
Time displayed on the clock can be adjusted on  of the multi-information display. (→P. 97)
- ⑥ Speedometer
- ⑦ Fuel gauge
- ⑧ Shift position display (→P. 236, 240)
- ⑨ Odometer and trip meter (→P. 104)



■ Rev indicator (F SPORT models)

When the engine speed reaches a set speed, a ring-shaped indicator will be displayed on the tachometer.

The desired engine speed at which the Rev indicator will begin to be displayed can be set on  of the multi-information display. (→P. 97)



■ Rev peak (F SPORT models)

The engine speed reaches or exceeds 5000 rpm, an afterimage of the tachometer will be displayed at the highest engine speed for approximately 1 second.



**Instrument panel light control**

The brightness of the instrument panel lights can be adjusted.

① Darker

② Brighter

- The brightness of the instrument panel lights can be adjusted individually for day mode and night mode\*.
- If the brightness is adjusted when the surroundings are bright and the tail lights are on (day mode brightness adjustment), the brightness level of night mode will be adjusted at the same time.

\*: Day mode and night mode: →P. 89

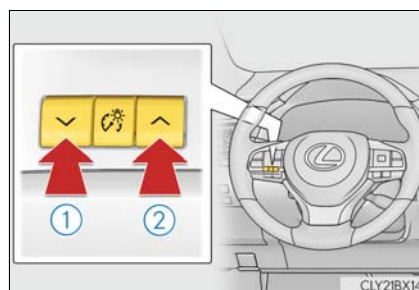

■ **The meters and display illuminate when**

The engine switch is in IGNITION ON mode.

■ **Brightness of the meters (day mode and night mode)**

The brightness of the meters is changed between day mode and night mode.

- Day mode: When the tail lights are off or when the tail lights are on but the surrounding area is bright
- Night mode: When the tail lights are on and the surrounding area is dark

■ **Outside temperature display**

● In the following situations, the correct outside temperature may not be displayed, or the display may take longer than normal to change:

- When stopped, or driving at low speeds (less than 12 mph [20 km/h])
- When the outside temperature has changed suddenly (at the entrance/exit of a garage, tunnel, etc.)

● When “-” or “E” is displayed, the system may be malfunctioning.  
Take your vehicle to your Lexus dealer.

■ **Clock settings screen (vehicles with a navigation system only)**

If the clock adjustment screen is displayed continuously when attempting to change the clock settings, the system may be malfunctioning.  
Have the vehicle inspected by your Lexus dealer.

■ **Customization**

Some functions can be customized. (→P. 97)



**NOTICE**

■ **To prevent damage to the engine and its components**

- Do not let the indicator needle of the tachometer enter the red zone, which indicates the maximum engine speed.
- The engine may be overheating if the engine coolant temperature gauge is in the red zone (H). In this case, immediately stop the vehicle in a safe place, and check the engine after it has cooled completely. (→P. 692)

## Multi-information display

### Summary of functions

The multi-information display presents the driver with a variety of driving-related data, such as the current outside temperature. The multi-information display can also be used to change the display settings and other settings.

▶ Except F SPORT models

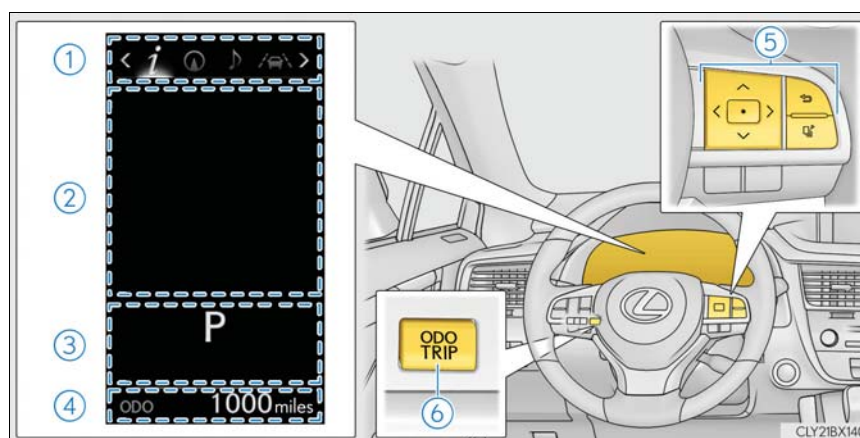

#### ① Menu icon display area

Displays the following items.

When a menu icon is not selected, the outside temperature and clock are displayed.

- Menu icons (→P. 93)
- Outside temperature (→P. 86)
- Clock (→P. 86)

#### ② Content display area

A variety of information can be displayed by selecting a menu icon. Additionally, warning or suggestion/advice pop-up displays will be displayed in some situations.

- Menu icon content (→P. 93)
- Suggestion function (→P. 105)
- Warning message (→P. 661)

#### ③ Indicator/shift position display area

Displays the following items:

- Indicators (→P. 80)
- Shift position display (→P. 236, 240)

## ④ Odometer/trip meter display area (→P. 104)

Displays the following items:

- Odometer/trip meter
-  Distance until next engine oil change

## ⑤ Meter control switches (→P. 92)

## ⑥ “ODO/TRIP” switch (→P. 93)

- ▶ F SPORT models

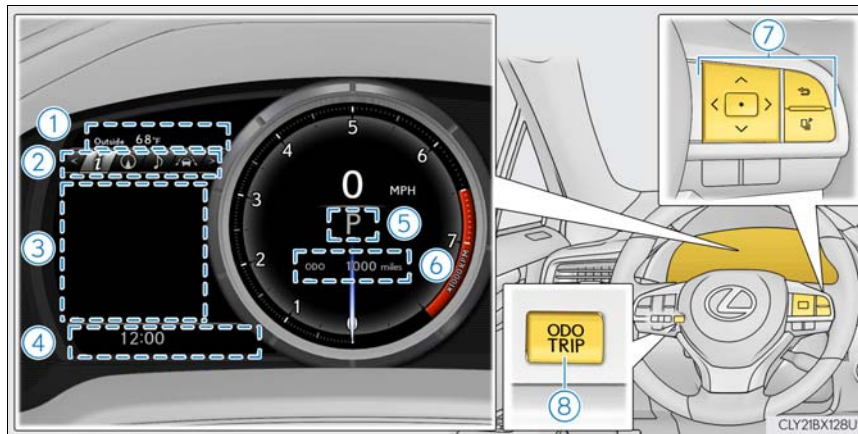

2

Instrument cluster

## ① Outside temperature (→P. 86)

## ② Menu icons (→P. 93)

## ③ Content display area

A variety of information can be displayed by selecting a menu icon. Additionally, warning or suggestion/advice pop-up displays will be displayed in some situations.

- Menu icon content (→P. 93)
- Suggestion function (→P. 105)
- Warning message (→P. 661)

## ④ Indicators/clock

- Indicators (→P. 80)
- Clock (→P. 86)

## ⑤ Shift position display (→P. 236, 240)

## ⑥ Odometer/trip meter display area (→P. 104)

Displays the following items:

- Odometer/trip meter
-  Distance until next engine oil change

## ⑦ Meter control switches (→P. 92)



## ⑧ “ODO/TRIP” switch (→P. 93)

## Using the multi-information display

### ◆ Using the content display area

The content display area is operated using the meter control switches.

①   : Select menu icons

  : Change displayed content, scroll up/down the screen and move the cursor

② Press: Enter/Set

Press and hold: Reset

③ Return to the previous screen

Pressing and holding the switch will display the first screen of the selected menu icon.

④ Press: Display the top screen

Press and hold: Register current screen as the top screen

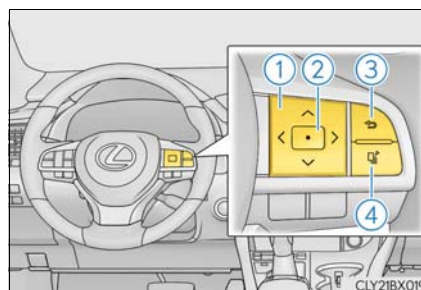



### ■ Registering a top screen

The displayed top screen can be changed to a registered screen of your choice.

To register a screen as the top screen, display the desired screen and press and hold .

- A message asking to confirm if registration is desired will be displayed. If the selected screen cannot be registered, a registration failure message will be displayed.
- When no screen has been registered, the drive information screen will be displayed.

### ■ Resetting drive information

To reset the average fuel economy (after reset)/average vehicle speed (after reset)/elapsed time (after reset) that are displayed on , display the desired item and press and hold .

If both of the displayed items are resettable, a message will be displayed asking which item(s) to reset.

### ◆ Using the odometer/trip meter display area

Items in this area are operated using the “ODO/TRIP” switch.

Press: Change displayed item

Each time the switch is pressed, the displayed item will be changed.

Press and hold: Reset

Display the desired trip meter and press and hold the switch to reset the trip meter.

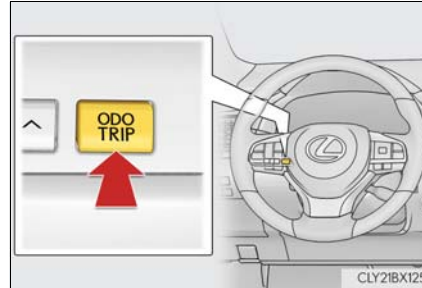

2

### Menu icons

Select a menu icon to display its content.



Drive information (→P. 94)

Select to display various drive data.



Navigation system-linked display (if equipped)

Select to display the following navigation system-linked information.

- Route guidance
- Compass display (heading-up display)



Audio system-linked display

Select to enable selection of an audio source or track on the meter using the meter control switches.



Driving assist system information

Select to display the operational status of the following systems:

- Dynamic radar cruise control with full-speed range (→P. 300)
- LKA (Lane-Keeping Assist) (→P. 291)



Warning message display (→P. 661)

Select to display warning messages and measures to be taken if a malfunction is detected.



Settings display (→P. 97)

Select to change the meter display settings and other settings.

## Drive information

### ■ Drive information 1/Drive information 2/Drive information 3

Displays drive information such as the following:

- Drive information 1
  - Current fuel consumption
  - Average fuel economy (after reset)
- Drive information 2
  - Distance (driving range)
  - Average vehicle speed (after reset)
- Drive information 3
  - Average fuel economy (after refuel)
  - Elapsed time (after start)

Displayed items (listed below) can be changed on . (→P. 97)

Item		Content
Current fuel consumption		Displays instantaneous current fuel consumption
Average fuel economy	After reset	Displays average fuel consumption since the display was reset <sup>*1,2</sup>
	After start	Displays average fuel consumption since engine start <sup>*2</sup>
	After refuel	Displays average fuel consumption since refuel <sup>*2,3</sup>
Average vehicle speed	After reset	Displays average vehicle speed since the display was reset <sup>*1</sup>
	After start	Displays average vehicle speed since engine start
Elapsed time	After reset	Displays elapsed time since the display was reset <sup>*1</sup>
	After start	Displays elapsed time since engine start
Distance	Driving range	Displays driving range with remaining fuel <sup>*3,4</sup>
	After start	Displays drive distance since vehicle start
Other	Blank	No item

- \*1: Resetting: →P. 92
- \*2: Use the displayed fuel consumption as a reference.
- \*3: When only a small amount of fuel is added to the tank, the display may not be updated.  
When refueling, turn the engine switch off. If the vehicle is refueled without turning the engine switch off, the display may not be updated.
- \*4: This distance is computed based on your average fuel consumption. As a result, the actual distance that can be driven may differ from that displayed.

#### ■ Eco Driving Indicator

→P. 105

#### ■ Sway warning

Detects the sway of the vehicle within a lane, which is often associated with a decrease in the driver's attention level, and displays the decrease in attention using a bar display.

The shorter the bar length, the more the driver may need to rest.

This display is a part of the LKA (Lane-Keeping Assist) system. The display is enabled when the operating conditions of the vehicle sway warning are met.  
(→P. 291)

#### ■ AWD Control (if equipped)

Displays the driving force applied to each wheel using segments.

The greater the number of segments displayed, the greater the driving force applied.



■ **G-force (if equipped)**

Displays lateral G-forces on the vehicle.

Also displays, around the periphery of the G-force display, the left and right steering amount, accelerator pedal input, and brake fluid pressure.

- ① Acceleration G-force on the vehicle
- ② Current G-force value (analyzed value of front/rear and left/right G-forces)
- ③ Record of the maximum G-forces
- ④ Accelerator pedal input
- ⑤ Brake fluid pressure
- ⑥ Steering amount



This display is intended for use as a guideline. Depending on factors such as the road surface condition, temperature and vehicle speed, the display may not show the actual condition of the vehicle.

● **Resetting the record of maximum G-forces**

Press and hold  to reset the record.

● **Peak hold function**

If lateral G-forces of 0.5 G or greater are generated, the G-force value display will turn amber and be held for 2 seconds.

■ **Tire pressure**

→P. 605

■ **Units (if equipped)**

The units of measure used can be changed while driving.

Unlike the units setting performed on , the units setting performed on  can be changed while driving.

■ **Blank (No items)**

Displays no drive information contents.

## Settings display (⚙️)

### ◆ Changing settings



Use the meter control switches on the steering wheel to change settings.

- 1 Press < or > to select ⚙️.
- 2 Operate the switches to select a desired item.
- 3 Change the setting by referring to the message displayed on the screen.

### ◆ Setting items

#### ■ 🚗 LKA (Lane-Keeping Assist) (→P. 291)

The following LKA system settings can be changed:



Item	Settings	Details
Lane center tracing	On	Select to enable/disable the lane centering function.*1
	Off	
Steering assist	On	Select to enable/disable steering wheel assistance.*2
	Off	
Alert		Select to set a vibrator or buzzer as the notification method used to warn the driver.
		
Alert sensitivity	High	Select to set the warning sensitivity.
	Normal	
Sway warning	On	Select to enable/disable the vehicle sway warning.
	Off	
Sway sensitivity	High	Select to set the vehicle sway warning sensitivity.
	Medium	
	Low	

\*1: If the lane centering function is enabled/disabled, steering wheel assistance will also be enabled/disabled accordingly.

\*2: If the steering wheel assistance is disabled, lane centering function will also be disabled automatically.

■  **PCS (Pre-Collision System) (→P. 281)**

The following pre-collision system settings can be changed:

Item	Settings	Details
PCS	On	Select to enable/disable the pre-collision system.
	Off	
Warning sensitivity		Select to change the warning timing.
		
		

■  **BSM (Blind Spot Monitor) (if equipped) (→P. 313)**

The following Blind Spot Monitor settings can be changed:

Item	Settings	Details
BSM	On	Select to enable/disable the Blind Spot Monitor function.
	Off	
RCTA *	On	Select to enable/disable the Rear Cross Traffic Alert function.
	Off	

\*: The Rear Cross Traffic Alert function can be enabled/disabled only when the Blind Spot Monitor function is enabled.

■  **Intuitive parking assist (if equipped) (→P. 326)**



Item	Settings	Details
Intuitive parking assist	On	Select to enable/disable the intuitive parking assist.
	Off	

■  ICS (Intelligent Clearance Sonar) (if equipped) (→P. 336)

Item	Settings	Details
ICS	On	Select to enable/disable the Intelligent Clearance Sonar system.
	Off	

■ HUD (Head-up display) (if equipped) (→P. 108)

The following head-up display settings can be changed:

Item	Settings	Details
Brightness/Position		Select to adjust the brightness/position of the head-up display. <ul style="list-style-type: none"> <li>• Press the  switch to adjust the display brightness.</li> <li>• Press the  switch to adjust the display position.</li> </ul>
Gauge information	No display	Select to set the content displayed on the head-up display.
	Eco Driving Indicator	
	Tachometer	
Driving support	Navigation system (if equipped)	Select to enable/disable head-up display content.
	Driving Assist (if equipped)	
	Compass (if equipped)	
	Audio system	

■ **Clock (on the multi-information display) (→P. 86)**





- ▶ Vehicles with a navigation system

The following clock setting can be changed:

Item	Settings	Details
Display mode	12-hour display	Select to set the display mode of the clock.
	24-hour display	







- ▶ Vehicles with a Lexus Display Audio system

The following clock settings can be changed:

Press the  /  switch to select an item and then press the  /  switch to change the setting or adjust the time.



Item	Settings	Details
Display mode	12-hour display	Select to set the display mode of the clock.
	24-hour display	
Adjust time		Select to adjust the hour/minute.

### ■ Vehicle settings

Item	Settings	Details
 <b>PBD (Power back door) (→P. 130)</b> The following power back door settings can be changed:		
System settings	All On	Select to enable the power back door system.
	Touchless Sensor Off (if equipped)	Select to disable the touchless sensor. (Other power back door functions remain enabled.)
	All Off	Select to disable the power back door system.
Open position adjustment	 5	Select to set the open position at which the power back door will stop when opened automatically.
	 4	
	 3	
	 2	
	 1	
Volume	3 (Loud)	Select to set the volume of the buzzer which sounds when the power back door is operated.
	2 (Medium)	
	1 (Low)	
<b>TPMS (Tire pressure warning system) (→P. 605)</b>		
Tire pressure warning system initialization		Select to initialize the tire pressure warning system. To perform initialization, press and hold the  switch. Before performing initialization, make sure to adjust the inflation pressure of each tire to the specified level. (→P. 606)

Item	Settings	Details
<b>Scheduled maintenance (U.S.A. only)</b>		
Maintenance data reset		Select to reset the message indicating maintenance is required, after the required maintenance is performed. (→P. 585)
<b>Oil maintenance</b>		
Engine oil maintenance data reset		Select to reset the engine oil maintenance information (message indicating maintenance is required and distance until the next oil change) after engine oil maintenance is performed. (→P. 597)

■ Meter settings

Item	Settings	Details
Language		Select to change the language displayed.
Units		Select to change the units of measure displayed.
 (Eco Driving Indicator Light)	On Off	Select to enable/disable the Eco Driving Indicator Light. (→P. 105)
 Switch settings		Select to display how to change the top screen.
Drive information 1		Select to select up to 2 items that will be displayed on each Drive information screen (Drive information 1 screen, Drive information 2 screen, and Drive information 3 screen) respectively. (Selectable items: →P. 94)
Drive information 2		
Drive information 3		

Item	Settings	Details
Pop-up display	Intersection guidance (if equipped)	Select to enable/disable the pop-up display.
	Incoming calls	
	Brightness adjustment	
Color (except F SPORT models)	2 available colors	Select to set the color of the cursor on the multi-information display.
Needle (F SPORT models)	3 available colors	Select to set the tachometer needle color.
Rev indicator (F SPORT models)	On	Select to enable/disable the Rev indicator. (→P. 88)
	Off	
	Rev setting	Select to set the desired engine speed at which the Rev indicator will begin to be displayed. Selectable engine speed range: 2000 rpm to 6500 rpm
Rev peak (F SPORT models)	On	Select to enable/disable the Rev peak. (→P. 88)
	Off	
Default setting		Select to reset the meter display settings to the default setting.



### Odometer/trip meter display area

#### ◆ Display items

##### ■ Odometer

Displays the total distance the vehicle has been driven.

##### ■ Trip meter A/trip meter B

Displays the distance the vehicle has been driven since the meter was last reset. Trip meters A and B can be used to record and display different distances independently.

To reset, display the desired trip meter and press and hold the "ODO/TRIP" switch.

##### ■ Distance until next engine oil change

Displays the distance the vehicle can be driven until an oil change is necessary.

#### ◆ Pop-up display

In some situations the following will be temporarily displayed:

##### ■ Distance until next engine oil change

Displays the distance until the next engine oil change. This display will be displayed in the following situations:

- When the engine switch is turned to IGNITION ON mode.
- When a warning message indicating that oil maintenance should be performed soon or is required is displayed.

### Suggestion function

Displays suggestions to the driver in the following situations. To select a response to a displayed suggestion, use the meter control switches.

The suggestion function can be turned on/off. (Customizable features: →P. 723)

#### ■ Suggestion to enable the power back door

If the power back door system is disabled (setting on  set to off) and the power back door switch on the instrument panel is operated, a suggestion message will be displayed asking if you wish to enable the power back door system. To enable the power back door system, select "Yes".

After enabling the power back door system, press the power back door switch again to open or close the power back door.

#### ■ Suggestion to turn off the headlights

If the headlights are left on for a certain amount of time after the engine switch has been turned off, a suggestion message will be displayed asking if you wish to turn the headlights off. To turn the headlights off, select "Yes".

If a front door is opened after the engine switch is turned off, this suggestion message will not be displayed.

#### ■ Eco Driving Indicator

- ① Eco Driving Indicator Light  
During Eco-friendly acceleration (Eco driving), the Eco Driving Indicator Light will turn on. When the acceleration exceeds the Zone of Eco driving, or when the vehicle is stopped, the light turns off.
- ② Eco Driving Indicator Zone Display  
Suggests the Zone of Eco driving with current Eco driving ratio based on acceleration.
- ③ Eco driving ratio based on acceleration  
If the acceleration exceeds the Zone of Eco driving, the right side of the Eco Driving Indicator Zone Display will illuminate.
- ④ Zone of Eco driving

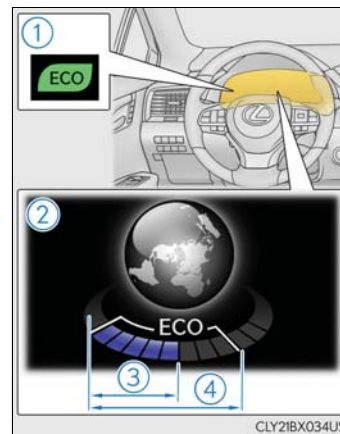

Eco Driving Indicator will not operate under the following conditions:

- The shift lever is in any position other than D.
- A paddle shift switch (if equipped) is operated.
- Sport mode is selected.
- The driving mode is set to customized mode and the powertrain control is set to power (→P. 373)
- The vehicle speed is approximately 80 mph (130 km/h) or higher.

**■ Background color of the indicator/shift position display area (except F SPORT models)**

The background color of the indicator/shift position display area is changed according to the driving mode as follows (→P. 373):

- Eco drive mode: Blue
- Sport mode: Red

**■ G-force display (if equipped)**

- The G-force values may not be zero even when the vehicle is parked, such as when it is parked on an incline.
- Depending on the vehicle usage conditions, the brake fluid pressure display may not reach its maximum reading even though the brake pedal is fully depressed.
- If a battery terminal is disconnected and reconnected, the steering amount display may be disabled temporarily. After driving the vehicle for a while, the display will be enabled.

**■ Suspension of the settings display**

- Some settings cannot be changed while driving. When changing settings, park the vehicle in a safe place.
- If a warning message is displayed, operation of the settings display will be suspended.

**■ Tire pressure**

- It may take a few minutes to display the tire inflation pressure after the engine switch is turned to IGNITION ON mode. It may also take a few minutes to display the tire inflation pressure after inflation pressure has been adjusted.
- “---” may be displayed if the tire position information cannot be determined due to unfavorable radio wave conditions.
- Tire inflation pressure changes with temperature. The displayed values may also be different from the values measured using a tire pressure gauge.

**■ Liquid crystal display**

Small spots or light spots may appear on the display. This phenomenon is characteristic of liquid crystal displays, and there is no problem continuing to use the display.

**■ Customization**

Some functions can be customized. (→P. 97, 722)

 **WARNING****■ Caution for use while driving**

- When operating the multi-information display while driving, pay extra attention to the safety of the area around the vehicle.
- Do not look continuously at the multi-information display while driving as you may fail to see pedestrians, objects on the road, etc. ahead of the vehicle.

**■ The information display at low temperatures**

Allow the interior of the vehicle to warm up before using the liquid crystal information display. At extremely low temperatures, the information display monitor may respond slowly, and display changes may be delayed.

For example, there is a lag between the driver's shifting and the new gear number appearing on the display. This lag could cause the driver to downshift again, causing rapid and excessive engine braking and possibly an accident resulting in death or injury.

**■ Cautions during setting up the display**

As the engine needs to be running during setting up the display, ensure that the vehicle is parked in a place with adequate ventilation. In a closed area such as a garage, exhaust gases including harmful carbon monoxide (CO) may collect and enter the vehicle. This may lead to death or a serious health hazard.

 **NOTICE****■ While setting up the display**

To prevent battery discharge, ensure that the engine is running while setting up the display features.

## Head-up display\*

### Summary of functions

The head-up display is linked to the meters and navigation system (if equipped) and projects a variety of information in front of the driver, such as the current vehicle speed and route guidance to a set destination.

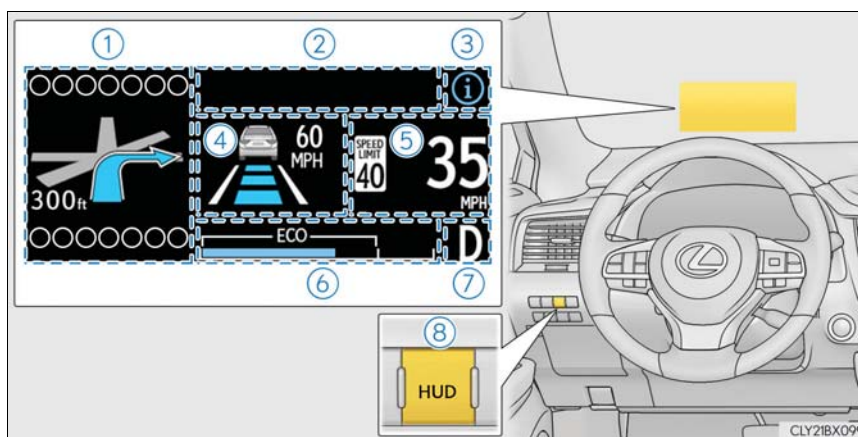

- ① Navigation system-linked display area (if equipped) (→P. 111)

Displays the following items, which are linked to the navigation system:

- Street name
- Route guidance to destination
- Compass

- ② Message display area (→P. 110)

Displays the following items:

- Warning/Message (if equipped)
- Audio system operation status
- Outside temperature

- ③  /  icon (→P. 110)

- ④ Driving assist system status display area (if equipped)

Displays the operational status of the following systems:

- Dynamic radar cruise control with full-speed range (→P. 300)
- LKA (Lane-Keeping Assist) (→P. 291)
- Intuitive parking assist (→P. 326)
- Intelligent Clearance Sonar (ICS) (→P. 336)

Displayed content is the same as that displayed on the multi-information display. For details, refer to the explanations of each system.

\*: If equipped

- ⑤ Vehicle speed display area
  - Displays the following items:
    - Vehicle speed
    - Speed limit (vehicles with a navigation system) (U.S.A. only)
- ⑥ Eco Driving Indicator/Tachometer (→P. 111)
- ⑦ Shift position display (→P. 236, 240)
- ⑧ HUD (Head-up display) switch (→P. 109)

### Using the head-up display

#### ◆ Enabling/Disabling the head-up display

Press the HUD (Head-up display) switch.

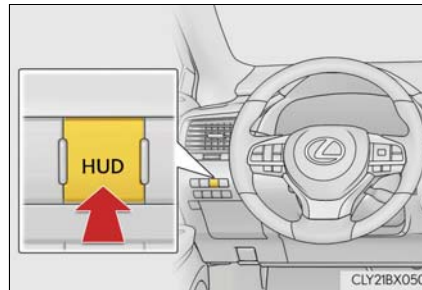

#### ◆ Changing settings of the head-up display

Select  on the multi-information display (→P. 97) to change the following settings:

##### ■ Display brightness/position

Select to adjust the brightness and position of the head-up display.

##### ■ Display content

Select to enable/disable the following items:



- Route guidance to destination (if equipped)
- Driving assist system status (if equipped)
- Compass (if equipped)
- Audio system operation status

##### ■ Eco Driving Indicator/Tachometer

Select to display Eco Driving Indicator/tachometer/no content.

 /  icons

Displays the following multi-information display linked icons:

- : Master warning icon  
Displayed when a warning message is displayed on the multi-information display. (→P. 661)
- : Information icon  
Displayed when a suggestion/advice pop-up display is displayed on the multi-information display. (→P. 105)

**Message display area**

Displays the following items in the appropriate situation:

**■ Warning/Message (if equipped)**

Displays the following system warning/messages:

- Pre-collision warning (pre-collision system)
- Alert from the Intelligent Clearance Sonar system
- Notification message (Dynamic radar cruise control with full-speed range)

**■ Audio system operation status**

Displayed when the audio system is operated.

**■ Outside temperature**

Displayed in the following situations:

- When the engine switch is turned to IGNITION ON mode
- When the low outside temperature indicator is flashing

Displayed content is the same as that displayed on the multi-information display. For details, refer to the explanation of the outside temperature display on the multi-information display. (→P. 86)

### Navigation system-linked display area (if equipped)

Displays the following items which are linked to the navigation system:

#### ■ Street name

The name of the street that the vehicle is currently driving on is displayed on the bottom of the display area.

When the navigation system is performing route guidance, the name of the next street will be displayed on the top of the display area.

#### ■ Route guidance to destination

Displayed when the navigation system is performing route guidance. When approaching an intersection, an arrow will be displayed to indicate the suggested direction of travel.

#### ■ Compass

Displays the direction of travel.

### Eco Driving Indicator/Tachometer

#### ■ Eco Driving Indicator

- ① Eco Driving Indicator Zone Display
- ② Eco driving ratio based on acceleration
- ③ Zone of Eco driving

Displayed content is the same as that displayed on the multi-information display (Eco Driving Indicator). For details, refer to P. 105.

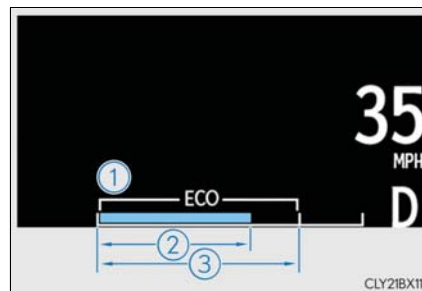

#### ■ Tachometer

Displays the engine speed in revolutions per minute.



■ **Head-up display**

The head-up display may seem dark or hard to see when viewed through sunglasses, especially polarized sunglasses.

Adjust the brightness of the head-up display or remove your sunglasses.

■ **When the battery is disconnected**

The customize settings of the head-up display will be reset.

■ **Display brightness**

The brightness of the head-up display can be adjusted on  of the multi-information display. Also, it is automatically adjusted according to the ambient brightness.

■ **Enabling/disabling of the head-up display**

If the head-up display is disabled, it will remain disabled when the engine switch is turned off then back to IGNITION ON mode.

■ **Automatic adjustment of the head-up display position**

A desired head-up display position can be entered to memory and recalled automatically by the driving position memory system. (→P. 172)

■ **Street name display (vehicles with a navigation system)**

Only street names which are included in the map data will be displayed.

 **WARNING**

■ **Before using the head-up display**

- Check that the position and brightness of the head-up display image does not interfere with safe driving. Incorrect adjustment of the image's position or brightness may obstruct the driver's view and lead to an accident, resulting in death or serious injury.
- Do not continuously look at the head-up display while driving as you may fail to see pedestrians, objects on the road, etc. ahead of the vehicle.

■ **Caution for changing settings of the head-up display**

As the engine needs to be running while changing the settings of the head-up display, ensure that the vehicle is parked in a place with adequate ventilation. In a closed area such as a garage, exhaust gases including harmful carbon monoxide (CO) may collect and enter the vehicle. This may lead to death or a serious health hazard.

 NOTICE**■ To prevent damage to components**

- Do not place any drinks near the head-up display projector. If the projector gets wet, electrical malfunctions may result.
- Do not place anything on or put stickers onto the head-up display projector. Doing so could interrupt head-up display indications.
- Do not touch the inside of the head-up display projector or thrust sharp edges or the like into the projector. Doing so could cause mechanical malfunctions.

**■ When changing the settings of the head-up display**

To prevent battery discharge, ensure that the engine is running while the changing the settings of the head-up display.

## Fuel consumption information

Fuel consumption information can be displayed on the audio system.

Vehicles with a navigation system (12.3-inch display): The fuel consumption information can be displayed and operated on the side display.

- ① Audio system screen
- ② "MENU" button
- ③ Lexus Display Audio controller
- ④ "MENU" button
- ⑤ Remote Touch knob
- ⑥ "ENTER" button

\*1: Vehicles with a Lexus Display Audio system

\*2: Vehicles with a navigation system

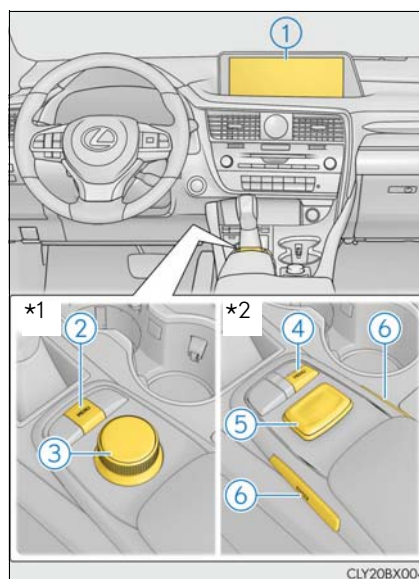

### Trip information

- ▶ Lexus Display Audio screen

Press the “MENU” button on the Lexus Display Audio controller, then select “Info” on the “Menu” screen, and then select “Fuel Consumption”.

If the “Trip Information” screen does not appear, move the controller to the right and select “Trip Information”.

- ① Fuel consumption in the past 15 minutes
- ② Current fuel consumption
- ③ Average vehicle speed since the engine was started.
- ④ Elapsed time since the engine was started.
- ⑤ Cruising range (→P. 117)

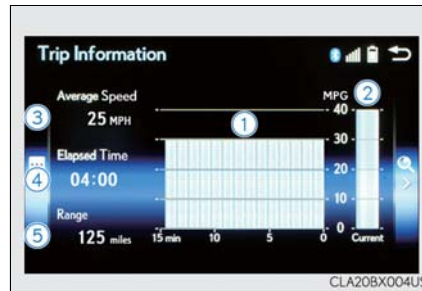

- ▶ Navigation system screen

Press the “MENU” button on the Remote Touch, then select  on the “Menu” screen, and then select “Fuel Consumption”.

If the “Past Record” screen is displayed, select “Trip Information”.

- ① Resetting the consumption data
- ② Fuel consumption in the past 15 minutes
- ③ Current fuel consumption
- ④ Average vehicle speed since the engine was started.
- ⑤ Elapsed time since the engine was started.
- ⑥ Cruising range (→P. 117)



Average fuel consumption for the past 15 minutes is divided by color into past averages and averages attained since the engine switch was last turned to IGNITION ON mode. Use the displayed average fuel consumption as a reference.

The image is an example only.

### Past record

- ▶ Lexus Display Audio screen

Press the “MENU” button on the Lexus Display Audio controller, then select “Info” on the “Menu” screen, and then select “Fuel Consumption”.

If the “Past Record” screen does not appear, move the controller to the right and select “Past Record”.

- ① Previous fuel consumption record
- ② Current fuel consumption
- ③ Best recorded fuel consumption



- ▶ Navigation system screen

Press the “MENU” button on the Remote Touch, then select **i** on the “Menu” screen, and then select “Fuel Consumption”.

If the “Trip Information” screen is displayed, select “Past Record”.

- ① Resetting the past record data
- ② Best recorded fuel consumption
- ③ Average fuel consumption
- ④ Previous fuel consumption record
- ⑤ Updating the average fuel consumption data



The average fuel consumption history is divided by color into past averages and the average fuel consumption since the last updated. Use the displayed average fuel consumption as a reference.

The image is an example only.

**■ Updating the past record data**

- ▶ Vehicles with a Lexus Display Audio system

Update the average fuel consumption by moving the controller to the left and select "Update" to measure the current fuel consumption again.

- ▶ Vehicles with a navigation system

Update the average fuel consumption by selecting "Update" to measure the current fuel consumption again.

**■ Resetting the data**

- ▶ Vehicles with a Lexus Display Audio system

The fuel consumption data can be deleted by moving the controller to the left and select "Clear".

- ▶ Vehicles with a navigation system

The fuel consumption data can be deleted by selecting "Clear".

**■ Cruising range**

Displays the estimated maximum distance that can be driven with the quantity of fuel remaining.

This distance is computed based on your average fuel consumption.

As a result, the actual distance that can be driven may differ from that displayed.

**Using the side display (vehicles with a navigation system [12.3-inch display])**

Vehicle information can be displayed on the side display (→P. 501), then select “<” or “>” to select the desired screen.

▶ Fuel consumption

Displays the average fuel consumption for the past 10 minutes in 1 minute intervals, as well as the cruising range.

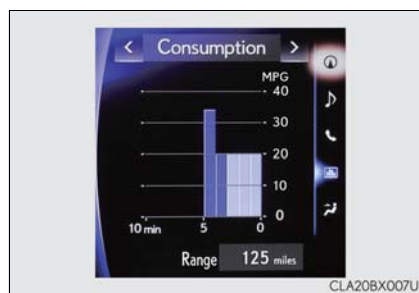

▶ Past record

Displays the average fuel consumption and highest fuel consumption.



▶ Trip information

Displays the cruising range, average fuel consumption and the amount of time elapsed since the engine was started.

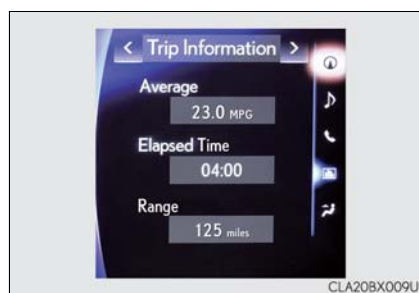

The image is an example only, and may vary slightly from actual conditions.

**Operation of  
each component****3**

- 3-1. Key information**
  - Keys ..... 120
- 3-2. Opening, closing and locking the doors**
  - Side doors .....124
  - Power back door ..... 130
  - Smart access system with push-button start..... 146
- 3-3. Adjusting the seats**
  - Front seats..... 156
  - Rear seats.....157
  - Driving position memory .....172
  - Head restraints ..... 177
- 3-4. Adjusting the steering wheel and mirrors**
  - Steering wheel ..... 180
  - Inside rear view mirror ..... 182
  - Outside rear view mirrors..... 184
- 3-5. Opening, closing the windows and moon roof**
  - Power windows ..... 187
  - Moon roof .....191
  - Panoramic moon roof..... 195



## Keys

### The keys

The following keys are provided with the vehicle.

- ① Electronic keys
  - Operating the smart access system with push-button start (→P. 146)
  - Operating the wireless remote control function
- ② Mechanical keys
- ③ Key number plate

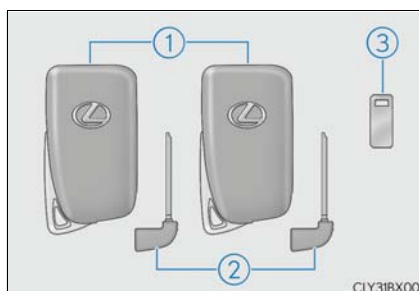

### Wireless remote control

- ① Locks all the doors (→P. 124)
- ② Unlocks all the doors (→P. 124)
- ③ Opens the windows<sup>\*2</sup> and the moon roof<sup>\*1, 2</sup> or panoramic moon roof<sup>\*1, 2</sup> (→P. 124)
- ④ Opens and closes the power back door (→P. 130)
- ⑤ Sounds the alarm (→P. 121)

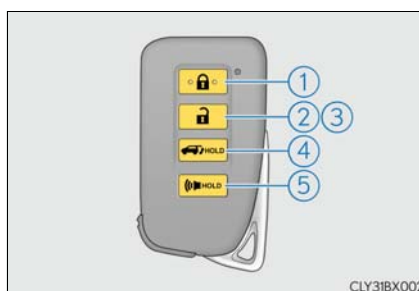

\*1: If equipped

\*2: This setting must be customized at your Lexus dealer.

### Using the mechanical key

To take out the mechanical key, push the release button and take the key out.

The mechanical key can only be inserted in one direction, as the key only has grooves on one side. If the key cannot be inserted in a lock cylinder, turn it over and re-attempt to insert it.

After using the mechanical key, store it in the electronic key. Carry the mechanical key together with the electronic key. If the electronic key battery is depleted or the entry function does not operate properly, you will need the mechanical key. (→P. 684)

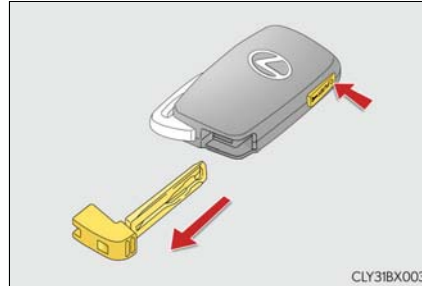

#### ■ Panic mode

When  HOLD is pressed for longer than about one second, an alarm will sound intermittently and the vehicle lights will flash to deter any person from trying to break into or damage your vehicle.

To stop the alarm, press any button on the electronic key.

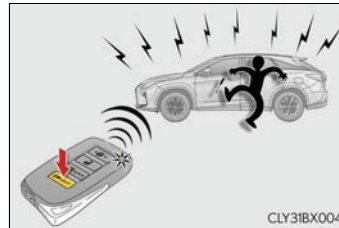

#### ■ When required to leave the vehicle's key with a parking attendant

Lock the glove box as circumstances demand. (→P. 530)

Remove the mechanical key for your own use and provide the attendant with the electronic key only.

#### ■ If you lose your mechanical keys

New genuine mechanical keys can be made by your Lexus dealer using another mechanical key and the key number stamped on your key number plate. Keep the plate in a safe place such as your wallet, not in the vehicle.

#### ■ When riding in an aircraft

When bringing an electronic key onto an aircraft, make sure you do not press any buttons on the electronic key while inside the aircraft cabin. If you are carrying an electronic key in your bag, etc., ensure that the buttons are not likely to be pressed accidentally. Pressing a button may cause the electronic key to emit radio waves that could interfere with the operation of the aircraft.

■ **Electronic key battery depletion**

- The standard battery life is 1 to 2 years.
- If the battery becomes low, an alarm will sound in the cabin when the engine is stopped. (→P. 623)
- As the electronic key always receives radio waves, the battery will become depleted even if the electronic key is not used. The following symptoms indicate that the electronic key battery may be depleted. Replace the battery when necessary. (→P. 623)
  - The smart access system with push-button start or the wireless remote control does not operate.
  - The detection area becomes smaller.
  - The LED indicator on the key surface does not turn on.
- To reduce key battery depletion when the electronic key is to not be used for long periods of time, set the electronic key to the battery-saving mode. (→P. 148)
- To avoid serious deterioration, do not leave the electronic key within 3 ft. (1 m) of the following electrical appliances that produce a magnetic field:
  - TVs
  - Personal computers
  - Cellular phones, cordless phones and battery chargers
  - Recharging cellular phones or cordless phones
  - Induction cookers
  - Table lamps

■ **Replacing the battery**

→P. 623

■ **Confirmation of the registered key number**

The number of keys already registered to the vehicle can be confirmed. Ask your Lexus dealer for details.

■ **If a wrong key is used**

The key cylinder rotates freely, isolated from the internal mechanism.

 NOTICE**■ To prevent key damage**

- Do not drop the keys, subject them to strong shocks or bend them.
- Do not expose the keys to high temperatures for long periods of time.
- Do not get the keys wet or wash them in an ultrasonic washer, etc.
- Do not attach metallic or magnetic materials to the keys or place the keys close to such materials.
- Do not disassemble the keys.
- Do not attach a sticker or anything else to the surface of the electronic key.
- Do not place the keys near objects that produce magnetic fields, such as TVs, audio systems and induction cookers, or medical electrical equipment, such as low-frequency therapy equipment.

**■ Carrying the electronic key on your person**

Carry the electronic key 3.9 in. (10 cm) or more away from electric appliances that are turned on. Radio waves emitted from electric appliances within 3.9 in. (10 cm) of the electronic key may interfere with the key, causing the key to not function properly.

**■ In case of a smart access system with push-button start malfunction or other key-related problems**

Take your vehicle with all the electronic keys provided with your vehicle to your Lexus dealer.

**■ When an electronic key is lost**

If the electronic key remains lost, the risk of vehicle theft increases significantly. Visit your Lexus dealer immediately with all remaining electronic keys that were provided with your vehicle.

## Side doors

The vehicle can be locked and unlocked using the entry function, wireless remote control or door lock switches.

### Locking and unlocking the doors from the outside

#### ◆ Smart access system with push-button start

Carry the electronic key to enable this function.

- ① Grip the driver's door handle to unlock the door. Grip any passenger door handle to unlock all the doors.\*

Make sure to touch the sensor on the back of the handle.

The doors cannot be unlocked for 3 seconds after the doors are locked.

\*: The door unlock settings can be changed. (→P. 128, 726)

- ② Touch the lock sensor (indentation on the surface of the door handle) to lock all the doors.

Check that the door is securely locked.

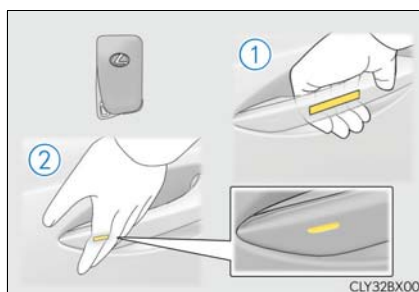

#### ◆ Wireless remote control

- ① Locks all the doors

Check that the door is securely locked.

- ② Unlocks all the doors

Pressing the button unlocks the driver's door. Pressing the button again within 3 seconds unlocks the other doors.

Press and hold to open the windows\*2 and the moon roof\*1, 2 or panoramic moon roof\*1, 2

\*1: If equipped

\*2: This setting must be customized at your Lexus dealer.

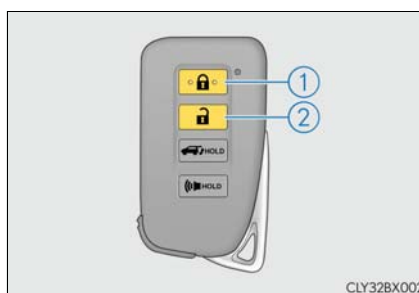

**■ Operation signals**

Doors:

A buzzer sounds and the emergency flashers flash to indicate that the doors have been locked/unlocked. (Locked: Once; Unlocked: Twice)

Windows and moon roof or panoramic moon roof:

A buzzer sounds.

**■ Security feature**

If a door is not opened within approximately 60 seconds after the vehicle is unlocked, the security feature automatically locks the vehicle again.

**■ When the door cannot be locked by the lock sensor on the surface of the door handle**

When the door cannot be locked even if the lock sensor on the surface of the door handle is touched by a finger, touch the lock sensor with the palm.

When gloves are being worn, remove the gloves.

**■ Door lock buzzer**

If an attempt to lock the doors is made when a door is not fully closed, a buzzer sounds continuously for 5 seconds. Fully close the door to stop the buzzer, and lock the vehicle once more.

**■ Setting the alarm**

Locking the doors will set the alarm system. (→P. 77)

**■ If the smart access system with push-button start or the wireless remote control does not operate properly**

- Use the mechanical key to lock and unlock the doors. (→P. 684)
- Replace the key battery with a new one if it is depleted. (→P. 623)

### Locking and unlocking the doors from the inside

#### ◆ Door lock switches (to lock/unlock)

- ① Locks all the doors
- ② Unlocks all the doors

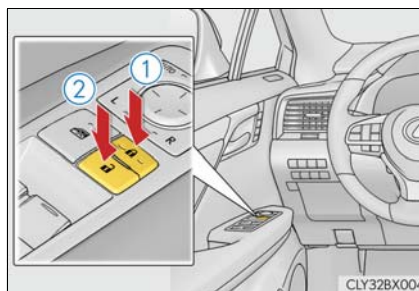

#### ◆ Inside lock buttons (to lock)

Push down the inside lock button to lock the door.

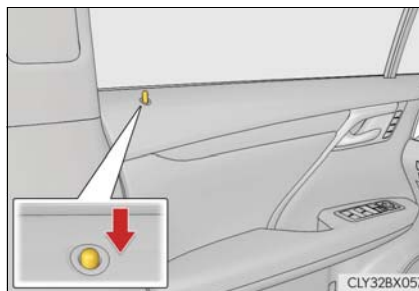

#### ◆ Inside door handles (to unlock)

▶ For the front doors  
Pull the handle to unlock and open the door.

When the door is unlocked, the inside lock button will pop up.

▶ For the rear doors  
Pull the handle to unlock the door.  
Pull the handle a second time to open the door.

When the door is unlocked, the inside lock button will pop up.

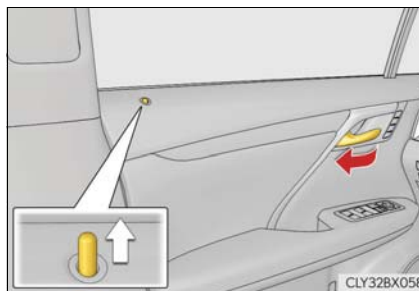

### Locking the doors from the outside without a key

- 1 Push down the inside lock button.
- 2 Close the door.

The door cannot be locked if the engine switch is in ACCESSORY or IGNITION ON mode, or the electronic key is left inside the vehicle. However, the key may not be detected correctly and the door may be locked.

### Rear door child-protector lock

The door cannot be opened from inside the vehicle when the lock is set.

- 1 Unlock
- 2 Lock

These locks can be set to prevent children from opening the rear doors. Push down on each rear door switch to lock both rear doors.

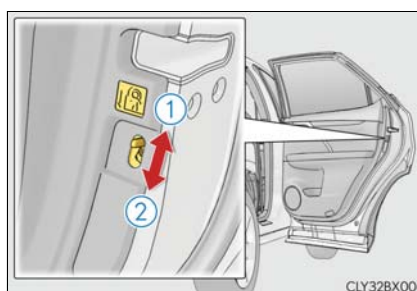

### Automatic door locking and unlocking systems

The following functions can be set or canceled:





For instructions on customizing, refer to P. 724.

Function	Operation
Speed linked door locking function	All doors are automatically locked when vehicle speed is approximately 12 mph (20 km/h) or higher.
Shift position linked door locking function	All doors are automatically locked when shifting the shift lever out of P.
Shift position linked door unlocking function	All doors are automatically unlocked when shifting the shift lever to P.
Driver's door linked door unlocking function	All doors are automatically unlocked when driver's door is opened.





### ■ Switching the door unlock function

It is possible to set which doors the entry function unlocks using the wireless remote control.

- 1 Turn the engine switch off.
- 2 When the indicator light on the key surface is not on, press and hold , HOLD or HOLD for approximately 5 seconds while pressing and holding .

The setting changes each time an operation is performed, as shown below. (When changing the setting continuously, release the buttons, wait for at least 5 seconds, and repeat step 2.)

Multi-information display	Unlocking function	Beep
	Holding the driver's door handle unlocks only the driver's door.	Exterior: Beeps 3 times Interior: Pings once
	Holding any of the passenger door handles unlocks all the doors.	
	Holding a door handle unlocks all the doors.	Exterior: Beeps twice Interior: Pings once

To prevent unintended triggering of the alarm, unlock the doors using the wireless remote control and open and close a door once after the settings have been changed. (If a door is not opened within 60 seconds after  is pressed, the doors will be locked again and the alarm will automatically be set.)

In a case that the alarm is triggered, immediately stop the alarm. (→P. 77)

### ■ Impact detection door lock release system

In the event that the vehicle is subject to a strong impact, all the doors are unlocked. Depending on the force of the impact or the type of accident, however, the system may not operate.

### ■ Using the mechanical key

The doors can also be locked and unlocked with the mechanical key. (→P. 684)

### ■ Open door warning buzzer

If the vehicle speed reaches 3 mph (5 km/h), the master warning light flashes and a buzzer sounds to indicate that door(s) or the hood is not fully closed.

The open door(s) or hood is displayed on the multi-information display.

**■ Conditions affecting the operation of the smart access system with push-button start or wireless remote control**

→P. 148

**■ Customization**

Some functions can be customized. (→P. 722)

**⚠ WARNING****■ To prevent an accident**

Observe the following precautions while driving the vehicle.  
Failure to do so may result in a door opening and an occupant falling out, resulting in death or serious injury.

- Ensure that all doors are properly closed and locked.
- Do not pull the inside handle of the doors while driving.

Be especially careful for the front doors, as the doors may be opened even if the inside lock buttons are in locked position.

- Set the rear door child-protector locks when children are seated in the rear seats.

**■ When opening or closing a door**

Check the surroundings of the vehicle such as whether the vehicle is on an incline, whether there is enough space for a door to open and whether a strong wind is blowing. When opening or closing the door, hold the door handle tightly to prepare for any unpredictable movement.

## Power back door

The power back door can be locked/unlocked and opened/closed by the following procedures.

### Locking and unlocking the power back door from the outside

#### ◆ Smart access system with push-button start

Carry the electronic key to enable this function.

- ① Locks all the doors  
Check that the door is securely locked.
- ② Unlocks all the doors  
The doors cannot be unlocked for 3 seconds after the doors are locked.

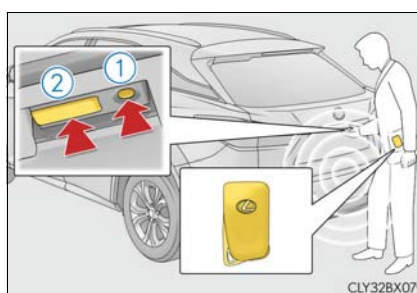

#### ◆ Wireless remote control

→P. 124

### Locking and unlocking the power back door from the inside

#### ◆ Door lock switch

→P. 126

### Opening/closing the power back door using the wireless remote control

Press and hold the switch for approximately 1 second.

The power back door can be operated whether it is locked\* or unlocked.

Pressing the switch while the power back door is opening/closing will stop the operation.

Pressing and holding the switch again for approximately 1 second will operate the power back door in the opposite direction.



\*: Opening of the power back door when it is locked can be disabled by a customized setting. (→P. 727)

### Opening/closing the power back door from the inside

Press and hold the switch for approximately 1 second.

A buzzer will sound and the power back door will automatically open or close. However, if the power back door is locked, it will not open.

Pressing the switch while the power back door is opening/closing will stop the operation.

Pressing and holding the switch again for approximately 1 second will operate the power back door in the opposite direction.

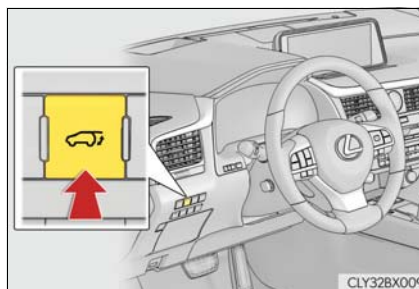

### Opening the power back door from the outside

#### ■ Back door opener switch

When the power back door is unlocked: Press the back door opener switch.

When the power back door is locked: While carrying an electronic key, press and hold the back door opener switch.

A buzzer will sound and the power back door will automatically open.

Pressing the switch while the power back door is opening/closing will stop the operation.

#### ■ Wireless remote control

→P.130

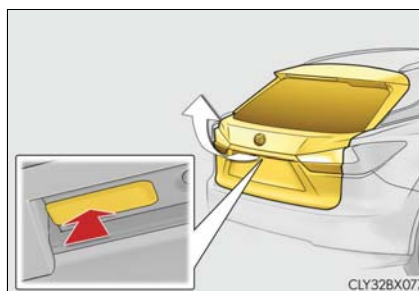

3

Operation of each component

■ **Touchless sensor (vehicles with a touchless power back door)**

The touchless power back door enables automatic opening of the power back door by holding a hand over the upper part of the rear emblem or touching the upper part of the rear emblem. When operating the touchless power back door, make sure that the touchless sensor operation is enabled (→P. 101) and that you are carrying an electronic key.

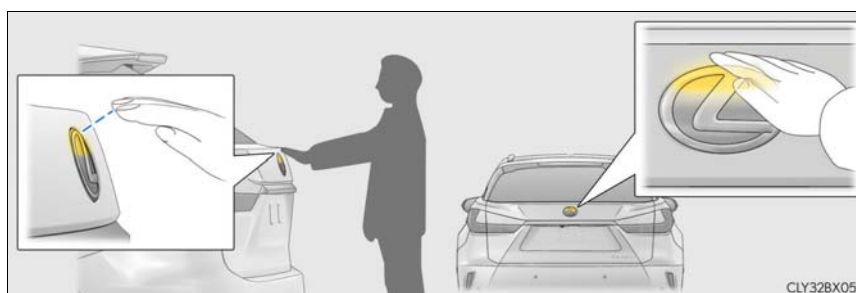

- 1** While carrying an electronic key, move your hand slowly toward the upper part of the rear emblem and hold it there until a buzzer sounds. (The upper part of the rear emblem can also be touched.)

When all of the doors are locked: When your hand is detected, all of the doors will be unlocked.

- 2** Immediately after the buzzer sounds, move your hand away.

If you do not move your hand away, a buzzer will sound twice and the power back door will not operate.

- 3** Check that the power back door begins to open.

To stop the power back door partway, touch the rear emblem.

To operate the power back door again, use a power back door switch. (→P. 131, 133) (Holding your hand over the upper part of the rear emblem will not operate the touchless sensor again.)

### Closing the power back door from the outside

#### ■ Using the power back door switch to close the power back door

Press the  switch.

A buzzer will sound and the power back door will automatically close.

Pressing the  switch while the power back door is closing will stop the operation. Pressing the switch again will open the power back door automatically.

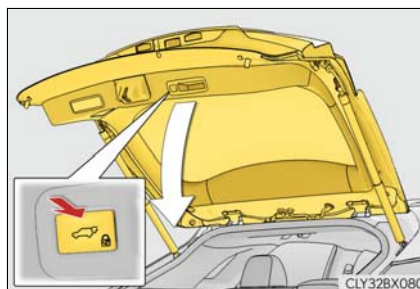

#### ▶ Close & lock function

Press the  switch twice.

A different buzzer than the normal one will sound and the power back door will begin closing automatically. When the power back door is closed, all of the doors will lock simultaneously and operation signals will indicate that all of the doors have been locked.

If the  switch is pressed while the power back door is closing, the operation will stop.

Pressing the switch again will open the power back door automatically.

#### ■ Using the back door handle to close the power back door

Lower the power back door using the back door handle.

A buzzer will sound and the power back door will automatically close.

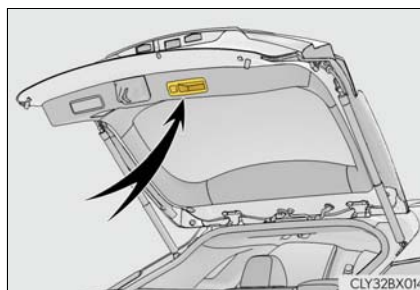

### Changing the setting of the power back door system

The power back door settings can be changed on the multi-information display. (→P. 97)

### Adjusting the open position of the power back door

The position at which the power back door will stop when opened automatically can be changed.

▶ When setting using the  switch

**1** Stop the power back door at the desired position. (→P. 131, 133)

**2** Press and hold the  switch on the lower part of the power back door for 2 seconds.

- When setting is complete, a buzzer will sound 4 times.
- The next time the power back door is opened, it will stop at that position.

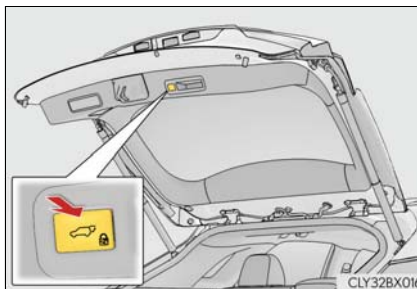

▶ When setting using the multi-information display

The open position can be set using the multi-information display. (→P. 90)

▶ When setting on the audio system screen

The open position can be set on the audio system screen. (→P. 725)

Priority for the open position is given to the last position set using the  switch, multi-information display, or audio system screen.

To return the adjusted open position to the default position (→P. 138)

### ■ Power back door operating conditions

If the following conditions are met with the power back door operation enabled (→P. 101), the power back door can be opened and closed automatically.

- When an electronic key is being carried and the back door opener switch is pressed\*
- When the wireless remote control is used\*
- When the engine switch is in IGNITION ON mode, the vehicle speed must be lower than 2 mph (3 km/h) and one of the following conditions must be met in addition to the above conditions:
  - The parking brake is engaged.
  - The brake pedal is depressed.
  - The shift lever is in P.

\*: When the operation of the power back door when it is locked has been disabled by a customized setting, operate the power back door after it has been unlocked. (→P. 727)

#### ▶ Touchless sensor (vehicles with a touchless power back door)

The power back door will open automatically when the touchless sensor operation is enabled (→P. 101) and the following conditions are met:

- The power back door is fully closed.
- The electronic key is within the operational range (→P. 146)
- A hand is held over the upper part of the rear emblem with fingers closed. (The upper part of the rear emblem can also be touched.)

The power back door may also be operated by holding either of the following over the upper part of the rear emblem. Make sure to hold it close enough to the rear emblem.

- A gloved hand
- An elbow

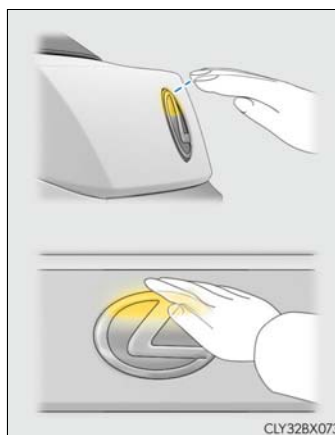

### ■ Security feature

If the power back door is not opened within approximately 60 seconds after the vehicle is unlocked, the security feature will automatically lock the doors again.



■ **Luggage compartment lights**

- RX350: The luggage compartment lights turn on when the power back door is opened with the respective luggage compartment light switch on.

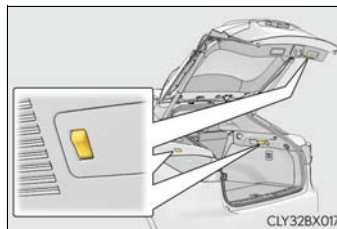

- RX350L: The luggage compartment lights turn on when the back door is opened.
- When the engine switch is turned off, the lights will go off automatically after 20 minutes.

■ **If the power back door opener is inoperative**

The power back door can be unlocked from the inside.

- 1 Remove the cover.

To protect the cover, place a rag between the flathead screwdriver and cover as shown in the illustration.

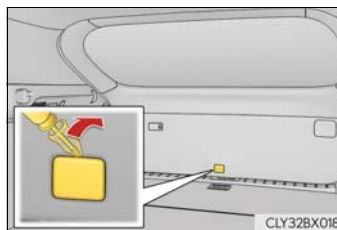

- 2 Move the lever.



**■ Back door closer**

In the event that the power back door is left slightly open, the back door closer will automatically close it to the fully closed position.

- The back door closer can function when the engine switch is in any mode.
- The power back door can be opened using the back door opener switch even if the back door closer is operating.

**■ Operation of the power back door**

- When the power back door begins to operate, the emergency flashers will flash twice and a buzzer will sound.
- When the power back door is disabled (→P. 101), the power back door will not operate but can be opened and closed manually.
- The power back door turns to manual operation when the back door opener switch is pressed while the power back door is in an automatic opening/closing operation.
- If anything obstructs the power back door while opening, a buzzer will sound and the power back door will stop immediately. If anything obstructs the power back door while closing, a buzzer will sound and the power back door will automatically move slightly in the opposite direction and then stop.

**■ Back door reserve lock function**

This function reserves the locking of the power back door when the power back door is open. If the following operations are performed, all of the doors except the power back door will lock and then the power back door will lock when it is completely closed.

- 1 Close all of the doors, except the power back door.
- 2 Perform an automatic closing operation of the power back door and lock the doors using the wireless remote control (→P. 124) or smart access system with push-button start (→P. 124, 130) while the power back door is closing.

Also, if the back door does not fully close due to the operation of the jam protection function, etc., while the back door is automatically closing after a reserve lock operation is performed, the reserve lock function is canceled and all the doors will unlock.

■ **Close & lock function**

When the power back door is open, this function closes the power back door and then locks all of the doors simultaneously.

Performing the following procedure will lock all of the doors when the power back door is completely closed.

- 1 Close all of the doors except the power back door.
- 2 While carrying an electronic key, press the  switch on the lower part of the power back door (→P. 133) twice.

A different buzzer than the normal one will sound and then the power back door will begin closing automatically. When the power back door is closed, all of the doors will lock simultaneously and operation signals will indicate that all of the doors have been locked.

To enable this function, the following conditions must be met:

- The most recent power back door operation was an automatic opening operation and the power back door is stopped.
- No electronic keys for your vehicle are in the vehicle.

■ **When reconnecting the battery**

To enable the power back door to operate properly, close the power back door manually.

■ **Jam protection function**

Sensors are installed in the right and left sides of the power back door. When the door is automatically closing and the sensors are pushed due to an object being caught, etc., the jam protection function will operate.

From that position the door will automatically move a little in the opposite direction and then the function will stop.

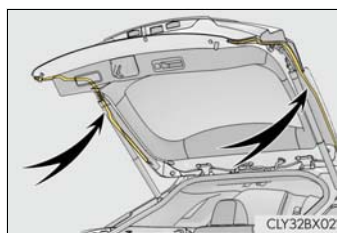

■ **Returning the power back door opening position to the default setting**

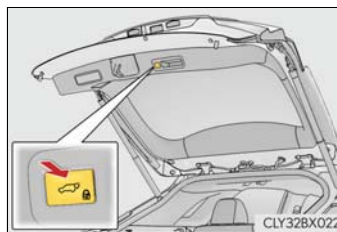

Press and hold the  switch on the lower part of the power back door for 7 seconds.

A buzzer will sound twice. The next time the power back door is opened, it will open to the default position.



### ■ Situations in which the close & lock function may not operate properly

In the following situations, the close & lock function may not operate properly:

- If the  switch on the lower part of the power back door (→P. 133) is pressed by a hand which is holding an electronic key
- If the  switch on the lower part of the power back door (→P. 133) is pressed when the electronic key is in a bag, etc. that is placed on the ground
- If the  switch on the lower part of the power back door (→P. 133) is pressed with the electronic key not near the vehicle.

### ■ Situations in which the touchless sensor may malfunction (vehicles with a touchless power back door)

In the following situations, the touchless sensor may operate unintentionally.

To prevent unintentional operation, keep the electronic key out of the operational range or disable the touchless sensor operation. (→P. 101)

- When a large amount of water is applied to the rear emblem, such as in heavy rain
- When the vehicle is being washed and water is applied to the rear emblem
- When dirt is wiped off the rear emblem
- If someone leans toward or against the rear emblem
- When a metal object is brought near the rear emblem
- When a vehicle cover is installed or removed near the rear emblem

### ■ Situations in which the touchless sensor may not operate properly (vehicles with a touchless power back door)

If the touchless sensor does not operate in the following situations, use the back door opener switch to open the power back door. (→P. 133)

- In the following situations, the sensitivity of the touchless sensor may be temporarily reduced and the touchless sensor may not operate:
  - When a large amount of water is applied to the rear emblem, such as in heavy rain
  - When the vehicle is being washed and water is applied to the rear emblem
  - For several seconds after dirt is wiped off the rear emblem
  - When the rear emblem is covered with mud, snow, ice, etc.
  - When the vehicle has been parked for a while near objects that may move and contact the rear emblem, such as tall grass or trees
  - When an external radio wave source is near the touchless sensor
- The touchless sensor may not operate in the following situations:
  - When an electronic key is not being carried
  - When an electronic key is not within the operational range
  - When an external radio wave source interferes with the communication between the vehicle and electronic key (→P. 148)
  - When the power back door is not fully closed
  - When a hand is held parallel to the rear emblem \*

\*: The detection settings can be changed by your Lexus dealer. (→P. 725)

### ■ Customization

Some functions can be customized. (→P. 97, 722)

 **WARNING**

Observe the following precautions.  
Failure to do so may cause parts of the body to be caught, resulting in death or serious injury.

**■ Before driving the vehicle**

Before driving the vehicle, make sure that the power back door is fully closed. If the power back door is not fully closed, it may open unexpectedly while driving, causing an accident.

**■ Caution while driving**

- Keep the power back door closed while driving.  
If the power back door is left open, it may hit nearby objects while driving or luggage may be unexpectedly thrown out, causing an accident.  
In addition, exhaust gases may enter the vehicle, causing death or a serious health hazard. Make sure to close the power back door before driving.
- Never let anyone sit in the luggage compartment.  
In the event of sudden braking, sudden swerving or a collision, they are susceptible to death or serious injury.

**■ When children are in the vehicle**

Observe the following precautions.  
Failure to do so may result in death or serious injury.

- Do not allow children to play in the luggage compartment.  
If a child is accidentally locked in the luggage compartment, they could have heat exhaustion or other injuries.
- Do not allow a child to open or close the power back door.  
Doing so may cause the power back door to move unexpectedly, or cause the child's hands, arms, head, or neck to be caught by the closing power back door. (The power back door will not operate when it is disabled: →P. 101)

**⚠ WARNING****■ Operating the power back door**

Observe the following precautions.

Failure to do so may cause parts of the body to be caught, resulting in death or serious injury.

- Remove any heavy loads, such as snow and ice, from the power back door before opening it. Failure to do so may cause the power back door to suddenly shut again after it is opened.
- When opening or closing the power back door, thoroughly check to make sure the surrounding area is safe.
- If anyone is in the vicinity, make sure they are safe and let them know that the power back door is about to open or close.
- Use caution when opening or closing the power back door in windy weather as it may move abruptly in strong wind.
- The power back door may suddenly shut if it is not opened fully, while on a steep incline. Make sure that the power back door is secure before using the luggage compartment.



- When closing the power back door, take extra care to prevent your fingers, etc., from being caught.
- When closing the power back door, make sure to press it lightly on its outer surface. If the back door handle is used to fully close the power back door, it may result in hands or arms being caught.



- Do not pull on the back door spindle (→P. 144) to close the power back door, and do not hang on the back door spindle. Doing so may cause hands to be caught or the back door spindle to break, causing an accident.
- If a bicycle carrier or similar heavy object is attached to the power back door, it may suddenly shut again after being opened, causing someone's hands, arms, head or neck to be caught and injured. When installing an accessory part to the power back door, using a genuine Lexus part is recommended.

**⚠ WARNING**

■ **Back door closer**

- In the event that the power back door is left slightly open, the back door closer will automatically close it to the fully closed position. It takes several seconds before the back door closer begins to operate. Be careful not to get fingers caught or anything else in the power back door, as this may cause bone fractures or other serious injuries.

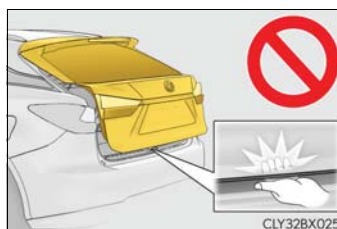

- Use caution when using the back door closer as it still operates when the power back door system is disabled.

■ **Power back door**

Observe the following precautions when operating the power back door. Failure to do so may cause death or serious injury.

- Check the safety of the surrounding area to make sure there are no obstacles or anything that could cause any of your belongings to get caught.
- If anyone is in the vicinity, make sure they are safe and let them know that the power back door is about to open or close.
- If the power back door system is disabled (→P. 101) while the power back door is operating, the power back door will stop operating. The power back door must then be operated manually. Take extra care in this situation, as the power back door may open or close suddenly.
- If the operating conditions of the power back door (→P. 135) are no longer met, a buzzer may sound and the power back door may stop opening or closing. The power back door must then be operated manually. Take extra care on an incline in this situation, as the power back door may move suddenly.
- On an incline, the power back door may suddenly shut after it opens. Make sure the power back door is fully open and secure.
- In the following situations, the power back door may detect an abnormality and automatic operation may be stopped. In this case, the power back door must then be operated manually. Take extra care in this situation, as the stopped power back door may suddenly open or close, causing an accident.
  - When the power back door contacts an obstacle
  - When the battery voltage suddenly drops, such as when the engine switch is turned to IGNITION ON mode or the engine is started during automatic operation

**⚠ WARNING**

- If a bicycle carrier or similar heavy object is attached to the power back door, the power back door may not operate, causing a malfunction, or the power back door may suddenly shut again after being opened, causing someone's hands, arms, head or neck to be caught and injured. When installing an accessory part to the power back door, using a genuine Lexus part is recommended.

**■ Jam protection function**

Observe the following precautions.

Failure to do so may cause death or serious injury.

- Never use any part of your body to intentionally activate the jam protection function.
- The jam protection function may not work if something gets caught just before the power back door fully closes. Be careful not to get fingers caught or anything else.
- The jam protection function may not work depending on the shape of the object that is caught. Be careful not to catch fingers or anything else.



 NOTICE

■ **Back door spindles**

The power back door is equipped with spindles that hold the power back door in place. Observe the following precautions. Failure to do so may cause damage to the back door spindle, resulting in malfunction.

- Do not attach any foreign objects, such as stickers, plastic sheets, or adhesives to the spindle rod.
- Do not attach any accessories other than genuine Lexus parts to the power back door.
- Do not place your hand on the spindle or apply lateral forces to it.

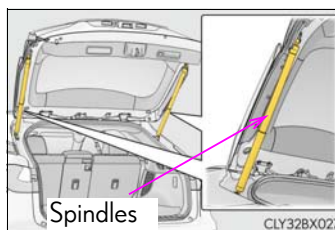

■ **To prevent back door closer malfunction**

- Do not apply excessive force to the power back door while the back door closer is operating. Applying excessive force may cause the back door closer to malfunction.
- If the power back door is opened and closed repeatedly in a short amount of time, the back door closer may stop operating. In this case, manually open the power back door once and wait for a while before attempting to close it again.

■ **To prevent malfunction of the power back door**

- Make sure that there is no ice between the power back door and frame that would prevent movement of the power back door. Operating the power back door when excessive load is present on the power back door may cause a malfunction.
- Do not apply excessive force to the power back door while the power back door is operating.
- Take care not to damage the sensors installed on the right and left edges of the power back door (→P. 138) with a knife or other sharp object. If a sensor is disconnected, the power back door will not close automatically.

■ **Close & lock function**

When closing the power back door using the close & lock function, a different buzzer than the normal one will sound before the operation begins.

To check that the operation has started correctly, check that a different buzzer than the normal one has sounded.

Additionally, when the power back door is fully closed and locked, operation signals will indicate that all of the doors have been locked.

Before leaving the vehicle, make sure that the operational signals have operated and that all of the doors are locked.

 NOTICE

**■ Touchless sensor precautions (vehicles with a touchless power back door)**

The touchless sensor is located behind the rear emblem. Observe the following to ensure that the touchless power back door function operates properly:

- Operate the touchless sensor while carrying an electronic key within the operational range.

- Keep the rear emblem clean at all times.

If the rear emblem is dirty or covered with snow, the touchless sensor may not operate. In this situation, clean off the dirt or snow, move the vehicle from the current position and then check if the touchless sensor operates. If it does not operate, have the vehicle inspected by your Lexus dealer.

- Do not apply coatings that have a rain clearing (hydrophilic) effect, or other coatings, to the rear emblem.

- Do not park the vehicle near objects that may move and contact the rear emblem, such as tall grass or trees.

If the vehicle has been parked for a while near objects that may move and contact the rear emblem, such as tall grass or trees, the touchless sensor may not operate. In this situation, move the vehicle from the current position and then check if the touchless sensor operates. If it does not operate, have the vehicle inspected by your Lexus dealer.

- Do not subject the touchless sensor or its surrounding area to a strong impact.

If the touchless sensor or its surrounding area has been subjected to a strong impact, the touchless sensor may not operate properly.

If the touchless sensor does not operate in the following situations, have the vehicle inspected by your Lexus dealer.

- The touchless sensor or its surrounding area has been subjected to a strong impact.
- The rear emblem is scratched or damaged.

- Do not disassemble the rear emblem.

- Do not attach stickers to the rear emblem.

- Do not paint the rear emblem.

- If a bicycle carrier or similar heavy object is attached to the power back door, disable the touchless sensor. (→P. 101)

**■ To prevent unintentional operation (vehicles with a touchless power back door)**

When the touchless sensor is not to be used, disable the touchless sensor operation using the multi-information display (→P. 101)

**■ If the vehicle has not been driven for a long time (vehicles with a touchless power back door)**

If the vehicle has not been driven for a long time, the touchless power back door may not operate. In this case, turn the engine switch to IGNITION ON mode and then operate the touchless power back door.

If the touchless power back door still does not operate, have the vehicle inspected by your Lexus dealer.

## Smart access system with push-button start

The following operations can be performed simply by carrying the electronic key on your person, for example in your pocket. The driver should always carry the electronic key.

- Locks and unlocks the doors (→P. 124)
- Locks and unlocks the back door (→P. 130)
- Starts and stops the engine (→P. 231)

### ■ Antenna location

- ① Antennas outside the cabin
- ② Antennas inside the cabin
- ③ Antenna outside the luggage compartment

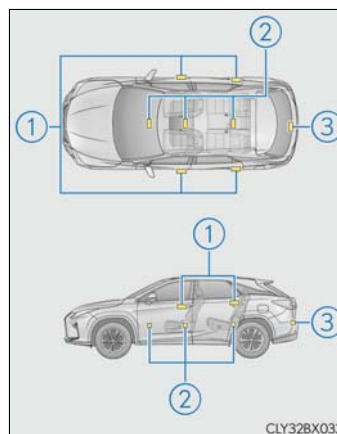

### ■ Effective range (areas within which the electronic key is detected)

- When locking or unlocking the doors  
The system can be operated when the electronic key is within about 2.3 ft. (0.7 m) of an outside door handle. (Only the doors detecting the key can be operated.)
- When starting the engine or changing engine switch modes  
The system can be operated when the electronic key is inside the vehicle.

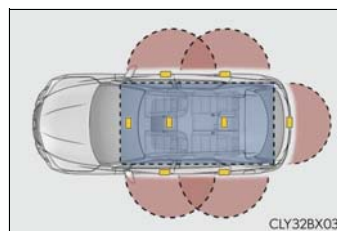

### ■ Alarms and warning messages

A combination of exterior and interior alarms as well as warning messages shown on the multi-information display are used to prevent theft of the vehicle and accidents resulting from erroneous operation. Take appropriate measures in response to any warning message on the multi-information display. (→P. 661)

When only an alarm sounds, circumstances and correction procedures are as follows.

Alarm	Situation	Correction procedure
Exterior alarm sounds once for 5 seconds	An attempt was made to lock the vehicle while a door was open.	Close all of the doors and lock the doors again.
Interior alarm pings repeatedly	The engine switch was turned to ACCESSORY mode while the driver's door was open (The driver's door was opened when the engine switch was in ACCESSORY mode).	Turn the engine switch off and close the driver's door.

### ■ If a warning message is displayed indicating that there is a malfunction in the smart access system with push-button start

→P. 661



### ■ Battery-saving function

The battery-saving function will be activated in order to prevent the electronic key battery and the battery from being discharged while the vehicle is not in operation for a long time.

- In the following situations, the smart access system with push-button start may take some time to unlock the doors.
  - The electronic key has been left in an area of approximately 6 ft. (2 m) of the outside of the vehicle for 10 minutes or longer.
  - The smart access system with push-button start has not been used for 5 days or longer.
- If the smart access system with push-button start has not been used for 14 days or longer, the doors cannot be unlocked at any doors except the driver's door. In this case, take hold of the driver's door handle, or use the wireless remote control or the mechanical key, to unlock the doors.

■ **Electronic Key battery-Saving Function**

When battery-saving mode is set, battery depletion is minimized by stopping the electronic key from receiving radio waves.

Press  twice while pressing and holding . Confirm that the electronic key indicator flashes 4 times.

While the battery-saving mode is set, the smart access system with push-button start cannot be used. To cancel the function, press any of the electronic key buttons.



■ **Conditions affecting operation**

The smart access system with push-button start, wireless remote control and engine immobilizer system use weak radio waves. In the following situations, the communication between the electronic key and the vehicle may be affected, preventing the smart access system with push-button start, wireless remote control and engine immobilizer system from operating properly. (Ways of coping: →P. 684)

- When the electronic key battery is depleted
- Near a TV tower, electric power plant, gas station, radio station, large display, airport or other facility that generates strong radio waves or electrical noise
- When the electronic key is in contact with, or is covered by the following metallic objects
  - Cards to which aluminum foil is attached
  - Cigarette boxes that have aluminum foil inside
  - Metallic wallets or bags
  - Coins
  - Hand warmers made of metal
  - Media such as CDs and DVDs
- When other wireless keys (that emit radio waves) are being used nearby
- When carrying the electronic key together with the following devices that emit radio waves
  - Portable radio, cellular phone, cordless phone or other wireless communication devices
  - Another vehicle's electronic key, another electronic key of your vehicle, or a wireless key that emits radio waves
  - Personal computers or personal digital assistants (PDAs)
  - Digital audio players
  - Portable game systems
- If window tint with a metallic content or metallic objects are attached to the rear window
- When the electronic key is placed near a battery charger or electronic devices
- When the vehicle is parked in a pay parking spot where radio waves are emitted

### ■ Note for the entry function

- Even when the electronic key is within the effective range (detection areas), the system may not operate properly in the following cases:
  - The electronic key is too close to the window or outside door handle, near the ground, or in a high place when the doors are locked or unlocked.
  - The electronic key is near the ground or in a high place, or too close to the rear bumper center when the back door is opened.
  - The electronic key is on the instrument panel, luggage compartment, floor, or in the door pockets or glove box when the engine is started or engine switch modes are changed.
- Do not leave the electronic key on top of the instrument panel or near the door pockets when exiting the vehicle. Depending on the radio wave reception conditions, it may be detected by the antenna outside the cabin and the door will become lockable from the outside, possibly trapping the electronic key inside the vehicle.
- As long as the electronic key is within the effective range, the doors may be locked or unlocked by anyone.
- Even if the electronic key is not inside the vehicle, it may be possible to start the engine if the electronic key is near the window.
- The doors may unlock if a large amount of water splashes on the door handle, such as in the rain or in a car wash when the electronic key is within the effective range. (The door will automatically be locked after approximately 60 seconds if the doors are not opened and closed.)
- If the wireless remote control is used to lock the doors when the electronic key is near the vehicle, there is a possibility that the door may not be unlocked by the entry function. (Use the wireless remote control to unlock the doors.)
- Touching the door lock sensor while wearing gloves may delay or prevent lock operation. Remove the gloves and touch the lock sensor again.
- When the lock operation is performed using the lock sensor, recognition signals will be shown up to two consecutive times. After this, no recognition signals will be given.\*
- If the door handle becomes wet while the electronic key is within the effective range, the door may lock and unlock repeatedly. In that case, follow the following correction procedures to wash the vehicle:
  - Place the electronic key in a location 6 ft. (2 m) or more away from the vehicle. (Take care to ensure that the key is not stolen.)
  - Set the electronic key to battery-saving mode to disable the smart access system with push-button start. (→P. 148)
- If the electronic key is inside the vehicle and a door handle becomes wet during a car wash, a message may be shown on the multi-information display and a buzzer will sound outside the vehicle. To turn off the alarm, lock all the doors.
- The lock sensor may not work properly if it comes into contact with ice, snow, mud, etc. Clean the lock sensor and attempt to operate it again.
- A sudden approach to the effective range or door handle may prevent the doors from being unlocked. In this case, return the door handle to the original position and check that the doors unlock before pulling the door handle again.
- If there is another electronic key in the detection area, it may take slightly longer to unlock the doors after the door handle is gripped.

- Fingernails may scrape against the door during operation of the door handle. Be careful not to injure fingernails or damage the surface of the door.

\*: This setting can be customized at your Lexus dealer.

■ **When the vehicle is not driven for extended periods**

- To prevent theft of the vehicle, do not leave the electronic key within 6 ft. (2 m) of the vehicle.
- The smart access system with push-button start can be deactivated in advance. (→P. 722)
- Setting the electronic key to battery-saving mode helps to reduce key battery depletion. (→P. 148)

■ **To operate the system properly**

Make sure to carry the electronic key when operating the system. Do not get the electronic key too close to the vehicle when operating the system from the outside of the vehicle.

Depending on the position and holding condition of the electronic key, the key may not be detected correctly and the system may not operate properly. (The alarm may go off accidentally, or the door lock prevention may not operate.)

■ **If the smart access system with push-button start does not operate properly**

- Locking and unlocking the doors: Use the mechanical key. (→P. 684)
- Starting the engine: →P. 685

■ **Customization**

Some functions can be customized. (→P. 722)

■ **If the smart access system with push-button start has been deactivated in a customized setting**

- Locking and unlocking the doors:  
Use the wireless remote control or mechanical key. (→P. 124, 130, 684)
- Starting the engine and changing engine switch modes: →P. 685
- Stopping the engine: →P. 231

**■ Certification for the smart access system with push-button start**

- ▶ Except for vehicles sold in Canada

FCC ID: NI4TMLF15-2 ✓

This device complies with part 15 of the FCC Rules. Operation is subject to the following two conditions: (1) This device may not cause harmful interference, and (2) this device must accept any interference received, including interference that may cause undesired operation.

Changes or modifications not expressly approved by the party responsible for compliance could void the user's authority to operate the equipment.

FCC ID: NI4TMLF15-2

This device complies with part 15 of the FCC Rules. Operation is subject to the following two conditions: (1) This device may not cause harmful interference, and (2) this device must accept any interference received, including interference that may cause undesired operation.

Changes or modifications not expressly approved by the party responsible for compliance could void the user's authority to operate the equipment.

FCC ID: NI4TMLF15-2 ✓

This device complies with part 15 of the FCC Rules. Operation is subject to the following two conditions: (1) This device may not cause harmful interference, and (2) this device must accept any interference received, including interference that may cause undesired operation.

Changes or modifications not expressly approved by the party responsible for compliance could void the user's authority to operate the equipment.



FCC ID: HYQ23AAP FCC ID: HYQ14FBB
--------------------------------------

**NOTE:**

This device complies with part 15 of the FCC Rules. Operation is subject to the following two conditions: (1) This device may not cause harmful interference, and (2) this device must accept any interference received, including interference that may cause undesired operation.

**FCC WARNING:**

Changes or modifications not expressly approved by the party responsible for compliance could void the user's authority to operate the equipment.

FCC ID: HYQ23AAP FCC ID: HYQ14FBB
--------------------------------------

**NOTE:**

This device complies with part 15 of the FCC Rules. Operation is subject to the following two conditions: (1) This device may not cause harmful interference, and (2) this device must accept any interference received, including interference that may cause undesired operation.

**FCC WARNING:**

Changes or modifications not expressly approved by the party responsible for compliance could void the user's authority to operate the equipment.

FCC ID: HYQ23AAP FCC ID: HYQ14FBB
--------------------------------------

**NOTE:**

This device complies with part 15 of the FCC Rules. Operation is subject to the following two conditions: (1) This device may not cause harmful interference, and (2) this device must accept any interference received, including interference that may cause undesired operation.

**FCC WARNING:**

Changes or modifications not expressly approved by the party responsible for compliance could void the user's authority to operate the equipment.

- For vehicles sold in Canada

This device complies with Industry Canada's licence-exempt RSSs. Operation is subject to the following two conditions: (1) This device may not cause interference; and (2) This device must accept any interference, including interference that may cause undesired operation of the device.

Le présent appareil est conforme aux CNR d'Industrie Canada applicables aux appareils radio exempts de licence. L'exploitation est autorisée aux deux conditions suivantes : (1) l'appareil ne doit pas produire de brouillage; (2) l'utilisateur de l'appareil doit accepter tout brouillage radioélectrique subi, même si le brouillage est susceptible d'en compromettre le fonctionnement.

This device complies with Industry Canada's licence-exempt RSSs. Operation is subject to the following two conditions: (1) This device may not cause interference; and (2) This device must accept any interference, including interference that may cause undesired operation of the device.

Le présent appareil est conforme aux CNR d'Industrie Canada applicables aux appareils radio exempts de licence. L'exploitation est autorisée aux deux conditions suivantes : (1) l'appareil ne doit pas produire de brouillage; (2) l'utilisateur de l'appareil doit accepter tout brouillage radioélectrique subi, même si le brouillage est susceptible d'en compromettre le fonctionnement.

**NOTE:**

This device complies with Industry Canada's licence-exempt RSSs.  
Operation is subject to the following two conditions:

- (1) This device may not cause interference; and
- (2) This device must accept any interference, including interference that may cause undesired operation of the device.

**NOTE:**

Le présent appareil est conforme aux CNR d'Industrie Canada applicables aux appareils radio exempts de licence. L'exploitation est autorisée aux deux conditions suivantes:

- (1) l'appareil ne doit pas produire de brouillage;
- (2) l'utilisateur de l'appareil doit accepter tout brouillage radioélectrique subi, même si le brouillage est susceptible d'en compromettre le fonctionnement.

**NOTE:**

This device complies with Industry Canada's licence-exempt RSSs.  
Operation is subject to the following two conditions:

- (1) This device may not cause interference; and
- (2) This device must accept any interference, including interference that may cause undesired operation of the device.

**NOTE:**

Le présent appareil est conforme aux CNR d'Industrie Canada applicables aux appareils radio exempts de licence. L'exploitation est autorisée aux deux conditions suivantes:

- (1) l'appareil ne doit pas produire de brouillage;
- (2) l'utilisateur de l'appareil doit accepter tout brouillage radioélectrique subi, même si le brouillage est susceptible d'en compromettre le fonctionnement.

 **WARNING****■ Caution regarding interference with electronic devices**

- People with implantable cardiac pacemakers, cardiac resynchronization therapy-pacemakers or implantable cardioverter defibrillators should keep away from the smart access system with push-button start antennas. (→P. 146)  
The radio waves may affect the operation of such devices. If necessary, the entry function can be disabled. Ask your Lexus dealer for details, such as the frequency of radio waves and timing of the emitted radio waves. Then, consult your doctor to see if you should disable the entry function.
- Users of any electrical medical device other than implantable cardiac pacemakers, cardiac resynchronization therapy-pacemakers or implantable cardioverter defibrillators should consult the manufacturer of the device for information about its operation under the influence of radio waves.  
Radio waves could have unexpected effects on the operation of such medical devices.

Ask your Lexus dealer for details on disabling the entry function.

3

Operation of each component

## Front seats

### Adjustment procedure

- ① Seat position adjustment switch
- ② Seat cushion (front) angle adjustment switch
- ③ Vertical height adjustment switch
- ④ Seatback angle adjustment switch
- ⑤ Lumbar support firmness adjustment switch
- ⑥ Lumbar support height adjustment switch (if equipped)
- ⑦ Seat cushion length adjustment switch (if equipped)

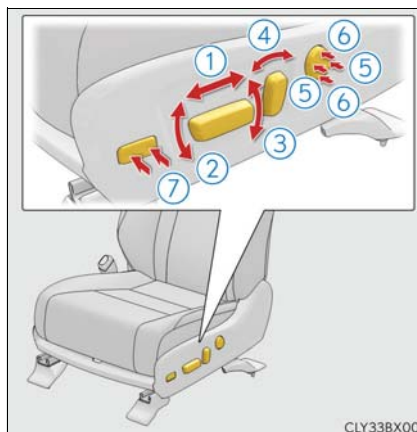

### ■ Power easy access system

The driver's seat (on some models) and steering wheel move in accordance with engine switch mode and the driver's seat belt condition. (→P. 172)

### ⚠ WARNING

#### ■ When adjusting the seat position

- Take care when adjusting the seat position to ensure that other passengers are not injured by the moving seat.
- Do not put your hands under the seat or near the moving parts to avoid injury. Fingers or hands may become jammed in the seat mechanism.
- Make sure to leave enough space around the feet so they do not get stuck.

#### ■ Seat adjustment

To reduce the risk of sliding under the lap belt during a collision, do not recline the seat more than necessary.

If the seat is too reclined, the lap belt may slide past the hips and apply restraint forces directly to the abdomen, or your neck may contact the shoulder belt, increasing the risk of death or serious injury in the event of an accident.

Adjustments should not be made while driving as the seat may unexpectedly move and cause the driver to lose control of the vehicle.

## Rear seats

### Second-row seats (RX350)

#### ▶ Manual seat

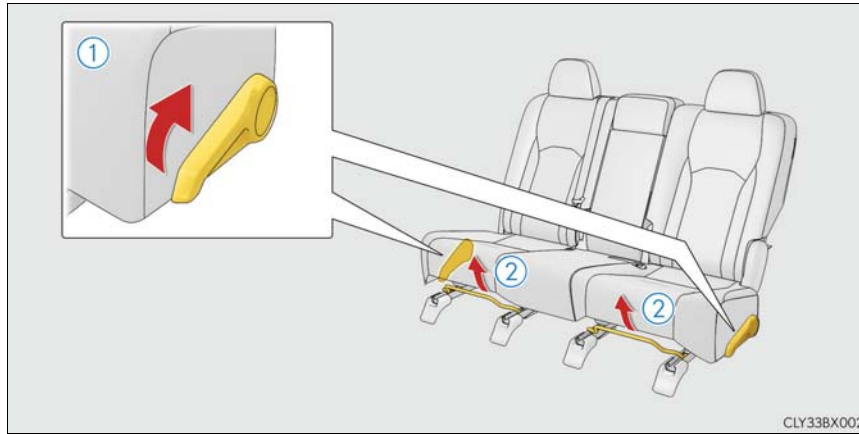

- ① Seatback angle adjustment lever
- ② Seat position adjustment lever

#### ▶ Power seat

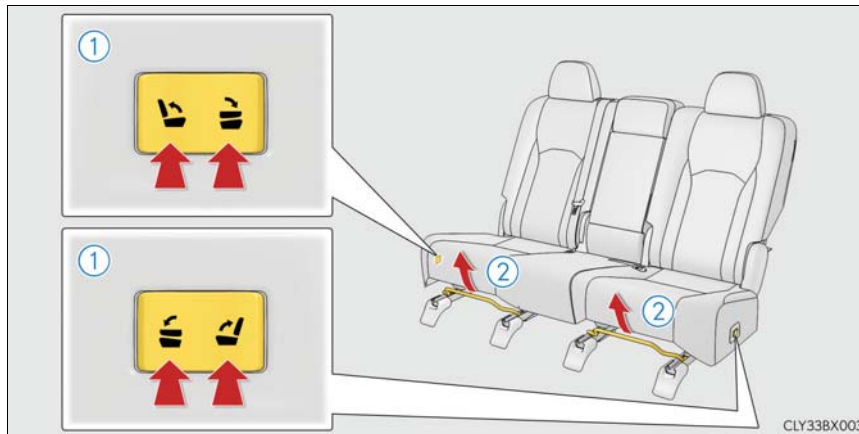

- ① Seatback angle adjustment switch
- ② Seat position adjustment lever

Second-row seats (RX350L)

▶ Separate seat

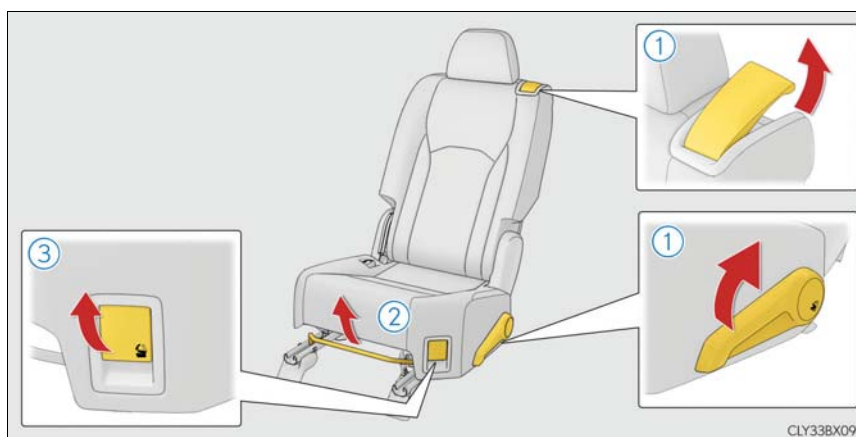

- ① Seatback angle adjustment lever
- ② Seat position adjustment lever
- ③ Seatback folding lever

▶ Bench seat

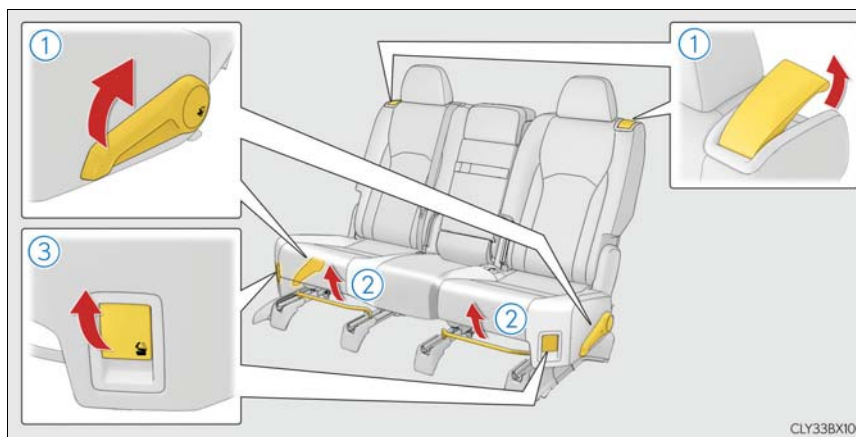

- ① Seatback angle adjustment lever
- ② Seat position adjustment lever
- ③ Seatback folding lever

## Third-row seats (RX350L)



- ① Right seat fold switch
- ② Right seat return switch
- ③ Left seat fold switch
- ④ Left seat return switch

3

Operation of each component



### Folding the second-row seat seatbacks (RX350)

■ Before folding the rear seatbacks

- 1 Stow the center seat seat belt buckle.
- 2 Lower the rear seat head restraints to the lowest position. (→P. 177)

■ Folding the rear seatbacks (manual seat)

- ▶ Using the seatback angle adjustment lever

Pull the lever and fold the rear seat-back.

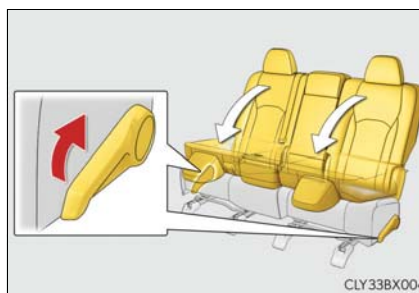

- ▶ Using the lever in the luggage compartment

Pull the lever and fold the rear seat-back.

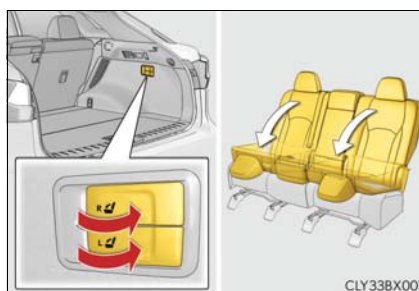

### ■ Folding the rear seatbacks (power seat)

Press and hold the fold switch until the rear seatback begins to operate.

A buzzer will sound and then the operation will start. When the operation is completed, the buzzer will sound again.

To stop the operation partway, press either side of the switch for the operating seat. Any rear seat operation switch for the operating seat, regardless of location, can be used to stop the operation. (A buzzer may sound depending on the position that the rear seatback is stopped.)

- ▶ Using the seatback angle adjustment switch
- ▶ Using the switch in the luggage compartment

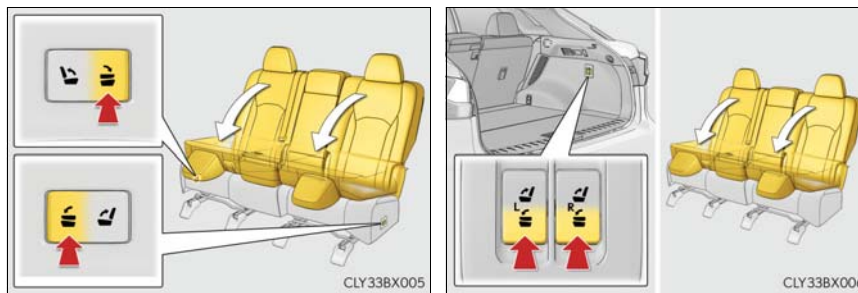

When using the seatback angle adjustment switch: If the rear seatback is reclined, adjust it to the most upright position and then press the switch again.

### ■ Returning the rear seatbacks (manual seat)

- 1 Lift the rear seatback until it locks in position.

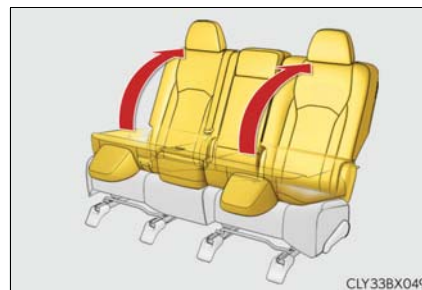

- 2 Check that the plate of the seat belt is on the front side of the seatback.



■ Returning the rear seatbacks (power seat)

- 1 Press and hold the return switch until the rear seatback begins to operate.

A buzzer will sound and then the operation will start. When the operation is completed, the buzzer will sound twice again.

To stop the operation partway, press either side of the switch for the operating seat. Any rear seat operation switch for the operating seat, regardless of location, can be used to stop the operation. (A buzzer may sound depending on the position that the rear seatback is stopped.)

- ▶ Using the seatback angle adjustment switch
- ▶ Using the switch in the luggage compartment

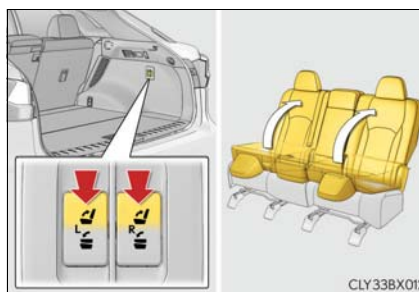
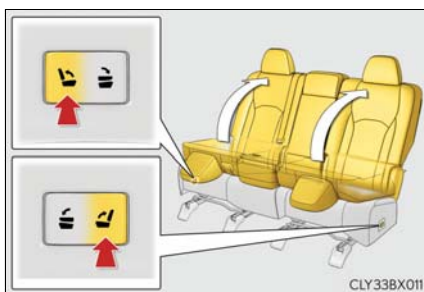

- 2 Check that the plate of the seat belt is on the front side of the seatback.

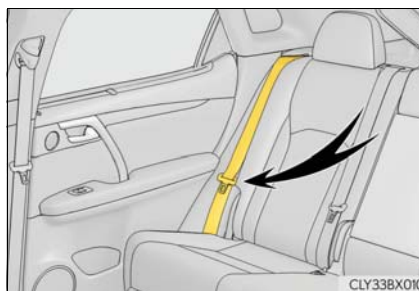

■ Folding the rear center seatback only

Pull the lock release lever on the back side of the seatback and fold the center seatback.

To return the rear center seatback to its original position, lift it until it locks in position.

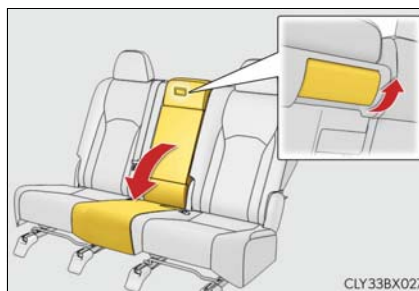

### Folding the second-row seat seatbacks (RX350L)

#### ■ Before folding the second-row seat seatbacks

- 1 To prevent the seat belt from being damaged, hook it to the seat belt hanger.

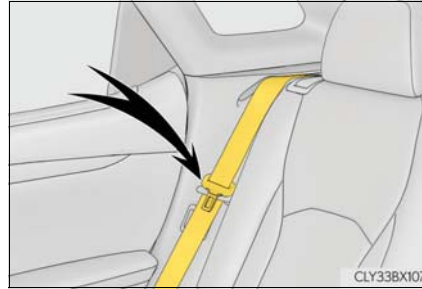

- 2 Stow the center seat seat belt buckle.
- 3 Lower the second-row seat head restraints to the lowest position. (→P. 177)

#### ■ Folding the second-row seat seatbacks

- ▶ Separate seat

- 1 Pull the seatback angle adjustment lever and tilt the seatback forward.

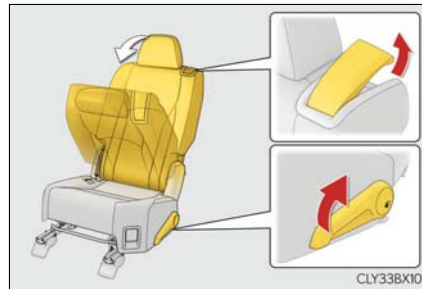

- 2 Pull the seatback folding lever and fold the seatback.

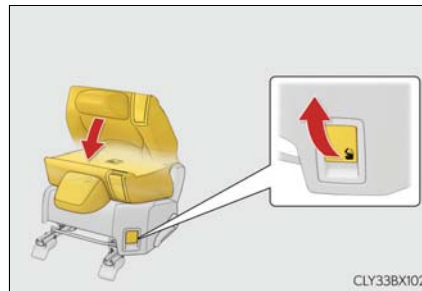

3

Operation of each component

▶ Bench seat

- 1 Pull the seatback angle adjustment lever and tilt the seatback forward.

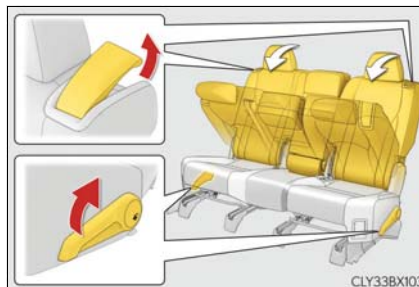

- 2 Pull the seatback folding lever and fold the seatback.

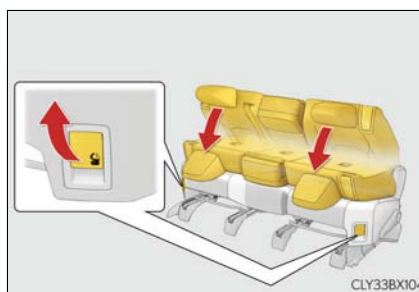

■ Returning the second-row seat seatbacks

Lift the second-row seat seatback until it locks in position.



■ Folding the second-row center seatback only

Pull the lock release lever on the back side of the seatback and fold the center seatback.

To return the second-row center seatback to its original position, lift it until it locks in position.

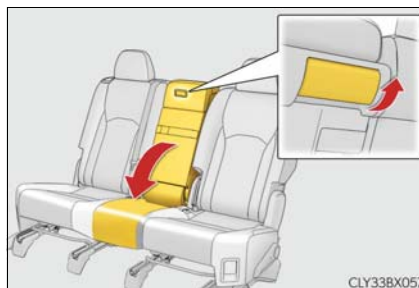

### Moving the second-row seat for third-row seat access (RX350L)

#### ■ Before moving the second-row seat

To prevent the seat belt from being damaged, hook it to the seat belt hanger.



#### ■ When entering/exiting the vehicle

Pull the seatback angle adjustment lever A or B to tilt the seatback forward and then slide the seat forward.

Make sure that the second-row seat is free of passengers and obstructions before operating the seatback tilt lever.

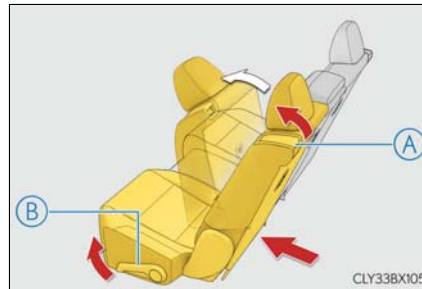

#### ■ After passengers have entered/exited the vehicle

Tilt back and slide the second-row seat until it locks in position.

3

Operation of each component

### Folding the third-row seat seatbacks (RX350L)

#### ■ Before folding the third-row seat seatbacks

- 1 To prevent the seat belt from being damaged, hook it to the seat belt hanger.

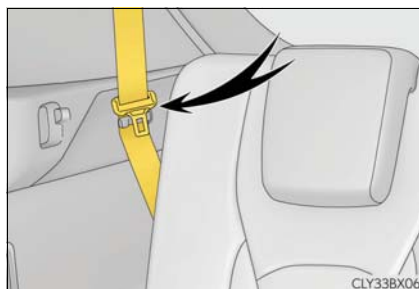

- 2 Lower the third-row seat head restraints to the lowest position. (→P. 177)

#### ■ Folding the third-row seat seatbacks

Press and hold the  side of the switch until the seatback is folded completely.

A buzzer will sound twice before the operation begins and twice when the operation is complete.

If the switch is released while the seatback is operating, the seatback will stop and a buzzer will sound continuously.



#### ■ Returning the third-row seat seatbacks

Press and hold the  side of the switch until the seatback is fully upright.

A buzzer will sound twice before the operation begins and twice when the operation is complete.

If the switch is released while the seatback is operating, the seatback will stop and a buzzer will sound continuously.



#### ■ The rear seatbacks can be adjusted when (power second-row seat)

When the rear seatback is in a position within the range A shown in the illustration, the rear seat operation switch (rear seat) can be used to adjust the rear seatback.

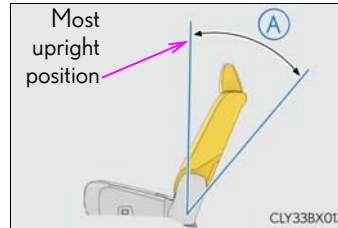

#### ■ Engine switch mode conditions under which the rear seatbacks can be folded down or raised

The rear seatbacks can be folded down or raised when the engine switch is in either of the following modes:

- When the engine switch is turned off or in ACCESSORY mode
- When the engine switch is in IGNITION ON mode and any of the following conditions are met:
  - The parking brake is engaged.
  - The brake pedal is depressed.
  - The shift lever is in P.

#### ■ The rear seatbacks can be folded down when (power second-row seat)

When all of the following conditions are met, a rear seat operation switch can be used to fold down the rear seatback:

- When using the rear seat operation switch (rear seat): The rear seatback is in a position within the range A shown in the illustration with the rear door nearest to the seat to be operated open
- When using the rear seat operation switch (luggage compartment): The rear seatback is in a position within the range B shown in the illustration with the back door open
- The other seat operation switch for the seat to be operated is not being pressed.

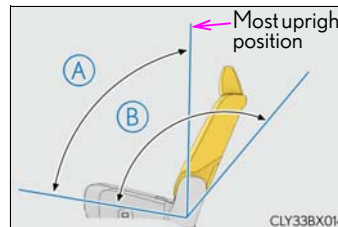



■ **The rear seatbacks can be raised when (power second-row seat)**

When all of the following conditions are met, a rear seat operation switch can be used to return the rear seatback:

- When using the rear seat operation switch (rear seat): The rear seatback is in a position within the range A shown in the illustration with the back door open
- When using the rear seat operation switch (rear seat): The rear door nearest to the seat to be operated is open
- The other seat operation switch for the seat to be operated is not being pressed.

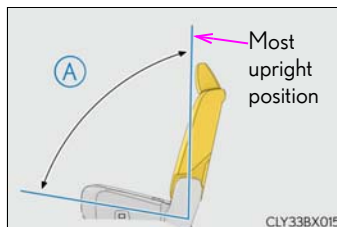

■ **Fully reclining the rear seatback (power second-row seat)**

Operate the rear seat operation switch (rear seat) to recline the rear seatback and stop it partway. To set the rear seatback to the rear-most position, press the button again.

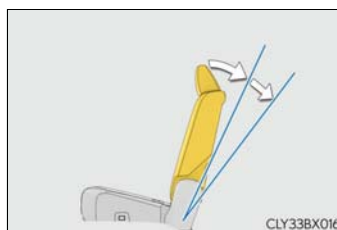

■ **The third-row seats can be folded when (RX350L)**

- The vehicle is stopped.
- The back door is open. (When using the switches in the luggage compartment)
- A seat side switch and switch in the luggage compartment are not being operated simultaneously.

■ **Precautions for power seats (if equipped)**

If a seat cover or seat cushion is used on a power seat, the power seat may not operate properly.

Before folding the seatback of a power seat, make sure that the seat and area around the seat is free of obstructions which may interfere the operation.



■ **Rear seatback jam protection function (power seat)**

When folding or returning the seatback of a power seat, if an object is detected between the seatback and seat cushion or behind the seatback, the seatback may stop or move in the opposite direction slightly.

A buzzer will sound continuously when the seatback stops and intermittently when moving in the opposite direction.

■ **If a buzzer sounds continuously after a third-row seat seatback is completely folded (RX350L)**

The power seat system may be malfunctioning or it may need to be initialized. To initialize the system, perform the following procedure. (It is necessary to perform this procedure with two people.)

- 1 Check that the seat is free of obstructions.
- 2 Press and hold the  side switch of the luggage compartment side switch for the seat which the buzzer is sounding.
- 3 Within 10 seconds of the performing the above step, press the  side switch of the seat side switch 5 times.
- 4 When a buzzer sounds 3 times, release the luggage compartment side switch.
- 5 Press the  side switch of the seat side switch until the seatback is folded completely.

A buzzer will sound twice when the operation is complete.

If the buzzer does not stop sounding even though the above procedure has been performed, have the vehicle inspected by your Lexus dealer.

 **WARNING**

■ **When a rear seatback is folded**

Observe the following precautions.  
Failure to do so may result in death or serious injury.

- Do not fold down the rear seatbacks while driving.
- Stop the vehicle on level ground, apply the parking brake and shift the shift lever to P.
- Do not allow anyone to sit on a folded rear seatback or in the luggage compartment while driving.
- Do not allow children to enter the luggage compartment.

■ **When operating the rear seatback**

Observe the following precautions.  
Failure to do so may result in death or serious injury.

- Make sure that passengers are clear of the rear seatback before operating it.
- To prevent hands and other body parts from being caught, keep them away from the gaps in the seats and the moving parts of the seats when operating a rear seatback.
- Power seat: Do not let children operate the rear seatback. Other passengers may get caught in the seat.
- Power seat: Make sure that all passengers are clear of a seat before folding it. Do not let passengers sit in the seat while it is being folded.

 **WARNING****■ Seat adjustment**

- Second-row seats: To reduce the risk of sliding under the lap belt during a collision, do not recline the seat more than necessary. If the seat is reclined excessively, the lap belt may slide past the hips and apply restraint forces directly to the abdomen, or your neck may contact the shoulder belt, increasing the risk of death or serious injury in the event of an accident.
- Adjustments should not be made while driving as the seat may unexpectedly move and cause the driver to lose control of the vehicle.

**■ After adjusting the rear seats**

Observe the following precautions.

Failure to do so may result in death or serious injury.

- Manual seats: Make sure that the rear seatback is securely locked in position by lightly pushing it back and forth.
- Check that the seat belts are not twisted or caught between or behind in the rear seatback.

**■ Jam protection function (power seats)**

Observe the following precautions.

Failure to do so may result in death or serious injury.

- Never use any part of your body to intentionally activate the jam protection function.
- The jam protection function may not operate if something is caught just before the fully folded position. Be careful so that fingers, etc. do not get caught.
- The jam protection function may not operate depending on the shape or position of the obstruction. Be careful so that fingers, etc. do not get caught.

**■ Precautions for third-row seat (RX350L)**

When operating a third-row seat, make sure to press and hold the switch until the third-row seat seatback is completely folded/upright. Do not use a third-row seat in a position other than the completely upright position, as doing so may lead to death or serious injury in an accident. (If the switch is released while the seatback is still moving, a buzzer will sound continuously until the seatback is completely folded/upright.)

 NOTICE**■ Before folding a rear seat seatback**

- Second-row seats: Make sure to stow the center seat belt buckle and armrest before folding the second-row seat seatbacks. (→P. 555)
- Third-row seats: Make sure that the third-row seats and trays are free of obstructions before folding the seatbacks. Otherwise the seat or tray may be damaged.

**■ When moving the second-row seat for third-row seat access (RX350L)**

Do not slide the second-row seat forward if an electronic device is connected to the power outlet on the rear console. Otherwise, the second-row seat may contact the electronic device, possibly resulting in damage to the device.

**■ Before returning the third-row seat seatbacks to the upright position (RX350L)**

If the luggage cover is installed in the luggage compartment, make sure to remove it before returning the third-row seat seatbacks. (→P. 537) Otherwise, the luggage cover may be damaged.

### Driving position memory\*

This feature automatically adjusts the driver's seat (on some models), steering wheel, outside rear view mirrors and head-up display (if equipped) to make entering and exiting the vehicle easier or to suit your preferences.

### Power easy access system (driver's side only)

The seat and steering wheel are automatically adjusted to allow the driver to enter and exit the vehicle easily.

When all of the following have been performed, the seat and steering wheel are automatically adjusted to a position that allows driver to enter and exit the vehicle easily.

- The shift lever has been shifted to P.
- The engine switch has been turned off.
- The driver's seat belt has been unfastened.

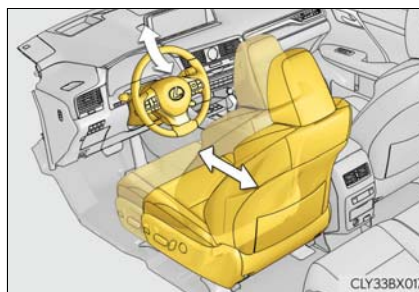

When any of the following has been performed, the seat and steering wheel automatically return to their original positions.

- The engine switch has been turned to ACCESSORY mode or IGNITION ON mode.
- The driver's seat belt has been fastened.

#### ■ Operation of the power easy access system

When exiting the vehicle, the power easy access system may not operate if the seat is already close to the rearmost position, etc.

#### ■ Customization

Some functions can be customized. (→P. 722)

\*: If equipped

### Driving position memory

Your preferred driving position (the position of the driver's seat, steering wheel, outside rear view mirrors and head-up display\*) can be recorded and recalled by pressing a button.

Three different driving positions can be recorded into memory.

\*: If equipped

#### ■ Recording procedure

- 1 Check that the shift lever is in P.
- 2 Turn the engine switch to IGNITION ON mode.
- 3 Adjust the driver's seat, steering wheel, outside rear view mirrors and head-up display (if equipped) to the desired positions.
- 4 While pressing the "SET" button, or within 3 seconds after the "SET" button is pressed, press button "1", "2" or "3" until the buzzer sounds.

If the selected button has already been preset, the previously recorded position will be overwritten.

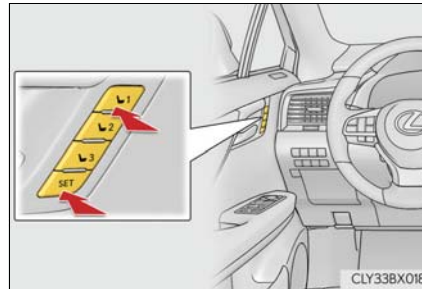

3

Operation of each component

■ **Recall procedure**

- 1 Check that the shift lever is in P.
- 2 Turn the engine switch to IGNITION ON mode.
- 3 Press one of the buttons for the driving position you want to recall until the buzzer sounds.

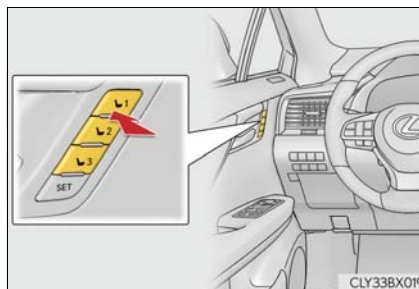

■ **To stop the position recall operation part-way through**

Perform any of the following:

- Press the "SET" button.
- Press button "1", "2" or "3".
- Operate any of the seat adjustment switches (only cancels seat position recall).
- Operate the tilt and telescopic steering control switch (only cancels steering wheel position recall).

■ **Seat positions that can be memorized (→P. 156)**

The adjusted positions other than the position adjusted by lumbar support switch can be recorded.

■ **Operating the driving position memory after turning the engine switch off**

Recorded seat positions can be activated up to 180 seconds after the driver's door is opened and another 60 seconds after it is closed again.

■ **In order to correctly use the driving position memory function**

If a seat position is already in the furthest possible position and the seat is operated in the same direction, the recorded position may be slightly different when it is recalled.

### Memory recall function (driver's side only)

Each electronic key can be registered to recall your preferred driving position.

#### ■ Registering procedure

Record your driving position to button "1", "2" or "3" before performing the following:

Carry only the key you want to register, and then close the driver's door.

If 2 or more keys are in the vehicle, the driving position cannot be recorded properly.

- 1 Check that the shift lever is in P.
- 2 Turn the engine switch to IGNITION ON mode.
- 3 Recall the driving position that you want to record.
- 4 While pressing the recalled button, press and hold the door lock switch (either lock or unlock) until the buzzer sounds.

If the button could not be registered, the buzzer sounds continuously for approximately 3 seconds.

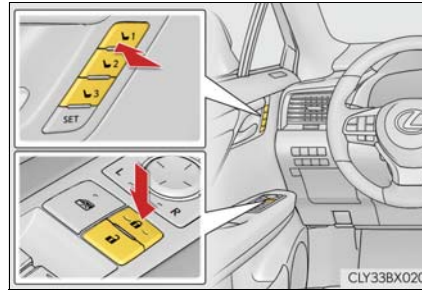

#### ■ Recall procedure

- 1 Make sure that the doors are locked before recalling the driving position. Carry the electronic key that has been registered to the driving position, and then unlock and open the driver's door using the smart access system with push-button start or wireless remote control.

The driving position will move to the recorded position (not including the steering wheel and head-up display\*). However, the seat will move to a position slightly behind the recorded position in order to make entering the vehicle easier.

If the driving position is in a position that has already been recorded, the seat and outside rear view mirrors will not move.

\*: If equipped

- 2 Turn the engine switch to ACCESSORY mode or IGNITION ON mode, or fasten a seat belt.

The seat, steering wheel and head-up display (if equipped) will move to the recorded position.

3

Operation of each component



■ **Cancelation procedure**

Carry only the key you want to cancel and then close the driver's door.  
If 2 or more keys are in the vehicle, the driving position cannot be canceled properly.

- 1 Turn the engine switch to IGNITION ON mode.
- 2 While pressing the "SET" button, press and hold the door lock switch (either lock or unlock) until the buzzer sounds twice.

If it button could not be canceled, the buzzer sounds continuously for approximately 3 seconds.

---

■ **Recalling the driving position using the memory recall function**

- Different driving positions can be registered for each electronic key. Therefore, the driving position that is recalled may be different depending on the key being carried.
- If a door other than the driver's door is unlocked with the smart access system with push-button start, the driving position cannot be recalled. In this case, press the driving position button which has been set.

■ **Customization**

Some functions can be customized. (→P. 722)

 **WARNING**

■ **Seat adjustment caution**

Take care during seat adjustment so that the seat does not strike the rear passenger or squeeze your body against the steering wheel.

## Head restraints

Head restraints are provided for all seats.

### Front seats

#### ◆ Vertical adjustment

- ① Up  
Pull the head restraints up.
- ② Down  
Push the head restraint down while pressing the lock release button.

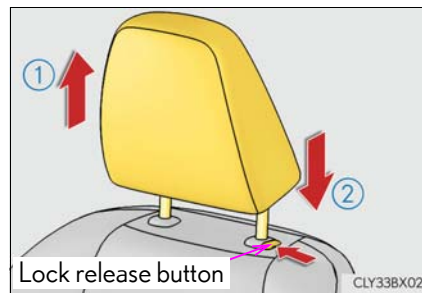

#### ◆ Horizontal adjustment (if equipped)

The position of the head restraint can be adjusted forward in 4 stages.

If the head restraint is pulled forward from the foremost position, it will return to the rearmost position.

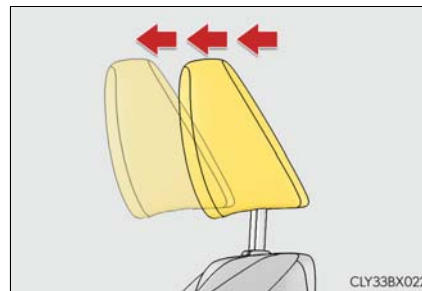

### Second-row seats

- ① Up  
Pull the head restraints up.
- ② Down  
Push the head restraint down while pressing the lock release button.

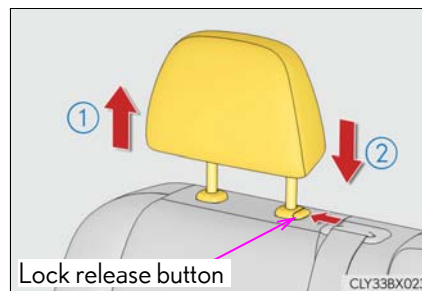

3

Operation of each component

### Third-row seats (RX350L)

- ① Up  
Pull the head restraints up.
- ② Down  
Push the head restraint down while pressing the lock release button.

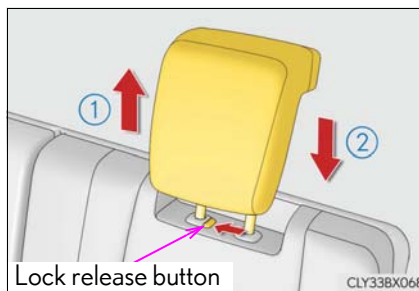

#### ■ Removing the head restraints

##### ▶ Front and second-row seats

Pull the head restraint up while pressing the lock release button.

If the head restraint touches the ceiling, making the removal difficult, change the seat height or angle. (→P. 156, 157)

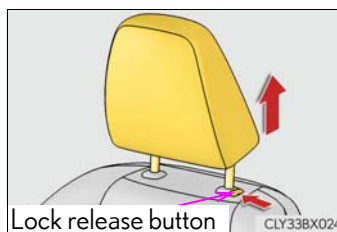

##### ▶ Third-row seats

Pull the head restraint up while pressing the lock release button.

If the head restraint touches the ceiling, making the removal difficult, change the seat angle. (→ P. 157)

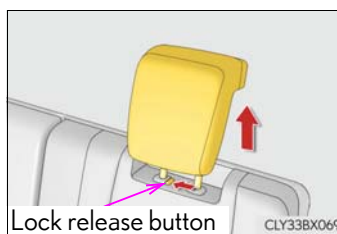

#### ■ Installing the head restraints

##### ▶ Front and second-row seats

Align the head restraint with the installation holes and push it down to the lock position.

Press and hold the lock release button when lowering the head restraint.

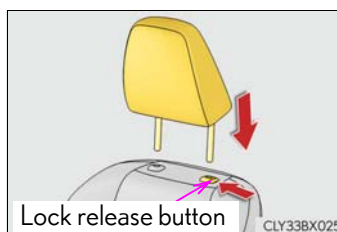

▶ Third-row seats

Align the head restraint with the installation holes and push it down to the lock position.  
Press and hold the lock release button when lowering the head restraint.

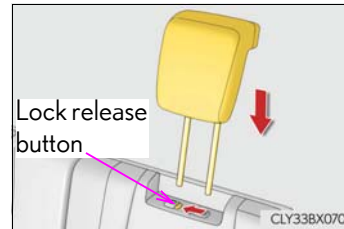

■ Adjusting the height of the head restraints

Make sure that the head restraints are adjusted so that the center of the head restraint is closest to the top of your ears.

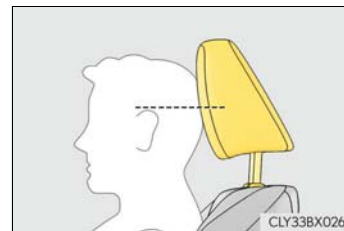

■ Adjusting the second-row center and third-row seat head restraints

Always raise the head restraint one level from the stowed position when using.

**⚠ WARNING**

■ Head restraint precautions

Observe the following precautions regarding the head restraints.  
Failure to do so may result in death or serious injury.

- Use the head restraints designed for each respective seat.
- Adjust the head restraints to the correct position at all times.
- After adjusting the head restraints, push down on them and make sure they are locked in position.
- Do not drive with the head restraints removed.

## Steering wheel

### Adjustment procedure

Operating the switch moves the steering wheel in the following directions:

- ① Up
- ② Down
- ③ Toward the driver
- ④ Away from the driver

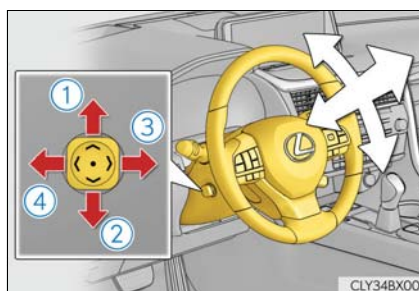

### Auto tilt away

When the engine switch is turned off, the steering wheel returns to its stowed position by moving up and away to enable easier driver entry and exit.

Turning the engine switch to ACCESSORY or IGNITION ON mode will return the steering wheel to the original position.



### Horn

To sound the horn, press on or close to the  mark.

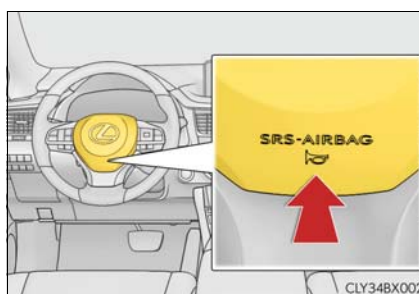

**■ The steering wheel can be adjusted when**

The engine switch is in ACCESSORY or IGNITION ON mode\*.

\*: If the driver's seat belt is fastened, the steering wheel can be adjusted regardless of engine switch mode.

**■ Automatic adjustment of the steering position (if equipped)**

A desired steering position can be entered to memory and recalled automatically by the driving position memory system. (→P. 172)

**■ Power easy access system**

The steering wheel and driver's seat (on some models) move in accordance with engine switch mode and the driver's seat belt condition. (→P. 172)

**■ Customization**

Some functions can be customized. (→P. 722)

**⚠ WARNING**

Do not adjust the steering wheel while driving.  
Doing so may cause the driver to mishandle the vehicle and cause an accident, resulting in death or serious injury.

## Inside rear view mirror

The rear view mirror's position can be adjusted to enable sufficient confirmation of the rear view.

### Adjusting the height of rear view mirror

The height of the rear view mirror can be adjusted to suit your driving posture.

Adjust the height of the rear view mirror by moving it up and down.



### Auto anti-glare function

Responding to the level of brightness of the headlights of vehicles behind, the reflected light is automatically reduced.

Changing automatic anti-glare function mode

ON/OFF

When the automatic anti-glare function is in ON mode, the indicator illuminates. The function will set to ON mode each time the engine switch is turned to IGNITION ON mode.

Pressing the button turns the function to OFF mode. (The indicator also turns off.)

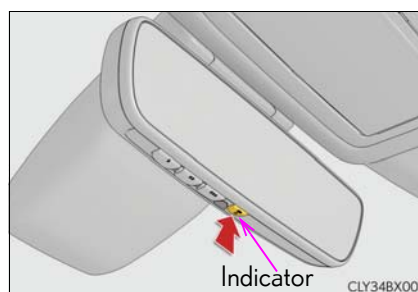

**■ To prevent sensor error**

To ensure that the sensors operate properly, do not touch or cover them.

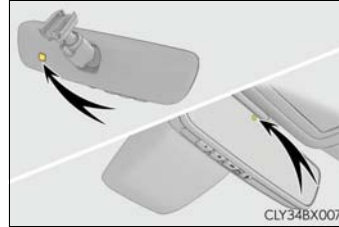
**⚠ WARNING**

Do not adjust the position of the mirror while driving. Doing so may lead to mishandling of the vehicle and cause an accident, resulting in death or serious injury.

3

Operation of each component



## Outside rear view mirrors

### Adjustment procedure

**1** To select a mirror to adjust, press the switch.

- ① Left
- ② Right

Pressing the same switch again will put the switch in neutral.

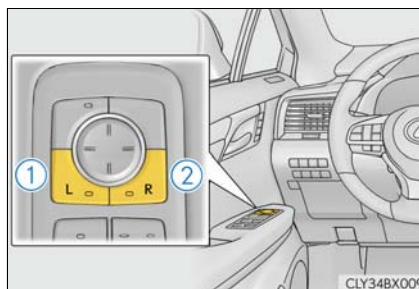

**2** To adjust the mirror, press the switch.

- ① Up
- ② Right
- ③ Down
- ④ Left

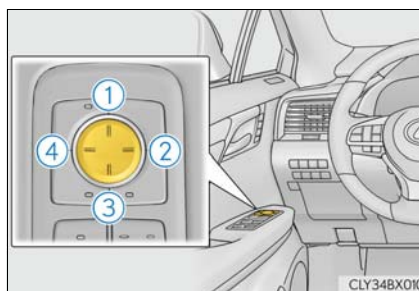

### Folding the mirrors (manual type)

Push the mirror back in the direction of the vehicle's rear.

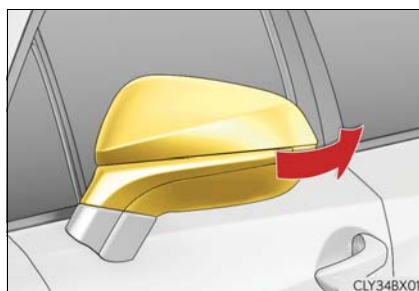

### Folding and extending the mirrors (power type)

#### ■ Using the switch

Press the switch to fold the mirrors.

Press it again to extend them to the original position.

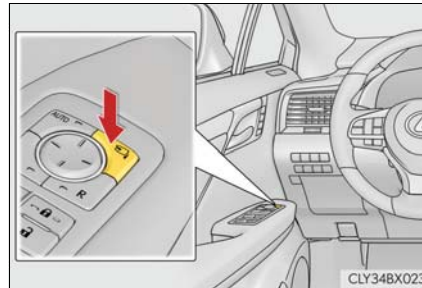

#### ■ Setting automatic mode

Automatic mode allows the folding or extending of the mirrors to be linked to locking/unlocking of the doors.

Press the "AUTO" switch to set automatic mode.

The indicator will come on.

Pressing the switch once more will return to manual mode.

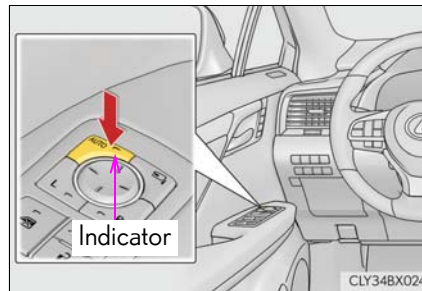

3

Operation of each component

### Linked mirror function when reversing

When the mirror select switch is in the "L" or "R" position, the outside rear view mirrors will automatically angle downwards when the vehicle is reversing in order to give a better view of the ground.

To disable this function, select neither "L" nor "R" of the mirror select switch.

#### ■ Adjusting the mirror angle when the vehicle is reversing

With the shift lever in R, adjust the mirror angle at a desired position.

The adjusted angle will be memorized and the mirror will automatically tilt to the memorized angle whenever the shift lever is shifted to R from next time.

The memorized downward tilt position of the mirror is linked to the normal position (angle adjusted with the shift lever in other than R). Therefore, if the normal position is changed after adjustment, the tilt position will also change.

When the normal position is changed, readjust the angle in reversing.

**■ Mirror angle can be adjusted when**

The engine switch is in ACCESSORY or IGNITION ON mode.

**■ When disconnecting and reconnecting battery terminals (vehicles with an automatic folding/extending mirror function)**

The automatic folding/extending mirror function will return to off as default. To turn the function on, press the switch again to select on.

**■ When the mirrors are fogged up**

The outside rear view mirrors can be cleared using the mirror defoggers. Turn on the rear window defogger to turn on the outside rear view mirror defoggers. (→P. 513)

**■ Automatic adjustment of the mirror angle (if equipped)**

A desired mirror face angle can be entered to memory and recalled automatically by the driving position memory. (→P. 172)

**■ Auto anti-glare function (if equipped)**

When the anti-glare inside rear view mirror is set to automatic mode, the outside rear view mirrors will activate in conjunction with the anti-glare inside rear view mirror to reduce reflected light. (→P. 182)

**■ Using automatic mode in cold weather (if equipped)**

When automatic mode is used in cold weather, the door mirror could freeze up and automatic stowing and return may not be possible. In this case, remove any ice and snow from the door mirror, then either operate the mirror using manual mode or move the mirror by hand.

**■ Customization**

Some functions can be customized. (→P. 722)

**WARNING****■ Important points while driving**

Observe the following precautions while driving.

Failing to do so may result in loss of control of the vehicle and cause an accident, resulting in death or serious injury.

● Do not adjust the mirrors while driving.

● Do not drive with the mirrors folded.

● Both the driver and passenger side mirrors must be extended and properly adjusted before driving.

**■ When a mirror is moving**

To avoid personal injury and mirror malfunction, be careful not to get your hand caught by the moving mirror.

**■ When the mirror defoggers are operating**

Do not touch the rear view mirror surfaces, as they can become very hot and burn you.

## Power windows

### Opening and closing procedures

The power windows can be opened and closed using the switches.

Operating the switch moves the windows as follows:

- ① Closing
- ② One-touch closing\*
- ③ Opening
- ④ One-touch opening\*

\*: To stop the window partway, operate the switch in the opposite direction.

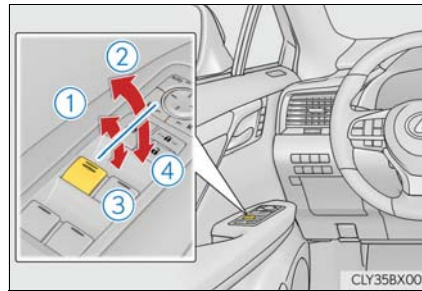

### Window lock switch

Press the switch down to lock the passenger windows. The indicator light will come on when the passenger windows are locked.

Use this switch to prevent children from accidentally opening or closing a passenger window.

The passenger windows can still be opened and closed using the driver's switch even if the lock switch is on.

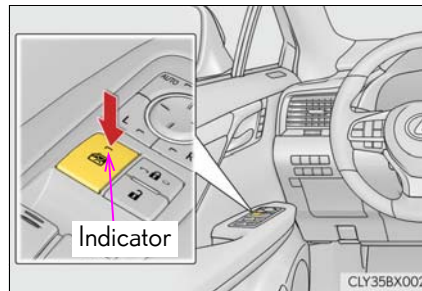

3

Operation of each component

**■ The power windows can be operated when**

The engine switch is in IGNITION ON mode.

**■ Operating the power windows after turning the engine off**

The power windows can be operated for approximately 45 seconds even after the engine switch is turned to ACCESSORY mode or turned off. They cannot, however, be operated once either front door is opened.

**■ Jam protection function**

If an object becomes jammed between the window and the window frame while the window is closing, window movement is stopped and the window is opened slightly.

**■ Catch protection function**

If an object becomes caught between the door and window while the window is opening, window movement is stopped.

**■ When the window cannot be opened or closed**

When the jam protection function or catch protection function operates unusually and the door window cannot be opened or closed, perform the following operations with the power window switch of that door.

- Stop the vehicle. With the engine switch in IGNITION ON mode, within 4 seconds of the jam protection function or catch protection function activating, continuously operate the power window switch in the one-touch closing direction or one-touch opening direction so that the door window can be opened and closed.
- If the door window cannot be opened and closed even when performing the above operations, perform the following procedure for function initialization.
  - 1 Turn the engine switch to IGNITION ON mode.
  - 2 Pull and hold the power window switch in the one-touch closing direction and completely close the door window.
  - 3 Release the power window switch for a moment, resume pulling the switch in the one-touch closing direction, and hold it there for approximately 6 seconds or more.
  - 4 Press and hold the power window switch in the one-touch opening direction. After the door window is completely opened, continue holding the switch for an additional 1 second or more.
  - 5 Release the power window switch for a moment, resume pushing the switch in the one-touch opening direction, and hold it there for approximately 4 seconds or more.
  - 6 Pull and hold the power window switch in the one-touch closing direction again. After the door window is completely closed, continue holding the switch for a further 1 second or more.

If you release the switch while the window is moving, start again from the beginning.

If the window reverses and cannot be fully closed or opened, have the vehicle inspected by your Lexus dealer.

**■ Door lock linked window operation**

- The power windows can be opened and closed using the mechanical key.\* (→P. 685)
- The power windows can be opened using the wireless remote control.\* (→P. 124)

\*: These settings must be customized at your Lexus dealer.

**■ Alarm**

The alarm may be triggered if the alarm is set and a power window is closed using the door lock linked power window operation function. (→P. 77)

**■ When the battery is disconnected**

The window lock switch is disabled. If necessary, press the window lock switch after reconnecting the battery.

**■ Power windows open warning buzzer**

A buzzer sounds and a message is shown on the multi-information display in the instrument cluster when the engine switch is turned off and the driver's door is opened with the power windows open.

**■ Customization**

Some functions can be customized. (→P. 722)

**⚠ WARNING**

Observe the following precautions.  
Failing to do so may result in death or serious injury.

**■ Opening and closing the windows**

- The driver is responsible for all the power window operations, including the operation for the passengers. In order to prevent accidental operation, especially by a child, do not let a child operate the power windows. It is possible for children and other passengers to have body parts caught in the power window. Also, when riding with a child, it is recommended to use the window lock switch. (→P. 187)

- Check to make sure that all passengers do not have any part of their body in a position where it could be caught when a window is being operated.



- When using the wireless remote control or mechanical key and operating the power windows, operate the power window after checking to make sure that there is no possibility of any passenger having any of their body parts caught in the window. Also do not let a child operate power window by the wireless remote control or mechanical key. It is possible for children and other passengers to get caught in the power window.
- When exiting the vehicle, turn the engine switch off, carry the key and exit the vehicle along with the child. There may be accidental operation, due to mischief, etc., that may possibly lead to an accident.

**■ Jam protection function**

- Never use any part of your body to intentionally activate the jam protection function.
- The jam protection function may not work if something gets jammed just before the window is fully closed. Be careful not to get any part of your body jammed in the window.

**■ Catch protection function**

- Never use any part of your body or clothing to intentionally activate the catch protection function.
- The catch protection function may not work if something gets caught just before the window is fully opened. Be careful not to get any part of your body or clothing caught in the window.

## Moon roof\*

Use the overhead switches to open and close the moon roof and tilt it up and down.

### Opening and closing

- ① Opens the moon roof\*  
The moon roof stops slightly before the fully open position to reduce wind noise. Press the switch again to fully open the moon roof.
  - ② Closes the moon roof\*
- \*: Lightly press either side of the moon roof switch to stop the moon roof part-way.

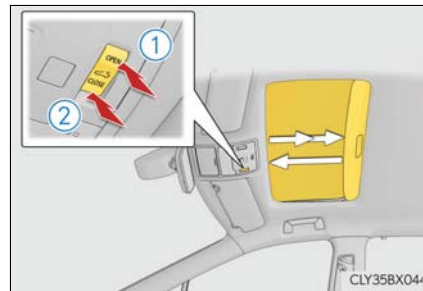

### Tilting up and down

- ① Tilts the moon roof up\*
  - ② Tilts the moon roof down\*
- \*: Lightly press either side of the moon roof switch to stop the moon roof part-way.

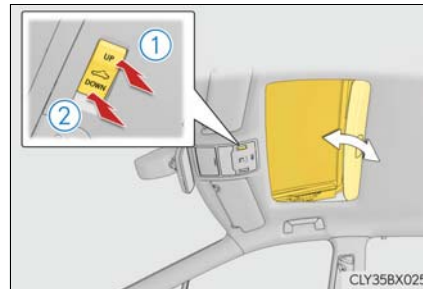

3

Operation of each component

\*: If equipped



**■ The moon roof can be operated when**

The engine switch is in IGNITION ON mode.

**■ Operating the moon roof after turning the engine off**

The moon roof can be operated for approximately 45 seconds after the engine switch is turned to ACCESSORY mode or turned off. It cannot, however, be operated once the driver's door is opened.

**■ Jam protection function**

If an object is detected between the moon roof and the frame while the moon roof is closing or tilting down, travel is stopped and the moon roof opens slightly.

**■ Sunshade**

The sunshade can be opened and closed manually. However, the sunshade will open automatically when the moon roof is opened.

**■ Door lock linked moon roof operation**

● The moon roof can be opened and closed using the mechanical key.\* (→P. 685)

● The moon roof can be opened using the wireless remote control.\* (→P. 124)

\*: These settings must be customized at your Lexus dealer.

### ■ When the moon roof does not close normally

Perform the following procedure:

- If the moon roof closes but then re-opens slightly

- 1 Stop the vehicle.
- 2 Press and hold the "CLOSE" switch.\*1  
The moon roof will close, reopen and pause for approximately 10 seconds.\*2 Then it will close again, tilt up and pause for approximately 1 second. Finally, it will tilt down, open and close.
- 3 Check to make sure that the moon roof is completely closed and then release the switch.

- If the moon roof tilts down but then tilts back up

- 1 Stop the vehicle.
- 2 Press and hold the "UP" switch\*1 until the moon roof moves into the tilt up position and stops.
- 3 Release the "UP" switch once and then press and hold the "UP" switch again.\*1  
The moon roof will pause for approximately 10 seconds in the tilt up position.\*2 Then it will adjust slightly and pause for approximately 1 second. Finally, it will tilt down, open and close.
- 4 Check to make sure that the moon roof is completely closed and then release the switch.

\*1: If the switch is released at the incorrect time, the procedure will have to be performed again from the beginning.

\*2: If the switch is released after the above mentioned 10 second pause, automatic operation will be disabled. In that case, press and hold the "CLOSE" or "UP" switch, and the moon roof will tilt up and pause for approximately 1 second. Then it will tilt down, open and close. Check to make sure that the moon roof is completely closed and then release the switch.

If the moon roof does not fully close even after performing the above procedure correctly, have the vehicle inspected by your Lexus dealer.

### ■ Alarm

The alarm may be triggered if the alarm is set and the moon roof is closed using the door lock linked moon roof operation function. (→P. 77)

### ■ Moon roof open warning buzzer

A buzzer sounds and a message is shown on the multi-information display in the instrument cluster when the engine switch is turned off and the driver's door is opened with the moon roof open.

### ■ Customization

Some functions can be customized. (→P. 722)

**⚠ WARNING**

Observe the following precautions.  
Failing to do so may cause death or serious injury.

**■ Opening the moon roof**

- Do not allow any passengers to put their hands or heads outside the vehicle while it is moving.
- Do not sit on top of the moon roof.

**■ Opening and closing the moon roof**

- The driver is responsible for moon roof opening and closing operations.  
In order to prevent accidental operation, especially by a child, do not let a child operate the moon roof. It is possible for children and other passengers to have body parts caught in the moon roof.
- Check to make sure that all passengers do not have any part of their body in a position where it could be caught when the moon roof is being operated.
- When using the wireless remote control or mechanical key and operating the moon roof, operate the moon roof after checking to make sure that there is no possibility of any passenger having any of their body parts caught in the moon roof. Also, do not let a child operate moon roof by the wireless remote control or mechanical key. It is possible for children and other passengers to get caught in the moon roof.
- When exiting the vehicle, turn the engine switch off, carry the key and exit the vehicle along with the child. There may be accidental operation, due to mischief, etc., that may possibly lead to an accident.

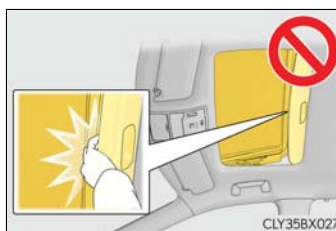

**■ Jam protection function**

- Never use any part of your body to intentionally activate the jam protection function.
- The jam protection function may not work if something gets caught just before the moon roof is fully closed. Also, the jam protection function is not designed to operate while the switch is being pressed. Take care so that your fingers, etc. do not get caught.

## Panoramic moon roof\*

Use the overhead switches to operate the panoramic moon roof and electronic sunshade.

### Opening and closing the electronic sunshade

- ① Opens the electronic sunshade  
Slide and hold the  switch backward. The electronic sunshade will fully open automatically.\*
- ② Closes the electronic sunshade  
Slide and hold the  switch forward. The electronic sunshade will fully close automatically.\*

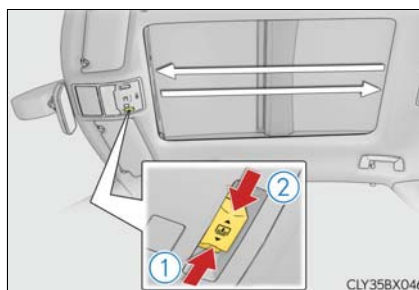

\*: Quickly slide and release the  switch in either direction to stop the electronic sunshade partway.

### Tilting the panoramic moon roof up and down

Tilts the panoramic moon roof up (press)\*

When the panoramic moon roof is tilted up, the electronic sunshade will open to the half-open position of the roof.

\*: Lightly press the  switch again to stop the panoramic moon roof partway.

Tilts the panoramic moon roof down (press and hold)

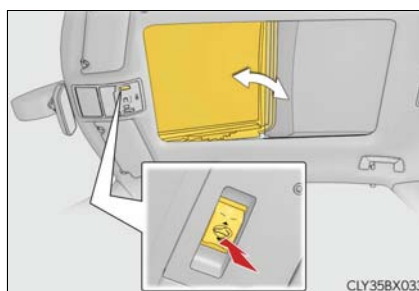

The panoramic moon roof can be tilted down only when it is in the tilt-up position.

3

Operation of each component

\*: If equipped

### Opening and closing the panoramic moon roof

Opens the panoramic moon roof\*

Slide and hold the  switch backward. The panoramic moon roof and electronic sunshade will open automatically.

The panoramic moon roof can be opened from the tilt-up position.

\*: Quickly slide and release the  switch in either direction to stop the panoramic moon roof partway.

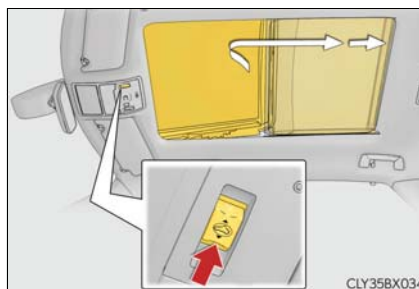

Closes the panoramic moon roof

Slide and hold the  switch forward. The panoramic moon roof will fully close automatically.

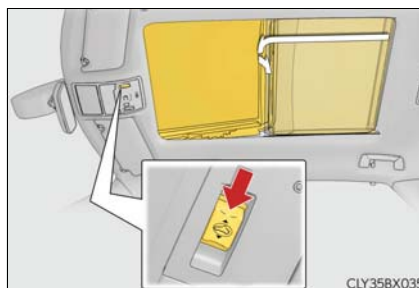

#### ■ The panoramic moon roof can be operated when

The engine switch is in IGNITION ON mode.

#### ■ Operating the panoramic moon roof after turning the engine off

The panoramic moon roof and electronic sunshade can be operated for approximately 45 seconds after the engine switch is turned to ACCESSORY mode or turned off. They cannot, however, be operated once the driver's door is opened.

#### ■ Jam protection function

If an object is detected between the panoramic moon roof and the frame in the following situations, travel is stopped and the panoramic moon roof opens slightly:

- The panoramic moon roof is closing or tilting down.
- The electronic sunshade is closing.

#### ■ Door lock linked panoramic moon roof operation

- The panoramic moon roof can be opened and closed using the mechanical key.\* (→P. 685)
- The panoramic moon roof can be opened using the wireless remote control.\* (→P. 124)

\*: These settings must be customized at your Lexus dealer.



### ■ Closing both the panoramic moon roof and electronic sunshade

Slide the  switch forward.

The electronic sunshade will close to the half-open position and pause. The panoramic moon roof will then fully close. Then the electronic sunshade will fully close.

### ■ When the panoramic moon roof or electronic sunshade does not close normally

Perform the following procedure:

- 1 Stop the vehicle.
- 2 Turn the engine switch to IGNITION ON mode.
- 3 Slide and hold the  switch or  switch forward. Continue pressing the switch for approximately 10 seconds after the panoramic moon roof or electronic sunshade closes and reopens. The panoramic moon roof and electronic sunshade will start to close.\*
- 4 Check that the panoramic moon roof and electronic sunshade are fully closed and release the switch.

\*: If the switch is released at the incorrect time, the procedure will have to be performed again from the beginning.

If the panoramic moon roof or electronic sunshade does not fully close even after performing the above procedure correctly, have the vehicle inspected by your Lexus dealer.

### ■ Alarm

A alarm may be triggered if the alarm is set and the panoramic moon roof is closed using the door lock linked panoramic moon roof operation function. (→P. 77)

### ■ Panoramic moon roof open warning buzzer

The buzzer sounds and a message is shown on the multi-information display in the instrument cluster when the engine switch is turned off and the driver's door is opened with the panoramic moon roof open.

### ■ Customization

Some functions can be customized. (→P. 722)

**⚠ WARNING**

Observe the following precautions.  
Failing to do so may cause death or serious injury.

**■ Opening and closing the electronic sunshade**

- Check to make sure that all passengers do not have any part of their body in a position where it could be caught when the electronic sunshade is being operated.
- Do not let a child operate the electronic sunshade. Closing the electronic sunshade on someone can cause death or serious injury.

**■ Opening and closing the panoramic moon roof**

- The driver is responsible for panoramic moon roof opening and closing operations. In order to prevent accidental operation, especially by a child, do not let a child operate the panoramic moon roof. It is possible for children and other passengers to have body parts caught in the panoramic moon roof.
- Check to make sure that all passengers do not have any part of their body in a position where it could be caught when the panoramic moon roof is being operated.
- When using the wireless remote control or mechanical key and operating the panoramic moon roof, operate the panoramic moon roof after checking to make sure that there is no possibility of any passenger having any of their body parts caught in the panoramic moon roof. Also, do not let a child operate panoramic moon roof by the wireless remote control or mechanical key. It is possible for children and other passengers to get caught in the panoramic moon roof.
- When exiting the vehicle, turn the engine switch off, carry the key and exit the vehicle along with the child. There may be accidental operation, due to mischief, etc., that may possibly lead to an accident.

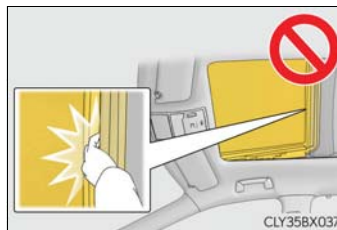
**■ Jam protection function**

- Never use any part of your body to intentionally activate the jam protection function.
- The jam protection function may not work if something gets caught just before the panoramic moon roof or electronic sunshade is fully closed. Also, the jam protection function is not designed to operate while the switch is being pressed. Take care so that your fingers, etc. do not get caught.

 **WARNING****■ To prevent burns or injuries**

Do not touch the area between the underside of the panoramic moon roof and the electronic sunshade. Your hand may get caught and you could injure yourself. Also, if the vehicle is left in direct sunlight for a long time, the underside of the panoramic moon roof could become very hot and could cause burns.

 **NOTICE****■ To prevent damage to the panoramic moon roof**

- Before opening the panoramic moon roof, make sure that there are no foreign objects, such as stones or ice, around the opening.
- Do not hit the surface or edge of the panoramic moon roof with hard objects.
- Do not continuously press the  switch after the panoramic moon roof has been fully opened or closed.

**■ After the vehicle has been washed or rained on**

Before opening the panoramic moon roof, wipe any water off the panoramic moon roof. Otherwise, water may enter the cabin when the panoramic moon roof is opened.



**4-1. Before driving**

Driving the vehicle.....	202
Cargo and luggage.....	210
Vehicle load limits.....	213
Trailer towing (vehicles with towing package).....	215
Trailer towing (vehicles without towing package).....	229
Dinghy towing.....	230

**4-2. Driving procedures**

Engine (ignition) switch.....	231
Automatic transmission (vehicles without paddle shift switches).....	236
Automatic transmission (vehicles with paddle shift switches).....	240
Turn signal lever.....	246
Parking brake.....	247
Brake Hold.....	250

<b>4-3. Operating the lights and wipers</b>	
Headlight switch.....	252
Automatic High Beam.....	256
Fog light switch.....	260
Windshield wipers and washer.....	261
Rear window wiper and washer.....	267
<b>4-4. Refueling</b>	
Opening the fuel tank cap.....	269
<b>4-5. Using the driving support systems</b>	
Lexus Safety System+ .....	274
PCS (Pre-Collision System).....	281
LKA (Lane-Keeping Assist).....	291
Dynamic radar cruise control with full-speed range.....	300
BSM (Blind Spot Monitor).....	313
• BSM function.....	317
• RCTA function.....	321
Intuitive parking assist.....	326
Intelligent Clearance Sonar (ICS).....	336
Lexus parking assist monitor.....	357
Driving mode select switch.....	373
All-wheel drive lock switch.....	377
Driving assist systems .....	378
<b>4-6. Driving tips</b>	
Winter driving tips.....	384
Utility vehicle precautions.....	388

## Driving the vehicle

The following procedures should be observed to ensure safe driving:

### Starting the engine

→P. 231

### Driving

- 1 With the brake pedal depressed, shift the shift lever to D. (→P. 240)
- 2 Release the parking brake. (→P. 248)  
If the parking brake is in automatic mode, the parking brake is released automatically when shifting the shift lever to any position other than P. (→P. 247)
- 3 Gradually release the brake pedal and gently depress the accelerator pedal to accelerate the vehicle.

### Stopping

- 1 With the shift lever in D, depress the brake pedal.
- 2 If necessary, set the parking brake. (→P. 248)  
If the vehicle is to be stopped for an extended period of time, shift the shift lever to P or N. (→P. 240)

### Parking the vehicle

- 1 With the shift lever in D, depress the brake pedal.
- 2 Set the parking brake (→P. 248), and shift the shift lever to P (→P. 240).
- 3 Press the engine switch to stop the engine.
- 4 Lock the door, making sure that you have the electronic key on your person.  
If parking on a hill, block the wheels as needed.

### Starting off on a uphill

- 1 With the brake pedal depressed, shift the shift lever to D. (→P. 240)
- 2 Pull the parking brake switch and parking brake is set manually. (→P. 248)
- 3 Release the brake pedal and gently depress the accelerator pedal to accelerate the vehicle.
- 4 Press the parking brake switch and parking brake is released manually. (→P. 248)

#### ■ When starting off on a uphill

The hill-start assist control will activate. (→P. 378)

#### ■ Driving in the rain

- Drive carefully when it is raining, because visibility will be reduced, the windows may become fogged-up, and the road will be slippery.
- Drive carefully when it starts to rain, because the road surface will be especially slippery.
- Refrain from high speeds when driving on an expressway in the rain, because there may be a layer of water between the tires and the road surface, preventing the steering and brakes from operating properly.

#### ■ Engine speed while driving

In the following conditions, the engine speed may become high while driving. This is due to automatic up-shifting control or down-shifting implementation to meet driving conditions. It does not indicate sudden acceleration.

- The vehicle is judged to be driving uphill or downhill
- When the accelerator pedal is released
- When the brake pedal is depressed while sport mode is selected

#### ■ Restraining the engine output (Brake Override System)

- When the accelerator and brake pedals are depressed at the same time, the engine output may be restrained.
- A warning message is displayed on the multi-information display while the system is operating. If a warning message is shown on the multi-information display, read the message and follow the instructions.

#### ■ Restraining sudden start (Drive-Start Control)

- When the following unusual operation is performed, the engine output may be restrained.
  - When the shift lever is shifted from R to D, D to R, N to R, P to D, or P to R (D includes M or S) with the accelerator pedal depressed, a warning message appears on the multi-information display. If a warning message is shown on the multi-information display, read the message and follow the instructions.
  - When the accelerator pedal is depressed too much while the vehicle is in reverse.
- While Drive-Start Control is being activated, your vehicle may have trouble escaping from the mud or fresh snow. In such case, deactivate TRAC (→P. 380) to cancel Drive-Start Control so that the vehicle may become able to escape from the mud or fresh snow.

■ **Breaking in your new Lexus**

To extend the life of the vehicle, observing the following precautions is recommended:

- For the first 200 miles (300 km):  
Avoid sudden stops.
- For the first 500 miles (800 km):  
Do not tow a trailer.
- For the first 1000 miles (1600 km):
  - Do not drive at extremely high speeds.
  - Avoid sudden acceleration.
  - Do not drive continuously in low gears.
  - Do not drive at a constant speed for extended periods.

■ **Operating your vehicle in a foreign country**

Comply with the relevant vehicle registration laws and confirm the availability of the correct fuel. (→P. 700)

■ **Eco-friendly driving**

→P. 111

**⚠ WARNING**

Observe the following precautions.  
Failure to do so may result in death or serious injury.

**■ When starting the vehicle**

Always keep your foot on the brake pedal while stopped engine running. This prevents the vehicle from creeping.

**■ When driving the vehicle**

- Do not drive if you are unfamiliar with the location of the brake and accelerator pedals to avoid depressing the wrong pedal.
  - Accidentally depressing the accelerator pedal instead of the brake pedal will result in sudden acceleration that may lead to an accident.
  - When backing up, you may twist your body around, leading to difficulty in operating the pedals. Make sure to operate the pedals properly.
  - Make sure to keep a correct driving posture even when moving the vehicle only slightly. This allows you to depress the brake and accelerator pedals properly.
  - Depress the brake pedal using your right foot. Depressing the brake pedal using your left foot may delay response in an emergency, resulting in an accident.
- Do not drive the vehicle over or stop the vehicle near flammable materials. The exhaust system and exhaust gases can be extremely hot. These hot parts may cause a fire if there is any flammable material nearby.
- During normal driving, do not turn off the engine. Turning the engine off while driving will not cause loss of steering or braking control, but the power assist to these systems will be lost. This will make it more difficult to steer and brake, so you should pull over and stop the vehicle as soon as it is safe to do so. However, in the event of an emergency, such as if it becomes impossible to stop the vehicle in the normal way: →P. 645
- Use engine braking (downshift) to maintain a safe speed when driving down a steep hill. Using the brakes continuously may cause the brakes to overheat and lose effectiveness. (→P. 240)
- Do not adjust the positions of the steering wheel, the seat, or the inside or outside rear view mirrors while driving. Doing so may result in a loss of vehicle control.
- Always check that all passengers' arms, heads or other parts of their body are not outside the vehicle.
- AWD models: Do not drive the vehicle off-road. This is not an AWD vehicle designed for off-road driving. Proceed with all due caution if it becomes unavoidable to drive off-road.
- Do not drive across a river or through other bodies of water. This may cause electric/electronic components to short circuit, damage the engine or cause other serious damage to the vehicle.
- Do not drive in excess of the speed limit. Even if the legal speed limit permits it, do not drive over 85 mph (140 km/h) unless your vehicle has high-speed capability tires. Driving over 85 mph (140 km/h) may result in tire failure, loss of control and possible injury. Be sure to consult a tire dealer to determine whether the tires on your vehicle are high-speed capability tires or not before driving at such speeds.

 **WARNING**

Observe the following precautions.  
Failure to do so may result in death or serious injury.

■ **When driving on slippery road surfaces**

- Sudden braking, acceleration and steering may cause tire slippage and reduce your ability to control the vehicle.
- Sudden acceleration, engine braking due to shifting, or changes in engine speed could cause the vehicle to skid.
- After driving through a puddle, lightly depress the brake pedal to make sure that the brakes are functioning properly. Wet brake pads may prevent the brakes from functioning properly. If the brakes on only one side are wet and not functioning properly, steering control may be affected.

■ **When shifting the shift lever**

- Do not let the vehicle roll backward while the shift lever is in a driving position, or roll forward while the shift lever is in R.  
Doing so may cause the engine to stall or lead to poor brake and steering performance, resulting in an accident or damage to the vehicle.
- Do not shift the shift lever to P while the vehicle is moving.  
Doing so can damage the transmission and may result in a loss of vehicle control.
- Do not shift the shift lever to R while the vehicle is moving forward.  
Doing so can damage the transmission and may result in a loss of vehicle control.
- Do not shift the shift lever to a driving position while the vehicle is moving backward.  
Doing so can damage the transmission and may result in a loss of vehicle control.
- Shifting the shift lever to N while the vehicle is moving will disengage the engine. Engine braking is not available when N is selected.
- Be careful not to shift the shift lever with the accelerator pedal depressed.  
Shifting the shift lever to any position other than P or N may lead to unexpected rapid acceleration of the vehicle that may cause an accident and result in death or serious injury.

■ **If you hear a squealing or scraping noise (brake pad wear limit indicators)**

Have the brake pads checked and replaced by your Lexus dealer as soon as possible. Rotor damage may result if the pads are not replaced when needed.

It is dangerous to drive the vehicle when the wear limits of the brake pads and/or those of the brake discs are exceeded.

**⚠ WARNING**

Observe the following precautions.  
Failure to do so may result in death or serious injury.

**■ When the vehicle is stopped**

- Do not race the engine.  
If the shift lever is in any position other than P or N, the vehicle may accelerate suddenly and unexpectedly, causing an accident.
- In order to prevent accidents due to the vehicle rolling away, always keep depressing the brake pedal while the engine is running, and apply the parking brake as necessary.
- If the vehicle is stopped on an incline, in order to prevent accidents caused by the vehicle rolling forward or backward, always depress the brake pedal and securely apply the parking brake as needed.
- Avoid revving or racing the engine.  
Running the engine at high speed while the vehicle is stopped may cause the exhaust system to overheat, which could result in a fire if combustible material is nearby.

**■ When the vehicle is parked**

- Do not leave glasses, cigarette lighters, spray cans, or soft drink cans in the vehicle when it is in the sun.  
Doing so may result in the following:
  - Gas may leak from a cigarette lighter or spray can, and may lead to a fire.
  - The temperature inside the vehicle may cause the plastic lenses and plastic material of glasses to deform or crack.
  - Soft drink cans may fracture, causing the contents to spray over the interior of the vehicle, and may also cause a short circuit in the vehicle's electrical components.
- Do not leave cigarette lighters in the vehicle. If a cigarette lighter is in a place such as the glove box or on the floor, it may be lit accidentally when luggage is loaded or the seat is adjusted, causing a fire.
- Do not attach adhesive discs to the windshield or windows. Do not place containers such as air fresheners on the instrument panel or dashboard. Adhesive discs or containers may act as lenses, causing a fire in the vehicle.
- Do not leave a door or window open if the curved glass is coated with a metallized film such as a silver-colored one. Reflected sunlight may cause the glass to act as a lens, causing a fire.
- Always apply the parking brake, shift the shift lever to P, stop the engine and lock the vehicle.  
Do not leave the vehicle unattended while the engine is running.  
If the vehicle is parked with the shift lever in P but the parking brake is not set, the vehicle may start to move, possibly leading to an accident.
- Do not touch the exhaust pipes while the engine is running or immediately after turning the engine off.  
Doing so may cause burns.



 **WARNING**

Observe the following precautions.  
Failure to do so may result in death or serious injury.

■ **When taking a nap in the vehicle**

Always turn the engine off. Otherwise, if you accidentally move the shift lever or depress the accelerator pedal, this could cause an accident or fire due to engine overheating. Additionally, if the vehicle is parked in a poorly ventilated area, exhaust gases may collect and enter the vehicle, leading to death or a serious health hazard.

■ **When braking**

- When the brakes are wet, drive more cautiously.  
Braking distance increases when the brakes are wet, and this may cause one side of the vehicle to brake differently than the other side. Also, the parking brake may not securely hold the vehicle.
- If the brake booster device does not operate, do not follow other vehicles closely and avoid hills or sharp turns that require braking.  
In this case, braking is still possible, but the brake pedal should be depressed more firmly than usual. Also, the braking distance will increase. Have your brakes fixed immediately.
- Do not pump the brake pedal if the engine stalls.  
Each push on the brake pedal uses up the reserve for the power-assisted brakes.
- The brake system consists of 2 individual hydraulic systems; if one of the systems fails, the other will still operate. In this case, the brake pedal should be depressed more firmly than usual and the braking distance will increase.  
Have your brakes fixed immediately.

■ **If the vehicle becomes stuck (AWD models)**

Do not spin the wheels excessively when any of the tires is up in the air, or the vehicle is stuck in sand, mud, etc. This may damage the driveline components or propel the vehicle forward or backward, causing an accident.

 NOTICE

■ **When driving the vehicle**

- Do not depress the accelerator and brake pedals at the same time during driving, as this may restrain driving torque.
- Do not use the accelerator pedal or depress the accelerator and brake pedals at the same time to hold the vehicle on a hill.

■ **When parking the vehicle**

Always set the parking brake and shift the shift lever to P. Failure to do so may cause the vehicle to move or the vehicle may accelerate suddenly if the accelerator pedal is accidentally depressed.

■ **Avoiding damage to vehicle parts**

- Do not turn the steering wheel fully in either direction and hold it there for an extended period of time.  
Doing so may damage the power steering motor.
- When driving over bumps on the road, drive as slowly as possible to avoid damaging the wheels, underside of the vehicle, etc.

■ **If you get a flat tire while driving**

A flat or damaged tire may cause the following situations. Hold the steering wheel firmly and gradually depress the brake pedal to slow down the vehicle.

- It may be difficult to control your vehicle.
- The vehicle will make abnormal sounds or vibrations.
- The vehicle will lean abnormally.

Information on what to do in case of a flat tire (→P. 666)

■ **When encountering flooded roads**

Do not drive on a road that has flooded after heavy rain, etc. Doing so may cause the following serious damage to the vehicle:

- Engine stalling
- Short in electrical components
- Engine damage caused by water immersion

In the event that you drive on a flooded road and the vehicle is flooded, be sure to have your Lexus dealer check the following:

- Brake function
- Changes in quantity and quality of oil and fluid used for the engine, transaxle, transfer (AWD models), rear differential (AWD models), etc.
- Lubricant condition for the propeller shaft (AWD models), bearings and suspension joints (where possible), and the function of all joints, bearings, etc.

## Cargo and luggage

Take notice of the following information about storage precautions, cargo capacity and load.

### Capacity and distribution

Cargo capacity depends on the total weight of the occupants.

(Cargo capacity) = (Total load capacity) – (Total weight of occupants)

#### Steps for Determining Correct Load Limit –

- (1) Locate the statement “The combined weight of occupants and cargo should never exceed XXX kg or XXX lbs.” on your vehicle’s placard.
- (2) Determine the combined weight of the driver and passengers that will be riding in your vehicle.
- (3) Subtract the combined weight of the driver and passengers from XXX kg or XXX lbs.
- (4) The resulting figure equals the available amount of cargo and luggage load capacity.  
For example, if the “XXX” amount equals 1400 lbs. and there will be five 150 lb passengers in your vehicle, the amount of available cargo and luggage load capacity is 650 lbs. (1400 – 750 (5 × 150) = 650 lbs.)
- (5) Determine the combined weight of luggage and cargo being loaded on the vehicle. That weight may not safely exceed the available cargo and luggage load capacity calculated in Step 4.
- (6) If your vehicle will be towing a trailer, load from your trailer will be transferred to your vehicle. Consult this manual to determine how this reduces the available cargo and luggage load capacity of your vehicle.

(→P. 213)

Vehicles without towing package: Lexus does not recommend towing a trailer with your vehicle. Your vehicle is not designed for trailer towing.

### Calculation formula for your vehicle

- ① Cargo capacity
- ② Total load capacity (vehicle capacity weight) (→P. 698)

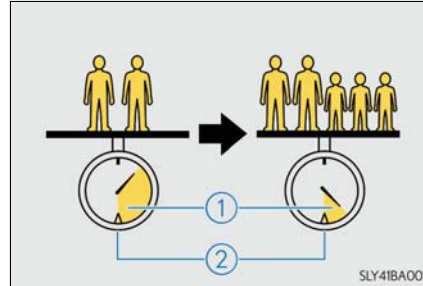

When 2 people with the combined weight of A lb. (kg) are riding in your vehicle, which has a total load capacity (vehicle capacity weight) of B lb. (kg), the available amount of cargo and luggage load capacity will be C lb. (kg) as follows:

$$B^{*2} \text{ lb. (kg)} - A^{*1} \text{ lb. (kg)} = C^{*3} \text{ lb. (kg)}$$

\*1: A = Weight of people

\*2: B = Total load capacity

\*3: C = Available cargo and luggage load

In this condition, if 3 more passengers with the combined weight of D lb. (kg) get on, the available cargo and luggage load will be reduced E lb. (kg) as follows:

$$C \text{ lb. (kg)} - D^{*4} \text{ lb. (kg)} = E^{*5} \text{ lb. (kg)}$$

\*4: D = Additional weight of people

\*5: E = Available cargo and luggage load

As shown in the example above, if the number of occupants increases, the cargo and luggage load will be reduced by an amount that equals the increased weight due to the additional occupants. In other words, if an increase in the number of occupants causes an excess of the total load capacity (combined weight of occupants plus cargo and luggage load), you must reduce the cargo and luggage on your vehicle.

#### **⚠ WARNING**

##### ■ Things that must not be carried in the luggage compartment

The following things may cause a fire if loaded in the luggage compartment:

- Receptacles containing gasoline
- Aerosol cans

 **WARNING****■ Storage precautions**

Observe the following precautions.

Failure to do so may prevent the pedals from being depressed properly, may block the driver's vision, or may result in items hitting the driver or passengers, possibly causing an accident.

- Stow cargo and luggage in the luggage compartment whenever possible.
- Do not stack cargo and luggage in the luggage compartment higher than the seat-backs.
- When you fold down the rear seats, long items should not be placed directly behind the front seats.
- Never allow anyone to ride in the luggage compartment. It is not designed for passengers. They should ride in their seats with their seat belts properly fastened.
- Do not place cargo or luggage in or on the following locations.
  - At the feet of the driver
  - On the front passenger or rear seats (when stacking items)
  - On the luggage cover
  - On the instrument panel
  - On the dashboard
- Secure all items in the occupant compartment.

**■ Capacity and distribution**

- Do not exceed the maximum axle weight rating or the total vehicle weight rating.
- Even if the total load of occupant's weight and the cargo load is less than the total load capacity, do not apply the load unevenly. Improper loading may cause deterioration of steering or braking control which may cause death or serious injury.

**■ Roof luggage carrier precautions**

Observe the following precautions:

- Place the cargo so that its weight is distributed evenly between the front and rear axles.
- If loading long or wide cargo, never exceed the vehicle overall length or width. (→P. 698)
- Before driving, make sure the cargo is securely fastened on the roof luggage carrier.
- Loading cargo on the roof luggage carrier will make the center of gravity of the vehicle higher. Avoid high speeds, sudden starts, sharp turns, sudden braking or abrupt maneuvers, otherwise it may result in loss of control or vehicle rollover due to failure to operate this vehicle correctly and result in death or serious injury.
- If driving for a long distance, on rough roads, or at high speeds, stop the vehicle now and then during the trip to make sure the cargo remains in its place.
- Do not exceed 165 lb. (75 kg) cargo weight on the roof luggage carrier.

 **NOTICE****■ When loading cargo (vehicles with a moon roof or panoramic moon roof)**

Be careful not to scratch the surface of the moon roof or panoramic moon roof.

## Vehicle load limits

Vehicle load limits include total load capacity, seating capacity, trailer weight rating and cargo capacity.

### ◆ Total load capacity (vehicle capacity weight): →P. 698

Total load capacity means the combined weight of occupants, cargo and luggage.

### ◆ Seating capacity

#### ▶ RX350

5 occupants (Front 2, Rear 3)

#### ▶ RX350L

Vehicles with rear separate seat:

6 occupants (Front 2, Rear 4)

Vehicles with rear bench seat:

7 occupants (Front 2, Rear 5)

Seating capacity means the maximum number of occupants whose estimated average weight is 150 lb. (68 kg) per person.

### ◆ TWR (Trailer Weight Rating) (vehicles with towing package): →P. 219, 698

TWR means the maximum gross trailer weight (trailer weight plus its cargo weight) that your vehicle is able to tow.

### ◆ TWR (Trailer Weight Rating) (vehicles without towing package)

Lexus does not recommend towing a trailer with your vehicle.

### ◆ Cargo capacity

Cargo capacity may increase or decrease depending on the weight and the number of occupants.

■ **Total load capacity and seating capacity**

These details are also described on the tire and loading information label. (→P. 613)

 **WARNING**

■ **Overloading the vehicle**

Do not overload the vehicle.

It may not only cause damage to the tires, but also degrade steering and braking ability, resulting in an accident.

## Trailer towing (vehicles with towing package)

Your vehicle is designed primarily as a passenger-and-load-carrying vehicle. Towing a trailer can have an adverse impact on handling, performance, braking, durability, and fuel consumption. For your safety and the safety of others, you must not overload your vehicle or trailer. You must also ensure that you are using appropriate towing equipment, that the towing equipment has been installed correctly and used properly, and that you employ the requisite driving habits.

Vehicle-trailer stability and braking performance are affected by trailer stability, brake performance and setting, trailer brakes, the hitch and hitch systems (if equipped).

To tow a trailer safely, use extreme care and drive the vehicle in accordance with your trailer's characteristics and operating conditions.

Lexus warranties do not apply to damage or malfunction caused by towing a trailer for commercial purposes.

Contact your Lexus dealer for further information about additional requirements such as a towing kit, etc.



**Towing related terms**

■ **GCWR (Gross Combination Weight Rating)**

The maximum allowable gross combination weight. The gross combination weight is the sum of the total vehicle weight (including the occupants, cargo and any optional equipment installed on the vehicle) and the weight of the trailer being towed (including the cargo in the trailer).

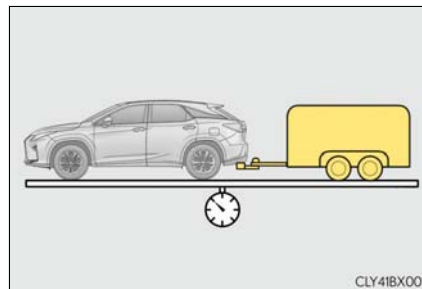

■ **GVWR (Gross Vehicle Weight Rating)**

The maximum allowable gross vehicle weight. The gross vehicle weight is the total weight of the vehicle. When towing a trailer, it is the sum of the vehicle weight (including the occupants, cargo and any optional equipment installed on the vehicle) and the tongue weight.

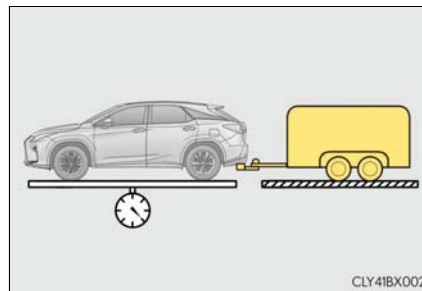

■ **GAWR (Gross Axle Weight Rating)**

The maximum allowable gross axle weight. The gross axle weight is the load placed on each axle (front and rear).

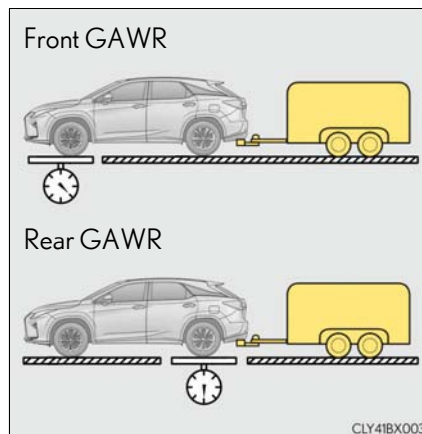

### ■ TWR (Trailer Weight Rating)

The maximum allowable gross trailer weight. The gross trailer weight is the sum of the trailer weight and the weight of the cargo in the trailer.

TWR is calculated assuming base vehicle with one driver, one front passenger, towing package (if available), hitch and hitch systems (if required).

Additional optional equipment, passengers and cargo in the vehicle will reduce the trailer weight rating so as not to exceed GCWR, GVWR and GAWR.

If the gross trailer weight exceeds 3000 lb. (1360 kg), it is recommended to use a trailer with 2 or more axles.

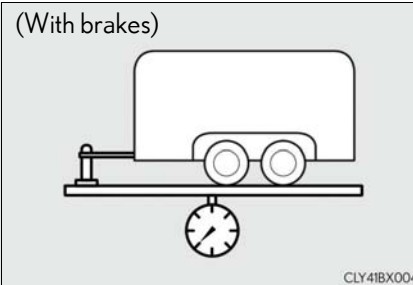

### ■ Unbraked TWR (Unbraked Trailer Weight Rating)

The trailer weight rating for towing a trailer without a trailer service brake system.

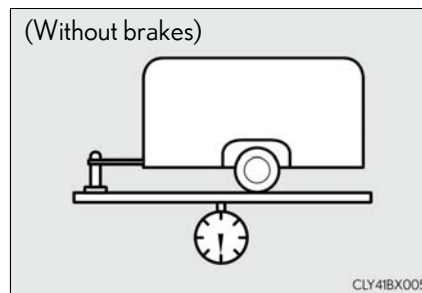

### ■ Tongue Weight

The load placed on the trailer hitch ball. (→P. 220)

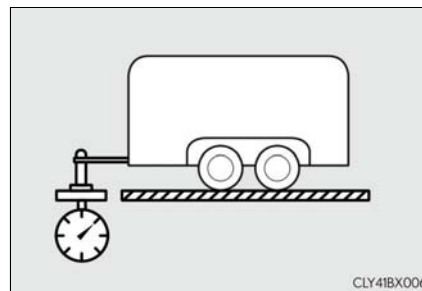

### Weight limits

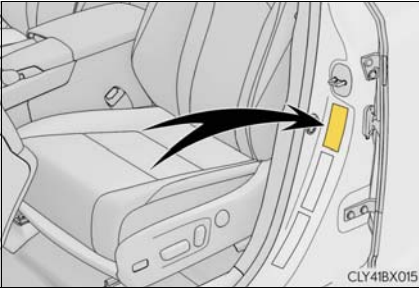
- The gross trailer weight must never exceed 3500 lb. (1585 kg).
  - The gross combination weight must never exceed the following:
    - ▶ RX350  
2WD models: 9165 lb. (4157 kg)  
AWD models: 9360 lb. (4246 kg)
    - ▶ RX350L  
2WD models: 9205 lb. (4175 kg)  
AWD models: 9360 lb. (4246 kg)
  - The gross vehicle weight must never exceed the GVWR indicated on the Certification Label.
  - The gross axle weight on each axle must never exceed the GAWR indicated on the Certification Label.
- 
- The diagram shows the interior of a vehicle, specifically the driver's side door area. A yellow rectangular label is highlighted on the door sill. A black arrow points from the text to this label. The label is the Certification Label mentioned in the text. The diagram is labeled 'CLY41BX015' in the bottom right corner.
- If the gross trailer weight is over the unbraked TWR, trailer service brakes are required.
  - If the gross trailer weight is over 2000 lb. (907 kg), a sway control device with sufficient capacity is required.

### GCWR, TWR and Unbraked TWR

Confirm that the gross trailer weight, gross combination weight, gross vehicle weight, gross axle weight and tongue weight are all within the limits.

#### ■ GCWR\*

##### ▶ RX350

2WD models: 9165 lb. (4157 kg)

AWD models: 9360 lb. (4246 kg)

##### ▶ RX350L

2WD models: 9205 lb. (4175 kg)

AWD models: 9360 lb. (4246 kg)

#### ■ TWR\*

3500 lb. (1585 kg)

#### ■ Unbraked TWR\*

1000 lb. (450 kg)

\*: These models meet the tow-vehicle trailering requirement of SAE International per SAE J2807.

### Trailer Tongue Weight

- A recommended tongue weight varies in accordance with the types of trailers or towing as described below.
- To ensure the recommended values shown below, the trailer must be loaded by referring to the following instructions.

- Tongue Weight

The gross trailer weight should be distributed so that the tongue weight is 9% to 11%.

(Tongue weight / Gross trailer weight x 100 = 9% to 11%)

- ① Gross trailer weight
- ② Tongue weight

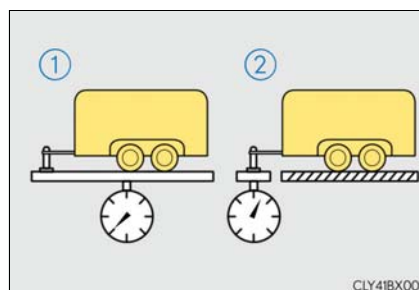

The gross trailer weight, gross axle weight and tongue weight can be measured with platform scales found at a highway weighing station, building supply company, trucking company, junk yard, etc.

### Hitch

Trailer hitch assemblies have different weight capacities. Lexus recommends the use of Lexus hitch/bracket for your vehicle. For details, contact your Lexus dealer.

- If you wish to install a trailer hitch, contact your Lexus dealer.
- Use only a hitch that conforms to the gross trailer weight requirement of your vehicle.
- Follow the directions supplied by the hitch manufacturer.
- Lubricate the hitch ball with a light coating of grease.
- Remove the trailer hitch whenever you are not towing a trailer. After removing the hitch, seal any mounting hole in the vehicle body to prevent entry of any substances into the vehicle.

### Selecting trailer ball

Use the correct trailer ball for your application.

- ① Trailer ball load rating  
Matches or exceeds the gross trailer weight rating of the trailer.
- ② Ball diameter  
Matches the size of the trailer coupler. Most couplers are stamped with the required trailer ball size.

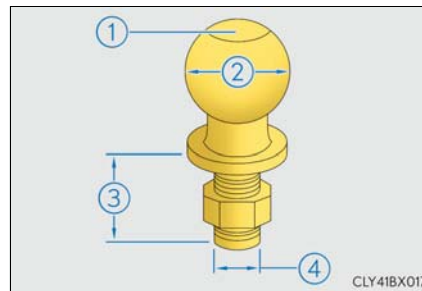

Trailer class	Typical trailer ball size
IV	2 5/16 in.
II and III	2 in.
I	1 7/8 in.

- ③ Shank length  
Protrudes beyond the bottom of the lock washer and nut by at least 2 threads.
- ④ Shank diameter  
Matches the ball mount hole diameter size.

### Positions for towing hitch receiver and hitch ball

- ▶ RX350
  - ① Weight carrying ball position:  
44.96 in. (1142 mm)
  - ② Hitch receiver pin hole position:  
35.94 in. (913 mm)
- ▶ RX350L
  - ① Weight carrying ball position:  
49.72 in. (1263 mm)
  - ② Hitch receiver pin hole position:  
45.08 in. (1145 mm)

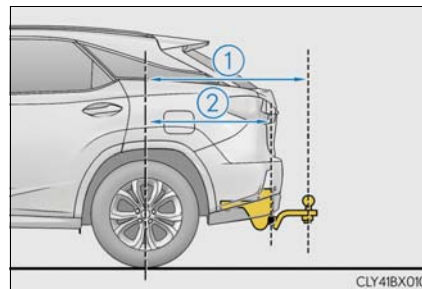

### Connecting trailer lights

Use the wire harness stored in the rear end under body.

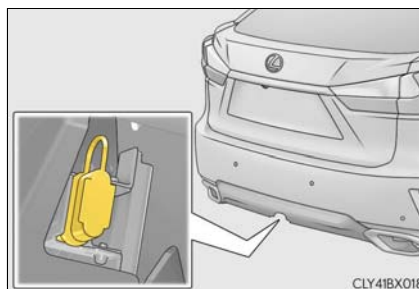

#### ■ Auto current cut-off function

In case of over current, the auto cut-off function stops the power flowing to the trailer lights to prevent damage to the vehicle's electrical system.

This function is activated when the rated current of any of the following trailer light circuit components is exceeded:

- Tail lights: maximum 7.8 A
- Stop/turn signal light (right): maximum 4.5 A
- Stop/turn signal light (left): maximum 4.5 A

#### ■ When the auto current cut function is activated

If a trailer light does not come on due to the activation of the auto current cut function, the light system will need to be reset.

Follow the reset procedure shown below.

- If a tail light does not come on, turn off the headlight switch.
- If the right-side stop/turn signal light does not come on, put the turn signal in the off position or remove foot from the brake pedal.
- If the left-side stop/turn signal light does not come on, put the turn signal in the off position or remove foot from the brake pedal.

If the emergency flashers do not operate, press the emergency flasher switch to turn them off.

After the light system is reset, operate the light switches again to see if the lights operate normally.

If the lights do not operate normally, have the vehicle inspected by your Lexus dealer.

### Trailer towing tips

Your vehicle will handle differently when towing a trailer. Help to avoid an accident, death or serious injury, keep the following in mind when towing:

- Speed limits for towing a trailer vary by state or province. Do not exceed the posted towing speed limit.
- Lexus recommends that the vehicle-trailer speed limit is 65 mph (104 km/h) on a flat, straight, dry road. Do not exceed this limit, the posted towing speed limit or the speed limit for your trailer as set forth in your trailer owner's manual, whichever is lowest. Instability of the towing vehicle-trailer combination (trailer sway) increases as speed increases. Exceeding speed limits may cause loss of control.
- Before starting out, check the trailer lights, tires and the vehicle-trailer connections. Recheck after driving a short distance.
- Practice turning, stopping and reversing with the trailer attached in an area away from traffic until you become accustomed to the feel of the vehicle-trailer combination.
- Reversing with a trailer attached is difficult and requires practice. Grip the bottom of the steering wheel and move your hand to the left to move the trailer to the left. Move your hand to the right to move the trailer to right. (This is generally opposite to reversing without a trailer attached.) Avoid sharp or prolonged turning. Have someone guide you when reversing to reduce the risk of an accident.
- As stopping distance is increased when towing a trailer, vehicle-to-vehicle distance should be increased. For each 10 mph (16 km/h) of speed, allow at least one vehicle and trailer length.
- Avoid sudden braking as you may skid, resulting in the trailer jackknifing and a loss of vehicle control. This is especially true on wet or slippery surfaces.
- Avoid jerky starts or sudden acceleration.
- Avoid jerky steering and sharp turns, and slow down before making a turn.
- Note that when making a turn, the trailer wheels will be closer than the vehicle wheels to the inside of the turn. Compensate by making a wider than normal turning radius.
- Slow down before making a turn, in cross winds, on wet or slippery surfaces, etc.  
Increasing vehicle speed can destabilize the trailer.
- Take care when passing other vehicles. Passing requires considerable distance. After passing a vehicle, do not forget the length of your trailer, and be sure you have plenty of room before changing lanes.



- To maintain engine braking efficiency and charging system performance when using engine braking, do not put the transmission in D. If in the M or S mode, the transmission shift range position must be in 6 or lower. (→P. 240)
- Instability happens more frequently when descending steep or long downhill grades. Before descending, slow down and downshift. Do not make sudden downshifts while descending steep or long downhill grades.
- Avoid holding the brake pedal down too long or applying the brakes too frequently. This could cause the brakes to overheat and result in reduced braking efficiency.
- Due to the added load of the trailer, your vehicle's engine may overheat on hot days (at temperatures over 85°F [30°C]) when driving up a long or steep grade. If the engine coolant temperature gauge indicates overheating, immediately turn off the air conditioning (if in use), pull your vehicle off the road and stop in a safe spot. (→P. 692)
- Always place wheel blocks under both the vehicle's and the trailer's wheels when parking. Put the transmission in P and apply the parking brake. Avoid parking on a slope, but if unavoidable, do so only after performing the following:
  - 1 Apply the brakes and keep them applied.
  - 2 Have someone place wheel blocks under both the vehicle's and trailer's wheels.
  - 3 When the wheel blocks are in place, release the brakes slowly until the blocks absorb the load.
  - 4 Shift into P and apply the parking brake.
  - 5 Turn off the engine.
- When restarting after parking on a slope:
  - 1 With the transmission in P, start the engine. Be sure to keep the brake pedal depressed.
  - 2 Shift into a forward gear. If reversing, shift into R.
  - 3 If the parking brake is in manual mode, release the parking brake. (→P. 248)
  - 4 Release the brake pedal, and slowly pull or back away from the wheel blocks. Stop and apply the brakes.
  - 5 Have someone retrieve the blocks.

### ■ Matching trailer ball height to trailer coupler height

No matter which class of tow hitch applies, for a more safe trailer hookup, the trailer ball setup must be the proper height for the coupler on the trailer.

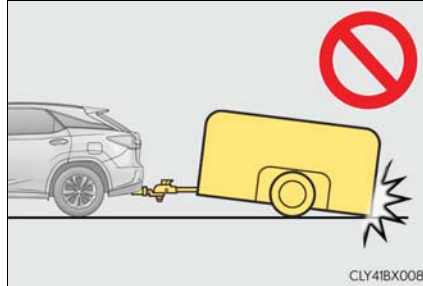

- ① Coupler
- ② Trailer ball

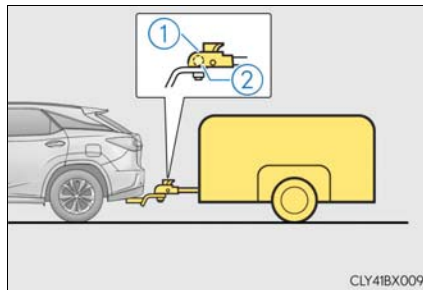

### ■ Before towing

Check that the following conditions are met:

- Ensure that your vehicle's tires are properly inflated. (→P. 704)
- Trailer tires are inflated according to the trailer manufacturer's recommendation.
- All trailer lights work as required by law.
- All lights work each time you connect them.
- The trailer ball is set at the proper height for the coupler on the trailer.
- The trailer is level when it is hitched.  
Do not drive if the trailer is not level, and check for improper tongue weight, overloading, worn suspension, or other possible causes.
- The trailer cargo is securely loaded.
- The rear view mirrors conform to all applicable federal, state/provincial or local regulations. If they do not, install rear view mirrors appropriate for towing purposes.

### ■ AVS (adaptive variable suspension system) (if equipped)

The suspension can be switched for improvement in driveability. (→P. 379)

**■ Break-in schedule**

If your vehicle is new or equipped with any new power train components (such as an engine, transaxle, transfer (AWD models), rear differential (AWD models) or wheel bearing), Lexus recommends that you do not tow a trailer until the vehicle has been driven for over 500 miles (800 km).

After the vehicle has been driven for over 500 miles (800 km), you can start towing. However, for the next 500 miles (800 km), drive the vehicle at a speed of less than 50 mph (80 km/h) when towing a trailer, and avoid full throttle acceleration.

**■ Maintenance**

- If you tow a trailer, your vehicle will require more frequent maintenance due to the additional load. (See “Warranty and Services Guide”, “Owner’s Manual Supplement” or “Scheduled Maintenance”.)
- Retighten the fixing bolts of the towing ball and bracket after approximately 600 miles (1000 km) of trailer towing.

**■ If trailer sway occurs**

One or more factors (crosswinds, passing vehicles, rough roads, etc.) can adversely affect handling of your vehicle and trailer, causing instability.

- If trailer swaying occurs:
  - Firmly grip the steering wheel. Steer straight ahead.  
Do not try to control trailer swaying by turning the steering wheel.
  - Begin releasing the accelerator pedal immediately but very gradually to reduce speed.  
Do not increase speed. Do not apply vehicle brakes.

If you make no extreme correction with the steering or brakes, your vehicle and trailer should stabilize. (if enabled, Trailer Sway Control can also help to stabilize the vehicle and trailer.)

- After the trailer swaying has stopped:
  - Stop in a safe place. Get all occupants out of the vehicle.
  - Check the tires of the vehicle and the trailer.
  - Check the load in the trailer.  
Make sure the load has not shifted.  
Make sure the tongue weight is appropriate, if possible.
  - Check the load in the vehicle.  
Make sure the vehicle is not overloaded after occupants get in.

If you cannot find any problems, the speed at which trailer swaying occurred is beyond the limit of your particular vehicle-trailer combination.

Drive at a lower speed to prevent instability. Remember that swaying of the towing vehicle-trailer increases as speed increases.

**⚠ WARNING****■ Trailer towing precautions**

To tow a trailer safely, use extreme care and drive the vehicle in accordance with the trailer's characteristics and operating conditions. Failure to do so could cause an accident resulting in death or serious injury. Vehicle stability and braking performance are affected by trailer stability, brake setting and performance, and the hitch. Your vehicle will handle differently when towing a trailer.

**■ To avoid accident or injury**

- Do not exceed the TWR, unbraked TWR, GCWR, GVWR or GAWR.
- If the gross trailer weight is over 2000 lb. (907 kg), a sway control device with sufficient capacity is required.
- Adjust the tongue weight within the appropriate range. Place heavier loads as close to the trailer axle as possible.
- Do not exceed 65 mph (104 km/h), the posted towing speed limit or the speed limit for your trailer as set forth in your trailer owner's manual, whichever is lowest. Slow down sufficiently before making a turn, in cross winds, on wet or slippery surface, etc. to help avoid an accident. If you experience a vehicle-trailer instability from reducing a certain speed, slow down and make sure you keep your vehicle speed under the speed of which you experience the instability.
- Do not make jerky, abrupt or sharp turns.
- Do not apply the brakes suddenly as you may skid, resulting in jackknifing and loss of vehicle control. This is especially true on wet or slippery surfaces.
- Do not exceed the trailer hitch assembly weight, gross vehicle weight, gross axle weight and trailer tongue weight capacities.
- Do not use the following systems when trailer towing.
  - Dynamic radar cruise control with full-speed range
  - LKA (Lane-Keeping Assist)
  - PCS (Pre-Collision System)
  - BSM (Blind Spot Monitor)\*
- \*: If equipped
- Slow down and downshift before descending steep or long downhill grades. Do not make sudden downshifts while descending steep or long downhill grades.
- Vehicle-trailer instability is more likely on steep long downhills. Before descending steep or long downhill grades, slow down and downshift. Do not make sudden downshifts when descending steep or long downhill grades. Avoid holding the brake pedal down too long or applying the brakes too frequently. This could cause the brakes to overheat and result in reduced braking efficiency.
- Do not tow a trailer when the compact spare tire is installed on your vehicle.

 **WARNING****■ Hitch**

Trailer hitch assemblies have different weight capacities established by the hitch manufacturer. Even though the vehicle may be physically capable of towing a higher weight, the operator must determine the maximum weight rating of the particular hitch assembly and never exceed the maximum weight rating specified for the trailer-hitch. Exceeding the maximum weight rating set by the trailer-hitch manufacturer can cause an accident resulting in death or serious personal injuries.

**■ When towing a trailer**

Lexus recommends trailers with brakes that conform to any applicable federal and state/provincial regulations.

- If the gross trailer weight exceeds unbraked TWR, trailer brakes are required. Lexus recommends trailers with brakes that conform to all applicable federal and state/provincial regulations.
- Never tap into your vehicle's hydraulic system, as this will lower the vehicle's braking effectiveness.
- Never tow a trailer without using a safety chain securely attached to both the trailer and the vehicle. If damage occurs to the coupling unit or hitch ball, there is danger of the trailer wandering into another lane.

 **NOTICE****■ When installing a trailer hitch**

Use only the position recommended by your Lexus dealer. Do not install the trailer hitch on the bumper; this may cause body damage.

**■ Do not directly splice trailer lights**

Do not directly splice trailer lights. Directly splicing trailer lights may damage your vehicle's electrical system and cause a malfunction.

## Trailer towing (vehicles without towing package)

Lexus does not recommend towing a trailer with your vehicle. Lexus also does not recommend the installation of a tow hitch or the use of a tow hitch carrier for a wheelchair, scooter, bicycle, etc. Your vehicle is not designed for trailer towing or for the use of tow hitch mounted carriers.



4

Driving

## Dinghy towing

Your vehicle is not designed to be dinghy towed (with 4 wheels on the ground) behind a motor home.

 NOTICE

■ To avoid serious damage to your vehicle

Do not tow your vehicle with the four wheels on the ground.

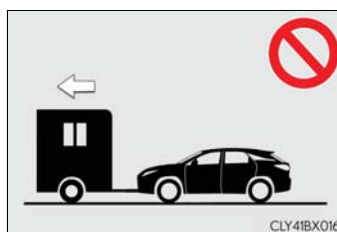

■ To prevent causing serious damage to the transmission and Dynamic Torque Control AWD system (AWD models)

2WD models: Never tow this vehicle from the rear with the front wheels on the ground. This may cause serious damage to the transmission.



AWD models: Never tow this vehicle with any of the wheels on the ground. This may cause serious damage to the transmission and Dynamic Torque Control AWD system.

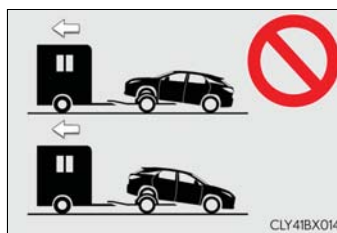

## Engine (ignition) switch

Performing the following operations when carrying the electronic key on your person starts the engine or changes engine switch modes.

### Starting the engine

- 1 Check that the parking brake is set.
- 2 Check that the shift lever is in P.
- 3 Firmly depress the brake pedal.  
 and a message will be displayed on the multi-information display. If it is not displayed, the engine cannot be started.

- 4 Press the engine switch shortly and firmly.

When operating the engine switch, one short, firm press is enough. It is not necessary to press and hold the switch.

The engine will crank until it starts or for up to 30 seconds, whichever is less.

Continue depressing the brake pedal until the engine is completely started.

The engine can be started from any engine switch mode.



4

Driving

### Stopping the engine

- 1 Stop the vehicle completely.
- 2 Set the parking brake (→P. 247), and shift the shift lever to P.
- 3 Press the engine switch.
- 4 Release the brake pedal and check that the display on the meters is off.



### Changing engine switch modes

Modes can be changed by pressing the engine switch with brake pedal released. (The mode changes each time the switch is pressed.)

① Off\*

The emergency flashers can be used.

② ACCESSORY mode

Some electrical components such as the audio system can be used.

“ACCESSORY” will be displayed on the meters.

③ IGNITION ON mode

All electrical components can be used. “IGNITION ON” will be displayed on the meters.

\*: If the shift lever is in a position other than P when turning off the engine, the engine switch will be turned to ACCESSORY mode, not to off.

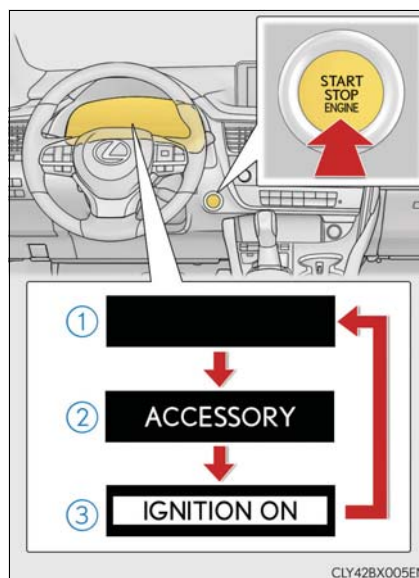

### When stopping the engine with the shift lever in a position other than P

If the engine is stopped with the shift lever in a position other than P, the engine switch will not be turned off but instead be turned to ACCESSORY mode. Perform the following procedure to turn the switch off:

- 1 Check that the parking brake is set.
- 2 Shift the shift lever to P.
- 3 Check that “Turn Off Vehicle” is displayed on the multi-information display and then press the engine switch once.
- 4 Check that “Turn Off Vehicle” on the multi-information display is off.

#### ■ Auto power off function

If the vehicle is left in ACCESSORY mode for more than 20 minutes or IGNITION ON mode (with the engine not running) for more than an hour with the shift lever in P, the engine switch will automatically turn off. However, this function cannot entirely prevent battery discharge. Do not leave the vehicle with the engine switch in ACCESSORY or IGNITION ON mode for long periods of time when the engine is not running.

#### ■ Electronic key battery depletion

→P. 122

#### ■ Conditions affecting operation

→P. 148

#### ■ Note for the entry function

→P. 149

#### ■ If the engine does not start

- The engine immobilizer system may not have been deactivated. (→P. 74)  
Contact your Lexus dealer.
- Check that the shift lever is securely set in P. The engine may not start if the shift lever is displaced out of P. "To Start Vehicle, Put Shift Lever into P" will be displayed on the multi-information display.

#### ■ Steering lock

After turning the engine switch off and opening and closing the doors, the steering wheel will be locked due to the steering lock function. Operating the engine switch again automatically cancels the steering lock.

#### ■ When the steering lock cannot be released

"Steering Wheel Lock Press Engine Switch while Turning Wheel" will be displayed on the multi-information display.

Check that the shift lever is in P. Press the engine switch shortly and firmly while turning the steering wheel left and right.



#### ■ Steering lock motor overheating prevention

To prevent the steering lock motor from overheating, operation of the motor may be suspended if the engine is turned on and off repeatedly in a short period of time. In this case, refrain from operating the engine switch. After about 10 seconds, the steering lock motor will resume functioning.

#### ■ When "Access System with Elec. Key Malfunction See Owner's Manual" is displayed on the multi-information display

The system may be malfunctioning. Have the vehicle inspected by your Lexus dealer immediately.

- **If the electronic key battery is depleted**  
→P. 623
- **Operation of the engine switch**
  - If the switch is not pressed shortly and firmly, the engine switch mode may not change or the engine may not start.
  - If attempting to restart the engine immediately after turning the engine switch off, the engine may not start in some cases. After turning the engine switch off, please wait a few seconds before restarting the engine.
- **If the smart access system with push-button start has been deactivated by a customized setting**  
→P. 684

 **WARNING**

■ **When starting the engine**

Always start the engine while sitting in the driver's seat. Do not depress the accelerator pedal while starting the engine under any circumstances. Doing so may cause an accident resulting in death or serious injury.

■ **Caution while driving**

If engine failure occurs while the vehicle is moving, do not lock or open the doors until the vehicle reaches a safe and complete stop. Activation of the steering lock in this circumstance may lead to an accident, resulting in death or serious injury.

■ **Stopping the engine in an emergency**

If you want to stop the engine in an emergency while driving the vehicle, press and hold the engine switch for more than 2 seconds, or press it briefly 3 times or more in succession. (→P. 645)

However, do not touch the engine switch while driving except in an emergency. Turning the engine off while driving will not cause loss of steering or braking control, but the power assist to these systems will be lost. This will make it more difficult to steer and brake, so you should pull over and stop the vehicle as soon as it is safe to do so.

 NOTICE**■ To prevent battery discharge**

- Do not leave the engine switch in ACCESSORY or IGNITION ON mode for long periods of time without the engine running.
- If "ACCESSORY" or "IGNITION ON" is displayed on the meters while the engine is not running, the engine switch is not off. Exit the vehicle after turning the engine switch off.
- Do not stop the engine when the shift lever is in a position other than P. If the engine is stopped in another shift lever position, the engine switch will not be turned off but instead be turned to ACCESSORY mode. If the vehicle is left in ACCESSORY mode, battery discharge may occur.

**■ When starting the engine**

- Do not race a cold engine.
- If the engine becomes difficult to start or stalls frequently, have your vehicle checked by your Lexus dealer immediately.

**■ Symptoms indicating a malfunction with the engine switch**

If the engine switch seems to be operating somewhat differently than usual, such as the switch sticking slightly, there may be a malfunction. Contact your Lexus dealer immediately.

## Automatic transmission (vehicles without paddle shift switches)

### Shifting the shift lever

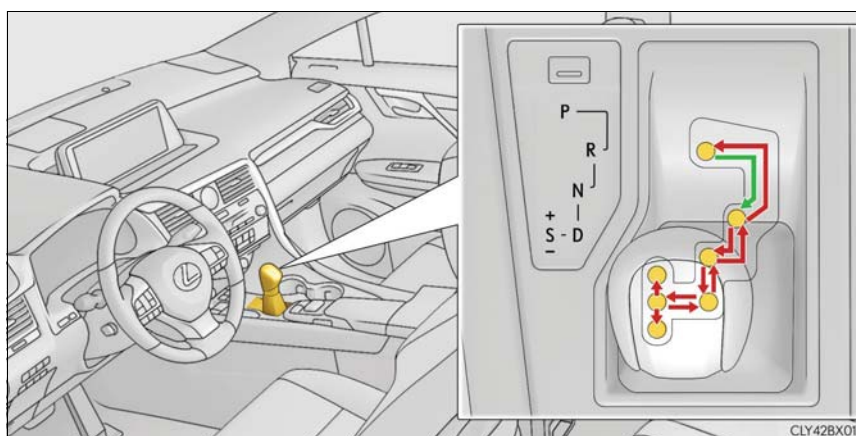

- ← While the engine switch is in IGNITION ON mode, move the shift lever with the brake pedal depressed.
- When shifting the shift lever between P and D, make sure that the vehicle is completely stopped.

### Shift position purpose

Shift position	Objective or function
P	Parking the vehicle/starting the engine
R	Reversing
N	Condition in which the power is not transmission
D	Normal driving <sup>*1</sup>
S	S mode driving <sup>*2</sup> (→P. 237)

<sup>\*1</sup>: Shifting to the D position allows the system to select a gear suitable for the driving conditions. Setting the shift lever to the D position is recommended for normal driving.

<sup>\*2</sup>: Selecting shift ranges using S mode restricts the upper limit of the possible gear ranges, controls engine braking forces, and prevents unnecessary upshifting.

### Selecting the driving mode

→P. 373

### Selecting shift ranges in S mode

To enter S mode, shift the shift lever to the S position. The shift range can then be selected by operating the shift lever. Changing the shift range allows restriction of the upper limit of the gears to be used, preventing unnecessary upshifting and enabling the level of engine braking force to be selected.

① Upshifting

② Downshifting

The initial shift range in S mode is set automatically between 3 and 7 according to vehicle speed and driving conditions.

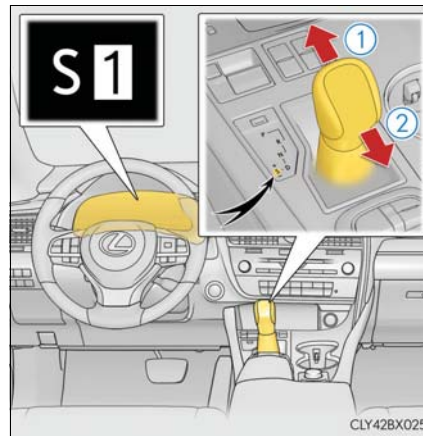

4

Driving

### Shift ranges and their functions

Meter display	Function
S2 - S8	A gear in the range between 1 and the selected gear is automatically chosen depending on vehicle speed and driving conditions
S1	Setting the gear at 1

A lower shift range will provide greater engine braking forces than a higher shift range.

**■ S mode**

- When the shift range is 6 or lower, holding the shift lever toward "+" sets the shift range to 8.
- To prevent the engine from over-revving, upshifting may automatically occur.
- To protect the automatic transmission, a function is adopted that automatically selects a higher shift range when the fluid temperature is high.

**■ To protect the automatic transmission**

If the automatic transmission fluid temperature is high, "Transmission Fluid Temp High See Owner's Manual" will be displayed on the multi-information display and the vehicle will go into transmission protection mode automatically. Have the vehicle inspected by your Lexus dealer.

**■ Downshifting restrictions warning buzzer**

To help ensure safety and driving performance, downshifting operation may sometimes be restricted. In some circumstances, downshifting may not be possible even when the shift lever is operated. (A buzzer will sound twice.)

**■ When driving with dynamic radar cruise control with full-speed range activated**

Even when performing the following actions with the intent of enabling engine braking, engine braking will not occur because dynamic radar cruise control with full-speed range will not be canceled.

- While driving in D or S mode, downshifting to 7, 6, 5 or 4. (→P. 300)
- When switching the driving mode to sport mode while driving in the D position (→P. 373)

**■ Restraining sudden start (Drive-Start Control)**

When the following unusual operation is performed, the engine output may be restrained.

- When the shift lever is shifted from R to D, D to R, N to R, P to D, or P to R (D includes S) with the accelerator pedal depressed, a warning message appears on the multi-information display. If a warning message is shown on the multi-information display, read the message and follow the instructions.
- When the accelerator pedal is depressed too while the vehicle is in reverse.

**■ Shift lock system**

The shift lock system is a system to prevent accidental operation of the shift lever in starting.

The shift lever can be shifted from P only when the engine switch is in IGNITION ON mode and the brake pedal is being depressed.

### ■ If the shift lever cannot be shifted from P

First, check whether the brake pedal is being depressed.

If the shift lever cannot be shifted with your foot on the brake pedal, there may be a problem with the shift lock system. Have the vehicle inspected by your Lexus dealer immediately.

The following steps may be used as an emergency measure to ensure that the shift lever can be shifted.

Releasing the shift lock:

- 1 Turn the engine switch to IGNITION ON mode and check that the parking brake is set. (→P. 232, 247)
- 2 Turn the engine switch to off.
- 3 Depress the brake pedal.
- 4 Pry the cover up with a flathead screwdriver or equivalent tool.  
To prevent damage to the cover, cover the tip of the screwdriver with a rag.

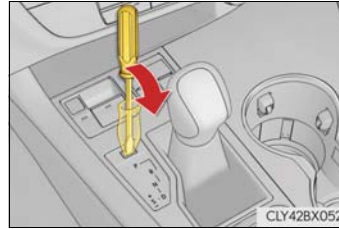

- 5 Press the shift lock override button.  
The shift lever can be shifted while the button is pressed

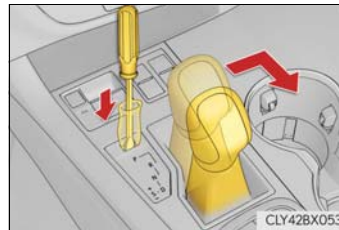

### ■ AI-SHIFT

The AI-SHIFT automatically selects the suitable gear according to driver performance and driving conditions.

The AI-SHIFT automatically operates when the shift lever is in D. (Shifting the shift lever to the S position cancels the function.)

#### ⚠ WARNING

##### ■ When driving on slippery road surfaces

Be careful of downshifting and sudden acceleration, as this could result in the vehicle skidding to the side or spinning.

##### ■ To prevent an accident when releasing the shift lock

Before pressing the shift lock override button, make sure to set the parking brake and depress the brake pedal.

If the accelerator pedal is accidentally depressed instead of the brake pedal when the shift lock override button is pressed and the shift lever is shifted out of P, the vehicle may suddenly start, possibly leading to an accident resulting in death or serious injury.



## Automatic transmission (vehicles with paddle shift switches)

### Shifting the shift lever

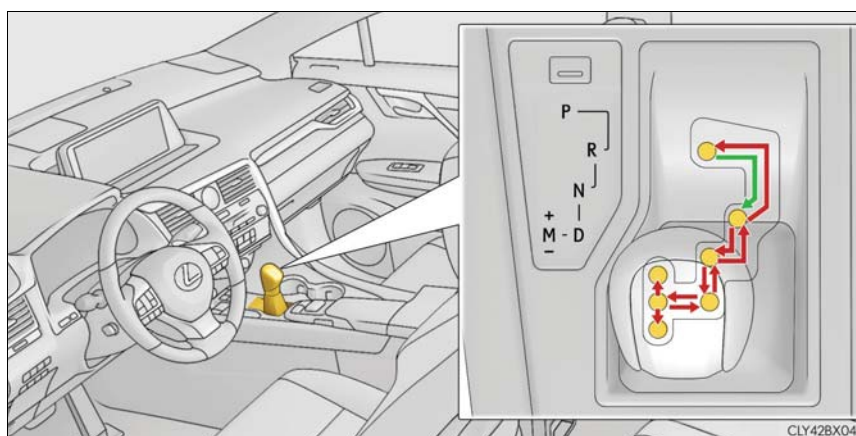

- ← While the engine switch is in IGNITION ON mode, move the shift lever with the brake pedal depressed.

When shifting the shift lever between P and D, make sure that the vehicle is completely stopped.

### Shift position purpose

Shift position	Objective or function
P	Parking the vehicle/starting the engine
R	Reversing
N	Condition in which the power is not transmission
D	Normal driving <sup>*1</sup>
M	M mode driving <sup>*2</sup> (→P. 242)

<sup>\*1</sup>: Shifting to the D position allows the system to select a gear suitable for the driving conditions.

Setting the shift lever to the D position is recommended for normal driving.

<sup>\*2</sup>: Selecting gears using M mode fixes the gear step, controls engine braking force, and prevents unnecessary upshifting.

### Selecting the driving mode

→P. 373

### Selecting shift ranges in the D position

To drive using temporary shift range selection, operate the “-” or “+” paddle shift switch.

When the “-” paddle shift switch is operated, the shift range will be downshifted to a range that enables engine braking force that is suitable to driving conditions. When the “+” paddle shift switch is operated, the shift range will be one gear higher than the gear in use during normal D position driving.

Changing the shift range allows restriction of the highest gear, preventing unnecessary upshifting and enabling the level of engine braking force to be selected.

① Upshifting

② Downshifting

The selected shift range, from D1 to D8, will be displayed on the meters.

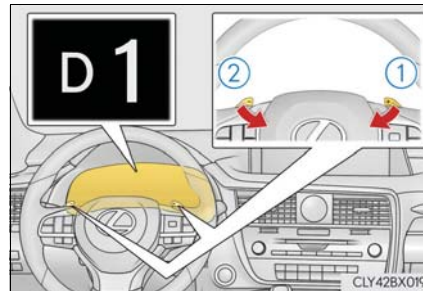

4

Driving

#### ■ Shift ranges and their functions

Meter display	Function
D2 - D8	A gear in the range between 1 and the selected gear is automatically chosen depending on vehicle speed and driving conditions
D1	Setting the gear at 1

A lower shift range will provide greater engine braking forces than a higher shift range.

### Selecting gears in the M position

To enter M mode, shift the shift lever to M. Gears can then be selected by operating the shift lever or paddle shift switches, allowing you to drive in the gear of your choosing.

- ① Upshifting
- ② Downshifting

The gear changes once every time the shift lever or paddle shift switch is operated.

The selected gear, from M1 to M8, will be fixed and displayed on the meters.

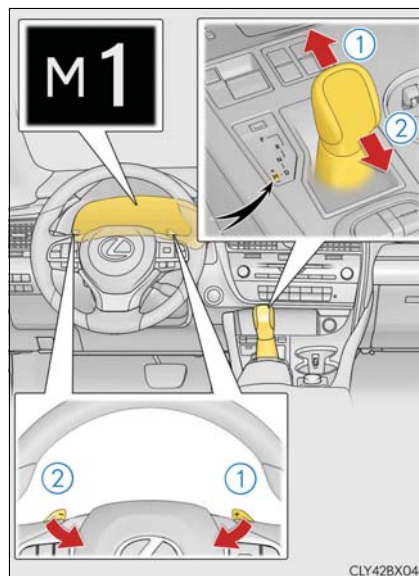

When in the M position, the gear will not change unless the shift lever or paddle shift switches are operated.

However, even when in the M position, the gears will be automatically changed in the following situation:

- When vehicle speed drops (downshift only).
- When the automatic transmission fluid or engine coolant temperature is low.
- When automatic transmission fluid temperature is high (upshift only).
- When the needle of the tachometer is in the red zone (the range which exceeds the allowable revs of the engine).

In the following situations, the gear will not shift even if the shift lever or paddle shift switches are operated.

- The vehicle speed is low (upshift only).

#### ■ Automatic deactivation of shift range selection in the D position

Shift range selection in the D position will be deactivated in the following situations:

- The "+" paddle shift switch is held down for a period of time
- When the vehicle comes to a stop
- If the accelerator pedal is depressed for more than a certain period of time
- When the shift lever is shifted to a position other than D

#### ■ To protect the automatic transmission

If the automatic transmission fluid temperature is high, "Transmission Fluid Temp High See Owner's Manual" will be displayed on the multi-information display and the vehicle will go into transmission protection mode automatically. Have the vehicle inspected by your Lexus dealer.

#### ■ Downshifting restriction warning buzzer

To help ensure safety and driving performance, downshifting operation may sometimes be restricted. In some circumstances, downshifting may not be possible even when the shift lever or paddle shift switch is operated. (A buzzer will sound twice.)

#### ■ When driving with dynamic radar cruise control with full-speed range activated

Even when performing the following actions with the intent of enabling engine braking, engine braking will not occur because dynamic radar cruise control with full-speed range will not be canceled.

- While driving in D position, downshifting to 7, 6, 5 or 4. (→P. 300)
- When switching the driving mode to sport mode while driving in the D position (→P. 373)

#### ■ Restraining sudden start (Drive-Start Control)

When the following unusual operation is performed, the engine output may be restrained.

- When the shift lever is shifted from R to D, D to R, N to R, P to D, or P to R (D includes M) with the accelerator pedal depressed, a warning message appears on the multi-information display. If a warning message is shown on the multi-information display, read the message and follow the instructions.
- When the accelerator pedal is depressed too while the vehicle is in reverse.

#### ■ Shift lock system

The shift lock system is a system to prevent accidental operation of the shift lever in starting.

The shift lever can be shifted from P only when the engine switch is in IGNITION ON mode and the brake pedal is being depressed.

■ **If the shift lever cannot be shifted from P**

First, check whether the brake pedal is being depressed.

If the shift lever cannot be shifted with your foot on the brake pedal, there may be a problem with the shift lock system. Have the vehicle inspected by your Lexus dealer immediately.

The following steps may be used as an emergency measure to ensure that the shift lever can be shifted.

Releasing the shift lock:

- 1 Turn the engine switch to IGNITION ON mode and check that the parking brake is set. (→P. 232, 247)
- 2 Turn the engine switch to off.
- 3 Depress the brake pedal.
- 4 Pry the cover up with a flathead screwdriver or equivalent tool.  
To prevent damage to the cover, cover the tip of the screwdriver with a rag.

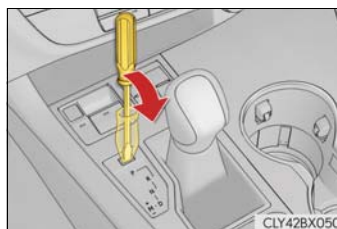

- 5 Press the shift lock override button.  
The shift lever can be shifted while the button is pressed

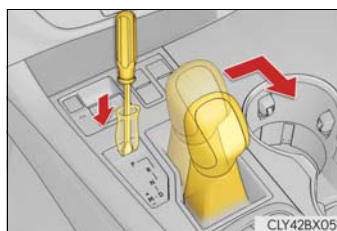

■ **AI-SHIFT**

- The AI-SHIFT automatically selects the suitable gear according to driver performance and driving conditions.

The AI-SHIFT automatically operates when the shift lever is in D. (Shifting the shift lever to the M position cancels the function.)

- G AI-SHIFT automatically selects a suitable gear for sporty driving according to driver's input and driving conditions. G AI-SHIFT operates automatically when the shift lever is in D and sport mode is selected for the driving mode. (Selecting normal mode with the driving mode select switch or shifting the shift lever to the M position cancels this function.)

 **WARNING****■ When driving on slippery road surfaces**

Be careful of downshifting and sudden acceleration, as this could result in the vehicle skidding to the side or spinning.

**■ To prevent an accident when releasing the shift lock**

Before pressing the shift lock override button, make sure to set the parking brake and depress the brake pedal.

If the accelerator pedal is accidentally depressed instead of the brake pedal when the shift lock override button is pressed and the shift lever is shifted out of P, the vehicle may suddenly start, possibly leading to an accident resulting in death or serious injury.

## Turn signal lever

### Operating instructions

- ① Right turn
- ② Lane change to the right (move the lever partway and release it)  
The right hand signals will flash 3 times.
- ③ Lane change to the left (move the lever partway and release it)  
The left hand signals will flash 3 times.
- ④ Left turn

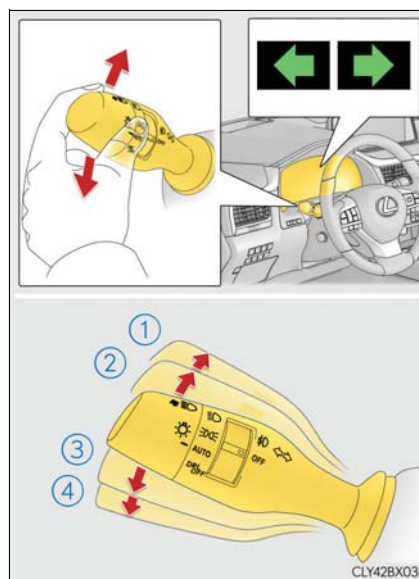

#### ■ Turn signals can be operated when

The engine switch is in IGNITION ON mode.

#### ■ If the indicator flashes faster than usual

Check that a light bulb in the front or rear turn signal lights has not burned out.

#### ■ If the turn signals stop flashing before a lane change has been performed

Operate the lever again.

#### ■ Customization

Some functions can be customized. (→P. 722)

## Parking brake

A mode can be selected from the following modes.

### Automatic mode

The parking brake is set or released automatically according to the shift lever operation.

Even when in automatic mode, the parking brake can be set and released manually. (→P. 248)

- ① Turns automatic mode on (while the vehicle is stopped, pull and hold the parking brake switch until the automatic mode lamp turns on)
  - When the shift lever is moved out of P, the parking brake will be released, and the parking brake indicator light and parking brake light turn off.
  - When the shift lever is moved into P, the parking brake will be set, and the parking brake indicator light and parking brake light turn on.

Operate the shift lever with the brake pedal depressed.

- ② Turns automatic mode off (while the vehicle is stopped, press and hold the parking brake switch until the automatic mode lamp turns off)

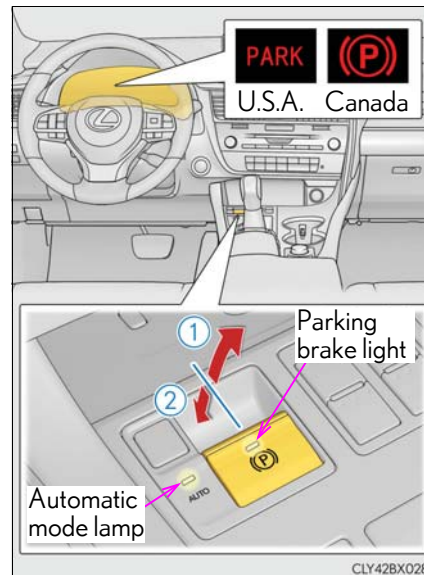



### Manual mode

The parking brake can be set and released manually.

① Sets the parking brake

The parking brake indicator light and parking brake light will turn on.

Pull and hold the parking brake switch if an emergency occurs and it is necessary to operate the parking brake while driving.

② Releases the parking brake

Operate the parking brake switch while depressing the brake pedal. Make sure that the parking brake indicator light and parking brake light turn off.

If the parking brake indicator light and parking brake lamp flashes, operate the switch again. (→P. 654)

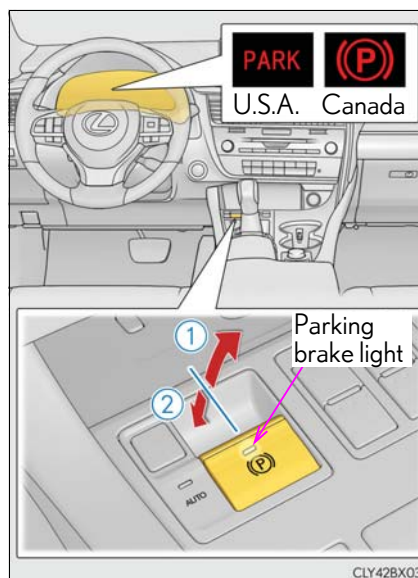

#### ■ Parking the vehicle

→P. 202

#### ■ Parking brake operation

- When the engine switch is not in IGNITION ON mode, the parking brake cannot be released using the parking brake switch.
- When the engine switch is not in IGNITION ON mode, automatic mode (automatic brake setting and releasing) is not available.

#### ■ If “Parking Brake Overheated Parking Brake Unavailable” is displayed on the multi-information display

If the parking brake is operated repeatedly over a short period of time, the system may restrict operation to prevent overheating. If this happens, refrain from operating the parking brake. Normal operation will return after about 1 minute.

#### ■ If “EPB Activation Stopped Incompletely” or “Parking Brake Unavailable” is displayed on the multi-information display

Operate the parking brake switch. If the message does not disappear after operating the switch several times, the system may be malfunctioning. Have the vehicle inspected by your Lexus dealer immediately.

#### ■ Parking brake operation sound

When the parking brake operates, a motor sound (whirring sound) may be heard. This does not indicate a malfunction.

#### ■ Parking brake indicator light and parking brake light

- Depending on the engine switch mode, the parking brake indicator light and parking brake light will turn on and stay on as described below:  
IGNITION ON mode: Comes on until the parking brake is released.  
Not in IGNITION ON mode: Stays on for approximately 15 seconds.
- When the engine switch is turned off with the parking brake set, the parking brake indicator light and parking brake light will stay on for about 15 seconds. This does not indicate a malfunction.

#### ■ Changing the mode

When changing the automatic mode on/off, the message will be shown on the multi-information display and the buzzer sounds.

#### ■ Parking brake engaged warning buzzer

A buzzer will sound if the vehicle is driven with the parking brake engaged. "Release Parking Brake" is displayed on the multi-information display.

#### ■ Warning messages and buzzers

Warning messages and buzzers are used to indicate a system malfunction or to inform the driver of the need for caution. If a warning message is shown on the multi-information display, read the message and follow the instructions.

#### ■ If the brake system warning light comes on

→P. 654

#### ■ Usage in winter time

→P. 385



#### WARNING

##### ■ When parking the vehicle

Do not leave a child in the vehicle alone. The parking brake may be released unintentionally and there is the danger of the vehicle moving that may lead to an accident resulting in death or serious injury.

##### ■ Parking brake switch

Do not set any objects near the parking brake switch. Objects may interfere with the switch and may lead the parking brake to unexpectedly operate.



#### NOTICE

##### ■ When parking the vehicle

Before you leave the vehicle, shift the shift lever to P, set the parking brake and make sure that the vehicle does not move.

##### ■ When the system malfunctions

Stop the vehicle in a safe place and check the warning messages.

##### ■ When the parking brake cannot be released due to a malfunction

Driving the vehicle with the parking brake set will lead to brake components overheating, which may affect braking performance and increase brake wear. Contact your Lexus dealer immediately if this occurs.

## Brake Hold

- ▶ Vehicles without paddle shift switches

The brake hold system keeps the brake applied when the shift lever is in D, S or N with the system on and the brake pedal has been depressed to stop the vehicle. The system releases the brake when the accelerator pedal is depressed with the shift lever in D or S to allow smooth start off.

- ▶ Vehicles with paddle shift switches

The brake hold system keeps the brake applied when the shift lever is in D, M or N with the system on and the brake pedal has been depressed to stop the vehicle. The system releases the brake when the accelerator pedal is depressed with the shift lever in D or M to allow smooth start off.

Turns the brake hold system on

The brake hold standby indicator (green) comes on. While the system is holding the brakes, the brake hold operated indicator (yellow) will illuminate.

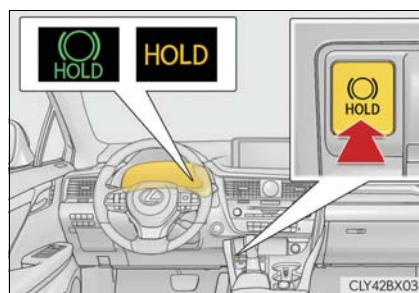

### ■ Brake hold system operating conditions

The brake hold system cannot be turned on in the following conditions:

- The driver's door is not closed.
- The driver's seat belt is not buckled.

If either of the conditions above are detected when the brake hold system is enabled, the system will turn off and the brake hold standby indicator light will go off. In addition, if any of the conditions are detected while the system is holding the brakes, a warning buzzer will sound and a message will be shown on the multi-information display. The parking brake will then be set automatically.

### ■ Brake hold function

- If the brake pedal is left released for a period of about 3 minutes after the system has started holding the brakes, the parking brake will be set automatically. In this case, a warning buzzer sounds and a message is shown on the multi-information display.
- To turn the system off while the system is holding the brakes, firmly depress the brake pedal and press the switch again.
- The brake hold function may not hold the vehicle when the vehicle is on a steep incline. In this situation, it may be necessary for the driver to apply the brakes. A warning buzzer will sound and the multi-information display will inform the driver of this situation. If a warning message is shown on the multi-information display, read the message and follow the instructions.

- **When the parking brake is set automatically while the system is holding the brakes**  
Perform any of the following operations to release the parking brake.
  - Depress the accelerator pedal. (The parking brake will not be released automatically if the seat belt is not fastened.)
  - Operate the parking brake switch with the brake pedal depressed.  
Make sure that the parking brake indicator light goes off. (→P. 247)
- **When an inspection at your Lexus dealer is necessary**  
When the brake hold standby indicator (green) does not illuminate even when the brake hold switch is pressed with the brake hold system operating conditions met, the system may be malfunctioning. Have the vehicle inspected at your Lexus dealer.
- **If “Brake Hold Fault Depress Brake to Deactivate Visit Your Dealer” is displayed on the multi-information display**  
The system may be malfunctioning. Have the vehicle inspected by your Lexus dealer.
- **Warning messages and buzzers**  
Warning messages and buzzers are used to indicate a system malfunction or to inform the driver of the need for caution. If a warning message is shown on the multi-information display, read the message and follow the instructions.
- **If the brake hold operated indicator flashes**  
→P. 654

 **WARNING**

- **When the vehicle is on a steep incline**  
When using the brake hold system on a steep incline exercise caution. The brake hold function may not hold the vehicle in such a situation.
- **When stopped on a slippery road**  
The system cannot stop the vehicle when the gripping ability of the tires has been exceeded. Do not use the system when stopped on a slippery road.

 **NOTICE**



- **When parking the vehicle**  
The brake hold system is not designed for use when parking the vehicle for a long period of time. Turning the engine switch off while the system is holding the brakes may release the brakes, which would cause the vehicle to move. When operating the engine switch, depress the brake pedal, shift the shift lever to P and set the parking brake.

## Headlight switch

The headlights can be operated manually or automatically.

### Operating instructions

Operating the  switch turns on the lights as follows:

- ①  The side marker, parking, tail, license plate, instrument panel lights, and daytime running lights (→P. 254) turn on.
- ②  The headlights and all the lights listed above (except daytime running lights) turn on.
- ③ AUTO The headlights, daytime running lights (→P. 254) and all the lights listed above turn on and off automatically. (When the engine switch is in IGNITION ON mode.)
- ④  Off  
(U.S.A.)
  - The daytime running lights (Canada) turn on. (→P. 254)

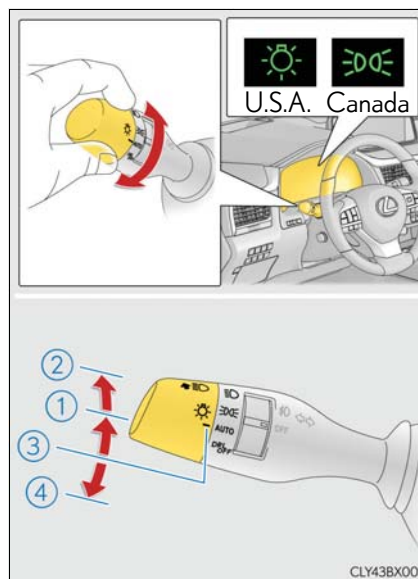

### Turning on the high beam headlights

- ① With the headlights on, push the lever away from you to turn on the high beams.  
Pull the lever toward you to the center position to turn the high beams off.
- ② Pull the lever toward you and release it to flash the high beams once.  
You can flash the high beams with the headlights on or off.

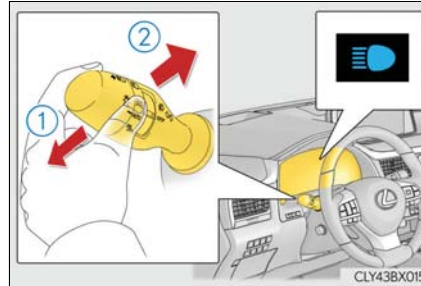

### AFS (Adaptive Front-lighting System) (if equipped)



AFS (Adaptive Front-lighting System) secures excellent visibility at intersections and on curves by automatically adjusting the direction of the light axis of the headlights according to vehicle speed and the degree of the tire's angle as controlled by steering input.

AFS operates at speeds of 6 mph (10 km/h) or higher.

### Cornering lights (if equipped)

- When the steering wheel or turn signal lever is operated while the headlights are on (low beam), a cornering light will turn on and light up the direction of movement of the vehicle. The cornering lights are designed to ensure excellent visibility when making a turn at an intersection.  
However, when vehicle speed is approximately 22 mph (35 km/h) or higher, the cornering lights will not turn on.
- When the shift lever is in R while the headlights are on (low beam), both cornering lights will turn on. This is designed to enhance visibility when parking.

■ **Daytime running light system**

- The daytime running lights illuminate using the same lights as the parking lights and illuminate brighter than the parking lights.
- To make your vehicle more visible to other drivers during daytime driving, the daytime running lights turn on automatically when all of the following conditions are met. (The daytime running lights are not designed for use at night.)
  - The engine is running
  - The parking brake is released
  - The headlight switch is in the  (Canada only),  or **AUTO** <sup>\*</sup> position

<sup>\*</sup>: When the surroundings are bright

The daytime running lights remain on after they illuminate, even if the parking brake is set again.

- For the U.S.A.: Daytime running lights can be turned off by operating the switch.
- Compared to turning on the headlights, the daytime running light system offers greater durability and consumes less electricity, so it can help improve fuel economy.

■ **Cornering lights (if equipped)**



When the cornering lights are on for more than 30 minutes, they will turn off automatically.

■ **Headlight control sensor**

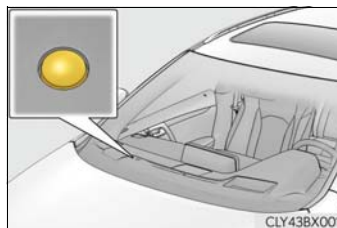
The sensor may not function properly if an object is placed on the sensor, or anything that blocks the sensor is affixed to the windshield. Doing so interferes with the sensor detecting the level of ambient light and may cause the automatic headlight system to malfunction.



■ **Automatic light off system**

- When the headlights come on: The headlights and tail lights turn off 30 seconds after a door is opened and closed if the engine switch is turned to **ACCESSORY** mode or turned off. (The lights turn off immediately if  on the key is pressed after all the doors are locked.)
- When only the tail lights come on: The tail lights turn off automatically if the engine switch is turned to **ACCESSORY** mode or turned off and the driver's door is opened. To turn the lights on again, turn the engine switch to **IGNITION ON** mode, or turn the light switch off once and then back to  or .

■ **Automatic headlight leveling system (if equipped)**

The level of the headlights is automatically adjusted according to the number of passengers and the loading condition of the vehicle to ensure that the headlights do not interfere with other road users.

■ **Light reminder buzzer**

A buzzer sounds when the engine switch is turned off or turned to **ACCESSORY** mode and the driver's door is opened while the lights are turned on.

#### ■ Welcome lighting

If the headlight switch is turned to **AUTO** and the surrounding area is dark, unlocking the doors using the smart access system with push-button start or wireless remote control will turn the parking lights and tail lights on automatically.

#### ■ Windshield wiper linked headlight illumination

When driving during daytime with the headlight switch turned to **AUTO**, if the windshield wipers are used, the headlights will turn on automatically after several seconds to help enhance the visibility of your vehicle.

#### ■ Battery-saving function

In order to prevent the battery of the vehicle from discharging, if the headlights and/or tail lights are on when the engine switch is turned off the battery saving function will operate and automatically turn off all the lights after approximately 20 minutes. When the engine switch is turned to **IGNITION ON** mode, the battery-saving function will be disabled.

When any of the following are performed, the battery-saving function is canceled once and then reactivated. All the lights will turn off automatically 20 minutes after the battery-saving function has been reactivated:

- When the headlight switch is operated
- When a door is opened or closed

#### ■ Customization

Some functions can be customized. (→P. 722)

#### NOTICE

#### ■ To prevent battery discharge

Do not leave the lights on longer than necessary when the engine is off.



## Automatic High Beam

The Automatic High Beam uses a camera sensor located behind the upper portion of the windshield to assess the brightness of the lights of vehicles ahead, streetlights, etc., and automatically turns the high beams on or off as necessary.

### WARNING

#### ■ Limitations of the Automatic High Beam

Do not overly rely on the Automatic High Beam. Always drive safely, taking care to observe your surroundings and turning the high beams on or off manually if necessary.

#### ■ To prevent incorrect operation of the Automatic High Beam system

Do not overload the vehicle.

## Activating the Automatic High Beam

- 1 Push the lever away from you with the headlight switch in the  or AUTO position.

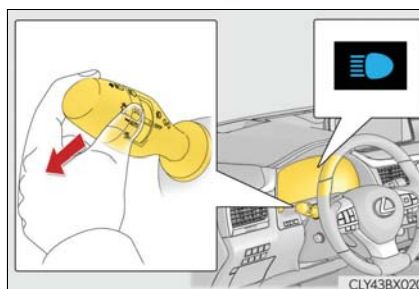

- 2 Press the Automatic High Beam switch. The Automatic High Beam indicator will come on when the system is operating.



### Turning the high beams on/off manually

#### ■ Switching to the low beams

Pull the lever to its original position.

The Automatic High Beam indicator will turn off.

Push the lever away from you to activate the Automatic High Beam system again.

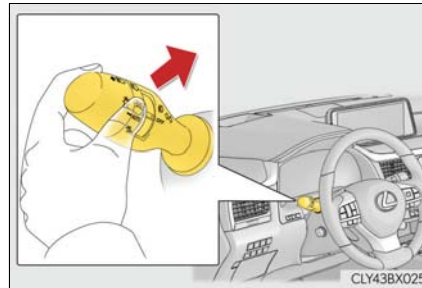

#### ■ Switching to the high beams

Press the Automatic High Beam switch.

The Automatic High Beam indicator will turn off and the high beam indicator will turn on.

Press the switch to activate the Automatic High Beam system again.

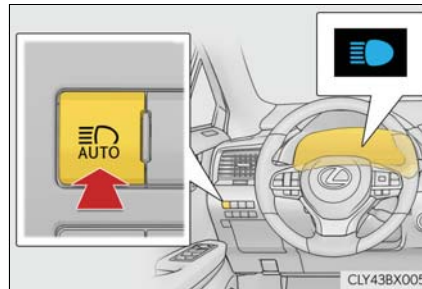

**■ Conditions to turn the high beams on/off automatically**

- When all of the following conditions are met, the high beams will be turned on automatically (after approximately 1 second):
  - The vehicle speed is approximately 21 mph (34 km/h) or more.
  - The area ahead of the vehicle is dark.
  - There are no vehicles ahead with headlights or tail lights turned on.
  - There are few streetlights on the road ahead.
- If any of the following conditions is met, the high beams will turn off automatically:
  - The vehicle speed is below approximately 17 mph (27 km/h).
  - The area ahead of the vehicle is not dark.
  - Vehicles ahead have their headlights or tail lights turned on.
  - There are many streetlights on the road ahead.

**■ Camera sensor detection information**

- The high beams may not be automatically turned off in the following situations:
  - When a vehicle suddenly appears from around a curve
  - When the vehicle is cut in front of by another vehicle
  - When vehicles ahead cannot be detected due to repeated curves, road dividers or roadside trees
  - When vehicles ahead appear in a faraway lane on a wide road
  - When the lights of vehicles ahead are not on
- The high beams may be turned off if a vehicle ahead that is using fog lights without its headlights turned on is detected.
- House lights, street lights, traffic signals, and illuminated billboards or signs and other reflective objects may cause the high beams to change to the low beams, or the low beams to remain on.
- The following factors may affect the amount of time taken for the high beams to turn on or off:
  - The brightness of the headlights, fog lights, and tail lights of vehicles ahead
  - The movement and direction of vehicles ahead
  - When a vehicle ahead only has operational lights on one side
  - When a vehicle ahead is a two-wheeled vehicle
  - The condition of the road (gradient, curve, condition of the road surface, etc.)
  - The number of passengers and amount of luggage in the vehicle
- The high beams may turn on or off unexpectedly.
- Bicycles or similar vehicles may not be detected.

- In the following situations the system may not be able to correctly detect the surrounding brightness level. This may cause the low beams to remain on or the high beams to flash or dazzle pedestrians or vehicles ahead. In such a case, it is necessary to manually switch between the high and low beams.
  - When driving in inclement weather (heavy rain, snow, fog, sandstorms, etc.)
  - When the windshield is obscured by fog, mist, ice, dirt, etc.
  - When the windshield is cracked or damaged
  - When the camera sensor is deformed or dirty
  - When the temperature of the camera sensor is extremely high
  - When the surrounding brightness level is equal to that of headlights, tail lights or fog lights
  - When headlights or tail lights of vehicles ahead are turned off, dirty, changing color, or not aimed properly
  - When the vehicle is hit by water, snow, dust, etc. from a preceding vehicle
  - When driving through an area of intermittently changing brightness and darkness
  - When frequently and repeatedly driving ascending/descending roads, or roads with rough, bumpy or uneven surfaces (such as stone-paved roads, gravel roads, etc.)
  - When frequently and repeatedly taking curves or driving on a winding road
  - When there is a highly reflective object ahead of the vehicle, such as a sign or mirror
  - When the back of a preceding vehicle is highly reflective, such as a container on a truck
  - When the vehicle's headlights are damaged or dirty, or are not aimed properly
  - When the vehicle is listing or tilting due to a flat tire, a trailer being towed, etc.
  - When the headlights are changed between the high beams and low beams repeatedly in an abnormal manner
  - When the driver believes that the high beams may be flashing or dazzling pedestrians or other drivers

#### ■ Temporarily lowering sensor sensitivity

The sensitivity of the sensor can be temporarily lowered.

- 1 Turn the engine switch off while the following conditions are met.
  - The headlight switch is in  or AUTO.
  - The headlight switch lever is in high beam position.
  - Automatic High Beam switch is on.
- 2 Turn the engine switch to IGNITION ON mode.
- 3 Within 30 seconds after 2, repeat pulling the headlight switch lever to the original position then pushing it to the high beam position quickly 10 times, then leave the lever in high beam position.
- 4 If the sensitivity is changed, the Automatic High Beam indicator is turn on and off 3 times.

Automatic High Beam (headlights) may turn on even when the vehicle is stopped.

## Fog light switch

The fog lights secure excellent visibility in difficult driving conditions, such as in rain and fog.

### Operating instructions

- ① OFF (U.S.A.) or ○ (Canada)  
Turns the fog lights off
- ②  Turns the fog lights on

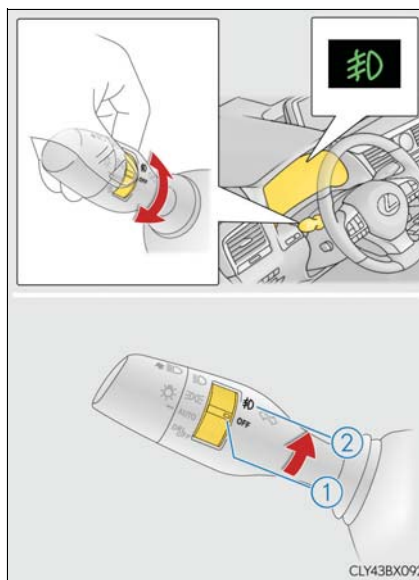

- Fog lights can be used when  
The headlights are on in low beam.

## Windshield wipers and washer

### Operating the wiper lever

Operating the  lever operates the wipers or washer as follows.

- ▶ Intermittent windshield wipers with interval adjuster

Wiper intervals can be adjusted when intermittent operation is selected.

The interval of intermittent operation varies according to vehicle speed.

- ① **OFF** (U.S.A.) or ○ (Canada)  
Off
- ② **INT** (U.S.A.) or  (Canada)  
Intermittent operation  
The intermittent windshield wiper operates more frequently as vehicle speed becomes higher.
- ③ **LO** (U.S.A.) or ▼ (Canada)  
Low speed operation
- ④ **HI** (U.S.A.) or ▼▼ (Canada)  
High speed operation
- ⑤ **MIST** (U.S.A.) or ▲ (Canada)  
Temporary operation
- ⑥ Increases the intermittent windshield wiper frequency
- ⑦ Decreases the intermittent windshield wiper frequency

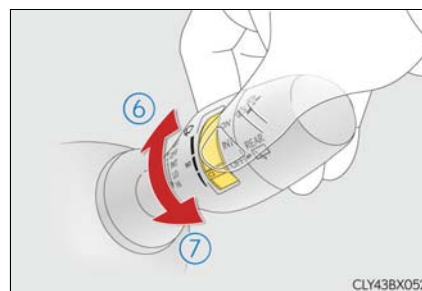
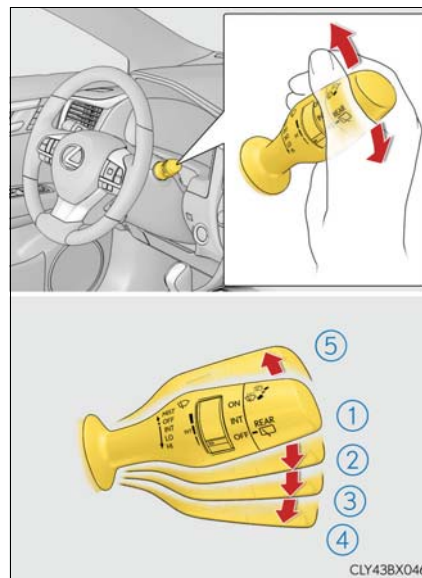

⑧  Washer/wiper dual operation

Pulling the lever operates the wipers and washer.

The wipers will automatically operate a couple of times after the washer squirts.

Vehicles with headlight cleaners:  
When the engine switch is in IGNITION ON mode and the headlights are on, if the lever is pulled, the headlight cleaners will operate once. After this, the headlight cleaners will operate every 5th time the lever is pulled.

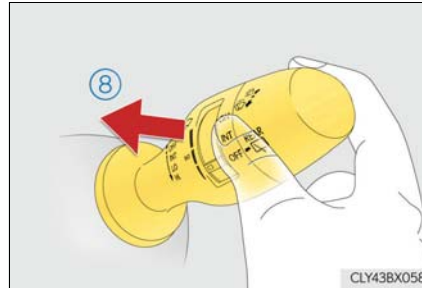

► Rain-sensing windshield wipers

When "AUTO" is selected, the wipers will operate automatically when the sensor detects falling rain. The system automatically adjusts wiper timing in accordance with rain volume and vehicle speed.

The sensor sensitivity can be adjusted when "AUTO" is selected.

① **OFF** (U.S.A.) or ○ (Canada)  
Off

② **AUTO** Rain-sensing operation

③ **LO** (U.S.A.) or ▼ (Canada)  
Low speed operation

④ **HI** (U.S.A.) or ▼ (Canada)  
High speed operation

⑤ **MIST** (U.S.A.) or ▲ (Canada)  
Temporary operation

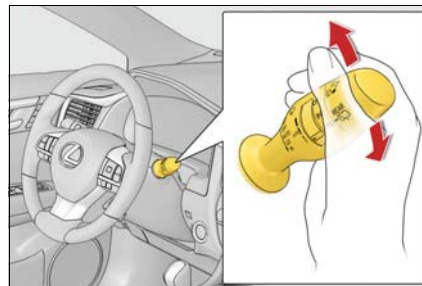

⑥ Increases the sensitivity

⑦ Decreases the sensitivity

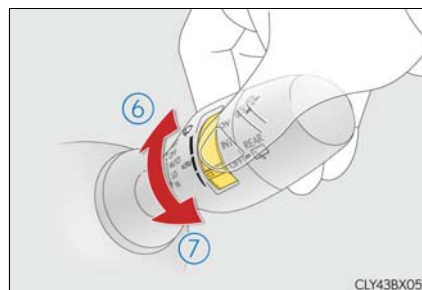

⑧  Washer/wiper dual operation

Pulling the lever operates the wipers and washer.

The wipers will automatically operate a couple of times after the washer squirts.

Vehicles with headlight cleaners:

When the engine switch is in IGNITION ON mode and the headlights are on, if the lever is pulled, the headlight cleaners will operate once. After this, the headlight cleaners will operate every 5th time the lever is pulled.



■ **The windshield wipers and washer can be operated when**

The engine switch is in IGNITION ON mode.

■ **Dripping prevention wiper sweep (vehicles with rain-sensing windshield wipers)**

After washing and wiping operation several times, the wipers operate one more time after a short delay to prevent dripping. However, this function will not operate while driving.

■ **Effects of vehicle speed on wiper operation**

Vehicle speed affects the Intermittent wiper interval.

■ **Raindrop sensor (vehicles with rain-sensing windshield wipers)**

- The raindrop sensor judges the amount of raindrops.

An optical sensor is adopted. It may not operate properly when sunlight from the rising or setting of the sun intermittently strikes the windshield, or if bugs, etc. are present on the windshield.

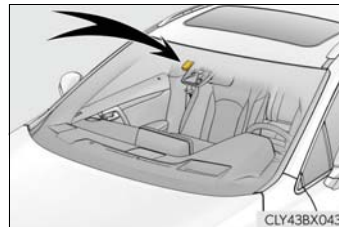

- If the wiper switch is turned to the "AUTO" position while the engine switch is in IGNITION ON mode, the wipers will operate once to show that AUTO mode is activated.
- When the sensor sensitivity ring is turned toward high while in "AUTO" position, the wipers will operate once to indicate that the sensor sensitivity is enhanced.
- If the temperature of the raindrop sensor is 194°F (90°C) or higher, or 5°F (-15°C) or lower, automatic operation may not occur. In this case, operate the wipers in any mode other than AUTO mode.

■ **If no windshield washer fluid sprays**

Check that the washer nozzles are not blocked, if there is washer fluid in the washer fluid tank.



■ **Front door opening linked windshield wiper stop function (vehicles with rain-sensing windshield wipers)**

When "AUTO" is selected and the windshield wipers are operating, if a front door is opened, the operation of the windshield wipers will be stopped to prevent anyone near the vehicle from being sprayed by water from the wipers, provided the vehicle is stopped with the parking brake applied or the shift lever in P. When the front door is closed, wiper operation will resume.

■ **Customization**

Some functions can be customized. (→P. 722)

 **WARNING**

■ **Caution regarding the use of windshield wipers in AUTO mode (vehicles with rain-sensing windshield wipers)**

The windshield wipers may operate unexpectedly if the sensor is touched or the windshield is subject to vibration in AUTO mode. Take care that your fingers, etc. do not become caught in the windshield wipers.

■ **Caution regarding the use of washer fluid**

When it is cold, do not use the washer fluid until the windshield becomes warm. The fluid may freeze on the windshield and cause low visibility. This may lead to an accident, resulting in death or serious injury.

 **NOTICE**

■ **When the windshield is dry**

Do not use the wipers, as they may damage the windshield.

■ **When the washer fluid tank is empty**

Do not operate the switch continually as the washer fluid pump may overheat.

■ **When a nozzle becomes blocked**

In this case, contact your Lexus dealer.

Do not try to clear it with a pin or other object. The nozzle will be damaged.

### Changing the windshield wiper rest position/Lifting the windshield wipers

When the windshield wipers are not being used, they retract to below the hood. To enable the windshield wipers to be lifted when parking in cold conditions or when replacing a windshield wiper insert, change the rest position of the windshield wipers to the service position using the wiper lever.

#### ■ Raising the wipers to the service position

Within approximately 40 seconds of turning the engine switch off, move the wiper lever to the **MIST** (U.S.A.) or **▲** (Canada) position and hold it for approximately 2 seconds or more.

The wipers will move to the service position.

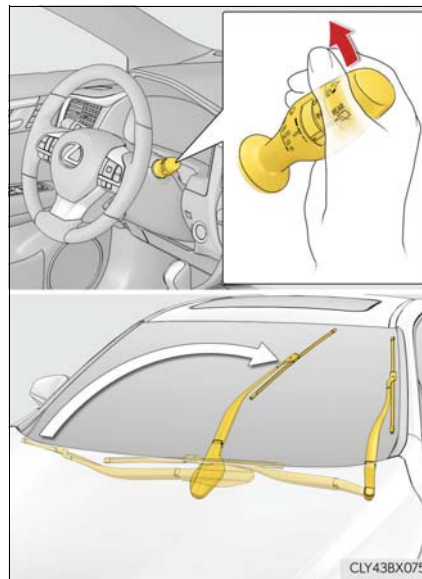

4

Driving

#### ■ Lifting the windshield wipers

While holding the hook portion of the wiper arm, lift the windshield wiper from the windshield.

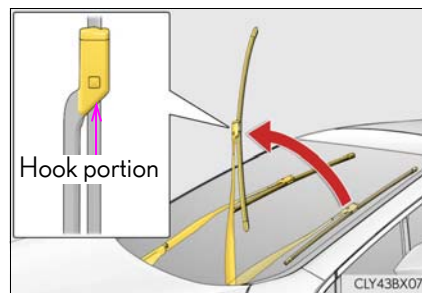

■ Lowering the windshield wipers to the retracted position

With the windshield wipers placed on the windshield, turn the engine switch to IGNITION ON mode and then move the wiper lever to an operating position. When the wiper switch is turned off, the windshield wipers will stop at the retracted position.

⚠ NOTICE

■ When lifting the windshield wipers

- Do not lift the windshield wipers when they are in the retracted position below the hood. Otherwise, they may contact the hood, possibly resulting in damage to a windshield wiper and/or the hood.
- Do not lift a windshield wiper by the wiper blade. Otherwise, the wiper blade may be deformed.



- Do not operate the wiper lever when the windshield wipers are lifted. Otherwise, the windshield wipers may contact the hood, possibly resulting in damage to the windshield wipers and/or hood.

## Rear window wiper and washer

### Operating the wiper lever

Operating the  switch operates the rear wiper as follows:

- ① **OFF** (U.S.A.) or ○ (Canada)  
Off
- ② **INT** (U.S.A.) or - - - (Canada)  
Intermittent operation
- ③ **ON** (U.S.A.) or — (Canada)  
Normal operation

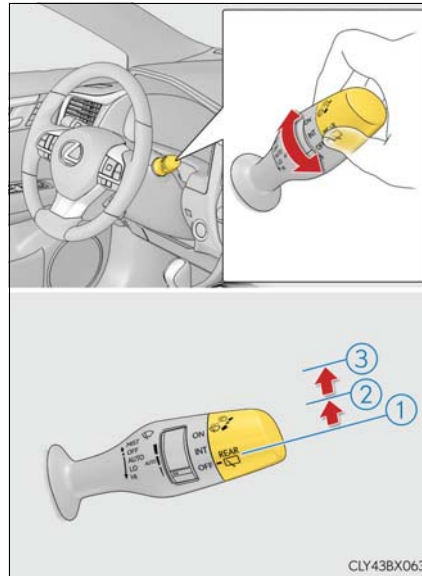

- ④  Washer/wiper dual operation

Pushing the lever operates the wiper and washer.

The wiper will automatically operate a couple of times after the washer squirts.

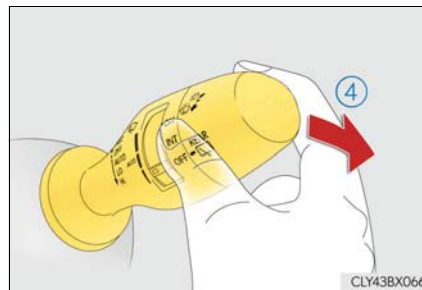

■ **The rear window wiper and washer can be operated when**

The engine switch is in IGNITION ON mode.

■ **If no washer fluid sprays**

Check that the washer nozzle is not blocked if there is washer fluid in the washer fluid tank.



NOTICE

■ **When the rear window is dry**

Do not use the wiper, as it may damage the rear window.

■ **When the washer fluid tank is empty**

Do not operate the switch continually as the washer fluid pump may overheat.

■ **When a nozzle becomes blocked**

In this case, contact your Lexus dealer.

Do not try to clear it with a pin or other object. The nozzle will be damaged.

## Opening the fuel tank cap

Perform the following steps to open the fuel tank cap:

### Before refueling the vehicle

- Close all the doors and windows, and turn the engine switch off.
- Confirm the type of fuel.

---

#### ■ Fuel types

→P. 706

#### ■ Fuel tank opening for unleaded gasoline

To help prevent incorrect fueling, your vehicle has a fuel tank opening that only accommodates the special nozzle on unleaded fuel pumps.

 **WARNING****■ When refueling the vehicle**

Observe the following precautions while refueling the vehicle. Failure to do so may result in death or serious injury.

- After exiting the vehicle and before opening the fuel door, touch an unpainted metal surface to discharge any static electricity. It is important to discharge static electricity before refueling because sparks resulting from static electricity can cause fuel vapors to ignite while refueling.
- Always hold the grips on the fuel tank cap and turn it slowly to remove it. A whooshing sound may be heard when the fuel tank cap is loosened. Wait until the sound cannot be heard before fully removing the cap. In hot weather, pressurized fuel may spray out of the filler neck and cause injury.
- Do not allow anyone that has not discharged static electricity from their body to come close to an open fuel tank.
- Do not inhale vaporized fuel. Fuel contains substances that are harmful if inhaled.
- Do not smoke while refueling the vehicle. Doing so may cause the fuel to ignite and cause a fire.
- Do not return to the vehicle or touch any person or object that is statically charged. This may cause static electricity to build up, resulting in a possible ignition hazard.

**■ When refueling**

Observe the following precautions to prevent fuel overflowing from the fuel tank:

- Securely insert the fuel nozzle into the fuel filler neck.
- Stop filling the tank after the fuel nozzle automatically clicks off.
- Do not top off the fuel tank.

 **NOTICE****■ Refueling**

Do not spill fuel during refueling. Doing so may damage the vehicle, such as causing the emission control system to operate abnormally or damaging fuel system components or the vehicle's painted surface.

### Opening the fuel tank cap

- 1 With the doors unlocked, press the center of the rear edge of the fuel filler door.

Push inward and take your hand away to slightly open the fuel filler door. Then open the door fully by hand.



- 2 Open the fuel filler door until it is securely locked.

- 3 Turn the fuel tank cap slowly and remove it, then put it into the holder on the fuel filler door.

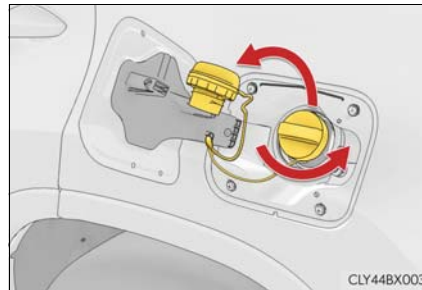



■ When the fuel filler door cannot be opened

▶ RX350

If the fuel filler door cannot be opened by pressing the rear edge of the fuel filler door with the doors unlocked, remove the cover inside the luggage compartment and pull the lever to open the fuel filler door.

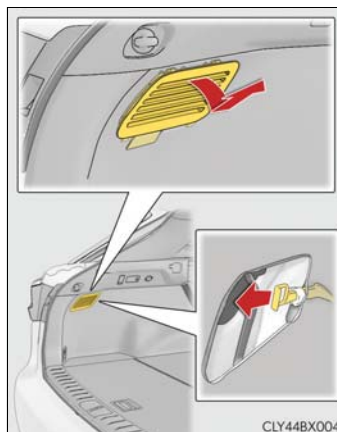

▶ RX350L

If the fuel filler door cannot be opened by pressing its rear edge with the doors unlocked, remove the cover inside the luggage compartment using a tool, such as a flathead screwdriver, and pull the lever to open the fuel filler door.

When using a screwdriver, make sure to wrap its tip with tape to protect the cover.

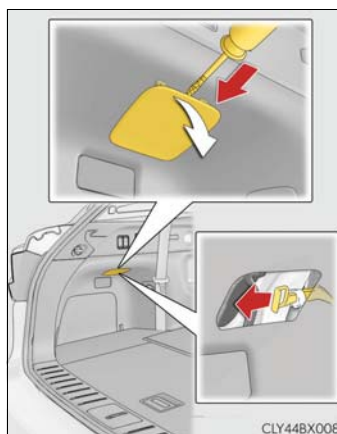

### Closing the fuel tank cap

- 1 After refueling, turn the fuel tank cap until you hear a click. Once the cap is released, it will turn slightly in the opposite direction.

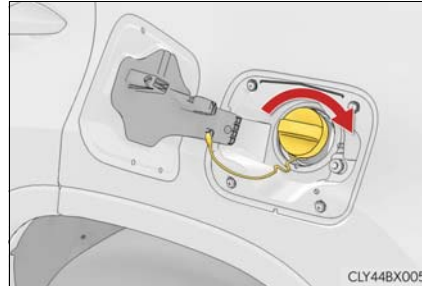

- 2 Close the fuel filler door, and press the center of the rear edge of the fuel filler door.  
When you lock the doors, the fuel filler door will lock also.

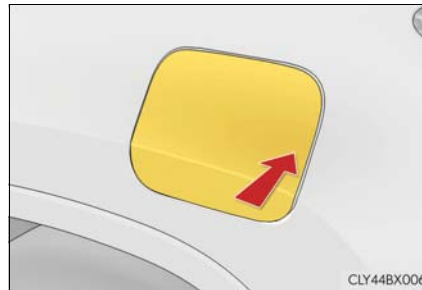

#### Fuel filler door lock condition

The fuel filler door may not be locked even when the vehicle's doors are locked in the following conditions:

- When operating the door lock button inside the vehicle
- When the automatic door locking system is operated (→P. 127)
- When the fuel filler door is closed after the vehicle's doors are locked

#### ⚠ WARNING

##### ■ When replacing the fuel tank cap

Do not use anything but a genuine Lexus fuel tank cap designed for your vehicle. Doing so may cause a fire or other incident which may result in death or serious injury.

## Lexus Safety System+

The Lexus Safety System+ consists of the following drive assist systems and contributes to a safe and comfortable driving experience:

◆ PCS (Pre-Collision System)

→P. 281

◆ LKA (Lane-Keeping Assist)

→P. 291

◆ Automatic High Beam

→P. 256

◆ Dynamic radar cruise control with full-speed range

→P. 300

 **WARNING**

■ **Lexus Safety System+**

The Lexus Safety System+ is designed to operate under the assumption that the driver will drive safely, and is designed to help reduce the impact to the occupants and the vehicle in the case of a collision or assist the driver in normal driving conditions.

As there is a limit to the degree of recognition accuracy and control performance that this system can provide, do not overly rely on this system. The driver is always responsible for paying attention to the vehicle's surroundings and driving safely.

### Vehicle data recording

The pre-collision system is equipped with a sophisticated computer that will record certain data, such as:

- Accelerator status
- Brake status
- Vehicle speed
- Operation status of the pre-collision system functions
- Information (such as the distance and relative speed between your vehicle and the vehicle ahead or other objects)
- Images from the camera sensor (available only when the pre-collision braking function or the pre-collision brake assist function was operating)

The pre-collision system does not record conversations, sounds or images of the inside of the vehicle.

- Data usage

Lexus may use the data recorded in this computer to diagnose malfunctions, conduct research and development, and improve quality.

Lexus will not disclose the recorded data to a third party except:

- With the consent of the vehicle owner or with the consent of the lessee if the vehicle is leased
- In response to an official request by the police, a court of law or a government agency
- For use by Lexus in a lawsuit
- For research purposes where the data is not tied to a specific vehicle or vehicle owner

- Recorded images can be erased using a specialized device.

The image recording function can be disabled. However, if the function is disabled, data from when the pre-collision system operates will not be available.

### Sensors

Two types of sensors, located behind the front grille and windshield, detect information necessary to operate the drive assist systems.

- ① Radar sensor
- ② Camera sensor

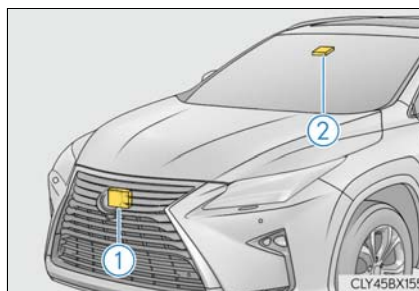

### ⚠ WARNING

#### ■ To avoid malfunction of the radar sensor

Observe the following precautions.

Otherwise, the radar sensor may not operate properly, possibly leading to an accident resulting in death or serious injury.

- Keep the radar sensor and front grille emblem clean at all times.

- ① Radar sensor
- ② Front grille emblem

If the front of the radar sensor or the front or back of the front grille emblem is dirty or covered with water droplets, snow, etc., clean it.

Clean the radar sensor and front grille emblem with a soft cloth so you do not mark or damage them.

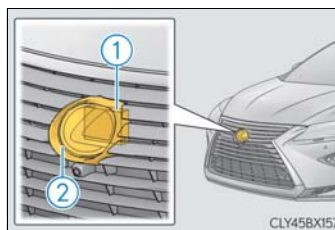

- Do not attach accessories, stickers (including transparent stickers) or other items to the radar sensor, front grille emblem or surrounding area.
- Do not subject the radar sensor or surrounding area to a strong impact.  
If the radar sensor, front grille, or front bumper has been subjected to a strong impact, have the vehicle inspected by your Lexus dealer.
- Do not disassemble the radar sensor.
- Do not modify or paint the radar sensor, front grille emblem or surrounding area.
- If the radar sensor, front grille, or front bumper needs to be removed and installed, or replaced, contact your Lexus dealer.

**⚠ WARNING****■ To avoid malfunction of the camera sensor**

Observe the following precautions.

Otherwise, the camera sensor may not operate properly, possibly leading to an accident resulting in death or serious injury.

- Keep the windshield clean at all times.
  - If the windshield is dirty or covered with an oily film, water droplets, snow, etc., clear the windshield.
  - If a glass coating agent is applied to the windshield, it will still be necessary to use the windshield wipers to remove water droplets, etc. from the area of the windshield in front of the camera sensor.
  - If the inner side of the windshield where the camera sensor is installed is dirty, contact your Lexus dealer.
- Do not attach objects, such as stickers, transparent stickers, and so forth, to the outer side of the windshield in front of the camera sensor (shaded area in the illustration).
  - A: From the top of the windshield to approximately 0.4 in. (1 cm) below the bottom of the camera sensor
  - B: Approximately 7.9 in. (20 cm) (Approximately 4.0 in. [10 cm] to the right and left from the center of the camera sensor)
- If the part of the windshield in front of the camera sensor is fogged up or covered with condensation or ice, use the windshield defogger to remove the fog, condensation or ice. (→P. 513)
- If water droplets cannot be properly removed from the area of the windshield in front of the camera sensor by the windshield wipers, replace the wiper insert or wiper blade.
  - To replace the wiper insert: →P. 621
  - If the wiper blades need to be replaced, contact your Lexus dealer.
- Do not attach window tinting to the windshield.
- Replace the windshield if it is damaged or cracked.  
If the windshield needs to be replaced, contact your Lexus dealer.
- Do not get the camera sensor wet.
- Do not allow bright lights to shine into the camera sensor.
- Do not dirty or damage the camera sensor.  
When cleaning the inside of the windshield, do not allow glass cleaner to contact the lens. Also, do not touch the lens.  
If the lens is dirty or damaged, contact your Lexus dealer.

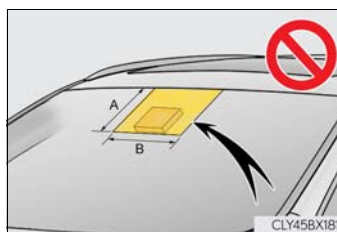

 **WARNING**

- Do not subject the camera sensor to a strong impact.
- Do not change the installation position or direction of the camera sensor or remove it.
- Do not disassemble the camera sensor.
- Do not modify any components of the vehicle around the camera sensor (inside rear view mirror, etc.) or ceiling.
- Do not attach any accessories that may obstruct the camera sensor to the hood, front grille or front bumper. Contact your Lexus dealer for details.
- If a surfboard or other long object is to be mounted on the roof, make sure that it will not obstruct the camera sensor.
- Do not modify the headlights or other lights.

---

**■ Certification**

FCC ID: HYQDNMWR008
---------------------

**NOTE:**

This device complies with part 15 of the FCC Rules. Operation is subject to the following two conditions: (1) This device may not cause harmful interference, and (2) this device must accept any interference received, including interference that may cause undesired operation.

**FCC WARNING:**

Changes or modifications not expressly approved by the party responsible for compliance could void the user's authority to operate the equipment.

**Radiofrequency radiation exposure Information:**

This equipment complies with FCC radiation exposure limits set forth for an uncontrolled environment. This equipment should be installed and operated with minimum distance of 20 cm between the radiator (antenna) and your body. This transmitter must not be co-located or operating in conjunction with any other antenna or transmitter.

**NOTE:**

This device complies with part 15 of the FCC Rules. Operation is subject to the following two conditions: (1) This device may not cause harmful interference, and (2) this device must accept any interference received, including interference that may cause undesired operation.

**FCC WARNING:**

Changes or modifications not expressly approved by the party responsible for compliance could void the user's authority to operate the equipment.

**Radiofrequency radiation exposure Information:**

This equipment complies with FCC radiation exposure limits set forth for an uncontrolled environment. This equipment should be installed and operated with minimum distance of 20 cm between the radiator (antenna) and your body. This transmitter must not be co-located or operating in conjunction with any other antenna or transmitter.



**NOTE:**

This device complies with Industry Canada licence-exempt RSS standard(s). Operation is subject to the following two conditions: (1) this device may not cause interference, and (2) this device must accept any interference, including interference that may cause undesired operation of the device.

This equipment complies with IC radiation exposure limits set forth for an uncontrolled environment and meets RSS-102 of the IC radio frequency (RF) Exposure rules. This equipment should be installed and operated keeping the radiator at least 20 cm or more away from person's body.

**NOTE:**

Le présent appareil est conforme aux CNR d'Industrie Canada applicables aux appareils radio exempts de licence. L'exploitation est autorisée aux deux conditions suivantes: (1) l'appareil ne doit pas produire de brouillage, et (2) l'utilisateur de l'appareil doit accepter tout brouillage radioélectrique subi, même si le brouillage est susceptible d'en compromettre le fonctionnement.

Cet équipement est conforme aux limites d'exposition aux rayonnements énoncées pour un environnement non contrôlé et respecte les règles d'exposition aux fréquences radioélectriques (RF) CNR-102 de l'IC. Cet équipement doit être installé et utilisé en gardant une distance de 20 cm ou plus entre le dispositif rayonnant et le corps.

## PCS (Pre-Collision System)

The pre-collision system uses a radar sensor and camera sensor to detect vehicles and pedestrians in front of your vehicle. When the system determines that the possibility of a frontal collision with a vehicle or pedestrian is high, a warning operates to urge the driver to take evasive action and the potential brake pressure is increased to help the driver avoid the collision. If the system determines that the possibility of a frontal collision with a vehicle or pedestrian is extremely high, the brakes are automatically applied to help avoid the collision or help reduce the impact of the collision.

The pre-collision system can be disabled/enabled and the warning timing can be changed. (→P. 284)

### ◆ Pre-collision warning

When the system determines that the possibility of a frontal collision is high, a buzzer will sound and a warning message will be displayed on the multi-information display to urge the driver to take evasive action.

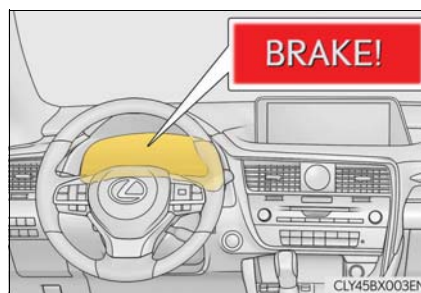

### ◆ Pre-collision brake assist

When the system determines that the possibility of a frontal collision is high, the system applies greater braking force in relation to how strongly the brake pedal is depressed.

### ◆ Pre-collision braking

When the system determines that the possibility of a frontal collision is high, the system warns the driver. If the system determines that the possibility of a frontal collision is extremely high, the brakes are automatically applied to help avoid the collision or reduce the collision speed.

### ◆ Suspension control (if equipped)

When the system determines that the possibility of a frontal collision is high, the Adaptive Variable Suspension System (→P. 379) will control the damping force of the shock absorbers to help maintain an appropriate vehicle posture.

 **WARNING****■ Limitations of the pre-collision system**

- The driver is solely responsible for safe driving. Always drive safely, taking care to observe your surroundings.  
Do not use the pre-collision system instead of normal braking operations under any circumstances. This system will not prevent collisions or lessen collision damage or injury in every situation. Do not overly rely on this system. Failure to do so may lead to an accident, resulting in death or serious injury.
- Although this system is designed to help avoid a collision or help reduce the impact of the collision, its effectiveness may change according to various conditions, therefore the system may not always be able to achieve the same level of performance.  
Read the following conditions carefully. Do not overly rely on this system and always drive carefully.
  - Conditions under which the system may operate even if there is no possibility of a collision: →P. 286
  - Conditions under which the system may not operate properly: →P. 288
- Do not attempt to test the operation of the pre-collision system yourself, as the system may not operate properly, possibly leading to an accident.

**■ Pre-collision braking**

- When the pre-collision braking function is operating, a large amount of braking force will be applied.
- If the vehicle is stopped by the operation of the pre-collision braking function, the pre-collision braking function operation will be canceled after approximately 2 seconds. Depress the brake pedal as necessary.
- The pre-collision braking function may not operate if certain operations are performed by the driver. If the accelerator pedal is being depressed strongly or the steering wheel is being turned, the system may determine that the driver is taking evasive action and possibly prevent the pre-collision braking function from operating.
- In some situations, while the pre-collision braking function is operating, operation of the function may be canceled if the accelerator pedal is depressed strongly or the steering wheel is turned and the system determines that the driver is taking evasive action.
- If the brake pedal is being depressed, the system may determine that the driver is taking evasive action and possibly delay the operation timing of the pre-collision braking function.

**⚠ WARNING****■ When to disable the pre-collision system**

In the following situations, disable the system, as it may not operate properly, possibly leading to an accident resulting in death or serious injury:

- When the vehicle is being towed
- When your vehicle is towing another vehicle
- When transporting the vehicle via truck, boat, train or similar means of transportation
- When the vehicle is raised on a lift with the engine running and the tires are allowed to rotate freely
- When inspecting the vehicle using a drum tester such as a chassis dynamometer or speedometer tester, or when using an on vehicle wheel balancer
- When a strong impact is applied to the front bumper or front grille, due to an accident or other reasons
- If the vehicle cannot be driven in a stable manner, such as when the vehicle has been in an accident or is malfunctioning
- When the vehicle is driven in a sporty manner or off-road
- When the tires are not properly inflated
- When the tires are very worn
- When tires of a size other than specified are installed
- When tire chains are installed
- When a compact spare tire or an emergency tire puncture repair kit is used
- If equipment (snow plow, etc.) that may obstruct the radar sensor or camera sensor is temporarily installed to the vehicle

### Changing settings of the pre-collision system

#### ■ Enabling/disabling the pre-collision system

The pre-collision system can be enabled/disabled on  (→P. 97) of the multi-information display.

The system is automatically enabled each time the engine switch is turned to IGNITION ON mode.

If the system is disabled, the PCS warning light will turn on and a message will be displayed on the multi-information display.



#### ■ Changing the pre-collision warning timing

The pre-collision warning timing can be changed on  (→P. 97) of the multi-information display.

The operation timing setting is retained when the engine switch is turned off.

- ① Far  
The warning will begin to operate earlier than with the default timing.
- ② Middle  
This is the default setting.
- ③ Near  
The warning will begin to operate later than with the default timing.

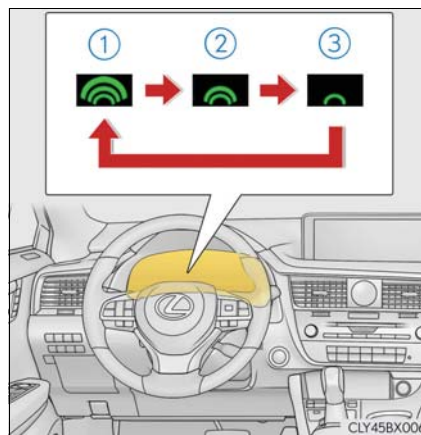

### ■ Operational conditions

The pre-collision system is enabled and the system determines that the possibility of a frontal collision with a vehicle or pedestrian is high.

Each function is operational at the following speeds:

- Pre-collision warning:
  - Vehicle speed is between approximately 7 and 110 mph (10 and 180 km/h). (For detecting a pedestrian, vehicle speed is between approximately 7 and 50 mph [10 and 80 km/h].)
  - The relative speed between your vehicle and the vehicle or pedestrian ahead is approximately 7 mph (10 km/h) or more.
- Pre-collision brake assist:
  - Vehicle speed is between approximately 20 and 110 mph (30 and 180 km/h). (For detecting a pedestrian, vehicle speed is between approximately 20 and 50 mph [30 and 80 km/h].)
  - The relative speed between your vehicle and the vehicle or pedestrian ahead is approximately 20 mph (30 km/h) or more.
- Pre-collision braking:
  - Vehicle speed is between approximately 7 and 110 mph (10 and 180 km/h). (For detecting a pedestrian, vehicle speed is between approximately 7 and 50 mph [10 and 80 km/h].)
  - The relative speed between your vehicle and the vehicle or pedestrian ahead is approximately 7 mph (10 km/h) or more.

The system may not operate in the following situations:

- If a battery terminal has been disconnected and reconnected and then the vehicle has not been driven for a certain amount of time
- If the shift lever is in R
- If VSC is disabled (only the pre-collision warning function will be operational)

### ■ Pedestrian detection function

The pre-collision system detects pedestrians based on the size, profile, and motion of a detected object. However, a pedestrian may not be detected depending on the surrounding brightness and the motion, posture, and angle of the detected object, preventing the system from operating properly. (→P. 289)



### ■ Cancellation of the pre-collision braking

If either of the following occur while the pre-collision braking function is operating, it will be canceled:

- The accelerator pedal is depressed strongly.
- The steering wheel is turned sharply or abruptly.

■ Conditions under which the system may operate even if there is no possibility of a collision

● In some situations such as the following, the system may determine that there is a possibility of a frontal collision and operate.

- When passing a vehicle or pedestrian
- When changing lanes while overtaking a preceding vehicle
- When overtaking a preceding vehicle that is changing lanes
- When overtaking a preceding vehicle that is making a left/right turn

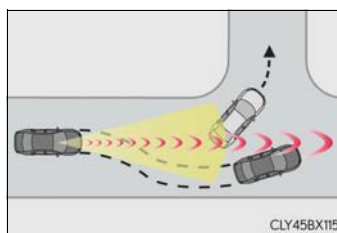

- When passing a vehicle in an oncoming lane that is stopped to make a right/left turn

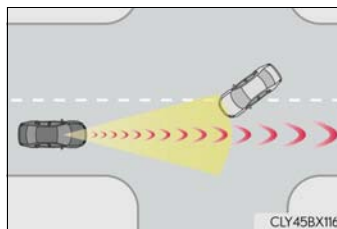

- When driving on a road where relative location to vehicle ahead in an adjacent lane may change, such as on a winding road

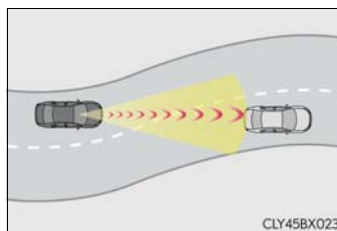

- When rapidly closing on a vehicle ahead
- If the front of the vehicle is raised or lowered, such as when the road surface is uneven or undulating
- When approaching objects on the roadside, such as guardrails, utility poles, trees, or walls
- When there is a vehicle, pedestrian, or object by the roadside at the entrance of a curve

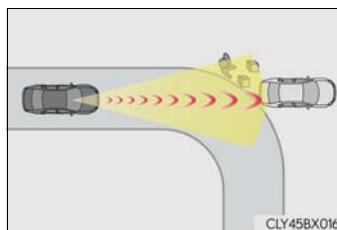

- When driving on a narrow path surrounded by a structure, such as in a tunnel or on an iron bridge

- When there is a metal object (manhole cover, steel plate, etc.), steps, or a protrusion on the road surface or roadside
- When a crossing pedestrian approaches very close to the vehicle

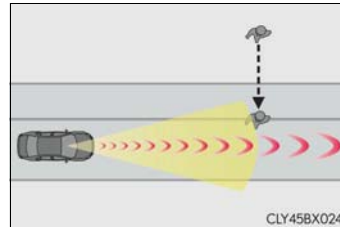

- When passing through a place with a low structure above the road (low ceiling, traffic sign, etc.)

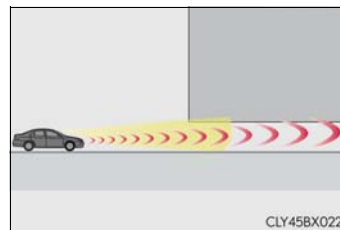

- When passing under an object (billboard, etc.) at the top of an uphill road

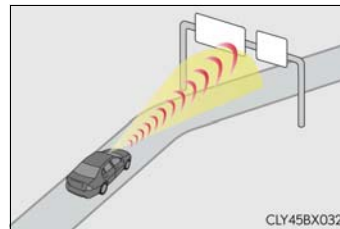

- When rapidly closing on an electric toll gate barrier, parking area barrier, or other barrier that opens and closes
- When using an automatic car wash
- When driving through or under objects that may contact the vehicle, such as thick grass, tree branches, or a banner

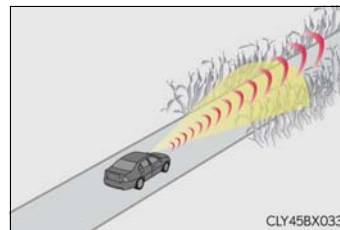

- When the vehicle is hit by water, snow, dust, etc. from a vehicle ahead
- When driving through steam or smoke
- When there are patterns or paint on the road or a wall that may be mistaken for a vehicle or pedestrian
- When driving near an object that reflects radio waves, such as a large truck or guardrail
- When driving near a TV tower, broadcasting station, electric power plant, or other location where strong radio waves or electrical noise may be present



■ Situations in which the system may not operate properly

● In some situations such as the following, a vehicle may not be detected by the radar sensor and camera sensor, preventing the system from operating properly:

- If an oncoming vehicle is approaching your vehicle
- If a vehicle ahead is a motorcycle or bicycle
- When approaching the side or front of a vehicle
- If a preceding vehicle has a small rear end, such as an unloaded truck
- If a preceding vehicle has a low rear end, such as a low bed trailer

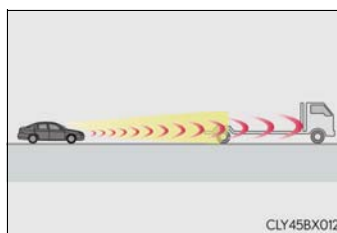

- If a vehicle ahead is carrying a load which protrudes past its rear bumper
- If a vehicle ahead has extremely high ground clearance

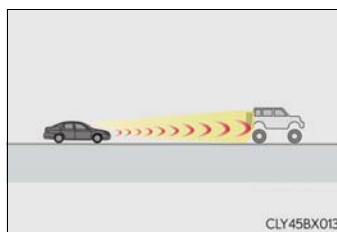

- If a vehicle ahead is irregularly shaped, such as a tractor or side car
- If the sun or other light is shining directly on a vehicle ahead
- If a vehicle cuts in front of your vehicle or emerges from beside a vehicle
- If a vehicle ahead makes an abrupt maneuver (such as sudden swerving, acceleration or deceleration)
- When suddenly cutting behind a preceding vehicle
- When a vehicle ahead is not directly in front of your vehicle

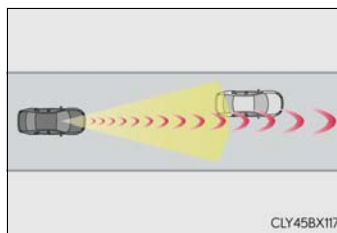

- When driving in inclement weather such as heavy rain, fog, snow or a sandstorm
- When the vehicle is hit by water, snow, dust, etc. from a vehicle ahead
- When driving through steam or smoke
- When driving in a place where the surrounding brightness changes suddenly, such as at the entrance or exit of a tunnel
- When a very bright light, such as the sun or the headlights of oncoming traffic, shines directly into the camera sensor
- When the surrounding area is dim, such as at dawn or dusk, or while at night or in a tunnel

- After the engine has started the vehicle has not been driven for a certain amount of time
- While making a left/right turn and for a few seconds after making a left/right turn
- While driving on a curve and for a few seconds after driving on a curve
- If your vehicle is skidding
- If the front of the vehicle is raised or lowered

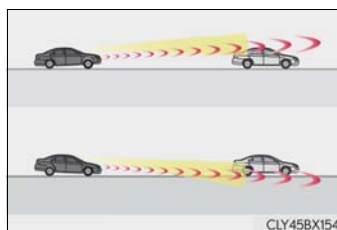

- If the wheels are misaligned
- If a wiper blade is blocking the camera sensor
- The vehicle is wobbling.
- The vehicle is being driven at extremely high speeds.
- When driving on a hill
- If the radar sensor or camera sensor is misaligned
- In some situations such as the following, sufficient braking force may not be obtained, preventing the system from performing properly:
  - If the braking functions cannot operate to their full extent, such as when the brake parts are extremely cold, extremely hot, or wet
  - If the vehicle is not properly maintained (brakes or tires are excessively worn, improper tire inflation pressure, etc.)
  - When the vehicle is being driven on a gravel road or other slippery surface
- Some pedestrians such as the following may not be detected by the radar sensor and camera sensor, preventing the system from operating properly:
  - Pedestrians shorter than approximately 3.2 ft. (1 m) or taller than approximately 6.5 ft. (2 m)
  - Pedestrians wearing oversized clothing (a rain coat, long skirt, etc.), making their silhouette obscure
  - Pedestrians who are carrying large baggage, holding an umbrella, etc., hiding part of their body
  - Pedestrians who are bending forward or squatting
  - Pedestrians who are pushing a stroller, wheelchair, bicycle or other vehicle
  - Groups of pedestrians which are close together
  - Pedestrians who are wearing white and look extremely bright
  - Pedestrians in the dark, such as at night or while in a tunnel
  - Pedestrians whose clothing appears to be nearly the same color or brightness as their surroundings
  - Pedestrians near walls, fences, guardrails, or large objects
  - Pedestrians who are on a metal object (manhole cover, steel plate, etc.) on the road
  - Pedestrians who are walking fast
  - Pedestrians who are changing speed abruptly
  - Pedestrians running out from behind a vehicle or a large object
  - Pedestrians who are extremely close to the side of the vehicle (outside rear view mirror, etc.)

**■ If the PCS warning light flashes or illuminates and a warning message is displayed on the multi-information display**

The pre-collision system may be temporarily unavailable or there may be a malfunction in the system.

- In the following situations, the warning light will turn off, the message will disappear and the system will become operational when normal operating conditions return:
  - When the radar sensor or camera sensor or the area around either sensor is hot, such as in the sun
  - When the radar sensor or camera sensor or the area around either sensor is cold, such as in an extremely cold environment
  - When a front sensor is dirty or covered with snow, etc.
  - When the part of the windshield in front of the camera sensor is fogged up or covered with condensation or ice (Defogging the windshield: →P. 513)
  - If the camera sensor is obstructed, such as when the hood is open or a sticker is attached to the windshield near the camera sensor
- If the PCS warning light continues to flash or remains illuminated or the warning message does not disappear even though the vehicle has returned to normal, the system may be malfunctioning. Have the vehicle inspected by your Lexus dealer immediately.

**■ If VSC is disabled**

- If VSC is disabled (→P. 381), the pre-collision brake assist and pre-collision braking functions are also disabled.
- The PCS warning light will turn on and “VSC Turned Off Pre-Collision Brake System Unavailable” will be displayed on the multi-information display.

## LKA (Lane-Keeping Assist)

### Summary of functions

When driving on highways and freeways with white or yellow lines, this function alerts the driver when the vehicle might depart from its lane and provides assistance by operating the steering wheel to keep the vehicle in its lane. Furthermore, the system also provides steering assistance when dynamic radar cruise control with full-speed range is operating to keep the vehicle in its lane.

The LKA system recognizes visible white or yellow lines with the camera sensor on the upper portion of the windshield.

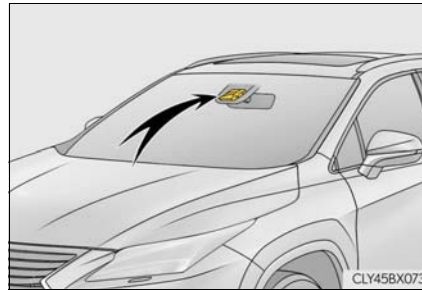

### Functions included in LKA system

#### ◆ Lane departure alert function

When the system determines that the vehicle might depart from its lane, a warning is displayed on the multi-information display, and either the warning buzzer sounds or the steering wheel vibrates to alert the driver.

When the warning buzzer sounds or the steering wheel vibrates, check the surrounding road situation and carefully operate the steering wheel to move the vehicle back to the center within the white (yellow) lines.

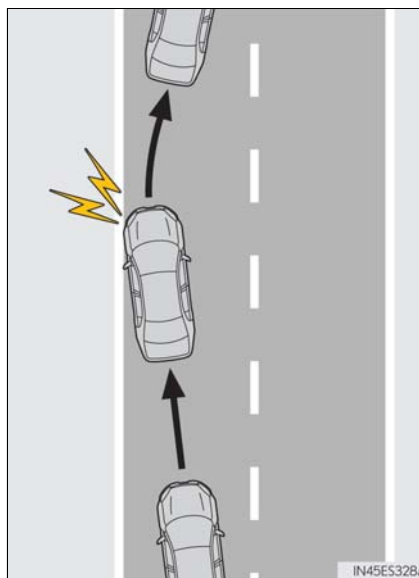

#### ◆ Steering assist function

When the system determines that the vehicle might depart from its lane, the system provides assistance as necessary by operating the steering wheel in small amounts for a short period of time to keep the vehicle in its lane.

If the system detects that the steering wheel has not been operated for a fixed amount of time or the steering wheel is not being firmly gripped, a warning is displayed on the multi-information display and the warning buzzer sounds.

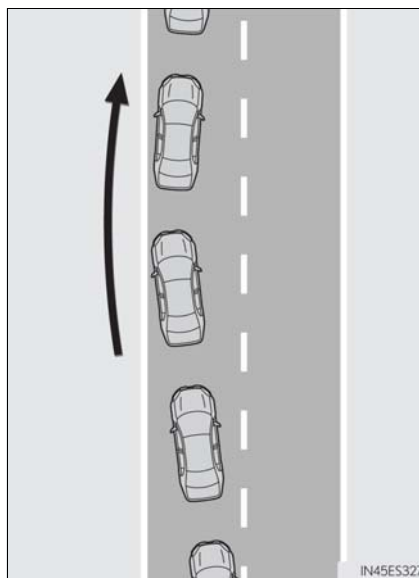

#### ◆ Vehicle sway warning

When the vehicle is swaying or appears as if it may depart from its lane multiple times, the warning buzzer sounds and a message is displayed on the multi-information display to alert the driver.

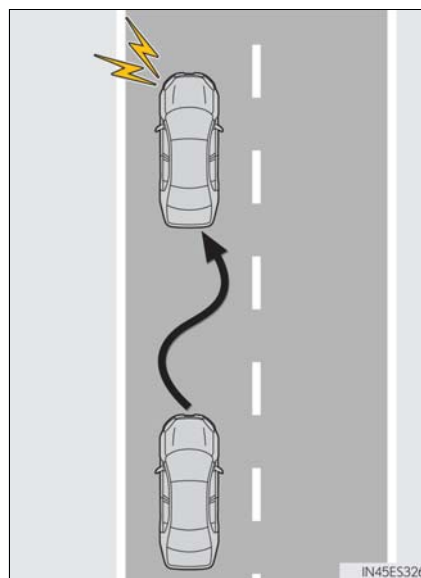

#### ◆ Lane centering function

This function is linked with radar cruise control and provides the required assistance by operating the steering wheel to keep the vehicle in its current lane.

When radar cruise control is not operating, the lane centering function does not operate.

If the system detects that the steering wheel has not been operated for a fixed amount of time or the steering wheel is not being firmly gripped, a warning is displayed on the multi-information display and the warning buzzer sounds.

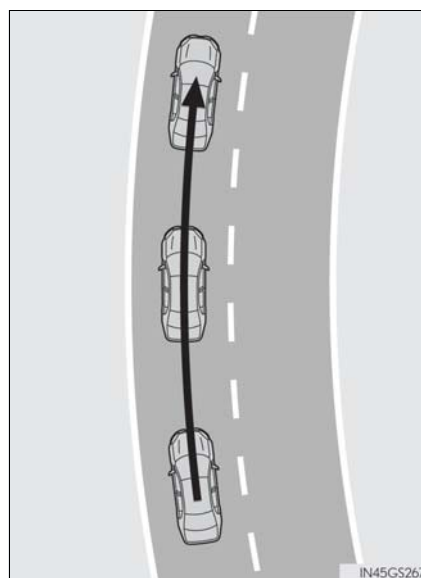

 **WARNING****■ Before using LKA system**

Do not rely solely upon the LKA system. LKA is not a system which automatically drives the vehicle or reduces the amount of attention that must be paid to the area in front of the vehicle. The driver must always assume full responsibility for driving safely by always paying careful attention to the surrounding conditions and operate the steering wheel to correct the path of the vehicle. Also, make sure to take adequate breaks when fatigued, such as from driving for a long period of time.

Failure to perform appropriate driving operations and pay careful attention may lead to an accident, resulting in death or serious injury.

**■ To avoid operating LKA by mistake**

When not using the LKA system, use the LKA switch to turn the system off.

**■ Situations unsuitable for LKA**

Do not use the LKA system in the following situations.

The system may not operate properly and lead to an accident, resulting in death or serious injury.

- A spare tire, tire chains, etc., are equipped.
- When the tires have been excessively worn, or when the tire inflation pressure is low.
- Tires which differ by structure, manufacturer, brand or tread pattern are used.
- Objects or patterns that could be mistaken for white (yellow) lines are present on the side of the road (guardrails, curbs, reflective poles, etc.).
- Vehicle is driven on a snow-covered road.
- White (yellow) lines are difficult to see due to rain, snow, fog, dust, etc.
- Asphalt repair marks, white (yellow) line marks, etc., are present due to road repair.
- Vehicle is driven in a temporary lane or restricted lane due to construction work.
- Vehicle is driven on a road surface which is slippery due to rainy weather, fallen snow, freezing, etc.
- Vehicle is driven in traffic lanes other than on highways and freeways.
- Vehicle is driven in a construction zone.
- When your vehicle is towing a trailer or during emergency towing

**■ Preventing LKA system malfunctions and operations performed by mistake**

- Do not modify the headlights or place stickers, etc., on the surface of the lights.
- Do not modify the suspension etc. If the suspension etc. needs to be replaced, contact your Lexus dealer.
- Do not install or place anything on the hood or grille. Also, do not install a grille guard (bull bars, kangaroo bar, etc.).
- If your windshield needs repairs, contact your Lexus dealer.

### Turning LKA system on

Press the LKA switch to turn the LKA system on.

The LKA indicator illuminates and a message is displayed on the multi-information display.

Press the LKA switch again to turn the LKA system off.

When the LKA system is turned on or off, operation of the LKA system continues in the same condition the next time the engine is started.

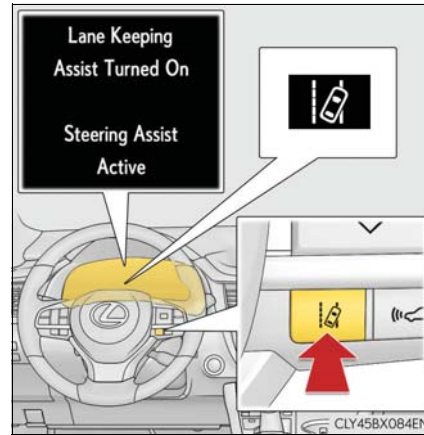



**Indications on the multi-information display**

① LKA indicator

The illumination condition of the indicator informs the driver of the system operation status.

Illuminated in white:  
LKA system is operating.

Illuminated in green:  
Steering wheel assistance of the steering assist function or lane centering function is operating.

Flashing in amber:  
Lane departure alert function is operating.

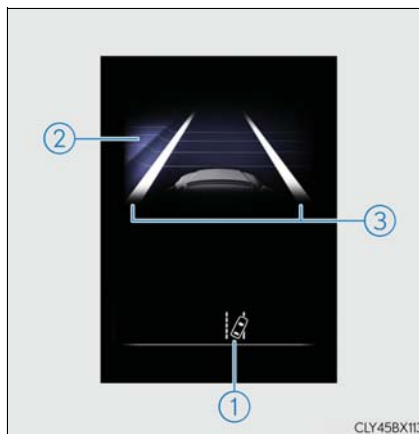

② Operation display of steering wheel operation support

Indicates that steering wheel assistance of the steering assist function or lane centering function is operating.

③ Lane departure alert function display

Displayed when the multi-information display is switched to the driving assist system information screen.

- ▶ Inside of displayed white lines is white
- ▶ Inside of displayed white lines is black



Indicates that the system is recognizing white (yellow) lines. When the vehicle departs from its lane, the white line displayed on the side the vehicle departs from flashes amber.



Indicates that the system is not able to recognize white (yellow) lines or is temporarily canceled.

**■ Operation conditions of each function****● Lane departure alert function**

This function operates when all of the following conditions are met.

- LKA is turned on.
- Vehicle speed is approximately 32 mph (50 km/h) or more.
- System recognizes white (yellow) lines.
- Width of traffic lane is approximately 9.8 ft. (3 m) or more.
- Turn signal lever is not operated.
- Vehicle is driven on a straight road or around a gentle curve with a radius of more than approximately 492 ft. (150 m).
- No system malfunctions are detected. (→P. 654)

**● Steering assist function**

This function operates when all of the following conditions are met in addition to the operation conditions for the lane departure alert function.

- Setting for "Steering Assist" in  of the multi-information display is set to "On". (→P. 97)
- Vehicle is not accelerated or decelerated by a fixed amount or more.
- Steering wheel is not operated with a steering force level suitable for changing lanes.
- ABS, VSC, TRAC and PCS are not operating.
- TRAC or VSC is not turned off.

**● Vehicle sway warning**

This function operates when all of the following conditions are met.

- Setting for "Sway Warning" in  of the multi-information display is set to "On". (→P. 97)
- Vehicle speed is approximately 32 mph (50 km/h) or more.
- Width of traffic lane is approximately 9.8 ft. (3 m) or more.
- No system malfunctions are detected. (→P. 654)

**● Lane centering function**

This function operates when all of the following conditions are met.

- LKA is turned on.
- Setting for "Lane Center" in  of the multi-information display are set to "On". (→P. 97)
- System recognizes white (yellow) lines.
- Dynamic radar cruise control with full-speed range is operating.
- Width of traffic lane is approximately 8.2 to 13.5 ft. (2.5 to 4.1 m).
- Turn signal lever is not operated.
- Vehicle is driven on a straight road or around a gentle curve with a radius of more than approximately 656 ft. (200 m).
- No system malfunctions are detected. (→P. 654)
- Vehicle does not accelerate or decelerate by a fixed amount or more.
- Steering wheel is not operated with a steering force level suitable for changing lanes.
- ABS, VSC, TRAC and PCS are not operating.
- TRAC or VSC is not turned off.
- Steering assist function is not operating.

■ **Temporary cancellation of functions**

When operation conditions are no longer met, a function may be temporarily canceled. However, when the operation conditions are met again, operation of the function is automatically restored. (→P. 297)

■ **Steering assist function/lane centering function**

Depending on the vehicle speed, lane departure situation, road conditions, etc., the operation of the functions may not be recognized or the functions may not operate.

■ **Lane departure alert function**

The warning buzzer may be difficult to hear due to external noise, audio playback, etc. Also, it may be difficult to feel steering wheel vibrations due to the road conditions, etc.

■ **Hands off steering wheel alert**

When the system determines that the driver has removed their hands from the steering wheel while the steering assist function or lane centering function is operating, a warning message is displayed on the multi-information display and the buzzer sounds.

■ **White (yellow) lines are only on one side of road**

The LKA system will not operate for the side on which white (yellow) lines could not be recognized.

#### ■ Conditions in which functions may not operate properly

In the following situations, the camera sensor may not detect white (yellow) lines and various functions may not operate normally.

- There are shadows on the road that run parallel with, or cover, the white (yellow) lines.
- The vehicle is driven in an area without white (yellow) lines, such as in front of a tollgate or checkpoint, or at an intersection, etc.
- The white (yellow) lines are cracked, "Botts' dots", "Raised pavement marker" or stones are present.
- The white (yellow) lines cannot be seen or are difficult to see due to sand, etc.
- The vehicle is driven on a road surface that is wet due to rain, puddles, etc.
- The traffic lines are yellow (which may be more difficult to recognize than lines that are white).
- The white (yellow) lines cross over a curb, etc.
- The vehicle is driven on a bright surface, such as concrete.
- The vehicle is driven on a surface that is bright due to reflected light, etc.
- The vehicle is driven in an area where the brightness changes suddenly, such as at the entrances and exits of tunnels, etc.
- Light from the headlights of an oncoming vehicle, the sun, etc., enters the camera.
- The vehicle is driven where the road diverges, merges, etc.
- The vehicle is driven on a slope.
- The vehicle is driven on a road which tilts left or right, or a winding road.
- The vehicle is driven on an unpaved or rough road.
- The vehicle is driven around a sharp curve.
- The traffic lane is excessively narrow or wide.
- The vehicle is extremely tilted due to carrying heavy luggage or having improper tire pressure.
- The distance to the preceding vehicle is extremely short.
- The vehicle is moving up and down a large amount due to road conditions during driving (poor roads or road seams).
- The headlight lenses are dirty and emit a faint amount of light at night, or the beam axis has deviated.
- The vehicle is struck by a crosswind.
- The vehicle has just changed lanes or crossed an intersection.
- Snow tires, etc., are equipped.

#### ■ If the LKA indicator is illuminated in amber and a warning message is displayed on the multi-information display

→P. 654

#### ■ Customization

Some functions can be customized. (→P. 97)

## Dynamic radar cruise control with full-speed range

### Summary of functions

In vehicle-to-vehicle distance control mode, the vehicle automatically accelerates, decelerates and stops to match the speed changes of the preceding vehicle even if the accelerator pedal is not depressed. In constant speed control mode, the vehicle runs at a fixed speed.

Use the dynamic radar cruise control with full-speed range on freeways and highways.

- Vehicle-to-vehicle distance control mode (→P. 303)
- Constant speed control mode (→P. 309)

- ① Vehicle-to-vehicle distance switch
- ② Display
- ③ Set speed
- ④ Indicators
- ⑤ Cruise control switch

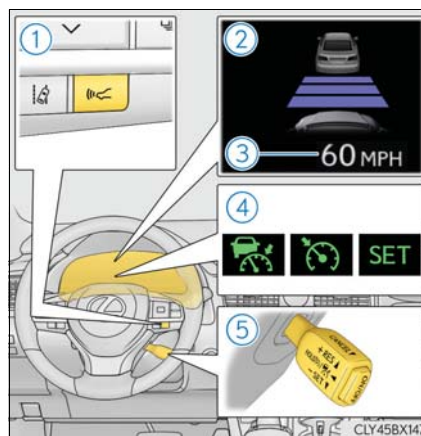

**⚠ WARNING****■ Before using dynamic radar cruise control with full-speed range**

- Driving safely is the sole responsibility of the driver. Do not rely solely on the system, and drive safely by always paying careful attention to your surroundings.
- The dynamic radar cruise control with full-speed range provides driving assistance to reduce the driver's burden. However, there are limitations to the assistance provided. Read the following conditions carefully. Do not overly rely on this system and always drive carefully.
  - When the sensor may not be correctly detecting the vehicle ahead: →P. 311
  - Conditions under which the vehicle-to-vehicle distance control mode may not function correctly: →P. 312
- Set the speed appropriately depending on the speed limit, traffic flow, road conditions, weather conditions, etc. The driver is responsible for checking the set speed.
- Even when the system is functioning normally, the condition of the preceding vehicle as detected by the system may differ from the condition observed by the driver. Therefore, the driver must always remain alert, assess the danger of each situation and drive safely. Relying on this system or assuming the system ensures safety while driving can lead to an accident, resulting in death or serious injury.
- Switch the dynamic radar cruise control with full-speed range off using the "ON/OFF" button when not in use.

**■ Cautions regarding the driving assist systems**

Observe the following precautions, as there are limitations to the assistance provided by the system.

Failure to do so may cause an accident resulting in death or serious injury.

- **Assisting the driver to measure following distance**  
The dynamic radar cruise control with full-speed range is only intended to help the driver in determining the following distance between the driver's own vehicle and a designated vehicle traveling ahead. It is not a mechanism that allows careless or inattentive driving, and it is not a system that can assist the driver in low-visibility conditions. It is still necessary for driver to pay close attention to the vehicle's surroundings.
- **Assisting the driver to judge proper following distance**  
The dynamic radar cruise control with full-speed range determines whether the following distance between the driver's own vehicle and a designated vehicle traveling ahead is within a set range. It is not capable of making any other type of judgement. Therefore, it is absolutely necessary for the driver to remain vigilant and to determine whether or not there is a possibility of danger in any given situation.
- **Assisting the driver to operate the vehicle**  
The dynamic radar cruise control with full-speed range has limited capability to prevent or avoid a collision with a vehicle traveling ahead. Therefore, if there is ever any danger, the driver must take immediate and direct control of the vehicle and act appropriately in order to ensure the safety of all involved.

 **WARNING****■ Situations unsuitable for dynamic radar cruise control with full-speed range**

Do not use dynamic radar cruise control with full-speed range in any of the following situations.

Doing so may result in inappropriate speed control and could cause an accident resulting in death or serious injury.

- Roads where there are pedestrians, cyclers, etc.
- In heavy traffic
- On roads with sharp bends
- On winding roads
- On slippery roads, such as those covered with rain, ice or snow
- On steep downhills, or where there are sudden changes between sharp up and down gradients  
Vehicle speed may exceed the set speed when driving down a steep hill.
- At entrances to freeways and highways
- When weather conditions are bad enough that they may prevent the sensors from detecting correctly (fog, snow, sandstorm, heavy rain, etc.)
- When there is rain, snow, etc. on the front surface of the radar sensor or camera sensor
- In traffic conditions that require frequent repeated acceleration and deceleration
- When your vehicle is towing a trailer or during emergency towing
- When an approach warning buzzer is heard often

### Driving in vehicle-to-vehicle distance control mode

This mode employs a radar sensor to detect the presence of vehicles up to approximately 328 ft. (100 m) ahead, determines the current vehicle-to-vehicle following distance, and operates to maintain a suitable following distance from the vehicle ahead.

Note that vehicle-to-vehicle distance will close in when traveling on downhill slopes.

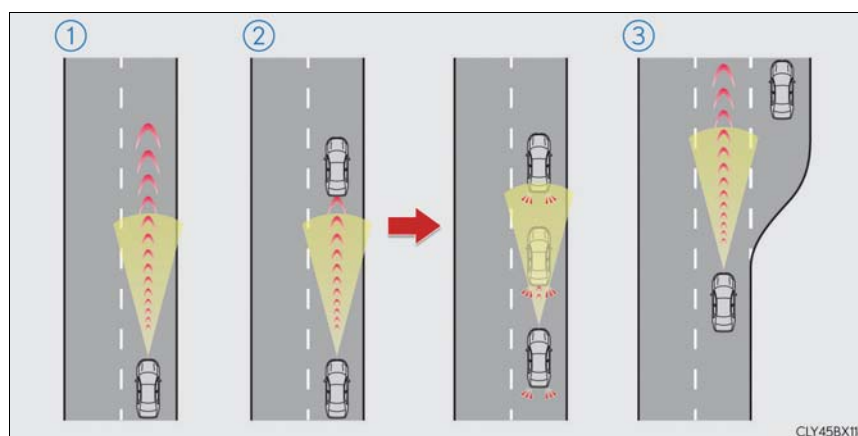

- ① Example of constant speed cruising  
When there are no vehicles ahead

The vehicle travels at the speed set by the driver. The desired vehicle-to-vehicle distance can also be set by operating the vehicle-to-vehicle distance switch.

- ② Example of deceleration cruising and follow-up cruising  
When a preceding vehicle driving slower than the set speed appears

When a vehicle is detected running ahead of you, the system automatically decelerates your vehicle. When a greater reduction in vehicle speed is necessary, the system applies the brakes (the stop lights will come on at this time). The system will respond to changes in the speed of the vehicle ahead in order to maintain the vehicle-to-vehicle distance set by the driver. Approach warning warns you when the system cannot decelerate sufficiently to prevent your vehicle from closing in on the vehicle ahead. When the vehicle ahead of you stops, your vehicle will also stop (vehicle is stopped by system control). After the vehicle ahead starts off, pushing the cruise control lever up or depressing the accelerator pedal will resume follow-up cruising.

- ③ Example of acceleration  
When there are no longer any preceding vehicles driving slower than the set speed

The system accelerates until the set speed is reached. The system then returns to constant speed cruising.



**Setting the vehicle speed (vehicle-to-vehicle distance control mode)**

- 1 Press the "ON/OFF" button to activate the cruise control.

Radar cruise control indicator will come on and a message will be displayed on the multi-information display.

Press the button again to deactivate the cruise control.

If the "ON/OFF" button is pressed and held for 1.5 seconds or more, the system turns on in constant speed control mode. (→P. 309)

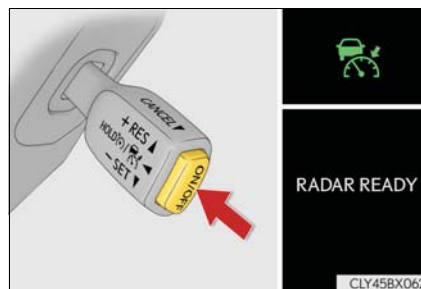

- 2 Accelerate or decelerate, with accelerator pedal operation, to the desired vehicle speed (at or above approximately 30 mph [50 km/h]) and push the lever down to set the speed.

Cruise control "SET" indicator will come on.

The vehicle speed at the moment the lever is released becomes the set speed.

If the lever is operated while the vehicle speed is below approximately 30 mph (50 km/h) and a preceding vehicle is present, the set speed will be adjusted to approximately 30 mph (50 km/h).

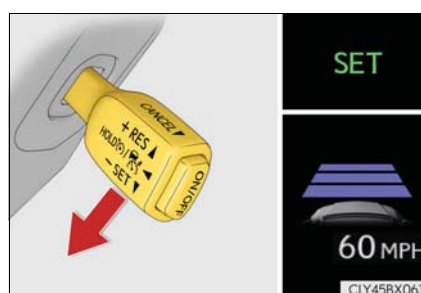

### Adjusting the set speed

To change the set speed, operate the lever until the desired set speed is displayed.

① Increases the speed

(Except when the vehicle has been stopped by system control in vehicle-to-vehicle distance control mode)

② Decreases the speed

Fine adjustment: Momentarily move the lever in the desired direction.

Large adjustment: Hold the lever up or down to change the speed, and release when the desired speed is reached.

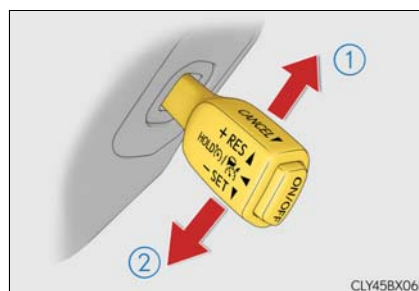

In the vehicle-to-vehicle distance control mode, the set speed will be increased or decreased as follows:

► For the U.S. mainland and Hawaii

Fine adjustment: By 1 mph (1.6 km/h)<sup>\*1</sup> or 1 km/h (0.6 mph)<sup>\*2</sup> each time the lever is operated

Large adjustment: Increases or decreases in 1 mph (1.6 km/h)<sup>\*1</sup> or 1 km/h (0.6 mph)<sup>\*2</sup> increments for as long as the lever is held

► For Canada, Guam, Saipan and Puerto Rico

Fine adjustment: By 1 mph (1.6 km/h)<sup>\*1</sup> or 1 km/h (0.6 mph)<sup>\*2</sup> each time the lever is operated

Large adjustment: Increases or decreases in 5 mph (8 km/h)<sup>\*1</sup> or 5 km/h (3.1 mph)<sup>\*2</sup> increments for as long as the lever is held

In the constant speed control mode (→P. 309), the set speed will be increased or decreased as follows:

Fine adjustment: By 1 mph (1.6 km/h)<sup>\*1</sup> or 1 km/h (0.6 mph)<sup>\*2</sup> each time the lever is operated

Large adjustment: The speed will continue to change while the lever is held.

\*1: When the set speed is shown in "MPH"

\*2: When the set speed is shown in "km/h"

**Changing the vehicle-to-vehicle distance (vehicle-to-vehicle distance control mode)**

Pressing the switch changes the vehicle-to-vehicle distance as follows:

- ① Long
- ② Medium
- ③ Short

The vehicle-to-vehicle distance is set automatically to long mode when the engine switch is turned to IGNITION ON mode.

If a vehicle is running ahead of you, the preceding vehicle mark will also be displayed.

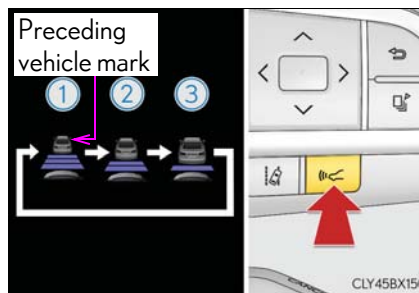

**Vehicle-to-vehicle distance settings (vehicle-to-vehicle distance control mode)**

Select a distance from the table below. Note that the distances shown correspond to a vehicle speed of 50 mph (80 km/h). Vehicle-to-vehicle distance increases/decreases in accordance with vehicle speed. When the vehicle is stopped by system control, the vehicle stops at a certain vehicle-to-vehicle distance depending on the situation.

Distance options	Vehicle-to-vehicle distance
Long	Approximately 160 ft. (50 m)
Medium	Approximately 130 ft. (40 m)
Short	Approximately 100 ft. (30 m)

### Resuming follow-up cruising when the vehicle has been stopped by system control (vehicle-to-vehicle distance control mode)

After the vehicle ahead of you starts off, push the lever up.

Your vehicle will also resume follow-up cruising if the accelerator pedal is depressed after the vehicle ahead of you starts off.

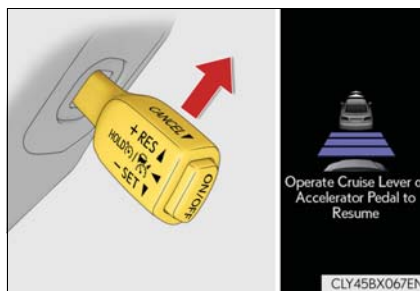

### Canceling and resuming the speed control

- ① Pulling the lever toward you cancels the speed control.

The speed control is also canceled when the brake pedal is depressed.

(When the vehicle has been stopped by system control, depressing the brake pedal does not cancel the setting.)

- ② Pushing the lever up resumes the cruise control and returns vehicle speed to the set speed.

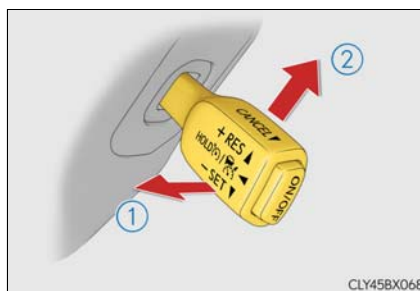

However, when a vehicle ahead is not detected, cruise control does not resume when the vehicle speed is approximately 25 mph (40 km/h) or less.

### Approach warning (vehicle-to-vehicle distance control mode)

When your vehicle is too close to a vehicle ahead, and sufficient automatic deceleration via the cruise control is not possible, the display will flash and the buzzer will sound to alert the driver. An example of this would be if another driver cuts in front of you while you are following a vehicle. Depress the brake pedal to ensure an appropriate vehicle-to-vehicle distance.

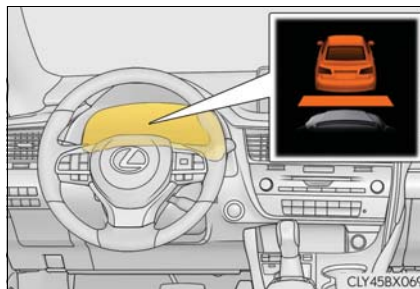

#### ■ Warnings may not occur when

In the following instances, warnings may not occur even when the vehicle-to-vehicle distance is small.

- When the speed of the preceding vehicle matches or exceeds your vehicle speed
- When the preceding vehicle is traveling at an extremely slow speed
- Immediately after the cruise control speed was set
- When depressing the accelerator pedal

### Selecting constant speed control mode

When constant speed control mode is selected, your vehicle will maintain a set speed without controlling the vehicle-to-vehicle distance. Select this mode only when vehicle-to-vehicle distance control mode does not function correctly due to a dirty radar sensor, etc.

- 1 With the cruise control off, press and hold the "ON/OFF" button for 1.5 seconds or more.

Immediately after the "ON/OFF" button is pressed, the radar cruise control indicator will come on. Afterwards, it switches to the cruise control indicator.

Switching to constant speed control mode is only possible when operating the lever with the cruise control off.

- 2 Accelerate or decelerate, with accelerator pedal operation, to the desired vehicle speed (at or above approximately 25 mph [40 km/h]) and push the lever down to set the speed.

Cruise control "SET" indicator will come on.

The vehicle speed at the moment the lever is released becomes the set speed.

Adjusting the speed setting: →P. 305

Canceling and resuming the speed setting: →P. 307

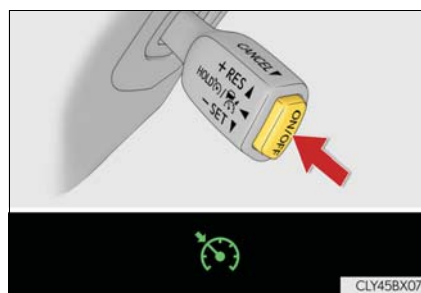

**■ Dynamic radar cruise control with full-speed range can be set when**

- The shift lever is in the D or range 4 or higher of S has been selected. (vehicles without paddle shift switches)
- The shift lever is in D. (vehicles with paddle shift switches)
- Range 4 or higher of D has been selected by using the paddle shift switch. (vehicles with paddle shift switches)
- Vehicle speed is at or above approximately 30 mph (50 km/h). However, when a preceding vehicle is detected, the dynamic radar cruise control with full-speed range can be set even if the vehicle speed is below approximately 30 mph (50 km/h).

**■ Accelerating after setting the vehicle speed**

The vehicle can accelerate by operating the accelerator pedal. After accelerating, the set speed resumes. However, during vehicle-to-vehicle distance control mode, the vehicle speed may decrease below the set speed in order to maintain the distance to the preceding vehicle.

**■ When the vehicle stops while follow-up cruising**

- Pushing the lever up while the vehicle ahead stops will resume follow-up cruising if the vehicle ahead starts off within approximately 3 seconds after the switch is pressed.
- If the vehicle ahead starts off within 3 seconds after your vehicle stops, follow-up cruising will be resumed.

**■ Automatic cancelation of vehicle-to-vehicle distance control mode**

Vehicle-to-vehicle distance control mode is automatically canceled in the following situations.

- Actual vehicle speed falls below approximately 25 mph (40 km/h) when there are no vehicles ahead.
- The preceding vehicle leaves the lane when your vehicle is following at a vehicle speed at or below approximately 25 mph (40 km/h). Otherwise, the sensor cannot properly detect the vehicle. ("Radar Cruise Control Not Available No Preceding Vehicles" is displayed on the multi-information display)
- VSC is activated.
- TRAC is activated for a period of time.
- When the VSC or TRAC system is turned off.
- The sensor cannot detect correctly because it is covered in some way.
- Pre-collision braking is activated.
- The parking brake is operated.
- The vehicle is stopped by system control on a steep incline.
- The following are detected when the vehicle has been stopped by system control:
  - The driver is not wearing a seat belt.
  - The driver's door is opened.
  - The vehicle has been stopped for about 3 minutes

If vehicle-to-vehicle distance control mode is automatically canceled for any other reason, there may be a malfunction in the system. Contact your Lexus dealer.

#### ■ Automatic cancelation of constant speed control mode

Constant speed control mode is automatically canceled in the following situations:

- Actual vehicle speed is more than approximately 10 mph (16 km/h) below the set vehicle speed.
- Actual vehicle speed falls below approximately 25 mph (40 km/h).
- VSC is activated.
- TRAC is activated for a period of time.
- When the VSC or TRAC system is turned off.
- Pre-collision braking is activated.

If constant speed control mode is automatically canceled for any other reason, there may be a malfunction in the system. Contact your Lexus dealer.

#### ■ Warning messages and buzzers for dynamic radar cruise control with full-speed range

Warning messages and buzzers are used to indicate a system malfunction or to inform the driver of the need for caution while driving. If a warning message is shown on the multi-information display, read the message and follow the instructions.

#### ■ When the sensor may not be correctly detecting the vehicle ahead

In the case of the following and depending on the conditions, operate the brake pedal when deceleration of the system is insufficient or operate the accelerator pedal when acceleration is required.

As the sensor may not be able to correctly detect these types of vehicles, the approach warning (→P. 308) may not be activated.

- Vehicles that cut in suddenly
- Vehicles traveling at low speeds
- Vehicles that are not moving in the same lane
- Vehicles with small rear ends (trailers with no load on board, etc.)

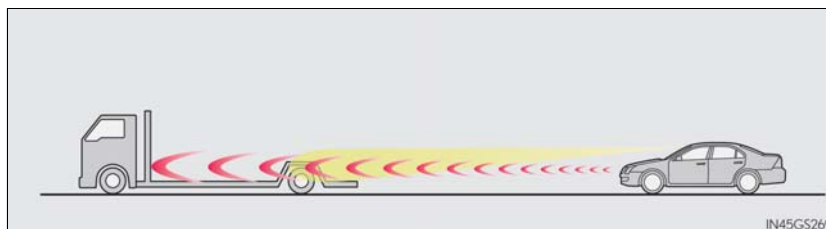



## 312 4-5. Using the driving support systems

- Motorcycles traveling in the same lane
- When water or snow thrown up by the surrounding vehicles hinders the detecting of the sensor
- When your vehicle is pointing upwards (caused by a heavy load in the luggage compartment, etc.)

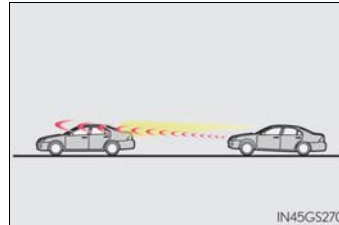

- Preceding vehicle has an extremely high ground clearance

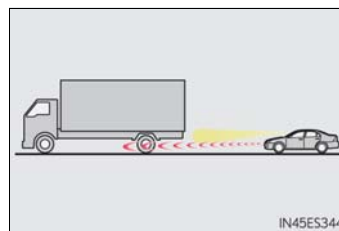

### ■ Conditions under which the vehicle-to-vehicle distance control mode may not function correctly

In the case of the following conditions, operate the brake pedal (or accelerator pedal, depending on the situation) as necessary.

As the sensor may not be able to correctly detect vehicles ahead, the system may not operate properly.

- When the road curves or when the lanes are narrow

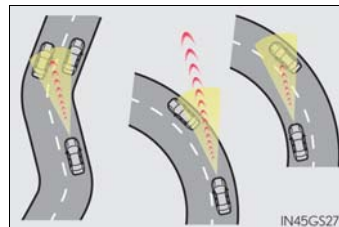

- When steering wheel operation or your position in the lane is unstable

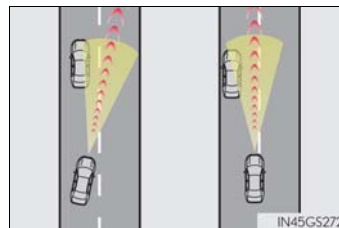

- When the vehicle ahead of you decelerates suddenly

## BSM (Blind Spot Monitor)\*

### Summary of the Blind Spot Monitor

The Blind Spot Monitor is a system that has 2 functions:

- The BSM (Blind Spot Monitor) function  
Assists the driver in making a decision when changing lanes
- The RCTA (Rear Cross Traffic Alert) function  
Assists the driver when backing up

These functions use same sensors.

\*: If equipped

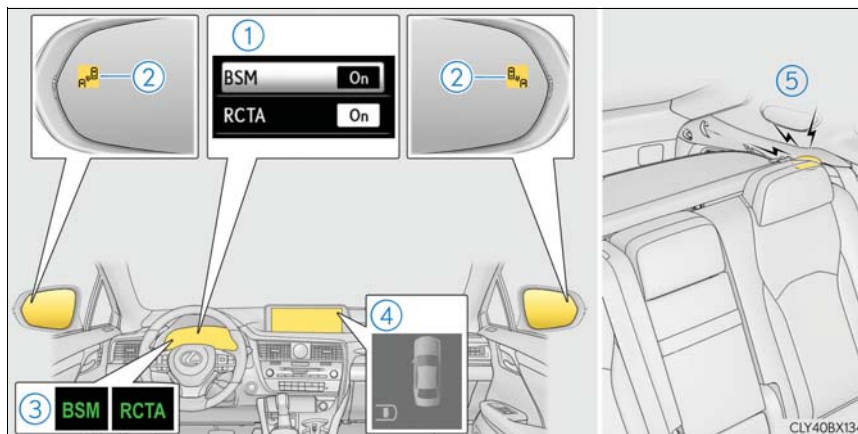

- ① Multi-information display
 

Turning the BSM function/RCTA function on/off. (→P. 315)  
The RCTA function is available when the BSM function is on.
- ② Outside rear view mirror indicators
 

BSM function:  
When a vehicle is detected in a blind spot of the outside rear view mirrors or approaching rapidly from behind into a blind spot, the outside rear view mirror indicator on the detected side will illuminate. If the turn signal lever is operated toward the detected side, the outside rear view mirror indicator flashes.

RCTA function:  
When a vehicle approaching from the right or left at the rear of the vehicle is detected, both outside rear view mirror indicators will flash.
- ③ “BSM” indicator/“RCTA” indicator
 

When the BSM function/RCTA function is turned on, the indicator illuminates.
- ④ Monitor screen display (RCTA function only) (if equipped)
 

If a vehicle approaching from the right or left at the rear of the vehicle is detected, the RCTA icon (→P. 322) for the detected side will be displayed on the monitor screen. This illustration shows an example of a vehicle approaching from the left at the rear of the vehicle.
- ⑤ RCTA buzzer (RCTA function only)
 

If a vehicle approaching from the right or left at the rear of the vehicle is detected, a buzzer will sound. The buzzer also sounds for approximately 1 second immediately after the BSM function is operated to turn the system on.

### Turning the BSM function/RCTA function on/off

- 1 Press “<” or “>” of the meter control switches, select .
- 2 Press “^” or “v” of the meter control switches, select “BSM”.
- 3 Press “^” or “v” of the meter control switches, select “BSM” or “RCTA”.

#### ■ Outside rear view mirror indicator visibility

In strong sunlight, the outside rear view mirror indicator may be difficult to see.

#### ■ Hearing the RCTA buzzer

The RCTA buzzer may be difficult to hear over loud noises, such as if the audio system volume is high.

#### ■ When there is a malfunction in the Blind Spot Monitor

If a system malfunction is detected due to any of the following, a warning message will be displayed: (→P. 661)

- A sensor is malfunctioning
- A sensor is dirty or covered with snow or a sticker
- The outside temperature is extremely high or low
- Sensor voltage is abnormal
- A sensor is misaligned

#### ■ Certification for the Blind Spot Monitor

- ▶ For vehicles sold in the U.S.A.

FCC ID : OAYSRR3A

This device complies with part 15 of the FCC Rules. Operation is subject to the following two conditions:

- (1) This device may not cause harmful interference, and
- (2) this device must accept any interference received, including interference that may cause undesired operation.

#### FCC Warning

Changes or modifications not expressly approved by the party responsible for compliance could void the user's authority to operate the equipment.

- ▶ For vehicles sold in Canada

Applicable law : Canada 310

This device complies with Industry Canada licence-exempt RSS standard(s). Operation is subject to the following two conditions: (1) this device may not cause interference, and (2) this device must accept any interference, including interference that may cause undesired operation of the device.

Frequency bands : 24.05 - 24.25GHz

Output power : less than 20 milliwatts

## 316 4-5. Using the driving support systems

Droit applicable : Canada 310

Le présent appareil est conforme aux CNR d'Industrie Canada applicables aux appareils radio exempts de licence. L'exploitation est autorisée aux deux conditions suivantes : (1) l'appareil ne doit pas produire de brouillage, et (2) l'utilisateur de l'appareil doit accepter tout brouillage radioélectrique subi, même si le brouillage est susceptible d'en compromettre le fonctionnement.

Bandes de fréquences : 24.05 - 24.25GHz

Puissance émise : Moins de 20 milliwatts

### ■ Customization

Some functions can be customized. (→P. 325, 722)

#### WARNING

##### ■ Handling the radar sensor

Blind Spot Monitor sensors are installed behind the left and right sides of the rear bumper respectively. Observe the following to ensure the Blind Spot Monitor can function correctly.

- Keep the sensors and the surrounding areas on the rear bumper clean at all times.  
If a sensor or its surrounding area on the rear bumper is dirty or covered with snow, the Blind Spot Monitor may not operate and a warning message (→P. 661) will be displayed. In this situation, clear off the dirt or snow and drive the vehicle with the operation conditions of the BSM function (→P. 319) satisfied for approximately 10 minutes. If the warning message does not disappear, have the vehicle inspected by your Lexus dealer.
- Do not subject a sensor or its surrounding area on the rear bumper to a strong impact.  
If a sensor is moved even slightly off position, the system may malfunction and vehicles may not be detected correctly.  
In the following situations, have your vehicle inspected by your Lexus dealer.
  - A sensor or its surrounding area is subject to a strong impact.
  - If the surrounding area of a sensor is scratched or dented, or part of them has become disconnected.
- Do not disassemble the sensor.
- Do not attach stickers to the sensor or surrounding area on the rear bumper.
- Do not modify the sensor or surrounding area on the rear bumper.
- Do not paint the rear bumper any color other than an official Lexus color.

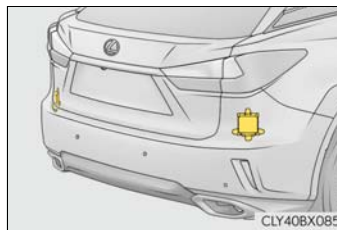

### BSM function

The BSM function uses radar sensors to detect the following vehicles traveling in adjacent lanes and advises the driver of the presence of such vehicles via the indicators on the outside rear view mirrors.

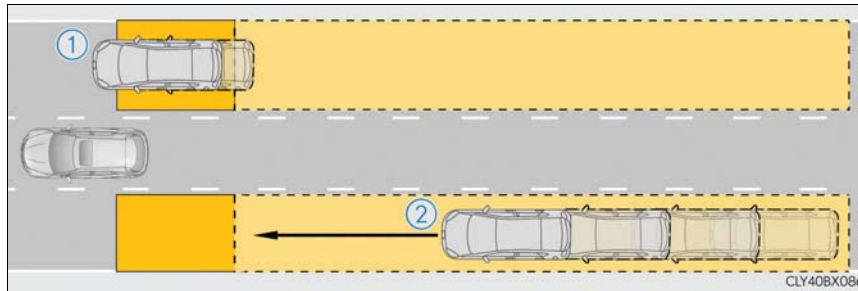

- ① Vehicles that are traveling in areas that are not visible using the outside rear view mirrors (the blind spots)
- ② Vehicles that are approaching rapidly from behind in areas that are not visible using the outside rear view mirrors (the blind spots)

### BSM function detection areas

The areas that vehicles can be detected in are outlined below.

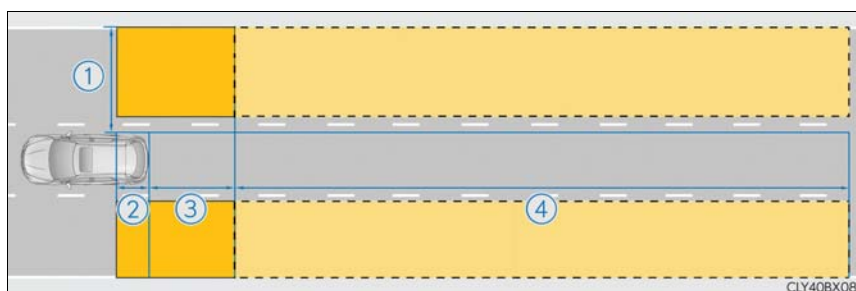

The range of each detection area is:

- ① Approximately 1.6 ft. (0.5 m) to 11.5 ft. (3.5 m) from either side of the vehicle\*

\*: The area between the side of the vehicle and 1.6 ft. (0.5 m) from the side of the vehicle cannot be detected.

- ② Approximately 3.3 ft. (1 m) forward of the rear bumper

- ③ Approximately 9.8 ft. (3 m) from the rear bumper

- ④ Approximately 9.8 ft. (3 m) to 197 ft. (60 m) from the rear bumper\*

\*: The greater the difference in speed between your vehicle and the detected vehicle is, the farther away the vehicle will be detected, causing the outside rear view mirror indicator to illuminate or flash.

#### **⚠ WARNING**

##### **■ Cautions regarding the use of the function**

The driver is solely responsible for safe driving. Always drive safely, taking care to observe your surroundings.

The BSM function is a supplementary function which alerts the driver that a vehicle is in a blind spot of the outside rear view mirrors or is approaching rapidly from behind into a blind spot. Do not overly rely on the BSM function. As the function cannot judge if it is safe to change lanes, over reliance could lead to an accident resulting in death or serious injury.

As the system may not function correctly under certain conditions, the driver's own visual confirmation of safety is necessary.

**■ The BSM function is operational when**

The BSM function is operational when all of the following conditions are met:

- The BSM function is on.
- The shift lever is in a position other than R.
- The vehicle speed is greater than approximately 10 mph (16 km/h).

**■ The BSM function will detect a vehicle when**

The BSM function will detect a vehicle present in the detection area in the following situations:

- A vehicle in an adjacent lane overtakes your vehicle.
- Another vehicle enters the detection area when it changes lanes.

**■ Conditions under which the BSM function will not detect a vehicle**

The BSM function is not designed to detect the following types of vehicles and/or objects:

- Small motorcycles, bicycles, pedestrians, etc. \*
- Vehicles traveling in the opposite direction
- Guardrails, walls, signs, parked vehicles and similar stationary objects \*
- Following vehicles that are in the same lane \*
- Vehicles traveling 2 lanes away from your vehicle \*

\*: Depending on the conditions, detection of a vehicle and/or object may occur.



**■ Conditions under which the BSM function may not function correctly**

- The BSM function may not detect vehicles correctly in the following situations:
  - When the sensor is misaligned due to a strong impact to the sensor or its surrounding area
  - When mud, snow, ice, a sticker, etc. is covering the sensor or surrounding area on the rear bumper
  - When driving on a road surface that is wet with standing water during bad weather, such as heavy rain, snow, or fog
  - When multiple vehicles are approaching with only a small gap between each vehicle
  - When the distance between your vehicle and a following vehicle is short
  - When there is a significant difference in speed between your vehicle and the vehicle that enters the detection area
  - When the difference in speed between your vehicle and another vehicle is changing
  - When a vehicle enters a detection area traveling at about the same speed as your vehicle
  - As your vehicle starts from a stop, a vehicle remains in the detection area
  - When driving up and down consecutive steep inclines, such as hills, dips on the road, etc.
  - When driving on roads with sharp bends, consecutive curves, or uneven surfaces
  - When vehicle lanes are wide, or when driving on the edge of a lane, and the vehicle in an adjacent lane is far away from your vehicle
  - When towing a trailer (vehicles with towing package)
  - When items such as a bicycle carrier are installed on the rear of the vehicle
  - When there is a significant difference in height between your vehicle and the vehicle that enters the detection area
  - Immediately after the BSM function is turned on
- Instances of the BSM function unnecessarily detecting a vehicle and/or object may increase in the following situations:
  - When the sensor is misaligned due to a strong impact to the sensor or its surrounding area
  - When the distance between your vehicle and a guardrail, wall, etc. that enters the detection area is short
  - When driving up and down consecutive steep inclines, such as hills, dips on the road, etc.
  - When vehicle lanes are narrow, or when driving on the edge of a lane, and a vehicle traveling in a lane other than the adjacent lanes enters the detection area
  - When driving on roads with sharp bends, consecutive curves, or uneven surfaces
  - When the tires are slipping or spinning
  - When the distance between your vehicle and a following vehicle is short
  - When a bicycle carrier or other accessory is installed to the rear of the vehicle
  - When towing a trailer (vehicles with towing package)

### RCTA function

The RCTA function uses radar sensors to detect vehicles approaching from the right or left at the rear of the vehicle and alerts the driver of the presence of such vehicles by flashing the outside rear view mirror indicators and sounding a buzzer.

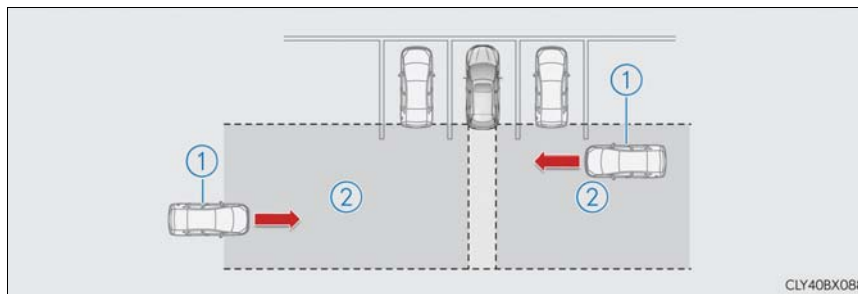

- ① Approaching vehicles
- ② Detection areas of approaching vehicles





#### ■ Rear Cross Traffic Auto Brake function (if equipped)

When the Intelligent Clearance Sonar with Rear Cross Traffic Auto Brake is enabled and a vehicle approaching from the right or left at the rear of the vehicle is detected, the Rear Cross Traffic Auto Brake function will perform brake control to reduce the likelihood of an impact with the approaching vehicle.

Intelligent Clearance Sonar with Rear Cross Traffic Auto Brake: →P. 336

■ RCTA icon display (if equipped)

When a vehicle approaching from the right or left at the rear of the vehicle is detected, the following will be displayed on the audio system screen.

Display	Content
	A vehicle is approaching from the left at the rear of the vehicle
	A vehicle is approaching from the right at the rear of the vehicle
	Vehicles are approaching from both sides of the vehicle
	The RCTA function is malfunctioning (→P. 315)

 **WARNING**

■ **Cautions regarding the use of the function**

The driver is solely responsible for safe driving. Always drive safely, taking care to observe your surroundings.

The RCTA function is only a supplementary function which alerts the driver that a vehicle is approaching from the right or left at the rear of the vehicle. As the RCTA function may not function correctly under certain conditions, the driver's own visual confirmation of safety is necessary. Over reliance on this function may lead to an accident resulting death or serious injury.

### RCTA function detection areas

The areas that vehicles can be detected in are outlined below.

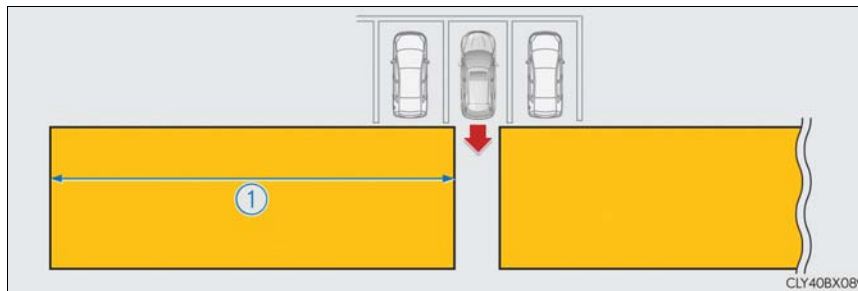

The buzzer can alert the driver of faster vehicles approaching from farther away.

Example:

Approaching vehicle	Speed	① Approximate alert distance
Fast	18 mph (28 km/h)	65 ft. (20 m)
Slow	5 mph (8 km/h)	18 ft. (5.5 m)

4

Driving

#### ■ The RCTA function is operational when

The RCTA function operates when all of the following conditions are met:

- The RCTA function is on.
- The shift lever is in R.
- The vehicle speed is less than approximately 5 mph (8 km/h).
- The approaching vehicle speed is between approximately 5 mph (8 km/h) and 18 mph (28 km/h).

■ **Conditions under which the RCTA function will not detect a vehicle**

The RCTA function is not designed to detect the following types of vehicles and/or objects:

- Vehicles approaching from directly behind
- Vehicles backing up in a parking space next to your vehicle
- Vehicles that the sensors cannot detect due to obstructions

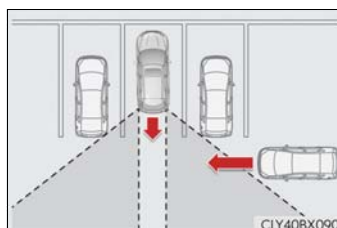

- Guardrails, walls, signs, parked vehicles and similar stationary objects \*
- Small motorcycles, bicycles, pedestrians, etc. \*
- Vehicles moving away from your vehicle
- Vehicles approaching from the parking spaces next to your vehicle \*

\*: Depending on the conditions, detection of a vehicle and/or object may occur.

■ **Conditions under which the RCTA function may not function correctly**

- The RCTA function may not detect vehicles correctly in the following situations:
  - When the sensor is misaligned due to a strong impact to the sensor or its surrounding area
  - When mud, snow, ice, a sticker, etc. is covering the sensor or surrounding area on the rear bumper
  - When driving on a road surface that is wet with standing water during bad weather, such as heavy rain, snow, or fog
  - When multiple vehicles are approaching with only a small gap between each vehicle
  - When a vehicle is approaching at high speed
  - When towing a trailer (vehicles with towing package)
  - When backing up on a slope with a sharp change in grade

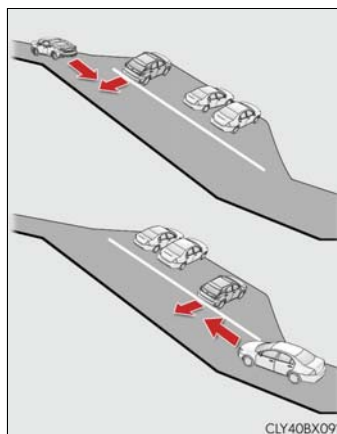

- When backing out of a shallow angle parking spot

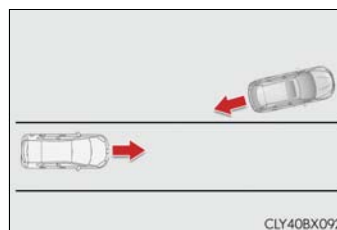

- Immediately after the RCTA function is turned on
- Immediately after the engine is started with the RCTA function on
- When the sensors cannot detect a vehicle due to obstructions

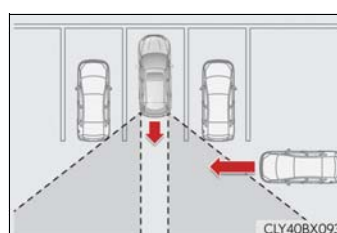

- Instances of the RCTA function unnecessarily detecting a vehicle and/or object may increase in the following situations:

- When a vehicle passes by the side of your vehicle
- When the parking space faces a street and vehicles are being driven on the street

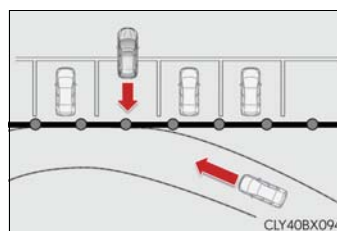

- When the distance between your vehicle and metal objects, such as a guardrail, wall, sign, or parked vehicle, which may reflect electrical waves toward the rear of the vehicle, is short

### Setting up BSM function/RCTA function

You can change the BSM function/RCTA function settings.

- 1 Press the "MENU" button on the Remote Touch, and then select  on the screen.
- 2 Select "Vehicle", and then select "Blind Spot Monitor Settings" on the screen.
- 3 Select the desired setting. (→P. 731)

## Intuitive parking assist\*

The distance from your vehicle to a nearby wall or other stationary object when parallel parking or maneuvering into a garage is measured by the sensors and communicated via the displays and a buzzer. Always check the surrounding area when using this system.

### Types of sensors

▶ Except F SPORT models

▶ F SPORT models

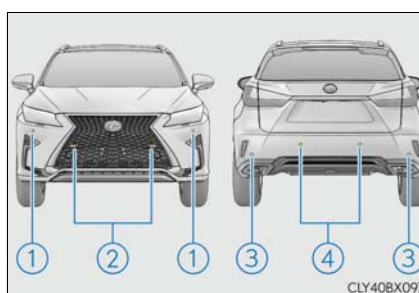
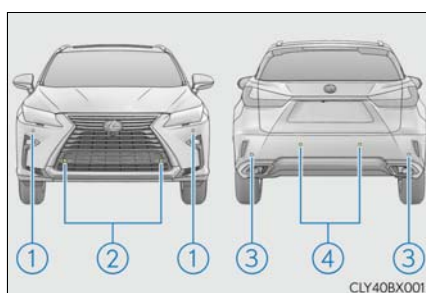

- ① Front corner sensors
- ② Front center sensors
- ③ Rear corner sensors
- ④ Rear center sensors

### Turning the intuitive parking assist on/off

- 1 Press “<” or “>” of the meter control switches, select .
- 2 Press “^” or “v” of the meter control switches, select “Parking Assist”.

When on, the indicator light comes on to inform the driver that the system is operational.



\*: If equipped

## Display

When the sensors detect an obstacle, the following displays inform the driver of the position and distance to the obstacle.

### ■ Multi-information display

- ① Front corner sensor operation
- ② Front center sensor operation
- ③ Rear corner sensor operation
- ④ Rear center sensor operation

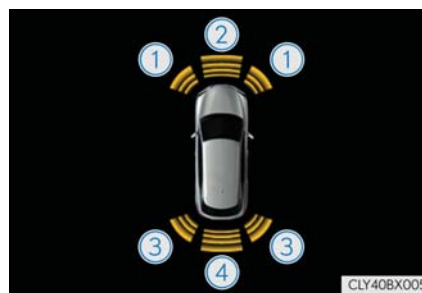

### ■ Lexus Display Audio or navigation system (8-inch display) screen

- ① Intuitive parking assist
 

When the vehicle is moving forward. A graphic is automatically displayed when an obstacle is detected. The screen can be set so that the graphic is not displayed. (→P. 332)

: Select to mute the buzzer sounds.
- ② Intuitive parking assist
- ③ Rear Cross Traffic Alert (if equipped)
 

When the vehicle is moving backward. A simplified image is displayed on the upper part of the screen when an obstacle is detected.



4

Driving



■ Navigation system (12.3-inch display) screen

- ① Intuitive parking assist
- ② Rear Cross Traffic Alert (if equipped)

A graphic is automatically displayed on the side display when an obstacle is detected. The screen can be set so that the graphic is not displayed. (→P. 332)









: Select to mute the buzzer sounds. This function is available when the vehicle is moving forward.





**Sensor detection display, obstacle distance**

■ **Distance display**

Sensors that detect an obstacle will illuminate continuously or blink.

Display*1	Insert display		Approximate distance to object	
	Lexus parking assist monitor*4	Panoramic view monitor	Front and rear center sensor	Front and rear corner sensor
 (continuous)	 (blinking slowly)	 (blinking slowly)	Front center sensor: 3.3 ft. (100 cm) to 2.0 ft. (60 cm) Rear center sensor: 4.9 ft. (150 cm) to 2.0 ft. (60 cm)	—
 (continuous)	 (blinking)	 (blinking)	2.0 ft. (60 cm) to 1.5 ft. (45 cm)	▶ RX350 Front corner sensor: 2.0 ft. (60 cm) to 1.5 ft. (45 cm) Rear corner sensor: 2.0 ft. (60 cm) to 1.5 ft. (45 cm)
 (continuous)	 (blinking rapidly)	 (blinking rapidly)	1.5 ft. (45 cm) to 1.2 ft. (35 cm)	1.5 ft. (45 cm) to 1.2 ft. (35 cm)

Display *1	Insert display		Approximate distance to object	
	Lexus parking assist monitor *4	Panoramic view monitor	Front and rear center sensor	Front and rear corner sensor
 (blinking *2 or continuous *3)	 (continuous)	 (continuous)	Less than 1.2 ft. (35 cm)	Less than 1.2 ft. (35 cm)

\*1: The images may differ from those shown in the illustrations. (→P. 327)

\*2: Multi-information display

\*3: Audio system screen

\*4: Lexus Display Audio or navigation system (8-inch display) screen

■ **Buzzer operation and distance to an object**

A buzzer sounds when the sensors are operating.

- The buzzer sounds faster as the vehicle approaches an object.  
When the vehicle comes within the following distance of the object, the buzzer sounds continuously: Approximately 1.2 ft. (35 cm).
- When 2 or more objects are detected simultaneously, the buzzer system responds to the nearest object. If one or both come within the above distances, the beep will repeat a long tone, followed by fast beeps.

**Detection range of the sensors**

- ① Approximately 3.3 ft. (100 cm)
- ② Approximately 4.9 ft. (150 cm)
- ③ Approximately 2.0 ft. (60 cm)
- ④ RX350:  
Approximately 2.0 ft. (60 cm)  
RX350L:  
Approximately 2.1 ft. (66 cm)

The diagram shows the detection range of the sensors. Note that the sensors cannot detect objects that are extremely close to the vehicle.

The range of the sensors may change depending on the shape of the object, etc.

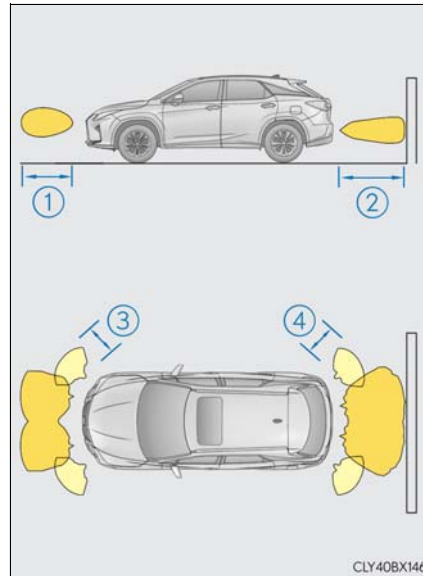

### Setting up intuitive parking assist

You can change the buzzer sounds volume and the screen operating conditions when the engine switch is in IGNITION ON mode.

- 1 Press the "MENU" button on the Lexus Display Audio controller/Remote Touch, and then select  on the screen.
- 2 Select "Vehicle", and then select "LEXUS Park Assist" on the screen.
- 3 Select the desired item.

▶ Lexus Display Audio screen

▶ Navigation system screen

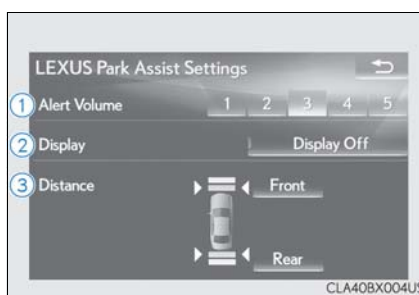
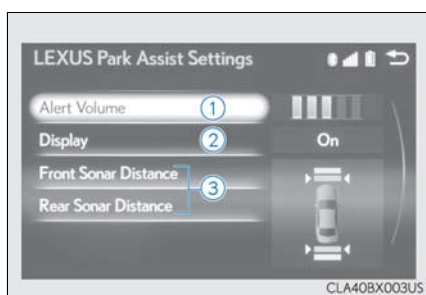

- 1 The buzzer sounds volume can be adjusted.
- 2 On or off can be selected for intuitive parking assist display.
- 3 Both the front or rear center sensors display and tone indication can be set.

#### ■ The intuitive parking assist can be operated when

- Front corner sensors:
  - The engine switch is in IGNITION ON mode.
  - The shift lever is in other than P.
  - The vehicle speed is less than about 6 mph (10 km/h).  
(At any speed when the shift lever is in R)
- Front center sensors:
  - The engine switch is in IGNITION ON mode.
  - The shift lever is in other than P or R.
  - The vehicle speed is less than about 6 mph (10 km/h).
- Rear corner and rear center sensors:
  - The engine switch is in IGNITION ON mode.
  - The shift lever is in R.

#### ■ Intuitive parking assist display

- Vehicles with a Lexus Display Audio system/navigation system (8-inch display): When an object is detected while the Lexus parking assist monitor or panoramic view monitor is in use, the warning indicator will appear in the upper part of the screen even if the display setting has been set to off.
- Vehicles with a navigation system (12.3-inch display): If the intuitive parking assist display is set to on, detected objects will also be displayed on the panoramic view monitor. For details, refer to "NAVIGATION SYSTEM OWNER'S MANUAL".

#### ■ Sensor detection information

- The sensor's detection areas are limited to the areas around the vehicle's bumper.
- Certain vehicle conditions and the surrounding environment may affect the ability of a sensor to correctly detect an object. Particular instances where this may occur are listed below.
  - There is dirt, snow or ice on the sensor. (Wiping the sensors will resolve this problem.)
  - The sensor is frozen. (Thawing the area will resolve this problem.)  
In especially cold weather, if a sensor is frozen the screen may show an abnormal display, or obstacles may not be detected.
  - The sensor is covered in any way.
  - The vehicle is leaning considerably to one side.
  - When a sensor or the area around a sensor is extremely hot or cold.
  - On an extremely bumpy road, on an incline, on gravel, or on grass.
  - The vicinity of the vehicle is noisy due to vehicle horns, motorcycle engines, air brakes of large vehicles, or other loud noises producing ultrasonic waves.
  - There is another vehicle equipped with parking assist sensors in the vicinity.
  - The sensor is coated with a sheet of spray or heavy rain.
  - The bumper or sensor receives a strong impact.
  - If the vehicle is significantly tilted.
  - The vehicle is approaching a tall or curved curb.
  - In harsh sunlight or intense cold weather.
  - The area directly under the bumpers is not detected.
  - If objects draw too close to the sensor.
  - People may not be detected if they are wearing certain types of clothing.

In addition to the examples above, there are instances in which, because of their shape, signs and other objects may be judged by a sensor to be closer than they are.

- The shape of the object may prevent a sensor from detecting it. Pay particular attention to the following objects:
  - Wires, fences, ropes, etc.
  - Cotton, snow and other materials that absorb sound waves
  - Sharply-angled objects
  - Low obstacles
  - Tall obstacles with upper sections projecting outwards in the direction of your vehicle
- The following situations may occur during use.
  - Depending on the shape of the object and other factors, the detection distance may shorten, or detection may be impossible.
  - Objects may not be detected if they are too close to the sensor.
  - There will be a short delay between object detection and display. Even at slow speeds, there is a possibility that the object will come within the sensor's detection areas before the display is shown and the buzzer sounds.
  - Thin posts or objects lower than the sensor may not be detected when approached, even if they have been detected once.
  - It might be difficult to hear beeps due to the volume of audio system or air flow noise of the air conditioning system.
- **If “Clean Parking Assist Sensor” is displayed on the multi-information display**

A sensor may be dirty or covered with snow or ice. In such cases, if it is removed from the sensor, the system should return to normal.

Also, due to the sensor being frozen at low temperatures, a malfunction display may appear or an object may not be detected. If the sensor thaws out, the system should return to normal.
- **If “Parking Assist Malfunction” is displayed on the multi-information display**

Depending on the malfunction of the sensor, the device may not be working normally. Have the vehicle inspected by your Lexus dealer.
- **Certification**
  - ▶ For vehicles sold in Canada

This ISM device complies with Canadian ICES-001.  
Cet appareil ISM est conforme à la norme NMB-001 du Canada.
- **Customization**

Some functions can be customized. (→P. 332, 722)

**⚠ WARNING****■ When using the intuitive parking assist**

Observe the following precautions.

Failing to do so may result in the vehicle being unable to be driven safely and possibly cause an accident.

- Do not use the sensor at speeds in excess of 6 mph (10 km/h).
- The sensors' detection areas and reaction times are limited. When moving forward or reversing, check the areas surrounding the vehicle (especially the sides of the vehicle) for safety, and drive slowly, using the brake to control the vehicle's speed.
- Do not install accessories within the sensors' detection areas.
- The vehicle is equipped with a fender pole or wireless antenna.
- The front or rear bumper or a sensor receives a strong impact.
- A non-genuine Lexus suspension (lowered suspension, etc.) is installed.
- Towing eyelets are installed.
- A backlit license plate is installed.

**■ When using intuitive parking assist**

In the following situations, the system may not function correctly due to a sensor malfunction, etc. Have the vehicle checked by your Lexus dealer.

- The intuitive parking assist operation display flashes, and a buzzer sounds when no obstacles are detected.
- If the area around a sensor collides with something, or is subjected to strong impact.
- If the bumper collides with something.
- If the display shows continuously without beeping, except when the buzzer mute switch has been turned on.
- If a display error occurs, first check the sensor.  
If the error occurs even if there is no ice, snow or mud on the sensor, it is likely that the sensor is malfunctioning.

**■ Notes when washing the vehicle**

Do not apply intensive bursts of water or steam to the sensor area.

Doing so may result in the sensor malfunctioning.

- When using a high pressure washer to wash the vehicle, do not spray the sensors directly, as doing so may cause a sensor to malfunction.
- When using steam to clean the vehicle, do not direct steam too close to the sensors as doing so may cause a sensor to malfunction.



## Intelligent Clearance Sonar (ICS)\*

If a collision with a wall or other stationary object may occur due to the vehicle suddenly moving forward due to an accidental accelerator pedal operation, the vehicle moving the unintended direction due to the wrong shift position being selected, or while parking or traveling at low speeds, the sensors detect stationary objects, such as a wall, in the traveling direction of the vehicle, and the system operates to lessen an impact with a stationary object and reduce the resulting collision damage.

### Examples of system operation

The system will operate in situations such as the following if a stationary object is detected in the traveling direction of the vehicle.

- ◆ When traveling at a low speed and the brake pedal is not depressed, or is depressed late

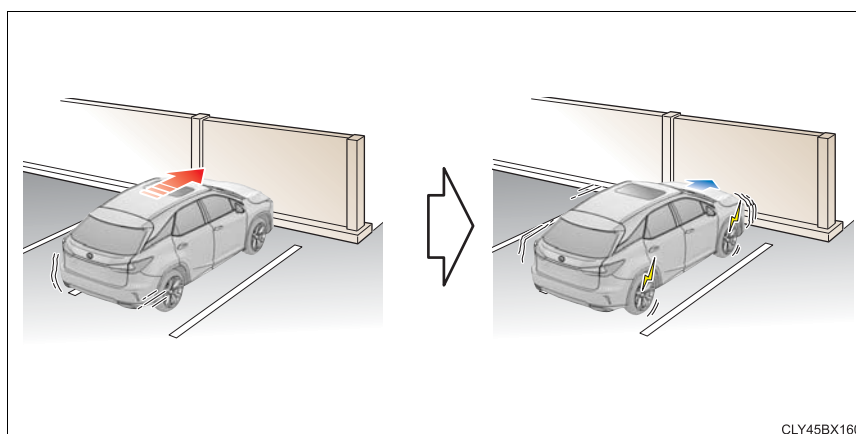

\*: If equipped

◆ When the accelerator pedal is depressed excessively

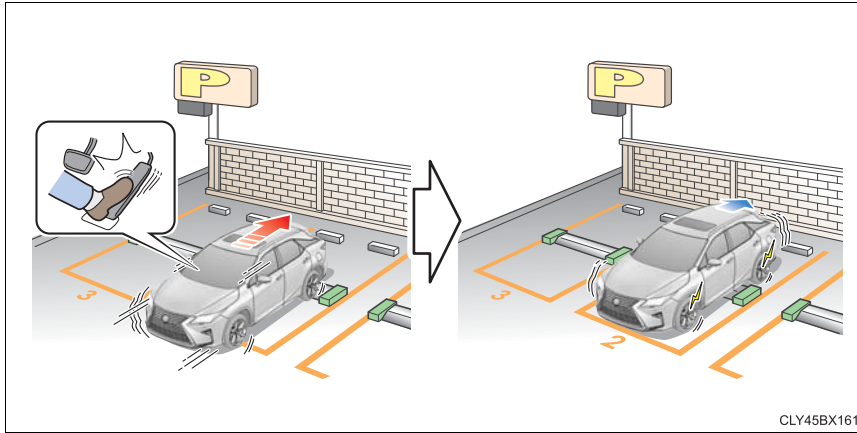

CLY45BX161

◆ When the vehicle moves in the unintended direction due to the wrong shift position being selected

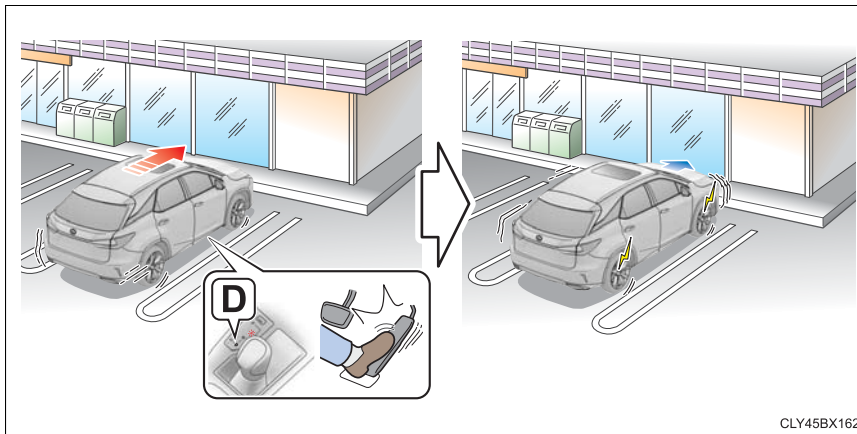

CLY45BX162

### Rear Cross Traffic Auto Brake function (if equipped)

If a rear radar sensor detects a vehicle approaching from the right or left at the rear of the vehicle and the system determines that the possibility of a collision is high, this function will perform brake control to reduce the likelihood of an impact with the approaching vehicle.

#### ■ Examples of system operation

This function will operate in situations such as the following if a vehicle is detected in the traveling direction of the vehicle.

- ◆ When reversing, a vehicle is approaching and the brake pedal is not depressed, or is depressed late

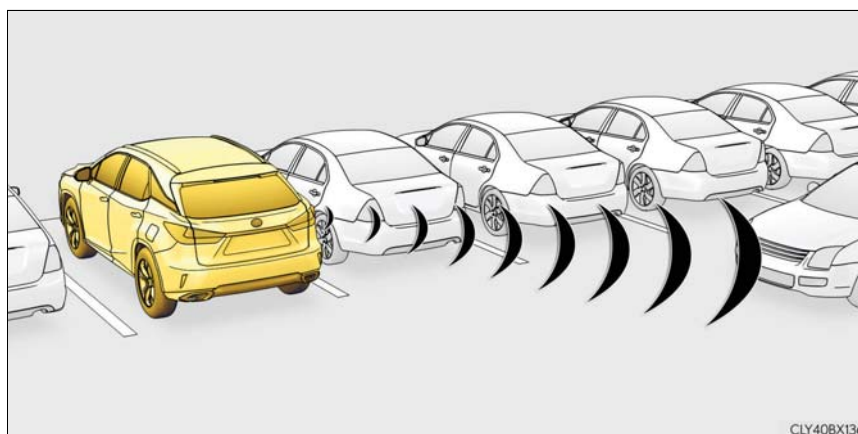

### Types of sensors

▶ Except F SPORT models

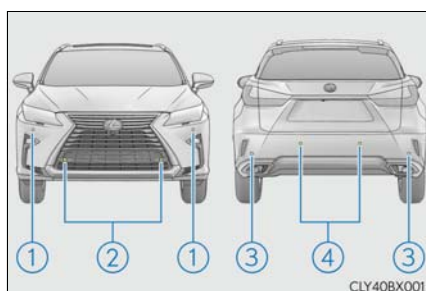

▶ F SPORT models

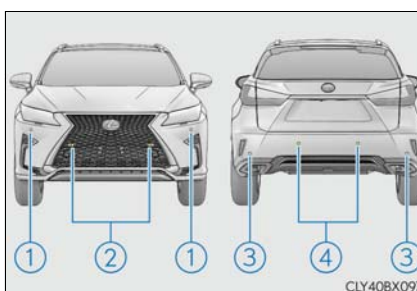

- ① Front corner sensors
- ② Front center sensors
- ③ Rear corner sensors
- ④ Rear center sensors

### Turning the Intelligent Clearance Sonar system on/off

- 1 Select on the multi-information display.
- 2 Press or of the meter control switch and select "ICS".
- 3 Press of the meter control switch.
- 4 Select the "Yes" and push .

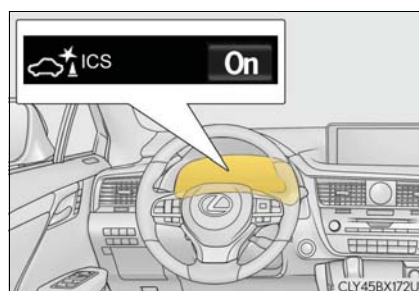

When the Intelligent Clearance Sonar is disabled, the ICS OFF indicator illuminates.

To re-enable the system when it was disabled, select on the multi-information display, select "ICS" and then "On". If disabled using this method, the system will not be re-enabled by turning the engine switch off and then to IGNITION ON mode.

**Displays and buzzers for engine output restriction control and brake control**

If the engine output restriction control or brake control operates, a buzzer will sound and a message will be displayed on the multi-information display to alert the driver.

Depending on the situation, engine output restriction control will operate to either limit acceleration or restrict output as much as possible.

Control	Situation	Multi-information display	ICS OFF Indicator	Buzzer
Engine output restriction control is operating (acceleration restriction)	Acceleration greater than a certain amount is not possible.	"Object Detected Acceleration Reduced"	Not illuminated	Short beep
Engine output restriction control is operating (output restricted as much as possible)	Stronger-than-normal brake operation is necessary.	"BRAKE!"		
Brake control is operating	Emergency braking is necessary.			
Vehicle stopped by system operation	The vehicle has been stopped by brake control operation.	"Switch to Brake"	Illuminated	

### Intelligent Clearance Sonar function

If the Intelligent Clearance Sonar function detects that a collision with a wall or other stationary object is possible, the engine output will be restricted to restrain any increase in the vehicle speed. (Engine output restriction control: See A below.)

Additionally, if the accelerator pedal continues to be depressed, the brakes will be applied automatically to reduce the vehicle speed. (Brake control: See B below.)

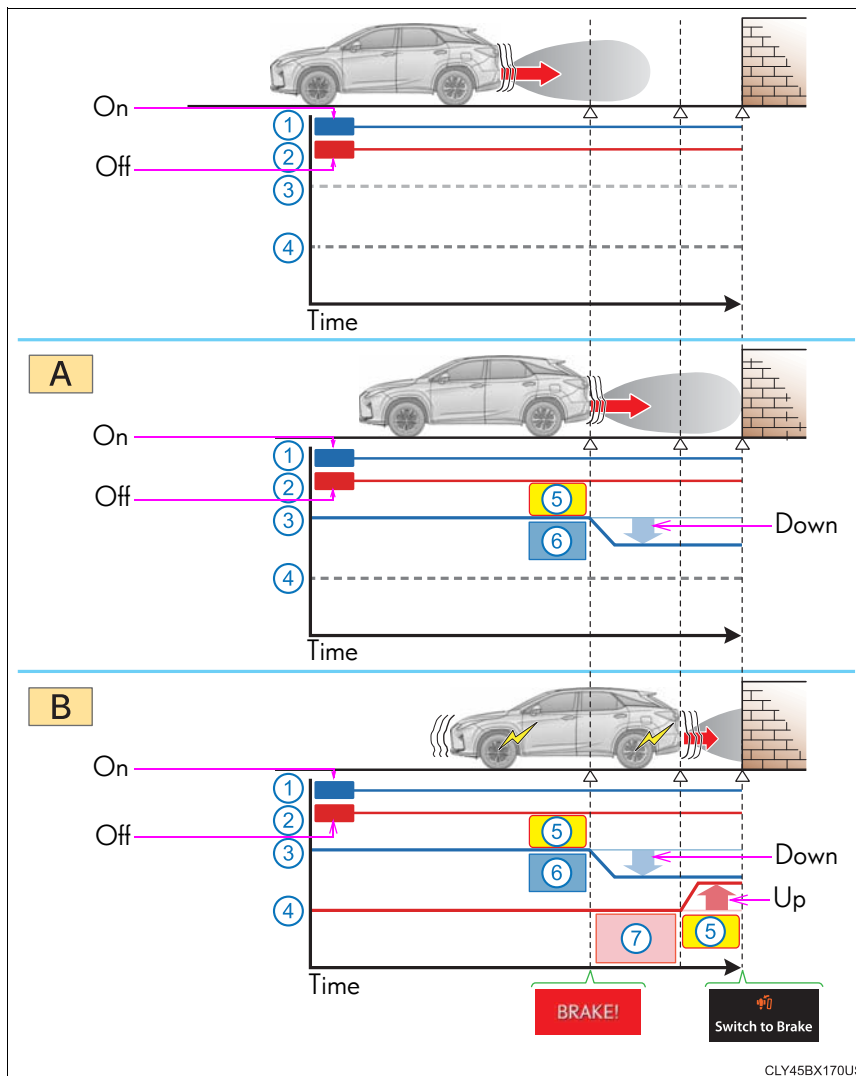

CLY45BX170US

- ① Accelerator pedal
- ② Brake pedal
- ③ Engine output
- ④ Braking force
- ⑤ Start of control
- ⑥ High possibility of a collision
- ⑦ Extremely high possibility of a collision

**■ The Intelligent Clearance Sonar function will operate when**

The function will operate when the ICS OFF indicator is not illuminated or flashing (→P. 339, 347) and all of the following conditions are met:

- Engine output restriction control
  - The Intelligent Clearance Sonar system is enabled.
  - The vehicle speed is 10 mph (15 km/h) or less.
  - There is a stationary object in the traveling direction of the vehicle and 6 to 13 ft. (2 to 4 m) away.
  - The system determines that a stronger-than-normal brake operation is necessary to avoid a collision.
- Brake control
  - Engine output restriction control is operating.
  - The system determines that an emergency brake operation is necessary to avoid a collision.

**■ The Intelligent Clearance Sonar function will stop operating when**

The function will stop operating if any of the following conditions are met:

- Engine output restriction control
  - The Intelligent Clearance Sonar system is disabled.
  - The collision becomes avoidable with normal brake operation.
  - The stationary object is no longer 6 to 13 ft. (2 to 4 m) away in the traveling direction of the vehicle.
- Brake control
  - The Intelligent Clearance Sonar system is disabled.
  - Approximately 2 seconds elapse after the vehicle is stopped by brake control.
  - The brake pedal is depressed after the vehicle is stopped by brake control.
  - The stationary object is no longer 6 to 13 ft. (2 to 4 m) away in the traveling direction of the vehicle.

**■ Detection range of the Intelligent Clearance Sonar function**

The detection range of the Intelligent Clearance Sonar function differs from the detection range of the intuitive parking assist. (→P. 331)

Therefore, even if the intuitive parking assist detects an object and provides a warning, the Intelligent Clearance Sonar function may not start operating.

**■ If the Intelligent Clearance Sonar function has operated**

If the vehicle is stopped due to operation of the Intelligent Clearance Sonar function, the Intelligent Clearance Sonar system will be disabled and the ICS OFF indicator will illuminate.



**■ Re-enabling the Intelligent Clearance Sonar system**

To re-enable the Intelligent Clearance Sonar system when it is disabled due to operation of the Intelligent Clearance Sonar function, either enable the system again (→P. 339), or turn the engine switch off and then back to IGNITION ON mode.

Additionally, if the object becomes no longer in the traveling direction of the vehicle or if the traveling direction of the vehicle changes (such as changing from moving forward to backing up, or from backing up to moving forward), the system will be re-enabled automatically.

**■ Objects that the Intelligent Clearance Sonar function may not detect**

The sensors may not be able to detect certain objects, such as the following.

- Cotton cloth, snow, and other materials that are poor reflectors of ultrasonic waves.  
(People may also not be detected depending on the type of clothing they are wearing.)
- Objects which are not perpendicular to the ground, are not perpendicular to the traveling direction of the vehicle, are uneven or are waving.
- Low objects
- Thin objects such as wires, fences, ropes and signposts
- Objects that are extremely close to the bumper

**■ Intuitive parking assist buzzer**

Regardless of whether the intuitive parking assist system is enabled or not (→P. 326), if the Intelligent Clearance Sonar system is enabled (→P. 339), the front or rear sensors detect an object and brake control is performed, the intuitive parking assist buzzer will sound to notify the driver of the approximate distance to the object.

■ **Situations in which the Intelligent Clearance Sonar function may operate even if there is no possibility of a collision**

In some situations such as the following, the Intelligent Clearance Sonar function may operate even though there is no possibility of a collision.

● **Vehicle surroundings**

- When driving on a narrow road

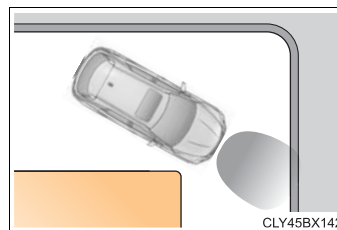

- When driving on a gravel road or in an area with tall grass

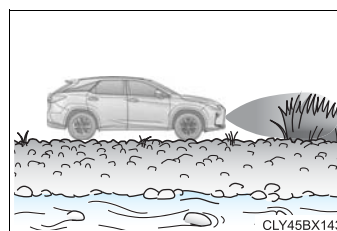

- When driving toward a banner, flag, low-hanging branch or boom barrier (such as those used at railroad crossings, toll gates and parking lots).
- When driving on a narrow path surrounded by a structure, such as in a tunnel or on an iron bridge
- When parallel parking
- When there is a rut or hole in the surface of the road
- When driving on a metal cover (grating), such as those used for drainage ditches
- When driving on a steep slope
- If a sensor is hit by a large amount of water, such as when driving on a flooded road
- **Weather**
  - If a sensor is covered with ice, snow, dirt, etc. (when cleared, the system will return to normal)
  - If heavy rain or water strikes a sensor
  - When driving in inclement weather such as fog, snow or a sandstorm
- **Other ultrasonic waves sources**
  - When vehicle horns, vehicle detectors, motorcycle engines, air brakes of large vehicles, the clearance sonar of other vehicles or other devices which produce ultrasonic waves are near the vehicle
  - If a sticker or an electronic component, such as a backlit license plate (especially fluorescent type), fog lights, a fender pole or wireless antenna is installed near a sensor
- **Changes in the vehicle posture**
  - If the vehicle is significantly tilted
  - If the front of the vehicle is raised or lowered due to the carried load
  - If the orientation of a sensor has been changed due to a collision or other impact

■ **If the Intelligent Clearance Sonar function operates unnecessarily such as at a railroad crossing**

Even in the event that the Intelligent Clearance Sonar function operates unnecessarily, such as at a railroad crossing, brake control will be canceled after approximately 2 seconds, allowing you to proceed forward and leave the area, Brake control can also be canceled by depressing the brake pedal. Depressing the accelerator pedal again will allow you to proceed forward and leave the area.

■ **Situations in which the Intelligent Clearance Sonar Brake function may not operate properly**

In some situations such as the following, this function may not operate properly.

● **Weather**

- When a sensor or the area around a sensor is extremely hot or cold

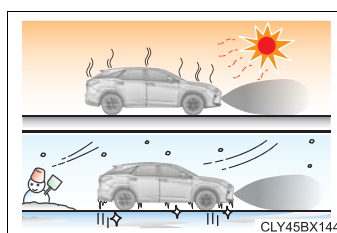

- When strong winds are blowing

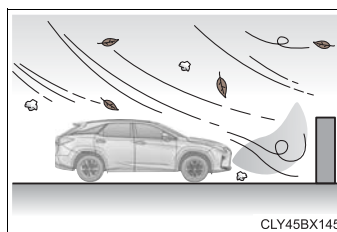

- If a sensor is covered with ice, snow, dirt, etc. (when cleared, the system will return to normal)
- If heavy rain or water strikes a sensor
- When driving in inclement weather such as fog, snow or a sandstorm

● **Vehicle surroundings**

- When an object that cannot be detected is between the vehicle and a detected object
- If an object such as a vehicle, motorcycle, bicycle or pedestrian cuts in front of the vehicle or runs out from the side of the vehicle.

● **Other ultrasonic waves sources**

- When vehicle horns, vehicle detectors, motorcycle engines, air brakes of large vehicles, the clearance sonar of other vehicles or other devices which produce ultrasonic waves are near the vehicle
- If a sticker or an electronic component, such as a backlit license plate (especially fluorescent type), fog lights, a fender pole or wireless antenna is installed near a sensor

● **Changes in the vehicle posture**

- If the vehicle is significantly tilted
- If the front of the vehicle is raised or lowered due to the carried load
- If the orientation of a sensor has been changed due to a collision or other impact

**■ If a battery terminal has been disconnected and reconnected**

The system needs to be initialized.

To initialize the system, drive the vehicle straight ahead for 5 seconds or more at a speed of approximately 22 mph (35 km/h) or more.

**■ If “ICS Unavailable” is displayed on the multi-information display and the ICS OFF indicator is flashing**

- A sensor may be covered with ice, snow, dirt, etc. Remove the ice, snow, dirt, etc., from the sensor to return the system to normal.

Also, due to ice forming on a sensor at low temperatures, a warning message may be displayed or the sensor may not be able to detect an object. Once the ice melts, the system will return to normal.

- If this message continues to be displayed even after cleaning the sensor, or is displayed even though the sensor is clean, have the vehicle inspected by your Lexus dealer.
- Initialization may not have been performed after a battery terminal was disconnected and reconnected. Initialize the system. (→P. 347)

**■ If “ICS Malfunction Visit Your Dealer” is displayed on the multi-information display and the ICS OFF indicator is flashing**

The system may be malfunctioning. Have the vehicle inspected by your Lexus dealer.

 **WARNING****■ Limitations of the Intelligent Clearance Sonar system**

Do not overly rely on the system, as doing so may lead to an accident.

- The driver is solely responsible for safe driving. Always drive carefully, taking care to observe your surroundings. The Intelligent Clearance Sonar system is designed to provide support to lessen the severity of collisions. However, it may not operate in some situations.
- The Intelligent Clearance Sonar system is not designed to stop the vehicle completely. Additionally, even if the system has stopped the vehicle, it is necessary to depress the brake pedal immediately as brake control will be canceled after approximately 2 seconds.

**■ To ensure the Intelligent Clearance Sonar system can operate properly**

Observe the following precautions regarding the sensors (→P. 339). Failure to do so may cause a sensor to not operate properly, and may cause an accident.

- Do not modify, disassemble or paint the sensors.
- Do not replace a sensor with a part other than a genuine part.
- Do not subject a sensor or its surrounding area to a strong impact.
- Do not damage the sensors, and always keep them clean.

Observe the following precautions regarding the radar sensors (→P. 316). Failure to do so may cause a radar sensor to not operate properly, and may cause an accident.

- Do not modify, disassemble or paint the sensors.
- Do not replace a radar sensor with a part other than a genuine part.
- Do not subject a radar sensor or its surrounding area to a strong impact.
- Do not damage the radar sensors, and always keep the radar sensors and their surrounding area on the bumper clean.

**■ Handling the suspension**

Do not modify the suspension, as changes to the height or inclination of the vehicle may prevent the sensors from detecting objects correctly or cause the system to not operate or operate unnecessarily.

 NOTICE**■ To prevent the system from malfunctioning**

- If the area around a sensor is subjected to an impact, the system may not operate properly due to the sensor being misaligned. Have the vehicle inspected by your Lexus dealer.
- When using a high pressure washer to wash the vehicle, do not spray the sensors directly, as doing so may cause a sensor to malfunction.
- When using steam to clean the vehicle, do not direct steam too close to the sensors as doing so may cause a sensor to malfunction.

**■ To prevent a radar sensor from malfunctioning**

- If the area around a radar sensor is subjected to an impact, the system may not operate properly due to a sensor malfunction. Have the vehicle inspected by your Lexus dealer.
- Observe the radar sensor handling precautions. (→P. 316)

**■ To prevent unnecessary operation of the Intelligent Clearance Sonar system**

In the following situations, disable the Intelligent Clearance Sonar system as the system may operate even though there is no possibility of a collision.

- When inspecting the vehicle using a chassis roller, chassis dynamo or free roller
- When loading the vehicle onto a boat, truck or other transport vessel
- If the suspension has been modified or tires of a size other than specified are installed
- If the front of the vehicle is raised or lowered due to the carried load
- If towing eyelets are installed

### **Rear Cross Traffic Auto Brake function (if equipped)**

If the Rear Cross Traffic Auto Brake function detects that a collision with an approaching vehicle is possible, the engine output will be restricted to restrain any increase in vehicle speed. (Engine output restriction control: See A below.)

Additionally, if the accelerator pedal continues to be depressed, the brakes will be applied automatically to reduce the vehicle speed. (Brake control: See B below.)

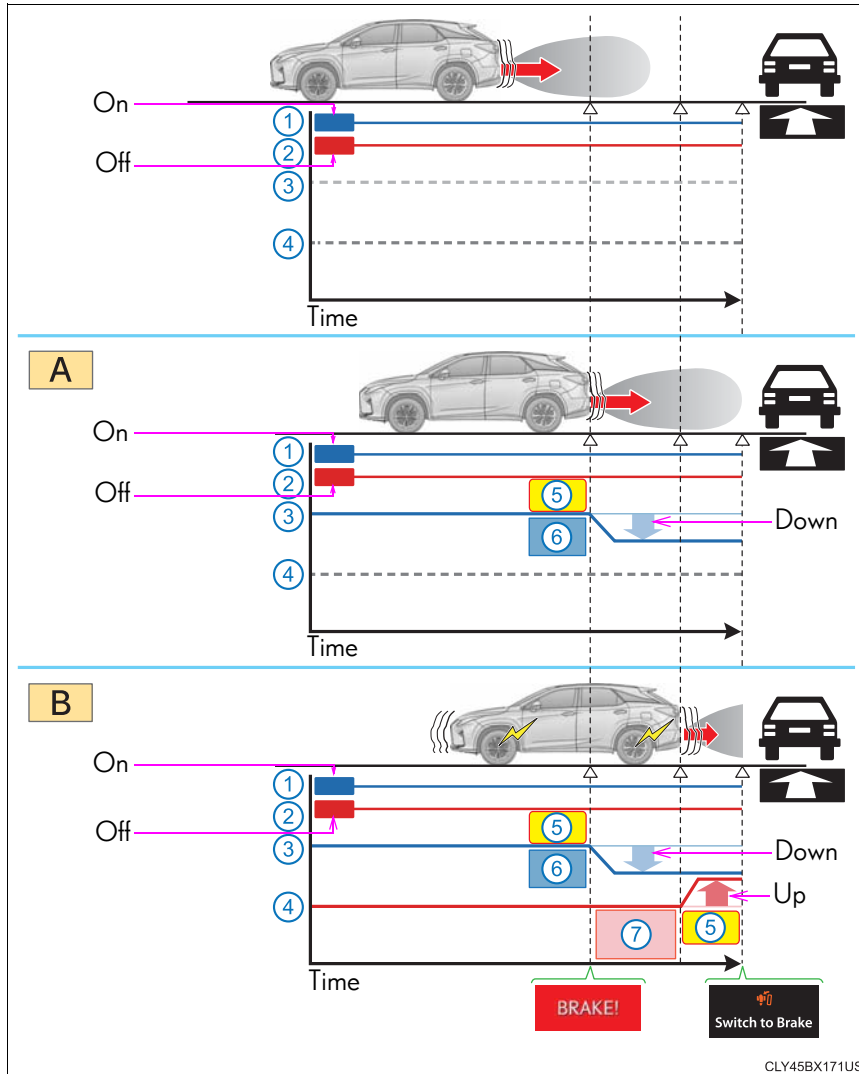

4  
Driving

- ① Accelerator pedal
- ② Brake pedal
- ③ Engine output
- ④ Braking force
- ⑤ Start of control
- ⑥ High possibility of a collision
- ⑦ Extremely high possibility of a collision



**■ The Rear Cross Traffic Auto Brake function will operate when**

The function will operate when the ICS OFF indicator is not illuminated or flashing (→P. 339, 347) and all of the following conditions are met:

- Engine output restriction control
  - The Intelligent Clearance Sonar with Rear Cross Traffic Auto Brake is enabled.
  - The vehicle speed is 10 mph (15 km/h) or less.
  - The shift lever is in R.
  - The system determines that a stronger than normal brake operation is necessary to avoid a collision with an approaching vehicle.
- Brake control
  - Engine output restriction control is operating.
  - The system determines that an emergency brake operation is necessary to avoid a collision with an approaching vehicle.

**■ The Rear Cross Traffic Auto Brake function will stop operating when**

The function will stop operating if any of the following conditions are met:

- Engine output restriction control
  - The Intelligent Clearance Sonar with Rear Cross Traffic Auto Brake is disabled.
  - The collision becomes avoidable with normal brake operation.
  - A vehicle is no longer approaching from the right or left at the rear of the vehicle.
- Brake control
  - The Intelligent Clearance Sonar with Rear Cross Traffic Auto Brake is disabled.
  - Approximately 2 seconds elapse after the vehicle is stopped by brake control.
  - The brake pedal is depressed after the vehicle is stopped by brake control.
  - A vehicle is no longer approaching from the right or left at the rear of the vehicle.

**■ Detection area of the Rear Cross Traffic Auto Brake function**

The detection area of the Rear Cross Traffic Auto Brake function differs from the detection area of the RCTA function (→P. 323).

Therefore, even if the RCTA function detects a vehicle and provides an alert, the Rear Cross Traffic Auto Brake function may not start operating.

**■ If the Rear Cross Traffic Auto Brake function has operated**

If the vehicle is stopped due to operation of the Rear Cross Traffic Auto Brake function, the Rear Cross Traffic Auto Brake function will be disabled and the ICS OFF indicator will illuminate.

#### ■ Re-enabling the Rear Cross Traffic Auto Brake function

To re-enable the Rear Cross Traffic Auto Brake function when it is disabled during operation of the Rear Cross Traffic Auto Brake function, either enable the system again (→P. 339), or turn the engine switch off and then back to IGNITION ON mode.

Additionally, if there is no longer a vehicle approaching from the right or left at the rear of the vehicle, or if the traveling direction of the vehicle changes (such as changing from moving forward to backing up or from backing up to moving forward), the system will be re-enabled automatically.

#### ■ Conditions under which the Rear Cross Traffic Auto Brake function will not detect a vehicle

The Rear Cross Traffic Auto Brake function is not designed to detect the following types of vehicles and/or objects:

- Vehicles approaching from directly behind
- Vehicles backing up in a parking space next to your vehicle
- Vehicles that the sensors cannot detect due to obstructions
- Vehicles which suddenly accelerate or decelerate near your vehicle

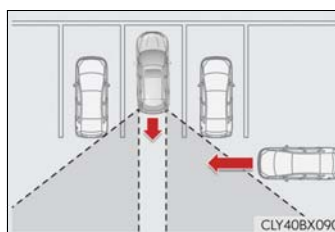

- Guardrails, walls, signs, parked vehicles and similar stationary objects \*
- Small motorcycles, bicycles, pedestrians, etc. \*
- Vehicles moving away from your vehicle
- Vehicles approaching from the parking spaces next to your vehicle \*

\*: Depending on the conditions, detection of a vehicle and/or object may occur.

#### ■ RCTA function buzzer

Regardless of whether the RCTA function is enabled or not (→P. 315), if the Rear Cross Traffic Auto Brake function is enabled and brake control is performed, a buzzer will sound to notify the driver.

■ Situations in which the system may operate even though there is no possibility of a collision

In some situations such as the following, the Rear Cross Traffic Auto Brake function may operate even though there is no possibility of a collision.

- When the parking space faces a street and vehicles are being driven on the street

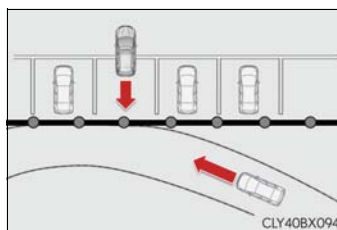

- When a detected vehicle turns while approaching the vehicle

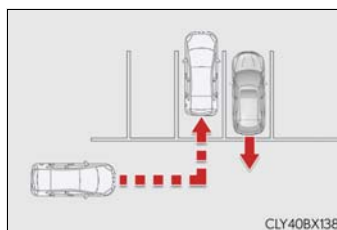

- When a vehicle passes by the side of your vehicle



- When the distance between your vehicle and metal objects, such as a guardrail, wall, sign, or parked vehicle, which may reflect electrical waves toward the rear of the vehicle, is short
- When there are spinning objects near your vehicle such as the fan of an air conditioning unit
- When water is splashed or sprayed toward the rear bumper, such as from a sprinkler

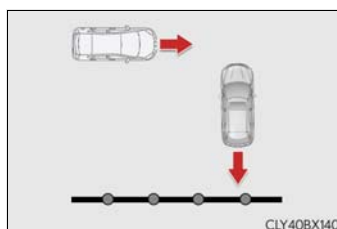

### ■ Situations in which the Rear Cross Traffic Auto Brake function may not operate properly

In some situations such as the following, this function may not operate properly.

- Objects and vehicles which the radar sensors are not designed to detect
  - Stationary objects
  - Vehicles which are moving away from your vehicle
  - Pedestrians, motorcycles, bicycles, etc.\*
  - Objects which are extremely close to a radar sensor
  - Vehicles which are approaching from the right or left at the rear of the vehicle at a traveling speed of less than approximately 5 mph (8 km/h)
  - Vehicles which are approaching from the right or left at the rear of the vehicle at a traveling speed of more than approximately 15 mph (24 km/h)

\*: Depending on conditions, detection of a vehicle and/or object may occur.

- Situations in which the radar sensors may not be able to detect an object
  - When a sensor or the area around a sensor is extremely hot or cold
  - If the rear bumper is covered with ice, snow, dirt, etc.
  - If heavy rain or water strikes the vehicle
  - When the detection area of a radar sensor is obstructed by an adjacent vehicle
  - If the vehicle is significantly tilted
  - If towing eyelets are installed
  - If the suspension has been modified or tires of a size other than specified are installed
  - If the front of the vehicle is raised or lowered due to the carried load
  - If a sticker or an electronic component, such as a backlit license plate (especially fluorescent type), fog lights, a fender pole or wireless antenna is installed near a radar sensor
  - If the orientation of a radar sensor has been changed due to a collision or other impact or removal and installation
  - When multiple vehicles are approaching with only a small gap between each vehicle
  - When a vehicle is approaching at high speed

#### ● Situations in which the radar sensor may not detect a vehicle

- When a vehicle approaches from the right or left at the rear of the vehicle while you are turning while backing up
- When turning while backing up

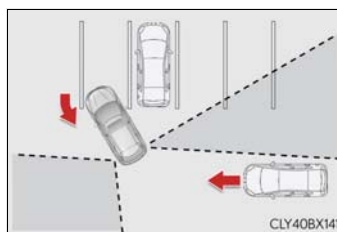

- When backing out of a shallow angle parking spot

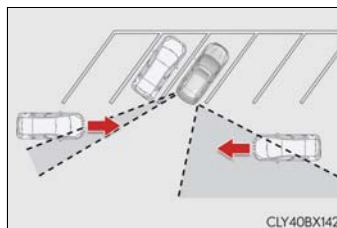

**356** 4-5. Using the driving support systems

- Vehicles that the sensors cannot detect due to obstructions

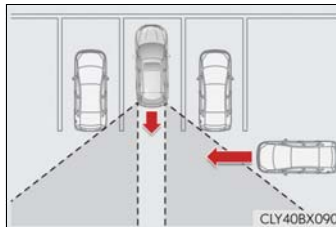

- When backing up on a slope with a sharp change in grade

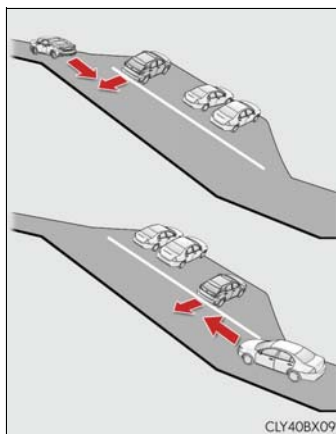

- When a vehicle turns into the detection area

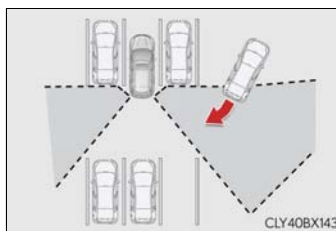

■ Handling the radar sensors  
→P.316

## Lexus parking assist monitor\*

The parking assist monitor assists the driver by displaying an image of the view behind the vehicle while backing up, for example while parking.

The screen illustrations used in this text are intended as examples, and may differ from the image that is actually displayed on the screen.

The rear view image is displayed when the shift lever is in R and the engine switch is in IGNITION ON mode.

The parking assist monitor system will be deactivated when the shift lever is in any position other than R.

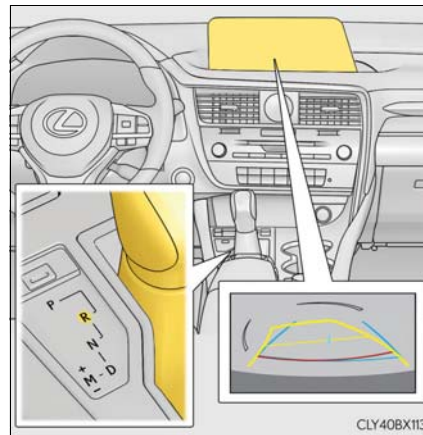

4

Driving

\*: If equipped

### Using the Lexus parking assist monitor

■ **Screen display**

The parking assist monitor screen will be displayed if the shift position is shifted to R while the engine switch is in IGNITION ON mode.

- ① Intuitive parking assist (if equipped)
- ② Rear Cross Traffic Alert (if equipped)

A simplified image is displayed on the upper part of the screen when an obstacle is detected.

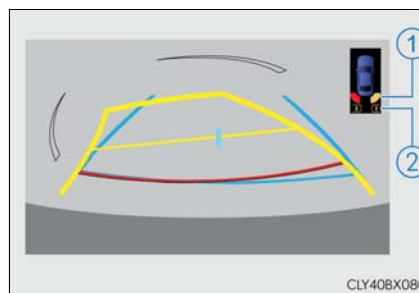

■ **Using the system**

Use any of the following modes.

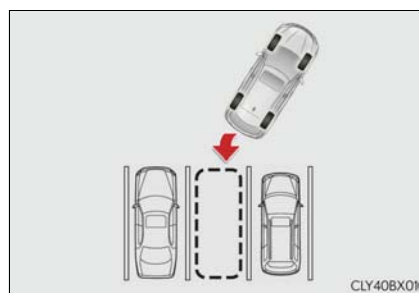

- Estimated course line display mode (→P. 360)

Estimated course lines are displayed which move in accordance with the operation of the steering wheel.

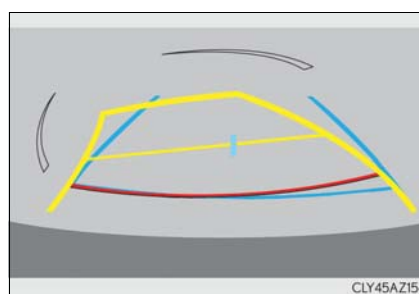

- Parking assist guide line display mode (→P. 362)

The steering wheel return points (parking assist guide lines) are displayed.

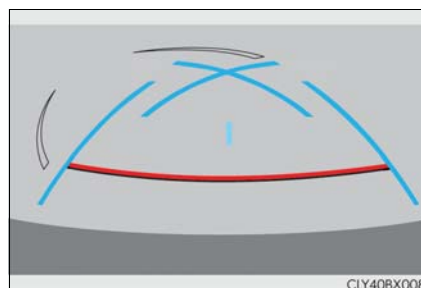

- Distance guide line display mode

Distance guide lines only are displayed.

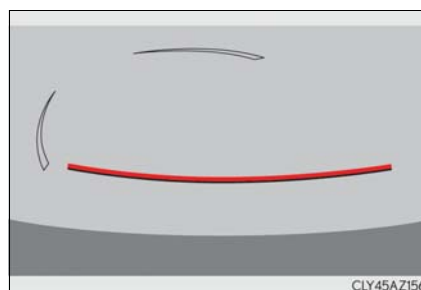

### Switching the display mode

When the shift lever is in any position other than R, the display mode can be changed in the following procedure.

- 1 Press the "MENU" button on the Lexus Display Audio controller/Remote touch, and then select  on the screen.
- 2 Select "Vehicle", and then select "Backup Camera Guide Line Settings" on the screen.
- 3 Select the desired display mode.
  - ① Estimated course line display mode (→P. 360)
  - ② Parking assist guide line display mode (→P. 362)
  - ③ Distance guide line display mode  
Distance guide lines only are displayed.





### Estimated course line display mode

■ Screen description

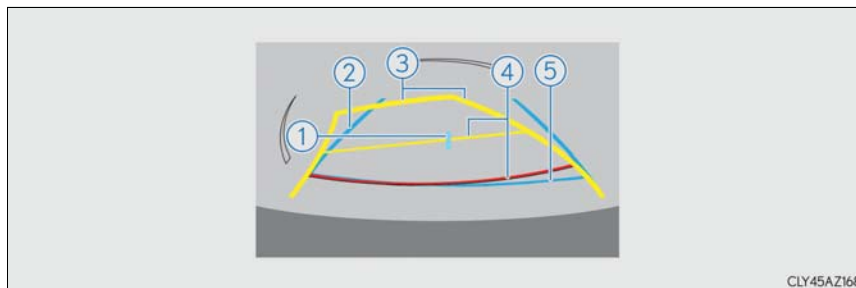

- ① Vehicle center guide line  
The line indicates the estimated vehicle center on the ground.
- ② Vehicle width guide line  
The line indicates a guide path when the vehicle is being backed straight up.  
The displayed width is wider than the actual vehicle width.  
The line aligns with the estimated course lines when the steering wheel is straight.
- ③ Estimated course lines  
The lines show an estimated course when the steering wheel is turned.
- ④ Distance guide line  
The line moves, together with the estimated course lines, in sync with the steering wheel. The line shows points approximately 1.5 ft. (0.5 m) (red) and approximately 3 ft. (1 m) (yellow) from the center of the edge of the bumper.
- ⑤ Distance guide line  
The line shows distance behind the vehicle, a point approximately 1.5 ft. (0.5 m) (blue) from the edge of the bumper.

### ■ Parking operation

When parking in a space which is in the reverse direction to the space described in the procedure below, the steering directions will be reversed.

- 1 Shift the shift lever to R.
- 2 Turn the steering wheel so that the estimated course lines are within the parking space, and back up slowly.
  - ① Parking space
  - ② Estimated course lines

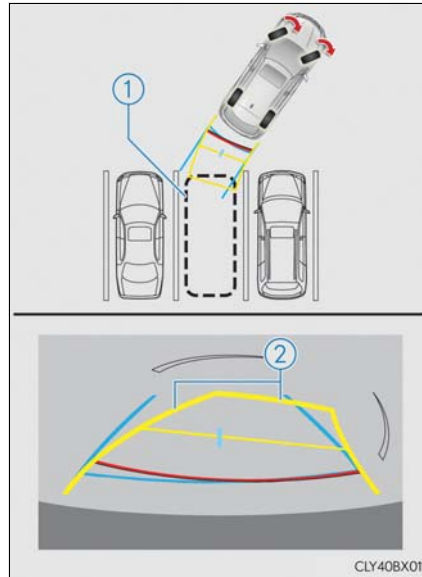

- 3 When the rear position of the vehicle has entered the parking space, turn the steering wheel so that the vehicle width guide lines are within the left and right dividing lines of the parking space.
  - ③ Vehicle width guide line

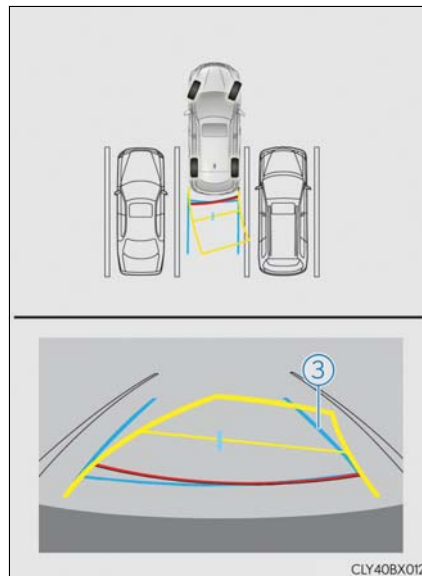

- 4 Once the vehicle width guide lines and the parking space lines are parallel, straighten the steering wheel and back up slowly until the vehicle has completely entered the parking space.
- 5 Stop the vehicle in an appropriate place, and finish parking.

### Parking assist guide line display mode

#### ■ Screen description

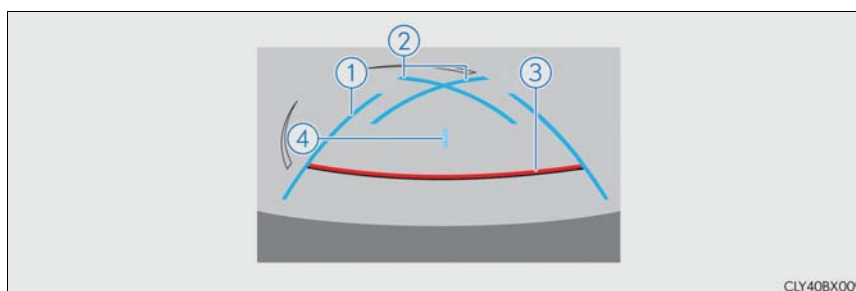

- ① Vehicle width guide lines  
These lines indicate a guide path when the vehicle is being backed straight up. The displayed width is wider than the actual vehicle width.
- ② Parking assist guide lines  
These lines indicate the path of the smallest turn possible behind the vehicle.  
These lines also indicate the approximate position of the steering wheel when parking.
- ③ Distance guide line  
This line (red) indicates points approximately 1.5 ft. (0.5 m) behind the rear bumper of your vehicle.
- ④ Vehicle center guide line  
The line indicates the estimated vehicle center on the ground.

### ■ Parking operation

When parking in a space which is in the reverse direction to the space described in the procedure below, the steering directions will be reversed.

- 1 Shift the shift lever to R.
- 2 Back up until the parking assist guide line meets the edge of the left-hand dividing line of the parking space.
  - ① Parking assist guide line
  - ② Parking space dividing line

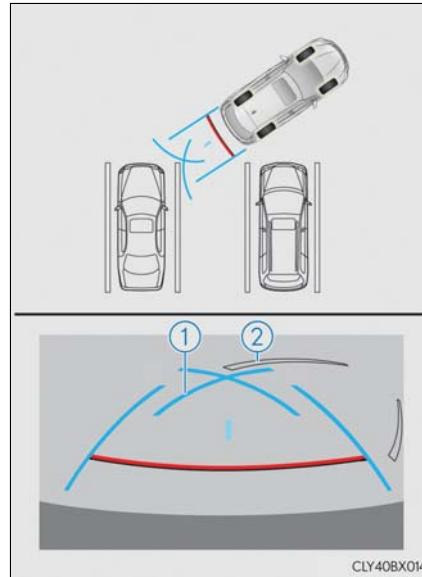

- 3 Turn the steering wheel all the way to the right, and back up slowly.
- 4 Once the vehicle is parallel with the parking space, straighten the steering wheel and back up slowly until the vehicle has completely entered the parking space.
- 5 Stop the vehicle in an appropriate place, and finish parking.

### Lexus parking assist monitor precautions

#### ■ Area displayed on screen

The parking assist monitor displays an image of the view from the bumper of the rear area of the vehicle.

The image of the Lexus parking assist monitor can be adjusted. (Vehicles with a Lexus Display Audio system: →P. 411) (Vehicles with a navigation system: →“NAVIGATION SYSTEM OWNER'S MANUAL”.)

- The area displayed on the screen may vary according to vehicle orientation conditions.
- Objects which are close to either corner of the bumper or under the bumper cannot be seen on the screen.
- The camera uses a special lens. The distance of the image that appears on the screen differs from the actual distance.
- Items which are located higher than the camera may not be displayed on the monitor.
- If your vehicle is equipped with a backlit license plate, it may interfere with the display.

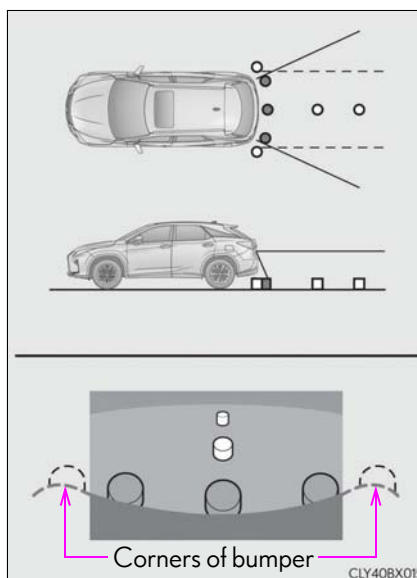

**■ Lexus parking assist monitor camera**

The camera for the parking assist monitor is located above the license plate.

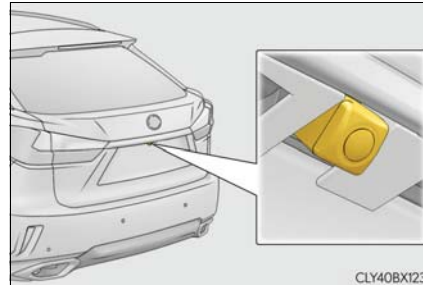
**● Using the camera**

If dirt or foreign matter (such as water droplets, snow, mud etc.) is adhering to the camera, it cannot transmit a clear image. In this case, flush it with a large quantity of water and wipe the camera lens clean with a soft and wet cloth.

**■ Differences between the screen and the actual road**

The distance guide lines and the vehicle width guide lines may not actually be parallel with the dividing lines of the parking space, even when they appear to be so. Be sure to check visually.

The distances between the vehicle width guide lines and the left and right dividing lines of the parking space may not be equal, even when they appear to be so. Be sure to check visually.

The distance guide lines give a distance guide for flat road surfaces. In any of the following situations, there is a margin of error between the guide lines on the screen and the actual distance/course on the road.

- When the ground behind the vehicle slopes up sharply

The distance guide lines will appear to be closer to the vehicle than the actual distance. Because of this, objects will appear to be farther away than they actually are. In the same way, there will be a margin of error between the guidelines and the actual distance/course on the road.

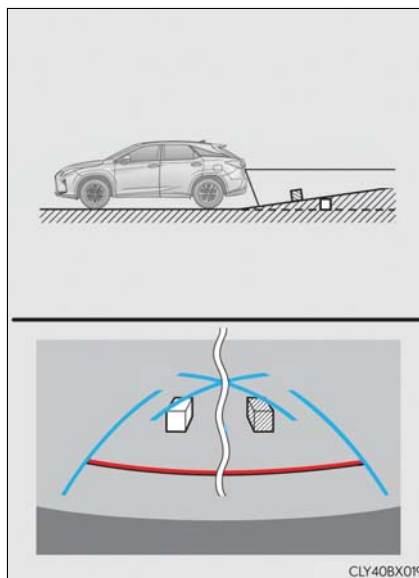

- When the ground behind the vehicle slopes down sharply

The distance guide lines will appear to be further from the vehicle than the actual distance. Because of this, objects will appear to be closer than they actually are. In the same way, there will be a margin of error between the guidelines and the actual distance/course on the road.

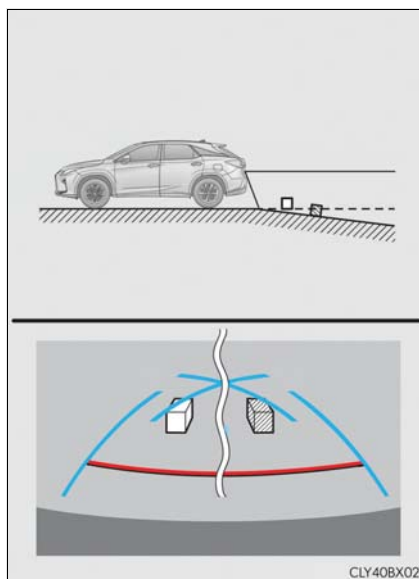

- When any part of the vehicle sags

When any part of the vehicle sags due to the number of passengers or the distribution of the load, there is a margin of error between the guide lines on the screen and the actual distance/course on the road.

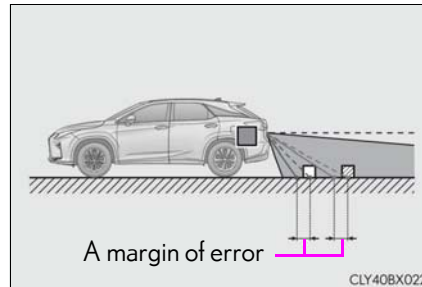

- When approaching three-dimensional objects

The estimated course lines target a flat surfaced objects (such as the road). It is not possible to determine the position of three-dimensional objects (such as vehicles) using the estimated course lines and distance guide lines. When approaching a three-dimensional object that extends outward (such as the flatbed of a truck), be careful of the following.

- Estimated course lines

Visually check the surroundings and the area behind the vehicle. In the case shown in the illustration, the truck appears to be outside of the estimated course lines and the vehicle does not look as if it will hit the truck. However, the rear body of the truck may actually cross over the estimated course lines. In reality if you back up as guided by the estimated course lines, the vehicle may hit the truck.

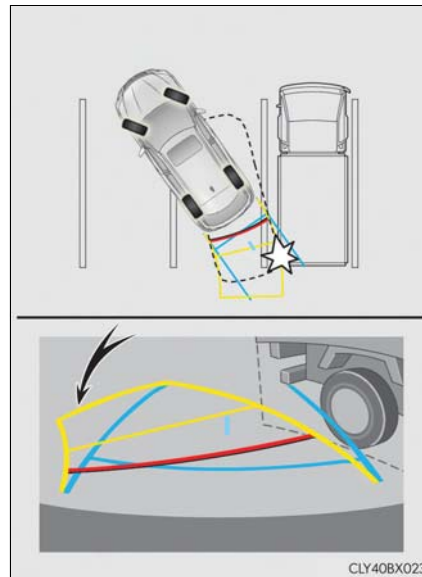



● Distance guidelines

Visually check the surroundings and the area behind the vehicle. On the screen, it appears that a truck is parking at point ②. However, in reality if you back up to point ①, you will hit the truck. On the screen, it appears that ① is closest and ③ is farthest away. However, in reality, the distance to ① and ③ is the same and ② is farther than ① and ③.

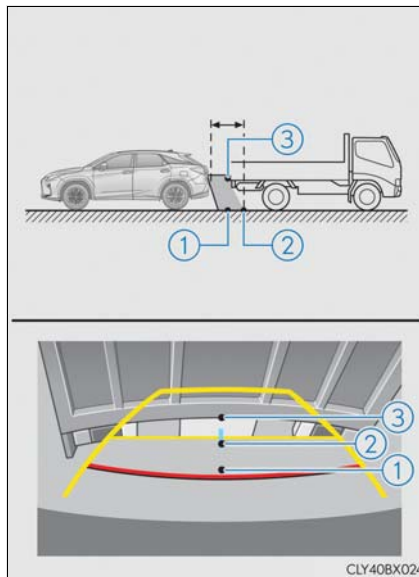

### Things you should know

#### ■ If you notice any symptoms

If you notice any of the following symptoms, refer to the likely cause and the solution, and re-check.

If the symptom is not resolved by the solution, have the vehicle inspected by your Lexus dealer.

Likely cause	Solution
<b>□ The image is difficult to see</b>	
<ul style="list-style-type: none"> <li>• The vehicle is in a dark area</li> <li>• The temperature around the lens is either high or low</li> <li>• The outside temperature is low</li> <li>• There are water droplets on the camera</li> <li>• It is raining or humid</li> <li>• Foreign matter (mud, etc.) is adhering to the camera</li> <li>• There are scratches on the camera</li> <li>• Sunlight or headlights are shining directly into the camera</li> <li>• The vehicle is under fluorescent lights, sodium lights, mercury lights etc.</li> </ul>	<p>If this happens due to these causes, it does not indicate a malfunction. Back up while visually checking the vehicle's surroundings. (Use the monitor again once conditions have been improved.)</p> <p>The image on the Lexus parking assist monitor system screen can be adjusted. (Vehicles with a Lexus Display Audio system: →P. 411) (Vehicles with a navigation system: →"NAVIGATION SYSTEM OWNER'S MANUAL".)</p>
<b>□ The image is blurry</b>	
Dirt or foreign matter (such as water droplets, snow, mud, etc.) is adhering to the camera.	Flush the camera with a large quantity of water and wipe the camera lens clean with a soft and wet cloth.
<b>□ The image is out of alignment</b>	
The camera or surrounding area has received a strong impact.	Have the vehicle inspected by your Lexus dealer.
<b>□ The guide lines are very far out of alignment</b>	
The camera position is out of alignment.	Have the vehicle inspected by your Lexus dealer.
<ul style="list-style-type: none"> <li>• The vehicle is tilted (there is a heavy load on the vehicle, tire pressure is low due to a tire puncture, etc.)</li> <li>• The vehicle is used on an incline.</li> </ul>	<p>If this happens due to these causes, it does not indicate a malfunction. Back up while visually checking the vehicle's surroundings.</p>

**370** 4-5. Using the driving support systems

Likely cause	Solution
<b>❑ The estimated course lines move even though the steering wheel is straight</b>	
There is a malfunction in the signals being output by the steering sensor.	Have the vehicle inspected by your Lexus dealer.
<b>❑ Guide lines are not displayed</b>	
The back door is open.	Close the back door. If this does not resolve the symptom, have the vehicle inspected by your Lexus dealer.
<b>❑ The estimated course lines are not displayed</b>	
<ul style="list-style-type: none"> <li>• The steering wheel has been moved while the battery was being reinstalled.</li> <li>• Battery power is low.</li> <li>• The steering sensor has been reinstalled.</li> <li>• There is a malfunction in the signals being output by the steering sensor.</li> </ul>	Stop the vehicle, and turn the steering wheel as far as it will go to the left and right. If this does not resolve the symptom, have the vehicle inspected by your Lexus dealer.

**⚠ WARNING****■ When using the Lexus parking assist monitor system**

The parking assist monitor is a supplemental device intended to assist the driver when backing up. When backing up, be sure to check visually behind and all around the vehicle before proceeding.

Observe the following precautions to avoid an accident that could result in death or serious injuries.

- Never depend on the parking assist monitor entirely when backing up. The image and the position of the guide lines displayed on the screen may differ from the actual state.  
Use caution, just as you would when backing up any vehicle.
- Be sure to back up slowly, depressing the brake pedal to control vehicle speed.
- If you seem likely to hit nearby vehicles, obstacles, people or mount the shoulder, depress the brake pedal to stop the vehicle.
- The instructions given are only guidelines.  
When and how much to turn the steering wheel will vary according to traffic conditions, road surface conditions, vehicle condition, etc. when parking. It is necessary to be fully aware of this before using the parking assist system.
- When parking, be sure to check that the parking space will accommodate your vehicle before maneuvering into it.
- Do not use the parking assist monitor in the following cases:
  - On icy or slick road surfaces, or in snow
  - When using tire chains or emergency tires
  - When the back door is not closed completely
  - On roads that are not flat or straight, such as curves or slopes.
- In low temperatures, the screen may darken or the image may become faint. The image could distort when the vehicle is moving, or you may become unable to see the image on the screen. Be sure to check direct visually and with the mirrors all around the vehicle before proceeding.
- If the tire sizes are changed, the position of the guide lines displayed on the screen may change.
- The camera uses a special lens. The distances between objects and pedestrians that appear in the image displayed on the screen will differ from the actual distances. (→P. 365)
- Estimated course line display mode: If the steering wheel is straight and the vehicle width guide lines and the estimated course lines are not in alignment, have the vehicle inspected by your Lexus dealer.

 NOTICE

■ **How to use the camera**

- The parking assist monitor may not operate properly in the following cases.
  - If the back of the vehicle is hit, the position and mounting angle of the camera may change.
  - As the camera has a water proof construction, do not detach, disassemble or modify it. This may cause incorrect operation.
  - When cleaning the camera lens, flush the camera with a large quantity of water and wipe it with a soft and wet cloth. Strongly rubbing the camera lens may cause the camera lens to be scratched and unable to transmit a clear image.
  - Do not allow organic solvent, car wax, window cleaner or glass coat to adhere to the camera. If this happens, wipe it off as soon as possible.
  - If the temperature changes rapidly, such as when hot water is poured on the vehicle in cold weather, the system may not operate normally.
  - When washing the vehicle, do not apply intensive bursts of water to the camera or camera area. Doing so may result in the camera malfunctioning.
  - When the camera is used under fluorescent lights, sodium light or mercury light etc., the lights and the illuminated areas may appear to flicker.
- Do not expose the camera to strong impact as this could cause a malfunction. If this happens, have the vehicle inspected by your Lexus dealer as soon as possible.

## Driving mode select switch

The driving modes can be selected to suit driving conditions.

- ▶ Vehicles without Adaptive Variable Suspension System

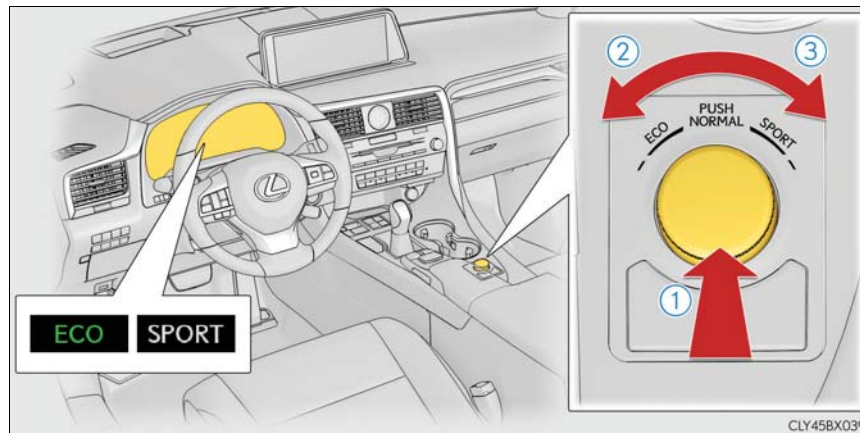

### ① Normal mode

Provides an optimal balance of fuel economy, quietness, and dynamic performance. Suitable for city driving.

Press the switch to change the driving mode to normal mode when Eco drive mode or sport mode is selected.

### ② Eco drive mode

Helps the driver accelerate in an eco-friendly manner and improve fuel economy through moderate throttle characteristics and by controlling the operation of the air conditioning system (heating/cooling).

When not in Eco drive mode, if the driving mode select switch is turned to the left, the Eco drive mode indicator will come on.

### ③ Sport mode

Controls the transmission and engine to provide quick, powerful acceleration. This mode also changes the steering feel, making it suitable for when agile driving response is desired, such as when driving on roads with many curves.

When not in sport mode, if the driving mode select switch is turned to the right, the "SPORT" indicator will come on.

▶ Vehicles with Adaptive Variable Suspension System

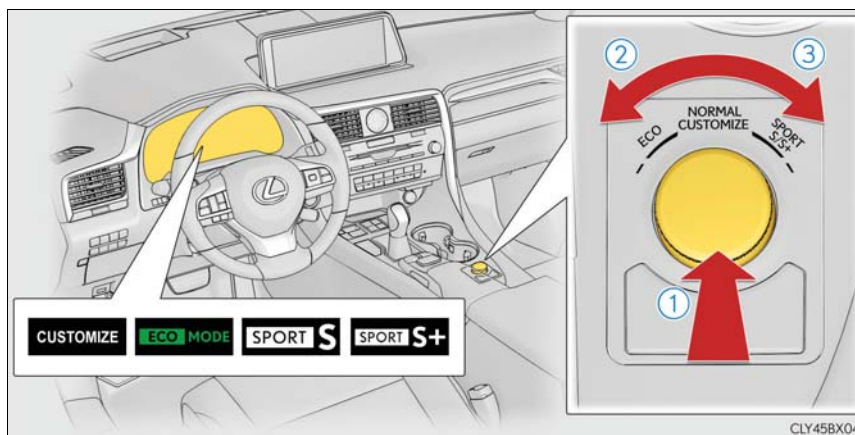

① Normal mode/Customized mode

Normal mode and customized mode are selected by pressing the driving mode select switch. Each time the switch is pressed, the driving mode changes between normal mode and customized mode. When customized mode is selected, the “CUSTOMIZE” indicator will be illuminated.

When Eco drive mode or sport mode is selected, pressing the switch changes the driving mode to normal mode.

- Normal mode

Provides an optimal balance of fuel economy, quietness, and dynamic performance. Suitable for city driving.

- Customized mode

Allows you to drive with the following functions set to your preferred settings.

Customized mode settings can only be changed on the drive mode customization display of the audio system screen.

(Displaying the drive mode customization display: →P. 722)

Function	Setting
Powertrain	Normal
	Power
	Eco
Chassis	Normal
	Sport
Air conditioning system	Normal
	Eco

② Eco drive mode

Helps the driver accelerate in an eco-friendly manner and improve fuel economy through moderate throttle characteristics and by controlling the operation of the air conditioning system (heating/cooling).

When not in Eco drive mode, if the driving mode select switch is turned to the left, the Eco drive mode indicator will come on.

③ Sport mode

• SPORT S mode

Controls the transmission and engine to provide quick, powerful acceleration. This mode is suitable for when agile driving response is desired, such as when driving on roads with many curves.

When not in SPORT S mode, if the driving mode select switch is turned to the right, the "SPORT S" indicator will come on.

• SPORT S+ mode

Helps to ensure steering performance and driving stability by simultaneously controlling the steering and suspension in addition to the transmission and engine. Suitable for sportier driving.

When in SPORT S mode, if the driving mode select switch is turned to the right, the "SPORT S+" indicator will come on.



■ **Operation of the air conditioning system in Eco drive mode**

Eco drive mode controls the heating/cooling operations and fan speed of the air conditioning system to enhance fuel efficiency. To improve air conditioning performance, adjust the fan speed or turn off Eco drive mode.

■ **Automatic deactivation of sport mode and customized mode**

If the engine switch is turned off after driving in sport mode or customized mode, the drive mode will be changed to normal mode.

■ **Driving mode pop-up display (12.3-inch display only)**

When the driving mode is changed, the selected driving mode will be temporarily displayed on the side display. (→P. 500)

## All-wheel drive lock switch (AWD models)

All-wheel drive lock mode can be used when a large amount of drive power needs to be applied to all the wheels, such as when the vehicle gets stuck in mud and you need to free it.

Press the switch.

The torque of the engine is distributed to the rear wheels to the maximum extent possible in accordance with driving conditions.

Pressing the switch again cancels all-wheel drive lock mode and returns the Dynamic Torque Control AWD system to normal mode. (→P. 379)

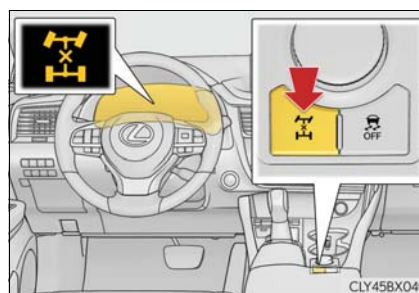

### ■ All-wheel drive lock mode can be operated when

The engine switch is in IGNITION ON mode.

### ■ Automatic release for the all-wheel drive lock mode

- All-wheel drive lock mode is canceled when the brakes are applied to ensure the ABS and VSC systems operate effectively.
- All-wheel drive lock mode is canceled when the vehicle speed exceeds 25 mph (40 km/h).

## Driving assist systems

To keep driving safety and performance, the following systems operate automatically in response to various driving situations. Be aware, however, that these systems are supplementary and should not be relied upon too heavily when operating the vehicle.

### ◆ ABS (Anti-lock Brake System)

Helps to prevent wheel lock when the brakes are applied suddenly, or if the brakes are applied while driving on a slippery road surface

### ◆ Brake assist

Generates an increased level of braking force after the brake pedal is depressed when the system detects a panic stop situation

### ◆ VSC (Vehicle Stability Control)

Helps the driver to control skidding when swerving suddenly or turning on slippery road surfaces.

### ◆ Enhanced VSC (Enhanced Vehicle Stability Control)

Provides cooperative control of the ABS, TRAC, VSC and EPS. Helps to maintain directional stability when swerving on slippery road surfaces by controlling steering performance.

### ◆ Trailer Sway Control

Helps the driver to control trailer sway by selectively applying brake pressure for individual wheels and reducing driving torque when trailer sway is detected.

### ◆ TRAC (Traction Control)

Helps to maintain drive power and prevent the drive wheels from spinning when starting the vehicle or accelerating on slippery roads

### ◆ Hill-start assist control

Helps to reduce the backward movement of the vehicle when starting on an uphill

### ◆ EPS (Electric Power Steering)

Employs an electric motor to reduce the amount of effort needed to turn the steering wheel

---

**◆ Dynamic Torque Control AWD system (AWD models)**

---

Automatically switches from front-wheel drive to all-wheel drive (AWD) according to the driving conditions, helping to ensure reliable handling and stability. Examples of conditions where the system will switch to AWD are when cornering, going uphill, starting off or accelerating, and when the road surface is slippery due to snow, rain, etc.

**◆ Adaptive Variable Suspension System (if equipped)**

---

Controls the damping force of the shock absorber of each wheel according to the road and driving conditions, helping achieve a comfortable ride, excellent driveability and a high level of stability.

If SPORT S+ mode is selected using the driving mode select switch, the damping force will become more suitable for sporty driving. (→P. 374)

**◆ VDIM (Vehicle Dynamics Integrated Management) (if equipped)**

---

Provides integrated control of the ABS, brake assist, TRAC, VSC, hill-start assist control and EPS systems

Helps to maintain vehicle stability when swerving on slippery road surfaces by controlling the brakes and engine output

### When the TRAC/VSC/Trailer Sway Control systems are operating

The slip indicator light will flash while the TRAC/VSC/Trailer Sway Control systems are operating.



### Disabling the TRAC system

If the vehicle gets stuck in mud, dirt or snow, the TRAC system may reduce power from the engine to the wheels. Pressing  to turn the system off may make it easier for you to rock the vehicle in order to free it.

To turn the TRAC system off, quickly press and release .

The "Traction Control Turned Off" will be shown on the multi-information display. Press  again to turn the system back on.

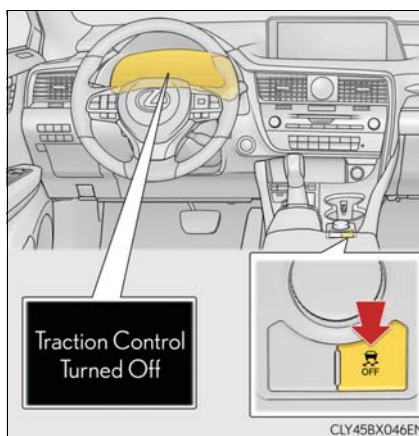

### ■ Turning off both TRAC, VSC and Trailer Sway Control systems

To turn the TRAC, VSC and Trailer Sway Control systems off, press and hold  for more than 3 seconds while the vehicle is stopped.

The VSC OFF indicator light will come on and the "Traction Control Turned Off" will be shown on the multi-information display.\*

Press  again to turn the systems back on.

\*: On vehicles with PCS (Pre-Collision System), pre-collision brake assist and pre-collision braking will also be disabled. The PCS warning light will come on and a message will be displayed on the multi-information display. (→P. 290)

### ■ When the message is displayed on the multi-information display showing that TRAC has been disabled even if has not been pressed

TRAC cannot be operated. Contact your Lexus dealer.

### ■ Operating conditions of hill-start assist control

When the following four conditions are met, the hill-start assist control will operate:

- The shift lever is in a position other than P or N (when starting off forward/backward on an upward incline).
- The vehicle is stopped
- The accelerator pedal is not depressed
- The parking brake is not engaged

### ■ Automatic system cancelation of hill-start assist control

The hill-start assist control will turn off in any of the following situations:

- The shift lever is shifted to P or N
- The accelerator pedal is depressed
- The parking brake is engaged
- 2 seconds at maximum elapsed after the brake pedal is released

### ■ Sounds and vibrations caused by the ABS, brake assist, VSC, Trailer Sway Control, TRAC and hill-start assist control systems

- A sound may be heard from the engine compartment when the brake pedal is depressed repeatedly, when the engine is started or just after the vehicle begins to move. This sound does not indicate that a malfunction has occurred in any of these systems.
- Any of the following conditions may occur when the above systems are operating. None of these indicates that a malfunction has occurred.
  - Vibrations may be felt through the vehicle body and steering.
  - A motor sound may be heard also after the vehicle comes to a stop.
  - The brake pedal may pulsate slightly after the ABS is activated.
  - The brake pedal may move down slightly after the ABS is activated.

### ■ EPS operation sound

When the steering wheel is operated, a motor sound (whirring sound) may be heard. This does not indicate a malfunction.

■ **Automatic reactivation of TRAC, Trailer Sway Control and VSC systems**

After turning the TRAC, Trailer Sway Control and VSC systems off, the systems will be automatically re-enabled in the following situations:

- When the engine switch is turned off
- If only the TRAC system is turned off, the TRAC will turn on when vehicle speed increases

If both the TRAC and VSC systems are turned off, automatic re-enabling will not occur when vehicle speed increases.

■ **Reduced effectiveness of the EPS system**

The effectiveness of the EPS system is reduced to prevent the system from overheating when there is frequent steering input over an extended period of time. The steering wheel may feel heavy as a result. Should this occur, refrain from excessive steering input or stop the vehicle and turn the engine off. The EPS system should return to normal within 10 minutes.

 **WARNING**

■ **The ABS does not operate effectively when**

- The limits of tire gripping performance have been exceeded (such as excessively worn tires on a snow covered road).
- The vehicle hydroplanes while driving at high speed on wet or slick roads.

■ **Stopping distance when the ABS is operating may exceed that of normal conditions**

The ABS is not designed to shorten the vehicle's stopping distance. Always maintain a safe distance from the vehicle in front of you, especially in the following situations:

- When driving on dirt, gravel or snow-covered roads
- When driving with tire chains
- When driving over bumps on the road
- When driving over roads with potholes or uneven surfaces

■ **TRAC/VSC may not operate effectively when**

Directional control and power may not be achievable while driving on slippery road surfaces, even if the TRAC/VSC system is operating. Drive the vehicle carefully in conditions where stability and power may be lost.

**⚠ WARNING**

- **Hill-start assist control does not operate effectively when**
  - Do not overly rely on hill-start assist control. Hill-start assist control may not operate effectively on steep inclines and roads covered with ice.
  - Unlike the parking brake, hill-start assist control is not intended to hold the vehicle stationary for an extended period of time. Do not attempt to use hill-start assist control to hold the vehicle on an incline, as doing so may lead to an accident.
- **When the TRAC/VSC/Trailer Sway Control is activated**

The slip indicator light flashes. Always drive carefully. Reckless driving may cause an accident. Exercise particular care when the indicator light flashes.
- **When the TRAC/VSC/Trailer Sway Control systems are turned off**

Be especially careful and drive at a speed appropriate to the road conditions. As these are the systems to help ensure vehicle stability and driving force, do not turn the TRAC/VSC/Trailer Sway Control systems off unless necessary.

Trailer Sway Control is part of the VSC system and will not operate if VSC is turned off or experiences a malfunction.
- **Replacing tires**

Make sure that all tires are of the specified size, brand, tread pattern and total load capacity. In addition, make sure that the tires are inflated to the recommended tire inflation pressure level.

The ABS, TRAC, Trailer Sway Control and VSC systems will not function correctly if different tires are installed on the vehicle.

Contact your Lexus dealer for further information when replacing tires or wheels.
- **Handling of tires and the suspension**

Using tires with any kind of problem or modifying the suspension will affect the driving assist systems, and may cause a system to malfunction.
- **Trailer Sway Control precaution**

The Trailer Sway Control system is not able to reduce trailer sway in all situations. Depending on many factors such as the conditions of the vehicle, trailer, road surface, and driving environment, the Trailer Sway Control system may not be effective. Refer to your trailer owner's manual for information on how to tow your trailer properly.
- **If trailer sway occurs**

Observe the following precautions.

Failing to do so may cause death or serious injury.

  - Firmly grip the steering wheel. Steer straight ahead.  
Do not try to control trailer sway by turning the steering wheel.
  - Begin releasing the accelerator pedal immediately but very gradually to reduce speed.  
Do not increase speed. Do not apply vehicle brakes.

If you make no extreme correction with the steering or brakes, your vehicle and trailer should stabilize. (→P. 226)



## Winter driving tips

Carry out the necessary preparations and inspections before driving the vehicle in winter. Always drive the vehicle in a manner appropriate to the prevailing weather conditions.

### Pre-winter preparations

- Use fluids that are appropriate to the prevailing outside temperatures.
  - Engine oil
  - Engine coolant
  - Washer fluid
- Have a service technician inspect the condition of the battery.
- Have the vehicle fitted with four snow tires or purchase a set of tire chains for the front tires.

Ensure that all tires are of the specified size and the same brand, and that chains match the size of the tires.

### Before driving the vehicle

Perform the following according to the driving conditions:

- Do not try to forcibly open a window or move a wiper that is frozen. Pour warm water over the frozen area to melt the ice. Wipe away the water immediately to prevent it from freezing.
- To ensure proper operation of the climate control system fan, remove any snow that has accumulated on the air inlet vents in front of the windshield.
- Check for and remove any excess ice or snow that may have accumulated on the exterior lights, vehicle's roof, chassis, around the tires or on the brakes.
- Remove any snow or mud from the bottom of your shoes before getting in the vehicle.

### When driving the vehicle

Accelerate the vehicle slowly, keep a safe distance between you and the vehicle ahead, and drive at a reduced speed suitable to road conditions.

### When parking the vehicle

- Park the vehicle and move the shift lever to P without setting the parking brake. The parking brake may freeze up, preventing it from being released. If the vehicle is parked without setting the parking brake, make sure to block the wheels.

Failure to do so may be dangerous because it may cause the vehicle to move unexpectedly, possibly leading to an accident.

When the parking brake is in automatic mode, release the parking brake after shifting the shift lever to P. (→P. 247)

- If the vehicle is parked without setting the parking brake, confirm that the shift lever cannot be moved out of P\*.

\*: The shift lever will be locked if it is attempted to be shifted from P to any other position without depressing the brake pedal. If the shift lever can be shifted from P, there may be a problem with the shift lock system. Have the vehicle inspected by your Lexus dealer immediately.

4

Driving

### Selecting tire chains

Use the correct tire chain size when mounting the tire chains. Chain size is regulated for each tire size.

Side chain:

- ① 0.12 in. (3 mm) in diameter
- ② 0.43 in. (10.8 mm) in width
- ③ 0.98 in. (25 mm) in length

Cross chain:

- ④ 0.15 in. (3.9 mm) in diameter
- ⑤ 0.54 in. (13.8 mm) in width
- ⑥ 1.00 in. (25.3 mm) in length

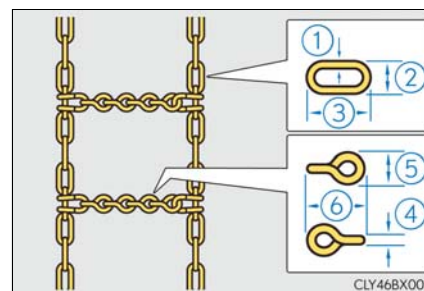

### Regulations on the use of tire chains

Regulations regarding the use of tire chains vary depending on location and type of road. Always check local regulations before installing chains.

### Windshield wipers

To enable the windshield wipers to be lifted when heavy snow or icy conditions are expected, change the rest position of the windshield wipers from the retracted position below the hood to the service position using the wiper lever. (→P. 265)

#### ■ Tire chain installation

Observe the following precautions when installing and removing chains:

- Install and remove tire chains in a safe location.
- Install tire chains on the front tires only. Do not install tire chains on the rear tires.
- Install tire chains on front tires as tightly as possible. Retighten chains after driving 1/4 - 1/2 mile (0.5 - 1.0 km).
- Install tire chains following the instructions provided with the tire chains.

#### WARNING

##### ■ Driving with snow tires

Observe the following precautions to reduce the risk of accidents.

Failure to do so may result in a loss of vehicle control and cause death or serious injury.

- Use tires of the specified size.
- Maintain the recommended level of air pressure.
- Do not drive in excess of 75 mph (120 km/h), regardless of the type of snow tires being used.
- Use snow tires on all, not just some wheels.

##### ■ Driving with tire chains

Observe the following precautions to reduce the risk of accidents.

Failure to do so may result in the vehicle being unable to be driven safely, and may cause death or serious injury.

- Do not drive in excess of the speed limit specified for the tire chains being used, or 30 mph (50 km/h), whichever is lower.
- Avoid driving on bumpy road surfaces or over potholes.
- Avoid sudden acceleration, abrupt steering, sudden braking and shifting operations that cause sudden engine braking.
- Slow down sufficiently before entering a curve to ensure that vehicle control is maintained.
- Do not use the LKA (Lane-Keeping Assist) system.

 NOTICE**■ Repairing or replacing snow tires**

Request repairs or replacement of snow tires from Lexus dealers or legitimate tire retailers.

This is because the removal and attachment of snow tires affects the operation of the tire pressure warning valves and transmitters.

**■ Fitting tire chains**

The tire pressure warning valves and transmitters may not function correctly when tire chains are fitted.

## Utility vehicle precautions

This vehicle belongs to the utility vehicle class, which has higher ground clearance and narrower tread in relation to the height of its center of gravity.

### Utility vehicle feature

- Specific design characteristics give it a higher center of gravity than ordinary passenger cars. This vehicle design feature causes this type of vehicle to be more likely to rollover. And, utility vehicles have a significantly higher rollover rate than other types of vehicles.
- An advantage of the higher ground clearance is a better view of the road allowing you to anticipate problems.
- It is not designed for cornering at the same speeds as ordinary passenger cars any more than low-slung sports cars are designed to perform satisfactorily under off-road conditions. Therefore, sharp turns at excessive speeds may cause the vehicle to rollover.

### WARNING

#### ■ Utility vehicle precautions

Always observe the following precautions to minimize the risk of death, serious injury or damage to your vehicle:

- In a rollover crash, an unbelted person is significantly more likely to die than a person wearing a seat belt. Therefore, the driver and all passengers should always fasten their seat belts.
- Avoid sharp turns or abrupt maneuvers, if at all possible.  
Failure to operate this vehicle correctly may result in loss of control or vehicle rollover causing death or serious injury.
- Loading cargo on the roof luggage carrier will make the center of the vehicle gravity higher. Avoid high speeds, sudden starts, sharp turns, sudden braking or abrupt maneuvers, otherwise it may result in loss of control or vehicle rollover due to failure to operate this vehicle correctly.
- Always slow down in gusty crosswinds. Because of its profile and higher center of gravity, your vehicle is more sensitive to side winds than an ordinary passenger car. Slowing down will allow you to have better control.
- Do not drive horizontally across steep slopes. Driving straight up or straight down is preferred. Your vehicle (or any similar off-road vehicle) can tip over sideways much more easily than forward or backward.

### Off-road driving

Your vehicle is not designed to be driven off-road. However, in the event that off-road driving cannot be avoided, please observe the following precautions to help avoid the areas prohibited to vehicles.

- Drive your vehicle only in areas where off-road vehicles are permitted to travel.
- Respect private property. Get owner's permission before entering private property.
- Do not enter areas that are closed. Honor gates, barriers and signs that restrict travel.
- Stay on established roads. When conditions are wet, driving techniques should be changed or travel delayed to prevent damage to roads.

#### ■ Additional information for off-road driving

- ▶ For owners in U.S. mainland, Hawaii and Puerto Rico:

To obtain additional information pertaining to driving your vehicle off-road, consult the following organizations.

- State and Local Parks and Recreation Departments
- State Motor Vehicle Bureau
- Recreational Vehicle Clubs
- U.S. Forest Service and Bureau of Land Management

 **WARNING****■ Off-road driving precautions**

Always observe the following precautions to minimize the risk of death, serious injury or damage to your vehicle:

- Drive carefully when off the road. Do not take unnecessary risks by driving in dangerous places.
- Do not grip the steering wheel spokes when driving off-road. A bad bump could jerk the wheel and injure your hands. Keep both hands and especially your thumbs on the outside of the rim.
- Always check your brakes for effectiveness immediately after driving in sand, mud, water or snow.
- After driving through tall grass, mud, rock, sand, rivers, etc., check that there is no grass, bush, paper, rags, stone, sand, etc. adhering or trapped on the underbody. Clear off any such matter from the underbody. If the vehicle is used with these materials trapped or adhering to the underbody, a breakdown or fire could occur.
- When driving off-road or in rugged terrain, do not drive at excessive speeds, jump, make sharp turns, strike objects, etc. This may cause loss of control or vehicle rollover causing death or serious injury. You are also risking expensive damage to your vehicle's suspension and chassis.

 **NOTICE****■ To prevent water damage**

Take all necessary safety measures to ensure that water damage to the engine or other components does not occur.

- Water entering the engine air intake will cause severe engine damage.
- Water entering the automatic transmission will cause deterioration in shift quality, locking up of your transmission accompanied by vibration, and ultimately damage.
- Water can wash the grease from wheel bearings, causing rusting and premature failure, and may also enter the differential, transmission and transfer (AWD models only) case, reducing the gear oil's lubricating qualities.

**■ When you drive through water**

If driving through water, such as when crossing shallow streams, first check the depth of the water and the bottom of the riverbed for firmness. Drive slowly and avoid deep water.

**■ Inspection after off-road driving**

- Sand and mud that has accumulated around brake discs may affect braking efficiency and may damage brake system components.
- Always perform a maintenance inspection after each day of off-road driving that has taken you through rough terrain, sand, mud, or water. For scheduled maintenance information, refer to the "Warranty and Services Guide/Owner's Manual Supplement/Scheduled Maintenance".





**5-1. Basic Operations**

Lexus Display Audio system .....	394
Steering wheel audio switches.....	400
Mobile Assistant.....	401
USB/AUX ports .....	403

**5-2. Setup**

Setup menu .....	406
General settings.....	407
Voice settings.....	410
Display settings.....	411

**5-3. Using the audio system**

Selecting the audio source .....	412
Optimal use of the audio system .....	413
Audio settings .....	414
Audio menu screen operation .....	417

**5-4. Using the radio**

Radio operation.....	420
----------------------	-----

**5-5. Playing an audio CD and MP3/WMA/AAC discs**

CD player operation .....	427
---------------------------	-----

## Lexus Display Audio system

### 5

- 5-6. Using an external device**
  - Listening to an iPod.....434
  - Using USB memory device..... 438
  - Using the AUX port .....442
- 5-7. Connecting Bluetooth®**
  - Steps for using Bluetooth® devices.....443
  - Registering a Bluetooth® device.....445
  - Selecting a Bluetooth® device.....446
  - Connecting a Bluetooth® audio player.....447
  - Connecting a Bluetooth® phone ..... 448
  - Displaying a Bluetooth® device details .....449
  - Detailed Bluetooth® settings.....450
- 5-8. Bluetooth® Audio**
  - Listening to Bluetooth® Audio.....453
- 5-9. Bluetooth® Phone**
  - Using a Bluetooth® Phone.....455
  - Making a call.....457
  - Receiving a call .....460
  - Speaking on the phone.....461
  - Using a Bluetooth® phone message.....463
  - Using the steering wheel switches.....465
  - Bluetooth® phone settings .....466
- 5-10. Phonebook**
  - Contact settings .....468
  - Messaging setting.....471
- 5-11. Bluetooth®**
  - What to do if.. (Troubleshooting).....472
  - Bluetooth® .....476
- 5-12. Other function**
  - "Information" screen.....482
  - USB photo .....484
  - Weather information.....486
  - Voice command system .....487

## Lexus Display Audio system \*

Use the following buttons to start listening to the audio system.

### Lexus Display Audio operation buttons

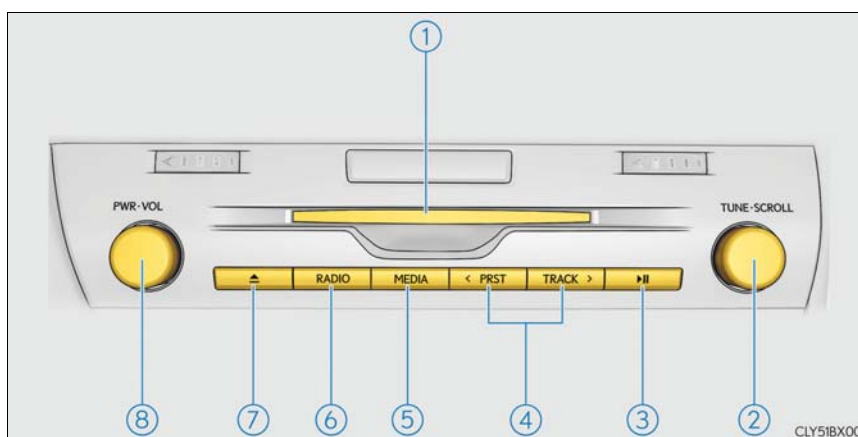

- ① Disc slot
- ② “TUNE•SCROLL” knob  
Select a radio station band, track or file.
- ③ Except radio and A/V mode: Pause or resume playing a track or file.  
Radio and A/V mode: Turn mute on/off.
- ④ Select preset radio stations, or access a desired track or file.
- ⑤ Display the media top screen.
- ⑥ Display the radio top screen.
- ⑦ Eject a disc.
- ⑧ “PWR•VOL” knob  
Press to turn the audio system on/off, and turn to adjust the volume.

\*: If equipped

### ■ “Menu” screen

To display the “Menu” screen, press the “MENU” button on the Lexus Display Audio controller.



Button	Function
“Radio”	Display the radio top screen (→P. 420)
“Media”	Display the media top screen (→P. 427, 434, 438, 442, 447)
“Climate”	Display the air conditioning control screen (→P. 506, 508)
“Phone”	Display the phone top screen (→P. 455)
“Connected Navi” <sup>*</sup>	If a turn-by-turn navigation application has been downloaded to a connected phone, the application will be displayed and can be used.
“Info”	Display the “Information” screen (→P. 482)
“Setup”	Display the “Setup” screen (→P. 406)
“Display”	Display the display settings screen (→P. 411)

<sup>\*</sup>: Available in the 48 states, D.C. and Alaska

### Lexus Display Audio controller

By using the Lexus Display Audio controller, you can control the audio system, hands-free system, etc.

- ① Display the "Source" screen or audio top screen (→P. 412)
- ② Display the "Menu" screen (→P. 395)
- ③ Back button  
Display the previous screen
- ④ Turn or move the controller to select a function and number.

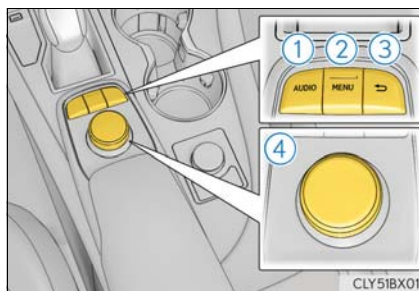

Move the controller to display the left or right side of the screen.

Push the controller to enter the selected function and number.

#### ■ Using the Lexus Display Audio controller

- ① Select: Turn or move the controller.
- ② Enter: Push the controller.

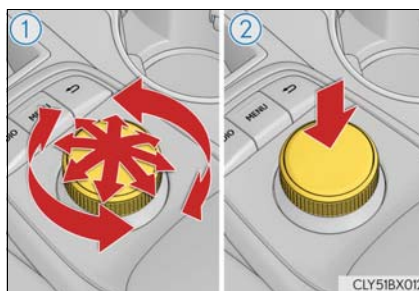

**Basic screen operation**

When a list is displayed, use the appropriate button to scroll through the list.

- ① Select the list by turning the controller.
- ② Return to the previous screen.
- ③ Indicator turns on when you can move the controller left to view additional screen text.
- ④ Indicator turns on when you can move the controller right to view additional screen text.

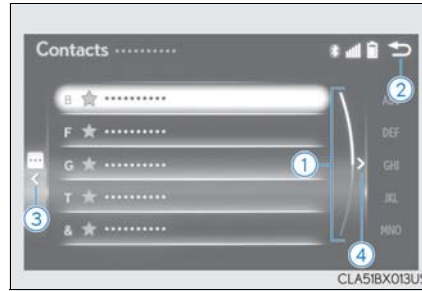

## Inputting letters and numbers

### ■ Input mode

Letters and numbers are inputted via the screen.

- ① Turn the controller to select the desired character and press the controller to input the character.
- ② When this indicator is shown, you can change input fields by moving the controller forward.
- ③ When this indicator is shown, you can change character types by moving the controller to the right and then selecting the desired character type.
- ④ Select to erase characters one by one. Select and hold to erase all characters.
- ⑤ Select to complete data input.

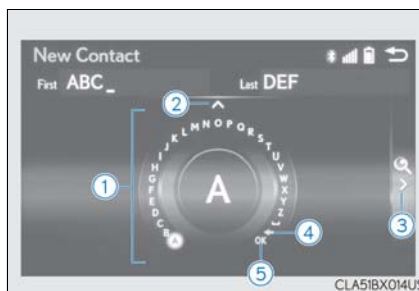

### ■ Input field mode

When in the input field you can move the cursor to the desired position.

- ① Turn the controller to move the cursor left or right.
- ② When this indicator is shown, you can move the cursor to the right input field by moving the controller to the right.
- ③ When this indicator is shown, you can move the cursor to the left input field by moving the controller to the left.
- ④ When this indicator is shown, you can change to input mode by moving the controller backward.

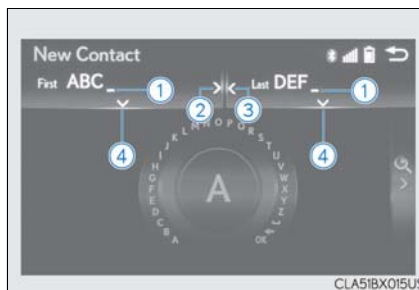

#### ■ When using the screen

- Under extremely cold conditions, the Lexus Display Audio controller may react slowly.
- If the screen is cold, the display may be dark, or the system may seem to be operating slightly slower than normal.
- The screen may seem dark and hard to see when viewed through sunglasses. Change your angle of viewing, adjust the display on the “Display” screen (→P. 411) or remove your sunglasses.

#### ■ Using cellular phones

Interference may be heard through the audio system’s speakers if a cellular phone is being used inside or close to the vehicle while the audio system is operating.

#### WARNING

##### ■ Using the Lexus Display Audio controller

Be careful when touching the Lexus Display Audio controller in extreme temperatures as it may become very hot or cold due to the temperature inside the vehicle.

##### ■ Laser product

- CAUTION  
USE OF CONTROL OR ADJUSTMENT OR PERFORMANCE OF PROCEDURES OTHER THAN THOSE SPECIFIED HEREIN MAY RESULT IN HAZARDOUS RADIATION EXPOSURE.
- CAUTION  
THE USE OF OPTICAL INSTRUMENTS WITH THIS PRODUCT WILL INCREASE EYE HAZARD.

#### NOTICE

##### ■ To prevent Lexus Display Audio controller malfunction

- Do not allow the Lexus Display Audio controller to come into contact with food, liquid, stickers or lit cigarettes as doing so may cause it to change color, emit a strange odor or stop functioning.
- Do not subject the Lexus Display Audio controller to excessive pressure or strong impact as the controller may bend or break off.

##### ■ To prevent battery discharge

Do not leave the audio system on longer than necessary when the engine is off.

##### ■ To avoid damaging the audio system

Take care not to spill drinks or other fluids on the audio system.



## Steering wheel audio switches

Some audio features can be controlled using the switches on the steering wheel.

Operation may differ depending on the type of audio system or navigation system. For details, refer to the manual provided with the audio system or navigation system.

### Operating the audio system using the steering wheel switches

- ① Volume switch
  - Increases/decreases volume
  - Press and hold: Continuously increases/decreases volume
- ② Radio mode:
  - Press: Select a radio station
  - Press and hold: Seek up/down

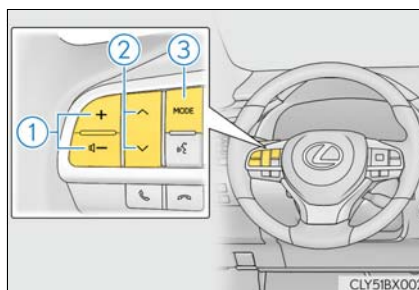

CD, MP3/WMA/AAC disc, Bluetooth<sup>®</sup>, iPod or USB mode:

- Press: Select a track/file/video
  - Press and hold: Quickly move up/down through tracks/files/videos.
- ③ "MODE" switch
    - Turns the power on, selects audio source
    - Press and hold this switch to mute or pause the current operation. To cancel the mute or pause, press and hold.

#### WARNING

##### To reduce the risk of an accident

Exercise care when operating the audio switches on the steering wheel.

## Mobile Assistant

The Mobile Assistant feature will activate Apple's Siri® Eyes Free mode via the steering wheel switches. To operate the Mobile Assistant, a compatible cellular phone must be registered and connected to this system via Bluetooth®. (→P. 443)

- 1 Press and hold the off hook switch until you hear the beeps that indicate the system is listening.

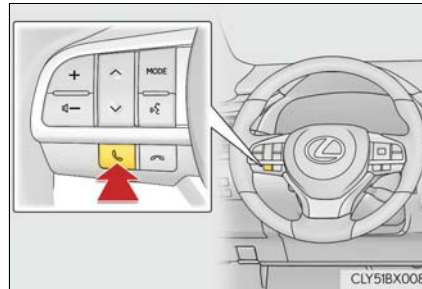

- 2 The Mobile Assistant can be used only when the neighboring screen is displayed.

To cancel the Mobile Assistant, select "Cancel", or press and hold the off hook switch.

To restart the Mobile Assistant for additional commands, press the off hook switch. Mobile Assistant can only be restarted after the system responds to a voice command. After some phone and music commands, the Mobile Assistant feature will automatically end to complete the requested action.

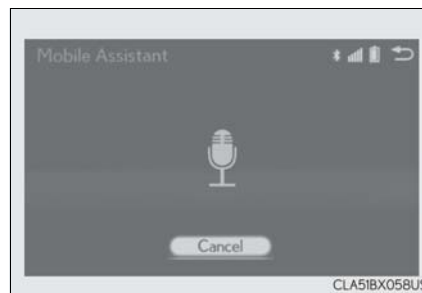

**■ Adjusting the volume**

The volume of the Mobile Assistant can be adjusted using the “PWR·VOL” knob or steering wheel volume switches. The Mobile Assistant and phone call volumes are synchronized.

**■ Microphone**

It is not necessary to speak directly into the microphone when using the Mobile Assistant.

- Wait for the listening beeps before using the Mobile Assistant.
- The Mobile Assistant may not recognize commands in the following situations:
  - When spoken too quickly.
  - When spoken at a low or high volume.
  - When the roof or windows are open.
  - When passengers are talking while the Mobile Assistant is being used.
  - When the air conditioning system’s fan speed is set high.
  - When the air conditioning vents are turned toward the microphone.

**■ Mobile Assistant precautions**

- The available features and functions may vary based on the iOS version installed on the connected device.
- Some Siri features are limited in Eyes Free mode. If you attempt to use an unavailable function, Siri will inform you that the function is not available.
- If Siri is not enabled on the cellular phone connected via Bluetooth<sup>®</sup>, an error message will be displayed on the screen.
- While a phone call is active, the Mobile Assistant cannot be used.
- If using the navigation feature of the cellular phone, ensure the active audio source is Bluetooth<sup>®</sup> audio or iPod in order to hear turn by turn direction prompts.

## USB/AUX ports

Connect an iPod, USB memory device or portable audio player to the USB/AUX port as indicated below. Select “iPod”, “USB”, “AUX” or “External” on the audio source selection screen and the device can be operated via Lexus Display Audio system.

### Connecting using the USB/AUX port

- 1 Press the knob.

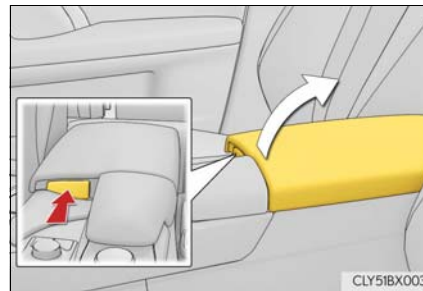

- 2 Open the cover.

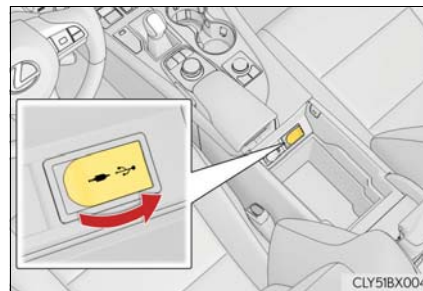

#### ■ iPod

Open the cover and connect an iPod using an iPod cable.

Turn on the power of the iPod if it is not turned on.

#### ■ USB memory

Open the cover and connect the USB memory device.

Turn on the power, if applicable, of the USB memory device if it is not turned on.

#### ■ Portable audio player

Open the cover and connect the portable audio player.

Turn on the power of the portable audio player if it is not turned on.

### Using a 4-pole AUX cable

To view a video on an iPod video or VTR, it is necessary to use a 4-pole AUX cable to connect the portable audio device.

When connecting a portable audio device to the AUX port, use a 4-pole AUX cable with a plug that matches the exact layout shown in the illustration.

- ① Connected device (portable audio device, etc.)
- ② Left audio
- ③ Right audio
- ④ Ground
- ⑤ Video

When using an iPod video, a cable that has a 4-pole AUX plug and a USB connector is necessary. Connect the plug and connector to the AUX and USB ports.

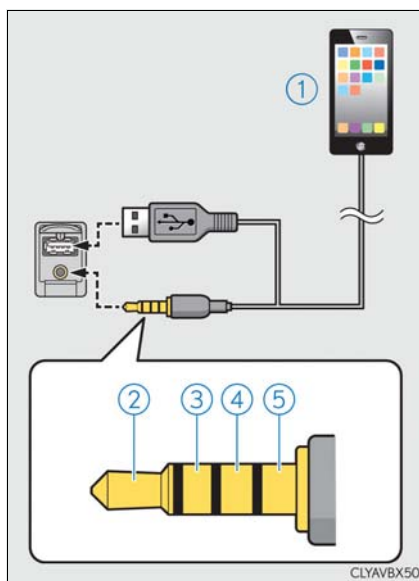

**■ When using a 4-pole AUX cable**

If a 4-pole AUX cable with a different layout is used, audio and/or video may not be output properly.

**■ When using the USB/AUX port**

There is clearance between the lid and console box to allow the cable routed to outside the console box.

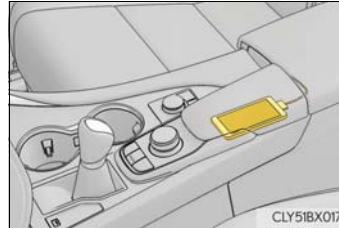
**⚠ WARNING****■ While driving**

Do not connect a device or operate the device controls.

**⚠ NOTICE****■ To prevent damage to the device or its terminals**

Depending on the size and shape of the device that is connected to the system, the console box/auxiliary box may not close fully. In this case, do not forcibly close the console box/auxiliary box as this may damage the device or the terminal, etc.

## Setup menu

The Lexus Display Audio system can be adjusted to the desired settings.

### Display "Setup" screen

Go to "Setup": "MENU" button → "Setup"

- ① Change the settings for operation sounds, screen animation, etc. (→P. 407)
- ② Change the settings for voice guidance. (→P. 410)
- ③ Change the settings for registering, removing, connecting and disconnecting Bluetooth® devices. (→P. 445, 446, 447, 448)
- ④ Change the settings for FM radio, iPod, etc. (→P. 414)
- ⑤ Change the settings for vehicle customization. (→P. 722)
- ⑥ Change the settings for phone sound, phonebook, etc. (→P. 466)
- ⑦ Set the pop up reminder for mobile data usage notification.

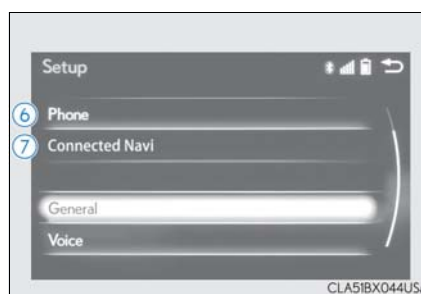

## General settings

Settings are available for adjusting the operation sounds, screen animation, etc.

### Screen for general settings

Go to “General Settings”: “MENU” button → “Setup” → “General”



Button	Function
“Language”	Change language. The selectable languages may differ depending on the model or region.
“Units of Measurement”	Change the distance unit.
“Beep”	Set the beep sound on/off.
“Button Color”	Change the button color.
“Customize Images”	Change the startup image and screen off image. (→P. 408)
“Animation”	Set the animation effect on/off.
“Delete Personal Data”	Delete personal data (→P. 409)
“Software Update”	Update program versions. For details, contact your Lexus dealer.
“Gracenote® Database Update”	Update gracenote database versions. For details, contact your Lexus dealer
“Software Information”	Display the open source license.
“Auto Detect iPhone App”	Select to set a pop-up message displayed on an iPhone connected via Bluetooth® on/off when an application on the iPhone needs to be activated.



### Customizing images

- 1 Go to “Customize Images”: “MENU” button → “Setup” → “General” → “Customize Images”
- 2 Select “Set Images” and then select the desired image.
  - 1 Set as startup image.
  - 2 Set as screen off image.
  - 3 Set as startup image and screen off image.



#### ■ Adding an image

- 1 Connect a USB memory device. (→P. 403)
  - 2 Select “Copy from USB” on the “Customize Images” screen and then select the desired image.
  - 3 Move the controller to the left and then select “Copy”.
- Up to 10 images can be downloaded.

#### ■ Deleting images

Select “Delete Images” on the “Customize Images” screen and then select the desired images.

#### ■ USB memory

When saving the images to a USB memory device, name the folder that the images are saved to “Image”.

##### ● Compatible device formats

The following device format can be used:

- USB communication format: USB2.0 FS (480 Mbps)
- File system format: FAT16/32 (Windows)
- Correspondence class: Mass storage class

The following types of files can be used:

- The image’s file format must be JPEG.
- The file name may only contain ASCII characters.

##### ● JPEG file compatibility

Compatible image size: Maximum 5MB

 NOTICE

- To prevent damage to the USB memory device or its terminals  
→P. 441

**Deleting personal data**

- 1 Go to "Delete Personal Data": "MENU" button → "Setup" → "General" → "Delete Personal Data"
- 2 Select "Delete".

Check carefully beforehand, as data cannot be retrieved once deleted.

The following personal data will be deleted or changed to its default settings.

- Phonebook data
- Call history data
- Favorite data
- Bluetooth® devices data
- Phone sound settings
- Detailed Bluetooth® settings
- Audio/video setting
- Customized image data
- FM info setting
- iPod tagging information
- Software update history
- Software update detail information
- Phone display setting
- Contact/call history setting
- Messaging setting
- Traffic information map
- Weather information
- Phonebook data for voice recognition
- Music data for voice recognition

## Voice settings

You can adjust the guidance volume setting.

Go to "Voice Settings": "MENU" button → "Setup" → "Voice"

- ① Adjust the voice guidance volume setting.
- ② Set the voice recognition prompts on/off.
- ③ Select to train voice recognition.

The voice command system adapt the user accent.



### ■ Return to the default settings

Move the controller to the left and select "Default".

## Display settings

Settings are available for adjusting the contrast and brightness of the screen. The display can also be turned off.

### Screen for display settings

Go to "Display": "MENU" button → "Display"

- ① Turn off screen.
- ② Adjust screen quality.
- ③ Adjust screen quality of the rear view monitor camera.
- ④ Change to day mode.

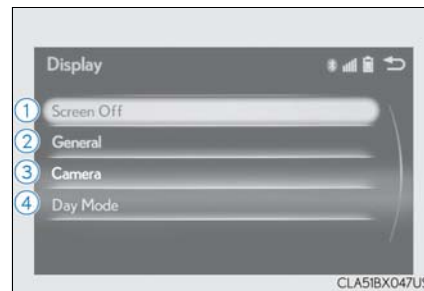

### Screen off

This setting turns the screen off. To turn it on, press any button such as the "AUDIO" button or "MENU" button.

If a screen off image has been set, the set image will be displayed.

### Day mode

When the headlights are turned on, the screen dims.

However, the screen can be switched to day mode by selecting "Day Mode".

The screen will stay in day mode when the headlights are turned on until "Day Mode" is selected again.

### Adjusting the screen quality

- ① Select "General" or "Camera" on the "Display" screen or select "Display" on audio menu screen. (→P. 417)
- ② Adjust the display as desired by turning the controller clockwise (+) or counterclockwise (-).  
To select "Contrast", "Brightness", "Color" or "Tone", move the controller to the left. ("Color" and "Tone" are available when "Display" on the audio settings screen for each audio source is selected.)

#### ■ Changing the sample image (when "General" is selected)

Move the controller to the right and select the desired sample image.

## Selecting the audio source

Switching between audio sources, such as the radio and CD, is explained in this section.

### Changing audio source

- 1 Press the "AUDIO" button to display the "Source" screen.  
If the "Source" screen is not displayed, press the button again.
- 2 Select the desired audio source.  
The audio source can be selected by pressing the "RADIO" or "MEDIA" button.

### Using the steering wheel switches to change audio sources

Press the "MODE" switch when the audio system is turned on. The audio source changes each time the "MODE" switch is pressed.

---

#### ■ Rearranging the list

The listing order of the source list can be rearranged.

- 1 Move the controller to the left while on the "Source" screen.
- 2 Select "Audio Source Select".
- 3 Select an item you wish to move and then select where to move the item to.

## Optimal use of the audio system

On the “Sound Settings” screen, sound quality (Treble/Mid/Bass), volume balance and DSP settings can be adjusted.

### How to adjust the sound settings and sound quality

Go to “Sound Settings”: Move the controller to the left on the audio top screen → “Sound Settings”

To change between the sound setting screen and DSP setting screen, move the controller to the right then select the desired screen.

#### ▶ “Sound Settings”

- ① ② ③ Adjusts the treble, mid or bass.
- ④ Adjusts the front/rear audio balance.
- ⑤ Adjusts the left/right audio balance.

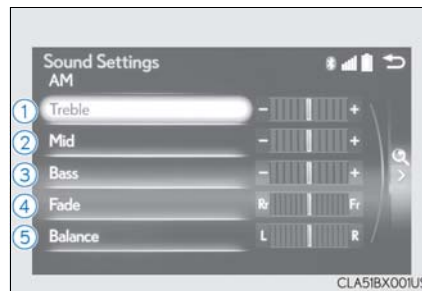

#### ▶ “DSP”

- ① Sets the automatic sound levelizer (ASL) on/off
- ② Sets the surround function on/off



#### ■ The sound quality level is adjusted individually

The treble, mid and bass levels can be adjusted for each audio mode separately.

#### ■ About Automatic Sound Levelizer (ASL)

ASL automatically adjusts the volume and tone quality according to the vehicle speed.

## Audio settings

### Screen for audio settings

Go to "Audio Settings": "MENU" button → "Setup" → "Audio"

- ① Change radio settings (→P. 414)
- ② Change iPod settings (→P. 415)
- ③ Change A/V settings (→P. 415)
- ④ Change the cover art settings (→P. 416)
- ⑤ Change USB settings (→P. 416)

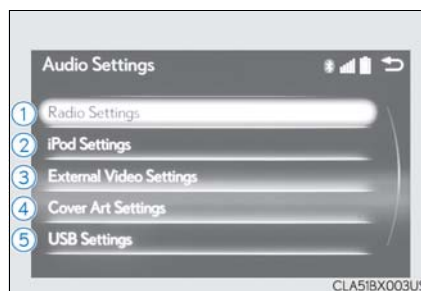

### Changing radio settings

To display the radio settings screen in a different way, select "Radio Settings" on the audio menu screen. (→P. 417)

- ① Set the displaying RBDS text message on/off
- ② Change the number of radio presets



### Changing iPod settings

To display the iPod settings screen in a different way, select “iPod Settings” on the audio menu screen. (→P. 417)

- ① Change the screen size (video mode)
- ② Change the cover art settings (→P. 416)
- ③ Adjust the screen quality (video mode) (→P. 411)
- ④ Change video sound input port

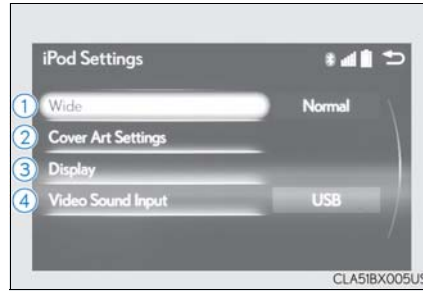

### Changing A/V settings

To display the A/V settings screen in a different way, select “External Video Settings” on the audio menu screen. (→P. 417)

- ① Change the screen size
- ② Change the video signal
- ③ Adjust the screen quality (video mode) (→P. 411)

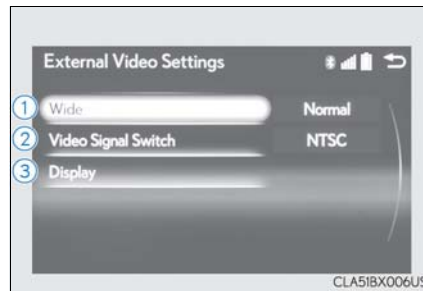



### Changing the cover art settings

To display the cover art settings screen in a different way, select “Cover Art Settings” on the audio menu screen. (→P. 417)

- ① Select to set the cover art display on/off.
- ② Select to set the priority of the Gracenote database on/off.



### Changing USB settings

To display the USB settings screen in a different way, select “USB Settings” on the audio menu screen. (→P. 417)

- ① Change the cover art settings (→P. 416)



## Audio menu screen operation

You can change the settings and control functions for each audio source.

### Audio menu screen

Go to audio menu screen: Move the controller to the left on the audio top screen

▶ Radio mode

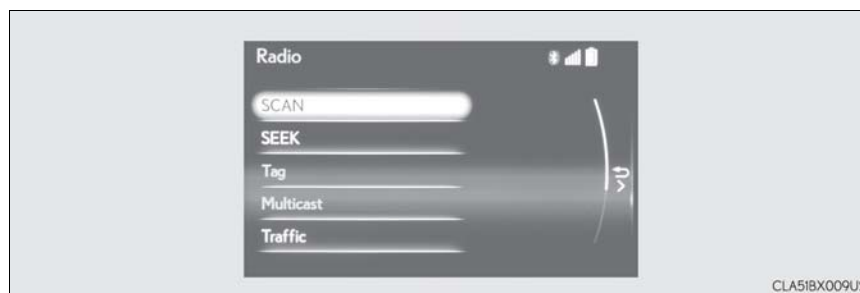

Button	Function	Target radio mode
"SCAN"	Scans for receivable stations	AM, FM
"SEEK"	Seeks a station of the nearest frequency (stops when a station is found)	AM, FM
"Tag"	Captures the song title and artist name information for potential purchase (when the "HD" indicator on the selected station is appears)	FM
"Multicast"	Changes the channel of HD Radio (HD2, HD3, HD4 where applicable)	FM
"Traffic"	Seeks a station of the traffic announcement	FM
"HD Radio"	Selects to set the station list shows of HD radio on/off	AM, FM
"Radio Settings"	Changes radio settings (→P. 414)	All mode
"Sound Settings"	Changes sound settings (→P. 413)	All mode

► Media mode



Button	Function	Target audio source
"Play"	Plays or pauses a track/file	All media (except A/V)
"Pause"		
"Track Up"	Selects a track/file	All media (except A/V)
"Track Down"		
"File Up"		
"File Down"		
"Folder Up"	Selects a folder/album	MP3/WMA/AAC disc, USB
"Folder Down"		
"Fast Forward"	Selects and hold: Fast-forward or rewind a track/file	All media (except A/V)
"Rewind"		
"Repeat"	Selects a repeat mode (→P. 419)	All media (except A/V)
"Random"	Selects a random/shuffle play mode (→P. 419)	All media (except A/V)
"Shuffle"		
"Full Screen"	Selects a full screen mode	iPod, A/V
"Connect"	Connects a Bluetooth® device (→P. 443)	Bluetooth®
"Cover Art Settings"	Changes the cover art settings (→P. 416)	CD, MP3/WMA/AAC disc, Bluetooth®
"iPod Settings"	Changes iPod settings (→P. 415)	iPod
"USB Settings"	Changes USB settings (→P. 416)	USB
"External Settings" Video	Changes A/V settings (→P. 415)	A/V

Button	Function	Target audio source
"Sound Settings"	Changes sound settings (→P. 413)	All media

### Repeat play

Mode	Action
"Track Repeat"	File/track repeat
"Repeat"	
"RPT"	
"On"	
"Folder Repeat"	Folder/album repeat
"Album Repeat"	

### Random/shuffle playback

Mode	Action
"1 DISC"	Random/shuffle play of the disc/folder/album
"Random"	
"Shuffle"	
"Folder Random"	Random/shuffle play of all folders/albums
"ALBUM RAND"	
"Album Shuffle"	

## Radio operation

Select "AM", "FM" or "SAT" on the audio source selection screen to begin listening to the radio.

### Radio top screen

Pressing the "RADIO" button displays the radio top screen from any screen of the selected source.

#### ■ Menu screen

→P. 417

### Selecting a station (AM or FM radio)

Tune in to the desired station using one of the following methods.

#### ■ Seek tuning

Press and hold then release the "< PRST" or "TRACK >" button.

Seek tuning can also be operated on the menu screen. (→P. 417)

The radio will begin seeking up or down for a station of the nearest frequency and will stop when a station is found.

#### ■ Manual tuning

Turn the "TUNE•SCROLL" knob.

#### ■ Preset stations

Select the desired preset station by pressing the "< PRST" or "TRACK >" button, or turning and pressing the controller.

#### ■ Station list

1 Move the controller to the right and selecting "Station List".

2 AM radio: Selecting a desired station.

FM radio: Selecting a desired type of station and selecting a desired station.

To refreshing the station list, select "Refresh". Select "Source" on the refresh screen, can be change to the other audio source while refreshing.

### Selecting an HD Radio channel

When "HD Radio" is set to "On", available stations with HD Radio channels are marked with "HD").

- 1 In AM or FM mode, select a station marked with "HD").
- 2 Turn the "TUNE•SCROLL" knob to select an HD Radio channel.  
HD Radio channels can also be selected by selecting "Multicast" on the menu screen. (→P. 417)

### Selecting a channel (XM Satellite Radio)

Select in to the desired channel using one of the following methods.

#### ■ Turning up/down the channel

Press and hold the "< PRST" or "TRACK >" button or turn the "TUNE•SCROLL" knob.

#### ■ Preset channels

Select the desired preset channel by pressing the "< PRST" or "TRACK >" button or controller.

#### ■ Channel list

- 1 Move the controller to the right and selecting "Select a SAT Category".
- 2 Selecting a desired category of channel and selecting a desired channel.

### Setting presets

- 1 Search for desired stations or channel.
- 2 Select and hold one of the preset until you hear a beep.

### Display the text message

#### ■ Display the song information

Move the controller to the right and selecting "Text".

#### ■ Display the Additional information (HD radio)

Move the controller to the right and selecting "Additional Information".

### HD Radio™ Technology

HD Radio™ Technology is the digital evolution of analog AM/FM radio. Your radio product has a special receiver which allows it to receive digital broadcasts (where available) in addition to the analog broadcasts it already receives.

Digital broadcasts have better sound quality than analog broadcasts as digital broadcasts provide free, crystal clear audio with no static or distortion. For more information, and a guide to available radio stations and programming, refer to [www.hdradio.com](http://www.hdradio.com).

“HD Radio features included in Lexus radios:

Digital Sound - HD Radio broadcasts deliver crystal-clear, digital audio quality to listeners.

HD2/HD3 Channels - FM stations can provide additional digital only audio programming with expanded content and format choices on HD2/HD3 channels.

PSD - Program Service Data (PSD) gives you on-screen information such as artist name and song title.

iTunes Tagging - Listeners can tag (store) songs they like for later review and purchase through iTunes.

Artist Experience - Images related to the broadcast are displayed on the radio screen, such as album cover art and station logos.”



HD Radio Technology manufactured under license from iBiquity Digital Corporation. U.S. and Foreign Patents. HD Radio™ and the HD, HD Radio, and “Arc” logos are proprietary trademarks of iBiquity Digital Corp.

### ■ HD Radio™ Technology troubleshooting guide

Experience	Cause	Action
Mismatch of time alignment- a user may hear a short period of programming replayed or an echo, stutter or skip.	The radio stations analog and digital volume are not properly aligned or the station is in ballgame mode.	None, radio broadcast issue. A user can contact the radio station.
Sound fades, blending in and out.	Radio is shifting between analog and digital audio.	Reception issue, may clear-up as the vehicle continues to be driven. Set "HD Radio" to off, can force radio in an analog audio.
Audio mute condition when an HD2/HD3 multicast channel had been playing.	The radio does not have access to digital signals at the moment.	This is normal behavior, wait until the digital signal returns. If out of the coverage area, seek a new station.
Audio mute delay when selecting an HD2/HD3 multicast channel preset.	The digital multicast content is not available until HD Radio™ broadcast can be decoded and make the audio available. This takes up to 7 seconds.	This is normal behavior, wait for the audio to become available.
Text information does not match the present song audio.	Data service issue at the radio broadcaster.	Broadcaster should be notified. Complete the form: <a href="http://www.ibequity.com/automotive/report_radio_station_experiences">www.ibequity.com/automotive/report_radio_station_experiences</a> .
No text information shown for the present selected frequency.	Data service issue by the radio broadcaster.	Broadcaster should be notified. Complete the form: <a href="http://www.ibequity.com/automotive/report_radio_station_experiences">www.ibequity.com/automotive/report_radio_station_experiences</a> .

### ■ Reception sensitivity

- Maintaining perfect radio reception at all times is difficult due to the continually changing position of the antenna, differences in signal strength and surrounding objects, such as trains, transmitters, etc.
- The radio antenna is mounted inside the rear window. To maintain clear radio reception, do not attach metallic window tinting or other metallic objects to the antenna wire mounted inside the rear window.



<p><b>XM Radio Services – Descriptions</b></p> <p><b>Radio and Entertainment</b>  XM offers more than 170 satellite radio channels of commercial-free music and premier sports, news, talk, and entertainment. XM is broadcast via satellites to millions of listeners across the continental United States. XM subscribers listen to XM on satellite radio receivers for the car, home, and portable use. More information about XM is available online at <a href="http://www.siriusxm.com">www.siriusxm.com</a>.</p>	<p><b>XM Radio Services – Descriptions</b></p> <p><b>Radio and Entertainment</b>  XM offers more than 170 satellite radio channels of commercial-free music and premier sports, news, talk, and entertainment. XM is broadcast via satellites to millions of listeners across the continental United States. XM subscribers listen to XM on satellite radio receivers for the car, home, and portable use. More information about XM is available online at <a href="http://www.siriusxm.ca">www.siriusxm.ca</a>.</p>
<p><b>Infotainment and Data services</b>  XM offers a variety of advanced Infotainment and data services:</p>	<p><b>Infotainment and Data services</b>  XM offers a variety of advanced Infotainment and data services:</p>
<p><b>XM Radio Services – Subscription Instructions</b></p> <p>For XM Services requiring a subscription (such as XM Radio, and some Infotainment &amp; data services), the following paragraph shall be included.</p> <p>Required XM Radio and some Infotainment &amp; data services monthly subscriptions sold separately after trial period. Subscription fee is consumer only. All fees and programming subject to change. Subscriptions are subject to the Customer Agreement available at <a href="http://www.siriusxm.com">www.siriusxm.com</a>. XM service only available in the 48 contiguous United States. © 2011 Sirius XM Radio Inc. Sirius, XM and all related marks and logos are trademarks of Sirius XM Radio Inc. All other marks, channel names and logos are the property of their respective owners.</p> <p>For more information, program schedules, and to subscribe or extend subscription after complimentary trial period; more information is available at:</p> <p>USA Customers:  Visit <a href="http://www.siriusxm.com">www.siriusxm.com</a> or call 1-877-447-0011</p>	<p><b>XM Radio Services – Subscription Instructions</b></p> <p>For XM Services requiring a subscription (such as XM Radio, and some Infotainment &amp; data services), the following paragraph shall be included.</p> <p>Required XM Radio and some Infotainment &amp; data services monthly subscriptions sold separately after trial period. Subscription fee is consumer only. All fees and programming subject to change. Subscriptions are subject to the Customer Agreement available at <a href="http://www.siriusxm.ca">www.siriusxm.ca</a>. XM service only available in 10 Canadian provinces. © 2011 Sirius XM Radio Inc. Sirius, XM and all related marks and logos are trademarks of Sirius XM Radio Inc. All other marks, channel names and logos are the property of their respective owners.</p> <p>For more information, program schedules, and to subscribe or extend subscription after complimentary trial period; more information is available at:</p> <p>Canadian Customers:  Visit <a href="http://www.siriusxm.ca">www.siriusxm.ca</a> or call 1-877-438-9677</p>

<p><b>XM Radio Services – Legal Disclaimers and Warnings</b></p> <p>Fees and Taxes – Subscription fee, taxes, one time activation fee, and other fees may apply. Subscription fee is consumer only. All fees and programming subject to change. Subscriptions subject to Customer Agreement available at <a href="http://www.siriusxm.com">www.siriusxm.com</a>. XM service only available in the 48 contiguous United States and Canada.</p> <p>Explicit Language Notice – Channels with frequent explicit language are indicated with an "XL" preceding the channel name. Channel blocking is available for XM Satellite Radio receivers by notifying XM at:</p> <p>USA Customers – Visit <a href="http://www.siriusxm.com">www.siriusxm.com</a> Or calling 1-877-447-0011</p>	<p><b>XM Radio Services – Legal Disclaimers and Warnings</b></p> <p>Fees and Taxes – Subscription fee, taxes, one time activation fee, and other fees may apply. Subscription fee is consumer only. All fees and programming subject to change. Subscriptions subject to Customer Agreement available at <a href="http://www.siriusxm.ca">www.siriusxm.ca</a>. XM service only available in the 48 contiguous United States and Canada*.</p> <p>*Canada – some deterioration of service may occur in extreme northern latitudes. This is beyond the control of XM Satellite Radio.</p> <p>Explicit Language Notice – Channels with frequent explicit language are indicated with an "XL" preceding the channel name. Channel blocking is available for XM Satellite Radio receivers by notifying XM at:</p> <p>Canadian Customers – Visit <a href="http://www.siriusxm.ca">www.siriusxm.ca</a> Or calling 1-877-438-9677</p>
--	--

It is prohibited to copy, decompile, disassemble, reverse engineer, hack, manipulate, or otherwise make available any technology or software incorporated in receivers compatible with the XM Satellite Radio System or that support the XM website, the Online Service or any of its content. Furthermore, the AMBE® voice compression software included in this product is protected by intellectual property rights including patent rights, copyrights, and trade secrets of Digital Voice Systems, Inc.

Note: this applies to XM receivers only and not XM Ready devices.

■ If the satellite radio does not operate normally

If a problem occurs with the XM tuner, a message will appear on the screen. Refer to the table below to identify the problem, and take the suggested corrective action.

SAT Check Antenna	The XM antenna is not connected. Check whether the XM antenna cable is attached securely.
	There is a short-circuit in the antenna or the surrounding antenna cable. See a Lexus certified dealer.
SAT Ch Unauthorized	You have not subscribed to XM Satellite Radio. The radio is being updated with the latest encryption code. Contact XM Satellite Radio for subscription information. When a contract is canceled, you can choose "Ch000" and all free-to-air channels.
	The premium channel you selected is not authorized. Wait for about 2 seconds until the radio returns to the previous channel or "Ch001". If it does not change automatically, select another channel. To listen to the premium channel, contact XM Satellite Radio.
SAT No Signal	The XM signal is too weak at the current location. Wait until your vehicle reaches a location with a stronger signal.
SAT Loading	The unit is acquiring audio or program information. Wait until the unit has received the information.
SAT Channel Off Air	The channel you selected is not broadcasting any programming. Select another channel.
-----	There is no song/program title or artist name/feature associated with the channel at that time. No action is required.
SAT Chan Unavailable	The channel you selected is no longer available. Wait for about 2 seconds until the radio returns to the previous channel or "Ch001". If it does not change automatically, select another channel.

Contact the XM Listener Care Center at 1-877-447-0011 (U.S.A.) or 1-877-438-9677 (Canada).

## CD player operation

Insert a disc, press the "MEDIA" button or select "DISC" on the "Source" screen with a disc inserted to begin listening to a CD.

### CD top screen

Pressing the "MEDIA" button displays the CD top screen from any screen of the selected source.

#### ■ Menu screen

→P. 417

#### ■ Selecting a track/file

Press the "< PRST" or "TRACK >" button or turn the "TUNE•SCROLL" knob to select the desired track/file number.

To fast-forward or rewind, press and hold the "< PRST" or "TRACK >" button.

#### ■ Selecting the track by the list (CD)

Move the controller to the right and then select the desired track.

#### ■ Selecting a folder (MP3/WMA/AAC disc)

1 Move the controller to the right and then select "Folders".

2 Select the desired folder. Then select a file to begin using the selected folder.

#### ■ Selecting a file by the selected folder (MP3/WMA/AAC disc)

1 Move the controller to the right and then select "Files".

2 Select the desired file.

### ■ Error messages

If the following error messages appear on the screen, refer to the table and take the appropriate measures. If the problem is not rectified, take the vehicle to your Lexus dealer.

Message	Cause	Correction procedures
"Check disc"	<ul style="list-style-type: none"> <li>• The disc is dirty or damaged.</li> <li>• The disc is inserted upside down.</li> <li>• The disc is not playable with the player.</li> </ul>	<ul style="list-style-type: none"> <li>• Clean the disc.</li> <li>• Insert the disc correctly.</li> <li>• Confirm the disc is playable with the player.</li> </ul>
"DISC Error"	There is a malfunction within the system.	Eject the disc.
"No music files found."	No playable data is included on the disc.	Eject the disc.

### ■ Discs that can be used

Discs with the marks shown below can be used.

Playback may not be possible depending on recording format or disc features, or due to scratches, dirt or deterioration.



CDs with copy-protection features may not play correctly.

### ■ CD player protection feature

To protect the internal components, playback is automatically stopped when a problem is detected.

### ■ If a disc is left inside the CD player or in the ejected position for extended periods

Disc may be damaged and may not play properly.

### ■ Lens cleaners

Do not use lens cleaners. Doing so may damage the CD player.

### ■ MP3, WMA and AAC files

MP3 (MPEG Audio LAYER3) is a standard audio compression format.

Files can be compressed to approximately 1/10 of their original size by using MP3 compression.

WMA (Windows Media Audio) is a Microsoft audio compression format.

This format compresses audio data to a size smaller than that of the MP3 format.

AAC is short for Advanced Audio Coding and refers to an audio compression technology standard used with MPEG2 and MPEG4.

MP3, WMA and AAC file and media/formats compatibility are limited.

- MP3 file compatibility
  - Compatible standards  
MP3 (MPEG1 LAYER3, MPEG2 LSF LAYER3)
  - Compatible sampling frequencies  
MPEG1 LAYER3: 32, 44.1, 48 (kHz)  
MPEG2 LSF LAYER3: 16, 22.05, 24 (kHz)
  - Compatible bit rates (compatible with VBR)  
MPEG1 LAYER3: 32-320 (kbps)  
MPEG2 LSF LAYER3: 8-160 (kbps)
  - Compatible channel modes: stereo, joint stereo, dual channel and monaural
- WMA file compatibility
  - Compatible standards  
WMA Ver. 7, 8, 9 (only compatible with Window Media Audio Standard)
  - Compatible sampling frequencies  
32, 44.1, 48 (kHz)
  - Compatible bit rates (only compatible with 2-channel playback)  
Ver. 7, 8: CBR 48-192 (kbps)  
Ver. 9: CBR 48-320 (kbps)
- AAC file compatibility
  - Compatible standards  
MPEG4/AAC-LC
  - Compatible sampling frequencies  
11.025/12/16/22.05/24/32/44.1/48 (kHz)
  - Compatible bit rates  
16-320 (kbps)
  - Compatible channel modes: 1 ch and 2 ch
- Compatible media  
Media that can be used for MP3, WMA and AAC playback are CD-Rs and CD-RWs. Playback in some instances may not be possible if the CD-R or CD-RW is not finalized. Playback may not be possible or the audio may jump if the disc is scratched or marked with fingerprints.
- Compatible disc formats  
The following disc formats can be used.
  - Disc formats: CD-ROM Mode 1 and Mode 2  
CD-ROM XA Mode 2, Form 1 and Form 2
  - File formats: ISO9660 Level 1, Level 2, (Romeo, Joliet)  
UDF (2.01 or lower)

MP3, WMA and AAC files written in any format other than those listed above may not play correctly, and their file names and folder names may not be displayed correctly.

Items related to standards and limitations are as follows.

  - Maximum directory hierarchy: 8 levels (including the root)
  - Maximum length of folder names/file names: 32 characters
  - Maximum number of folders: 192 (including the root)
  - Maximum number of files per disc: 255

- **File names**

The only files that can be recognized as MP3/WMA/AAC and played are those with the extension .mp3, .wma or .m4a.
- **Discs containing multi-session recordings**

As the audio system is compatible with multi session discs, it is possible to play discs that contain MP3, WMA and AAC files. However, only the first session can be played.
- **ID3, WMA and AAC tags**

ID3 tags can be added to MP3 files, making it possible to record the track title, artist name, etc.

The system is compatible with ID3 Ver. 1.0, 1.1, and Ver. 2.2, 2.3 ID3 tags. (The number of characters is based on ID3 Ver. 1.0 and 1.1.)

WMA tags can be added to WMA files, making it possible to record the track title and artist name in the same way as with ID3 tags.

AAC tags can be added to AAC files, making it possible to record the track title and artist name in the same way as with ID3 tags.
- **MP3, WMA and AAC playback**

When a disc containing MP3, WMA or AAC files is inserted, all files on the disc are first checked. Once the file check is finished, the first MP3, WMA or AAC file is played. To make the file check finish more quickly, we recommend you do not write any files to the disc other than MP3, WMA or AAC files or create any unnecessary folders.

Discs that contain a mixture of music data and MP3, WMA or AAC format data cannot be played.
- **Extensions**

If the file extensions .mp3, .wma and .m4a are used for files other than MP3, WMA and AAC files, they may be mistakenly recognized and played as MP3, WMA and AAC files. This may result in large amounts of interference and damage to the speakers.
- **Playback**
  - To play MP3 files with steady sound quality, we recommend a fixed bit rate of at least 128 kbps and a sampling frequency of 44.1 kHz.
  - CD-R or CD-RW playback may not be possible in some instances, depending on the characteristics of the disc.
  - There is a wide variety of freeware and other encoding software for MP3, WMA and AAC files on the market, and depending on the status of the encoding and the file format, poor sound quality or noise at the start of playback may result. In some cases, playback may not be possible at all.
  - When files other than MP3, WMA or AAC files are recorded on a disc, it may take more time to recognize the disc and in some cases, playback may not be possible at all.
  - Microsoft, Windows, and Windows Media are the registered trademarks of Microsoft Corporation in the U.S.A. and other countries.

**■ The Gracenote® media database**

- Gracenote, the Gracenote logo and logotype, "Powered by Gracenote" and Gracenote MusicID are either registered trademarks or trademarks of Gracenote, Inc. in the United States and/or other countries.





**Gracenote® End User License Agreement**

This application or device contains software from Gracenote, Inc. of Emeryville, California ("Gracenote"). The software from Gracenote (the "Gracenote Software") enables this application to perform disc and/or file identification and obtain music-related information, including name, artist, track, and title information ("Gracenote Data") from online servers or embedded databases (collectively, "Gracenote Servers") and to perform other functions. You may use Gracenote Data only by means of the intended End-User functions of this application or device.

You agree that you will use Gracenote Data, the Gracenote Software, and Gracenote Servers for your own personal non-commercial use only. You agree not to assign, copy, transfer or transmit the Gracenote Software or any Gracenote Data to any third party. **YOU AGREE NOT TO USE OR EXPLOIT GRACENOTE DATA, THE GRACENOTE SOFTWARE, OR GRACENOTE SERVERS, EXCEPT AS EXPRESSLY PERMITTED HEREIN.**

You agree that your non-exclusive license to use the Gracenote Data, the Gracenote Software, and Gracenote Servers will terminate if you violate these restrictions. If your license terminates, you agree to cease any and all use of the Gracenote Data, the Gracenote Software, and Gracenote Servers. Gracenote reserves all rights in Gracenote Data, the Gracenote Software, and the Gracenote Servers, including all ownership rights. Under no circumstances will Gracenote become liable for any payment to you for any information that you provide. You agree that Gracenote, Inc. may enforce its rights under this Agreement against you directly in its own name.

The Gracenote service uses a unique identifier to track queries for statistical purposes. The purpose of a randomly assigned numeric identifier is to allow the Gracenote service to count queries without knowing anything about who you are. For more information, see the web page for the Gracenote Privacy Policy for the Gracenote service.

The Gracenote Software and each item of Gracenote Data are licensed to you "AS IS."

Gracenote makes no representations or warranties, express or implied, regarding the accuracy of any Gracenote Data from in the Gracenote Servers. Gracenote reserves the right to delete data from the Gracenote Servers or to change data categories for any cause that Gracenote deems sufficient. No warranty is made that the Gracenote Software or Gracenote Servers are error-free or that functioning of Gracenote Software or Gracenote Servers will be uninterrupted. Gracenote is not obligated to provide you with new enhanced or additional data types or categories that Gracenote may provide in the future and is free to discontinue its services at any time.

**GRACENOTE DISCLAIMS ALL WARRANTIES EXPRESS OR IMPLIED, INCLUDING, BUT NOT LIMITED TO, IMPLIED WARRANTIES OF MERCHANTABILITY, FITNESS FOR A PARTICULAR PURPOSE, TITLE, AND NON-INFRINGEMENT. GRACENOTE DOES NOT WARRANT THE RESULTS THAT WILL BE OBTAINED BY YOUR USE OF THE GRACENOTE SOFTWARE OR ANY GRACENOTE SERVER. IN NO CASE WILL GRACENOTE BE LIABLE FOR ANY CONSEQUENTIAL OR INCIDENTAL DAMAGES OR FOR ANY LOST PROFITS OR LOST REVENUES.**

copyright © 2000 to present Gracenote

 NOTICE

■ **Discs and adapters that cannot be used**

Do not use the following types of discs.

Also, do not use 3 in. (8 cm) disc adapters, DualDiscs or printable discs.

Doing so may damage the player and/or disc insert/eject function.

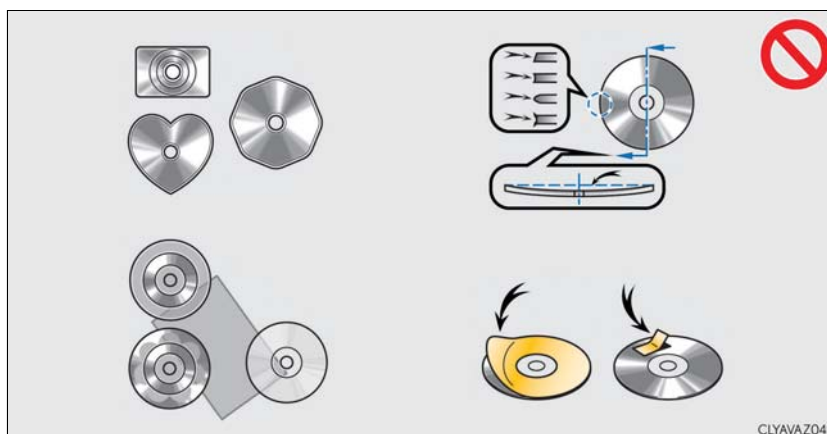

- Discs that have a diameter that is not 4.7 in. (12 cm).
- Low-quality or deformed discs.
- Discs with a transparent or translucent recording area.
- Discs that have tape, stickers or labels attached to them, or that have had the label peeled off.

■ **Player precautions**

Failure to follow the precautions below may result in damage to the discs or the player itself.

- Do not insert anything other than discs into the disc slot.
- Do not apply oil to the player.
- Store discs away from direct sunlight.
- Never try to disassemble any part of the player.

## Listening to an iPod

Connecting an iPod enables you to enjoy music from the vehicle speakers. Press the “MEDIA” button or select “iPod” on the audio source selection screen.

### Connecting an iPod

→P. 403

### iPod top screen

Pressing the “MEDIA” button displays the iPod top screen from any screen of the selected source.

- **Menu screen**

→P. 417

- **Selecting a song**

Press the “< PRST” or “TRACK >” button or turn the “TUNE•SCROLL” knob to select the desired song number.

To fast-forward or rewind, press and hold the “< PRST” or “TRACK >” button.

- **Selecting a play mode**

- 1 Move the controller to the right and then select “Browse”.
- 2 Select the desired play mode, and then select a song to begin using the selected play mode.

- **Displaying the now playing list**

Move the controller to the right and then select “Now Playing List”.

**■ iPod cover art**

- Depending on the iPod and songs in the iPod, iPod cover art may be displayed.
- This function can be changed to on/off. (→P. 416)
- It may take time to display iPod cover art, and the iPod may not be operated while the cover art display is in process.

**■ iPod functions**

- When an iPod is connected and the audio source is changed to iPod mode, the iPod will resume play from the same point in which it was last used.
- Depending on the iPod that is connected to the system, certain functions may not be available. If a function is unavailable due to a malfunction (as opposed to a system specification), disconnecting the device and reconnecting it may resolve the problem.
- Depending on the iPod, while connected to the system, the iPod cannot be operated with its own controls. It is necessary to use the controls of the vehicle's audio system instead.
- When the battery level of an iPod is very low, the iPod may not operate. If so, charge the iPod before use.
- Compatible models (→P. 437)

**■ iPod problems**

To resolve most problems encountered when using your iPod, disconnect your iPod from the vehicle iPod connection and reset it. For instructions on how to reset your iPod, refer to your iPod Owner's Manual.

■ Error messages

If the following error messages appear on the screen, refer to the table and take the appropriate measures. If the problem is not rectified, take the vehicle to your Lexus dealer.

Message	Cause/Correction procedures
“Connection error. Please consult your Owner’s Manual for instructions on how to connect the iPod.”	This indicates a problem in the iPod or its connection.
“There are no songs available for playback. Please add compatible files to your iPod.”	This indicates that there is no music data in the iPod.
“No items available.”	This indicates that songs are not found in a selected playlist.
“Please check the iPod firmware version.”	This indicates that the software version is not compatible. Please check the compatible models. (→P. 437)
“Unable to authorize the iPod.”	This indicates that the Lexus Display Audio system failed to authorize the iPod. Please check your iPod.

 NOTICE

■ To prevent damage to the iPod or its terminals

- Depending on the size and shape of the iPod that is connected to the system, the console box may not close fully. In this case, do not forcibly close the console box as this may damage the iPod or the terminal, etc.
- Do not leave the iPod in the vehicle. The temperature inside the vehicle may become high.
- Do not push down on or apply unnecessary pressure to the iPod while it is connected.
- Do not insert foreign objects into the port.

## ■ Certifications

### iPod



- "Made for iPod", "Made for iPhone", and "Made for iPad" mean that an electronic accessory has been designed to connect specifically to iPod, iPhone, or iPad, respectively, and has been certified by the developer to meet Apple performance standards.
- Apple is not responsible for the operation of this device or its compliance with safety and regulatory standards. Please note that the use of this accessory with iPod, iPhone, or iPad may affect wireless performance.
- iPad, iPhone, iPod, iPod classic, iPod nano, and iPod touch are trademarks of Apple Inc., registered in the U.S. and other countries. Lightning is a trademark of Apple Inc.
- The Lightning connector works with iPhone 5s, iPhone 5c, iPhone 5, iPod touch (5th generation), and iPod nano (7th generation).
- The 30-pin connector works with iPhone 4S, iPhone 4, iPhone 3GS, iPhone 3G, iPhone, iPod touch (1st through 4th generation), iPod classic, and iPod nano (1st through 6th generation).
- USB works with iPhone 5s, iPhone 5c, iPhone 5, iPhone 4S, iPhone 4, iPhone 3GS, iPhone 3G, iPhone, iPod touch (1st through 5th generation), iPod classic, and iPod nano (1st through 7th generation).
- Bluetooth® technology works with iPhone 5s, iPhone 5c, iPhone 5, iPhone 4S, iPhone 4, iPhone 3GS, iPhone 3G, iPhone, and iPod touch (2nd through 5th generation).

### COMPATIBLE MODELS

The following iPod®, iPod nano®, iPod classic®, iPod touch®, and iPhone® devices can be used with this system.

Made for

- iPod touch (5th generation)\*
- iPod touch (4th generation)
- iPod touch (3rd generation)
- iPod touch (2nd generation)
- iPod touch (1st generation)
- iPod classic
- iPod with video
- iPod nano (7th generation)\*
- iPod nano (6th generation)
- iPod nano (5th generation)
- iPod nano (4th generation)
- iPod nano (3rd generation)
- iPod nano (2nd generation)
- iPod nano (1st generation)

- iPhone 5s\*
- iPhone 5c\*
- iPhone 5\*
- iPhone 4S
- iPhone 4
- iPhone 3GS
- iPhone 3G
- iPhone

\*: iPod video not supported

#### INFORMATION

- Depending on differences between models or software versions etc., some models might be incompatible with this system.

## Using USB memory device

Connecting a USB memory device enables you to enjoy music from the vehicle speakers.

Select "USB" or "USB2" on the audio source selection screen.

### Connecting a USB memory device

→P. 403

### USB top screen

Pressing the "MEDIA" button displays the USB top screen from any screen of the selected source.

#### ■ Menu screen

→P. 417

#### ■ Selecting a file

Press the "< PRST" or "TRACK >" button or turn the "TUNE•SCROLL" knob to select the desired file number.

To fast-forward or rewind, press and hold the "< PRST" or "TRACK >" button.

#### ■ Selecting a play mode

- 1 Move the controller to the right and select "Browse".
- 2 Select the desired play mode, then select a file to begin the selected play mode.

#### ■ Displaying the now playing list

Move the controller to the right and select "Now Playing List".

### ■ USB memory functions

- Depending on the USB memory device that is connected to the system, the device itself may not be operable and certain functions may not be available. If the device is inoperable or a function is unavailable due to a malfunction (as opposed to a system specification), disconnecting the device and reconnecting it may resolve the problem.
- If the USB memory device still does not begin operation after being disconnected and reconnected, format the device.

### ■ Error messages for USB memory

If the following error messages appear on the screen, refer to the table and take the appropriate measures. If the problem is not rectified, take the vehicle to your Lexus dealer.

Message	Cause/Correction procedures
"Connection error. Please consult your Owner's Manual for instructions on how to connect the USB device."	This indicates a problem with the USB memory device or its connection.
"There are no files available for playback. Please add compatible files to your USB device."	This indicates that no MP3/WMA/AAC files are included on the USB memory device.

### ■ USB memory

- Compatible devices  
USB memory devices that can be used for MP3, WMA and AAC playback.
- Compatible device formats  
The following device format can be used:
  - USB communication format: USB2.0 FS (480 Mbps)
  - File system format: FAT16/32 (Windows)
  - Correspondence class: Mass storage class  
MP3, WMA and AAC files written to a device with any format other than those listed above may not play correctly, and their file names and folder names may not be displayed correctly.
 Items related to standards and limitations are as follows:
  - Maximum directory hierarchy: 8 levels
  - Maximum number of folders in a device: 3000 (including the root)
  - Maximum number of files in a device: 9999
  - Maximum number of files per folder: 255



- MP3, WMA and AAC files

MP3 (MPEG Audio LAYER 3) is a standard audio compression format.

Files can be compressed to approximately 1/10 of their original size using MP3 compression.

WMA (Windows Media Audio) is a Microsoft audio compression format. This format compresses audio data to a size smaller than that of the MP3 format.

AAC is short for Advanced Audio Coding and refers to an audio compression technology standard used with MPEG2 and MPEG4.

MP3, WMA and AAC file and media/formats compatibility are limited.

- MP3 file compatibility

- Compatible standards  
MP3 (MPEG1 AUDIO LAYERIII, MPEG2 AUDIO LAYERIII)
- Compatible sampling frequencies  
MPEG1 AUDIO LAYERIII: 32, 44.1, 48 (kHz)  
MPEG2 AUDIO LAYERIII: 16, 22.05, 24 (kHz)
- Compatible bit rates (compatible with VBR)  
MPEG1 AUDIO LAYERIII: 32-320 (kbps)  
MPEG2 AUDIO LAYERIII: 8-160 (kbps)
- Compatible channel modes: stereo, joint stereo, dual channel and monaural

- WMA file compatibility

- Compatible standards  
WMA Ver. 7, 8, 9 (only compatible with Window Media Audio Standard)
- Compatible sampling frequencies  
32, 44.1, 48 (kHz)
- Compatible bit rates (only compatible with 2-channel playback)  
Ver. 7, 8: CBR 48-192 (kbps)  
Ver. 9: CBR 48-320 (kbps)

- AAC file compatibility

- Compatible standards  
MPEG4/AAC-LC
- Compatible sampling frequencies  
11.025/12/16/22.05/24/32/44.1/48 (kHz)
- Compatible bit rates  
16-320 (kbps)
- Compatible channel modes: 1 ch and 2 ch

- MP4, WMV and AVI files

The following resolutions can be used:

128x96, 160x120, 176x144 (QCIF), 320x240 (QVGA), 352x240 (SIF),  
352x288 (CIF), 640x480 (VGA), 720x480 (NTSC), 720x576 (PAL)

- File names

The only files that can be recognized as MP3/WMA/AAC and played are those with the extension .mp3, .wma or .m4a.

- ID3, WMA and AAC tags

ID3 tags can be added to MP3 files, making it possible to record the track title, artist name, etc.

The system is compatible with ID3 Ver. 1.0, 1.1, and Ver. 2.2, 2.3 ID3 tags. (The number of characters is based on ID3 Ver. 1.0 and 1.1.)

WMA tags can be added to WMA files, making it possible to record the track title and artist name in the same way as with ID3 tags.

AAC tags can be added to AAC files, making it possible to record the track title and artist name in the same way as with ID3 tags.

- MP3, WMA and AAC playback

- When a device containing MP3, WMA or AAC files is connected, all files in the USB memory device are checked. Once the file check is finished, the first MP3, WMA or AAC file is played. To make the file check finish more quickly, we recommend that you do not include any files other than MP3, WMA or AAC files or create any unnecessary folders.

- When a USB memory device is connected and the audio source is changed to USB memory mode, the USB memory device will start playing the first file in the first folder. If the same device is removed and reconnected (and the contents have not been changed), the USB memory device will resume play from the same point in which it was last used.

- Extensions

If the file extensions .mp3, .wma and .m4a are used for files other than MP3, WMA and AAC files, they will be skipped (not played).

- Playback

- To play MP3 files with steady sound quality, we recommend a fixed bit rate of at least 128 kbps and a sampling frequency of 44.1 kHz.

- There is a wide variety of freeware and other encoding software for MP3, WMA and AAC files on the market, and depending on the status of the encoding and the file format, poor sound quality or noise at the start of playback may result. In some cases, playback may not be possible at all.

- Microsoft, Windows, and Windows Media are the registered trademarks of Microsoft Corporation in the U.S.A. and other countries.

 NOTICE

■ To prevent damage to the USB memory device or its terminals

- Depending on the size and shape of the USB memory that is connected to the system, the console box may not close fully. In this case, do not forcibly close the console box as this may damage the USB memory or the terminal, etc.
- Do not leave the USB memory device in the vehicle. The temperature inside the vehicle may become high.
- Do not push down on or apply unnecessary pressure to the USB memory device while it is connected.
- Do not insert foreign objects into the port.

## Using the AUX port

To use the AUX port, connect a portable player, press the “MEDIA” button or select “AUX” or “External” on the “Source” screen.

### Connecting a portable player

→P. 403

### Top screen

Pressing the “MEDIA” button displays the top screen from any screen of the selected source.

#### ■ Menu screen

→P. 417

#### ■ Operating portable players connected to the audio system

Volume can be adjusted using the vehicle’s audio controls. All other adjustments must be made on the portable player itself.

#### ■ When using a portable player connected to the power outlet

Noise may occur during playback. Use the power source of the portable player.



#### NOTICE

#### ■ To prevent damage to the portable player or its terminal

- Depending on the size and shape of the portable player that is connected to the system, the console box may not close fully. In this case, do not forcibly close the console box as this may damage the portable player or the terminal, etc.
- Do not leave portable player in the vehicle. The temperature inside the vehicle may become high.
- Do not push down on or apply unnecessary pressure to the portable player while it is connected.
- Do not insert foreign objects into the port.

## Steps for using Bluetooth® devices

The following can be performed using Bluetooth® wireless communication:

- A portable audio player can be operated and listened to via the Lexus Display Audio system
- Hands-free phone calls can be made via a cellular phone

In order to use wireless communication, register and connect a Bluetooth® device by performing the following procedures.

### Device registration/connection flow

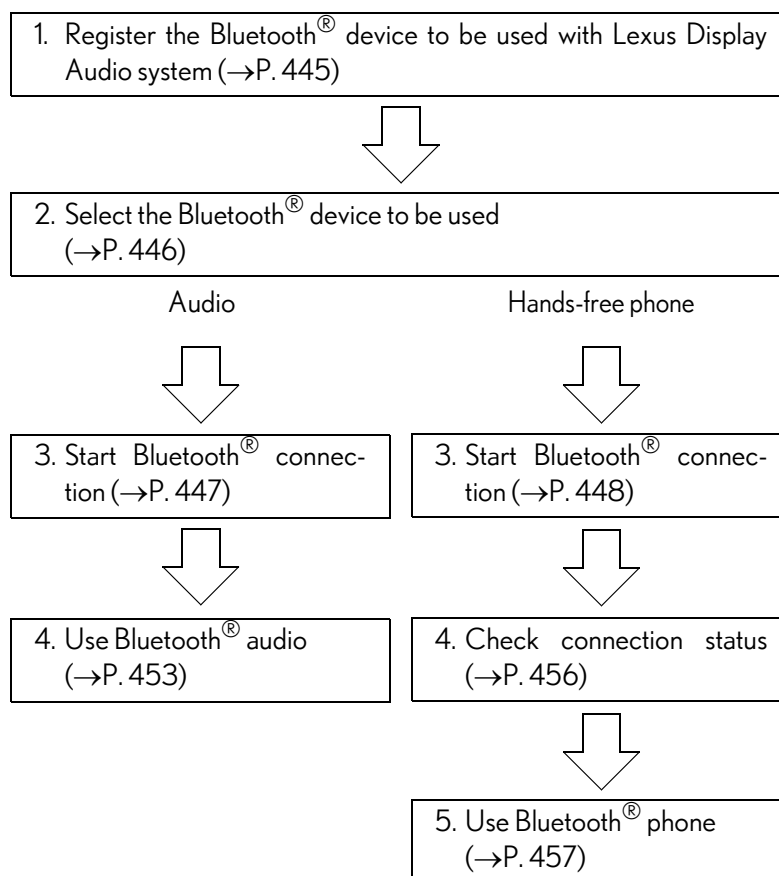

### **“Bluetooth\* Setup” screen**

Go to “Bluetooth\* Setup”: “MENU” button → “Setup” → “Bluetooth\*”

\*: Bluetooth is a registered trademark of Bluetooth SIG, Inc.

---

■ **When displaying “Bluetooth\* Setup” screen from the “Bluetooth\* Audio” screen**

1 Display the “Bluetooth\* Audio” screen. (→P. 453)

2 Move the controller to the left and select “Connect”.

■ **When displaying “Bluetooth\* Setup” screen from the phone top screen**

1 Display the phone top screen. (→P. 455)

2 Move the controller to the left and select “Connect Phone”.

\*: Bluetooth is a registered trademark of Bluetooth SIG, Inc.

## Registering a Bluetooth® device

Bluetooth® compatible phones (HFP) and portable audio players (AVP) can be registered simultaneously. You can register up to 5 Bluetooth® devices.

### How to register a Bluetooth® device

- 1 Turn the Bluetooth® connection setting of your device set to on.
- 2 Go to "Bluetooth\* Setup": "MENU" button → "Setup" → "Bluetooth\*"
- 3 Move the controller to the left and then select "Add Device".

- 4 When this screen is displayed, search for the device name displayed on this screen on your Bluetooth® device.

For operation of the Bluetooth® device, see the manual that comes with your Bluetooth® device.

- 5 Register the Bluetooth® device using your Bluetooth® device.

A PIN code are not required for SSP (Secure Simple Pairing) compatible Bluetooth® devices. Depending on the device, you may need to select Yes to register, or No to cancel on the device.

If an error message is displayed, follow the guidance on the screen to try again.

\*: Bluetooth is a registered trademark of Bluetooth SIG, Inc.



### Removing a Bluetooth® device

- 1 Go to "Bluetooth\* Setup": "MENU" button → "Setup" → "Bluetooth\*"
- 2 Move the controller to the left and then select "Remove Device".
- 3 Select the device to remove.

\*: Bluetooth is a registered trademark of Bluetooth SIG, Inc.

## Selecting a Bluetooth® device

If multiple Bluetooth® devices are registered, follow the procedure below to select the Bluetooth® device to be used. You may only use one device at a time.

### How to select a Bluetooth® device

- 1 Go to "Bluetooth<sup>\*1</sup> Setup": "MENU" button → "Setup" → "Bluetooth<sup>\*1</sup>"
- 2 Select the device to connect.
- 3 Select "Connect XX<sup>\*2</sup>", "Connect as a Phone" or "Connect as an Audio Player".

"Connect XX<sup>\*2</sup>" means connect both the phone and audio functions of one device.

If the desired Bluetooth® device is not displayed, register the device.  
(→P. 445)

\*1: Bluetooth is a registered trademark of Bluetooth SIG, Inc.

\*2: XX represents the selected device name.

## Connecting a Bluetooth® audio player

There are 2 portable audio player connection settings available: connecting from the vehicle and connecting from the portable player.

### Connecting method is set to “Vehicle”

When a registered Bluetooth® audio player is in standby for a connection, it will automatically connect to the system when the engine switch is turned to ACCESSORY or IGNITION ON mode.

When automatic connection priority is set to on and there is more than one registered Bluetooth® audio player available, the system will automatically connect to the Bluetooth® audio player with the highest priority. (→P. 450)

### Connecting method is set to “Device”

Operate the portable player and connect it to the Bluetooth® audio system.

- 1 Go to “Bluetooth\*1 Setup”: “MENU” button → “Setup” → “Bluetooth\*1”
- 2 Select the device to connect.
- 3 Select “Connect XX\*2” or “Connect as an Audio Player”.

If the desired Bluetooth® device is not displayed, register the device. (→P. 445)

\*1: Bluetooth is a registered trademark of Bluetooth SIG, Inc.

\*2: XX represents the selected device name.



## Connecting a Bluetooth® phone

There are two connecting methods available: automatic and manual.

### Auto connection

When you register a phone, auto connection will be activated. It is recommended to have the system set to this mode and leave the Bluetooth® phone in a place where a good connection can be established.

When the engine switch is turned to ACCESSORY or IGNITION ON mode, the system will search for a nearby cellular phone you have registered.

Next, the system automatically connects with the most recent phone that was connected. The connected result is displayed.

When automatic connection priority is set to on and there is more than one registered Bluetooth® phone available, the system will automatically connect to the Bluetooth® phone with the highest priority. (→P. 450)

### Manual connection

When auto connection has failed or “Bluetooth\*1 Power” is turned off, you must connect the Bluetooth® device manually.

- 1 Go to “Bluetooth\*1 Setup”: “MENU” button → “Setup” → “Bluetooth\*1”
- 2 Select the device to connect.
- 3 Select “Connect XX\*2”, “Connect as a Phone” or “Connect as an Audio Player”.

If the desired Bluetooth® device is not displayed, register the device. (→P. 445)

\*1: Bluetooth is a registered trademark of Bluetooth SIG, Inc.

\*2: XX represents the selected device name.

### ■ Reconnecting a Bluetooth® phone

If the system cannot connect due to poor signal strength with the engine switch in ACCESSORY or IGNITION ON mode, the system will automatically attempt to reconnect.

### ■ Connecting a phone while Bluetooth® audio is playing

- Bluetooth® audio will stop temporarily.
- It may take time to connect.

## Displaying a Bluetooth® device details

You can confirm and change the registered device details.

### Bluetooth® device registration status

- 1 Go to “Bluetooth\* Setup”: “MENU” button → “Setup” → “Bluetooth\*”
- 2 Select the desired device and then select “Device Info”.

- ① Change the name of the device
- ② Change the connection method  
 “Vehicle”: Connect the audio system to the portable audio player.  
 “Device”: Connect the portable audio player to the audio system
- ③ Device address
- ④ Device phone number



Depending on the model of phone, the number may not be displayed.

- ⑤ Compatibility profile of the device

\*: Bluetooth is a registered trademark of Bluetooth SIG, Inc.

#### Restoring the default settings

Move the controller to the left and select “Default” on the “Device Information” screen.

## Detailed Bluetooth® settings

You can confirm and change the detailed Bluetooth® settings.

### “System Settings” screen

- 1 Go to “Bluetooth\* Setup”: “MENU” button → “Setup” → “Bluetooth\*”
- 2 Move the controller to the left and then select “System Settings”.
  - ① Select to set automatic connection of a Bluetooth® device on/off
  - ② Select to change the automatic connection priority of the registered Bluetooth® devices (→P. 450)
  - ③ Select to edit the system information (→P. 452)



\*: Bluetooth is a registered trademark of Bluetooth SIG, Inc.

### ■ Restoring the default settings

Move the controller to the left and select “Default” on the “System Settings” screen.

### Setting automatic connection priority

- 1 Go to “Bluetooth\* Setup”: “MENU” button → “Setup” → “Bluetooth\*”
- 2 Move the controller to the left and then select “System Settings”.
  - 3 Select “Preferred Device Settings”.
    - ① Select to set automatic connection priority on/off
    - ② Select to change the automatic connection priority of the registered Bluetooth® phones (→P. 451)
    - ③ Select to change the automatic connection priority of the registered Bluetooth® audio players (→P. 451)



\*: Bluetooth is a registered trademark of Bluetooth SIG, Inc.

**Restoring the default settings**

Move the controller to the left and select "Default" on the "Preferred Device Settings" screen.

**Changing Bluetooth® device automatic connection priority**

- 1** Go to "Bluetooth\* Setup": "MENU" button → "Setup" → "Bluetooth\*"
- 2** Move the controller to the left and then select "System Settings".
- 3** Select "Preferred Device Settings".
- 4** If "Preferred Device Settings" is set to off, set it to on.
- 5** To change the automatic connection priority of the registered Bluetooth® phones, select "Preferred Phones". To change the automatic connection priority of the registered Bluetooth® audio players, select "Preferred Audio Players".
- 6** Select the desired Bluetooth® device.
- 7** Move the controller to the left and then select "Up" or "Down" to change the preferred order.

A newly registered Bluetooth® device will automatically be given the highest automatic connection priority.

\*: Bluetooth is a registered trademark of Bluetooth SIG, Inc.

### Editing the system information

- 1 Go to “Bluetooth\* Setup”: “MENU” button → “Setup” → “Bluetooth\*”
- 2 Move the controller to the left and then select “System Settings”.
- 3 Select “System Information”.

① Change the system name

② Change the PIN-code

You can change the PIN-code that is used to register your Bluetooth® devices in the system.

③ Device address

④ Select to set the display of the phone status on/off

You can set the system to show the status confirmation display when connecting a phone.

⑤ Select to set the display of the audio player status on/off

You can set the system to show the status confirmation display when connecting an audio player.

⑥ Compatibility profile of the system

\*: Bluetooth is a registered trademark of Bluetooth SIG, Inc.



#### Restoring the default settings

Move the controller to the left and select “Default” on the “System Information” screen.

## Listening to Bluetooth® Audio

The Bluetooth® audio system enables the user to enjoy music played on a portable player from the vehicle speakers via wireless communication.

When a Bluetooth® device cannot be connected, check the connection status on the “Bluetooth\* Audio” screen. If the device is not connected, either register or reconnect the device. (→P. 445, 447)

\*: Bluetooth is a registered trademark of Bluetooth SIG, Inc.

### Bluetooth® audio top screen

Pressing the “MEDIA” button displays the Bluetooth® audio top screen from any screen of the selected source.

■ **Menu screen**

→P. 417

■ **Selecting a song**

Press the “< PRST” or “TRACK >” button or turn the “TUNE•SCROLL” knob to select the desired song number.

To fast-forward or reverse, press and hold the “< PRST” or “TRACK >” button.

■ **Selecting a play mode**

- 1 Move the controller to the right and then select “Browse”.
- 2 Select the desired play mode, and then select a song to begin using the selected play mode.

■ **Displaying the now playing list**

Move the controller to the right and then select “Now Playing List”.

## Using a Bluetooth® Phone

The hands-free system is a function that allows you to use your cellular phone without touching it.

This system supports Bluetooth®. Bluetooth® is a wireless data system that allows the cellular phone to wirelessly connect to the hands-free system and make/receive calls.

Before making a phone call, check the connection status, battery charge, call area and signal strength. (→P. 456)

If a Bluetooth® device cannot be connected, check the connection status. If the device is not connected, either register or reconnect it. (→P. 445, 448)

### Phone top screen

To display the screen shown below, press the off-hook switch on the steering wheel or select "Phone" on the "Menu" screen.

- ① Phone name
- ② Bluetooth® connection status (→P. 456)
- ③ Displays the call history screen (→P. 459)
- ④ Displays the favorites screen (→P. 459)
- ⑤ Displays the contacts screen (→P. 457)
- ⑥ Displays the dial pad screen (→P. 457)
- ⑦ Displays the message inbox screen (→P. 463)

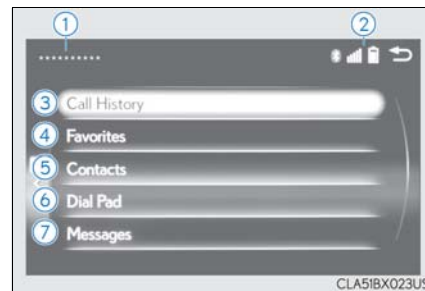

5

Lexus Display Audio system



◆ Phone switch (→P. 465)

◆ Microphone

The vehicle's built-in microphone is used when talking on the phone.

The person to whom you are speaking to can be heard from the front speakers.

To use the hands-free system, you must register your Bluetooth® phone in the system. (→P. 445)

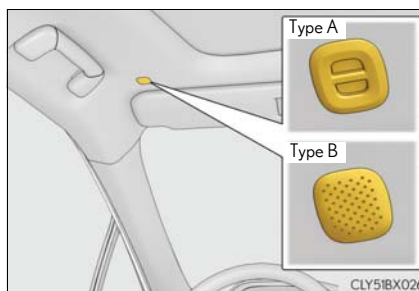







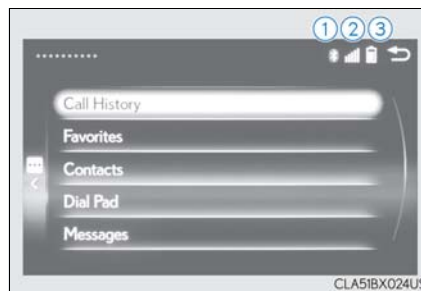

**Status display**

You can check indicators such as signal strength and battery charge on any screen.

- ① Connection status
- ② Signal strength
- ③ Battery charge



Indicators	Conditions		
	Good	Poor	Not connected
Connection status	 (Blue)	 (Gray)	
Signal strength	 Excellent	 Poor	
Battery charge	 Full	 Empty	

## Making a call

Once a Bluetooth® phone is registered, you can make a call using the following procedure:

### Dialing

- 1 Go to “Dial Pad”: “MENU” button → “Phone” → “Dial Pad”
- 2 Input a phone number. (→P. 398)
- 3 Press the off-hook switch on the steering wheel or select .

### Dialing from the phonebook

You can dial a number from the phonebook data imported from your cellular phone. The system has one phonebook for each registered phone. Up to 2500 contacts may be stored in each phonebook. (→P. 458)

- 1 Go to “Contacts”: “MENU” button → “Phone” → “Contacts”
- 2 Choose the desired contact to call from the list.
- 3 Choose the number and then press the off-hook switch on the steering wheel or press the controller.

**When the phonebook is empty**

You can transfer the phone numbers in a Bluetooth® phone to the system. Operation methods differ between PBAP (Phone Book Access Profile) compatible and PBAP incompatible Bluetooth® phones. If the cellular phone does not support either PBAP or OPP (Object Push Profile) service, you cannot transfer contacts.

- 1** Press the off-hook switch on the steering wheel.  
If the phonebook is empty, a message will be displayed.
  - ▶ For a PBAP compatible Bluetooth® phone and “Automatic Transfer” is off
- 2** To enable automatic transfer of new contacts from a cellular phone every time it is connected, select “Always”. (→P. 468)  
Select “Once” if you want to transfer new contacts from a cellular phone.
  - ▶ For a PBAP incompatible and OPP compatible Bluetooth® phone
- 2** Select “Transfer” and operate your cellular phone to transfer new contacts from a cellular phone.  
Select “Add” if you want to add a new contact manually.

### Dialing from favorites

You can make a call using numbers registered in the favorites.

- 1 Go to "Favorites": "MENU" button → "Phone" → "Favorites"
- 2 Choose the desired contact to call from the list.
- 3 Choose the number and then press the off-hook switch on the steering wheel or press the controller.

### Dialing from history

You can make a call using the call history.

- 1 Go to "Call History": "MENU" button → "Phone" → "Call History"
- 2 Select the desired entry from the list.
- 3 Press the off-hook switch on the steering wheel or select .

#### ■ Call history list

- If you make a call to or receive a call from a number registered in the phonebook, the name is displayed in the call history.
- If you make multiple calls to the same number, only the last call made is displayed in the call history.

#### ■ International calls

Depending on the mobile phone in use, you may not be able to make international calls.

#### ■ Calling by using the latest call history entry

- 1 Press the off-hook switch on the steering wheel to display the phone top screen.
- 2 Press the switch again to display the "Call History" screen.
- 3 Press the switch again to select the latest call history entry.

## Receiving a call

When a call is received, the following screen is displayed together with a sound.

### To answer the phone

Press the off-hook switch on the steering wheel or select .



### To refuse a call

Press the on-hook switch on the steering wheel or select .

#### ■ International calls

Depending on the cellular phone in use, received international calls may not be displayed correctly.

## Speaking on the phone

The following screen is displayed when speaking on the phone.

### To adjust the transmit volume

Select “Transmit Volume”. To restore default volume, move the controller to the left on the “Transmit Volume” screen and then select “Default”.



### To adjust in call volume

Move the controller to the left and then select “In-Call Volume”. You can also adjust the volume using the “PWR•VOL” knob or the steering switches.

### To prevent the other party from hearing your voice

Select “Mute”.

### Inputting tones

When using phone services such as an answering service or a bank, you can store phone numbers and code numbers in the contacts using “p” or “w” symbols (eg. 056133 w 0123p#1).

- ▶ Contact including a phone number only

- 1 Move the controller to the left and then select “0-9”.
- 2 Input the number.

- ▶ Phone number containing a “p” symbol

When the “p” symbol is dialed in an outgoing call, there will be a pause for 2 seconds before the following digits are dialed automatically.

- ▶ Phone number containing a “w” symbol

When the “w” symbol is dialed in an outgoing call, you need to go to the “Release Tones” screen to dial the following digits. Move the controller to the left and then select “Release Tones”.

### To transfer a call

Select “Handset Mode” to change from a hands-free call to a cellular phone call or vice versa.

### To hang up

Press the on-hook switch on the steering wheel or select .

### Call waiting

When a call is interrupted by a third party while talking, an incoming call message will be displayed.

To talk with the other party:

Press the off-hook switch on the steering wheel or select .

To refuse the call:

Press the on-hook switch on the steering wheel or select .



Every time you press the off-hook switch on the steering wheel or select  during call waiting, you will be switched to the other party.

### ■ Transferring calls

- It is not possible to transfer from hands-free to the cellular phone while driving.
- If you transfer from the cellular phone to hands-free, the hands-free screen will be displayed, and you can operate the system using the screen.
- Transfer method and operation may vary according to the cellular phone used.
- For operation of the cellular phone in use, see the phone’s manual.

### ■ Call waiting operation

Call waiting operation may differ depending on your phone company and cellular phone.

## Using a Bluetooth® phone message

Once a MAP-profile compatible Bluetooth® phone is registered, you can check the E-mail/SMS/MMS and reply to a message using the following procedures:

### Checking messages

- 1 Go to message screen: "MENU" button → "Phone" → "Messages"
- 2 Select a message.

Moving the controller to the left while on the message list screen displays the setting screen. (→P. 471)

Move the controller to the right while on the message screen and then select an account to display a message list for the selected account.

### Message screen

Selecting "Next" or "Previous" displays the next or previous message.  
If a message is too long, select "Read More" to display the full text.

#### ■ Option menu

Move the controller to the left while on the message screen.

- 1 Select a prepared message and send a reply message
- 2 Call a sender  
If more than one phone number is registered for a sender, a phone number selection screen will be displayed.



- 3 Call a phone number written in a message
- 4 Select "Play" to have a message read out loud.  
Select "Stop" to stop this function.
- 5 Select "Mark Unread" to mark E-mail that has been read as unread. Select "Mark Read" to mark E-mail that has not been read as read.



### Replying to a message

- 1 Move the controller to the left while on the message screen.
- 2 Select "Quick Message" to display the "Quick Message" screen.
- 3 Select the desired message and then select "Send".

#### ■ Editing a quick message

- 1 Move the controller to the left while on the message screen.
- 2 Select "Quick Message" and move the cursor to the desired message.
- 3 Move the controller to the left and select "Edit".

To return to the default message after editing, select "Default".

### Receiving a message popup function

This function is available when the "E-mail Notification Popup" or "SMS/MMS Notification Popup" are set to on. (→P. 467)

- ▶ "Incoming E-mail Display" or "Incoming SMS/MMS Display" are set to "Drop-Down"

When E-mail/ SMS/MMS are received, the incoming message is displayed on the upper side of the screen with a sound.

- ▶ "Incoming E-mail Display" or "Incoming SMS/MMS Display" are set to "Full Screen"

When E-mail/ SMS/MMS are received, the incoming message screen is displayed with a sound and it can be operated on the screen.

- 1 Check the message
- 2 Refuse to check the message
- 3 Call to receive the message sender's phone number



## Using the steering wheel switches

The steering wheel switches can be used to operate a connected cellular phone.

### Operating a phone using the steering wheel switches

① Volume switch

During an incoming call: Adjusts the ring tone volume

During speaking on the phone: Adjusts in call volume

The voice guidance volume cannot be adjusted using this button.

② Talk switch

Press: Turns the voice command system on

Press and hold: Turns the voice command system off

③ On-hook switch

- End call
- Refuse call

④ Off-hook switch

- Start call
- Receiving
- Phone top screen display

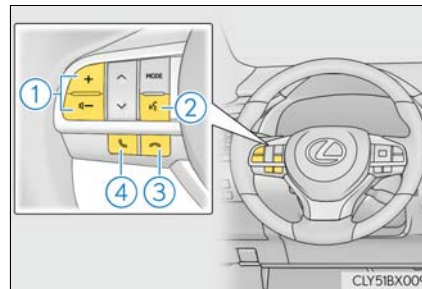

## Bluetooth® phone settings

You can adjust the hands-free system to your desired settings.

### “Phone Settings” screen

Go to “Phone Settings”: “MENU” button → “Setup” → “Phone”

- ① Register and connect a Bluetooth® device (→P. 445)
- ② Adjust the call volume and message readout volume (→P. 466)
- ③ Change display settings (→P. 467)
- ④ Change the contact/call history settings (→P. 468)
- ⑤ Change messaging settings (→P. 471)



### Sound settings

- ① Change the ring tone type
- ② Adjust the ring tone volume
- ③ Adjust in call tone volume
- ④ Change the incoming SMS/MMS tone type
- ⑤ Adjust the incoming SMS/MMS tone volume
- ⑥ Change the incoming e-mail tone type
- ⑦ Adjust the incoming e-mail tone volume
- ⑧ Adjust the message readout volume

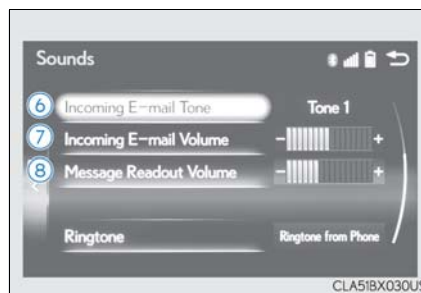

### Display settings

- ① Change the incoming call display
- ② Set the new SMS/MMS notification display on/off
- ③ Change the incoming SMS/MMS display
- ④ Set the new e-mail notification display on/off
- ⑤ Change the incoming e-mail display.
- ⑥ Set the phonebook/history transfer status notification display on/off

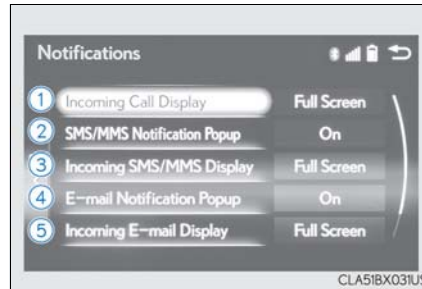

#### ■ To return to the default volume settings

Move the controller to the left and then select "Default".

## Contact settings

Individual phonebooks from up to 5 phones can be registered to the system. The data for 2500 contacts (up to 4 numbers per contact) can be registered into the system's phonebook.

### "Contacts/Call History" screen

Go to "Contacts/Call History": "MENU" button → "Setup" → "Phone" → "Contacts/Call History"

- ① For PBAP compatible Bluetooth<sup>®</sup> phones: Select to change the contact/history transfer settings (→P. 469)
- ② Update contacts (→P. 469) (PBAP incompatible Bluetooth<sup>®</sup> phones, or compatible phones with "Automatic Transfer" off)
- ③ Change the sort contacts mode
- ④ Add a favorite (→P. 470)
- ⑤ Delete a favorite (→P. 470)
- ⑥ Delete call history (PBAP incompatible Bluetooth<sup>®</sup> phones, or compatible phones with "Automatic Transfer" off)
- ⑦ Add a new contact (PBAP incompatible Bluetooth<sup>®</sup> phones, or compatible phones with "Automatic Transfer" off)
 

Input the name, phone number and phone number type to add a new contact.
- ⑧ Edit a contact (PBAP incompatible Bluetooth<sup>®</sup> phones, or compatible phones with "Automatic Transfer" off)
 

Select the desired contact to edit.
- ⑨ Delete contacts (→P. 470) (PBAP incompatible Bluetooth<sup>®</sup> phones, or compatible phones with "Automatic Transfer" off)

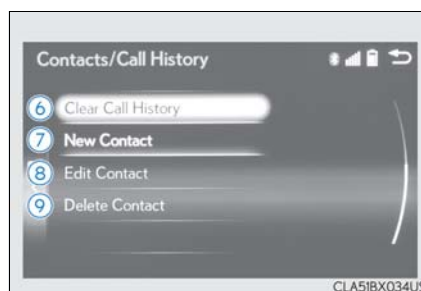

### ■ Return to the default settings

Move the controller to the left and select "Default".

## Transferring a phone number

You can transfer the phone numbers in your Bluetooth® phone to the system. Operation methods differ between PBAP compatible and PBAP incompatible Bluetooth® phones. If your cellular phone does not support either PBAP or OPP services, you cannot transfer contacts.

► For PBAP compatible Bluetooth® phones

Go to "Automatic Transfer": "MENU" button → "Setup" → "Phone" → "Contacts/Call History" → "Automatic Transfer"

- ① Select to set the automatic phonebook download on/off

With this setting on, phonebook data will be automatically transferred.

Depending on the cellular phone, call history will be also transferred.

- ② Select to update contacts from the connected phone
- ③ Select to set the display of contact images on/off

► For PBAP compatible Bluetooth® phones when "Automatic Transfer" is set to off and PBAP incompatible Bluetooth® phones

Go to "Transfer Contacts from Phone": "MENU" button → "Setup" → "Phone" → "Contacts/Call History" → "Transfer Contacts from Phone"

- ① Select to transfer the contact from the connected cellular phone and replace the current one
- ② Select to transfer the desired contact data from the connected cellular phone to add to the current one

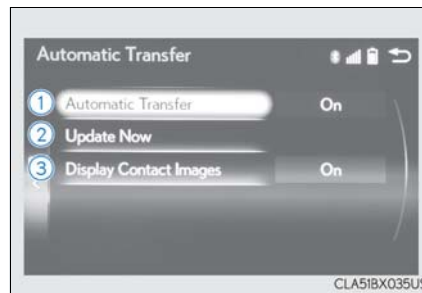

### ■ Return to the default automatic transfer settings

Move the controller to the left and select "Default" on the "Automatic Transfer" screen.

### Registering favorites

You can register the desired contact from the phonebook. Up to 15 contacts per phone can be registered.

- 1 Go to "Add Favorite": "MENU" button → "Setup" → "Phone" → "Contacts/Call History" → "Add Favorite"
- 2 Choose the contact to register.

### Removing favorites

- 1 Go to "Remove Favorite": "MENU" button → "Setup" → "Phone" → "Contacts/Call History" → "Remove Favorite"
- 2 Select the desired contacts.  
You can select all contacts by selecting "Select All".
- 3 Move the controller to the left and select "Remove".

### Deleting the contacts data

- 1 Go to "Delete Contact": "MENU" button → "Setup" → "Phone" → "Contacts/Call History" → "Delete Contact"
- 2 Select the desired contacts.  
You can select all contacts by selecting "Select All".
- 3 Move the controller to the left and select "Delete".

#### ■ Phonebook data

Phonebook data is managed separately for every registered phone. When one phone is connected, you cannot read the registered data of the other phones.

#### ■ When transferring contacts

Transfer contacts while the engine is running.

If the cellular phone is OPP or PBAP compatible, you may need to input "1234" on the cellular phone for OBEX certification.

#### ■ When you have selected "Replace Contacts" or "Add Contact" to transfer contacts

If the cellular phone does not support OPP service, you cannot use these functions. You can transfer the phonebook data only by operating your phone.

#### ■ Transferring contacts while Bluetooth® audio is playing

Bluetooth® audio will disconnect. It will reconnect automatically when data transfer finishes. It may not reconnect depending on the phone which is connected.

## Messaging setting

Go to "Messaging": "MENU" button → "Setup" → "Phone" → "Messaging"

- ① Set the message forwarding from cellular phones on/off
- ② Set the automatic message read out function on/off
- ③ Set the cellular phone's message read and unread status update function on/off
- ④ Select to set display of messaging account names on/off



When set to on, messaging account names used on the cellular phone will be displayed.

- ⑤ Set the signature function on/off

### ■ Restoring the default settings

Move the controller to the left then select "Default" on the "Messaging" screen.



## What to do if... (Troubleshooting)

If there is a problem with the hands-free system or a Bluetooth® device, first check the table below.

- ▶ When using the hands-free system with a Bluetooth® device

The hands-free system or Bluetooth® device does not work.
The connected device may not be a compatible Bluetooth® cellular phone. → For a list of specific devices which operation has been confirmed on this system, check with your Lexus dealer or the following website: <a href="http://www.lexus.com/MobileLink">http://www.lexus.com/MobileLink</a>
The Bluetooth® version of the connected cellular phone may be older than the specified version. → Use a cellular phone with Bluetooth® version 2.0 or higher (recommended: Ver. 3.0 with EDR or higher). (→P. 478)

## ▶ When registering/connecting a cellular phone

A cellular phone cannot be registered.
An incorrect passcode was entered on the cellular phone. → <b>Enter the correct passcode on the cellular phone.</b>
The registration operation has not been completed on the cellular phone side. → <b>Complete the registration operation on the cellular phone (approve registration on the phone).</b>
Old registration information remains on either this system or the cellular phone. → <b>Delete the existing registration information from both this system and the cellular phone, then register the cellular phone you wish to connect to this system. (→P. 445)</b>
A Bluetooth® connection cannot be made.
Another Bluetooth® device is already connected. → <b>Manually connect the cellular phone you wish to use to this system. (→P. 448)</b>
Bluetooth® function is not enabled on the cellular phone. → <b>Enable the Bluetooth® function on the cellular phone.</b>

## ▶ When making/receiving a call

A call cannot be made/received.
Your vehicle is in a "No Service" area. → <b>Move to where "No Service" no longer appears on the display.</b>

▶ When using the phonebook

Phonebook data cannot be transferred manually/automatically.
The profile version of the connected cellular phone may not be compatible with transferring phonebook data. → <b>For a list of specific devices which operation has been confirmed on this system, check with your Lexus dealer or the following website:</b> <a href="http://www.lexus.com/MobileLink">http://www.lexus.com/MobileLink</a>
Automatic phonebook transfer function on this system is set to off. → <b>Set automatic phonebook transfer function on this system to on. (→P. 468)</b>
Passcode has not been entered on the cellular phone. → <b>Enter the passcode on the cellular phone if requested (default passcode: 1234).</b>
Transfer operation on the cellular phone has not completed. → <b>Complete transfer operation on the cellular phone (approve transfer operation on the phone).</b>
Phonebook data cannot be edited.
Automatic phonebook transfer function on this system is set to on. → <b>Set automatic phonebook transfer function on this system to off. (→P. 468)</b>

▶ When using the Bluetooth® message function

Messages cannot be viewed.
Message transfer is not enabled on the cellular phone. → <b>Enable message transfer on the cellular phone (approve message transfer on the phone).</b>
Automatic transfer function on this system is set to off. → <b>Set automatic transfer function on this system to on. (→P. 468)</b>
New message notifications are not displayed.
Notification of SMS/MMS/E-mail reception on this system is set to off. → <b>Set notification of SMS/MMS/E-mail reception on this system to on. (→P. 467)</b>
Automatic message transfer function is not enabled on the cellular phone. → <b>Enable automatic transfer function on the cellular phone.</b>

## ▶ In other situations

Even though all conceivable measures have been taken, the symptom status does not change.

The cellular phone is not close enough to this system.  
→ **Bring the cellular phone closer to this system.**

The cellular phone is the most likely cause of the symptom.  
→ **Turn the cellular phone off, remove and reinstall the battery pack, and then restart the cellular phone.**  
→ **Enable the cellular phone's Bluetooth® connection.**  
→ **Stop the cellular phone's security software and close all applications.**  
→ **Before using an application installed on the cellular phone, carefully check its source and how its operation might affect this system.**

## Bluetooth®

### ■ When using the Bluetooth® audio system

- In the following situations, the system may not function.
  - If the portable audio player is turned off
  - If the portable audio player is not connected
  - If the portable audio player's battery is low
- There may be a delay if a cellular phone connection is made during Bluetooth® audio play.
- Depending on the type of portable audio player that is connected to the system, operation may differ slightly and certain functions may not be available.

### ■ When using the hands-free system

- The audio system is muted when making a call.
- If both parties speak at the same time, it may be difficult to hear.
- If the received call volume is overly loud, an echo may be heard.  
If the Bluetooth® phone is too close to the system, quality of the sound may deteriorate and connection status may deteriorate.
- In the following situations, it may be difficult to hear the other party:
  - When driving on unpaved roads
  - When driving at high speeds
  - If a window is open
  - If the air conditioning is blowing directly on the microphone
  - If there is interference from the network of the cellular phone
- Depending on the type phone, certain functions may not be available.

### ■ Conditions under which the system will not operate

- If using a cellular phone that does not support Bluetooth®
- If the cellular phone is turned off
- If you are outside of cellular phone service coverage
- If the cellular phone is not connected
- If the cellular phone's battery is low
- When outgoing calls are controlled, due to heavy traffic on phone lines, etc.
- When the cellular phone itself cannot be used
- When transferring phonebook data from the cellular phone

**■ Bluetooth® antenna**

The antenna is built into the display.

If the portable audio player is behind the seat or in the glove box or console box, or is touching or covered by metal objects, the connection status may deteriorate.

If the cellular phone is behind the seat or in the console box, or touching or covered by metal objects, the connection status may deteriorate.

**■ Battery charge/signal status**

- This display may not correspond exactly with the portable audio player or cellular phone itself.

- This system does not have a charging function.

- The portable audio player or cellular phone battery will be depleted quickly when the device is connected to Bluetooth®.

**■ When using the Bluetooth® audio and hands-free system at the same time**

The following problems may occur.

- The Bluetooth® audio connection may be interrupted.

- Noise may be heard during Bluetooth® audio playback.

**■ About the contact in this system**

The following data is stored for every registered cellular phone. When another phone is connecting, you cannot read the registered data.

- Contact data

- Call history

- Favorite

- Message

When removing a Bluetooth® phone from the system, the above-mentioned data is also deleted.

**■ About Bluetooth®**

The Bluetooth® word mark and logos are registered trademarks owned by Bluetooth SIG, Inc. and any use of such marks by PIONEER CORPORATION is under license. Other trademarks and trade names are those of their respective

### ■ Compatible models

The Bluetooth® audio system supports portable audio players with the following specifications

- Bluetooth® specifications:  
Ver. 2.0 or higher (Recommended: Ver. 3.0 +EDR or higher)
- Profiles:
  - A2DP (Advanced Audio Distribution Profile) Ver. 1.0, or higher  
(Recommended: Ver. 1.3 or higher)  
This is a profile to transmit stereo audio or high quality sound to the audio system.
  - AVRCP (Audio/Video Remote Control Profile) Ver. 1.0 or higher  
(Recommended: Ver. 1.5 or higher)  
This is a profile to allow remote control the A/V equipment.

However, please note that some functions may be limited depending on the type of portable audio player connected.

The hands-free system supports cellular phones with the following specifications.

- Bluetooth® specification:  
Ver. 2.0 or higher (Recommended: Ver. 3.0 +EDR or higher)
- Profiles:
  - HFP (Hands Free Profile) Ver. 1.0 or higher (Recommended: Ver. 1.6 or higher)  
This is a profile to allow hands-free phone calls using a cellular phone or head set. It has outgoing and incoming call functions.
  - OPP (Object Push Profile) Ver. 1.1 or higher (Recommended: Ver. 1.2)  
This is a profile to transfer phonebook data. When a Bluetooth® compatible cellular phone has both PBAP and OPP, OPP cannot be used.
  - PBAP (Phone Book Access Profile) Ver. 1.0 or higher (Recommended: Ver. 1.1)  
This is a profile to transfer phonebook data.
  - MAP (Message Access Profile) Ver.1.0 or higher  
This is a profile to using phone message.

If the cellular phone does not support HFP, you cannot register it with the hands-free system. OPP, PBAP or MAP services must be selected individually.

### ■ Reconnecting the portable audio player

If the portable audio player is disconnected due to poor reception when the engine switch is in ACCESSORY or IGNITION ON mode, the system automatically reconnects the portable audio player.

If you have switched off the portable audio player yourself, follow the instructions below to reconnect:

- Select the portable audio player again
- Enter the portable audio player

### ■ When you sell your car

Be sure to delete your personal data. (→P. 409)

## ■ Certification

FCC ID: AJDK066
[For 2.4 GHz Radio Transmitters] This equipment complies with FCC/ISED radiation exposure limits set forth for an uncontrolled environment and meets the FCC radio frequency (RF) Exposure Guidelines and RSS-102 of the IC radio frequency (RF) Exposure rules. This equipment should be installed and operated keeping the radiator at least 20 cm or more away from person's body.
This transmitter must not be co-located or operated in conjunction with any other antenna or transmitter.
This device complies with Part 15 of FCC Rules and Innovation, Science, and Economic Development Canada licence-exempt RSS standard(s). Operation is subject to the following two conditions: (1) this device may not cause interference, and (2) this device must accept any interference, including interference that may cause undesired operation of this device.
Information to User - Alteration or modifications carried out without appropriate authorization may invalidate the user's right to operate the equipment.



IC: 775E-K066
<p>[For 2.4 GHz Radio Transmitters] This equipment complies with FCC/ISED radiation exposure limits set forth for an uncontrolled environment and meets the FCC radio frequency (RF) Exposure Guidelines and RSS-102 of the ISED radio frequency (RF) Exposure rules. This equipment should be installed and operated keeping the radiator at least 20 cm or more away from person's body.</p>
<p>[Pour 2,4 GHz émetteurs radio] Cet équipement est conforme aux limites d'exposition aux rayonnements énoncées pour un environnement non contrôlé et respecte les règles les radioélectriques (RF) de la FCC lignes directrices d'exposition et d'exposition aux fréquences radioélectriques (RF) CNR-102 de l'ISDE. Cet équipement doit être installé et utilisé en gardant une distance de 20 cm ou plus entre le radiateur et le corps humain.</p>
<p>This device complies with Part 15 of FCC Rules and Innovation, Science, and Economic Development Canada licence-exempt RSSs. Operation is subject to the following two conditions: (1) This device may not cause interference; and (2) This device must accept any interference, including interference that may cause undesired operation of the device.</p>
<p>Le présent appareil est conforme aux la partie 15 des règles de la FCC et CNR d'Innovation, Sciences et Développement économique Canada applicables aux appareils radio exempts de licence. L'exploitation est autorisée aux deux conditions suivantes: (1) l'appareil ne doit pas produire de brouillage; (2) l'utilisateur de l'appareil doit accepter tout brouillage radioélectrique subi, même si le brouillage est susceptible d'en compromettre le fonctionnement.</p>

CAUTION: Use of controls or adjustments or performance of procedures other than those specified herein may result in hazardous radiation exposure.  
CAUTION: The use of optical instruments with this product will increase eye hazard.

**⚠ WARNING****■ While driving**

Do not operate the portable audio player, cellular phone or connect a device to the Bluetooth® system.

**■ Caution regarding interference with electronic devices**

- Your audio unit is fitted with Bluetooth® antennas. People with implantable cardiac pacemakers, cardiac resynchronization therapy-pacemakers or implantable cardioverter defibrillators should maintain a reasonable distance between themselves and the Bluetooth® antennas. The radio waves may affect the operation of such devices.
- Before using Bluetooth® devices, users of any electrical medical device other than implantable cardiac pacemakers, cardiac resynchronization therapy-pacemakers or implantable cardioverter defibrillators should consult the manufacturer of the device for information about its operation under the influence of radio waves. Radio waves could have unexpected effects on the operation of such medical devices.

**⚠ NOTICE****■ When leaving the vehicle**

Do not leave your portable audio player or cellular phone in the vehicle. The inside of the vehicle may become hot, causing damage to the portable audio player or cellular phone.

## “Information” screen

### Display “Information” screen

Go to “Information”: “MENU” button → “Info”

- ① Display the fuel consumption.  
(→P. 115)
- ② Display the “USB Photo” screen.  
(→P. 484)
- ③ Display the Traffic Map picture.  
Available when in a traffic supported  
HD Radio coverage area
- ④ Display the weather information.  
(→P. 486)



### Traffic information map

Go to “Traffic Map”: “MENU” button → “Info” → “Traffic Incidents”

- ① Current position of your car
  - ② Traffic information line
- The line color means the following:
- Red: Heavy congestion
  - Yellow: Moderate traffic
  - Green: Free flowing traffic



## ■ Certification for U.S. owners

### I. Clear Channel Disclaimers

"Total Traffic Network, a division of Clear Channel Broadcasting, Inc., owns or holds the rights to the traffic, news, sports, weather, stocks and other data (the "TOTAL TRAFFIC-HD+ Data") and TOTAL TRAFFIC-HD+ network through which it is delivered, together the "TTN Service". Use of the TTN Service is subject to the terms of these Device End User Terms.

"The TTN Service is informational only. User assumes all risk of use. Total Traffic Network and its suppliers and licensors make no representations about the accuracy or timeliness of any of the TOTAL TRAFFIC-HD+ Data, including traffic and road conditions, route usability, or speed."

"TOTAL TRAFFIC-HD+ NETWORK DATA IS PROVIDED "AS IS," AND "WHERE IS". TOTAL TRAFFIC NETWORK AND ITS SUPPLIERS AND LICENSORS EXPRESSLY DISCLAIM ALL WARRANTIES WITH RESPECT TO THE DATA (INCLUDING, WITHOUT LIMITATION, THAT THE DATA WILL BE ERROR-FREE, WILL OPERATE WITHOUT INTERRUPTION OR THAT THE DATA WILL BE ACCURATE), EXPRESS, IMPLIED OR STATUTORY, INCLUDING, WITHOUT LIMITATION, THE IMPLIED WARRANTIES OF MERCHANTABILITY, NON-INFRINGEMENT, FITNESS FOR A PARTICULAR PURPOSE, OR THOSE ARISING FROM A COURSE OF DEALING OR USAGE OF TRADE."

"TOTAL TRAFFIC NETWORK AND ITS SUPPLIERS AND LICENSORS WILL NOT BE LIABLE TO YOU FOR ANY INDIRECT, SPECIAL, CONSEQUENTIAL, EXEMPLARY, OR INCIDENTAL DAMAGES (INCLUDING, WITHOUT LIMITATION, LOST REVENUES, ANTICIPATED REVENUES, OR PROFITS RELATING TO THE SAME) ARISING FROM ANY CLAIM RELATING DIRECTLY OR INDIRECTLY TO USE OF THE DATA, WHETHER A CLAIM FOR SUCH DAMAGES IS BASED ON WARRANTY, CONTRACT, TORT (INCLUDING, WITHOUT LIMITATION, NEGLIGENCE OR STRICT LIABILITY) OR ANY OTHER LEGAL THEORY."

### II. The Weather Channel's (TWC's) Disclaimers

THE FOLLOWING TERMS APPLY TO THE USE OF ANY MATERIAL, DATA OR INFORMATION PROVIDED BY THE WEATHER CHANNEL, LLC ("THE WEATHER CHANNEL"), INCLUDING WEATHER-RELATED INFORMATION AND REPORTS, OBTAINED BY YOU OR OTHERS THROUGH THE TTN SERVICE ("THE WC DATA").

#### DISCLAIMER OF WARRANTIES.

YOUR USE OF THE WC DATA IS AT YOUR SOLE RISK. THE WC DATA IS PROVIDED ON AN "AS IS" AND "AS AVAILABLE" BASIS. THE WEATHER CHANNEL EXPRESSLY DISCLAIMS ALL WARRANTIES OF ANY KIND, WHETHER EXPRESS OR IMPLIED, INCLUDING, BUT NOT LIMITED TO THE IMPLIED WARRANTIES OF MERCHANTABILITY, FITNESS FOR A PARTICULAR PURPOSE AND NON-INFRINGEMENT. THE WEATHER CHANNEL MAKES NO REPRESENTATION OR WARRANTY THAT (i) THE WC DATA WILL MEET YOUR REQUIREMENTS, (ii) THE WC DATA WILL BE UNINTERRUPTED, TIMELY, SECURE, OR ERROR-FREE, (iii) THE RESULTS THAT MAY BE OBTAINED FROM THE USE OF THE WC DATA WILL BE ACCURATE OR RELIABLE, OR (iv) ANY ERRORS OR BUGS IN THE WC DATA WILL BE CORRECTED. ACCORDINGLY, THE WEATHER CHANNEL SHALL NOT BE RESPONSIBLE OR LIABLE FOR THE ACCURACY, USEFULNESS OR AVAILABILITY OF THE WC DATA.

#### LIMITATION OF LIABILITY.

YOU EXPRESSLY UNDERSTAND AND AGREE THAT THE WEATHER CHANNEL, ITS SUPPLIERS, ITS LICENSORS AND ITS AFFILIATE COMPANIES SHALL NOT BE LIABLE, UNDER ANY LEGAL THEORY, INCLUDING CONTRACT, TORT, NEGLIGENCE OR STRICT LIABILITY, FOR ANY DIRECT, INDIRECT, INCIDENTAL, SPECIAL, PUNITIVE, CONSEQUENTIAL OR EXEMPLARY DAMAGES, INCLUDING BUT NOT LIMITED TO, DAMAGES FOR LOSS OF PROFITS, GOODWILL, USE, DATA OR OTHER INTANGIBLE LOSSES (EVEN IF THE WEATHER CHANNEL HAS BEEN ADVISED OF THE POSSIBILITY OF SUCH DAMAGES), RESULTING FROM OR ARISING OUT OF YOUR USE OF, OR YOUR INABILITY TO USE, THE WC DATA, THIS AGREEMENT, OR ANY OTHER MATTER RELATING TO THE WC DATA. YOUR SOLE AND EXCLUSIVE REMEDY FOR ANY DISPUTE WITH THE WEATHER CHANNEL RELATED TO THE WC DATA OR CONTENT SHALL BE CANCELLATION OF RECEIPT OF THE WC DATA.

SOME JURISDICTIONS DO NOT ALLOW THE EXCLUSION OF CERTAIN WARRANTIES OR THE LIMITATION OR EXCLUSION OF LIABILITY FOR INCIDENTAL OR CONSEQUENTIAL DAMAGES. ACCORDINGLY, SOME OF THE ABOVE LIMITATIONS MAY NOT APPLY TO YOU.

## USB photo

Connecting a USB memory device enables you to enjoy photo on the Lexus Display Audio display.

### USB photo screen

Go to "USB Photo": "MENU" button → "Info" → "USB1 Photo" or "USB2 Photo"

### Connecting a USB memory device

→P. 403

### Menu screen

Move the controller to the left to display the menu screen.

- ① Change the full screen mode.
- ② Select to set the slide show display on/off.  
Start the slide show at a selected folder.
- ③ Change the play speed.
- ④ Change the play mode.



### Selecting a folder and a file

- 1 Move the controller to the right and select "Browse".
- 2 Select the desired folder, and then select a desired file to begin using the selected folder.

**■ USB memory functions**

→P. 439

**■ USB memory****● Compatible devices**

USB memory device that can be used for JPEG display.

**● Compatible device formats**

The following device format can be used:

- USB communication format: USB2.0 FS (480 Mbps)
- File system format: FAT16/32 (Windows)
- Correspondence class: Mass storage class

**● JPEG file compatibility**

- Compatible image size: Maximum 10MB
- Compatible pixel size: Maximum 10,000,000 pixels

**NOTICE****■ To prevent damage to the USB memory device or its terminals**

→P. 441

## Weather information

Weather information for the selected city is displayed.  
Available when in weather supported HD Radio coverage area

### How to check the weather information

- 1 Go to "Weather": "MENU" button → "Info" → "Weather"
- 2 Select the desired city/location.

- 1 Current location of your car
- 2 Select of the recently checked location list  
Select the desired location on the recently checked location list.
- 3 Select of the National City list.  
Select the region on the region list and then select the city on the National City list.



- 4 Select of the local location list  
Select the location on the local location list.

#### ■ Select the time

Select "Current Weather" on the "Weather" screen.

- 1 Display the current weather information.
- 2 Display the 3 days weather information.  
You can display detail of a week, move the controller right and then select the desired week.



- 3 Display the 6/12 hour weather information.

## Voice command system

The voice command system enables the audio and hands-free systems to be operated using voice commands.

Operations of the voice command system can be performed by selecting the menu corresponding to each function on the right part of the screen. Even if any menu is selected, commands displayed on all menus can be operated.

### Using the voice command system

- 1 Press the talk switch.  
To cancel the voice command system, press and hold the talk switch.
- 2 After a beep sounds, say the desired command.  
On the list screen, you can select the desired command.

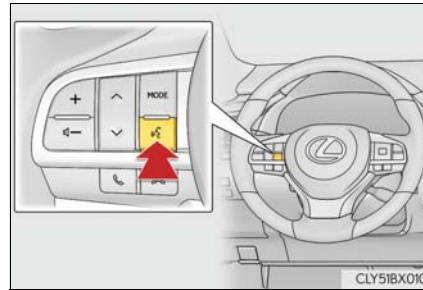

#### ■ Menu screen

To display the menu screen, move the controller to the left.

▶ "Hints" screen

▶ Except "Hints" screen



- ① Offer examples of commands and operation methods
- ② Adjust the settings for voice guidance volume and voice recognition prompts. Select to train voice recognition. ("Hints" screen) (→P. 410)
- ③ Start over voice recognition (except "Hints" screen)
- ④ Cancel voice recognition



■ **Microphone**

→P. 456

■ **When using the microphone**

- It is unnecessary to speak directly into the microphone when giving a command.
- Wait for the confirmation beep before speaking a command.
- Voice commands may not be recognized if:
  - Spoken too quickly.
  - Spoken at a low or high volume.
  - The roof or windows are open.
  - Passengers are talking while voice commands are spoken.
  - The air conditioning speed is set high.
  - The air conditioning vents are turned towards the microphone.
- In the following conditions, the system may not recognize the command properly and using voice commands may not be possible:
  - The command is incorrect or unclear. Note that certain words, accents or speech patterns may be difficult for the system to recognize.
  - There is excessive background noise, such as wind noise.

■ **When searching for a track**

- A USB memory or iPod must be connected to enable track searching and playback. (→P. 403)
- When a USB memory or iPod is connected, recognition data is created so tracks can be searched using voice commands.
- Recognition data is updated under the following conditions:
  - When the USB memory or iPod data has changed.
  - When the voice recognition language is changed. (→P. 407)
- While the recognition data is being created or being updated, a track search cannot be performed using a voice command.

■ **The Gracenote® media database**

■ **The Gracenote® media database**

- Gracenote, the Gracenote logo and logotype, "Powered by Gracenote" and Gracenote MusicID are either registered trademarks or trademarks of Gracenote, Inc. in the United States and/or other countries.



**Gracenote® End User License Agreement**

This application or device contains software from Gracenote, Inc. of Emeryville, California (“Gracenote”). The software from Gracenote (the “Gracenote Software”) enables this application to perform disc and/or file identification and obtain music-related information, including name, artist, track, and title information (“Gracenote Data”) from online servers or embedded databases (collectively, “Gracenote Servers”) and to perform other functions. You may use Gracenote Data only by means of the intended End-User functions of this application or device.

You agree that you will use Gracenote Data, the Gracenote Software, and Gracenote Servers for your own personal non-commercial use only. You agree not to assign, copy, transfer or transmit the Gracenote Software or any Gracenote Data to any third party. **YOU AGREE NOT TO USE OR EXPLOIT GRACENOTE DATA, THE GRACENOTE SOFTWARE, OR GRACENOTE SERVERS, EXCEPT AS EXPRESSLY PERMITTED HEREIN.**

You agree that your non-exclusive license to use the Gracenote Data, the Gracenote Software, and Gracenote Servers will terminate if you violate these restrictions. If your license terminates, you agree to cease any and all use of the Gracenote Data, the Gracenote Software, and Gracenote Servers. Gracenote reserves all rights in Gracenote Data, the Gracenote Software, and the Gracenote Servers, including all ownership rights. Under no circumstances will Gracenote become liable for any payment to you for any information that you provide. You agree that Gracenote, Inc. may enforce its rights under this Agreement against you directly in its own name.

The Gracenote service uses a unique identifier to track queries for statistical purposes. The purpose of a randomly assigned numeric identifier is to allow the Gracenote service to count queries without knowing anything about who you are. For more information, see the web page for the Gracenote Privacy Policy for the Gracenote service.

The Gracenote Software and each item of Gracenote Data are licensed to you “AS IS.”

Gracenote makes no representations or warranties, express or implied, regarding the accuracy of any Gracenote Data from in the Gracenote Servers. Gracenote reserves the right to delete data from the Gracenote Servers or to change data categories for any cause that Gracenote deems sufficient. No warranty is made that the Gracenote Software or Gracenote Servers are error-free or that functioning of Gracenote Software or Gracenote Servers will be uninterrupted. Gracenote is not obligated to provide you with new enhanced or additional data types or categories that Gracenote may provide in the future and is free to discontinue its services at any time.

**GRACENOTE DISCLAIMS ALL WARRANTIES EXPRESS OR IMPLIED, INCLUDING, BUT NOT LIMITED TO, IMPLIED WARRANTIES OF MERCHANTABILITY, FITNESS FOR A PARTICULAR PURPOSE, TITLE, AND NON-INFRINGEMENT. GRACENOTE DOES NOT WARRANT THE RESULTS THAT WILL BE OBTAINED BY YOUR USE OF THE GRACENOTE SOFTWARE OR ANY GRACENOTE SERVER. IN NO CASE WILL GRACENOTE BE LIABLE FOR ANY CONSEQUENTIAL OR INCIDENTAL DAMAGES OR FOR ANY LOST PROFITS OR LOST REVENUES.**

copyright © 2000 to present Gracenote

### Casual speech recognition

Due to natural language speech recognition technology, this system enables recognition of a command when spoken naturally. However, the system cannot recognize every variation of each command.

In some situations, it is possible to omit the command for the procedure and directly state the desired operation.

This function is available in English, Spanish and French.

#### ■ Expression examples for each function

Command	Expression examples
"Call <name> <type>"	Get me <Robert Brown>. I need to call <Robert Brown> at <Work> right away.
"Dial <number>"	Please dial the number <3334445555>. Ring <3334445555>.
"Play Artist <name>"	Play the artist <XXXXX>. I'd like to hear the band <XXXXX>.*
"Play Album <name>"	Play album <XXXXX>. Music from album <XXXXX>.*

\*: Say the desired artist name or album name in the place of the "<>".

### Command list

Some recognizable voice commands and their actions are shown below as examples.

#### ► Basic

Command	Action
"Help"	Prompts voice guidance to offer examples of commands or operation methods
"Go Back"	Returns to the previous screen
"Go to <tab>"	Displays the command list of the selected tab

## ▶ Phone

Command	Action
"Redial"	Places a call to the phone number of the latest outgoing call
"Call Back"	Places a call to the phone number of latest incoming call
"Show Recent Calls"	Displays the call history screen
"Dial <phone number>"	Places a call to the said phone number
"Call <contacts> <phone types>"	Place a call to the said phone type of the contact from the phone book

## ▶ Radio

Command	Action
"Tune to <frequency> AM"	Changes the radio to the specified AM frequency
"Tune to <frequency> FM"	Changes the radio to the specified FM frequency
"Tune to FM <frequency> HD <number>"	Changes the radio to the specified HD radio station
"Tune to preset <number>"	Changes the radio to the specified preset radio station
"Tune to <name>"	Changes the radio to the satellite radio channel with the specified name
"Tune to channel <number>"	Changes the radio to the specified satellite radio channel number
"Play <genre> satellite station"	Changes the radio to a satellite radio channel of the specified genre
"AM Radio"	Selects AM radio mode
"FM Radio"	Selects FM radio mode
"Sirius XM"	Selects satellite radio mode

## ▶ Audio

Command	Action
"Play Playlist <playlists>"	Plays tracks from the selected playlist
"Play Artist <artist>"	Plays tracks from the selected artist
"Play Song <songs>"	Plays the selected track
"Play Album <albums>"	Plays tracks from the selected album
"Turn Music On/Off"	Turns the audio system on/off
"Play the <audio sources>"	Selects audio source

## ▶ Info

Command	Action
"Show Forecast"	Displays weather information
"Show Traffic"	Displays traffic information



- 6-1. Basic operation of the Remote Touch screen**
  - Remote Touch.....496
  - 12.3-inch display ..... 500
- 6-2. Using the air conditioning system and defogger**
  - Lexus Climate Concierge.....502
  - Front automatic air conditioning system.....503
  - Rear automatic air conditioning system..... 518
  - Heated steering wheel/ seat heaters/ seat ventilators ..... 521
- 6-3. Using the interior lights**
  - Interior lights list ..... 524
    - Interior lights ..... 525
    - Personal lights ..... 526

## Interior features

## 6

**6-4. Using the storage features**

List of storage features.....	528
• Glove box .....	530
• Console box.....	530
• Cup holders.....	531
• Door pockets.....	533
• Bottle holders .....	533
• Coin box .....	534
• Auxiliary boxes.....	535
Luggage compartment features.....	536

**6-5. Using the other interior features**

Other interior features .....	543
• Sun visors .....	543
• Vanity mirrors .....	543
• Clock .....	544
• Wireless charger .....	544
• Power outlets.....	551
• USB charging ports .....	553
• Front passenger footwell hooks .....	554
• Rear door sunshades .....	554
• Armrest.....	555
• Assist grips.....	556
• Coat hooks.....	556
Garage door opener .....	557
Compass .....	564
LEXUS Enform Safety Connect.....	568
LEXUS Enform Remote .....	573
LEXUS Enform Service Connect.....	574



## Remote Touch\*

The Remote Touch can be used to operate the Remote Touch screens.  
For details, refer to the “NAVIGATION SYSTEM OWNER’S MANUAL”.

- ▶ Vehicles with 8-inch display

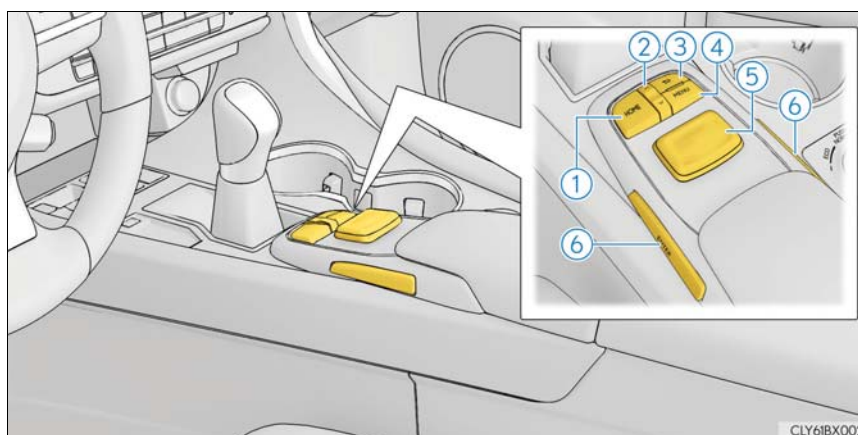

- ▶ Vehicles with 12.3-inch display

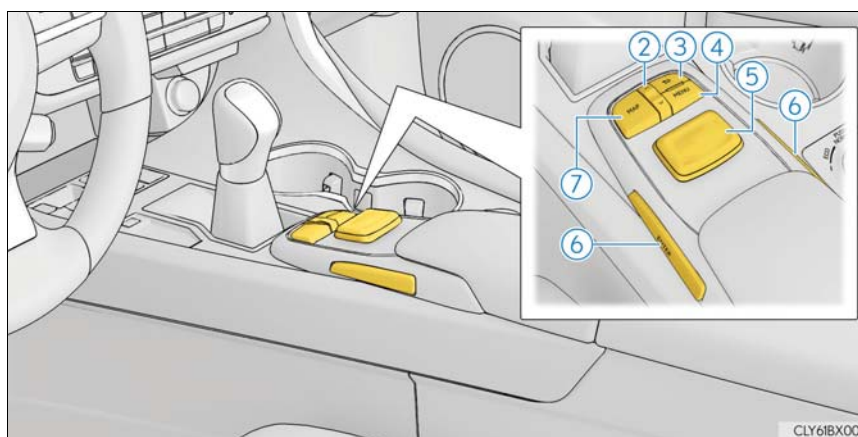

\*: If equipped

- ① "HOME" button  
Press this button to display the home screen.
- ② "∧∨" button  
Press this button to change map scale and scroll through lists.
- ③ Back button  
Press to display the previous screen.
- ④ "MENU" button  
Press to display the "Menu" screen. (→P. 499)
- ⑤ Remote Touch knob  
Move in the desired direction to select a function, letter and screen button.  
Press the knob to enter the selected function, letter or screen button.
- ⑥ "ENTER" button  
Press to enter the selected function, letter or screen button.
- ⑦ "MAP" button  
Press this button to display the vehicle's current position.

### Remote Touch operation

- ① Select: Move the Remote Touch knob in the desired direction.
- ② Enter: Push the Remote Touch knob or an "ENTER" button.

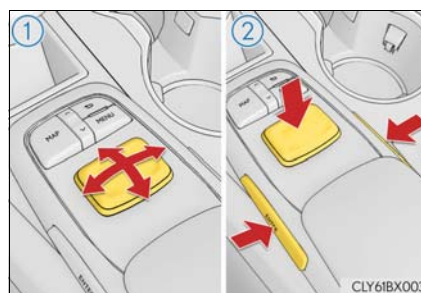

**■ Screen display during low temperatures**

When the ambient temperature is extremely low, screen response may be delayed even if the Remote Touch is operated.

** WARNING****■ When using the Remote Touch**

- Do not allow fingers, fingernails or hair to become caught in the Remote Touch as this may cause an injury.
- Be careful when selecting the Remote Touch in extreme temperatures as it may become very hot or cold due to the temperature inside the vehicle.

** NOTICE****■ To prevent damage to the Remote Touch**

- Do not allow the Remote Touch to come into contact with food, liquid, stickers or lit cigarettes as doing so may cause it to change color, emit a strange odor or stop functioning.
- Do not subject the Remote Touch to excessive pressure or strong impact as the knob may bend or break off.
- Do not allow coins, contact lenses or other such items to become caught in the Remote Touch as this may cause it to stop functioning.
- Items of clothing may rip if they become caught on the Remote Touch knob.
- If your hand or any object is on the Remote Touch knob when the engine switch is in ACCESSORY mode, the Remote Touch knob may not operate properly.

### “Menu” screen

Press the “MENU” button on the Remote Touch to display the “Menu” screen.







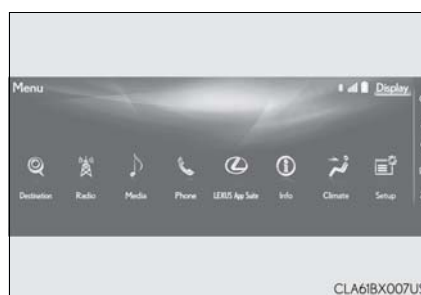
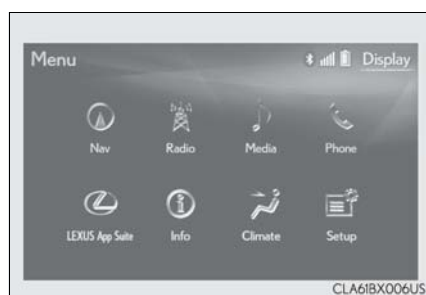

The display may differ depending on the type of the system.

Vehicles with 12.3-inch display: When the split-screen display is selected, the “Menu” screen will be displayed on the main display. (→P. 500)

▶ Vehicles with 8-inch display

▶ Vehicles with 12.3-inch display



Switch	Function
	Select to display the map screen (Vehicles with 8-inch display).*
	Select to display the radio control screen.*
	Select to display the media control screen.*
	Select to display the hands-free operation screen.*
	Select to display the “LEXUS App Suite” screen.*
	Select to display the “Information” screen.*
	Select to display the air conditioning control screen. (→P. 506, 508)
	Select to display the “Setup” screen.*
	Select to display the “Destination” screen (Vehicles with 12.3-inch display).*
“Display”	Select to adjust the contrast and brightness of the screens, turn the screen off, etc.*

\*: Refer to the “NAVIGATION SYSTEM OWNER’S MANUAL”.

## 12.3-inch display\*

### 12.3-inch display overview

#### ■ Full screen display

The following functions can be displayed full screen:

- Initial screen
- "Menu" screen (→P. 499)
- Map screen\*

\*: Refer to the "NAVIGATION SYSTEM OWNER'S MANUAL".

#### ■ Split-screen display

Different information can be displayed on the left and right of the screen. For example, audio screen can be displayed and operated while the fuel consumption information screen is being displayed. The large screen on the left of the display is called the main display, and the small screen to the right is called the side display.



\*: If equipped

### Split-screen display operation

#### ■ Selecting the operation screen

When selecting the main display, move the Remote Touch knob to the left.  
When selecting the side display, move the Remote Touch knob to the right.

#### ■ Main display

For details about the functions and operation of the main display, refer to the respective section and "NAVIGATION SYSTEM OWNER'S MANUAL".

#### ■ Side display

##### ▶ Basic screens

To change the screen displayed on the side display, use the screen buttons on the right side of the display.

- ① Navigation system\*
- ② Audio\*
- ③ Phone\*
- ④ Vehicle information (→P. 118)
- ⑤ Air conditioning system (→P. 509)



##### ▶ Interruption screens

Each of the following screens is displayed automatically in accordance with conditions.

- Intuitive parking assist (if equipped) (→P. 327)
- Phone\*
- Destination Assist\*
- Driving mode (→P. 373)

\*: Refer to the "NAVIGATION SYSTEM OWNER'S MANUAL".

## Lexus Climate Concierge\*

The climate control seats are automatically controlled according to the set temperature of the air conditioning system, outside temperature, cabin temperature, etc. Lexus Climate Concierge allows a comfortable condition to be maintained without adjusting each system.

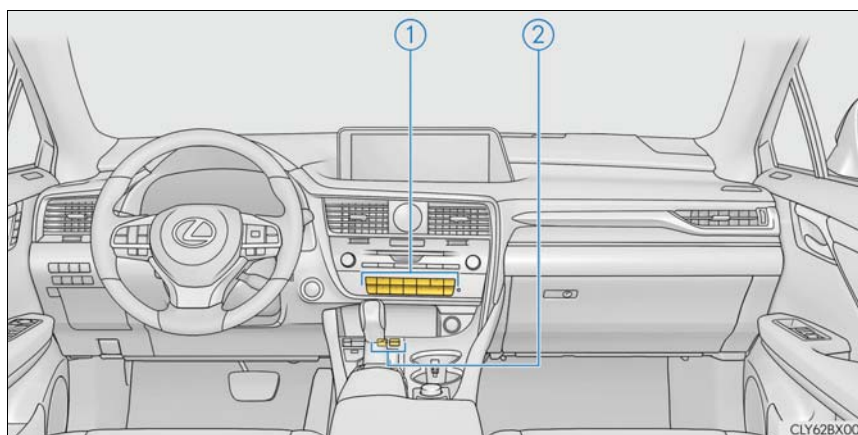

- ① Front automatic air conditioning system (→P. 510)  
Set the air conditioning system to automatic mode.  
The temperature for the driver's seat and front passenger's seat can be adjusted individually.
- ② Seat heaters and ventilators (→P. 522, 523)  
Select "AUTO" mode on each seat.  
Seat heater or ventilation is automatically selected according to the set temperature of the air conditioning system, outside temperature, etc.

\*: If equipped

## Front automatic air conditioning system

Air outlets and fan speed are automatically adjusted according to the temperature setting.

Vehicles with a Lexus Display Audio system: Press the "MENU" button on the Lexus Display Audio controller, then select "Climate" to display the air conditioning control screen.

For details on the Lexus Display Audio controller, refer to "Lexus Display Audio controller" on P. 396.

Vehicles with a navigation system: Press the "MENU" button on the Remote Touch, then select  to display the air conditioning control screen.

Vehicles with a navigation system (12.3-inch display): The air conditioning system can be displayed and operated on the side display. (→P. 501)

For details on the Remote Touch, refer to the "NAVIGATION SYSTEM OWNER'S MANUAL".

### Control panel

#### ▶ RX350

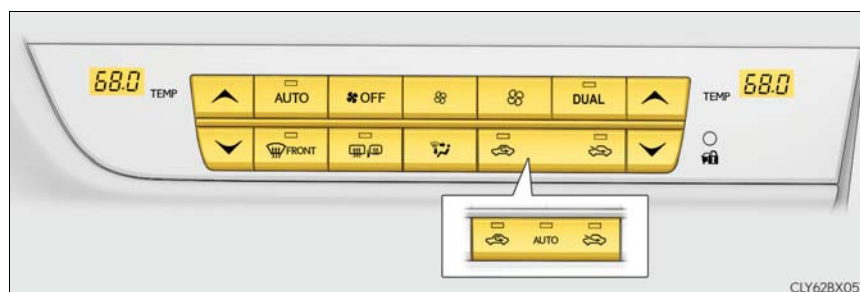

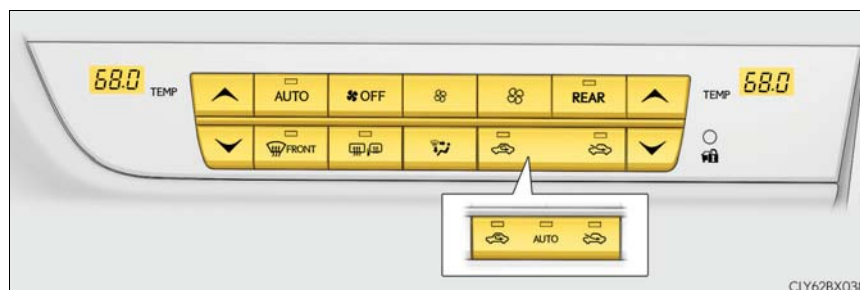

#### ▶ RX350L







■ **Adjusting the temperature setting**

Press  to increase the temperature and  to decrease the temperature.

■ **Adjusting the fan speed setting**

Press  to increase the fan speed and  to decrease the fan speed.

Press the “OFF” button to turn the fan off.

### ■ Change the airflow mode

To change the air outlets, press .

- ▶ Vehicles with a Lexus Display Audio system
- ▶ Vehicles with a navigation system

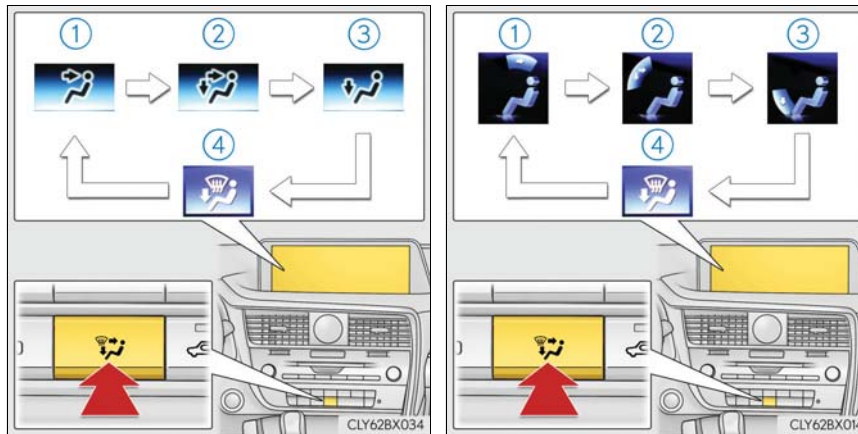

The air outlets used are switched each time the button is pressed.

- ① Air flows to the upper body.
- ② Air flows to the upper body and feet.
- ③ Air flows to the feet.
- ④ Air flows to the feet and the windshield defogger operates.

### ■ Other functions

- Switching between outside air and recirculated air modes (→P. 513)
- Defogging the windshield (→P. 513)
- Defogging the rear window and outside rear view mirrors (→P. 513)

### Control screen (RX350)

▶ Lexus Display Audio screen

- ① Adjust the left-hand side temperature setting
- ② Adjust the fan speed setting
- ③ Select to set auto mode on/off
- ④ Select to set eco mode on/off (→P. 516)
- ⑤ Select to set cooling and dehumidification function on/off



If the **A/C** indicator is turned off, the system will blow ambient temperature air or heated air.

- ⑥ Display the option control screen (→P. 507)
- ⑦ Select the air flow mode
- ⑧ Adjust the right-hand side temperature setting

▶ Navigation system screen

- ① Adjust the left-hand side temperature setting
- ② Adjust the fan speed setting
- ③ Select the air flow mode
- ④ Adjust the right-hand side temperature setting
- ⑤ Display the option control screen (→P. 507)



- ⑥ Select to set automatic mode on/off
- ⑦ Select to set cooling and dehumidification function on/off

If the **A/C** indicator is turned off, the system will blow ambient temperature air or heated air.

- ⑧ Select to set eco mode on/off (→P. 516)

### ■ Option control screen

Select  on the air conditioning control screen to display the option control screen. The functions can be switched on and off.

▶ Lexus Display Audio screen

▶ Navigation system screen



- ① Prevent ice from building up on the windshield and wiper blades (if equipped) (→P. 513)
- ② Select to set S-FLOW mode (→P. 511)

### ■ Side display operation screen (Vehicles with a navigation system [12.3-inch display])

- ① Select the air flow mode
- ② Adjust the left-hand side temperature setting
- ③ Adjust the fan speed setting
- ④ Adjust the right-hand side temperature setting
- ⑤ Select to set auto mode on/off
- ⑥ Select to set cooling and dehumidification function on/off

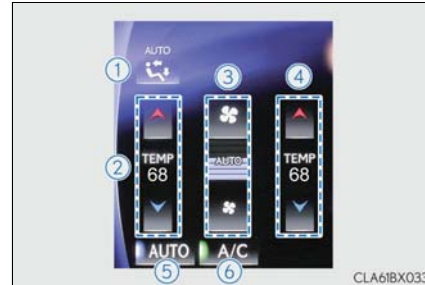

If the  indicator is turned off, the system will blow ambient temperature air or heated air.

### Control screen (RX350L)

▶ Lexus Display Audio screen

- ① Adjust the left-hand side temperature setting
- ② Adjust the fan speed setting
- ③ Select to set auto mode on/off
- ④ Select to set eco mode on/off (→P. 516)
- ⑤ Select to set cooling and dehumidification function on/off

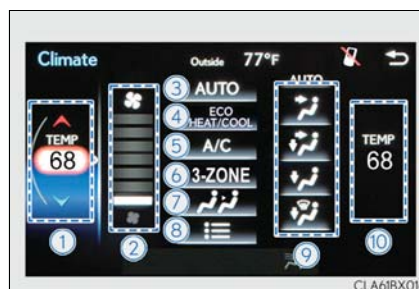

If the **A/C** indicator is turned off, the system will blow ambient temperature air or heated air.

- ⑥ Adjust the temperature for driver, passenger and rear seats separately ("3-ZONE" mode) (→P. 510)
- ⑦ Display the rear air conditioning control screen (→P. 512)
- ⑧ Display the option control screen (→P. 509)
- ⑨ Select the air flow mode
- ⑩ Adjust the right-hand side temperature setting

▶ Navigation system screen

- ① Adjust the left-hand side temperature setting
- ② Adjust the fan speed setting
- ③ Select the air flow mode
- ④ Adjust the right-hand side temperature setting
- ⑤ Display the option control screen (→P. 509)



- ⑥ Select to set automatic mode on/off
- ⑦ Select to set cooling and dehumidification function on/off

If the **A/C** indicator is turned off, the system will blow ambient temperature air or heated air.

- ⑧ Adjust the temperature for driver, passenger and rear seats separately ("3-ZONE" mode) (→P. 510)
- ⑨ Select to set eco mode on/off (→P. 516)
- ⑩ Display the rear air conditioning control screen (→P. 512)

### ■ Option control screen

Select  on the air conditioning control screen to display the option control screen. The functions can be switched on and off.

▶ Lexus Display Audio screen

▶ Navigation system screen



- ① Prevent ice from building up on the windshield and wiper blades (if equipped) (→P. 513)
- ② Select to set S-FLOW mode (→P. 511)

### ■ Side display operation screen (Vehicles with a navigation system [12.3-inch display])

- ① Select the air flow mode
- ② Adjust the left-hand side temperature setting
- ③ Adjust the fan speed setting
- ④ Adjust the right-hand side temperature setting
- ⑤ Select to set auto mode on/off
- ⑥ Select to set cooling and dehumidification function on/off

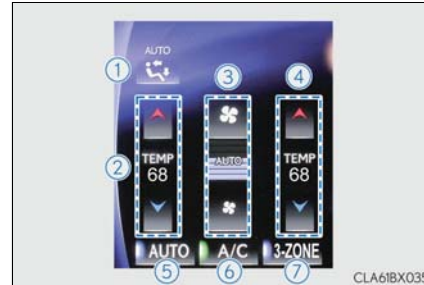

- If the  indicator is turned off, the system will blow ambient temperature air or heated air.
- ⑦ Adjust the temperature for driver, passenger and rear seats separately ("3-ZONE" mode) (→P. 510)

### Air conditioning controls

#### ■ Using the automatic mode

- 1 Press the "AUTO" button or select "AUTO" on the air conditioning control screen.
- 2 Press  to switch to automatic air intake mode. (if equipped)  
The air conditioning system automatically switches between outside air and recirculated air modes.
- 3 Adjust the temperature setting.
- 4 To stop the operation, press the "OFF" button.

#### ■ Automatic mode indicator

If the fan speed setting or air flow modes are operated, the automatic mode indicator goes off. However, automatic mode for functions other than that operated is maintained.

#### ■ Adjusting the temperature for driver and passenger seats separately ("DUAL" mode)(RX350)

To turn on the "DUAL" mode, perform any of the following procedures:

- Press "DUAL" button.
- Adjust the temperature setting of the passenger side with the passenger side temperature adjustment button.

The indicator comes on when the "DUAL" mode is on.

#### ■ Adjusting the temperature for driver, passenger and rear seats separately ("3-ZONE" mode)(RX350L)

To turn on the "3-ZONE" mode, perform any of the following procedures:

- Select "3-ZONE" on the air conditioning control screen.
- Select "3-ZONE" on the side display operation screen.(Vehicles with a navigation system [12.3-inch display])
- Adjust the temperature setting of the passenger side with the passenger side temperature adjustment button.

The indicator comes on when the "3-ZONE" mode is on.

### ■ S-FLOW mode

In S-FLOW mode, priority for the airflow is given to the front seats, reducing the airflow and air conditioning effect on the rear seats. When in S-FLOW mode, airflow from the rear air conditioning system is stopped. (RX350L)

Operation in S-FLOW mode differs according to the following conditions:

- Priority is given to the driver's seat only when: Manual S-FLOW mode: When no passenger is judged to be in the front passenger seat.

Automatic S-FLOW mode: When no passengers are judged to be in the front passenger seat or rear seats.

- Priority is given to the front seats when: Manual S-FLOW mode is selected or no passengers are judged to be in the rear seats when in automatic S-FLOW mode.
- S-FLOW mode will be disabled when: A passenger is judged to be in a rear seat when in automatic S-FLOW mode.

Depending on the set temperature, operation in S-FLOW mode may not change as described above.

When certain conditions are met and priority is given to the driver's seat only, the temperature indicator for the front passenger side will turn off.

How the system judges if a passenger is in the vehicle: →P. 515

The following S-FLOW modes are available:

- ▶ Automatic S-FLOW mode

In this mode, when a passenger is judged to be in a rear seat, S-FLOW mode will be automatically disabled.

The  indicator will illuminate when S-FLOW mode is enabled.

To enable/disable S-FLOW mode and enter manual S-FLOW mode, select  on the option control screen.

How the system judges if a passenger is in the vehicle: →P. 515

- ▶ Manual S-FLOW mode

When  is selected, S-FLOW mode will be manually enabled/disabled.

The  indicator will illuminate when S-FLOW mode is enabled.

In manual S-FLOW mode, as the system does not judge if a passenger is in a rear seat, S-FLOW mode will not be disabled automatically.

To disable S-FLOW mode automatically by opening and closing a rear door or operating the rear air conditioning system (RX350L), change to automatic S-FLOW mode. (→P. 515)



### Changing the rear seat settings (RX350L)

Press the "REAR" button or select  on the air conditioning control screen to display the rear air conditioning control screen.

▶ Lexus Display Audio screen

▶ Navigation system screen

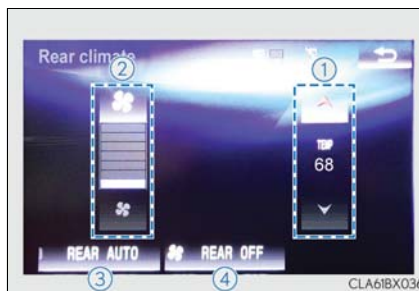

- ① Adjust the temperature setting
- ② Adjust the fan speed setting
- ③ Select to set auto mode on/off
- ④ Turn the fan off

#### ■ Using the automatic mode

- 1 Select the "REAR AUTO".
- 2 Adjust the temperature setting.
- 3 To stop the operation, select "REAR OFF".

#### ■ Automatic mode indicator



If the fan speed setting or air flow modes are operated, the automatic mode indicator goes off. However, automatic mode for functions other than that operated is maintained.

## Other functions

### ■ Switching between outside air and recirculated air modes



#### ▶ Type A

Press .

The mode switches between  (recirculated air mode) and  (outside air mode) modes each time the button is pressed.

#### ▶ Type B

Press .

The mode switches between  (recirculated air mode), automatic and  (outside air mode) modes each time the button is pressed.

When the system is switched to automatic mode, the air conditioning system operates automatically.

### ■ Defogging the windshield

Defoggers are used to defog the windshield and front side windows.

Press .

Set the outside/recirculated air mode button to outside air mode if the recirculated air mode is used. (It may switch automatically.)

To defog the windshield and the side windows early, turn the air flow and temperature up.

To return to the previous mode, press  again when the windshield is defogged.

### ■ Defogging the rear window and outside rear view mirrors

Defoggers are used to defog the rear window and to remove raindrops, dew and frost from the outside rear view mirrors.

Press .

The defoggers will automatically turn off after a period of time.

### ■ Windshield wiper de-icer (if equipped)

This feature is used to prevent ice from building up on the windshield and wiper blades.

Select  on the option control screen.

When the windshield wiper de-icer is on,  is displayed on the air conditioning control screen.

The windshield wiper de-icer will automatically turn off after a period of time.

### Air outlets

#### ■ Location of air outlets

The air outlets and air volume changes according to the selected air flow mode.

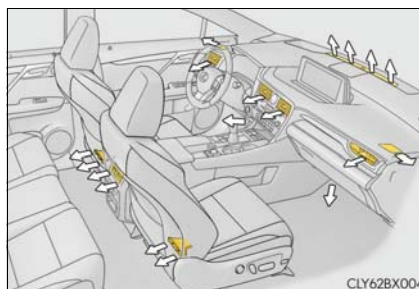

#### ■ Adjusting the position of and opening and closing the air outlets

##### ▶ Front side

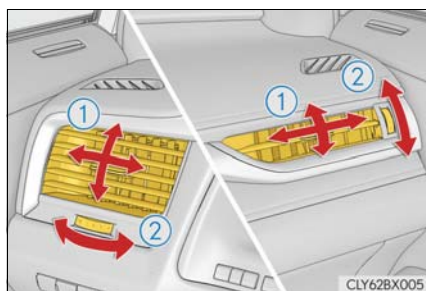

##### ▶ Front center

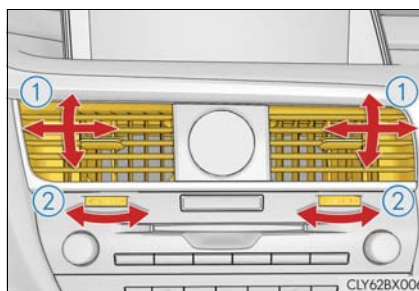

##### ▶ Rear

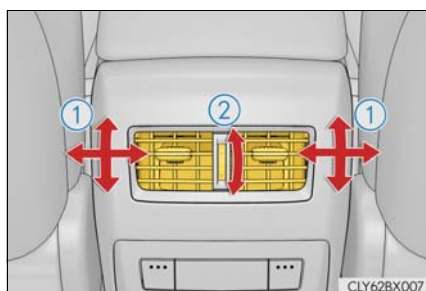

- ① Direct air flow to the left or right, up or down
- ② Turn the knob to open or close the vent

### ■ Registering air conditioning settings to electronic keys (vehicles with driving position memory)

- Unlocking the vehicle using an electronic key and turning the engine switch to IGNITION ON mode will recall that key's registered air conditioning settings.
- When the engine switch is turned off, the current air conditioning settings will automatically be registered to the electronic key that was used to unlock the vehicle.
- The system may not operate correctly if more than one electronic key is in the vicinity or if the smart access system with push-button start is used to unlock a passenger door.
- The doors that can recall the air conditioning setting when unlocked using the smart access system with push-button start can be changed.\* For details, contact your Lexus dealer.

\*: The doors that can recall the driving position memory are changed at the same time.

### ■ Using automatic mode

Fan speed is adjusted automatically according to the temperature setting and the ambient conditions.

Therefore, the fan may stop for a while until warm or cool air is ready to flow immediately after the "AUTO" button is pressed or "AUTO" is selected.

### ■ How the system judges if a passenger is in the vehicle when in S-FLOW mode

In S-FLOW mode, the system judges if a passenger is in the vehicle as follows:

- Front passenger seat: A passenger is judged to be in the front passenger seat when the system detects an object on the front passenger seat, fastening of the front passenger seat belt, changing of the set temperature for the front passenger seat or the opening and closing of the front passenger door. (However, when only opening and closing of the front passenger door is detected, the system will judge that a passenger is not in the front passenger seat after the vehicle speed reaches approximately 12 mph (20 km/h) or more.)
- Rear seats (automatic S-FLOW mode only): A passenger is judged to be in a rear seat when the system detects the opening and closing of a rear door or the operation of the rear air conditioning system (RX350L).

If a passenger is judged to be in the vehicle, the system will retain the judgement for a certain amount of time after the engine switch is turned off.

### ■ Operation of automatic S-FLOW mode

When the system is operating in automatic S-FLOW mode, if the system detects the opening and closing of a rear door or the operation of the rear air conditioning system (RX350L), S-FLOW mode will be disabled. To enable S-FLOW mode, select  on the option control screen. (In this case, the system will operate in manual S-FLOW mode.)

### ■ Changing from manual S-FLOW mode to automatic S-FLOW mode

- 1 Select  on the option control screen to disable S-FLOW mode.
- 2 Turn the engine switch off.
- 3 Wait for 60 minutes or more and change the engine switch to IGNITION ON mode.

### ■ Using the voice command system (vehicles with a navigation system)

Air conditioning system can be operated using voice commands. For details, refer to the "NAVIGATION SYSTEM OWNER'S MANUAL".

■ **When the outside temperature exceeds 75°F (24°C) and the air conditioning system is on**

- In order to reduce the air conditioning power consumption, the air conditioning system may switch to recirculated air mode automatically. This may also reduce fuel consumption.
- Recirculated air mode is selected as a default mode when the engine switch is turned to IGNITION ON mode.
- It is possible to switch to outside air mode at any time by pressing the outside/recirculated air mode button.

■ **Automatic mode for air intake control (if equipped)**

In automatic mode, the system detects exhaust gas and other pollutants and automatically switches between outside air and recirculated air modes.

When the dehumidification function is off, and the fan is operating, turning automatic mode on will activate the dehumidification function.

■ **Fogging up of the windows**

- The windows will easily fog up when the humidity in the vehicle is high. Selecting "A/C" will dehumidify the air from the outlets and defog the windshield effectively.
- If you turn "A/C" off, the windows may fog up more easily.
- The windows may fog up if the recirculated air mode is used.

■ **Outside/recirculated air mode**

- When driving on dusty roads such as tunnels or in heavy traffic, set the outside/recirculated air mode button to the recirculated air mode. This is effective in preventing outside air from entering the vehicle interior. During cooling operation, setting the recirculated air mode will also cool the vehicle interior effectively.
- Outside/recirculated air mode may automatically switch depending on the temperature setting or the inside temperature.

■ **When the outside temperature is low**

The dehumidification function may not operate even when "A/C" is selected.

■ **Operation of the air conditioning system in Eco drive mode**

- In the Eco drive mode, the air conditioning system is controlled as follows to prioritize fuel efficiency
  - Engine speed and compressor operation controlled to restrict heating/cooling capacity
  - Fan speed restricted when automatic mode is selected
- To improve air conditioning performance, perform the following operations:
  - Adjust the fan speed
  - Turn off Eco drive mode

### ■ Ventilation and air conditioning odors

- To let fresh air in, set the air conditioning system to the outside air mode.
- During use, various odors from inside and outside the vehicle may enter into and accumulate in the air conditioning system. This may then cause odor to be emitted from the vents.
- To reduce potential odors from occurring:
  - It is recommended that the air conditioning system be set to outside air mode prior to turning the vehicle off.
  - The start timing of the blower may be delayed for a short period of time immediately after the air conditioning system is started in automatic mode.

### ■ Air conditioning filter

→P. 618

### ■ Customization

Some functions can be customized. (→P. 722)

## ⚠ WARNING

### ■ To prevent the windshield from fogging up

- Do not use  during cool air operation in extremely humid weather. The difference between the temperature of the outside air and that of the windshield can cause the outer surface of the windshield to fog up, blocking your vision.
- Do not place anything on the instrument panel which may cover the air outlets. Otherwise, air flow may be obstructed, preventing the windshield defoggers from defogging.



### ■ To prevent burns

- Do not touch the rear view mirror surfaces when the outside rear view mirror defoggers are on.
- Do not touch the glass at lower part of the windshield or to the side of the front pillars when the windshield wiper de-icer is on. (if equipped)

## ⚠ NOTICE

### ■ To prevent battery discharge

Do not leave the air conditioning system on longer than necessary when the engine is off.

## Rear automatic air conditioning system (RX350L)

Air outlets and fan speed are automatically adjusted according to the temperature setting.

### Control panel

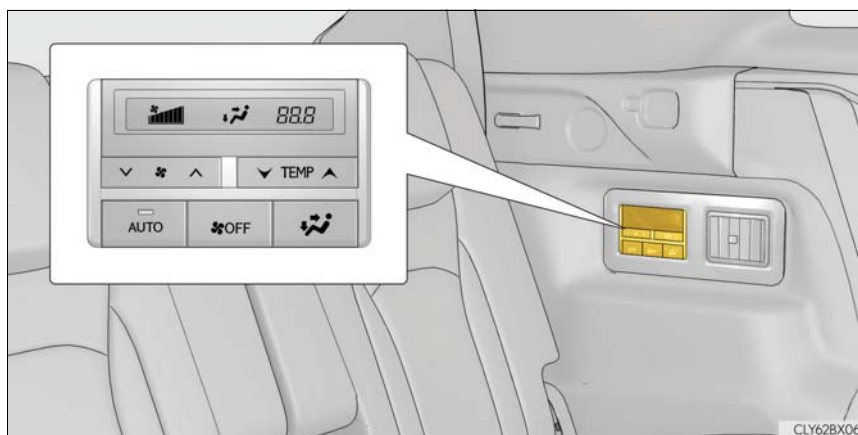

#### ■ Adjusting the temperature setting

Press **TEMP ▲** to increase the temperature and **▼ TEMP** to decrease the temperature.

#### ■ Adjusting the fan speed setting

Press **\* ▲** to increase the fan speed and **▼ \*** to decrease the fan speed.

Press the “OFF” button to turn the fan off.

### ■ Change the airflow mode

To change the air outlets, press



The air outlets used are switched each time the button is pressed.

- ① Air flows to the upper body.
- ② Air flows to the upper body and feet.
- ③ Air flows to the feet.

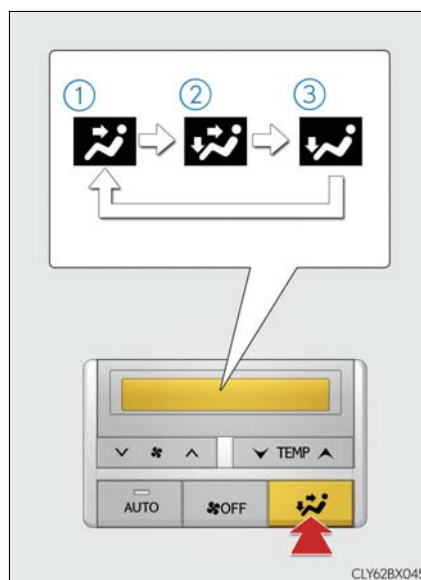

## Air conditioning controls

### ■ Using the automatic mode

- ① Press the "AUTO" button
- ② Adjust the temperature setting.
- ③ To stop the operation, press the "OFF" button.

### ■ Automatic mode indicator

If the fan speed setting or air flow modes are operated, the automatic mode indicator goes off. However, automatic mode for functions other than that operated is maintained.



## Air outlets

### ■ Location of air outlets

The air outlets and air volume changes according to the selected air flow mode.

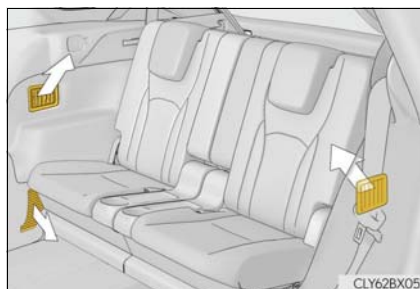

### ■ Adjusting the position of and opening and closing the air outlets

Adjusting the position of and opening and closing the air outlets

- ① Direct air flow to the left or right, up or down
- ② Turn the knob fully to the back of the vehicle to close the vent

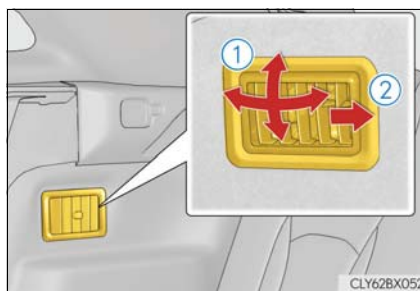

### ⚠ NOTICE

#### ■ To prevent battery discharge

Do not leave the air conditioning system on longer than necessary when the engine is off.

## Heated steering wheel<sup>\*</sup> / seat heaters<sup>\*</sup> / seat ventilators<sup>\*</sup>

Heated steering wheel and seat heaters heat the side grips of the steering wheel and seats, respectively. Seat ventilators maintain good ventilation using a fan built into the seats.

### WARNING

- Care should be taken to prevent injury if anyone in the following categories comes in contact with the steering wheel and seats when the heater is on:
  - Babies, small children, the elderly, the sick and the physically challenged
  - Persons with sensitive skin
  - Persons who are fatigued
  - Persons who have taken alcohol or drugs that induce sleep (sleeping drugs, cold remedies, etc.)
- Observe the following precautions to prevent minor burns or overheating:
  - Do not cover the seat with a blanket or cushion when using the seat heater.
  - Do not use seat heater more than necessary.

### NOTICE

- Do not put heavy objects that have an uneven surface on the seat and do not stick sharp objects (needles, nails, etc.) into the seat.
- To prevent battery discharge, do not use the functions when the engine is off.

\*: If equipped

### Heated steering wheel

Turns the heated steering wheel on/off

The indicator light comes on when the heated steering wheel is operating.



#### ■ Operation condition

The heated steering wheel can be used when the engine switch is in IGNITION ON mode.

#### ■ Timer

The heated steering wheel will automatically turn off after about 30 minutes.

### Front seat heaters

When any switch is pressed, the system is set to automatic mode and the "AUTO" indicator (green) lights up.

Each time the switch is pressed, the operation condition changes as follows.

Hi (3 segments lit) → Mid (2 segments lit) → Lo (1 segment lit) → Off

The level indicator (amber) lights up during operation.

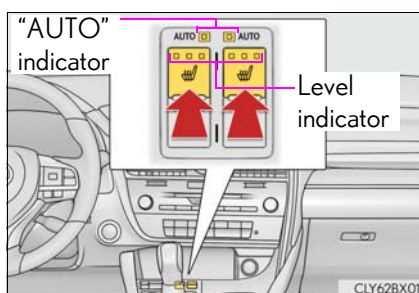

#### ■ Operation condition

The front seat heaters can be used when the engine switch is in IGNITION ON mode.

#### ■ When the air conditioning system is operating in S-FLOW mode

If a passenger is not detected in the front passenger seat, the seat heater of the front passenger's seat will be turned off if on. (→P. 511)

#### ■ Customization

Some functions can be customized. (→P. 722)

### Second-row seat heaters

#### ▶ Type A

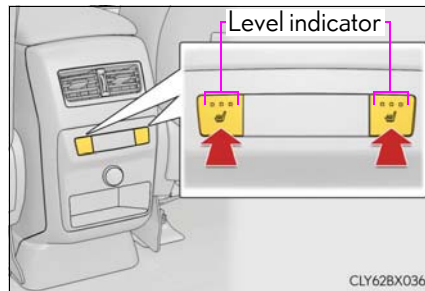

#### ▶ Type B

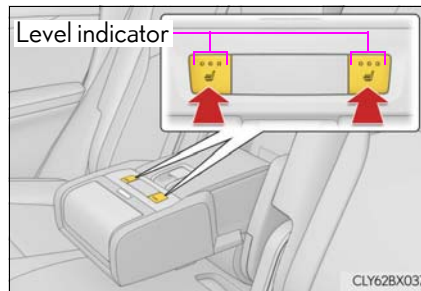

Each time the switch is pressed, the operation condition changes as follows. Hi (3 segments lit) → Mid (2 segments lit) → Lo (1 segment lit) → Off

The level indicator (amber) lights up during operation.

#### ■ Operation condition

The second-row seat heaters can be used when the engine switch is in IGNITION ON mode.

### Seat ventilators

When any switch is pressed, the system is set to automatic mode and the "AUTO" indicator (green) lights up.

Each time the switch is pressed, the operation condition changes as follows. Hi (3 segments lit) → Mid (2 segments lit) → Lo (1 segment lit) → Off

The level indicator (green) lights up during operation.

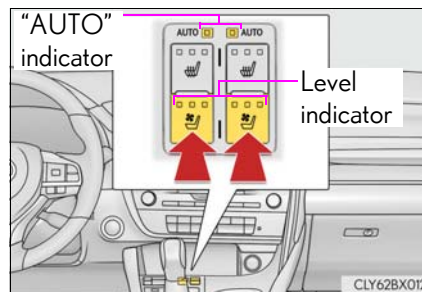

#### ■ Operation condition

The seat ventilators can be used when the engine switch is in IGNITION ON mode.

#### ■ When the air conditioning system is operating in S-FLOW mode

If a passenger is not detected in the front passenger seat, the seat ventilator of the front passenger's seat will be turned off if on. (→P. 511)

#### ■ Customization

Some functions can be customized. (→P. 722)

## Interior lights list

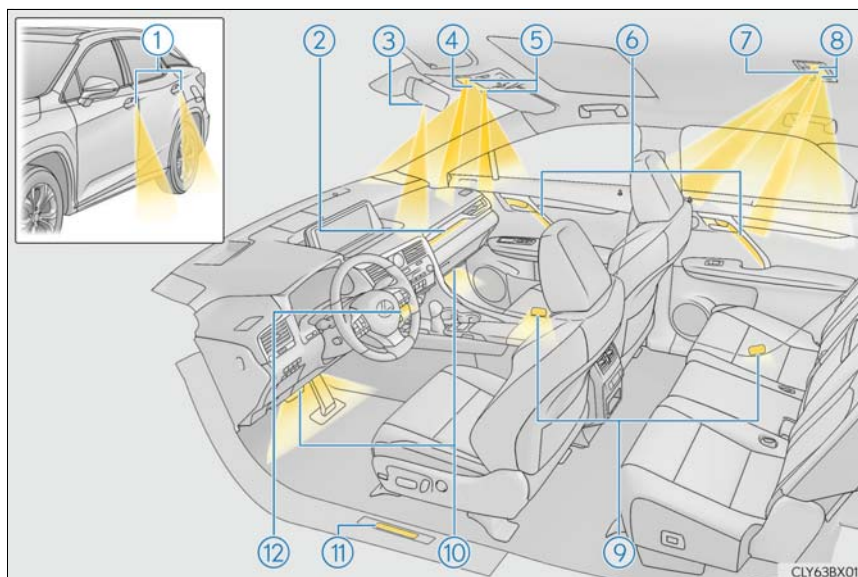

- |  |                                  |
|--|----------------------------------|
| ① Outer foot lights                                | ⑦ Rear interior light (→P. 525)  |
| ② Instrument panel ornament light<br>(if equipped) | ⑧ Rear personal lights (→P. 526) |
| ③ Shift lever light                                | ⑨ Door courtesy lights           |
| ④ Front interior light (→P. 525)                   | ⑩ Footwell lights                |
| ⑤ Front personal lights (→P. 526)                  | ⑪ Scuff lights (if equipped)     |
| ⑥ Door trim ornament lights<br>(if equipped)       | ⑫ Front center console light     |

**Interior lights**

The rear interior light turns on/off together with the front interior light.

Turns the lights on/off (touch the light)

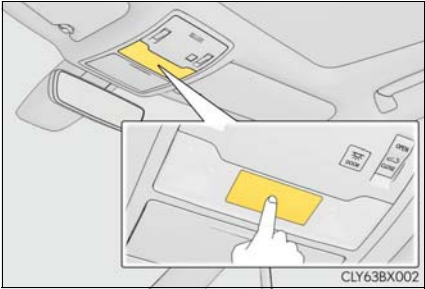

Turns the door position on/off

- ① On
- ② Off

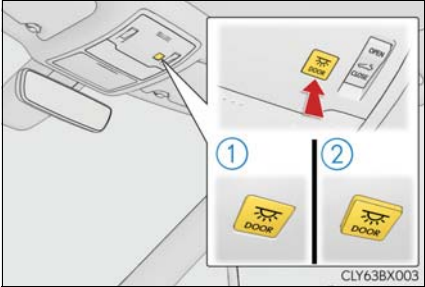

### Personal lights

► Front

Turns the lights on/off (touch the lights)

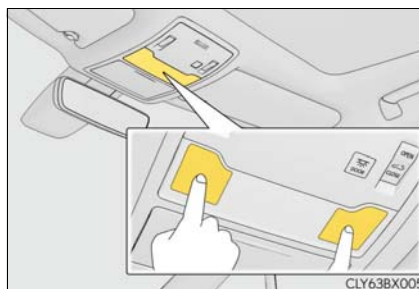

► Rear

Turns the lights on/off

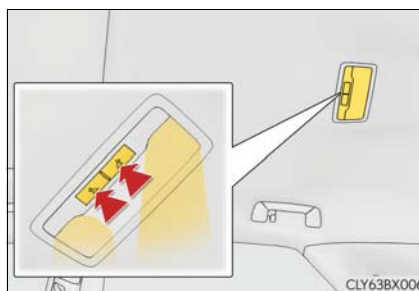

- Illuminated entry system: The lights automatically turn on/off according to engine switch mode, the presence of the electronic key, whether the doors are locked/unlocked, and whether the doors are opened/closed.
- If the interior lights remain on when the engine switch is turned off, the lights will go off automatically after 20 minutes.
- In the following cases, the interior lights and front personal lights may not respond as normal.
  - When water, dirt, etc., have adhered to the lens surface
  - When operated with a wet hand
  - When wearing gloves, etc.
- Some functions can be customized. (→P. 722)

 NOTICE

- Never remove the lens for the front interior light and front personal lights. Otherwise, the lights will be damaged. If the lens need to remove, contact your Lexus dealer.
- To prevent battery discharge, do not leave the lights on longer than necessary when the engine is off.



## List of storage features

► Vehicles with bench-type second-row seats

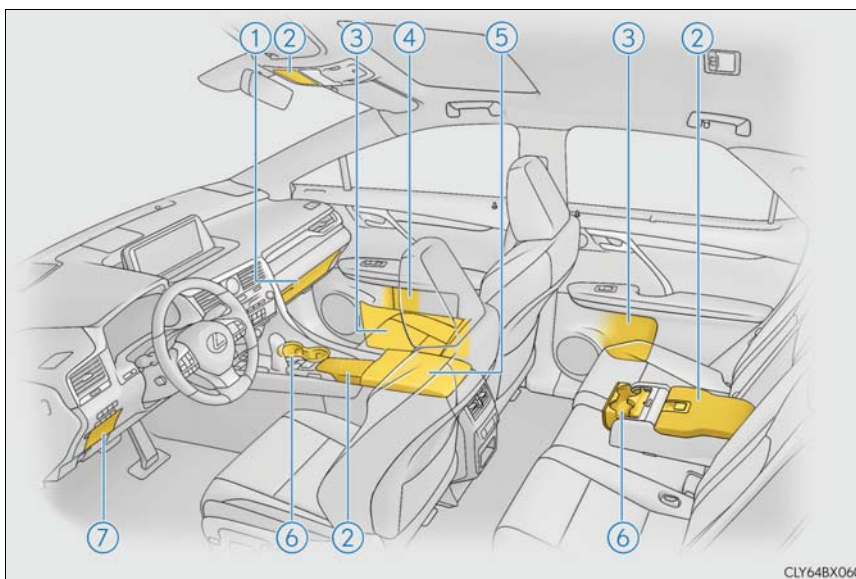

- |  |                            |
|--|----------------------------|
| ① Glove box (→P. 530)                        | ④ Bottle holders (→P. 533) |
| ② Auxiliary boxes (if equipped)<br>(→P. 535) | ⑤ Console box (→P. 530)    |
| ③ Door pockets (→P. 533)                     | ⑥ Cup holders (→P. 531)    |
|  | ⑦ Coin box (→P. 534)       |

## ▶ Vehicles with separate-type second-row seats

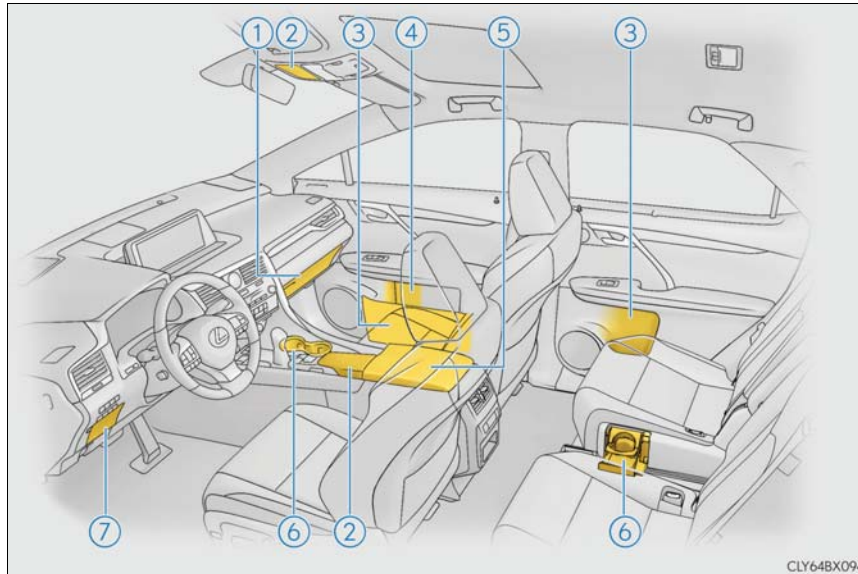

- |   |                            |
|---|----------------------------|
| ① Glove box (→P. 530)                     | ④ Bottle holders (→P. 533) |
| ② Auxiliary boxes (if equipped) (→P. 535) | ⑤ Console box (→P. 530)    |
| ③ Door pockets (→P. 533)                  | ⑥ Cup holders (→P. 531)    |
|   | ⑦ Coin box (→P. 534)       |

**⚠ WARNING**

- Do not leave glasses, lighters or spray cans in the storage spaces, as this may cause the following when cabin temperature becomes high:
  - Glasses may be deformed by heat or cracked if they come into contact with other stored items.
  - Lighters or spray cans may explode. If they come into contact with other stored items, the lighter may catch fire or the spray can may release gas, causing a fire hazard.
- When driving or when the storage compartments are not in use, keep the lids closed. In the event of sudden braking or sudden swerving, an accident may occur due to an occupant being struck by an open lid or the items stored inside.

### Glove box

- ① Open (press the button)
- ② Unlock with the mechanical key
- ③ Lock with the mechanical key

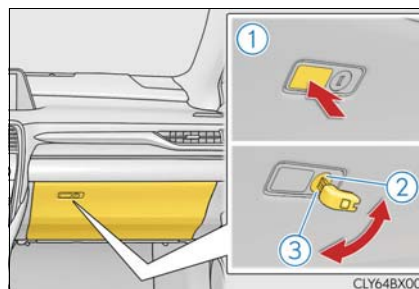

The glove box light turns on when the tail lights are on.

### Console box

Push the knob.

Lift by hand to fully open the console box.

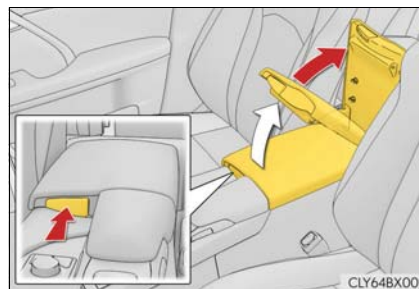

- The console box light turns on when the tail lights are on.
- A pen can be stored in the pen holder on the underside of the lid.

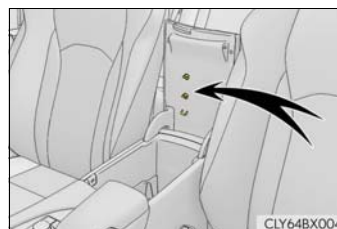

- Remove the tray to access a storage space under the tray.

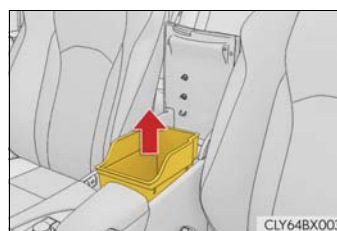

**Cup holders**

▶ Front seats



▶ Second-row seats (Type A)

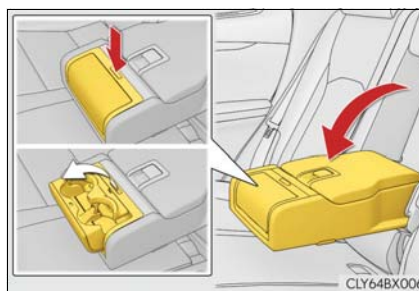

Pull down the armrest and  
Then press down the button.

▶ Second-row seats (Type B)

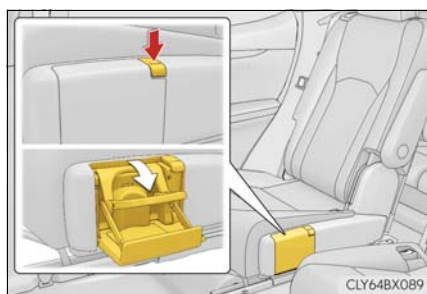

Press in the button.

The depth of the front cup holder can be changed.

- 1 To store a water bottle, push down the bottom of the cup holder.



- 2 To return the bottom to its original position, press the button.



 **WARNING**

- Do not place anything other than cups, aluminum cans, or water bottles in the cup holders. Other items may be thrown out of the holders in the event of an accident or sudden braking, possibly causing injury. If possible, cover hot drinks to prevent burns.
- Rear cup holder: When not in use, keep the cup holders are closed. Injuries may result in the event of an accident or sudden braking.

 **NOTICE**

To prevent damage to the rear cup holder, stow the cup holder before stowing the arm-rest.

**Door pockets**

▶ Front

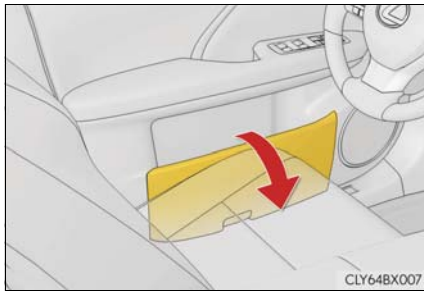

▶ Rear

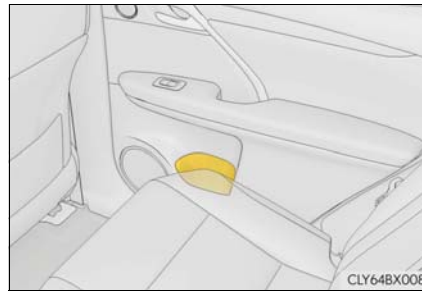

The door pockets can be opened and closed.

**⚠ WARNING**

Front door pockets: Keep the door pockets closed while driving. Injuries may result in the event of an accident or sudden braking.

**Bottle holders**

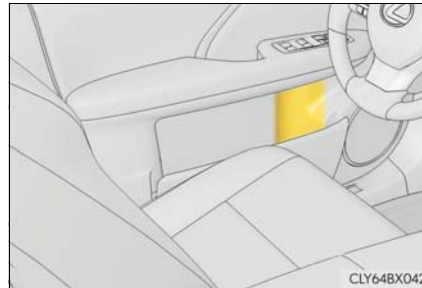

- When storing a bottle, close the cap.
- The bottle may not be stored depending on its size or shape.

 **NOTICE**

Do not place open bottle, glass or paper cups containing liquid in the bottle holders. Otherwise, contained liquid may be spilled. Glass cups may break if used in the bottle holders.

**Coin box**

Press in the button.

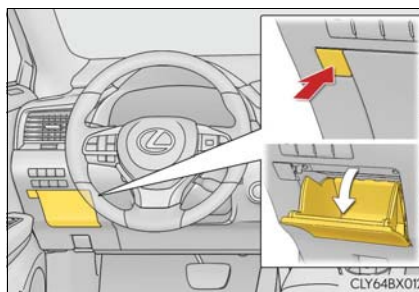

 **WARNING**

Keep the coin box closed while driving.  
Injuries may result in the event of an accident or sudden braking.

### Auxiliary boxes

#### ▶ Type A

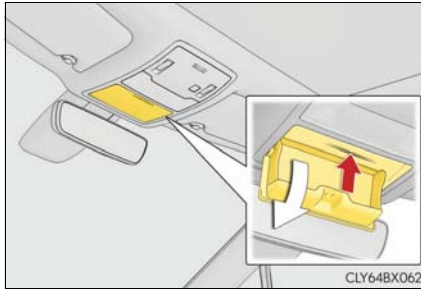

Press in the lid.

#### ▶ Type B

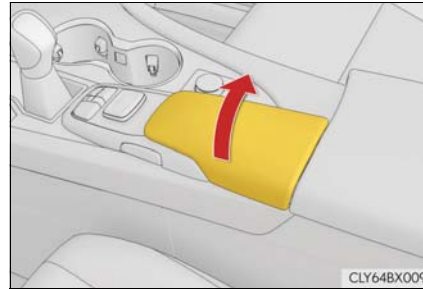

Lift the lid.

#### ▶ Type C (if equipped)



Pull up the lever to release the lock, and lift the lid.

#### ⚠ WARNING

Type A: Do not store items heavier than 0.44 lb. (200 g).  
Doing so may cause the auxiliary box to open and the items inside may fall out, resulting in an accident.



## Luggage compartment features

### Cargo hooks

▶ RX350

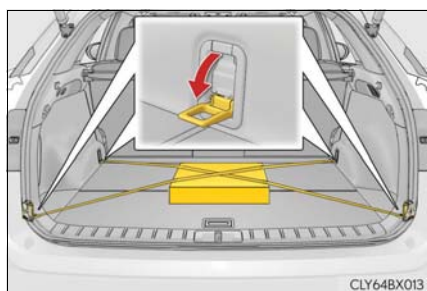

▶ RX350L

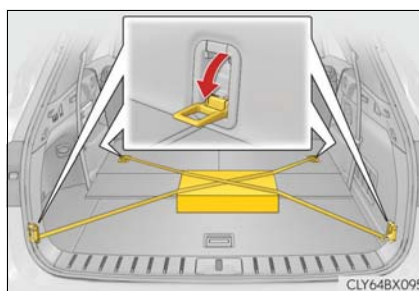

Pull down the hook to use.

The cargo hooks are provided for securing loose items.

#### **⚠ WARNING**

To avoid injury, always return the hooks to their stowed positions when not in use.

### Cargo net hooks

To hang the cargo net, use the cargo net hooks and rear cargo hooks.

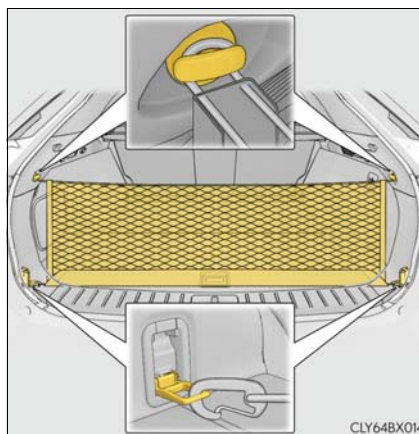

#### **⚠ WARNING**

To avoid injury, always return the hooks to their stowed positions when not in use.

### Grocery bag hooks

#### ▶ RX350

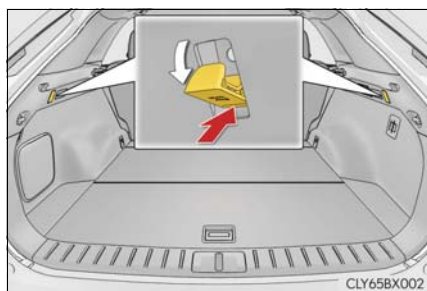

CLY65BX002

#### ▶ RX350L



CLY64BX096

To use the grocery bag hook, push it in.

#### ⚠ NOTICE

Do not hang any object heavier than 8.8 lb. (4 kg) on the grocery bag hooks.

### Luggage cover

#### ■ Removing the luggage cover unit (RX350L)

Remove the deck board and side auxiliary box cover and take out the luggage cover unit. (→P. 541)

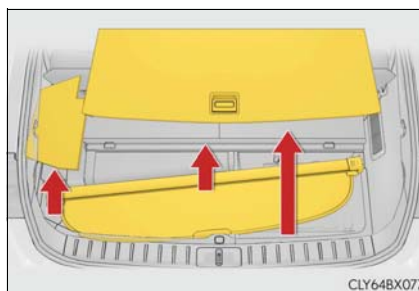

CLY64BX077

■ Using the luggage cover

RX350L: Before installing the luggage cover, fold down the third-row seats. (→P. 157)

- 1 Insert either end of the luggage cover into the recess, then compress the other end of the luggage cover and insert it into the recess.

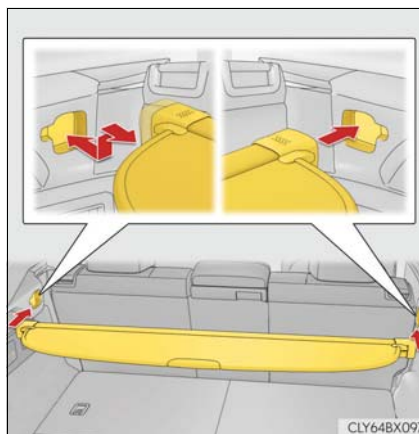

- 2 Pull out the luggage cover and hook it onto the anchors.

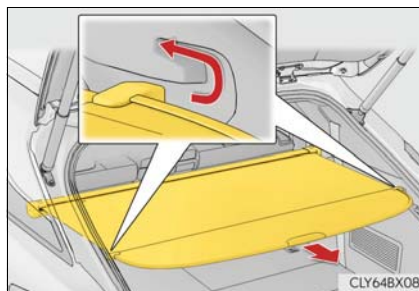

### ■ Removing the luggage cover

- 1 Release the cover from the left and right anchors and allow it to retract.

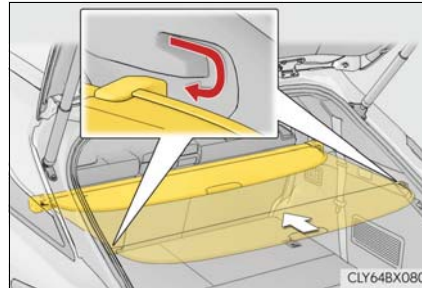

- 2 Compress the end of the luggage cover and lift the luggage cover up.

RX350: After removing the luggage cover, place it somewhere other than the passenger compartment.

RX350L: Stow the luggage cover under the deck board and side auxiliary box cover.

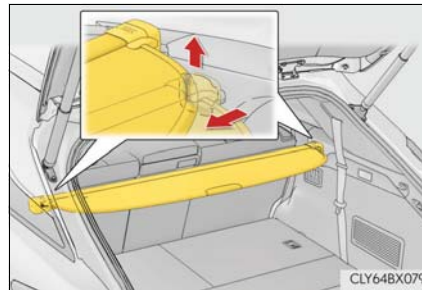

### ⚠ WARNING

- Do not place anything on the luggage cover. In the event of sudden braking or turning, the item may go flying and strike an occupant. This could lead to an unexpected accident, resulting in death or serious injury.
- Do not allow children to climb on the luggage cover. Climbing on the luggage cover could result in damage to the luggage cover, possibly causing death or serious injury to the child.

### Auxiliary boxes (RX350)

- 1 Pull the lever up and fold the flap of the deck board.

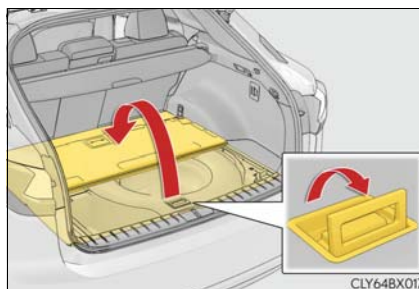

- 2 Lift the deck board and disengage the hook on the underside of the deck board.

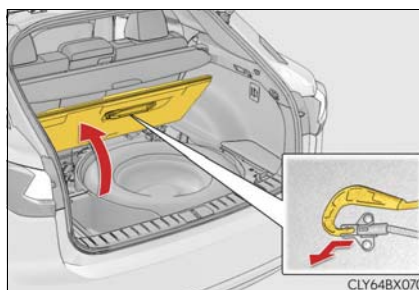

- 3 Attach the hook to the upper edge of the back door opening as shown.

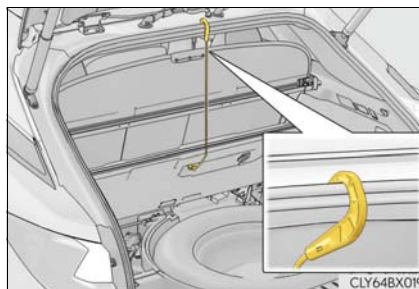

► Deck floor box

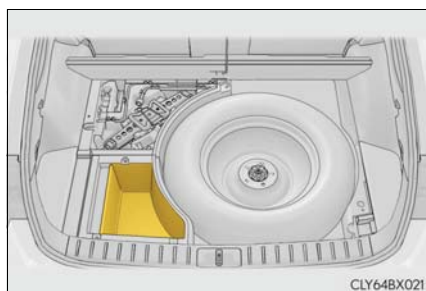

► Side auxiliary box

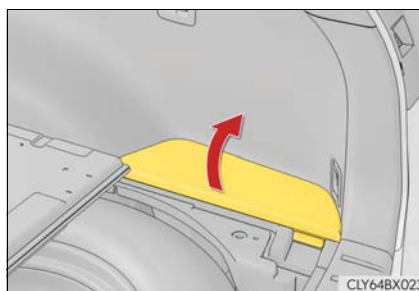

**⚠ WARNING**

If the deck board is folded or removed, return it to its original position before driving. In the event of sudden braking, an accident may occur due to an occupant being struck by the deck board or the items stored in the deck under tray.

**⚠ NOTICE**

When closing the back door, do not leave the deck board hook hooked on the edge of the back door opening. The deck board hook may get damaged.

**Auxiliary boxes (RX350L)**

- 1 Pull up the lever, lift the deck board and pull out the hook from the underside of the deck board.

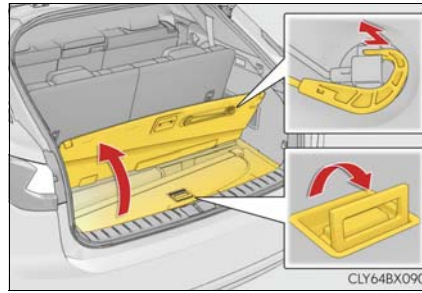

- 2 Attach the hook to the upper edge of the back door opening as shown.

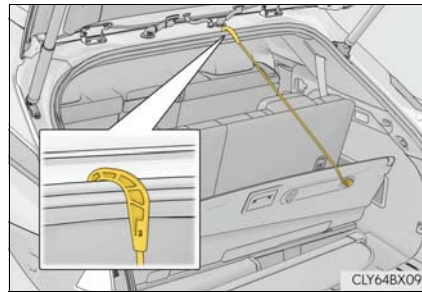

▶ Deck floor box (if equipped)

▶ Side auxiliary box

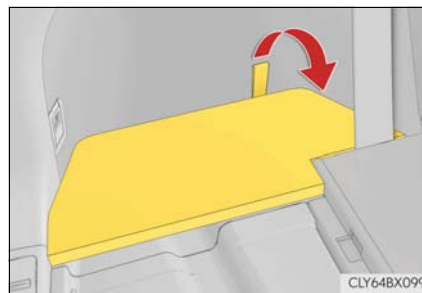
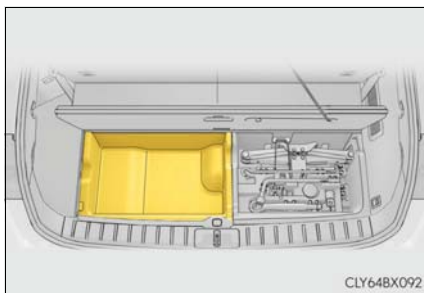

 **WARNING**

- If the deck board is folded or removed, return it to its original position before driving. In the event of sudden braking, an accident may occur due to an occupant being struck by the deck board or the items stored in the deck under tray.
- When installing the side auxiliary box and side auxiliary box cover, make sure that the third-row seat seatbelt is positioned correctly. If the seatbelt is positioned incorrectly, the seatbelt may be damaged when a passenger uses the seatbelt. Also, in the case of sudden braking, the side auxiliary box cover may come off and things stored in the side auxiliary box may fly about and strike an occupant, possibly resulting in death or serious injury.

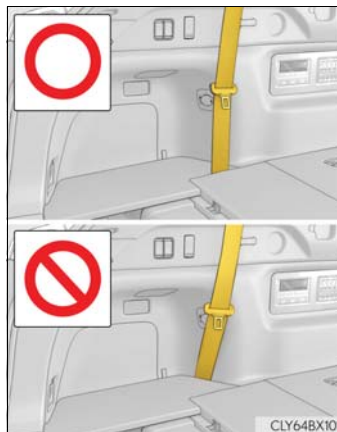

 **NOTICE**

When closing the back door, do not leave the deck board hook hooked on the edge of the back door opening. The deck board hook may get damaged.

## Other interior features

### Sun visors

- ① To set the visor in the forward position, flip it down.
- ② To set the visor in the side position, flip down, unhook, and swing it to the side.
- ③ To use the side extender, place the visor in the side position, then slide it backward.

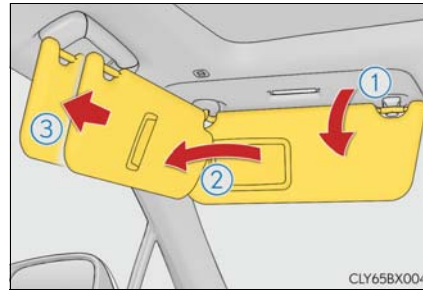

### Vanity mirrors

Slide the cover to open.

The light turns on when the cover is opened.

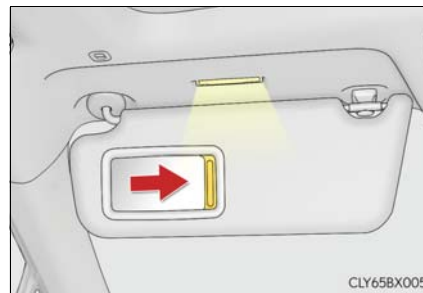

If the vanity lights remain on when the engine switch is turned off, the light will go off automatically after 20 minutes.

#### NOTICE

To prevent battery discharge, do not leave the vanity lights on for extended periods while the engine is off.



### Clock

- ▶ Vehicles with a Lexus Display Audio system

The clock can be adjusted by pressing the buttons.

- ① Pressing and holding will move the clock hands backward.
- ② Pressing and holding will move the clock hands forward.

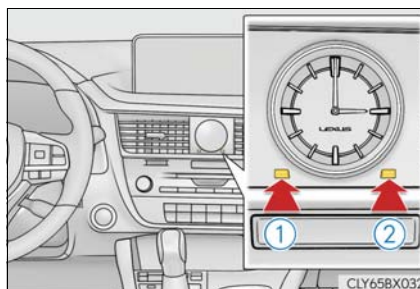

- ▶ Vehicles with a navigation system

The GPS clock's time is automatically adjusted by utilizing GPS time information.

For details, refer to "NAVIGATION SYSTEM OWNER'S MANUAL".

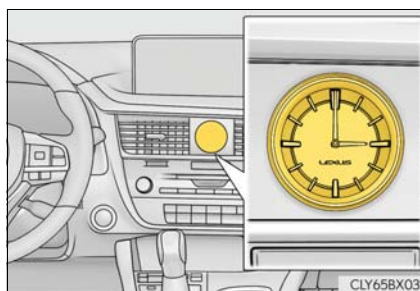

### Wireless charger (if equipped)

A portable device, such as a smartphone or mobile battery, can be charged by just placing it on the charging area, provided the device is compatible with the Qi wireless charging standard created by the Wireless Power Consortium.

The wireless charger cannot be used with a portable device that is larger than the charging area. Additionally, depending on the portable device, the wireless charger may not operate properly. Refer to the operation manual of the portable device.

#### ■ The "Qi" symbol

The "Qi" symbol is a trademark of the Wireless Power Consortium.



### ■ Name for all parts

- ① Power supply switch
- ② Operation indicator light
- ③ Charge area

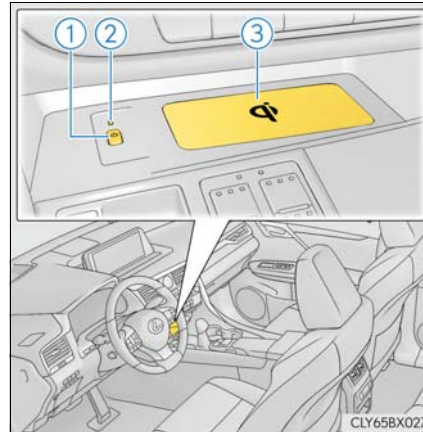

### ■ Using the wireless charger

- 1 Press the power supply switch of the wireless charger.

Pressing the switch again turns the wireless charger off.

When turned on, the operation indicator light (green) comes on.

When the engine switch is turned off, the on/off state of the wireless charger will be memorized.



- 2 Place a portable device on the charging area with its charging surface facing down.

While charging, the operation indicator light (orange) will be illuminated.

If charging does not begin, move the portable device as close to the center of the charging area as possible.



When charging is complete, the operation indicator light (green) will illuminate.

#### ● Recharging function

- If a certain amount of time has elapsed since charging completed and the portable device has not been moved, the wireless charger will restart charging.
- If the portable device is moved within the charging area, charging will stop temporarily then restart.

■ Operation indicator light status

Operation indicator light	State
Off	The Wireless charger is off
Green (illuminated)	Standby (charging is possible)
	Charging is complete*
Orange (illuminated)	A portable device has been placed on the charging area (identifying the portable device)
	Charging in progress

\*: Depending on the portable device, the operation indicator light may stay illuminated (orange) after charging has completed.

● If the operation indicator light blinks

If an error is detected, the operation indicator light will blink (orange). Take the appropriate measures according to the table below.

Operation indicator light	Suspected causes	Measure
Blinks (orange) at a one second interval continuously	Vehicle to charger communication failure.	Contact your Lexus dealer.
Blinks (orange) 3 times repeatedly	A foreign object exists between the portable device and charging area.	Remove the foreign object.
	Portable device is not positioned properly on the charging area.	Move the portable device toward the center of the charging area.
Blinks (orange) 4 times repeatedly	The temperature of the wireless charger is excessively high.	Stop charging immediately and continue charging after a while.

■ The wireless charger can be operated when

The engine switch is in ACCESSORY or IGNITION ON mode.

■ Portable devices that can be charged

- Portable devices compatible with the Qi wireless charging standard can be charged by the wireless charger. However, compatibility with all devices which meet the Qi wireless charging standard is not guaranteed.
- The wireless charger is designed to supply low power electricity (5 W or less) to a cellular phone, smartphone, or other portable device.

■ **If a cover or accessory is attached to the portable device**

Do not charge a portable device if a cover or accessory which is not Qi compatible is attached. Depending on the type of cover and/or accessory attached, it may not be possible to charge the portable device. If the portable device is placed on the charging area and does not charge, remove the cover and/or accessories.

■ **If interference is heard in AM radio broadcasts while charging**

Turn off the wireless charger and check if the noise is reduced. If noise is reduced, press and hold the power supply switch of the wireless charger for 2 seconds. The frequency of the wireless charger is changed and noise may be reduced. When the frequency is changed, the operation indicator light will blink (orange) 2 times.

■ **Charging precautions**

- If the electronic key cannot be detected in the cabin, charging cannot be performed. When a door is opened and closed, charging may be temporarily suspended.
- While charging, the wireless charger and the portable device will become warm. This is not a malfunction.  
If a portable device becomes warm while charging and charging stops due to the protection function of the portable device, wait until the portable device cools down and charge it again.

■ **Sound generated during operation**

When the power supply switch is turned on or while a portable device is being identified, operation sounds may be heard. This is not a malfunction.

■ **Cleaning the wireless charger**

→P. 582

■ **Certification for the wireless charger**

**FCC Provided Information:**

This equipment has been tested and found to comply with Part 18 of the FCC Rules. These limits are designed to provide reasonable protection against harmful interference in a residential installation. Any changes or modifications not expressly approved by the party responsible for compliance could void the user's authority to operate this equipment. This device complies with Part 18 of the FCC Rules. Operation is subject to the following two conditions:  
(1) This device may not cause harmful interference, and (2) this device must accept any interference received, including interference that may cause undesired operation.

**Declaration of Conformity**

Trade Name:	Panasonic
Model Numbers:	CA-QL85E0AJ, CA-QL85H0AJ, CA-QL85H1AJ and CA-QL85H2AJ
Responsible Party:	Panasonic Corporation of North America Two Riverfront Plaza, Newark, NJ 07102-5490
Support Contact:	<a href="http://shop.panasonic.com/support/">http://shop.panasonic.com/support/</a>

# Panasonic

PRODUCT SAFETY AND COMPLIANCE DEPARTMENT, PANASONIC CORPORATION OF NORTH AMERICA, TWO RIVERFRONT PLAZA, 9<sup>TH</sup> FLOOR, NEWARK, NJ 07102-5490

## FCC Declaration of Conformity

Product Name	Panasonic In-Vehicle Wireless Charger
Model Numbers	CA-QL85E0AJ, CA-QL85H0AJ, CA-QL85H1AJ, CA-QL85H2AJ
FCC Rule Parts	47 CFR, FCC Part 18 for ISM Equipment FCC's KDB 0680106 D01 RF Exposure Wireless Charging Apps v02
Product Description	<ul style="list-style-type: none"> <li>All In-Vehicle Wireless Chargers contain same primary coil, type YEFXU00276 with rated power transfer operating frequency of 105-140 kHz, charge operating voltage 100V peak-to-peak and output rating DC 10.5-16.0V, 1A and 13.2 watts</li> <li>This product receives its operating power from host vehicle it is installed into and enables wireless battery charging of any mobile device with Qi mark placed on charging pad.</li> </ul>
Special Conditions	<ul style="list-style-type: none"> <li>Must be provided with product label with FCC logo.</li> <li>Must be provided with User Manual with responsible party's name, address and telephone number or website address.</li> <li>Must be installed and used exclusively within transportation vehicle.</li> </ul>
FCC Test Reports	UL Japan EMI Test Report 10120384-R1, updated August 20, 2014. This reported CA-QS03J1AJ was tested, which represents Models CA-QL85E0AJ, CA-QL85H0AJ, CA-QL85H1AJ and CA-QL85H2AJ. This test report demonstrated compliance with FCC Part 18, Subpart C and Section 18.305(b) and was tested in accordance with test procedure MP-5
RF Exposure Evaluation Test Reports	<p>UL Japan MPE Test Report 10197157S-E-R1, updated August 20, 2014. This reported CA-QS03J1AJ was tested, which represents CA-QL Series.</p> <ul style="list-style-type: none"> <li>Wireless Charging Pad complies with KDB 0680106 D01 RF Exposure Wireless Charging Apps v02.</li> <li>Test results for magnetic field strength is 0.391 (A/m) at 118 kHz charging mode and 30% of MPE limits for 110-200 kHz is 0.489 (A/m).</li> <li>Test results for electro-magnetic field strength is 147.40 (V/m) at 118 kHz charging mode and 30% of MPE limits for 110-200 kHz is 184.2 (V/m). MPE limits comply with limits in Table 1(B), refer to test report section 5.</li> </ul>
Responsible Applicant	Panasonic Corporation Automotive & Industrial Systems Company 4261, Ikonobe-cho, Tsuzuki-ku, Yokohama-shi, 224-8520, Japan
Responsible Sales Company	Panasonic Consumer Electronics Company Division of Panasonic Corporation of North America Two Riverfront Plaza, Newark, NJ 07102-5490 Support Contact: <a href="http://www.panasonic.com/contactinfo">http://www.panasonic.com/contactinfo</a>



Issued by: Richard Mullen  
PSCD Issue Date: October 23, 2014  
Updated Date: January 16, 2015  
Applicant Ref No.: PAS-14-F012A  
PSCD Ref No.: DoC 2014-065A

*Richard Mullen*

Richard Mullen  
October 23, 2014  
January 16, 2015  
PAS-14-F012A  
DoC 2014-065A

 **WARNING****■ Caution while driving**

When charging a portable device while driving, for safety reasons, the driver should not operate the portable device.

**■ Caution regarding interference with electronic devices**

People with implantable cardiac pacemakers, cardiac resynchronization therapy pacemakers or implantable cardioverter defibrillators, as well as any other electrical medical device, should consult their physician about the usage of the wireless charger.

Operations of the wireless charger may have an affect on medical devices.

**■ To prevent damage or burns**

Observe the following precautions.

Failure to do so may result in the possibility of fire, equipment failure or damage, or burns due to heat.

- Do not put any metallic objects between the charging area and the portable device while charging.
- Do not attach metallic objects, such as aluminum stickers, to the charging area.
- Do not cover the wireless charger with a cloth or other object while charging.
- Do not attempt to charge portable devices which are not compatible with the Qi wireless charging standard.
- Do not disassemble, modify or remove the wireless charger.
- Do not apply force or impact to the wireless charger.

 NOTICE**■ Conditions in which the wireless charger may not operate correctly**

In the following situations, the wireless charger may not operate correctly:

- When a portable device is fully charged
- When there is a foreign object between the charging area and portable device
- When a portable device becomes hot while charging
- When a portable device is placed on the wireless area with its charging surface facing up
- When a portable device is not centered on the charging area
- When the vehicle is near a TV tower, electric power plant, gas station, radio station, large display, airport or other facility that generates strong radio waves or electrical noise
- When the portable device is in contact with, or is covered by any of the following metallic objects:
  - Cards to which aluminum foil is attached
  - Cigarette boxes that have aluminum foil inside
  - Metallic wallets or bags
  - Coins
  - Metal hand warmers
  - Media such as CDs and DVDs
- When wireless keys (that emit radio waves) other than those of your vehicle are being used nearby.

If in situations other than above the wireless charger does not operate properly or the operation indicator light is blinking, the wireless charger may be malfunctioning. Contact your Lexus dealer.

**■ To prevent failure or damage to data**

- Do not bring magnetic cards, such as a credit card, or magnetic recording media, close to the wireless charger while charging. Otherwise, data may be erased due to the influence of magnetism.  
Additionally, do not bring precision instruments such as wrist watches, close to the wireless charger, as such objects may malfunction.
- Do not leave portable devices in the cabin. The temperature inside the cabin may become high when parked in the sun, and cause damage to the device.

**■ To prevent battery discharge**

Do not use the wireless charger for a long period of time with the engine is stopped.

### Power outlets

Please use as a power supply for electronic goods that use less than 12 VDC/10 A (power consumption of 120 W).

Observe the following when using electronic goods:

- Make sure that the power consumption of all the connected power outlets on the instrument panel and in the luggage compartment is less than 120 W.
- Make sure that the power consumption of all the connected power outlets inside the console box and on the rear console is less than 120 W.

▶ On the instrument panel

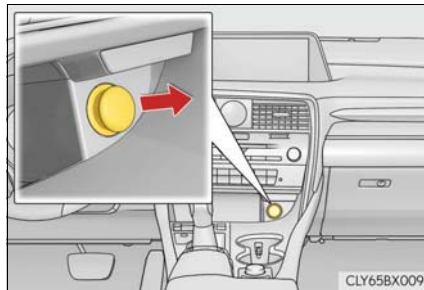

Remove the cap.

▶ Inside the console box

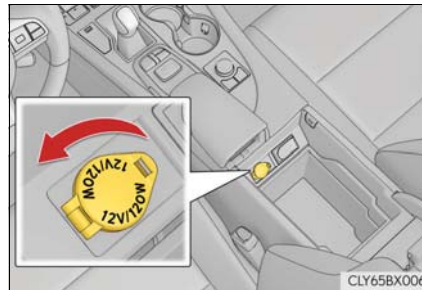

Open the lid.

▶ On the rear console (if equipped)

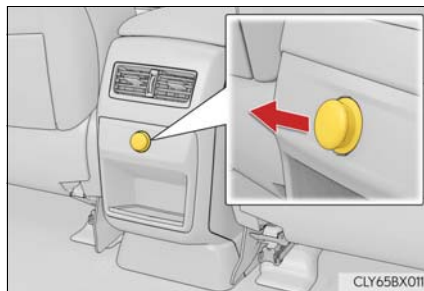

Remove the cap.

▶ In the luggage compartment (RX350)

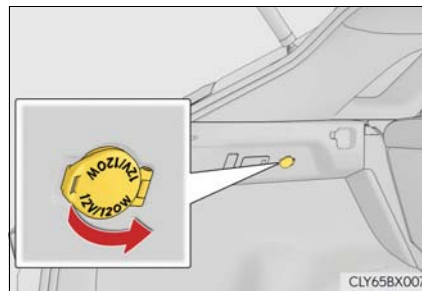

Open the lid.



- ▶ In the luggage compartment (RX350L)

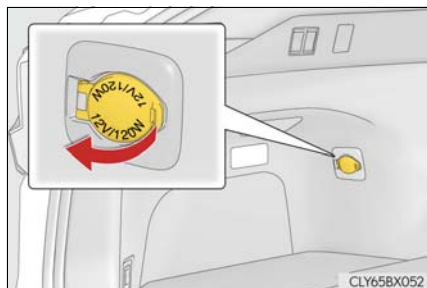

Open the lid.

- The power outlets can be used when the engine switch is in ACCESSORY or IGNITION ON mode.
- The shape of the console box rim allows power cables to be passed through when the console box lid is closed.

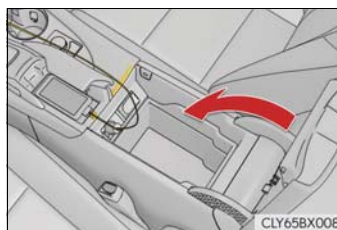

 NOTICE

- To avoid damaging the power outlets, install the cap or close the lid when the power outlets is not in use. Foreign objects or liquids that enter the power outlets may cause a short circuit.
- To prevent battery discharge, do not use the power outlets longer than necessary when the engine is off.

### USB charging ports (RX350L)

The USB charging ports are used to supply 2.1 A of electricity at 5 V to external devices. The USB charging ports are for charging only. They are not designed for data transfer or other purposes. Depending on the external device, it may not charge properly. Refer to the manual included with the device before using a USB charging port.

#### ■ Using the USB charging ports

Open the console box lid and open the lid.



#### ■ The USB charging ports can be used when

The engine switch is in ACCESSORY or IGNITION ON mode.

#### ■ Situations in which the USB charging ports may not operate correctly

- If a device which consumes more than 2.1 A at 5 V is connected
- If a device designed to communicate with a personal computer, such as a USB memory device, is connected
- If the connected external device is turned off (depending on device)
- If the temperature inside the vehicle is high, such as after the vehicle has been parked in the sun

#### ■ About connected external devices

Depending on the connected external device, charging may occasionally be suspended and then start again. This is not a malfunction.

 NOTICE

- **To prevent damage to the USB charging ports**
  - Do not insert foreign objects into the ports.
  - Do not spill water or other liquids into the ports.
  - When the USB charging ports are not in use, close the lids. If a foreign object or liquid enters a port may cause a short circuit.
  - Do not apply excessive force to or impact the USB charging ports.
  - Do not disassemble or modify the USB charging ports.
- **To prevent damage to external devices**
  - Do not leave external devices in the vehicle. The temperature inside the vehicle may become high, resulting in damage to an external device.
  - Do not push down on or apply unnecessary force to an external device or the cable of an external device while it is connected.
- **To prevent battery discharge**
  - Do not use the USB charging ports for a long period of time with the engine stopped.

**Front passenger footwell hooks**

Use the front passenger footwell hooks to help support and prevent objects placed on the floor, such as a grocery bag, from overturning.

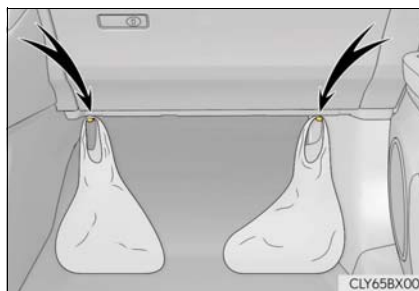

 NOTICE

To prevent the hooks from being damaged, do not hang anything from a hook or apply excessive force to it.

**Rear door sunshades (if equipped)**

Pull the sunshade up using the tab and hook the sunshade on to the anchors.

To lower the sunshade, pull it up slightly using the tab, unhook it from the anchors, and lower it slowly.

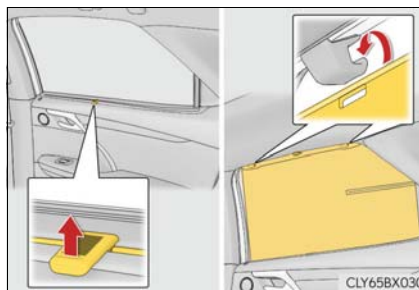

**⚠ WARNING**

When a rear door sunshade is in use, do not put fingers, etc. on the anchors or in the groove of the rear door sunshade. Otherwise, a finger, etc. may get caught, possibly causing an injury.

**⚠ NOTICE**

- Do not put anything in an area where it may interfere with the operation of a rear door sunshade.
- To prevent damage to the rear door sunshades, do not apply excessive load or attach items to the rear door sunshades.

**Armrest**

## ▶ Type A

Fold down the armrest for use.



## ▶ Type B

To adjust the armrest angle, raise the armrest to the highest position and then lower the armrest to the lowest position.

Raise the armrest again to the desired position and the armrest will be locked at that position.

When the armrest is locked, the armrest cannot be lowered.

To lower the armrest, raise the armrest to the highest position again.

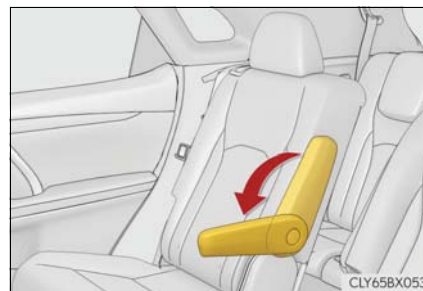
**⚠ NOTICE**

To prevent damage to the armrest, do not apply too much load on the armrest.

### Assist grips

An assist grip installed on the ceiling can be used to support your body while sitting on the seat.



#### WARNING

Do not use the assist grip when getting in or out of the vehicle or rising from your seat.

#### NOTICE

To prevent damage to the assist grip, do not hang any heavy object or put a heavy load on the assist grip.

### Coat hooks

The coat hooks are provided with the rear assist grips.

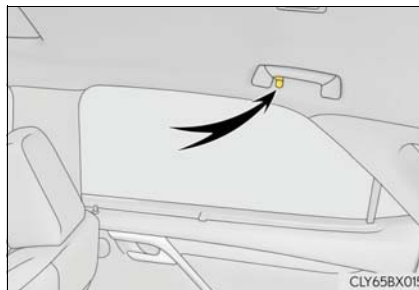

#### WARNING

Do not hang coat hangers or other hard or sharp objects on the hook. If the SRS curtain shield airbags deploy, these items may become projectiles, causing death or serious injury.

## Garage door opener

The garage door opener can be programmed to operate garage doors, gates, entry doors, door locks, home lighting systems, security systems, and other devices.

### Programming the HomeLink®

The HomeLink® wireless control system in your vehicle has 3 buttons which can be programmed to operate 3 different devices. Refer to the programming methods on the following pages to determine the method which is appropriate for the device.

- ① HomeLink® indicator light
- ② Garage door operation indicators
- ③ HomeLink® icon  
Illuminates while HomeLink® is operating.
- ④ Buttons

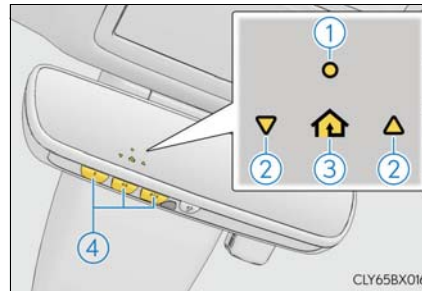

#### ■ Before programming HomeLink®

- During programming, it is possible that garage doors, gates, or other devices may operate. For this reason, make sure that people and objects are clear of the garage door or other devices. (→P. 563)
- It is recommended that a new battery be placed in the remote control transmitter for more accurate programming.
- Garage door opener motors manufactured after 1995 may be equipped with rolling code protection. If this is the case, you may need a stepladder or other sturdy, safe device to reach the “Learn” or “Smart” button on the garage door opener motor.

■ Programming HomeLink®

Steps 1 through 3 must be performed within 60 seconds, otherwise the indicator light will stop flashing and programming will not be able to be completed.

1 Press and release the HomeLink® button you want to program and check that the HomeLink® indicator light flashes (orange).

2 Point the remote control transmitter for the device at the rear view mirror, 1 to 3 in. (25 to 75 mm) from the HomeLink® buttons.

Keep the HomeLink® indicator light in view while programming.

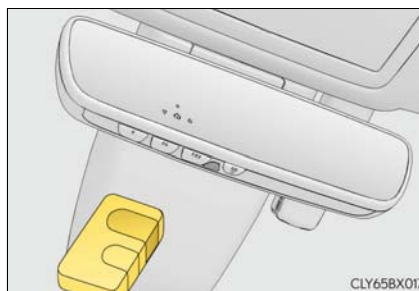

3 Program a device.

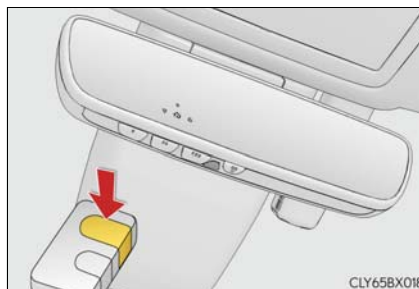

► Programming a device other than an entry gate (for U.S.A. owners)

Press and hold the handheld transmitter button until the HomeLink® indicator light changes from slowly flashing orange to rapidly flashing green (rolling code) or continuously lit green (fixed code), then release the button.

► Programming an entry gate (for U.S.A. owners)/Programming a device in the Canadian market

Press and release the remote control transmitter button at 2 second intervals, repeatedly, until the HomeLink® indicator light changes from slowly flashing (orange) to rapidly flashing (green) (rolling code) or continuously lit (green) (fixed code).

- 4 Test the HomeLink<sup>®</sup> operation by pressing the newly programmed button and observing the indicator light:
  - Indicator light illuminates: Programming of a fixed code device has completed. The garage door or other device should operate when a HomeLink<sup>®</sup> button is pressed and released.
  - Indicator light flashes rapidly: The garage door opener motor or other device is equipped with a rolling code. To complete programming, firmly press and hold the HomeLink<sup>®</sup> button for 2 seconds then release it.
  - If the garage door or other device does not operate, proceed to “Programming a rolling code system”.
- 5 Repeat the steps above to program another device for any of the remaining HomeLink<sup>®</sup> buttons.

#### ■ Programming a rolling code system

2 or more people may be necessary to complete rolling code programming.

- 1 Locate the “Learn” or “Smart” button on the garage door opener motor in the garage.

This button can usually be found where the hanging antenna wire is attached to the unit. The name and color of the button may vary by manufacturer. Refer to the Owner’s manual supplied with the garage door opener motor for details.

- 2 Press and release the “Learn” or “Smart” button.  
Perform 3 within 30 seconds after performing 2.

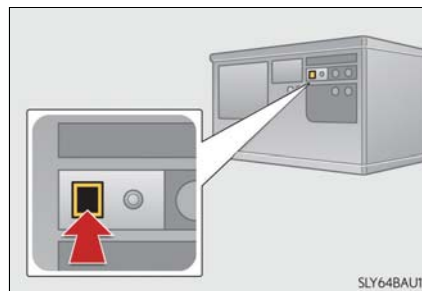
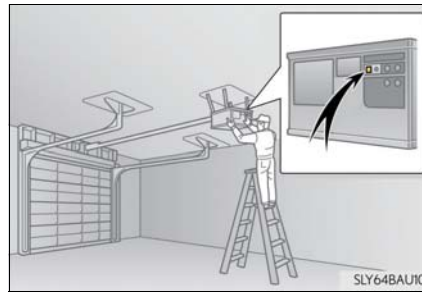



- 3 Press and hold the desired HomeLink<sup>®</sup> button (inside the vehicle) for 2 seconds and release it. Repeat this sequence (press/hold/release) up to 3 times to complete programming.

If the garage door opener motor operates when the HomeLink<sup>®</sup> button is pressed, the garage door opener motor recognizes the HomeLink<sup>®</sup> signal.



#### ■ Enabling 2-way communication with a garage door (only available for compatible devices)

When enabled, 2-way communication allows you to check the status of the opening and closing of a garage door through indicators in your vehicle.

2-way communication is only available if the garage door opener motor used is a compatible device. (To check device compatibility, refer to [www.HomeLink.com](http://www.HomeLink.com).)

- 1 Within 5 seconds after programming the garage door opener has been completed, if the garage door opener motor is trained to HomeLink<sup>®</sup>, both garage door operation indicators will flash rapidly (green) and the light on the garage door opener motor will blink twice, indicating that 2-way communication is enabled.

If the indicators do not flash, perform 2 and 3 within the first 10 presses of the HomeLink<sup>®</sup> button after programming has been completed.

- 2 Press a programmed HomeLink<sup>®</sup> button to operate a garage door.
- 3 Within 1 minute of pressing the HomeLink<sup>®</sup> button, after the garage door operation has stopped, press the "Learn" or "Smart" button on the garage door opener motor. Within 5 seconds of the establishment of 2-way communication with the garage door opener, both garage door operation indicators in the vehicle will flash rapidly (green) and the light on the garage door opener motor will blink twice, indicating that 2-way communication is enabled.

### ■ Reprogramming a single HomeLink<sup>®</sup> button

When the following procedure is performed, buttons which already have devices registered to them can be overwritten:

- 1 With one hand, press and hold the desired HomeLink<sup>®</sup> button.
- 2 When the HomeLink<sup>®</sup> indicator starts flashing (orange), continue to hold the HomeLink<sup>®</sup> button and perform "Programming HomeLink<sup>®</sup>" 1 (it takes 20 seconds for the HomeLink<sup>®</sup> indicator to start flashing).

### Operating HomeLink<sup>®</sup>

Press the appropriate HomeLink<sup>®</sup> button. The HomeLink<sup>®</sup> indicator light should turn on.

### Garage door operation indicators

The status of the opening and closing of a garage door is shown by the indicators.

- 1 Opening
- 2 Closing

This function is only available if the garage door opener motor used is a compatible device. (To check device compatibility, refer to [www.HomeLink.com](http://www.HomeLink.com).)

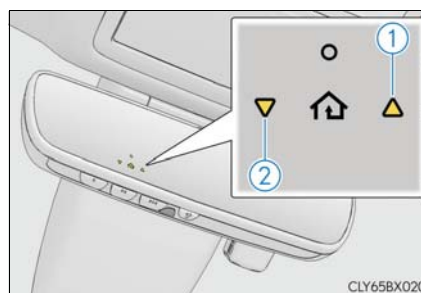

Color	Status
Orange (flashing)	Currently opening/closing
Green	Opening/closing has completed
Red (flashing)	Feedback signals cannot be received

The indicators can operate within approximately 820 ft. (250 m) of the garage door. However, if there are obstructions between the garage door and the vehicle, such as houses and trees, feedback signals from the garage door may not be received.

To recall the previous door operation status, press and release either Home-

Link<sup>®</sup> buttons  and  or  and  simultaneously. The last recorded status will be displayed for 3 seconds.

### Erasing the entire HomeLink® memory (all three codes)

Press and hold the 2 outside buttons for 10 seconds until the HomeLink® indicator light changes from continuously lit (orange) to rapidly flashing (green).

If you sell your vehicle, be sure to erase the programs stored in the HomeLink® memory.



#### ■ Codes stored in the HomeLink® memory

- The registered codes are not erased even if the battery cable is disconnected.
- If learning failed when registering a different code to a HomeLink® button that already has a code registered to it, the already registered code will not be erased.

#### ■ Before programming

- Install a new battery in the transmitter.
- The battery side of the transmitter must be pointed away from the HomeLink®.

#### ■ Certification for the garage door opener

- ▶ For vehicles sold in the U.S.A.

This device complies with part 15 of the FCC Rules. Operation is subject to the following two conditions: (1) This device may not cause harmful interference, and (2) this device must accept any interference received, including interference that may cause undesired operation.

changes or modifications not expressly approved by the party responsible for compliance could void the user's authority to operate the equipment.

- For vehicles sold in Canada

*This device complies with Industry Canada's licence-exempt RSSs. Operation is subject to the following two conditions:*

- (1) This device may not cause interference; and*
- (2) This device must accept any interference, including interference that may cause undesired operation of the device.*

*Le présent appareil est conforme aux CNR d'Industrie Canada applicables aux appareils radio exempts de licence. L'exploitation est autorisée aux deux conditions suivantes :*

- (1) L'appareil ne doit pas produire de brouillage;*
- (2) L'utilisateur de l'appareil doit accepter tout brouillage radioélectrique subi, même si le brouillage est susceptible d'en compromettre le fonctionnement.*

#### ■ When support is necessary

Visit on the web at [www.homelink.com/lexus](http://www.homelink.com/lexus) or call 1-800-355-3515.

#### WARNING

##### ■ When programming a garage door or other remote control device

The garage door or other device may operate, so ensure people and objects are out of danger to prevent injury or potential harm.

##### ■ Conforming to federal safety standards

Do not use the HomeLink<sup>®</sup> compatible transceiver with any garage door opener or device that lacks safety stop and reverse features as required by federal safety standards.

This includes any garage door that cannot detect an interfering object. A door or device without these features increases the risk of death or serious injury.

##### ■ When operating or programming HomeLink<sup>®</sup>

Never allow a child to operate or play with the HomeLink<sup>®</sup> buttons.

## Compass\*

The compass on the inside rear view mirror indicates the direction in which the vehicle is heading.

### Operation

To turn the compass on or off, press and hold the switch for 3 seconds.

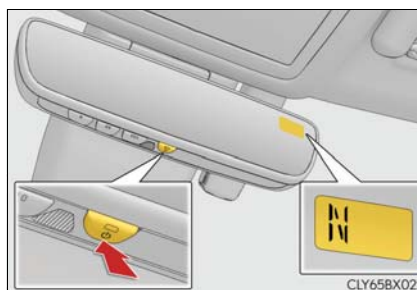

### Displays and directions

Display	Direction
"N"	North
"NE"	Northeast
"E"	East
"SE"	Southeast
"S"	South
"SW"	Southwest
"W"	West
"NW"	Northwest

\*: If equipped

### Calibrating the compass

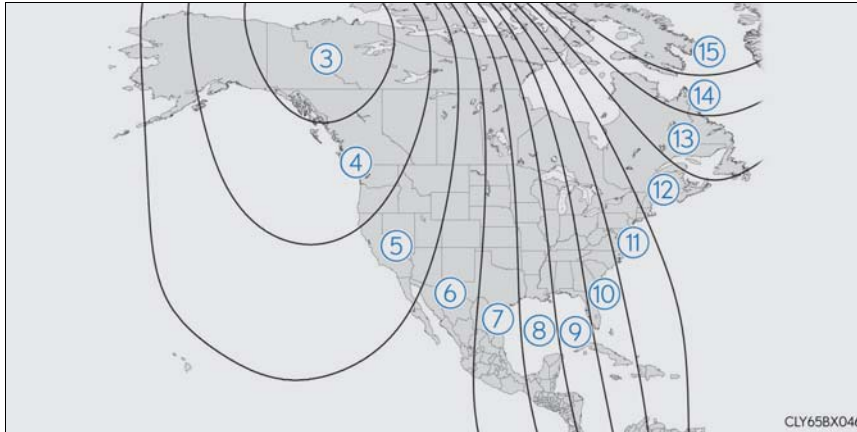

The direction display deviates from the true direction determined by the earth's magnetic field. The amount of deviation varies according to the geographic position of the vehicle.

If you cross over a map boundary shown in illustration, the compass will deviate. To obtain higher precision or perfect calibration, refer to the following.

#### ■ Deviation calibration

- 1 Stop the vehicle.
- 2 Press and hold the switch for 6 seconds.  
A number (1 to 15) appears on the compass display.

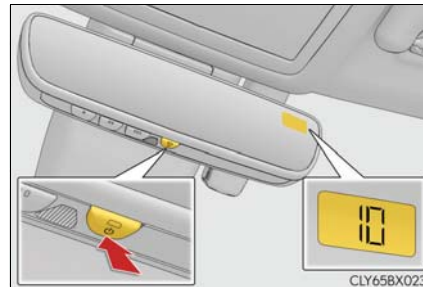

- 3 Press the switch and, referring to the map above, select the number of the zone where you are.  
If the direction is displayed several seconds after adjustment, the calibration is complete.

■ **Circling calibration**

- 1 Stop the vehicle in a place where it is safe to drive in a circle.
- 2 Press and hold the button for 9 seconds.  
"C" appears on the compass display.

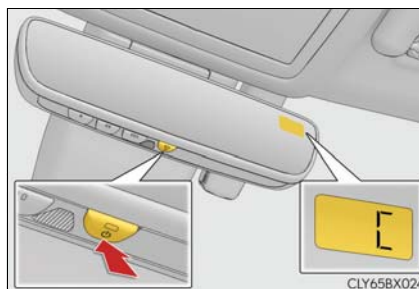

- 3 Drive the vehicle at 5 mph (8 km/h) or less in a circle until a direction is displayed.  
If there is not enough space to drive in a circle, drive around the block until a direction is displayed.



■ **Conditions unfavorable to correct operation**

The compass may not show the correct direction in the following conditions:

- The vehicle is stopped immediately after turning.
- The vehicle is on an inclined surface.
- The vehicle is in a place where the earth's magnetic field is subject to interference by artificial magnetic fields (underground car park/parking lot, under a steel tower, between buildings, roof car park/parking lot, near an intersection, near a large vehicle, etc.).
- The vehicle has become magnetized.  
(There is a magnet or metal object near the inside rear view mirror.)
- The battery has been disconnected.
- A door is open.

 **WARNING**

- **While driving the vehicle**  
Do not adjust the display. Adjust the display only when the vehicle is stopped.
- **When doing the circling calibration**  
Secure a wide space, and watch out for people and vehicles in the vicinity. Do not violate any local traffic rules while performing circling calibration.

 **NOTICE**

- **To avoid compass malfunctions**  
Do not place magnets or any metal objects near the inside rear view mirror. Doing this may cause the compass sensor to malfunction.
- **To ensure normal operation of the compass**
  - Do not perform a circling calibration of the compass in a place where the earth's magnetic field is subject to interference by artificial magnetic fields.
  - During calibration, do not operate electric systems (moon roof, panoramic moon roof, power windows, etc.) as they may interfere with the calibration.



## LEXUS Enform Safety Connect\*

Safety Connect is a subscription-based telematics service that uses Global Positioning System (GPS) data and embedded cellular technology to provide safety and security features to subscribers. Safety Connect is supported by Lexus' designated response center, which operates 24 hours per day, 7 days per week.

Safety Connect service is available by subscription on select, telematics hardware-equipped vehicles.

By using the Safety Connect service, you are agreeing to be bound by the Telematics Subscription Service Agreement and its Terms and Conditions, as in effect and amended from time to time, a current copy of which is available at [Lexus.com](http://Lexus.com). All use of the Safety Connect service is subject to such then-applicable Terms and Conditions.

### System components

- ① Microphone
- ② "SOS" button
- ③ LED light indicators

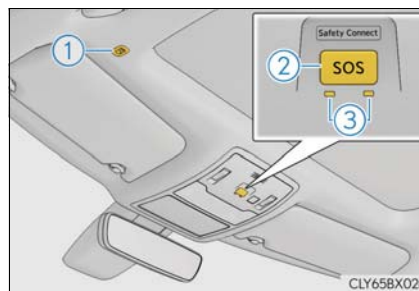

\*: If equipped

## Services

Subscribers have the following Safety Connect services available:

- Automatic Collision Notification\*  
Helps drivers receive necessary response from emergency service providers.  
(→P. 571)
- \*: U.S. Patent No. 7,508,298 B2
- Stolen Vehicle Location  
Helps drivers in the event of vehicle theft. (→P. 571)
- Emergency Assistance Button (“SOS”)  
Connects drivers to response-center support. (→P. 571)
- Enhanced Roadside Assistance  
Provides drivers various on-road assistance. (→P. 571)

## Subscription

After you have signed the Telematics Subscription Service Agreement and are enrolled, you can begin receiving services.

A variety of subscription terms is available for purchase. Contact your Lexus dealer, call 1-800-25-LEXUS (1-800-255-3987) in the United States (1-877-539-8777 in Puerto Rico, 1-800-26-LEXUS in Canada) or push the “SOS” button in your vehicle for further subscription details.

**■ Safety Connect Services Information**

- Phone calls using the vehicles Bluetooth® technology will not be possible during Safety Connect.
- Safety Connect is available beginning Fall 2009 on select Lexus models (in the contiguous United States only). Contact with the Safety Connect response center is dependent upon the telematics device being in operative condition, cellular connection availability, and GPS satellite signal reception, which can limit the ability to reach the response center or receive emergency service support. Enrollment and Telematics Subscription Service Agreement required. A variety of subscription terms is available; charges vary by subscription term selected and location.
- Automatic Collision Notification, Emergency Assistance and Stolen Vehicle Location will function in the United States, including Hawaii and Alaska, Puerto Rico and in Canada, and Enhanced Roadside Assistance will function in the United States, Puerto Rico and in Canada.
- Automatic Collision Notification, Emergency Assistance, Stolen Vehicle Location and Enhanced Roadside Assistance will not function in the United States Virgin Islands. No Safety Connect services will function outside of the United States in countries other than Canada.  
For vehicles first sold in the USVI, no Safety Connect services will function in and outside the United States Virgin Islands.
- Safety Connect services are not subject to section 255 of the Telecommunications Act and the device is not TTY compatible.

**■ Languages**

The Safety Connect response center will offer support in multiple languages. The Safety Connect system will offer voice prompts in English, Spanish and French. Please indicate your language of choice when enrolling.

**■ When contacting the response center**

You may be unable to contact the response center if the network is busy.

**Safety Connect LED light Indicators**

When the engine switch is turned to IGNITION ON mode, the red indicator light comes on for 2 seconds then turns off. Afterward, the green indicator light comes on, indicating that the service is active.

The following indicator light patterns indicate specific system usage conditions:

- Green indicator light on = Active service
- Green indicator light flashing = Safety Connect call in process
- Red indicator light (except at vehicle start-up) = System malfunction (contact your Lexus dealer)
- No indicator light (off) = Safety Connect service not active

## Safety Connect services

### ■ Automatic Collision Notification

In case of either airbag deployment or severe rear-end collision, the system is designed to automatically call the response center. The responding agent receives the vehicle's location and attempts to speak with the vehicle occupants to assess the level of emergency. If the occupants are unable to communicate, the agent automatically treats the call as an emergency, contacts the nearest emergency services provider to describe the situation, and requests that assistance be sent to the location.

### ■ Stolen Vehicle Location

If your vehicle is stolen, Safety Connect can work with local authorities to assist them in locating and recovering the vehicle. After filing a police report, call the Safety Connect response center at 1-800-25-LEXUS (1-800-255-3987) and follow the prompts for Safety Connect to initiate this service.

In addition to assisting law enforcement with recovery of a stolen vehicle, Safety-Connect-equipped vehicle location data may, under certain circumstances, be shared with third parties to locate your vehicle. Further information is available at [Lexus.com](http://Lexus.com).

### ■ Emergency Assistance Button ("SOS")

In the event of an emergency on the road, push the "SOS" button to reach the Safety Connect response center. The answering agent will determine your vehicle's location, assess the emergency, and dispatch the necessary assistance required.

If you accidentally press the "SOS" button, tell the response-center agent that you are not experiencing an emergency.

### ■ Enhanced Roadside Assistance

Enhanced Roadside Assistance adds GPS data to the already included warranty-based Lexus roadside service.

Subscribers can press the "SOS" button to reach a Safety Connect response-center agent, who can help with a wide range of needs, such as: towing, flat tire, fuel delivery, etc. For a description of the Roadside Assistance services and their limitations, please see the Safety Connect Terms and Conditions, which are available at [Lexus.com](http://Lexus.com).

**Safety information for Safety Connect**

Important! Read this information about exposure to radio frequency signals before using Safety Connect;

The Safety Connect system installed in your vehicle is a low-power radio transmitter and receiver. It receives and also sends out radio frequency (RF) signals.

In August 1996, the Federal Communications Commission (FCC) adopted RF exposure guidelines with safety levels for mobile wireless phones. Those guidelines are consistent with the safety standards previously set by the following U.S. and international standards bodies.

- ANSI (American National Standards Institute) C95.1 [1992]
- NCRP (National Council on Radiation Protection and Measurement) Report 86 [1986]
- ICNIRP (International Commission on Non-Ionizing Radiation Protection) [1996]

Those standards were based on comprehensive and periodic evaluations of the relevant scientific literature. Over 120 scientists, engineers, and physicians from universities, and government health agencies and industries reviewed the available body of research to develop the ANSI Standard (C95.1).

The design of Safety Connect complies with the FCC guidelines in addition to those standards.

**■ Certification for Lexus Enform**

FCC ID: O6Y-CDMRF101

FCC ID: XOECDMRF101B

FCC ID: N7NGTM2

FCC WARNING:

This equipment complies with FCC radiation exposure limits set forth for an uncontrolled environment and meets the FCC radio frequency (RF) Exposure Guidelines in Supplement C to OET65. This equipment should be installed and operated keeping the radiator at least 20cm or more away from person's body (excluding extremities: hands, wrists, feet and ankles).

## LEXUS Enform Remote\*

Lexus Enform Remote is a cellular phone application that lets you view and remotely control certain aspects of your vehicle.

For details about the functions and services of this application, refer to <http://www.lexus.com/enform/>.

Function of the Lexus Enform Remote is achieved by using an embedded cellular device in the vehicle (DCM: Data Communication Module).

### Subscription

After you sign the Telematics Subscription Service Agreement, download the Lexus Enform Remote app from your cellular phone's app store, and register within the app (or enroll and complete registration at the dealer), you can begin using these services. (→P. 568)

A variety of subscription terms are available. Contact your Lexus dealer, or call 1-800-25-LEXUS (1-800-255-3987) for further subscription details.

#### ■ Availability of service

- Lexus Enform Remote is available in the contiguous United States, Washington D.C. and Alaska.
- Lexus Enform Remote is not available in Puerto Rico, Canada, and in the United States Virgin Islands.

#### ■ Lexus Enform Remote Information

- Lexus Enform Remote should only be used by authorized users.
- Laws in some communities may require that the vehicle be within view of the user when operating Lexus Enform Remote.  
In some states, use of Lexus Enform Remote may violate state or local laws. Before using Lexus Enform Remote, check your state and local laws.
- Any malfunction of the Lexus should be repaired by your Lexus dealer.
- Lexus Enform Remote is designed to work at temperatures above -22°F (-30°C). This specification is related to the Lexus Enform Remote operation, but is dependent on the vehicle's operating temperature range which may be different.
- Content is subject to change without notice.
- Some features of the Lexus Enform Remote may not be available on some models.
- Additional information can be found at [www.lexus.com/enform/](http://www.lexus.com/enform/).
- Availability of functions of the Lexus Enform service is dependent on network reception level.

#### ■ Safety information for Lexus Enform Remote

Refer to the safety information for Safety Connect: →P. 572

\*: If equipped

## LEXUS Enform Service Connect\*

Lexus Enform Service Connect uses embedded telematics hardware to collect and transmit vehicle data that allows Lexus to provide:

- Vehicle Health Report (VHR)  
(Safety Recalls, Service Campaigns, Current Vehicle Alerts, Required Maintenance, and Vehicle Condition Status)
- Maintenance Notifications
- Vehicle Alert Notifications

For details about this service and how to register, refer to <http://www.lexus.com/enform/>.

The Lexus Enform Service Connect is achieved by using a Data Communication Module (DCM) built in the vehicle.

### ■ Availability of service

- Lexus Enform Service Connect is available in the contiguous United States, Washington D.C., and Alaska.
- Lexus Enform Service Connect is not available in Puerto Rico, Canada, and the United States Virgin Islands.

### ■ Lexus Enform Service Connect Information

Availability of functions of the Lexus Enform Service Connect is dependent on network reception level.

### ■ Safety information for Lexus Enform Service Connect

Refer to the safety information for Safety Connect: →P. 572

\*: If equipped

## Maintenance and care

## 7

**7-1. Maintenance and care**

Cleaning and protecting  
the vehicle exterior ..... 576

Cleaning and protecting  
the vehicle interior ..... 581

**7-2. Maintenance**

Maintenance  
requirements ..... 584

General maintenance ..... 586

Emission inspection and  
maintenance (I/M)  
programs ..... 589

**7-3. Do-it-yourself  
maintenance**

Do-it-yourself service  
precautions ..... 590

Hood ..... 592

Positioning a floor jack ..... 593

Engine compartment ..... 594

Tires ..... 604

Tire inflation pressure ..... 613

Wheels ..... 616

Air conditioning filter ..... 618

Windshield wiper inserts ..... 621

Electronic key battery ..... 623

Checking and replacing  
fuses ..... 625

Headlight aim ..... 628

Light bulbs ..... 630



## Cleaning and protecting the vehicle exterior

Perform the following to protect the vehicle and maintain it in prime condition:

- Working from top to bottom, liberally apply water to the vehicle body, wheel wells and underside of the vehicle to remove any dirt and dust.
- Wash the vehicle body using a sponge or soft cloth, such as a chamois.
- For hard-to-remove marks, use car wash soap and rinse thoroughly with water.
- Wipe away any water.
- Wax the vehicle when the waterproof coating deteriorates.

If water does not bead on a clean surface, apply wax when the vehicle body is cool.

### ■ Self-restoring coat

The vehicle body has a self-restoring coating that is resistant to small surface scratches caused in a car wash etc.

- The coating lasts for 5 to 8 years from when the vehicle is delivered from the plant.
- The restoration time differs depending on the depth of the scratch and outside temperature. The restoration time may become shorter when the coating is warmed by applying warm water.
- Deep scratches caused by keys, coins, etc. cannot be restored.
- Do not use wax that contain abrasives.

### ■ Automatic car washes

- Before washing the vehicle:
  - Fold the mirrors
  - Turn off the power back doorStart washing from the front of the vehicle. Extend the mirrors before driving.
- Brushes used in automatic car washes may scratch the vehicle surface and harm your vehicle's paint.
- Rear spoiler may not be washable in some automatic car washes. There may also be an increased risk of damage to vehicle.

### ■ High pressure car washes

- Do not allow the nozzles of the car wash to come within close proximity of the windows.
- Before using the car wash, check that the fuel filler door on your vehicle is closed properly.

**■ Note for a smart access system with push-button start**

- If the door handle becomes wet while the electronic key is within the effective range, the door may lock and unlock repeatedly. Place the key in a position 6 ft. (2 m) or more separate from the vehicle while the vehicle is being washed. (Take care to ensure that the key is not stolen.)
- If the electronic key is inside the vehicle and a door handle becomes wet during a car wash, a buzzer will sound outside the vehicle. To turn off the alarm, lock all the doors.
- Set the electronic key to battery-saving mode to disable the smart access system with push-button start. (→P. 147)

**■ Aluminum wheels**

- Remove any dirt immediately by using a neutral detergent.
- Wash detergent off with water immediately after use.
- To protect the paint from damage, make sure to observe the following precautions.
  - Do not use acidic, alkaline or abrasive detergent
  - Do not use hard brushes
  - Do not use detergent on the wheels when they are hot, such as after driving or parking in hot weather

**■ Bumpers**

Do not scrub with abrasive cleaners.

**■ Front side windows water-repellent coating**

- The following precautions can extend the effectiveness of the water-repellent coating.
  - Remove any dirt, etc. from the front side windows regularly.
  - Do not allow dirt and dust to accumulate on the windows for a long period.  
Clean the windows with a soft, damp cloth as soon as possible.
  - Do not use wax or glass cleaners that contain abrasives when cleaning the windows.
  - Do not use any metallic objects to remove condensation build up.
- When the water-repellent performance has become insufficient, the coating can be repaired. Contact your Lexus dealer.

**⚠ WARNING****■ When washing the vehicle**

Do not apply water to the inside of the engine compartment. Doing so may cause the electrical components, etc. to catch fire.

**■ When cleaning the windshield (vehicles with rain-sensing windshield wipers)**

Set the wiper switch to off.  
If the wiper switch is in "AUTO", the wipers may operate unexpectedly in the following situations, and may result in hands being caught or other serious injuries and cause damage to the wiper blades.

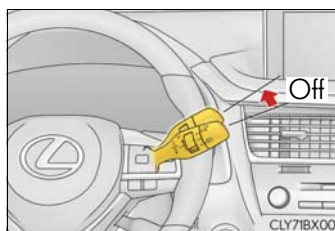

- When the upper part of the windshield where the raindrop sensor is located is touched by hand
- When a wet rag or similar is held close to the raindrop sensor
- If something bumps against the windshield
- If you directly touch the raindrop sensor body or if something bumps into the raindrop sensor

**■ Precautions regarding the exhaust pipes and rear bumper diffusers**

Exhaust gasses cause the exhaust pipes and rear bumper diffusers to become quite hot.

When washing the vehicle, be careful not to touch the pipes and diffusers until they have cooled sufficiently, as touching hot exhaust pipes and rear bumper diffusers can cause burns.

**■ Precautions regarding the rear bumper with Blind Spot Monitor (if equipped)**

If the paint of the rear bumper is chipped or scratched, the system may malfunction. If this occurs, consult your Lexus dealer.

 NOTICE**■ To prevent paint deterioration and corrosion on the body and components (aluminum wheels, etc.)**

- Wash the vehicle immediately in the following cases:
  - After driving near the sea coast
  - After driving on salted roads
  - If you see coal tar or tree sap on the paint surface
  - If you see dead insects, insect droppings or bird droppings on the paint
  - After driving in an area contaminated with soot, oily smoke, mine dust, iron powder or chemical substances
  - If the vehicle becomes heavily soiled with dust or mud
  - If liquids such as benzene and gasoline are spilled on the paint surface
- If the paint is chipped or scratched, have it repaired immediately.
- To prevent the wheels from corroding, remove any dirt and store in a place with low humidity when storing the wheels.

**■ Cleaning the exterior lights**

- Wash carefully. Do not use organic substances or scrub with a hard brush. This may damage the surfaces of the lights.
- Do not apply wax to the surfaces of the lights. Wax may cause damage to the lenses.

**■ When using an automatic car wash (vehicles with rain-sensing windshield wipers)**

Set the wiper switch to the off position.  
If the wiper switch is in "AUTO", the wipers may operate and the wiper blades may be damaged.

 NOTICE

■ **When using a high pressure car wash**

- When washing the vehicle, do not let water of the high pressure washer hit directly or the vicinity of the camera. Due to the shock from the high pressure water, it is possible the device may not operate as normal.
- Do not bring the nozzle tip close to boots (rubber or resin manufactured cover), connectors or the following parts. The parts may be damaged if they come into contact with high-pressure water.
  - Traction related parts
  - Steering parts
  - Suspension parts
  - Brake parts
- Vehicles with towing package: Do not point the nozzle of a high pressure washer at the areas shown in the illustration, as high pressure water may damage the oil cooler.

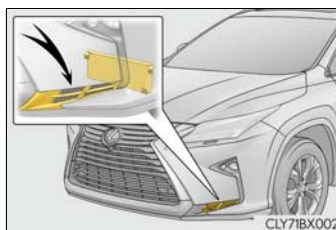

## Cleaning and protecting the vehicle interior

The following procedures will help protect your vehicle's interior and keep it in top condition:

### Protecting the vehicle interior

- Remove dirt and dust using a vacuum cleaner. Wipe dirty surfaces with a cloth dampened with lukewarm water.
- If dirt cannot be removed, wipe it off with a soft cloth dampened with neutral detergent diluted to approximately 1%.  
Wring out any excess water from the cloth and thoroughly wipe off remaining traces of detergent and water.

### Cleaning the leather areas

- Remove dirt and dust using a vacuum cleaner.
- Wipe off any excess dirt and dust with a soft cloth dampened with diluted detergent.  
Use a diluted water solution of approximately 5% neutral wool detergent.
- Wring out any excess water from the cloth and thoroughly wipe off all remaining traces of detergent.
- Wipe the surface with a dry, soft cloth to remove any remaining moisture. Allow the leather to dry in a shaded and ventilated area.

### Cleaning the synthetic leather areas

- Remove dirt and dust using a vacuum cleaner.
- Wipe it off with a soft cloth dampened with neutral detergent diluted to approximately 1%.
- Wring out any excess water from the cloth and thoroughly wipe off remaining traces of detergent and water.

■ **Caring for leather areas**

Lexus recommends cleaning the interior of the vehicle at least twice a year to maintain the quality of the vehicle's interior.

■ **Shampooing the carpets**

There are several commercial foaming-type cleaners available. Use a sponge or brush to apply the foam. Rub in overlapping circles. Do not use water. Wipe dirty surfaces and let them dry. Excellent results are obtained by keeping the carpet as dry as possible.

■ **Seat belts**

Clean with mild soap and lukewarm water using a cloth or sponge. Also check the belts periodically for excessive wear, fraying or cuts.

 **WARNING**

■ **Water in the vehicle**

- Do not splash or spill liquid in the vehicle.  
Doing so may cause electrical components, etc. to malfunction or catch fire.
- Do not get any of the SRS components or wiring in the vehicle interior wet.  
(→P. 38)  
An electrical malfunction may cause the airbags to deploy or not function properly, resulting in death or serious injury.
- Vehicles with wireless charger:  
Do not let the wireless charger (→P. 545) get wet. Failure to do so may cause the charger to become hot and cause burns or could cause electric shock resulting in death or serious injury.

■ **Cleaning the interior (especially instrument panel)**

Do not use polish wax or polish cleaner. The instrument panel may reflect off the windshield, obstructing the driver's view and leading to an accident, resulting in death or serious injury.

 NOTICE**■ Cleaning detergents**

- Do not use the following types of detergent, as they may discolor the vehicle interior or cause streaks or damage to painted surfaces:
  - Non-seat portions: Organic substances such as benzene or gasoline, alkaline or acidic solutions, dye, and bleach
  - Seats: Alkaline or acidic solutions, such as thinner, benzene, and alcohol
- Do not use polish wax or polish cleaner. The instrument panel's or other interior part's painted surface may be damaged.

**■ Preventing damage to leather surfaces**

Observe the following precautions to avoid damage to and deterioration of leather surfaces:

- Remove any dust or dirt from leather surfaces immediately.
- Do not expose the vehicle to direct sunlight for extended periods of time. Park the vehicle in the shade, especially during summer.
- Do not place items made of vinyl, plastic, or containing wax on the upholstery, as they may stick to the leather surface if the vehicle interior heats up significantly.

**■ Water on the floor**

Do not wash the vehicle floor with water.

Vehicle systems such as the audio system may be damaged if water comes into contact with electrical components such as the audio system above or under the floor of the vehicle. Water may also cause the body to rust.

**■ When cleaning the inside of the windshield**

Do not allow glass cleaner to contact the lens. Also, do not touch the lens.  
(→P. 276)

**■ Cleaning the inside of the rear window**

- Do not use glass cleaner to clean the rear window, as this may cause damage to the rear window defogger heater wires or antenna. Use a cloth dampened with luke-warm water to gently wipe the window clean. Wipe the window in strokes running parallel to the heater wires or antenna.
- Be careful not to scratch or damage the heater wires or antenna.



## Maintenance requirements

To ensure safe and economical driving, day-to-day care and regular maintenance are essential. It is the owner's responsibility to perform regular checks. Lexus recommends the following maintenance:

### General maintenance

General maintenance should be performed on a daily basis. This can be done by yourself or by a Lexus dealer.

### Scheduled maintenance

Scheduled maintenance should be performed at specified intervals according to the maintenance schedule.

For details about maintenance items and schedules, refer to the "Warranty and Service Guide", "Owner's Manual Supplement" or "Scheduled Maintenance".

### Do-it-yourself maintenance

You can perform some maintenance procedures by yourself.

Please be aware that do-it-yourself maintenance may affect warranty coverage.

The use of Lexus repair manuals is recommended.

For details about warranty coverage, refer to the separate "Owner's Guide", "Warranty and Service Guide", "Owner's Manual Supplement" or "Warranty Booklet".





### ■ Repair and replacement

It is recommended that genuine Lexus parts be used for repairs to ensure performance of each system. If non-Lexus parts are used in replacement or if a repair shop other than a Lexus dealer performs repairs, confirm the warranty coverage.

### ■ Resetting the message indicating maintenance is required (U.S.A. only)

After the required maintenance is performed according to the maintenance schedule, please reset the message.

To reset the message, follow the procedures described below:

- 1 Select  on the multi-information display.(→P. 97)
- 2 Press  or  of the meter control switch, select the “Scheduled Maintenance” screen and then press and hold the .
- 3 Select the “Yes” and push .
- 4 A message will be displayed on the multi-information display when the reset procedure has been completed.

### ■ Allow inspection and repairs to be performed by a Lexus dealer

- Lexus technicians are well-trained specialists and are kept up to date with the latest service information. They are well informed about the operation of all systems on your vehicle.
- Keep a copy of the repair order. It proves that the maintenance that has been performed is under warranty coverage. If any problem should arise while your vehicle is under warranty, your Lexus dealer will promptly take care of it.

### WARNING

#### ■ If your vehicle is not properly maintained

Improper maintenance could result in serious damage to the vehicle and possible serious injury or death.

#### ■ Handling of the battery

- Engine exhaust, some of its constituents, and a wide variety of automobile components contain or emit chemicals known to the State of California to cause cancer and birth defects and other reproductive harm. Work in a well ventilated area.
- Oils, fuels and fluids contained in vehicles as well as waste produced by component wear contain or emit chemicals known to the State of California to cause cancer and birth defects or other reproductive harm. Avoid exposure and wash any affected area immediately.
- Battery posts, terminals and related accessories contain lead and lead compounds which are known to cause brain damage. Wash your hands after handling. (→P. 601)

## General maintenance

Listed below are the general maintenance items that should be performed at the intervals specified in the “Warranty and Service Guide” or “Owner’s Manual Supplement”. It is recommended that any problem you notice should be brought to the attention of your Lexus dealer or qualified service shop for advice.

### Engine compartment

Items	Check points
Battery	Check the connections. (→P. 601)
Brake fluid	Is the brake fluid at the correct level? (→P. 600)
Engine coolant	Is the engine coolant at the correct level? (→P. 598)
Engine oil	Is the engine oil at the correct level? (→P. 595)
Exhaust system	There should not be any fumes or strange sounds.
Radiator/condenser	The radiator and condenser should be free from foreign objects. (→P. 599)
Washer fluid	Is there sufficient washer fluid? (→P. 603)

### Vehicle interior

Items	Check points
Accelerator pedal	<ul style="list-style-type: none"> <li>The accelerator pedal should move smoothly (without uneven pedal effort or catching).</li> </ul>
Automatic transmission "Park" mechanism	<ul style="list-style-type: none"> <li>When parked on a slope and the shift lever is in P, is the vehicle securely stopped?</li> </ul>
Brake pedal	<ul style="list-style-type: none"> <li>Does the brake pedal move smoothly?</li> <li>Does the brake pedal have appropriate clearance from the floor? (→P. 704)</li> <li>Does the brake pedal have the correct amount of free play? (→P. 704)</li> </ul>
Brakes	<ul style="list-style-type: none"> <li>The vehicle should not pull to one side when the brakes are applied.</li> <li>The brakes should work effectively.</li> <li>The brake pedal should not feel spongy.</li> <li>The brake pedal should not get too close to the floor when the brakes are applied.</li> </ul>
Head restraints	<ul style="list-style-type: none"> <li>Do the head restraints move smoothly and lock securely?</li> </ul>
Indicators/buzzers	<ul style="list-style-type: none"> <li>Do the indicators and buzzers function properly?</li> </ul>
Lights	<ul style="list-style-type: none"> <li>Do all the lights come on?</li> <li>Are the headlights aimed correctly?* (→P. 628)</li> </ul>
Parking brake	<ul style="list-style-type: none"> <li>Does the parking brake switch operate normally?</li> <li>When parked on a slope and the parking brake is on, is the vehicle securely stopped?</li> </ul>
Seat belts	<ul style="list-style-type: none"> <li>Do the seat belts operate smoothly?</li> <li>The seat belts should not be damaged.</li> </ul>
Seats	<ul style="list-style-type: none"> <li>Do the seat controls operate properly?</li> </ul>
Steering wheel	<ul style="list-style-type: none"> <li>Does the steering wheel rotate smoothly?</li> <li>Does the steering wheel have the correct amount of free play?</li> <li>There should not be any strange sounds coming from the steering wheel.</li> </ul>

\*: Vehicles with single-beam headlights

**Vehicle exterior**

Items	Check points
Doors	<ul style="list-style-type: none"> <li>• Do the doors operate smoothly?</li> </ul>
Engine hood	<ul style="list-style-type: none"> <li>• Does the engine hood lock system work properly?</li> </ul>
Fluid leaks	<ul style="list-style-type: none"> <li>• There should not be any signs of fluid leakage after the vehicle has been parked.</li> </ul>
Tires	<ul style="list-style-type: none"> <li>• Is the tire inflation pressure correct?</li> <li>• The tires should not be damaged or excessively worn.</li> <li>• Have the tires been rotated according to the maintenance schedule?</li> <li>• The wheel nuts should not be loose.</li> </ul>
Windshield wipers/ rear window wiper	<ul style="list-style-type: none"> <li>• The wiper blades should not show any signs of cracking, splitting, wear, contamination or deformation.</li> <li>• The wiper blades should clear the windshield/rear window without streaking or skipping.</li> </ul>

**⚠ WARNING**

■ **If the engine is running**

Turn the engine off and ensure that there is adequate ventilation before performing maintenance checks.

## Emission inspection and maintenance (I/M) programs

Some states have vehicle emission inspection programs which include OBD (On Board Diagnostics) checks. The OBD system monitors the operation of the emission control system.

### If the malfunction indicator lamp comes on

The OBD system determines that a problem exists somewhere in the emission control system. Your vehicle may not pass the I/M test and may need to be repaired. Contact your Lexus dealer to service the vehicle.

### Your vehicle may not pass the I/M test in the following situations:

- When the battery is disconnected or discharged  
Readiness codes that are set during ordinary driving are erased.  
Also, depending on your driving habits, the readiness codes may not be completely set.
- When the fuel tank cap is loose  
The malfunction indicator lamp comes on indicating a temporary malfunction and your vehicle may not pass the I/M test.

### When the malfunction indicator lamp still remains on after several driving trips

The error code in the OBD system will not be cleared unless the vehicle is driven 40 or more times.

### If your vehicle does not pass the I/M test

Contact your Lexus dealer to prepare the vehicle for re-testing.

## Do-it-yourself service precautions

If you perform maintenance by yourself, be sure to follow the correct procedure as given in these sections.

Items	Parts and tools
Battery condition (→P. 601)	<ul style="list-style-type: none"> <li>• Warm water</li> <li>• Baking soda</li> <li>• Grease</li> <li>• Conventional wrench (for terminal clamp bolts)</li> </ul>
Brake fluid level (→P. 600)	<ul style="list-style-type: none"> <li>• FMVSS No.116 DOT 3 or SAE J1703 brake fluid</li> <li>• Rag or paper towel</li> <li>• Funnel (used only for adding brake fluid)</li> </ul>
Engine coolant level (→P. 598)	<ul style="list-style-type: none"> <li>• "Toyota Super Long Life Coolant" or a similar high quality ethylene glycol-based non-silicate, non-amine, non-nitrite and non-borate coolant with long-life hybrid organic acid technology</li> <li>For the U.S.A.: "Toyota Super Long Life Coolant" is pre-mixed with 50% coolant and 50% deionized water.</li> <li>For Canada: "Toyota Super Long Life Coolant" is pre-mixed with 55% coolant and 45% deionized water.</li> <li>• Funnel (used only for adding engine coolant)</li> </ul>
Engine oil level (→P. 595)	<ul style="list-style-type: none"> <li>• "Toyota Genuine Motor Oil" or equivalent</li> <li>• Rag or paper towel</li> <li>• Funnel (used only for adding engine oil)</li> </ul>
Fuses (→P. 625)	<ul style="list-style-type: none"> <li>• Fuse with same amperage rating as original</li> </ul>
Headlight aim* (→P. 628)	<ul style="list-style-type: none"> <li>• Phillips-head screwdriver</li> </ul>
Light bulbs (→P. 630)	<ul style="list-style-type: none"> <li>• Bulb with same number and wattage rating as original</li> <li>• Flathead screwdriver</li> <li>• Wrench</li> </ul>
Radiator and condenser (→P. 599)	—

Items	Parts and tools
Tire inflation pressure (→P. 613)	<ul style="list-style-type: none"> <li>• Tire pressure gauge</li> <li>• Compressed air source</li> </ul>
Washer fluid (→P. 603)	<ul style="list-style-type: none"> <li>• Water or washer fluid containing antifreeze (for winter use)</li> <li>• Funnel (used only for adding water or washer fluid)</li> </ul>

\*: Vehicles with single-beam headlights

### WARNING

The engine compartment contains many mechanisms and fluids that may move suddenly, become hot, or become electrically energized. To avoid death or serious injury, observe the following precautions.

#### ■ When working on the engine compartment

- Keep hands, clothing and tools away from the moving fan and engine drive belt.
- Be careful not to touch the engine, radiator, exhaust manifold, etc. right after driving as they may be hot. Oil and other fluids may also be hot.
- Do not leave anything that may burn easily, such as paper and rags, in the engine compartment.
- Do not smoke, cause sparks or expose an open flame to fuel or the battery. Fuel and battery fumes are flammable.
- Be extremely cautious when working on the battery. It contains poisonous and corrosive sulfuric acid.

#### ■ When working near the electric cooling fans or radiator grille

Be sure the engine switch is off.

With the engine switch in IGNITION ON mode, the electric cooling fans may automatically start to run if the air conditioning is on and/or the coolant temperature is high. (→P. 599)

#### ■ Safety glasses

Wear safety glasses to prevent flying or falling material, fluid spray, etc. from getting in your eyes.

### NOTICE

#### ■ If you remove the air cleaner filter

Driving with the air cleaner filter removed may cause excessive engine wear due to dirt in the air.



## Hood

Release the lock from the inside of the vehicle to open the hood.

- 1 Pull the hood lock release lever.  
The hood will pop up slightly.

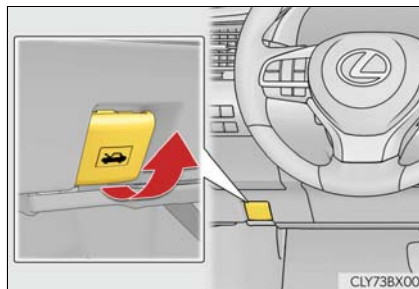

- 2 Pull up the auxiliary catch lever and lift the hood.

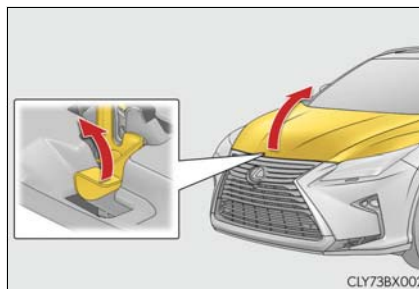

### WARNING

#### ■ Pre-driving check

Check that the hood is fully closed and locked.  
If the hood is not locked properly, it may open while the vehicle is in motion and cause an accident, which may result in death or serious injury.

## Positioning a floor jack

When using a floor jack, follow the instructions in the manual provided with the jack and perform the operation safely.

When raising your vehicle with a floor jack, position the jack correctly. Improper placement may damage your vehicle or cause injury.

### ◆ Front

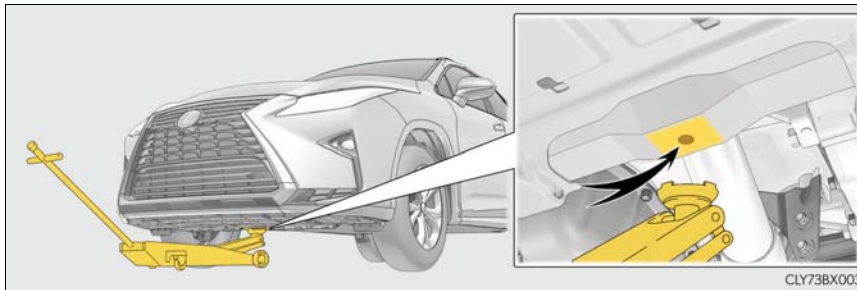

### ◆ Rear

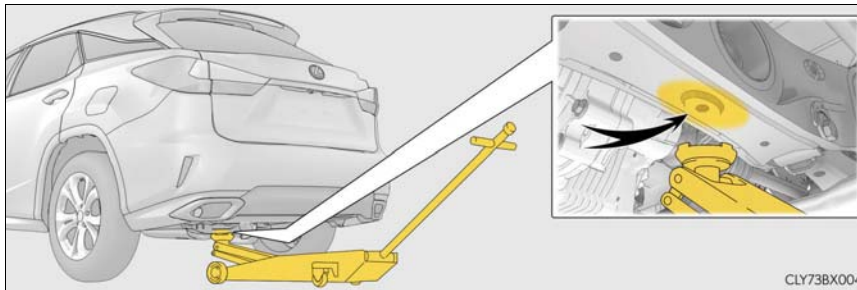

## Engine compartment

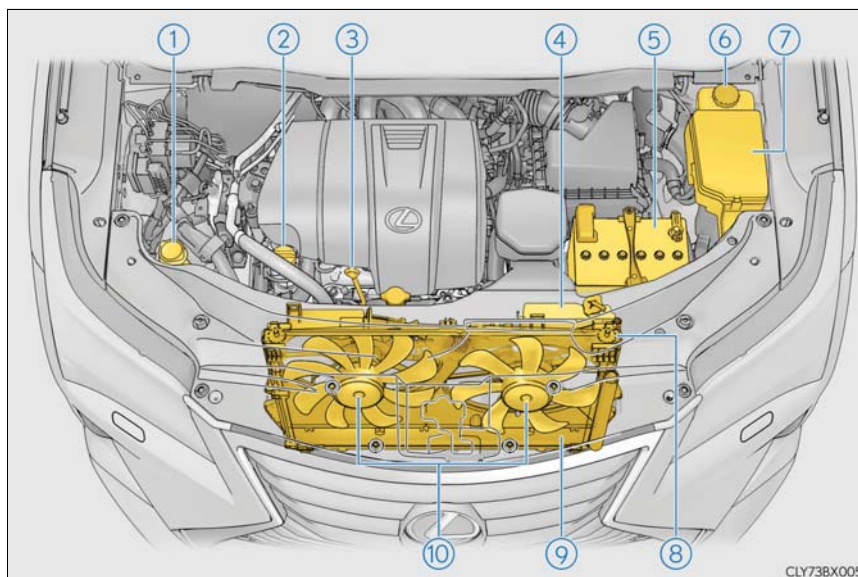

- |                                       |                                   |
|---------------------------------------|-----------------------------------|
| ① Washer fluid tank (→P. 603)         | ⑤ Battery (→P. 601)               |
| ② Engine oil filler cap (→P. 596)     | ⑥ Brake fluid reservoir (→P. 600) |
| ③ Engine oil level dipstick (→P. 595) | ⑦ Fuse box (→P. 625)              |
| ④ Engine coolant reservoir (→P. 598)  | ⑧ Radiator (→P. 599)              |
|                                       | ⑨ Condenser (→P. 599)             |
|                                       | ⑩ Electric cooling fans           |

## Engine oil

With the engine at operating temperature and turned off, check the oil level on the dipstick.

### ■ Checking the engine oil

- 1 Park the vehicle on level ground. After warming up the engine and turning off the engine, wait more than 5 minutes for the oil to drain back into the bottom of the engine.
- 2 Holding a rag under the end, pull the dipstick out.

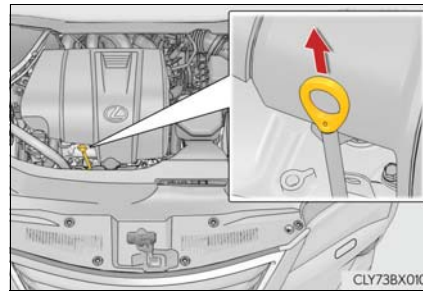

- 3 Wipe the dipstick clean.
- 4 Reinsert the dipstick fully.
- 5 Holding a rag under the end, pull the dipstick out and check the oil level.

- ① Low
- ② Normal
- ③ Excessive

The shape of the dipstick may differ depending on the type of vehicle or engine.

- 6 Wipe the dipstick and reinsert it fully.

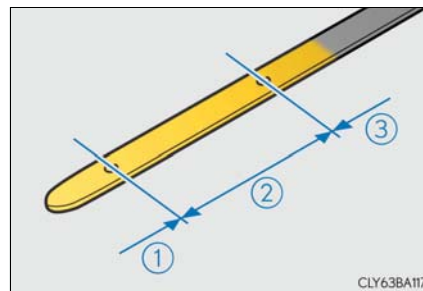

■ Adding engine oil

If the oil level is below or near the low level mark, add engine oil of the same type as that already in the engine.

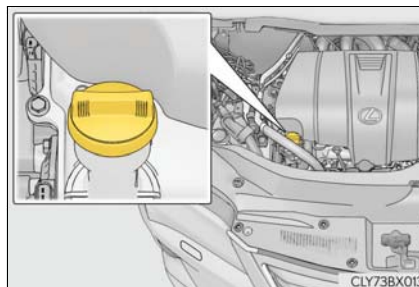

Make sure to check the oil type and prepare the items needed before adding oil.

Engine oil selection	→P. 701
Oil quantity (Low → Full)	1.9 qt. (1.8 L, 1.6 Imp. qt.)
Items	Clean funnel

- 1 Remove the oil filler cap by turning it counterclockwise.
- 2 Add engine oil slowly, checking the dipstick.
- 3 Install the oil filler cap by turning it clockwise.





■ Engine oil consumption

A certain amount of engine oil will be consumed while driving. In the following situations, oil consumption may increase, and engine oil may need to be refilled in between oil maintenance intervals.

- When the engine is new, for example directly after purchasing the vehicle or after replacing the engine
- If low quality oil or oil of an inappropriate viscosity is used
- When driving at high engine speeds or with a heavy load, when towing, or when driving while accelerating or decelerating frequently
- When leaving the engine idling for a long time, or when driving frequently through heavy traffic

### ■ After changing the engine oil

The engine oil maintenance data should be reset. Perform the following procedures:

- 1 Select  on the multi-information display. (→P. 97)
- 2 Press  or  of the meter control switch, select the "Vehicle Settings" then "Oil Maintenance". (To confirm setting, press .)
- 3 Select the "Yes" and push .
- 4 A message is displayed on the multi-information display.

### WARNING

#### ■ Used engine oil

- Used engine oil contains potentially harmful contaminants which may cause skin disorders such as inflammation and skin cancer, so care should be taken to avoid prolonged and repeated contact. To remove used engine oil from your skin, wash thoroughly with soap and water.
- Dispose of used oil and filters only in a safe and acceptable manner. Do not dispose of used oil and filters in household trash, in sewers or onto the ground. Call your Lexus dealer, service station or auto parts store for information concerning recycling or disposal.
- Do not leave used engine oil within the reach of children.

### NOTICE

#### ■ To prevent serious engine damage

Check the oil level on a regular basis.

#### ■ When replacing the engine oil

- Be careful not to spill engine oil on the vehicle components.
- Avoid overfilling, or the engine could be damaged.
- Check the oil level on the dipstick every time you refill the vehicle.
- Be sure the engine oil filler cap is properly tightened.

## Coolant

The coolant level is satisfactory if it is between the “FULL” and “LOW” lines on the reservoir when the engine is cold.

- ① Reservoir cap
- ② “FULL” line
- ③ “LOW” line

If the level is on or below the “LOW” line, add coolant up to the “FULL” line. (→P. 692)

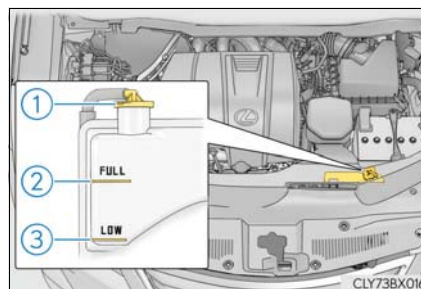

### ■ Coolant selection

Only use “Toyota Super Long Life Coolant” or a similar high quality ethylene glycol based non-silicate, non-amine, non-nitrite, and non-borate coolant with long-life hybrid organic acid technology.

U.S.A.:

“Toyota Super Long Life Coolant” is a mixture of 50% coolant and 50% deionized water. (Minimum temperature: -31°F [-35°C])

Canada:

“Toyota Super Long Life Coolant” is a mixture of 55% coolant and 45% deionized water. (Minimum temperature: -44°F [-42°C])

For more details about coolant, contact your Lexus dealer.

### ■ If the coolant level drops within a short time of replenishing

Visually check the radiator, hoses, engine coolant reservoir cap, drain cock and water pump.

If you cannot find a leak, have your Lexus dealer test the cap and check for leaks in the cooling system.

### ⚠ WARNING

#### ■ When the engine is hot

Do not remove the engine coolant reservoir cap and radiator cap.

The cooling system may be under pressure and may spray hot coolant if the cap is removed, causing serious injuries, such as burns.

 NOTICE■ **When adding coolant**

Coolant is neither plain water nor straight antifreeze. The correct mixture of water and antifreeze must be used to provide proper lubrication, corrosion protection and cooling. Be sure to read the antifreeze or coolant label.

■ **If you spill coolant**

Be sure to wash it off with water to prevent it from damaging parts or paint.

**Radiator and condenser**

Check the radiator and condenser and clear away any foreign objects.

If either of the above parts is extremely dirty or you are not sure of their condition, have your vehicle inspected by your Lexus dealer.

 WARNING■ **When the engine is hot**

Do not touch the radiator or condenser as they may be hot and cause serious injuries, such as burns.



## Brake fluid

### ■ Checking fluid level

The brake fluid level should be between the “MAX” and “MIN” lines on the tank.

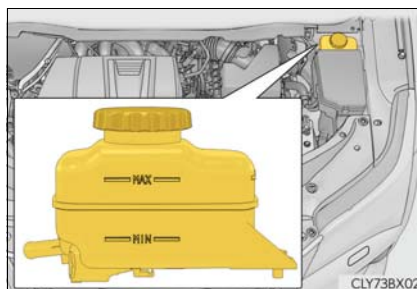

### ■ Adding fluid

Make sure to check the fluid type and prepare the necessary item.

Fluid type	FMVSS No.116 DOT 3 or SAE J1703 brake fluid
Items	Clean funnel

### ■ Brake fluid can absorb moisture from the air

Excess moisture in the brake fluid can cause a dangerous loss of braking efficiency. Use only newly opened brake fluid.

#### WARNING

##### ■ When filling the reservoir

Take care as brake fluid can harm your hands and eyes and damage painted surfaces. If fluid gets on your hands or in your eyes, flush the affected area with clean water immediately.

If you still experience discomfort, see a doctor.

#### NOTICE

##### ■ If the fluid level is low or high

It is normal for the brake fluid level to go down slightly as the brake pads wear out or when the fluid level in the accumulator is high.

If the reservoir needs frequent refilling, there may be a serious problem.

## Battery

Check the battery as follows.

### ■ Battery exterior

Make sure that the battery terminals are not corroded and that there are no loose connections, cracks, or loose clamps.

- ① Terminals
- ② Hold-down clamp

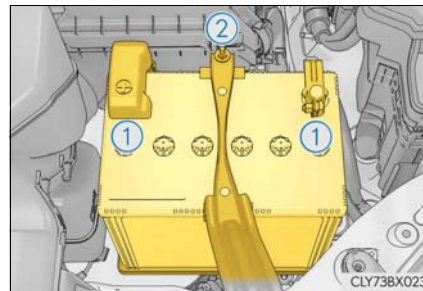

### ■ Before recharging

When recharging, the battery produces hydrogen gas which is flammable and explosive. Therefore, observe the following precautions before recharging:

- If recharging with the battery installed on the vehicle, be sure to disconnect the ground cable.
- Make sure the power switch on the charger is off when connecting and disconnecting the charger cables to the battery.

### ■ After recharging/reconnecting the battery

- The engine may not start. Follow the procedure below to initialize the system.
  - ① Shift the shift lever to P.
  - ② Open and close any of the doors.
  - ③ Restart the engine.
- Unlocking the doors using the smart access system with push-button start may not be possible immediately after reconnecting the battery. If this happens, use the wireless remote control or the mechanical key to lock/unlock the doors.
- Start the engine with the engine switch in ACCESSORY mode. The engine may not start with the engine switch turned off. However, the engine will operate normally from the second attempt.
- The engine switch mode is recorded by the vehicle. If the battery is reconnected, the vehicle will return the engine switch mode to the status it was in before the battery was disconnected. Make sure to turn off the power before disconnect the battery. Take extra care when connecting the battery if the engine switch mode prior to discharge is unknown.

If the system will not start even after multiple attempts at all methods above, contact your Lexus dealer.

 **WARNING****■ Chemicals in the battery**

Battery contains poisonous and corrosive sulfuric acid and may produce hydrogen gas which is flammable and explosive. To reduce the risk of death or serious injury, take the following precautions while working on or near the battery:

- Do not cause sparks by touching the battery terminals with tools.
- Do not smoke or light a match near the battery.
- Avoid contact with eyes, skin and clothes.
- Never inhale or swallow electrolyte.
- Wear protective safety glasses when working near the battery.
- Keep children away from the battery.

**■ Where to safely charge the battery**

Always charge the battery in an open area. Do not charge the battery in a garage or closed room where there is insufficient ventilation.

**■ How to recharge the battery**

Only perform a slow charge (5 A or less). The battery may explode if charged at a quicker rate.

**■ Emergency measures regarding electrolyte**

- If electrolyte gets in your eyes  
Flush your eyes with clean water for at least 15 minutes and get immediate medical attention. If possible, continue to apply water with a sponge or cloth while traveling to the nearest medical facility.
- If electrolyte gets on your skin  
Wash the affected area thoroughly. If you feel pain or burning, get medical attention immediately.
- If electrolyte gets on your clothes  
It can soak through clothing on to your skin. Immediately take off the clothing and follow the procedure above if necessary.
- If you accidentally swallow electrolyte  
Drink a large quantity of water or milk. Get emergency medical attention immediately.

**■ When there is insufficient battery fluid**

Do not use if there is insufficient fluid in the battery. There is a possible danger that the battery may explode.

 **NOTICE****■ When recharging the battery**

Never recharge the battery while the engine is running. Also, be sure all accessories are turned off.

**■ When adding distilled water**

Avoid overfilling. Water spilled during battery recharging may cause corrosion.

### Washer fluid

If none of the washer does not work or the “Windshield Washer Fluid Low” appears on the multi-information display, the washer tank may be empty. Add washer fluid.

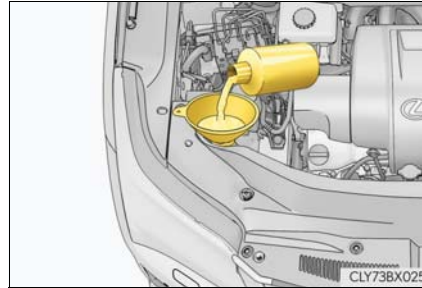

#### WARNING

##### ■ When adding washer fluid

Do not add washer fluid when the engine is hot or operating as washer fluid contains alcohol and may catch fire if spilled on the engine, etc.

#### NOTICE

##### ■ Do not use any fluid other than washer fluid

Do not use soapy water or engine antifreeze instead of washer fluid. Doing so may cause streaking on the vehicle's painted surfaces, as well as damaging the pump leading to problems of the washer fluid not spraying.

##### ■ Diluting washer fluid

Dilute washer fluid with water as necessary. Refer to the freezing temperatures listed on the label of the washer fluid bottle.

## Tires

Replace or rotate tires in accordance with maintenance schedules and treadwear.

### Checking tires

Check if the treadwear indicators are showing on the tires. Also check the tires for uneven wear, such as excessive wear on one side of the tread.

Check the spare tire condition and pressure if not rotated.

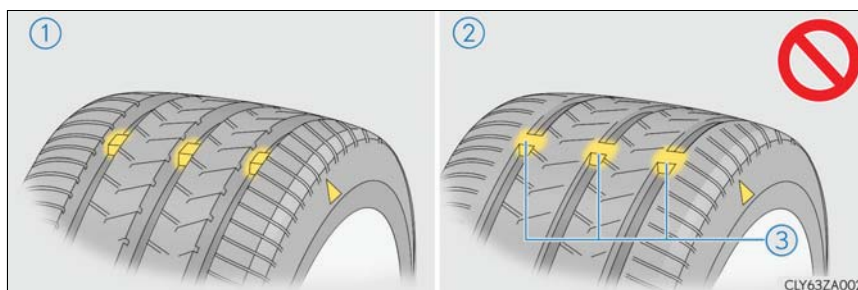

- ① New tread
- ② Worn tread
- ③ Treadwear indicator

The location of treadwear indicators is shown by a "TWI" or "Δ" mark, etc., molded into the sidewall of each tire.

Replace the tires if the treadwear indicators are showing on a tire.

### Tire rotation

Rotate the tires in the order shown.

To equalize tire wear and extend tire life, Lexus recommends that tire rotation is carried out at the same interval as tire inspection.

Do not fail to initialize the tire pressure warning system after tire rotation.

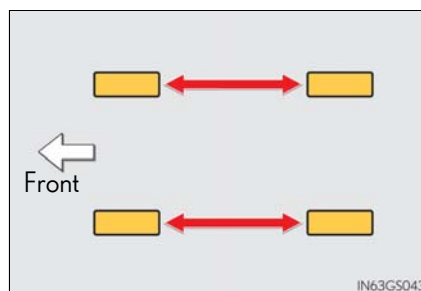

### Tire pressure warning system

Your vehicle is equipped with a tire pressure warning system that uses tire pressure warning valves and transmitters to detect low tire inflation pressure before serious problems arise.

- The tire pressure detected by the tire pressure warning system can be displayed on the multi-information display.

The illustration used is intended as an example, and may differ from the image that is actually displayed on the multi-information display.



- If the tire pressure drops below a predetermined level, the driver is warned by a screen display and a warning light. (→P. 656)

The illustration used is intended as an example, and may differ from the image that is actually displayed on the multi-information display.



#### ◆ Installing tire pressure warning valves and transmitters

When replacing tires or wheels, tire pressure warning valves and transmitters must also be installed.

When new tire pressure warning valves and transmitters are installed, new ID codes must be registered in the tire pressure warning computer and the tire pressure warning system must be initialized. Have tire pressure warning valve and transmitter ID codes registered by your Lexus dealer. (→P. 606)

#### ◆ Initializing the tire pressure warning system

- The tire pressure warning system must be initialized in the following circumstances:

- When the tire inflation pressure is changed such as when changing traveling speed.
- When the tire inflation pressure is changed such as when the tire size is changed.
- When rotating the tires

When the tire pressure warning system is initialized, the current tire inflation pressure is set as the benchmark pressure.

### ■ How to initialize the tire pressure warning system

- 1 Park the vehicle in a safe place and turn the engine switch off.

Initialization cannot be performed while the vehicle is moving.



- 2 Adjust the tire inflation pressure to the specified cold tire inflation pressure level. (→P. 704)

Make sure to adjust the tire pressure to the specified cold tire inflation pressure level. The tire pressure warning system will operate based on this pressure level.

- 3 Turn the engine switch to IGNITION ON mode.

- 4 Select  on the multi-information display. (→P. 97)

- 5 Press  or  of the meter control switch, select the "Vehicle Settings" screen and then press the .

- 6 Press  or  of the meter control switch, select the "TPMS" screen and then press and hold the  until the tire pressure warning light blinks slowly 3 times.

"- -" will be displayed for inflation pressure of each tire on the multi-information display while the tire pressure warning system determines the position of each tire.

When position of each tire is determined, the inflation pressure of each tire will be displayed on the multi-information display.

- 7 Drive the vehicle at approximately 25 mph (40 km/h) or more for approximately 10 to 30 minutes until the inflation pressure of each tire is displayed on the multi-information display.

If tire inflation pressure becomes low before the inflation pressure is displayed, the tire pressure warning light will come on.

Depending on the vehicle and driving conditions, initialization may take up to approximately 1 hour to complete.



### ◆ Registering ID codes

The tire pressure warning valve and transmitter is equipped with a unique ID code. When replacing a tire pressure warning valve and transmitter, it is necessary to register the ID code. Have the ID code registered by your Lexus dealer.

### ■ When to replace your vehicle's tires

Tires should be replaced if:

- The treadwear indicators are showing on a tire.
- You have tire damage such as cuts, splits, cracks deep enough to expose the fabric, and bulges indicating internal damage.
- A tire goes flat repeatedly or cannot be properly repaired due to the size or location of a cut or other damage.

If you are not sure, consult with your Lexus dealer.

### ■ Replacing tires and wheels

If the ID code of the tire pressure warning valve and transmitter is not registered, the tire pressure warning system will not work properly. After driving for about 20 minutes, the tire pressure warning light blinks for 1 minute and stays on to indicate a system malfunction.

### ■ Tire life

Any tire over 6 years old must be checked by a qualified technician even if it has seldom or never been used or damage is not obvious.

### ■ Proper storage of the spare tire (RX350L)

As an improperly stored spare tire may cause damage to the wire cable that holds it, check that the spare tire is stored properly on a daily basis.

- If the stored spare tire appears to be slanted or rattles while driving, the spare tire may not be properly stored. Store the spare tire again by performing the following tire change procedure correctly:

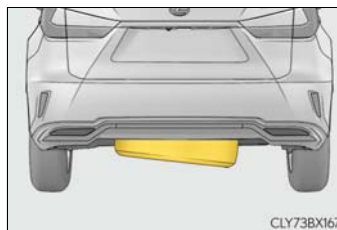

- 1 If the spare tire is slanted, the hoist assembly may be stuck in the wheel opening. If the spare tire rattles while driving, it may not be fully raised. Lower the spare tire to the ground and make sure that the hoist assembly is perpendicular to the wheel opening.

- 2 Raise the tire slowly and steadily until a click is heard and the jack handle skips.

If the spare tire cannot be lowered, the wire cable may be severed. Have the vehicle inspected at your Lexus dealer.

### ■ Routine tire inflation pressure checks

The tire pressure warning system does not replace routine tire inflation pressure checks. Make sure to check tire inflation pressure as part of your routine of daily vehicle checks.



■ **Maximum load of tire**

Check that the maximum load of the replacement tire is greater than 1/2 of the Gross Axle Weight Ratings (GAWR) of either the front axle or the rear axle, whichever is greater.

For the GAWR, see the Certification Label. For the maximum load of the tire, see the load limit at maximum cold tire inflation pressure mentioned on the sidewall of the tire. (→P. 709)

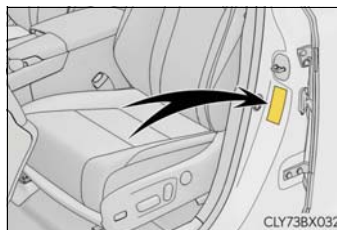

■ **Tire types**

● Summer tires

Summer tires are high-speed performance tires best suited to highway driving under dry conditions. Since summer tires do not have the same traction performance as snow tires, summer tires are inadequate for driving on snow-covered or icy roads. For driving on snow-covered roads or icy roads, the use of snow tires is recommended. When installing snow tires, be sure to replace all four tires.

● All season tires

All season tires are designed to provide better traction in snow and to be adequate for driving in most winter conditions as well as for use year-round. All season tires, however, do not have adequate traction performance compared with snow tires in heavy or loose snow. Also, all season tires fall short in acceleration and handling performance compared with summer tires in highway driving.

● Snow tires

For driving on snow-covered roads or icy roads, we recommend using snow tires. If you need snow tires, select tires of the same size, construction and load capacity as the originally installed tires. Since your vehicle has radial tires as original equipment, make sure your snow tires also have radial construction. Do not install studded tires without first checking local regulations for possible restrictions. Snow tires should be installed on all wheels. (→P. 384)

■ **Initializing the tire pressure warning system**

Initialize the system with the tire inflation pressure adjusted to the specified level.

■ **If the tread on snow tires wears down below 0.16 in. (4 mm)**

The effectiveness of the tires as snow tires is lost.

■ **If you press the tire pressure warning reset switch accidentally**

If initialization is performed, adjust the tire inflation pressure to the specified level and initialize the tire pressure warning system again.

#### ■ Situations in which the tire pressure warning system may not operate properly

- In the following cases, the tire pressure warning system may not operate properly.
  - If non-genuine Lexus wheels are used.
  - A tire has been replaced with a tire that is not an OE (Original Equipment) tire.
  - A tire has been replaced with a tire that is not of the specified size.
  - Tire chains, etc. are equipped.
  - If a window tint that affects the radio wave signals is installed.
  - If there is a lot of snow or ice on the vehicle, particularly around the wheels or wheel housings.
  - If the tire inflation pressure is extremely higher than the specified level.
  - If wheel without the tire pressure warning valve and transmitter is used.
  - If the ID code on the tire pressure warning valves and transmitters is not registered in the tire pressure warning computer.
- Performance may be affected in the following situations.
  - Near a TV tower, electric power plant, gas station, radio station, large display, airport or other facility that generates strong radio waves or electrical noise.
  - When carrying a portable radio, cellular phone, cordless phone or other wireless communication device.

If tire position information is not correctly displayed due to the radio wave conditions, the display may be corrected by driving and changing the radio wave conditions.
- When the vehicle is parked, the time taken for the warning to start or go off could be extended.
- When tire inflation pressure declines rapidly for example when a tire has burst, the warning may not function.

#### ■ The initialization operation

- Make sure to carry out initialization after adjusting the tire inflation pressure. Also, make sure the tires are cold before carrying out initialization or tire inflation pressure adjustment.
- If you have accidentally turned the engine switch off during initialization, it is not necessary to press the reset switch again as initialization will restart automatically when the engine switch has been turned to IGNITION ON mode for the next time.
- If you accidentally press the reset switch when initialization is not necessary, adjust the tire inflation pressure to the specified level when the tires are cold, and conduct initialization again.
- While the position of each tire is being determined and the inflation pressures are not being displayed on the multi-information display, if the inflation pressure of a tire drops, the tire pressure warning light will come on.

■ **Warning performance of the tire pressure warning system**

The warning of the tire pressure warning system will change in accordance with the conditions under which it was initialized. For this reason, the system may give a warning even if the tire pressure does not reach a low enough level, or if the pressure is higher than the pressure that was adjusted to when the system was initialized.

■ **When initialization of the tire pressure warning system has failed**

Initialization may take longer to complete if the vehicle is driven on an unpaved road. When performing initialization, drive on a paved road if possible. Depending on the driving environment and condition of the tires, initialization will be completed in approximately 10 to 30 minutes. If initialization is not complete after driving approximately 10 to 30 minutes, continue driving for a while.

If the inflation pressure of each tire is not displayed after driving for approximately 1 hour, perform the following procedure.

- Park the vehicle in a safe place for approximately 20 minutes. Then drive straight (with occasional left and right turns) at approximately 25 mph (40 km/h) or more for approximately 10 to 30 minutes.

However, in the following situations, the tire inflation pressure will not be recorded and the system will not operate properly. Perform initialization again.

- When operating the tire pressure warning reset switch, the tire pressure warning light does not blink 3 times.
- After performing initialization, the tire pressure warning light blinks for 1 minute then stays on while driving.

If the inflation pressure of each tire is still not displayed, have the vehicle inspected by your Lexus dealer.

**■ Certification for tire pressure warning system**

- ▶ Except for vehicles sold in Canada

**FCC ID: PAXPMVC015****NOTE**

This device complies with part 15 of the FCC Rules. Operation is subject to the following two conditions:  
(1) This device may not cause harmful interference, and (2) this device must accept any interference received, including interference that may cause undesired operation.

**FCC WARNING**

Changes or modifications not expressly approved by the party responsible for compliance could void the user's authority to operate the equipment.

- ▶ For vehicles sold in Canada

**Model:PMV-C015****NOTE**

This device complies with Industry Canada licence-exempt RSS standard(s). Operation is subject to the following two conditions: (1) this device may not cause interference, and (2) this device must accept any interference, including interference that may cause undesired operation of the device.

**NOTE**

Le présent appareil est conforme aux CNR d'Industrie Canada applicables aux appareils radio exempts de licence. L'exploitation est autorisée aux deux conditions suivantes : (1) l'appareil ne doit pas produire de brouillage, et (2) l'utilisateur de l'appareil doit accepter tout brouillage radioélectrique subi, même si le brouillage est susceptible d'en compromettre le fonctionnement.

 **WARNING****■ When inspecting or replacing tires**

Observe the following precautions to prevent accidents. Failure to do so may cause damage to parts of the drive train as well as dangerous handling characteristics, which may lead to an accident resulting in death or serious injury.

- Do not mix tires of different makes, models or tread patterns.  
Also, do not mix tires of remarkably different treadwear.
- Do not use tire sizes other than those recommended by Lexus.
- Do not mix differently constructed tires (radial, bias-belted or bias-ply tires).
- Do not mix summer, all season and snow tires.
- Do not use tires that have been used on another vehicle.  
Do not use tires if you do not know how they were used previously.
- Do not tow if your vehicle has a compact spare tire installed.

**■ When initializing the tire pressure warning system**

Do not initialize tire inflation pressure without first adjusting the tire inflation pressure to the specified level. Otherwise, the tire pressure warning light may not come on even if the tire inflation pressure is low, or it may come on when the tire inflation pressure is actually normal.

 **NOTICE****■ Repairing or replacing tires, wheels, tire pressure warning valves, transmitters and tire valve caps**

- When removing or fitting the wheels, tires or the tire pressure warning valves and transmitters, contact your Lexus dealer as the tire pressure warning valves and transmitters may be damaged if not handled correctly.
- Make sure to install the tire valve caps. If the tire valve caps are not installed, water could enter the tire pressure warning valves and the tire pressure warning valves could be bound.
- When replacing tire valve caps, do not use tire valve caps other than those specified.  
The cap may become stuck.

**■ To avoid damage to the tire pressure warning valves and transmitters**

When a tire is repaired with liquid sealants, the tire pressure warning valve and transmitter may not operate properly. If a liquid sealant is used, contact your Lexus dealer or other qualified service shop as soon as possible. Make sure to replace the tire pressure warning valve and transmitter when replacing the tire. (→P. 605)

**■ Driving on rough roads**

Take particular care when driving on roads with loose surfaces or potholes. These conditions may cause losses in tire inflation pressure, reducing the cushioning ability of the tires. In addition, driving on rough roads may cause damage to the tires themselves, as well as the vehicle's wheels and body.

**■ If tire inflation pressure of each tire becomes low while driving**

Do not continue driving, or your tires and/or wheels may be ruined.

## Tire inflation pressure

### Tire inflation pressure

The recommended cold tire inflation pressure and tire size are displayed on the tire and loading information label.  
(→P.704)

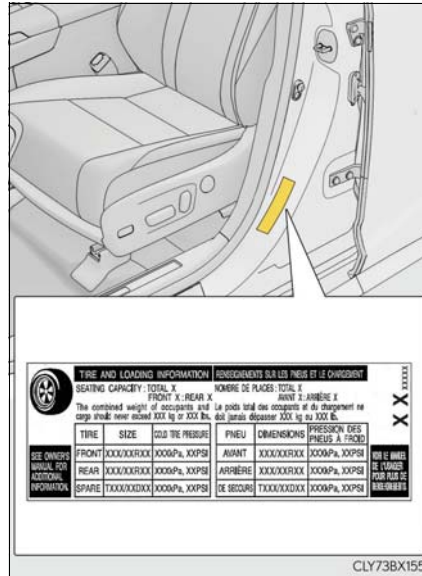

### Inspection and adjustment procedure

- ① Tire valve
- ② Tire pressure gauge

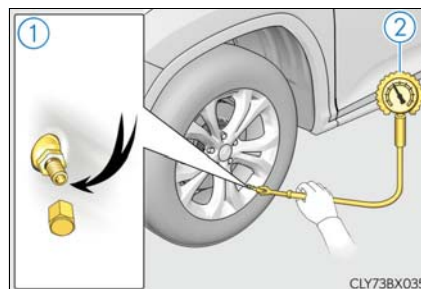

- 1 Remove the tire valve cap.
- 2 Press the tip of the tire pressure gauge onto the tire valve.
- 3 Read the pressure using the gauge gradations.
- 4 If the tire inflation pressure is not at the recommended level, adjust the pressure.  
If you add too much air, press the center of the valve to deflate.
- 5 After completing the tire inflation pressure measurement and adjustment, apply soapy water to the valve and check for leakage.
- 6 Put the tire valve cap back on.

#### ■ Tire inflation pressure check interval

You should check tire inflation pressure every two weeks, or at least once a month. Do not forget to check the spare.

#### ■ Effects of incorrect tire inflation pressure

Driving with incorrect tire inflation pressure may result in the following:

- Reduced fuel economy
- Reduced driving comfort and poor handling
- Reduced tire life due to wear
- Reduced safety
- Damage to the drive train

If a tire needs frequent inflating, have it checked by your Lexus dealer.

### ■ Instructions for checking tire inflation pressure

When checking tire inflation pressure, observe the following:

- Check only when the tires are cold.  
If your vehicle has been parked for at least 3 hours or has not been driven for more than 1 mile or 1.5 km, you will get an accurate cold tire inflation pressure reading.
- Always use a tire pressure gauge.  
It is difficult to judge if a tire is properly inflated based only on its appearance.
- It is normal for the tire inflation pressure to be higher after driving as heat is generated in the tire. Do not reduce tire inflation pressure after driving.
- Never exceed the vehicle capacity weight.  
Passengers and luggage weight should be placed so that the vehicle is balanced.

### WARNING

#### ■ Proper inflation is critical to save tire performance

Keep your tires properly inflated.

If the tires are not properly inflated, the following conditions may occur which could lead to an accident resulting in death or serious injury:

- Excessive wear
- Uneven wear
- Poor handling
- Possibility of blowouts resulting from overheated tires
- Air leaking from between tire and wheel
- Wheel deformation and/or tire damage
- Greater possibility of tire damage while driving (due to road hazards, expansion joints, sharp edges on the road, etc.)

### NOTICE

#### ■ When inspecting and adjusting tire inflation pressure

Be sure to put the tire valve caps back on.

If a valve cap is not installed, dirt or moisture may get into the valve and cause an air leak, resulting in decreased tire inflation pressure.



## Wheels

If a wheel is bent, cracked or heavily corroded, it should be replaced. Otherwise, the tire may separate from the wheel or cause a loss of handling control.

### Wheel selection

When replacing wheels, care should be taken to ensure that they are equivalent to those removed in load capacity, diameter, rim width and inset\*.

Replacement wheels are available at your Lexus dealer.

\*: Conventionally referred to as "offset".

Lexus does not recommend using the following:

- Wheels of different sizes or types
- Used wheels
- Bent wheels that have been straightened

### Aluminum wheel precautions

- Use only Lexus wheel nuts and wrenches designed for use with your aluminum wheels.
- When rotating, repairing or changing your tires, check that the wheel nuts are still tight after driving 1000 miles (1600 km).
- Be careful not to damage the aluminum wheels when using tire chains.
- Use only Lexus genuine balance weights or equivalent and a plastic or rubber hammer when balancing your wheels.

### ■ When replacing wheels

The wheels of your vehicle are equipped with tire pressure warning valves and transmitters that allow the tire pressure warning system to provide advance warning in the event of a loss in tire inflation pressure. Whenever wheels are replaced, tire pressure warning valves and transmitters must be installed. (→P. 605)

**⚠ WARNING****■ When replacing wheels**

- Do not use wheels that are a different size from those recommended in the Owner's Manual, as this may result in a loss of handling control.
- Never use an inner tube in a leaking wheel which is designed for a tubeless tire. Doing so may result in an accident, causing death or serious injury.

**■ Use of defective wheels prohibited**

Do not use cracked or deformed wheels.  
Doing so could cause the tire to leak air during driving, possibly causing an accident.

**⚠ NOTICE****■ Replacing tire pressure warning valves and transmitters**

- Because tire repair or replacement may affect the tire pressure warning valves and transmitters, make sure to have tires serviced by your Lexus dealer or other qualified service shop. In addition, make sure to purchase your tire pressure warning valves and transmitters at your Lexus dealer.
- Ensure that only genuine Lexus wheels are used on your vehicle.  
Tire pressure warning valves and transmitters may not work properly with non-genuine wheels.

**■ Selectable Color Trim (if equipped)**

- If rattles, noise, or other problems occur while Selectable Color Trim are installed, contact your Lexus dealer.
- Do not remove or install Selectable Color Trim yourself, as it may be damaged. Have the Selectable Color Trim removed and installed by your Lexus dealer.

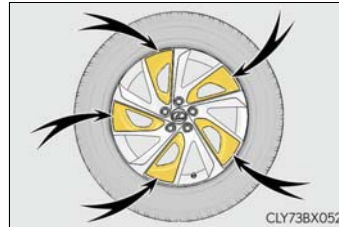

## Air conditioning filter

The air conditioning filter must be changed regularly to maintain air conditioning efficiency.

### Removal method

- 1 Turn the engine switch off.
- 2 Open the glove box. Slide off the damper.

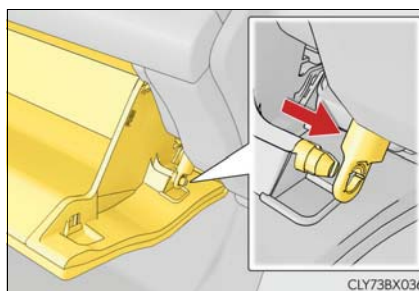

- 3 Push in the glove box on the vehicle's outer side to disconnect the claws. Then pull out the glove box and disconnect the lower claws.

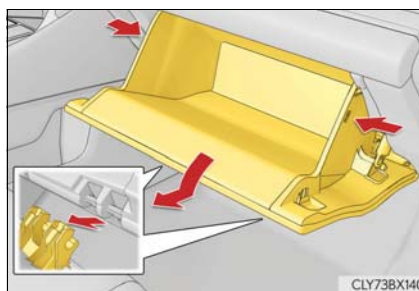

- 4 Remove the cover.

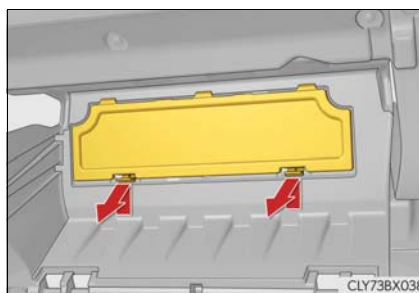

- 5 Remove the filter cover.
- ① Unlock the filter cover.
  - ② Move the filter cover in the direction of the arrow, and then pull it out of the claws.

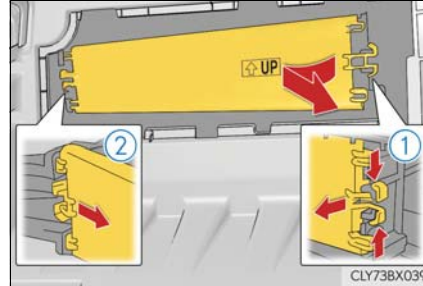

- 6 Remove the filter case.
- There may be foreign objects on top of the air conditioning filter.

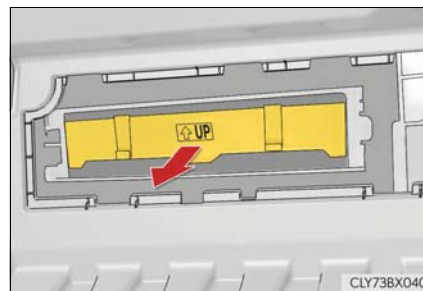

- 7 Remove the air conditioning filter from the filter case and replace it with a new one.
- The "↑UP" marks shown on the filter and the filter case should be pointing up.

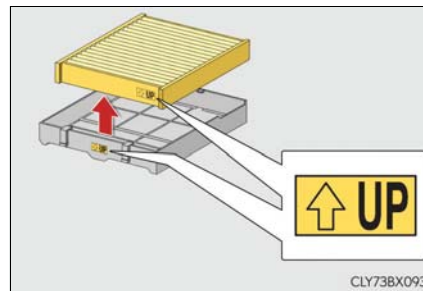

#### ■ Checking interval

Inspect and replace the air conditioning filter according to the maintenance schedule. In dusty areas or areas with heavy traffic flow, early replacement may be required. (For scheduled maintenance information, please refer to the "Owner's Manual Supplement" or "Scheduled Maintenance".)

#### ■ If air flow from the vents decreases dramatically

The filter may be clogged. Check the filter and replace if necessary.

#### ■ Air conditioning filter with deodorizing function

When fragrances are placed in your vehicle, the deodorizing effect may become significantly weakened in a short period.

When an air conditioning odor comes out continuously, replace the air conditioning filter.

 NOTICE

■ **When using the air conditioning system**

Make sure that a filter is always installed.  
Using the air conditioning system without a filter may cause damage to the system.

■ **To prevent damage to the filter cover**

When moving the filter cover in the direction of arrow to release the fitting, pay attention not to apply excessive force to the claws. Otherwise, the claws may be damaged.

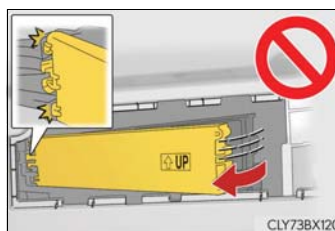

## Windshield wiper inserts

### Replacing a windshield wiper insert

- 1 Change the rest position of the windshield wipers to the service position using the wiper lever and then lift a windshield wiper. (→P. 265)

- 2 While pressing and holding the wiper blade lock release button, remove the wiper blade.

When performing this operation, make sure to hold the hook portion of the wiper arm securely.

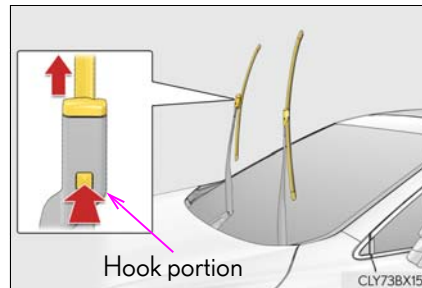

- 3 While disengaging the cap lock, using a tool such as a flathead screwdriver if necessary, remove the wiper insert.

Hold the cap on the end of the wiper insert when removing the wiper insert. (The cap is integrated into the wiper insert.)

If using a screwdriver, make sure to wrap its tip with tape to protect the wiper blade.

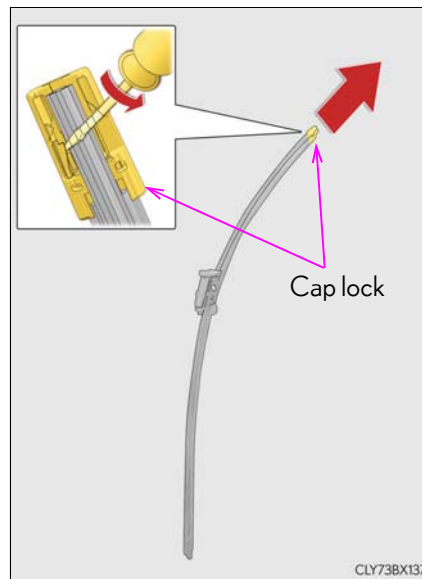

- 4 Install a new wiper insert.

Make sure to push the wiper insert firmly until the cap lock is engaged.

After installation, check that the cap lock is locked securely.

- 5 Install the wiper blade to the wiper arm.

Make sure to push the wiper blade until it is locked.

When performing this operation, make sure to hold the hook portion of the wiper arm securely.

After installation, check that the wiper blade is locked securely.

- 6 After replacing the wiper inserts, place the windshield wipers on the windshield and lower them to the retracted position. (→P. 266)

Do not drive the vehicle with the windshield wipers lifted.

---

■ **Replacing the rear wiper insert**

Have the rear wiper insert replaced by your Lexus dealer.

■ **Handling of the windshield wiper blades and inserts**

Improper handling of the windshield wiper blades and inserts may cause them to be damaged. If it is difficult to follow the wiper blade and insert replacement procedure precisely, contact your Lexus dealer.

## Electronic key battery

Replace the battery with a new one if it is depleted.

### You will need the following items:

- Flathead screwdriver
- Lithium battery CR2032

### Replacing the battery

- 1 Take out the mechanical key.

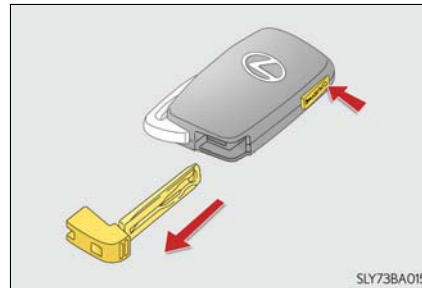

- 2 Remove the cover.

To prevent damage to the key, cover the tip of the flathead screwdriver with a tape.

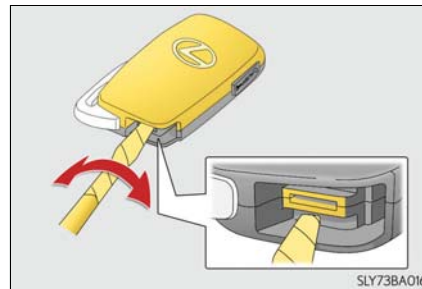

- 3 Remove the depleted battery.

When removing the cover, the electronic key module may stick to the cover and the battery may not be visible. In this case, remove the electronic key module in order to remove the battery.

Insert a new battery with the "+" terminal facing up.

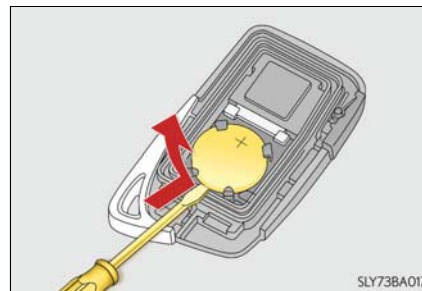



■ **Use a CR2032 lithium battery**

- Batteries can be purchased at your Lexus dealer, local electrical appliance shops or camera stores.
- Replace only with the same or equivalent type recommended by the manufacturer.
- Dispose of used batteries according to the local laws.

■ **If the electronic key battery is depleted**

The following symptoms may occur:

- The smart access system with push-button start and wireless remote control will not function properly.
- The operational range will be reduced.

 **WARNING**

■ **Removed battery and other parts**

These parts are small and if swallowed by a child, they can cause choking. Keep away from children. Failure to do so could result in death or serious injury.

 **NOTICE**

■ **For normal operation after replacing the battery**

Observe the following precautions to prevent accidents:

- Always work with dry hands.  
Moisture may cause the battery to rust.
- Do not touch or move any other component inside the remote control.
- Do not bend either of the battery terminals.

## Checking and replacing fuses

If any of the electrical components do not operate, a fuse may have blown. If this happens, check and replace the fuses as necessary.

1 Turn the engine switch off.

2 Open the fuse box cover.

▶ Engine compartment

Push the tab in and lift the lid off.

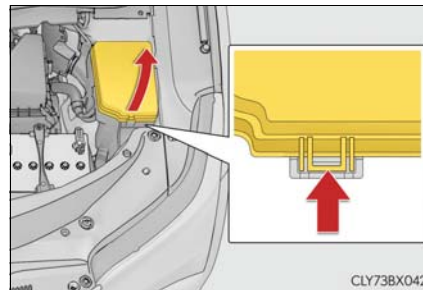

▶ Driver's side instrument panel

Remove the lid.

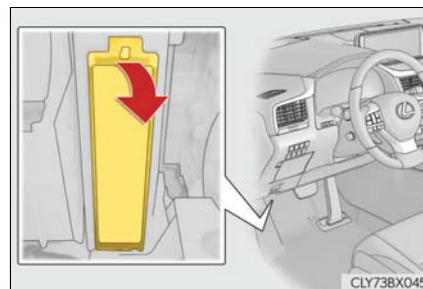

- 3 Remove the fuse with the pullout tool.  
Only some fuses can be removed using the pullout tool.

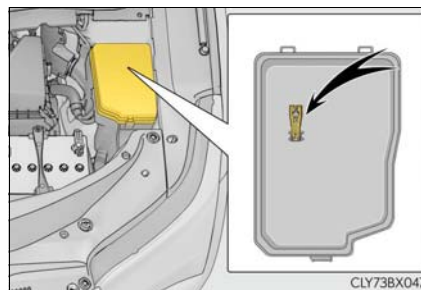

- 4 Check if the fuse is blown.

- ① Normal fuse
- ② Blown fuse

Replace the blown fuse with a new fuse of an appropriate amperage rating. The amperage rating can be found on the fuse box lid.

Many types of fuse are used on this vehicle. This illustration shows a common type of fuse used on this vehicle.

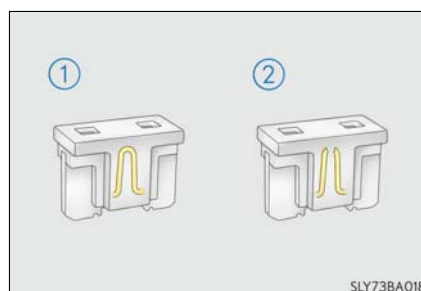

■ **After a fuse is replaced**

- If the lights do not turn on even after the fuse has been replaced, a bulb may need replacement. (→P. 630)
- If the replaced fuse blows again, have the vehicle inspected by your Lexus dealer.

■ **If there is an overload in a circuit**

The fuses are designed to blow, protecting the wiring harness from damage.

■ **When replacing light bulbs**

Lexus recommends that you use genuine Lexus products designed for this vehicle. Because certain bulbs are connected to circuits designed to prevent overload, nongenuine parts or parts not designed for this vehicle may be unusable.

**⚠ WARNING**

■ **To prevent system breakdowns and vehicle fire**

Observe the following precautions.

Failure to do so may cause damage to the vehicle, and possibly a fire or injury.

- Never use a fuse of a higher amperage rating than that indicated, or use any other object in place of a fuse.
- Always use a genuine Lexus fuse or equivalent.  
Never replace a fuse with a wire, even as a temporary fix.
- Do not modify the fuses or fuse boxes.

 NOTICE**■ Before replacing fuses**

Have the cause of electrical overload determined and repaired by your Lexus dealer as soon as possible.

## Headlight aim (vehicles with single-beam headlights)

### Vertical movement adjusting bolts

- ① Adjustment bolt A
- ② Adjustment bolt B



### Before checking the headlight aim

- 1 Make sure the vehicle has a full tank of gasoline and the area around the headlight is not deformed.
- 2 Park the vehicle on level ground.
- 3 Sit in the driver's seat.
- 4 Bounce the vehicle several times.

### Adjusting the headlight aim

- 1 Using a Phillips-head screwdriver, turn bolt A in either direction.

Remember the turning direction and the number of turns.

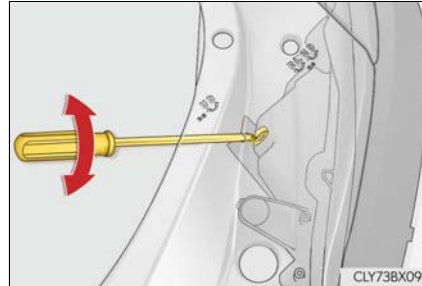

- 2 Turn bolt B the same number of turns and in the same direction as step 1.

If the headlight cannot be adjusted using this procedure, take the vehicle to your Lexus dealer to adjust the headlight aim.

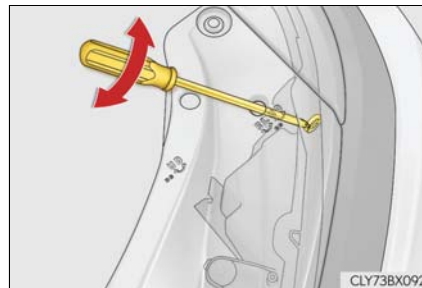

## Light bulbs

You may replace the following bulbs by yourself. The difficulty level of replacement varies depending on the bulb. If necessary bulb replacement seems difficult to perform, contact your Lexus dealer.

For more information about replacing other light bulbs, contact your Lexus dealer.

### Preparing for light bulb replacement

Check the wattage of the light bulb to be replaced. (→P. 705)

### Canceling the power back door system

→P. 134

**Bulb locations**

## ■ Front

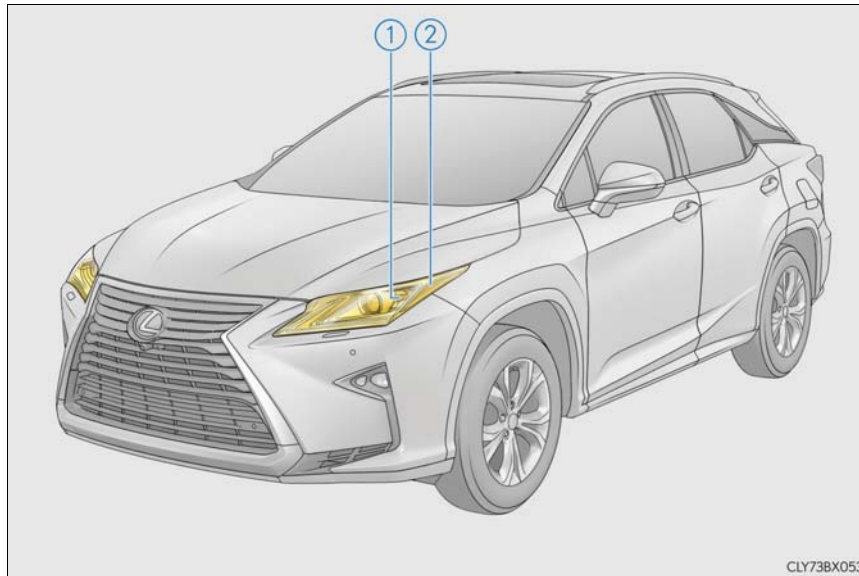

- ① Front turn signal light (vehicles with single-beam headlights)
- ② Front side marker light (vehicles with single-beam headlights)



■ Rear

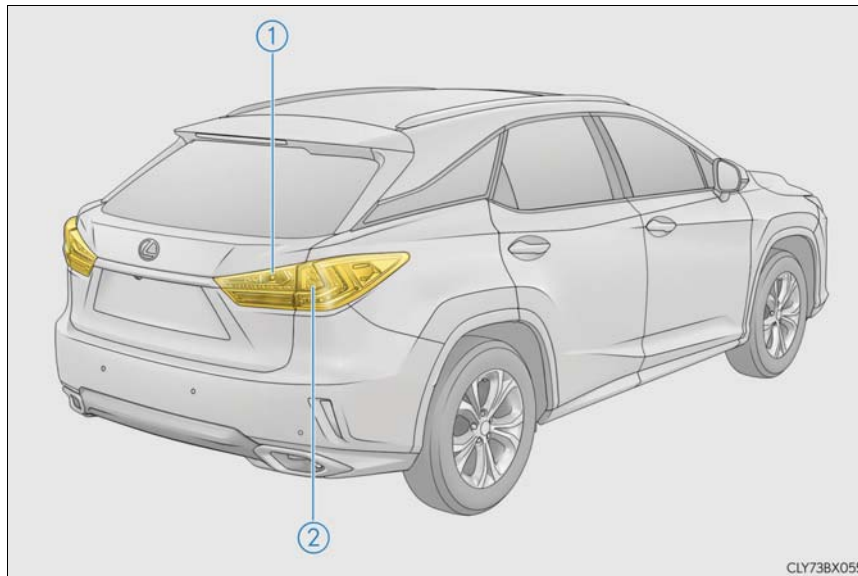

- ① Back-up light
- ② Rear turn signal light (vehicles with single-beam headlights)

## Replacing light bulbs

### ■ Front side marker lights (vehicles with single-beam headlights)

- 1 To ensure enough space to perform work, turn the steering wheel to rotate the front wheel away from the bulb to be replaced.

Remove the 3 fender liner clips.

Turn the steering wheel to the left when replacing the right side light bulb, and turn the steering wheel to the right when replacing the left side light bulb.

When removing a fender liner clip, use a flathead screwdriver to pry the center portion out and then remove the whole clip.

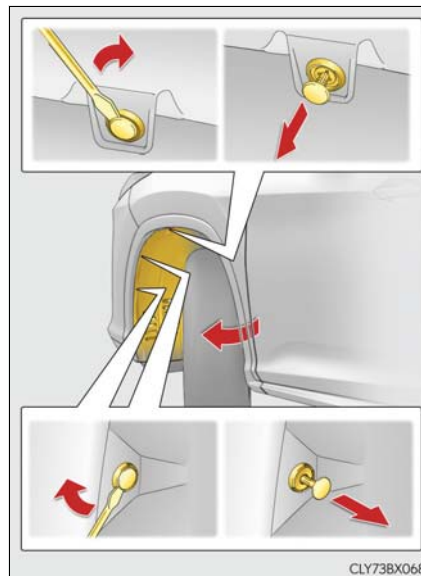

- 2 Pull back the fender liner until the connector is visible.

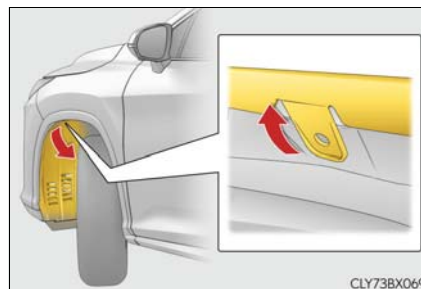

- 3 Partially remove the fender liner and turn the bulb base counter-clockwise and remove it.

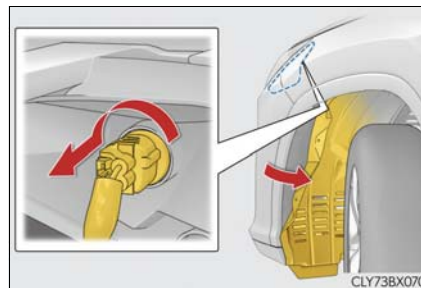

- 4** Remove the light bulb.

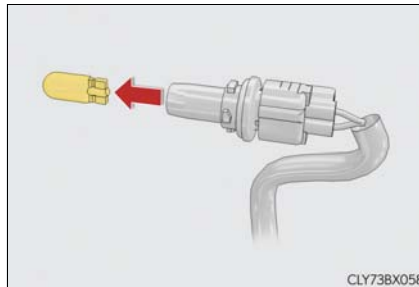

- 5** Install a new light bulb and then install the bulb base to the light unit by inserting it and turning it clockwise.

After installing the bulb base, wiggle it lightly to make sure it is securely installed and turn the lights on to visually check that there is no light leaking from between the bulb base and light unit.

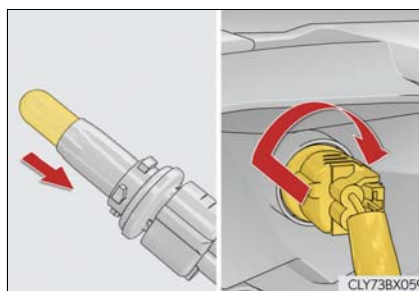

- 6** Reinstall the fender liner and install the 3 fender liner clips.

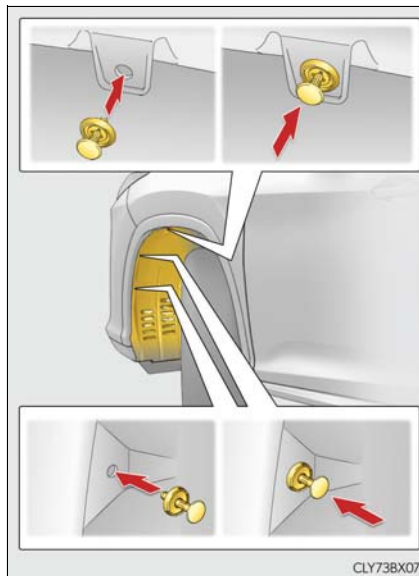

### ■ Front turn signal lights (vehicles with single-beam headlights)

- 1** To ensure enough space to perform work, turn the steering wheel to rotate the front wheel away from the bulb to be replaced.

Remove the 3 fender liner clips.

Turn the steering wheel to the left when replacing the right side light bulb, and turn the steering wheel to the right when replacing the left side light bulb.

When removing a fender liner clip, use a flathead screwdriver to pry the center portion out and then remove the whole clip.

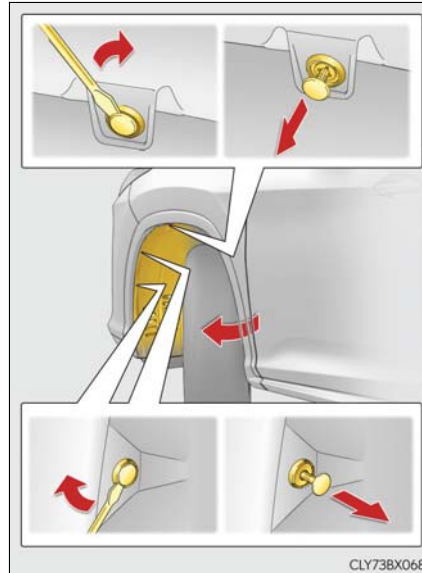

- 2** Pull back the fender liner until the connector is visible.

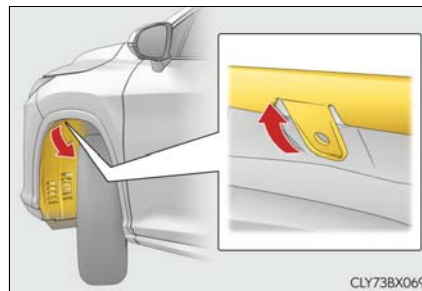

- 3** Partially remove the fender liner and turn the bulb base counter-clockwise and remove it.

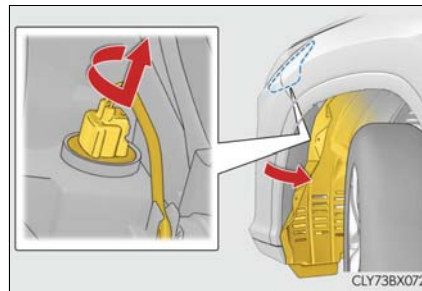

- 4 Remove the light bulb.

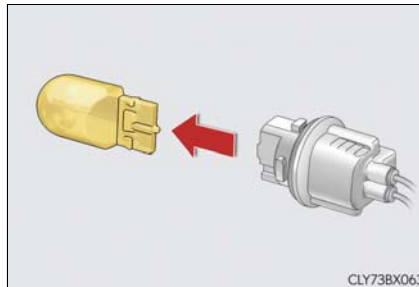

- 5 Install a new light bulb and then install the bulb base to the light unit by inserting it and turning it clockwise.

After installing the bulb base, wiggle it lightly to make sure it is securely installed and turn on the turn signal lights to visually check that there is no light leaking from between the bulb base and light unit.

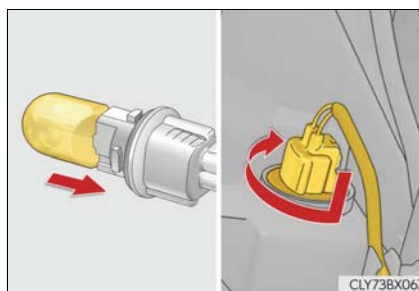

- 6 Reinstall the fender liner and install the 3 fender liner clips.

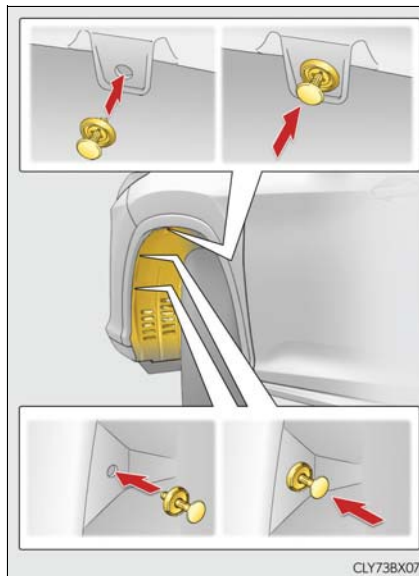

**■ Rear turn signal lights (vehicles with single-beam headlights)**

- 1** Open the back door and apply protective tape to the vehicle body around the taillight.

Use masking tape, etc. Do not use duct tape, as it may leave residue or damage the paint when removed.

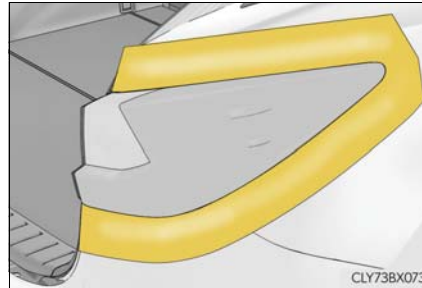

- 2** Using a flathead screwdriver, remove the cover.

To prevent scratching the vehicle, wrap the tip of the flathead screwdriver with a cloth, etc.

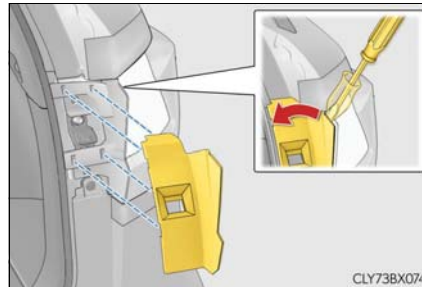

- 3** Remove the 2 screws.

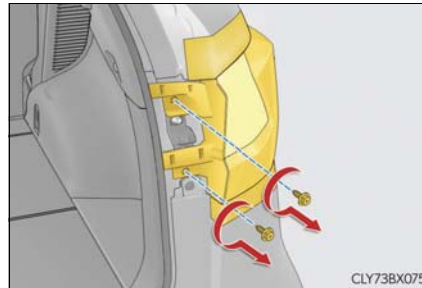

4 Remove the taillight unit.

- ① Attach 2 long pieces of masking tape to the taillight unit and fold the excess in half.
- ② Hold the folded portion and pull it toward the rear of the vehicle to remove the light unit.

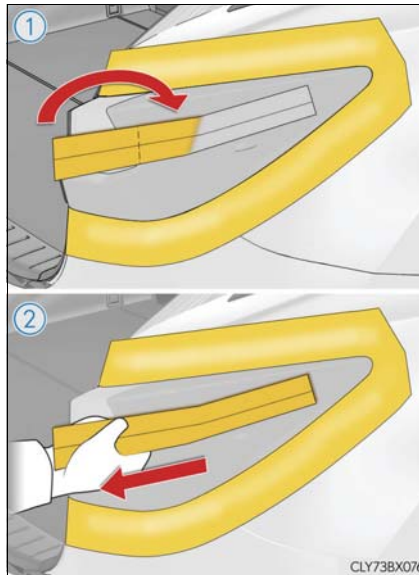

5 Turn the bulb base counterclockwise and remove it.

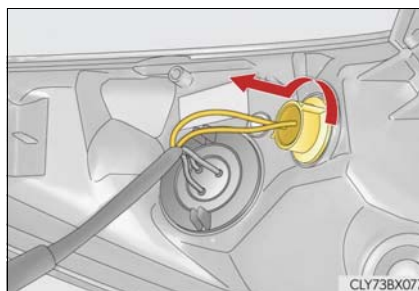

6 Remove the light bulb.

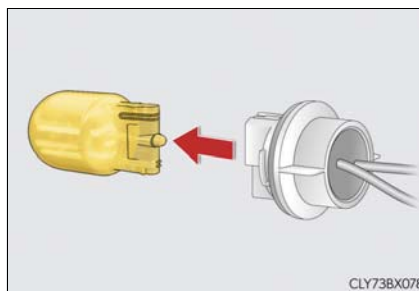

- 7** Install a new light bulb and then install the bulb base to the light unit by inserting it and turning it clockwise.

After installing the bulb base, wiggle it lightly to make sure it is securely installed and turn on the rear turn signal lights to visually check that there is no light leaking from between the bulb base and light unit.

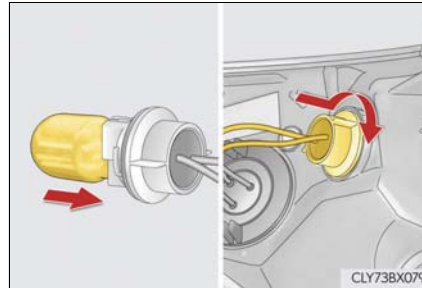

- 8** Install the light unit.

Align the tabs and push the light unit toward the front of the vehicle to install it.

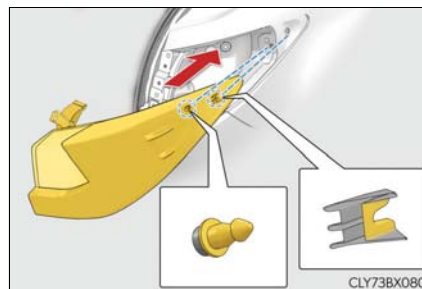

- 9** Install the 2 screws.

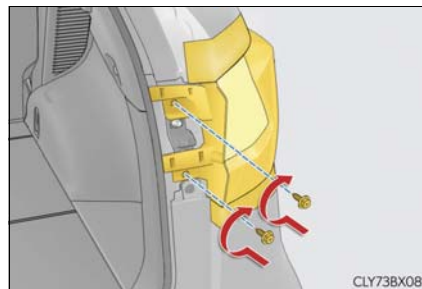

- 10** Install the cover.

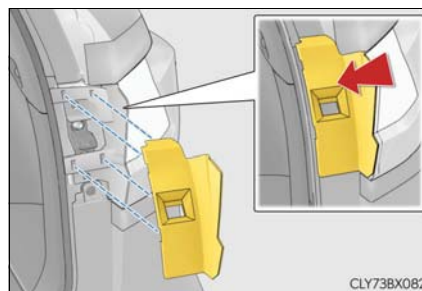

- 11** Remove the protective tape.



■ Back-up lights

- 1 Open the back door and remove the cover.

Using a flathead screwdriver, remove the cover.

To prevent scratching to the vehicle, wrap the tip of the flathead screwdriver with a cloth, etc.



- 2 Turn the bulb base counterclockwise and remove it.

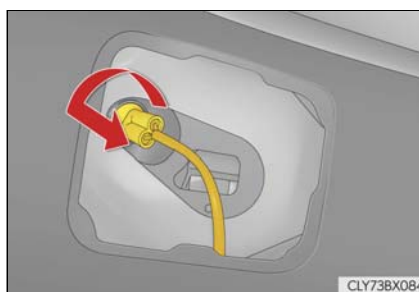

- 3 Remove the light bulb.

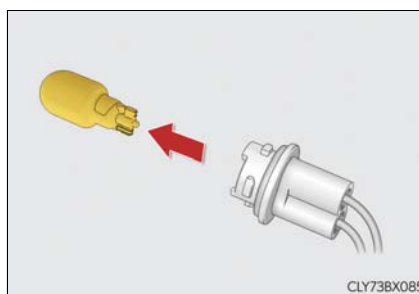

- 4 Install a new light bulb and then install the bulb base to the light unit by inserting it and turning it clockwise.

After installing the bulb base, wiggle it lightly to make sure it is securely installed and turn on the back-up lights to visually check that there is no light leaking from between the bulb base and light unit.

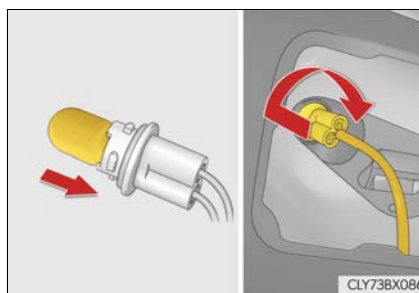

**5** Install the cover.

Align the tabs of the cover with the grooves and install the cover.

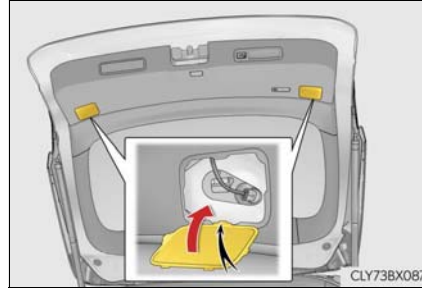
**■ Replacing the following bulbs**

If any of the lights listed below has burnt out, have it replaced by your Lexus dealer.

- Headlight low beams
- Headlight high beams
- Front turn signal lights (vehicles with triple-beam headlights)
- Parking lights and daytime running lights
- Fog lights
- Cornering lights (if equipped)
- Front side marker lights (vehicles with triple-beam headlights)
- Side turn signal lights
- Stop/tail lights
- Rear turn signal light (vehicles with triple-beam headlights)
- Rear side marker lights
- High mounted stoplight
- License plate lights
- Outer foot lights

#### ■ LED lights

The headlight low beams, headlight high beams, front turn signal lights (vehicles with triple-beam headlights), parking lights and daytime running lights, fog lights, cornering lights (if equipped), front side marker lights (vehicles with triple-beam headlights), side turn signal lights, stop/tail lights, rear turn signal light (vehicles with triple-beam headlights), rear side marker lights, high mounted stoplight, license plate lights, and outer foot lights consist of a number of LEDs. If any of the LEDs has burned out, take your vehicle to your Lexus dealer to have the light replaced.

#### ■ Condensation build-up on the inside of a lens

Temporary condensation build-up on the inside of the headlight lens does not indicate a malfunction. Contact your Lexus dealer for more information in the following situations:

- Large drops of water have built up on the inside of a lens.
- Water has built up inside a headlight.

#### ■ When replacing light bulbs

→P. 626

#### WARNING

##### ■ To prevent injury

Before performing any light bulb replacement procedure, be sure to turn the engine switch off. Failure to do so may result in burns from hot components or a part of your body may get caught on an operating component, possibly causing serious injury.

##### ■ Replacing light bulbs

- Turn off the lights. Do not attempt to replace the bulb immediately after turning off the lights.  
The bulbs become very hot and may cause burns.
- Do not touch the glass portion of the light bulb with bare hands. When it is unavoidable to hold the glass portion, use and hold with a clean dry cloth to avoid getting moisture and oils on the bulb.  
Also, if the bulb is scratched or dropped, it may blow out or crack.
- Fully install light bulbs and any parts used to secure them. Failure to do so may result in heat damage, fire, or water entering the headlight unit. This may damage the headlights or cause condensation to build up on the lens.
- Do not attempt to repair or disassemble the light bulbs, connectors, electric circuits or component parts.  
Doing so may result in death or serious injury due to electric shock.

##### ■ To prevent damage or fire

- Make sure bulbs are fully seated and locked.
- Check the wattage of the bulb before installing to prevent heat damage.

## When trouble arises

## 8

**8-1. Essential information**

Emergency flashers ..... 644

If your vehicle has  
to be stopped in  
an emergency ..... 645

**8-2. Steps to take in  
an emergency**

If your vehicle needs  
to be towed..... 646

If you think something is  
wrong ..... 652

Fuel pump shut off  
system ..... 653

If a warning light turns on  
or a warning buzzer  
sounds..... 654

If a warning message is  
displayed..... 661

If you have a flat tire ..... 666

If the engine will not start ..... 682

If the electronic key does  
not operate properly ..... 684

If the vehicle battery is  
discharged ..... 687

If your vehicle overheats ..... 692

If the vehicle becomes  
stuck ..... 695

## Emergency flashers

The emergency flashers are used to warn other drivers when the vehicle has to be stopped on the road due to a breakdown, etc.

Press the switch.

All the turn signal lights will flash. To turn them off, press the switch once again.

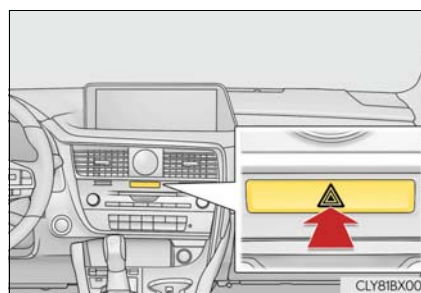

### ■ Emergency flashers

If the emergency flashers are used for a long time while the engine is not operating, the battery may discharge.

## If your vehicle has to be stopped in an emergency

Only in an emergency, such as if it becomes impossible to stop the vehicle in the normal way, stop the vehicle using the following procedure:

- 1 Steadily step on the brake pedal with both feet and firmly depress it.  
Do not pump the brake pedal repeatedly as this will increase the effort required to slow the vehicle.
- 2 Shift the shift lever to N.
  - ▶ If the shift lever is shifted to N
- 3 After slowing down, stop the vehicle in a safe place by the road.
- 4 Stop the engine.
  - ▶ If the shift lever cannot be shifted to N
- 3 Keep depressing the brake pedal with both feet to reduce vehicle speed as much as possible.
- 4 To stop the engine, press and hold the engine switch for 2 consecutive seconds or more, or press it briefly 3 times or more in succession.



- 5 Stop the vehicle in a safe place by the road.

### WARNING

#### ■ If the engine has to be turned off while driving

Power assist for the brakes and steering wheel will be lost, making the brake pedal harder to depress and the steering wheel heavier to turn. Decelerate as much as possible before turning off the engine.

## If your vehicle needs to be towed

If towing is necessary, we recommend having your vehicle towed by your Lexus dealer or commercial towing service, using a wheel-lift type truck or flatbed truck.

Use a safety chain system for all towing, and abide by all state/provincial and local laws.

2WD models: If towing your vehicle with a wheel-lift type truck from the front, the vehicle's rear wheels and axles must be in good conditions. (→P. 647, 650)  
If they are damaged, use a towing dolly or flatbed truck.

AWD models: If towing your vehicle with a wheel-lift type truck, use a towing dolly. (→P. 647, 650)

## Situations when it is necessary to contact dealers before towing

The following may indicate a problem with your transmission. Contact your Lexus dealer or commercial towing service before towing.

- The engine is running but the vehicle does not move.
- The vehicle makes an abnormal sound.

## Towing with a sling-type truck

Do not tow with a sling-type truck to prevent body damage.



**Towing with a wheel-lift type truck**

- ▶ From the front (2WD models)

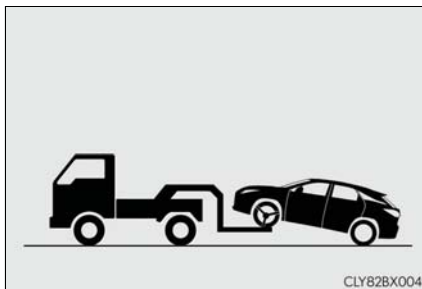

Release the parking brake.

- ▶ From the front (AWD models)

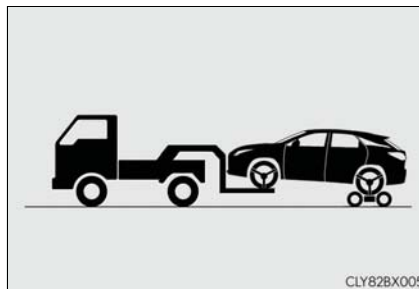

Use a towing dolly under the rear wheels.

- ▶ From the rear

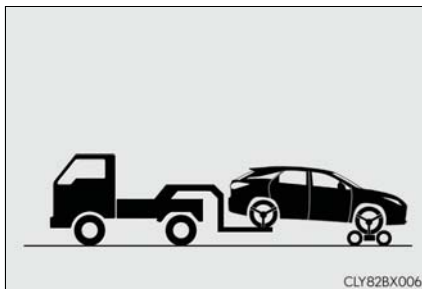

Use a towing dolly under the front wheels.



### Using a flatbed truck

If your vehicle is transported by a flatbed truck, it should be tied down at the locations shown in the illustration.

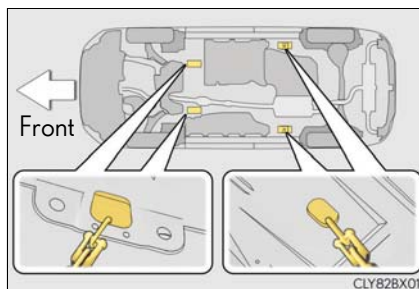

If you use chains or cables to tie down your vehicle, the angles shaded in black must be 45°.

Do not overly tighten the tie downs or the vehicle may be damaged.

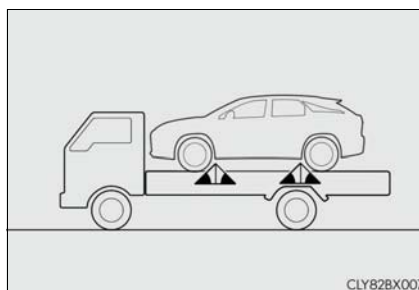

### Emergency towing (vehicles with towing eyelets)

If a tow truck is not available in an emergency, your vehicle may be temporarily towed using cables or chains secured to the emergency towing eyelets. This should only be attempted on hard surfaced roads for at most 50 miles (80 km) at under 18 mph (30 km/h).

A driver must be in the vehicle to steer and operate the brakes. The vehicle's wheels, drive train, axles, steering and brakes must be in good condition.

**Emergency towing procedure (vehicles with a towing eyelet)**

- 1 Take out the towing eyelet. (→P. 667)
- 2 Remove the eyelet cover.

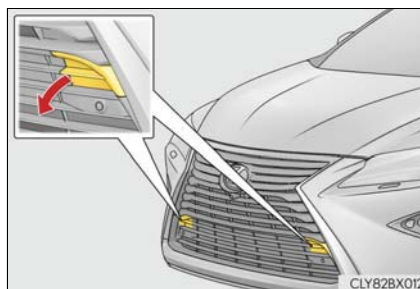

- 3 Insert the towing eyelet into the hole and tighten partially by hand.



- 4 Tighten down the towing eyelet securely using a wheel nut wrench or hard metal bar.

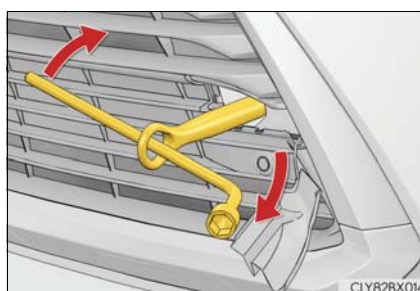

- 5 Securely attach cables or chains to the towing eyelet.  
Take care not to damage the vehicle body.
- 6 Enter the vehicle being towed and start the engine.  
If the engine does not start, turn the engine switch to IGNITION ON mode.
- 7 Shift the shift lever to N and release the parking brake.  
When the shift lever cannot be shifted: →P. 239, 244

### ■ While towing

If the engine is not running, the power assist for the brakes and steering will not function, making steering and braking more difficult.

### ■ Wheel nut wrench

Wheel nut wrench is installed in luggage compartment. (→P. 667)

## ⚠ WARNING

Observe the following precautions.  
Failure to do so may result in death or serious injury.

### ■ When towing the vehicle

#### ▶ 2WD models

Be sure to transport the vehicle with the front wheels raised or with all four wheels raised off the ground. If the vehicle is towed with the front wheels contacting the ground, the drivetrain and related parts may be damaged.

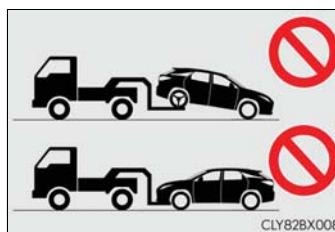

#### ▶ AWD models

Be sure to transport the vehicle with all four wheels raised off the ground. If the vehicle is towed with the tires contacting the ground, the drivetrain or related parts may be damaged, the vehicle may fly off the truck.

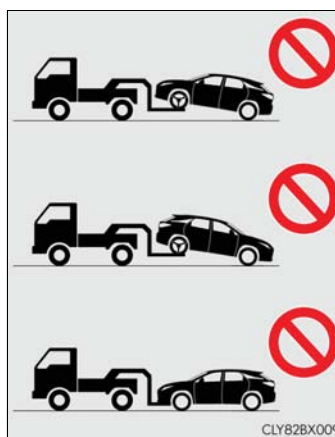

### ■ While towing

- When towing using cables or chains, avoid sudden starts, etc. which place excessive stress on the towing eyelets, cables or chains. The towing eyelets, cables or chains may become damaged, broken debris may hit people, and cause serious damage.

- Do not turn the engine switch off.

There is a possibility that the steering wheel is locked and cannot be operated.

### ■ Installing towing eyelets to the vehicle

Make sure that towing eyelets are installed securely.

If not securely installed, towing eyelets may come loose during towing.

 NOTICE**■ To prevent damage to the vehicle when towing using a wheel-lift type truck**

- Do not tow the vehicle from the rear when the engine switch is off. The steering lock mechanism is not strong enough to hold the front wheels straight.
- When raising the vehicle, ensure adequate ground clearance for towing at the opposite end of the raised vehicle. Without adequate clearance, the vehicle could be damaged while being towed.

**■ To prevent damage to the vehicle when towing with a sling-type truck**

Do not tow with a sling-type truck, either from the front or rear.

**■ To prevent damage to the vehicle during emergency towing**

Do not secure cables or chains to the suspension components.

**■ Recreational towing (behind motor home, etc)**

Never dinghy tow your vehicle to prevent causing serious damage to the Dynamic Torque Control AWD system (AWD models) and transmission. (→P. 230)

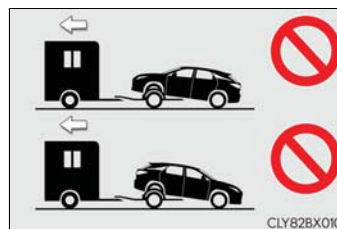

## If you think something is wrong

If you notice any of the following symptoms, your vehicle probably needs adjustment or repair. Contact your Lexus dealer as soon as possible.

### Visible symptoms

- Fluid leaks under the vehicle  
(Water dripping from the air conditioning after use is normal.)
- Flat-looking tires or uneven tire wear
- Engine coolant temperature gauge needle continually points higher than normal

### Audible symptoms

- Changes in exhaust sound
- Excessive tire squeal when cornering
- Strange noises related to the suspension system
- Pinging or other noises related to the engine

### Operational symptoms

- Engine missing, stumbling or running roughly
- Appreciable loss of power
- Vehicle pulls heavily to one side when braking
- Vehicle pulls heavily to one side when driving on a level road
- Loss of brake effectiveness, spongy feeling, pedal almost touches the floor

## Fuel pump shut off system

To minimize the risk of fuel leakage when the engine stalls or when an airbag inflates upon collision, the fuel pump shut off system stops the supply of fuel to the engine.

Follow the procedure below to restart the engine after the system is activated.

- 1 Turn the engine switch to ACCESSORY mode or turn it off.
- 2 Restart the engine.

 NOTICE

■ **Before starting the engine**









Inspect the ground under the vehicle.







If you find that fuel has leaked onto the ground, the fuel system has been damaged and is in need of repair. Do not restart the engine.

## If a warning light turns on or a warning buzzer sounds







Calmly perform the following actions if any of the warning lights comes on or flashes. If a light comes on or flashes, but then goes off, this does not necessarily indicate a malfunction in the system. However, if this continues to occur, have the vehicle inspected by your Lexus dealer.

### Warning light and warning buzzer list

Warning light	Warning light/Details/Actions
 (U.S.A.)  (Canada)	<b>Brake system warning light</b> Indicates that: <ul style="list-style-type: none"> <li>• The brake fluid level is low; or</li> <li>• The brake system is malfunctioning</li> </ul> → <b>Immediately stop the vehicle in a safe place and contact your Lexus dealer. Continuing to drive the vehicle may be dangerous.</b>
	<b>Brake system warning light</b> Indicates a malfunction in the electric parking brake → <b>Have the vehicle inspected by your Lexus dealer immediately.</b>
 (If equipped)	<b>Charging system warning light</b> Indicates a malfunction in the vehicle's charging system → <b>Immediately stop the vehicle in a safe place and contact your Lexus dealer. Continuing to drive the vehicle may be dangerous.</b>
 (U.S.A.)  (Canada)	<b>Malfunction indicator lamp</b> Indicates a malfunction in: <ul style="list-style-type: none"> <li>• The electronic engine control system;</li> <li>• The electronic throttle control system; or</li> <li>• The electronic automatic transmission control system</li> </ul> → <b>Have the vehicle inspected by your Lexus dealer immediately.</b>
	<b>SRS warning light</b> Indicates a malfunction in: <ul style="list-style-type: none"> <li>• The SRS airbag system;</li> <li>• The front passenger occupant classification system; or</li> <li>• The seat belt pretensioner system</li> </ul> → <b>Have the vehicle inspected by your Lexus dealer immediately.</b>
 (U.S.A.)  (Canada)	<b>ABS warning light</b> Indicates a malfunction in: <ul style="list-style-type: none"> <li>• The ABS; or</li> <li>• The brake assist system</li> </ul> → <b>Have the vehicle inspected by your Lexus dealer immediately.</b>

Warning light	Warning light/Details/Actions
 <p>(Flashes) (U.S.A.)</p>  <p>(Flashes) (Canada)</p>	<p><b>Parking brake indicator</b> It is possible that the parking brake is not fully engaged or released → <b>Operate the parking brake switch once again.</b> This light comes on when the parking brake is not released. If the light turns off after the parking brake is fully released, the system is operating normally.</p>
 <p>(Flashes)</p>	<p><b>Brake hold operated indicator</b> Indicates a malfunction in the brake hold system → <b>Have the vehicle inspected by your Lexus dealer immediately.</b></p>
 	<p><b>Electric power steering system warning light (warning buzzer)</b> Indicates a malfunction in the EPS (Electric Power Steering) system → <b>Have the vehicle inspected by your Lexus dealer immediately.</b></p>
	<p><b>LKA indicator</b> Indicates a malfunction in the LKA (Lane-Keeping Assist) → <b>When “Lane Keeping Assist Unavailable” is displayed on the multi-information display, turn the LKA system off, drive the vehicle for a short time, and then turn the LKA system back on. (→P. 295)</b> <b>When a message other than above is displayed, follow the instructions displayed in the message.</b></p>
	<p><b>Slip indicator</b> When the warning light is illuminated: Indicates a malfunction in:  <ul style="list-style-type: none"> <li>• The VSC system;</li> <li>• The TRAC system;</li> <li>• The Trailer Sway Control; or</li> <li>• The hill-start assist control system</li> </ul>           → <b>Have the vehicle inspected by your Lexus dealer immediately.</b>            When the warning light flashes: Indicates that the VSC, TRAC or Trailer Sway Control system is operating</p>



Warning light	Warning light/Details/Actions
 <p>(Flashes or illuminates)</p>	<p><b>PCS warning light</b>  Indicates a malfunction in the PCS (Pre-Collision System) or that the system is temporarily unavailable due to the vehicle being extremely hot/cold, or dirt around a front sensor, etc.  (→P. 290, 664)  → <b>Follow the instructions displayed on the multi-information display.</b> (→P. 290, 664)  If the PCS (Pre-Collision System) or VSC (Vehicle Stability Control) system is disabled, the PCS warning light will illuminate.  → P. 290</p>
 <p>(Flashes) (If equipped)</p>	<p><b>ICS OFF indicator</b>  When a buzzer sounds:  Indicates a malfunction in the Intelligent Clearance Sonar system  → <b>Have the vehicle inspected by your Lexus dealer immediately.</b>  When a buzzer does not sound:  Indicates that the system is temporarily unavailable, possibly due to a sensor being dirty or covered with ice, etc.  → <b>Clear the dirt, etc.</b></p>
	<p><b>Low fuel level warning light</b>  Indicates that remaining fuel is approximately 2.8 gal. (10.8 L, 2.3 Imp. gal.) or less  → <b>Refuel the vehicle.</b></p>
	<p><b>Driver's and front passenger's seat belt reminder light (warning buzzer)*1</b>  Warns the driver and/or front passenger to fasten their seat belts  → <b>Fasten the seat belt.</b>  If the front passenger's seat is occupied, the front passenger's seat belt also needs to be fastened to make the warning light (warning buzzer) turn off.</p>
 <p>(RX350)</p>  <p>(RX350L)</p>	<p><b>Rear passengers' seat belt reminder light (warning buzzer)*2</b>  Warns the rear passengers to fasten their seat belts  → <b>Fasten the seat belt.</b></p>
	<p><b>Tire pressure warning light</b>  Indicates the following:  • Low tire pressure due to flat tire;  • Low tire pressure due to natural causes; or  • The tire pressure warning system is malfunctioning  → <b>Immediately stop the vehicle in a safe place.</b>  <b>Handling method</b> (→P. 658)</p>

Warning light	Warning light/Details/Actions
	<p><b>Master warning light</b>            A buzzer sounds and the warning light comes on and flashes to indicate that the master warning system has detected a malfunction.            → P. 661</p>

\*1: Driver's and front passenger's seat belt warning buzzer:

The driver's seat belt warning buzzer sounds to alert the driver that his or her seat belt is not fastened. Once the engine switch is turned to IGNITION ON mode, the buzzer sounds for 6 seconds. If the vehicle reaches a speed of 12 mph (20 km/h), the buzzer sounds once. If the seat belt is still unfastened after 24 seconds, the buzzer will sound intermittently for 10 seconds. Then, if the seat belt is still unfastened, the buzzer will sound in a different tone for 20 more seconds.

The front passenger's seat belt warning buzzer sounds to alert the front passenger that his or her seat belt is not fastened. The buzzer sounds once if the vehicle reaches a speed of 12 mph (20 km/h). If the seat belt is still unfastened after 24 seconds, the buzzer will sound intermittently for 10 seconds. Then, if the seat belt is still unfastened, the buzzer will sound in a different tone for 20 more seconds.

\*2: Rear passengers' seat belt warning buzzer:

The rear passengers' seat belt warning buzzer sounds to alert the rear passengers that his or her seat belt is not fastened. The buzzer sounds for 6 seconds after the vehicle reaches a speed of 20 km/h (12 mph). Then, if the seat belt is still unfastened, the buzzer will sound in a different tone for 24 more seconds.

#### ■ SRS warning light

This warning light system monitors the airbag sensor assembly, front impact sensors, side impact sensors (front door), side impact sensors (rear), driver's seat position sensor, driver's seat belt buckle switch, front passenger occupant classification system (ECU and sensors), "AIR BAG ON" indicator light, "AIR BAG OFF" indicator light, front passenger's seat belt buckle switch, driver's seat belt pretensioner, front passenger's seat belt pretensioner and force limiter, airbags, interconnecting wiring and power sources. (→P. 36)

#### ■ Front passenger detection sensor, seat belt reminder and warning buzzer

- If luggage is placed on the front passenger seat, the front passenger detection sensor may cause the warning light to flash and the warning buzzer to sound even if a passenger is not sitting in the seat.
- If a cushion is placed on the seat, the sensor may not detect a passenger, and the warning light may not operate properly.

#### ■ Electric power steering system warning light (warning buzzer)

When the battery charge becomes insufficient or the voltage temporarily drops, the electric power steering system warning light may come on and the warning buzzer may sound.

■ **If the malfunction indicator lamp comes on while driving**

First check the following:

- Is the fuel tank empty?  
If it is, fill the fuel tank immediately.
- Is the fuel tank cap loose?  
If it is, tighten it securely.

The light will go off after several driving trips.

If the light does not go off even after several trips, contact your Lexus dealer as soon as possible.

■ **When the tire pressure warning light comes on**

Inspect the tires to check if a tire is punctured.

If a tire is punctured: →P. 666

If none of the tires are punctured:

Turn the engine switch off then turn it to IGNITION ON mode. Check if the tire pressure warning light comes on or blinks.

▶ If the tire pressure warning light comes on

- 1 After the temperature of the tires has lowered sufficiently, check the inflation pressure of each tire and adjust them to the specified level.
- 2 If the warning light does not turn off even after several minutes have elapsed, check that the inflation pressure of each tire is at the specified level and perform initialization. (→P. 606)

If the warning light does not turn off several minutes after the initialization has been performed, have the vehicle inspected by your Lexus dealer immediately.

▶ If the tire pressure warning light blinks for 1 minute then stays on

There may be a malfunction in the tire pressure warning system. Have the vehicle inspected by your Lexus dealer immediately.

■ **The tire pressure warning light may come on due to natural causes**

The tire pressure warning light may come on due to natural causes such as natural air leaks and tire inflation pressure changes caused by temperature. In this case, adjusting the tire inflation pressure will turn off the warning light (after a few minutes).

■ **When a tire is replaced with a spare tire**

The compact spare tire is not equipped with a tire pressure warning valve and transmitter. If a tire goes flat, the tire pressure warning light will not turn off even though the flat tire has been replaced with the spare tire. Replace the spare tire with the repaired tire and adjust the tire inflation pressure. The tire pressure warning light will go off after a few minutes.

■ **Conditions that the tire pressure warning system may not function properly**

→P. 609

■ **Warning buzzer**

In some cases, the buzzer may not be heard due to being in a noisy location or audio sound.

■ **Customization**

Some functions can be customized. (→P. 722)

 **WARNING****■ If both the ABS and the brake system warning lights remain on**

Stop your vehicle in a safe place immediately and contact your Lexus dealer. The vehicle will become extremely unstable during braking, and the ABS system may fail, which could cause an accident resulting in death or serious injury.

**■ When the electric power steering system warning light comes on**

When the light comes on yellow, the assist to the power steering is restricted. When the light comes on red, the assist to the power steering is lost and handling operations of the steering wheel become extremely heavy. When steering wheel operations are heavier than usual, grip the steering wheel firmly and operate it using more force than usual.

**■ If the tire pressure warning light comes on**

Be sure to observe the following precautions. Failure to do so could cause a loss of vehicle control and result in death or serious injury.

- Stop your vehicle in a safe place as soon as possible. Adjust the tire inflation pressure immediately.
- If the tire pressure warning light comes on even after tire inflation pressure adjustment, it is probable that you have a flat tire. Check the tires. If a tire is flat, change it with the spare tire and have the flat tire repaired by the nearest Lexus dealer.
- Avoid abrupt maneuvering and braking. If the vehicle tires deteriorate, you could lose control of the steering wheel or the brakes.

**■ If a blowout or sudden air leakage should occur**

The tire pressure warning system may not activate immediately.

 **WARNING****■ Maintenance of the tires**

Each tire, including the spare (if provided), should be checked monthly when cold and inflated to the inflation pressure recommended by the vehicle manufacturer on the vehicle placard or tire inflation pressure label (tire and load information label). (If your vehicle has tires of a different size than the size indicated on the vehicle placard or tire inflation pressure label [tire and load information label], you should determine the proper tire inflation pressure for those tires.)

As an added safety feature, your vehicle has been equipped with a tire pressure monitoring system (TPMS-tire pressure warning system) that illuminates a low tire pressure telltale (tire pressure warning light) when one or more of your tires is significantly under-inflated. Accordingly, when the low tire pressure telltale (tire pressure warning light) illuminates, you should stop and check your tires as soon as possible, and inflate them to the proper pressure. Driving on a significantly under-inflated tire causes the tire to overheat and can lead to tire failure. Under-inflation also reduces fuel efficiency and tire tread life, and may affect the vehicle's handling and stopping ability.

Please note that the TPMS (tire pressure warning system) is not a substitute for proper tire maintenance, and it is the driver's responsibility to maintain correct tire pressure, even if under-inflation has not reached the level to trigger illumination of the TPMS low tire pressure telltale (tire pressure warning light).

Your vehicle has also been equipped with a TPMS (tire pressure warning system) malfunction indicator to indicate when the system is not operating properly. The TPMS (tire pressure warning system) malfunction indicator is combined with the low tire pressure telltale (tire pressure warning light). When the system detects a malfunction, the telltale will flash for approximately one minute and then remain continuously illuminated. This sequence will continue upon subsequent vehicle start-ups as long as the malfunction exists. When the malfunction indicator is illuminated, the system may not be able to detect or signal low tire pressure as intended.

TPMS (tire pressure warning system) malfunctions may occur for a variety of reasons, including the installation of replacement or alternate tires or wheels on the vehicle that prevent the TPMS (tire pressure warning system) from functioning properly. Always check the TPMS (tire pressure warning system) malfunction telltale after replacing one or more tires or wheels on your vehicle to ensure that the replacement or alternate tires and wheels allow the TPMS (tire pressure warning system) to continue to function properly.

 **NOTICE****■ To ensure the tire pressure warning system operates properly**

Do not install tires with different specifications or makers, as the tire pressure warning system may not operate properly.

## If a warning message is displayed

The multi-information display shows warnings of system malfunctions, incorrectly performed operations, and messages that indicate a need for maintenance. When a message is shown, perform the correction procedure appropriate to the message.

▶ Except F SPORT models



▶ F SPORT models



### ① Master warning light

The master warning light also comes on or flashes in order to indicate that a message is currently being displayed on the multi-information display.

### ② Multi-information display

If any of the warning messages are shown again after the appropriate actions have been performed, contact your Lexus dealer.

## Messages and warnings

The warning lights and warning buzzers operate as follows depending on the content of the message. If a message indicates the need for inspection by a dealer, have the vehicle inspected by your Lexus dealer immediately.

	System warning light	Warning buzzer*	Warning
Comes on	—	Sounds	Indicates an important situation, such as when a system related to driving is malfunctioning or that danger may result if the correction procedure is not performed
—	Comes on or flashes	Sounds	Indicates an important situation, such as when the systems shown on the multi-information display may be malfunctioning

	System warning light	Warning buzzer*	Warning
Flashes	—	Sounds	Indicates a situation, such as when damage to the vehicle or danger may result
Comes on	—	Does not sound	Indicates a condition, such as malfunction of electrical components, their condition, or indicates the need for maintenance
Flashes	—	Does not sound	Indicates a situation, such as when an operation has been performed incorrectly, or indicates how to perform an operation correctly

\*: A buzzer sounds the first time a message is shown on the multi-information display.

**If a message instructing to refer to the Owner's Manual is displayed**

- If the following messages are shown, there may be a malfunction. Immediately stop the vehicle in a safe place and contact your Lexus dealer. Continuing to drive the vehicle may be dangerous.
  - “Braking Power Low Stop in a Safe Place See Owner’s Manual”
  - “Oil Pressure Low Stop in a Safe Place See Owner’s Manual”
  - “Charging System Malfunction See Owner’s Manual”
- If the following message is shown, there may be a malfunction. Immediately have the vehicle inspected by your Lexus dealer.
  - “Access System with Elec. Key Malfunction See Owner’s Manual”
- If “Engine Coolant Temp High Stop in a Safe Place See Owner’s Manual” is displayed, following the instructions, accordingly. (→P. 692)
- If “Transmission Fluid Temp High See Owner’s Manual” is shown, the automatic transmission fluid temperature may be too high. Immediately stop the vehicle in a safe place, shift the shift lever to P with the engine running and wait until the message is cleared. If the message is not cleared, contact your Lexus dealer.

**Other messages displayed on the multi-information display**

Take the appropriate actions as instructed in the message displayed.

If any of the following messages are displayed, also refer to this Owner's Manual.

**■ If "Shift to P Before Exiting Vehicle" is shown**

Message is displayed when the driver's door is opened without turning the engine switch off with the shift lever in any position other than P.

Shift the shift lever to P.

**■ If "Power Turned Off to Save Battery" is displayed**

This message is displayed when the power was cut off due to the automatic power off function.

The next time the engine is started, increase the engine speed slightly and maintain it at that speed for approximately 5 minutes to recharge the battery.

**■ If "AWD System Overheated Switching to 2WD Mode" or "AWD System Overheated 2WD Mode Engaged" is displayed (AWD models)**

This message may be displayed when driving under extremely high load conditions.

Drive the vehicle at low speeds or stop the vehicle in a safe place with the engine running until the message is cleared.

If the message is not cleared, have the vehicle inspected by your Lexus dealer.

**■ If "A New Key has been Registered Contact Your Dealer for Details" is displayed**

This message will be displayed each time the driver's door is opened when the doors are unlocked from the outside for approximately one week after a new electronic key has been registered.

If this message is displayed but you have not had a new electronic key registered, ask your Lexus dealer to check if an unknown electronic key (other than those in your possession) has been registered.

**■ When "Headlight System Malfunction Visit Your Dealer" is displayed**

The following systems may be malfunctioning. Have the vehicle inspected by your Lexus dealer immediately.

- The LED headlight system
- The automatic headlight leveling system
- Automatic High Beam
- AFS (Adaptive Front-lighting System) (if equipped)



■ **If “Forward Camera System Unavailable” or “Forward Camera System Unavailable Clean Windshield” is displayed**

The following systems may be suspended until the problem shown in the message is resolved. (→P. 290)

- PCS (Pre-Collision System)
- LKA (Lane-Keeping Assist)
- Dynamic radar cruise control with full-speed range
- Automatic High Beam

■ **If “Oil Maintenance Required Soon” is shown**

Indicates that the engine oil is scheduled to be changed.

Check the engine oil, and change if necessary. After changing the engine oil, the message should be reset. (→P. 597)

■ **If “Oil Maintenance Required” is shown**

Indicates that the engine oil should be changed.

Check and change the engine oil, and oil filter by your Lexus dealer. After changing the engine oil, the message should be reset. (→P. 597)

■ **If “Maintenance Required Soon” is displayed (U.S.A. only)**

Indicates that all maintenance according to the driven distance on the maintenance schedule\* should be performed soon.

Comes on approximately 4500 miles (7200 km) after the message has been reset.

If necessary, perform maintenance. Please reset the message after the maintenance is performed. (→P. 585)

\*: Refer to the separate “Scheduled Maintenance” or “Owner’s Manual Supplement” for the maintenance interval applicable to your vehicle.

■ **If “Maintenance Required Visit Your Dealer” is displayed (U.S.A. only)**

Indicates that all maintenance is required to correspond to the driven distance on the maintenance schedule\*.

Comes on approximately 5000 miles (8000 km) after the message has been reset.

(The indicator will not work properly unless the message has been reset.)

Perform the necessary maintenance. Please reset the message after the maintenance is performed. (→P. 585)

\*: Refer to the separate “Scheduled Maintenance” or “Owner’s Manual Supplement” for the maintenance interval applicable to your vehicle.

■ **System warning lights**

The master warning light does not come on or flash in the following cases. Instead, a separate system warning light will come on along with a message shown on the multi-information display.

- “Antilock Brake System Malfunction Visit Your Dealer”:  
The ABS warning light comes on. (→P. 654)
- “Charging System Malfunction See Owner’s Manual” (F SPORT models):  
The charging system warning light comes on. (→P. 654)

■ **Warning buzzer**

→P. 658

 NOTICE

■ **“High Power Consumption Partial Limit On AC/Heater Operation” is frequently shown**

There is a possible malfunction relating to the charging system or the battery may be deteriorating. Have the vehicle inspected by your Lexus dealer.

## If you have a flat tire

Your vehicle is equipped with a spare tire. The flat tire can be replaced with the spare tire.

For details about tires: →P. 604

### WARNING

#### ■ If you have a flat tire

Do not continue driving with a flat tire.

Driving even a short distance with a flat tire can damage the tire and the wheel beyond repair, which could result in an accident.

## Before jacking up the vehicle

- Stop the vehicle in a safe place on a hard, flat surface.
- Set the parking brake.
- Shift the shift lever to P.
- Stop the engine.
- Turn on the emergency flashers. (→P. 644)

**Location of the spare tire, jack and tools**

## ▶ RX350

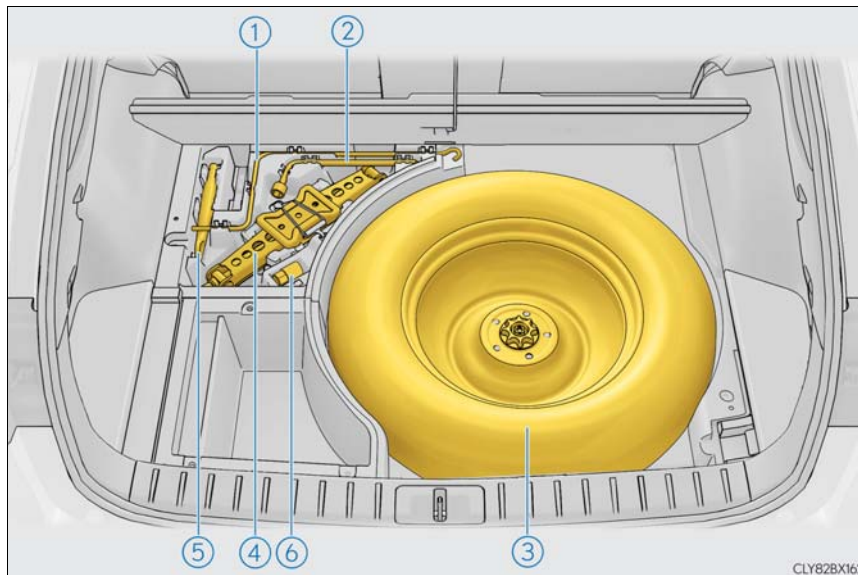

- ① Jack handle
- ② Wheel nut wrench
- ③ Spare tire
- ④ Jack
- ⑤ Towing eyelet (if equipped)
- ⑥ Wheel lock key\* (if equipped)

\*: Documentation relating to the wheel lock key, such as the registration and I.D. card, is inside the glove box.

► RX350L

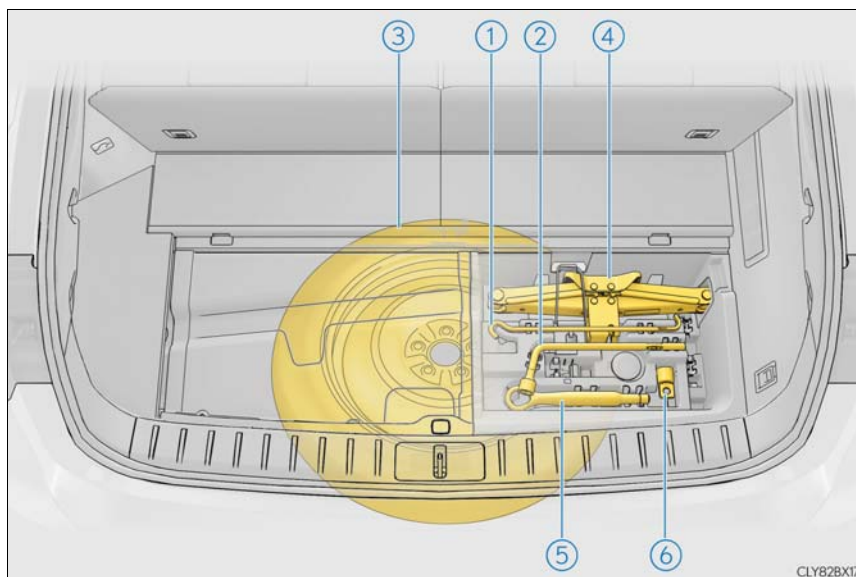

- |                    |                  |
|--------------------|------------------|
| ① Jack handle      | ④ Jack           |
| ② Wheel nut wrench | ⑤ Towing eyelet  |
| ③ Spare tire       | ⑥ Adapter socket |

**⚠ WARNING**

■ **Using the tire jack**

Observe the following precautions.

Improper use of the tire jack may cause the vehicle to suddenly fall off the jack, leading to death or serious injury.

- Do not use the tire jack for any purpose other than replacing tires or installing and removing tire chains.
- Only use the tire jack that comes with this vehicle for replacing a flat tire. Do not use it on other vehicles, and do not use other tire jacks for replacing tires on this vehicle.
- Put the jack properly in its jack point.
- Do not put any part of your body under the vehicle while it is supported by the jack.
- Do not start the engine or drive the vehicle while the vehicle is supported by the jack.
- Do not raise the vehicle while someone is inside.
- When raising the vehicle, do not put an object on or under the jack.
- Do not raise the vehicle to a height greater than that required to replace the tire.
- Use a jack stand if it is necessary to get under the vehicle.
- When lowering the vehicle, make sure that there is no-one near the vehicle. If there are people nearby, warn them vocally before lowering.

### Wheel lock nut (if equipped)

When replacing tires on a vehicle with wheel lock nuts, use the following procedures to remove and install the wheel lock nuts. The wheel lock key is stored in the tray inside the luggage compartment. Always return the wheel lock key to its original position after use, so that it does not get lost.

#### ■ Removal

For ease of removal, the wheel lock nut should always be the first one loosened.

- 1 Place the wheel lock key on top of the wheel lock nut, turning until the wheel lock key and wheel lock nut patterns engage.
- 2 Place the wheel nut wrench on the wheel lock key, and while applying pressure on the wheel lock key, loosen the wheel lock nut.

#### ■ Installation

For ease of installation, the wheel lock nut should always be the last one tightened.

- 1 By hand, install a wheel lock nut on each wheel.
- 2 Place the wheel lock key on top of the wheel lock nut, turning until the wheel lock key and wheel lock nut patterns engage.
- 3 Place the wheel nut wrench on the wheel lock key, and while applying pressure on the wheel lock key, tighten the wheel lock nut to the recommended torque.

#### NOTICE

Do not use an impact wrench. Using an impact wrench may cause permanent damage to wheel lock nut and wheel lock key. If in doubt about wheel lock application, contact your Lexus dealer.

### Taking out the jack

**1** Secure the deck board using the hook. (→P. 540)

**2** Disengage the hook and take out the jack.

RX350: Remove the wheel nut wrench and then the jack

RX350L: Remove the jack handle and then the jack

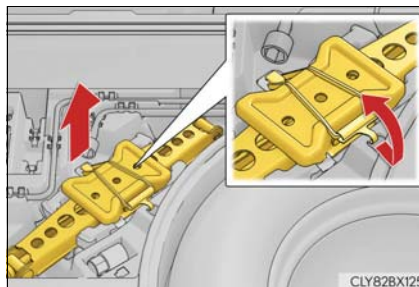

### Taking out the spare tire

▶ RX350

**1** Secure the deck board using the hook. (→P. 540)

**2** Loosen the center fastener that secures the spare tire.

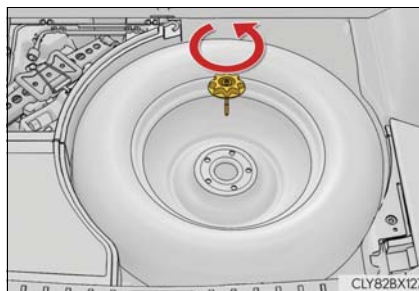

▶ RX350L

**1** Remove the deck board.

**2** Remove the cover.

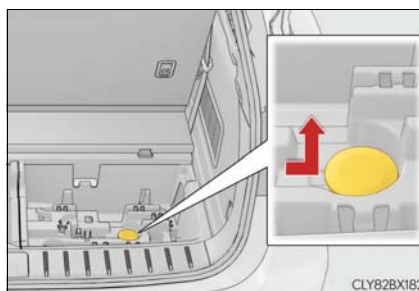

- 3 Attach the adapter socket to the spare tire clamp bolt.

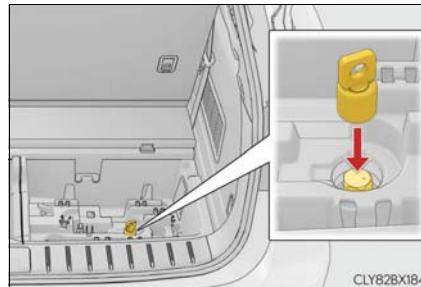

- 4 Assemble the jack handle extension.

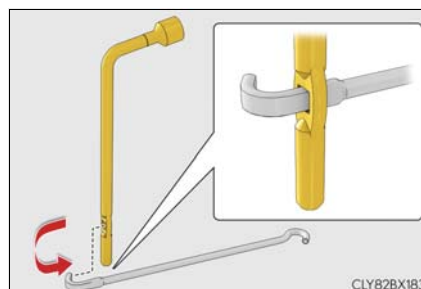

- 5 Connect the jack handle to the adapter socket. Turn the jack handle counterclockwise.

The tire will be lowered completely to the ground.

Turn the jack handle slowly to lower the spare tire. If the handle is turned quickly, the wire cable may come off the shaft inside the unit and the tire may not be lowered.

If the spare tire cannot be lowered: →P. 674

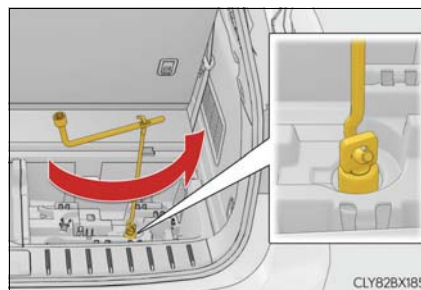

- 6 Pull out the spare tire and stand it against the bumper.

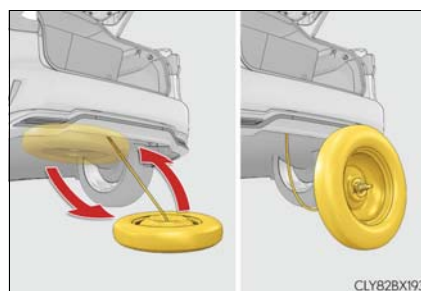



**672** 8-2. Steps to take in an emergency

- 7 Fully depress the secondary latch (A) and remove the holding bracket (B) from the hoist assembly (C).

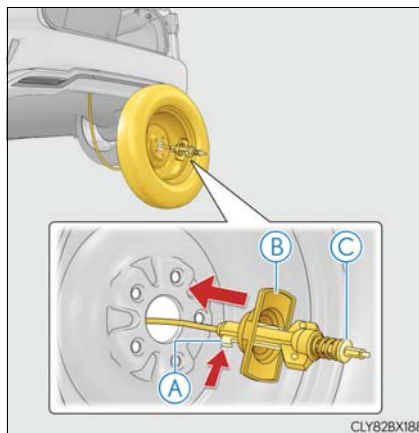

- 8 Tilt the bracket (B) and pass it through the wheel opening. Then remove the hoist assembly (C).

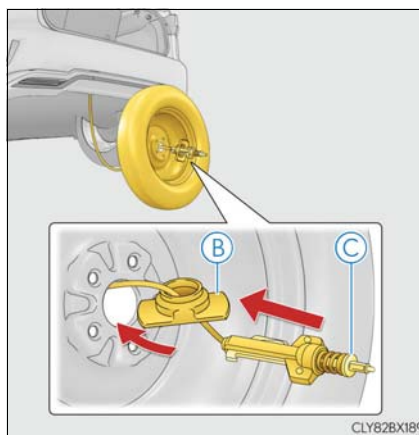

**⚠ WARNING**

■ **When storing the spare tire**

Be careful not to catch fingers or other body parts between the spare tire and the body of the vehicle.

## Replacing a flat tire

- 1 Chock the tires.



Flat tire		Wheel chock positions
Front	Left-hand side	Behind the rear right-hand side tire
	Right-hand side	Behind the rear left-hand side tire
Rear	Left-hand side	In front of the front right-hand side tire
	Right-hand side	In front of the front left-hand side tire

- 2 Slightly loosen the wheel nuts (one turn).

For vehicles with wheel lock nuts, loosen the wheel lock nut first.

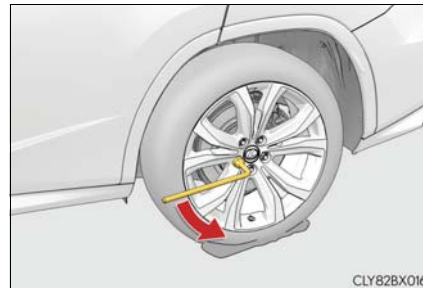

- 3 Turn the tire jack portion (A) by hand until the notch of the jack is in contact with the jack point.

The jack point guides are located under the rocker panel. They indicate the jack point positions.

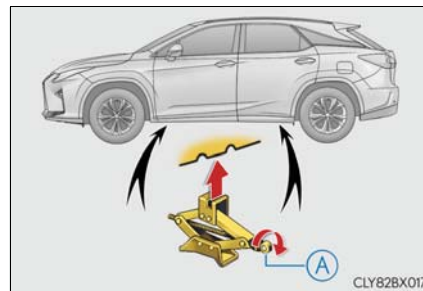

**674** 8-2. Steps to take in an emergency

- 4** Raise the vehicle until the tire is slightly raised off the ground.

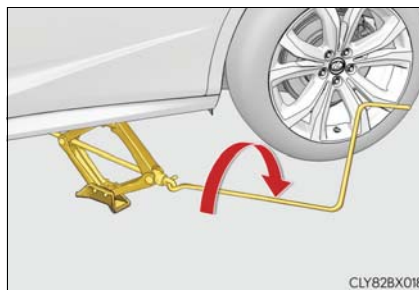

- 5** Remove all the wheel nuts and the tire.

When resting the tire on the ground, place the tire so that the wheel design faces up to avoid scratching the wheel surface.

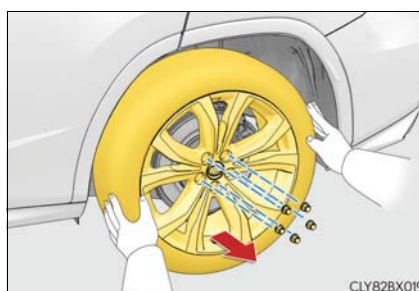

■ **If the spare tire cannot be lowered (RX350L)**

If the spare tire cannot be lowered, it may not have been stowed properly. Perform the following procedure:

- 1** Fully tighten the spare tire clamp bolt by turning the jack handle clockwise until two clicks are heard and the jack handle skips.

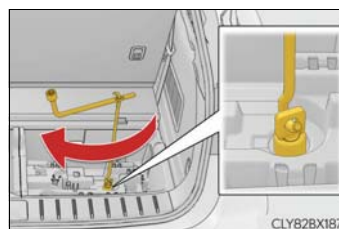

- 2** Turn the jack handle counterclockwise to lower the spare tire.

If the spare tire still cannot be lowered, attempt to fully tighten the spare tire clamp bolt again by turning the jack handle clockwise. Then turn it counterclockwise at least 2 turns to lower the spare tire.

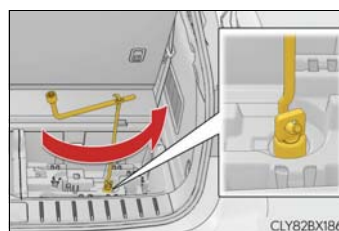

If the spare tire still cannot be lowered, the wire cable may be severed. Have the vehicle inspected by your Lexus dealer.

**⚠ WARNING****■ When holding a tire with Selectable Color Trim (if equipped)**

Do not hold the tire by the Selectable Color Trim. Otherwise, the Selectable Color Trim may be damaged or may fall off causing the tire to drop, possibly causing injury.

**■ Replacing a flat tire**

- Do not touch the disc wheels or the area around the brakes immediately after the vehicle has been driven.

After the vehicle has been driven the disc wheels and the area around the brakes will be extremely hot. Touching these areas with hands, feet or other body parts while changing a tire, etc. may result in burns.

- Failure to follow these precautions could cause the wheel nuts to loosen and the tire to fall off, resulting in death or serious injury.

- Never use oil or grease on the wheel bolts or wheel nuts.  
Oil and grease may cause the wheel nuts to be excessively tightened, leading to bolt or disc wheel damage. In addition, the oil or grease can cause the wheel nuts to loosen and the wheel may fall off, causing a serious accident.  
Remove any oil or grease from the wheel bolts or wheel nuts.
- Have the wheel nuts tightened with a torque wrench to 76 ft•lbf (103 N•m, 10.5 kgf•m) as soon as possible after changing wheels.
- When installing a tire, only use wheel nuts that have been specifically designed for that wheel.
- If there are any cracks or deformations in the bolt screws, nut threads or bolt holes of the wheel, have the vehicle inspected by your Lexus dealer.

- Observe the following precautions. (RX350L)

Failure to do so may result in serious injury:

- Do not try to remove the wheel ornament by hand. Take due care in handling the ornament to avoid unexpected personal injury.
- Lower the spare tire completely to the ground before removing it from under the vehicle.

**■ Replacing a flat tire for vehicles with power back door**

In cases such as when replacing tires, make sure to turn off the power back door main switch (→P. 101). Failure to do so may cause the back door to operate unintentionally if the power back door switch is accidentally touched, resulting in hands and fingers being caught and injured.

### Installing the spare tire

- 1 Remove any dirt or foreign matter from the wheel contact surface.

If foreign matter is on the wheel contact surface, the wheel nuts may loosen while the vehicle is in motion, causing the tire to come off.

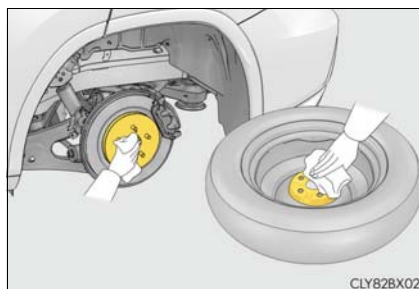

- 2 Install the spare tire and loosely tighten each wheel nut by hand by approximately the same amount.

Tighten the wheel nuts until the tapered portion comes into loose contact with the disc wheel seat.

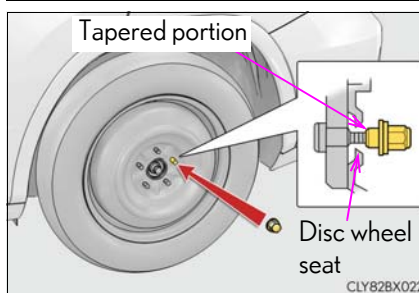

- 3 Lower the vehicle.

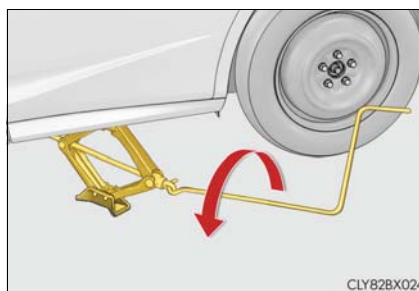

- 4 Firmly tighten each wheel nut two or three times in the order shown in the illustration.

For vehicles with wheel lock nuts, tighten the wheel lock nut last.

**Tightening torque:**  
76 ft•lbf (103 N•m, 10.5 kgf•m)

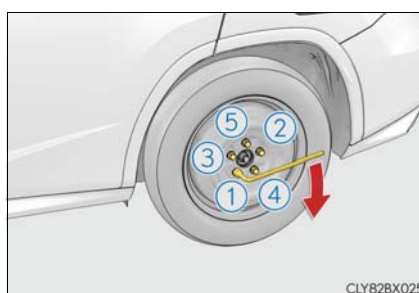

- 5 RX350: Stow the flat tire, tire jack and all tools.  
RX350L: →P. 677

**⚠ WARNING****■ Stowing the flat tire**

Failure to follow steps listed under stowing the tire may result in damage to the spare tire carrier and loss of the tire, which could result in serious injury or death.

**Stowing the flat tire, jack and all tools (RX350L)**

- 1 Remove the center wheel ornament by pushing from the reverse side.  
Be careful not to lose the wheel ornament.

- 2 Stand the tire against the bumper with the inner surface facing toward you. Pass the hoist assembly (C) and holding bracket (B) through the wheel opening.

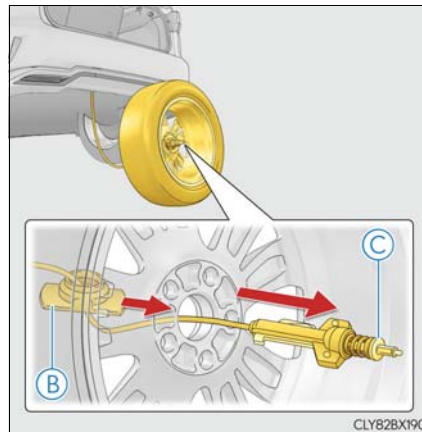

- 3 Fully depress the secondary latch (A) and install the bracket (B) to the hoist assembly (C).

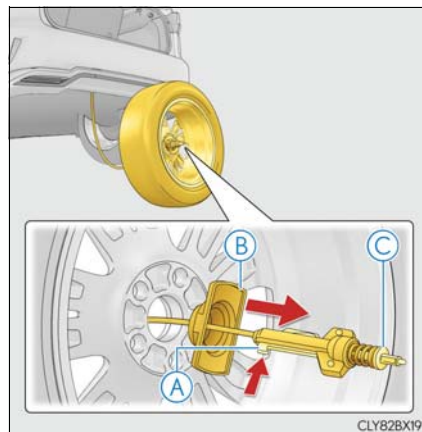

**678** 8-2. Steps to take in an emergency

- 4** Lay the tire on the ground with the outer surface (valve stem) facing up.

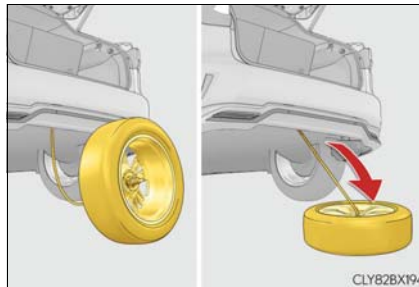

- 5** Before raising the tire, make sure that the hoist assembly is perpendicular to the wheel opening. (Try to place the tire directly beneath the vehicle, near where the wire cable is hanging from.)

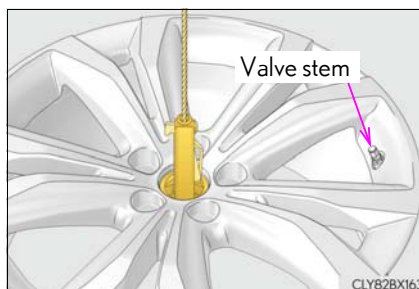

- 6** Using the jack handle and adapter socket, tighten the tire clamp bolt by turning it clockwise until the tire is in the correct position and two clicks are heard as the jack handle skips.

- 7** Confirm it is not loose after tightening:

- ① Push and pull the tire
- ② Try rotating

Visually check to ensure tire is not hung on surrounding parts.  
If looseness or misassembly exists, repeat steps **2** to **7**.

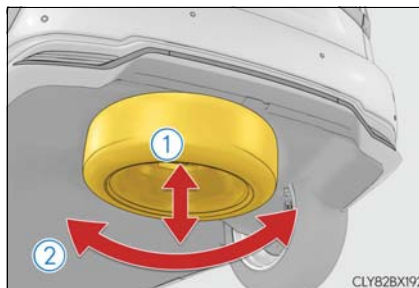

- 8** Repeat step **7**, any time the tire is lowered or disturbed.
- 9** Stow the jack and all tools.

**■ The compact spare tire**

- The compact spare tire is identified by the label "TEMPORARY USE ONLY" on the tire sidewall.  
Use the compact spare tire temporarily, and only in an emergency.
- Make sure to check the tire inflation pressure of the compact spare tire. (→P. 704)

**■ When using the compact spare tire**

As the compact spare tire is not equipped with a tire pressure warning valve and transmitter, low inflation pressure of the spare tire will not be indicated by the tire pressure warning system. Also, if you replace the compact spare tire after the tire pressure warning light comes on, the light remains on.

**■ When the compact spare tire is equipped**

When driving with the compact spare tire installed, the vehicle height will be different than when driving with standard tires.

**■ If you have a flat front tire on a road covered with snow or ice**

Install the compact spare tire on one of the rear wheels of the vehicle. Perform the following steps and fit tire chains to the front tires:

- 1 Replace a rear tire with the compact spare tire.
- 2 Replace the flat front tire with the tire removed from the rear of the vehicle.
- 3 Fit tire chains to the front tires.



 **WARNING**
**■ When using the compact spare tire**

- Remember that the compact spare tire provided is specifically designed for use with your vehicle. Do not use your compact spare tire on another vehicle.
- Do not use more than one compact spare tire simultaneously.
- Replace the compact spare tire with a standard tire as soon as possible.
- Avoid sudden acceleration, abrupt steering, sudden braking and shifting operations that cause sudden engine braking.

**■ When the compact spare tire is attached**

The vehicle speed may not be correctly detected, and the following systems may not operate correctly:

- |  |  |
|--|--|
| • ABS & Brake assist                                 | • AFS (Adaptive Front-lighting System) (if equipped) |
| • VSC  | • Tire pressure warning system                       |
| • TRAC   | • Intuitive parking assist (if equipped)             |
| • Trailer Sway Control                               | • Intelligent Clearance Sonar (ICS) (if equipped)    |
| • EPS  | • Lexus parking assist monitor (if equipped)         |
| • VDIM (if equipped)                                 | • Panoramic view monitor (if equipped)               |
| • Adaptive Variable Suspension System (if equipped)  | • BSM (Blind Spot Monitor) (if equipped)             |
| • Dynamic radar cruise control with full-speed range | • Navigation system (if equipped)                    |
| • PCS (Pre-Collision System)                         |  |
| • LKA (Lane-keeping Assist)                          |  |
| • Automatic High Beam                                |  |

Also, not only can the following system not be utilized fully, but it may even negatively affect the drive-train components:

- AWD system (AWD models)

**■ Speed limit when using the compact spare tire**

Do not drive at speeds in excess of 50 mph (80 km/h) when a compact spare tire is installed on the vehicle.

The compact spare tire is not designed for driving at high speeds. Failure to observe this precaution may lead to an accident causing death or serious injury.

**■ After using the tools and jack**

Before driving, make sure all the tools and jack are securely in place in their storage location to reduce the possibility of personal injury during a collision or sudden braking.

 NOTICE

■ **Be careful when driving over bumps with the compact spare tire installed on the vehicle**

When driving with the compact spare tire installed, the vehicle height will be different than when driving with standard tires. Be careful when driving over uneven road surfaces, etc.

■ **Driving with tire chains and the compact spare tire**

Do not fit tire chains to the compact spare tire. Tire chains may damage the vehicle body and adversely affect driving performance.

■ **When replacing the tires**

When removing or fitting the wheels, tires or the tire pressure warning valve and transmitter, contact your Lexus dealer as the tire pressure warning valve and transmitter may be damaged if not handled correctly.

■ **When stowing the flat tire (RX350L)**

- Ensure that there is no object caught between the tire and the vehicle underbody.
- Securely tighten the spare tire clamp bolt to hold the spare wheel carrier by the hook.
- Stow the flat tire in the spare tire location. Failure to do so may cause damage to the spare tire carrier. Proper storage reduces the possibility of injury in a collision or during sudden braking.
- Have the flat tire repaired and the spare tire replaced with it as soon as possible.

■ **Proper storage of the spare tire (RX350L)**

- If the hoist assembly is slanted when stowing a tire, the hoist assembly may become stuck in the wheel opening and the tire may not be raised properly, causing damage to the wheel or the wire cable.



- If the spare tire clamp bolt is turned without a tire on the hoist assembly, the wire cable may not be able to be lowered. If the wire cable cannot be lowered, contact your Lexus dealer.

## If the engine will not start

If the engine will not start even though correct starting procedures are being followed (→P. 231), consider each of the following points:

### The engine will not start even though the starter motor operates normally.

One of the following may be the cause of the problem:

- There may not be sufficient fuel in the vehicle's tank.  
Refuel the vehicle.
- The engine may be flooded.  
Try to restart the engine again following correct starting procedures.  
(→P. 231)
- There may be a malfunction in the engine immobilizer system. (→P. 74)

### The starter motor turns over slowly, the interior lights and headlights are dim, or the horn does not sound or sounds at a low volume.

One of the following may be the cause of the problem:

- The battery terminal connections may be loose or corroded.
- The battery may be discharged. (→P. 687)

### The starter motor does not turn over

The engine starting system may be malfunctioning due to an electrical problem such as electronic key battery depletion or a blown fuse. However, an interim measure is available to start the engine. (→P. 683)

**The starter motor does not turn over, the interior lights and headlights do not turn on, or the horn does not sound.**

One of the following may be the cause of the problem:

- One or both of the battery terminals may be disconnected.
- The battery may be discharged. (→P. 687)
- There may be a malfunction in the steering lock system.

Contact your Lexus dealer if the problem cannot be repaired, or if repair procedures are unknown.

**Emergency start function**

When the engine does not start, the following steps can be used as an interim measure to start the engine if the engine switch is functioning normally.

- 1 Turn the engine switch to IGNITION ON mode and check that the parking brake is set. (→P. 232, 247)
- 2 Shift the shift lever to P.
- 3 Turn the engine switch to ACCESSORY mode.
- 4 Press and hold the engine switch for about 15 seconds while depressing the brake pedal firmly.

Even if the engine can be started using the above steps, the system may be malfunctioning. Have the vehicle inspected by your Lexus dealer.

## If the electronic key does not operate properly

If communication between the electronic key and vehicle is interrupted (→P. 148) or the electronic key cannot be used because the battery is depleted, the smart access system with push-button start and wireless remote control cannot be used. In such cases, the doors can be opened and the engine can be started by following the procedure below.

### Locking and unlocking the doors

#### ■ Unlocking the door

Use the mechanical key (→P. 121) in order to perform the following operations:

- 1 Insert the mechanical key while pulling on the driver's door handle.

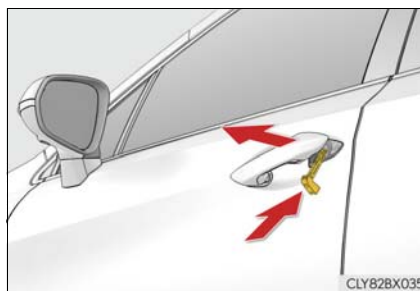

- 2 Unlocking the door.  
Turning the key rearward unlocks the driver's door. Turning the key again unlocks the other doors.

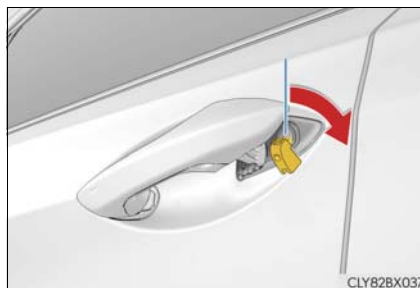

- 3 Remove the key, return the handle, and then pull the handle again.

### ■ Locking the door

- 1 With the door open, push down the inside lock button.

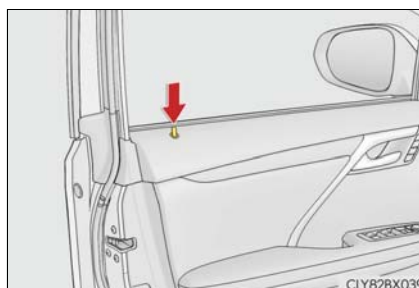

- 2 Close the door.

### ■ Key linked functions

- ① Closes the windows and the moon roof\* or panoramic moon roof\* (turn and hold)
- ② Opens the windows and the moon roof\* or panoramic moon roof\* (turn and hold)

These settings must be customized at your Lexus dealer.

\*: If equipped





### Starting the engine

- 1 Ensure that the shift lever is in P and depress the brake pedal.
- 2 Touch the Lexus emblem side of the electronic key to the engine switch.

When the electronic key is detected, a buzzer sounds and the engine switch will turn to IGNITION ON mode.

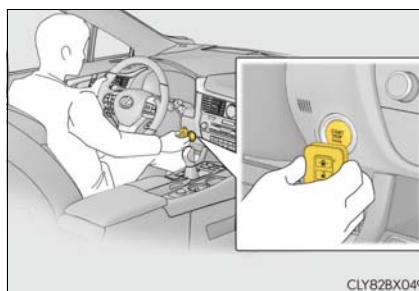
When the smart access system with push-button start is deactivated in customization setting, the engine switch will turn to ACCESSORY mode.



- 3 Firmly depress the brake pedal and check that  is shown on the multi-information display.
- 4 Press the engine switch shortly and firmly.

In the event that the engine still cannot be started, contact your Lexus dealer.

**■ Stopping the engine**

Shift the shift lever to P, set the parking brake, and press the engine switch as you normally do when stopping the engine.

**■ Replacing the key battery**

As the above procedure is a temporary measure, it is recommended that the electronic key battery be replaced immediately when the battery is depleted. (→P. 623)

**■ Changing engine switch modes**

Release the brake pedal and press the engine switch in step **3** above.

The engine does not start and modes will be changed each time the switch is pressed. (→P. 232)

**■ When the electronic key does not work properly**

- Make sure that the smart access system with push-button start has not been deactivated in the customization setting. If it is off, turn the function on. (Customizable features →P. 722)
- Check if battery-saving mode is set. If it is set, cancel the function. (→P. 148)

**WARNING****■ When using the mechanical key and operating the power windows or the moon roof or panoramic moon roof**

Operate the power window or the moon roof or panoramic moon roof after checking to make sure that there is no possibility of any passenger having any of their body parts caught in the window or the moon roof or panoramic moon roof.

Also, do not allow children to operate the mechanical key. It is possible for children and other passengers to get caught in the power window or the moon roof or panoramic moon roof.

## If the vehicle battery is discharged

The following procedures may be used to start the engine if the vehicle's battery is discharged.

You can also call your Lexus dealer or a qualified repair shop.

If you have a set of jumper (or booster) cables and a second vehicle with a battery, you can jump start your vehicle by following the steps below.

- 1 Confirm that the electronic key is being carried.

When connecting the jumper (or booster) cables, depending on the situation, the alarm may activate and doors locked. (→P. 78)



- 2 Open the hood (→P. 592)



- 3** Connect the jumper cables according to the following procedure:

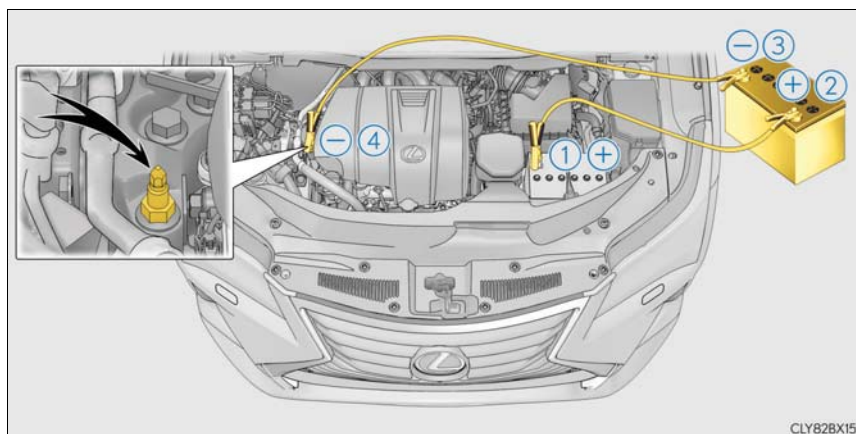

- ① Connect a positive jumper cable clamp to the positive (+) battery terminal on your vehicle.
  - ② Connect the clamp on the other end of the positive cable to the positive (+) battery terminal on the second vehicle.
  - ③ Connect a negative cable clamp to the negative (-) battery terminal on the second vehicle.
  - ④ Connect the clamp at the other end of the negative cable to a solid, stationary, unpainted metallic point away from the battery and any moving parts, as shown in the illustration.
- 4** Start the engine of the second vehicle. Increase the engine speed slightly and maintain at that level for approximately 5 minutes to recharge the battery of your vehicle.
  - 5** Open and close any of the doors of your vehicle with the engine switch off.
  - 6** Maintain the engine speed of the second vehicle and start the engine of your vehicle by turning the engine switch to IGNITION ON mode.
  - 7** Once the vehicle's engine has started, remove the jumper cables in the exact reverse order from which they were connected.

Once the engine starts, have the vehicle inspected at your Lexus dealer as soon as possible.

**■ Starting the engine when the battery is discharged**

The engine cannot be started by push-starting.

**■ To prevent battery discharge**

- Turn off the headlights and the audio system while the engine is off.
- Turn off any unnecessary electrical components when the vehicle is running at a low speed for an extended period, such as in heavy traffic.

**■ When removing the battery terminals**

When the battery terminals are removed, the information stored in the ECU is cleared. Before removing the battery terminals, contact your Lexus dealer.

**■ Charging the battery**

The electricity stored in the battery will discharge gradually even when the vehicle is not in use, due to natural discharge and the draining effects of certain electrical appliances. If the vehicle is left for a long time, the battery may discharge, and the engine may be unable to start. (The battery recharges automatically during driving.)

**■ When the battery is removed or discharged**

- In some cases, it may not be possible to unlock the doors using the smart access system with push-button start when the battery is discharged. Use the wireless remote control or the mechanical key to lock or unlock the doors.
- The engine may not start on the first attempt after the battery has recharged but will start normally after the second attempt. This is not a malfunction.
- The engine switch mode is memorized by the vehicle. When the battery is reconnected, the system will return to the mode it was in before the battery was discharged. Before disconnecting the battery, turn the engine switch off. If you are unsure what mode the engine switch was in before the battery discharged, be especially careful when reconnecting the battery.
- The power back door must be initialized. (→P. 138)

**■ When replacing the battery**

- Use a battery with the same case size as the previous battery and an equivalent 20 hour rate capacity (20HR) or greater.
  - If the sizes differ, the battery cannot be properly secured.
  - If the 20 hour rate capacity is low, even if the time period where the vehicle is not used is a short time, the battery may discharge and the engine may not be able to start.
- For details, consult your Lexus dealer.

 **WARNING****■ When removing the battery terminals**

Always remove the negative (-) terminal first. If the positive (+) terminal contacts any metal in the surrounding area when the positive (+) terminal is removed, a spark may occur, leading to a fire in addition to electrical shocks and death or serious injury.

**■ Avoiding battery fires or explosions**

Observe the following precautions to prevent accidentally igniting the flammable gas that may be emitted from the battery:

- Make sure each jumper cable is connected to the correct terminal and that it is not unintentionally in contact with any other than the intended terminal.
- Do not allow the other end of the jumper cable connected to the “+” terminal to come into contact with any other parts or metal surfaces in the area, such as brackets or unpainted metal.
- Do not allow the + and - clamps of the jumper cables to come into contact with each other.
- Do not smoke, use matches, cigarette lighters or allow open flame near the battery.

**■ Battery precautions**

The battery contains poisonous and corrosive acidic electrolyte, while related parts contain lead and lead compounds. Observe the following precautions when handling the battery:

- When working with the battery, always wear safety glasses and take care not to allow any battery fluids (acid) to come into contact with skin, clothing or the vehicle body.
- Do not lean over the battery.
- In the event that battery fluid comes into contact with the skin or eyes, immediately wash the affected area with water and seek medical attention.  
Place a wet sponge or cloth over the affected area until medical attention can be received.
- Always wash your hands after handling the battery support, terminals, and other battery-related parts.
- Do not allow children near the battery.

 **WARNING****■ When replacing the battery**

- When the vent plug and indicator are close to the hold down clamp, the battery fluid (sulfuric acid) may leak.
- For information regarding battery replacement, contact your Lexus dealer.

 **NOTICE****■ When handling jumper cables**

When connecting the jumper cables, ensure that they do not become entangled in the cooling fans or engine drive belt.

## If your vehicle overheats

The following may indicate that your vehicle is overheating.

- The needle of the engine coolant temperature gauge (→P. 86) enters the red zone, or a loss of engine power is experienced. (For example, the vehicle speed does not increase.)
- “Engine Coolant Temp High Stop in a Safe Place See Owner’s Manual” is shown on the multi-information display.
- Steam comes out from under the hood.

### Correction procedures

- 1 Stop the vehicle in a safe place and turn off the air conditioning system, and then stop the engine.
- 2 If you see steam:  
Carefully lift the hood after the steam subsides.  
If you do not see steam:  
Carefully lift the hood.

- 3 After the engine has cooled down sufficiently, inspect the hoses and radiator core (radiator) for any leaks.

- 1 Radiator
- 2 Cooling fans

If a large amount of coolant leaks, immediately contact your Lexus dealer.

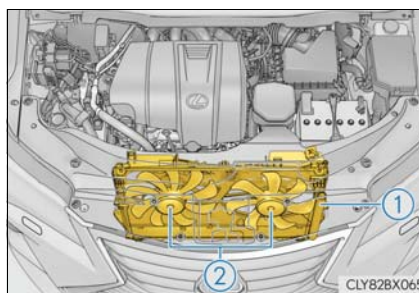

- 4 The coolant level is satisfactory if it is between the “FULL” and “LOW” lines on the reservoir.

- 1 Reservoir
- 2 “FULL” line
- 3 “LOW” line
- 4 Radiator cap

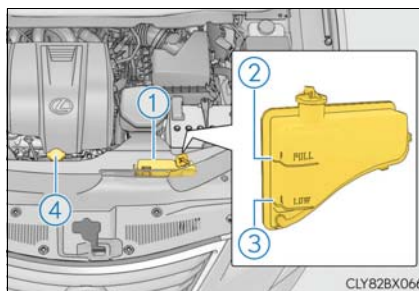

- 5** Add coolant if necessary.  
Water can be used in an emergency if coolant is unavailable.

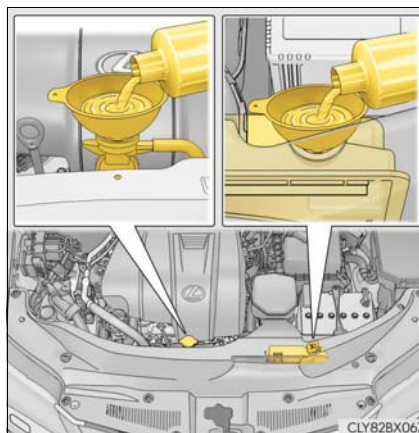

- 6** Start the engine and turn the air conditioning system on to check that the radiator cooling fans operate and to check for coolant leaks from the radiator or hoses.  
The fans operate when the air conditioning system is turned on immediately after a cold start. Confirm that the fans are operating by checking the fan sound and air flow. If it is difficult to check these, turn the air conditioning system on and off repeatedly. (The fans may not operate in freezing temperatures.)
- 7** If the fans are not operating:  
Stop the engine immediately and contact your Lexus dealer.  
If the fans are operating:  
Have the vehicle inspected at the nearest Lexus dealer.
- 8** Check if “Engine Coolant Temp High Stop in a Safe Place See Owner’s Manual” is shown on the multi-information display.  
If the message does not disappear:  
Stop the engine and contact your Lexus dealer.  
If the message is not displayed:  
Have the vehicle inspected at the nearest Lexus dealer.

 **WARNING****■ To prevent an accident or injury when inspecting under the hood of your vehicle**

Observe the following precautions.

Failure to do so may result in serious injury such as burns.

- If steam is seen coming from under the hood, do not open the hood until the steam has subsided. The engine compartment may be very hot.
- Keep hands and clothing (especially a tie, a scarf or a muffler) away from the fans and belts. Failure to do so may cause the hands or clothing to be caught, resulting in serious injury.
- Do not loosen the radiator cap and the coolant reservoir cap while the engine and radiator are hot.  
High temperature steam or coolant could spray out.

 **NOTICE****■ When adding engine coolant**

Add coolant slowly after the engine has cooled down sufficiently. Adding cool coolant to a hot engine too quickly can cause damage to the engine.

**■ To prevent damage to the cooling system**

Observe the following precautions:

- Avoid contaminating the coolant with foreign matter (such as sand or dust etc.).
- Do not use any coolant additive.

## If the vehicle becomes stuck

Carry out the following procedures if the tires spin or the vehicle becomes stuck in mud, dirt or snow:

- 1 Stop the engine. Shift the shift lever to P and set the parking brake.
- 2 Remove the mud, snow or sand from around the front wheels.
- 3 Place wood, stones or some other material under the front wheels to help provide traction.
- 4 Restart the engine.
- 5 AWD models: Activate all-wheel drive lock mode. (→P. 377)
- 6 Shift the shift lever to D or R and release the parking brake. Then, while exercising caution, depress the accelerator pedal.

### ■ When it is difficult to free the vehicle

Press  to turn off TRAC.





 **WARNING****■ When attempting to free a stuck vehicle**

If you choose to push the vehicle back and forth to free it, make sure the surrounding area is clear to avoid striking other vehicles, objects or people. The vehicle may also lunge forward or lunge back suddenly as it becomes free. Use extreme caution.

**■ When shifting the shift lever**

Be careful not to shift the shift lever with the accelerator pedal depressed. This may lead to unexpected rapid acceleration of the vehicle that may cause an accident resulting in death or serious injury.

 **NOTICE****■ To avoid damage to the transmission and other components**

- Avoid spinning the front wheels and depressing the accelerator pedal more than necessary.
- If the vehicle remains stuck even after these procedures are performed, the vehicle may require towing to be freed.
- When a warning message for the automatic transmission fluid temperature is displayed while attempting to free a stuck vehicle, immediately remove your foot from the accelerator pedal and wait until the warning message disappears. Otherwise, the transmission may become damaged. (→P. 662)

Vehicle specifications

9

9-1. Specifications

- Maintenance data (fuel, oil level, etc.) .....698
- Fuel information.....706
- Tire information .....709

9-2. Customization

- Customizable features ..... 722

9-3. Initialization

- Items to initialize ..... 735

**Maintenance data (fuel, oil level, etc.)**

**Dimensions and weight**

Overall length		192.5 in. (4890 mm) <sup>*1</sup> 196.9 in. (5000 mm) <sup>*2</sup>
Overall width		74.6 in. (1895 mm)
Overall height <sup>*3</sup>		67.7 in. (1720 mm)
Wheelbase		109.8 in. (2790 mm)
Tread	Front	64.4 in. (1635 mm) <sup>*1</sup> 64.5 in. (1640 mm) <sup>*2</sup>
	Rear	64.0 in. (1625 mm) <sup>*1</sup> 64.1 in. (1630 mm) <sup>*2</sup>
Vehicle capacity weight (Occupants + luggage)		1050 lb. (480 kg) <sup>*1,5</sup> 920 lb. (420 kg) <sup>*1,6</sup> 1140 lb. (520 kg) <sup>*2,7</sup> 1235 lb. (560 kg) <sup>*2,8</sup>
Trailer Weight Rating <sup>*4</sup> (Trailer weight + cargo weight)		3500 lb. (1585 kg)

\*1: RX350

\*2: RX350L

\*3: Unladen vehicle

\*4: Vehicles with towing package

\*5: For GGL25L-BWZGBA models<sup>\*9</sup>

\*6: Except for GGL25L-BWZGBA models<sup>\*9</sup>

\*7: Vehicles with separate seat

\*8: Vehicles with bench seat

\*9: The model code is indicated on the Certification Label. (→P. 699)

## Vehicle identification

### ■ Vehicle identification number

The vehicle identification number (VIN) is the legal identifier for your vehicle. This is the primary identification number for your Lexus. It is used in registering the ownership of your vehicle.

This number is stamped on the top left of the instrument panel.



This number is also on the Certification Label.

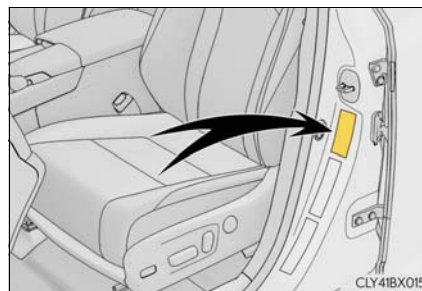

On some models, this number is also stamped under the right-hand front seat.

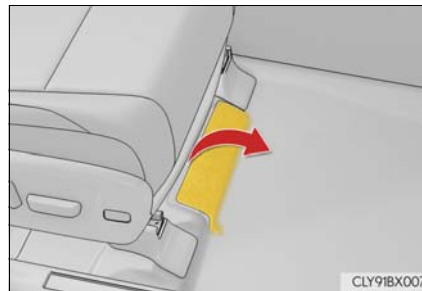

■ Engine number

The engine number is stamped on the engine block as shown.

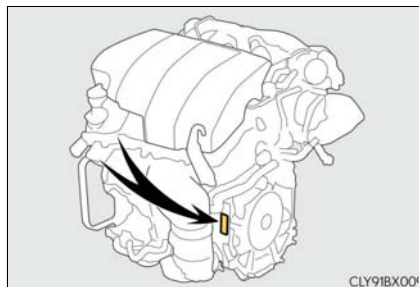

**Engine**

Model	3.5 L 6-cylinder (2GR-FKS)
Type	6-cylinder V type, 4-cycle, gasoline
Bore and stroke	3.70 × 3.27 in. (94.0 × 83.0 mm)
Displacement	210.9 cu. in. (3456 cm <sup>3</sup> )
Valve clearance (engine cold)	Automatic adjustment
Drive belt tension	Automatic adjustment

**Fuel**

Fuel type	Unleaded gasoline only
Octane Rating	87 (Research Octane Number 91) or higher
Fuel tank capacity (Reference)	19.2 gal. (72.5 L, 15.9 Imp. gal.)

**Lubrication system**

Oil capacity (Drain and refill - reference <sup>*</sup> )	
With filter	<ul style="list-style-type: none"> <li>▶ Vehicles with towing package 5.8 qt. (5.5 L, 4.8 Imp. qt.)</li> <li>▶ Vehicles without towing package 5.7 qt. (5.4 L, 4.8 Imp. qt.)</li> </ul>
Without filter	5.6 qt. (5.3 L, 4.7 Imp. qt.)

<sup>\*</sup>: The engine oil capacity is a reference quantity to be used when changing the engine oil. Warm up and turn off the engine, wait more than 5 minutes, and check the oil level on the dipstick.

### ■ Engine oil selection

“Toyota Genuine Motor Oil” is used in your Lexus vehicle. Use Lexus approved “Toyota Genuine Motor Oil” or equivalent to satisfy the following grade and viscosity.

Oil grade: ILSAC GF-5 multigrade engine oil

Recommended viscosity: SAE 0W-20

SAE 0W-20 is the best choice for good fuel economy and good starting in cold weather.

If SAE 0W-20 is not available, SAE 5W-20 oil may be used. However, it must be replaced with SAE 0W-20 at the next oil change.

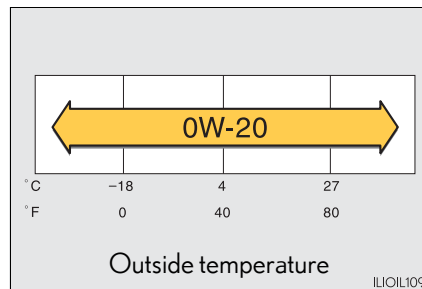

Oil viscosity (0W-20 is explained here as an example):

- The 0W in 0W-20 indicates the characteristic of the oil which allows cold startability. Oils with a lower value before the W allow for easier starting of the engine in cold weather.
- The 20 in 0W-20 indicates the viscosity characteristic of the oil when the oil is at high temperature. An oil with a higher viscosity (one with a higher value) may be better suited if the vehicle is operated at high speeds, or under extreme load conditions.

How to read oil container label:

The International Lubricant Specification Advisory Committee (ILSAC) Certification Mark is added to some oil containers to help you select the oil you should use.



### Cooling system

Capacity*	<ul style="list-style-type: none"> <li>▶ RX350 (Vehicles without towing package) 9.5 qt. (9.0 L, 7.9 Imp. qt.)</li> <li>▶ RX350 (Vehicles with towing package) 10.5 qt. (9.9 L, 8.7 Imp. qt.)</li> <li>▶ RX350L 13.1 qt. (12.4 L, 11 Imp. qt.)</li> </ul>
Coolant type	<p>Use either of the following:</p> <ul style="list-style-type: none"> <li>• "Toyota Super Long Life Coolant"</li> <li>• Similar high-quality ethylene glycol-based non-silicate, non-amine, non-nitrite, and non-borate coolant with long-life hybrid organic acid technology</li> </ul> <p>Do not use plain water alone.</p>

\*: The coolant capacity is a reference quantity.  
If replacement is necessary, contact your Lexus dealer.

### Ignition system (spark plug)

Make	DENSO FK20HBR8
Gap	0.03 in. (0.8 mm)

 NOTICE

■ Iridium-tipped spark plugs

Use only iridium-tipped spark plugs. Do not adjust the spark plug gap.

### Electrical system

Battery	
Open voltage at 68°F (20°C):	<p>12.6 V or higher: Fully charged            12.2 – 12.4 V: Half charged            12.0 V or lower: Discharged            (Turn the engine switch off and turn on the headlights for 20 to 30 seconds.)</p>
Charging rates	5 A max.

### Automatic transmission

Fluid capacity*	7.2 qt. (6.8 L, 6.0 Imp. qt.)
Fluid type	Toyota Genuine ATF WS

\*: The fluid capacity is a reference quantity.

If replacement is necessary, contact your Lexus dealer.

#### NOTICE

##### ■ Transmission fluid type

Using transmission fluid other than “Toyota Genuine ATF WS” may cause deterioration in shift quality, locking up of your transmission accompanied by vibration, and ultimately damage the transmission of your vehicle.

### Transfer (AWD models)

Oil capacity	0.8 qt. (0.8 L, 0.7 Imp. qt.)
Oil type and viscosity	Toyota Genuine Differential gear oil LT 75W-85 GL-5 or equivalent

Your Lexus vehicle is filled with “Toyota Genuine Differential Gear Oil” at the factory.

Use Lexus approved “Toyota Genuine Differential Gear Oil” or an equivalent of matching quality to satisfy the above specification. Please contact your Lexus dealer for further details.

### Rear differential (AWD models)

Oil capacity	0.5 qt. (0.5 L, 0.4 Imp. qt.)
Oil type and viscosity	Toyota Genuine Differential gear oil LT 75W-85 GL-5 or equivalent

Your Lexus vehicle is filled with “Toyota Genuine Differential Gear Oil” at the factory.

Use Lexus approved “Toyota Genuine Differential Gear Oil” or an equivalent of matching quality to satisfy the above specification. Please contact your Lexus dealer for further details.



### Brakes

Pedal clearance*	3.4 in. (86 mm) Min.
Brake pad wear limit	0.04 in. (1.0 mm)
Pedal free play	0.04 – 0.24 in. (1.0 – 6.0 mm)
Fluid type	FMVSS No. 116 DOT 3 or SAE J1703

\*: Minimum pedal clearance when depressed with a force of 110 lbf (490 N, 50.0 kgf) while the engine is running.

### Steering

Free play	Less than 1.2 in. (30 mm)
-----------	---------------------------

### Tires and wheels

► Type A

Tire size	235/65R18 106V, T165/90D18 107M (spare)
Tire inflation pressure (Recommended cold tire inflation pressure)	<ul style="list-style-type: none"> <li>► Front tire 33 psi (230 kPa, 2.3 kgf/cm<sup>2</sup> or bar)</li> <li>► Rear tire 33 psi (230 kPa, 2.3 kgf/cm<sup>2</sup> or bar)</li> <li>► Spare tire 60 psi (420 kPa, 4.2 kgf/cm<sup>2</sup> or bar)</li> </ul> Driving at high speeds (above 100 mph [160 km/h]) (in countries where such speeds are permitted by law) Add 5 psi (30 kPa, 0.3 kgf/cm <sup>2</sup> or bar) to the front and rear tires. Never exceed the maximum cold tire inflation pressure indicated on the tire sidewall.
Wheel size	18 × 8 J, 18 × 4 T (spare)
Wheel nut torque	76 ft•lbf (103 N•m, 10.5 kgf•m)

## ► Type B

Tire size	235/55R20 102V, T165/90D18 107M (spare)
Tire inflation pressure (Recommended cold tire inflation pressure)	<ul style="list-style-type: none"> <li>► Front tire 33 psi (230 kPa, 2.3 kgf/cm<sup>2</sup> or bar)</li> <li>► Rear tire 33 psi (230 kPa, 2.3 kgf/cm<sup>2</sup> or bar)</li> <li>► Spare tire 60 psi (420 kPa, 4.2 kgf/cm<sup>2</sup> or bar)</li> </ul> Driving at high speeds (above 100 mph [160 km/h]) (in countries where such speeds are permitted by law) Add 11 psi (70 kPa, 0.7 kgf/cm <sup>2</sup> or bar) to the front and rear tires. Never exceed the maximum cold tire inflation pressure indicated on the tire sidewall.
Wheel size	20 × 8 J, 18 × 4 T (spare)
Wheel nut torque	76 ft•lbf (103 N•m, 10.5 kgf•m)

## Light bulbs

	Light bulbs	Bulb No.	W	Type
Exterior	Front side marker lights <sup>*1</sup>	—	5	B
	Front turn signal lights <sup>*1</sup>	7444NA	28/8	A
	Rear turn signal lights <sup>*1</sup>	—	21	A
	Back-up lights	921	16	B
Interior	Door courtesy lights <sup>*2</sup>	—	5	B
	Vanity lights	—	8	B
	Luggage compartment light	—	5	B

A: Wedge base bulbs (amber)

B: Wedge base bulbs (clear)

<sup>\*1</sup>: Vehicles with single-beam headlights<sup>\*2</sup>: Vehicles without door trim ornament lights

## Fuel information

**You must only use unleaded gasoline.**

**Select octane rating 87 (Research Octane Number 91) or higher. Use of unleaded gasoline with an octane rating lower than 87 may result in engine knocking. Persistent knocking can lead to engine damage.**

At minimum, the gasoline you use should meet the specifications of ASTM D4814 in the U.S.A.

### ■ Gasoline quality

In very few cases, driveability problems may be caused by the brand of gasoline you are using. If driveability problems persist, try changing the brand of gasoline. If this does not correct the problem, consult your Lexus dealer.

### ■ Gasoline quality standards

- Automotive manufacturers in the U.S.A., Europe and Japan have developed a specification for fuel quality called the World-Wide Fuel Charter (WWFC), which is expected to be applied worldwide.
- The WWFC improves air quality by lowering emissions in vehicle fleets, and improves customer satisfaction through better performance.

### ■ Recommendation of the use of gasoline containing detergent additives

- Lexus recommends the use of gasoline that contains detergent additives to avoid the build-up of engine deposits.
- All gasoline sold in the U.S.A. contains minimum detergent additives to clean and/or keep clean intake systems, per EPA's lowest additives concentration program.
- Lexus strongly recommends the use of Top Tier Detergent Gasoline. For more information on Top Tier Detergent Gasoline and a list of marketers, please go to the official website [www.toptiergas.com](http://www.toptiergas.com).

### ■ Recommendation of the use of low emissions gasoline

Gasolines containing oxygenates such as ethers and ethanol, as well as reformulated gasolines, are available in some cities. These fuels are typically acceptable for use, providing they meet other fuel requirements.

Lexus recommends these fuels, since the formulations allow for reduced vehicle emissions.

### ■ Non-recommendation of the use of blended gasoline

- Use only gasoline containing up to 15% ethanol.

DO NOT use any flex-fuel or gasoline that could contain more than 15% ethanol, including from any pump labeled E30, E50, E85 (which are only some examples of fuel containing more than 15% ethanol).

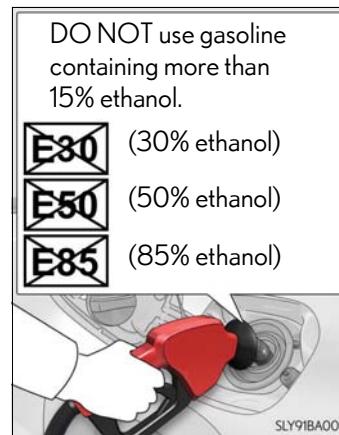

- If you use gasohol in your vehicle, be sure that it has an octane rating no lower than 87.
- Lexus does not recommend the use of gasoline containing methanol.

### ■ Non-recommendation of the use of gasoline containing MMT

Some gasoline contains an octane enhancing additive called MMT (Methylcyclopentadienyl Manganese Tricarbonyl).

Lexus does not recommend the use of gasoline that contains MMT. If fuel containing MMT is used, your emission control system may be adversely affected.

The malfunction indicator lamp on the instrument cluster may come on. If this happens, contact your Lexus dealer for service.

### ■ If your engine knocks

- Consult your Lexus dealer.
- You may occasionally notice light knocking for a short time while accelerating or driving uphill. This is normal and there is no need for concern.

 NOTICE

■ **Notice on fuel quality**

- Do not use improper fuels. If improper fuels are used, the engine will be damaged.
- Do not use leaded gasoline.  
Leaded gasoline can cause damage to your vehicle's three-way catalytic converters causing the emission control system to malfunction.
- Do not use gasohol other than the type previously stated.  
Other gasohol may cause fuel system damage or vehicle performance problems.
- Using unleaded gasoline with an octane number or rating lower than the level previously stated will cause persistent heavy knocking.  
At worst, this will lead to engine damage.

■ **Fuel-related poor driveability**

If poor driveability (poor hot starting, vaporization, engine knocking, etc.) is encountered after using a different type of fuel, discontinue the use of that type of fuel.

■ **When refueling with gasohol**

Take care not to spill gasohol. It can damage your vehicle's paint.

## Tire information

### Typical tire symbols

► Full-size tire

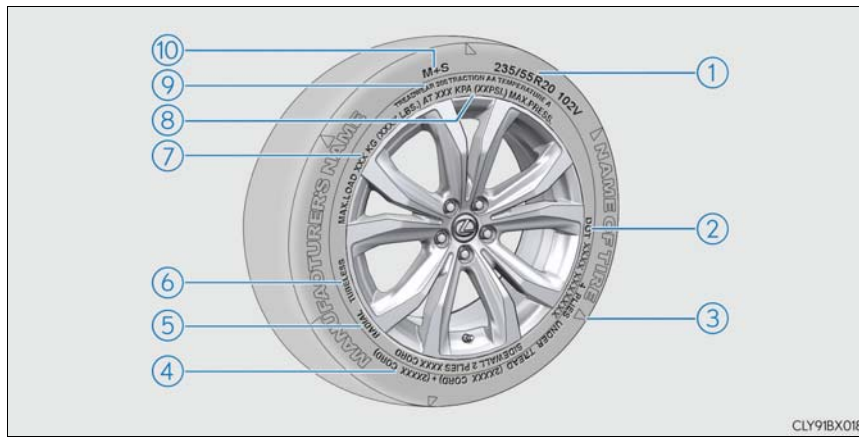

► Compact spare tire

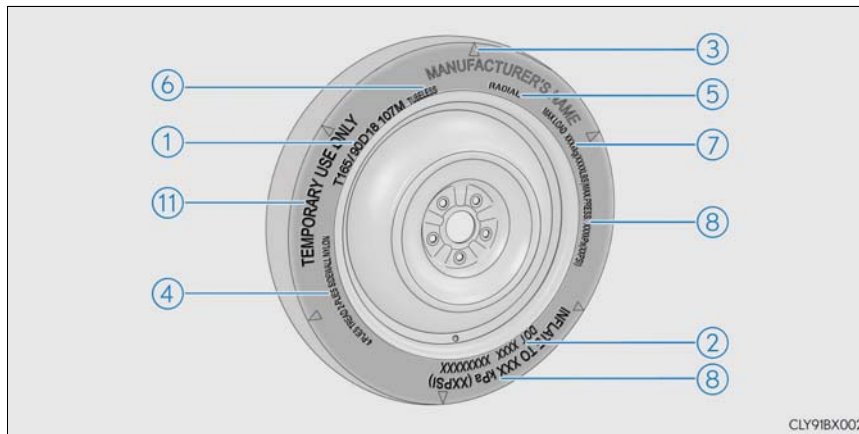

- ① Tire size (→P. 712)
- ② DOT and Tire Identification Number (TIN) (→P. 711)
- ③ Location of treadwear indicators (→P. 604)
- ④ Tire ply composition and materials  
Plies are layers of rubber-coated parallel cords. Cords are the strands which form the plies in a tire.
- ⑤ Radial tires or bias-ply tires  
A radial tire has "RADIAL" on the sidewall. A tire not marked "RADIAL" is a bias-ply tire.
- ⑥ TUBELESS or TUBE TYPE  
A tubeless tire does not have a tube and air is directly put into the tire. A tube type tire has a tube inside the tire and the tube maintains the air pressure.
- ⑦ Load limit at maximum cold tire inflation pressure (→P. 608)
- ⑧ Maximum cold tire inflation pressure (→P. 704)  
This means the pressure to which a tire may be inflated.
- ⑨ Uniform tire quality grading  
For details, see "Uniform Tire Quality Grading" that follows.
- ⑩ Summer tires or all season tires (→P. 608)  
An all season tire has "M+S" on the sidewall. A tire not marked "M+S" is a summer tire.
- ⑪ "TEMPORARY USE ONLY"  
A compact spare tire is identified by the phrase "TEMPORARY USE ONLY" molded on its sidewall. This tire is designed for temporary emergency use only.

### Typical DOT and Tire Identification Number (TIN)

#### ▶ Type A

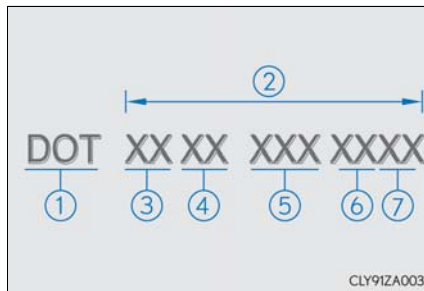

#### ▶ Type B

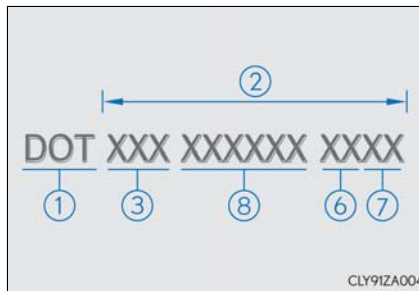

- ① DOT symbol\*
- ② Tire Identification Number (TIN)
- ③ Tire manufacturer's identification mark
- ④ Tire size code
- ⑤ Manufacturer's optional tire type code (3 or 4 letters)
- ⑥ Manufacturing week
- ⑦ Manufacturing year
- ⑧ Manufacturer's code

\*: The DOT symbol certifies that the tire conforms to applicable Federal Motor Vehicle Safety Standards.



### Tire size

#### ■ Typical tire size information

The illustration indicates typical tire size.

- ① Tire use  
(P = Passenger car,  
T = Temporary use)
- ② Section width (millimeters)
- ③ Aspect ratio  
(tire height to section width)
- ④ Tire construction code  
(R = Radial, D = Diagonal)
- ⑤ Wheel diameter (inches)
- ⑥ Load index (2 digits or 3 digits)
- ⑦ Speed symbol (alphabet with one letter)

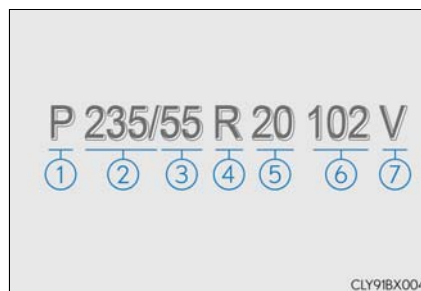

#### ■ Tire dimensions

- ① Section width
- ② Tire height
- ③ Wheel diameter

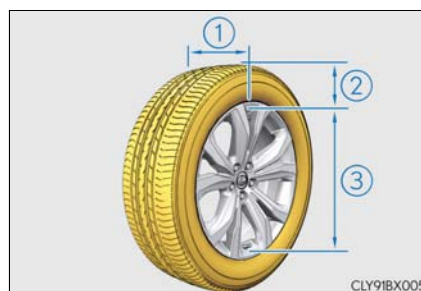

**Tire section names**

- ① Bead
- ② Sidewall
- ③ Shoulder
- ④ Tread
- ⑤ Belt
- ⑥ Inner liner
- ⑦ Reinforcing rubber
- ⑧ Carcass
- ⑨ Rim lines
- ⑩ Bead wires
- ⑪ Chafer

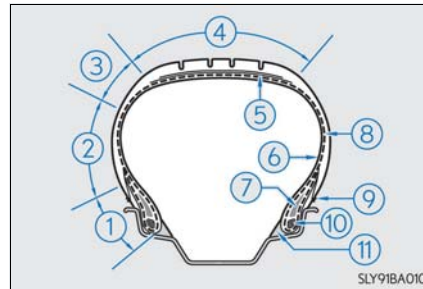

### Uniform Tire Quality Grading

This information has been prepared in accordance with regulations issued by the National Highway Traffic Safety Administration of the U.S. Department of Transportation.

It provides the purchasers and/or prospective purchasers of Lexus vehicles with information on uniform tire quality grading.

Your Lexus dealer will help answer any questions you may have as you read this information.

#### ■ DOT quality grades

All passenger vehicle tires must conform to Federal Safety Requirements in addition to these grades. Quality grades can be found where applicable on the tire sidewall between tread shoulder and maximum section width.

For example: Treadwear 200 Traction AA Temperature A

#### ■ Treadwear

The treadwear grade is a comparative rating based on the wear rate of the tire when tested under controlled conditions on a specified government test course.

For example, a tire graded 150 would wear one and a half (1 - 1/2) times as well on the government course as a tire graded 100.

The relative performance of tires depends upon the actual conditions of their use. Performance may differ significantly from the norm due to variations in driving habits, service practices and differences in road characteristics and climate.

#### ■ Traction AA, A, B, C

The traction grades, from highest to lowest, are AA, A, B and C, and they represent the tire's ability to stop on wet pavement as measured under controlled conditions on specified government test surfaces of asphalt and concrete.

A tire marked C may have poor traction performance.

Warning: The traction grade assigned to this tire is based on braking (straight ahead) traction tests and does not include cornering (turning) traction.

### ■ Temperature A, B, C

The temperature grades are A (the highest), B, and C, representing the tire's resistance to the generation of heat and its ability to dissipate heat when tested under controlled conditions on a specified indoor laboratory test wheel.

Sustained high temperature can cause the material of the tire to degenerate and reduce tire life, and excessive temperature can lead to sudden tire failure.

Grade C corresponds to a level of performance which all passenger car tires must meet under the Federal Motor Vehicle Safety Standard No. 109.

Grades B and A represent higher levels of performance on the laboratory test wheel than the minimum required by law.

Warning: The temperature grades of a tire assume that it is properly inflated and not overloaded.

Excessive speed, underinflation, or excessive loading, either separately or in combination, can cause heat buildup and possible tire failure.

### Glossary of tire terminology

Tire related term	Meaning
Cold tire inflation pressure	Tire pressure when the vehicle has been parked for three hours or more, or has not been driven more than 1 mile or 1.5 km under that condition
Maximum inflation pressure	The maximum cold inflated pressure to which a tire may be inflated, shown on the sidewall of the tire
Recommended inflation pressure	Cold tire inflation pressure recommended by a manufacturer
Accessory weight	The combined weight (in excess of those standard items which may be replaced) of automatic transmission, power steering, power brakes, power windows, power seats, radio and heater, to the extent that these items are available as factory-installed equipment (whether installed or not)
Curb weight	The weight of a motor vehicle with standard equipment, including the maximum capacity of fuel, oil and coolant, and if so equipped, air conditioning and additional weight optional engine
Maximum loaded vehicle weight	The sum of: (a) Curb weight (b) Accessory weight (c) Vehicle capacity weight (d) Production options weight
Normal occupant weight	150 lb. (68 kg) times the number of occupants specified in the second column of Table 1* that follows
Occupant distribution	Distribution of occupants in a vehicle as specified in the third column of Table 1* below

Tire related term	Meaning
Production options weight	The combined weight of installed regular production options weighing over 5 lb. (2.3 kg) in excess of the standard items which they replace, not previously considered in curb weight or accessory weight, including heavy duty brakes, ride levelers, roof rack, heavy duty battery, and special trim
Rim	A metal support for a tire or a tire and tube assembly upon which the tire beads are seated
Rim diameter (Wheel diameter)	Nominal diameter of the bead seat
Rim size designation	Rim diameter and width
Rim type designation	The industry manufacturer's designation for a rim by style or code
Rim width	Nominal distance between rim flanges
Vehicle capacity weight (Total load capacity)	The rated cargo and luggage load plus 150 lb. (68 kg) times the vehicle's designated seating capacity
Vehicle maximum load on the tire	The load on an individual tire that is determined by distributing to each axle its share of the maximum loaded vehicle weight, and dividing by two
Vehicle normal load on the tire	The load on an individual tire that is determined by distributing to each axle its share of curb weight, accessory weight, and normal occupant weight (distributed in accordance with Table 1* below), and dividing by two
Weather side	The surface area of the rim not covered by the inflated tire
Bead	The part of the tire that is made of steel wires, wrapped or reinforced by ply cords and that is shaped to fit the rim

Tire related term	Meaning
Bead separation	A breakdown of the bond between components in the bead
Bias ply tire	A pneumatic tire in which the ply cords that extend to the beads are laid at alternate angles substantially less than 90 degrees to the centerline of the tread
Carcass	The tire structure, except tread and sidewall rubber which, when inflated, bears the load
Chunking	The breaking away of pieces of the tread or sidewall
Cord	The strands forming the plies in the tire
Cord separation	The parting of cords from adjacent rubber compounds
Cracking	Any parting within the tread, sidewall, or innerliner of the tire extending to cord material
CT	A pneumatic tire with an inverted flange tire and rim system in which the rim is designed with rim flanges pointed radially inward and the tire is designed to fit on the underside of the rim in a manner that encloses the rim flanges inside the air cavity of the tire
Extra load tire	A tire designed to operate at higher loads and at higher inflation pressures than the corresponding standard tire
Groove	The space between two adjacent tread ribs
Innerliner	The layer(s) forming the inside surface of a tubeless tire that contains the inflating medium within the tire
Innerliner separation	The parting of the innerliner from cord material in the carcass

Tire related term	Meaning
Intended outboard sidewall	(a) The sidewall that contains a whitewall, bears white lettering, or bears manufacturer, brand, and/or model name molding that is higher or deeper than the same molding on the other sidewall of the tire, or (b) The outward facing sidewall of an asymmetrical tire that has a particular side that must always face outward when mounted on a vehicle
Light truck (LT) tire	A tire designated by its manufacturer as primarily intended for use on lightweight trucks or multipurpose passenger vehicles
Load rating	The maximum load that a tire is rated to carry for a given inflation pressure
Maximum load rating	The load rating for a tire at the maximum permissible inflation pressure for that tire
Maximum permissible inflation pressure	The maximum cold inflation pressure to which a tire may be inflated
Measuring rim	The rim on which a tire is fitted for physical dimension requirements
Open splice	Any parting at any junction of tread, sidewall, or innerliner that extends to cord material
Outer diameter	The overall diameter of an inflated new tire
Overall width	The linear distance between the exteriors of the sidewalls of an inflated tire, including elevations due to labeling, decorations, or protective bands or ribs
Passenger car tire	A tire intended for use on passenger cars, multipurpose passenger vehicles, and trucks, that have a gross vehicle weight rating (GVWR) of 10,000 lb. or less.
Ply	A layer of rubber-coated parallel cords
Ply separation	A parting of rubber compound between adjacent plies



Tire related term	Meaning
Pneumatic tire	A mechanical device made of rubber, chemicals, fabric and steel or other materials, that, when mounted on an automotive wheel, provides the traction and contains the gas or fluid that sustains the load
Radial ply tire	A pneumatic tire in which the ply cords that extend to the beads are laid at substantially 90 degrees to the centerline of the tread
Reinforced tire	A tire designed to operate at higher loads and at higher inflation pressures than the corresponding standard tire
Section width	The linear distance between the exteriors of the sidewalls of an inflated tire, excluding elevations due to labeling, decoration, or protective bands
Sidewall	That portion of a tire between the tread and bead
Sidewall separation	The parting of the rubber compound from the cord material in the sidewall
Snow tire	A tire that attains a traction index equal to or greater than 110, compared to the ASTM E-1136 Standard Reference Test Tire, when using the snow traction test as described in ASTM F-1805-00, Standard Test Method for Single Wheel Driving Traction in a Straight Line on Snow-and Ice-Covered Surfaces, and which is marked with an Alpine Symbol (  ) on at least one sidewall
Test rim	The rim on which a tire is fitted for testing, and may be any rim listed as appropriate for use with that tire
Tread	That portion of a tire that comes into contact with the road
Tread rib	A tread section running circumferentially around a tire

Tire related term	Meaning
Tread separation	Pulling away of the tread from the tire carcass
Treadwear indicators (TWI)	The projections within the principal grooves designed to give a visual indication of the degrees of wear of the tread
Wheel-holding fixture	The fixture used to hold the wheel and tire assembly securely during testing

\*: Table 1— Occupant loading and distribution for vehicle normal load for various designated seating capacities

Designated seating capacity, Number of occupants	Vehicle normal load, Number of occupants	Occupant distribution in a normally loaded vehicle
2 through 4	2	2 in front
5 through 10	3	2 in front, 1 in second seat
11 through 15	5	2 in front, 1 in second seat, 1 in third seat, 1 in fourth seat
16 through 20	7	2 in front, 2 in second seat, 2 in third seat, 1 in fourth seat

## Customizable features

Your vehicle includes a variety of electronic features that can be personalized to suit your preferences. The settings of these features can be changed using the multi-information display, on the audio system screen, or at your Lexus dealer.

### Customizing vehicle features

When customizing vehicle features, ensure that the vehicle is parked in a safe place with the shift lever in P and the parking brake set.

#### ■ Changing on the audio system screen

- ▶ Vehicles with a navigation system

**1** Press the "MENU" button on the Remote Touch.

**2** Select  on the "Menu" screen and select .

Various setting can be changed. Refer to the list of settings that can be changed for details.

- ▶ Vehicles with a Lexus Display Audio system

**1** Press the "MENU" button on the Lexus Display Audio controller.

**2** Select "Setup" on the "Menu" screen and select "Vehicle".

Various setting can be changed. Refer to the list of settings that can be changed for details.

#### ■ Changing using the multi-information display

→P. 97



### Customizable Features

Some function settings are changed simultaneously with other functions being customized. Contact your Lexus dealer for further details.

- ① Settings that can be changed on the audio system screen
- ② Settings that can be changed by your Lexus dealer

Definition of symbols: ○ = Available, - =Not available

#### ■ Gauges, meters and multi-information display (→P. 86, 90)

Function	Default setting	Customized setting	①	②
Language	English	French	○	-
		Spanish		
Units*1	miles (MPG US)	miles (MPG Imperial)	○	-
		km (L/100 km)		
		km (km/L)		
Color*2	Color 1 	Color 2 	○	-
Suggestion function	On	Off	-	○

\*1: The default setting varies according to countries.

\*2: Except F SPORT models

■ Door lock (→P. 124, 684)

Function	Default setting	Customized setting	①	②
Unlocking using a mechanical key	Driver's door unlocked in one step, all doors unlocked in two step	All doors unlocked in one step	-	○
Automatic door locking function	Shift position linked door locking operation	Off		
		Speed linked door locking operation	○	○
Automatic door unlocking function	Shift position linked door unlocking operation	Off		
		Driver's door linked door unlocking operation	○	○

## ■ Power back door (→P. 130)

Function	Default setting	Customized setting	①	②
Power back door switch operation	Press for 1 second	One short press	–	○
Automatic closing of the back door when lowered	On	Off	–	○
Automatic opening of the back door using the back door opener switch	On	Off	–	○
Power back door opening position	5	1 to 5	○	○
Buzzer volume	Level 3	Level 1	–	○
		Level 2		
Power back door/touchless sensor*	On	Power back door: On Touchless sensor: Off	–	○
		Off		
Power back door open/close buzzer	When the back door begins to operate: On While the back door is operating: Off	Off	–	○
		When the back door begins to operate: Off While the back door is operating: On On		
Touchless sensor* sensitivity	Level 2 (standard)	Level 1 (lowest) to level 3 (highest)	–	○

\*: If equipped



■ Smart access system with push-button start and wireless remote control (→P. 124, 146)

Function	Default setting	Customized setting	①	②
Operation buzzer volume	5	Off	<input type="radio"/>	<input type="radio"/>
		1 to 7		
Operation signal (Emergency flashers)	On	Off	<input type="radio"/>	<input type="radio"/>
Time elapsed before automatic door lock function is activated if door is not opened after being unlocked	60 seconds	Off	-	<input type="radio"/>
		30 seconds		
		120 seconds		
Open door warning buzzer	Off	On	-	<input type="radio"/>
Reservation lock	On	Off	-	<input type="radio"/>

■ Smart access system with push-button start (→P. 124, 146)

Function	Default setting	Customized setting	①	②
Smart access system with push-button start	On	Off	-	<input type="radio"/>
The doors that are unlocked using the smart access system with push-button start can be selected	Driver's door	All the doors	<input type="radio"/>	<input type="radio"/>
Number of consecutive door lock operations	2 times	As many as desired	-	<input type="radio"/>

■ Wireless remote control (→P. 120, 124, 130)

Function	Default setting	Customized setting	①	②
Wireless remote control	On	Off	–	○
Unlocking operation	Driver's door unlocked in one step, all doors unlocked in two step	All doors unlocked in one step	○	○
Panic function	On	Off	–	○
Opening/closing of the power back door using the  HOLD switch of the wireless remote control	Open: Press for 1 second* <sup>1</sup> Close: Press for 1 second	Off	–	○
		Open: Press for 1 second with the back door unlocked Close: Press for 1 second		
		Open: One short press with the back door unlocked Close: One short press		
		Open: Press twice with the back door unlocked Close: Press twice		
		Open: Press twice* <sup>1</sup> Close: Press twice		
Door unlocked when the power back door is opened using the  HOLD switch of the wireless remote control* <sup>2</sup>	All the doors	Back door	–	○

\*<sup>1</sup>: This setting enables opening of the power back door when it is locked or unlocked.

\*<sup>2</sup>: This function is available only when a customized setting that enables opening of the power back door when it is either locked or unlocked is selected. (See \*<sup>1</sup> above.)



■ Driving position memory\* (→P. 172)

Function	Default setting	Customized setting	①	②
Driver's seat movement when exiting the vehicle	Standard	Off	○	○
		Partial		
Selecting doors linked to the memory recall function	Driver's door	All doors	–	○

\*: If equipped

■ Steering wheel (→P. 180)

Function	Default setting	Customized setting	①	②
Auto tilt away function	On	Off	–	○

■ Outside rear view mirrors (→P. 184)

Function	Default setting	Customized setting	①	②
Automatic mirror folding and extending operation*	Linked to the locking/unlocking of the doors	Off	–	○
		Linked to operation of the engine switch		

\*: If equipped

■ Power windows, and moon roof\* or panoramic moon roof\*  
(→P. 187, 191, 195)

Function	Default setting	Customized setting	①	②
Mechanical key linked operation	Off	On	–	○
Wireless remote control linked operation	Off	On (open only)	–	○
Wireless remote control linked operation signal (buzzer)	On	Off	–	○

\*: If equipped

■ Moon roof\* (→P. 191)

Function	Default setting	Customized setting	①	②
Linked operation of components when mechanical key is used (open only)	Slide only	Tilt only	–	○
Linked operation of components when wireless remote control is used	Slide only	Tilt only	–	○

\*: If equipped

■ Turn signal lever (→P. 246)

Function	Default setting	Customized setting	①	②
The number of times the turn signal lights flash automatically when the turn signal lever is moved to the first position during a lane change	3	5	-	○
		7		
		Off		

■ Automatic light control system (→P. 252)

Function	Default setting	Customized setting	①	②
Light sensor sensitivity	Standard	-2 to 2	○	○
Time elapsed before headlights automatically turn off after doors are closed	30 seconds	Off	○	○
		60 seconds		
		90 seconds		

■ Lights (→P. 252)

Function	Default setting	Customized setting	①	②
Daytime running lights	On	Off*1	○	○
Welcome lighting	On	Off	-	○
AFS (Adaptive Front-lighting System)*2	On	Off	-	○
Windshield wiper linked headlight illumination	On	Off	-	○

\*1: Except for Canada

\*2: If equipped

■ Rain-sensing windshield wipers\* (→P. 261)

Function	Default setting	Customized setting	①	②
Wiper operation when the wiper switch is in the "AUTO" position	Rain-sensing operation	Intermittent operation linked to vehicle speed (with interval adjuster)	-	○

\*: If equipped

### ■ Intuitive parking assist\*<sup>1</sup> (→P. 326)

Function	Default setting	Customized setting	①	②
Detection distance of the front center sensor	Far	Near	<input type="radio"/>	<input type="radio"/>
Detection distance of the rear center sensor	Far	Near	<input type="radio"/>	<input type="radio"/>
Buzzer volume	3	1 to 5	<input type="radio"/>	<input type="radio"/>
Display setting * <sup>2</sup>	All sensors displayed	Display off	<input type="radio"/>	<input type="radio"/>

\*<sup>1</sup>: If equipped

\*<sup>2</sup>: When intuitive parking assist is operating.

### ■ BSM (Blind Spot Monitor)\* (→P. 313)

Function	Default setting	Customized setting	①	②
Outside rear view mirror indicator brightness	Bright	Dim	<input type="radio"/>	<input type="radio"/>
Alert timing for presence of approaching vehicle (BSM function only)	Intermediate	Early	<input type="radio"/>	<input type="radio"/>
		Late		
		Only when in blind spot		
RCTA buzzer volume	Level 2	Level 1	<input type="radio"/>	-
		Level 3		

\*: If equipped

■ Driving mode select switch (→P. 373)

Function	Default setting	Customized setting	①	②
Powertrain control in customized mode*	Normal	Power	○	-
		Eco		
Chassis control in customized mode*	Normal	Sport	○	-
Air conditioning* operation in customized mode	Normal	Eco	○	-

\*: If equipped

■ Front automatic air conditioning system (→P. 503)

Function	Default setting	Customized setting	①	②
A/C auto switch operation	On	Off	○	○
Exhaust gas sensor sensitivity*	Standard	-3 to 3	○	○

\*: If equipped

■ Seat heaters\*/seat ventilators\* (→P. 522, 523)

Function	Default setting	Customized setting	①	②
Driver's seat temperature preference in automatic mode	Standard	-2 (cooler) to 2 (warmer)	○	○
Front passenger's seat temperature preference in automatic mode	Standard	-2 (cooler) to 2 (warmer)	○	○

\*: If equipped

## ■ Illumination (→P. 524)

Function	Default setting	Customized setting	①	②
Time elapsed before the interior lights turn off	15 seconds	Off	○	○
		7.5 seconds		
		30 seconds		
Operation after the engine switch is turned off	On	Off	–	○
Operation when the doors are unlocked	On	Off	–	○
Operation when you approach the vehicle with the electronic key on your person	On	Off	–	○
Footwell lights and front center console light	On	Off	–	○
Instrument panel ornament light* and door trim ornament lights*	On	Off	–	○
Time elapsed before the outer foot lights turn off	15 seconds	Off	○	○
		7.5 seconds		
		30 seconds		
Operation of the outer foot lights when you approach the vehicle with the electronic key on your person	On	Off	–	○
Operation of the outer foot lights when the doors are unlocked with the power door lock switch	On	Off	–	○
Operation of the outer foot lights when a door is opened	On	Off	–	○
Fading out of the outer foot lights when they turn off	Long	Short	–	○

\*: If equipped

■ Seat belt reminder (→P. 656)

Function	Default setting	Customized setting	①	②
Vehicle speed linked seat belt reminder buzzer	On	Off	–	○

■ Vehicle customization

- When the smart access system with push-button start is off, the entry unlock function cannot be customized.
- When the doors remain closed after unlocking the doors and the timer activated automatic door lock function activates, signals will be generated in accordance with the operation buzzer volume and operational signal (Emergency flashers) function settings.
- Some settings can be changed using a switch or the audio system screen. If a setting is changed using a switch, the changed setting will not be reflected on the audio system screen until the engine switch is turned off and then to IGNITION ON mode.

 **WARNING**

■ Cautions during customization

As the engine needs to be running during customization, ensure that the vehicle is parked in a place with adequate ventilation. In a closed area such as a garage, exhaust gases including harmful carbon monoxide (CO) may collect and enter the vehicle. This may lead to death or a serious health hazard.

 **NOTICE**

■ During customization

To prevent battery discharge, ensure that the engine is running while customizing features.

## Items to initialize

The following items must be initialized for normal system operation after such cases as the battery being reconnected, or maintenance being performed on the vehicle.

Item	When to initialize	Reference
Message indicating maintenance is required (U.S.A. only)	<ul style="list-style-type: none"> <li>• After the maintenance is performed</li> </ul>	P. 585
Tire pressure warning system	<ul style="list-style-type: none"> <li>• When changing the tire inflation pressure by changing traveling speed</li> <li>• When changing the tire size</li> <li>• When rotating the tires</li> </ul>	P. 606
Oil maintenance	<ul style="list-style-type: none"> <li>• After the maintenance is performed</li> </ul>	P. 597
Intelligent Clearance Sonar (ICS)*	<ul style="list-style-type: none"> <li>• After reconnecting or changing the battery</li> </ul>	P. 347
Power back door	<ul style="list-style-type: none"> <li>• After reconnecting or changing the battery</li> </ul>	P. 138

\*: If equipped





**737**

**For owners**

**10**

Reporting safety defects for  
U.S. owners ..... 738

Seat belt instructions for  
Canadian owners (in French) ..... 739

SRS airbag instructions for  
Canadian owners (in French) ..... 740

Headlight aim instructions for  
Canadian owners (in French) ..... 748

## Reporting safety defects for U.S. owners

If you believe that your vehicle has a defect which could cause a crash or could cause injury or death, you should immediately inform the National Highway Traffic Safety Administration (NHTSA) in addition to notifying the Lexus Division of Toyota Motor Sales, U.S.A., Inc. (Toll-free: 1-800-25-LEXUS).

If NHTSA receives similar complaints, it may open an investigation, and if it finds that a safety defect exists in a group of vehicles, it may order a recall and remedy campaign. However, NHTSA cannot become involved in individual problems between you, your dealer, or Lexus Division of Toyota Motor Sales, U.S.A., Inc.

To contact NHTSA, you may call the Vehicle Safety Hotline toll-free at 1-888-327-4236 (TTY: 1-800-424-9153); go to <http://www.safercar.gov>; or write to: Administrator, NHTSA, 1200 New Jersey Ave, S.E., Washington, DC 20590. You can also obtain other information about motor vehicle safety from <http://www.safercar.gov>.

## Seat belt instructions for Canadian owners (in French)

The following is a French explanation of seat belt instructions extracted from the seat belt section in this manual.

See the seat belt section for more detailed seat belt instructions in English.

### Utilisation correcte des ceintures de sécurité

- Déroulez la sangle diagonale de telle sorte qu'elle passe bien sur l'épaule, sans pour autant être en contact avec le cou ou glisser de l'épaule.
- Placez la sangle abdominale le plus bas possible sur les hanches.
- Réglez la position du dossier de siège. Asseyez-vous le dos droit et calez-vous bien dans le siège.
- Ne vrillez pas la ceinture de sécurité.



### Entretien et soin

#### ■ Ceintures de sécurité

Nettoyez avec un chiffon ou une éponge humidifiés avec de l'eau savonneuse tiède. Vérifiez régulièrement que les ceintures ne sont pas usées, effilochées ou entaillées excessivement.

#### ⚠ AVERTISSEMENT

#### ■ Détérioration et usure des ceintures de sécurité

Inspectez le système de ceintures de sécurité régulièrement. Contrôlez l'absence de coupures, d'effilochages et de pièces desserrées. N'utilisez pas une ceinture de sécurité endommagée avant qu'elle ne soit remplacée. Une ceinture de sécurité endommagée ne permet pas de protéger un occupant de blessures graves ou mortelles.

## SRS airbag instructions for Canadian owners (in French)

The following is a French explanation of SRS airbag instructions extracted from the SRS airbag section in this manual.

See the SRS airbag section for more detailed SRS airbag instructions in English.

### ► RX350

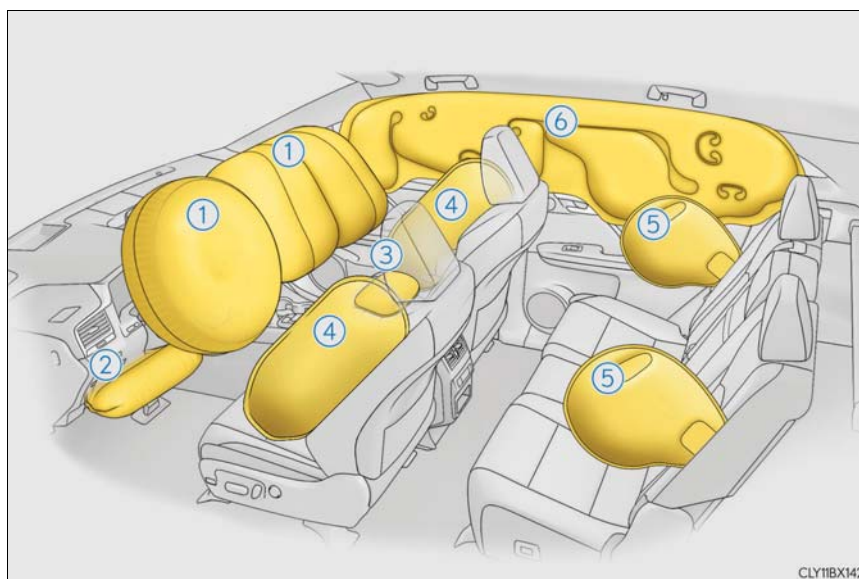

## ▶ RX350L

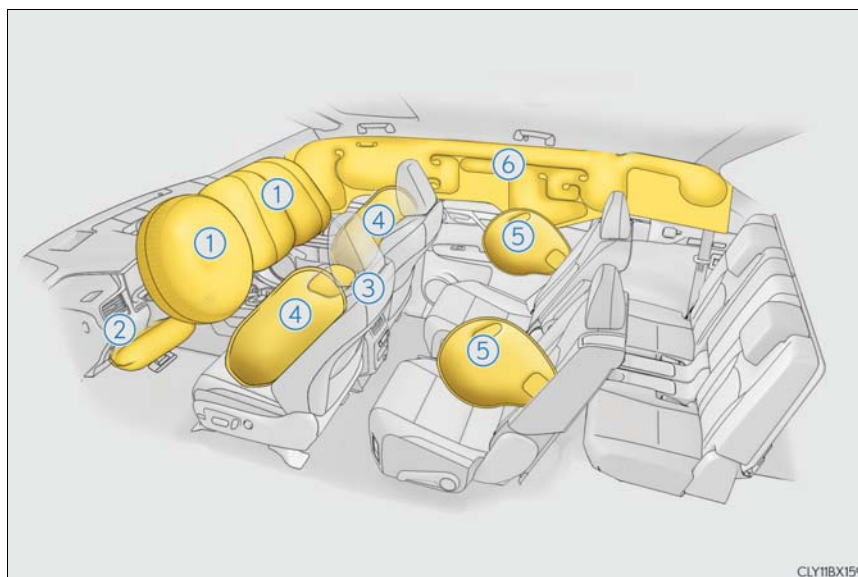
◆ **Coussins gonflables frontaux SRS**

- ① Coussin gonflable conducteur/coussin gonflable du passager avant SRS  
Participent à la protection de la tête et du thorax du conducteur et du passager avant contre les chocs contre les éléments de l'habitacle
- ② Coussin gonflable de genoux SRS  
Participent à la protection du conducteur
- ③ Coussin gonflable de coussin de siège SRS  
Contribue à retenir le passager avant.

◆ **Coussins gonflables latéraux et rideaux SRS**

- ④ Coussins gonflables latéraux avant SRS  
Participent à la protection du torse des occupants de siège avant
- ⑤ Coussins gonflables latéraux arrière SRS  
Participent à la protection du torse des occupants des sièges latéraux arrière
- ⑥ Coussins gonflables rideaux SRS
  - Participent principalement à la protection de la tête des occupants des sièges latéraux
  - Peut contribuer à empêcher les occupants d'être éjectés du véhicule en cas de tonneau

### Composants du système de coussins gonflables SRS

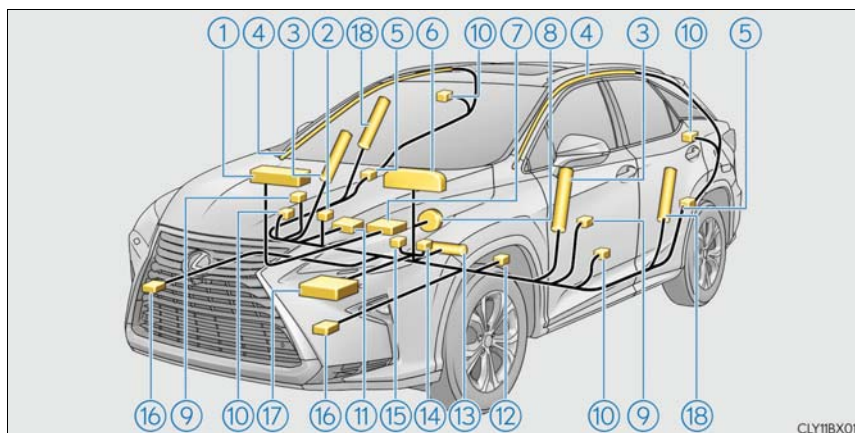

- |   |  |
|---|--|
| ① Coussin gonflable passager avant  | ⑩ Prétensionneurs de ceintures de sécurité et limiteurs de force |
| ② Témoins indicateurs "AIRBAG ON" et "AIR BAG OFF"                                  | ⑪ Coussin gonflable de coussin de siège passager                 |
| ③ Coussins gonflables latéraux avant  | ⑫ Capteur de position du siège conducteur                        |
| ④ Coussins gonflables rideaux   | ⑬ Coussin gonflable de genoux du conducteur                      |
| ⑤ Capteurs d'impact latéral (arrière)   | ⑭ Contact de boucle de ceinture de sécurité conducteur           |
| ⑥ Témoin d'avertissement SRS  | ⑮ Contact de boucle de ceinture de sécurité du passager avant    |
| ⑦ Système de classification de l'occupant du siège passager avant (ECU et capteurs) | ⑯ Capteurs d'impact avant  |
| ⑧ Coussin gonflable conducteur  | ⑰ Ensemble de capteurs de coussins gonflables                    |
| ⑨ Capteurs d'impact latéral (porte avant)   | ⑱ Coussins gonflables latéraux arrière                           |

Votre véhicule est équipé de COUSSINS GONFLABLES INTELLIGENTS conçus selon les normes de sécurité américaines applicables aux véhicules à moteur (FMVSS208). L'ensemble de capteurs de coussins gonflables (ECU) régule le déploiement des coussins gonflables sur la base des informations qu'il reçoit des capteurs, etc., indiqués ci-dessus dans le schéma illustrant les composants du système. Parmi ces informations figurent la gravité du choc et l'occupation du véhicule par les passagers. Le déploiement rapide des coussins gonflables est obtenu au moyen d'une réaction chimique dans les dispositifs pyrotechniques, qui produit un gaz inoffensif permettant d'amortir le mouvement des occupants.

#### AVERTISSEMENT

##### ■ Précautions relatives aux coussins gonflables SRS

Respectez les précautions suivantes concernant les coussins gonflables SRS.

Le non-respect de ces précautions peut occasionner des blessures graves, voire mortelles.

- Le conducteur et tous les passagers du véhicule doivent porter correctement leur ceinture de sécurité.  
Les coussins gonflables SRS sont des dispositifs supplémentaires à utiliser avec les ceintures de sécurité.
- Le coussin gonflable conducteur SRS se déploie avec une force considérable, pouvant occasionner des blessures graves, voire mortelles, si le conducteur se trouve très près du coussin gonflable. L'autorité fédérale chargée de la sécurité routière aux États-Unis (NHTSA) conseille:

La zone à risque du coussin gonflable conducteur se situant dans les premiers 2 à 3 in. (50 à 75 mm) de déploiement, vous placer à 10 in. (250 mm) de votre coussin gonflable conducteur vous garantit une marge de sécurité suffisante. Cette distance est à mesurer entre le centre du volant et le sternum. Si vous êtes assis à moins de 10 in. (250 mm), vous pouvez changer votre position de conduite de plusieurs façons:

- Reculez votre siège le plus possible, de manière à pouvoir encore atteindre confortablement les pédales.
- Inclinez légèrement le dossier du siège.  
Bien que les véhicules aient une conception différente, un grand nombre de conducteurs peuvent s'asseoir à une distance de 10 in. (250 mm), même avec le siège conducteur complètement avancé, simplement en inclinant un peu le dossier de votre siège. Si vous avez des difficultés à voir la route après avoir incliné le dossier de votre siège, utilisez un coussin ferme et antidérapant pour vous rehausser ou remontez le siège si votre véhicule est équipé de cette fonction.
- Si votre volant est réglable, inclinez-le vers le bas. Cela a pour effet d'orienter le coussin gonflable en direction de votre poitrine plutôt que de votre tête et de votre cou.

Régalez votre siège selon les recommandations de la NHTSA ci-dessus, tout en conservant le contrôle des pédales, du volant et la vue des commandes du tableau de bord.



**⚠ AVERTISSEMENT**

■ **Précautions relatives aux coussins gonflables SRS**

- Si vous attachez une rallonge de ceinture de sécurité aux boucles de ceinture de sécurité avant, sans l'attacher au pêne de la ceinture de sécurité, les coussins gonflables frontaux SRS déterminent que le conducteur et le passager avant ont attaché leur ceinture de sécurité, bien que la ceinture de sécurité ne soit pas attachée. Dans ce cas, les coussins gonflables frontaux SRS peuvent ne pas se déployer correctement en cas de collision, pouvant occasionner des blessures graves, voire mortelles. Veillez à porter la ceinture de sécurité avec la rallonge de ceinture de sécurité.



- Le coussin gonflable passager avant SRS se déploie également avec une force considérable, pouvant occasionner des blessures graves, voire mortelles, si le passager avant se trouve très près du coussin gonflable. Le siège du passager avant doit être éloigné le plus possible du coussin gonflable en réglant le dossier de siège de façon à ce que le passager avant soit assis bien droit dans le siège.
- Les nourrissons et les enfants qui ne sont pas correctement assis et/ou attachés peuvent être grièvement blessés ou tués par le déploiement d'un coussin gonflable. Un nourrisson ou un enfant trop petit pour utiliser une ceinture de sécurité doit être correctement attaché au moyen d'un siège de sécurité enfant. Lexus recommande vivement d'installer tous les nourrissons et enfants sur les sièges arrière du véhicule et de prévoir pour eux des systèmes de retenue adaptés. Les sièges arrière sont plus sûrs pour les nourrissons et les enfants que le siège du passager avant.
- N'installez jamais un siège de sécurité enfant type dos à la route sur le siège passager avant, même si le témoin indicateur "AIR BAG OFF" est allumé. En cas d'accident, par la violence et la vitesse de son déploiement, le coussin gonflable du passager avant peut blesser grièvement, voire tuer l'enfant si le siège de sécurité enfant type dos à la route est installé sur le siège passager avant.

**⚠ AVERTISSEMENT**

■ **Précautions relatives aux coussins gonflables SRS**

- Ne vous asseyez pas sur le bord du siège et ne vous appuyez pas contre la planche de bord.



- Ne laissez pas un enfant rester debout devant le coussin gonflable passager avant SRS ou s'asseoir sur les genoux du passager avant.
- Ne laissez pas les occupants des sièges avant voyager avec un objet sur les genoux.



- Ne vous appuyez pas contre la porte, le rail latéral de toit ou les montants avant, latéraux et arrière.



- Ne laissez personne s'agenouiller sur les sièges passagers en appui contre la porte ou sortir la tête ou les mains à l'extérieur du véhicule.



**⚠ AVERTISSEMENT**

■ **Précautions relatives aux coussins gonflables SRS**

- Ne fixez rien et ne posez rien sur des emplacements tels que la planche de bord, la garniture du volant et la partie inférieure du tableau de bord.

Ces éléments peuvent se transformer en projectiles lorsque les coussins gonflables conducteur, passager avant et genoux SRS se déploient.

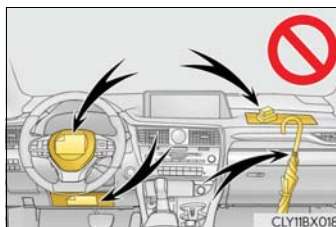

- Ne fixez rien aux portes, à la vitre du pare-brise, aux vitres latérales, aux montants avant et arrière, au rail latéral de toit et à la poignée de maintien.



- Ne suspendez aucun cintre ou objet dur aux crochets à vêtements. Tous ces objets pourraient se transformer en projectiles et causer des blessures graves, voire mortelles en cas de déploiement des coussins gonflables rideaux SRS.
- Si un cache en vinyle est placé sur la zone où le coussin gonflable de genoux SRS se déploie, assurez-vous de le retirer.
- N'utilisez aucun accessoire de siège recouvrant les zones de déploiement des coussins gonflables latéraux SRS et du coussin gonflable de coussin de siège SRS, car il risque de gêner le déploiement des coussins gonflables SRS. De tels accessoires peuvent empêcher les coussins gonflables latéraux et le coussin gonflable de coussin de siège SRS de s'activer correctement, désactiver le système ou entraîner le déploiement accidentel des coussins gonflables latéraux et du coussin gonflable de coussin de siège SRS, occasionnant des blessures graves, voire mortelles.
- Évitez de faire subir des chocs ou des pressions excessives aux parties autour des composants de coussins gonflables SRS ou aux portes avant. En effet, cela pourrait entraîner un dysfonctionnement des coussins gonflables SRS.
- Ne touchez aucun composant immédiatement après le déploiement (gonflage) des coussins gonflables SRS, car ils peuvent être chauds.

 **AVERTISSEMENT**

■ **Précautions relatives aux coussins gonflables SRS**

- Si vous avez des difficultés à respirer après le déploiement des coussins gonflables SRS, ouvrez une porte ou une vitre pour faire entrer de l'air frais, ou bien descendez du véhicule si cela ne présente pas de danger. Essayez tout résidu dès que possible afin d'éviter d'éventuelles irritations de la peau.
- Si les parties renfermant les coussins gonflables SRS, comme les garnitures du volant et des montants avant et arrière, sont endommagées ou craquelées, faites-les remplacer par votre concessionnaire Lexus.
- Ne placez rien sur le siège du passager avant, comme un coussin par exemple. Cela a pour conséquence de répartir le poids du passager sur toute la surface du siège, ce qui empêche le capteur de détecter correctement le poids du passager. En conséquence, les coussins gonflables frontaux SRS du passager avant risquent de ne pas se déployer en cas de collision.

■ **Modification et mise au rebut des composants du système de coussins gonflables SRS**

Ne mettez pas votre véhicule au rebut et ne procédez à aucune des modifications suivantes sans consulter votre concessionnaire Lexus. Les coussins gonflables SRS peuvent ne pas fonctionner correctement ou se déployer (se gonfler) accidentellement, provoquant la mort ou de graves blessures.

- Installation, dépose, démontage et réparation des coussins gonflables SRS
- Réparations, modifications, démontage ou remplacement du volant, du tableau de bord, des sièges ou de leur garnissage, des montants avant, latéraux et arrière, des rails latéraux de toit, des panneaux de porte avant, de la garniture de porte avant ou des haut-parleurs de porte avant
- Modifications du panneau de porte avant (par exemple, perçage d'un trou dans le panneau)
- Réparations ou modifications des ailes avant, du pare-chocs avant ou des flancs de l'habitacle
- Installation d'un protège-calandre (pare-buffle, pare-kangourou, etc.), de chasse-neige, de treuils ou d'un porte-bagages de toit
- Modifications du système de suspension du véhicule
- Installation d'appareils électroniques tels que les émetteurs/récepteurs radios mobiles et les lecteurs CD
- Modifications de votre véhicule pour une personne atteinte d'un handicap physique

## Headlight aim instructions for Canadian owners (in French) (vehicles with single-beam headlights)

The following is a French explanation of headlight aim instructions from the headlight aim section in this manual.

### Boulons de réglage du mouvement vertical

- ① Boulon de réglage A
- ② Boulon de réglage B



### Avant de vérifier le réglage des phares

- ① Vérifiez que le réservoir de carburant du véhicule est plein et que la zone autour des phares n'est pas déformée.
- ② Stationnez le véhicule sur une surface plane.
- ③ Installez-vous dans le siège conducteur.
- ④ Balancez le véhicule plusieurs fois.

## Réglage du faisceau des phares

- 1 À l'aide d'un tournevis cruciforme, tournez le boulon A dans n'importe quel sens.

Mémorisez le sens dans lequel vous avez tourné et le nombre de tours.

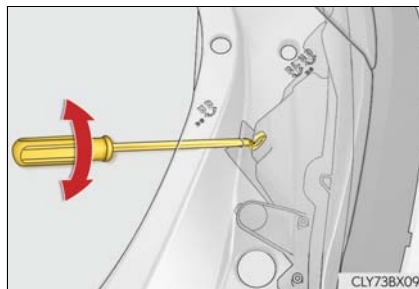

- 2 Tournez le boulon B du même nombre de tours dans le même sens qu'à l'étape 1.

Si vous n'arrivez pas à régler le phare en procédant de la sorte, confiez le véhicule à votre concessionnaire Lexus pour qu'il règle le faisceau des phares.

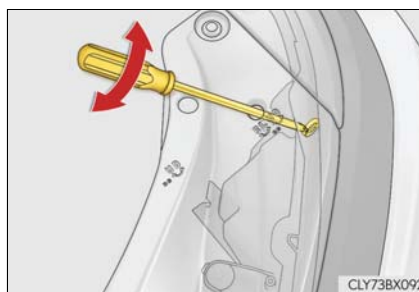



Index

What to do if...  
(Troubleshooting)..... 752  
Alphabetical index..... 756

For vehicles with a navigation system, refer to the "NAVIGATION SYSTEM OWNER'S MANUAL" for information regarding the equipment listed below.

- Navigation system
- Audio/visual system
- Rear seat entertainment system
- Panoramic view monitor
- Lexus Enform



## What to do if... (Troubleshooting)

If you have a problem, check the following before contacting your Lexus dealer.

### The doors cannot be locked, unlocked, opened or closed



#### You lose your keys

- If you lose your mechanical keys, new genuine mechanical keys can be made by your Lexus dealer. (→P. 121)
- If you lose your electronic keys, the risk of vehicle theft increases significantly. Contact your Lexus dealer immediately. (→P. 123)



#### The doors cannot be locked or unlocked

- Is the electronic key battery weak or depleted? (→P. 623)
- Is the engine switch in IGNITION ON mode?  
When locking the doors, turn the engine switch off. (→P. 232)
- Is the electronic key left inside the vehicle?  
When locking the doors, make sure that you have the electronic key on your person.
- The function may not operate properly due to the condition of the radio wave. (→P. 148)



#### The rear door cannot be opened

- Is the child-protector lock set?  
The rear door cannot be opened from inside the vehicle when the lock is set. Open the rear door from outside and then unlock the child-protector lock. (→P. 127)

**If you think something is wrong****The engine does not start**

- Did you press the engine switch while firmly depressing the brake pedal? (→P. 231)
- Is the shift lever in P? (→P. 233)
- Is the electronic key anywhere detectable inside the vehicle? (→P. 146)
- Is the steering wheel unlocked? (→P. 233)
- Is the electronic key battery weak or depleted?  
In this case, the engine can be started in a temporary way. (→P. 685)
- Is the battery discharged? (→P. 687)

**The shift lever cannot be shifted from P even if you depress the brake pedal**

- Is the engine switch in IGNITION ON mode?  
If you cannot release the shift lever by depressing the brake pedal with the engine switch in IGNITION ON mode (→P. 239, 244)

**The steering wheel cannot be turned after the engine is stopped**

- It is locked automatically to prevent theft of the vehicle. (→P. 233)

**The windows do not open or close by operating the power window switches**

- Is the window lock switch pressed?  
The power window except for the one at the driver's seat cannot be operated if the window lock switch is pressed. (→P. 187)

**The engine switch is turned off automatically**

- The auto power off function will be operated if the vehicle is left in ACCESSORY or IGNITION ON mode (the engine is not operating) for a period of time. (→P. 233)

 **A warning buzzer sounds during driving**

- The seat belt reminder light is flashing  
Are the driver and the passengers wearing the seat belts?  
(→P. 656, 656)
  - The parking brake indicator is on  
Is the parking brake released? (→P. 247)
- Depending on the situation, other types of warning buzzer may also sound.  
(→P. 654, 661)

 **An alarm is activated and the horn sounds**

- Did anyone inside the vehicle open a door during setting the alarm?  
The sensor detects it and the alarm sounds. (→P. 77)
- Do one of the following to stop the alarms:
- Unlock the doors.
  - Turn the engine switch to ACCESSORY or IGNITION ON mode, or start the engine.

 **A warning buzzer sounds when leaving the vehicle**

- Is the message displayed on the multi-information display?  
Check the message on the multi-information display. (→P. 661)

 **A warning light turns on or a warning message is displayed**

- When a warning light turns on or a warning message is displayed, refer to P. 654, 661.

**When a problem has occurred****If you have a flat tire**

- Stop the vehicle in a safe place and replace the flat tire with the spare tire.  
(→P. 666)

**The vehicle becomes stuck**

- Try the procedure for when the vehicle becomes stuck in mud, dirt, or snow.  
(→P. 695)

## Alphabetical index

### A

A/C .....	503	Airbags .....	36
Air conditioning filter .....	618	Airbag operating conditions .....	43
Automatic air conditioning		Airbag precautions for your	
system .....	503, 518	child .....	39
S-FLOW mode .....	511	Airbag warning light .....	654
ABS (Anti-lock Brake System) .....	378	Correct driving posture .....	30
Warning light .....	654	Curtain shield airbag	
Adaptive Front-lighting System		operating conditions .....	43
(AFS) .....	253	Curtain shield airbag	
Adaptive Variable Suspension		precautions .....	41
System .....	379	Front passenger occupant	
AFS (Adaptive Front-lighting		classification system .....	47
System) .....	253	General airbag precautions .....	39
Air conditioning filter .....	618	Locations of airbags .....	36
Air conditioning system		Modification and disposal of	
Air conditioning filter .....	618	airbags .....	42
Automatic air conditioning		Seat cushion airbag .....	37
system .....	503, 518	Side airbag operating	
S-FLOW mode .....	511	conditions .....	43
		Side airbag precautions .....	39
		Side and curtain shield airbags	
		operating conditions .....	43
		Side and curtain shield airbags	
		precautions .....	39
		SRS airbag instructions for	
		Canadian owners .....	740
		SRS airbags .....	36

Alarm.....	77	Audio system	
All-wheel drive lock mode .....	377	(with navigation system)*	
Anchor brackets.....	57	Automatic air conditioning	
Antenna		system.....	503, 518
Radio .....	423	Air conditioning filter .....	618
Smart access system		S-FLOW mode.....	511
with push-button start.....	146	Automatic headlight leveling	
Anti-lock Brake System (ABS).....	378	system.....	254
Warning light .....	654	Automatic High Beam.....	256
Approach warning.....	308	Automatic light control system .....	252
Armrest .....	555	Automatic transmission.....	236, 240
Assist grips .....	556	If the shift lever cannot be	
Audio system (with Lexus		shifted from P .....	239, 244
Display Audio System) .....	394	M mode.....	242
Antenna .....	423	Paddle shift switches.....	241, 242
Audio input.....	403	S mode.....	237
AUX port.....	403	AUX port .....	403
Bluetooth® audio .....	453	Auxiliary boxes .....	535, 540
CD player .....	427		
iPod.....	434		
MP3/WMA disc .....	427		
Optimal use .....	413		
Portable music player .....	442		
Radio .....	420		
Setup menu.....	406		
Steering wheel audio			
switches.....	400		
USB memory.....	438		

\*: Refer to the "NAVIGATION SYSTEM OWNER'S MANUAL".

## B

- Back door
  - Power back door ..... 130
  - Touchless power back door ..... 132
  - Wireless remote control ..... 130
- Back-up lights
  - Replacing light bulbs ..... 630
  - Wattage ..... 705
- Battery
  - Battery checking ..... 601
  - If the battery is discharged ..... 687
  - Preparing and checking before
    - winter ..... 384
  - Warning light ..... 654
- Blind Spot Monitor (BSM) ..... 313
  - Blind Spot Monitor function ..... 317
  - Rear Cross Traffic
    - Alert function ..... 321
- Bluetooth® ..... 476
  - Audio system ..... 453
  - Hands-free system
    - (for cellular phone) ..... 455
- Bottle holders ..... 533
- Brake
  - Brake Hold ..... 250
  - Fluid ..... 704
  - Parking brake ..... 247
  - Warning light ..... 654
- Brake assist ..... 378
- Brake Hold ..... 250
  - Warning light ..... 655
- Break-in tips ..... 204
- Brightness control
  - Instrument panel light control ..... 88
- BSM (Blind Spot Monitor) ..... 313
  - Blind Spot Monitor function ..... 317
  - Rear Cross Traffic Alert
    - function ..... 321

## C

<b>Care</b>	
Aluminum wheels .....	577
Exterior .....	576
Interior .....	581
Seat belts .....	582
Self-restoring coat .....	576
<b>Cargo capacity</b> .....	210, 698
<b>Cargo hooks</b> .....	536
<b>Cargo net hooks</b> .....	536
<b>CD player</b> .....	427
<b>Chains</b> .....	385
<b>Child restraint system</b> .....	55
Booster seats installation .....	64
Convertible seats installation .....	62
Front passenger occupant classification system .....	47
Infant seats definition .....	61
Infant seats installation .....	57
Installing CRS with LATCH anchors .....	67
Installing CRS with seat belts .....	61
Installing CRS with top tether strap .....	70
LATCH anchors .....	67
<b>Child safety</b> .....	54
Airbag precautions .....	39
Battery precautions .....	602, 690
Child restraint system .....	55
How your child should wear the seat belt .....	33
Installing child restraints .....	55
Moon roof precautions .....	194
Panoramic moon roof precautions .....	198
Power back door precautions .....	140
Power window lock switch .....	187
Power window precautions .....	190
Rear door child-protectors .....	127
Removed key battery precautions .....	624
Seat belt extender precautions .....	35
Seat belt precautions .....	35
Seat heater precautions .....	521



Child-protectors.....	127	Coolant	
Cleaning.....	576, 581	Capacity.....	702
Aluminum wheels.....	577	Checking.....	598
Exterior.....	576	Preparing and checking	
Interior.....	581	before winter.....	384
Seat belts.....	582	Cooling system.....	598
Clock.....	86, 544	Engine overheating.....	692
Coat hooks.....	556	Cornering lights.....	253
Compass.....	564	Cruise control	
Condenser.....	599	Dynamic radar cruise control	
Console box.....	530	with full-speed range.....	300
Consumption screen.....	94, 114	Cup holders.....	531
		Curtain shield airbags.....	37
		Customizable features.....	722
		Customized mode.....	373

## D

- Daytime running light system..... 254
- Defogger
  - Outside rear view mirrors..... 513
  - Rear window ..... 513
  - Windshield..... 513
- Differential..... 703
- Dimensions ..... 698
- Dinghy towing..... 230
- Display
  - Dynamic radar cruise control
    - with full-speed range..... 300
  - LKA (Lane-Keeping Assist)..... 296
  - Multi-information display ..... 90
  - Warning messages..... 661
- Do-it-yourself maintenance..... 590
- Doors
  - Automatic door locking and
    - unlocking system..... 127
  - Door lock..... 126
  - Outside rear view mirrors..... 184
  - Power back door..... 130
  - Rear door child-protectors ..... 127
  - Side doors ..... 124
  - Side windows..... 187
- Drive information..... 94
- Drive-start control ..... 203, 238, 243
- Driver's seat belt reminder light .... 656
- Driver's seat position memory..... 172
- Driving
  - Break-in tips..... 204
  - Correct posture..... 30
  - Driving mode select switch..... 373
  - Procedures..... 202
  - Winter drive tips ..... 384
- Driving position memory ..... 172
  - Memory recall function ..... 175
  - Power easy access system..... 172
- Dynamic radar cruise control
  - with full-speed range..... 300
- Dynamic Torque Control AWD
  - system..... 379

## E

Eco drive mode.....	373
Eco Driving Indicator.....	105
EDR (Event data recorder).....	10
Electric Power Steering (EPS) .....	378
Warning light .....	655
Electronic key .....	120
Battery-saving function.....	147
If the electronic key does not operate properly.....	684
Replacing the battery.....	623
Emergency flashers.....	644
Emergency, in case of	
If a warning buzzer sounds.....	654
If a warning light turns on.....	654
If a warning message is displayed.....	661
If the battery is discharged .....	687
If the electronic key does not operate properly.....	684
If the engine will not start.....	682
If you have a flat tire .....	666
If you lose your keys .....	121, 123
If you think something is wrong.....	652
If your vehicle becomes stuck....	695
If your vehicle has to be stopped in an emergency..	645
If your vehicle needs to be towed.....	646
If your vehicle overheats .....	692

Engine	
ACCESSORY mode.....	232
Compartment .....	594
Engine switch .....	231
Hood.....	592
How to start the engine.....	231
Identification number .....	700
If your vehicle has to be stopped in an emergency.....	645
Ignition switch (engine switch) ....	231
Overheating.....	692
Engine coolant	
Capacity.....	702
Checking.....	598
Preparing and checking before winter .....	384
Engine coolant temperature gauge .....	86
Engine immobilizer system.....	74
Engine oil	
Capacity.....	700
Checking.....	595
Preparing and checking before winter .....	384
Engine oil maintenance data.....	597
Engine switch.....	231
Enhanced VSC .....	378
EPS	
(Electronic Power Steering) .....	378
Warning light.....	655
Event data recorder (EDR).....	10

## F

Flat tire .....	666	Front side marker lights	
Floor mats .....	28	Light switch.....	252
Fluid		Replacing light bulbs .....	630
Automatic transmission .....	703	Wattage .....	705
Brake.....	704	Front turn signal lights	
Washer .....	603	Replacing light bulbs .....	630
Fog lights		Turn signal lever.....	246
Replacing light bulbs.....	630	Wattage .....	705
Switch.....	260	Fuel	
Front automatic air		Capacity.....	700
conditioning system .....	503	Fuel gauge .....	86
Front passenger footwell hooks.....	554	Information.....	706
Front passenger occupant		Refueling .....	269
classification system.....	47	Type.....	700
Front passenger's seat belt		Fuel filler door.....	269
reminder light .....	656	Refueling .....	269
Front seat heaters.....	522	When the fuel filler door	
Front seats .....	156	cannot be opened.....	272
Adjustment.....	156	Fuses.....	625
Cleaning.....	581		
Correct driving posture .....	30		
Driving position memory .....	172		
Head restraints.....	177		
Power easy access system .....	172		
Seat heaters .....	522		
Seat position memory.....	172		

**G**

Garage door opener ..... 557  
 Gauges ..... 86  
 Glove box ..... 530  
 Grocery bag hooks ..... 537

**H**

Hands-free system  
 (for cellular phone) ..... 455  
 Head restraints ..... 177  
 Head-up display ..... 108  
 Headlight cleaner ..... 261  
 Headlights ..... 252  
     Automatic headlight leveling ..... 254  
     Automatic High Beam ..... 256  
     Light switch ..... 252  
     Replacing light bulbs ..... 630  
     Wattage ..... 705  
     Windshield wiper linked  
         headlight illumination ..... 255  
 Heated steering wheel ..... 522

**Heaters**

Automatic air conditioning  
     system ..... 503, 518  
 Heated steering wheel ..... 522  
 Outside rear view mirrors ..... 513  
 Seat heaters ..... 522, 523

**High mounted stoplight**

Replacing ..... 630

**Hill-start assist control** ..... 378

**Hood** ..... 592

**Hooks**

Cargo hooks ..... 536  
 Cargo net hooks ..... 536  
 Front passenger footwell  
     hooks ..... 554  
 Grocery bag hooks ..... 537  
 Retaining hooks (floor mat) ..... 28

**Horn** ..... 180

**HUD (Head-up display)** ..... 108

## I

I/M test .....	589
ICS (Intelligent Clearance Sonar) .....	336
Indicator .....	82
Warning light .....	656
Warning messages .....	340, 347
Identification	
Engine .....	700
Vehicle .....	699
Ignition switch (engine switch) .....	231
Illuminated entry system .....	527
Immobilizer system .....	74
Indicators .....	80
Initialization	
Engine oil maintenance data .....	597
Items to initialize .....	735
Power back door .....	138
Tire pressure warning system .....	605
Inside rear view mirror .....	182
Instrument panel light control .....	88
Intelligent Clearance Sonar (ICS) .....	336
Indicator .....	82
Warning light .....	656
Warning messages .....	340, 347
Interior lights .....	524
Switch .....	525
Wattage .....	705
Intuitive parking assist .....	326

## J

Jack	
Positioning a floor jack .....	593
Vehicle-equipped jack .....	667
Jack handle .....	667
Jam protection function	
Electronic sunshade .....	196
Moon roof .....	192
Panoramic moon roof .....	196
Power back door opener and closer .....	138
Power windows .....	188

## K

Keyless entry	
Smart access system with push-button start .....	146
Wireless remote control .....	120, 130
Keys .....	120
Battery-saving function .....	148
Electronic key .....	120
Engine switch .....	231
If the electronic key does not operate properly .....	684
If you lose your keys .....	123
Key number plate .....	120
Keyless entry .....	120
Mechanical key .....	121
Replacing the battery .....	623
Warning buzzer .....	125
Wireless remote control .....	120
Knee airbags .....	37

\*: Refer to the "NAVIGATION SYSTEM OWNER'S MANUAL".

## L

Lane-Keeping Assist (LKA).....	291	License plate lights	
Language (multi-information display).....	102	Light switch.....	252
LATCH anchors .....	67	Replacing light bulbs .....	630
Lever		<b>Light</b>	
Auxiliary catch lever .....	592	Automatic High Beam.....	256
Hood lock release lever .....	592	Cornering lights .....	253
Shift lever.....	236, 240	Fog light switch.....	260
Turn signal lever .....	246	Headlight switch .....	252
Wiper lever .....	261, 267	Illuminated entry system.....	527
Lexus Climate Concierge .....	502	Interior light list.....	524
Lexus Display Audio controller.....	396	Interior lights .....	525
Lexus Enform*		Luggage compartment light.....	136
Lexus Enform Remote* .....	573	Personal lights.....	526
LEXUS Enform Safety		Replacing light bulbs .....	630
Connect.....	568	Turn signal lever.....	246
LEXUS Enform Service		Vanity lights .....	543
Connect* .....	574	Wattage .....	705
Lexus parking assist monitor .....	357	Welcome lighting.....	255
Display.....	358	<b>Light bulbs</b>	
Precautions.....	364	Replacing.....	630
Lexus Safety System+.....	274	Wattage .....	705
Automatic High Beam .....	256	LKA (Lane-Keeping Assist) .....	291
Dynamic radar cruise control		Lock steering column.....	233
with full-speed range.....	300	Luggage cover .....	537
LKA (Lane-Keeping Assist).....	291		
PCS (Pre-Collision System).....	281		

## M

## Maintenance

- Do-it-yourself maintenance.....590
- General maintenance .....586
- Maintenance data.....698
- Maintenance requirements.....584

## Malfunction indicator lamp .....654

## Memory recall function .....175

## Meter

- Head-up display.....108
- Indicators.....80
- Instrument panel light control.....88
- Meters.....86
- Multi-information display .....90
- Settings.....97
- Warning lights.....654
- Warning messages.....661

## Microphone.....456

## Mirrors

- Inside rear view mirror .....182
- Outside rear view mirror
  - defoggers.....513
- Outside rear view mirrors.....184
- Vanity mirrors.....543

## Moon roof

- Door lock linked moon roof
  - operation .....189
- Jam protection function.....192
- Operation.....191

## MP3 disc .....427

## Multi-information display

- AWD Control display.....95
- Clock.....86
- Drive information.....94
- Dynamic radar cruise control
  - with full-speed range .....300
- G-force display .....96
- Language.....102
- LKA (Lane-Keeping Assist).....296
- Outside temperature.....86
- PCS
  - (Pre-Collision System) .....281
- Settings .....97
- Suggestion function.....105
- Sway warning display.....95
- Warning messages .....661

## N

## Navigation system \*

## Noise from under vehicle .....8

\*: Refer to the "NAVIGATION SYSTEM OWNER'S MANUAL".



## O

Odometer .....	104
Oil	
Engine oil.....	700
Rear differential oil.....	703
Transfer oil.....	703
Opener	
Fuel filler door.....	271
Hood.....	592
Power back door.....	131
Outside rear view mirrors .....	184
Adjusting and folding.....	184
Blind Spot Monitor (BSM).....	313
Linked mirror function when reversing.....	185
Mirror position memory.....	172
Outside rear view mirror defoggers.....	513
Outside temperature display .....	86
Overheating.....	692

## P

Paddle shift switches .....	241, 242
Panic mode .....	121
Panoramic moon roof .....	195
Jam protection function.....	196
Operation.....	195

Parking brake .....	247
Parking brake engaged warning buzzer/message.....	249
Warning light.....	655
Parking lights	
Light switch.....	252
Replacing light bulbs .....	630
PCS (Pre-Collision System).....	281
Warning light.....	656
Personal lights .....	526
Power back door .....	130
Touchless power back door.....	132
Wireless remote control.....	130
Power back door opener and closer .....	130
Power easy access system.....	172
Power outlets.....	551
Power steering (Electric Power Steering system).....	378
Warning light.....	655
Power windows	
Door lock linked window operation.....	189
Jam protection function.....	188
Operation.....	187
Window lock switch .....	187
Pre-Collision System (PCS).....	281
Warning light.....	656

## R

Radar cruise control	
(dynamic radar cruise control	
with full-speed range) .....	300
Radiator .....	599
Radio.....	420
Rear automatic air conditioning	
system .....	518
Rear Cross Traffic Alert .....	313
Rear Cross Traffic Auto Brake.....	350
Rear door sunshades.....	554
Rear passengers' seat belt	
reminder light .....	656
Rear seat	
Folding down the rear	
seatbacks.....	157
Rear side marker lights	
Light switch.....	252
Replacing light bulbs.....	630
Rear turn signal lights	
Replacing light bulbs.....	630
Turn signal lever .....	246
Wattage.....	705
Rear view mirror	
Inside rear view mirror.....	182
Outside rear view mirrors.....	184
Rear window defogger.....	513
Rear window wiper .....	267
Refueling.....	269
Capacity.....	700
Fuel types.....	700
Opening the fuel tank cap.....	269
When the fuel filler door	
cannot be opened.....	272
Remote Touch* .....	496
Replacing	
Electronic key battery .....	623
Fuses .....	625
Light bulbs.....	630
Tires.....	666
Windshield wiper inserts.....	621
Reporting safety defects for	
U.S. owners .....	738
Resetting the message indicating	
maintenance is required .....	585
Rev indicator .....	88
Rev peak .....	88

**S**

S-FLOW mode..... 511

Seat belts..... 32

    Adjusting the seat belt.....32

    Automatic Locking Retractor.....33

    Child restraint system

        installation.....55

    Cleaning and maintaining the

        seat belt..... 582

    Emergency Locking Retractor .....33

    How to wear your seat belt.....32

    How your child should

        wear the seat belt .....33

    Pregnant women, proper seat

        belt use.....34

    Reminder light and buzzer .....656

    Seat belt extender.....33

    Seat belt instructions for

        Canadian owners.....739

    Seat belt pretensioners .....33

    SRS warning light..... 654

Seat position memory..... 172

Seat ventilators .....523

Seating capacity.....213

**Seats**

Adjustment.....156

Adjustment precautions.....156

Child seats/child restraint

    system installation .....55

Cleaning.....581

Driving position memory.....172

Folding down the rear

    seatbacks .....157

Front seat heaters.....522

Head restraint.....177

Power easy access system.....172

Properly sitting in the seat.....30

Second-row seat heaters.....523

Seat position memory.....172

Seat ventilators.....523

**Sensor**

Automatic headlight system .....254

Camera sensor.....276

Inside rear view mirror.....183

Intuitive parking assist.....326

Radar sensor.....276

Rain-sensing windshield

    wipers.....263

Touchless sensor.....132

- Service reminder indicators ..... 80
- Shift lever
  - Automatic transmission ..... 236, 240
  - If the shift lever cannot be shifted from P..... 239, 244
- Shift lock system..... 238, 243
- Side airbags ..... 37
- Side doors..... 124
- Side marker lights
  - Light switch..... 252
  - Replacing light bulbs..... 630
- Side mirrors ..... 184
  - Adjusting and folding..... 184
  - BSM (Blind Spot Monitor)..... 313
  - Heaters..... 513
- Side turn signal lights
  - Replacing light bulbs..... 630
  - Turn signal lever ..... 246
- Smart access system with push-button start ..... 146
  - Antenna location..... 146
  - Entry functions..... 124, 130
  - Starting the engine ..... 231
- Snow tires ..... 386
- Spare tire
  - Inflation pressure..... 704
  - Storage location ..... 667
- Spark plug..... 702
- Specifications..... 698
- Speedometer ..... 86
- Sport mode..... 373
- Steering wheel ..... 180
  - Adjustment..... 180
  - Audio switches ..... 400
  - Heated steering wheel ..... 522
  - Power easy access system..... 172
  - Telephone switches..... 465
- Stop lights
  - Replacing light bulbs ..... 630
- Storage feature ..... 528
- Storage precautions ..... 528
- Stuck
  - If the vehicle becomes stuck..... 695
- Sun visors..... 543
- Sunshade
  - Panoramic moon roof..... 195
  - Rear door ..... 554
  - Roof ..... 192

## Switches

All-wheel drive lock switch.....	377
Audio remote control switches.....	400
Automatic High Beam switch.....	256
Brake hold switch.....	250
Cruise control switch.....	300
Door lock switch.....	126
Driving mode select switch.....	373
Driving position memory switches.....	172
Electronic sunshade switch.....	195
Emergency flashers switch.....	644
Engine switch.....	231
Fog light switch.....	260
Garage door opener switches.....	557
Heated steering wheel switch.....	522
HUD (Head-up display) switches.....	108
Ignition switch.....	231
Light switch.....	252
LKA (Lane-Keeping Assist) switch.....	295
Meter control switches.....	92
Moon roof switches.....	191
"ODO/TRIP" switch.....	93

Outside rear view mirror switches.....	184
Paddle shift switches.....	241, 242
Panoramic moon roof switches.....	195
Parking brake switch.....	247
Power back door opener and closer switch.....	131, 133
Power window switch.....	187
Rear window and outside rear view mirror defoggers switch.....	513
Rear window wiper and washer switch.....	267
Seat heater switches.....	522, 523
Seat ventilator switches.....	523
"SOS" button.....	568
Talk switch.....	465, 487
Telephone switches.....	465
Vehicle-to-vehicle distance button.....	300
VSC OFF switch.....	380
Window lock switch.....	187
Windshield wiper and washer switch.....	261

## T

- Tachometer ..... 86
- Tail lights
  - Light switch ..... 252
  - Replacing light bulbs ..... 630
- Talk switch ..... 465, 487
- Telephone switch ..... 465
- Theft deterrent system
  - Alarm ..... 77
  - Engine immobilizer system ..... 74
- Tire inflation pressure
  - Maintenance data ..... 704
  - Warning light ..... 656
- Tire information ..... 709
  - Glossary ..... 716
  - Size ..... 712
  - Tire identification number ..... 711
  - Uniform Tire Quality
    - Grading ..... 714
- Tire pressure warning system
  - Initializing ..... 605
  - Installing tire pressure warning
    - valves and transmitters ..... 605
  - Registering ID codes ..... 606
  - Warning light ..... 656
- Tires ..... 604
  - Chains ..... 385
  - Checking ..... 604
  - Glossary ..... 716
  - If you have a flat tire ..... 666
  - Inflation pressure ..... 613, 704
  - Replacing ..... 666
  - Rotating tires ..... 604
  - Size ..... 704
  - Snow tires ..... 386
  - Spare tire ..... 666, 704
  - Tire identification number ..... 711
  - Tire pressure warning system ..... 605
  - Uniform Tire Quality
    - Grading ..... 714
    - Warning light ..... 656
- Tools ..... 667
- Top tether strap ..... 70
- Total load capacity ..... 698
- Touchless power back door ..... 132
- Towing
  - Dinghy towing ..... 230
  - Emergency towing ..... 646
  - Towing eyelet ..... 649
  - Trailer Sway Control ..... 378
  - Trailer towing ..... 215, 229
- TRAC (Traction Control) ..... 378
- Traction Control (TRAC) ..... 378
- Trailer Sway Control ..... 378
- Trailer towing ..... 215, 229

Transmission  
   Automatic transmission ..... 236, 240  
   Driving mode select switch ..... 373  
   If the shift lever cannot be  
     shifted from P ..... 239, 244  
   M mode ..... 242  
   Paddle shift switches ..... 241, 242  
   S mode ..... 237  
 Trip meters ..... 104  
 Turn signal lights  
   Replacing light bulbs ..... 630  
   Turn signal lever ..... 246  
   Wattage ..... 705

**U**

USB charging ports ..... 553  
 USB memory ..... 438  
 USB port ..... 403

**V**

Vanity lights ..... 543  
   Wattage ..... 705  
 Vanity mirrors ..... 543  
   Vanity lights ..... 543  
 VDIM (Vehicle Dynamics  
   Integrated Management) ..... 379  
 Vehicle data recordings ..... 9  
 Vehicle Dynamics Integrated  
   Management (VDIM) ..... 379  
 Vehicle identification number ..... 699  
 Vehicle Stability Control (VSC) ..... 378  
 Voice command system ..... 487  
 VSC (Vehicle Stability Control) ..... 378

**W**

Warning buzzers  
   Approach warning ..... 308  
   Downshifting ..... 243  
   Intuitive parking assist ..... 330  
   Lane departure alert  
     function ..... 292  
   Light reminder ..... 254  
   Open door ..... 128  
   Pre-collision warning ..... 281  
   Seat belt reminder ..... 656  
   Vehicle sway warning ..... 293  
 Warning lights  
   ABS ..... 654  
   Brake hold operated indicator .. 655  
   Brake system ..... 654  
   Charging system ..... 654  
   Electric power steering ..... 655  
   ICS OFF indicator ..... 656  
   LKA indicator ..... 655  
   Low fuel level ..... 656  
   Malfunction indicator lamp ..... 654  
   Master warning light ..... 657  
   Parking brake indicator ..... 655  
   PCS warning light ..... 656  
   Seat belt reminder light ..... 656  
   Slip indicator ..... 655  
   SRS ..... 654  
   Tire pressure ..... 656  
 Warning messages ..... 661

Washer		Windshield wipers .....	261
Checking.....	603	Intermittent windshield wipers .....	261
Preparing and checking		Rain-sensing windshield	
before winter .....	384	wipers.....	262
Switch.....	261, 267	Replacing a windshield wiper	
Washing and waxing.....	576	insert .....	621
Weights		Winter driving tips .....	384
Cargo capacity .....	210, 698	Wireless charger.....	544
Load limits.....	213, 698	Wireless communication.....	443, 453
Weights.....	698	Wireless remote control.....	120
Wheels.....	616	Battery-saving function .....	147
Replacing wheels.....	616	Locking/Unlocking .....	120
Size.....	704	Panic mode .....	121
Window glasses.....	187	Replacing the battery .....	623
Window lock switch.....	187	WMA disc.....	427
Windows			
Power windows.....	187		
Rear window defogger.....	514		
Washer .....	261, 267		
Windshield wiper de-icer .....	513		
Windshield wiper inserts.....	621		

## X

XM® Satellite Radio .....	420
---------------------------	-----



<b>GAS STATION INFORMATION</b>									
Auxiliary catch lever P. 592	Fuel filler door P. 271								
Hood lock release lever P. 592	Tire inflation pressure P. 704								
Fuel tank capacity (Reference)	19.2 gal. (72.5 L, 15.9 Imp. gal.)								
Fuel type	Unleaded gasoline only <span style="float: right;">P. 700</span>								
Cold tire inflation pressure	P. 704								
Engine oil capacity (Drain and refill – reference)	<table style="width: 100%; border-collapse: collapse;"> <tr> <td style="padding-left: 20px;">With filter</td> <td style="text-align: right;">qt. (L, Imp. qt.)</td> </tr> <tr> <td style="padding-left: 40px;">Vehicles with towing package</td> <td style="text-align: right;">5.8 (5.5, 4.8)</td> </tr> <tr> <td style="padding-left: 40px;">Vehicles without towing package</td> <td style="text-align: right;">5.7 (5.4, 4.8)</td> </tr> <tr> <td style="padding-left: 20px;">Without filter</td> <td style="text-align: right;">5.6 (5.3, 4.7)</td> </tr> </table>	With filter	qt. (L, Imp. qt.)	Vehicles with towing package	5.8 (5.5, 4.8)	Vehicles without towing package	5.7 (5.4, 4.8)	Without filter	5.6 (5.3, 4.7)
With filter	qt. (L, Imp. qt.)								
Vehicles with towing package	5.8 (5.5, 4.8)								
Vehicles without towing package	5.7 (5.4, 4.8)								
Without filter	5.6 (5.3, 4.7)								
Engine oil type	“Toyota Genuine Motor Oil” or equivalent Oil grade: ILSAC GF-5 multigrade engine oil Recommended viscosity: SAE 0W-20 <span style="float: right;">P. 701</span>								