

Pictorial index	Search by illustration	
For safety and security	Make sure to read through them (Main topics: Child seat, theft deterrent system)	1
Vehicle status information and indicators	Reading driving-related information (Main topics: Meters, multi-information display)	2
Before driving	Opening and closing the doors and windows, adjustment before driving (Main topics: Keys, doors, seats)	3
Driving	Operations and advice which are necessary for driving (Main topics: Starting engine, refueling)	4
Interior features	Usage of the interior features (Main topics: Air conditioner, storage features)	5
Maintenance and care	Caring for your vehicle and maintenance procedures (Main topics: Interior and exterior, light bulbs)	6
When trouble arises	What to do in case of malfunction and emergency (Main topics: Battery discharge, flat tire)	7
Vehicle specifications	Vehicle specifications, customizable features (Main topics: Fuel, oil, tire inflation pressure)	8
For owners	Reporting safety defects for U.S. owners, seat belt and SRS airbag instructions for Canadian owners	9
Index	Search by symptom	
	Search alphabetically	

2 TABLE OF CONTENTS

For your information	6
Reading this manual	10
How to search	11
Pictorial index	12

1 For safety and security

1-1. For safe use	
Before driving	22
For safe driving.....	23
Seat belts	24
SRS airbags	29
Pop Up Hood	38
Front passenger occupant classification system	40
Exhaust gas precautions	44
1-2. Child safety	
Riding with children.....	45
Child restraint systems	45
1-3. Lexus Enform	
Lexus Enform Safety Connect ..	58
1-4. Theft deterrent system	
Engine immobilizer system	63
Alarm.....	65

2 Vehicle status information and indicators

2-1. Instrument cluster	
Warning lights and indicators....	68
Gauges and meters (except F SPORT models)	73
Gauges and meters (F SPORT models).....	76
Multi-information display.....	80
Head-up display	87
Fuel consumption information....	91

3 Before driving

3-1. Key information	
Keys	96
3-2. Opening, closing and locking the doors and trunk	
Doors	100
Trunk.....	104
Smart access system with push-button start	111
3-3. Adjusting the seats	
Front seats.....	119
Power rear seat	126
Driving position memory	130
Rear seat position memory.....	134
Head restraints	135
3-4. Adjusting the steering wheel and mirrors	
Steering wheel	138
Inside rear view mirror	139
Outside rear view mirrors.....	140
3-5. Opening, closing the windows and moon roof	
Power windows	142
Moon roof.....	145
Panoramic moon roof.....	147

4 Driving

4-1. Before driving	
Driving the vehicle.....	154
Cargo and luggage.....	160
Vehicle load limits.....	162
Trailer towing.....	163
Dinghy towing	163

4-2. Driving procedures
 Engine (ignition) switch 164
 Automatic transmission..... 167
 Turn signal lever..... 173
 Parking brake 174
 Brake Hold..... 177

4-3. Operating the lights and wipers
 Headlight switch..... 179
 AHB (Automatic High Beam)
 182
 Windshield wipers and washer
 184

4-4. Refueling
 Opening the fuel tank cap..... 189

4-5. Using the driving support systems
 Lexus Safety System + A..... 191
 Lexus Safety System + 2.0..... 198
 PCS (Pre-Collision System) (veh-
 icles with Lexus Safety System +
 A) 204
 PCS (Pre-Collision System) (veh-
 icles with Lexus Safety System +
 2.0)..... 215
 FCTA (Front Cross Traffic Alert)
 222
 LTA (Lane Tracing Assist)..... 225
 Dynamic radar cruise control with
 full-speed range..... 237
 RSA (Road Sign Assist)..... 247
 BSM (Blind Spot Monitor) 250
 PKSA (Parking Support Alert)
 255
 Intuitive parking assist 257
 RCTA (Rear cross traffic alert)
 function..... 263
 RCD (Rear Camera Detection)
 function..... 267

PKSB (Parking Support Brake)
 270
 Parking Support Brake function
 (static objects)..... 276
 Parking Support Brake function
 (rear-crossing vehicles) 282
 Parking Support Brake function
 (rear pedestrians)..... 286
 Driving mode select switch 289
 Electronically modulated air sus-
 pension..... 291
 Driving assist systems 294

4-6. Driving tips
 Winter driving tips 300

5 Interior features

5-1. Remote Touch/Display
 Remote Touch..... 304
 Center Display..... 306
 Rear Multi Operation Panel ... 308

5-2. Lexus Climate Concierge
 Lexus Climate Concierge..... 311

**5-3. Using the air conditioning system
 and defogger**
 Front automatic air conditioning
 system..... 313
 Rear automatic air conditioning
 system..... 323
 Heated steering wheel/seat heat-
 ers/seat ventilators..... 326

5-4. Using the interior lights
 Interior lights list 331

5-5. Using the storage features
 List of storage features 335
 Trunk features 340



4 TABLE OF CONTENTS

- 5-6. Using the other interior features
 - Other interior features 343
 - Garage door opener 350

6 Maintenance and care

- 6-1. Maintenance and care
 - Cleaning and protecting the vehicle exterior 358
 - Cleaning and protecting the vehicle interior 361
- 6-2. Maintenance
 - Maintenance requirements 364
 - General maintenance 365
 - Emission inspection and maintenance (I/M) programs 368
- 6-3. Do-it-yourself maintenance
 - Do-it-yourself service precautions 369
 - Hood 371
 - Positioning a floor jack 371
 - Engine compartment 373
 - Battery 380
 - Tires 382
 - Replacing the tire 391
 - Tire inflation pressure 395
 - Wheels 396
 - Air conditioning filter 398
 - Electronic key battery 399
 - Checking and replacing fuses 401
 - Light bulbs 404

7 When trouble arises

- 7-1. Essential information
 - Emergency flashers 406
 - If your vehicle has to be stopped in an emergency 406
 - If the vehicle is trapped in rising water 407
- 7-2. Steps to take in an emergency
 - If your vehicle needs to be towed 409
 - If you think something is wrong 413
 - Fuel pump shut off system 414
 - If a warning light turns on or a warning buzzer sounds 415
 - If a warning message is displayed 425
 - If you have a flat tire 429
 - If the engine will not start 430
 - If you lose your keys 432
 - If the fuel filler door cannot be opened 432
 - If the electronic key does not operate properly 433
 - If the vehicle battery is discharged 435
 - If your vehicle overheats 440
 - If the vehicle becomes stuck ... 443

8 Vehicle specifications

- 8-1. Specifications
 - Maintenance data (fuel, oil level, etc.) 446
 - Fuel information 455

Tire information.....	457	
8-2. Customization		
Customizable features.....	466	
8-3. Initialization		
Items to initialize	481	
9 For owners		1
9-1. For owners		2
Reporting safety defects for U.S. owners	484	
Seat belt instructions for Canadian owners (in French).....	484	3
SRS airbag instructions for Canadian owners (in French).....	486	4
Index		5
What to do if... (Troubleshooting)	494	6
Alphabetical Index.....	497	7
		8
		9

For your information

Main Owner's Manual

Please note that this manual applies to all models and explains all equipment, including options. Therefore, you may find some explanations for equipment not installed on your vehicle.

All specifications provided in this manual are current at the time of printing. However, because of the Lexus policy of continual product improvement, we reserve the right to make changes at any time without notice.

Depending on specifications, the vehicle shown in the illustrations may differ from your vehicle in terms of color and equipment.

Noise from under vehicle after turning off the engine

Approximately five hours after the engine is turned off, you may hear sound coming from under the vehicle for several minutes. This is the sound of a fuel evaporation leakage check and, it does not indicate a malfunction.

Accessories, spare parts and modification of your Lexus

A wide variety of non-genuine spare parts and accessories for Lexus vehicles are currently available in the market. You should know that Toyota does not warrant these products and is not responsible for their performance, repair, or replacement, or for any dam-

age they may cause to, or adverse effect they may have on, your Lexus vehicle.

This vehicle should not be modified with non-genuine Lexus products. Modification with non-genuine Lexus products could affect its performance, safety or durability, and may even violate governmental regulations. In addition, damage or performance problems resulting from the modification may not be covered under warranty.

Installation of a mobile two-way radio system

The installation of a mobile two-way radio system in your vehicle could affect electronic systems such as:

- Multiport fuel injection system/sequential multiport fuel injection system
- Lexus Safety System + A
- Lexus Safety System + 2.0
- Anti-lock brake system
- Vehicle dynamics integrated management
- SRS airbag system
- Seat belt pretensioner system

Be sure to check with your Lexus dealer for precautionary measures or special instructions regarding installation of a mobile two-way radio system.

Vehicle data recordings

The vehicle is equipped with sophisti-

cated computers that will record certain data, such as:

The recorded data varies according to the vehicle grade level and options with which it is equipped.

These computers do not record conversations or sounds, and only record images outside of the vehicle in certain situations.

- Engine speed / Electric motor speed (traction motor speed)
- Accelerator status
- Brake status
- Vehicle speed
- Operation status of the driving assist systems, such as the ABS and pre-collision system
- Images from the front camera (available only when certain safety systems are activated, which varies depending on the vehicle specifications).

● Data Transmission

Your vehicle may transmit the data recorded in these computers to Lexus without notification to you.

● Data usage

Lexus may use the data recorded in this computer to diagnose malfunctions, conduct research and development, and improve quality.

Lexus will not disclose the recorded data to a third party except:

- With the consent of the vehicle owner or with the consent of the lessee if the vehicle is leased
- In response to an official request by the police, a court of law or a government agency

- For use by Lexus in a lawsuit
- For research purposes where the data is not tied to a specific vehicle or vehicle owner
- Recorded image information can be erased by your Lexus dealer.

The image recording function can be disabled. However, if the function is disabled, data from when the pre-collision system operates will not be available.

- To learn more about the vehicle data collected, used and shared by Lexus, please visit www.lexus.com/privacyvts/.

Usage of data collected through Lexus Enform (U.S. mainland only)

If your Lexus has Lexus Enform and if you have subscribed to those services, please refer to the Lexus Enform Telematics Subscription Service Agreement for information on data collected and its usage.

To learn more about the vehicle data collected, used and shared by Lexus, please visit www.lexus.com/privacyvts/.

Event data recorder

This vehicle is equipped with an event data recorder (EDR). The main purpose of an EDR is to record, in certain crash or near crash-like situations, such as an air bag deployment or hitting a road obstacle, data that will assist in understanding how a vehicle's systems performed. The EDR is designed to record data related to vehicle dynam-

ics and safety systems for a short period of time, typically 30 seconds or less.

The EDR in this vehicle is designed to record such data as:

- How various systems in your vehicle were operating;
- Whether or not the driver and passenger safety belts were buckled/fastened;
- How far (if at all) the driver was depressing the accelerator and/or brake pedal; and,
- How fast the vehicle was traveling.

These data can help provide a better understanding of the circumstances in which crashes and injuries occur.

NOTE: EDR data are recorded by your vehicle only if a non-trivial crash situation occurs; no data are recorded by the EDR under normal driving conditions and no personal data (e.g., name, gender, age, and crash location) are recorded. However, other parties, such as law enforcement, could combine the EDR data with the type of personally identifying data routinely acquired during a crash investigation.

To read data recorded by an EDR, special equipment is required, and access to the vehicle or the EDR is needed. In addition to the vehicle manufacturer, other parties, such as law enforcement, that have the special equipment, can read the information if they have access to the vehicle or the EDR.

- Disclosure of the EDR data

Lexus will not disclose the data recorded in an EDR to a third party except when:

- An agreement from the vehicle's owner (or the lessee for a leased vehicle) is obtained
- In response to an official request by the police, a court of law or a government agency
- For use by Lexus in a lawsuit

However, if necessary, Lexus may:

- Use the data for research on vehicle safety performance
- Disclose the data to a third party for research purposes without disclosing information about the specific vehicle or vehicle owner

Scrapping of your Lexus

The SRS airbag, seat belt pretensioner devices and Pop Up Hood system in your Lexus contain explosive chemicals. If the vehicle is scrapped with the airbags, seat belt pretensioners and Pop Up Hood micro gas generators left as they are, this may cause an accident such as fire. Be sure to have the systems of the SRS airbag, seat belt pretensioner and Pop Up Hood micro gas generators removed and disposed of by a qualified service shop or by your Lexus dealer before you scrap your vehicle.

Perchlorate Material

Special handling may apply, See www.dtsc.ca.gov/hazardouswaste/perchlorate.

Your vehicle has components that may contain perchlorate. These components may include airbag, seat belt pre-

tensioners, Pop Up Hood system, and wireless remote control batteries.

**WARNING****■ General precautions while driving**

Driving under the influence: Never drive your vehicle when under the influence of alcohol or drugs that have impaired your ability to operate your vehicle. Alcohol and certain drugs delay reaction time, impair judgment and reduce coordination, which could lead to an accident that could result in death or serious injury.

Defensive driving: Always drive defensively. Anticipate mistakes that other drivers or pedestrians might make and be ready to avoid accidents.

Driver distraction: Always give your full attention to driving. Anything that distracts the driver, such as adjusting controls, talking on a cellular phone or reading can result in a collision with resulting death or serious injury to you, your occupants or others.

■ General precaution regarding children's safety



Never leave children unattended in the vehicle, and never allow children to have or use the key.

Children may be able to start the vehicle or shift the vehicle into neutral. There is also a danger that children may injure themselves by playing with the windows, the moon roof, or other features of the vehicle. In addition, heat build-up or extremely cold temperatures inside the vehicle can be fatal to children.

Reading this manual



Explains symbols used in this manual.

Symbols in this manual

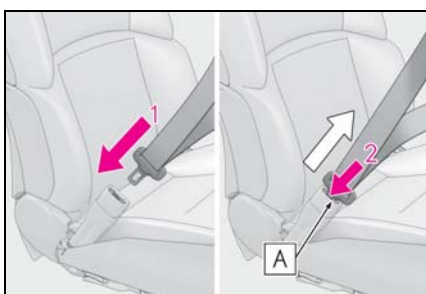

Symbols	Meanings
	WARNING: Explains something that, if not obeyed, could cause death or serious injury to people.
	NOTICE: Explains something that, if not obeyed, could cause damage to or a malfunction in the vehicle or its equipment.
	Indicates operating or working procedures. Follow the steps in numerical order.

Symbols in illustrations

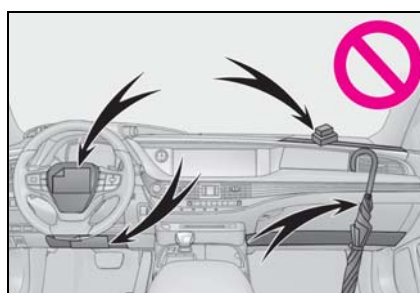

Symbols	Meanings
	Indicates the action (pushing, turning, etc.) used to operate switches and other devices.
	Indicates the outcome of an operation (e.g. a lid opens).



Symbols	Meanings
	Indicates the component or position being explained.
	Means Do not, Do not do this, or Do not let this happen.

How to search

■ Searching by name

- Alphabetical index: →P.497

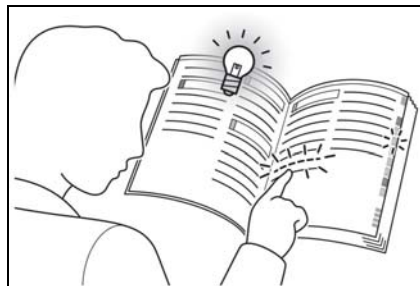
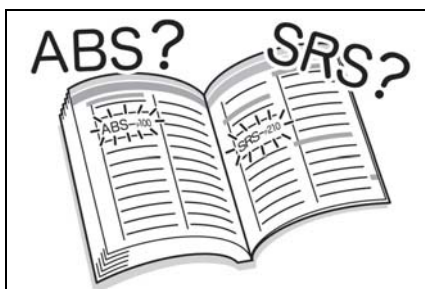

■ Searching by installation position

- Pictorial index: →P.12

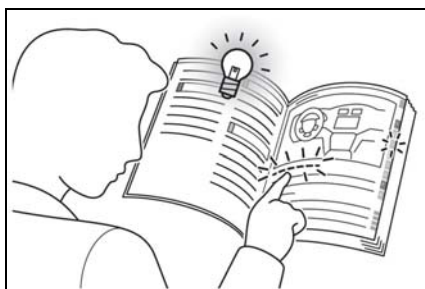

■ Searching by symptom or sound

- What to do if... (Troubleshooting):
→P.494



■ Searching by title

- Table of contents: →P.2

Pictorial index

■ Exterior

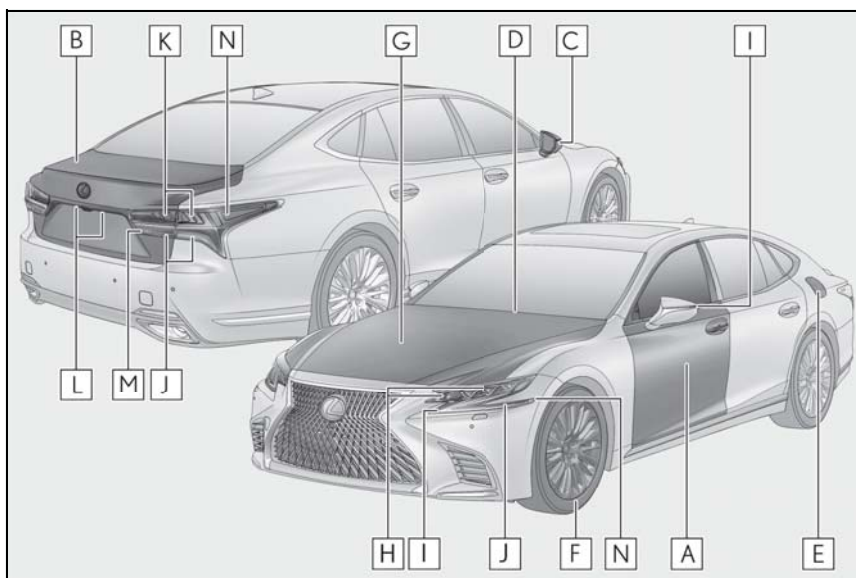

A	Doors	P.100
	Locking/unlocking	P.100
	Opening/closing the side windows	P.142
	Locking/unlocking by using the mechanical key	P.433
	Warning lights/warning messages	P.415, 425
B	Trunk	P.104
	Opening from inside the cabin	P.106
	Opening from outside	P.107
	Opening by using the mechanical key	P.433
	Warning lights/warning messages	P.415, 425
C	Outside rear view mirrors	P.140
	Adjusting the mirror angle	P.140
	Folding the mirrors	P.141
	Driving position memory	P.130
	Defogging the mirrors	P.313
D	Windshield wipers	P.184

Precautions for winter season	P.300
To prevent freezing (windshield wiper de-icer)*	P.318
Precautions for car wash	P.359
E Fuel filler door	P.189
Refueling method	P.189
Fuel type/fuel tank capacity	P.447
F Tires	P.382
Tire size/inflation pressure	P.382, 452
Winter tires/tire chains	P.300
Checking/rotation/tire pressure warning system	P.382
Coping with flat tires	P.429
G Hood	P.371
Opening	P.371
Engine compartment cover	P.374
Engine oil	P.448
Coping with overheating	P.440
Warning messages	P.425

Light bulbs of the exterior lights for driving (Replacing method: P.404)

H Headlights/cornering lights	P.179
I Parking lights/daytime running lights	P.179
J Turn signal lights	P.173
K Tail lights	P.179
Stop lights	
Hill-start assist control	P.295
L License plate lights	P.179
M Back-up lights	
Changing the shift position to R	P.167
N Side marker lights	P.179

* : If equipped

■ Instrument panel

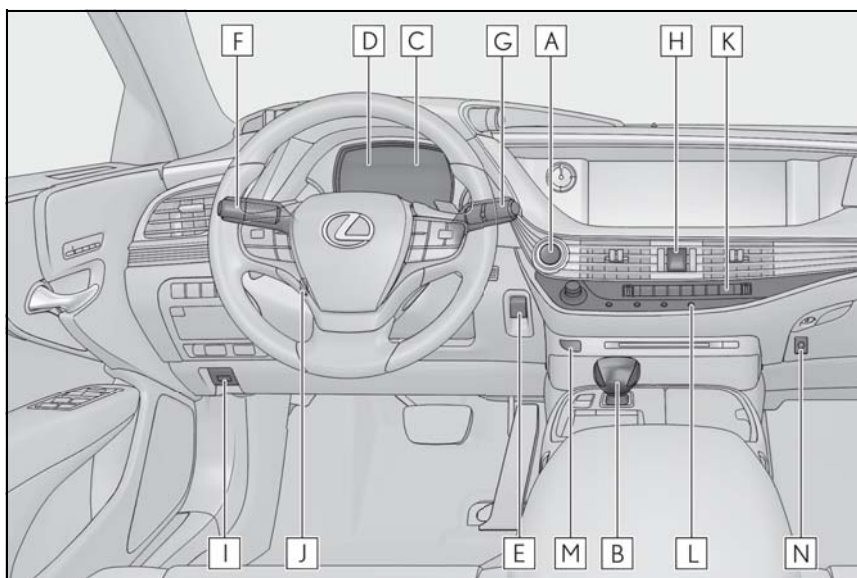

A	Engine switch	P.164
	Starting the engine/changing the modes	P.164
	Emergency stop of the engine	P.406
	When the engine will not start	P.430
	Warning messages	P.425
B	Shift lever	P.167
	Changing the shift position	P.169
	Precautions for towing	P.409
C	Meters	P.73, 76
	Reading the meters/adjusting the instrument panel light	P.73, 75, 76, 79
	Warning lights/indicator lights	P.68
	When a warning light turns on	P.415
D	Multi-information display	P.80
	Display	P.80
	When a warning message is displayed	P.425
E	Parking brake switch	P.174

	Applying/releasing the parking brake.....	P.174
	Precautions for winter season.....	P.301
	Warning buzzer/messages.....	P.425
F	Turn signal lever	P.173
	Headlight switch	P.179
	Headlights/parking lights/tail lights/license plate lights/daytime running lights	P.179
	AHB (Automatic High Beam).....	P.182
G	Windshield wiper and washer switch	P.184
	Usage.....	P.184
	Adding washer fluid.....	P.379
	Warning messages.....	P.425
H	Emergency flasher switch	P.406
I	Hood lock release lever	P.371
J	Tilt and telescopic steering control switch	P.138
	Adjustment.....	P.138
	Driving position memory.....	P.130
K	Air conditioning system	P.313
	Usage.....	P.313
	Rear window defogger.....	P.313
L	Audio system *	
M	Brake hold switch	P.177
N	Trunk opener main switch	P.110

*: Refer to "NAVIGATION AND MULTIMEDIA SYSTEM OWNER'S MANUAL".

■ Switches

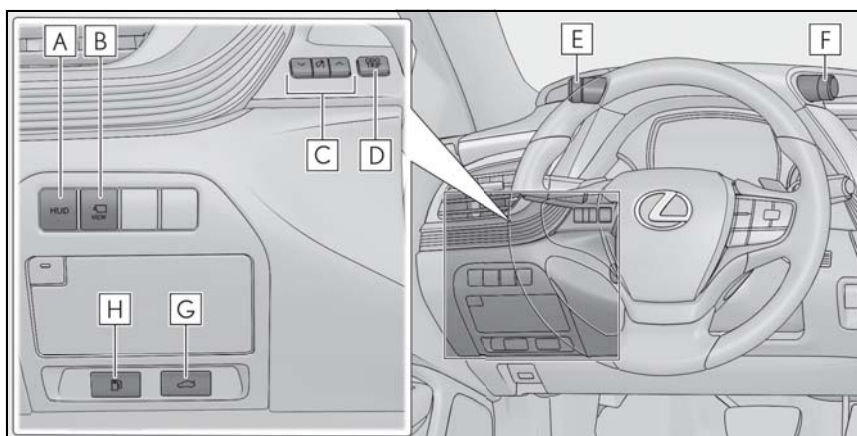

- A** HUD (Head-up display) switch^{*1}..... P.87
- B** Camera switch^{*1,2}
- C** Instrument panel light control switches P.75, 79
- D** “ODO TRIP” switch P.74, 79
- E** VSC OFF switch..... P.296
Snow mode switch P.171
- F** Driving mode select switch P.289
- G** Trunk opener switch..... P.106
- H** Fuel filler door opener switch..... P.190

^{*1}: If equipped

^{*2}: Refer to “NAVIGATION AND MULTIMEDIA SYSTEM OWNER’S MANUAL”.

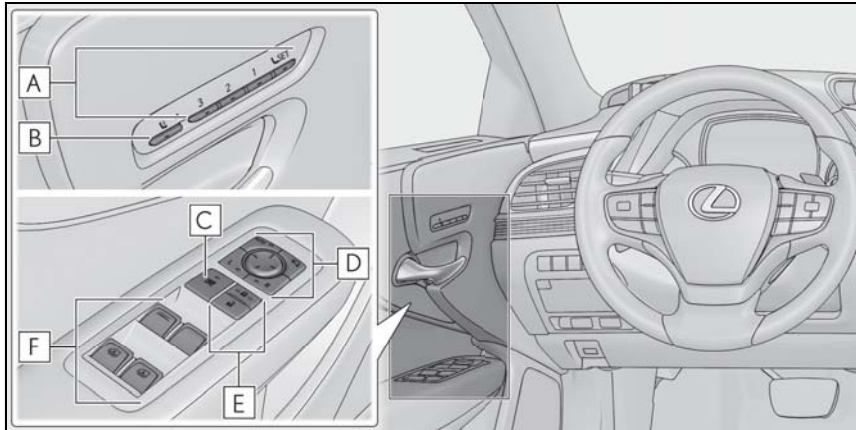

- A** Position memory buttons P.130
- B** Mode change button P.121
- C** Window lock switch P.144
- D** Outside rear view mirror switches P.140
- E** Door lock switches P.102
- F** Power window switches P.142
- Rear door sunshade switches* P.347

*: If equipped

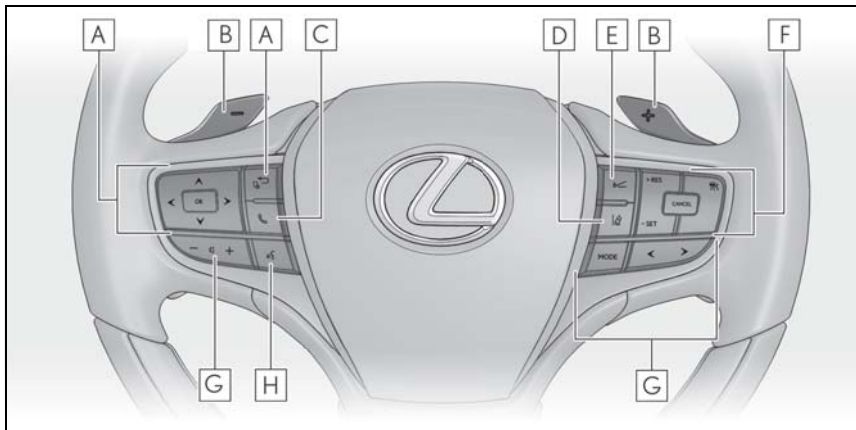

- A** Meter control switches P.81
- B** Paddle shift switches P.171,172

- C** Phone switch*
- D** LTA (Lane Tracing Assist) switch P.225
- E** Vehicle-to-vehicle distance switch P.241
- F** Cruise control switches P.237
- G** Audio remote control switches*
- H** Talk switch*

*: Refer to "NAVIGATION AND MULTIMEDIA SYSTEM OWNER'S MANUAL".

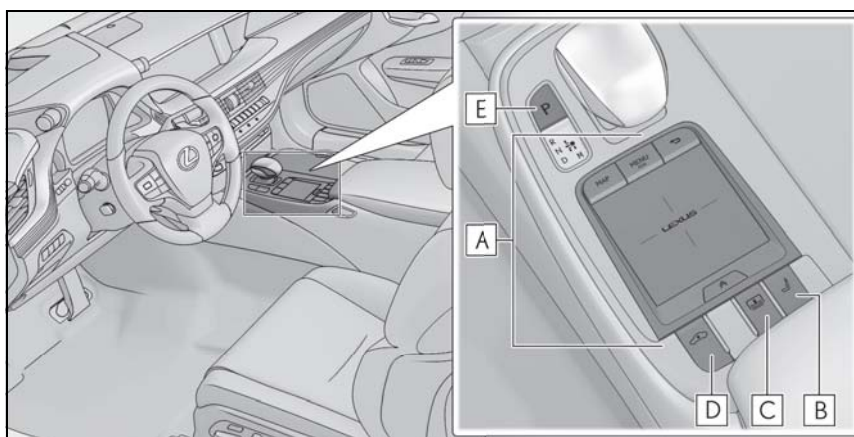

- A** Remote Touch*¹ P.304
- B** Seat switch P.120
- C** Rear sunshade switch*² P.348
- D** Vehicle height adjustment switch*² P.291
- E** P position switch P.170

*¹: Refer to "NAVIGATION AND MULTIMEDIA SYSTEM OWNER'S MANUAL".

*²: If equipped

■ Interior

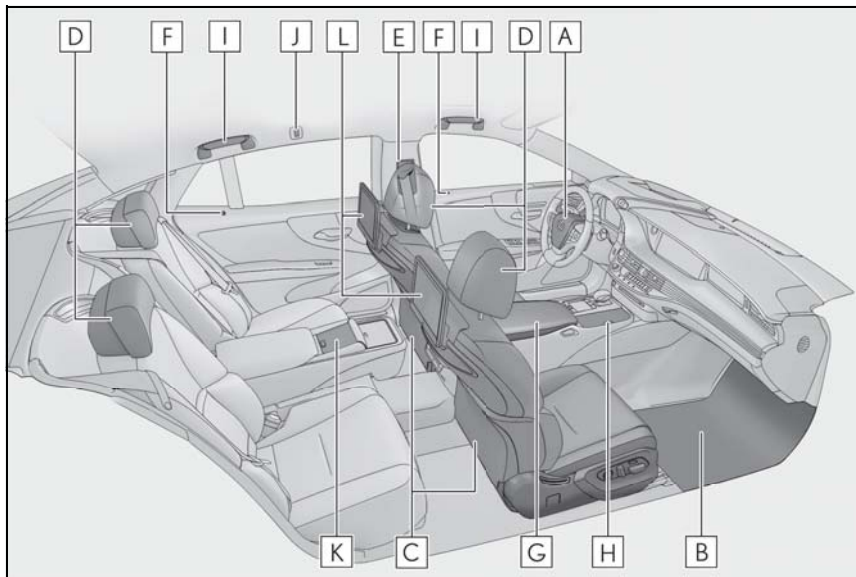

A	SRS airbags.....	P.29
B	Floor mats.....	P.22
C	Front seats.....	P.119
D	Head restraints.....	P.135
E	Seat belts.....	P.24
F	Inside lock buttons.....	P.102
G	Console box.....	P.338
H	Cup holders.....	P.337
I	Assist grips.....	P.344
J	Coat hooks.....	P.344
K	Rear Multi Operation Panel ^{*1}	P.308
L	Rear seat entertainment system ^{*1,2}	

^{*1}: If equipped

^{*2}: Refer to "NAVIGATION AND MULTIMEDIA SYSTEM OWNER'S MANUAL".

■ Ceiling

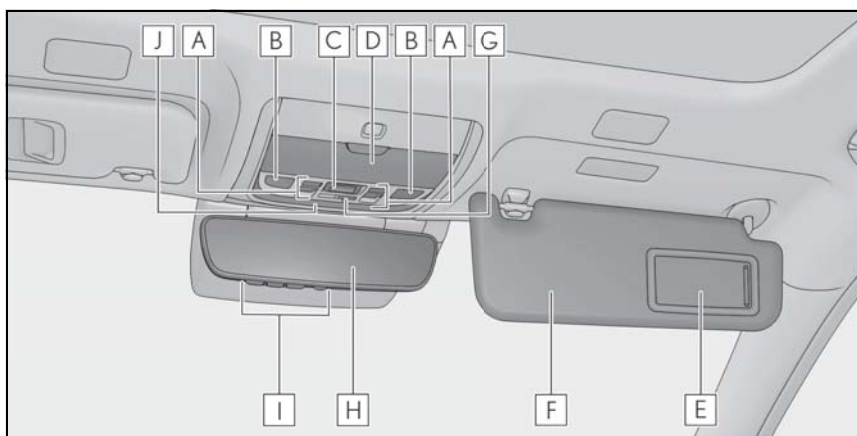

A	Moon roof switches *	P.145
	Panoramic moon roof switches *	P.147
B	Personal lights	P.333
C	“SOS” button *	P.58
D	Auxiliary box	P.339
E	Vanity mirrors	P.347
F	Sun visors	P.346
G	Door-linked interior light switch	P.333
H	Inside rear view mirror	P.139
I	Garage door opener buttons	P.350
J	Interior light	P.332

* : If equipped

For safety and security

1

21

- 1-1. For safe use**
 - Before driving22
 - For safe driving..... 23
 - Seat belts24
 - SRS airbags 29
 - Pop Up Hood38
 - Front passenger occupant classification system 40
 - Exhaust gas precautions 44
- 1-2. Child safety**
 - Riding with children..... 45
 - Child restraint systems 45
- 1-3. Lexus Enform**
 - Lexus Enform Safety Connect 58
- 1-4. Theft deterrent system**
 - Engine immobilizer system 63
 - Alarm..... 65

1

For safety and security

Before driving

Observe the following before starting off in the vehicle to ensure safety of driving.

Installing floor mats

Use only floor mats designed specifically for vehicles of the same model and model year as your vehicle. Fix them securely in place onto the carpet.

- 1 Insert the retaining hooks (clips) into the floor mat eyelets.

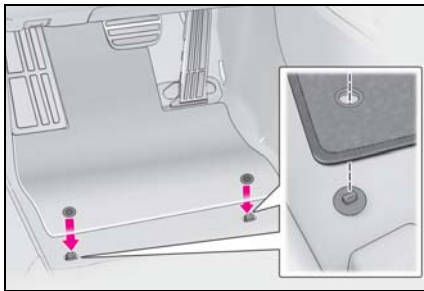

- 2 Turn the upper knob of each retaining hook (clip) to secure the floor mats in place.

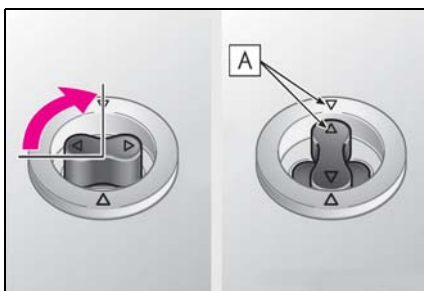

Always align the \triangle marks **A**.

The shape of the retaining hooks (clips) may differ from that shown in the illustration.

⚠ WARNING

Observe the following precautions. Failure to do so may cause the driver's floor mat to slip, possibly interfering with the pedals while driving. An unexpectedly high speed may result or it may become difficult to stop the vehicle. This could lead to an accident, resulting in death or serious injury.

■ When installing the driver's floor mat

- Do not use floor mats designed for other models or different model year vehicles, even if they are Lexus Genuine floor mats.
- Only use floor mats designed for the driver's seat.
- Always install the floor mat securely using the retaining hooks (clips) provided.
- Do not use two or more floor mats on top of each other.
- Do not place the floor mat bottom-side up or upside-down.

■ Before driving

- Check that the floor mat is securely fixed in the correct place with all the provided retaining hooks (clips). Be especially careful to perform this check after cleaning the floor.

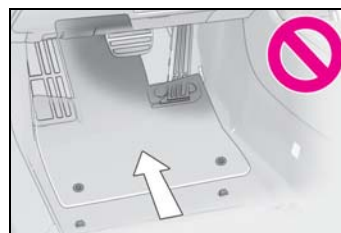

- With the engine stopped and the shift position in P, fully depress each pedal to the floor to make sure it does not interfere with the floor mat.

For safe driving

For safe driving, adjust the seat and mirror to an appropriate position before driving.

Correct driving posture

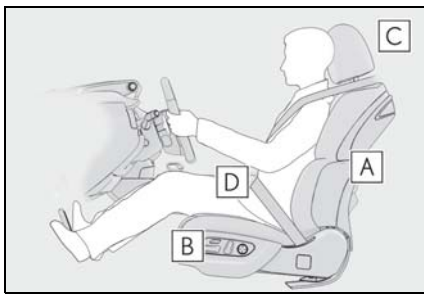

- A** Adjust the angle of the seatback so that you are sitting straight up and so that you do not have to lean forward to steer. (→P.119)
- B** Adjust the seat so that you can depress the pedals fully and so that your arms bend slightly at the elbow when gripping the steering wheel. (→P.119)
- C** Lock the head restraint in place with the center of the head restraint closest to the top of your ears. (→P.135)
- D** Wear the seat belt correctly. (→P.24)

WARNING

■ For safe driving

Observe the following precautions. Failure to do so may result in death or serious injury.

- Do not adjust the position of the driver's seat while driving. Doing so could cause the driver to lose control of the vehicle.
- Do not place a cushion between the driver or passenger and the seatback. A cushion may prevent correct posture from being achieved, and reduce the effectiveness of the seat belt and head restraint.
- Do not place anything under the front seats. Objects placed under the front seats may become jammed in the seat tracks and stop the seat from locking in place. This may lead to an accident and the adjustment mechanism may also be damaged.
- Always observe the legal speed limit when driving on public roads.
- When driving over long distances, take regular breaks before you start to feel tired. Also, if you feel tired or sleepy while driving, do not force yourself to continue driving and take a break immediately.

Correct use of the seat belts

Make sure that all occupants are wearing their seat belts before driving the vehicle. (→P.24)

Use a child restraint system appropriate for the child until the child becomes large enough to properly wear the vehicle's seat belt. (→P.45)

Adjusting the mirrors

Make sure that you can see backward clearly by adjusting the inside and outside rear view mirrors properly. (→P.139, 140)

Seat belts

Make sure that all occupants are wearing their seat belts before driving the vehicle.

WARNING

Observe the following precautions to reduce the risk of injury in the event of sudden braking, sudden swerving or an accident. Failure to do so may cause death or serious injury.

■ Wearing a seat belt

- Ensure that all passengers wear a seat belt.
- Always wear a seat belt properly.
- Each seat belt should be used by one person only. Do not use a seat belt for more than one person at once, including children.
- Lexus recommends that children be seated in the rear seat and always use a seat belt and/or an appropriate child restraint system.
- To achieve a proper seating position, do not recline the seat more than necessary. The seat belt is most effective when the occupants are sitting up straight and well back in the seats.
- Do not wear the shoulder belt under your arm.
- Always wear your seat belt low and snug across your hips.

■ Pregnant women

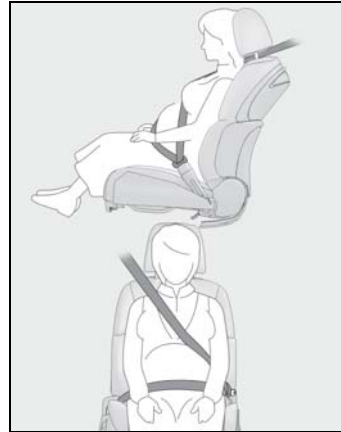

Obtain medical advice and wear the seat belt in the proper way. (→P.25)

Women who are pregnant should position the lap belt as low as possible over the hips in the same manner as other occupants, extending the shoulder belt completely over the shoulder and avoiding belt contact with the rounding of the abdominal area.

If the seat belt is not worn properly, not only the pregnant woman, but also the fetus could suffer death or serious injury as a result of sudden braking or a collision.

■ People suffering illness

Obtain medical advice and wear the seat belt in the proper way. (→P.25)

■ When children are in the vehicle

→P.53

■ Seat belt damage and wear

- Do not damage the seat belts by allowing the belt, plate, or buckle to be jammed in the door.
- Inspect the seat belt system periodically. Check for cuts, fraying, and loose parts. Do not use a damaged seat belt until it is replaced. Damaged seat belts cannot protect an occupant from death or serious injury.

⚠ WARNING

- Ensure that the belt and plate are locked and the belt is not twisted. If the seat belt does not function correctly, immediately contact your Lexus dealer.
- Replace the seat assembly, including the belts, if your vehicle has been involved in a serious accident, even if there is no obvious damage.
- Do not attempt to install, remove, modify, disassemble or dispose of the seat belts. Have any necessary repairs carried out by your Lexus dealer. Inappropriate handling may lead to incorrect operation.

Correct use of the seat belts

- Extend the shoulder belt so that it comes fully over the shoulder, but does not come into contact with the neck or slide off the shoulder.



- Position the lap belt as low as possible over the hips.
- Adjust the position of the seatback. Sit up straight and well back in the seat.
- Do not twist the seat belt.

■ Child seat belt usage

The seat belts of your vehicle were principally designed for persons of adult size.

- Use a child restraint system appropriate for the child, until the child becomes large enough to properly wear the vehicle's seat belt. (→P.45)
- When the child becomes large enough to properly wear the vehicle's seat belt, follow the instructions regarding seat belt usage. (→P.24)

■ Seat belt extender

If your seat belts cannot be fastened securely because they are not long enough, a personalized seat belt extender is available from your Lexus dealer free of charge.

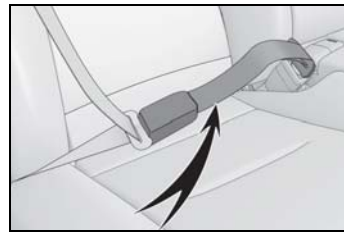
**⚠ WARNING****■ Using a seat belt extender**

Observe the following precautions to reduce the risk of injury in the event of sudden braking, sudden swerving or an accident. Failure to do so may cause death or serious injury.

- Do not wear the seat belt extender if you can fasten the seat belt without the extender.
- Do not use the seat belt extender when installing a child restraint system because the belt will not securely hold the child restraint system, increasing the risk of death or serious injury in the event of an accident.
- The personalized extender may not be safe on another vehicle, when used by another person, or at a different seating position other than the one originally intended.

**NOTICE**

■ **When using a seat belt extender**

When releasing the seat belt, press on the buckle release button on the extender, not on the seat belt. This helps prevent damage to the vehicle interior and the extender itself.

Fastening and releasing the seat belt

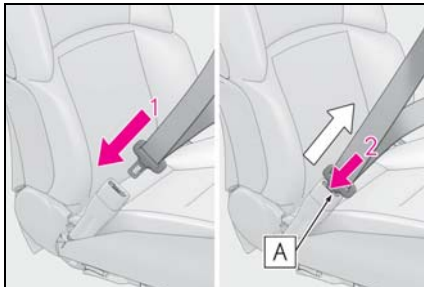

- 1** To fasten the seat belt, push the plate into the buckle until a click sound is heard.
- 2** To release the seat belt, press the release button **A**.

If the seat belt cannot be pulled out of the retractor, firmly pull the belt and release it.

■ Emergency locking retractor (ELR)

The retractor will lock the belt during a sudden stop or on impact. It may also lock if you lean forward too quickly. A slow, easy motion will allow the belt to extend so that you can move around fully.

■ Automatic locking retractor (ALR)

When a passenger's shoulder belt is completely extended and then retracted even slightly, the belt is locked in that position and cannot be extended. This feature is used to hold the child restraint system (CRS) firmly. To free the belt again, fully retract the belt and then pull the belt out once more. (→P.45)

Easy Access Buckle (front seats)*

The front seat belt buckles move outward automatically for easier access.

▶ When entering the vehicle

When a front door is opened, the seat belt buckle for the corresponding seat will move outward automatically. The buckle will retract automatically after the plate is inserted and locked to the buckle.

▶ When exiting the vehicle (driver's seat only)

If the engine switch is turned off when the driver's seat belt is fastened, the driver's seat belt buckle will move outward. The buckle will retract automatically when the driver's seat belt is released.

* : If equipped

■ Easy Access Buckle

- When the seat belt buckle is in the outward position and not latched, if the front passenger's seat is not occupied and the vehicle is driven, the seat belt buckle will return to its original position.
- If an occupant exits the vehicle and leaves the front door open and then enters the vehicle again, the seat belt buckle will not operate until the door is closed and then opened again.

■ Customization

Some functions can be customized. (→P.466)

Adjusting the seat belt shoulder anchor height (front seats)

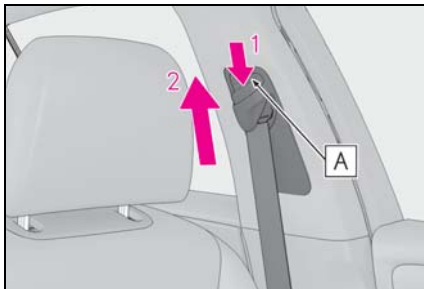

- 1 Push the seat belt shoulder anchor down while pressing the release button **A**.
- 2 Push the seat belt shoulder anchor up.

Move the height adjuster up and down as needed until you hear a click.

⚠ WARNING

■ Adjustable shoulder anchor

Always make sure the shoulder belt is positioned across the center of your shoulder. The belt should be kept away from your neck, but not falling off your shoulder. Failure to do so could reduce the amount of protection in an accident and cause death or serious injuries in the event of a sudden stop, sudden swerve or accident.

Seat belt pretensioners (front and outboard rear seats)

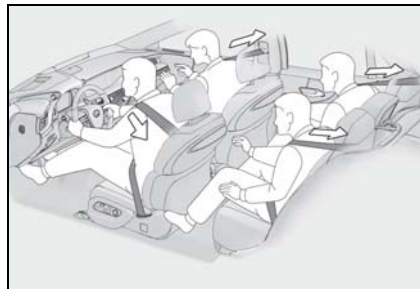

The pretensioners help the seat belts to quickly restrain the occupants by retracting the seat belts when the vehicle is subjected to certain types of severe frontal or side collision or a vehicle rollover.

The pretensioners do not activate in the event of a minor frontal impact, a minor side impact or a rear impact.

■ Replacing the belt after the pretensioner has been activated

If the vehicle is involved in multiple collisions, the pretensioner will activate for the first collision, but will not activate for the second or subsequent collisions.

⚠ WARNING

■ Seat belt pretensioners

Observe the following precautions to reduce the risk of injury in the event of sudden braking, sudden swerving or an accident. Failure to do so may cause death or serious injury.

**WARNING**

- Do not place anything, such as a cushion, on the front passenger's seat. Doing so will disperse the passenger's weight, which prevents the sensor from detecting the passenger's weight properly. As a result, the seat belt pretensioner for the front passenger's seat may not activate in the event of a collision.
- If the pretensioner has activated, the SRS warning light will come on. In that case, the seat belt cannot be used again and must be replaced at your Lexus dealer.

Pre-collision seat belts with comfort function (front seats of vehicles with Lexus Safety System + A)

When the vehicle speed reaches approximately 12 mph (20 km/h) or higher, the seat belts will retract slightly to remove any slack.

If the system determines that a collision is unavoidable, the front seat belts will retract before the collision. (→P.205)

■ Pre-collision seat belts with comfort function

A motor sound may be heard when a front seat belt is released or a front door is opened. This does not indicate a malfunction.

■ Customization

Some functions can be customized. (→P.466)

SRS airbags

The SRS airbags inflate when the vehicle is subjected to certain types of severe impacts that may cause significant injury to the occupants. They work together with the seat belts to help reduce the risk of death or serious injury.

SRS airbag system

■ Location of the SRS airbags

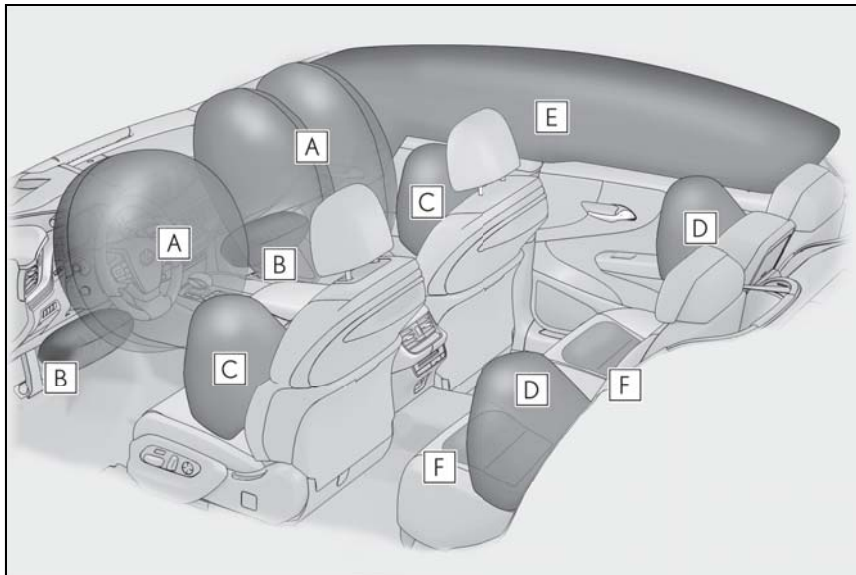

► SRS front airbags

- A** SRS driver airbag/front passenger airbag
Can help protect the head and chest of the driver and front passenger from impact with interior components
- B** SRS knee airbags
Can help provide driver and front passenger protection

► SRS side and curtain shield airbags

- C** SRS front side airbags
Can help protect the torso of the front seat occupants
- D** SRS rear side airbags
Can help protect the torso of occupants in the rear outer seats

- E** SRS curtain shield airbags
 - Can help protect primarily the head of occupants in the outer seats
 - Can help prevent the occupants from being thrown from the vehicle in the event of vehicle rollover
- F** SRS seat cushion airbags (if equipped)
 - Can help restrain the power rear seat occupants

■ SRS airbag system components

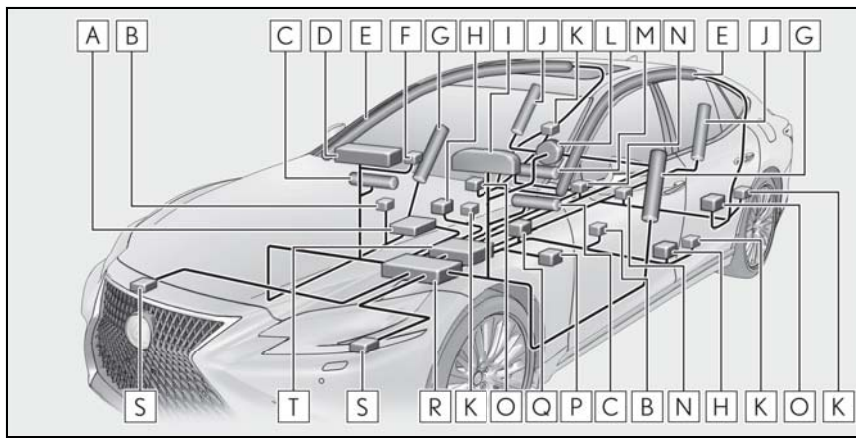

- A** Front passenger occupant classification system (ECU and sensors)
- B** Side impact sensors (front door)
- C** Knee airbags
- D** Front passenger airbag
- E** Curtain shield airbags
- F** “AIR BAG ON” and “AIR BAG OFF” indicator lights
- G** Front side airbags
- H** Side impact sensors (front)
- I** SRS warning light
- J** Rear side airbags
- K** Seat belt pretensioners
- L** Driver airbag
- M** Seat cushion airbags (if equipped)
- N** Rear seat belt buckle switches (if equipped)
- O** Side impact sensors (rear)

- P** Driver's seat position sensor
- Q** Driver's seat belt buckle switch
- R** Airbag sensor assembly
- S** Front impact sensors
- T** Pop Up Hood computer assembly

Your vehicle is equipped with ADVANCED AIRBAGS designed based on the US motor vehicle safety standards (FMVSS208). The airbag sensor assembly (ECU) controls airbag deployment based on information obtained from the sensors etc. shown in the system components diagram above. This information includes crash severity and occupant information. As the airbags deploy, a chemical reaction in the inflators quickly fills the airbags with non-toxic gas to help restrain the motion of the occupants.

■ If the SRS airbags deploy (inflate)

- Slight abrasions, burns, bruising etc., may be sustained from SRS airbags, due to the extremely high speed deployment (inflation) by hot gases.
- A loud noise and white powder will be emitted.
- Parts of the airbag module (steering wheel hub, airbag cover and inflator) as well as the seats, parts of the front and rear pillars, and roof side rails, may be hot for several minutes. The airbag itself may also be hot.
- The windshield may crack.
- All of the doors will be unlocked. (→P.101)
- The brakes and stop lights will be controlled automatically. (→P.294)
- The interior lights will turn on automatically. (→P.334)
- The emergency flashers will be turned on automatically. (→P.406)
- Fuel supply to the engine will be stopped. (→P.414)
- For Lexus Enform Safety Connect subscribers, if any of the following situations occur, the system is designed to send an emergency call to the response center, notifying them of the vehicle's location (without needing to push the "SOS" but-

ton) and an agent will attempt to speak with the occupants to ascertain the level of emergency and assistance required. If the occupants are unable to communicate, the agent automatically treats the call as an emergency and helps to dispatch the necessary emergency services. (→P.58)

- An SRS airbag is deployed.
- A seat belt pretensioner is activated.
- The vehicle is involved in a severe rear-end collision.

■ PCS-linked SRS airbag deployment control (vehicles with Lexus Safety System + A)

If the PCS (Pre-Collision System) determines that the possibility of a side collision is high, the SRS side and curtain shield airbags will be prepared to operate.

■ SRS airbag deployment conditions (SRS front airbags/SRS seat cushion airbags)

- The SRS front airbags and SRS seat cushion airbags will deploy in the event of an impact that exceeds the set threshold level (the level of force corresponding to an approximately 12 - 18 mph [20 - 30 km/h] frontal collision with a fixed wall that does not move or deform).

However, this threshold velocity will be considerably higher in the following situations:

- If the vehicle strikes an object, such as a

parked vehicle or sign pole, which can move or deform on impact

- If the vehicle is involved in an underride collision, such as a collision in which the front of the vehicle underrides, or goes under, the bed of a truck

- Depending on the type of collision, it is possible that only the seat belt pretensioners will activate.
- The SRS front airbags for the front passenger will not activate if there is no passenger sitting in the front passenger seat. However, the SRS front airbags for the front passenger may deploy if luggage is put in the seat, even if the seat is unoccupied.
- The SRS seat cushion airbags on the rear seat will not operate if the occupant is not wearing a seat belt.

■ SRS airbag deployment conditions (SRS side and curtain shield airbags)

- The SRS side and curtain shield airbags will deploy in the event of an impact that exceeds the set threshold level (the level of force corresponding to the impact force produced by an approximately 3300 lb. [1500 kg] vehicle colliding with the vehicle cabin from a direction perpendicular to the vehicle orientation at an approximate speed of 12 - 18 mph [20 - 30 km/h]).
- Both SRS curtain shield airbags may deploy in the event of a severe side collision.
- Both SRS curtain shield airbags will deploy in the event of vehicle rollover.
- Both SRS curtain shield airbags may also deploy in the event of a severe frontal collision.

■ Conditions under which the SRS airbags may deploy (inflate), other than a collision

The SRS front airbags, SRS curtain shield airbags and SRS seat cushion airbags may also deploy if a serious impact occurs to the underside of your vehicle. Some examples are shown in the illustration.

- Hitting a curb, edge of pavement or hard surface

- Falling into or jumping over a deep hole
- Landing hard or falling

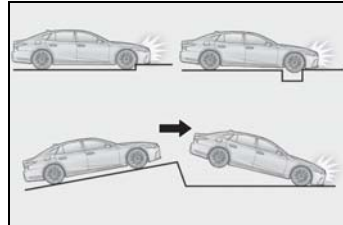

The SRS curtain shield airbags may also deploy under the situations shown in the illustration.

- The angle of vehicle tip-up is marginal.
- The vehicle skids and hits a curb stone.

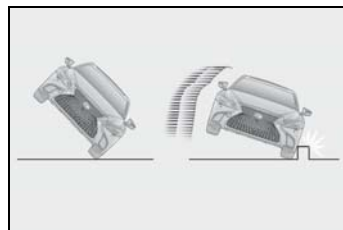

■ Types of collisions that may not deploy the SRS airbags (SRS front airbags/SRS seat cushion airbags)

The SRS front airbags and SRS seat cushion airbags do not generally inflate if the vehicle is involved in a side or rear collision, if it rolls over, or if it is involved in a low-speed frontal collision. But, whenever a collision of any type causes sufficient forward deceleration of the vehicle, deployment of the SRS front airbags and SRS seat cushion airbags may occur.

- Collision from the side
- Collision from the rear
- Vehicle rollover

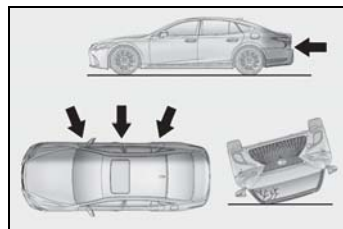

■ **Types of collisions that may not deploy the SRS airbags (SRS side and curtain shield airbags)**

The SRS side and curtain shield airbags may not activate if the vehicle is subjected to a collision from the side at certain angles, or a collision to the side of the vehicle body other than the passenger compartment.

- Collision from the side to the vehicle body other than the passenger compartment
- Collision from the side at an angle

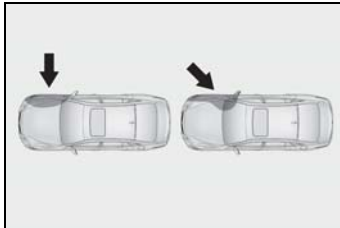

The SRS side airbags do not generally inflate if the vehicle is involved in a frontal or rear collision, if it rolls over, or if it is involved in a low-speed side collision.

- Collision from the front
- Collision from the rear
- Vehicle rollover

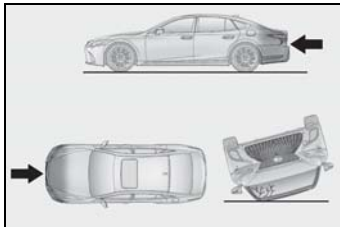

The SRS curtain shield airbags do not generally inflate if the vehicle is involved in a rear collision, if it pitches end over end, or if it is involved in a low-speed side or low-speed frontal collision.

- Collision from the rear
- Pitching end over end

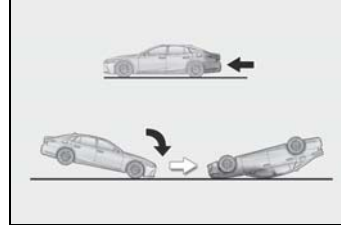

■ **When to contact your Lexus dealer**

In the following cases, the vehicle will require inspection and/or repair. Contact your Lexus dealer as soon as possible.

- Any of the SRS airbags have been inflated.
- The front of the vehicle is damaged or deformed, or was involved in an accident that was not severe enough to cause the SRS front airbags and SRS cushion airbags to inflate.

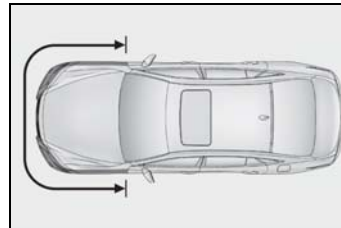

- A portion of a door or its surrounding area is damaged, deformed or has had a hole made in it, or the vehicle was involved in an accident that was not severe enough to cause the SRS side and curtain shield airbags to inflate.

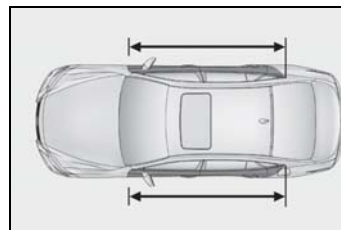

- The pad section of the steering wheel, dashboard near the front passenger airbag or lower portion of the instrument panel is scratched, cracked, or otherwise damaged.

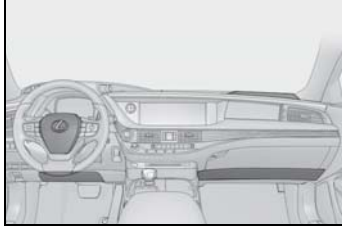

- Vehicles with power rear seat: The seat cushion surface is scratched, cracked, or otherwise damaged.

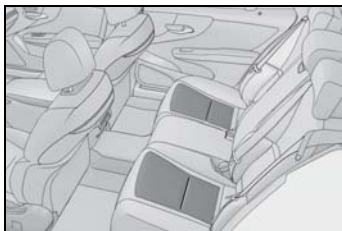

- The surface of the seats with the side airbag is scratched, cracked, or otherwise damaged.

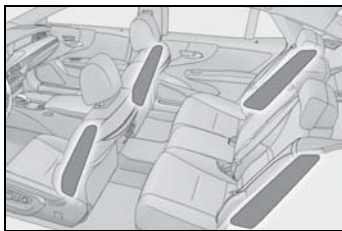

- The portion of the front pillars, rear pillars or roof side rail garnishes (padding) containing the curtain shield airbags inside is scratched, cracked, or otherwise damaged.



WARNING

■ SRS airbag precautions

Observe the following precautions regarding the SRS airbags. Failure to do so may cause death or serious injury.

- The driver and all passengers in the vehicle must wear their seat belts properly. The SRS airbags are supplemental devices to be used with the seat belts.
- The SRS driver airbag deploys with considerable force, and can cause death or serious injury especially if the driver is very close to the airbag.

The National Highway Traffic Safety Administration (NHTSA) advises: Since the risk zone for the driver's airbag is the first 2 - 3 in. (50 - 75 mm) of inflation, placing yourself 10 in. (250 mm) from your driver airbag provides you with a clear margin of safety. This distance is measured from the center of the steering wheel to your breastbone. If you sit less than 10 in. (250 mm) away now, you can change your driving position in several ways:

- Move your seat to the rear as far as you can while still reaching the pedals comfortably.

⚠ WARNING

- Slightly recline the back of the seat. Although vehicle designs vary, many drivers can achieve the 10 in. (250 mm) distance, even with the driver seat all the way forward, simply by reclining the back of the seat somewhat. If reclining the back of your seat makes it hard to see the road, raise yourself by using a firm, non-slippery cushion, or raise the seat if your vehicle has that feature.
- If your steering wheel is adjustable, tilt it downward. This points the airbag toward your chest instead of your head and neck.

The seat should be adjusted as recommended by NHTSA above, while still maintaining control of the foot pedals, steering wheel, and your view of the instrument panel controls.

- If the seat belt extender has been connected to the front seat belt buckles but the seat belt extender has not also been fastened to the latch plate of the seat belt, the SRS front airbags will judge that the driver and front passenger are wearing the seat belt even though the seat belt has not been connected. In this case, the SRS front airbags may not activate correctly in a collision, resulting in death or serious injury in the event of a collision. Be sure to wear the seat belt with the seat belt extender.



- The SRS front passenger airbag also deploys with considerable force, and can cause death or serious injury especially if the front passenger is very close to the airbag. The front passenger seat should be as far from the airbag as possible with the seatback adjusted, so the front passenger sits upright.
- Improperly seated and/or restrained infants and children can be killed or seriously injured by a deploying airbag. An infant or child who is too small to use a seat belt should be properly secured using a child restraint system. Lexus strongly recommends that all infants and children be placed in the rear seats of the vehicle and properly restrained. The rear seats are safer for infants and children than the front passenger seat. (→P.45)

⚠ WARNING

- Do not sit on the edge of the seat or lean against the dashboard.

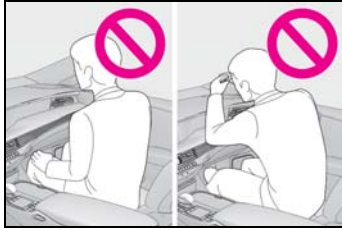

- Do not allow a child to stand in front of the SRS front passenger airbag unit or sit on the knees of a front passenger.

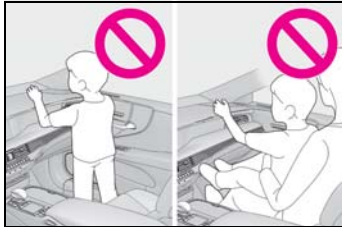

- Do not allow the front seat occupants to hold items on their knees.
- Do not lean against the door, the roof side rail or the front, side and rear pillars.



- Do not allow anyone to kneel on the passenger seats toward the door or put their head or hands outside the vehicle.



- Do not attach anything to or lean anything against areas such as the dashboard, steering wheel pad and lower portion of the instrument panel. These items can become projectiles when the SRS driver, front passenger and knee airbags deploy.

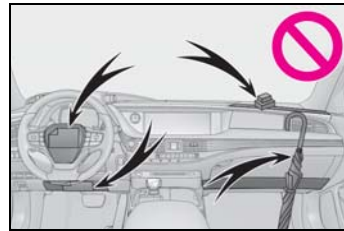

- Do not attach anything to areas such as a door, windshield, side windows, front or rear pillar, roof side rail and assist grip.

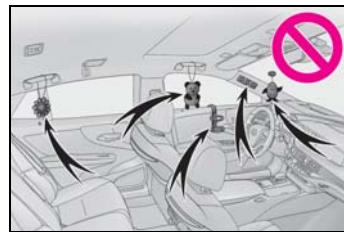

- Do not hang coat hangers or hard objects on the coat hooks. All of these items could become projectiles and may cause death or serious injury, should the SRS curtain shield airbags deploy.

⚠ WARNING

- If a vinyl cover is put on the area where the SRS knee airbag will deploy, be sure to remove it.
- Do not use seat accessories which cover the parts where the SRS side airbags inflate as they may interfere with inflation of the SRS airbags. Such accessories may prevent the side airbags from activating correctly, disable the system or cause the side airbags to inflate accidentally, resulting in death or serious injury.
- Do not strike or apply significant levels of force to the area of the SRS airbag components or the front doors. Doing so can cause the SRS airbags to malfunction.
- Do not touch any of the component parts immediately after the SRS airbags have deployed (inflated) as they may be hot.
- If breathing becomes difficult after the SRS airbags have deployed, open a door or window to allow fresh air in, or leave the vehicle if it is safe to do so. Wash off any residue as soon as possible to prevent skin irritation.
- If the areas where the SRS airbags are stored, such as the steering wheel pad and front and rear pillar garnishes are damaged or cracked, have them replaced by your Lexus dealer.
- Do not place anything, such as a cushion, on the front passenger's seat. Doing so will disperse the passenger's weight, which prevents the sensor from detecting the passenger's weight properly. As a result, the SRS front airbags for the front passenger may not deploy in the event of a collision.

■ Modification and disposal of SRS airbag system components

Do not dispose of your vehicle or perform any of the following modifications without consulting your Lexus dealer. The SRS airbags may malfunction or deploy (inflate) accidentally, causing death or serious injury.

- Installation, removal, disassembly and repair of the SRS airbags
- Repairs, modifications, removal or replacement of the steering wheel, instrument panel, dashboard, seats or seat upholstery, front, side and rear pillars, roof side rails, front door panels, front door trims or front door speakers
- Modifications to the front door panel (such as making a hole in it)
- Repairs or modifications of the front fender, front bumper, or side of the occupant compartment
- Installation of a grille guard (bull bars, kangaroo bar, etc.), snow plows, winches or roof luggage carrier
- Modifications to the vehicle's suspension system
- Installation of electronic devices such as mobile two-way radios and CD players
- Modifications to your vehicle for a person with a physical disability

Pop Up Hood

In the event of a frontal collision with a body, such as a pedestrian, the Pop Up Hood system raises the hood to reduce the possibility of a serious impact to the pedestrian's head area by adding clearance to the engine compartment.

When the sensors located at the back of the front bumper detect a frontal impact with a body, such as a pedestrian, which meets or exceeds the threshold level while the vehicle is being driven within the operational speed range, the system operates.

System components

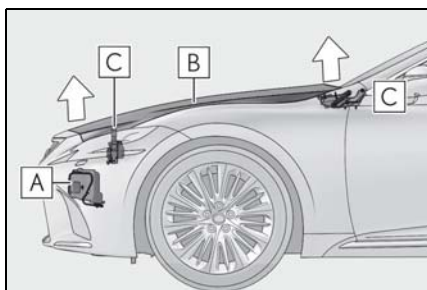

A Sensors

B Hood

C Lifters

Pop Up Hood precautions

- Before scrapping your vehicle, make sure to contact your Lexus dealer.
- The Pop Up Hood system cannot be reused once it has operated. Have it replaced by your Lexus dealer.

PCS-linked Pop Up Hood operation control

If the PCS (Pre-Collision System) determines that the possibility of a collision with a pedestrian or bicyclist is high, the Pop Up Hood will be prepared to operate.

Pop Up Hood operational conditions

The Pop Up Hood will operate when the vehicle detects an impact such as the following:

- The front bumper detects a frontal impact equivalent to or greater than that of a pedestrian while the vehicle being driven within the operational speed range of approximately 16 to 34 mph (25 to 55 km/h). (The system is operated by an impact of threshold level or greater, even in the case of a minor collision that may not leave a trace on the front bumper. Also, depending on the impact conditions or vehicle speed, the system may operate by a collision with a light or small object or a small animal.)
- In other situations, such as the following the system may operate when an impact is applied to the lower part of the vehicle or front bumper:
 - Colliding with a curb
 - Falling into a deep hole
 - Landing hard
 - Hitting the slope of a parking lot, an undulating road, a protruding object or falling object

Conditions under which the Pop Up Hood may not operate properly

- If a pedestrian collides with the right or left corner of the front bumper or the side of the vehicle. As such impacts may be difficult to detect, the system may not operate.
- If the vehicle speed is not detected correctly, such as if the vehicle is sliding sideways, the system may not operate properly.

Conditions under which the Pop Up Hood will not operate

The Pop Up Hood will not operate in the following situations:

- Colliding with a lying person

- A frontal impact applied to the front bumper while driving at speeds outside of the operational speed range
- A side impact or rear impact
- A vehicle rollover (In some accident situations, the Pop Up Hood may operate.)

 **WARNING**

■ **When the Pop Up Hood is operated**

- Do not pull the hood lock release lever. Doing so after the Pop Up Hood has operated will further raise the hood and may cause an injury. Do not drive with the hood raised, as doing so may block the driver's vision, possibly causing an accident.
- Do not forcibly push down the hood. As the popped up hood cannot be lowered by hand, doing so may deform the hood or cause an injury.
- If the Pop Up Hood has operated, have it replaced by your Lexus dealer. If the Pop Up Hood has operated, stop the vehicle in a safe place and contact your Lexus dealer.
- Do not touch the lifters immediately after the Pop Up Hood has operated, as the lifters may be hot and burn you.

 **NOTICE**

■ **Pop Up Hood precautions**

- Make sure to close the hood before driving, as the system may not operate properly if the hood is not fully closed.
- Make sure that all 4 tires are of the specified size and inflated to the specified tire pressure. If tires of a different size are used, the system may not operate properly.
- If something has hit the area around the front bumper, the sensors may be damaged even if the Pop Up Hood has not operated. Have the vehicle inspected by your Lexus dealer.

- Do not remove or repair the parts or wiring of the Pop Up Hood, as doing so may cause accidental operation or prevent the system from operating properly. If repair or replacement is necessary, contact your Lexus dealer.

- Do not remove such components as the front bumper, hood or suspension, or replace them with non-genuine parts, as doing so may prevent the system from operating properly.

- Do not install anything to the front bumper or hood, as doing so may prevent the sensors from detecting an impact correctly and prevent the system from operating properly.

- Do not close the hood with force or apply load to the lifters, as doing so may damage the lifters and prevent the system from operating properly.

- Do not modify the suspension, as changes made to the vehicle height may prevent the system from operating properly.

Front passenger occupant classification system

Your vehicle is equipped with a front passenger occupant classification system. This system detects the conditions of the front passenger seat and activates or deactivates the front passenger airbag and front passenger knee airbag.

System components

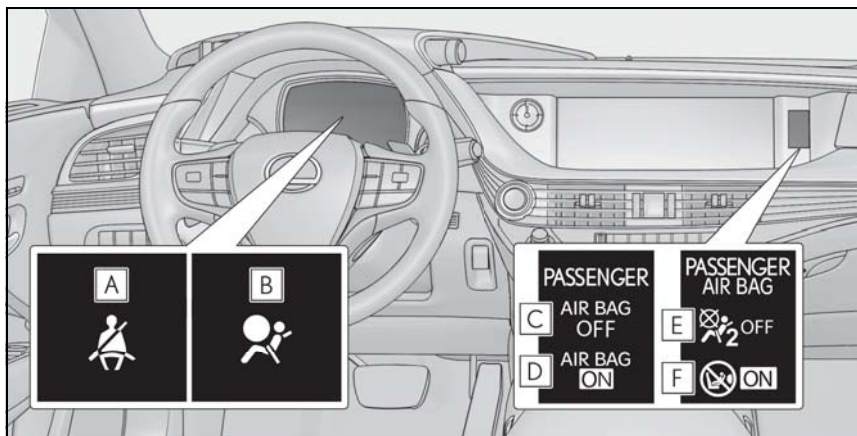

A Driver's and front passenger's seat belt reminder light

B SRS warning light

► For the U.S.A.

C "AIR BAG OFF" indicator light

D "AIR BAG ON" indicator light

► For Canada

E "AIR BAG OFF" indicator light

F "AIR BAG ON" indicator light

! WARNING

■ Front passenger occupant classification system precautions

Observe the following precautions regarding the front passenger occupant classification system. Failure to do so may cause death or serious injury.

● Wear the seat belt properly.

● Make sure the front passenger's seat belt plate has not been left inserted into the buckle before someone sits in the front passenger seat.

⚠ WARNING

- Make sure the "AIR BAG OFF" indicator light is not illuminated when using the seat belt extender for the front passenger seat. If the "AIR BAG OFF" indicator light is illuminated, disconnect the extender tongue from the seat belt buckle, and reconnect the seat belt. Reconnect the seat belt extender after making sure the "AIR BAG ON" indicator light is illuminated. If you use the seat belt extender while the "AIR BAG OFF" indicator light is illuminated, the SRS airbags for the front passenger will not activate, which could cause death or serious injury in the event of a collision.
- Do not apply a heavy load to the front passenger seat or equipment (e.g. seatback pocket).
- Do not put weight on the front passenger seat by putting your hands or feet on the front passenger seat seatback from the rear passenger seat.
- Do not let a rear passenger lift the front passenger seat with their feet or press on the seatback with their legs.
- Do not put objects under the front passenger seat.
- Do not recline the front passenger seatback so far that it touches a rear seat. This may cause the "AIR BAG OFF" indicator light to be illuminated, which indicates that the SRS airbags for the front passenger will not activate in the event of a severe accident. If the seatback touches the rear seat, return the seatback to a position where it does not touch the rear seat. Keep the front passenger seatback as upright as possible when the vehicle is moving. Reclining the seatback excessively may lessen the effectiveness of the seat belt system.
- If an adult sits in the front passenger seat, the "AIR BAG ON" indicator light is illuminated. If the "AIR BAG OFF" indicator is illuminated, ask the passenger to sit up straight, well back in the seat, feet on the floor, and with the seat belt worn correctly. If the "AIR BAG OFF" indicator still remains illuminated, either ask the passenger to move to the rear seat, or if that is not possible, move the front passenger seat fully rearward.
- When it is unavoidable to install a forward-facing child restraint system on the front passenger seat, install the child restraint system on the front passenger seat in the proper order. (→P.46)
- Do not modify or remove the front seats.
- Do not kick the front passenger seat or subject it to severe impact. Otherwise, the SRS warning light may come on to indicate a malfunction of the front passenger occupant classification system. In this case, contact your Lexus dealer immediately.
- Child restraint systems installed on the rear seat should not contact the front seatbacks.
- Do not use a seat accessory, such as a cushion and seat cover, that covers the seat cushion surface.
- Do not modify or replace the upholstery of the front seat.

Condition and operation in the front passenger occupant classification system

■ Adult^{*1}

Indicator/warning light	"AIR BAG ON" and "AIR BAG OFF" indicator lights	"AIR BAG ON"
	SRS warning light	Off
	Driver's and front passenger's seat belt reminder light	Off ^{*2} or flashing ^{*3}
Devices	Front passenger airbag	Activated
	Front passenger knee airbag	

■ Child^{*4}

Indicator/warning light	"AIR BAG ON" and "AIR BAG OFF" indicator lights	"AIR BAG OFF" or "AIR BAG ON" ^{*4}
	SRS warning light	Off
	Driver's and front passenger's seat belt reminder light	Off ^{*2} or flashing ^{*3}
Devices	Front passenger airbag	Deactivated or activated ^{*4}
	Front passenger knee airbag	

■ Child restraint system with infant^{*5}

Indicator/warning light	"AIR BAG ON" and "AIR BAG OFF" indicator lights	"AIR BAG OFF" ^{*6}
	SRS warning light	Off
	Driver's and front passenger's seat belt reminder light	Off ^{*2} or flashing ^{*3}
Devices	Front passenger airbag	Deactivated
	Front passenger knee airbag	

■ Unoccupied

Indicator/warning light	"AIR BAG ON" and "AIR BAG OFF" indicator lights	"AIR BAG OFF"
	SRS warning light	Off
	Driver's and front passenger's seat belt reminder light	
Devices	Front passenger airbag	Deactivated
	Front passenger knee airbag	

■ There is a malfunction in the system

Indicator/warning light	"AIR BAG ON" and "AIR BAG OFF" indicator lights	"AIR BAG OFF"
	SRS warning light	On
	Driver's and front passenger's seat belt reminder light	Off
Devices	Front passenger airbag	Deactivated
	Front passenger knee airbag	

*1: The system judges a person of adult size as an adult. When a smaller adult sits in the front passenger seat, the system may not recognize him/her as an adult depending on his/her physique and posture.

*2: In the event the front passenger is wearing a seat belt

*3: In the event the front passenger does not wear a seat belt

*4: For some children, child in seat, child in booster seat or child in convertible seat, the system may not recognize him/her as a child. Factors which may affect this can be the physique or posture.

*5: Never install a rear-facing child restraint system on the front passenger seat. A forward-facing child restraint system should only be installed on the front passenger seat when it is unavoidable. (→P.45)

*6: In case the indicator light is not illuminated, consult this manual on how to install the child restraint system properly. (→P.46)

Exhaust gas precautions

Harmful substance to the human body is included in exhaust gases if inhaled.

 **WARNING**

Exhaust gases include harmful carbon monoxide (CO), which is colorless and odorless. Observe the following precautions.

Failure to do so may cause exhaust gases enter the vehicle and may lead to an accident caused by light-headedness, or may lead to death or a serious health hazard.

■ Important points while driving

- Keep the trunk lid closed.
- If you smell exhaust gases in the vehicle even when the trunk lid is closed, open the windows and have the vehicle inspected at your Lexus dealer as soon as possible.

■ When parking

- If the vehicle is in a poorly ventilated area or a closed area, such as a garage, stop the engine.
- Do not leave the vehicle with the engine on for a long time.
If such a situation cannot be avoided, park the vehicle in an open space and ensure that exhaust fumes do not enter the vehicle interior.
- Do not leave the engine running in an area with snow build-up, or where it is snowing. If snowbanks build up around the vehicle while the engine is running, exhaust gases may collect and enter the vehicle.

■ Exhaust pipe

The exhaust system needs to be checked periodically. If there is a hole or crack caused by corrosion, damage to a joint or abnormal exhaust noise, be sure to have the vehicle inspected and repaired by your Lexus dealer.

Riding with children

Observe the following precautions when children are in the vehicle. Use a child restraint system appropriate for the child, until the child becomes large enough to properly wear the vehicle's seat belt.

- It is recommended that children sit in the rear seats to avoid accidental contact with the shift lever, wiper switch etc.
- Use the rear door child-protector lock or the window lock switch to avoid children opening the door while driving or operating the power window accidentally. (→P.103, 144)
- Do not let small children operate equipment which may catch or pinch body parts, such as the power window, hood, trunk, seats etc.

WARNING

■ When children are in the vehicle

Never leave children unattended in the vehicle, and never allow children to have or use the key.

Children may be able to start the vehicle or shift the vehicle into neutral. There is also a danger that children may injure themselves by playing with the windows, the moon roof or panoramic moon roof, or other features of the vehicle. In addition, heat build-up or extremely cold temperatures inside the vehicle can be fatal to children.

Child restraint systems

Before installing a child restraint system in the vehicle, there are precautions that need to be observed, different types of child restraint systems, as well as installation methods, etc., written in this manual.

Use a child restraint system when riding with a small child that cannot properly use a seat belt. For the child's safety, install the child restraint system to a rear seat. Be sure to follow the installation method that is in the operation manual enclosed with the restraint system.

Table of contents

Points to remember: P.45

Child restraint system: P.46

When using a child restraint system: P.47

Child restraint system installation method

- Fixed with a seat belt: P.49
- Fixed with a child restraint LATCH anchor: P.53
- Using an anchor bracket (for top tether strap): P.55

Points to remember

The laws of all 50 states of the U.S.A. as well as Canada now require the use of child restraint systems.

- Prioritize and observe the warnings, as well as the laws and regula-

tions for child restraint systems.

- Use a child restraint system until the child becomes large enough to properly wear the vehicle's seat belt.
- Choose a child restraint system that suits your vehicle and is appropriate to the age and size of the child.

WARNING

■ When a child is riding

Observe the following precautions. Failure to do so may result in death or serious injury.

- For effective protection in automobile accidents and sudden stops, a child must be properly restrained, using a seat belt or child restraint system which is correctly installed. For installation details, refer to the operation manual enclosed with the child restraint system. General installation instruction is provided in this manual.
- Lexus strongly urges the use of a proper child restraint system that conforms to the weight and size of the child, installed on the rear seat. According to accident statistics, the child is safer when properly restrained in the rear seat than in the front seat.

- Holding a child in your or someone else's arms is not a substitute for a child restraint system. In an accident, the child can be crushed against the windshield or between the holder and the interior of the vehicle.

■ Handling the child restraint system



If the child restraint system is not properly fixed in place, the child or other passengers may be seriously injured or even killed in the event of sudden braking, sudden swerving, or an accident.

- If the vehicle were to receive a strong impact from an accident, etc., it is possible that the child restraint system has damage that is not readily visible. In such cases, do not reuse the restraint system.
- Make sure you have complied with all installation instructions provided with the child restraint system manufacturer and that the system is properly secured.
- Keep the child restraint system properly secured on the seat even if it is not in use. Do not store the child restraint system unsecured in the passenger compartment.
- If it is necessary to detach the child restraint system, remove it from the vehicle or store it securely in the trunk.

Child restraint system

■ Types of child restraint system installation methods

Confirm with the operation manual enclosed with the child restraint system about the installation of the child restraint system.

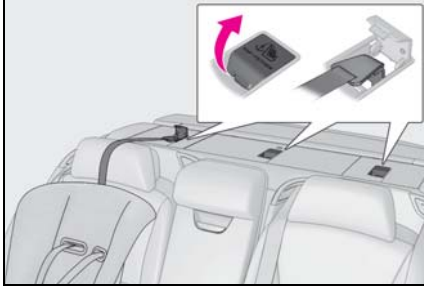
	Installation method	Page
Seat belt attachment		P.49
Child restraint LATCH anchors attachment		P.53
Anchor brackets (for top tether strap) attachment		P.55

When using a child restraint system

■ When installing a child restraint system to a front passenger seat

For the safety of a child, install child restraint systems to a rear seats. When installing child restraint system to a front passenger seat is unavoidable, adjust the seat as follows and install the child restraint system.

- Move the front seat fully rearward.
- Adjust the seatback angle to the most upright position.
- Adjust the front of the seat cushion to the lowest position.
- Adjust the seat height to the uppermost position.
- Adjust the lumbar support to the lowest position.
- Adjust the shoulder bolster to the

lowest position (if equipped).

- Adjust the pelvic support to the lowest position.
- Adjust the seatback side bolster to the widest position (if equipped).
- Adjust the seat cushion side bolster to the lowest position (if equipped).
- Adjust the hip support to the lowest position (if equipped).
- If the head restraint interferes with the child restraint system installation and the head restraint can be removed, remove the head restraint. Otherwise, put the head restraint in the upper most position.

- Adjust the head restraint to the lowest and rearmost position.
- Adjust the shoulder bolster to the lowest position.
- Adjust the lumbar support to the lowest position.
- Adjust the pelvic support to the lowest position.
- Disable the automatic rear seat operation. (→P.308)
- For the rear seat with an ottoman (if equipped): Adjust the seatback to the most upright position and ottoman (footrest) to the stowed position.



■ **When installing a child restraint system to a power rear seat (if equipped)**

When using a child restraint system in an outer rear seat, adjust the seat as follows and install the child restraint system.

- Adjust the seat cushion to the fully rearward position.
- Adjust the upper seatback to the rearmost position.
- Adjust the front of the seat cushion to the lowest position.



⚠ WARNING

■ **When using a child restraint system**

Observe the following precautions. Failure to do so may result in death or serious injury.

- Never install a rear-facing child restraint system on the front passenger seat even if the "AIR BAG OFF" indicator light is illuminated. In the event of an accident, the force of the rapid inflation of the front passenger airbag can cause death or serious injury to the child if the rear-facing child restraint system is installed on the front passenger seat.

⚠ WARNING

- A forward-facing child restraint system may be installed on the front passenger seat only when it is unavoidable. A child restraint system that requires a top tether strap should not be used in the front passenger seat since there is no top tether strap anchor for the front passenger seat.
- A forward-facing child restraint system may be installed on the front passenger seat only when it is unavoidable. When installing a forward-facing child restraint system on the front passenger seat, adjust the seatback angle to the most upright position, move the seat to the rearmost position, and raise the seat to the upper most position, even if the "AIR BAG OFF" indicator light is illuminated.



- Do not allow the child to lean his/her head or any part of his/her body against the door or the area of the seat, front or rear pillars, or roof side rails from which the SRS side airbags or SRS curtain shield airbags deploy even if the child is seated in the child restraint system. It is dangerous if the SRS side and curtain shield airbags inflate, and the impact could cause death or serious injury to the child.



- When a booster seat is installed, always ensure that the shoulder belt is positioned across the center of the child's shoulder. The belt should be kept away from the child's neck, but not so that it could fall off the child's shoulder.
- Use child restraint system suitable to the age and size of the child and install it to the rear seat.
- If the driver's seat interferes with the child restraint system and prevents it from being attached correctly, attach the child restraint system to the right-hand rear seat.

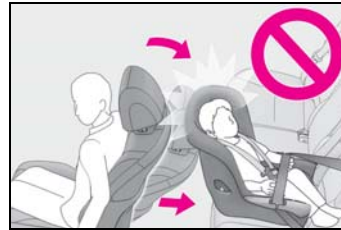

- Adjust the front passenger seat so that it does not interfere with the child restraint system.

Child restraint system fixed with a seat belt

A child restraint system for a small child or baby must itself be properly restrained on the seat with the lap portion of the lap/shoulder belt.

■ Installing child restraint system using a seat belt (child restraint lock function belt)

Install the child restraint system in accordance to the operation manual enclosed with the child restraint system.

■ **Rear-facing — Infant seat/convertible seat**

1 Adjust the rear seat

Vehicles with power rear seat: If there is a gap between the child seat and the seatback, adjust the seatback angle until good contact is achieved.

2 Place the child restraint system on the rear seat facing the rear of the vehicle.

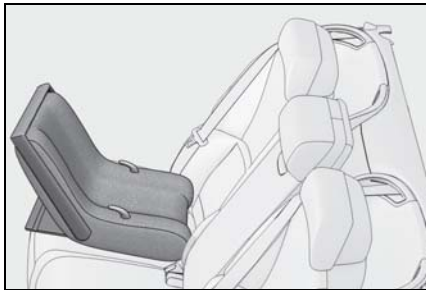

3 Run the seat belt through the child restraint system and insert the plate into the buckle. Make sure that the belt is not twisted.

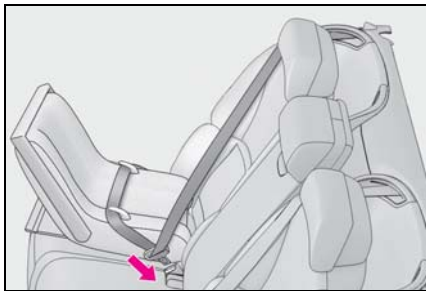

4 Fully extend the shoulder belt and allow it to retract to put it in lock

mode. In lock mode, the belt cannot be extended.



5 While pushing the child restraint system down into the rear seat, allow the shoulder belt to retract until the child restraint system is securely in place.

After the shoulder belt has retracted to a point where there is no slack in the belt, pull the belt to check that it cannot be extended.

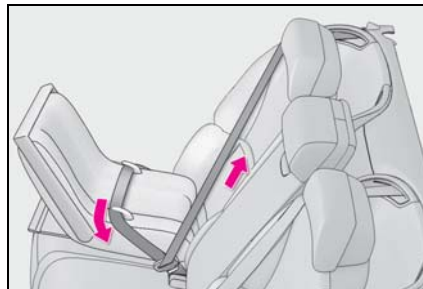

6 After installing the child restraint system, rock it back and forth to ensure that it is installed securely. (→P.53)

■ **Forward-facing — Convertible seat**

1 Adjust the seat

- ▶ When using the front passenger seat

If installing the child restraint system to the front passenger seat is unavoidable-

able, refer to P.47 for front passenger seat adjustment.

► When using the rear seat

If there is a gap between the child seat and the seatback, adjust the seatback angle until good contact is achieved.

- 2 Place the child restraint system on the seat facing the front of the vehicle.



- 3 Run the seat belt through the child restraint system and insert the plate into the buckle. Make sure that the belt is not twisted.

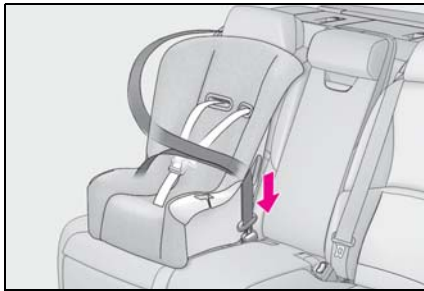

- 4 Fully extend the shoulder belt and allow it to retract to put it in lock

mode. In lock mode, the belt cannot be extended.

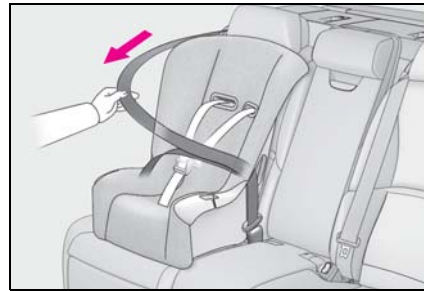

- 5 While pushing the child restraint system into the rear seat, allow the shoulder belt to retract until the child restraint system is securely in place.

After the shoulder belt has retracted to a point where there is no slack in the belt, pull the belt to check that it cannot be extended.

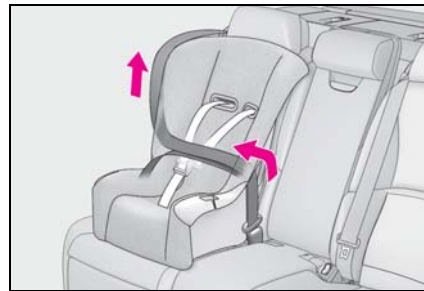

- 6 If the child restraint has a top tether strap, follow the child restraint manufacturer's operation manual regarding the installation, using the top tether strap to latch onto the top tether strap anchor. (→P.55)
- 7 After installing the child restraint system, rock it back and forth to ensure that it is installed securely. (→P.53)

■ **Booster seat**

- 1 If installing the child restraint system to the front passenger seat is unavoidable, refer to P.47 for front passenger seat adjustment.
- 2 Place the child restraint system on the seat facing the front of the vehicle.

▶ **Booster type**

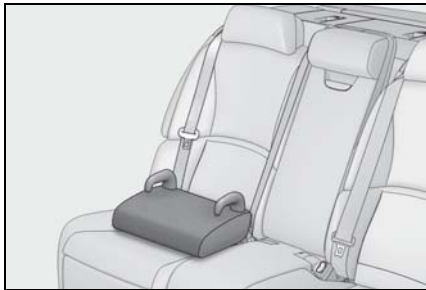

▶ **High back type**



- 4 Sit the child in the child restraint system. Fit the seat belt to the child restraint system according to the manufacturer's instructions and insert the plate into the buckle. Make sure that the belt is not twisted.

Check that the shoulder belt is correctly positioned over the child's shoulder and that the lap belt is as low as possible.

(→P.24)

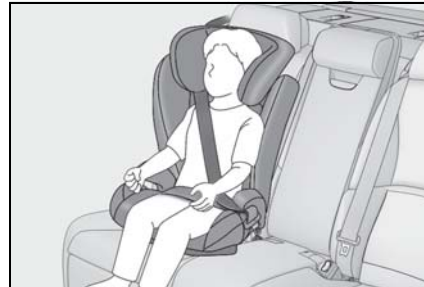

■ **Removing a child restraint system installed with a seat belt**

Press the buckle release button and fully retract the seat belt.

When releasing the buckle, the child restraint system may spring up due to the rebound of the seat cushion. Release the buckle while holding down the child restraint system.

Since the seat belt automatically reels itself, slowly return it to the stowing position.

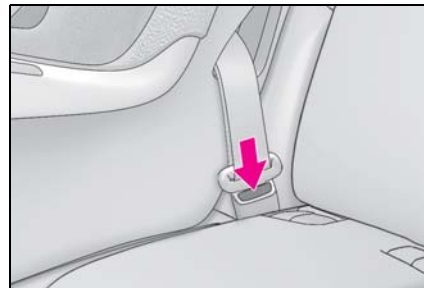

⚠ WARNING

■ **When installing a child restraint system**

Observe the following precautions. Failure to do so may result in death or serious injury.

⚠ WARNING

- Do not allow children to play with the seat belt. If the seat belt becomes twisted around a child's neck, it may lead to choking or other serious injuries that could result in death. If this occurs and the buckle cannot be unfastened, scissors should be used to cut the belt.
- Ensure that the belt and plate are securely locked and the seat belt is not twisted.
- Shake the child restraint system left and right, and forward and backward to ensure that it has been securely installed.
- After securing a child restraint system, never adjust the seat.
- When a booster seat is installed, always ensure that the shoulder belt is positioned across the center of the child's shoulder. The belt should be kept away from the child's neck, but not so that it could fall off the child's shoulder.
- Follow all installation instructions provided by the child restraint system manufacturer.
- When securing some types of child restraint systems in rear seats, it may not be possible to properly use the seat belts in positions next to the child restraint without interfering with it or affecting seat belt effectiveness. Be sure your seat belt fits snugly across your shoulder and low on your hips. If it does not, or if it interferes with the child restraint, move to a different position. Failure to do so may result in death or serious injury.

- When installing a child restraint system in the rear center seat, adjust both seat cushions to the same position and align both seatbacks at the same angle. Otherwise, the child restraint system cannot be securely restrained and this may cause death or serious injuries in the event of sudden braking, sudden swerving or an accident.

■ When installing a booster seat

To prevent the belt from going into ALR lock mode, do not fully extend the shoulder belt. ALR mode causes the belt to tighten only. This could cause injury or discomfort to the child. (→P.26)

■ Do not use a seat belt extender

If a seat belt extender is used when installing a child restraint system, the seat belt will not securely hold the child restraint system, which could cause death or serious injury to the child or other passengers in the event of sudden braking, sudden swerving or an accident.

Child restraint system fixed with a child restraint LATCH anchor**■ Child restraint LATCH anchors**

LATCH anchors are provided for the outboard rear seat. (Buttons displaying the location of the anchors are attached to the seats.)

**■ Installation with LATCH system**

Install the child restraint system in

54 1-2. Child safety

accordance to the operation manual enclosed with the child restraint system.

- 1 Vehicles with power rear seat:
Adjust the seat

If there is a gap between the child seat and the seatback, adjust the seatback angle until good contact is achieved. (→P.48)

- 2 Open the cover.

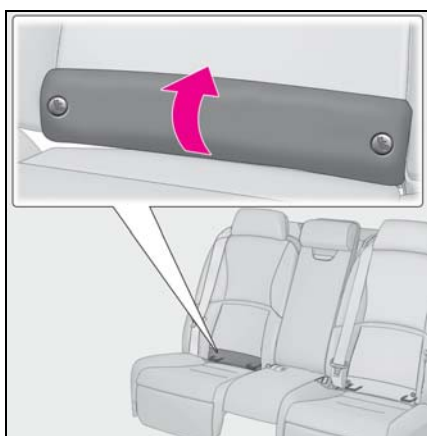

- 3 Insert the tab **B** into the slit **A** of the cover.

The cover will be held open.

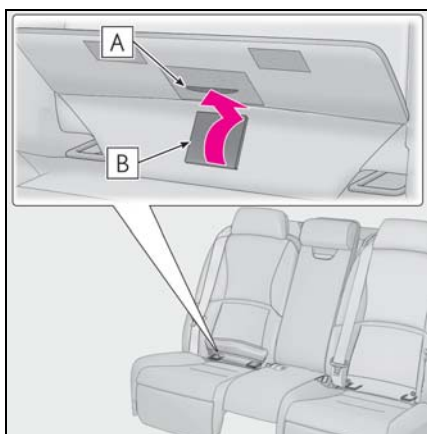

- ▶ Type A

- 4 Latch the hooks of the lower straps onto the LATCH anchors.

For owners in Canada:

The symbol on a child restraint system indicates **A** the presence of a lower connector system.

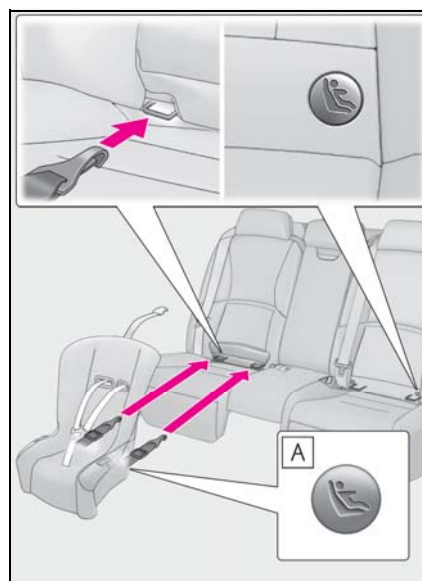

- A** Canada only

- ▶ Type B

- 4 Latch the buckles onto the LATCH anchors.

For owners in Canada:

The symbol on a child restraint sys-

tem indicates **A** the presence of a lower connector system.

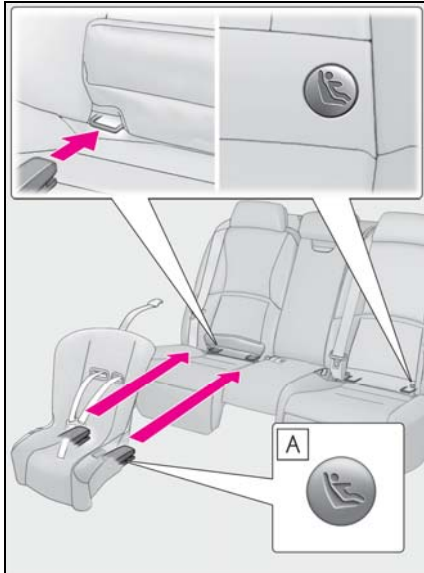

A Canada only

- 5** If the child restraint has a top tether strap, follow the child restraint manufacturer's operation manual regarding the installation, using the top tether strap to latch onto the top tether strap anchor. (→P.55)
- 6** After installing the child restraint system, rock it back and forth to ensure that it is installed securely. (→P.53)

■ Laws and regulations pertaining to anchors

The LATCH system conforms to FMVSS225 or CMVSS210.2. Child restraint systems conforming to FMVSS213 or CMVSS213 specifications can be used. This vehicle is designed to conform to SAE J1819.

⚠ WARNING

■ When installing a child restraint system

Observe the following precautions. Failure to do so may result in death or serious injury.

- After securing a child restraint system, never adjust the seat.
- When using the LATCH anchors, be sure that there are no foreign objects around the anchors and that the seat belt is not caught behind the child restraint system.
- Follow all installation instructions provided by the child restraint system manufacturer.
- When securing some types of child restraint systems in rear seats, it may not be possible to properly use the seat belts in positions next to the child restraint without interfering with it or affecting seat belt effectiveness. Be sure your seat belt fits snugly across your shoulder and low on your hips. If it does not, or if it interferes with the child restraint, move to a different position. Failure to do so may result in death or serious injury.

Using an anchor bracket (for top tether strap)

■ Anchor brackets (for top tether strap)

Anchor brackets are provided for each rear seat.

Use anchor brackets when fixing the top tether strap.

▶ Outboard rear seats

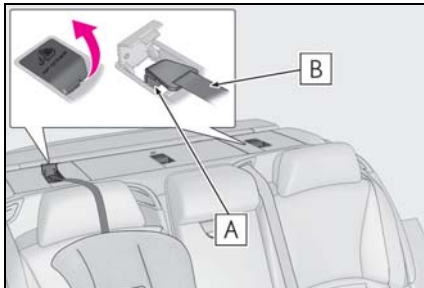

- A** Anchor brackets
- B** Top tether strap

▶ Rear center seat

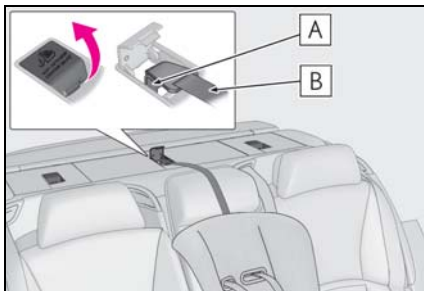

- A** Anchor bracket
- B** Top tether strap

■ Fixing the top tether strap to the anchor bracket

Install the child restraint system in accordance to the operation manual enclosed with the child restraint system.

Open the anchor bracket cover, latch the hook onto the anchor bracket and tighten the top tether strap.

Make sure the top tether strap is securely latched. (→P.53)

▶ Outboard rear seats

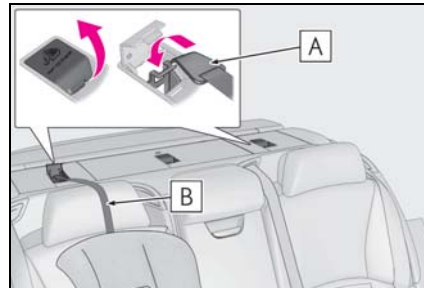

- A** Hook
- B** Top tether strap

▶ Rear center seat

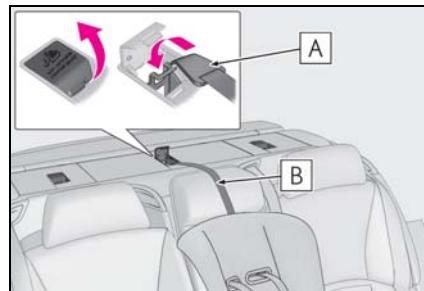

- A** Hook
- B** Top tether strap

■ Laws and regulations pertaining to anchors

The LATCH system conforms to FMVSS225 or CMVSS210.2. Child restraint systems conforming to FMVSS213 or CMVSS213 specifications can be used. This vehicle is designed to conform to SAE J1819.

⚠ WARNING

■ When installing a child restraint system

Observe the following precautions. Failure to do so may result in death or serious injury.

 **WARNING**

- Firmly attach the top tether strap and make sure that the belt is not twisted.
- Do not attach the top tether strap to anything other than the anchor bracket.
- After securing a child restraint system, never adjust the seat.
- Follow all installation instructions provided by the child restraint system manufacturer.
- Be sure to have the top tether strap pass over the top of the head restraint. If the belt passes below the head restraint, it is possible that the child restraint system may not be securely fixed.

 **NOTICE****■ Anchor brackets (for top tether strap)**

When not in use, make certain to close the lid. If it remains open, the lid may be damaged.

Lexus Enform Safety Connect*

*: If equipped

Safety Connect is a subscription-based telematics service that uses Global Positioning System (GPS) data and embedded cellular technology to provide safety and security features to subscribers. Safety Connect is supported by Lexus' designated response center, which operates 24 hours per day, 7 days per week.

Safety Connect service is available by subscription on select, telematics hardware-equipped vehicles.

By using the Safety Connect service, you are agreeing to be bound by the Telematics Subscription Service Agreement and its Terms and Conditions, as in effect and amended from time to time, a current copy of which is available at Lexus.com. All use of the Safety Connect service is subject to such then-applicable Terms and Conditions.

System components

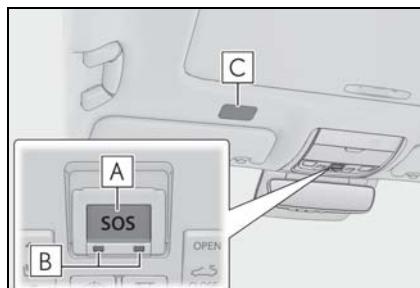

- A** "SOS" button
- B** LED light indicators
- C** Microphone

■ Certification for Lexus Enform

FCC ID: JOYJ79
IC: 574B-J79

FCC/IC WARNING:

Changes or modifications not expressly approved by the manufacture could void the user's authority to operate the equipment. This device complies with Part 15 of the FCC Rules and Industry Canada license-exempt RSS standards. Operation is subject to the following two conditions:

- (1) this device may not cause harmful interference, and
- (2) this device must accept any interference, including interference that may cause undesired operation of the device.

This equipment complies with IC RSS-102 radiation exposure limits set forth for uncontrolled environment.

The antennas used for this transmitter must be installed to provide a separation distance of least 20cm from all persons.

FCC/IC AVERTISSEMENT:

L'utilisateur est averti que les changements ou modifications non expressément approuvés par le fabricant pourraient annuler l'autorité de l'utilisateur à utiliser l'équipement.

Ce appareil est compatible avec la Partie 15 du règlement FCC et de la Licence de l'industrie canadienne et des normes exemptes de RSS. Opération soumise aux deux conditions suivantes :

- (1) ce appareil ne doit pas causer des interférences nuisibles, et
- (2) cet appareil doit accepté toutes les interférences, y compris les interférences qui peuvent entraîner un fonctionnement indésirable de l'appareil.

Cet appareil est compatible aux limites d'exposition aux radiation IC RSS-102 définies pour un environnement non contrôlé.

Les antennes utilisées pour cet émetteur doivent être installées à une distance d'au moins 20 cm de toutes les personnes.

Services

Subscribers have the following Safety Connect services available:

● Automatic Collision Notification*

Helps drivers receive necessary response from emergency service providers. (→P.61)

*: U.S. Patent No. 7,508,298 B2

- Stolen Vehicle Location

Helps drivers in the event of vehicle theft. (→P.61)

- Emergency Assistance Button (“SOS”)

Connects drivers to response-center support. (→P.61)

- Enhanced Roadside Assistance

Provides drivers various on-road assistance. (→P.61)

Subscription

After you have signed the Telematics Subscription Service Agreement and are enrolled, you can begin receiving services.

A variety of subscription terms is available for purchase. Contact your Lexus dealer, call the following or push the “SOS” button in your vehicle for further subscription details.

- The United States

1-800-25-LEXUS (1-800-255-3987)

- Canada

1-800-26-LEXUS (1-800-265-3987)

- Puerto Rico

1-877-539-8777

■ Safety Connect Services Information

- Phone calls using the vehicles Bluetooth® technology will not be possible during Safety Connect.
- Safety Connect is available beginning Fall 2009 on select Lexus models (in the contiguous United States only). Contact with the Safety Connect response center is dependent upon the telematics device

being in operative condition, cellular connection availability, and GPS satellite signal reception, which can limit the ability to reach the response center or receive emergency service support. Enrollment and Telematics Subscription Service Agreement required. A variety of subscription terms is available; charges vary by subscription term selected and location.

- Automatic Collision Notification, Emergency Assistance and Stolen Vehicle Location will function in the United States, including Hawaii and Alaska, Puerto Rico and in Canada, and Enhanced Roadside Assistance will function in the United States, Puerto Rico and in Canada.
- Automatic Collision Notification, Emergency Assistance, Stolen Vehicle and Enhanced Road Assistance will not function in the United States Virgin Islands. For vehicles first sold in the USVI, no Safety Connect services will function in and outside the United States Virgin Islands.
- Safety Connect services are not subject to section 255 of the Telecommunications Act and the device is not TTY compatible.

■ Languages

The Safety Connect response center will offer support in multiple languages. The Safety Connect system will offer voice prompts in English, Spanish, and French. Please indicate your language of choice when enrolling.

■ When contacting the response center

You may be unable to contact the response center if the network is busy.

Safety Connect LED light Indicators

When the engine switch is turned to IGNITION ON mode, the red indicator light comes on for 2 seconds then turns off. Afterward, the green indica-

tor light comes on, indicating that the service is active.

The following indicator light patterns indicate specific system usage conditions:

- Green indicator light on = Active service
- Green indicator light flashing = Safety Connect call in process
- Red indicator light (except at vehicle start-up) = System malfunction (contact your Lexus dealer)
- No indicator light (off) = Safety Connect service not active

Safety Connect services

■ Automatic Collision Notification

In case of either airbag deployment or severe rear-end collision, the system is designed to automatically call the response center. The responding agent receives the vehicle's location and attempts to speak with the vehicle occupants to assess the level of emergency. If the occupants are unable to communicate, the agent automatically treats the call as an emergency, contacts the nearest emergency services provider to describe the situation, and requests that assistance be sent to the location.

■ Stolen Vehicle Location

If your vehicle is stolen, Safety Connect can work with local authorities to assist them in locating and recovering the vehicle. After filing a police report, call the Safety Connect response center at

1-800-25-LEXUS (1-800-255-3987) in the United States, 1-877-539-8777 in Puerto Rico or 1-800-265-3987 in Canada, and follow the prompts for Safety Connect to initiate this service.

In addition to assisting law enforcement with recovery of a stolen vehicle, Safety-Connect-equipped vehicle location data may, under certain circumstances, be shared with third parties to locate your vehicle. Further information is available at Lexus.com.

■ Emergency Assistance Button ("SOS")

In the event of an emergency on the road, push the "SOS" button to reach the Safety Connect response center. The answering agent will determine your vehicle's location, assess the emergency, and dispatch the necessary assistance required.

If you accidentally press the "SOS" button, tell the response-center agent that you are not experiencing an emergency.

■ Enhanced Roadside Assistance

Enhanced Roadside Assistance adds GPS data to the already included warranty-based Lexus roadside service.

Subscribers can press the "SOS" button to reach a Safety Connect response-center agent, who can help with a wide range of needs, such as: towing, flat tire, fuel delivery, etc. For a description of the Roadside Assistance services and their limitations, please see the Safety Connect Terms and Conditions, which are available at

Lexus.com.

plies with the FCC guidelines in addition to those standards.

Safety information for Safety Connect

Important! Read this information about exposure to radio frequency signals before using Safety Connect;

The Safety Connect system installed in your vehicle is a low-power radio transmitter and receiver. It receives and also sends out radio frequency (RF) signals.

In August 1996, the Federal Communications Commission (FCC) adopted RF exposure guidelines with safety levels for mobile wireless phones. Those guidelines are consistent with the safety standards previously set by the following U.S. and international standards bodies.

- ANSI (American National Standards Institute) C95.1 [1992]
- NCRP (National Council on Radiation Protection and Measurement) Report 86 [1986]
- ICNIRP (International Commission on Non-Ionizing Radiation Protection) [1996]

Those standards were based on comprehensive and periodic evaluations of the relevant scientific literature. Over 120 scientists, engineers, and physicians from universities, and government health agencies and industries reviewed the available body of research to develop the ANSI Standard (C95.1).

The design of Safety Connect com-

Engine immobilizer system

The vehicle's keys have built-in transponder chips that prevent the engine from starting if a key has not been previously registered in the vehicle's on-board computer.

Never leave the keys inside the vehicle when you leave the vehicle.

This system is designed to help prevent vehicle theft but does not guarantee absolute security against all vehicle thefts.

Operating the system

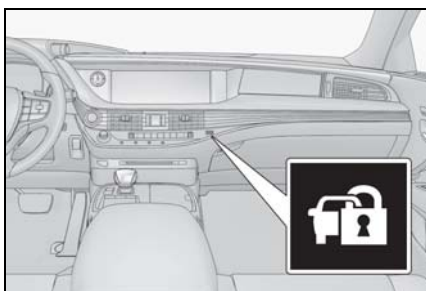

■ Certification for the engine immobilizer system

- ▶ For vehicles sold in the U.S.A., Hawaii, Guam and Puerto Rico

FCC ID: NI4TMIMB-3

This device complies with part 15 of the FCC Rules. Operation is subject to the following two conditions: (1) This device may not cause harmful interference, and (2) this device must accept any interference received, including interference that may cause undesired operation.

Changes or modifications not expressly approved by the party responsible for compliance could void the user's authority to operate the equipment.

The indicator light flashes after the engine switch has been turned off to indicate that the system is operating.

The indicator light stops flashing after the engine switch has been turned to ACCESSORY or IGNITION ON mode to indicate that the system has been canceled.

■ System maintenance

The vehicle has a maintenance-free type engine immobilizer system.

■ Conditions that may cause the system to malfunction

- If the grip portion of the key is in contact with a metallic object
- If the key is in close proximity to or touching a key to the security system (key with a built-in transponder chip) of another vehicle

- ▶ For vehicles sold in Canada

This device complies with Industry Canada's licence-exempt RSSs. Operation is subject to the following two conditions: (1) This device may not cause interference; and (2) This device must accept any interference, including interference that may cause undesired operation of the device.

Le présent appareil est conforme aux CNR d'Industrie Canada applicables aux appareils radio exempts de licence. L'exploitation est autorisée aux deux conditions suivantes : 1) l'appareil ne doit pas produire de brouillage; 2) l'utilisateur de l'appareil doit accepter tout brouillage radioélectrique subi, même si le brouillage est susceptible d'en compromettre le fonctionnement.

 NOTICE
<p>■ To ensure the system operates correctly</p> <p>Do not modify or remove the system. If modified or removed, the proper operation of the system cannot be guaranteed.</p>

Alarm

The alarm uses light and sound to give an alert when an intrusion is detected.

The alarm is triggered in the following situations when the alarm is set:

- A locked door or trunk is unlocked or opened in any way other than using the entry function, wireless remote control or mechanical key. (The doors will lock again automatically.)
- The hood is opened.

Setting/canceling/stopping the alarm system

■ Items to check before locking the vehicle

To prevent unexpected triggering of the alarm and vehicle theft, make sure of the following:

- Nobody is in the vehicle.
- The windows, moon roof (if equipped) and panoramic moon roof (if equipped) are closed before the alarm is set.
- No valuables or other personal items are left in the vehicle.

■ Setting

Close the doors, trunk and hood, and lock all the doors. The system will be set automatically after 30 seconds.

The indicator light changes from being on to flashing when the system is set.

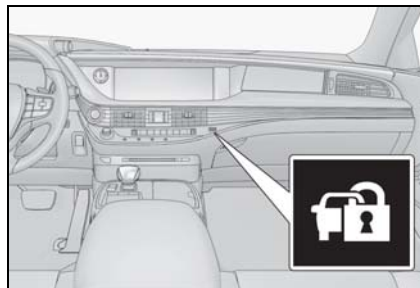

■ Canceling or stopping

Do one of the following to deactivate or stop the alarms:

- Unlock the doors.
- Turn the engine switch to ACCESSORY or IGNITION ON mode, or start the engine. (The alarm will be deactivated or stopped after a few seconds.)

■ System maintenance

The vehicle has a maintenance-free type alarm system.

■ Triggering of the alarm

The alarm may be triggered in the following situations:

(Stopping the alarm deactivates the alarm system.)

- The trunk is opened using the mechanical key.

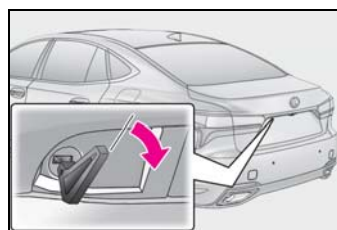

- A person inside the vehicle opens a door, the trunk or hood, or unlocks the vehicle.

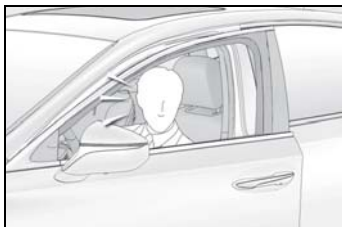

- The battery is recharged or replaced when the vehicle is locked. (→P.438)

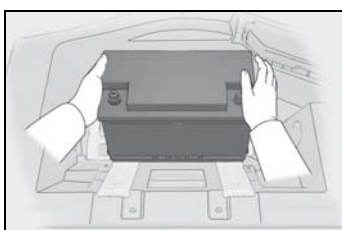

■ Alarm-operated door lock

In the following cases, depending on the situation, the door may automatically lock to prevent improper entry into the vehicle:

- When a person remaining in the vehicle unlocks the door and the alarm is activated.
- While the alarm is activated, a person remaining in the vehicle unlocks the door.



NOTICE

■ To ensure the system operates correctly

Do not modify or remove the system. If modified or removed, the proper operation of the system cannot be guaranteed.

**Vehicle status information
and indicators**

2

67

2-1. Instrument cluster

Warning lights and indicators **68**

Gauges and meters (except F SPORT models) **73**

Gauges and meters (F SPORT models) **76**

Multi-information display **80**

Head-up display **87**

Fuel consumption information **91**

2

Vehicle status information and indicators

Warning lights and indicators

The warning lights and indicators on the instrument cluster, center panel and outside rear view mirrors inform the driver of the status of the vehicle's various systems.

Warning lights and indicators displayed on the instrument cluster

For the purpose of explanation, the following illustrations display all warning lights and indicators illuminated.

- ▶ Except F SPORT models





























- ▶ F SPORT models



Warning lights

Warning lights inform the driver of malfunctions in the indicated vehicle's systems.

 BRAKE	Brake system warning light ^{*1} (→P.415) (U.S.A.)
	Brake system warning light ^{*1} (red) (→P.415) (Canada)
	Brake system warning light ^{*1} (yellow) (→P.415)
	High coolant temperature warning light ^{*2} (→P.415)
	Charging system warning light ^{*2} (→P.416)
	Low engine oil pressure warning light ^{*2} (→P.416)
	Malfunction indicator lamp ^{*1} (→P.416) (U.S.A.)
	Malfunction indicator lamp ^{*1} (→P.416) (Canada)
	SRS warning light ^{*1} (→P.416)
	Pop Up Hood warning light ^{*1} (→P.417)
	ABS warning light ^{*1} (→P.417) (U.S.A.)
	ABS warning light ^{*1} (→P.417) (Canada)
	Brake Override System warning light/Drive-Start Control warning light ^{*2} (→P.417)

	Electric power steering system warning light ^{*1} (→P.418) (red)
	Electric power steering system warning light ^{*1} (→P.418) (yellow)
	Low fuel level warning light (→P.418)
	Driver's and front passenger's seat belt reminder light (→P.418)
	Rear passengers' seat belt reminder lights ^{*3} (→P.419)
	Tire pressure warning light ^{*1} (→P.419)
	LTA indicator (→P.419) (orange)
	Intuitive parking assist OFF indicator ^{*1} (if equipped) (→P.420) (flashes)
	RCTA OFF indicator ^{*1} (if equipped) (→P.420) (flashes)
	RCD OFF indicator (if equipped) (→P.420) (flashes)
	PKSB OFF indicator ^{*1} (if equipped) (→P.421) (flashes)
	PCS warning light ^{*1} (→P.421) (flashes or illuminates)
	Slip indicator ^{*1} (→P.421)
	Parking brake indicator (flashes) (→P.422) (U.S.A.)

2

Vehicle status information and indicators



Parking brake indicator
(flashes) (→P.422)
(Canada)



Brake hold operated indicator^{*1}
(flashes) (→P.422)



Master warning light^{*4}
(→P.422)

^{*1}: These lights come on when the engine switch is turned to IGNITION ON mode to indicate that a system check is being performed. They will turn off after the engine is started, or after a few seconds. There may be a malfunction in a system if the lights do not come on, or turn off. Have the vehicle inspected by your Lexus dealer.

^{*2}: This light illuminates on the multi-information display.

^{*3}: This light illuminates on the center panel.

^{*4}: F SPORT models: This light comes on when the engine switch is turned to IGNITION ON mode to indicate that a system check is being performed. They will turn off after the engine is started, or after a few seconds. There may be a malfunction in a system if the lights do not come on, or turn off. Have the vehicle inspected by your Lexus dealer.

**WARNING****■ If a safety system warning light does not come on**

Should a safety system light such as the ABS and SRS warning light not come on when you start the engine, this could mean that these systems are not available to help protect you in an accident, which could result in death or serious injury. Have the vehicle inspected by your Lexus dealer immediately if this occurs.

Indicators

The indicators inform the driver of the operating state of the vehicle's various systems.



Turn signal indicator (→P.173)



Headlight indicator (→P.179)
(U.S.A.)



Tail light indicator (→P.179)
(Canada)



Headlight high beam indicator
(→P.180)



AHB indicator (→P.182)



PCS warning light^{*1,2}
(→P.207, 217)



Cruise control indicator
(→P.244)



Dynamic radar cruise control indicator (→P.237)



Cruise control "SET" indicator
(→P.237)



LTA indicator (→P.231)
(white)



LTA indicator (→P.231)
(green)

















LTA indicator (→P.231)
(orange)
(flashes)





BSM outside rear view mirror indicators^{*1,3} (if equipped)
(→P.250, 263)











BSM indicator (if equipped)
(→P.250)



-  Intuitive parking assist OFF indicator^{*1,2} (if equipped) (→P.258)
-  RCTA OFF indicator^{*1,2} (if equipped) (→P.263)
-  RCD OFF indicator^{*2} (if equipped) (→P.267)
-  PKSB OFF indicator^{*1,2} (if equipped) (→P.271)
-  Slip indicator^{*1} (→P.296) (flashes)
-  VSC OFF indicator^{*1,2} (→P.296)
-  High mode indicator (if equipped) (→P.292)
-  Smart access system with push-button start indicator^{*4} (→P.164)
-  Parking brake indicator (U.S.A.) (→P.174)
-  Parking brake indicator (Canada) (→P.174)
-  Brake hold standby indicator^{*1} (→P.177)
-  Brake hold operated indicator^{*1} (→P.177)
-  Eco Driving Indicator Light^{*1} (→P.83)
-  Low outside temperature indicator^{*5} (→P.73, 76)
-  Security indicator^{*6} (→P.63, 65)

-  "AIR BAG ON/OFF" indicator^{*1,6} (→P.40) (U.S.A.)
-  "AIR BAG ON/OFF" indicator^{*1,6} (→P.40) (Canada)

● Drive mode indicators
▶ Except F SPORT models

-  Snow mode indicator (→P.171)
-  Normal mode indicator (→P.289)
-  Custom mode indicator (if equipped) (→P.289)
-  Comfort mode indicator (if equipped) (→P.289)
-  Eco drive mode indicator (→P.289)
-  Sport mode indicator (if equipped) (→P.289)
-  Sport S mode indicator (if equipped) (→P.289)
-  Sport S+ mode indicator (if equipped) (→P.289)

▶ F SPORT models

-  Snow mode indicator (→P.171)
-  Normal mode indicator (→P.289)
-  Custom mode indicator (→P.289)

2

Vehicle status information and indicators



Comfort mode indicator
(→P.289)



Eco drive mode indicator
(→P.289)



Sport S mode indicator
(→P.289)



Sport S+ mode indicator
(→P.289)

*1: These lights come on when the engine switch is turned to IGNITION ON mode to indicate that a system check is being performed. They will turn off after the engine is started, or after a few seconds. There may be a malfunction in a system if the lights do not come on, or turn off. Have the vehicle inspected by your Lexus dealer.

*2: This light comes on when the system is turned off.

*3: This light illuminates on the outside rear view mirrors.

*4: This light illuminates on the multi-information display.

*5: When the outside temperature is approximately 37°F (3°C) or lower, this indicator will flash for approximately 10 seconds, then stay on.

*6: This light illuminates on the center panel.

Gauges and meters (except F SPORT models)

Meter display

■ Locations of gauges and meters

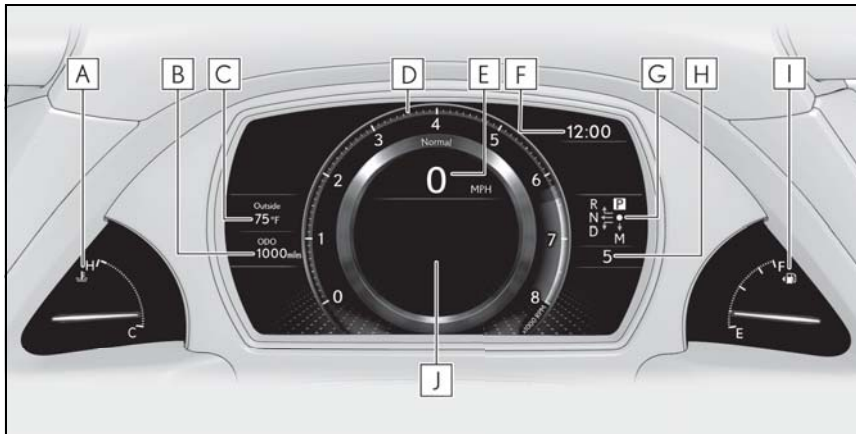

The units of measure may differ depending on the intended destination of the vehicle.

A Engine coolant temperature gauge

Displays the engine coolant temperature

B Odometer and trip meter display (→P.74)

C Outside temperature

Displays the outside temperature within the range of -40°F (-40°C) to 122°F (50°C)

D Tachometer

Displays the engine speed in revolutions per minute

When sport mode is selected for the driving mode, the periphery of the tachometer will change color and the scale of the tachometer will be emphasized.

E Speedometer

F Clock

Time displayed is linked to the analog clock on the center panel. (→P.345)

G Shift position indicator (→P.169)

H Shift range/gear position (→P.167)

I Fuel gauge

Displays the quantity of fuel remaining in the tank

J Multi-information display

Presents the driver with a variety of vehicle data (→P.80)

Displays warning messages if a malfunction occurs (→P.425)

■ **Outside temperature display**

- In the following situations, the correct outside temperature may not be displayed, or the display may take longer than normal to change:
 - When stopped, or driving at low speeds (less than 12 mph [20 km/h])
 - When the outside temperature has changed suddenly (at the entrance/exit of a garage, tunnel, etc.)
- When “-” or “E” is displayed, the system may be malfunctioning. Take your vehicle to your Lexus dealer.

■ **Liquid crystal display**

→P.81

■ **Customization**

The gauges and meters can be customized on  of the multi-information display. (→P.85)

 **WARNING**

■ **The information display at low temperatures**

Allow the interior of the vehicle to warm up before using the liquid crystal information display. At extremely low temperatures, the information display monitor may respond slowly, and display changes may be delayed.

For example, there is a lag between the driver’s shifting and the new gear number appearing on the display. This lag could cause the driver to downshift again, causing rapid and excessive engine braking and possibly an accident resulting in death or injury.

 **NOTICE**

■ **To prevent damage to the engine and its components**

- Do not let the indicator needle of the tachometer enter the red zone, which indicates the maximum engine speed.

- The engine may be overheating if the engine coolant temperature gauge is in the red zone (H). In this case, immediately stop the vehicle in a safe place, and check the engine after it has cooled completely. (→P.440)

Odometer and trip meter display

■ **Display items**

- Odometer

Displays the total distance the vehicle has been driven.

- Trip meter A/trip meter B

Displays the distance the vehicle has been driven since the meter was last reset. Trip meters A and B can be used to record and display different distances independently.

- Distance until next engine oil change

Displays the distance the vehicle can be driven until an oil change is necessary.

■ **Changing the display**

Each time the “ODO TRIP” switch is pressed, the displayed item will be changed. When the trip meter is displayed, pressing and holding the switch will reset the trip meter.

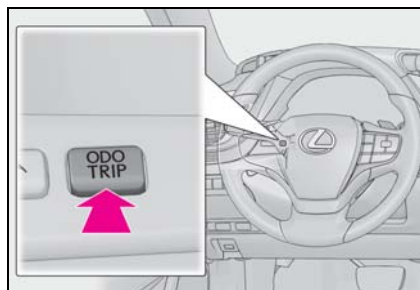

■ Pop-up display

Distance until the next engine oil change will be displayed when a warning message indicating that oil maintenance should be performed soon or is required is displayed.

Changing the instrument panel light brightness

The brightness of the instrument panel lights can be adjusted.

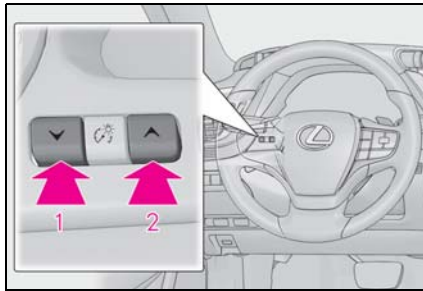

- 1 Darker
- 2 Brighter

■ Brightness of the meters (day mode and night mode)

The brightness of the meters changes between day mode and night mode.

- Day mode: When the tail lights are off or when the tail lights are on but the surrounding area is bright
- Night mode: When the tail lights are on and the surrounding area is dark

Gauges and meters (F SPORT models)

Meter display

■ Locations of gauges and meters

When the main meter is moved to the right, some of the meter displays and the gauge layout will change. (→P.80)

► Main meter in center position

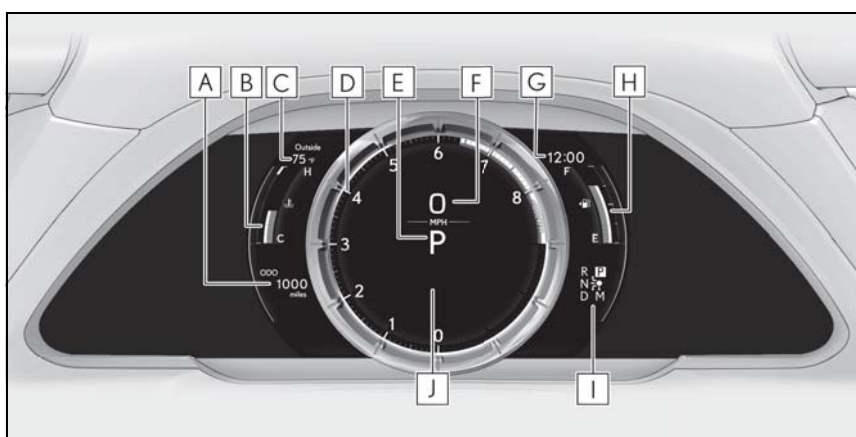

The units of measure may differ depending on the intended destination of the vehicle.

A Odometer and trip meter display (→P.79)

B Engine coolant temperature gauge

Displays the engine coolant temperature

C Outside temperature

Displays the outside temperature within the range of -40°F (-40°C) to 122°F (50°C)

D Tachometer

Displays the engine speed in revolutions per minute

When sport mode is selected for the driving mode, the periphery of the tachometer will change color and the scale of the tachometer will be emphasized.

• Rev indicator (→P.78)

• Rev peak (→P.78)

E Shift position/shift range/gear position (→P.167)

F Speedometer

G Clock

Time displayed is linked to the analog clock on the center panel. (→P.345)

H Fuel gauge

Displays the quantity of fuel remaining in the tank

I Shift position indicator (→P.169)**J** Multi-information display

Presents the driver with a variety of vehicle data (→P.80)

Displays warning messages if a malfunction occurs (→P.425)

▶ Main meter moved to the right

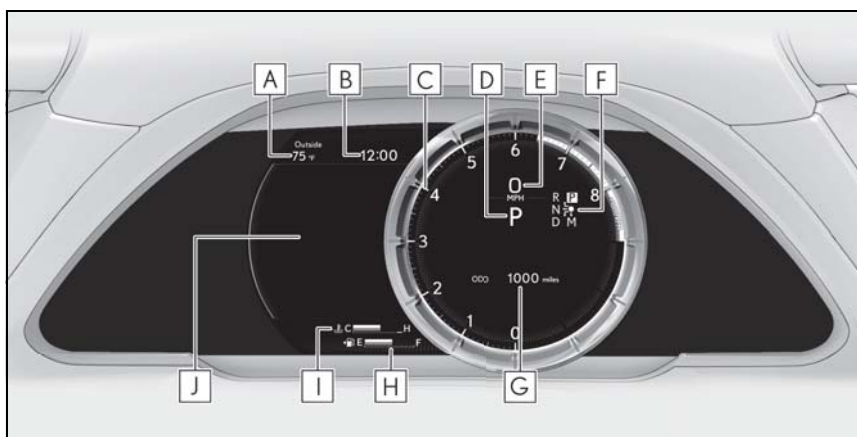

The units of measure may differ depending on the intended destination of the vehicle.

A Outside temperature

Displays the outside temperature within the range of -40°F (-40°C) to 122°F (50°C)

B Clock

Time displayed is linked to the analog clock on the center panel. (→P.345)

C Tachometer

Displays the engine speed in revolutions per minute

When sport mode is selected for the driving mode, the periphery of the tachometer will change color and the scale of the tachometer will be emphasized.

- Rev indicator (→P.78)
- Rev peak (→P.78)

D Shift position/shift range/gear position (→P.167)**E** Speedometer**F** Shift position indicator (→P.169)**G** Odometer and trip meter display (→P.79)**H** Fuel gauge

Displays the quantity of fuel remaining in the tank

I Engine coolant temperature gauge

Displays the engine coolant temperature

J Multi-information display

Presents the driver with a variety of vehicle data (→P.80)

Displays warning messages if a malfunction occurs (→P.425)

■ Rev indicator

When the engine speed reaches a set speed or the red zone, a ring-shaped indicator (A) will be displayed on the tachometer.

The indicators will be displayed in amber when the engine speed reaches a set speed, and in red when the engine speed reaches the red zone.

The engine speed at which the rev indicator will begin to be displayed can be set on  of the multi-information display. (→P.85)



■ Rev peak

When the engine speed reaches or exceeds 5000 rpm, an afterimage of the tachometer will be displayed at the highest engine speed for approximately 1 second.



■ Outside temperature display

- In the following situations, the correct outside temperature may not be displayed, or the display may take longer than normal to change:
 - When stopped, or driving at low speeds (less than 12 mph [20 km/h])
 - When the outside temperature has changed suddenly (at the entrance/exit of a garage, tunnel, etc.)
- When “-” or “E” is displayed, the system may be malfunctioning. Take your vehicle to your Lexus dealer.

■ Liquid crystal display

→P.81

■ Customization

The gauges and meters can be customized on  of the multi-information display. (→P.85)

! WARNING

■ The information display at low temperatures

Allow the interior of the vehicle to warm up before using the liquid crystal information display. At extremely low temperatures, the information display monitor may respond slowly, and display changes may be delayed.

⚠ WARNING

For example, there is a lag between the driver's shifting and the new gear number appearing on the display. This lag could cause the driver to downshift again, causing rapid and excessive engine braking and possibly an accident resulting in death or injury.

⚠ NOTICE

■ **To prevent damage to the engine and its components**

- Do not let the indicator needle of the tachometer enter the red zone, which indicates the maximum engine speed.
- The engine may be overheating if the engine coolant temperature gauge is in the red zone (H). In this case, immediately stop the vehicle in a safe place, and check the engine after it has cooled completely. (→P.440)

Odometer and trip meter display

■ **Display items**

● **Odometer**

Displays the total distance the vehicle has been driven.

● **Trip meter A/trip meter B**

Displays the distance the vehicle has been driven since the meter was last reset. Trip meters A and B can be used to record and display different distances independently.

● **Distance until next engine oil change**

Displays the distance the vehicle can be driven until an oil change is necessary.

■ **Changing the display**

Each time the "ODO TRIP" switch is pressed, the displayed item will be

changed. When the trip meter is displayed, pressing and holding the switch will reset the trip meter.

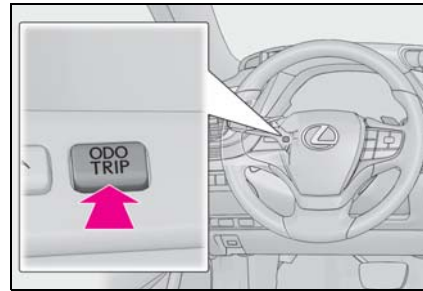

■ **Pop-up display**

The distance until the next engine oil change will be displayed when a warning message indicating that oil maintenance should be performed soon or is required is displayed.

Changing the instrument panel light brightness

The brightness of the instrument panel lights can be adjusted.

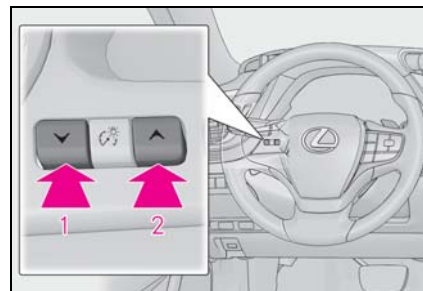

1 Darker

2 Brighter

■ **Brightness of the meters (day mode and night mode)**

The brightness of the meters changes between day mode and night mode.

- Day mode: When the tail lights are off or

when the tail lights are on but the surrounding area is bright

- Night mode: When the tail lights are on and the surrounding area is dark

Changing the main meter location

The display can be switched between the center and side positions.



Multi-information display

Display and menu icons

■ Display (except F SPORT models)

By selecting menu icons on the multi-information display, a variety of driving-related information can be displayed. The multi-information display can also be used to change display settings and other vehicle settings.

Warning or suggestion/advice pop-up displays are also displayed in certain situations.



■ Display (F SPORT models)

▶ Main meter in center position

The multi-information display presents the driver with a variety of driving-related information.

Warning or suggestion/advice pop-up displays are also displayed in certain situations.

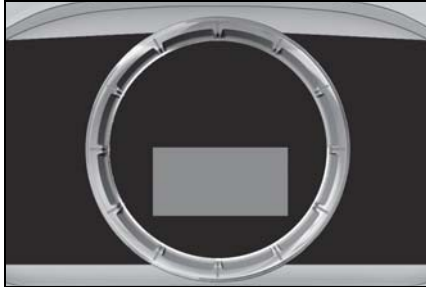

► Main meter moved to the right

By selecting menu icons on the multi-information display, a variety of driving-related information can be displayed. The multi-information display can also be used to change display settings and other vehicle settings.



Warning or suggestion/advice pop-up displays are also displayed in certain situations.







■ Menu icons

The menu icons will be displayed by pressing ◀ or ▶ of the meter control switch.

F SPORT models: The menu icons can be displayed when the main meter is moved to the right.

-  Driving information display (→P.82)
-  Navigation system-linked display (if equipped) (→P.84)

-  Audio system-linked display (→P.85)
-  Driving support system information display (→P.85)
-  Warning message display (→P.425)
-  Settings display (→P.85)

■ Liquid crystal display

Small spots or light spots may appear on the display. This phenomenon is characteristic of liquid crystal displays, and there is no problem continuing to use the display.

 **WARNING**

■ Caution for use while driving

- When operating the multi-information display while driving, pay extra attention to the safety of the area around the vehicle.
- Do not look continuously at the multi-information display while driving as you may fail to see pedestrians, objects on the road, etc. ahead of the vehicle.





■ The information display at low temperatures

→P.74, 78

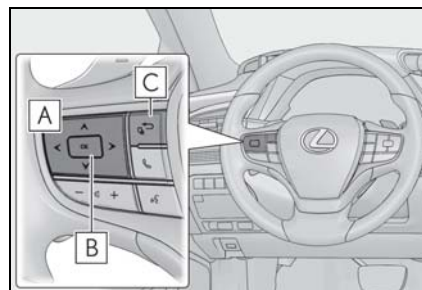
Changing the meter display

The multi-information display is operated using the meter control switches.



- A**  /  : Select menu icons
 /  : Change displayed content, scroll up/down the screen and move the cursor up/down





- B** Press: Enter/Set
 Press and hold: Reset

- C** Move the main meter ^{*} and return to the previous screen

* : F SPORT models

Content of driving information



■ Display items (except F SPORT models)

Press  or  of the meter control switch and select . Then press  or  to display the following items:

- Drive information 1
- Drive information 2
- Eco Driving Indicator
- Boost gauge
- Tire pressure (→P.384)
- Display off

■ Display items (F SPORT models)

▶ Main meter in center position





Press  or  of the meter control switch to display the following items:

- Drive information 1
- Drive information 2
- Tire pressure (→P.384)
- Gear positions
- Units
- Display off

- Driving support system information ^{*} (→P.85)

* : Can be selected when a driving support system is enabled. (→P.225, 237)

▶ Main meter moved to the right

Press  or  of the meter control switch and select . Then press  or  to display the following items:

- Drive information 1
- Drive information 2
- Eco Driving Indicator
- Boost gauge
- G-force
- Gear Position
- Tire pressure (→P.384)
- Display off

■ Drive information 1/Drive information 2

Displays drive information such as the following:

Use the displayed values as a reference only.

- Drive information 1
 - Current fuel consumption
 - Average fuel economy (after reset)
- Drive information 2
 - Distance (driving range)
 - Average vehicle speed (after reset)

Displayed items (listed below) can be changed on . (→P.85)

- Current fuel consumption

Bar type: Displays instantaneous current fuel consumption

- Average fuel economy

After reset: Displays average fuel consumption since the display was reset^{*1}

After start: Displays average fuel consumption since engine start

After refuel: Displays average fuel consumption since refuel

- Average vehicle speed

After reset: Displays average vehicle speed since the display was reset^{*1}

After start: Displays average vehicle speed since engine start

- Elapsed time

After reset: Displays elapsed time since the display was reset^{*1}

After start: Displays elapsed time since engine start

- Distance

Driving range: Displays driving range with remaining fuel^{*2,3}

After start: Displays the distance driven since engine start

- Other

Blank: No item

^{*1}: To reset, display the desired item and press and hold **OK** of the meter control switch.

^{*2}: This distance is computed based on your average fuel consumption. As a result, the actual distance that can be driven may differ from that displayed.

^{*3}: When only a small amount of fuel is added to the tank, the display may not be updated.
When refueling, turn the engine switch off. If the vehicle is refueled without turning the engine switch off, the display

may not be updated.

■ Eco Driving Indicator

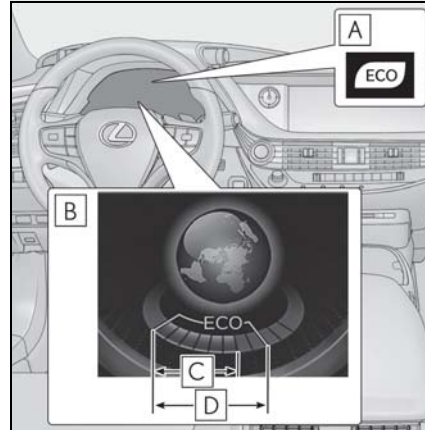

A Eco Driving Indicator Light

During Eco-friendly acceleration (Eco driving), the Eco Driving Indicator Light will turn on. When the acceleration exceeds the Zone of Eco driving, or when the vehicle is stopped, the light turns off.

B Eco Driving Indicator Zone Display

Suggests the Zone of Eco driving with current Eco driving ratio based on acceleration.

C Eco driving ratio based on acceleration

If the acceleration exceeds the Zone of Eco driving, the right side of the Eco Driving Indicator Zone Display will illuminate. At this time, the Eco Driving Indicator Light will turn off.

D Zone of Eco driving

■ Boost gauge

Displays the boost pressure. The display will change color if the specified pressure is exceeded.

This display is intended for use as a guideline. Depending on factors such as the road

surface condition, temperature and vehicle speed, the display may not show the actual condition of the vehicle.

■ G-force (F SPORT models)

Displays lateral G-forces on the vehicle. Also displays, around the periphery of the G-force display, the left and right steering amount, accelerator pedal input, and brake fluid pressure.

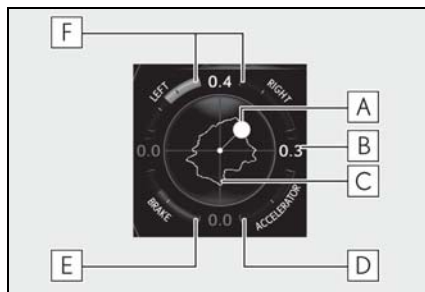

- A** Acceleration G-force on the vehicle
- B** Current G-force value (analyzed value of front/rear and left/right G-forces)
- C** Record of the maximum G-forces
- D** Accelerator pedal input
- E** Brake fluid pressure
- F** Steering amount

This display is intended for use as a guideline. Depending on factors such as the road surface condition, temperature and vehicle speed, the display may not show the actual condition of the vehicle.

- Resetting the record of maximum G-forces

Press and hold **OK** of the meter control switch to reset the record.

- Peak hold function

If lateral G-forces of 0.5 G or greater are generated, the G-force value display will turn amber and be held for 2 seconds.

■ Gear Position (F SPORT models)

Displays the current shift range or gear position when the shift position is in D or M.

■ Units (F SPORT models)

The units of measure used can be changed while driving.

Unlike the units setting performed on the settings display, the units setting performed on the drive information display can be changed while driving.

■ Eco Driving Indicator

Eco Driving Indicator will not operate under the following conditions:

- The shift position is in any position other than D.
- A paddle shift switch is operated.
- The driving mode is set to sport mode.
- The driving mode is set to custom mode and the powertrain control is set to power (→P.289)
- Snow mode is selected.
- The vehicle speed is approximately 80 mph (130 km/h) or higher.

Navigation system-linked display (if equipped)

Select to display the following navigation system-linked information.

- Route guidance to destination
- Compass display (heading-up display)

■ Route guidance to destination display

When the route guidance to destination

display is enabled on the head-up display, it will not be displayed on the multi-information display. (→P.89)

Audio system-linked display

Select to enable selection of an audio source or track on the meter using the meter control switches.

Driving support system information display

Select to display the operational status of the following systems:

- LTA (Lane Tracing Assist) (→P.225)
- Dynamic radar cruise control with full-speed range (→P.237)
- RSA (Road Sign Assist) (if equipped) (→P.247)

Settings display

■ Meter display settings that can be changed

- Language

Select to change the language displayed.

- Units

Select to change the units of measure displayed.

- Speedometer display (except F SPORT models)

Select to set the display of the speedometer to digital/analog/both digital and analog.

- Drive information 1/Drive information 2

Select to select up to 2 items (→P.82) that will be displayed on each Drive information

screen (Drive information 1 screen and Drive information 2 screen) respectively.

- Clock

Select to switch between 12-hour display and 24-hour display.

- Pop-up display

Select to enable/disable pop-up displays for each relevant system.

- Accent color

Select to change the accent color on the screen, such as the cursor color.

- Rev indicator (F SPORT models)

- Select to enable/disable the rev indicator.

- Select to set the engine speed at which the rev indicator (amber) will begin to be displayed.

- Rev peak (F SPORT models)

Select to enable/disable the rev peak.

- Eco Driving Indicator Light

Select to enable/disable the Eco Driving Indicator Light.

- Default setting

Select to reset the meter display settings to the default setting.

■ Vehicle functions and settings that can be changed

→P.466

■ Suspension of the settings display

- Some settings cannot be changed while driving. When changing settings, park the vehicle in a safe place.

- If a warning message is displayed, operation of the settings display will be suspended.

 **WARNING****■ Cautions during setting up the display**

As the engine needs to be running during setting up the display, ensure that the vehicle is parked in a place with adequate ventilation. In a closed area such as a garage, exhaust gases including harmful carbon monoxide (CO) may collect and enter the vehicle. This may lead to death or a serious health hazard.

 **NOTICE****■ During setting up the display**

To prevent battery discharge, ensure that the engine is running while setting up the display features.

Suggestion function

Displays suggestions to the driver in the following situations. To select a response to a displayed suggestion, use the meter control switches.

■ Suggestion to turn off the headlights

If the headlights are left on for a certain amount of time with the headlight switch in *AUTO* after the engine switch has been turned off, a suggestion message will be displayed asking if you wish to turn the headlights off.

To turn the headlights off, select "Yes".

If a front door is opened after the engine switch is turned off, this suggestion message will not be displayed.

■ Customization

Some functions can be customized.
(→P.466)

Head-up display*

*: If equipped

The head-up display projects a variety of driving-related information and the operating state of the driving support systems on the windshield.

System components

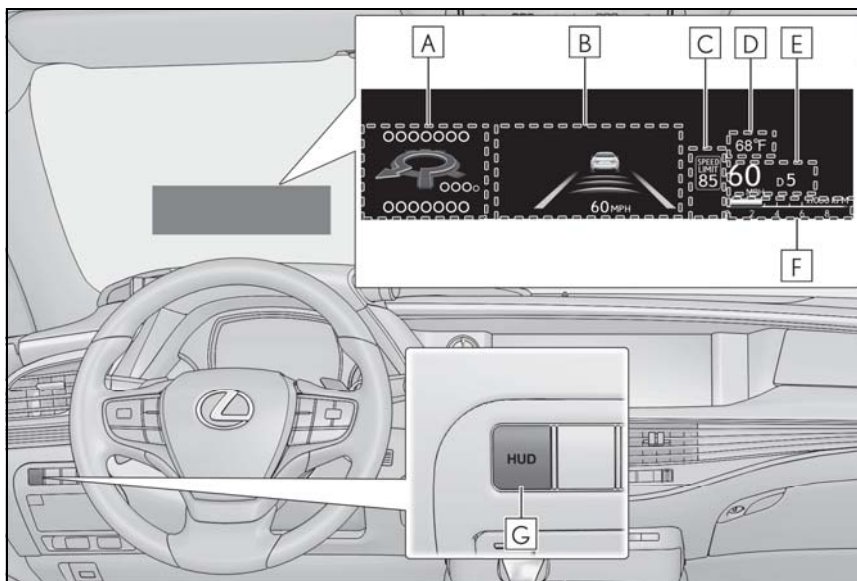

2

Vehicle status information and indicators

Illustrations used in this text are intended as examples, and may differ from the image that is actually displayed by the head-up display.

A Navigation system-linked display area (if equipped)

Displays the following items which are linked to the navigation system:

- Route guidance to destination
- Street name
- Compass (heading-up display)

B Driving support system display area (→P.90)

C Speed limit/RSA (Road Sign Assist) display area (if equipped)

Displays the following items:

- Speed limit of the current road (linked to the navigation system) (U.S.A. only)
- RSA (Road Sign Assist) display (→P.247)

D Outside temperature display area

E Driving information display area

Displays the following items:

- Speedometer
- Shift position/shift range/gear position (→P.167)

F Tachometer/Eco Driving Indicator display area (→P.90)

G HUD (Head-up display) switch

■ Head-up display will operate when

The engine switch is in IGNITION ON mode.

■ When using the head-up display

The head-up display may seem dark or hard to see when viewed through sunglasses, especially polarized sunglasses. Adjust the brightness of the head-up display or remove your sunglasses.

■ Street name display

Only street names which are included in the map data will be displayed.

■ Outside temperature display

- When the ambient temperature is approximately 37°F (3°C) or lower, the low outside temperature indicator will flash for approximately 10 seconds and the outside temperature display will turn off. In this case, the display will be displayed again when the outside temperature becomes approximately 41°F (5°C) or higher.
- In the following situations, the correct outside temperature may not be displayed, or the display may take longer than normal to change:
 - When stopped, or driving at low speeds (less than 12 mph [20 km/h])
 - When the outside temperature has changed suddenly (at the entrance/exit of a garage, tunnel, etc.)
- When "--" or "E" is displayed, the system may be malfunctioning. Take your vehicle to your Lexus dealer.

WARNING

■ When using the head-up display

- Check that the position and brightness of the head-up display image does not interfere with safe driving. Incorrect adjustment of the image's position or brightness may obstruct the driver's view and lead to an accident, resulting in death or serious injury.
- Do not continuously look at the head-up display while driving as you may fail to see pedestrians, objects on the road, etc. ahead of the vehicle.

NOTICE

■ Head-up display projector

- Do not place any drinks near the head-up display projector. If the projector gets wet, electrical malfunctions may result.

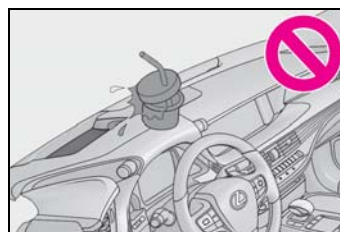

- Do not place anything on or put stickers onto the head-up display projector. Doing so could interrupt head-up display indications.
- Do not touch the inside of the head-up display projector or thrust sharp edges or the like into the projector. Doing so could cause mechanical malfunctions.

Using the head-up display

■ Enabling/disabling the head-up display

Press the HUD switch.

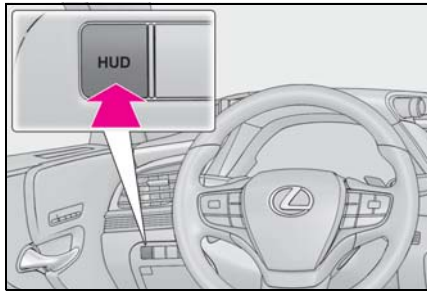

■ Changing settings of the head-up display

The following settings can be changed on  of the multi-information display. (→P.466)

- Brightness and vertical position of the head-up display

Select to adjust the brightness or vertical position of the head-up display.

- Tachometer/Eco Driving Indicator

Select to display the tachometer, Eco Driving Indicator or no content.

- Display content

Select to enable/disable the following items:

- Route guidance to destination/street name
- Driving support system display*
- Compass (heading-up display)
- Audio system operation status

*: Make sure to enable this display when using the driving support systems

- Display angle

Select to adjust the angle of the head-up display.

■ Enabling/disabling of the head-up display

If the head-up display is disabled, it will remain disabled when the engine switch is turned off then back to IGNITION ON mode.

■ Display brightness

The brightness of the head-up display can be adjusted on  of the multi-information display. Also, it is automatically adjusted according to the ambient brightness.

■ Head-up display automatic position adjustment

If the display position is recorded into memory, the head-up display will be automatically adjusted to the desired position. (→P.130)

■ When the battery is disconnected

The customize settings of the head-up display will be reset.

⚠ WARNING

■ Caution for changing settings of the head-up display

As the engine needs to be running while changing the settings of the head-up display, ensure that the vehicle is parked in a place with adequate ventilation. In a closed area such as a garage, exhaust gases including harmful carbon monoxide (CO) may collect and enter the vehicle. This may lead to death or a serious health hazard.

⚠ NOTICE

■ When changing the settings of the head-up display

To prevent battery discharge, ensure that the engine is running while the changing the settings of the head-up display.

Driving support system display area

Displays the operational status of the following systems:

- LTA (Lane Tracing Assist) (→P.225)
- Dynamic radar cruise control with full-speed range (→P.237)

Details of content displayed on the head-up display may differ from that displayed on the multi-information display. For details, refer to the explanation of each system.

Pop-up display

Pop-up displays for the following systems will be displayed when necessary.

■ Driving support systems

Displays a warning/suggestion/advice message or the operating state of a relevant system.

- PCS (Pre-Collision System) (→P.204, 215)
- FCTA (Front Cross Traffic Alert) (if equipped) (→P.222)
- Intuitive parking assist (if equipped) (→P.257)
- Parking Support Brake function (for static objects) (if equipped) (→P.276)
- Brake Override System (→P.155)
- Drive-Start Control (→P.155)

Details of content displayed on the head-up display may differ from that displayed on the multi-information display. For details, refer to the explanation of each system.

■ / icons

These icons are linked to the multi-information display

: Master warning icon

Displayed when a warning message is displayed on the multi-information display. (→P.425)

: Information icon

Displayed when a suggestion pop-up display (→P.86) or advice pop-up display is displayed on the multi-information display.

■ Warning message

Some warning messages are displayed when necessary, according to certain conditions.

Details of content displayed on the head-up display may differ from that displayed on the multi-information display.

■ Audio system operation status

Displayed when an audio remote control switch on the steering wheel is operated.

■ Hands-free system status

Displayed when the hands-free system is operated.

■ When a pop-up display is displayed

When a pop-up display is displayed, a current display may no longer be displayed. In this case, the display will return after the pop-up display disappears.

Tachometer/Eco Driving Indicator

■ Tachometer

Displays the engine speed in revolu-

tions per minute.

■ Eco Driving Indicator

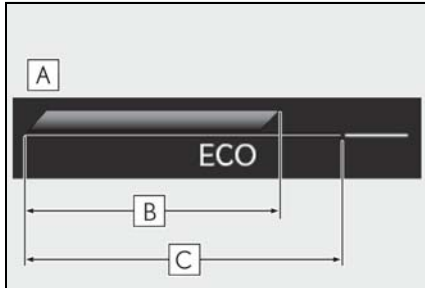

A Eco Driving Indicator Zone Display

B Eco driving ratio based on acceleration

C Zone of Eco driving

Displayed content is the same as that displayed on the multi-information display (Eco Driving Indicator). For details, refer to P.83.

Fuel consumption information

Fuel consumption information can be displayed on the Center Display.

The fuel consumption information can be displayed and operated on the side display.

System components

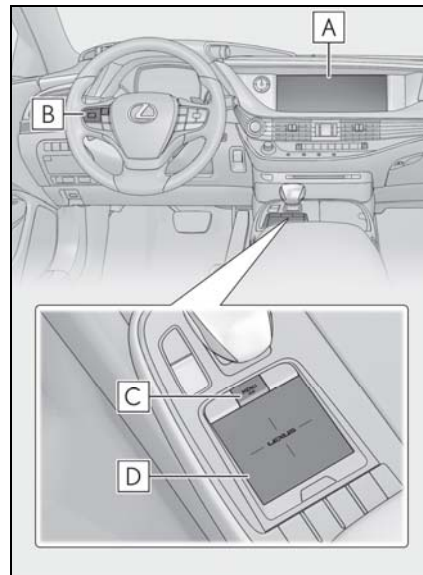

A Center Display

B Meter control switches

C "MENU" button

D Touchpad

Consumption

■ Trip information

Press the "MENU" button on the Remote Touch, then select  on the

2

Vehicle status information and indicators

menu screen.

If a screen other than “Trip Information” is displayed, select “Trip Information”.

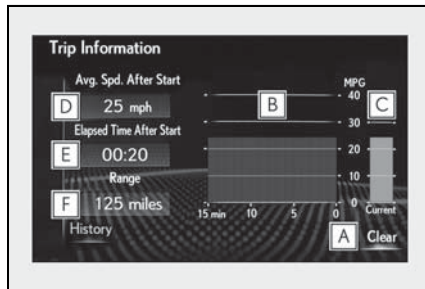

- A** Resetting the consumption data
- B** Fuel consumption in the past 15 minutes
- C** Current fuel consumption
- D** Average vehicle speed since the engine was started.
- E** Elapsed time since the engine was started.
- F** Cruising range

Average fuel consumption for the past 15 minutes is divided by color into past averages and averages attained since the engine switch was last turned to IGNITION ON mode. Use the displayed average fuel consumption as a reference.

The image is an example only, and may vary slightly from actual conditions.

■ History

Press the “MENU” button on the

Remote Touch, then select  on the menu screen.

If a screen other than “History” is displayed, select “History”.

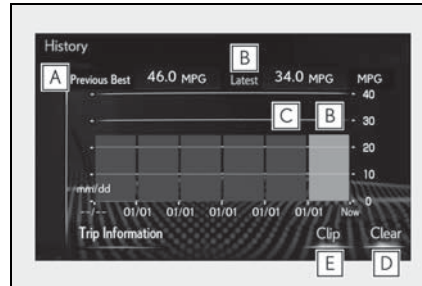

- A** Best recorded fuel consumption
- B** Latest fuel consumption
- C** Previous fuel consumption record
- D** Resetting the history data
- E** Updating the latest fuel consumption data

The average fuel consumption history is divided by color into past averages and the average fuel consumption since the last updated. Use the displayed average fuel consumption as a reference.

The image is an example only, and may vary slightly from actual conditions.

■ Updating the history data

Update the latest fuel consumption by selecting “Clip” to measure the current fuel consumption again.

■ Resetting the data

The fuel consumption data can be deleted by selecting “Clear”.

■ Cruising range

Displays the estimated maximum distance that can be driven with the quantity of fuel remaining.

This distance is computed based on your average fuel consumption.

As a result, the actual distance that can be driven may differ from that displayed.

Using the side display

Display the vehicle information on the side display (→P.307), and then select **<** or **>** to display the desired screen.

The image is an example only, and may vary slightly from actual conditions.

■ Trip information (type A)

Displays the average fuel consumption for the past 10 minutes in 1 minute intervals, as well as the cruising range.

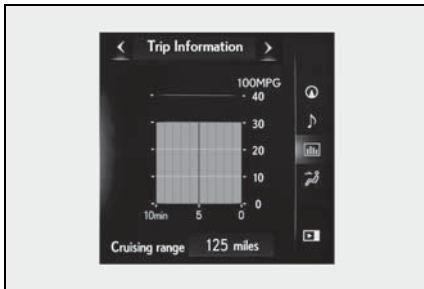

Use the displayed average fuel consumption as a reference.

■ Trip information (type B)

Displays the cruising range, latest fuel consumption and the amount of time elapsed since the engine was started.

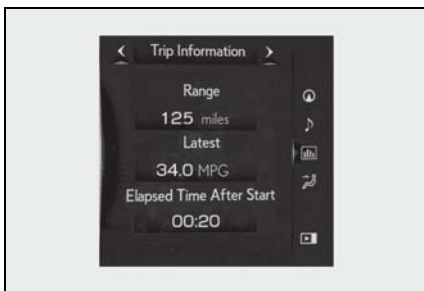

Use the displayed average fuel consumption as a reference.

■ History

Displays the average fuel consumption and highest fuel consumption.

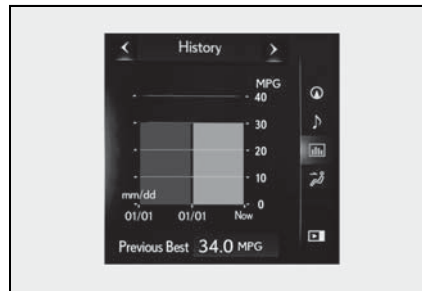

Use the displayed average fuel consumption as a reference.

2

Vehicle status information and indicators

- 3-1. Key information**
 - Keys 96
- 3-2. Opening, closing and locking the doors and trunk**
 - Doors..... 100
 - Trunk..... 104
 - Smart access system with push-button start 111
- 3-3. Adjusting the seats**
 - Front seats..... 119
 - Power rear seat..... 126
 - Driving position memory 130
 - Rear seat position memory 134
 - Head restraints..... 135
- 3-4. Adjusting the steering wheel and mirrors**
 - Steering wheel..... 138
 - Inside rear view mirror..... 139
 - Outside rear view mirrors..... 140
- 3-5. Opening, closing the windows and moon roof**
 - Power windows..... 142
 - Moon roof 145
 - Panoramic moon roof 147

Keys

The keys

The following keys are provided with the vehicle.

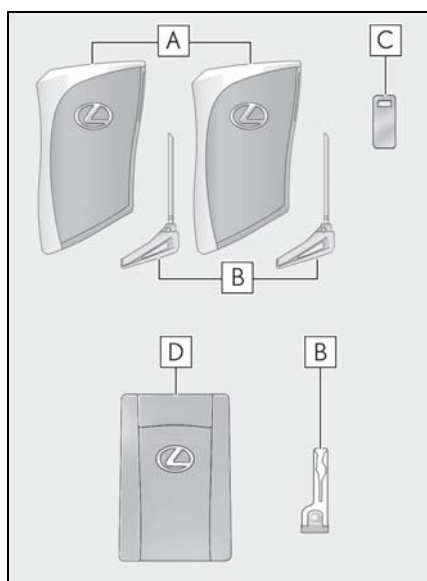

A Electronic keys

- Operating the smart access system with push-button start (→P.111)
- Operating the wireless remote control function (→P.98)

B Mechanical keys

C Key number plate

D Card key (electronic key) (if equipped)

Operating the smart access system with push-button start (→P.111)

■ Card key (if equipped)

- The card key is not waterproof.
- The mechanical key that is stored inside the card key should be used only if a problem arises, such as when the card

key does not operate properly.

- If it is difficult to take out the mechanical key, push down the lock release button using a pen tip etc. If it is still difficult to pull it out, use a coin etc.
- To store the mechanical key in the card key, insert it while pressing the lock release button.

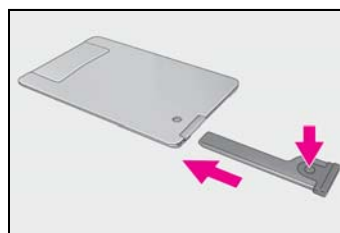

- If the battery cover is not installed and the battery falls out or if the battery was removed because the key got wet, reinstall the battery with the positive terminal facing the Lexus emblem.

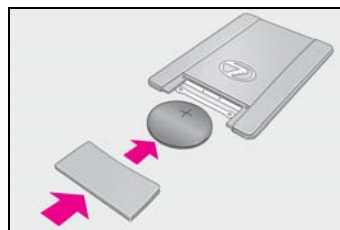

■ When riding in an aircraft

When bringing an electronic key onto an aircraft, make sure you do not press any buttons on the electronic key while inside the aircraft cabin. If you are carrying an electronic key in your bag etc., ensure that the buttons are not likely to be pressed accidentally. Pressing a button may cause the electronic key to emit radio waves that could interfere with the operation of the aircraft.

■ Electronic key battery depletion

- The standard battery life is 1 to 2 years. (The card key battery life is about a year and a half.)
- If the battery becomes low, an alarm will sound in the cabin and a message will be shown on the multi-information display when the engine is stopped.

- To reduce key battery depletion when the electronic key is to not be used for long periods of time, set the electronic key to the battery-saving mode. (→P.113)
- As the electronic key always receives radio waves, the battery will become depleted even if the electronic key is not used. The following symptoms indicate that the electronic key battery may be depleted. Replace the battery when necessary.
 - The smart access system with push-button start or the wireless remote control does not operate.
 - The detection area becomes smaller.
 - The LED indicator on the key surface does not turn on.
- To avoid serious deterioration, do not leave the electronic key within 3 ft. (1 m) of the following electrical appliances that produce a magnetic field:
 - TVs
 - Personal computers
 - Cellular phones, cordless phones and battery chargers
 - Recharging cellular phones or cordless phones
 - Table lamps
 - Induction cookers

■ Replacing the battery

→P.399

■ Confirmation of the number of registered keys

The number of keys already registered to the vehicle can be confirmed. Ask your Lexus dealer for details.

■ If “A New Key has been Registered Contact Your Dealer for Details” is shown on the multi-information display

This message will be displayed each time the driver's door is opened when the doors are unlocked from the outside for approximately 10 days after a new electronic key has been registered.

If this message is displayed but you have not had a new electronic key registered, ask your Lexus dealer to check if an unknown electronic key (other than those in your possession) has been registered.

NOTICE

■ To prevent key damage

- Do not drop the keys, subject them to strong shocks or bend them.
- Do not expose the keys to high temperatures for a long period of time.
- Do not get the keys wet or wash them in an ultrasonic washer etc.
- Do not attach metallic or magnetic materials to the keys or place the keys close to such materials.
- Do not disassemble the keys.
- Do not attach a sticker or anything else to the surface of the electronic key.
- Do not place the keys near objects that produce magnetic fields, such as TVs, audio systems and induction cookers, or medical electrical equipment, such as low-frequency therapy equipment.

■ Carrying the electronic key on your person

Carry the electronic key 3.9 in. (10 cm) or more away from electric appliances that are turned on. Radio waves emitted from electric appliances within 3.9 in. (10 cm) of the electronic key may interfere with the key, causing the key to not function properly.

■ In case of a smart access system with push-button start malfunction or other key-related problems

→P.433

■ When an electronic key is lost

→P.432

■ Handling the card key (if equipped)

- Do not apply excess force when inserting the mechanical key into the card key. Doing so may damage the card key.

 NOTICE

- If the battery or card key terminals get wet, the battery may corrode and the card key may stop working. If the key is dropped into water, or if drinking water, etc. is spilled on the key, immediately remove the battery cover and wipe the battery and terminals. (To remove the battery cover, lightly grasp and pull it.) If the battery is corroded, have your Lexus dealer replace the battery.
- Do not crush the battery cover or use a screwdriver to remove the battery cover. Forcibly removing the battery cover may bend or damage the key.
- If the battery cover is frequently removed, the battery cover may become loose.
- When installing the battery, make sure to check the direction of the battery. Installing the battery in the wrong direction may cause the battery to deplete rapidly.
- The surface of the card key may be damaged, or its coating may peel off in the following situations:
 - The card key is carried together with hard objects, such as coins and keys.
 - The card key is scraped with a sharp object, such as the tip of a mechanical pencil.
 - The surface of the card key is wiped with thinner or benzene.

Wireless remote control

The electronic keys are equipped with the following wireless remote control:

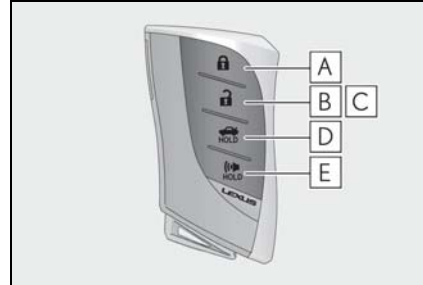

- A** Locks the doors (→P.100)
- B** Unlocks the doors (→P.100)
- C** Opens the windows^{*1} and moon roof^{*1,2} or panoramic moon roof^{*1,2} (→P.100)
- D** Opens the trunk (→P.107)
- E** Sounds the alarm

^{*1}: This setting must be customized at your Lexus dealer.

^{*2}: If equipped

■ Theft deterrent panic mode

When  is pressed for longer than about one second, an alarm will sound intermittently and the vehicle lights will flash to deter any person from trying to break into or damage your vehicle.

To stop the alarm, press any button on the electronic key.

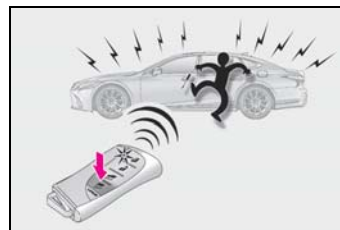

Using the mechanical key

To take out the mechanical key, push the release button and take the key out.

The mechanical key can only be inserted in one direction, as the key only has grooves on one side. If the key cannot be inserted in a lock cylinder, turn it over and re-attempt to insert it.

After using the mechanical key, store it in the electronic key. Carry the mechanical key together with the electronic key. If the electronic key battery is depleted or the entry function does not operate properly, you will need the mechanical key. (→P.433)

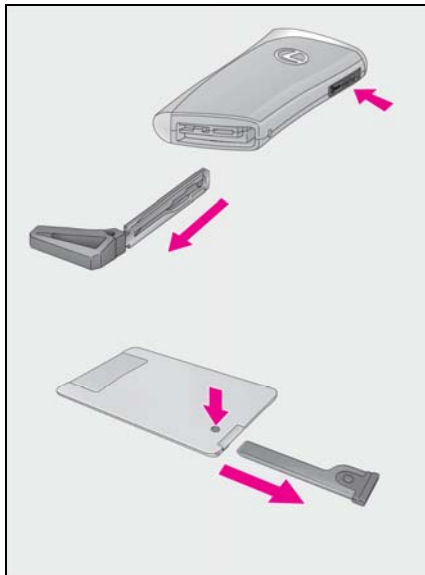

■ **When required to leave the vehicle's key with a parking attendant**

Turn the trunk opener main switch off (→P.110) and lock the glove box (→P.336) as circumstances demand. Remove the mechanical key for your own use and provide the attendant with the electronic key only.

■ **If you lose your mechanical keys**

→P.432

■ **If a wrong key is used**

The key cylinder rotates freely, isolated from the internal mechanism.

Doors

Unlocking and locking the doors from the outside

Smart access system with push-button start

Carry the electronic key to enable this function.

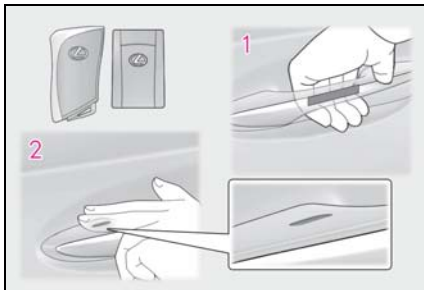

- 1 Grip the driver's door handle to unlock the door. Holding the driver's door handle for approximately 2 seconds unlocks all the doors. Grip any passenger door handle to unlock all the doors.*

Make sure to touch the sensor on the back of the handle.

The doors cannot be unlocked for 3 seconds after the doors are locked.

*: The door unlock settings can be changed.

- 2 Touch the lock sensor (indentation on the upper part of the door handle) to lock all the doors.

Check that the door is securely locked.

Wireless remote control

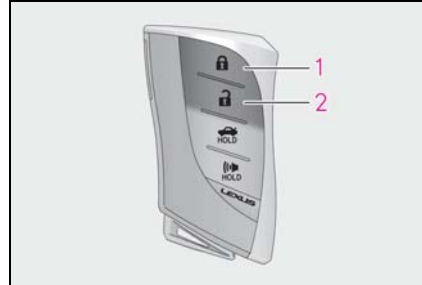

- 1 Locks all the doors

Check that the door is securely locked.

- 2 Unlocks all the doors

Pressing the button unlocks the driver's door. Pressing the button again within 5 seconds unlocks the other door.





Press and hold to open the windows*¹ and moon roof*^{1,2} or panoramic moon roof*^{1,2}.

*¹: This setting must be customized at your Lexus dealer.



*²: If equipped

Switching the door unlock function

It is possible to set which doors the entry function unlocks using the wireless remote control.

- 1 Turn the engine switch off.
- 2 When the indicator light on the key surface is not on, press and hold ,  or  for approximately 5 seconds while pressing and holding .

The setting changes each time an operation is performed, as shown below. (When changing the setting continuously, release the buttons, wait for at least 5 seconds, and repeat step 2.)

Multi-information display/Beep	Unlocking function
 <p>Exterior: Beeps 3 times Interior: Pings once</p>	<p>Holding the driver's door handle unlocks only the driver's door.</p>
 <p>Exterior: Beeps twice Interior: Pings once</p>	<p>Holding any of the passenger door handles unlocks all the doors.</p>
 <p>Exterior: Beeps twice Interior: Pings once</p>	<p>Holding a door handle unlocks all the doors.</p>

To prevent unintended triggering of the alarm, unlock the doors using the wireless remote control and open and close a door once after the settings have been changed. (If a door is not opened within 60 seconds after  is pressed, the doors will be locked again and the alarm will automatically be set.)

In a case that the alarm is triggered, immediately stop the alarm. (→P.65)

■ Impact detection door lock release system

In the event that the vehicle is subject to a strong impact, all the doors are unlocked. Depending on the force of the impact or the type of accident, however, the system may not operate.

■ Operation signals

A buzzer sounds and the emergency flashers flash to indicate that the doors have been locked/unlocked. (Locked: once; Unlocked: twice)

A buzzer sounds to indicate that the windows and moon roof or panoramic moon roof are operating.

■ Security feature

If a door is not opened within approximately

60 seconds after the vehicle is unlocked, the security feature automatically locks the vehicle again.

■ When the doors cannot be locked by the lock sensor on the upper part of the door handle

When the doors cannot be locked even if the lock sensor on the upper part of the door handle is touched by a finger, touch the lock sensor with the palm.

If you are wearing gloves, remove them.

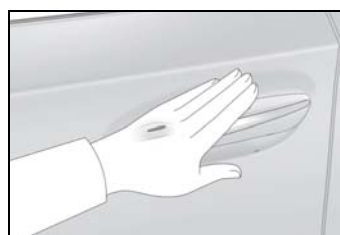

■ Open door warning buzzer

If an attempt to lock the doors is made when a door is not fully closed, a buzzer sounds continuously for 5 seconds. Fully close the door to stop the buzzer, and lock the vehicle once more.

■ Setting the alarm

Locking the doors will set the alarm system. (→P.65)

■ Conditions affecting the operation of the smart access system with push-button start or wireless remote control

→P.113

■ If the smart access system with push-button start or the wireless remote control does not operate properly

Use the mechanical key to lock and unlock the doors. (→P.433)

Replace the key battery with a new one if it is depleted. (→P.399)

■ If the battery is discharged

The doors cannot be locked and unlocked using the smart access system with push-button start or wireless remote control. Lock or unlock the doors using the mechanical key. (→P.433)

■ Customization

Some functions can be customized.
(→P.466)



WARNING

■ To prevent an accident

Observe the following precautions while driving the vehicle. Failure to do so may result in a door opening and an occupant throwing out of the vehicle, resulting in death or serious injury.

- Ensure that all doors are properly closed and locked.

- Do not pull the inside handle of the doors while driving.

Be especially careful for the front doors, as the doors may be opened even if the inside lock buttons are in locked position.

- Set the rear door child-protector locks when children are seated in the rear seats.

■ When opening or closing a door

Check the surroundings of the vehicle such as whether the vehicle is on an incline, whether there is enough space for a door to open and whether a strong wind is blowing. When opening or closing the door, hold the door handle tightly to prepare for any unpredictable movement.

■ Vehicle height control precautions (vehicles with electronically modulated air suspension)

In the following situations, make sure to check the safety of the area around the vehicle, as the vehicle height may change and part of someone's body may be caught in the vehicle, possibly causing injury or the vehicle may be damaged.

- When opening a door
- When unlocking the doors using the smart access system with push-button start

Unlocking and locking the doors from the inside

■ Door lock switches (to lock/unlock)

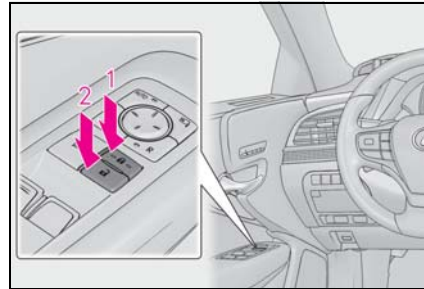

- 1 Locks all the doors
- 2 Unlocks all the doors

■ Inside lock buttons (to lock)

Push down the inside lock button to lock the door.

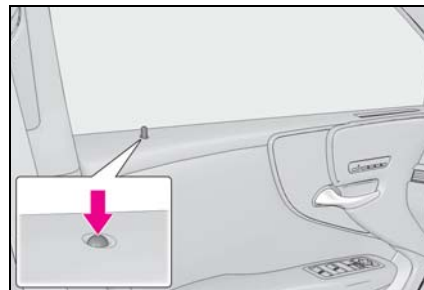

■ Inside door handles (to unlock)

- ▶ For the front doors

Pull the handle to unlock and open the door.

When the door is unlocked, the inside lock button will pop up.

- ▶ For the rear doors

Pull the handle to unlock the door. Pull the handle a second time to open the door.

When the door is unlocked, the inside lock button will pop up.

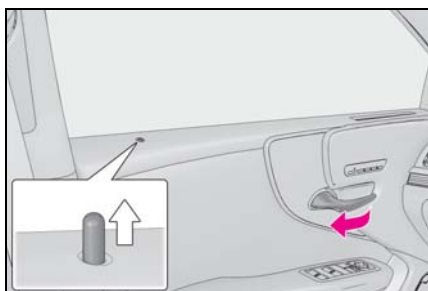

■ Locking the front doors from the outside without a key

- 1 Push down the inside lock button.
- 2 Close the door.

The door cannot be locked if the engine switch is in ACCESSORY or IGNITION ON mode, or the electronic key is left inside the vehicle. However, the key may not be detected correctly and the door may be locked.

■ Door closer (if equipped)

In the event that a door is left slightly open, the door closer will automatically close it to the fully closed position.

- The door closer will operate regardless of the engine switch mode.
- The door closer will not function if the door has been closed while pulling the inside or outside door handle.
- The door can be opened by pulling the inside or outside door handle, even when the door closer is operating (except when the lock button is in the lock position or the child-protector lock is set).
- A motor sound may be heard for several seconds after the door closer closes the door. This does not indicate a malfunction.

■ Open door warning buzzer

If a door or the trunk is not fully closed, a buzzer will sound when the vehicle speed reaches 3 mph (5 km/h). The open door(s) or trunk is indicated on the multi-information display.

⚠ WARNING

■ Door closer (if equipped)

In the event that a door is left slightly open, the door closer will automatically close it to the fully closed position. It takes several seconds before the door easy closer begins to operate. If the child-protector lock is set, the door closer will not stop during operation even if an attempt is made to open the door from inside the vehicle. Be careful not to catch fingers or anything else in the door. Failure to do so may result in serious injury.

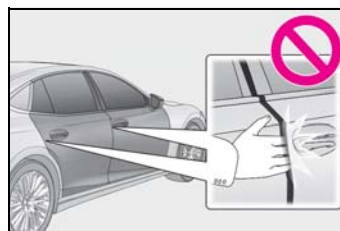

⚠ NOTICE

■ To prevent door closer malfunction (if equipped)

Do not frequently repeat opening and closing of doors, or apply excessive force to a door while the door closer is operating.

Rear door child-protector lock

The door cannot be opened from inside the vehicle when the lock is set.

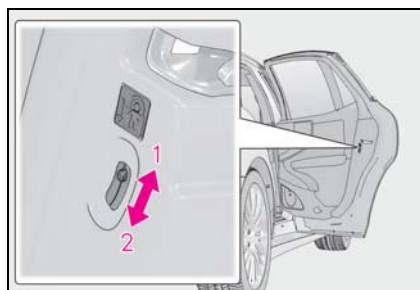

3

Before driving

1 Unlock**2** Lock

These locks can be set to prevent children from opening the rear doors. Push down on each rear door switch to lock both rear doors.

Automatic door locking and unlocking systems

The following functions can be set or canceled:

For instructions on customizing, refer to P.466.

Function	Operation
Speed linked door locking function	All doors are automatically locked when vehicle speed is approximately 12 mph (20 km/h) or higher.
Shift position linked door locking function	All doors are automatically locked when the shift position is shifted to a position other than P.
Shift position linked door unlocking function	All doors are automatically unlocked when the shift position is shifted to P.
Driver's door linked door unlocking function	All doors are automatically unlocked when driver's door is opened within approximately 45 seconds after turning the engine switch off.

Trunk

The trunk can be opened using the trunk opener switch, entry function or wireless remote control.

If the vehicle is equipped with a power trunk opener and closer, the trunk can be closed using the trunk closer.

WARNING

Observe the following precautions. Failure to do so may result in death or serious injury.

■ Before driving

- Make sure that the trunk lid is fully closed. If the trunk lid is not fully closed, it may open unexpectedly while driving and hit near-by objects or luggage in the trunk may be thrown out, causing an accident.
- Do not allow children to play in the trunk. If a child is accidentally locked in the trunk, they could suffer from heat exhaustion, suffocation or other injuries.
- Do not allow a child to open or close the trunk lid. Doing so may cause the trunk lid to open unexpectedly, or cause the child's hands, head, or neck to be caught by the closing trunk lid.

■ Important points while driving

Never let anyone sit in the trunk. In the event of sudden braking or a collision, they are susceptible to death or serious injury.

■ Using the trunk

Observe the following precautions. Failure to do so may cause parts of the body to be caught, resulting in serious injury.

⚠ WARNING

- Remove any heavy loads, such as snow and ice, from the trunk lid before opening it. Failure to do so may cause the trunk lid to suddenly shut again after it is opened.
- When opening or closing the trunk lid, thoroughly check to make sure the surrounding area is safe.
- If anyone is in the vicinity, make sure they are safe and let them know that the trunk is about to open or close.
- Use caution when opening or closing the trunk lid in windy weather as it may move abruptly in strong wind.
- The trunk lid may suddenly shut if it is not opened fully. It is more difficult to open or close the trunk lid on an incline than on a level surface, so beware of the trunk lid unexpectedly opening or closing by itself. Make sure that the trunk lid is fully open and secure before using the trunk.

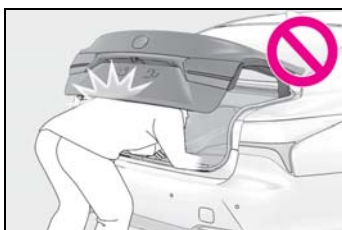

- When closing the trunk lid, take extra care to prevent your fingers etc. from being caught.



- When closing the trunk lid, make sure to press it lightly on its outer surface. If the trunk handle is used to fully close the trunk lid, it may result in hands or arms being caught.
- Do not attach any accessories other than genuine Lexus parts to the trunk lid. Such additional weight on the trunk lid may cause the lid to suddenly shut again after it is opened.

■ Trunk easy closer

In the event that the trunk lid is left slightly open, the trunk easy closer will automatically close it to the fully closed position. It takes several seconds before the trunk easy closer begins to operate. Be careful not to catch fingers or anything else in the trunk lid, as this may cause bone fractures or other serious injuries.

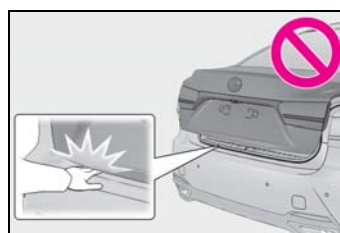
**■ Power trunk opener and closer (if equipped)**

Observe the following precautions when operating the power trunk opener and closer.

Failure to do so may cause serious injury.

- Check the safety of the surrounding area to make sure there are no obstacles or anything that could cause any of your belongings to get caught.
- If anyone is in the vicinity, make sure they are safe and let them know that the trunk is about to open or close.
- If the trunk closer switch is pressed while the trunk lid is opening during automatic operation, the trunk lid stops opening. Take extra care when on an incline, as the trunk lid may open or close suddenly.

⚠ WARNING

- On an incline, the trunk lid may suddenly shut after it opens automatically. Make sure the trunk lid is fully open and secure before using the trunk.
- In the following situations, the power trunk opener and closer may detect an abnormality and automatic operation may be stopped. In this case, the trunk lid has to be operated manually. Take extra care in this situation, as the stopped trunk lid may suddenly shut, causing an accident.
 - When the trunk lid contacts an obstacle
 - When the battery voltage suddenly drops, such as when the engine switch is turned to IGNITION ON mode or the engine is started during automatic operation
- Do not attach any accessories other than genuine Lexus parts to the trunk lid. The power trunk opener and closer may not operate, causing itself to malfunction, or the trunk lid may suddenly shut again after it is opened.

■ Hands Free Power Trunk Lid (if equipped)

Observe the following precautions. Failure to do so may cause serious injury.

- Exhaust gasses cause the exhaust pipes to become quite hot. When operating the Hands Free Power Trunk Lid, be careful not to touch the exhaust pipe.
- Do not operate the Hands Free Power Trunk Lid if there is little space under the rear bumper.

■ Jam protection function

Observe the following precautions. Failure to do so may cause serious injury.

- Never use any part of your body to intentionally activate the jam protection function.

- The jam protection function may not work if something gets caught just before the trunk lid fully closes. Be careful not to catch fingers or anything else in the trunk lid.

- The jam protection function may not work depending on the shape of the object that is caught. Be careful not to catch fingers or anything else.

⚠ NOTICE**■ To prevent trunk easy closer malfunctions**

Do not apply force to the trunk lid while the trunk easy closer is operating.

■ To prevent damage to the power trunk opener and closer (vehicles with power trunk opener and closer)

- Make sure that there is no luggage or snow on the trunk lid before operating the power trunk opener and closer. In addition, make sure that there is no ice between the trunk lid and frame that prevents movement of the trunk lid. Operating the power trunk opener and closer when excessive load is present on the trunk lid may cause a malfunction.
- Do not apply excessive force to the trunk lid while the power trunk opener and closer is operating.

Opening/closing the trunk**■ Trunk opener switch**

Press the trunk opener switch.

If the vehicle is equipped with a power trunk opener and closer, the trunk lid will fully open.

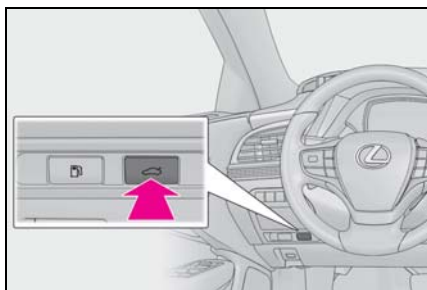

■ Smart access system with push-button start

While carrying the electronic key, press the button.

If the vehicle is equipped with a power trunk opener and closer, the trunk lid will fully open.

If the button is pressed while the trunk lid is opening, the trunk lid will stop moving.

When all the doors are unlocked using one of the following methods, the trunk can be opened without the electronic key:

- Entry function
- Wireless remote control
- Door lock switches
- Automatic door unlocking system
- Mechanical key

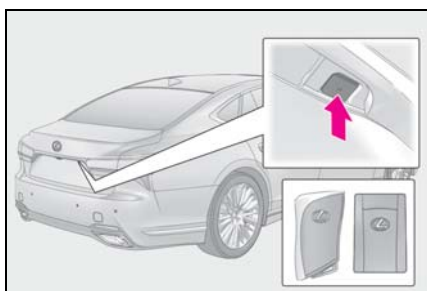

■ Wireless remote control

Press and hold the switch.

A buzzer sounds.

If the vehicle is equipped with a power trunk opener and closer, the trunk lid will fully open.

If the button is pressed while the trunk lid is opening, the trunk lid will stop moving.

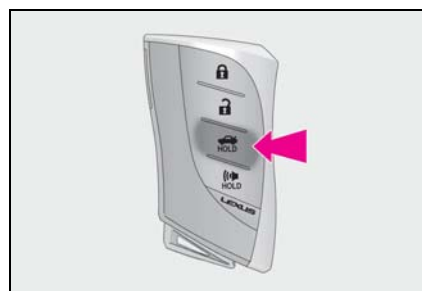

■ Hands Free Power Trunk Lid (if equipped)

- 1 While carrying an electronic key, stand within the smart access system with push-button start operation area, approximately 11.8 to 19.7 in. (30 to 50 cm) from the rear bumper.

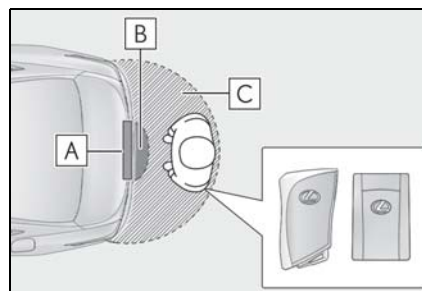

- A** Hands Free Power Trunk Lid sensor
- B** Hands Free Power Trunk Lid operation detection area
- C** Smart access system with push-button start operation detection area (→P.112)

3

Before driving

- 2 Perform a kick operation by moving your foot to within approximately 3.9 in. (10 cm) of the rear bumper and then pulling it back.
 - Perform the entire kick operation within 1 second.
 - The trunk lid will not start operating while a foot is detected under the rear bumper.
 - Operate the Hands Free Power Trunk Lid without contacting the rear bumper with your foot.
 - If another electronic key is in the cabin or trunk, it may take slightly longer than normal for the operation to begin.

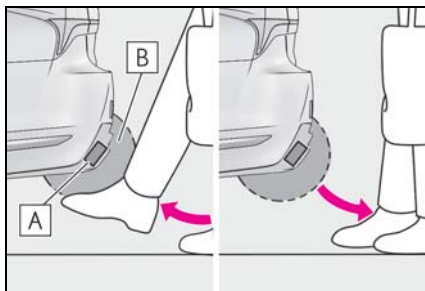

- A** Hands Free Power Trunk Lid sensor
- B** Hands Free Power Trunk Lid operation detection area

- 3 When the sensor detects that your foot is pulled back, a buzzer will sound and the trunk will automatically fully open/close.

If a foot is moved under the rear bumper while the trunk lid is opening, the trunk lid will stop moving.

If a foot is moved under the rear bumper while the trunk lid is closing, the trunk lid will open.

■ Trunk closer switch (vehicles with power trunk opener and closer)

Press the trunk closer switch.

A buzzer will sound and the trunk lid will fully close.

Pressing the switch while the trunk lid is closing opens the trunk lid again.

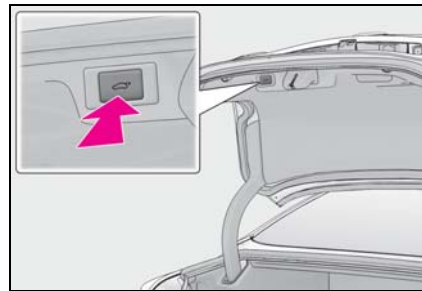

■ Trunk grip

Using the trunk grip, pull down the trunk lid without applying sideways force and push the trunk lid down from the outside to close it.

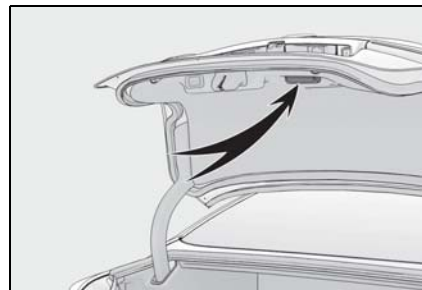

■ Trunk lid light/trunk light

- The trunk lid light/trunk light turns on when the trunk is opened.
- If the trunk lid light/trunk light is left on when the engine switch is turned off, the light will go off automatically after 20 minutes.

■ Trunk easy closer

In the event that the trunk lid is left slightly open, the trunk easy closer will automati-

cally close it to the fully closed position.

- The trunk easy closer will operate regardless of the engine switch mode.
- If the trunk easy closer does not operate, open the trunk to the half open position or more and then close it.

■ Function to prevent the trunk being locked with the electronic key inside

- When all doors are locked, closing the trunk lid with the electronic key left inside the trunk will sound an alarm. In this case, the trunk lid can be opened pressing the trunk release button on the trunk lid.
- If the spare electronic key is put in the trunk with all the doors locked, the key confinement prevention function is activated so the trunk can be opened. In order to prevent theft, take all electronic keys with you when leaving the vehicle.
- If the electronic key is put in the trunk with all the doors locked, the key may not be detected depending on the location of the key and the surrounding radio wave conditions. In this case, the key confinement prevention function cannot be activated, causing the doors to lock when the trunk is closed. Make sure to check where the key is before closing the trunk.
- The key confinement prevention function cannot be activated if any one of the doors is unlocked. In this case, open the trunk using the trunk opener.

■ Overload protection function (vehicles with power trunk opener and closer)

The trunk lid will not operate when excessive load is present on the top of the trunk lid.

■ Fall-down protection function (vehicles with power trunk opener and closer)

While the trunk lid is opening automatically, applying excessive force to it will stop the opening operation to prevent the trunk lid from rapidly falling down.

■ Jam protection function (vehicles with power trunk opener and closer)

While the trunk lid is closing automatically, the trunk lid will stop closing and open if

something gets caught.

■ Internal trunk release lever

The trunk lid can be opened by pulling the glow-in-the-dark lever located on the inside of the trunk lid to the side.

The lever will continue to glow for some time after the trunk lid is closed.

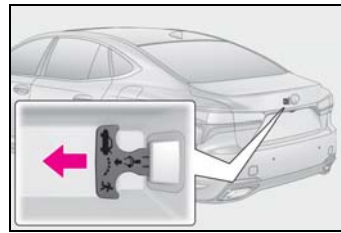

■ Using the mechanical key

The trunk can be also opened using the mechanical key. (→P.433)

If the trunk is unlocked using the mechanical key, the power trunk lid and trunk easy closer will not be operational. To return them to an operational state, fully close the trunk lid by hand.

■ If the smart access system with push-button start or the wireless remote control does not operate properly

Use the mechanical key to unlock the trunk. (→P.433)

Replace the key battery with a new one if it is depleted.

■ Hands Free Power Trunk Lid operating conditions (if equipped)

- When the Hands Free Power Trunk Lid (kick sensor) operation setting is turned on and the engine switch is turned off
- When an electronic key is carried within the operation range

■ Situations in which the Hands Free Power Trunk Lid may not operate properly (if equipped)

In the following situations, the Hands Free Power Trunk Lid may not operate properly:

- When a foot remains under the rear bumper
- If the rear bumper is strongly hit with a foot or is touched for a while

If the rear bumper has been touched for a while, wait for a short time before attempting to operate the Hands Free Power Trunk Lid again.

- When standing excessively close to the rear bumper
- When an external radio wave source interferes with the communication between the electronic key and the vehicle (→P.113)
- When the vehicle is parked near an electrical noise source which affects the sensitivity of the Hands Free Power Trunk Lid, such as a pay parking spot, gas station, electrically heated road, or fluorescent light
- When the vehicle is near a TV tower, electric power plant, radio station, large display, airport or other facility that generates strong radio waves or electrical noise
- When a large amount of water is applied to the rear bumper, such as when the vehicle is being washed or in heavy rain
- When mud, snow, ice, etc. is attached to the rear bumper
- When the vehicle has been parked for a while near objects that may move and contact the rear bumper, such as plants
- When an accessory is installed to the rear bumper

If an accessory has been installed, turn the Hands Free Power Trunk Lid (kick sensor) operation setting off.

■ Preventing unintentional operation of the Hands Free Power Trunk Lid (if equipped)

When an electronic key is in the operation detection area, the Hands Free Power Trunk Lid may operate unintentionally, so be careful in the following situations:

- When a large amount of water is applied to the rear bumper, such as when the vehicle is being washed or in heavy rain
- When dirt is wiped off the rear bumper
- When a small animal or small object, such as a ball, moves under the rear bumper

- When an object is moved from under the rear bumper
- If someone is swinging their legs while sitting on the rear bumper
- If the legs or another part of someone's body contacts the rear bumper while passing by the vehicle
- When the vehicle is parked near an electrical noise source which affects the sensitivity of the Hands Free Power Trunk Lid, such as a pay parking spot, gas station, electrically heated road, or fluorescent light
- When the vehicle is near a TV tower, electric power plant, radio station, large display, airport or other facility that generates strong radio waves or electrical noise
- When the vehicle is parked in a place where objects such as plants are near the rear bumper
- If luggage, etc. is set near the rear bumper
- If accessories or a vehicle cover is installed/removed near the rear bumper
- When the vehicle is being towed

To prevent unintentional operation, turn the Hands Free Power Trunk Lid (kick sensor) operation setting off.

■ Open door warning buzzer

→P.103

■ Customization

Some functions can be customized. (→P.466)

Luggage security system

The trunk opener switch can be temporarily disabled to protect luggage stored in the trunk against theft.

Turn the main switch in the glove box off to disable the trunk opener.

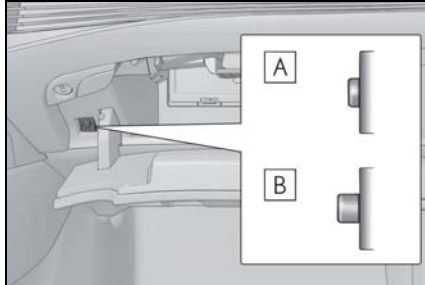

A On

B Off

The trunk lid cannot be opened even with the wireless remote control, entry function or Hands Free Power Trunk Lid.

■ When leaving a key to the vehicle with a parking attendant

→P.99

Smart access system with push-button start

The following operations can be performed simply by carrying the electronic key (including the card key) on your person, for example in your pocket. The driver should always carry the electronic key.

- Locks and unlocks the doors (→P.100)
- Opens the trunk (→P.107)
- Starts the engine (→P.164)

■ Antenna location

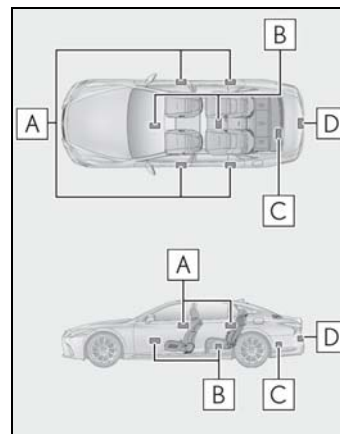

A Antennas outside the cabin

B Antennas inside the cabin

C Antenna inside the trunk

D Antenna outside the trunk

■ **Effective range (areas within which the electronic key is detected)**

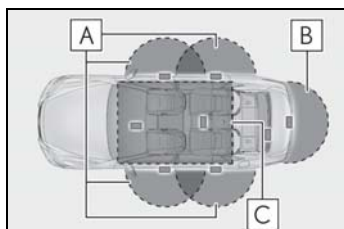

A When locking or unlocking the doors

The system can be operated when the electronic key is within about 2.3 ft. (0.7 m) of an outside door handle. (Only the doors detecting the key can be operated.)

B When opening the trunk

The system can be operated when the electronic key is within about 2.3 ft. (0.7 m) of the trunk release button.

C When starting the engine or changing engine switch modes

The system can be operated when the electronic key is inside the vehicle.

■ **Alarms and warning messages**

An alarm sounds and warning messages are displayed on the multi-information display to protect against unexpected accidents or theft of the vehicle resulting from erroneous operation. When a warning message is displayed, take appropriate measures based on the displayed message. (→P.425)

When only an alarm sounds, circumstances and correction procedures are as follows.

- When an exterior alarm sounds once for 5 seconds

Situation	Correction procedure
An attempt was made to lock the vehicle while a door was open.	Close all of the doors and lock the doors again.
The trunk was closed while the electronic key was still inside the trunk and all the doors were locked.	Retrieve the electronic key from the trunk and close the trunk lid.

- When an interior alarm sounds continuously

Situation	Correction procedure
The engine switch was turned to ACCESSORY mode while the driver's door was open (The driver's door was opened when the engine switch was in ACCESSORY mode).	Turn the engine switch off and close the driver's door.
The engine switch was turned off while the driver's door was open.	Close the driver's door.

■ **If "Key Detected in Vehicle" is shown on the multi-information display**

An attempt was made to lock the doors using the smart access system with push-button start while the electronic key was still inside the vehicle. Retrieve the electronic key from the vehicle and lock the doors again.

■ **Battery-saving function**



The battery-saving function will be activated in order to prevent the electronic key battery and the battery from being discharged while the vehicle is not in operation for a long time.

- In the following situations, the smart access system with push-button start may

- take some time to unlock the doors.
- The electronic key has been left in an area of approximately 6 ft. (2 m) of the outside of the vehicle for 10 minutes or longer.
- The smart access system with push-button start has not been used for 5 days or longer.
- If the smart access system with push-button start has not been used for 14 days or longer, the doors cannot be unlocked at any doors except the driver's door. In this case, take hold of the driver's door handle, or use the wireless remote control or the mechanical key, to unlock the doors.

■ Turning an electronic key to battery-saving mode

When battery-saving mode is set, battery depletion is minimized by stopping the electronic key from receiving radio waves.

Press  twice while pressing and holding . Confirm that the electronic key indicator flashes 4 times.

While the battery-saving mode is set, the smart access system with push-button start cannot be used. To cancel the function, press any of the electronic key buttons.

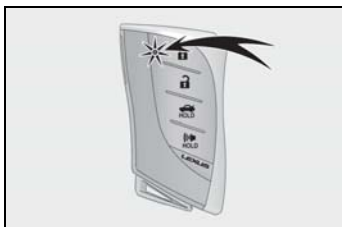

■ Conditions affecting operation

The smart access system with push-button start uses weak radio waves. In the following situations, the communication between the electronic key and the vehicle may be affected, preventing the smart access system with push-button start, wireless remote control and engine immobilizer system from operating properly. (Ways of coping: →P.433)

- When the electronic key battery is depleted
- Near a TV tower, electric power plant, gas station, radio station, large display, airport or other facility that generates strong radio waves or electrical noise
- When carrying a portable radio, cellular phone, cordless phone or other wireless communication device
- When the electronic key is in contact with, or is covered by the following metallic objects
 - Cards to which aluminum foil is attached
 - Cigarette boxes that have aluminum foil inside
 - Metallic wallets or bags
 - Coins
 - Hand warmers made of metal
 - Media such as CDs and DVDs
- When other wireless keys (that emit radio waves) are being used nearby
- When carrying the electronic key together with the following devices that emit radio waves
 - Another vehicle's electronic key or a wireless key that emits radio waves
 - Personal computers or personal digital assistants (PDAs)
 - Digital audio players
 - Portable game systems
- If window tint with a metallic content or metallic objects are attached to the rear window
- When the electronic key is placed near a battery charger or electronic devices
- When the vehicle is parked in a pay parking spot where radio waves are emitted.

■ Note for the entry function

- Even when the electronic key is within the effective range (detection areas), the system may not operate properly in the following cases:
 - The electronic key is too close to the window or outside door handle, near the ground, or in a high place when the doors are locked or unlocked.
 - The electronic key is near the ground or in a high place, or too close to the center of the rear bumper when the trunk is opened.
 - The electronic key is on the instrument panel, rear package tray or floor, or in the door pockets or glove box when the

engine is started or engine switch modes are changed.

- Do not leave the electronic key on top of the instrument panel or near the door pockets when exiting the vehicle. Depending on the radio wave reception conditions, it may be detected by the antenna outside the cabin and the doors will become lockable from the outside, possibly trapping the electronic key inside the vehicle.
- As long as the electronic key is within the effective range, the doors may be locked or unlocked by anyone. However, only the doors detecting the electronic key can be used to unlock the vehicle.
- Even if the electronic key is not inside the vehicle, it may be possible to start the engine if the electronic key is near the window.
- The doors may unlock or lock if a large amount of water splashes on the door handle, such as in the rain or in a car wash, when the electronic key is within the effective range. (The doors will automatically be locked after approximately 60 seconds if the doors are not opened and closed.)
- If the wireless remote control is used to lock the doors when the electronic key is near the vehicle, there is a possibility that the door may not be unlocked by the entry function. (Use the wireless remote control to unlock the doors.)
- Touching the door lock sensor while wearing gloves may delay or prevent lock operation.
- When the lock operation is performed using the lock sensor, recognition signals will be shown up to two consecutive times. After this, no recognition signals will be given.
- If the door handle becomes wet while the electronic key is within the effective range, the door may lock and unlock repeatedly. In this case, follow the following correction procedures to wash the vehicle:
 - Place the electronic key in a location 6 ft. (2 m) or more away from the vehicle. (Take care to ensure that the key is not

stolen.)

- Set the electronic key to battery-saving mode to disable the smart access system with push-button start. (→P.113)
- If the electronic key is inside the vehicle and a door handle becomes wet during a car wash, a message may be shown on the multi-information display and a buzzer will sound outside the vehicle. To turn off the alarm, lock all the doors.
- The lock sensor may not work properly if it comes into contact with ice, snow, mud, etc. Clean the lock sensor and attempt to operate it again.
- A sudden approach to the effective range or door handle may prevent the doors from being unlocked. In this case, return the door handle to the original position and check that the doors unlock before pulling the door handle again.
- If there is another electronic key in the detection area, it may take slightly longer to unlock the doors after the door handle is gripped.

■ When the vehicle is not driven for extended periods

- To prevent theft of the vehicle, do not leave the electronic key within 6 ft. (2 m) of the vehicle.
- The smart access system with push-button start can be deactivated in advance.
- Setting the electronic key to battery-saving mode helps to reduce key battery depletion. (→P.113)

■ To operate the system properly

- Make sure to carry the electronic key when operating the system. Do not get the electronic key too close to the vehicle when operating the system from the outside of the vehicle.

Depending on the position and holding condition of the electronic key, the key may not be detected correctly and the system may not operate properly. (The alarm may go off accidentally, or the door lock prevention function may not operate.)

- Do not leave the electronic key inside the trunk.

The key confinement prevention function may not operate, depending on the location of the key (the inside edge of the trunk), conditions (inside a metal bag, close to metallic objects) and the radio waves in the surrounding area. (→P.109)

■ **If the smart access system with push-button start does not operate properly**

- Locking and unlocking the doors and trunk: →P.433
- Starting the engine: →P.434

■ **Certification for the smart access system with push-button start**

- ▶ For vehicles sold in the U.S.A., Hawaii, Guam and Puerto Rico

FCC ID: NI4TMLF15-1 ✓

This device complies with part 15 of the FCC Rules. Operation is subject to the following two conditions: (1) This device may not cause harmful interference, and (2) this device must accept any interference received, including interference that may cause undesired operation.

Changes or modifications not expressly approved by the party responsible for compliance could void the user's authority to operate the equipment.

■ **Customization**

Some functions can be customized. (→P.466)

■ **If the smart access system with push-button start has been deactivated in a customized setting**

- Locking and unlocking the doors and opening the trunk:
Use the wireless remote control or mechanical key. (→P.100, 107, 433)
- Starting the engine and changing engine switch modes: →P.434
- Stopping the engine: →P.165

FCC ID: HYQ23AAY
FCC ID: HYQ14FBF
FCC ID: HYQ14CBG

NOTE:

This device complies with part 15 of the FCC Rules. Operation is subject to the following two conditions: (1) This device may not cause harmful interference, and (2) this device must accept any interference received, including interference that may cause undesired operation.

FCC WARNING:

Changes or modifications not expressly approved by the party responsible for compliance could void the user's authority to operate the equipment.

<For 14FBF>

The FCC ID/IC Certification number is affixed inside the equipment. You can find the ID/number when replacing the battery.

► For vehicles sold in Canada

This device complies with Industry Canada's licence-exempt RSSs. Operation is subject to the following two conditions: (1) This device may not cause interference; and (2) This device must accept any interference, including interference that may cause undesired operation of the device.

Le présent appareil est conforme aux CNR d'Industrie Canada applicables aux appareils radio exempts de licence. L'exploitation est autorisée aux deux conditions suivantes : 1) l'appareil ne doit pas produire de brouillage; 2) l'utilisateur de l'appareil doit accepter tout brouillage radioélectrique subi, même si le brouillage est susceptible d'en compromettre le fonctionnement.

NOTE:

This device complies with Industry Canada's licence-exempt RSSs. Operation is subject to the following two conditions:

- (1) This device may not cause interference; and
- (2) This device must accept any interference, including interference that may cause undesired operation of the device.

<For 14FBB>

The FCC ID/IC Certification number is affixed inside the equipment. You can find the ID/number when replacing the battery.

NOTE:

Le présent appareil est conforme aux CNR d'Industrie Canada applicables aux appareils radio exempts de licence. L'exploitation est autorisée aux deux conditions suivantes:

- (1) l'appareil ne doit pas produire de brouillage;
- (2) l'utilisateur de l'appareil doit accepter tout brouillage radioélectrique subi, même si le brouillage est susceptible d'en compromettre le fonctionnement.

<Pour 14FBB>

L'identification FCC/le numéro d'accréditation IC est apposé(e) à l'intérieur de l'appareil. Cette identification/ce numéro est visible au remplacement de la pile.

**WARNING****■ Caution regarding interference with electronic devices**

- People with implantable cardiac pacemakers, cardiac resynchronization therapy-pacemakers or implantable cardioverter defibrillators should keep away from the smart access system with push-button start antennas. (→P.111)

The radio waves may affect the operation of such devices. If necessary, the entry function can be disabled. Ask your Lexus dealer for details, such as the frequency of radio waves and timing of the emitted radio waves. Then, consult your doctor to see if you should disable the entry function.

- Users of any electrical medical device other than implantable cardiac pacemakers, cardiac resynchronization therapy-pacemakers or implantable cardioverter defibrillators should consult the manufacturer of the device for information about its operation under the influence of radio waves. Radio waves could have unexpected effects on the operation of such medical devices.

Ask your Lexus dealer for details on disabling the entry function.

Front seats

WARNING

■ When adjusting the seat position

- Take care when adjusting the seat position to ensure that other passengers are not injured by the moving seat.
- Do not put your hands under the seat or near the moving parts to avoid injury. Fingers or hands may become jammed in the seat mechanism.
- Make sure to leave enough space around the feet so they do not get stuck.

■ Seat adjustment

To reduce the risk of sliding under the lap belt during a collision, do not recline the seat more than necessary. If the seat is too reclined, the lap belt may slide past the hips and apply restraint forces directly to the abdomen, or your neck may contact the shoulder belt, increasing the risk of death or serious injury in the event of an accident. Adjustments should not be made while driving as the seat may unexpectedly move and cause the driver to lose control of the vehicle.

■ Operating the front passenger's seat from the driver's seat or rear seat

Do not operate the front passenger's seat when a passenger is seated in it. In addition, do not let anyone sit down in the front passenger's seat while the seat is being operated or when the head restraint is being folded. The front passenger may catch their legs between the instrument panel and seat, or the head restraint may interfere with their head, resulting in injury.

■ When the front passenger's seat is folded forward

If the outside rear view mirror is difficult to see, due to the position of the front passenger's seat, move the front passenger's seat to an appropriate position. Doing so may lead to mishandling of the vehicle and cause an accident, resulting in death or serious injury.

NOTICE

■ Operating the front passenger's seat from the driver's seat or rear seat

Before operating the front passenger's seat, make sure that there is no luggage or any other objects on the seat or in the footwell that could prevent its operation. Such items may result in excess force being applied, causing damage to the seat and/or the luggage.

Adjustment procedure

■ Seat adjustment switches

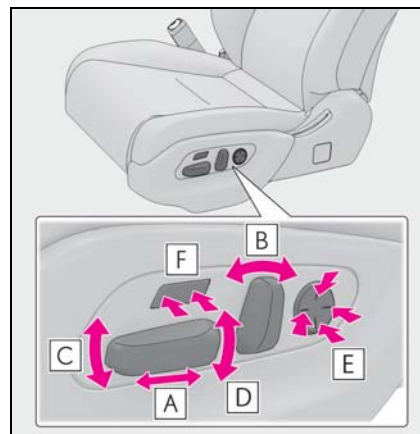

- A** Seat position adjustment switch
- B** Seatback angle adjustment switch
- C** Seat cushion (front) angle adjustment switch
- D** Vertical height adjustment switch

3

Before driving

- E** Lumbar support adjustment switch
- F** Seat cushion length adjustment switch (if equipped)

■ **Center Display**

- 1 Press the seat switch.

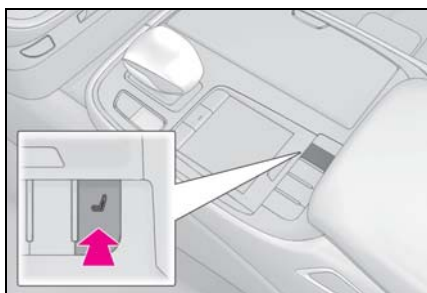

- 2 Using the Remote Touch pad, select "Driver Seat Adjustment" or "Passenger Seat Adjustment".
- 3 Select the button for the desired adjustment.

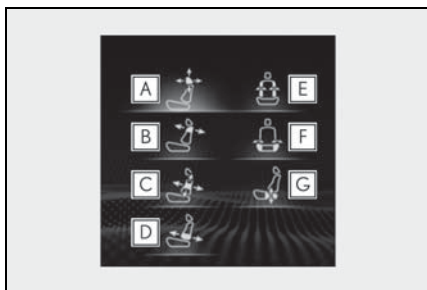

- A** Head restraint adjustment (if equipped) (→P.135)
- B** Shoulder bolster adjustment (if equipped)
- C** Lumbar support adjustment
- D** Pelvic support adjustment
- E** Seatback side bolster adjustment (if equipped)
- F** Seat cushion side bolster adjustment (if equipped)

- G** Hip support adjustment (if equipped)

- 4 Perform adjustment using the displayed buttons.

The seat will move while a button is selected.

■ **When adjusting the front seats**

While adjusting a front seat, to avoid contact with the ceiling, instrument panel or rear seats, the operation of the seat may be restricted or parts of the seat other than that being adjusted may move.

■ **Operation after the engine switch is turned off**

After a certain time elapses after the engine switch is turned off, the following parts of the front seats will move to their neutral positions.

- Shoulder bolster (if equipped)
- Lumbar support
- Pelvic support
- Seatback side bolster (if equipped)
- Seat cushion side bolster (if equipped)
- Hip support (if equipped)

■ **Automatic angle adjustment of the rear displays (if equipped)**

When a seat is adjusted, the angle of the rear display will be adjusted automatically to maintain an optimal viewing angle for the rear display from the rear seat.

■ **Pre-collision seatbacks for the passenger seats**

→P.205, 215

■ **Customization**

Some functions can be customized. (→P.466)

Operating the front passenger's seat from the driver's seat

■ Using the driver's seat adjustment switches to adjust the front passenger's seat (front passenger mode)

The mode of the driver's seat adjustment switches can be changed to adjust the front passenger's seat.

- 1 Press the mode change button on the driver's side door.

The indicator **A** will illuminate when front passenger mode is selected.

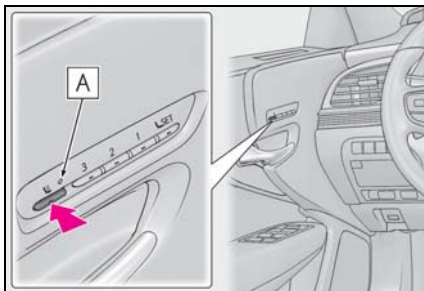

- 2 Using the seat adjustment switches on the driver's seat, adjust the front passenger's seat.

To cancel front passenger mode, press the mode change button again.

Front passenger mode will be canceled automatically if the driver's seat adjustment switches are not operated for approximately 30 seconds.

■ Using the Center Display (vehicles with a foldable head restraint)

- 1 Press the seat switch.

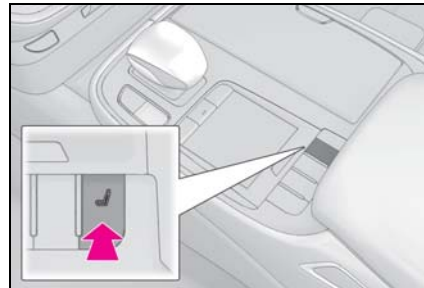

- 2 Press the sub function button of the Remote Touch. (→P.304)
- 3 Select the button for the desired operation.



- A** Moves the front passenger's seat forward and folds the seatback and head restraint forward
- B** Moves the front passenger's seat backward and the seatback and head restraint to the upright position

If the rear seat behind the front passenger's seat is not in the upright position, it will move to the upright position before the front passenger's seat moves to its upright position.

To stop the front passenger seat while it is moving, select the **A** or **B** button or press the seat switch.

3

Before driving

■ Operating the foldable head restraint using the driver's seat adjustment switches in front passenger mode (if equipped)

- When the front passenger's seatback angle is adjusted using the driver's seat adjustment switches in front passenger mode, the front passenger's head restraint will operate automatically as follows:
 - When the front passenger's seatback is moved forward to the upright position, the head restraint will lower and fold forward when the seatback angle adjustment switch is released.
 - When the front passenger's seatback is moved backward to the upright position, the head restraint will move to the upright position when the seatback angle adjustment switch is released.
- If any of the following conditions are met, the front passenger's head restraint will not fold forward even though the front passenger's seatback angle is being adjusted using the driver's seat adjustment switches in front passenger mode:
 - The engine switch is in ACCESSORY mode or off.
 - The weight of an occupant or heavy object, etc. is detected on the front passenger's seat.

Once weight is detected on the seat, the seat will be judged as occupied until the front passenger's door is opened then closed or the engine switch is turned off.

- Vehicles without a rear seat entertainment system: The front passenger's seat is in the rear most position.
- The front passenger's seat belt is fastened.
- The front passenger's door is open. (The front seat will not move forward.)
- The front passenger's seat is not in the lowest position.
- The front passenger's seat seat cushion (front) is not in the lowest position.
- The front passenger's seat seat cushion is extended (if equipped).
- If either of the following conditions is met, the front passenger's head restraint will not return to the upright position even

though the front passenger's seatback angle is being adjusted using the driver's seat adjustment switches in front passenger mode:

- The engine switch is in ACCESSORY mode or off.
- The front passenger's seat position is moved to a position forward of the neutral position.

■ Operating the foldable head restraint using the front passenger's seat adjustment switches (if equipped)

When the front passenger's head restraint is folded forward and the front passenger's door is open, if the front passenger's seat adjustment switches are used to move the seat backward or recline the seatback, the head restraint will move to the upright position automatically when the switch is released.

To stop the operation of the front passenger's head restraint part-way, perform any of the following operations:

- Operate any front passenger's seat adjustment switch.

The head restraint will stop when the seat position adjustment switch or seatback angle adjustment switch is operated to move the seat backward or recline the seatback, and will resume operating when the switch is released.

- Press the "SET" button.
- Press the "1", "2" or "3" button.
- Press the seat switch.

■ Operation of the front passenger's seat using the Center Display will be canceled when (vehicles with a foldable head restraint)

In the following situations, the front passenger's seat cannot be operated using the Center Display:

- The engine switch is in ACCESSORY mode or off.
- The weight of an occupant or heavy object, etc. is detected on the front passenger's seat.

Once weight is detected on the seat, the

seat will be judged as occupied until the front passenger's door is opened then closed or the engine switch is turned off.

- The front passenger's seat belt is fastened.
- The front passenger's door is open. (The front seat will not move forward.)

■ **When the front passenger's seat is folded forward**

By reclining the front passenger's seat seat-back, the forward view of the rear passenger can be improved.

Operating the front passenger's seat from the rear seat (vehicles without power rear seat)

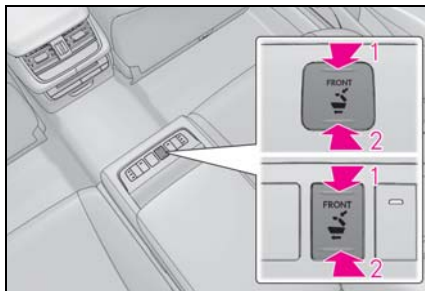

- 1** Press and hold to move the front passenger's seat forward and fold the seatback forward.
- 2** Press and hold to move the front passenger's seat backward and move the seatback to the upright position.

Operating the front passenger's seat from the rear seat (vehicles with power rear seat)

■ **Automatic operation**

- 1** Display the home screen on the Rear Multi Operation Panel (→P.308) and then touch "Seat".

- 2** Touch the button for the desired operation.

When the operating conditions are not met, the buttons will be grayed out.



- A** Move the front passenger's seat forward and fold the seatback forward.

On vehicles with a foldable head restraint, the head restraint will also fold forward.

- B** Move the front passenger's seat backward and the seatback to the upright position.

If the rear seat behind the front passenger's seat is not in the upright position, it will move to the upright position before the front passenger's seat moves to its previous position.

On vehicles with a foldable head restraint, the head restraint will also move to the upright position.

To stop the front passenger seat while it is moving, touch "STOP".

■ **Manual operation**

- 1** Display the home screen on the Rear Multi Operation Panel (→P.308) and then touch "Seat".
- 2** Touch "Right"

3

Before driving

- 3 Touch the button for the desired operation.

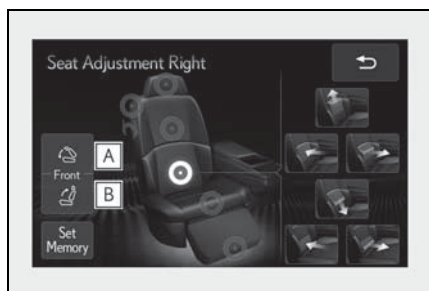

- A Touch and hold to move the front passenger's seat forward and fold the seatback forward.

On vehicles with a foldable head restraint, the head restraint will also fold forward.

- B Touch and hold to move the front passenger's seat backward and the seatback to the upright position.

On vehicles with a foldable head restraint, the head restraint will also move to the upright position.

■ Operating the front passenger's seat from the rear seat

- In the following situations, the front passenger's seat cannot be operated using the Rear Multi Operation Panel:
 - The engine switch is in ACCESSORY mode or off.
 - The rear seat belt is not fastened and weight is not detected on the rear seat.

Once weight is detected on the seat, the seat will be judged as occupied until a rear door is opened then closed or the engine switch is turned off and the doors are locked.

- The weight of an occupant or heavy object, etc. is detected on the front passenger's seat.

Once weight is detected on the seat, the seat will be judged as occupied until the front passenger's door is opened then

closed or the engine switch is turned off.

- The front passenger's seat belt is fastened.
- The front passenger's door is open. (The front seat will not move forward.)
- If the rear armrest is stowed while the seat position is being adjusted, the operation will stop.

■ Canceling an operation

To cancel an operation, press and hold the



button of the Rear Multi Operation Panel or press it 3 times in quick succession.

■ When the front passenger's seat is folded forward

→P.123

Front seat refresh system (if equipped)

Pneumatic chambers built into the front seat apply pressure to the occupant's body at different modes and intensities.

- 1 Press the seat switch.

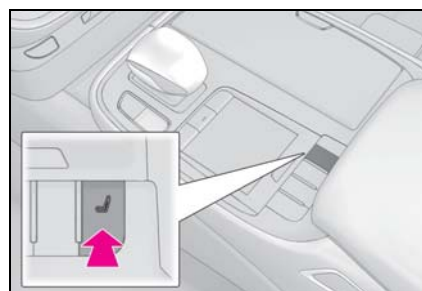

- 2 Using the Remote Touch pad, select "Driver Seat Refresh" or "Passenger Seat Refresh".

- 3 Select the desired mode.

- "Centripetal"

Applies pressure sequentially from the front of the seat cushion to top of the seat-

back

- “Centrifugal”

Applies pressure sequentially from the top of the seatback to the front of the seat cushion

- “Upper Body”

Applies pressure sequentially from the bottom to the top of the seatback

- “Lower Body”

Applies pressure sequentially from the front to the back of the seat cushion

- “Lumbar”

Applies pressure sequentially from the bottom to the top of the lumbar area of the seatback

4 Select the desired intensity and then confirm the setting.

The intensity can be adjusted in 5 steps.

To stop the operation select “Stop”.

If a seat is not occupied, do not operate the front seat refresh system for that seat.

Refresh system

- Operating conditions
 - The engine switch is in IGNITION ON mode.
 - The temperature in the cabin is not extremely high.
 - For the front passenger’s seat: The weight of an occupant is detected on the front passenger’s seat or the front passenger’s seat belt is fastened.

Once weight is detected on the seat, the seat will be judged as occupied until the front passenger’s door is opened then closed or the engine switch is turned off.

- Automatic stop function
 - The operation will be canceled automatically after approximately 15 minutes.
 - If the power easy access system begins operating, the front seat refresh system will stop.

! WARNING

Important points while driving

Do not adjust the driver’s seat refresh system while driving. Using it may affect your ability to control the vehicle, possibly leading to an accident resulting in death or serious injury.

Using the refresh system

- Those who are pregnant, have recently given birth, or suffer from ailments requiring rest (heart disease etc.) should consult a doctor before use.
- Do not allow children to use the refresh function.
- Do not use immediately after consuming a meal or alcohol, or for an extended period of time.
- If you feel sick while using the refresh function, immediately discontinue use.

3

Before driving

Power rear seat*

*: If equipped

⚠ WARNING**■ When adjusting the seat position**

- Take care when adjusting the seat position to ensure that other passengers are not injured by the moving seat.
- When adjusting the rear seat with an ottoman, make sure there is sufficient space so that a foot does not get caught between the ottoman and front passenger seat. (If equipped)
- Vehicles with a rear seat entertainment system: When the rear seat is moving to the Entertainment Mode position, do not allow hands near the rear display. Otherwise, a hand or finger may be caught, possibly causing injury.

■ Seat adjustment

To reduce the risk of sliding under the lap belt during a collision, do not recline the seat more than necessary. If the seat is too reclined, the lap belt may slide past the hips and apply restraint forces directly to the abdomen, or your neck may contact the shoulder belt, increasing the risk of death or serious injury in the event of an accident. Adjustments should not be made while driving as the seat may unexpectedly move and cause the driver to lose control of the vehicle.

■ Using the ottoman (if equipped)

- Do not sit on the ottoman.
- If someone sits on the ottoman, the seat belt cannot be fitted properly, and they may be thrown from the seat, resulting in death or serious injury in the event of an accident or sudden braking.

- When getting in or out of the vehicle, retract the ottoman. If the ottoman is not retracted, it may cause a fall, resulting in injury.
- Do not operate the ottoman when the vehicle is moving.
- Do not allow anyone to put their hands or feet under the rear seat when stowing the ottoman.

⚠ NOTICE**■ To prevent an ottoman malfunction (if equipped)**

- Do not place any objects in the rear seat footwell that could prevent the operation of the ottoman.
- Do not place heavy luggage on the ottoman.
- Do not place any objects under the ottoman while it is raised for use. These objects may interfere with the ottoman being folded, causing damage to the ottoman or the objects themselves.

■ To prevent a rear display malfunction (if equipped)

Do not attempt to move the rear display by hand, as doing so may damage the rear display.

Adjustment procedure**■ Automatic operation**

The seat can be moved to preset positions.

- 1 Display the home screen on the Rear Multi Operation Panel (→P.308) and then touch "Seat".
- 2 Touch the desired preset button.

When the operating conditions are not

met, the preset buttons will be grayed out.

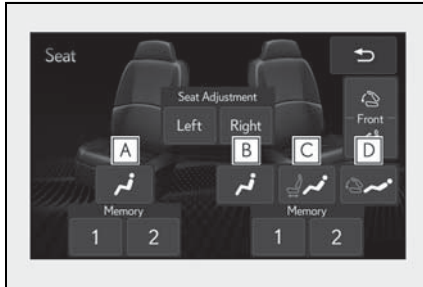

- A** Moves the left-hand rear seat to the upright position (Business Mode)
- B** Moves the right-hand rear seat to the upright position (Business Mode)
- C** Moves the rear seat with an ottoman to a slightly reclined position (Entertainment Mode) (if equipped)

Vehicles without a rear seat entertainment system: Moves the front passenger's seat forward.

Vehicles with a rear seat entertainment system: Moves the front passenger's seat and rear display to allow the rear display to be comfortably viewed.

- D** Moves the rear seat with an ottoman to a deeply reclined position (Relaxation Mode) (if equipped)

Moves the front passenger's seat forward and folds the seatback and head restraint forward.

To stop the front passenger seat while it is moving, touch "STOP".

Manual operation

- 1** Display the home screen on the Rear Multi Operation Panel (→P.308) and then touch "Seat".
- 2** Touch "Left" or "Right".

- 3** Select the button for the desired adjustment.

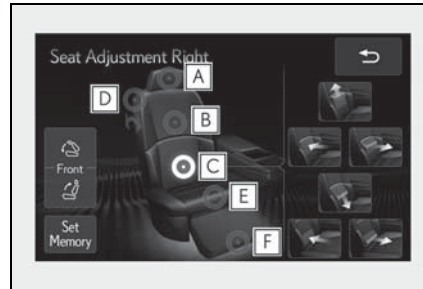

- A** Head restraint adjustment (→P.135)
- B** Shoulder bolster adjustment
- C** Lumbar/pelvic support adjustment
- D** Seatback angle adjustment
- E** Seat cushion (front) angle adjustment
- F** Ottoman adjustment (if equipped)

- 4** Perform adjustment using the displayed buttons.

The seat will move while a button is touched.

Adjustment of the rear seat

- When a rear seat is close to a front seat, the operation of the rear seat may be restricted.
- If the rear armrest is stowed while the seat position is being adjusted, the operation will stop.

Operating conditions of Business Mode

When the rear seat belt is not fastened and weight is not detected on the rear seat, Business Mode cannot be selected.

Once weight is detected on the seat, the seat will be judged as occupied until a rear door is opened then closed or the engine switch is turned off and the doors are locked.

3

Before driving

■ **The rear seat with an ottoman cannot be moved to Entertainment Mode/Relaxation Mode when (if equipped)**

In the following situations, Entertainment Mode or Relaxation Mode cannot be selected:

- The engine switch is in ACCESSORY mode or off.
- The rear seat belt is not fastened and weight is not detected on the rear seat.

Once weight is detected on the seat, the seat will be judged as occupied until a rear door is opened then closed or the engine switch is turned off and the doors are locked.

- The weight of an occupant or heavy object, etc. is detected on the front passenger's seat.

Once weight is detected on the seat, the seat will be judged as occupied until the front passenger's door is opened then closed or the engine switch is turned off.

- The front passenger's seat belt is fastened.
- The front passenger's door is open.

■ **When the front passenger's seat is folded forward**

→P.123

■ **Automatic angle adjustment of the rear displays (if equipped)**

When a seat is adjusted, the angle of the rear display will be adjusted automatically to maintain an optimal viewing angle for the rear display from the rear seat.

■ **Operation after the engine switch is turned off**

After a certain time elapses after the engine switch is turned off, the following parts of the rear seats will move to their neutral positions.

- Shoulder bolster
- Lumbar/pelvic support

■ **Seat return function linked to the door opening operation**

The rear seat will return to the upright posi-

tion automatically when the rear door is opened for easier entry and exit of the vehicle.

For the rear seat with an ottoman (if equipped): When the rear door on the side with the rear seat with an ottoman is opened, the seatback of the rear seat with an ottoman will move to a more upright position. The seatback will move to the upright position after the door is closed and the system determines that the rear passenger has exited.

However, if the armrest is stowed, the rear seat will not move.

■ **Shift-linked rear seat reclining function**

When the shift position is shifted from P, to enhance rear visibility for the driver, the rear seats will recline slightly.

However, the shift-linked rear seat reclining function will not operate in the following situations:

- The weight of an occupant or heavy object, etc. is detected on a rear seat.

Once weight is detected on the seat, the seat will be judged as occupied until a rear door is opened then closed or the engine switch is turned off and the doors are locked.

- A rear seat belt is fastened.
- A rear door is open.
- The armrest is stowed.

When a front seat is close to a rear seat, the rear seats may not operate or the range of movement may be restricted.

■ **Canceling an operation**

To cancel an operation, press and hold the



button of the Rear Multi Operation Panel or press it 3 times in quick succession.

■ **Pre-collision seatbacks for the passenger seats**

→P.205, 215

■ **Customization**

Some functions can be customized. (→P.466)

Returning the rear seat from the front seats

1 Press the seat switch.

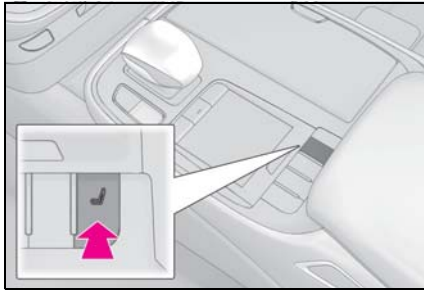

2 Press the sub function button of the Remote Touch. (→P.304)

3 Select **A**.

The rear seat will move to the upright position.



Operation of the rear seats from the front seats

In the following situations, the rear seats cannot be operated from the front seats.

- When the armrest is stowed and weight of an occupant, heavy object, etc. is detected on a rear seat

Once weight is detected on the seat, the seat will be judged as occupied until a rear door is opened then closed or the engine switch is turned off and the doors are locked.

- When the armrest is stowed and a rear seat belt is fastened.

! WARNING

When returning the rear seats to the neutral position

To avoid injuring the rear passengers, wait until they have gotten out of the vehicle before operating the switch.

Rear seat relaxation system (if equipped)

The rear seat relaxation system utilizes pneumatic chambers and dedicated heaters, and applies pressure to the occupant's body at different modes and intensities.

To display the rear seat relaxation system screen, display the home screen on the Rear Multi Operation Panel (→P.308) and then touch "Relaxation".

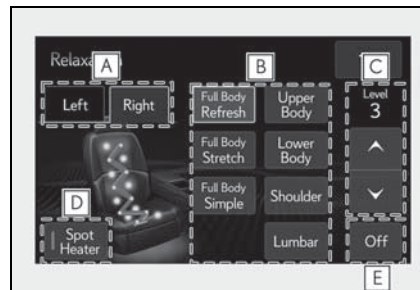

A Touch to select the desired rear seat.

B Touch to select the desired mode. When a button is touched, operation will begin.

C Touch to adjust the intensity. The intensity can be adjusted in 5 steps.

D Touch to turn the spot heaters on/off.

E Touch to stop the operation.

3
Before driving

If a seat is not occupied, do not operate the rear seat relaxation system for that seat.

■ **Relaxation system**

- Operating conditions
 - The engine switch is in IGNITION ON mode.
 - The temperature in the cabin is not extremely high.
 - The weight of an occupant is detected on the rear seat or the rear seat belt is fastened.

Once weight is detected on the seat, the seat will be judged as occupied until a rear door is opened then closed or the engine switch is turned off and the doors are locked.

- Automatic stop function
 - The operation will be canceled automatically after approximately 15 minutes.
 - If the door for a seat that the relaxation system is currently being used is opened, the relaxation system will stop operating.

⚠ WARNING

■ **Using the relaxation system**

- Those who are pregnant, have recently given birth, or suffer from ailments requiring rest (heart disease etc.) should consult a doctor before use.
- Do not allow children to use the relaxation function.
- Do not use immediately after consuming a meal or alcohol, or for an extended period of time.
- If you feel sick while using the relaxation function, immediately discontinue use.

Driving position memory

This feature automatically adjusts the positions of the front seats, steering wheel, outside rear view mirrors and head-up display (if equipped) to make entering and exiting the vehicle easier or to suit your preferences.

Up to 3 different driving positions can be recorded.

Each electronic key (including a card key) can be registered to recall your preferred driving position.

Power easy access system

The seat and steering wheel are automatically adjusted to allow the driver to enter and exit the vehicle easily.

► **Driver's seat**

When all of the following have been performed, the seat and steering wheel are automatically adjusted to a position that allows driver to enter and exit the vehicle easily.

- The shift position has been shifted to P.
- The engine switch has been turned off.
- The driver's seat belt has been unfastened.

When the driver's seat adjustment switches are in front passenger mode (→P.121), the seat and steering wheel will not move.

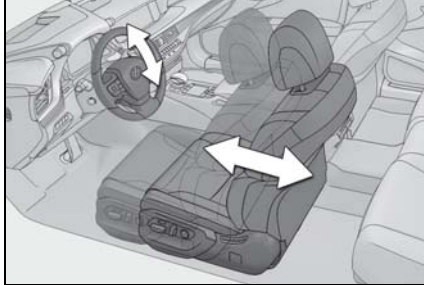

On vehicles with adjustable seat cushion side bolsters, when the driver's door is opened with the engine switch off, the seat cushion side bolsters will lower if they are in the default position.

When any of the following has been performed, the seat and steering wheel automatically return to their original positions.

- The engine switch has been turned to ACCESSORY mode or IGNITION ON mode.
- The driver's seat belt has been fastened.

► Front passenger's seat

If all of the following have been performed while the vehicle is stopped, the lumbar support, pelvic support, shoulder bolster (if equipped), seat-back side bolster (if equipped), and hip support (if equipped) will be moved to their default position. On vehicles with adjustable seat cushion side bolsters, the seat cushion side bolsters will lower.

- The passenger's seat belt has been unfastened.
- The front passenger's door is opened.

■ Operation of the power easy access system

- When exiting the vehicle, the power easy access system may not operate if the seat is already in the rearmost or uppermost position or close to the rear seat.
- If the seat position is adjusted during power easy access system operation, the automatic operation will stop. (The seat will change to manual operation.)
- If the seat position is adjusted during or after the power easy access system operation when the driver is exiting the vehicle, the power easy access system will not operate when entering the vehicle.

■ Seat cushion side bolster adjustment (if equipped)

If the seat cushion side bolsters have been lowered, when the front door is closed, the seat cushion side bolsters will move to their default position.

If the seat is adjusted while the seat cushion side bolsters are moving to the default position, their movement will be temporarily suspended. (The seat cushion side bolsters will move to the default position after a certain amount of time.)

■ Customization

Some functions can be customized. (→P.466)

Recording a driving position into memory

- 1 Turn the engine switch to IGNITION ON mode.
- 2 Check that the shift position is in P.
- 3 Adjust the driver's seat, steering wheel, outside rear view mirrors and head-up display (if equipped) to the desired positions.
- 4 While pressing the "SET" button, or within 3 seconds after the "SET"

button is pressed, press button “1”, “2” or “3” until the buzzer sounds.

If the selected button has already been preset, the previously recorded position will be overwritten.

When the driver’s seat adjustment switches are in front passenger mode (→P.121), the position of the driver’s seat cannot be registered.

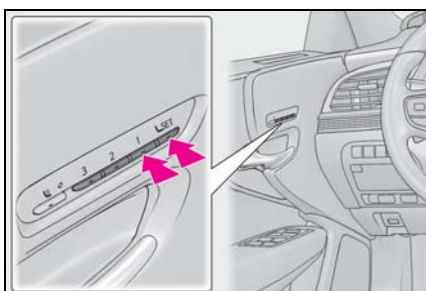

To record the position of the front passenger’s seat, adjust the front passenger’s seat to the desired position and perform step 4 using the buttons on the front passenger’s side.

■ **In order to correctly use the driving position memory function**

If a seat position is already in the furthest possible position and the seat is operated in the same direction, the recorded position may be slightly different when it is recalled.

! WARNING

■ **Seat adjustment caution**

Take care during seat adjustment so that the seat does not strike the rear passenger or squeeze your body against the steering wheel.

Recalling a driving position

- 1 Turn the engine switch to IGNITION ON mode.
- 2 Check that the shift position is in P.

- 3 Press one of the buttons for the driving position you want to recall until the buzzer sounds.

When the driver’s seat adjustment switches are in front passenger mode (→P.121), a driving position cannot be recalled.

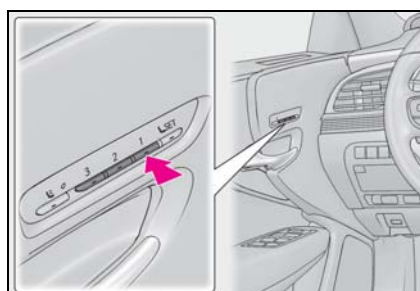

■ **To stop the position recall operation part-way through**

Perform any of the following operations:

- Press the “SET” button.
- Press button “1”, “2” or “3”.
- Press the mode change button.
- Operate any of the seat adjustment switches (only cancels seat position recall).
- Operate the tilt and telescopic steering control switch (only cancels steering wheel position recall).

■ **Recalling a driving position**

If a driving position is recalled, the movement of the front seat may be stopped part-way if the seat moves close to the rear seat.

If a rear passenger is determined to be in the vehicle, the rearward movement of the front seat may be stopped partway to ensure sufficient space for the rear passenger.

■ **Recalling the front passenger’s seat position (vehicles with a rear seat with an ottoman)**

If the ottoman of the rear seat is extended, the front passenger’s seat position cannot be recalled.

■ Operating the driving position memory after turning the engine switch off

Driver's seat:

Recorded seat positions can be activated up to 180 seconds after the driver's door is opened and another 60 seconds after it is closed again.

Front passenger's seat:

Recorded seat positions can be recalled up to 180 seconds after the front passenger's door is opened.

■ Registering/canceling/recall a driving position to an electronic key (including a card key) (memory recall function)

■ Registering procedure

Record your driving position to button "1", "2" or "3" before performing the following:

Carry only the key you want to register, and then close the driver's door.

If 2 or more keys are in the vehicle, the driving position cannot be recorded properly.

- 1 Turn the engine switch to IGNITION ON mode.
- 2 Check that the shift position is in P.
- 3 Recall the driving position that you want to record.
- 4 While pressing the recalled button, press and hold the door lock switch (either lock or unlock) until the buzzer sounds.

If the button could not be registered, the buzzer sounds continuously for approxi-

mately 3 seconds.

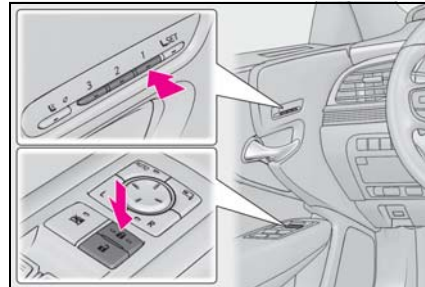

■ Cancellation procedure

Carry only the key you want to cancel and then close the driver's door. If 2 or more keys are in the vehicle, the driving position cannot be canceled properly.

- 1 Turn the engine switch to IGNITION ON mode.
- 2 Check that the shift position is in P.
- 3 While pressing the "SET" button, press and hold the door lock switch (either lock or unlock) until the buzzer sounds twice.

If the button could not be canceled, the buzzer sounds continuously for approximately 3 seconds.

■ Recall procedure

- 1 Make sure that the doors are locked before recalling the driving position. Carry the electronic key that has been registered to the driving position, and then unlock and open the driver's door using the smart access system with push-button start or wireless remote control.

The driving position will move to the recorded position (not including the steering wheel and head-up display [if equipped]). However, the seat will move to a position slightly behind the recorded position in order to make entering the vehi-

3

Before driving

cle easier.

If the driving position is in a position that has already been recorded, the seat and outside rear view mirrors will not move.

- 2 Turn the engine switch to ACCESSORY mode or IGNITION ON mode, or fasten a seat belt.

The seat, steering wheel and head-up display (if equipped) will move to the recorded position.

■ Recalling the driving position using the memory recall function

- Different driving positions can be registered for each electronic key. Therefore, the driving position that is recalled may be different depending on the key being carried.
- If a door other than the driver's door is unlocked with the smart access system with push-button start, the driving position cannot be recalled. In this case, press the driving position button which has been set.

■ Customization

Some functions can be customized. (→P.466)

Rear seat position memory*

*: If equipped

The rear seat position can be memorized and recalled with the touch of a button.

Recording a position into memory

- 1 Turn the engine switch to IGNITION ON mode.
- 2 Display the home screen on the Rear Multi Operation Panel (→P.308) and then touch "Seat".
- 3 Touch "Left" or "Right".
- 4 Adjust the rear seat to the desired position and then touch "Set Memory".
- 5 Touch "1" or "2".

If the preset is being used, the previously recorded seat position will be overwritten.

■ In order to correctly use the position memory function

If a seat position is already in the furthest possible position and the seat is operated in the same direction, the recorded position may be slightly different when it is recalled.

WARNING

■ Seat adjustment caution

Take care during seat adjustment so that the rear passengers do not strike the front seats.

Recalling the memorized position

- 1 Turn the engine switch to IGNITION ON mode.
- 2 Display the home screen on the Rear Multi Operation Panel (→P.308) and then touch "Seat".
- 3 Touch "1" or "2".

When the operating conditions are not met, the buttons will be grayed out.

To stop the operation touch "STOP".

If the seat is adjusted while a memorized position is being recalled, the automatic operation will stop. (The seat will change to manual operation.)

■ Operating condition

The weight of an occupant is detected on the rear seat or the rear seat belt is fastened.

Once weight is detected on the seat, the seat will be judged as occupied until the rear door is opened then closed or the engine switch is turned off.

■ Recalling a rear seat position

If a memorized rear seat position is recalled, the seat may stop part-way to ensure sufficient space for the rear passenger.

■ Recalling the ottoman position (if equipped)

When a seat position is recalled, the ottoman will not raise or extend. The ottoman position can only be recalled if the memorized position is lower and shorter than the current position.

Head restraints

Head restraints are provided for all seats.

Vehicles with power rear seat: The head restraint for the rear center seat is integrated into the seatback and cannot be adjusted.

⚠ WARNING

■ Head restraint precautions

Observe the following precautions regarding the head restraints. Failure to do so may result in death or serious injury.

- Use the head restraints designed for each respective seat.
- Adjust the head restraints to the correct position at all times.
- Manual type: After adjusting the head restraints, push down on them and make sure they are locked in position.
- Do not drive with the head restraints removed.

Adjusting a head restraint vertically and horizontally (power head restraints)

- ▶ Front seats

- 1 Press the seat switch.

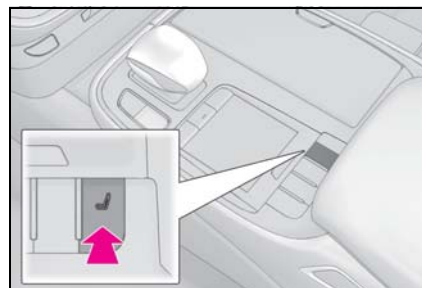

- 2 Using the Remote Touch pad, select “Driver Seat Adjustment” or “Passenger Seat Adjustment”.
- 3 Select **A** then the desired adjustment button **B**, **C**, **D**, or **E** to adjust the head restraint.

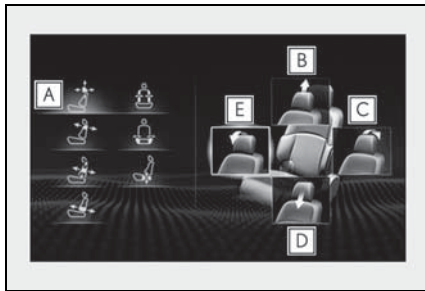

- B** Up
- C** Backward
- D** Down
- E** Forward

The head restraint moves while the adjustment button is selected.

- ▶ Rear seats
- 1 Display the home screen on the Rear Multi Operation Panel (→P.308) and then touch “Seat”.
- 2 Touch “Left” or “Right”.
- 3 Touch **A** then the desired adjustment button **B**, **C**, **D**, or **E** to adjust the head restraint.

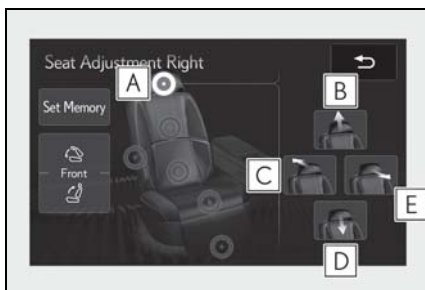

- B** Up
- C** Backward
- D** Down
- E** Forward

The head restraint moves while the adjustment button is touched.

Adjusting a head restraint vertically (manual head restraints)

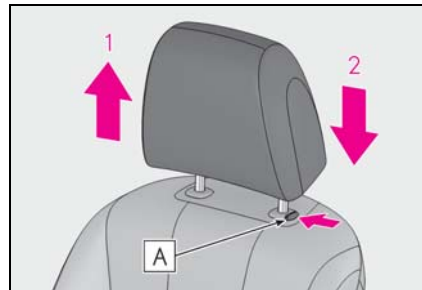

- 1 Up
Pull the head restraints up.
- 2 Down
Push the head restraint down while pressing the lock release button **A**.

Front seat head restraints (power head restraints)

Depending on the position of the front seat, the front head restraint may not be able to be adjusted upward if it is close to the ceiling.

Adjusting the height of the head restraints

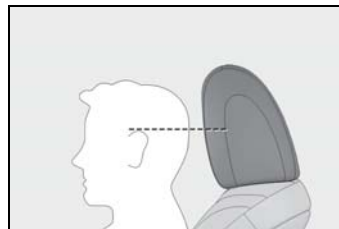

Make sure that the head restraints are

adjusted so that the center of the head restraint is closest to the top of your ears.

■ **Adjusting the rear seat head restraints (manual head restraints)**

Always raise the head restraint one level from the stowed position when using.

Adjusting a head restraint horizontally (manual head restraints)

The position of the head restraint can be adjusted forward in 4 stages.

If the head restraint is pulled forward from the foremost position, it will return to the rearmost position.



Adjusting the side supports (if equipped)

Push the sides of the head restraint.

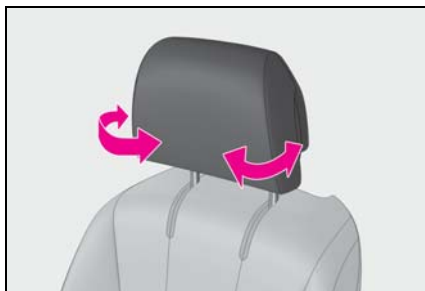

Removing the head restraints (manual head restraints)

Pull the head restraint up while pressing the lock release button **A**.

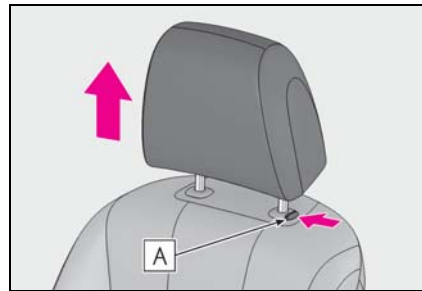

■ **Removing the head restraints (power head restraints)**

For removal and installation of the head restraint, contact your Lexus dealer.

Installing the head restraints (manual head restraints)

Align the head restraint with the installation holes and push it down to the lock position.

Press and hold the lock release button **A** when lowering the head restraint.

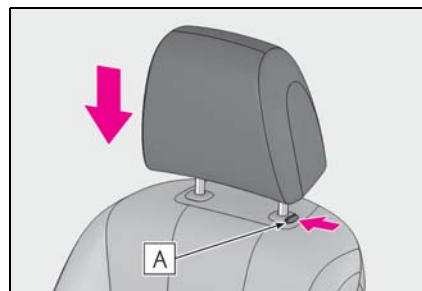

3

Before driving

Steering wheel

Adjustment procedure

Operating the switch moves the steering wheel in the following directions:

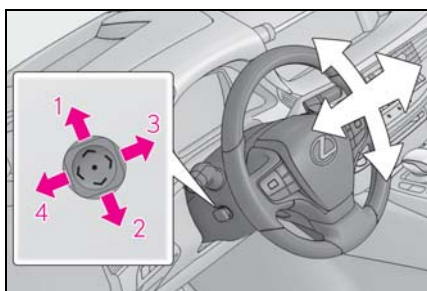

- 1 Up
- 2 Down
- 3 Toward the driver
- 4 Away from the driver

■ The steering wheel can be adjusted when

The engine switch is in ACCESSORY or IGNITION ON mode*.

*: If the driver's seat belt is fastened, the steering wheel can be adjusted regardless of engine switch mode.

■ Automatic adjustment of the steering position

A desired steering position can be entered to memory and recalled automatically by the driving position memory system. (→P.130)

■ Power easy access system

The steering wheel and driver's seat move in accordance with engine switch mode and the driver's seat belt condition. (→P.130)

■ Customization

Some functions can be customized. (→P.466)

! WARNING

■ Caution while driving

Do not adjust the steering wheel while driving. Doing so may cause the driver to mishandle the vehicle and cause an accident, resulting in death or serious injury.

Sounding the horn

Press on or close to the  mark.



Inside rear view mirror

The rear view mirror's position can be adjusted to enable sufficient confirmation of the rear view.

Adjusting the height of rear view mirror

The height of the rear view mirror can be adjusted to suit your driving posture.

Adjust the height of the rear view mirror by moving it up and down.

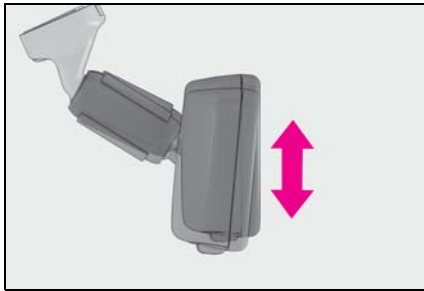

⚠ WARNING

■ Caution while driving

Do not adjust the position of the mirror while driving. Doing so may lead to mishandling of the vehicle and cause an accident, resulting in death or serious injury.

Anti-glare function

Responding to the level of brightness of the headlights of vehicles behind, the reflected light is automatically reduced.

Turn the automatic anti-glare function mode on/off

When the automatic anti-glare function is in ON mode, the indicator **A** illuminates. The function will set to ON mode each time the engine switch is turned to IGNITION ON mode.

Pressing the button turns the function to OFF mode. (The indicator **A** also turns off.)

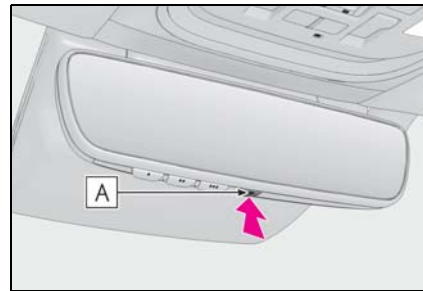

■ To prevent sensor error

To ensure that the sensors operate properly, do not touch or cover them.



3

Before driving

Outside rear view mirrors

The rear view mirror's position can be adjusted to enable sufficient confirmation of the rear view.

WARNING

■ Important points while driving

Observe the following precautions while driving.

Failure to do so may result in loss of control of the vehicle and cause an accident, resulting in death or serious injury.

- Do not adjust the mirrors while driving.
- Do not drive with the mirrors folded.
- Both the driver and passenger side mirrors must be extended and properly adjusted before driving.

Adjustment procedure

- 1 To select a mirror to adjust, press the switch.

The indicator comes on.

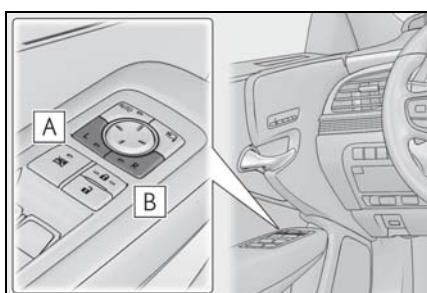

- A** Left
- B** Right

Pressing the same switch again will put the switch in neutral.

- 2 To adjust the mirror, press the switch.

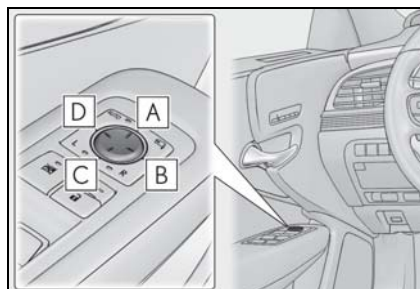

- A** Up
- B** Right
- C** Down
- D** Left

■ Mirror angle can be adjusted when

The engine switch is in ACCESSORY or IGNITION ON mode.

■ Defogging the mirrors

The outside rear view mirrors can be cleared using the mirror defoggers. Turn on the rear window defogger to turn on the outside rear view mirror defoggers. (→P.314)

■ Auto anti-glare function

When the anti-glare inside rear view mirror is set to automatic mode, the outside rear view mirrors will activate in conjunction with the anti-glare inside rear view mirror to reduce reflected light. (→P.139)

■ Automatic adjustment of the mirror angle

A desired mirror face angle can be entered to memory and recalled automatically by the driving position memory. (→P.130)

■ Linked mirror function when reversing

When either "L" or "R" of the mirror select switch is selected, the outside rear view mirrors will automatically angle downwards when the vehicle is reversing in order to give a better view of the ground.

To disable this function, select neither "L"

nor "R".

To set the mirror angle used when the vehicle is reversing, adjust the mirror angle at a desired position with the shift position in R.

The adjusted angle will be memorized and the mirror will automatically tilt to the memorized angle whenever the shift position is shifted to R from next time.

The memorized downward tilt position of the mirror is linked to the normal position (angle adjusted with the shift position in other than R). Therefore, if the normal position is changed after adjustment, the tilt position will also change.

When the normal position is changed, readjust the angle in reversing.

WARNING

■ When the mirror defoggers are operating

Do not touch the rear view mirror surfaces, as they can become very hot and burn you.

Folding and extending the mirrors

■ Using the switch

Press the switch to fold the mirrors.

Press it again to extend them to the original position.

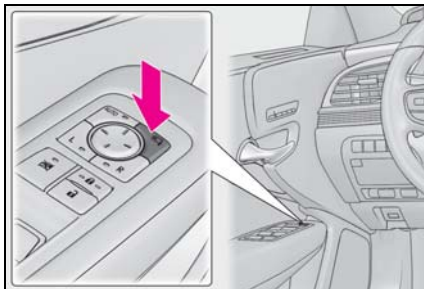

■ Setting automatic mode

Automatic mode allows the folding or extending of the mirrors to be linked to

locking/unlocking of the doors.

Press the "AUTO" switch to set automatic mode.

The indicator **A** will come on.

Pressing the switch once more will return to manual mode.

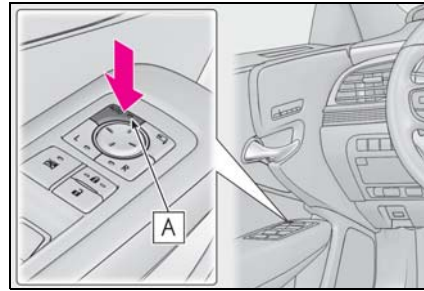

■ When disconnecting and reconnecting battery terminals

The automatic folding/extending mirror function will return to off as default. To turn the function on, press the switch again to select on.

■ Using automatic mode in cold weather

When automatic mode is used in cold weather, the door mirror could freeze up and automatic stowing and return may not be possible. In this case, remove any ice and snow from the door mirror, then either operate the mirror using manual mode or move the mirror by hand.

■ Customization

Some functions can be customized. (→P.466)

WARNING

■ When a mirror is moving

To avoid personal injury and mirror malfunction, be careful not to get your hand caught by the moving mirror.

Power windows

Opening and closing the power windows

The power windows can be opened and closed using the switches.

Operating the switch moves the windows as follows:

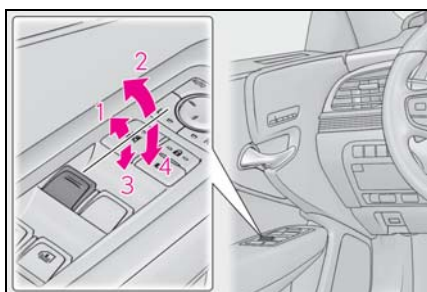

- 1 Closing
- 2 One-touch closing *
- 3 Opening
- 4 One-touch opening *

* : To stop the window partway, operate the switch in the opposite direction.

■ The power windows can be operated when

The engine switch is in IGNITION ON mode.

■ When the driver's power window switch is used to open a rear power window (vehicles with rear door sunshades)

If a rear door sunshade is extended or being extended when the driver's power window switch is pushed, only the rear door sunshade will be retracted. To open the rear power window from the driver's seat, push the driver's power window switch again.

■ Operating the power windows after turning the engine off

The power windows can be operated for approximately 45 seconds even after the

engine switch is turned to ACCESSORY mode or turned off. They cannot, however, be operated once either front door is opened.

■ Jam protection function

If an object becomes jammed between the window and the window frame while the window is closing, window movement is stopped and the window is opened slightly.

■ Catch protection function

If an object becomes caught between the door and window while the window is opening, window movement is stopped.

■ When the side window cannot be opened or closed

When the jam protection function or catch protection function operates unusually and the side window cannot be opened or closed, perform the following operations with the power window switch of that door.

- Stop the vehicle. With the engine switch in IGNITION ON mode, within 4 seconds of the jam protection function or catch protection function activating, continuously operate the power window switch in the one-touch closing direction or one-touch opening direction so that the side window can be opened and closed.

- If the side window cannot be opened and closed even when performing the above operations, perform the following procedure for function initialization.

- 1 Turn the engine switch to IGNITION ON mode.
- 2 Pull and hold the power window switch in the one-touch closing direction and completely close the side window.
- 3 Release the power window switch for a moment, resume pulling the switch in the one-touch closing direction, and hold it there for approximately 6 seconds or more.
- 4 Press and hold the power window switch in the one-touch opening direction. After the side window is completely opened, continue holding the switch for an additional 1 second or more.

- 5 Release the power window switch for a moment, resume pushing the switch in the one-touch opening direction, and hold it there for approximately 4 seconds or more.
- 6 Pull and hold the power window switch in the one-touch closing direction again. After the side window is completely closed, continue holding the switch for a further 1 second or more.

If you release the switch while the window is moving, start again from the beginning. If the window reverses and cannot be fully closed or opened, have the vehicle inspected by your Lexus dealer.

■ Door lock linked window operation

- The power windows can be opened and closed using the mechanical key.* (→P.434)
- The power windows can be opened using the wireless remote control.* (→P.100)

*: These settings must be customized at your Lexus dealer.

■ Power windows open warning buzzer

A buzzer sounds and a message is shown on the multi-information display in the instrument cluster when the engine switch is turned off and the driver's door is opened with the power windows open.

■ Customization

Some functions can be customized. (→P.466)

⚠ WARNING

Observe the following precautions. Failure to do so may result in death or serious injury.

■ Closing the windows

- The driver is responsible for all the power window operations, including the operation for the passengers. In order to prevent accidental operation, especially by a child, do not let a child operate the power windows. It is possible for children and other passengers to have body parts caught in the power window. Also, when riding with a child, it is recommended to use the window lock switch. (→P.144)
- Check to make sure that all passengers do not have any part of their body in a position where it could be caught when a window is being operated.

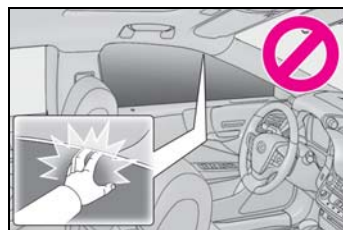

- When using the wireless remote control or mechanical key and operating the power windows, operate the power window after checking to make sure that there is no possibility of any passenger having any of their body parts caught in the window. Also do not let a child operate window by the wireless remote control or mechanical key. It is possible for children and other passengers to get caught in the power window.
- When exiting the vehicle, turn the engine switch off, carry the key and exit the vehicle along with the child. There may be accidental operation, due to mischief, etc., that may possibly lead to an accident.

■ Jam protection function

- Never use any part of your body to intentionally activate the jam protection function.

3

Before driving

⚠ WARNING

- The jam protection function may not work if something gets jammed just before the window is fully closed. Be careful not to get any part of your body jammed in the window.

■ Catch protection function

- Never use any part of your body or clothing to intentionally activate the catch protection function.
- The catch protection function may not work if something gets caught just before the window is fully opened. Be careful not to get any part of your body or clothing caught in the window.

■ When the battery is disconnected

The window lock switch is disabled. If necessary, press the window lock switch after reconnecting the battery.

Preventing accidental operation (window lock switch)

This function can be used to prevent children from accidentally opening or closing a passenger window.

Press the switch.

The indicator **A** will come on and the passenger windows will be locked.

The passenger windows can still be opened and closed using the driver's switch even if the lock switch is on.

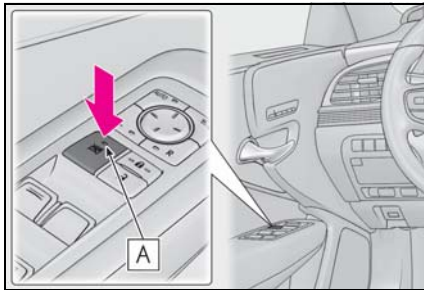
**■ The power windows can be operated when**

The engine switch is in IGNITION ON mode.

Moon roof*

*: If equipped

Use the overhead switches to open and close the moon roof and tilt it up and down.

Operating the moon roof

■ Opening and closing

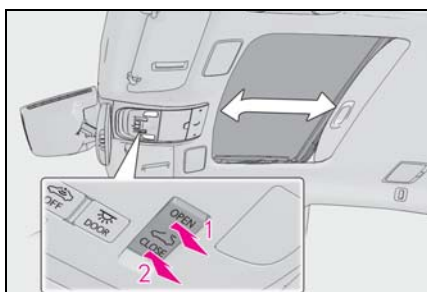

1 Opens the moon roof*
The moon roof tilts up and then fully opens.

2 Closes the moon roof*

*: Lightly press either side of the moon roof switch to stop the moon roof partway.

■ Tilting up and down

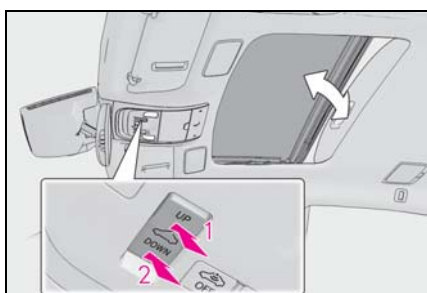

1 Tilts the moon roof up*

2 Tilts the moon roof down*

*: Lightly press either side of the moon roof switch to stop the moon roof partway.

■ The moon roof can be operated when

The engine switch is in IGNITION ON mode.

■ Operating the moon roof after turning the engine off

The moon roof can be operated for approximately 45 seconds after the engine switch is turned to ACCESSORY mode or turned off. It cannot, however, be operated once either front door is opened.

■ Jam protection function

If an object is detected between the moon roof and the frame while the moon roof is closing or tilting down, travel is stopped and the moon roof opens slightly.

■ Sunshade

The sunshade can be opened and closed manually. However, the sunshade will open automatically when the moon roof is opened.

■ Door lock linked moon roof operation

● The moon roof can be opened and closed using the mechanical key.* (→P.434)

● The moon roof can be opened using the wireless remote control.* (→P.100)

*: These settings must be customized at your Lexus dealer.

■ When the moon roof does not close normally

Perform the following procedure:

- 1** Stop the vehicle.
- 2** Press and hold the "CLOSE" switch.*

The moon roof will close, reopen and pause for approximately 10 seconds. Then it will close again and stop at the completely closed position.

- 3** Check to make sure that the moon roof is completely closed and then release the switch.

*: If the switch is released at the incorrect time, the procedure will have to be performed again from the beginning.

If the moon roof does not fully close even

3

Before driving

after performing the above procedure correctly, have the vehicle inspected by your Lexus dealer.

■ If the moon roof does not move normally

If the moon roof does not open or close normally or the automatic opening function does not operate, perform the following initialization procedure.

- 1 Stop the vehicle.
- 2 Press and hold the "DOWN" switch.*
The moon roof will stop at the tilt-up position. After that, it will open, close, tilt up, tilt down, and stop at the fully closed position.
- 3 Confirm that the moon roof has completely stopped and release the switch.

*: If you release the switch while the moon roof is moving, perform the procedure again from the beginning.

If, after performing the above procedures correctly, the moon roof still does not open or close normally or the automatic opening function does not operate, have the vehicle inspected by your Lexus dealer.

■ Moon roof open warning buzzer

A buzzer sounds and a message is shown on the multi-information display in the instrument cluster when the engine switch is turned off and the driver's door is opened with the moon roof open.

■ Customization

Some functions can be customized.
(→P.466)

⚠ WARNING

Observe the following precautions. Failure to do so may cause death or serious injury.

■ Opening the moon roof

- Do not allow any passengers to put their hands or heads outside the vehicle while it is moving.
- Do not sit on top of the moon roof.

■ Opening and closing the moon roof

- The driver is responsible for moon roof opening and closing operations. In order to prevent accidental operation, especially by a child, do not let a child operate the moon roof. It is possible for children and other passengers to have body parts caught in the moon roof.
- Check to make sure that all passengers do not have any part of their body in a position where it could be caught when the moon roof is being operated.

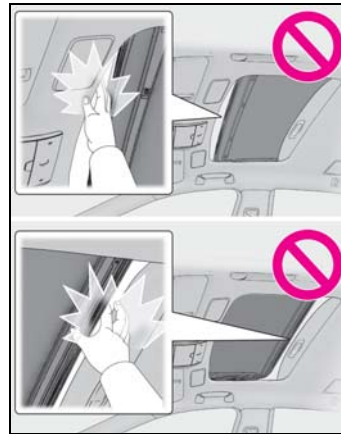

- When using the wireless remote control or mechanical key and operating the moon roof, operate the moon roof after checking to make sure that there is no possibility of any passenger having any of their body parts caught in the moon roof. Also, do not let a child operate moon roof by the wireless remote control or mechanical key. It is possible for children and other passengers to get caught in the moon roof.
- When exiting the vehicle, turn the engine switch off, carry the key and exit the vehicle along with the child. There may be accidental operation, due to mischief, etc., that may possibly lead to an accident.

! WARNING**■ Jam protection function**

- Never use any part of your body to intentionally activate the jam protection function.
- The jam protection function may not work if something gets caught just before the moon roof is fully closed. Also, the jam protection function is not designed to operate while the moon roof switch is being pressed. Take care so that your fingers, etc. do not get caught.

Panoramic moon roof*

* : If equipped

Use the overhead switches to operate the panoramic moon roof and electronic roof sunshade.

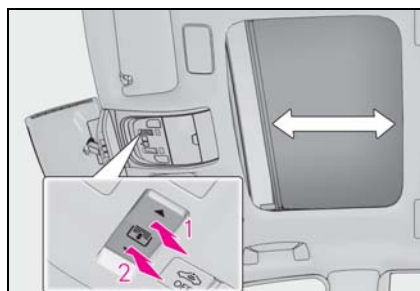
Operating the panoramic moon roof**■ Opening and closing the electronic front roof sunshade**

- 1** Opens the electronic front roof sunshade*
- 2** Closes the electronic front roof sunshade*

If the panoramic moon roof is not fully closed, it will close fully before the electronic front roof sunshade closes.

* : Lightly press either side of the front roof sunshade switch to stop the electronic front roof sunshade partway.

■ Opening and closing the electronic rear roof sunshade**► Rear roof sunshade switch**

Press the rear roof sunshade switch.

Lightly press the switch while the electronic rear roof sunshade is opening/closing will stop the operation.

3

Before driving

Press the switch again will operate the electronic rear roof sunshade in the opposite direction.

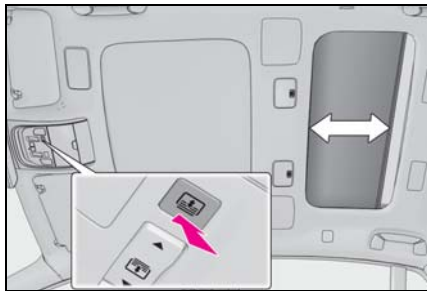

- ▶ Rear Multi Operation Panel
- 1 Display the Home screen (→P.308) and then touch “Shade/Lamp”.
- 2 Touch the button for the desired operation.



- A** Closes the electronic rear roof sunshade
- B** Opens the electronic rear roof sunshade

During a electronic rear roof sunshade open/close operation, if the rear roof sunshade open/close button is touched or the

 button of the Rear Multi Operation Panel is pressed and held or pressed 3 times, the operation will be canceled.

■ **Tilting the panoramic moon roof up and down**

Press the tilt switch.

When the panoramic moon roof is tilted up, the electronic front roof sunshade will open.

The panoramic moon roof can be tilted down only when it is in the tilt-up position.

Lightly press the switch while the panoramic moon roof is operating will stop the operation.

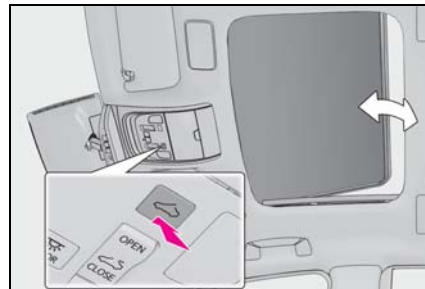

■ **Opening and closing the panoramic moon roof**

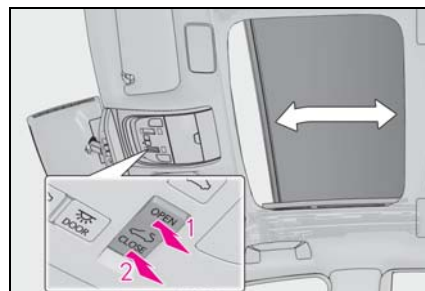

- 1 Opens the panoramic moon roof*

When the panoramic moon roof is opened, the electronic front roof sunshade will open.

The panoramic moon roof can be opened from the tilt-up position.

- 2 Closes the panoramic moon roof*

* : Lightly press either side of the panoramic moon roof switch to stop the panoramic moon roof partway.

■ The panoramic moon roof can be operated when

The engine switch is in IGNITION ON mode.

■ Operating the panoramic moon roof after turning the engine off

The panoramic moon roof and electronic roof sunshade can be operated for approximately 45 seconds after the engine switch is turned to ACCESSORY mode or turned off. It cannot, however, be operated once the driver's door is opened.

■ Jam protection function

If an object is detected between the panoramic moon roof and the frame in the following situations, travel is stopped and the panoramic moon roof opens slightly:

- The panoramic moon roof is closing or tilting down.
- The electronic roof sunshade is closing.

■ Door lock linked panoramic moon roof operation

- The panoramic moon roof can be opened and closed using the mechanical key.* (→P.434)
- The panoramic moon roof can be opened using the wireless remote control.* (→P.100)

*: These settings must be customized at your Lexus dealer.

■ When the panoramic moon roof or electronic front roof sunshade does not close normally

Perform the following procedure:

- 1 Stop the vehicle.
- 2 Turn the engine switch to IGNITION ON mode.
- 3 Press and hold the "CLOSE" switch or the front roof sunshade close switch. Continue pressing the switch for approximately 10 seconds after the panoramic moon roof or electronic front roof sunshade closes and reopens. The panoramic moon roof and electronic front roof sunshade will start to close.*

- 4 Check that the panoramic moon roof and electronic front roof sunshade are fully closed and release the switch.

*: If the switch is released at the incorrect time, the procedure will have to be performed again from the beginning.

If the panoramic moon roof or electronic front roof sunshade does not fully close even after performing the above procedure correctly, have the vehicle inspected by your Lexus dealer.

■ When the electronic rear roof sunshade does not close normally

Perform the following procedure:

- 1 Stop the vehicle.
- 2 Turn the engine switch to IGNITION ON mode.
- 3 Press and hold the rear roof sunshade switch. Continue pressing the switch for approximately 10 seconds after the electronic rear roof sunshade closes and reopens. The electronic rear roof sunshade will start to close.*
- 4 Check that the electronic rear roof sunshade are fully closed and release the switch.

*: If the switch is released at the incorrect time, the procedure will have to be performed again from the beginning.

If the panoramic moon roof or electronic front roof sunshade does not fully close even after performing the above procedure correctly, have the vehicle inspected by your Lexus dealer.

■ If the panoramic moon roof or electronic front roof sunshade does not move normally

If the panoramic moon roof or electronic front roof sunshade does not open or close normally or the automatic opening function does not operate, perform the following initialization procedure.

- 1 Stop the vehicle.
- 2 Turn the engine switch to IGNITION ON mode.
- 3 Fully close the panoramic moon roof and electronic front roof sunshade.

4 Press and hold the "CLOSE" switch.*

The electronic front roof sunshade will open after approximately 10 seconds. Then the panoramic moon roof will open, close, tilt up and tilt down. After that, the electronic front roof sunshade will fully close and stop.

5 Check that the panoramic moon roof and electronic front roof sunshade are fully closed and release the switch.

*: If the switch is released at the incorrect time, the procedure will have to be performed again from the beginning.

If, after performing the above procedures correctly, the panoramic moon roof and electronic front roof sunshade still does not open or close normally or the automatic opening function does not operate, have the vehicle inspected by your Lexus dealer.

■ If the electronic rear roof sunshade does not move normally

If the electronic rear roof sunshade does not open or close normally or the automatic opening function does not operate, perform the following initialization procedure.

- 1** Stop the vehicle.
- 2** Turn the engine switch to IGNITION ON mode.
- 3** Open the rear roof sunshade.
- 4** Press and hold the rear roof sunshade switch.*

Continue pressing the switch for approximately 10 seconds after the electronic rear roof sunshade closes. The electronic rear roof sunshade will begin operating again and stop at the fully closed position.

5 Check that the electronic rear roof sunshade are fully closed and release the switch.

*: If the switch is released at the incorrect time, the procedure will have to be performed again from the beginning.

If, after performing the above procedures correctly, the electronic rear roof sunshade still does not open or close normally or the automatic opening function does not operate, have the vehicle inspected by your Lexus dealer.

■ Panoramic moon roof open warning buzzer

A buzzer sounds and a message is shown on the multi-information display in the instrument cluster when the engine switch is turned off and the driver's door is opened with the panoramic moon roof open.

■ Customization

Some functions can be customized. (→P.466)

⚠ WARNING

Observe the following precautions. Failing to do so may cause death or serious injury.

■ Opening and closing the electronic roof sunshade

- Check to make sure that all passengers do not have any part of their body in a position where it could be caught when the electronic sunshade is being operated.
- Do not let a child operate the electronic sunshade. Closing the electronic roof sunshade on someone can cause death or serious injury.

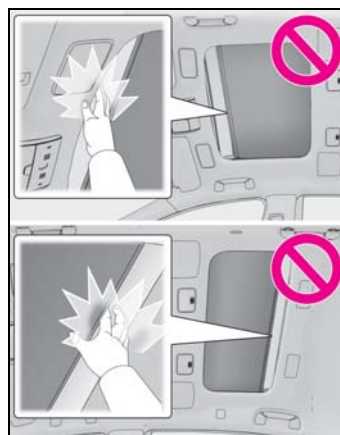
**■ Opening the panoramic moon roof**

- Do not allow any passengers to put their hands or heads outside the vehicle while it is moving.

⚠ WARNING

- Do not sit on top of the panoramic moon roof.
- **Opening and closing the panoramic moon roof**
- The driver is responsible for panoramic moon roof opening and closing operations. In order to prevent accidental operation, especially by a child, do not let a child operate the panoramic moon roof. It is possible for children and other passengers to have body parts caught in the panoramic moon roof.
- Check to make sure that all passengers do not have any part of their body in a position where it could be caught when the panoramic moon roof is being operated.

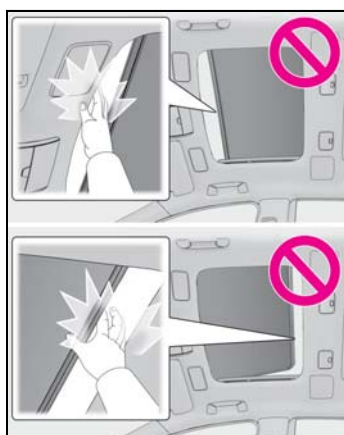

- When using the wireless remote control or mechanical key and operating the panoramic moon roof, operate the panoramic moon roof after checking to make sure that there is no possibility of any passenger having any of their body parts caught in the panoramic moon roof. Also, do not let a child operate panoramic moon roof by the wireless remote control or mechanical key. It is possible for children and other passengers to get caught in the panoramic moon roof.

- When exiting the vehicle, turn the engine switch off, carry the key and exit the vehicle along with the child. There may be accidental operation, due to mischief, etc., that may possibly lead to an accident.

■ **Jam protection function**

- Never use any part of your body to intentionally activate the jam protection function.
- The jam protection function may not work if something gets caught just before the panoramic moon roof or electronic roof sunshade is fully closed. Also, the jam protection function is not designed to operate while the switch is being pressed. Take care so that your fingers, etc. do not get caught.

■ **To prevent burns or injuries**

Do not touch the area between the underside of the panoramic moon roof and the electronic sunshade. Your hand may get caught and you could injure yourself. Also, if the vehicle is left in direct sunlight for a long time, the underside of the panoramic moon roof could become very hot and could cause burns.

⚠ NOTICE■ **To prevent damage to the panoramic moon roof**

- Before opening the panoramic moon roof, make sure that there are no foreign objects, such as stones or ice, around the opening.
- Do not hit the surface or edge of the panoramic moon roof with hard objects.

■ **After the vehicle has been washed or rained on**

Before opening the panoramic moon roof, wipe any water off the panoramic moon roof. Otherwise, water may enter the cabin when the panoramic moon roof is opened.

- 4-1. Before driving**
 - Driving the vehicle..... **154**
 - Cargo and luggage..... **160**
 - Vehicle load limits..... **162**
 - Trailer towing..... **163**
 - Dinghy towing **163**
- 4-2. Driving procedures**
 - Engine (ignition) switch **164**
 - Automatic transmission..... **167**
 - Turn signal lever..... **173**
 - Parking brake **174**
 - Brake Hold..... **177**
- 4-3. Operating the lights and wipers**
 - Headlight switch..... **179**
 - AHB (Automatic High Beam)
..... **182**
 - Windshield wipers and washer
..... **184**
- 4-4. Refueling**
 - Opening the fuel tank cap..... **189**
- 4-5. Using the driving support systems**
 - Lexus Safety System + A..... **191**
 - Lexus Safety System + 2.0..... **198**
 - PCS (Pre-Collision System) (vehicles with Lexus Safety System + A)..... **204**
 - PCS (Pre-Collision System) (vehicles with Lexus Safety System + 2.0)..... **215**
 - FCTA (Front Cross Traffic Alert)
..... **222**
 - LTA (Lane Tracing Assist) **225**
 - Dynamic radar cruise control with full-speed range..... **237**
 - RSA (Road Sign Assist)..... **247**
 - BSM (Blind Spot Monitor).... **250**
 - PKSA (Parking Support Alert)
..... **255**
 - Intuitive parking assist..... **257**
 - RCTA (Rear cross traffic alert) function..... **263**
 - RCD (Rear Camera Detection) function..... **267**
 - PKSB (Parking Support Brake)
..... **270**
 - Parking Support Brake function (static objects)..... **276**
 - Parking Support Brake function (rear-crossing vehicles) **282**
 - Parking Support Brake function (rear pedestrians)..... **286**
 - Driving mode select switch .. **289**
 - Electronically modulated air suspension..... **291**
 - Driving assist systems..... **294**
- 4-6. Driving tips**
 - Winter driving tips **300**

Driving the vehicle

The following procedures should be observed to ensure safe driving:

Driving procedure

■ Starting the engine

→P.164

■ Driving

- 1 With the brake pedal depressed, shift the shift position to D.
(→P.167)

Check that the shift position indicator shows D.

- 2 If the parking brake is in manual mode, release the parking brake.
(→P.174)
- 3 Gradually release the brake pedal and gently depress the accelerator pedal to accelerate the vehicle.

■ Stopping

- 1 With the shift position in D, depress the brake pedal.
- 2 If necessary, set the parking brake.

If the vehicle is to be stopped for an extended period of time, shift the shift position to P. (→P.170)

■ Parking the vehicle

- 1 With the shift position in D, depress the brake pedal to stop the vehicle completely.
- 2 If the parking brake is in manual mode, set the parking brake.
(→P.174)
- 3 Shift the shift position to P.
(→P.170)

Check that the shift position indicator shows P and the parking brake indicator is illuminated.

- 4 Press the engine switch to stop the engine.
- 5 Slowly release the brake pedal.
- 6 Lock the door, making sure that you have the electronic key on your person.

If parking on a hill, block the wheels as needed.

■ Starting off on a steep uphill

- 1 Make sure that the parking brake is set and shift the shift position to D.

Hill-start assist control will operate.
(→P.295)

- 2 Gently depress the accelerator pedal.
- 3 Release the parking brake.

■ Driving in the rain

- Drive carefully when it is raining, because visibility will be reduced, the windows may become fogged-up, and the road will be slippery.
- Drive carefully when it starts to rain, because the road surface will be especially slippery.
- Refrain from high speeds when driving on an expressway in the rain, because there may be a layer of water between the tires and the road surface, preventing the steering and brakes from operating properly.

■ Engine speed while driving

In the following conditions, the engine speed may become high while driving. This is due to automatic up-shifting control or down-shifting implementation to meet driving conditions. It does not indicate sudden acceleration.

- The vehicle is judged to be driving uphill or downhill

- When the accelerator pedal is released
- When the brake pedal is depressed
- **Restraining the engine output (Brake Override System)**
- When the accelerator and brake pedals are depressed at the same time, the engine output may be restrained.
- A warning message is displayed on the multi-information display while the system is operating.
- **Restraining sudden start (Drive-Start Control)**
- When the following unusual operation is performed, the engine output may be restrained.
 - When the shift position is shifted from R to D, D to R, N to R, P to D*, or P to R* (D includes M) with the accelerator pedal depressed, a warning message appears on the multi-information display. If a warning message is shown on the multi-information display, read the message and follow the instruction.
 - When the accelerator pedal is depressed too much while the vehicle is in reverse.
- *: Depending on the situation, the shift position may not be changed.
- While Drive-Start Control is being activated, your vehicle may have trouble escaping from the mud or fresh snow. In such case, deactivate TRAC (→P.296) to cancel Drive-Start Control so that the vehicle may become able to escape from the mud or fresh snow.
- **Breaking in your new Lexus**
- To extend the life of the vehicle, observing the following precautions is recommended:
 - For the first 186 miles (300 km):
Avoid sudden stops.
 - For the first 621 miles (1000 km):
 - Do not drive at extremely high speeds.
 - Avoid sudden acceleration.
 - Do not drive continuously in low gears.
 - Do not drive at a constant speed for extended periods.
- **Drum-in-disc type parking brake system**
- Your vehicle has a drum-in-disc type park-

ing brake system. This type of brake system needs bedding-down of the brake shoes periodically or whenever the parking brake shoes and/or drum are replaced. Have your Lexus dealer perform the bedding down operation.

■ **Brake pads and discs (F SPORT models)**

The brake pads and discs are designed for use under high load conditions. Therefore, brake noise may be generated depending on the vehicle speed, braking force and vehicle environment (temperature, humidity, etc.).

■ **Operating your vehicle in a foreign country**

Comply with the relevant vehicle registration laws and confirm the availability of the correct fuel. (→P.447)

■ **Idling time before engine stop**

To prevent damage to the turbocharger, allow the engine to idle immediately after high-speed driving or hill climbing.

Driving condition	Idling time
Normal city driving	Not necessary
High-speed driving (Constant speed of approx. 62 mph [100km/h])	Not necessary
Steep hill driving or continuous driving at 62 mph (100 km/h) or more (race track driving etc.)	Approximately 1 minute

⚠ WARNING

Observe the following precautions. Failure to do so may result in death or serious injury.

■ **When starting the vehicle**

Always keep your foot on the brake pedal while stopped with the engine running. This prevents the vehicle from creeping.

**WARNING****■ When driving the vehicle**

- Do not drive if you are unfamiliar with the location of the brake and accelerator pedals to avoid depressing the wrong pedal.
- Accidentally depressing the accelerator pedal instead of the brake pedal will result in sudden acceleration that may lead to an accident.
- When backing up, you may twist your body around, leading to a difficulty in operating the pedals. Make sure to operate the pedals properly.
- Make sure to keep a correct driving posture even when moving the vehicle only slightly. This allows you to depress the brake and accelerator pedals properly.
- Depress the brake pedal using your right foot. Depressing the brake pedal using your left foot may delay response in an emergency, resulting in an accident.
- Do not drive the vehicle over or stop the vehicle near flammable materials. The exhaust system and exhaust gases can be extremely hot. These hot parts may cause a fire if there is any flammable material nearby.
- Vehicles without Lexus Safety System + A: During normal driving, do not turn off the engine. Turning the engine off while driving will not cause loss of steering or braking control, but the power assist to these systems will be lost. This will make it more difficult to steer and brake, so you should pull over and stop the vehicle as soon as it is safe to do so.
However, in the event of an emergency, such as if it becomes impossible to stop the vehicle in the normal way: →P.406

- Vehicles with Lexus Safety System + A: During normal driving, do not turn off the engine. Turning the engine off while driving will not cause loss of steering or braking control, however, power assist to the steering will be lost. This will make it more difficult to steer smoothly, so you should pull over and stop the vehicle as soon as it is safe to do so.
In the event of an emergency, such as if it becomes impossible to stop the vehicle in the normal way: →P.406
- Use engine braking (downshift) to maintain a safe speed when driving down a steep hill.
Using the brakes continuously may cause the brakes to overheat and lose effectiveness. (→P.167)
- Do not adjust the positions of the steering wheel, the seat, or the inside or outside rear view mirrors while driving.
Doing so may result in a loss of vehicle control.
- Always check that all passengers' arms, heads or other parts of their body are not outside the vehicle.
- Do not drive in excess of the speed limit. Even if the legal speed limit permits it, do not drive over 85 mph (140 km/h) unless your vehicle has high-speed capability tires. Driving over 85 mph (140 km/h) may result in tire failure, loss of control and possible injury. Be sure to consult a tire dealer to determine whether the tires on your vehicle are high-speed capability tires or not before driving at such speeds.
- When driving on slippery road surfaces**
- Sudden braking, acceleration and steering may cause tire slippage and reduce your ability to control the vehicle.
- Sudden acceleration, engine braking due to shifting, or changes in engine speed could cause the vehicle to skid.

⚠ WARNING

- After driving through a puddle, lightly depress the brake pedal to make sure that the brakes are functioning properly. Wet brake pads may prevent the brakes from functioning properly. If the brakes on only one side are wet and not functioning properly, steering control may be affected.

■ When shifting the shift position

- Do not let the vehicle roll backward while a forward driving position is selected, or roll forward while the shift position is in R.
Doing so may cause the engine to stall or lead to poor brake and steering performance, resulting in an accident or damage to the vehicle.
- Do not shift the shift position to P while the vehicle is moving.
Doing so can damage the transmission and may result in a loss of vehicle control.
- Do not shift the shift position to R while the vehicle is moving forward.
Doing so can damage the transmission and may result in a loss of vehicle control.
- Do not shift the shift position to a driving position while the vehicle is moving backward.
Doing so can damage the transmission and may result in a loss of vehicle control.
- Changing the shift position to N while the vehicle is moving will disengage the engine from the transmission. Engine braking is not available when N is selected.

- Be careful not to change the shift position with the accelerator pedal depressed. Changing the shift position to any positions other than P or N may lead to unexpected rapid acceleration of the vehicle that may cause an accident and result in death or serious injury.

After changing the shift position, make sure to confirm the current shift position displayed on the shift position indicator inside the meter.

■ Brake pad wear

If any of the following situations occurs, have the brake pads visually checked and replaced by your Lexus dealer as soon as possible.

- If the brake pad wear limit of a brake pad is found to have been exceeded when visually checking the brake pads for each wheel (for the brake pad wear limit, refer to P.451)
- If a warning message is displayed on the multi-information display (only the right-side pads can be detected)

Rotor damage may result if the pads are not replaced when needed.

F SPORT models: Moderate levels of the brake pad and disc wear allow enhanced braking power. As a result, the discs may wear more quickly than conventional brake discs. Therefore, when replacing the brake pads, Lexus recommends that you also have the thickness of the discs measured.

It is dangerous to drive the vehicle when the wear limits of the brake pads and/or those of the brake discs are exceeded.

■ When the vehicle is stopped

- Do not race the engine.
If the vehicle is in any gear other than P or N, the vehicle may accelerate suddenly and unexpectedly, causing an accident.

**WARNING**

- In order to prevent accidents due to the vehicle rolling away, always keep depressing the brake pedal while the engine is running, and apply the parking brake as necessary.
- If the vehicle is stopped on an incline, in order to prevent accidents caused by the vehicle rolling forward or backward, always depress the brake pedal and securely apply the parking brake as needed.
- Avoid revving or racing the engine. Running the engine at high speed while the vehicle is stopped may cause the exhaust system to overheat, which could result in a fire if combustible material is nearby.
- **When the vehicle is parked**
 - Do not leave glasses, cigarette lighters, spray cans, or soft drink cans in the vehicle when it is in the sun. Doing so may result in the following:
 - Gas may leak from a cigarette lighter or spray can, and may lead to a fire.
 - The temperature inside the vehicle may cause the plastic lenses and plastic material of glasses to deform or crack.
 - Soft drink cans may fracture, causing the contents to spray over the interior of the vehicle, and may also cause a short circuit in the vehicle's electrical components.
 - Do not leave cigarette lighters in the vehicle. If a cigarette lighter is in a place such as the glove box or on the floor, it may be lit accidentally when luggage is loaded or the seat is adjusted, causing a fire.
 - Do not attach adhesive discs to the windshield or windows. Do not place containers such as air fresheners on the instrument panel or dashboard. Adhesive discs or containers may act as lenses, causing a fire in the vehicle.

- Do not leave a door or window open if the curved glass is coated with a metallized film such as a silver-colored one. Reflected sunlight may cause the glass to act as a lens, causing a fire.
- Always apply the parking brake, shift the shift position to P, stop the engine and lock the vehicle. Do not leave the vehicle unattended while the engine is running. If the vehicle is parked with the shift position in P but the parking brake is not set, the vehicle may start to move, possibly leading to an accident.
- Do not touch the exhaust pipes while the engine is running or immediately after turning the engine off. Doing so may cause burns.
- **When taking a nap in the vehicle**

Always turn the engine off. Otherwise, if you accidentally move the shift lever or depress the accelerator pedal, this could cause an accident or fire due to engine overheating. Additionally, if the vehicle is parked in a poorly ventilated area, exhaust gases may collect and enter the vehicle, leading to death or a serious health hazard.
- **When braking**
 - When the brakes are wet, drive more cautiously. Braking distance increases when the brakes are wet, and this may cause one side of the vehicle to brake differently than the other side. Also, the parking brake may not securely hold the vehicle.
 - Vehicles without Lexus Safety System + A: If the brake booster device does not operate, do not follow other vehicles closely and avoid hills or sharp turns that require braking. In this case, braking is still possible, but the brake pedal should be depressed more firmly than usual. Also, the braking distance will increase. Have your brakes fixed immediately.

⚠ WARNING

- Vehicles with Lexus Safety System + A: If the electronically controlled brake system does not operate, do not follow other vehicles closely and avoid hills or sharp turns that require braking. In this case, braking is still possible, but the brake pedal should be depressed more firmly than usual. Also, the braking distance will increase. Have your brakes fixed immediately.
- Vehicles without Lexus Safety System + A: Do not pump the brake pedal if the engine stalls. Each push on the brake pedal uses up the reserve for the power-assisted brakes.
- Vehicles without Lexus Safety System + A: The brake system consists of 2 individual hydraulic systems; if one of the systems fails, the other will still operate. In this case, the brake pedal should be depressed more firmly than usual and the braking distance will increase. Have your brakes fixed immediately.
- Vehicles with Lexus Safety System + A: The brake system consists of 2 or more individual hydraulic systems; if one of the systems fails, the other(s) will still operate. In this case, the brake pedal should be depressed more firmly than usual and the braking distance will increase. Have your brakes fixed immediately.

■ If the vehicle becomes stuck

Do not spin the wheels excessively when a driven wheel is up in the air, or the vehicle is stuck in sand, mud, etc. This may damage the driveline components or propel the vehicle forward or backward, causing an accident.

⚠ NOTICE**■ When driving the vehicle**

- Do not depress the accelerator and brake pedals at the same time during driving, as this may restrain the engine output.
- Do not use the accelerator pedal or depress the accelerator and brake pedals at the same time to hold the vehicle on a hill.

■ When parking the vehicle

Always set the parking brake, and shift the shift position to P. Failure to do so may cause the vehicle to move or the vehicle may accelerate suddenly if the accelerator pedal is accidentally depressed.

■ Avoiding damage to vehicle parts

- Do not turn the steering wheel fully in either direction and hold it there for an extended period of time. Doing so may damage the power steering motor.
- When driving over bumps in the road, drive as slowly as possible to avoid damaging the wheels, underside of the vehicle, etc.
- Make sure to idle the engine immediately after high-load driving. Stop the engine only after the turbocharger has cooled down. Failure to do so may cause damage to the turbocharger.

■ If you get a flat tire while driving

A flat or damaged tire may cause the following situations. Hold the steering wheel firmly and gradually depress the brake pedal to slow down the vehicle.

- It may be difficult to control your vehicle.
- The vehicle will make abnormal sounds or vibrations.
- The vehicle will lean abnormally.

**NOTICE**

Information on what to do in case of a flat tire (→P.429)

■ When encountering flooded roads

Do not drive on a road that has flooded after heavy rain etc. Doing so may cause the following serious damage to the vehicle:

- Engine stalling
- Short in electrical components
- Engine damage caused by water immersion

In the event that you drive on a flooded road and the vehicle is flooded, be sure to have your Lexus dealer check the following:

- Brake function
- Changes in quantity and quality of oil and fluid used for the engine, transmission, transfer (AWD models), differential, etc.
- Lubricant condition for the propeller shaft, bearings and suspension joints (where possible), and the function of all joints, bearings, etc.

If the shift control system is damaged by flooding, it may not be possible to shift the shift position to P, or from P to other positions. In this case, contact your Lexus dealer.

■ When parking the vehicle

Always set the parking brake, and shift the shift position to P. Failure to do so may cause the vehicle to move or the vehicle may accelerate suddenly if the accelerator pedal is accidentally depressed.

Cargo and luggage

Take notice of the following information about storage precautions, cargo capacity and load:

Capacity and distribution

Cargo capacity depends on the total weight of the occupants.

(Cargo capacity) = (Total load capacity) – (Total weight of occupants)

Steps for Determining Correct Load Limit –

- (1) Locate the statement “The combined weight of occupants and cargo should never exceed XXX kg or XXX lbs.” on your vehicle’s placard.
- (2) Determine the combined weight of the driver and passengers that will be riding in your vehicle.
- (3) Subtract the combined weight of the driver and passengers from XXX kg or XXX lbs.
- (4) The resulting figure equals the available amount of cargo and luggage load capacity.

For example, if the “XXX” amount equals 1400 lbs. and there will be five 150 lb passengers in your vehicle, the amount of available cargo and luggage load capacity is 650 lbs. (1400 – 750 (5 × 150) = 650 lbs.)

- (5) Determine the combined weight of luggage and cargo being loaded on the vehicle. That weight may not safely exceed the available cargo and lug-

gage load capacity calculated in Step 4.

(6) If your vehicle will be towing a trailer, load from your trailer will be transferred to your vehicle. Consult this manual to determine how this reduces the available cargo and luggage load capacity of your vehicle. (→P.162)

Lexus does not recommend towing a trailer with your vehicle. Your vehicle is not designed for trailer towing.

Calculation formula for your vehicle

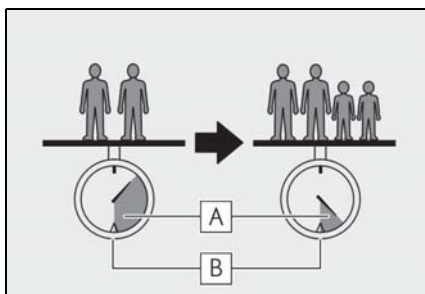

- A** Cargo capacity
- B** Total load capacity (vehicle capacity weight) (→P.446)

When 2 people with the combined weight of A lb. (kg) are riding in your vehicle, which has a total load capacity (vehicle capacity weight) of B lb. (kg), the available amount of cargo and luggage load capacity will be C lb. (kg) as follows:

$$B^{*2} \text{ lb. (kg)} - A^{*1} \text{ lb. (kg)} = C^{*3} \text{ lb. (kg)}$$

^{*1}: A =Weight of people
^{*2}: B =Total load capacity

^{*3}: C =Available cargo and luggage load

In this condition, if 3 more passengers with the combined weight of D lb. (kg) get on, the available cargo and luggage load will be reduced E lb. (kg) as follows:

$$C \text{ lb. (kg)} - D^{*4} \text{ lb. (kg)} = E^{*5} \text{ lb. (kg)}$$

^{*4}: D =Additional weight of people

^{*5}: E =Available cargo and luggage load

As shown in the example above, if the number of occupants increases, the cargo and luggage load will be reduced by an amount that equals the increased weight due to the additional occupants. In other words, if an increase in the number of occupants causes an excess of the total load capacity (combined weight of occupants plus cargo and luggage load), you must reduce the cargo and luggage on your vehicle.

WARNING

Things that must not be carried in the trunk

The following things may cause a fire if loaded in the trunk:

- Receptacles containing gasoline
- Aerosol cans

Storage precautions

Observe the following precautions. Failure to do so may prevent the pedals from being depressed properly, may block the driver's vision, or may result in items hitting the driver or passengers, possibly causing an accident.

- Stow cargo and luggage in the trunk whenever possible.

 **WARNING**

- Do not place cargo or luggage in or on the following locations.
 - At the feet of the driver
 - On the front passenger or rear seats (when stacking items)
 - On the package tray
 - On the instrument panel
 - On the dashboard
 - In front of the Center Display
- Secure all items in the occupant compartment.
- **Capacity and distribution**
 - Do not exceed the maximum axle weight rating or the total vehicle weight rating.
 - Even if the total load of occupant's weight and the cargo load is less than the total load capacity, do not apply the load unevenly. Improper loading may cause deterioration of steering or braking control which may cause death or serious injury.

Vehicle load limits

Vehicle load limits include total load capacity, seating capacity, towing capacity and cargo capacity.

- Total load capacity (vehicle capacity weight): →P.446

Total load capacity means the combined weight of occupants, cargo and luggage.

- Seating capacity: 5 occupants (Front 2, Rear 3)

Seating capacity means the maximum number of occupants whose estimated average weight is 150 lb. (68 kg) per person.

- Towing capacity

Lexus does not recommend towing a trailer with your vehicle.

- Cargo capacity

Cargo capacity may increase or decrease depending on the weight and the number of occupants.

■ **Total load capacity and seating capacity**

These details are also described on the tire and loading information label. (→P.395)

 **WARNING**

■ **Overloading the vehicle**

Do not overload the vehicle. It may not only cause damage to the tires, but also degrade steering and braking ability, resulting in an accident.

Trailer towing

Lexus does not recommend towing a trailer with your vehicle. Lexus also does not recommend the installation of a tow hitch or the use of a tow hitch carrier for a wheelchair, scooter, bicycle, etc. Your vehicle is not designed for trailer towing or for the use of tow hitch mounted carriers.



Dinghy towing

Your vehicle is not designed to be dinghy towed (with 4 wheels on the ground) behind a motor home.

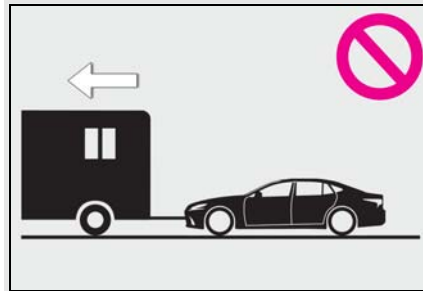

NOTICE

■ To avoid serious damage to your vehicle

Do not tow your vehicle with the four wheels on the ground.

Engine (ignition) switch

Performing the following operations when carrying the electronic key on your person starts the engine or changes engine switch modes.

Starting the engine

- 1 Press the parking brake switch to check that the parking brake is set. (→P.174)

The parking brake indicator will come on.

- 2 Firmly depress the brake pedal.

 and a message will be displayed on the multi-information display. If it is not displayed, the engine cannot be started.

- 3 Press the engine switch shortly and firmly.

When operating the engine switch, one short, firm press is enough. It is not necessary to press and hold the switch.

The engine will crank until it starts or for up to 30 seconds, whichever is less.

Continue depressing the brake pedal until the engine is completely started.

The engine can be started from any engine switch mode.

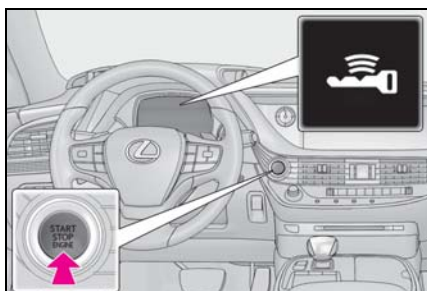

■ Engine switch illumination

According to the situation, the engine switch illumination operates as follows.

- When a door is opened, or the engine switch mode is changed from ACCESSORY or IGNITION ON mode to off, the engine switch illumination slowly blinks.
- When depressing the brake pedal with carrying the electronic key on your person, the engine switch illumination rapidly blinks.
- When the engine switch is in ACCESSORY or IGNITION ON mode, the engine switch illumination illuminates.

■ If the engine does not start

- The engine immobilizer system may not have been deactivated. (→P.63) Contact your Lexus dealer.
- If a message related to start-up is shown on the multi-information display, read the message and follow the instructions.

■ If the battery is discharged

The engine cannot be started using the smart access system with push-button start. Refer to P.435 to restart the engine.

■ Electronic key battery depletion

→P.96

■ Conditions affecting operation

→P.113

■ Notes for the entry function

→P.113

■ Steering lock function

- After turning the engine switch off and opening and closing the doors, the steering wheel will be locked due to the steering lock function. Operating the engine switch again automatically cancels the steering lock.
- When the steering lock cannot be released, "Push Engine Switch While Turning Steering Wheel in Either Direction" will be displayed on the multi-information display. Press the engine switch shortly and firmly

while turning the steering wheel left and right.

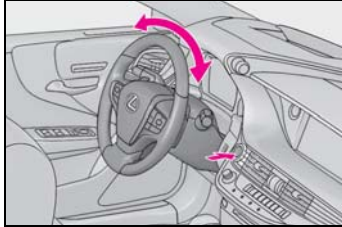

- To prevent the steering lock motor from overheating, operation of the motor may be suspended if the engine is turned on and off repeatedly in a short period of time. In this case, refrain from operating the engine switch. After about 10 seconds, the steering lock motor will resume functioning.

■ **Electronic key battery**

→P.399

■ **Operation of the engine switch**

- If the switch is not pressed shortly and firmly, the engine switch mode may not change or the engine may not start.
- If attempting to restart the engine immediately after turning the engine switch off, the engine may not start in some cases. After turning the engine switch off, please wait a few seconds before restarting the engine.

■ **Customization**

If the smart access system with push-button start has been deactivated in a customized setting, refer to P.433.

! WARNING

■ **When starting the engine**

Always start the engine while sitting in the driver's seat. Do not depress the accelerator pedal while starting the engine under any circumstances. Doing so may cause an accident resulting in death or serious injury.

■ **Caution while driving**

If engine failure occurs while the vehicle is moving, do not lock or open the doors until the vehicle reaches a safe and complete stop. Activation of the steering lock in this circumstance may lead to an accident, resulting in death or serious injury.

! NOTICE

■ **When starting the engine**

- Do not race a cold engine.
- If the engine becomes difficult to start or stalls frequently, have your vehicle checked by your Lexus dealer immediately.

■ **Symptoms indicating a malfunction with the engine switch**

If the engine switch seems to be operating somewhat differently than usual, such as the switch sticking slightly, there may be a malfunction. Contact your Lexus dealer immediately.

Stopping the engine

- 1 Stop the vehicle completely.
- 2 If the parking brake is in manual mode, set the parking brake. (→P.174)
- 3 Shift the shift position to P. (→P.170)

Check that the shift position indicator shows P and the parking brake indicator is illuminated.

- 4 Press the engine switch.

The engine will stop, and the meter display will be extinguished (the shift position indicator will be extinguished a few seconds after the meter display).

- 5 Release the brake pedal and check that "ACCESSORY" or "IGNI-

IGNITION ON" is not shown on the meter.

■ **Automatic P position selection function**
→P.170

⚠ WARNING

■ **Stopping the engine in an emergency**

● If you want to stop the engine in an emergency while driving the vehicle, press and hold the engine switch for more than 2 seconds, or press it briefly 3 times or more in succession. (→P.406)

However, do not touch the engine switch while driving except in an emergency. Turning the engine off while driving will not cause loss of steering or braking control, however, power assist to the steering will be lost. This will make it more difficult to steer smoothly, so you should pull over and stop the vehicle as soon as it is safe to do so.

● If the engine switch is operated while the vehicle is running, a warning message will be shown on the multi-information display and a buzzer sounds.

● When restarting the engine after an emergency shutdown, press the engine switch.

Changing engine switch modes

Modes can be changed by pressing the engine switch with the brake pedal released. (The mode changes each time the switch is pressed.)

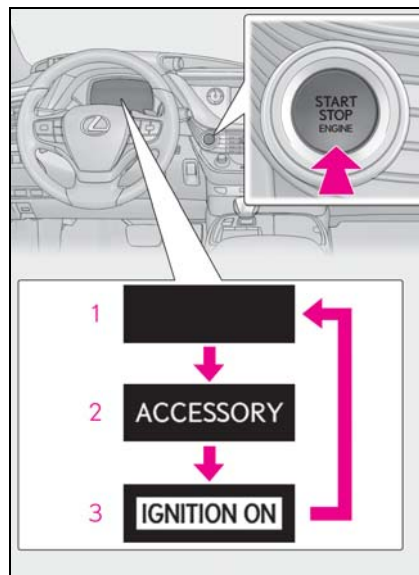

1 Off

The emergency flashers can be used.

2 ACCESSORY mode

Some electrical components such as the audio system can be used. "ACCESSORY" will be displayed on the meter.

3 IGNITION ON mode

All electrical components can be used. "IGNITION ON" will be displayed on the meter.

■ **Auto power off function**

If the vehicle is left in ACCESSORY mode for more than 20 minutes or IGNITION ON mode (with the engine not running) for more than an hour with the shift position in P, the engine switch will automatically turn off. However, this function cannot entirely prevent the battery discharge. Do not leave the vehicle with the engine switch in ACCESSORY or IGNITION ON mode for long periods of time when the engine is not running.

■ **When the shift control system malfunctions**

When attempting to turn the engine switch off while there is a malfunction in the shift control system, the engine switch mode may change to ACCESSORY mode. In this case, ACCESSORY mode may be turned off by applying the parking brake and pressing the engine switch again. If there is a malfunction in the system, have the vehicle inspected by your Lexus dealer immediately.

	NOTICE
<p>■ To prevent battery discharge</p> <ul style="list-style-type: none"> ● Do not leave the engine switch in ACCESSORY or IGNITION ON mode for long periods of time without the engine running. ● If “ACCESSORY” or “IGNITION ON” is displayed on the meter, the engine switch is not off. Exit the vehicle after turning the engine switch off. 	

Automatic transmission

Select the shift position depending on your purpose and situation.

Shift position purpose and functions

Shift position	Objective or function
P	Parking the vehicle/starting the engine
R	Reversing
N	Neutral (Condition in which the power is not transmitted)
D	Normal driving ^{*1}
M	M mode driving ^{*2} (→P.172)

^{*1}: To improve fuel efficiency and reduce noise, set the shift position in D for normal driving. You can choose gear range suitable for your driving situation by operating the paddle shift switches.

^{*2}: Any gear range can be fixed when driving in M mode.

■ **For the shift positions**

- When the engine switch is off or in ACCESSORY mode, the shift position cannot be changed.
- When the engine switch is in IGNITION ON mode, the shift position can only be changed to N.
- When the engine is running, the shift position can be changed from P to D, N or R.
- The shift position can only be changed to M directly from D.

In addition, if an attempt is made to change

the shift position by moving the shift lever or by pressing the P position switch in any of the following situations, the buzzer will sound and the shifting operation will be disabled or the shift position will automatically change to N. When this happens, select an appropriate shift position.

- Situations where the shifting operation will be disabled:
 - When an attempt is made to change the shift position from P to another position by moving the shift lever without depressing the brake pedal.
 - When an attempt is made to change the shift position from P or N to M by moving the shift lever.
 - When the P position switch is pressed while the vehicle is running.^{*1}
- Situations where the shift position will automatically change to N:
 - When an attempt is made to select the R position by moving the shift lever when the vehicle is moving forward.^{*2}
 - When an attempt is made to select the D position by moving the shift lever when the vehicle is moving in reverse.^{*3}
 - When the shift position is changed from R to M
- If N is selected while driving at a certain speed, even if the shift lever is not held in the N position, the shift position changes to N. In this situation, the buzzer sounds and a confirmation message is displayed on the multi-information display to inform the driver that the shift position has changed to N.

^{*1}: Shift position may be changed to P when driving at extremely low speeds.

^{*2}: Shift position may be changed to R when driving at low speeds.

^{*3}: Shift position may be changed to D when driving at low speeds.

■ Reverse warning buzzer

When shifting into R, a buzzer will sound to inform the driver that the shift position is in R.

■ To protect the automatic transmission

If the automatic transmission fluid tempera-

ture is high, "Transmission Fluid Temp High See Owner's Manual" will be displayed on the multi-information display and the vehicle will go into transmission protection mode automatically. Have the vehicle inspected by your Lexus dealer.

■ When driving with dynamic radar cruise control with full-speed range activated

Even when performing the following actions with the intent of enabling engine braking, engine braking will not be activated because dynamic radar cruise control with full-speed range will not be canceled.

- While driving in the D position, downshifting to 9, 8, 7, 6, 5 or 4.
- When switching the driving mode to sport mode while driving in the D position (→P.289)

■ Restraining sudden start (Drive-Start Control)

→P.155

■ AI-SHIFT

The AI-SHIFT automatically selects the suitable gear according to driver performance and driving conditions.

The AI-SHIFT automatically operates when the shift position is in D. (Shifting the shift position to the M position cancels the function.)

■ If a message about a shift operation is shown

To prevent the shift position from being selected incorrectly or the vehicle from moving unexpectedly, the shift position may be changed automatically or operating the shift lever may be required. In this case, change the shift position following the messages on the multi-information display.

■ After recharging/reconnecting the battery

→P.380

■ Customization

Some functions can be customized. (→P.466)

⚠ WARNING**■ When driving on slippery road surfaces**

Do not accelerate or shift the shift position suddenly.
Sudden changes in engine braking may cause the vehicle to spin or skid, resulting in an accident.

⚠ NOTICE**■ Situations where shift control system malfunctions are possible**

If any of the following situations occurs, shift control system malfunctions are possible.
Immediately stop the vehicle in a safe place on level ground, apply the parking brake, and then contact your Lexus dealer.

- When the warning message indicating the shift control system appears on the multi-information display.
- The display indicates that no shift position is selected for more than a few seconds.

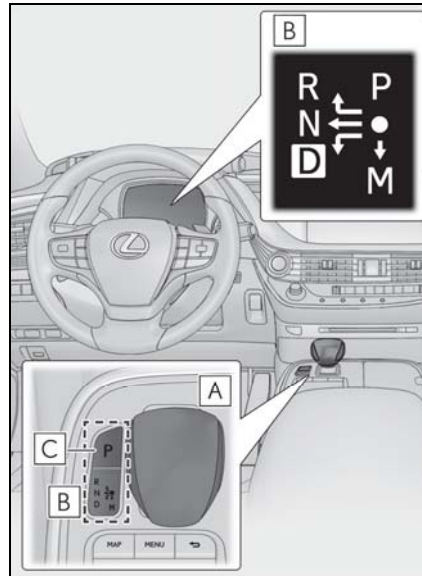
Shifting the shift lever**A** Shift lever

Operate the shift lever gently and securely in the direction of the arrow on the shift position indicator.

To shift to N, slide the shift lever in the direction of the arrow and hold it.

Release the shift lever after each shifting operation to allow it to return to its regular position (●).

Shifting to M is only possible when the shift position is in D.

When shifting from P to N, D or R, from N, D, M or R to P, from D or M to R, or from R to D, ensure that the brake pedal is being depressed and the vehicle is stationary.

B Shift position indicator

Meter display:

The current shift position is highlighted.

When any shift position other than D or M is selected, the arrow toward M and the M position indicator are displayed in gray.

Shift lever display:

The current shift position is illuminated. When selecting the shift position, make sure that the shift position has been changed to the desired position by checking the shift position indicator provided on the instrument cluster.

C P position switch

⚠ WARNING

- **For the shift lever**
 - Do not remove the shift lever knob or use anything but a genuine Lexus shift lever knob. Also, do not hang anything on the shift lever. Doing so could prevent the shift lever from returning to position, causing unexpected accidents to occur when the vehicle is in motion.
 - In order to prevent the shift position from accidentally being changed, do not touch the shift lever when not using them.

P position switch

■ **When shifting the shift position to P**

Fully stop the vehicle and set the parking brake, and then press the P position switch.

When the shift position is changed to P, the switch illuminates.

Check that the shift position indicator shows P.

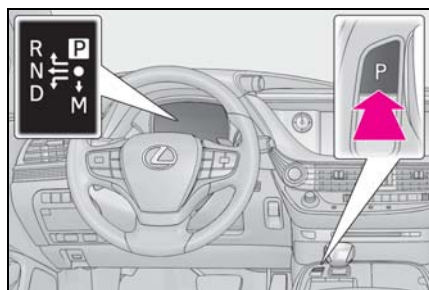

■ **Shifting the shift position from P to other positions**

- While depressing the brake pedal firmly, operate the shift lever. If the shift lever is operated without depressing the brake pedal, the buzzer will sound and the shifting operation will be disabled.
- When selecting the shift position, make sure that the shift position has been changed to the desired position by checking the shift position indicator provided on the instrument cluster.
- The shift position cannot be changed from P to M directly.

■ **Automatic P position selection function**

In the following situations, the shift position is automatically changed to P.

- When pressing the engine switch with the vehicle stopped while the engine switch is in IGNITION ON mode and the shift position is in a position other than P (after the shift position has changed to P, the engine switch will turn off)*
- When the vehicle is stopped after the engine has been stopped in an emergency while driving
- When voltage of the battery drops while the shift position is in a position other than P

*: When the engine switch is pressed while driving at extremely slow speeds, such as immediately before stopping the vehicle, the shift position may automatically change to P. Make sure that the vehicle is completely stopped before pressing the engine switch.

■ **If the shift position cannot be shifted from P**

There is a possibility that the battery is dis-

charged. Check the battery in this situation. (→P.435)

⚠ WARNING

■ P position switch

- Do not press the P position switch while the vehicle is moving. If the P position switch is pressed when driving at very low speeds (for example, directly before stopping the vehicle), the vehicle may stop suddenly when the shift position switches to P, which could lead to an accident.
- In order to prevent the shift position from accidentally being changed, do not touch the P position switch or shift lever when not using them.
- After changing the shift position to P, do not release the brake pedal until the shift position indicator shows P and the parking brake indicator is illuminated. Otherwise, the vehicle may move, possibly leading to an accident.

⚠ NOTICE

■ Notes regarding shift lever and P position switch operation

Avoid repeatedly operating the shift lever and P position switch in quick succession. The system protection function may activate and it will not be temporarily possible to shift the shift position other than P. If this happens, please wait for a while before attempting to change the shift position again.

Selecting the driving mode

- **Driving mode**
→P.289
- **Snow mode**
Snow mode can be selected to suit the conditions when driving on slippery

road surfaces, such as on snow.
Turn the snow mode switch backward.
The snow mode indicator illuminates.
Turn the snow mode switch backward again to return to normal mode.

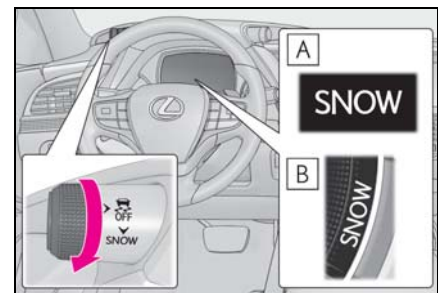

- A** Except F SPORT models
- B** F SPORT models

■ Snow mode automatic deactivation
Snow mode is automatically deactivated if the engine switch is turned off after driving in snow mode.

Selecting shift ranges in the D position

To drive using temporary shift range selection, operate the “-” or “+” paddle shift switch.
When the “-” paddle shift switch is operated, the shift range switches to a range that enables engine braking force that is suitable to driving conditions. When the “+” paddle shift switch is operated, the shift range switches to a range that is one range higher than the current range.
Changing the shift range allows restriction of the highest gear, preventing unnecessary upshifting and enabling the level of engine braking

force to be selected.

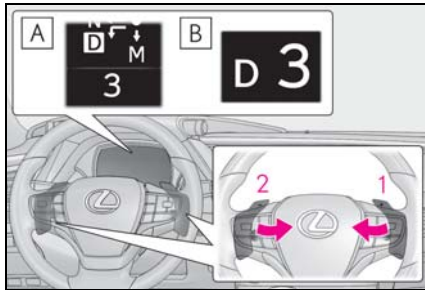

A Except F SPORT models

B F SPORT models

1 Upshifting

2 Downshifting

The selected shift range, from D1 to D10, will be displayed on the meter.

To return to normal D position driving, the “+” paddle shift switch must be held down for a period of time.

Meter display	Function
D2 - D10	A gear in the range between D1 and the selected shift range is automatically chosen depending on vehicle speed and driving conditions
D1	Setting the shift range at D1

A lower shift range will provide greater engine braking forces than a higher shift range.

Automatic deactivation of shift range selection in the D position

Shift range selection in the D position will be deactivated in the following situations:

- When the vehicle comes to a stop
- If the accelerator pedal is depressed for more than a certain period of time
- When the shift position is shifted to a

position other than D.

- When pressing and holding the “+” paddle shift switch

Downshifting restriction warning buzzer

To help ensure safety and driving performance, downshifting operation may sometimes be restricted. In some circumstances, downshifting may not be possible even when the paddle shift switch is operated. (A buzzer will sound twice.)

Selecting gears in the M position

To enter M mode, shift the shift position to M. Gears can be selected by operating the paddle shift switches, allowing you to drive in the gear of your choosing.

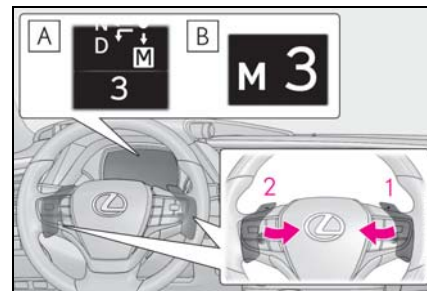

A Except F SPORT models

B F SPORT models

1 Upshifting

2 Downshifting

The gear changes once every time the paddle shift switch is operated.

The selected gear, from M1 to M10, will be fixed and displayed on the meter.

When in the M position, the gear will not change unless the paddle shift switches are operated.

However, even when in the M position, the gears will be automatically

changed in the following situations:

- When vehicle speed drops (downshift only).
- When it is necessary to protect the engine or automatic transmission when the engine coolant temperature is low, the automatic transmission fluid temperature is high or low, or other reasons.

Also, the gear will not shift when the vehicle speed is low, even if an upshift operation is performed.

■ **Downshifting restriction warning buzzer**

To help ensure safety and driving performance, downshifting operation may sometimes be restricted. In some circumstances, downshifting may not be possible even when the paddle shift switch is operated. (A buzzer will sound twice.)

Turn signal lever

Operating instructions

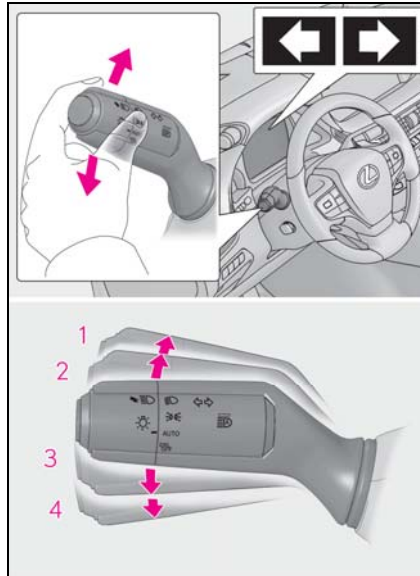

- 1 Right turn
- 2 Lane change to the right (move the lever partway and release it)
The right hand signals will flash 3 times.
- 3 Lane change to the left (move the lever partway and release it)
The left hand signals will flash 3 times.
- 4 Left turn

■ **Turn signals can be operated when**

The engine switch is in IGNITION ON mode.

■ **If the indicator flashes faster than usual**

Check that a light bulb in the front or rear turn signal lights has not burned out.

■ **If the turn signals stop flashing before a lane change has been performed**

Operate the lever again.

■ Customization

Some functions can be customized.
(→P.466)

Parking brake

The parking brake can be set or released automatically or manually.

In automatic mode, the parking brake can be set or released automatically according to the shift lever operation. Also, even in automatic mode, the parking brake can be set or released manually.

Operating instructions

■ Using the manual mode

The parking brake can be set and released manually.

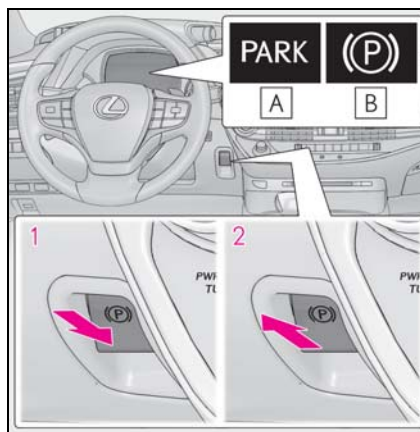

A U.S.A.

B Canada

- 1** Push the switch to set the parking brake

The parking brake indicator light will turn on.

Press and hold the parking brake switch if an emergency occurs and it is necessary to operate the parking brake while driving.

2 Pull the switch to release the parking brake

- Operate the parking brake switch while depressing the brake pedal.
- Using the parking brake automatic release function, the parking brake can be released by depressing the accelerator pedal. When using this function, slowly depress the accelerator pedal.

Make sure that the parking brake indicator light turn off.

■ **Turns automatic mode on**

While the vehicle is stopped, press and hold the parking brake switch until a message is shown on the multi-information display.

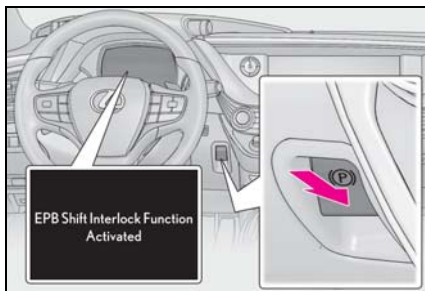

When the automatic mode is turned on, the parking brake operates as follows.

- When the shift position is shifted from P, the parking brake will be released, and the parking brake indicator light will turn off.
- When the shift position is shifted to P, the parking brake will be set, and the parking brake indicator light will turn on.

Operate the shift lever and P position switch with the vehicle stopped and the brake pedal depressed.

■ **Turns automatic mode off**

While the vehicle is stopped, pull and hold the parking brake switch until a message is shown on the multi-information display.

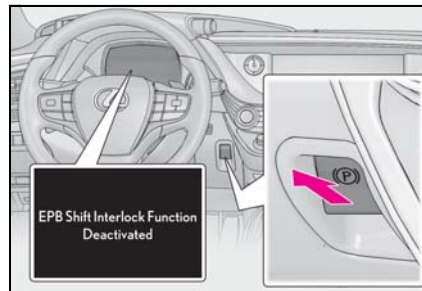

■ **Parking brake operation**

- When the engine switch is not in IGNITION ON mode, the parking brake cannot be released using the parking brake switch.
- When the engine switch is not in IGNITION ON mode, automatic mode (automatic brake setting and releasing) is not available.

■ **Parking brake automatic release function**

- When the shift position is shifted from P, the parking brake will be released in automatic mode.
- When all of the following conditions are met in manual mode, the parking brake can be released by depressing the accelerator pedal.
 - The driver's door is closed
 - The driver is wearing the seat belt
 - The shift position is in D, M or R

■ **If "EPB Frequently Operated Wait a Minute" is displayed on the multi-information display**

If the parking brake is operated repeatedly over a short period of time, the system may restrict operation to prevent overheating. If this happens, refrain from operating the parking brake. Normal operation will return after about 1 minute.

■ **If “EPB Activation Stopped Incompletely” or “EPB Unavailable” is displayed on the multi-information display**

Operate the parking brake switch. If the message does not disappear after operating the switch several times, the system may be malfunctioning. Have the vehicle inspected by your Lexus dealer.

■ **Parking brake operation sound**

When the parking brake operates, a motor sound (whirring sound) may be heard. This does not indicate a malfunction.

■ **Parking brake operation**

- Depending on the engine switch mode, the parking brake indicator light will turn on and stay on as described below:
IGNITION ON mode: Comes on until the parking brake is released.
Not in IGNITION ON mode: Stays on for approximately 15 seconds.
- When the engine switch is turned off with the parking brake set, the parking brake indicator light will stay on for about 15 seconds. This does not indicate a malfunction.

■ **When the parking brake switch malfunctions**

Automatic mode (automatic brake setting and releasing) will be turned on automatically.

■ **Parking the vehicle**

→P.154

■ **Parking brake engaged warning buzzer**

A buzzer will sound if the vehicle is driven with the parking brake engaged. “EPB Applied” is displayed on the multi-information display. (with the vehicle reached a speed of 3 mph [5 km/h])

■ **If the brake system warning light comes on**

→P.415

■ **Usage in winter time**

→P.300



WARNING

■ **When parking the vehicle**

Do not leave a child in the vehicle alone. The parking brake may be released unintentionally and there is the danger of the vehicle moving that may lead to an accident resulting in death or serious injury.



NOTICE

■ **When parking the vehicle**

Before you leave the vehicle, set the parking brake, shift the shift position to P and make sure that the vehicle does not move.

■ **When the system malfunctions**

Stop the vehicle in a safe place and check the warning messages.

■ **When the parking brake cannot be released due to a malfunction**

Driving the vehicle with the parking brake set will lead to brake components overheating, which may affect braking performance and increase brake wear.

Have the vehicle inspected by your Lexus dealer immediately if this occurs.

Brake Hold

The brake hold system keeps the brake applied when the shift position is in D, M or N with the system on and the brake pedal has been depressed to stop the vehicle. The system releases the brake when the accelerator pedal is depressed with the shift position in D or M to allow smooth start off.

Enabling the system

Press the brake hold switch to turn the system on

The brake hold standby indicator (green) **A** comes on. While the system is holding the brakes, the brake hold operated indicator (yellow) **B** comes on.

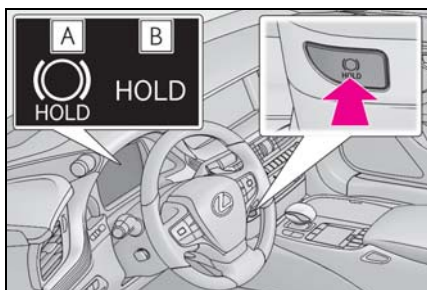

Brake hold system operating conditions

The brake hold system cannot be turned on in the following conditions:

- The driver's door is not closed.
- The driver is not wearing the seat belt.

If any of the conditions above are detected when the brake hold system is enabled, the system will turn off and the brake hold standby indicator light will go off. In addition, if any of the conditions are detected while the system is holding the brake, a warning buzzer will sound and a message

will be shown on the multi-information display. The parking brake will then be set automatically.

Brake hold function

- If the brake pedal is left released for a period of about 3 minutes after the system has started holding the brake, the parking brake will be set automatically. In this case, a warning buzzer sounds and a message is shown on the multi-information display.
- To turn the system off while the system is holding the brake, firmly depress the brake pedal and press the button again.
- The brake hold function may not hold the vehicle when the vehicle is on a steep incline. In this situation, it may be necessary for the driver to apply the brakes. A warning buzzer will sound and the multi-information display will inform the driver of this situation. If a warning message is shown on the multi-information display, read the message and follow the instructions.

When the parking brake is set automatically while the system is holding the brakes

Perform any of the following operations to release the parking brake.

- Depress the accelerator pedal. (The parking brake will not be released automatically if the seat belt is not fastened.)
- Operate the parking brake switch with the brake pedal depressed.

Make sure that the parking brake indicator light goes off. (→P.174)

When an inspection at your Lexus dealer is necessary

When the brake hold standby indicator (green) does not illuminate even when the brake hold switch is pressed with the brake hold system operating conditions met, the system may be malfunctioning. Have the vehicle inspected at your Lexus dealer.

- If “Brake Hold Fault Depress Brake to Deactivate Visit Your Dealer” or “Brake Hold Malfunction Visit Your Dealer” is displayed on the multi-information display

The system may be malfunctioning. Have the vehicle inspected by your Lexus dealer.

- **Warning messages and buzzers**

Warning messages and buzzers are used to indicate a system malfunction or to inform the driver of the need for caution. If a warning message is shown on the multi-information display, read the message and follow the instructions.

- **If the brake hold operated indicator flashes**

→P.422



WARNING

- **When the vehicle is on a steep incline**

When using the brake hold system on a steep incline exercise caution. The brake hold function may not hold the vehicle in such a situation.

- **When stopped on a slippery road**

The system cannot stop the vehicle when the gripping ability of the tires has been exceeded. Do not use the system when stopped on a slippery road.



NOTICE

- **When parking the vehicle**

The brake hold system is not designed for use when parking the vehicle for a long period of time. Turning the engine switch off while the system is holding the brake may release the brake, which would cause the vehicle to move. When operating the engine switch, depress the brake pedal, shift the shift position to P and set the parking brake.

Headlight switch

The headlights can be operated manually or automatically.

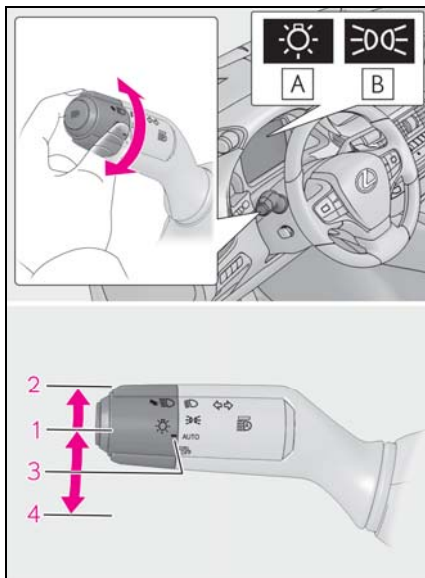

Operating instructions

Operating the  switch turns on the lights as follows:





A U.S.A.

B Canada

- 1**  The side marker, parking, tail, license plate, instrument panel lights, and daytime running lights (→P.179) turn on.
- 2**  The headlights and all lights listed above (except daytime running lights) turn on.
- 3** **AUTO** The headlights, daytime running lights (→P.179) and all the

lights listed above turn on and off automatically.



4  (U.S.A.) Off

 (Canada) The daytime running lights turn on. (→P.179)

AUTO mode can be used when

The engine switch is in IGNITION ON mode.

Daytime running light system

- The daytime running lights illuminate using the same lights as the parking lights and illuminate brighter than the parking lights.
- To make your vehicle more visible to other drivers during daytime driving, the daytime running lights turn on automatically when all of the following conditions are met. (The daytime running lights are not designed for use at night.)
 - The engine is running
 - The parking brake is released
 - The headlight switch is in the  (Canada only),  or **AUTO** * position

* : When the surroundings are bright

The daytime running lights remain on after they illuminate, even if the parking brake is set again.

- For the U.S.A.: Daytime running lights can be turned off by operating the switch.
- Compared to turning on the headlights, the daytime running light system offers greater durability and consumes less electricity, so it can help improve fuel economy.

Headlight control sensor

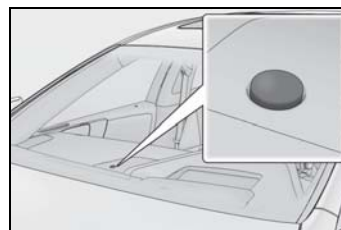



The sensor may not function properly if an object is placed on the sensor, or anything that blocks the sensor is affixed to the windshield.

Doing so interferes with the sensor detecting the level of ambient light and may cause the automatic headlight system to malfunction.

■ **Automatic light off system**

- When the headlights are on: The headlights and tail lights turn off 30 seconds after the driver's door is opened and closed if the engine switch is turned to ACCESSORY mode or turned off. (The lights turn off immediately if  on the key is pressed after all the doors are closed.)
- When only the tail lights are on: The tail lights turn off automatically if the engine switch is turned to ACCESSORY mode or turned off and the driver's door is opened.

To turn the lights on again, turn the engine switch to IGNITION ON mode, or turn the light switch off once and then back to  or .

■ **Light reminder buzzer**

A buzzer sounds when the engine switch is turned off or turned to ACCESSORY mode and the driver's door is opened while the lights are turned on.

■ **Automatic headlight leveling system**

The level of the headlights is automatically adjusted according to the number of passengers and the loading condition of the vehicle to ensure that the headlights do not interfere with other road users.

■ **Windshield wiper linked headlight illumination**

When driving during daytime with the headlight switch turned to AUTO, if the windshield wipers are used, the headlights will turn on automatically after several seconds to help enhance the visibility of your vehicle.

■ **Battery-saving function**

In order to prevent the battery of the vehicle

from discharging, if the headlights and/or tail lights are on when the engine switch is turned off the battery saving function will operate and automatically turn off all the lights after approximately 20 minutes.

When the engine switch is turned to IGNITION ON mode, the battery-saving function will be disabled.

When any of the following are performed, the battery-saving function is canceled once and then reactivated. All the lights will turn off automatically 20 minutes after the Battery-saving function has been reactivated:

- When the headlight switch is operated
- When a door is opened or closed

■ **Welcome light illumination control**

The parking lights and tail lights automatically turn on at night when the doors are unlocked using the entry function or wireless remote control if the light switch is in the AUTO position.

■ **Customization**

Some functions can be customized. (→P.466)

	NOTICE
■ To prevent battery discharge	
Do not leave the lights on longer than necessary when the engine is not running.	

Turning on the high beam headlights

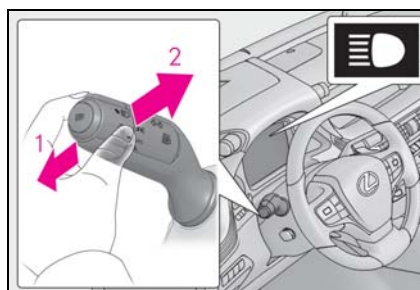

- 1 With the headlights on, push the

lever away from you to turn on the high beams.

Pull the lever toward you to the center position to turn the high beams off.

- 2** Pull the lever toward you and release it to flash the high beams once.

You can flash the high beams with the headlights on or off.

AFS (Adaptive Front-lighting System) (if equipped)

AFS (Adaptive Front-lighting System) secures excellent visibility at intersections and on curves by automatically adjusting the direction of the light axis of the headlights according to vehicle speed and the degree of the tire's angle as controlled by steering input.

AFS operates at speeds of approximately 6 mph (10 km/h) or higher.

■ Customization

Some functions can be customized. (→P.466)

Cornering lights

- When the steering wheel or turn signal lever is operated while the headlights are on (low beam), a cornering light will turn on and light up the direction of movement of the vehicle. The cornering lights are designed to ensure excellent visibility when making a turn at an intersection.

However, when vehicle speed is more than approximately 22 mph (35 km/h), the cornering lights will not turn on.

- When the shift position is in R while the headlights are on (low beam), both cornering lights will turn on. This is designed to enhance visibility when parking.

■ Cornering lights

When the cornering lights are on for more than 30 minutes, they will turn off automatically.

AHB (Automatic High Beam)

The Automatic High Beam uses a camera sensor located behind the upper portion of the windshield to assess the brightness of the lights of vehicles ahead, streetlights, etc., and automatically turns the high beams on or off as necessary.

WARNING

■ Limitations of the Automatic High Beam

Do not overly rely on the Automatic High Beam. Always drive safely, taking care to observe your surroundings and turning the high beams on or off manually if necessary.

■ To prevent incorrect operation of the Automatic High Beam system

Do not overload the vehicle.

Activating the Automatic High Beam

- 1 Press the Automatic High Beam switch.

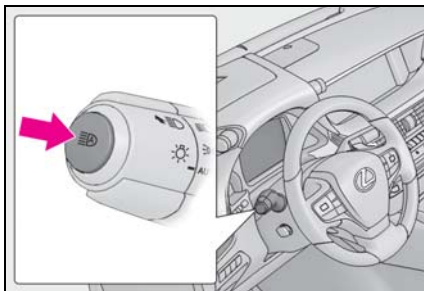

- 2 Push the lever away from you with the headlight switch in the  or AUTO position.

The AHB indicator will come on when the system is operating.

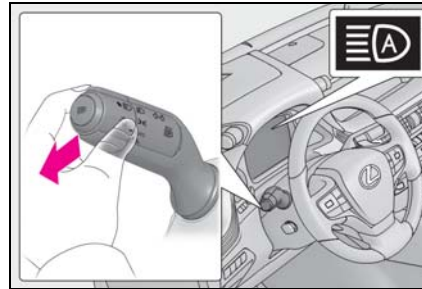

■ Conditions to turn the high beams on/off automatically

- When all of the following conditions are met, the high beams will be turned on automatically (after approximately 1 second):
 - The vehicle speed is approximately 21 mph (34 km/h) or more.
 - The area ahead of the vehicle is dark.
 - There are no vehicles ahead with headlights or tail lights turned on.
 - There are few streetlights on the road ahead.
- If any of the following conditions are met, the high beams will turn off automatically:
 - The vehicle speed is below approximately 17 mph (27 km/h).
 - The area ahead of the vehicle is not dark.
 - Vehicles ahead have their headlights or tail lights turned on.
 - There are many streetlights on the road ahead.

■ Camera sensor detection information

- The high beams may not be automatically turned off in the following situations:
 - When a vehicle suddenly appears from around a curve
 - When the vehicle is cut in front of by another vehicle
 - When vehicles ahead cannot be detected due to repeated curves, road dividers or roadside trees
 - When vehicles ahead appear in a far-away lane on a wide road
 - When the lights of vehicles ahead are not on
- The high beams may be turned off if a

- vehicle ahead that is using fog lights without its headlights turned on is detected.
- House lights, street lights, traffic signals, and illuminated billboards or signs and other reflective objects may cause the high beams to change to the low beams, or the low beams to remain on.
 - The following factors may affect the amount of time taken for the high beams to turn on or off:
 - The brightness of the headlights, fog lights, and tail lights of vehicles ahead
 - The movement and direction of vehicles ahead
 - When a vehicle ahead only has operational lights on one side
 - When a vehicle ahead is a two-wheeled vehicle
 - The condition of the road (gradient, curve, condition of the road surface, etc.)
 - The number of passengers and amount of luggage in the vehicle
 - The high beams may turn on or off unexpectedly.
 - Bicycles or similar vehicles may not be detected.
 - In the following situations the system may not be able to correctly detect the surrounding brightness level. This may cause the low beams to remain on or the high beams to flash or dazzle pedestrians or vehicles ahead. In such a case, it is necessary to manually switch between the high and low beams.
 - When driving in inclement weather (heavy rain, snow, fog, sandstorms, etc.)
 - When the windshield is obscured by fog, mist, ice, dirt, etc.
 - When the windshield is cracked or damaged
 - When the camera sensor is deformed or dirty
 - When the temperature of the camera sensor is extremely high
 - When the surrounding brightness level is equal to that of headlights, tail lights or fog lights
 - When headlights or tail lights of vehicles ahead are turned off, dirty, changing color, or not aimed properly
 - When the vehicle is hit by water, snow, dust, etc. from a preceding vehicle
 - When driving through an area of intermittently changing brightness and darkness
 - When frequently and repeatedly driving ascending/descending roads, or roads with rough, bumpy or uneven surfaces (such as stone-paved roads, gravel roads, etc.)
 - When frequently and repeatedly taking curves or driving on a winding road
 - When there is a highly reflective object ahead of the vehicle, such as a sign or mirror
 - When the back of a preceding vehicle is highly reflective, such as a container on a truck
 - When the vehicle's headlights are damaged or dirty, or are not aimed properly
 - When the vehicle is listing or tilting due to a flat tire, a trailer being towed, etc.
 - When the headlights are changed between the high beams and low beams repeatedly in an abnormal manner
 - When the driver believes that the high beams may be flashing or dazzling pedestrians or other drivers
- **Temporarily lowering sensor sensitivity**
- The sensitivity of the sensor can be temporarily lowered.
- 1 Turn the engine switch off while the following conditions are met.
 - The headlight switch is in  or AUTO.
 - The headlight switch lever is in high beam position.
 - Automatic High Beam switch is on.
 - 2 Turn the engine switch to IGNITION ON mode.
 - 3 Within 30 seconds after step 2, repeat pulling the headlight switch lever to the original position then pushing it to the high beam position quickly 10 times, then leave the lever in high beam position.
 - 4 If the sensitivity is changed, the AHB indicator is turn on and off 3 times.
- Automatic High Beam (headlights) may turn on even when the vehicle is stopped.

Turning the high beams on/off manually

■ **Switching to the low beams**

Pull the lever to its original position.

The AHB indicator will turn off.

Push the lever away from you to activate the Automatic High Beam system again.

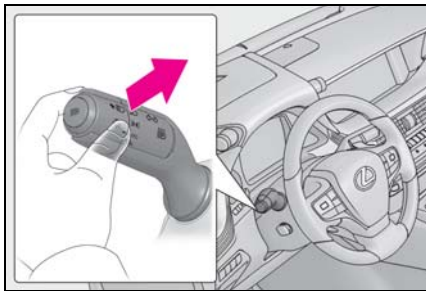

■ **Switching to the high beams**

Press the Automatic High Beam switch.

The AHB indicator will turn off and the high beam indicator will turn on.

Press the switch to activate the Automatic High Beam system again.

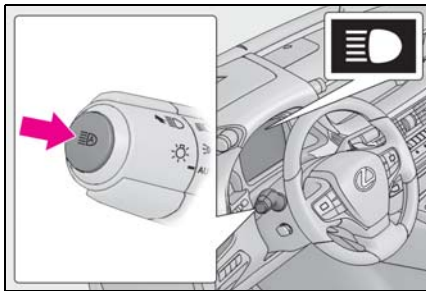

Windshield wipers and washer

Operating the lever can switch between automatic operation and manual operation, or can use the washer.

NOTICE

■ **When the windshield is dry**

Do not use the wipers, as they may damage the windshield.

Operating the wiper lever

Operate the  lever operates the wipers or washer as follows. When

AUTO is selected, the wipers will operate automatically when the sensor detects falling rain. The system automatically adjusts wiper timing in accordance with rain volume and vehicle speed.

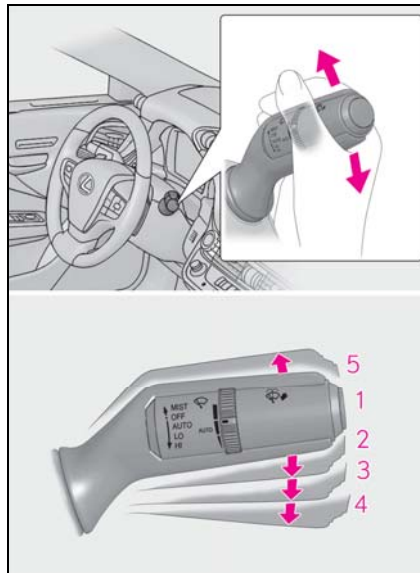

1 OFF (U.S.A.) or ○ (Canada)
Off

2 AUTO Rain-sensing wiper operation
The wipers will operate automatically when the sensor detects falling rain. The system automatically adjusts wiper timing in accordance with rain volume and vehicle speed.

3 LO (U.S.A.) or ▼ (Canada)
Low speed wiper operation

4 HI (U.S.A.) or ▼ (Canada)
High speed wiper operation

5 MIST (U.S.A.) or △ (Canada)
Temporary operation

When AUTO is selected, the sensor sensitivity can be adjusted by turning the switch ring.

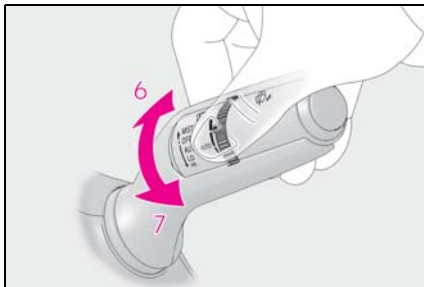

6 Increases the sensitivity
7 Decreases the sensitivity



8  Washer/wiper dual operation

Pulling the lever operates the wipers and washer.
(After operating several times, the wipers operate once more time after a short delay to prevent dripping. However, the dripping prevention does not operate while the vehicle is moving.)

Vehicles with headlight cleaners:
When the engine switch is in IGNITION ON mode and the headlights are on, if the lever is pulled, the headlight cleaners will operate once. After this, the headlight cleaners will operate every 5th time the lever is pulled.

■ **The windshield wiper and washer can be operated when**

The engine switch is in IGNITION ON mode.

■ **Effects of vehicle speed on wiper operation**

Even when the wipers are not in AUTO mode, vehicle speed affects the time until the drip prevention wiper sweep occurs.
With low speed windshield wiper operation selected, wiper operation will be switched from low speed to intermittent wiper operation only when the vehicle is stationary.
(However, when the sensor sensitivity is adjusted to the highest level, the mode cannot be switched.)

■ **Raindrop sensor**

● The raindrop sensor judges the amount of raindrops.
An optical sensor is adopted. It may not operate properly when sunlight from the rising or setting of the sun intermittently strikes the windshield, or if bugs etc. are present on the windshield.

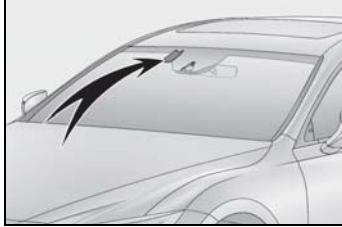

- If the wiper is turned to AUTO mode while the engine switch is in IGNITION ON mode, the wipers will operate once to show that AUTO mode is activated.
- If the temperature of the raindrop sensor is 185°F (85°C) or higher, or 5°F (-15°C) or lower, automatic operation may not occur. In this case, operate the wipers in any mode other than AUTO mode.

■ **If no windshield washer fluid sprays**

Check that the washer nozzles are not blocked if there is washer fluid in the windshield washer fluid reservoir.



■ **Front door opening linked windshield wiper stop function**

When AUTO is selected and the windshield wipers are operating, if a front door is opened while the vehicle is stopped and the P shift position is selected, operation of the windshield wipers will be stopped to prevent anyone near the vehicle from being sprayed by water from the wipers. When the front door is closed, wiper operation will resume.

■ **When stopping the engine in an emergency while driving**

If the windshield wipers are operating when the engine is stopped, the windshield wipers will operate in high speed operation. After the vehicle is stopped, operation will return to normal when the engine switch is turned

to IGNITION ON mode, or operation will stop when the driver's door is opened.

■ **Outside rear view mirror defogger activation linked to windshield wiper operation**

The outside rear view mirror defoggers automatically turn on when you operate the windshield wipers.

The outside rear view mirror defoggers automatically turn off approximately 15 minutes after the wipers stop.

For details about the outside rear view mirror defoggers: →P.314

WARNING

■ **Caution regarding the use of windshield wipers in AUTO mode**

The windshield wipers may operate unexpectedly if the sensor is touched or the windshield is subject to vibration in AUTO mode. Take care that your fingers or anything else do not become caught in the windshield wipers.

■ **Caution regarding the use of washer fluid**

When it is cold, do not use the washer fluid until the windshield becomes warm. The fluid may freeze on the windshield and cause low visibility. This may lead to an accident, resulting in death or serious injury.

NOTICE

■ **When there is no washer fluid spray from the nozzle**

Damage to the washer fluid pump may be caused if the lever is pulled toward you and held continually.

■ **When a nozzle becomes blocked**

In this case, contact your Lexus dealer. Do not try to clear it with a pin or other object. The nozzle will be damaged.

Changing the windshield wiper rest position/Lifting the windshield wipers

When the windshield wipers are not being used, they retract to below the hood. To enable the windshield wipers to be lifted when parking in cold conditions or when replacing a windshield wiper insert, change the rest position of the windshield wipers to the service position using the wiper lever.

■ **Raising the wipers to the service position**

Within approximately 45 seconds of turning the engine switch off, move the wiper lever to the **MIST** (U.S.A.) or **Δ** (Canada) position and hold it for approximately 2 seconds or more.

The wipers will move to the service position.

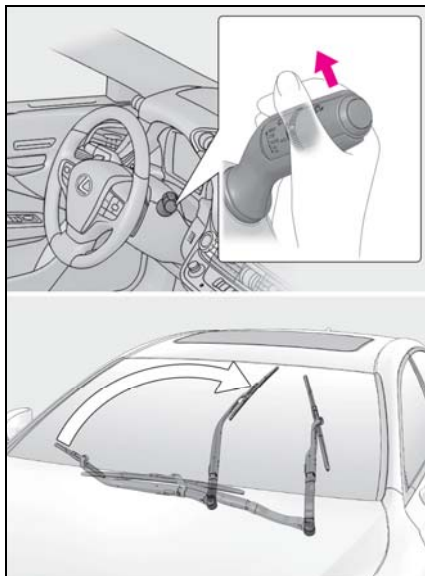

■ **Lifting the windshield wipers**

While holding the hook portion **A** of the wiper arm, lift the windshield wiper from the windshield.

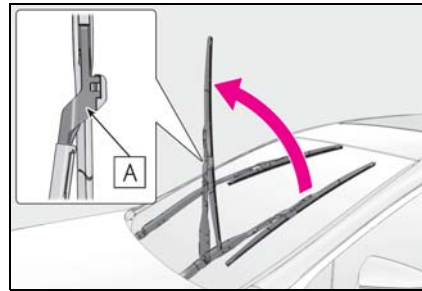

■ **Lowering the windshield wipers to the retracted position**

With the windshield wipers placed on the windshield, turn the engine switch to **IGNITION ON** mode and then move the wiper lever to an operating position. When the wiper switch is turned off, the windshield wipers will stop at the retracted position. Even if the wipers deviate while the engine switch is off, the wipers will return to the normal position.

NOTICE

■ **When lifting the windshield wipers**

- Do not lift the windshield wipers when they are in the retracted position below the hood. Otherwise, they may contact the hood, possibly resulting in damage to a windshield wiper and/or the hood.

 NOTICE

- Do not lift a windshield wiper by the wiper blade. Otherwise, the wiper blade may be deformed.

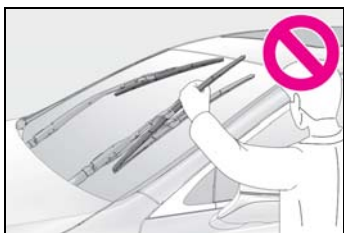

- Do not operate the wiper lever when the windshield wipers are lifted. Otherwise, the windshield wipers may contact the hood, possibly resulting in damage to the windshield wipers and/or hood.

Opening the fuel tank cap

Perform the following steps to open the fuel tank cap:

Before refueling the vehicle

- Close all the doors and windows, and turn the engine switch off.
- Confirm the type of fuel.

■ **Fuel types**

→P.455

■ **Fuel tank opening for unleaded gasoline**

To help prevent incorrect fueling, your vehicle has a fuel tank opening that only accommodates the special nozzle on unleaded fuel pumps.

 **WARNING**

■ **When refueling the vehicle**

Observe the following precautions while refueling the vehicle. Failure to do so may result in death or serious injury.

- After exiting the vehicle and before opening the fuel door, touch an unpainted metal surface to discharge any static electricity. It is important to discharge static electricity before refueling because sparks resulting from static electricity can cause fuel vapors to ignite while refueling.
- Always hold the grips on the fuel tank cap and turn it slowly to remove it. A whooshing sound may be heard when the fuel tank cap is loosened. Wait until the sound cannot be heard before fully removing the cap. In hot weather, pressurized fuel may spray out the filler neck and cause injury.

- Do not allow anyone that has not discharged static electricity from their body to come close to an open fuel tank.
- Do not inhale vaporized fuel. Fuel contains substances that are harmful if inhaled.
- Do not smoke while refueling the vehicle. Doing so may cause the fuel to ignite and cause a fire.
- Do not return to the vehicle or touch any person or object that is statically charged. This may cause static electricity to build up, resulting in a possible ignition hazard.

■ **When refueling**

Observe the following precautions to prevent fuel overflowing from the fuel tank:

- Securely insert the fuel nozzle into the fuel filler neck.
- Stop filling the tank after the fuel nozzle automatically clicks off.
- Do not top off the fuel tank.

 **NOTICE**

■ **Refueling**

Do not spill fuel during refueling. Doing so may damage the vehicle, such as causing the emission control system to operate abnormally or damaging fuel system components or the vehicle's painted surface.

Opening the fuel tank cap

- 1 Press the opener switch.

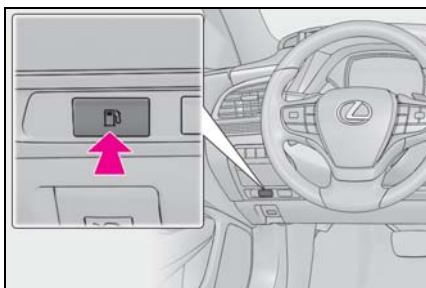

- 2 Turn the fuel tank cap slowly and remove it, then put it into the holder on the fuel filler door.

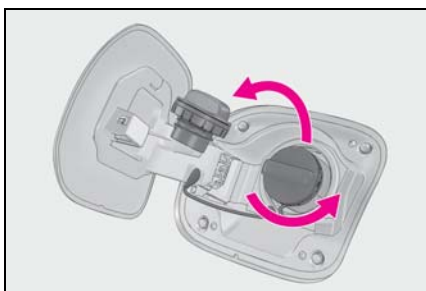

■ If the fuel filler door cannot be opened
→P.432

Closing the fuel tank cap

After refueling, turn the fuel tank cap until you hear a click. Once the cap is released, it will turn slightly in the opposite direction.

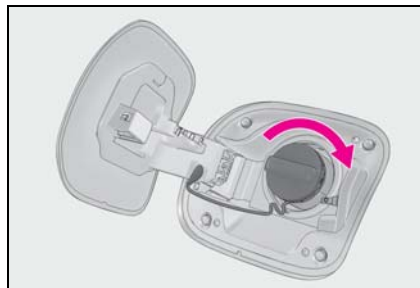

⚠ WARNING

■ When replacing the fuel tank cap

Do not use anything but a genuine Lexus fuel tank cap designed for your vehicle. Doing so may cause a fire or other incident which may result in death or serious injury.

Lexus Safety System + A*

*: If equipped

The Lexus Safety System + A consists of the following drive assist systems and contributes to a safe and comfortable driving experience:

Drive assist system

■ PCS (Pre-Collision System) (vehicles with Lexus Safety System + A)

→P.204

■ FCTA (Front Cross Traffic Alert)

→P.222

■ LTA (Lane Tracing Assist)

→P.225

■ AHB (Automatic High Beam)

→P.182

■ RSA (Road Sign Assist)*

*: If equipped

→P.247

■ Dynamic radar cruise control with full-speed range

→P.237

⚠ WARNING

■ Lexus Safety System + A

The Lexus Safety System + A is designed to operate under the assumption that the driver will drive safely, and is designed to help reduce the impact to the occupants and the vehicle in the case of a collision or assist the driver in normal driving conditions.

As there is a limit to the degree of recognition accuracy and control performance that this system can provide, do not overly rely on this system. The driver is always responsible for paying attention to the vehicle's surroundings and driving safely.

Sensors

Four types of sensors, located behind the front grille, front bumper, rear bumper and windshield, detect information necessary to operate the drive assist systems.

● Front

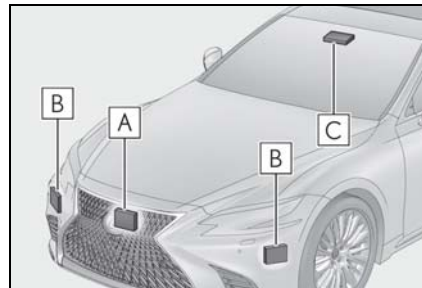

A Front radar sensor

B Front side radar sensors

C Front camera

● Rear

Rear side radar sensors (→P.250)

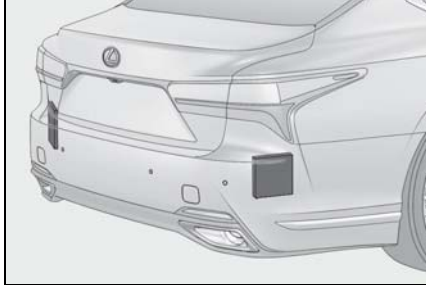

⚠ WARNING

■ To avoid malfunction of the front radar sensor

Observe the following precautions.

Otherwise, the radar sensor may not operate properly, possibly leading to an accident resulting in death or serious injury.

- Keep the radar sensor and the grille cover clean at all times.

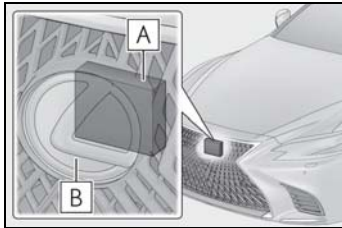

A Radar sensor

B Grille cover

If the front of the radar sensor or the front or back of the grille cover is dirty or covered with water droplets, snow, etc., clean it.

Clean the radar sensor and grille cover with a soft cloth to avoid damage them.

- Do not attach accessories, stickers (including transparent stickers) or other items to the radar sensor, grille cover or surrounding area.

- Do not subject the radar sensor or its surrounding area to a strong impact. If the radar sensor is moved even slightly off position, the system may malfunction and objects may not be detected correctly. If the radar sensor, front grille, or front bumper has been subjected to a strong impact, have the vehicle inspected by your Lexus dealer.

- Do not disassemble the radar sensor.

- Do not modify or paint the radar sensor or grille cover.

- If the radar sensor, front grille, or front bumper needs to be removed and installed, or replaced, contact your Lexus dealer.

■ To avoid malfunction of the front side radar sensors

Observe the following precautions.

Otherwise, the radar sensor may not operate properly, possibly leading to an accident resulting in death or serious injury.

⚠ WARNING

- Keep the radar sensors and their surrounding areas on the front bumper clean at all times.



If a radar sensor or its surrounding area on the front bumper is dirty or covered with snow, the system may not operate and a warning message (→P.428) will be displayed.

If this occurs, clean off the dirt or snow and drive the vehicle for approximately 10 minutes.

If the warning message does not disappear, have your vehicle inspected by your Lexus dealer.

- Do not attach accessories, stickers (including transparent stickers), aluminum tape or other items to the radar sensors or their surrounding area.
- Do not subject a radar sensor or its surrounding area on the front bumper to a strong impact.

If a radar sensor is moved even slightly off position, the system may malfunction and vehicles may not be detected correctly.

In the following situations, have your vehicle inspected by your Lexus dealer.

- If a radar sensor or its surrounding area is subject to a strong impact
- If the area on the front bumper around a radar sensor is scratched or dented, or the front bumper has become partially disengaged

- Do not disassemble the radar sensors.
- Do not modify the radar sensors or their surrounding area on the front bumper.
- If a radar sensor or the front bumper needs to be removed and installed, or replaced, contact your Lexus dealer.
- Do not paint the front bumper any color other than an official Lexus color.

■ To avoid malfunction of the front camera

Observe the following precautions.

Otherwise, the front camera may not operate properly, possibly leading to an accident resulting in death or serious injury.

- Keep the windshield clean at all times.
 - If the windshield is dirty or covered with an oily film, water droplets, snow, etc., clean the windshield.
 - As some glass coating agents may affect the detection performance of the front camera, consult your Lexus dealer when using a glass coating agent.
 - If a glass coating agent is applied to the windshield, it will still be necessary to use the windshield wipers to remove water droplets, etc. from the area of the windshield in front of the front camera.
 - If the inner side of the windshield where the front camera is installed is dirty, contact your Lexus dealer.

⚠ WARNING

- Do not attach objects, such as stickers, transparent stickers, and so forth, to the outer side of the windshield in front of the front camera (shaded area in the illustration).

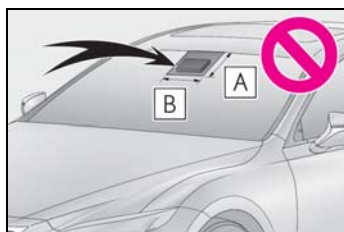

- A** From the top of the windshield to approximately 0.4 in. (1 cm) below the bottom of the front camera
- B** Approximately 14.2 in. (36 cm) (Approximately 7.1 in. [18 cm] to the right and left from the center of the front camera)

- If the part of the windshield in front of the front camera is fogged up or covered with condensation or ice, use the windshield defogger to remove the fog, condensation or ice. (→P.314)
- If water droplets cannot be properly removed from the area of the windshield in front of the front camera by the windshield wipers, replace the wiper insert or wiper blade.

If the wiper inserts or wiper blades need to be replaced, contact your Lexus dealer.

- Do not attach window tint to the windshield.
- Replace the windshield if it is damaged or cracked. If the windshield needs to be replaced, contact your Lexus dealer.
- Do not allow liquids to contact the front camera.

- Do not allow bright lights to shine into the front camera.
- Do not dirty or damage the front camera. When cleaning the inside of the windshield, do not allow glass cleaner to contact the lens of the front camera. Also, do not touch the lens. If the lens is dirty or damaged, contact your Lexus dealer.
- Do not subject the front camera to a strong impact.
- Do not change the installation position or direction of the front camera or remove it.
- Do not disassemble the front camera.
- Do not modify any components of the vehicle around the front camera (inside rear view mirror, etc.) or ceiling.
- Do not attach any accessories to the hood, front grille or front bumper that may obstruct the front camera. Contact your Lexus dealer for details.
- If a surfboard or other long object is to be mounted on the roof, make sure that it will not obstruct the front camera.
- Do not modify the headlights or other lights.

■ Certification

FCC ID: HYQDNMWR009

NOTE:

This device complies with part 15 of the FCC Rules. Operation is subject to the following two conditions: (1) This device may not cause harmful interference, and (2) this device must accept any interference received, including interference that may cause undesired operation.

FCC WARNING:

Changes or modifications not expressly approved by the party responsible for compliance could void the user's authority to operate the equipment.

Radiofrequency radiation exposure Information:

This equipment complies with FCC radiation exposure limits set forth for an uncontrolled environment. This equipment should be installed and operated with minimum distance of 20 cm between the radiator (antenna) and your body. This transmitter must not be co-located or operating in conjunction with any other antenna or transmitter.

NOTE:

This device complies with Industry Canada's licence-exempt RSSs. Operation is subject to the following two conditions: (1) This device may not cause interference; and (2) This device must accept any interference, including interference that may cause undesired operation of the device.

This equipment complies with IC radiation exposure limits set forth for an uncontrolled environment and meets RSS-102 of the IC radio frequency (RF) Exposure rules. This equipment should be installed and operated keeping the radiator at least 20 cm or more away from person's body.

NOTE:

Le présent appareil est conforme aux CNR d'Industrie Canada applicables aux appareils radio exempts de licence. L'exploitation est autorisée aux deux conditions suivantes: (1) l'appareil ne doit pas produire de brouillage; (2) l'utilisateur de l'appareil doit accepter tout brouillage radioélectrique subi, même si le brouillage est susceptible d'en compromettre le fonctionnement.

Cet équipement est conforme aux limites d'exposition aux rayonnements énoncées pour un environnement non contrôlé et respecte les règles d'exposition aux fréquences radioélectriques (RF) CNR-102 de l'IC. Cet équipement doit être installé et utilisé en gardant une distance de 20 cm ou plus entre le dispositif rayonnant et le corps.

■ **If a warning message is displayed on the multi-information display**

A system may be temporarily unavailable or there may be a malfunction in the system.

- In the following situations, perform the actions specified in the table. When the normal operating conditions are detected, the message will disappear and the system will become operational.

If the message does not disappear, contact your Lexus dealer.

Situation	Actions
When the area around a sensor is covered with dirt, moisture (fogged up, covered with condensation, ice, etc.), or other foreign matter	To clean the part of the windshield in front of the front camera, use the windshield wipers or the windshield defogger of the air conditioning system (→P.314).

Situation	Actions
When the temperature around the front camera is outside of the operational range, such as when the vehicle is in the sun or in an extremely cold environment	If the front camera is hot, such as after the vehicle had been parked in the sun, use the air conditioning system to decrease the temperature around the front camera. If a sunshade was used when the vehicle was parked, depending on its type, the sunlight reflected from the surface of the sunshade may cause the temperature of the front camera to become excessively high.
	If the front camera is cold, such after the vehicle is parked in an extremely cold environment, use the air conditioning system to increase the temperature around the front camera.
The area in front of the front camera is obstructed, such as when the hood is open or a sticker is attached to the part of the windshield in front of the front camera.	Close the hood, remove the sticker, etc. to clear the obstruction.

- In the following situations, if the situation has changed (or the vehicle has been driven for some time) and the normal operating conditions are detected, the message will disappear and the system will become operational.
 If the message does not disappear, contact your Lexus dealer.
- When the temperature around the radar sensor is outside of the operational range, such as when the vehicle is in the sun or in an extremely cold environment
- When the front camera cannot detect objects in front of the vehicle, such as when driving in the dark, snow, or fog, or when bright lights are shining into the front camera

Lexus Safety System + 2.0*

*: If equipped

The Lexus Safety System + 2.0 consists of the following drive assist systems and contributes to a safe and comfortable driving experience:

Driving assist system

- PCS (Pre-Collision System) (vehicles with Lexus Safety System + 2.0)

→P.215

- LTA (Lane Tracing Assist)

→P.225

- AHB (Automatic High Beam)

→P.182

- RSA (Road Sign Assist)*

→P.247

*: If equipped

- Dynamic radar cruise control with full-speed range

→P.237

⚠ WARNING

■ Lexus Safety System + 2.0

The Lexus Safety System + 2.0 is designed to operate under the assumption that the driver will drive safely, and is designed to help reduce the impact to the occupants and the vehicle in the case of a collision or assist the driver in normal driving conditions.

As there is a limit to the degree of recognition accuracy and control performance that this system can provide, do not overly rely on this system. The driver is always responsible for paying attention to the vehicle's surroundings and driving safely.

Sensors

Two types of sensors, located behind the front grille and windshield, detect information necessary to operate the drive assist systems.

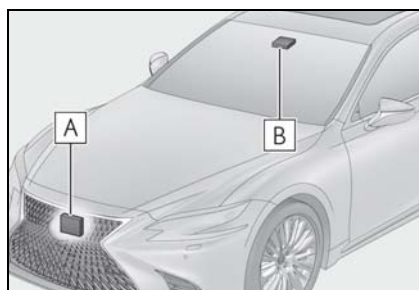

A Radar sensor

B Front camera

⚠ WARNING

■ To avoid malfunction of the radar sensor

Observe the following precautions.

Otherwise, the radar sensor may not operate properly, possibly leading to an accident resulting in death or serious injury.

⚠ WARNING

- Keep the radar sensor and the grille cover clean at all times.

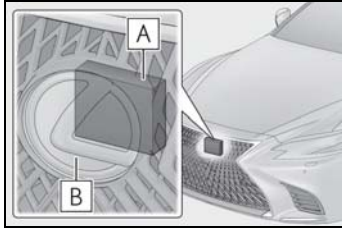

- A** Radar sensor
- B** Grille cover

If the front of the radar sensor or the front or back of the grille cover is dirty or covered with water droplets, snow, etc., clean it.

Clean the radar sensor and grille cover with a soft cloth to avoid damaging them.

- Do not attach accessories, stickers (including transparent stickers) or other items to the radar sensor, grille cover or surrounding area.
- Do not subject the radar sensor or its surrounding area to a strong impact. If the radar sensor, front grille, or front bumper has been subjected to a strong impact, have the vehicle inspected by your Lexus dealer.
- Do not disassemble the radar sensor.
- Do not modify or paint the radar sensor or grille cover.
- If the radar sensor, front grille, or front bumper needs to be removed and installed, or replaced, contact your Lexus dealer.

■ To avoid malfunction of the front camera

Observe the following precautions.

Otherwise, the front camera may not operate properly, possibly leading to an accident resulting in death or serious injury.

- Keep the windshield clean at all times.
 - If the windshield is dirty or covered with an oily film, water droplets, snow, etc., clean the windshield.
 - If a glass coating agent is applied to the windshield, it will still be necessary to use the windshield wipers to remove water droplets, etc. from the area of the windshield in front of the front camera.
 - If the inner side of the windshield where the front camera is installed is dirty, contact your Lexus dealer.
- Do not attach objects, such as stickers, transparent stickers, etc., to the outer side of the windshield in front of the front camera (shaded area in the illustration).

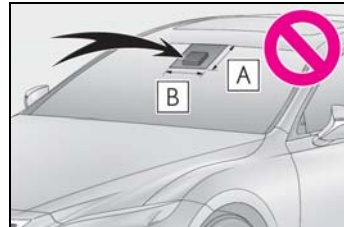

- A** From the top of the windshield to approximately 0.4 in. (1 cm) below the bottom of the front camera
- B** Approximately 7.9 in. (20 cm) (Approximately 4.0 in. [10 cm] to the right and left from the center of the front camera)

**WARNING**

- If the part of the windshield in front of the front camera is fogged up or covered with condensation, or ice, use the windshield defogger to remove the fog, condensation, or ice. (→P.314)

- If water droplets cannot be properly removed from the area of the windshield in front of the front camera by the windshield wipers, replace the wiper insert or wiper blade.

If the wiper inserts or wiper blades need to be replaced, contact your Lexus dealer.

- Do not attach window tint to the windshield.

- Replace the windshield if it is damaged or cracked.
If the windshield needs to be replaced, contact your Lexus dealer.

- Do not allow liquids to contact the front camera.

- Do not allow bright lights to shine into the front camera.

- Do not dirty or damage the front camera.

When cleaning the inside of the windshield, do not allow glass cleaner to contact the lens of the front camera. Also, do not touch the lens. If the lens is dirty or damaged, contact your Lexus dealer.

- Do not subject the front camera to a strong impact.

- Do not change the installation position or direction of the front camera or remove it.

- Do not disassemble the front camera.

- Do not modify any components of the vehicle around the front camera (inside rear view mirror, etc.) or ceiling.

- Do not attach any accessories to the hood, front grille or front bumper that may obstruct the front camera. Contact your Lexus dealer.

- If a surfboard or other long object is to be mounted on the roof, make sure that it will not obstruct the front camera.

- Do not modify the headlights or other lights.

■ Certification

FCC ID: HYQDNMWR009

NOTE:

This device complies with part 15 of the FCC Rules. Operation is subject to the following two conditions: (1) This device may not cause harmful interference, and (2) this device must accept any interference received, including interference that may cause undesired operation.

FCC WARNING:

Changes or modifications not expressly approved by the party responsible for compliance could void the user's authority to operate the equipment.

Radiofrequency radiation exposure Information:

This equipment complies with FCC radiation exposure limits set forth for an uncontrolled environment. This equipment should be installed and operated with minimum distance of 20 cm between the radiator (antenna) and your body. This transmitter must not be co-located or operating in conjunction with any other antenna or transmitter.

NOTE:

This device complies with Industry Canada's licence-exempt RSSs. Operation is subject to the following two conditions: (1) This device may not cause interference; and (2) This device must accept any interference, including interference that may cause undesired operation of the device.

This equipment complies with IC radiation exposure limits set forth for an uncontrolled environment and meets RSS-102 of the IC radio frequency (RF) Exposure rules. This equipment should be installed and operated keeping the radiator at least 20 cm or more away from person's body.

NOTE:

Le présent appareil est conforme aux CNR d'Industrie Canada applicables aux appareils radio exempts de licence. L'exploitation est autorisée aux deux conditions suivantes: (1) l'appareil ne doit pas produire de brouillage; (2) l'utilisateur de l'appareil doit accepter tout brouillage radioélectrique subi, même si le brouillage est susceptible d'en compromettre le fonctionnement.

Cet équipement est conforme aux limites d'exposition aux rayonnements énoncées pour un environnement non contrôlé et respecte les règles d'exposition aux fréquences radioélectriques (RF) CNR-102 de l'IC. Cet équipement doit être installé et utilisé en gardant une distance de 20 cm ou plus entre le dispositif rayonnant et le corps.

■ **If a warning message is displayed on the multi-information display**

A system may be temporarily unavailable or there may be a malfunction in the system.

- In the following situations, perform the actions specified in the table. When the normal operating conditions are detected, the message will disappear and the system will become operational.

If the message does not disappear, contact your Lexus dealer.

Situation	Actions
When the area around a sensor is covered with dirt, moisture (fogged up, covered with condensation, ice, etc.), or other foreign matter	To clean the part of the windshield in front of the front camera, use the windshield wipers or the windshield defogger of the air conditioning system (→P.314).
When the temperature around the front camera is outside of the operational range, such as when the vehicle is in the sun or in an extremely cold environment	If the front camera is hot, such as after the vehicle had been parked in the sun, use the air conditioning system to decrease the temperature around the front camera. If a sunshade was used when the vehicle was parked, depending on its type, the sunlight reflected from the surface of the sunshade may cause the temperature of the front camera to become excessively high.
	If the front camera is cold, such after the vehicle is parked in an extremely cold environment, use the air conditioning system to increase the temperature around the front camera.

Situation	Actions
The area in front of the front camera is obstructed, such as when the hood is open or a sticker is attached to the part of the windshield in front of the front camera.	Close the hood, remove the sticker, etc. to clear the obstruction.

- In the following situations, if the situation has changed (or the vehicle has been driven for some time) and the normal operating conditions are detected, the message will disappear and the system will become operational.
If the message does not disappear, contact your Lexus dealer.
- When the temperature around the radar sensor is outside of the operational range, such as when the vehicle is in the sun or in an extremely cold environment
- When the front camera cannot detect objects in front of the vehicle, such as when driving in the dark, snow, or fog, or when bright lights are shining into the front camera

**PCS (Pre-Collision System)
(vehicles with Lexus Safety
System + A)**

The pre-collision system uses a front radar sensor and front camera to detect vehicles and pedestrians/bicyclists in front of your vehicle and front side radar sensors to detect vehicles approaching from the front left or right side. When the system determines that the possibility of a frontal collision with a vehicle or pedestrian/bicyclist is high, a warning operates to urge the driver to take evasive action and the potential brake pressure is increased to help the driver avoid the collision. If the system determines that the possibility of a frontal collision with a vehicle or pedestrian/bicyclist is extremely high, the brakes are automatically applied to help avoid the collision or help reduce the impact of the collision.

The pre-collision system can be disabled/enabled and the warning timing can be changed. (→P.208)

System functions

■ **Pedestrian alert**

When the system determines that there is a possibility of a frontal collision with a stationary or moving pedestrian in front of your vehicle, a message will be displayed on the head-up display to warn the driver.

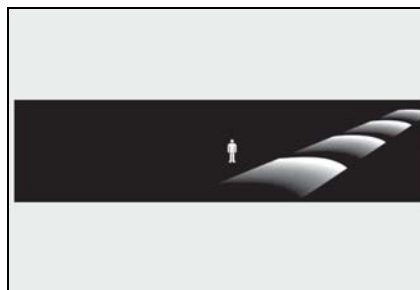

■ **Pre-collision warning**

When the system determines that the possibility of a frontal collision is high, a buzzer will sound and a warning message will be displayed on the multi-information display to urge the driver to take evasive action.

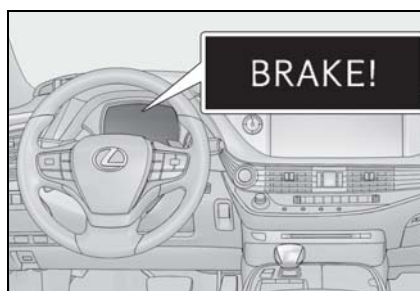

■ **Pre-collision brake assist**

When the system determines that the possibility of a frontal collision is high, the system applies greater braking force in relation to how strongly the brake pedal is depressed.

■ **Pre-collision braking**

If the system determines that the possibility of a frontal collision is extremely high, the brakes are automatically applied to help avoid the collision or reduce the impact of the collision.

■ **Active steering assist**

If the system determines that the possi-

bility of a collision with an object, such as a guardrail, or pedestrian is high, even though the brakes are applied, and that the collision may be avoidable through steering control, the system will steer the vehicle automatically to help avoid the collision or help reduce the impact of the collision.

■ Pre-collision seat belts (front seat only)

If the system determines that the possibility of a frontal collision is high, the system will retract the seat belts. Additionally, the system may retract the seat belts if the brakes are applied suddenly or control of the vehicle is lost.

■ Pre-collision seatbacks (front passenger's seat / power rear seat [if equipped])

If the system determines that the possibility of a frontal collision is high, it may move the seatbacks of the front passenger's seat and power rear seats to the upright position automatically, if reclined.

If a seat is being adjusted, it may not be moved by the pre-collision seat function.

■ Suspension control

When the system determines that the possibility of a frontal collision is high, the Adaptive Variable Suspension System (→P.295) will control the damping force of the shock absorbers to help maintain an appropriate vehicle posture.

■ Steering control

When the system determines that the possibility of a frontal collision is high

and the driver is operating the steering wheel, the LDH system (→P.295) will control the turning angle of the front and rear wheels and effort necessary to turn the steering wheel to help enhance steering responsiveness.

WARNING

■ Limitations of the pre-collision system

- The driver is solely responsible for safe driving. Always drive safely, taking care to observe your surroundings. Do not use the pre-collision system instead of normal braking operations under any circumstances. This system will not prevent collisions or lessen collision damage or injury in every situation. Do not overly rely on this system. Failure to do so may lead to an accident, resulting in death or serious injury.
- Although this system is designed to help avoid a collision or help reduce the impact of the collision, its effectiveness may change according to various conditions, therefore the system may not always be able to achieve the same level of performance. Read the following conditions carefully. Do not overly rely on this system and always drive carefully.
 - Conditions under which the system may operate even if there is no possibility of a collision: →P.210
 - Conditions under which the system may not operate properly: →P.212
- Do not attempt to test the operation of the pre-collision system yourself. Depending on the objects used for testing (dummies, cardboard objects imitating detectable objects, etc.), the system may not operate properly, possibly leading to an accident.

**WARNING****■ Pre-collision braking**

- When the pre-collision braking function is operating, a large amount of braking force will be applied.
- If the vehicle is stopped by the operation of the pre-collision braking function, the pre-collision braking function operation will be canceled after approximately 2 seconds. Depress the brake pedal as necessary.
- The pre-collision braking function may not operate if certain operations are performed by the driver. If the accelerator pedal is being depressed strongly or the steering wheel is being turned, the system may determine that the driver is taking evasive action and possibly prevent the pre-collision braking function from operating.
- In some situations, while the pre-collision braking function is operating, operation of the function may be canceled if the accelerator pedal is depressed strongly or the steering wheel is turned and the system determines that the driver is taking evasive action.
- If the brake pedal is being depressed, the system may determine that the driver is taking evasive action and possibly delay the operation timing of the pre-collision braking function.

■ Active steering assist

- The steering wheel may turn automatically when active steering assist is operating.
- As active steering assist operation will be canceled when the system determines that a collision has been avoided, operate the steering wheel as necessary.

- In the following situations, the system may determine that the driver is taking evasive action. In this case, the active steering assist may not operate or may be canceled.
 - If the accelerator pedal is being depressed strongly or the steering wheel is being operated. In this case the system may determine that the driver is taking evasive action and the pre-collision braking may not operate.
 - In some situations, while the active steering assist is operating, operation of the function may be canceled if the accelerator pedal is depressed strongly or the steering wheel is turned and the system determines that the driver is taking evasive action.
 - When the active steering assist is operating, if the steering wheel is held firmly or is operated in the opposite direction to that which the system is generating torque, the function may be canceled.
 - If the brake pedal is depressed, the system may determine that the driver is taking evasive action and the active steering assist operation may be delayed.

■ Pre-collision seat belts with comfort function

If the pre-collision seat belts have operated and the seat belts are locked in a retracted position, immediately stop the vehicle in a safe place, release and retract the seat belts to unlock them and then fasten them again.

Also, if a seat belt can be loosened, it can be unlocked by slightly retracting it without releasing it.

■ When to disable the pre-collision system

In the following situations, disable the system, as it may not operate properly, possibly leading to an accident resulting in death or serious injury:

- When the vehicle is being towed

⚠ WARNING

- When your vehicle is towing another vehicle
- When transporting the vehicle via truck, boat, train or similar means of transportation
- When the vehicle is raised on a lift with the engine running and the tires are allowed to rotate freely
- When inspecting the vehicle using a drum tester such as a chassis dynamometer or speedometer tester, or when using an on vehicle wheel balancer
- When a strong impact has been applied to the front bumper, rear bumper or front grille, due to an accident or other reasons
- If the vehicle cannot be driven in a stable manner, such as when the vehicle has been in an accident or is malfunctioning
- When the vehicle is driven in a sporty manner or off-road
- When the tires are not properly inflated
- When the tires are very worn
- When tires of a size other than specified are installed
- When tire chains are installed
- When a compact spare tire or an emergency tire puncture repair kit is used
- If equipment (snow plow, etc.) that may obstruct a radar sensor or the front camera is temporarily installed to the vehicle

Changing settings of the pre-collision system

■ **Enabling/disabling the pre-collision system**

The pre-collision system can be enabled/disabled on  (→P.80) of the multi-information display.

The system is automatically enabled each time the engine switch is turned to IGNITION ON mode.

If the system is disabled, the PCS warning light will turn on and a message will be displayed on the multi-information display.

If the pre-collision system is disabled, the pedestrian alert system will also be disabled. At this time, the FCTA (Front Cross Traffic Alert) (→P.222) system will also be disabled.



■ **Enabling/Disabling the pedestrian alert system**

The pedestrian alert can be enabled/disabled on  (→P.80) of the multi-information display. At this time, the FCTA (Front Cross Traffic Alert) system will also be enabled/disabled.

■ **Changing the pre-collision warning timing**

The pre-collision warning timing can be changed on  (→P.80) of the multi-information display. The warning timing for the pedestrian and FCTA (Front Cross Traffic Alert) system will also be changed.

The warning timing setting is retained when the engine switch is turned off. However, if the pre-collision system is disabled and re-enabled, the operation timing will return to the default setting (middle).

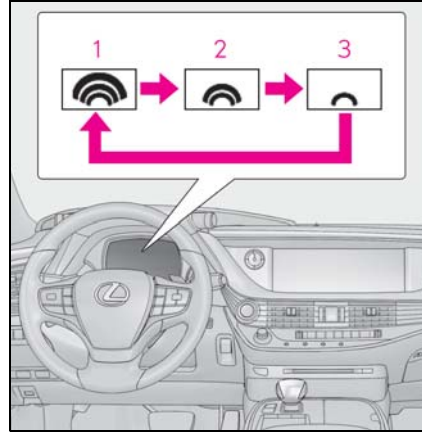

- 1 Early
- 2 Middle
This is the default setting.
- 3 Late

■ **Changing the pedestrian alert timing**

If the pre-collision warning timing is changed, the pedestrian alert and FCTA (Front Cross Traffic Alert) timing will also be changed accordingly.

■ **Operational conditions**

The pre-collision system is enabled and the system determines that the possibility of a frontal collision with a vehicle, pedestrian/bicyclist, guardrail, etc. or a front side collision with a vehicle is high. Each function is operational at the following speeds:

● Pedestrian alert

objects	Vehicle speed
Pedestrians	Approx. 20 to 40 mph (30 to 65 km/h)

● Pre-collision warning

objects	Vehicle speed	Relative speed between your vehicle and object
Preceding vehicles	Approx. 3 to 110 mph (5 to 180 km/h)	Approx. 3 to 110 mph (5 to 180 km/h)
Bicyclists and pedestrians	Approx. 3 to 50 mph (5 to 80 km/h)	Approx. 3 to 50 mph (5 to 80 km/h)

objects	Vehicle speed	Approaching vehicle speed
Vehicles approaching from the front left or right side	Approx. 7 to 37 mph (10 to 60 km/h)	Approx. 10 to 37 mph (15 to 60 km/h)

● Pre-collision brake assist

objects	Vehicle speed	Relative speed between your vehicle and object
Preceding vehicles	Approx. 20 to 110 mph (30 to 180 km/h)	Approx. 20 to 110 mph (30 to 180 km/h)
Bicyclists and pedestrians	Approx. 20 to 50 mph (30 to 80 km/h)	Approx. 20 to 50 mph (30 to 80 km/h)

objects	Vehicle speed	Approaching vehicle speed
Vehicles approaching from the front left or right side	Approx. 19 to 37 mph (30 to 60 km/h)	Approx. 10 to 37 mph (15 to 60 km/h)

● Pre-collision braking

objects	Vehicle speed	Relative speed between your vehicle and object
Preceding vehicles	Approx. 3 to 110 mph (5 to 180 km/h)	Approx. 3 to 110 mph (5 to 180 km/h)
Bicyclists and pedestrians	Approx. 3 to 50 mph (5 to 80 km/h)	Approx. 3 to 50 mph (5 to 80 km/h)

● Active steering assist

objects	Vehicle speed
Pedestrians	Approx. 25 to 40 mph (40 to 65 km/h)
Guardrail	Approx. 37 to 50 mph (60 to 80 km/h)

The system may not operate in the following situations:

- If a battery terminal has been disconnected and reconnected and then the vehicle has not been driven for a certain amount of time
- If the shift position is in R
- If VSC is disabled (only the pedestrian alert and pre-collision warning function will be operational)
- When there is insufficient safe or unobstructed space for the vehicle to be steered into
- When an object is approaching the area the vehicle is to be steered into

■ **Vehicle, pedestrian or bicyclist detection function**

The pre-collision system detects vehicles, pedestrians and bicyclists based on the size, profile, and motion of the person. However,

a vehicle, pedestrian or bicyclist may not be detected depending on the surrounding brightness and the motion, posture, and angle of the person, preventing the system from operating properly. (→P.212)
The illustration shows an image of vehicles, pedestrians and bicyclists.

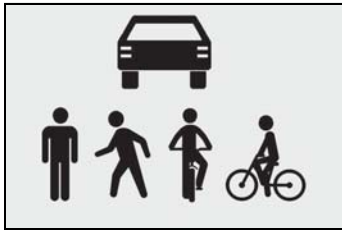

■ Cancellation of pre-collision braking and active steering assist

If either of the following occur while the pre-collision braking function is operating, it will be canceled:

- The accelerator pedal is depressed strongly.
- The steering wheel is turned sharply or abruptly.

■ Conditions under which the system may operate even if there is no possibility of a collision

- In some situations such as the following, the system may determine that there is a possibility of a frontal collision and operate.
- When passing a vehicle, pedestrian or bicyclist
- When changing lanes while overtaking a vehicle, pedestrian or bicyclist
- When approaching a vehicle, pedestrian or bicyclist in an adjacent lane or on the roadside, such as when changing the course of travel or driving on a winding road

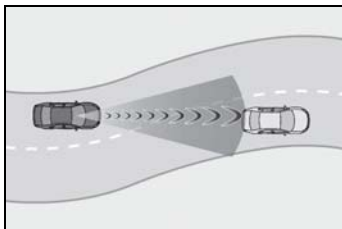

- When rapidly closing on a vehicle,

pedestrian, bicyclist, etc.

- When approaching objects on the roadside, such as vehicle, pedestrian, bicyclist, guardrails, traffic signs, utility poles, street lights, trees, walls, etc.
- When there is a vehicle, pedestrian, bicyclist or object by the roadside at the entrance of a curve

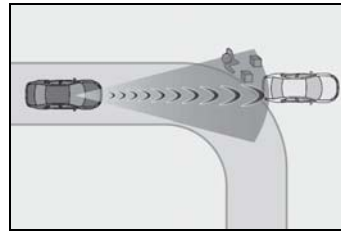

- When there are patterns or paint in front of your vehicle that may be mistaken for a vehicle, pedestrian or bicyclist
- When the front of your vehicle is hit by water, snow, dust, etc.
- When overtaking a vehicle, pedestrian or bicyclist that is changing lanes or making a right/left turn

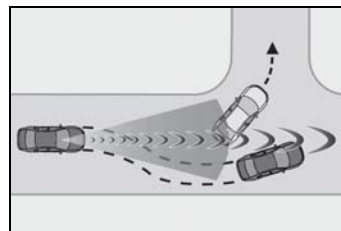

- When passing a vehicle, pedestrian or bicyclist in an oncoming lane that is stopped to make a right/left turn

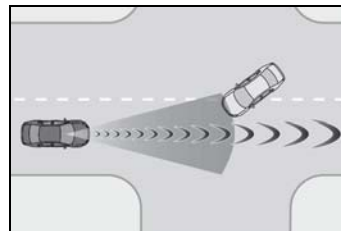

- When a vehicle, pedestrian or bicyclist approaches very close and then stops before entering the path of your vehicle
- If the front of your vehicle is raised or lowered, such as when on an uneven or undulating road surface

- When driving on a road surrounded by a structure, such as in a tunnel or on an iron bridge
- When there is a metal object (manhole cover, steel plate, etc.), steps, dips, or a protrusion on the road surface or road-side
- When a crossing pedestrian or bicyclist approaches very close to the vehicle

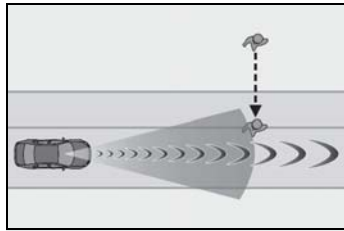

- When passing through a place with a low structure above the road such as a low ceiling, underpass, bridge girder, traffic sign, etc.

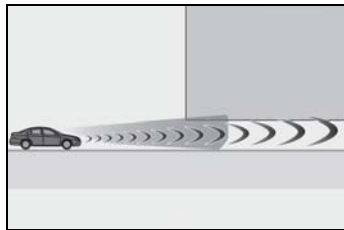

- When passing under an object (road sign, billboard, etc.)

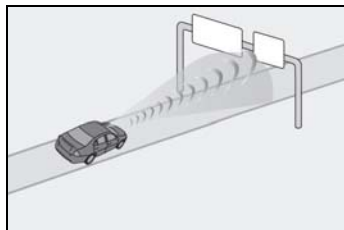

- When approaching an electric toll gate barrier, parking area barrier, or other barrier that opens and closes
- When using an automatic car wash
- When driving through or under objects that may contact the vehicle, such as thick grass, tree branches, or a banner

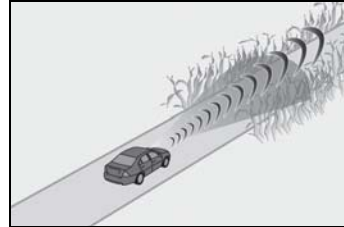

- When driving through steam or smoke
- When driving near an object that reflects radio waves, such as a large truck or guardrail
- When driving near a TV tower, broadcasting station, electric power plant, or other location where strong radio waves or electrical noise may be present
- When passing an oncoming vehicle on a narrow road
- When driving close to objects such as walls or poles on a median
- When passing an oncoming vehicle around a sharp curve
- When passing a vehicle which is making a left/right turn

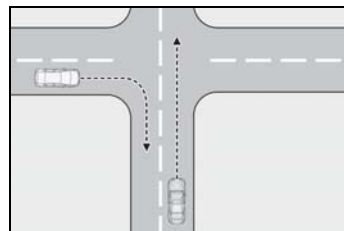

- When being passed by a vehicle approaching from the left or right side in front of your vehicle

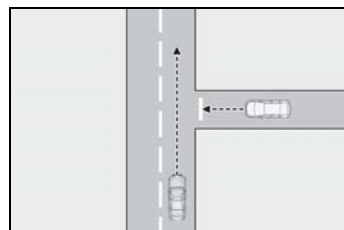

- When making a left/right turn while a vehicle is approaching from the left or right side in front of your vehicle

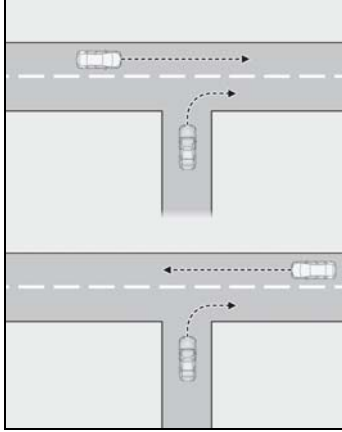

- When passing an object on the side of the road, such as a parked vehicle
- When passing an oncoming vehicle on a S curve
- When there is an object that may be mistaken for a pedestrian, such as a utility pole, tree, or pole on the roadside or at the entrance of a curve
- When there is a bicycle or motorcycle on the roadside at the entrance of a curve
- If the preceding vehicle is a bicycle or motorcycle
- The system may operate the pedestrian alert unnecessarily if it detects the following:
 - Pedestrians on a sidewalk
 - Bicycles and motorcycles
 - Patterns or paint on the road, a wall, median, billboard, etc. that may be mistaken for a pedestrian or bicyclist

■ **Situations in which the system may not operate properly**

- In some situations, such as the following, a vehicle, pedestrian or bicyclist may not be detected by the sensors, preventing the system from operating properly:
 - When a vehicle, pedestrian or bicyclist is approaching your vehicle
 - When your vehicle or a vehicle, pedestrian or bicyclist is wobbling
 - If a vehicle, pedestrian or bicyclist makes an abrupt maneuver (such as sudden swerving, acceleration or deceleration)
 - When your vehicle approaches a vehicle, pedestrian or bicyclist rapidly
 - When a vehicle, pedestrian or bicyclist is

not directly in front of your vehicle

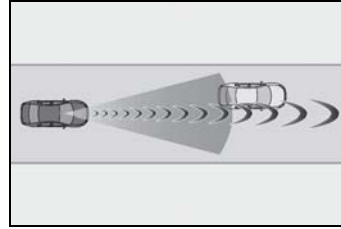

- When a vehicle, pedestrian or bicyclist is near a wall, fence, guardrail, manhole cover, vehicle, steel plate on the road, etc.
- When a vehicle, pedestrian or bicyclist is under a structure
- When part of a vehicle, pedestrian or bicyclist is hidden by an object, such as large baggage, an umbrella, or guardrail
- When multiple vehicles, pedestrians or bicyclists are close together
- If the sun or other light is shining directly on a vehicle, pedestrian, bicyclist or guardrail ahead
- When a vehicle, pedestrian or bicyclist is a shade of white and looks extremely bright
- When a vehicle, pedestrian or bicyclist appears to be nearly the same color or brightness as its surroundings
- If a vehicles, pedestrians or bicyclists cuts or suddenly emerges in front of your vehicle
- When the front of your vehicle is hit by water, snow, dust, etc.
- When a very bright light ahead, such as the sun or the headlights of oncoming traffic, shines directly into the front camera
- When approaching the side or front of a vehicle ahead
- If a vehicle ahead is a motorcycle
- If a vehicle ahead is narrow, such as a personal mobility vehicle
- If a preceding vehicle has a small rear end, such as an unloaded truck
- If a preceding vehicle has a low rear end, such as a low bed trailer



- If a vehicle ahead has extremely high ground clearance

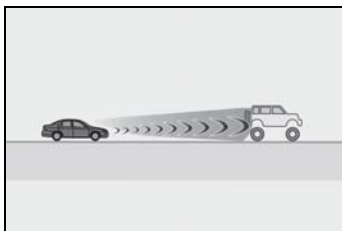

- If a vehicle ahead is carrying a load which protrudes past its rear bumper
- If a vehicle ahead is irregularly shaped, such as a tractor or side car
- If a vehicle ahead is a child sized bicycle, a bicycle that is carrying a large load, a bicycle ridden by more than one person, or a uniquely shaped bicycle (bicycle with a child seat, tandem bicycle, etc.)
- If a pedestrian/or the riding height of a bicyclist ahead is shorter than approximately 3.2 ft. (1 m) or taller than approximately 6.5 ft. (2 m)
- If a pedestrian/bicyclist is wearing oversized clothing (a rain coat, long skirt, etc.), making their silhouette obscure
- If a pedestrian is bending forward or squatting or bicyclist is bending forward
- If a pedestrian/bicyclist is moving fast
- If a pedestrian is pushing a stroller, wheelchair, bicycle or other vehicle
- When driving in inclement weather such as heavy rain, fog, snow or a sandstorm
- When driving through steam or smoke
- When the surrounding area is dim, such as at dawn or dusk, or while at night or in a tunnel, making a vehicle, pedestrian or bicyclist appear to be nearly the same color as its surroundings
- When driving in a place where the surrounding brightness changes suddenly, such as at the entrance or exit of a tunnel
- When driving in a location where there

are many objects which reflect radar, such as a tunnel or parking garage

- After the engine has started the vehicle has not been driven for a certain amount of time
- While making a left/right turn and for a few seconds after making a left/right turn
- While driving on a curve and for a few seconds after driving on a curve
- If your vehicle is skidding
- If the front of the vehicle is raised or lowered

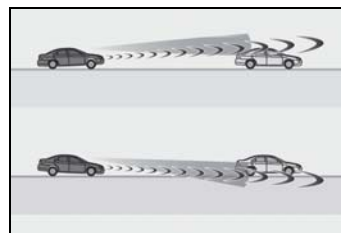

- If the wheels are misaligned
- If a wiper blade is blocking the front camera
- The vehicle is being driven at extremely high speeds.
- When driving on a hill
- If the radar sensor or front camera is misaligned
- If the headlights are misaligned
- When approaching a guardrail at a wide or narrow angle
- When a vehicle approaches your vehicle from the front left or right side while your vehicle is entering an intersection with poor visibility
- When a vehicle approaches your vehicle from the rear left or right side
- When a vehicle approaches the side of your vehicle at a shallow angle
- When driving on a road with a grade that changes sharply (sharp incline/decline)
- Pedestrians and bicyclists which are not illuminated by the headlights at night, in a tunnel, etc.
- Pedestrians and bicyclists which change speed or direction abruptly
- Pedestrians and bicyclists which suddenly emerge from behind a vehicle or large object
- Pedestrians and bicyclists which are extremely close to the side of the vehicle (outside rear view mirror, etc.)

- In some situations, such as the following, the sensors may not detect the lane lines or a safe space the vehicle can be steered into, preventing the active steering assist from operating properly:
 - When the white (yellow) lane lines are difficult to see, such as when they are faint, diverging/merging, or a shadow is cast upon them
 - When the lane is more wide or narrow than normal
 - When there is a light and dark pattern on the road surface, such as due to road repairs
 - If the system determines that a collision can be avoided by only using the brakes
 - When a pedestrian is detected near the centerline of the vehicle
 - In some situations such as the following, sufficient braking force or steering force may not be obtained, preventing the system from performing properly:
 - If the braking functions cannot operate to their full extent, such as when the brake parts are extremely cold, extremely hot, or wet
 - If the vehicle is not properly maintained (brakes or tires are excessively worn, improper tire inflation pressure, etc.)
 - When the vehicle is being driven on a gravel road or other slippery surface
 - If there are deep ruts in the road
 - When driving on a slope
 - When driving on a horizontally slanted road
 - Some guardrails, such as the following, may not be detected by the sensors, preventing the system from operating properly:
 - Guardrails which are less than approximately 1.9 ft. (60 cm) tall
 - Short guardrails
 - Irregularly-shaped guardrails (wire cable guardrails, guardrails made of thin poles, etc.)
 - Guardrails which are not illuminated by the headlights at night, in a tunnel, etc.
 - Guardrails which appear to be nearly the same color or brightness as their surroundings
 - Guardrails which appear to be nearly the same shape as their surroundings (walls, etc.)
 - Guardrails which are over a metal object (manhole cover, steel plate, etc.)
 - Guardrails which are hidden behind thick grass
 - Guardrails which are extremely close to the side of the vehicle (outside rear view mirror, etc.)
 - Curved guardrails or guardrails at the entrance of a curve
 - In some situations such as the following, the system may detect a pedestrian and display a warning on the head-up display, even though no pedestrian exists:
 - If the front of the vehicle is raised or lowered, such as when the road surface is uneven or undulating (due to ruts, etc.)
 - When driving on a slope
 - When driving on a horizontally slanted road
 - If the driver's posture (driver seat position) is extreme, such as excessively reclined
 - If the head-up display position is set extremely high
- **If VSC is disabled**
- If VSC is disabled (→P.294), the pre-collision brake assist and pre-collision braking functions are also disabled.
 - The PCS warning light will turn on and "VSC Turned Off Pre-Collision Brake System Unavailable" will be displayed on the multi-information display.

PCS (Pre-Collision System) (vehicles with Lexus Safety System + 2.0)

The pre-collision system uses a radar sensor and front camera to detect objects (→P.215) in front of the vehicle. When the system determines that the possibility of a frontal collision with an object is high, a warning operates to urge the driver to take evasive action and the potential brake pressure is increased to help the driver avoid the collision. If the system determines that the possibility of a frontal collision with an object is extremely high, the brakes are automatically applied to help avoid the collision or help reduce the impact of the collision.

The pre-collision system can be disabled/enabled and the warning timing can be changed. (→P.217)

Detectable objects

The system can detect the following:

- Vehicles
- Bicyclists
- Pedestrians

System functions

■ Pre-collision warning

When the system determines that the possibility of a frontal collision is high, a buzzer will sound and a warning mes-

sage will be displayed on the multi-information display to urge the driver to take evasive action.

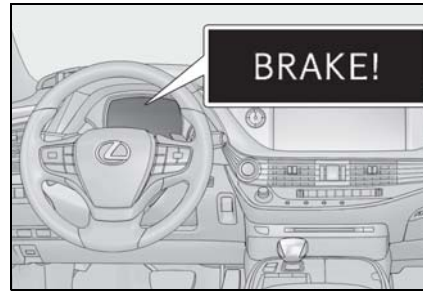

■ Pre-collision brake assist

When the system determines that the possibility of a frontal collision is high, the system applies greater braking force in relation to how strongly the brake pedal is depressed.

■ Pre-collision braking

If the system determines that the possibility of a frontal collision is extremely high, the brakes are automatically applied to help avoid the collision or reduce the impact of the collision.

■ Pre-collision seatbacks (front passenger's seat / power rear seat [if equipped])

If the system determines that the possibility of a frontal collision is high, it may move the seatbacks of the front passenger's seat and power rear seats to the upright position automatically, if reclined.

If a seat is being adjusted, it may not be moved by the pre-collision seat function.

■ Suspension control

When the system determines that the possibility of a frontal collision is high,

the Adaptive Variable Suspension System (→P.295) will control the damping force of the shock absorbers to help maintain an appropriate vehicle posture.

■ **Steering control**

When the system determines that the possibility of a frontal collision is high and the driver is operating the steering wheel, the LDH system (→P.295) will control the turning angle of the front and rear wheels and effort necessary to turn the steering wheel to help enhance steering responsiveness.

 **WARNING**

■ **Limitations of the pre-collision system**

- The driver is solely responsible for safe driving. Always drive safely, taking care to observe your surroundings. Do not use the pre-collision system instead of normal braking operations under any circumstances. This system will not prevent collisions or lessen collision damage or injury in every situation. Do not overly rely on this system. Failure to do so may lead to an accident, resulting in death or serious injury.
- Although this system is designed to help avoid a collision or help reduce the impact of the collision, its effectiveness may change according to various conditions, therefore the system may not always be able to achieve the same level of performance. Read the following conditions carefully. Do not overly rely on this system and always drive carefully.
 - Conditions under which the system may operate even if there is no possibility of a collision: →P.219
 - Conditions under which the system may not operate properly: →P.220

- Do not attempt to test the operation of the pre-collision system yourself. Depending on the objects used for testing (dummies, cardboard objects imitating detectable objects, etc.), the system may not operate properly, possibly leading to an accident.

■ **Pre-collision braking**

- When the pre-collision braking function is operating, a large amount of braking force will be applied.
- If the vehicle is stopped by the operation of the pre-collision braking function, the pre-collision braking function operation will be canceled after approximately 2 seconds. Depress the brake pedal as necessary.
- The pre-collision braking function may not operate if certain operations are performed by the driver. If the accelerator pedal is being depressed strongly or the steering wheel is being turned, the system may determine that the driver is taking evasive action and possibly prevent the pre-collision braking function from operating.
- In some situations, while the pre-collision braking function is operating, operation of the function may be canceled if the accelerator pedal is depressed strongly or the steering wheel is turned and the system determines that the driver is taking evasive action.
- If the brake pedal is being depressed, the system may determine that the driver is taking evasive action and possibly delay the operation timing of the pre-collision braking function.

■ **When to disable the pre-collision system**

In the following situations, disable the system, as it may not operate properly, possibly leading to an accident resulting in death or serious injury:

- When the vehicle is being towed

⚠ WARNING

- When your vehicle is towing another vehicle
- When transporting the vehicle via truck, boat, train or similar means of transportation
- When the vehicle is raised on a lift with the engine running and the tires are allowed to rotate freely
- When inspecting the vehicle using a drum tester such as a chassis dynamometer or speedometer tester, or when using an on vehicle wheel balancer
- When a strong impact is applied to the front bumper or front grille, due to an accident or other reasons
- If the vehicle cannot be driven in a stable manner, such as when the vehicle has been in an accident or is malfunctioning
- When the vehicle is driven in a sporty manner or off-road
- When the tires are not properly inflated
- When the tires are very worn
- When tires of a size other than specified are installed
- When tire chains are installed
- When a compact spare tire or an emergency tire puncture repair kit is used
- If equipment (snow plow, etc.) that may obstruct the radar sensor or front camera is temporarily installed to the vehicle

Changing settings of the pre-collision system**■ Enabling/disabling the pre-collision system**

The pre-collision system can be enabled/disabled on  (→P.80) of the multi-information display.

The system is automatically enabled each time the engine switch is turned to IGNITION ON mode.

If the system is disabled, the PCS warning light will turn on and a message will be displayed on the multi-information display.

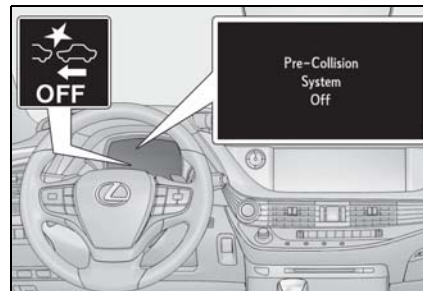
**■ Changing the pre-collision warning timing**

The pre-collision warning timing can be changed on  (→P.80) of the multi-information display.

The warning timing setting is retained when the engine switch is turned off. However, if the pre-collision system is disabled and re-enabled, the operation timing will return to the default setting (middle).

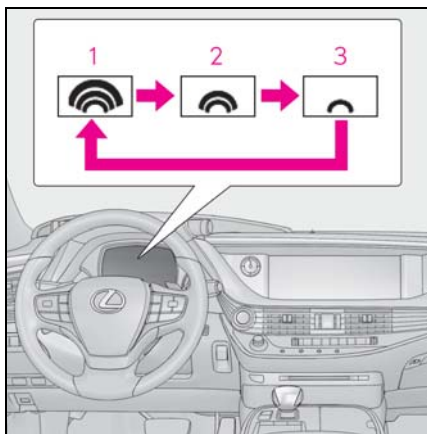

- 1 Early
 - 2 Middle
 - 3 Late
- This is the default setting.

■ Operational conditions

The pre-collision system is enabled and the system determines that the possibility of a frontal collision with a detected object is high. Each function is operational at the following speed

● Pre-collision warning

Detectable objects	Vehicle speed	Relative speed between your vehicle and object
Vehicles	Approx. 7 to 110 mph (10 to 180 km/h)	Approx. 7 to 110 mph (10 to 180 km/h)
Bicyclists and pedestrians	Approx. 7 to 50 mph (10 to 80 km/h)	Approx. 7 to 50 mph (10 to 80 km/h)

● Pre-collision brake assist

Detectable objects	Vehicle speed	Relative speed between your vehicle and object
Vehicles	Approx. 20 to 110 mph (30 to 180 km/h)	Approx. 20 to 110 mph (30 to 180 km/h)
Bicyclists and pedestrians	Approx. 20 to 50 mph (30 to 80 km/h)	Approx. 20 to 50 mph (30 to 80 km/h)

● Pre-collision braking

Detectable objects	Vehicle speed	Relative speed between your vehicle and object
Vehicles	Approx. 7 to 110 mph (10 to 180 km/h)	Approx. 7 to 110 mph (10 to 180 km/h)
Bicyclists and pedestrians	Approx. 7 to 50 mph (10 to 80 km/h)	Approx. 7 to 50 mph (10 to 80 km/h)

The system may not operate in the following situations:

- If a battery terminal has been disconnected and reconnected and then the vehicle has not been driven for a certain amount of time
- If the shift position is in R
- When the VSC OFF indicator is illuminated (only the pre-collision warning function will be operational)

■ Object detection function

The system detects objects based on their size, profile, motion, etc. However, an object may not be detected depending on the surrounding brightness and the motion, posture, and angle of the detected object, preventing the system from operating properly. (→P.220)

The illustration shows an image of detectable objects.



■ Cancellation of the pre-collision braking

If either of the following occur while the pre-collision braking function is operating, it will be canceled:

- The accelerator pedal is depressed strongly.
- The steering wheel is turned sharply or abruptly.

■ Conditions under which the system may operate even if there is no possibility of a collision

- In some situations such as the following, the system may determine that there is a

possibility of a frontal collision and operate.

- When passing a detectable object, etc.
- When changing lanes while overtaking a detectable object, etc.
- When approaching a detectable object in an adjacent lane or on the roadside, such as when changing the course of travel or driving on a winding road

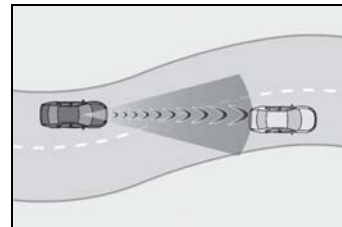

- When rapidly closing on a detectable object, etc.
- When approaching objects on the roadside, such as detectable objects, guardrails, utility poles, trees, or walls
- When there is detectable object or other object by the roadside at the entrance of a curve

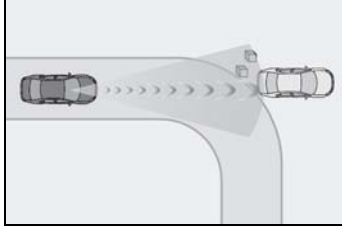

- When there are patterns or paint in front of your vehicle that may be mistaken for a detectable object
- When the front of your vehicle is hit by water, snow, dust, etc.
- When overtaking a detectable object that is changing lanes or making a right/left turn

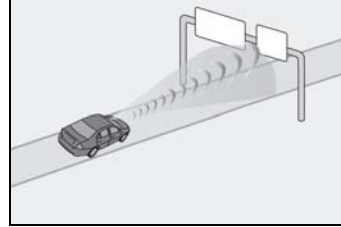

- When approaching an electric toll gate barrier, parking area barrier, or other barrier that opens and closes
- When using an automatic car wash
- When driving through or under objects that may contact your vehicle, such as thick grass, tree branches, or a banner

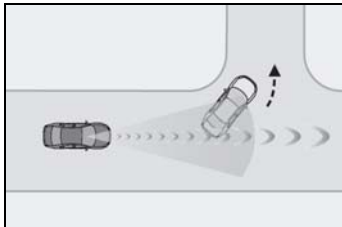

- When passing a detectable object in an oncoming lane that is stopped to make a right/left turn

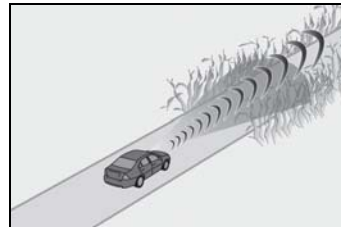

- When driving through steam or smoke
- When driving near an object that reflects radio waves, such as a large truck or guardrail
- When driving near a TV tower, broadcasting station, electric power plant, or other location where strong radio waves or electrical noise may be present

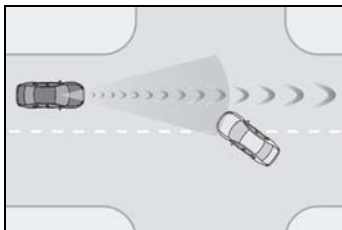

- When a detectable object approaches very close and then stops before entering the path of your vehicle
- If the front of your vehicle is raised or lowered, such as when on an uneven or undulating road surface
- When driving on a road surrounded by a structure, such as in a tunnel or on an iron bridge
- When there is a metal object (manhole cover, steel plate, etc.), steps, or a protrusion in front of your vehicle
- When passing under an object (road sign, billboard, etc.)

■ Situations in which the system may not operate properly

- In some situations such as the following, an object may not be detected by the radar sensor and front camera, preventing the system from operating properly:
 - When a detectable object is approaching your vehicle
 - When your vehicle or a detectable object is wobbling
 - If a detectable object makes an abrupt maneuver (such as sudden swerving, acceleration or deceleration)
 - When your vehicle approaches a detectable object rapidly
 - When a detectable object is not directly in front of your vehicle

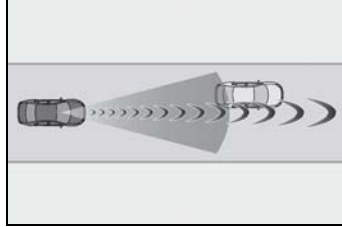

- When a detectable object is near a wall, fence, guardrail, manhole cover, vehicle, steel plate on the road, etc.
- When a detectable object is under a structure
- When part of a detectable object is hidden by an object, such as large baggage, an umbrella, or guardrail
- When multiple detectable objects are close together
- If the sun or other light is shining directly on a detectable object
- When a detectable object is a shade of white and looks extremely bright
- When a detectable object appears to be nearly the same color or brightness as its surroundings
- If a detectable object cuts or suddenly emerges in front of your vehicle
- When the front of your vehicle is hit by water, snow, dust, etc.
- When a very bright light ahead, such as the sun or the headlights of oncoming traffic, shines directly into the front camera
- When approaching the side or front of a vehicle ahead
- If a vehicle ahead is a motorcycle
- If a vehicle ahead is narrow, such as a personal mobility vehicle
- If a preceding vehicle has a small rear end, such as an unloaded truck
- If a preceding vehicle has a low rear end, such as a low bed trailer

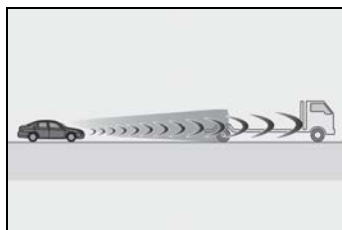

- If a vehicle ahead has extremely high

ground clearance

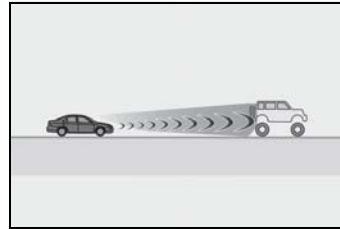

- If a vehicle ahead is carrying a load which protrudes past its rear bumper
- If a vehicle ahead is irregularly shaped, such as a tractor or side car
- If a vehicle ahead is a child sized bicycle, a bicycle that is carrying a large load, a bicycle ridden by more than one person, or a uniquely shaped bicycle (bicycle with a child seat, tandem bicycle, etc.)
- If a pedestrian/or the riding height of a bicyclist ahead is shorter than approximately 3.2 ft. (1 m) or taller than approximately 6.5 ft. (2 m)
- If a pedestrian/bicyclist is wearing oversized clothing (a rain coat, long skirt, etc.), making their silhouette obscure
- If a pedestrian is bending forward or squatting or bicyclist is bending forward
- If a pedestrian/bicyclist is moving fast
- If a pedestrian is pushing a stroller, wheelchair, bicycle or other vehicle
- When driving in inclement weather such as heavy rain, fog, snow or a sandstorm
- When driving through steam or smoke
- When the surrounding area is dim, such as at dawn or dusk, or while at night or in a tunnel, making a detectable object appear to be nearly the same color as its surroundings
- When driving in a place where the surrounding brightness changes suddenly, such as at the entrance or exit of a tunnel
- After the engine has started the vehicle has not been driven for a certain amount of time
- While making a left/right turn and for a few seconds after making a left/right turn
- While driving on a curve and for a few seconds after driving on a curve
- If your vehicle is skidding
- If the front of the vehicle is raised or lowered

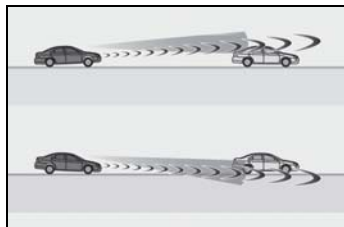

- If the wheels are misaligned
 - If a wiper blade is blocking the front camera
 - The vehicle is being driven at extremely high speeds
 - When driving on a hill
 - If the radar sensor or front camera is misaligned
- In some situations such as the following, sufficient braking force may not be obtained, preventing the system from performing properly:
 - If the braking functions cannot operate to their full extent, such as when the brake parts are extremely cold, extremely hot, or wet
 - If the vehicle is not properly maintained (brakes or tires are excessively worn, improper tire inflation pressure, etc.)
 - When the vehicle is being driven on a gravel road or other slippery surface
- **If VSC is disabled**
- If VSC is disabled (→P.296), the pre-collision brake assist and pre-collision braking functions are also disabled.
 - The PCS warning light will turn on and “VSC Turned Off Pre-Collision Brake System Unavailable” will be displayed on the multi-information display.

FCTA (Front Cross Traffic Alert)*

*: If equipped

When approaching an intersection at low speed, the radar sensors on the front side of the vehicle can detect approaching vehicles to the left and right of the front of the vehicle. In this case, the head-up display is used to inform the driver of detected vehicles.

FCTA system functions

When the system detects a vehicle approaching from the left or right in front of your vehicle when approaching an intersection, a notification will be displayed on the head-up display and panoramic view monitor*.

*: Refer to “NAVIGATION AND MULTI-MEDIA SYSTEM OWNER'S MANUAL”.

When the system determines that your vehicle may be about to enter an intersection even though a vehicle is approaching from the left or right in front of your vehicle, a buzzer will sound and a message will be displayed on the multi-information display to urge you to depress the brake pedal.

- Head-up display

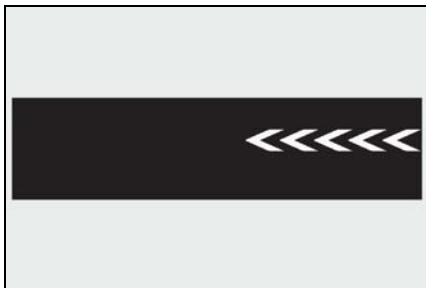

● Multi-information display



⚠ WARNING

■ **Cautions regarding the use of the function**

The driver is solely responsible for safe driving. Always drive safely, taking care to observe your surroundings.

The FCTA system is a supplementary system that informs the driver of vehicles approaching from the left and right of the front of the vehicle.

Do not overly rely on the FCTA system. Over reliance on the system may lead to an accident, resulting in death or serious injury.

The details of the warning display may differ from the actual traffic conditions.

Although the warning display will stop being displayed after a certain amount of time, this does not indicate that vehicles or pedestrians are no longer around your vehicle.

■ **The FCTA function is operational when**

The system operates when all of the following conditions are met.

- Setting for “PCS” and “CAUTION” in  (→P.80) of the multi-information display are set to “ON”.
- A shift position other than P or R is selected.
- Vehicle speed is approximately 9 mph (15 km/h) or lower.
- A vehicle is approaching from the left or right in front of your vehicle at a speed between approximately 6 mph (10 km/h) and 37 mph (60 km/h).
- There are no preceding vehicles ahead of your vehicle.
- The accelerator pedal is not strongly depressed.
- The brake pedal is not being strongly depressed.
- **Situations in which the system may operate even though no vehicles are approaching**

In certain situations, such as the following, the system may operate even though no vehicles are approaching:

- When approaching objects on the road-side, such as guardrails, traffic signs, utility poles, street lights, trees, or walls
- When driving near a TV tower, broadcasting station, electric power plant, or other location where strong radio waves or electrical noise may be present
- When passing an object on the side of the road, such as a parked vehicle
- When a vehicle or pedestrian is approaching from the left or right in front of your vehicle from far away
- When a vehicle or pedestrian is moving within a parking spot, etc. next to the lane your vehicle is driving in
- When a pedestrian or bicyclist is moving on a sidewalk
- When a vehicle or pedestrian is moving away from your vehicle
- When a vehicle approaching from the left or right in front of your vehicle is decelerating or stops
- When a vehicle approaching from the left or right in front of your vehicle makes a

left/right turn immediately in front of your vehicle

- When a pedestrian is approaching your vehicle
- When an oncoming vehicle makes a left/right turn
- When your vehicle enters an intersection before a vehicle approaching from the left or right in front of your vehicle
- When stopped at traffic light and a vehicle approaches from the left or right in front of your vehicle
- When driving in a location where there are objects which reflect radar, such as vehicles, guardrails, walls, traffic signs, etc.
- When making a left/right turn in front of an approaching vehicle

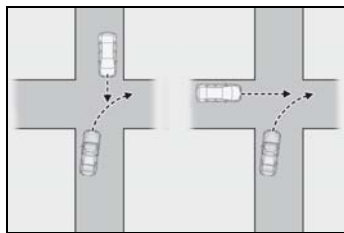

- When passing an oncoming vehicle
- When being overtaken by another vehicle
- When driving next to another vehicle or a pedestrian
- When a vehicle or pedestrian approaches the side of your vehicle

Some objects, such as the following, may be detected and cause the FCTA system to operate:

- Pedestrians

■ **Situations in which the system may not operate properly**

In some situations, such as the following, a vehicle may not be detected by a front side radar sensor, preventing the system from operating properly:

- If the front end or side of an approaching vehicle is small (sports cars, etc.)
- If the front end of an approaching vehicle

is low (low-slung sports cars, etc.)

- If the ground clearance of an approaching vehicle is extremely high
- If the shape of an approaching vehicle is unusual (tractors, motorcycles with side-cars, etc.)
- If a vehicle suddenly enters the detection area on the left or right in front of your vehicle from a parking lot, etc.

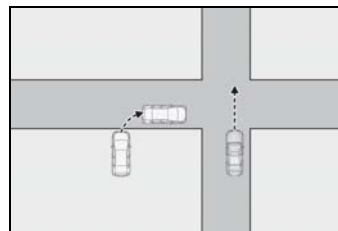

- If an approaching vehicle moves suddenly (sudden steering, acceleration, deceleration, etc.)
- When driving in inclement weather such as heavy rain, fog, snow or a sandstorm
- After the engine has been started and the vehicle has not been driven for a certain amount of time
- When driving on a road with a grade that changes sharply (sharp incline/decline)
- When driving around a sharp curve or on an undulating road
- If a vehicle is approaching from the left or right of the front of your vehicle diagonally
- When a vehicle is approaching from the left or right in front of your vehicle from far away
- When there is an object between your vehicle and an approaching vehicle
- When driving in a location where there are objects which reflect radar, such as guardrails, walls, vehicles, etc.
- When a group of vehicles which are close together approach
- Immediately after the FCTA system has been enabled

- If the PCS warning light illuminates and a message is displayed on the multi-information display

The system may be temporarily unavailable or may be malfunctioning.

LTA (Lane Tracing Assist)

When driving on highways and freeways with white (yellow) lane lines, this function alerts the driver when the vehicle might depart from its lane or course* and provides assistance by operating the steering wheel to keep the vehicle in its lane or course*. Furthermore, the system provides steering assistance when dynamic radar cruise control with full-speed range is operating to keep the vehicle in its lane and when changing lanes (vehicles with Lexus Safety System + A).

The LTA system recognizes white (yellow) lane lines or a course* using the front camera. Additionally, it detects preceding and surrounding vehicles (vehicles with Lexus Safety System + A) using the front camera and radar.

* : Boundary between asphalt and the side of the road, such as grass, soil, or a curb

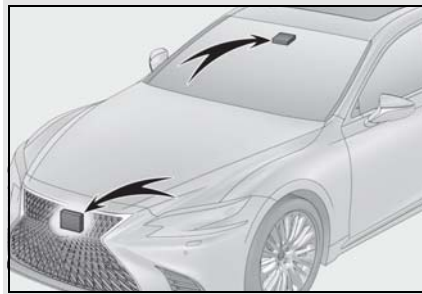

**WARNING****■ Before using LTA system**

Do not rely solely upon the LTA system. The LTA system does not automatically drive the vehicle or reduce the amount of attention that must be paid to the area in front of the vehicle. The driver must always assume full responsibility for driving safely by paying careful attention to the surrounding conditions and operating the steering wheel to correct the path of the vehicle. Also, the driver must take adequate breaks when fatigued, such as from driving for a long period of time.

Failure to perform appropriate driving operations and pay careful attention may lead to an accident, resulting in death or serious injury.

■ Situations unsuitable for LTA system

In the following situations, use the LTA switch to turn the system off. Failure to do so may lead to an accident, resulting in death or serious injury.

- Vehicle is driven on a road surface which is slippery due to rainy weather, fallen snow, freezing, etc.
- Vehicle is driven on a snow-covered road.
- White (yellow) lines are difficult to see due to rain, snow, fog, dust, etc.
- Vehicle is driven in a temporary lane or restricted lane due to construction work.
- Vehicle is driven in a construction zone.
- A spare tire, tire chains, etc. are equipped.
- When the tires have been excessively worn, or when the tire inflation pressure is low.
- When tires of a size other than specified are installed.

- Vehicle is driven in traffic lanes other than that highways and freeways.

- During emergency towing.

■ Situations in which the lane change assist function should not be used

- When driving on a one lane road or road without lane markers
- When there is no broken white line between your vehicle and the lane toward which the turn signal is operated

■ Preventing LTA system malfunctions and operations performed by mistake

- Do not modify the headlights or place stickers, etc. on the surface of the lights.
- Do not modify the suspension etc. If the suspension etc. needs to be replaced, contact your Lexus dealer.
- Do not install or place anything on the hood or grille. Also, do not install a grille guard (bull bars, kangaroo bar, etc.).
- If your windshield needs repairs, contact your Lexus dealer.

■ Conditions in which functions may not operate properly

In the following situations, the functions may not operate properly and the vehicle may depart from its lane. Drive safely by always paying careful attention to your surroundings and operate the steering wheel to correct the path of the vehicle without relying solely on the functions.

⚠ WARNING

- When the follow-up cruising display is displayed (→P.231) and the preceding vehicle changes lanes. (Your vehicle may follow the preceding vehicle and also change lanes.)

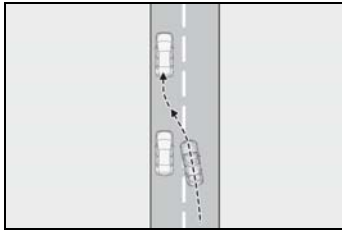

- When the follow-up cruising display is displayed (→P.231) and the preceding vehicle is swaying. (Your vehicle may sway accordingly and depart from the lane.)
- When the follow-up cruising display is displayed (→P.231) and the preceding vehicle departs from its lane. (Your vehicle may follow the preceding vehicle and depart from the lane.)
- When the follow-up cruising display is displayed (→P.231) and the preceding vehicle is being driven extremely close to the left/right lane line. (Your vehicle may follow the preceding vehicle and depart from the lane.)
- Vehicle is being driven around a sharp curve.
- Objects or patterns that could be mistaken for white (yellow) lines are present on the side of the road (guardrails, curbs, reflective poles, etc.).

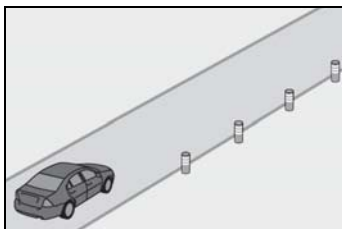

- Vehicle is driven where the road diverges, merges, etc.

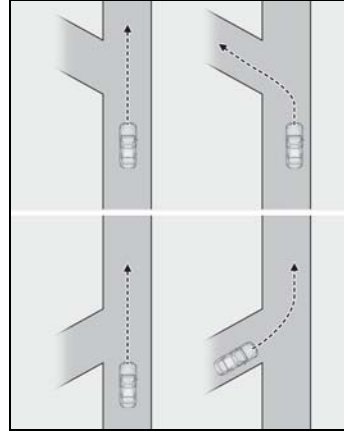

- Repair marks of asphalt, white (yellow) line marks, etc. are present due to road repair.

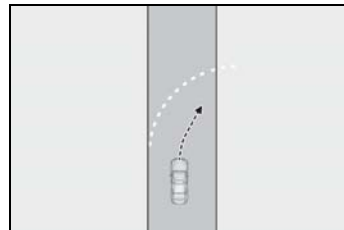

- There are shadows on the road that run parallel with, or cover, the white (yellow) lines.
- The vehicle is driven in an area without white (yellow) lines, such as in front of a tollgate or checkpoint, or at an intersection, etc.
- The white (yellow) lines are cracked, "Botts' dots", "Raised pavement marker" or stones are present.
- The white (yellow) lines cannot be seen or are difficult to see due to sand, etc.
- The vehicle is driven on a road surface that is wet due to rain, puddles, etc.

**WARNING**

- The traffic lines are yellow (which may be more difficult to recognize than lines that are white).
- The white (yellow) lines cross over a curb, etc.
- The vehicle is driven on a bright surface, such as concrete.
- If the edge of the road is not clear or straight.
- The vehicle is driven on a surface that is bright due to reflected light, etc.
- The vehicle is driven in an area where the brightness changes suddenly, such as at the entrances and exits of tunnels, etc.
- Light from the headlights of an oncoming vehicle, the sun, etc. enters the camera.
- The vehicle is driven on a slope.
- The vehicle is driven on a road which tilts left or right, or a winding road.
- The vehicle is driven on an unpaved or rough road.
- The traffic lane is excessively narrow or wide.
- The vehicle is extremely tilted due to carrying heavy luggage or having improper tire pressure.
- The distance to the preceding vehicle is extremely short.
- The vehicle is moving up and down a large amount due to road conditions during driving (poor roads or road seams).
- When driving in a tunnel or at night with the headlights off or when a headlight is dim due to its lens being dirty or it being misaligned.
- The vehicle is struck by a crosswind.

- The vehicle is affected by wind from a vehicle driven in a nearby lane.
- The vehicle has just changed lanes through operation of the steering wheel by the driver or crossed an intersection.
- Tires which differ by structure, manufacturer, brand or tread pattern are used.
- Snow tires, etc. are equipped.
- The vehicle is being driven at extremely high speeds.

Functions included in LTA system**■ Lane departure alert function**

When the system determines that the vehicle might depart from its lane or course^{*}, a warning is displayed on the multi-information display, and either a warning buzzer will sound or the steering wheel will vibrate to alert the driver.

When the warning buzzer sounds or the steering wheel vibrates, check the area around your vehicle and carefully operate the steering wheel to move the vehicle back to the center of the lane.

When the system determines that the vehicle might depart from its lane and that the possibility of a collision with an overtaking vehicle in the adjacent lane is high, the lane departure alert will operate even if the turn signals are operating.

*: Boundary between asphalt and the side of the road, such as grass, soil, or a curb

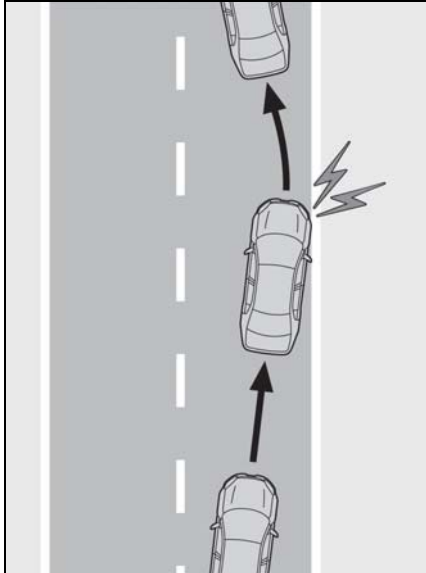

■ **Steering assist function**

When the system determines that the vehicle might depart from its lane or course^{*}, the system provides assistance as necessary by operating the steering wheel in small amounts for a short period of time to keep the vehicle in its lane.

If the system detects that the steering wheel has not been operated for a fixed amount of time or the steering wheel is not being firmly gripped, the steering assist function may be canceled temporarily, a warning message may be displayed on the multi-information display and a warning buzzer may sound. If the steering assist function is canceled, release the steering wheel and then grip it again to enable the function.

When the system determines that the vehicle might depart from its lane and that the possibility of a collision with an overtaking vehicle in the adjacent lane is high, the steering assist function will operate even if

the turn signals are operating.

*: Boundary between asphalt and the side of the road, such as grass, soil, or a curb

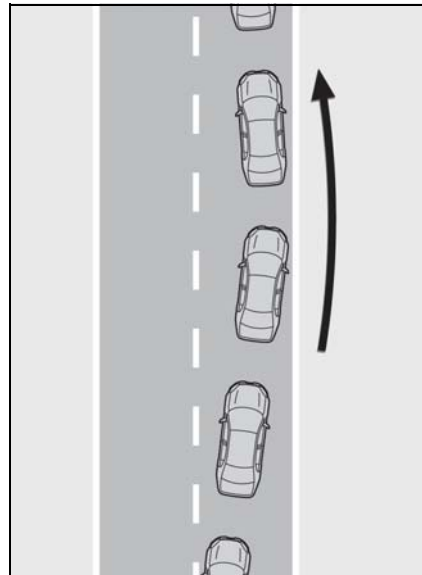

■ **Vehicle sway warning function**

When the vehicle is swaying within a lane, the warning buzzer will sound and a message will be displayed on the multi-information display to alert the driver.

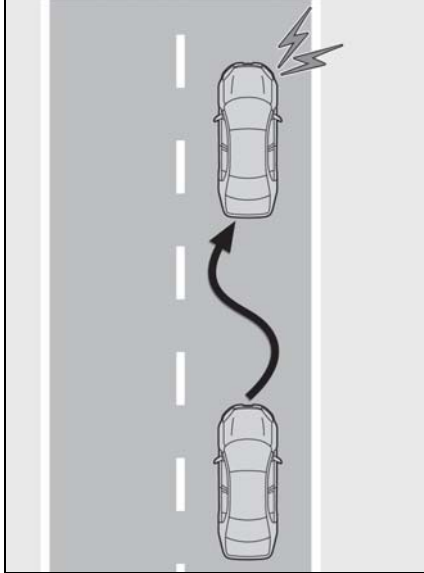

■ Lane centering function

This function is linked with dynamic radar cruise control with full-speed range and provides the required assistance by operating the steering wheel to keep the vehicle in its current lane.

When dynamic radar cruise control with full-speed range is not operating, the lane centering function does not operate.

In situations where the white (yellow) lane lines are difficult to see or are not visible, such as when in a traffic jam, this function will operate to help follow a preceding vehicle by monitoring the position of the preceding vehicle.

If the system detects that the steering wheel has not been operated for a fixed amount of time or the steering wheel is not being firmly gripped, a warning is displayed on the multi-information display and the warning buzzer sounds. Make sure to grip the steering wheel firmly.

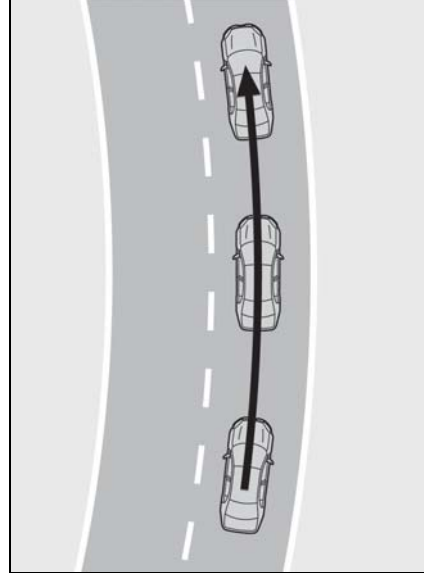

■ Lane change assist function (vehicles with Lexus Safety System + A)

This function is linked to the dynamic radar cruise control with full-speed range and provides assistance for performing lane changes by operating the steering wheel when you hold the turn signal lever partway (lane change position). (→P.173)

When lane change assist function is operating, the acceleration and deceleration of the vehicle is controlled while the preceding vehicle and vehicles driven in the lane toward which the turn signal is operated are monitored.

When the lane centering function is not operating, the lane change assist function will not operate.

The lane change assist function should not be operated when changing lanes on a road that is diverging or merging.

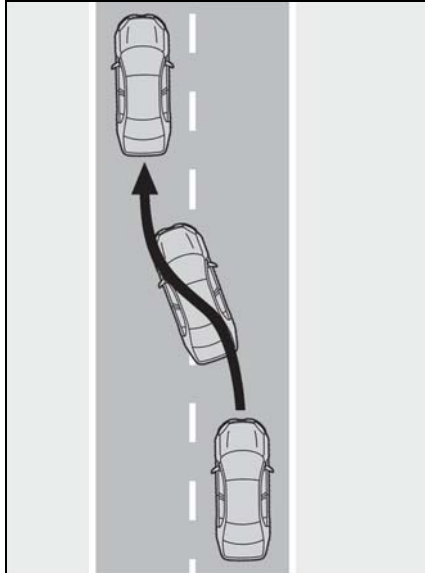

Turning LTA system on

Press the LTA switch to turn the LTA system on.

The LTA indicator illuminates and a message is displayed on the multi-information display.

Press the LTA switch again to turn the LTA system off.

When the LTA system is turned on or off, operation of the LTA system continues in the same condition the next time the engine is started.

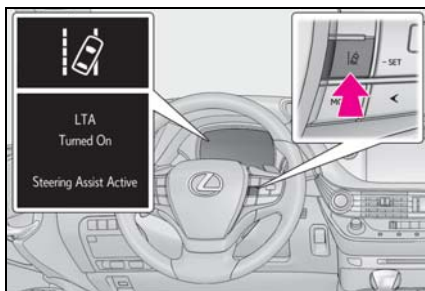

■ Lane change assist function (vehicles with Lexus Safety System + A)

Hold the turn signal lever partway (lane change position) for approximately 1 second.(→P.173)

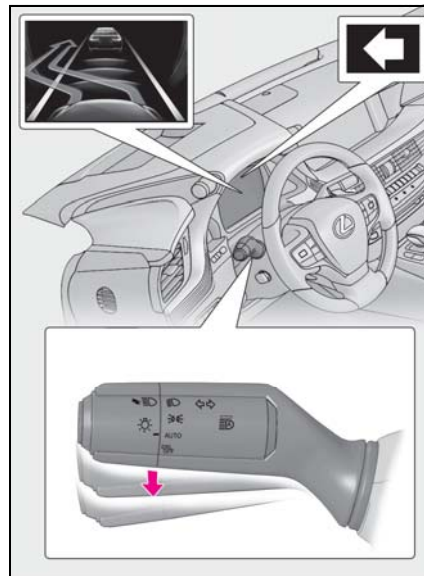

The direction you are signaling will be displayed on the multi-information display.

Indications on multi-information display

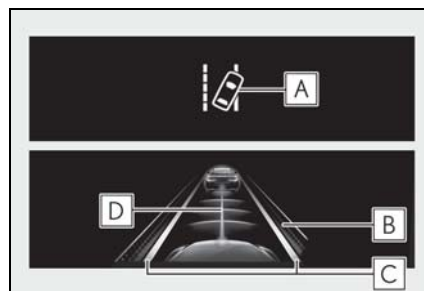

A LTA indicator

The illumination condition of the indicator informs the driver of the system operation status.

Illuminated in white: LTA system is operating.

Illuminated in green: Steering wheel assistance of the steering assist function or lane centering function is operating.

Flashing in orange: Lane departure alert function is operating.

B Operation display of steering wheel operation support

Displayed when the multi-information display is switched to the driving assist system information screen.

Indicates that steering wheel assistance of the steering assist function or lane centering function is operating.

Both outer sides of the lane are displayed: Indicates that steering wheel assist of the lane centering function is operating.

One outer side of the lane is displayed: Indicates that steering wheel assist of the steering assist function is operating.

Both outer sides of the lane are flashing: Alerts the driver that their input is necessary to stay in the center of the lane (lane centering function).

C Lane departure alert function display

Displayed when the multi-information display is switched to the driving assist system information screen.

- ▶ Inside of displayed white lines is white



Indicates that the system is recognizing white (yellow) lines or a course*. When the vehicle departs from its lane, the white line displayed on the side the vehicle departs from flashes orange.

- ▶ Inside of displayed white lines is black



Indicates that the system is not able to recognize white (yellow) lines or a course* or is temporarily canceled.

*: Boundary between asphalt and the side of the road, such as grass, soil, or a curb

D Follow-up cruising display

Displayed when the multi-information display is switched to the driving assist system information screen.

Indicates that steering assist of the lane centering function is operating by monitoring the position of a preceding vehicle.

When the follow-up cruising display is displayed, if the preceding vehicle moves, your vehicle may move in the same way.

Always pay careful attention to your surroundings and operate the steering wheel as necessary to correct the path of the vehicle and ensure safety.

■ Lane change assist function (vehicles with Lexus Safety System + A)

- Lane change assist display



Indicates that steering wheel assist of the lane change assist function is operating.

- Approaching vehicle warning display

Indicates that an approaching vehicle is detected in the adjacent lane.

- Warning display (vehicles with Lexus Safety System + A)

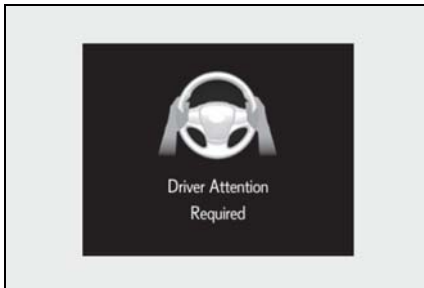

When the lane centering function is operating and the system determines that the vehicle may depart from its lane due to a sharp curve, etc., a warning display urging the driver to operate the steering wheel, will be displayed.

This display will also be displayed when operation of the lane change assist function is canceled.

In some situations a warning display may not be displayed.

Indications on head-up display (vehicles with Lexus Safety System + A)

Some displays, which are the same as those displayed on the multi-information display, will be displayed.

- LTA system curve display on the head-up display

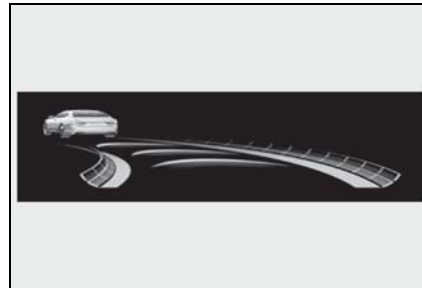

The curve display on the head-up display changes according to the direction and curvature of the curve.

- Operation conditions of each function

- Lane departure alert function

This function operates when all of the following conditions are met.

- LTA is turned on.
- Vehicle speed is approximately 32 mph (50 km/h) or more.^{*1}
- System recognizes white (yellow) lane lines or a course^{*2}. (When a white [yellow] line or course^{*2} is recognized on only one side, the system will operate only for the recognized side.)
- Width of traffic lane is approximately 9.8 ft. (3 m) or more.
- Turn signal lever is not operated. (Except when a vehicle is in the lane on the side the turn signal was operated)
- Vehicle is not being driven around a sharp curve.
- No system malfunctions are detected. (→P.237)

^{*1}: The function operates even if the vehi-

cle speed is less than approximately 32 mph (50 km/h) when the lane centering function is operating.

*2: Boundary between asphalt and the side of the road, such as grass, soil, or a curb

● Steering assist function

This function operates when all of the following conditions are met in addition to the operation conditions for the lane departure alert function.

- Setting for "Steering Assist" in  of the multi-information display is set to "ON". (→P.80)
- Vehicle is not accelerated or decelerated by a fixed amount or more.
- Steering wheel is not operated with a steering force level suitable for changing lanes.
- ABS, VSC, TRAC and PCS are not operating.
- TRAC or VSC is not turned off.
- Hands off steering wheel warning is not displayed. (→P.236)

● Vehicle sway warning function

This function operates when all of the following conditions are met.

- Setting for "Sway Warning" in  of the multi-information display is set to "ON". (→P.80)
- Vehicle speed is approximately 32 mph (50 km/h) or more.
- Width of traffic lane is approximately 9.8 ft. (3 m) or more.
- No system malfunctions are detected. (→P.237)

● Lane centering function

This function operates when all of the following conditions are met.

- LTA is turned on.
- Setting for "Steering Assist" and "Lane Center" in  of the multi-information display are set to "ON". (→P.80)
- This function recognizes white (yellow) lane lines or the position of a preceding vehicle (except when the preceding vehicle is small, such as a motorcycle).
- The dynamic radar cruise control with

full-speed range is operating in vehicle-to-vehicle distance control mode.

- Width of traffic lane is approximately 10 to 13 ft. (3 to 4 m).
- Turn signal lever is not operated.
- Vehicle is not being driven around a sharp curve.
- No system malfunctions are detected. (→P.237)
- Vehicle does not accelerate or decelerate by a fixed amount or more.
- Steering wheel is not operated with a steering force level suitable for changing lanes.
- ABS, VSC, TRAC and PCS are not operating.
- TRAC or VSC is not turned off.
- Hands off steering wheel warning is not displayed. (→P.236)
- The driver has one or both hands on the steering wheel.
- The vehicle is being driven in the center of a lane.
- Steering assist function is not operating.

● Lane change assist function (vehicles with Lexus Safety System + A)

This function will operate when all of the following conditions are met:

- The lane centering function is operating.
- "Lane Change Assist" is set to "ON" in  of the multi-information display. (→P.80)
- The vehicle speed is between approximately 57 and 85 mph (90 and 140 km/h).
- White (yellow) lane lines are detected by the system.
- A broken white line is detected between your vehicle and the lane toward which the turn signal is operated.
- The turn signal lever is held partway (lane change position) for approximately 1 second.
- A vehicle is not overtaking your vehicle or detected in the lane toward which the turn signal is operated.
- The vehicle is being driven straight or around a slight curve.
- The vehicle is not accelerating or decelerating more than a certain amount.
- The steering wheel is not being turned sufficiently to perform a lane change.

- ABS, VSC, TRAC and PCS are not operating.
- TRAC or VSC is not turned off.
- Hands off steering wheel warning is not displayed. (→P.236)
- The dynamic radar cruise control with full-speed range approach warning is not operating.
- The lane departure alert function is not operating.

■ Temporary cancellation of functions

- When operation conditions are no longer met, a function may be temporarily canceled. However, when the operation conditions are met again, operation of the function is automatically restored. (→P.233)
- If the operation conditions (→P.233) are no longer met while the lane centering function is operating, the steering wheel may vibrate and the buzzer may sound to indicate that the function has been temporarily canceled. However, if the “Alert” customization setting is set to , the system will notify the driver by vibrating the steering wheel instead of sounding the buzzer.
- If the operating conditions (→P.233) are no longer met, the lane change assist function will be canceled. (vehicles with Lexus Safety System + A)

If a message urging operation of the steering wheel is displayed, operate the steering wheel.

■ Steering assist function/lane centering function

- Depending on the vehicle speed, lane departure situation, road conditions, etc., the driver may not feel the function is operating or the function may not operate at all.
- The steering control of the function is overridden by the driver’s steering wheel operation.
- When the vehicle speed is approximately 31 mph (50 km/h) or less, the warning display of the lane centering function will not operate.
- Do not attempt to test the operation of

the steering assist function.

- The steering assist function may operate when attempting to cut closely in front of another vehicle while changing lanes.

■ Lane departure alert function

- The warning buzzer may be difficult to hear due to external noise, audio playback, etc. Also, it may be difficult to feel steering wheel vibrations due to the road conditions, etc.
- If the edge of the course* is not clear or straight, the lane departure alert function may not operate.
- It may not be possible for the system to determine if there is a danger of a collision with a vehicle in an adjacent lane.
- Do not attempt to test the operation of the lane departure alert function.
- This function may operate if, when changing lanes, your vehicle cuts closely in front of another vehicle.

*: Boundary between asphalt and the side of the road, such as grass, soil, or a curb

■ Lane change assist function (vehicles with Lexus Safety System + A)

Depending on the vehicle speed, vehicle condition, road conditions, or conditions of the area around the vehicle, the lane change assist function may not operate or it may be difficult to recognize that it has operated.

If steering control operation is excessive or insufficient, it can be corrected by the driver’s operation of the steering wheel.

In situations such as the following, the lane change assist function may be canceled:

- When the system no longer detects white (yellow) lane lines
- When the turn signal lever is operated fully (right/left turn position)
- When the vehicle speed is outside of the operational range of the function
- When the system detects operation of the steering wheel, brake or accelerator pedal by the driver

While the lane change assist function is

operating, if the system detects that a vehicle is quickly approaching in the lane toward which the turn signal is operated, the steering assist may slightly steer the vehicle away from the lane while a buzzer is sounding, the steering wheel is vibrating, and a warning display is displayed on the multi-information display, to help prevent the vehicle from entering the lane and alert the driver of the approaching vehicle.

■ **Hands off steering wheel alert**

In the following situations, a warning message urging the driver to hold the steering wheel and the symbol shown in the illustration are displayed on the multi-information display to warn the driver. The warning stops when the system determines that the driver holds the steering wheel. Always keep your hands on the steering wheel when using this system, regardless of warnings.

Depending on the vehicle condition and road conditions, the warning may not operate. Also, if the system determines that the vehicle is driving around a curve, warnings will occur earlier than during straight-lane driving.

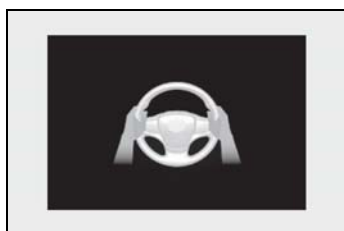

- When the system determines that the driver is driving without holding the steering wheel while the system is operating

If the driver continues to keep their hands off of the steering wheel, the buzzer sounds, the driver is warned and the function is temporarily canceled. This warning also operates in the same way when the driver continuously operates the steering wheel only a small amount.

The buzzer also sounds even if the alert type is set to .

- When the system determines that the vehicle may not turn and instead depart

from its lane while driving around a curve (vehicles with Lexus Safety System + 2.0)

- When the system determines that the driver is driving without holding the steering wheel while the steering wheel assist of the steering assist function is operating (vehicles with Lexus Safety System + 2.0)

If the driver continues to keep their hands off of the steering wheel and the steering wheel assist is operating, the buzzer sounds and the driver is warned. Each time the buzzer sounds, the continuing time of the buzzer becomes longer.

The buzzer also sounds even if the alert type is set to .

In situations such as the following, the system may not be able to detect when the driver's hands are on the steering wheel (vehicles with Lexus Safety System + A):

- If a steering wheel cover is installed.
- If the driver is wearing gloves.
- If something is attached to the steering wheel.
- If the driver is gripping the wood trim, stitched area, spokes, or other part of the steering wheel that does not have sensors.

In situations such as the following, the hands off steering wheel alert may not operate and the steering assist function and lane centering function may operate even if the driver's hands are off the steering wheel (vehicles with Lexus Safety System + A):

- If an object contacts the steering wheel.
- If a wide object or arms are held in front of the steering wheel.

■ **Vehicle sway warning function**

When the system determines that the vehicle is swaying while the vehicle sway warning function is operating, a buzzer sounds and a warning message urging the driver to rest and the symbol shown in the illustration are simultaneously displayed on the multi-information display.



Depending on the vehicle and road conditions, the warning may not operate.

■ **Warning message**

If the following warning message is displayed on the multi-information display and the LTA indicator illuminates in orange, follow the appropriate troubleshooting procedure. Also, if a different warning message is displayed, follow the instructions displayed on the screen.

- “LTA Malfunction Visit Your Dealer”

The system may not be operating properly. Have the vehicle inspected at your Lexus dealer.

- “LTA Unavailable”

The system is temporarily canceled due to a malfunction in a sensor other than the front camera. Turn the LTA system off, wait for a little while, and then turn the LTA system back on.

- “LTA Unavailable at Current Speed”

The function cannot be used as the vehicle speed exceeds the LTA operation range. Drive slower.

■ **Customization**

Function settings can be changed. (→P.466)

Dynamic radar cruise control with full-speed range

In vehicle-to-vehicle distance control mode, the vehicle automatically accelerates, decelerates and stops to match the speed changes of the preceding vehicle even if the accelerator pedal is not depressed. In constant speed control mode, the vehicle runs at a fixed speed.

Use the dynamic radar cruise control with full-speed range on freeways and highways.

- Vehicle-to-vehicle distance control mode (→P.240)
- Constant speed control mode (→P.244)

4
Driving

System Components

■ **Meter display**

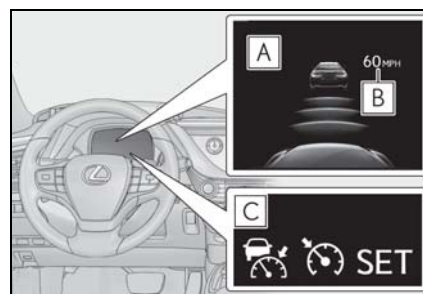

- A** Multi-information display
- B** Set speed
- C** Indicators

■ Operation switches

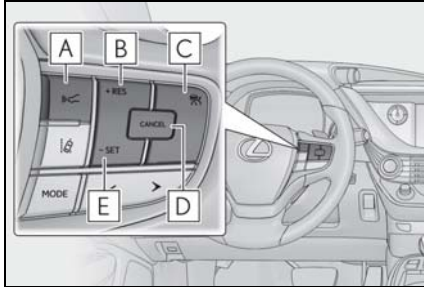

- A** Vehicle-to-vehicle distance switch
- B** "+RES" switch
- C** Cruise control main switch
- D** Cancel switch
- E** "-SET" switch

⚠ WARNING

■ Before using dynamic radar cruise control with full-speed range

- Driving safely is the sole responsibility of the driver. Do not rely solely on the system, and drive safely by always paying careful attention to your surroundings.
- The dynamic radar cruise control with full-speed range provides driving assistance to reduce the driver's burden. However, there are limitations to the assistance provided. Read the following conditions carefully. Do not overly rely on this system and always drive carefully.
 - When the sensor may not be correctly detecting the vehicle ahead: →P.245
 - Conditions under which the vehicle-to-vehicle distance control mode may not function correctly: →P.246
- Set the speed appropriately depending on the speed limit, traffic flow, road conditions, weather conditions, etc. The driver is responsible for checking the set speed.

- Even when the system is functioning normally, the condition of the preceding vehicle as detected by the system may differ from the condition observed by the driver. Therefore, the driver must always remain alert, assess the danger of each situation and drive safely. Relying solely on this system or assuming the system ensures safety while driving can lead to an accident, resulting in death or serious injury.

- Switch the dynamic radar cruise control with full-speed range setting to off, using the cruise control main switch when not in use.

■ Cautions regarding the driving assist systems

Observe the following precautions, as there are limitations to the assistance provided by the system. Failure to do so may cause an accident resulting in death or serious injury.

- Assisting the driver to measure following distance

The dynamic radar cruise control with full-speed range is only intended to help the driver in determining the following distance between the driver's own vehicle and a designated vehicle traveling ahead. It is not a mechanism that allows careless or inattentive driving, and it is not a system that can assist the driver in low-visibility conditions.

It is still necessary for driver to pay close attention to the vehicle's surroundings.

- Assisting the driver to judge proper following distance

The dynamic radar cruise control with full-speed range determines whether the following distance between the driver's own vehicle and a designated vehicle traveling ahead is within a set range. It is not capable of making any other type of judgement. Therefore, it is absolutely necessary for the driver to remain vigilant and to determine whether or not there is a possibility of danger in any given situation.

**WARNING**

- Assisting the driver to operate the vehicle

The dynamic radar cruise control with full-speed range does not include functions which will prevent or avoid collisions with vehicles ahead of your vehicle. Therefore, if there is ever any possibility of danger, the driver must take immediate and direct control of the vehicle and act appropriately in order to ensure the safety of all involved.

■ **Situations unsuitable for dynamic radar cruise control with full-speed range**

Do not use dynamic radar cruise control with full-speed range in any of the following situations. Doing so may result in inappropriate speed control and could cause an accident resulting in death or serious injury.

- Roads where there are pedestrians, cyclists, etc.
- In heavy traffic
- On roads with sharp bends
- On winding roads
- On slippery roads, such as those covered with rain, ice or snow
- On steep downhill, or where there are sudden changes between sharp up and down gradients
Vehicle speed may exceed the set speed when driving down a steep hill.
- At entrances to freeways and highways
- When weather conditions are bad enough that they may prevent the sensors from detecting correctly (fog, snow, sandstorm, heavy rain, etc.)
- When there is rain, snow, etc. on the front surface of the radar or front camera

- In traffic conditions that require frequent repeated acceleration and deceleration
- During emergency towing
- When an approach warning buzzer is heard often

Driving in vehicle-to-vehicle distance control mode

This mode employs a radar to detect the presence of vehicles up to approximately 328 ft. (100 m) ahead, determines the current vehicle-to-vehicle following distance, and operates to maintain a suitable following distance from the vehicle ahead. The desired vehicle-to-vehicle distance can also be set by operating the vehicle-to-vehicle distance switch.

When driving on downhill slopes, the vehicle-to-vehicle distance may become shorter.

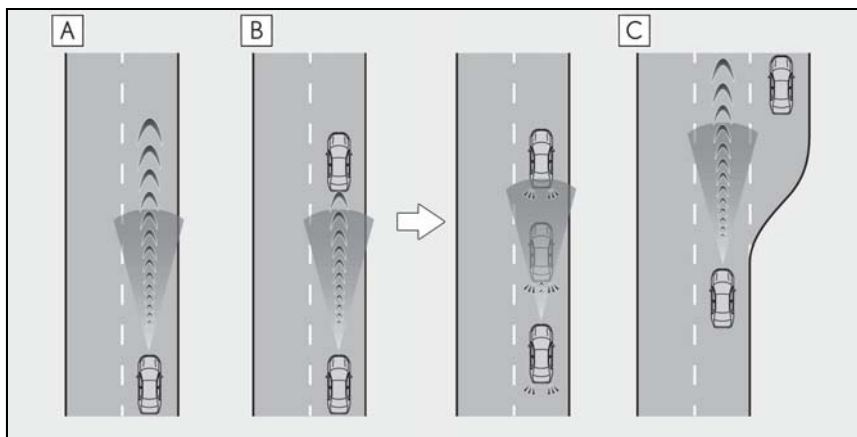

A Example of constant speed cruising
When there are no vehicles ahead

The vehicle travels at the speed set by the driver.

B Example of deceleration cruising and follow-up cruising

When a preceding vehicle driving slower than the set speed appears

When a vehicle is detected running ahead of you, the system automatically decelerates your vehicle. When a greater reduction in vehicle speed is necessary, the system applies the brakes (the stop lights will come on at this time). The system will respond to changes in the speed of the vehicle ahead in order to maintain the vehicle-to-vehicle distance set by the driver. Approach warning warns you when the system cannot decelerate sufficiently to prevent your vehicle from closing in on the vehicle ahead.

When the vehicle ahead of you stops, your vehicle will also stop (vehicle is stopped by system control). After the vehicle ahead starts off, pressing the “+RES” switch or depressing the accelerator pedal (start-off operation) will resume follow-up cruising. If the start-off operation is not performed, system control continues to keep your vehicle stopped.

When the turn signal lever is operated and your vehicle moves to a left lane while driving at 50 mph (80 km/h) or more, the vehicle will quickly accelerate to help to overtake a passing vehicle.

C Example of acceleration

When there are no longer any preceding vehicles driving slower than the set speed

The system accelerates until the set speed is reached. The system then returns to constant speed cruising.

Setting the vehicle speed (vehicle-to-vehicle distance control mode)

- 1 Press the cruise control main switch to activate the cruise control.

Radar cruise control indicator will come on and a message will be displayed on the multi-information display. Press the switch again to deactivate the cruise control.

If the cruise control main switch is pressed and held for 1.5 seconds or more, the system turns on in constant speed control mode. (→P.244)

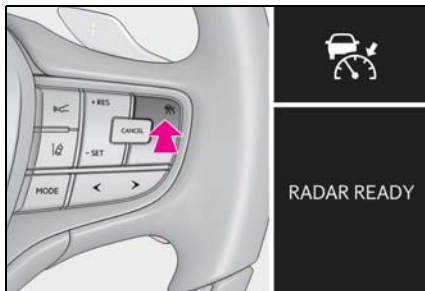

- 2 Accelerate or decelerate, with accelerator pedal operation, to the desired vehicle speed (at or above approximately 20 mph [30 km/h]) and press the “-SET” switch to set the speed.

Cruise control “SET” indicator will come on.

The vehicle speed at the moment the

switch is released becomes the set speed.

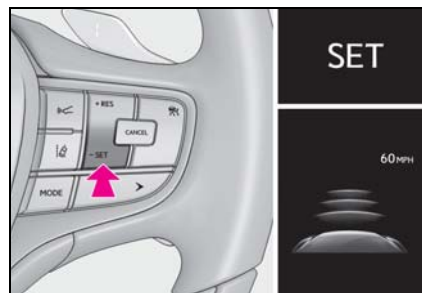

Adjusting the set speed

To change the set speed, press the “+RES” or “-SET” switch until the desired set speed is displayed.

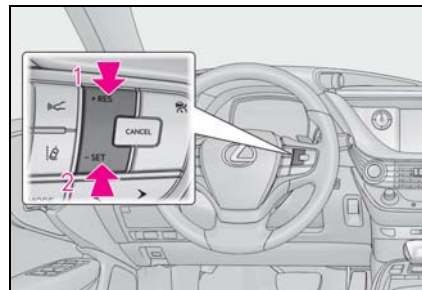

- 1 Increases the speed (Except when the vehicle has been stopped by system control in vehicle-to-vehicle distance control mode)
- 2 Decreases the speed

Fine adjustment: Press the switch.

Large adjustment: Press and hold the switch to change the speed, and release when the desired speed is reached.

In the vehicle-to-vehicle distance control mode, the set speed will be

increased or decreased as follows:

- ▶ For the U.S. mainland, Hawaii

Fine adjustment: By 1 mph (1.6 km/h)^{*1} or 1 km/h (0.6mph)^{*2} each time the switch is pressed

Large adjustment: Increases or decreases in 1mph (1.6 km/h)^{*1} or 1 km/h (0.6 mph)^{*2} increments for as long as the switch is held

- ▶ For Canada, Guam and Puerto Rico

Fine adjustment: By 1 mph (1.6 km/h)^{*1} or 1 km/h (0.6mph)^{*2} each time the switch is pressed

Large adjustment: Increases or decreases in 5 mph (8 km/h)^{*1} or 5 km/h (3.1 mph)^{*2} increments for as long as the switch is held

In the constant speed control mode (→P.244), the set speed will be increased or decreased as follows:

Fine adjustment: By 1 mph (1.6 km/h)^{*1} or 1 km/h (0.6 mph)^{*2} each time the switch is pressed

Large adjustment: The speed will continue to change while the switch is held.

^{*1}: When the set speed is shown in "MPH"

^{*2}: When the set speed is shown in "km/h"

Changing the vehicle-to-vehicle distance (vehicle-to-vehicle distance control mode)

Pressing the switch changes the vehicle-to-vehicle distance as follows:

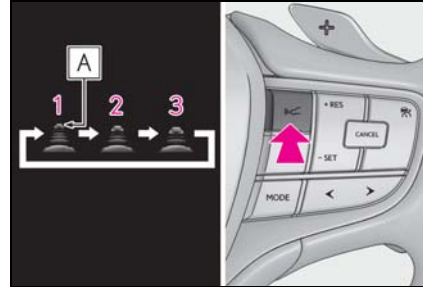

- 1 Long
- 2 Medium
- 3 Short

The vehicle-to-vehicle distance is set automatically to long mode when the engine switch is turned to IGNITION ON mode. If a vehicle is running ahead of you, the preceding vehicle mark **A** will also be displayed.

Vehicle-to-vehicle distance settings (vehicle-to-vehicle distance control mode)

Select a distance from the table below. Note that the distances shown correspond to a vehicle speed of 50 mph (80 km/h). Vehicle-to-vehicle distance increases/decreases in accordance with vehicle speed. When the vehicle is stopped by system control, the vehicle stops at a certain vehicle-to-vehicle distance depending on the situation.

Distance options	Vehicle-to-vehicle distance
Long	Approximately 160 ft. (50 m)

Distance options	Vehicle-to-vehicle distance
Medium	Approximately 130 ft. (40 m)
Short	Approximately 100 ft. (30 m)

Resuming follow-up cruising when the vehicle has been stopped by system control (vehicle-to-vehicle distance control mode)

After the vehicle ahead of you starts off, press the “+RES” switch. Your vehicle will also resume follow-up cruising if the accelerator pedal is depressed after the vehicle ahead of you starts off.

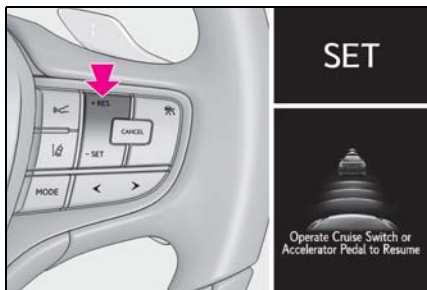

Canceling and resuming the speed control

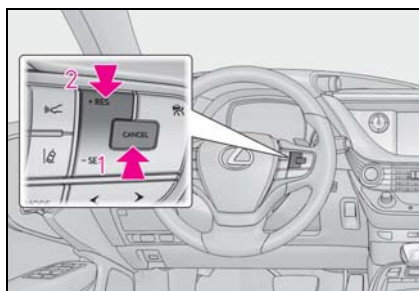

1 Pressing the cancel switch cancels the speed control.

The speed control is also canceled when the brake pedal is depressed. (When the vehicle has been stopped by system control, depressing the brake pedal does not cancel the setting.)

2 Pressing the “+RES” switch resumes the cruise control and returns vehicle speed to the set speed.

Approach warning (vehicle-to-vehicle distance control mode)

When your vehicle is too close to a vehicle ahead, and sufficient automatic deceleration via the cruise control is not possible, the display will flash and the buzzer will sound to alert the driver. An example of this would be if another driver cuts in front of you while you are following a vehicle. Depress the brake pedal to ensure an appropriate vehicle-to-vehicle distance.

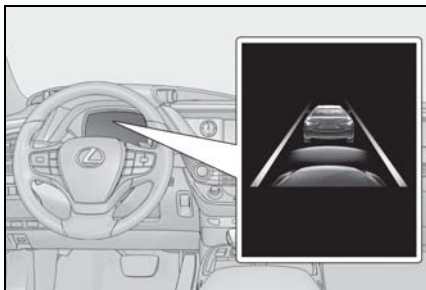

■ **Warnings may not occur when**

In the following instances, warnings may not occur even when the vehicle-to-vehicle distance is small.

- When the speed of the preceding vehicle matches or exceeds your vehicle speed
- When the preceding vehicle is traveling at an extremely slow speed
- Immediately after the cruise control speed was set
- When depressing the accelerator pedal

Selecting constant speed control mode

When constant speed control mode is selected, your vehicle will maintain a set speed without controlling the vehicle-to-vehicle distance. Select this mode only when vehicle-to-vehicle distance control mode does not function correctly due to a dirty radar, etc.

- 1 With the cruise control off, press and hold the cruise control main switch for 1.5 seconds or more.

Immediately after the switch is pressed, the radar cruise control indicator will come on. Afterwards, it switches to the cruise con-

trol indicator.

Switching to constant speed control mode is only possible when operating the switch with the cruise control off.

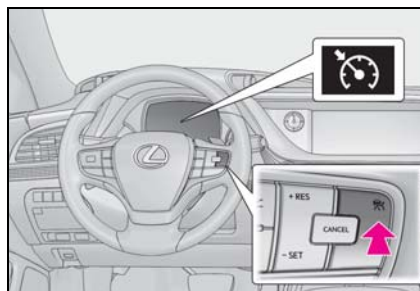

- 2 Accelerate or decelerate, with accelerator pedal operation, to the desired vehicle speed (at or above approximately 20 mph [30 km/h]) and press the “-SET” switch to set the speed.

Cruise control “SET” indicator will come on.

The vehicle speed at the moment the switch is released becomes the set speed.

Adjusting the speed setting: →P.241

Canceling and resuming the speed setting: →P.243

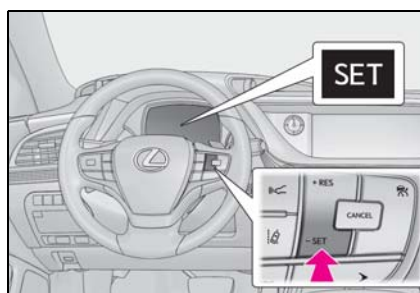

■ **Dynamic radar cruise control with full-speed range can be set when**

- The shift position is in D.
- Range 4 or higher of D has been selected by using the paddle shift switch.
- The desired set speed can be set when the vehicle speed is approximately 20

mph (30 km/h) or more.
(However, when the vehicle speed is set while driving at below approximately 20 mph [30 km/h], the set speed will be set to approximately 20 mph [30 km/h].)

■ Accelerating after setting the vehicle speed

The vehicle can accelerate by operating the accelerator pedal. After accelerating, the set speed resumes. However, during vehicle-to-vehicle distance control mode, the vehicle speed may decrease below the set speed in order to maintain the distance to the preceding vehicle.

■ When the vehicle stops while follow-up cruising

- Pressing the "+RES" switch while the vehicle ahead stops will resume follow-up cruising if the vehicle ahead starts off within approximately 3 seconds after the switch is pressed.
- If the vehicle ahead starts off within 3 seconds after your vehicle stops, follow-up cruising will be resumed.

■ Automatic cancelation of vehicle-to-vehicle distance control mode

Vehicle-to-vehicle distance control mode is automatically canceled in the following situations.

- VSC is activated.
- TRAC is activated for a period of time.
- When the VSC or TRAC system is turned off.
- When snow mode is set.
- The sensor cannot detect correctly because it is covered in some way.
- Pre-collision braking is activated.
- The parking brake is operated.
- The vehicle is stopped by system control on a steep incline.
- The following are detected when the vehicle has been stopped by system control:
 - The driver is not wearing a seat belt.
 - The driver's door is opened.
 - The vehicle has been stopped for about 3 minutes.

If vehicle-to-vehicle distance control mode is automatically canceled for any reasons other than the above, there may be a malfunction in the system. Contact your Lexus dealer.

■ Automatic cancelation of constant speed control mode

Constant speed control mode is automatically canceled in the following situations:

- Actual vehicle speed is more than approximately 10 mph (16 km/h) below the set vehicle speed.
- Actual vehicle speed falls below approximately 20 mph (30 km/h).
- VSC is activated.
- TRAC is activated for a period of time.
- When the VSC or TRAC system is turned off.
- Pre-collision braking is activated.

If constant speed control mode is automatically canceled for any reasons other than the above, there may be a malfunction in the system. Contact your Lexus dealer.

■ Brake operation

A brake operation sound may be heard and the brake pedal response may change, but these are not malfunctions.

■ Warning messages and buzzers for dynamic radar cruise control with full-speed range

Warning messages and buzzers are used to indicate a system malfunction or to inform the driver of the need for caution while driving. If a warning message is shown on the multi-information display, read the message and follow the instructions. (→P.196,202,425)

■ When the sensor may not be correctly detecting the vehicle ahead

In the case of the following and depending on the conditions, operate the brake pedal when deceleration of the system is insufficient or operate the accelerator pedal when acceleration is required.

As the sensor may not be able to correctly detect these types of vehicles, the approach warning (→P.243) may not be activated.

- Vehicles that cut in suddenly
- Vehicles traveling at low speeds
- Vehicles that are not moving in the same lane
- Vehicles with small rear ends (trailers with no load on board, etc.)

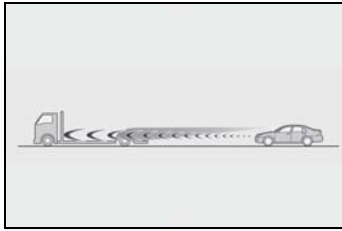

- Motorcycles traveling in the same lane
- When water or snow thrown up by the surrounding vehicles hinders the detecting of the sensor
- When your vehicle is pointing upwards (caused by a heavy load in the luggage compartment, etc.)

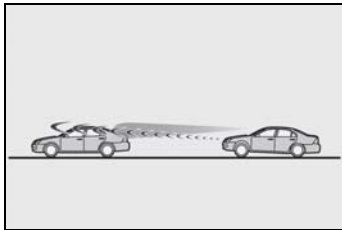

- Preceding vehicle has an extremely high ground clearance

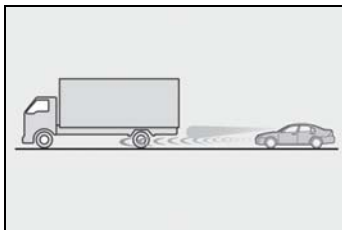

■ **Conditions under which the vehicle-to-vehicle distance control mode may not function correctly**

In the case of the following conditions, operate the brake pedal (or accelerator pedal, depending on the situation) as necessary.

As the sensor may not be able to correctly

detect vehicles ahead, the system may not operate properly.

- When the road curves or when the lanes are narrow

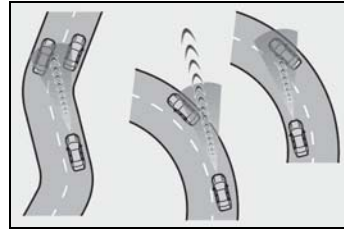

- When steering wheel operation or your position in the lane is unstable

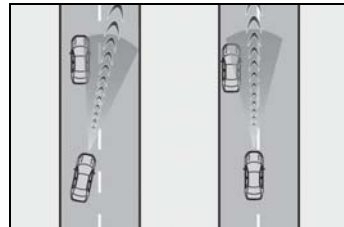

- When the vehicle ahead of you decelerates suddenly
- When driving on a road surrounded by a structure, such as in a tunnel or on a bridge
- While the vehicle speed is decreasing to the set speed after the vehicle accelerates by depressing the accelerator pedal

RSA (Road Sign Assist)*

*: If equipped

Summary of function

The RSA system recognizes specific road signs using the front camera and/or navigation system (when data is available) to provide information to the driver via the display.

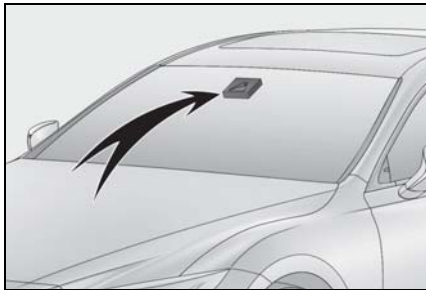

! WARNING

■ Before using the RSA

Do not rely solely upon the RSA system. RSA is a system which supports the driver by providing information, but it is not a replacement for a driver's own vision and awareness. Drive safely by always paying careful attention to the traffic rules.

Indication on the multi-information display

When the front camera recognizes a sign and/or information of a sign is

Supported types of road signs

The following types of road signs are recognized.

A non-official or recently introduced traffic signs may not be recognized.

available from navigation system, the sign will be displayed on the multi-information display.



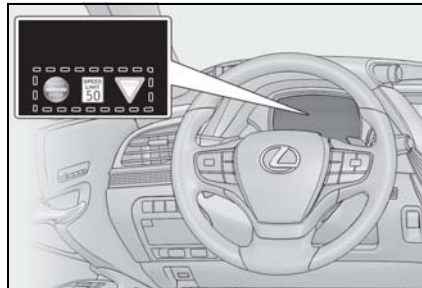

- When the Driving support system information display is selected, a maximum of 3 signs can be displayed. (→P.80)

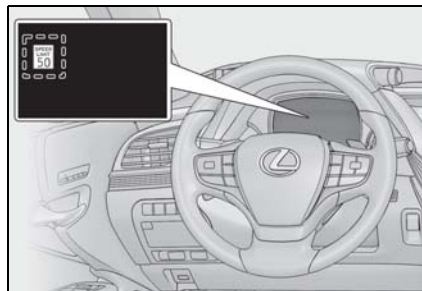

- When a tab other than the Driving support system information display is selected, only a recognized speed limit sign or do not enter sign (when notification is necessary) will be displayed. (→P.80)



If signs other than speed limit signs are recognized, they will be displayed in an overlapping stack under the current speed limit sign.

Type	Multi-information display
Speed limit	
Do Not Enter	
Stop	
Yield	



Warning display

In the following situations, the RSA system will alert the driver.

- When the vehicle speed exceeds the speed warning threshold of the speed limit sign displayed, the sign display will be emphasized and a buzzer will sound.
- When the RSA system recognizes a do not enter sign and determines that your vehicle has entered a no-entry area, the displayed sign will flash and a buzzer will sound.

Depending on the situation, traffic environment (traffic direction, speed unit) may be detected incorrectly and a warning display may not operate properly.

Setting procedure

- 1 Press **<** or **>** of the meter control switches and select .
- 2 Press **<** or **>** of the meter control switches and select "Vehicle Settings", then press **OK**.
- 3 Press **▲** or **▼** of the meter control switches and select , then press **OK**.
- 4 Press **▲** or **▼** of the meter control switches and select "RSA", then press **OK**.

Automatic turn-off of RSA sign display

In the following situations, a displayed speed limit sign will stop being displayed automatically:

- A new sign is not recognized for a certain distance.

In the following situations, do not enter, stop and yield signs will stop being displayed automatically:

- The system determines that your vehicle has passed the sign.
- The road changes due to a left or right

turn, etc.

■ **Conditions in which the function may not operate or detect correctly**

In the following situations, RSA does not operate normally and may not recognize signs, display the incorrect sign, etc. However, this does not indicate a malfunction.

- The front camera is misaligned due to a strong impact being applied to the sensor, etc.
- Dirt, snow, stickers, etc. are on the windshield near the front camera.
- In inclement weather such as heavy rain, fog, snow or sand storms
- Light from an oncoming vehicle, the sun, etc. enters the front camera.
- The sign is dirty, faded, tilted or bent.
- All or part of the sign is hidden by the leaves of a tree, a pole, etc.
- The sign is only visible to the front camera for a short amount of time.
- The driving scene (turning, lane change, etc.) is judged incorrectly.
- Even if it is a sign not appropriate for the currently traveled lane, such a sign exists directly after a freeway branches, or in an adjacent lane just before merging.
- Stickers are attached to the rear of the preceding vehicle.
- A sign resembling a system compatible sign is recognized.
- Side road speed signs may be detected and displayed (if positioned in sight of the front camera) while the vehicle is traveling on the main road.
- Roundabout exit road speed signs may be detected and displayed (if positioned in sight of the front camera) while traveling on a roundabout.
- The front of the vehicle is raised or lowered due to the carried load.
- The surrounding brightness is not sufficient or changes suddenly.
- When a sign intended for trucks, etc. is recognized.

■ **Speed limit sign display**

If the engine switch was last turned off while a speed limit sign was displayed on the multi-information display, the same sign displays again when the engine switch is turned to IGNITION ON mode.

■ **Customization**

Some functions can be customized. (Customizable features:→P.466)

BSM (Blind Spot Monitor)*

*: If equipped

The Blind Spot Monitor is a system that uses rear side radar sensors installed on the inner side of the rear bumper on the left and right side to assist the driver in confirming safety when changing lanes.

⚠ WARNING

■ **Cautions regarding the use of the system**

The driver is solely responsible for safe driving. Always drive safely, taking care to observe your surroundings.

The Blind Spot Monitor is a supplementary function which alerts the driver that a vehicle is in a blind spot of the outside rear view mirrors or is approaching rapidly from behind into a blind spot. Do not overly rely on the Blind Spot Monitor. As the function cannot judge if it is safe to change lanes, over reliance could lead to an accident resulting in death or serious injury.

As the system may not function correctly under certain conditions, the driver's own visual confirmation of safety is necessary.

System components

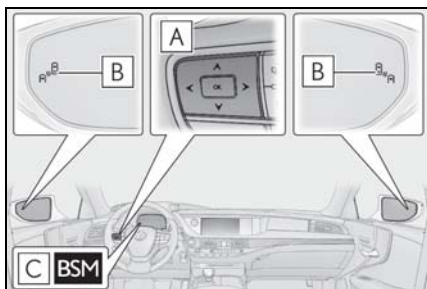

A Meter control switches
Turning the Blind Spot Monitor on/off.

B Outside rear view mirror indicators

When a vehicle is detected in a blind spot of the outside rear view mirrors or approaching rapidly from behind into a blind spot, the outside rear view mirror indicator on the detected side will illuminate. If the turn signal lever is operated toward the detected side, the outside rear view mirror indicator flashes.

C BSM indicator

Illuminates when the Blind Spot Monitor is enabled

■ **Outside rear view mirror indicator visibility**

In strong sunlight, the outside rear view mirror indicator may be difficult to see.

■ **When "BSM Not Available" is shown on the multi-information display**

Ice, snow, mud, etc., may be attached to the rear bumper around the sensors. (→P.251) The system should return to normal operation after removing the ice, snow, mud, etc. from the rear bumper. Additionally, the sensors may not operate normally when driving in extremely hot or cold environments.

■ **Customization**

Some functions can be customized. (→P.466)

■ Certification

- ▶ For vehicles sold in the U.S.A., Hawaii, Guam and Puerto Rico

FCC ID : OAYSRR3A

This device complies with part 15 of the FCC Rules. Operation is subject to the following two conditions:
 (1) This device may not cause harmful interference, and
 (2) this device must accept any interference received, including interference that may cause undesired operation.

FCC Warning

Changes or modifications not expressly approved by the party responsible for compliance could void the user's authority to operate the equipment.

- ▶ For vehicles sold in Canada

Applicable law : Canada 310

This device complies with Industry Canada licence-exempt RSS standard(s). Operation is subject to the following two conditions: (1) this device may not cause interference, and (2) this device must accept any interference, including interference that may cause undesired operation of the device.

Frequency bands : 24.05 - 24.25GHz

Output power : less than 20 milliwatts

Droit applicable : Canada 310

Le présent appareil est conforme aux CNR d'Industrie Canada applicables aux appareils radio exempts de licence. L'exploitation est autorisée aux deux conditions suivantes : (1) l'appareil ne doit pas produire de brouillage, et (2) l'utilisateur de l'appareil doit accepter tout brouillage radioélectrique subi, même si le brouillage est susceptible d'en compromettre le fonctionnement.

Bandes de fréquences : 24.05 - 24.25GHz

Puissance émise : Moins de 20 milliwatts

WARNING

■ Handling the rear side radar sensor

Blind Spot Monitor sensors are installed behind the left and right sides of the rear bumper respectively. Observe the following to ensure the Blind Spot Monitor can operate correctly.

⚠ WARNING

- Keep the sensors and the surrounding areas on the rear bumper clean at all times.

If a sensor or its surrounding area on the rear bumper is dirty or covered with snow, the Blind Spot Monitor may not operate and a warning message (→P.250) will be displayed. In this situation, clear off the dirt or snow and drive the vehicle with the operation conditions of the BSM function (→P.254) satisfied for approximately 10 minutes. If the warning message does not disappear, have the vehicle inspected by your Lexus dealer.

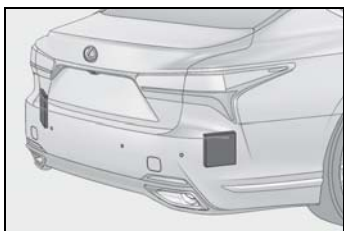



- Do not attach accessories, stickers (including transparent stickers), aluminum tape, etc. to a sensor or its surrounding area on the rear bumper.
- Do not subject a sensor or its surrounding area on the rear bumper to a strong impact. If a sensor is moved even slightly off position, the system may malfunction and vehicles may not be detected correctly. In the following situations, have your vehicle inspected by your Lexus dealer.
 - A sensor or its surrounding area is subject to a strong impact.
 - If the surrounding area of a sensor is scratched or dented, or part of them has become disconnected.
- Do not disassemble the sensor.

- Do not modify the sensor or surrounding area on the rear bumper.
- If a sensor or the rear bumper needs to be removed/installed or replaced, contact your Lexus dealer.
- Do not paint the rear bumper any color other than an official Lexus color.

Turning the Blind Spot Monitor on/off

Use the meter control switches to turn on/off the function.

- 1 Press **<** or **>** to select .
- 2 Press **▲** or **▼** to select  and then press **OK**.

Blind Spot Monitor operation

■ Vehicles that can be detected by the Blind Spot Monitor

The Blind Spot Monitor uses rear side radar sensors to detect the following vehicles traveling in adjacent lanes and advises the driver of the presence of such vehicles via the indicators on the outside rear view mirrors.

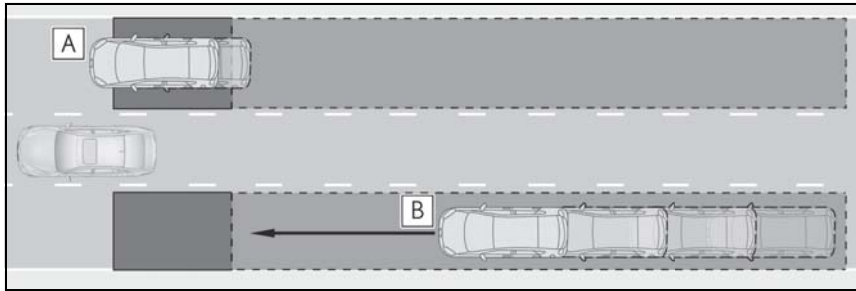

- A** Vehicles that are traveling in areas that are not visible using the outside rear view mirrors (the blind spots)
- B** Vehicles that are approaching rapidly from behind in areas that are not visible using the outside rear view mirrors (the blind spots)

■ The Blind Spot Monitor detection areas

The areas that vehicles can be detected in are outlined below.

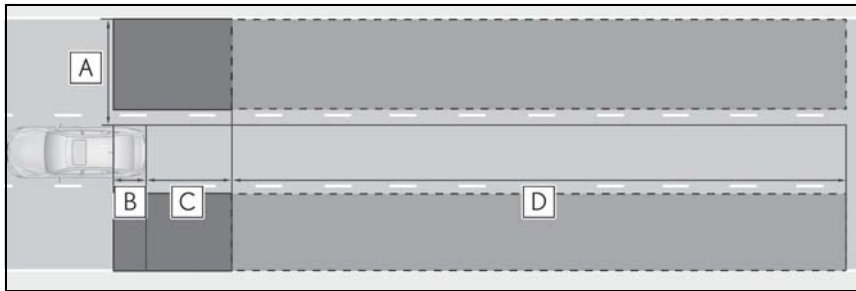

The range of each detection area is:

- A** Approximately 1.6 ft. (0.5 m) to 11.5 ft. (3.5 m) from either side of the vehicle ^{*1}
- B** Approximately 3.3 ft. (1 m) forward of the rear bumper
- C** Approximately 9.8 ft. (3 m) from the rear bumper
- D** Approximately 9.8 ft. (3 m) to 197 ft. (60 m) from the rear bumper ^{*2}

^{*1}: The area between the side of the vehicle and 1.6 ft. (0.5 m) from the side of the vehicle cannot be detected.

^{*2}: The greater the difference in speed between your vehicle and the detected vehicle is,

the farther away the vehicle will be detected, causing the outside rear view mirror indicator to illuminate or flash.

■ The Blind Spot Monitor is operational when

The Blind Spot Monitor is operational when all of the following conditions are met:

- The Blind Spot Monitor is on.
- The shift position is in a position other than R.
- The vehicle speed is greater than approximately 10 mph (16 km/h).

■ The Blind Spot Monitor will detect a vehicle when

The Blind Spot Monitor will detect a vehicle present in the detection area in the following situations:

- A vehicle in an adjacent lane overtakes your vehicle.
- You overtake a vehicle in an adjacent lane slowly.
- Another vehicle enters the detection area when it changes lanes.

■ Conditions under which the Blind Spot Monitor will not detect a vehicle

The Blind Spot Monitor is not designed to detect the following types of vehicles and/or objects:

- Small motorcycles, bicycles, pedestrians, etc.*
- Vehicles traveling in the opposite direction
- Guardrails, walls, signs, parked vehicles and similar stationary objects*
- Following vehicles that are in the same lane*
- Vehicles traveling 2 lanes away from your vehicle*
- Vehicles which are being overtaken rapidly by your vehicle*

*: Depending on the conditions, detection of a vehicle and/or object may occur.

■ Conditions under which the Blind Spot Monitor may not function correctly

- The Blind Spot Monitor may not detect vehicles correctly in the following situations:
 - When the sensor is misaligned due to a strong impact to the sensor or its surrounding area
 - When mud, snow, ice, a sticker, etc. is covering the sensor or surrounding area on the rear bumper
 - When driving on a road surface that is wet with standing water during bad weather, such as heavy rain, snow, or fog
 - When multiple vehicles are approaching with only a small gap between each vehicle
 - When the distance between your vehicle and a following vehicle is short
 - When there is a significant difference in speed between your vehicle and the vehicle that enters the detection area
 - When the difference in speed between your vehicle and another vehicle is changing
 - When a vehicle enters a detection area traveling at about the same speed as your vehicle
 - As your vehicle starts from a stop, a vehicle remains in the detection area
 - When driving up and down consecutive steep inclines, such as hills, dips in the road, etc.
 - When driving on roads with sharp bends, consecutive curves, or uneven surfaces
 - When vehicle lanes are wide, or when driving on the edge of a lane, and the vehicle in an adjacent lane is far away from your vehicle
 - When an accessory (such as a bicycle carrier) is installed to the rear of the vehicle
 - When there is a significant difference in height between your vehicle and the vehicle that enters the detection area
 - Immediately after the Blind Spot Monitor is turned on
- Instances of the Blind Spot Monitor unnecessarily detecting a vehicle and/or object may increase in the following situ-

ations:

- When the sensor is misaligned due to a strong impact to the sensor or its surrounding area
- When the distance between your vehicle and a guardrail, wall, etc. that enters the detection area is short
- When driving up and down consecutive steep inclines, such as hills, dips in the road, etc.
- When vehicle lanes are narrow, or when driving on the edge of a lane, and a vehicle traveling in a lane other than the adjacent lanes enters the detection area
- When driving on roads with sharp bends, consecutive curves, or uneven surfaces
- When the tires are slipping or spinning
- When the distance between your vehicle and a following vehicle is short
- When an accessory (such as a bicycle carrier) is installed to the rear of the vehicle

PKSA (Parking Support Alert)*

*: If equipped

The Parking Support Alert system consists of the following functions that operate when driving at a low speed or backing up, such as when parking. When the system determines that a collision with a detected object, such as a wall, or pedestrian is high, a warning operates to urge the driver to take evasive action.

PKSA (Parking Support Alert) system

■ Intuitive parking assist (if equipped)

Ultrasonic sensors are used to detect static objects in the detection area when driving at a low speed or backing up. (→P.257)

■ RCTA (Rear Cross Traffic Alert) function (if equipped)

Radar sensors are used to detect approaching vehicles in the detection areas behind the vehicle when backing up. (→P.263)

■ RCD (Rear camera detection) function (if equipped)

A rear camera sensor is used to detect pedestrians in the detection area behind the vehicle when backing up. (→P.267)











Setting the buzzer volume

off.

■ Adjusting the buzzer volume

The buzzer volume can be adjusted on the multi-information display. The volume of buzzers for the intuitive parking assist, RCTA function and RCD function will be adjusted simultaneously.

Use the meter control switches to change settings. (→P.81)

- 1 Press  or  to select .
- 2 Press  or  to select "PKSA" and then press .
- 3 Press  or  to select  and then press .

Each time the switch is pressed, the volume level will change between 1, 2, and 3.

■ Muting a buzzer

A mute button will be displayed on the multi-information display when an object or pedestrian is detected. To mute the buzzer, press .

The buzzers for the intuitive parking assist, RCTA function and RCD function will be muted simultaneously.

Mute will be canceled automatically in the following situations:

- When the shift position is changed.
- When the vehicle speed exceeds a certain speed.
- When the operating function is temporarily canceled.
- When the operating function is disabled manually.
- When the engine switch is turned

Intuitive parking assist*

*: If equipped

The distance from your vehicle to objects, such as a wall, when parallel parking or maneuvering into a garage is measured by the sensors and communicated via the multi-information display, head-up display (if equipped), Center Display and a buzzer. Always check the surrounding area when using this system.

System components

■ Types of sensors

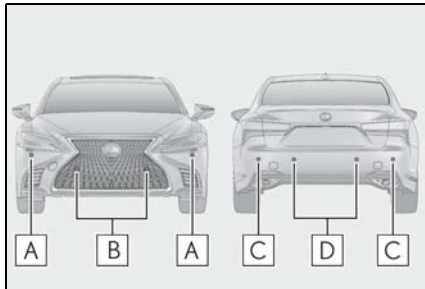

- A** Front corner sensors
- B** Front center sensors
- C** Rear corner sensors
- D** Rear center sensors

■ Display

When the sensors detect an object, such as a wall, a graphic is shown on the multi-information display, head-up display (if equipped) and Center Display depending on the position and distance to the object.

- Multi-information display and

head-up display

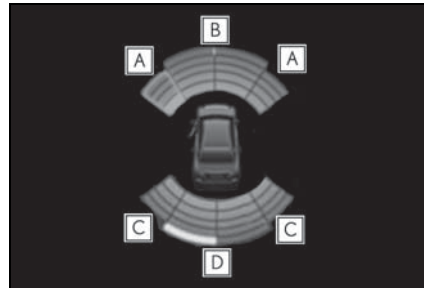

- A** Front corner sensor detection
- B** Front center sensor detection
- C** Rear corner sensor detection
- D** Rear center sensor detection

- Center Display

A graphic is shown when the Lexus parking assist monitor (if equipped) is displayed.

A simplified image is displayed on the Center Display when an object is detected.

- When the R shift position is selected

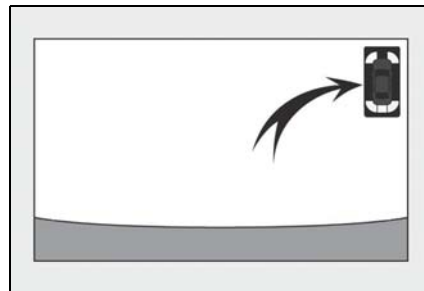

- When the N, M or D shift position is selected (vehicle moving forward)

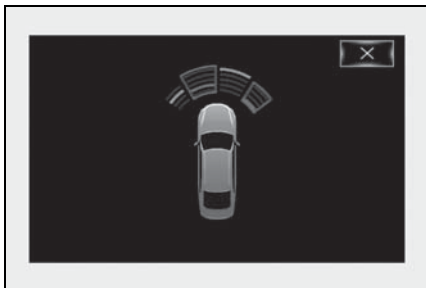

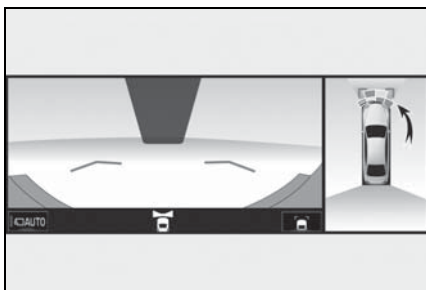

When an object is detected, a graphic will be displayed on the panoramic view monitor (if equipped).





Turning intuitive parking assist on/off

Use the meter control switches to enable/disable the Lexus parking assist-sensor. (→P.81)

- 1 Press **<** or **>** to select .
- 2 Press **▲** or **▼** to select "PKSA" and then press **OK**.
- 3 Press **▲** or **▼** to select  and then press **OK**.

When the intuitive parking assist function is disabled, the intuitive parking assist OFF indicator (→P.68) illuminates.

To re-enable the system when it was

disabled, select  on the multi-information display, select  and then On. If disabled using this method, the system will not be re-enabled by turning the engine switch off and then to IGNITION ON mode.

WARNING

■ When using the intuitive parking assist

Observe the following precautions. Failing to do so may result in the vehicle being unable to be driven safely and possibly cause an accident.

- Do not use the sensor at speeds in excess of 6 mph (10 km/h).
- The sensors' detection areas and reaction times are limited. When moving forward or reversing, check the areas surrounding the vehicle (especially the sides of the vehicle) for safety, and drive slowly, using the brake to control the vehicle's speed.
- Do not install accessories within the sensors' detection areas.
- The area directly under the bumpers is not detected.

■ When to disable the function

In the following situations, disable the function as it may operate even though there is no possibility of a collision.

- The vehicle is equipped with a fender pole, wireless antenna or fog lights.
- The front or rear bumper or a sensor receives a strong impact.
- A non-genuine Lexus suspension (lowered suspension, etc.) is installed.
- Towing eyelets are installed.
- A backlit licence plate is installed.

**WARNING****■ When using intuitive parking assist**

In the following situations, the system may not function correctly due to a sensor malfunction, etc. Have the vehicle checked by your Lexus dealer.

- The intuitive parking assist operation display flashes or shows continuously, and a buzzer sounds when no objects are detected.
- If the area around a sensor collides with something, or is subjected to strong impact.
- If the bumper or grille collides with something.
- If the display flashes or is displayed continuously and a buzzer does not sound, except when the mute function has been turned on.
- If a display error occurs, first check the sensor.
If the error occurs even when there is no ice, snow or mud on the sensor, it is likely that the sensor is malfunctioning.

■ Notes when washing the vehicle

Do not apply intensive bursts of water or steam to the sensor area.

Doing so may result in the sensor malfunctioning.

- When using a high pressure washer to wash the vehicle, do not spray the sensors directly, as doing so may cause a sensor to malfunction.
- When using steam to clean the vehicle, do not direct steam too close to the sensors as doing so may cause a sensor to malfunction.

■ The system can be operated when

- The engine switch is in IGNITION ON mode.
- Intuitive parking assist function is on.
- The vehicle speed is less than about 6

mph (10 km/h).

- A shift position other than P is selected.

■ Setting the buzzer volume

The buzzer volume can be adjusted on the multi-information display. (→P.256)

■ If “Parking Assist Unavailable Clean Parking Assist Sensor” is displayed on the multi-information display

A sensor may be covered with ice, snow, dirt, etc. Remove the ice, snow, dirt, etc., from the sensor to return the system to normal.

Also, due to ice forming on a sensor at low temperatures, a warning message may be displayed or the sensor may not be able to detect an object. Once the ice melts, the system will return to normal.

■ Sensor detection information

- The following situations may occur during use.
 - The sensors may be able to only detect objects near the front and rear bumpers.
 - Depending on the shape of the object and other factors, the detection distance may shorten, or detection may be impossible.
 - There will be a short delay between object detection and display. Even at low speeds, there is a possibility that the object will come within the sensor's detection areas before the display is shown and the warning beep sounds.
 - It might be difficult to hear the buzzer due to the volume of the audio system or air flow noise of the air conditioning system.
 - It may be difficult to hear the buzzer if buzzers for other systems are sounding.

■ Conditions under which the function may not function correctly

Certain vehicle conditions and the surrounding environment may affect the ability of a sensor to correctly detect objects. Particular instances where this may occur are listed below.

- There is dirt, snow or ice on a sensor. (Cleaning the sensors will resolve this problem.)
- A sensor is frozen. (Thawing the area will resolve this problem.)

In especially cold weather, if a sensor is frozen the sensor display may be displayed abnormally, or objects, such as a wall, may not be detected.

- A sensor is covered in any way.
- When a sensor or the area around a sensor is extremely hot or cold.
- On an extremely bumpy road, on an incline, on gravel, or on grass.
- The vicinity of the vehicle is noisy due to vehicle horns, motorcycle engines, air brakes of large vehicles, or other loud noises producing ultrasonic waves.
- There is another vehicle equipped with parking assist sensors in the vicinity.
- A sensor is coated with a sheet of spray or heavy rain.
- If a sensor is hit by a large amount of water, such as when driving on a flooded road.

■ **Certification**

- ▶ For vehicles sold in the U.S.A.

This device complies with Part 15 of the FCC Rules. Operation is subject to the following two conditions; (1) This device may not cause harmful interference, and (2) this device must accept any interference received, including interference that may cause undesired operation.

- ▶ For vehicles sold in Canada

This ISM device complies with Canadian ICES-001.
Cet appareil ISM est conforme a la norme NMB-001 du Canada.

- If the vehicle is significantly tilted.
- The vehicle is approaching a tall or curved curb.
- If objects draw too close to the sensor.

■ **Objects which may not be properly detected**

The shape of the object may prevent the sensor from detecting it. Pay particular attention to the following objects:

- Wires, fences, ropes, etc.
- Cotton, snow and other materials that absorb sound waves
- Sharply-angled objects
- Low objects
- Tall objects with upper sections projecting outwards in the direction of your vehicle

People may not be detected if they are wearing certain types of clothing.

Sensor detection display, object distance

■ **Detection range of the sensors**

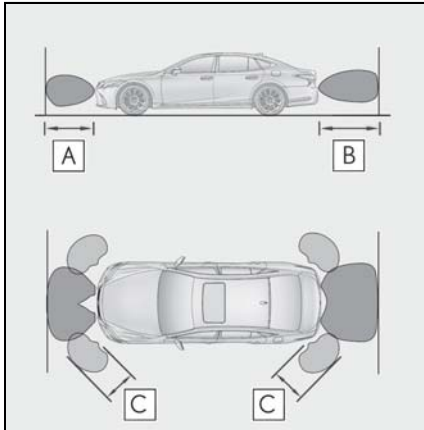

- A** Approximately 3.3 ft. (100 cm)
- B** Approximately 4.9 ft. (150 cm)
- C** Approximately 1.9 ft. (65 cm)

The diagram shows the detection range of the sensors. Note that the sensors cannot detect objects that are extremely close to the vehicle.

The range of the sensors may change depending on the shape of the object, etc.

■ **Multi-information display, head-up display (if equipped) and Center Display**

When an object is detected by a sensor, the approximate distance to the object will be displayed on the multi-information display, Center Display, and head-up display (if equipped). (As the distance to the object becomes short, the distance segments may blink.)

- Approximate distance to object: 4.9 ft. (150 cm) to 1.9 ft. (65 cm)* (Rear center sensor)

Multi-information display	Center Display	Head-up display



* : Automatic buzzer mute function is enabled. (→P.263)

- Approximate distance to object: 3.3 ft. (100 cm) to 1.9 ft. (65 cm)* (Front center sensor)

Multi-information display	Center Display	Head-up display



*: Automatic buzzer mute function is enabled. (→P.263)

- Approximate distance to object: 1.9 ft. (65 cm) to 1.5 ft. (45 cm)*

Multi-information display	Center Display	Head-up display
		



*: Automatic buzzer mute function is enabled. (→P.263)

- Approximate distance to object: 1.5 ft. (45 cm) to 1.0 ft. (30 cm)*

Multi-information display	Center Display	Head-up display
		

*: Automatic buzzer mute function is enabled. (→P.263)



- Approximate distance to object: 1.0 ft. (30 cm) to 0.5 ft. (15 cm)*¹

Multi-information display ^{*2}	Center Display ^{*2}	Head-up display ^{*1}
		

^{*1}: Automatic buzzer mute function is disabled. (→P.263)

^{*2}: The distance segments will blink slowly.

- Approximate distance to object: Less than 0.5 ft. (15 cm)^{*1}

Multi-information display ^{*2}	Center Display ^{*2}	Head-up display ^{*1}
		

^{*1}: Automatic buzzer mute function is disabled. (→P.263)

^{*2}: The distance segments will blink rapidly.

■ Buzzer operation and distance to an object

A buzzer sounds when the sensors are operating.

- The buzzer beeps faster as the vehicle approaches an object. When the vehicle comes within the following distance of the object, the buzzer sounds continuously:

Approximately 1.0 ft. (30 cm)

- When 2 or more objects are detected simultaneously, the buzzer sounds for the nearest object. If one or more objects come within approximately 1.0 ft. (30 cm) of the vehicle, the buzzer will repeat a long tone, followed by fast beeps.
- Automatic buzzer mute function: After a buzzer begins sounding, if the distance between the vehicle and the detected object does not become shorter, the buzzer will be muted automatically. (However, if the distance between the vehicle and object is 1.0 ft. (30 cm) or less, this function will not operate.)

The buzzer sounds volume can be adjusted. (→P.256)

RCTA (Rear cross traffic alert) function*

*: If equipped

The RCTA function uses the BSM rear side radar sensors installed behind the rear bumper. This function is intended to assist the driver in checking areas that are not easily visible when backing up.

System components

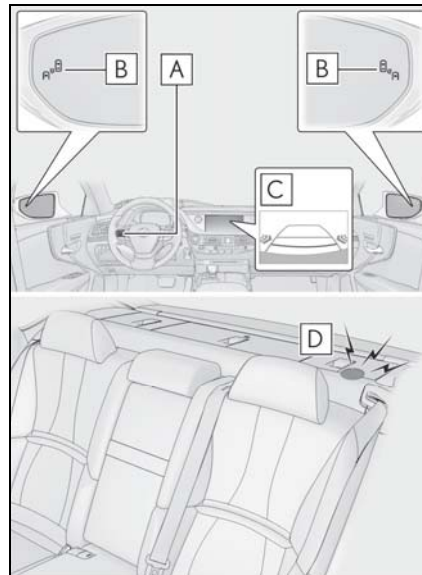

A Meter control switches

Turning the RCTA function on/off.

When the RCTA function is disabled, the RCTA OFF indicator illuminates.

B Outside rear view mirror indicators

When a vehicle approaching from the right or left at the rear of the vehicle is detected, both outside rear view mirror indicators will flash.

C Center Display

If a vehicle approaching from the right or left at the rear of the vehicle is detected, the RCTA icon (→P.265) for the detected side will be displayed on the Center Display. This illustration shows an example of a vehicle approaching from both sides of the vehicle.

D RCTA buzzer

If a vehicle approaching from the right or left at the rear of the vehicle is detected, a buzzer will sound. The buzzer also sounds for approximately 1 second immediately after the RCTA function is turned on.

Turning the RCTA function on/off

Use the meter control switches to enable/disable the RCTA function. (→P.81)

- 1 Press **<** or **>** to select .
- 2 Press **▲** or **▼** to select "PKSA" and then press **OK**.
- 3 Press **▲** or **▼** to select "RCTA" and then press **OK**.

When the RCTA function is disabled, the RCTA OFF indicator (→P.68) illuminates. (Each time the engine switch is turned off then changed to IGNITION ON mode, the RCTA function will be enabled automatically.)

RCTA function

■ Operation of the RCTA function

The RCTA function uses rear side radar sensors to detect vehicles approaching from the right or left at the rear of the vehicle and alerts the driver of the presence of such vehicles by flashing the outside rear view mirror indicators and sounding a buzzer.

WARNING

■ Cautions regarding the use of the function

The driver is solely responsible for safe driving. Always drive safely, taking care to observe your surroundings.

The RCTA function is only a supplementary function which alerts the driver that a vehicle is approaching from the right or left at the rear of the vehicle. As the RCTA function may not function correctly under certain conditions, the driver's own visual confirmation of safety is necessary. Over reliance on this function may lead to an accident resulting death or serious injury.

■ Outside rear view mirror indicator visibility

In strong sunlight, the outside rear view mirror indicator may be difficult to see.

■ Hearing the RCTA buzzer

The RCTA buzzer may be difficult to hear over loud noises, such as if the audio system volume is high.

■ When "RCTA Not Available" is shown on the multi-information display

Water, snow, mud, etc., may be attached to the rear bumper around the sensors. (→P.252) Removing the water, snow, mud, etc., from the attached to the rear bumper around the sensors to normal.

Additionally, the function may not function normally when used in extremely hot or cold environments.

■ Rear side radar sensors

→P.252

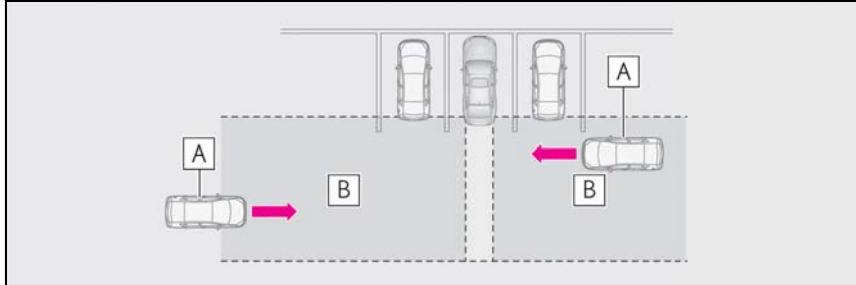

- A** Approaching vehicles
- B** Detection areas of approaching vehicles

■ **RCTA icon display**

When a vehicle approaching from the right or left at the rear of the vehicle is detected, the following will be displayed on the Center Display.

- Example (Lexus parking assist monitor) (if equipped): Vehicles are approaching from both sides of the vehicle

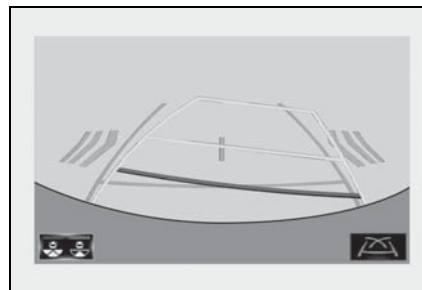

4
Driving

■ **RCTA function detection areas**

The areas that vehicles can be detected in are outlined below.

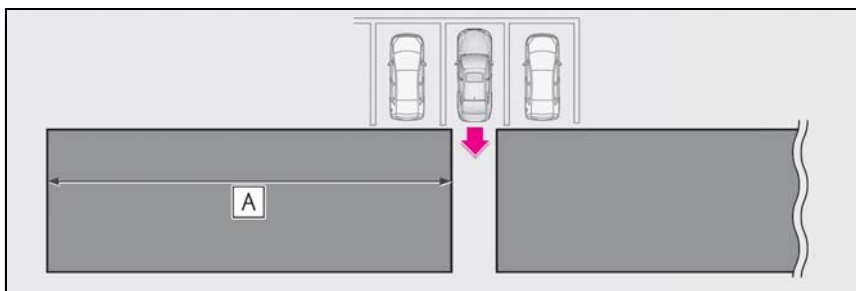

The buzzer can alert the driver of faster vehicles approaching from farther away.

Example:

Approaching vehicle speed	A Approximate alert distance
18 mph (28 km/h) (fast)	65 ft. (20 m)
5 mph (8 km/h) (slow)	18 ft. (5.5 m)

■ The RCTA function is operational when

The RCTA function operates when all of the following conditions are met:

- The engine switch is in IGNITION ON mode.
- The RCTA function is on.
- The shift position is in R.
- The vehicle speed is less than approximately 5 mph (8 km/h).
- The approaching vehicle speed is between approximately 5 mph (8 km/h) and 18 mph (28 km/h).

■ Setting the buzzer volume

The buzzer volume can be adjusted on the multi-information display. (→P.256)

■ Conditions under which the RCTA function will not detect a vehicle

The RCTA function is not designed to detect the following types of vehicles and/or objects:

- Vehicles approaching from directly behind
- Vehicles backing up in a parking space next to your vehicle
- Vehicles that the sensors cannot detect due to obstructions

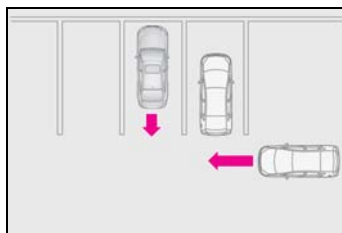

- Guardrails, walls, signs, parked vehicles and similar stationary objects*
- Small motorcycles, bicycles, pedestrians, etc.*
- Vehicles moving away from your vehicle
- Vehicles approaching from the parking spaces next to your vehicle*

*: Depending on the conditions, detection of a vehicle and/or object may occur.

■ Conditions under which the RCTA function may not function correctly

- The RCTA function may not detect vehicles correctly in the following situations:
 - When a sensor is misaligned due to a strong impact to the sensor or its surrounding area
 - When mud, snow, ice, a sticker, etc. is covering a sensor or its surrounding area on the rear bumper
 - When driving on a road surface that is wet with standing water during bad weather, such as heavy rain, snow, or fog
 - When multiple vehicles are approaching with only a small gap between each vehicle
 - If a vehicle is approaching the rear of your vehicle rapidly
 - When a towing eyelet is installed to the rear of the vehicle.
 - When backing up on a slope with a sharp change in grade

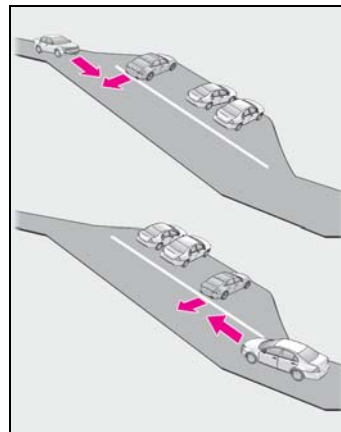

- When backing out of a shallow angle parking spot

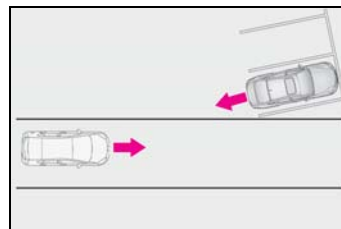

- Immediately after the RCTA function is turned on
- Immediately after the engine is started

- with the RCTA function on
- When the sensors cannot detect a vehicle due to obstructions

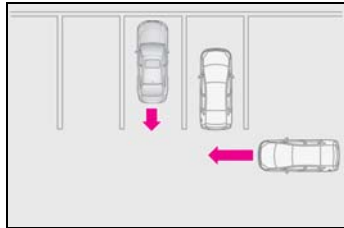

- Instances of the RCTA function unnecessarily detecting a vehicle and/or object may increase in the following situations:
- When a vehicle passes by the side of your vehicle
- When the parking space faces a street and vehicles are being driven on the street

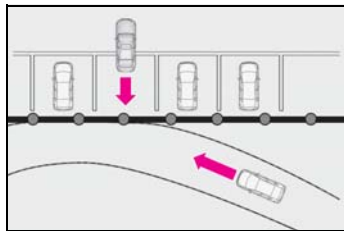

- When the distance between your vehicle and metal objects, such as a guardrail, wall, sign, or parked vehicle, which may reflect electrical waves toward the rear of the vehicle, is short
- When a towing eyelet is installed to the rear of the vehicle

RCD (Rear Camera Detection) function*

*: If equipped

When the vehicle is backing up, the rear camera detection function can detect pedestrians in the detection area behind the vehicle. If a pedestrian is detected, a buzzer will sound and an icon will be displayed on the Center Display to inform the driver of the pedestrian.

Center Display

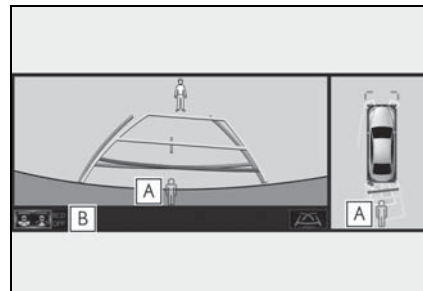

A Pedestrian detection icon
Displayed automatically when a pedestrian is detected.

B RCD OFF icon
When the RCD function is disabled, the RCD OFF icon illuminates. (Each time the engine switch is turned off then changed to IGNITION ON mode, the RCD function will be enabled automatically.)

Turning the RCD function on/off

Use the meter control switches to enable/disable the RCD function. (→P.81)

- 1 Press **<** or **>** to select .

2 Press **▲** or **▼** to select "PKSA" and then press **OK**.

3 Press **▲** or **▼** to select "RCD" and then press **OK**.

When the RCD function is disabled, the RCD OFF indicator (→P.68) illuminates.

When a pedestrian is detected

If the rear camera detection function detects a pedestrian in the detection area, the buzzer and pedestrian detection will operate as follows:

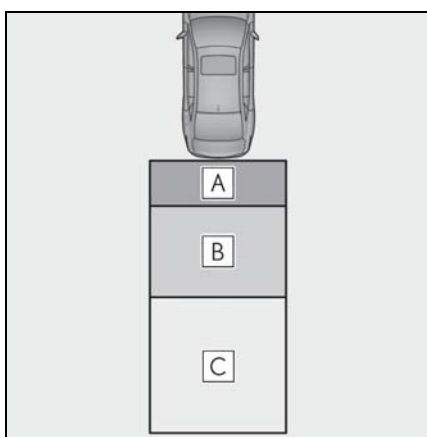

- A** If a pedestrian is detected in area **A**
 Buzzer: Sounds repeatedly
 Pedestrian detection icon: Blinks 3 times and then stays on
- B** If a pedestrian is detected in area **B**
 Buzzer (When the vehicle is stationary): Sounds 3 times
 Buzzer (When the vehicle is backing up, when a pedestrian approaches the rear of the vehicle):

Sounds repeatedly
 Pedestrian detection icon: Blinks 3 times and then stays on

- C** If the system determines that your vehicle may collide with a pedestrian in area **C**
 Buzzer: Sounds repeatedly
 Pedestrian detection icon: Blinks 3 times and then stays on

■ The rear camera detection function is operational when

- The engine switch is in IGNITION ON mode.
- RCD function is on.
- The shift position is in R.

■ Setting the buzzer volume

The buzzer volume can be adjusted on the multi-information display. (→P.256)

■ If "Rear Camera Detection Unavailable Remove the Dirt of Rear Camera" is displayed on the multi-information display

A rear camera lens may be dirty or covered with snow or ice. In such cases, if it is removed from the rear camera lens, the system should return to normal. (It may be necessary to drive the vehicle for some time before the system returns to normal.)

■ If "Rear Camera Detection Unavailable" is displayed on the multi-information display

- If this message is displayed after the battery has been disconnected and reconnected, fully turn the steering wheel to the left and then the right on level ground.
- If this message is displayed only when the R shift position is selected, the rear camera lens may be dirty. Clean the rear camera lens.

■ Situations in which the system may not operate properly

- Some pedestrians, such as the following, may not be detected by the rear camera detection function, preventing the function from operating properly:

- Pedestrians who are bending forward or squatting
- Pedestrians who are lying down
- Pedestrians who are running
- Pedestrians who suddenly enter the detection area
- People riding a bicycle, skateboard, or other light vehicle
- Pedestrians wearing oversized clothing such as a rain coat, long skirt, etc., making their silhouette obscure
- Pedestrians whose body is partially hidden by an object, such as a cart or umbrella
- Pedestrians which are obscured by darkness, such as at night
- In some situations, such as the following, pedestrians may not be detected by the rear camera detection function, preventing the function from operating properly:
 - When backing up in inclement weather (rain, snow, fog, etc.)
 - When the rear camera is obscured (dirt, snow, ice, etc. are attached) or scratched
 - When a very bright light, such as the sun, or the headlights of another vehicle, shines directly into the rear camera
 - When backing up in a place where the surrounding brightness changes suddenly, such as at the entrance or exit of a garage or underground parking lot
 - When backing up in a dim environment such as during dusk or in an underground parking lot
- Even though there are no pedestrians in the detection area, some objects, such as the following, may be detected, possibly causing the rear camera detection function to operate.
 - Three dimensional objects, such as a pole, traffic cone, fence, or parked vehicle
 - Moving objects, such as a car or motorcycle
 - Objects moving toward your vehicle when backing up, such as flags or puddles (or airborne matter, such as smoke, steam, rain, or snow)
 - Cobblestone or gravel roads, tram rails, road repairs, white lines, pedestrian crossings or fallen leaves on the road
 - Metal covers (gratings), such as those used for drainage ditches
- Objects reflected in a puddle or on a wet road surface
- The roadside or bumps on the road
- Shadows on the road
- In some situations, such as the following, the rear camera detection function may operate even though there are no pedestrians in the detection area.
 - When backing up toward the roadside or a bump on the road
 - If the vehicle is significantly tilted, such as when carrying a heavy load
 - When backing up toward an incline/decline
 - If the suspension has been modified or tires of a size other than specified are installed
 - If the rear of the vehicle is raised or lowered due to the carried load
 - If an electronic component, such as a backlit license plate or rear fog light, is installed near the rear camera
 - If a bumper protector, such as an additional trim strip, is installed to the rear bumper
 - If the orientation of the rear camera has been changed
 - If a towing eyelet is installed to the rear of the vehicle
 - When water is flowing over the rear camera lens
 - When the rear camera is obscured (dirt, snow, ice, etc. are attached) or scratched
 - If there is a flashing light in the detection area, such as the emergency flashers of another vehicle
- Situations in which the rear camera detection function may be difficult to notice
 - If buzzer may be difficult to hear if the surrounding area is noisy, the volume of the audio system volume is high, the air conditioning system is being used, etc.
 - If the temperature in the cabin is extremely high or low, the audio system screen may not operate correctly.

PKSB (Parking Support Brake)*

*: If equipped

The Parking Support Brake system consists of the following functions that operate when driving at a low speed or backing up, such as when parking. When the system determines that a collision with a detected object or pedestrian is high, a warning operates to urge the driver to take evasive action. If the system determines that the possibility of a collision with a detected object or pedestrian is extremely high, the brakes are automatically applied to help avoid the collision or help reduce the impact of the collision.

PKSB (Parking Support Brake) system

■ **Parking Support Brake function (static objects) (if equipped)**

Ultrasonic sensors are used to detect static objects, such as a wall, in the detection area when driving at a low speed or backing up. (→P.276)

■ **Parking Support Brake function (rear-crossing vehicles) (if equipped)**

Rear radar sensors are used to detect approaching vehicles in the detection area behind the vehicle when backing up. (→P.282)

■ **Parking Support Brake function (rear pedestrians) (if equipped)**

A rear camera sensor is used to detect pedestrians in the detection area behind the vehicle when backing up. (→P.286)

 **WARNING**

■ **Limitations of the Parking Support Brake system**

Do not overly rely on the system, as doing so may lead to an accident.

- The driver is solely responsible for safe driving. Always drive carefully, taking care to observe your surroundings. The Parking Support Brake system is designed to provide support to lessen the severity of collisions. However, it may not operate in some situations.
- The Parking Support Brake system is not designed to stop the vehicle completely. Additionally, even if the system has stopped the vehicle, it is necessary to depress the brake pedal immediately as brake control will be canceled after approximately 2 seconds.

 **NOTICE**







■ **If “Parking Support Brake Unavailable” is displayed on the multi-information display and the PKSB OFF indicator is flashing**

If this message is displayed immediately after the engine switch is changed to IGNITION ON mode, operate the vehicle carefully, paying attention to your surroundings. It may be necessary to drive the vehicle for a certain amount of time before the system returns to normal. (If the system is not return to normal after driving for a while, clean the rear camera lens.)



Enabling/Disabling the Parking Support Brake

The Parking Support Brake can be enabled/disabled on the multi-information display. All of the Parking Support Brake functions (static objects, rear-crossing vehicles, and rear pedestrians) are enabled/disabled simultaneously.

Use the meter control switches to enable/disable the parking support brake. (→P.81)

- 1 Press  or  to select .
- 2 Press  or  to select  and then press .

When the Parking Support Brake is disabled, the PKSB OFF indicator (→P.68) illuminates.

To re-enable the system when it was disabled, select  on the multi-information display, select  and then On. If disabled using this method, the system will not be re-enabled by turning the engine switch off and then to IGNITION ON mode.

Displays and buzzers for engine output restriction control and brake control

If the engine output restriction control or brake control operates, a buzzer will sound and a message will be displayed on the Center Display and multi-information display, to alert the driver. On vehicles with a head-up display, the head-up display will display the same message as the multi-information display.

Depending on the situation, engine output restriction control will operate to either

limit acceleration or restrict output as much as possible.

- Engine output restriction control is operating (acceleration restriction)

Acceleration greater than a certain amount is restricted by the system.

Center Display (Panoramic view monitor): No warning displayed

Multi-information display: "Object Detected Acceleration Reduced"

PKSB OFF indicator: Not illuminated

Buzzer: Does not sound

- Engine output restriction control is operating (output restricted as much as possible)

The system has determined that stronger-than-normal brake operation is necessary.

Center Display (Panoramic view monitor): "BRAKE!"

Multi-information display: "BRAKE!"

PKSB OFF indicator: Not illuminated

Buzzer: Short beep

- Brake control is operating

The system determined that emergency braking is necessary.

Center Display (Panoramic view monitor): "BRAKE!"

Multi-information display: "BRAKE!"

PKSB OFF indicator: Not illuminated

Buzzer: Short beep

- Vehicle stopped by system operation

The vehicle has been stopped by brake control operation.

Center Display (Panoramic view monitor): "Press Brake Pedal"

Multi-information display: "Switch to Brake" (If the accelerator pedal is not depressed, "Press Brake Pedal" will be displayed.)

PKSB OFF indicator: Illuminated
Buzzer: Short beep

System overview

If the Parking Support Brake determines that a collision with a detected object or pedestrian is possible, the engine output will be restricted to restrain any increase in the vehicle speed. (Engine output restriction control: See figure 2.) Additionally, if the accelerator pedal continues to be depressed, the brakes will be applied automatically to reduce the vehicle speed. (Brake control: See figure 3.)

- Figure 1 When the PKSB (Parking Support Brake) is disabled

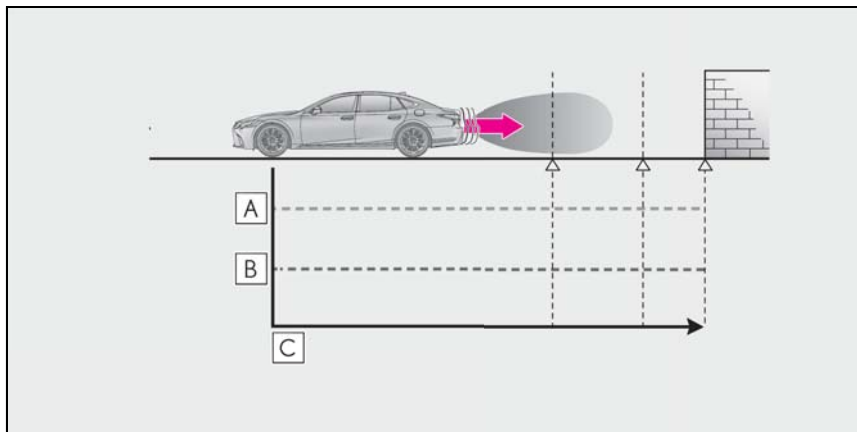

- A** Engine output
- B** Braking force
- C** Time

- Figure 2 When engine output restriction control operates

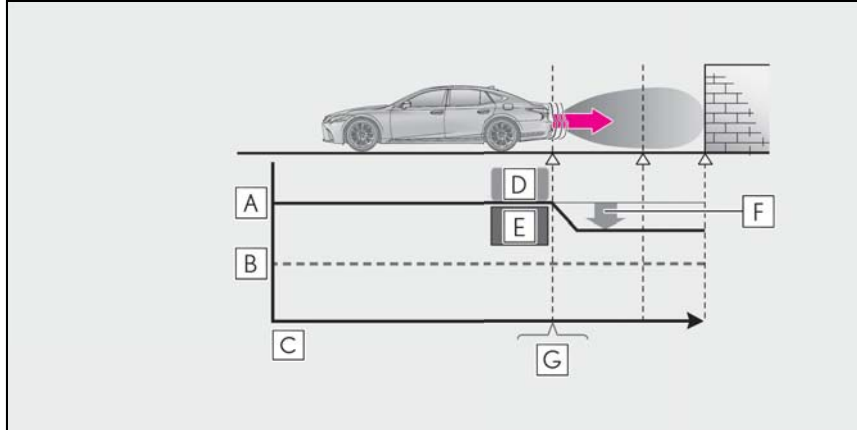

- A** Engine output
- B** Braking force
- C** Time
- D** Engine output restriction control begins operating
- E** System determines that possibility of collision with detected object is high
- F** Engine output reduced
- G** Example: Multi-information display: "BRAKE!"

● Figure 3 When brake control operates

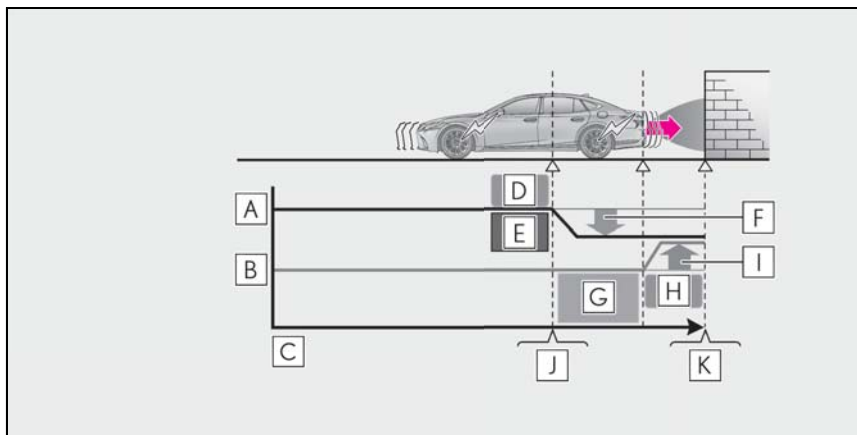

- A** Engine output
- B** Braking force
- C** Time

- D** Engine output restriction control begins operating
- E** System determines that possibility of collision with detected object is high
- F** Engine output reduced
- G** System determines that possibility of collision with detected object is extremely high
- H** Brake control begins operating
- I** Brake control strength increased
- J** Example: Multi-information display: "BRAKE!"
- K** Example: Multi-information display: "Switch to Brake"

■ If the Parking Support Brake has operated

If the vehicle is stopped due to operation of the Parking Support Brake, the Parking Support Brake will be disabled and the PKSB OFF indicator will illuminate. If the Parking Support Brake operates unnecessarily, brake control can be canceled by depressing the brake pedal or waiting for approximately 2 seconds for it to automatically be canceled. Then, the vehicle can be operated by depressing the accelerator pedal.

■ If "Parking Support Brake Unavailable" is displayed on the multi-information display and the PKSB OFF indicator is flashing

If the vehicle is stopped due to operation of the Parking Support Brake, the Parking Support Brake will be disabled and the PKSB OFF indicator will illuminate.

- A sensor may be covered with ice, snow, dirt, etc. Remove the ice, snow, dirt, etc., from the sensor to return the system to normal.
Also, due to ice forming on a sensor at low temperatures, a warning message may be displayed or the sensor may not be able to detect an object. Once the ice melts, the system will return to normal.
- If this message is displayed only when the R shift position is selected, the rear camera lens may be dirty. Clean the camera lens. If this message is displayed in any forward shift position, a sensor on the front or rear bumper may be dirty. Clean the sensors and their surrounding area on the bumpers.
- If this message continues to be displayed even after cleaning the sensor, or is displayed even though the sensor is clean, have the vehicle inspected by your Lexus dealer.
- Initialization may not have been performed after a battery terminal was disconnected and reconnected. Initialize the system. (→P.274)
If this message continues to be displayed even after initialization, have the vehicle inspected by your Lexus dealer.

■ If a battery terminal has been disconnected and reconnected

The system needs to be initialized. To initialize the system, drive the vehicle straight ahead for 5 seconds or more at a speed of approximately 22 mph (35 km/h) or more.

Additionally, for vehicles with the Parking Support Brake function, turn the steering wheel fully to the left and right with the vehicle stopped.

■ Re-enabling the Parking Support Brake

To re-enable the Parking Support Brake when it has been disabled due to operation of the Parking Support Brake, either enable the system again (→P.271), or turn the engine switch off and then back to IGNITION ON mode.

Additionally, if any of the following conditions are met, the system will be re-enabled automatically and the PKSB OFF indicator will turn off:

- The P shift position is selected
- The object is no longer detected in the traveling direction of the vehicle
- The traveling direction of the vehicle changes *

*: Except when the Parking Support Brake function (rear pedestrians) operated.

Parking Support Brake function (static objects)*

*: If equipped

If the sensors detect a static object, such as a wall, in the travelling direction of the vehicle and the system determines that a collision may occur due to the vehicle suddenly moving forward due to an accidental accelerator pedal operation, the vehicle moving the unintended direction due to the wrong shift position being selected, or while parking or traveling at low speeds, the system will operate to lessen the impact with the detected static object and reduce the resulting damage.

Examples of function operation

This function will operate in situations such as the following if an object is detected in the traveling direction of the vehicle.

- When traveling at a low speed and the brake pedal is not depressed, or is depressed late

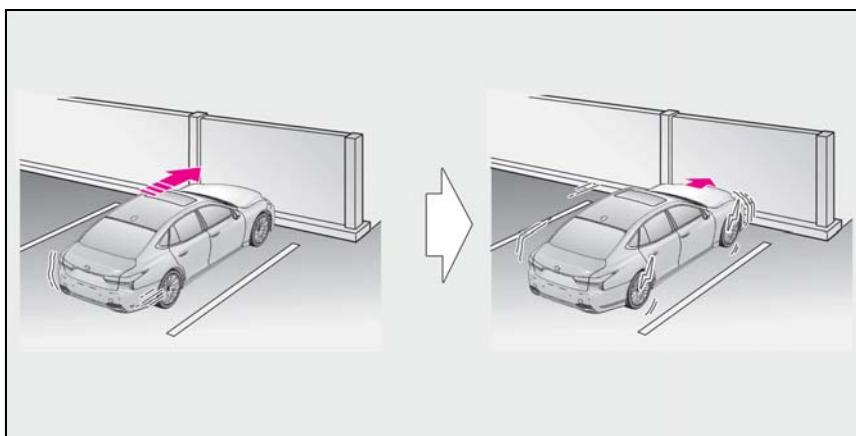

■ When the accelerator pedal is depressed excessively

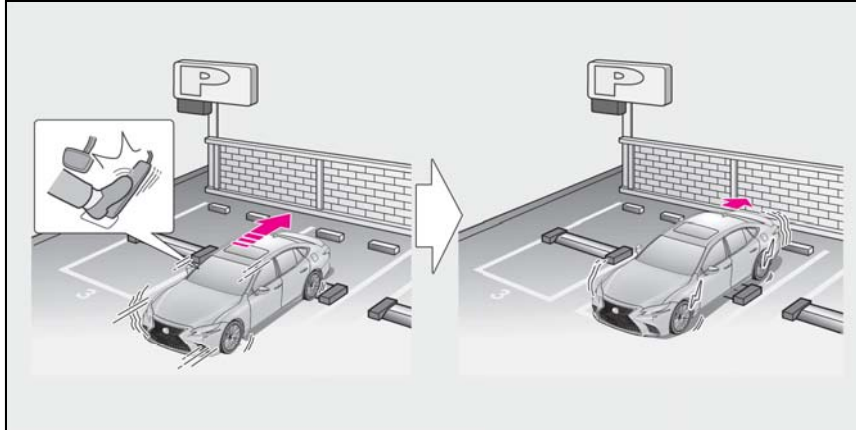

■ When the vehicle moves in the unintended direction due to the wrong shift position being selected

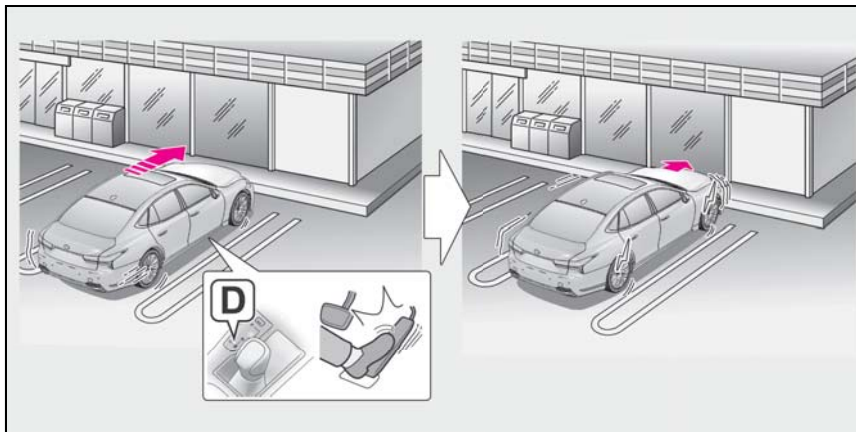

4
Driving

Types of sensors

→P.257

⚠ WARNING
■ To ensure the Parking Support Brake can operate properly
 Observe the following precautions regarding the sensors (→P.257). Failure to do so may cause a sensor to not operate properly, and may cause an accident.

- Do not modify, disassemble or paint the sensors.
- Do not replace a sensor with a part other than a genuine part.
- Do not subject a sensor or its surrounding area to a strong impact.
- Do not damage the sensors, and always keep them clean.

⚠ WARNING

- If the area around a radar sensor is subjected to an impact, the system may not operate properly due to a sensor malfunction. Have the vehicle inspected by your Lexus dealer.

■ Handling the suspension

Do not modify the suspension, as changes to the height or inclination of the vehicle may prevent the sensors from detecting objects correctly or cause the system to not operate or operate unnecessarily.

■ If the Parking Support Brake function (static objects) operates unnecessarily, such as at a railroad crossing

In the event that the Parking Support Brake function (static objects) operates unnecessarily, such as at a railroad crossing, brake control will be canceled after approximately 2 seconds, allowing you to proceed forward and leave the area, brake control can also be canceled by depressing the brake pedal. Depressing the accelerator pedal after brake control is canceled will allow you to proceed forward and leave the area.

■ Notes when washing the vehicle

Do not apply intensive bursts of water or steam to the sensor area.

Doing so may result in the sensor malfunctioning.

- When using a high pressure washer to wash the vehicle, do not spray the sensors directly, as doing so may cause a sensor to malfunction.
- When using steam to clean the vehicle, do not direct steam too close to the sensors as doing so may cause a sensor to malfunction.

■ When to disable the Parking Support Brake

In the following situations, disable the Parking Support Brake as the system may operate even though there is no possibility of a collision.

- When inspecting the vehicle using a chassis roller, chassis dynamo or free roller
- When loading the vehicle onto a boat, truck or other transport vessel
- If the suspension has been modified or tires of a size other than specified are installed
- If the front of the vehicle is raised or lowered due to the carried load
- When equipment that may obstruct a sensor is installed, such as a towing eyelet, bumper protector (an additional trim strip, etc.), bicycle carrier, or snow plow
- When using an automatic car wash

■ The Parking Support Brake function (static object) will operate when

The function will operate when the PKSB OFF indicator is not illuminated or flashing (→P.69, 70) and all of the following conditions are met:

- Engine output restriction control
 - The Parking Support Brake is enabled.
 - The vehicle speed is 9 mph (15 km/h) or less.
 - There is a static object in the traveling direction of the vehicle and 6 to 13 ft. (2 to 4 m) away.
 - The Parking Support Brake determines that a stronger-than-normal brake operation is necessary to avoid a collision.
- Brake control
 - Engine output restriction control is operating.
 - The Parking Support Brake determines that an immediate brake operation is necessary to avoid a collision.

■ The Parking Support Brake function (static objects) will stop operating when

The function will stop operating if any of the following conditions are met:

- Engine output restriction control
 - The Parking Support Brake is disabled.
 - The system determines that the collision

has become avoidable with normal brake operation.

- The static object is no longer 6 to 13 ft. (2 to 4 m) away from the vehicle or in the traveling direction of the vehicle.
- Brake control
- The Parking Support Brake is disabled.
- Approximately 2 seconds have elapsed since the vehicle was stopped by brake control.
- The brake pedal is depressed after the vehicle is stopped by brake control.
- The static object is no longer 6 to 13 ft. (2 to 4 m) away from the vehicle or in the traveling direction of the vehicle.

■ Re-enabling the Parking Support Brake function (static objects)

→P.275

■ Detection range of the Parking Support Brake function (static objects)

The detection range of the Parking Support Brake function (static objects) differs from the detection range of the intuitive parking assist. (→P.261) Therefore, even if the intuitive parking assist detects an object and provides a warning, the Parking Support Brake function (static objects) may not start operating.

■ Objects that the Parking Support Brake function (static objects) may not detect

The sensors may not be able to detect certain objects, such as the following:

- Pedestrian
- Cotton cloth, snow, and other materials that are poor reflectors of ultrasonic waves
- Objects which are not perpendicular to the ground, are not perpendicular to the traveling direction of the vehicle, are uneven or are waving
- Low objects
- Thin objects such as wires, fences, ropes and signposts
- Objects that are extremely close to the bumper
- Sharply-angled objects
- Tall objects with upper sections projecting outwards in the direction of your vehi-

cle

■ Intuitive parking assist buzzer

Regardless of whether the intuitive parking assist system is enabled or not (→P.258), if the Parking Support Brake function (static objects) is enabled (→P.271), the front or rear sensors detect an object and brake control is performed, the intuitive parking assist buzzer will sound to notify the driver of the approximate distance to the object.

■ Situations in which the Parking Support Brake function (static objects) may operate even if there is no possibility of a collision

In some situations, such as the following, the Parking Support Brake function (static objects) may operate even though there is no possibility of a collision.

- Vehicle surroundings
- When driving on a narrow road

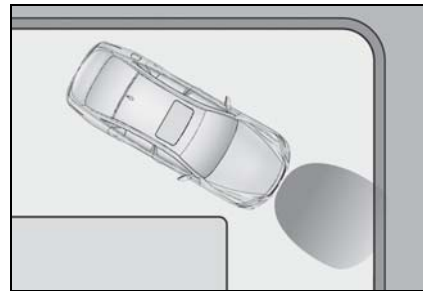

- When driving on a gravel road or in an area with tall grass

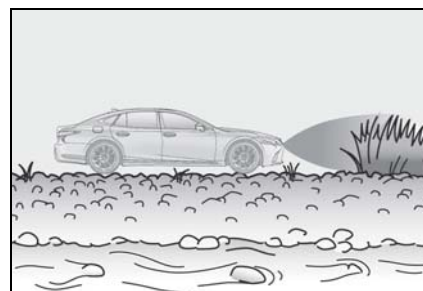

- When driving toward a banner, flag, low-hanging branch or boom barrier (such as those used at railroad crossings, toll gates and parking lots)
- When driving on a narrow path surrounded by a structure, such as in a tun-

- nel or on an iron bridge
- When parallel parking
- When there is a rut or hole in the surface of the road
- When driving on a metal cover (grating), such as those used for drainage ditches
- When driving on a steep slope
- If a sensor is hit by a large amount of water, such as when driving on a flooded road
- Weather
 - If a sensor is covered with ice, snow, dirt, etc. (when cleared, the system will return to normal)
 - If heavy rain or water strikes a sensor
 - When driving in inclement weather such as fog, snow or a sandstorm
 - When strong winds are blowing
- Other ultrasonic wave sources
 - When vehicle horns, vehicle detectors, motorcycle engines, air brakes of large vehicles, the clearance sonar of other vehicles or other devices which produce ultrasonic waves are near the vehicle
 - If a sticker or an electronic component, such as a backlit license plate (especially fluorescent type), fog lights, fender pole or wireless antenna is installed near a sensor
- Changes in the vehicle posture
 - If the vehicle is significantly tilted
 - If the front of the vehicle is raised or lowered due to the carried load
 - If the orientation of a sensor has been changed due to a collision or other impact
- **Situations in which the Parking Support Brake function (static objects) may not operate properly**

In some situations, such as the following, this function may not operate properly.

- Weather
 - When a sensor or the area around a sensor is extremely hot or cold

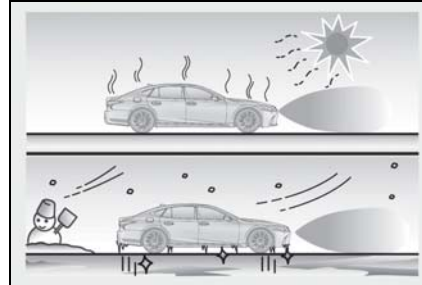

- When strong winds are blowing

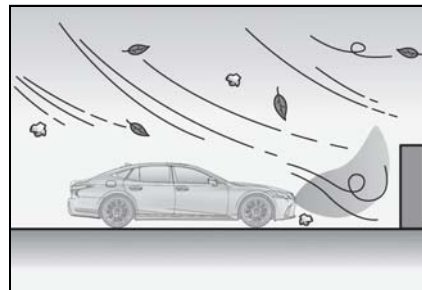

- If a sensor is covered with ice, snow, dirt, etc. (when cleared, the system will return to normal)
- If heavy rain or water strikes a sensor
- When driving in inclement weather such as fog, snow or a sandstorm
- When the sensor is frozen (Once the sensor thaws, the system will return to normal)
- Vehicle surroundings
 - When an object that cannot be detected is between the vehicle and a detected object
 - If an object such as a vehicle, motorcycle, bicycle or pedestrian cuts in front of the vehicle or runs out from the side of the vehicle
 - The vehicle is approaching a tall or curved curb.
 - On an extremely bumpy road, on an incline, on gravel, or on grass.
 - If objects draw too close to the sensor.
- Other ultrasonic wave sources
 - When vehicle horns, vehicle detectors, motorcycle engines, air brakes of large vehicles, the clearance sonar of other vehicles or other devices which produce ultrasonic waves are near the vehicle
 - If a sticker or an electronic component,

such as a backlit license plate (especially fluorescent type), fog lights, fender pole or wireless antenna is installed near a sensor

- Changes in the vehicle posture
 - If the vehicle is significantly tilted
 - If the front of the vehicle is raised or lowered due to the carried load
 - If the orientation of a sensor has been changed due to a collision or other impact
 - When equipment that may obstruct a sensor is installed, such as a bumper protector (an additional trim strip, etc.), bicycle carrier, or snow plow
 - If the suspension has been modified or tires of a size other than specified are installed
 - If a sensor has been painted or covered with a sticker, etc.

Parking Support Brake function (rear-crossing vehicles)*

*: If equipped

If a rear radar sensor detects a vehicle approaching from the right or left at the rear of the vehicle and the system determines that the possibility of a collision is high, this function will perform brake control to reduce the likelihood of an impact with the approaching vehicle.

Examples of function operation

This function will operate in situations such as the following if a vehicle is detected in the traveling direction of the vehicle.

- When reversing, a vehicle is approaching and the brake pedal is not depressed, or is depressed late

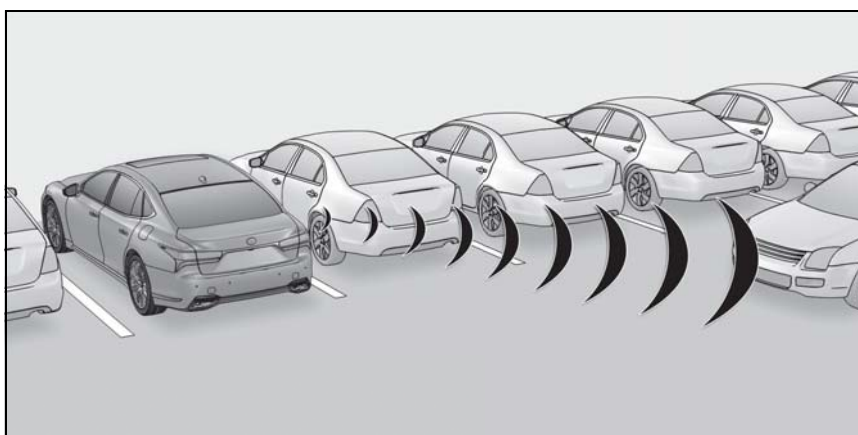

Types of sensors

→P.252

⚠ WARNING

Observe the following precautions regarding the rear radar sensors (→P.252). Failure to do so may cause a sensor to not operate properly, and may cause an accident.

- Do not modify, disassemble or paint the sensors.

- Do not replace a rear radar sensor with a part other than a genuine part.

- Do not damage the rear radar sensors, and always keep the radar sensors and their surrounding area on the bumper clean.

■ To prevent a rear radar sensor from malfunctioning

- If the area around a rear radar sensor is subjected to an impact, the system may not operate properly due to a sensor malfunction. Have the vehicle inspected by your Lexus dealer.

⚠ WARNING
 ● Observe the rear radar sensor handling precautions. (→P.271)

■ **The Parking Support Brake function (rear-crossing vehicles) will operate when**

The function will operate when the PKSB OFF indicator is not illuminated or flashing (→P.69, 70) and all of the following conditions are met:

- Engine output restriction control
 - The Parking Support Brake is enabled.
 - The vehicle speed is 9 mph (15 km/h) or less.
 - Vehicles which are approaching from the right or left at the rear of the vehicle at a traveling speed of less than approximately 5 mph (8 km/h)
 - The shift position is in R.
 - The Parking Support Brake determines that a stronger than normal brake operation is necessary to avoid a collision with an approaching vehicle.
- Brake control
 - Engine output restriction control is operating.
 - The Parking Support Brake determines that an emergency brake operation is necessary to avoid a collision with an approaching vehicle.

■ **The Parking Support Brake function (rear-crossing vehicles) will stop operating when**

The function will stop operating if any of the following conditions are met:

- Engine output restriction control
 - The Parking Support Brake is disabled.
 - The collision becomes avoidable with normal brake operation.
 - A vehicle is no longer approaching from the right or left at the rear of the vehicle.
- Brake control
 - The Parking Support Brake is disabled.
 - Approximately 2 seconds have elapsed since the vehicle was stopped by brake control.
 - The brake pedal is depressed after the vehicle is stopped by brake control.

- A vehicle is no longer approaching from the right or left at the rear of the vehicle.

■ **Re-enabling the Parking Support Brake function (rear-crossing vehicles)**

→P.275

■ **Detection area of the Parking Support Brake function (rear-crossing vehicles)**

The detection area of the Parking Support Brake function (rear-crossing vehicles) differs from the detection area of the RCTA function (→P.265). Therefore, even if the RCTA function detects a vehicle and provides an alert, the Parking Support Brake function (rear-crossing vehicles) may not start operating.

■ **Conditions under which the Parking Support Brake function (rear-crossing vehicles) will not detect a vehicle**

The Parking Support Brake function (rear-crossing vehicles) is not designed to detect the following types of vehicles and/or objects:

- Vehicles approaching from directly behind
- Vehicles backing up in a parking space next to your vehicle
- Vehicles that the sensors cannot detect due to obstructions

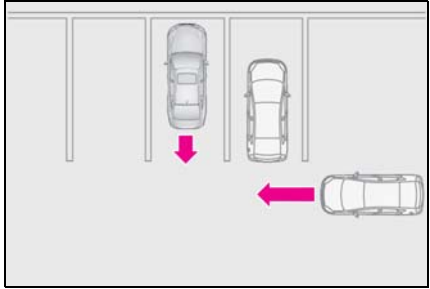

- Vehicles which suddenly accelerate or decelerate near your vehicle
- Guardrails, walls, signs, parked vehicles and similar stationary objects
- Small motorcycles, bicycles, pedestrians, etc.
- Vehicles moving away from your vehicle
- Vehicles approaching from the parking spaces next to your vehicle

- Objects which are extremely close to a radar sensor
- Vehicles which are approaching from the right or left at the rear of the vehicle at a traveling speed of less than approximately 5 mph (8 km/h)
- Vehicles which are approaching from the right or left at the rear of the vehicle at a traveling speed of more than approximately 15 mph (24 km/h)

■ **PKSB buzzer**

If the Parking Support Brake is enabled and brake control is performed, a buzzer will sound to notify the driver.

■ **Situations in which the system may operate even though there is no possibility of a collision**

In some situations such as the following, the Parking Support Brake function (rear-crossing vehicles) may operate even though there is no possibility of a collision.

- When the parking space faces a street and vehicles are being driven on the street

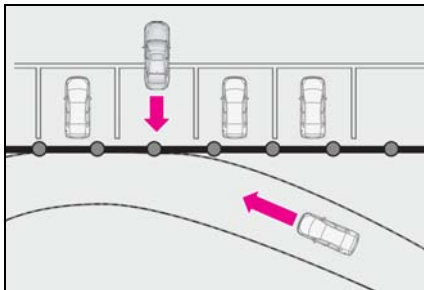

- When a detected vehicle turns while approaching the vehicle

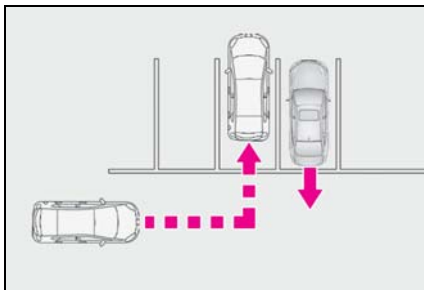

- When a vehicle passes by the side of your

vehicle

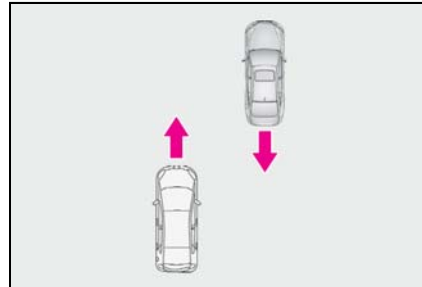

- When the distance between your vehicle and metal objects, such as a guardrail, wall, sign, or parked vehicle, which may reflect electrical waves toward the rear of the vehicle, is short

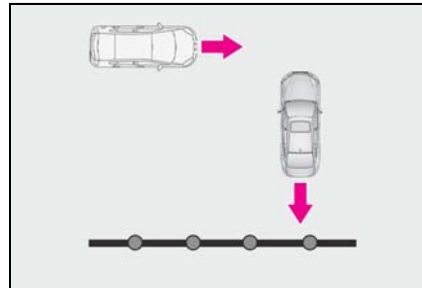

- When there are spinning objects near your vehicle such as the fan of an air conditioning unit
- When water is splashed or sprayed toward the rear bumper, such as from a sprinkler

■ **Situations in which the Parking Support Brake function (rear-crossing vehicles) may not operate properly**

In some situations, such as the following, the radar sensors may not detect an object and this function may not operate properly

- Stationary objects
- When a sensor or the area around a sensor is extremely hot or cold
- If the rear bumper is covered with ice, snow, dirt, etc.
- When it is raining heavily or water strikes the vehicle
- If the vehicle is significantly tilted

- When equipment that may obstruct a sensor is installed, such as a towing eye-let, bumper protector (an additional trim strip, etc.), bicycle carrier, or snow plow
- If the suspension has been modified or tires of a size other than specified are installed
- If the front of the vehicle is raised or lowered due to the carried load
- If an electronic component, such as a backlit license plate (especially fluorescent type), fog lights, fender pole or wireless antenna is installed near a radar sensor
- If the orientation of a radar sensor has been changed
- When multiple vehicles are approaching with only a small gap between each vehicle
- If a vehicle is approaching the rear of your vehicle rapidly
- Situations in which the radar sensor may not detect a vehicle
 - When a vehicle approaches from the right or left at the rear of the vehicle while you are turning while backing up
 - When turning while backing up

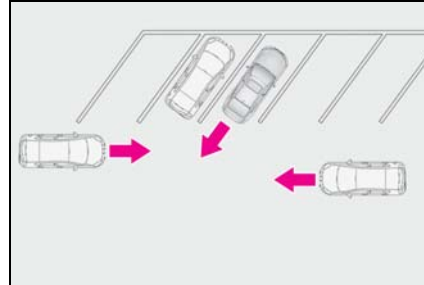

- When backing up on a slope with a sharp change in grade

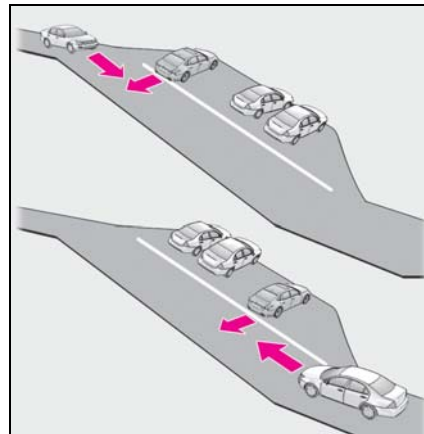

- When a vehicle turns into the detection area

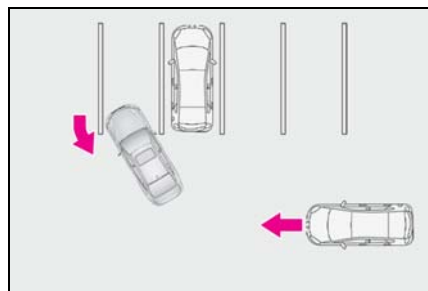
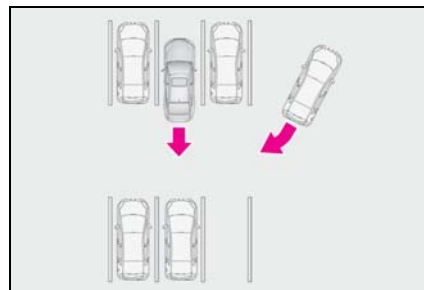

- When backing out of a shallow angle parking spot

Parking Support Brake function (rear pedestrians)*

*: If equipped

If the rear camera sensor detects a pedestrian behind the vehicle while backing up and the system determines that the possibility of colliding with the detected pedestrian is high, a buzzer will sound. If the system determines that the possibility of colliding with the detected pedestrian is extremely high, the brakes will be applied automatically to help reduce the impact of the collision.

Examples of system operation

When a pedestrian is detected behind the vehicle while backing up, the brake pedal is not depressed or is depressed late.

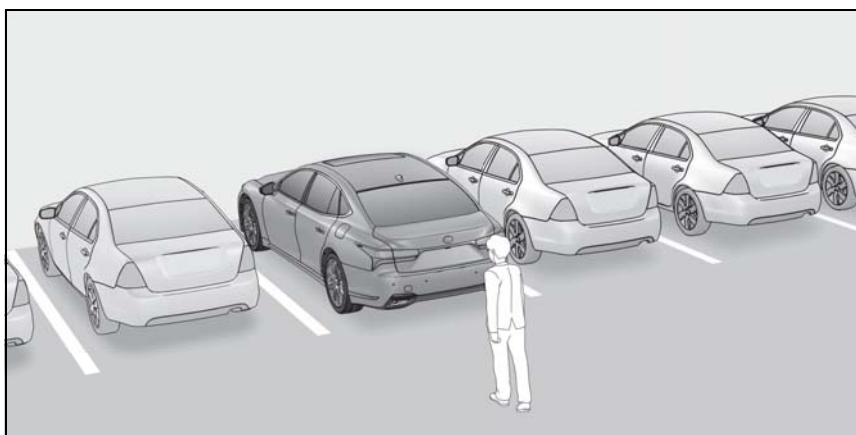

Center Display

Displays a message to urge the driver to take evasive action when a pedestrian is detected in the detection area behind the vehicle. (A message will also be displayed on the multi-information display and head-up display (if equipped).)

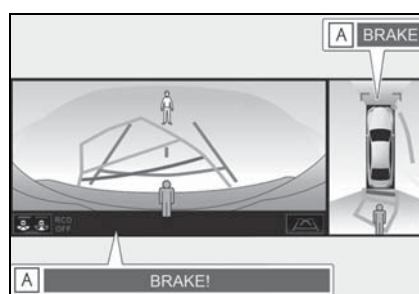

A Pedestrian detection icon with brake reminder

⚠ WARNING

■ **If the Parking Support Brake function (rear pedestrians) operates unnecessarily**

Depress the brake pedal immediately after the Parking Support Brake function (rear pedestrians) operates. (Operation of the function is canceled by depressing the brake pedal.)

■ **Correct use of the Parking Support Brake function (rear pedestrians)**

Do not overly rely on the Parking Support Brake function (rear pedestrians). Depending on the road conditions, vehicle conditions and weather, this function may not operate correctly. As the detection performance of the rear camera is limited, always drive safely, taking care to observe your surroundings. Additionally, if the PKSB OFF indicator is flashing or a warning message is displayed on the center display indicating that the Parking Support Brake function (rear pedestrians) is unavailable, the function cannot be used. Even if these warnings are not output, the driver is always responsible for paying attention to the vehicle's surroundings and driving safely.

■ **Parking Support Brake function (rear pedestrians) will operate when**

The function will operate when the PKSB OFF indicator is not illuminated or flashing (→P.69, 70) and all of the following conditions are met:

- Engine output restriction control
 - The Parking Support Brake is enabled.
 - The vehicle speed is 9 mph (15 km/h) or less.
 - The shift position is in R.
 - The rear camera sensor detects a pedestrian behind the vehicle while backing up and the system determines that the possibility of colliding with the detected pedestrian is high.
- Brake control
 - Engine output restriction control is operating.

- The Parking Support Brake determines that an emergency brake operation is necessary to avoid a collision with a pedestrian.

■ **The Parking Support Brake function (rear pedestrians) will stop operating when**

The function will stop operating if any of the following conditions are met:

- Engine output restriction control
 - The Parking Support Brake is disabled.
 - The collision becomes avoidable with normal brake operation.
 - The pedestrian is no longer detected behind your vehicle.
- Brake control
 - The Parking Support Brake is disabled.
 - Approximately 2 seconds have elapsed since the vehicle was stopped by brake control.
 - The brake pedal is depressed after the vehicle is stopped by brake control.
 - The pedestrian is no longer detected behind your vehicle.

■ **Re-enabling the Parking Support Brake function (rear pedestrians)**

→P.275

■ **Detection area of the Parking Support Brake function (rear pedestrians)**

The detection area of the Parking Support Brake function (rear pedestrians) differs from the detection area of the RCD function (→P.268). Therefore, even if the RCD function detects a vehicle and provides an alert, the Parking Support Brake function (rear-crossing vehicles) may not start operating.

■ **Situations in which the system may not operate properly**

- Some pedestrians, such as the following, may not be detected by the Parking Support Brake function (rear pedestrians), preventing the function from operating properly:
 - Pedestrians who are bending forward or squatting
 - Pedestrians who are lying down
 - Pedestrians who are running
 - Pedestrians who suddenly enter the detection area

- People riding a bicycle, skateboard, or other light vehicle
- Pedestrians wearing oversized clothing such as a rain coat, long skirt, etc., making their silhouette obscure
- Pedestrians whose body is partially hidden by an object, such as a cart or umbrella
- Pedestrians which are obscured by darkness, such as at night
- In some situations, such as the following, pedestrians may not be detected by the Parking Support Brake function (rear pedestrians), preventing the function from operating properly:
 - When backing up in inclement weather (rain, snow, fog, etc.)
 - When the rear camera is obscured (dirt, snow, ice, etc. are attached) or scratched
 - When a very bright light, such as the sun, or the headlights of another vehicle, shines directly into the rear camera
 - When backing up in a place where the surrounding brightness changes suddenly, such as at the entrance or exit of a garage or underground parking lot
 - When backing up in a dim environment such as during dusk or in an underground parking lot
- Even though there are no pedestrians in the detection area, some objects, such as the following, may be detected, possibly causing the Parking Support Brake function (rear pedestrians) to operate.
 - Three dimensional objects, such as a pole, traffic cone, fence, or parked vehicle
 - Moving objects, such as a car or motorcycle
 - Objects moving toward your vehicle when backing up, such as flags or puddles (or airborne matter, such as smoke, steam, rain, or snow)
 - Cobblestone or gravel roads, tram rails, road repairs, white lines, pedestrian crossings or fallen leaves on the road
 - Metal covers (gratings), such as those used for drainage ditches
 - Objects reflected in a puddle or on a wet road surface
 - The roadside or bumps on the road
 - Shadows on the road
- In some situations, such as the following, the Parking Support Brake function (rear pedestrians) may operate even though there are no pedestrians in the detection area.
 - When backing up toward the roadside or a bump on the road
 - If the vehicle is significantly tilted, such as when carrying a heavy load
 - When backing up toward an incline/decline
 - If the suspension has been modified or tires of a size other than specified are installed
 - If the rear of the vehicle is raised or lowered due to the carried load
 - If an electronic component, such as a backlit license plate or rear fog light, is installed near the rear camera
 - If a bumper protector, such as an additional trim strip, is installed to the rear bumper
 - If the orientation of the rear camera has been changed
 - If a towing eyelet is installed to the rear of the vehicle
 - When water is flowing over the rear camera lens
 - When the rear camera is obscured (dirt, snow, ice, etc. are attached) or scratched
 - If there is a flashing light in the detection area, such as the emergency flashers of another vehicle

Driving mode select switch

The driving modes can be selected to suit driving condition.

Selecting a drive mode

- ▶ Vehicles without Adaptive Variable Suspension System

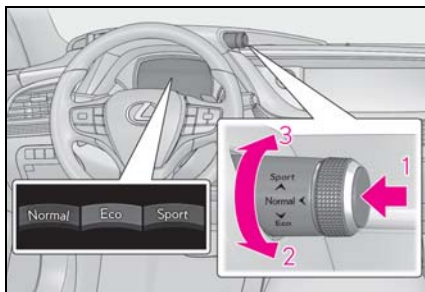

1 Normal mode
Provides an optimal balance of fuel economy, quietness, and dynamic performance. Suitable for city driving.

Press the switch to change the driving mode to normal mode when not in normal mode.

2 Eco drive mode
Helps the driver accelerate in an eco-friendly manner and improve fuel economy through moderate throttle characteristics and by controlling the operation of the air conditioning system (heating/cooling).

When not in Eco drive mode, if the driving mode select switch is turned backward, the Eco drive mode indicator will come on.

3 Sport mode
Controls the transmission and engine to provide quick, powerful acceleration. This mode also changes the steering feel, making it suitable for when agile driving response is desired, such as when driving

on roads with many curves.
When not in sport mode, if the driving mode select switch is turned forward, the sport mode indicator will come on.

- ▶ Vehicles with Adaptive Variable Suspension System

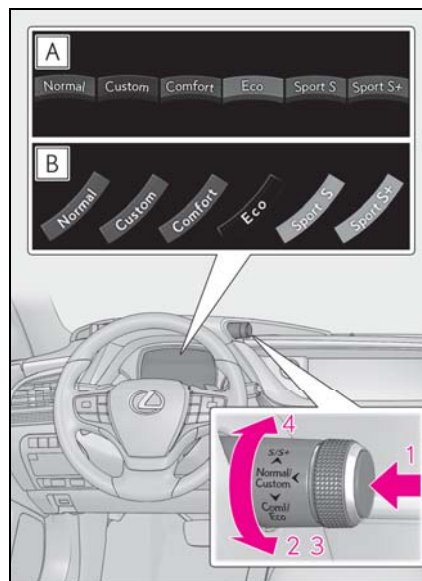

A Except F SPORT models

B F SPORT models

1 Normal mode/Custom mode
Normal mode and custom mode are selected by pressing the driving mode select switch. Each time the switch is pressed, the driving mode changes between normal mode and custom mode. When normal mode is selected, the normal mode indicator comes on.

When custom mode is selected, the custom mode indicator comes on.

Press the switch to change the driving mode to normal mode when not in normal mode.

- Normal mode

Provides an optimal balance of fuel economy, quietness, and dynamic performance.

Suitable for city driving.

When the shift position is in D, an appropriate gear for sporty driving may automatically be selected according to driver performance and driving conditions.

- Custom mode

Allows you to drive with the powertrain, chassis and air conditioning system functions set to your preferred settings. Custom mode settings can only be changed on the drive mode customization display of the Center Display. (→P.306)

2 Comfort mode

By controlling the suspension, riding comfort is further enhanced. Suitable for city driving.

When not in comfort mode and the driving mode select switch is turned backward, the comfort mode indicator comes on.

3 Eco drive mode

Helps the driver accelerate in an eco-friendly manner and improve fuel economy through moderate throttle characteristics and by controlling the operation of the air conditioning system (heating/cooling).

When in comfort mode, if the driving mode select switch is turned backward, the Eco drive mode indicator comes on.

4 Sport mode

- Sport S mode

Controls the transmission and engine to provide quick, powerful acceleration. This mode is suitable for when agile driving response is desired, such as when driving on roads with many curves.

When not in Sport S mode, if the driving mode select switch is turned forward, the Sport S mode indicator comes on.

- Sport S+ mode

Helps to ensure steering performance and driving stability by simultaneously con-

trolling the steering and suspension in addition to the transmission and engine.

Suitable for sportier driving.

When in Sport S mode, if the driving mode select switch is turned forward, the Sport S+ mode indicator comes on.

■ If the driving mode select switch is operated while the opening screen is being displayed

If the driving mode select switch is operated while the opening screen is being displayed, the driving mode will be changed and the meter display will change accordingly after the opening screen operation has completed.

■ Operation of the air conditioning system in Eco drive mode

Eco drive mode controls the heating/cooling operations and fan speed of the air conditioning system to enhance fuel efficiency. To improve air conditioning performance, perform the following operations:

- Turn off eco air conditioning mode (→P.318)
- Adjust the fan speed (→P.313)
- Turn off Eco drive mode

■ Automatic deactivation of sport mode and custom mode

If the engine switch is turned off after driving in sport mode or custom mode, the drive mode will be changed to normal mode.

■ Driving mode pop-up display

When the driving mode is changed, the selected driving mode will be temporarily displayed on the side display. (→P.307)

Electronically modulated air suspension*

*: If equipped

The height of the vehicle when driving can be selected using the vehicle height adjustment switch. The selected height level will be maintained regardless of the number of passengers or weight of cargo.

Additionally, settings of the following functions can be changed:

- Enabling/Disabling controls of access mode
- Temporarily disabling vehicle height control

■ Situations in which the vehicle height control may not operate properly

- In the following situations, the vehicle height may change slowly or may not change to the correct height:
 - When the vehicle comes into contact with snow, ice, stone, etc.
 - When the ambient temperature is low
 - When the accumulator tank pressure is low
- In the following situations, the vehicle height may not change:
 - If the hood or trunk is not fully closed
 - If the brake pedal depressed and the vehicle is stopped
 - When the vehicle is on a significantly uneven or undulating road
 - When the vehicle is on a slanted road or a slope

■ Operating sound of the air suspension compressor and valves

When the vehicle height is changed, such as due to passengers entering the vehicle or cargo being loaded, or when the vehicle height is changed using the vehicle height adjustment switch, the air suspension compressor and valves may operate and a

sound may be heard. This does not indicate a malfunction.

■ When the accumulator tank pressure is low

When the accumulator tank pressure is low, the air suspension compressor and valves may operate repeatedly even though the vehicle height is not being changed. This does not indicate a malfunction.

⚠ WARNING

■ Situations in which the operation of the electronically modulated air suspension should be temporarily disabled

In the following situations, make sure to temporarily disable all functions of the vehicle height control of the electronically modulated air suspension and then stop the engine. Otherwise, the vehicle height may change and part of your body may be caught under the vehicle, possibly causing injury.

- When the vehicle is parked on a curb
- If any of the wheels is not touching the ground
- If the vehicle needs to be jacked up
- If the vehicle is to be tied down
- If the vehicle is to be towed

■ Vehicle height control precautions

In the following situations, make sure to check the safety of the area around the vehicle, as the vehicle height may change and part of someone's body may be caught in the vehicle, possibly causing injury or the vehicle may be damaged.

- When opening a door
- When unlocking the doors using the smart access system with push-button start
- When changing the vehicle height using the vehicle height adjustment switch

 NOTICE

■ Parking precaution

If the vehicle is parked for a long time, the vehicle height may change due to changes in the ambient temperature. When parking the vehicle, make sure that the area above and below the vehicle is clear, so that the vehicle will not contact anything if its height changes.

Be careful when parking the vehicle in an area with a low ceiling or near low hanging objects, as the vehicle height will increase when passengers exit the vehicle and exit control of access mode operates.

Selecting the vehicle height

To adjust the vehicle height to one appropriate for road and driving conditions, press the vehicle height adjustment switch.

Turns high mode on/off.

When high mode is enabled, the high mode indicator on the meter will illuminate. The vehicle height will increase by approximately 0.8 in. (20 mm) from its normal position.

When the vehicle height is increased by a control of access mode press the vehicle height adjustment switch twice to enable/disable high mode.

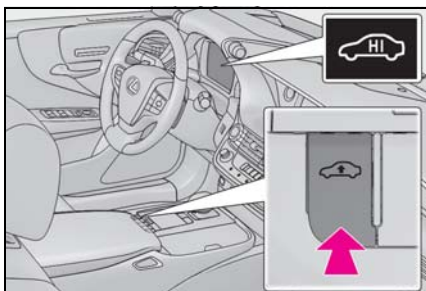

■ The vehicle height adjustment switch can be used to change the mode when

The engine switch is in IGNITION ON mode.

■ System protection function

If the vehicle height is repeatedly increased and decreased using the vehicle height adjustment switch, etc., the system may not operate temporarily.

Vehicle height control when entering/exiting the vehicle (“Access Mode”)

In order to improve the ease of entering and exiting the vehicle, the vehicle height will increase automatically.

▶ Enter control

If any of the following operations are performed, the vehicle height will increase automatically:

- When the doors are unlocked using the smart access system with push-button start
- When the doors are unlocked using the wireless remote control and then a door is opened.

The vehicle height will increase by approximately 1.2 in. (30 mm) from its normal position.

The vehicle height may not increase, if the vehicle height already reaches the selected height.

The vehicle will return to its normal height when the vehicle speed reaches approximately 12 mph (20 km/h).

▶ Exit control

When “Select Parking Height” is set to “High”, the vehicle height will automati-

cally increase when the P shift position is selected and a door is opened.

- 1 Press or to select .
- 2 Press or to select "Vehicle Settings" and then press .
- 3 Press or to select and then press .
- 4 Press or to select "Select Parking Height" and then press .

The vehicle height will increase by approximately 0.4 in. (10 mm) from its normal position.

The vehicle height may not increase, if the vehicle height already reaches the selected height.

The vehicle will return to its normal height when the vehicle speed reaches approximately 12 mph (20 km/h).

■ **Enabling/Disabling access mode**

- 1 Press the or meter control switch to select .
- 2 Press the or meter control switch to select "Vehicle Settings" and then press .
- 3 Press the or meter control switch to select and then press .
- 4 Press the or meter control switch to select "Access Mode" and then press .

The setting will change between

enabled/disabled each time the meter control switch is pressed.

■ **When the vehicle height has been increased by a control of access mode**

Press the vehicle height adjustment switch with the engine switch in any mode to return the vehicle to its previous vehicle height.

■ **Access mode operation**

- Access mode will not operate if the vehicle is not parked on a level road surface.
- When the P shift position is selected, if the doors are not locked and any door is opened from the outside, exit control will operate.

Temporarily disabling vehicle height control

4
Driving

Vehicle height control can be temporarily disabled using the meter control switches. (→P.81)

When to temporarily disable vehicle height control:→P.291

- 1 Press or to select .
- 2 Press or to select "Vehicle Settings" and then press .
- 3 Press or to select and then press .
- 4 Press or to select "Height Control" and then press .

This setting is memorized even if the engine switch is turned off.

Even if the vehicle height control functions are disabled, they will be enabled automatically when the vehicle speed reaches approximately 19 mph (30 km/h).

■ **When “Check Air Suspension System” is displayed on the multi-information display**

The system may not operate properly. Have the vehicle inspected by your Lexus dealer.

■ **Customization**

Some functions can be customized. (→P.466)

Driving assist systems

To keep driving safety and performance, the following systems operate automatically in response to various driving situations. Be aware, however, that these systems are supplementary and should not be relied upon too heavily when operating the vehicle.

Summary of the driving assist systems

■ **ECB (Electronically Controlled Brake System) (vehicles with Lexus Safety System + A)**

The electronically controlled system generates braking force corresponding to the brake operation

■ **ABS (Anti-lock Brake System)**

Helps to prevent wheel lock when the brakes are applied suddenly, or if the brakes are applied while driving on a slippery road surface

■ **Brake assist**

Generates an increased level of braking force after the brake pedal is depressed when the system detects a panic stop situation

■ **VSC (Vehicle Stability Control)**

Helps the driver to control skidding when swerving suddenly or turning on slippery road surfaces.

■ **Secondary Collision Brake**

When the airbag sensor detects a collision, the brakes and stop lights are

automatically controlled to reduce the vehicle speed and that helps reduce the possibility of further damage due to a secondary collision.

■ **TRAC (Traction Control)**

Helps to maintain drive power and prevent the drive wheels from spinning when starting the vehicle or accelerating on slippery roads

■ **Hill-start assist control**

Helps to reduce the backward movement of the vehicle when starting on an uphill

■ **VGRS (Variable Gear Ratio Steering) (if equipped)**

Adjusts the front wheel turning angle in accordance with the vehicle speed and steering wheel movement

■ **DRS (Dynamic Rear Steering) (if equipped)**

Contributes to the turning characteristics and responsiveness of the vehicle by adjusting the rear wheel angle of the vehicle in accordance with steering wheel movement.

■ **EPS (Electric Power Steering)**

Employs an electric motor to reduce the amount of effort needed to turn the steering wheel.

■ **Active stabilizer suspension system (if equipped)**

Reduces sway when cornering according to steering wheel movement in order to maintain a stable vehicle posture.

■ **Adaptive Variable Suspension System (if equipped)**

By independently controlling the damping force of the shock absorbers for each of the 4 wheels according to the road and driving conditions, this system helps riding comfort with superior vehicle stability, and helps good vehicle posture.

Also, the damping force changes depending on the selected driving mode. (→P.289)

■ **LDH (Lexus Dynamic Handling system) (if equipped)**

Provides integrated control of the VGRS, DRS and EPS. Contributes to turning characteristics at low speeds, responsiveness at medium speeds and safety at high speeds by controlling the steering angle of the front and rear wheels in accordance with the steering wheel operation and vehicle speed.

■ **VDIM (Vehicle Dynamics Integrated Management)**

Provides integrated control of the ABS, brake assist, TRAC, VSC, hill-start assist control, EPS, VGRS (if equipped), DRS (if equipped), active stabilizer suspension system (if equipped) and Adaptive Variable Suspension System (if equipped)

Helps to maintain vehicle stability when swerving on slippery road surfaces by controlling the brakes, engine output, steering assist, and steering ratio

■ **When the TRAC/VSC systems are operating (vehicles without Lexus Safety System + A)**

The slip indicator light will flash while the TRAC/VSC systems are operating.

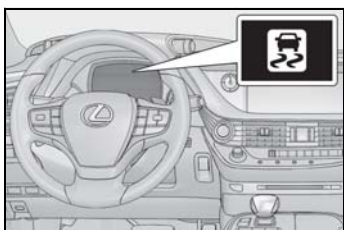

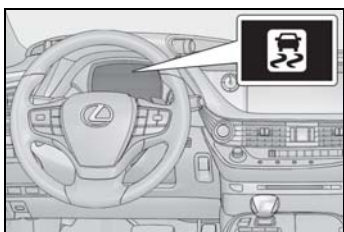

■ **When the TRAC/VSC/ABS systems are operating (vehicles with Lexus Safety System + A)**

The slip indicator light will flash while the TRAC/VSC/ABS systems are operating.



■ **Disabling the TRAC system**

If the vehicle gets stuck in mud, dirt or snow, the TRAC system may reduce power from the engine to the wheels. Pressing the  switch to turn the system off may make it easier for you to rock the vehicle in order to free it.

To turn the TRAC system off, quickly press and release the  switch.

The "Traction Control Turned Off" will be shown on the multi-information display.

Press the  switch again to turn the system back on.

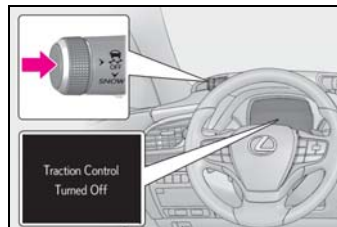

■ **Disabling both TRAC and VSC systems**

To turn the TRAC and VSC systems off, press and hold the  switch for more than 3 seconds while the vehicle is stopped. The VSC OFF indicator light will come on and the "Traction Control Turned Off" will be shown on the multi-information display.*

Press the  switch again to turn the system back on.

*: On vehicles with PCS (Pre-Collision System), PCS will also be disabled (only Pre-Collision warning is available). The PCS warning light will come on and a message will be displayed on the multi-information display. (→P.214, 222)

■ **When the message is displayed on the multi-information display showing that TRAC has been disabled even if the  switch has not been pressed**

TRAC cannot be operated. Contact your Lexus dealer.

■ **Operating conditions of hill-start assist control**

When the following four conditions are met, the hill-start assist control will operate:

- The shift position is in a position other than P or N (when stating off forward/backward on an upward incline)
- The vehicle is stopped
- The accelerator pedal is not depressed
- The parking brake is not engaged

■ **Automatic system cancelation of hill-start assist control**

The hill-start assist control will turn off in any

of the following situations:

- Shift the shift position to P or N
- The accelerator pedal is depressed
- The parking brake is engaged
- 2 seconds at maximum elapsed after the brake pedal is released

■ VGRS is disabled when

VGRS may stop operating in the following situations.

In this event, the steering wheel may move from its straight forward position, but it will return when the system restarts.

- When the steering wheel is operated for an extended period of time while the vehicle is stopped or is moving very slowly (on vehicles with LDH, DRS is disabled together with VGRS)
- When the steering wheel has been held fully to the left or right

The center position of the steering wheel may change when VGRS is disabled. However, the position will return to normal after VGRS is reactivated.

■ When the battery is disconnected (vehicles with VGRS)

The steering wheel may move from its straight forward position, but this will be corrected automatically when driving.

■ Sounds and vibrations caused by the ABS, brake assist, VSC, TRAC, hill-start assist control and VGRS systems

- A sound may be heard from the engine compartment when the brake pedal is depressed repeatedly, when the engine is started or just after the vehicle begins to move. This sound does not indicate that a malfunction has occurred in any of these systems.
- Any of the following conditions may occur when the above systems are operating. None of these indicates that a malfunction has occurred.
 - Vibrations may be felt through the vehicle body and steering.
 - A motor sound may be heard also after the vehicle comes to a stop.
 - Vehicles without Lexus Safety System + A: The brake pedal may pulsate slightly

after the ABS is activated.

- Vehicles without Lexus Safety System + A: The brake pedal may move down slightly after the ABS is activated.

■ ECB operating sound

ECB operating sound may be heard in the following cases, but it does not indicate that a malfunction has occurred.

- Operating sound heard from the engine compartment when the brake pedal is operated.
- Motor sound of the brake system heard from the front part of the vehicle when the driver's door is opened.
- Operating sound heard from the engine compartment when one or two minutes passed after the stop of the engine.

■ EPS, VGRS and DRS operation sound

When the steering wheel is operated, a motor sound (whirring sound) may be heard. This does not indicate a malfunction.

■ Automatic reactivation of TRAC and VSC systems

After turning the TRAC and VSC systems off, the systems will be automatically re-enabled in the following situations:

- When the engine switch is turned off
 - If only the TRAC system is turned off, the TRAC will turn on when vehicle speed increases
- If both the TRAC and VSC systems are turned off, automatic re-enabling will not occur when vehicle speed increases.

■ Reduced effectiveness of the EPS system

The effectiveness of the EPS system is reduced to prevent the system from overheating when there is frequent steering input over an extended period of time. The steering wheel may feel heavy as a result. Should this occur, refrain from excessive steering input or stop the vehicle and turn the engine off. The EPS system should return to normal within 10 minutes.

■ Secondary Collision Brake operating conditions

The vehicle speed is approximately 6 mph

(10 km/h) or more and the airbag sensor detects a collision. (The Secondary Collision Brake will not operate when the vehicle speed is below approximately 6 mph [10 km/h].)

■ **Secondary Collision Brake automatic cancellation**

The Secondary Collision Brake is automatically canceled in the following situations:

- The vehicle speed drops below approximately 6 mph (10 km/h)
- A certain amount of time elapses during operation
- The accelerator pedal is depressed a large amount

■ **When “Check VGRS System” or “CHECK DRS” is displayed on the multi-information display**

The VGRS or DRS may not operate properly. Have the vehicle inspected by your Lexus dealer.

 **WARNING**

■ **The ABS does not operate effectively when**

- The limits of tire gripping performance have been exceeded (such as excessively worn tires on a snow covered road).
- The vehicle hydroplanes while driving at high speed on wet or slick roads.

■ **Stopping distance when the ABS is operating may exceed that of normal conditions**

The ABS is not designed to shorten the vehicle’s stopping distance. Always maintain a safe distance from the vehicle in front of you, especially in the following situations:

- When driving on dirt, gravel or snow-covered roads
- When driving with tire chains
- When driving over bumps in the road

- When driving over roads with potholes or uneven surfaces

■ **TRAC/VSC may not operate effectively when**

Directional control and power may not be achievable while driving on slippery road surfaces, even if the TRAC/VSC system is operating. Drive the vehicle carefully in conditions where stability and power may be lost.

■ **Hill-start assist control does not operate effectively when**

- Do not overly rely on hill-start assist control. Hill-start assist control may not operate effectively on steep inclines and roads covered with ice.
- Unlike the parking brake, hill-start assist control is not intended to hold the vehicle stationary for an extended period of time. Do not attempt to use hill-start assist control to hold the vehicle on an incline, as doing so may lead to an accident.

■ **When the TRAC/VSC is activated (vehicles without Lexus Safety System + A)**

The slip indicator light flashes. Always drive carefully. Reckless driving may cause an accident. Exercise particular care when the indicator light flashes.

■ **When the TRAC/ABS/VSC is activated (vehicles with Lexus Safety System + A)**

The slip indicator light flashes. Always drive carefully. Reckless driving may cause an accident. Exercise particular care when the indicator light flashes.

■ **When the TRAC/VSC systems are turned off**

Be especially careful and drive at a speed appropriate to the road conditions. As these are the systems to help ensure vehicle stability and driving force, do not turn the TRAC/VSC systems off unless necessary.

**WARNING****■ Secondary Collision Brake**

Do not overly rely on the Secondary Collision Brake. This system is designed to help reduce the possibility of further damage due to a secondary collision, however, that effect changes according to various conditions. Overly relying on the system may result in death or serious injury.

■ Replacing tires

Make sure that all tires are of the specified size, brand, tread pattern and total load capacity. In addition, make sure that the tires are inflated to the recommended tire inflation pressure level.

The ABS, TRAC and VSC systems will not function correctly if different tires are installed on the vehicle.

Contact your Lexus dealer for further information when replacing tires or wheels.

■ Handling of tires and the suspension

Using tires with any kind of problem or modifying the suspension will affect the driving assist systems, and may cause a system to malfunction.

Winter driving tips

Carry out the necessary preparations and inspections before driving the vehicle in winter. Always drive the vehicle in a manner appropriate to the prevailing weather conditions.

Preparation for winter

- Use fluids that are appropriate to the prevailing outside temperatures.
 - Engine oil
 - Engine coolant
 - Washer fluid
- Have a service technician inspect the condition of the battery.
- Have the vehicle fitted with four snow tires or purchase a set of tire chains for the rear tires.*

Ensure that all tires are the specified size and brand, and that chains match the size of the tires.

*: Tire chains cannot be mounted on vehicles with front and rear tires of differing sizes.

WARNING

■ Driving with snow tires

Observe the following precautions to reduce the risk of accidents. Failure to do so may result in a loss of vehicle control and cause death or serious injury.

- Use tires of the specified size.
- Maintain the recommended level of air pressure.

- Do not drive in excess of 75 mph (120 km/h), regardless of the type of snow tires being used.

- Use snow tires on all, not just some wheels.

■ When installing tire chains

Before installing tire chains, make sure to disable all functions of the vehicle height control of the electronically modulated air suspension. Otherwise, the vehicle height may change while installing the tire chains and part of your body may be caught under the vehicle, possibly causing injury. (→P.293)

■ Driving with tire chains

Observe the following precautions to reduce the risk of accidents. Failure to do so may result in the vehicle being unable to be driven safely, and may cause death or serious injury.

- Do not drive in excess of the speed limit specified for the tire chains being used, or 30 mph (50 km/h), whichever is lower.

- Avoid driving on bumpy road surfaces or over potholes.

- Avoid sudden acceleration, abrupt steering, sudden braking and shifting operations that cause sudden engine braking.

- Slow down sufficiently before entering a curve to ensure that vehicle control is maintained.

- Do not use LTA (Lane Tracing Assist) system.

 NOTICE**■ Repairing or replacing snow tires**

Request repairs or replacement of snow tires from Lexus dealers or legitimate tire retailers.

This is because the removal and attachment of snow tires affects the operation of the tire pressure warning valves and transmitters.

Before driving the vehicle

Perform the following according to the driving conditions:

- Do not try to forcibly open a window or move a wiper that is frozen. Pour warm water over the frozen area to melt the ice. Wipe away the water immediately to prevent it from freezing.
- To ensure proper operation of the climate control system fan, remove any snow that has accumulated on the air inlet vents in front of the windshield.
- Check for and remove any excess ice or snow that may have accumulated on the exterior lights, vehicle's roof, chassis, around the tires or on the brakes.
- Remove any snow or mud from the bottom of your shoes before getting in the vehicle.

When driving the vehicle

Accelerate the vehicle slowly, keep a safe distance between you and the vehicle ahead, and drive at a reduced speed suitable to road conditions.

When parking the vehicle

Park the vehicle and shift the shift position to P without setting the parking brake. The parking brake may freeze up, preventing it from being released. If the vehicle is parked without setting the parking brake, make sure to block the wheels.

Failure to do so may be dangerous because it may cause the vehicle to move unexpectedly, possibly leading to an accident.

Selecting tire chains

- ▶ Vehicles with front and rear tires of the same size

Use the correct tire chain size when mounting the tire chains.

Chain size is regulated for each tire size.

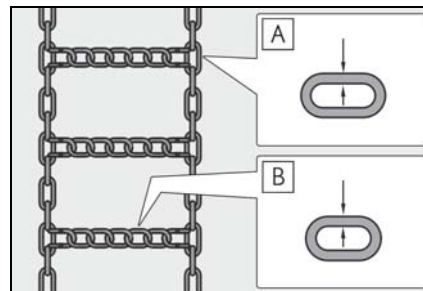

A Side chain (0.12 in. [3 mm] in diameter)

B Cross chain (0.16 in. [4 mm] in diameter)

- ▶ Vehicles with front and rear tires of differing sizes

Tire chains cannot be mounted.

Snow tires should be used instead.

Regulations on the use of tire chains

Regulations regarding the use of tire chains vary depending on location and type of road. Always check local regulations before installing chains.

■ Tire chain installation

Observe the following precautions when installing and removing chains:

- Install and remove tire chains in a safe location.
- Install tire chains on the rear tires. Do not install tire chains on the front tires.
- Install tire chains on the rear tires as tightly as possible. Retighten chains after driving 1/4—1/2 mile (0.5—1.0 km).
- Install tire chains following the instructions provided with the tire chains.



NOTICE

■ Fitting tire chains

The tire pressure warning valves and transmitters may not function correctly when tire chains are fitted.

Windshield wipers

To enable the windshield wipers to be lifted when heavy snow or icy conditions are expected, change the rest position of the windshield wipers from the retracted position below the hood to the service position using the wiper lever. (→P.187)

- 5-1. Remote Touch/Display**
 - Remote Touch.....**304**
 - Center Display.....**306**
 - Rear Multi Operation Panel
.....**308**
- 5-2. Lexus Climate Concierge**
 - Lexus Climate Concierge.....**311**
- 5-3. Using the air conditioning system and defogger**
 - Front automatic air conditioning
system**313**
 - Rear automatic air conditioning
system**323**
 - Heated steering wheel/seat heat-
ers/seat ventilators.....**326**
- 5-4. Using the interior lights**
 - Interior lights list.....**331**
- 5-5. Using the storage features**
 - List of storage features.....**335**
 - Trunk features.....**340**
- 5-6. Using the other interior features**
 - Other interior features**343**
 - Garage door opener**350**

Remote Touch

The Remote Touch can be used to operate the Center Display.

For details on the Remote touch, refer to “NAVIGATION AND MULTIMEDIA SYSTEM OWNER’S MANUAL”.

Remote Touch operation

■ Switches

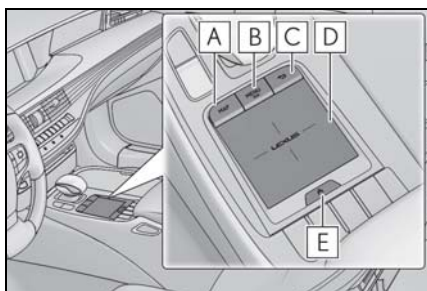

A “MAP” button

Vehicles with navigation function:
Press this button to display the vehicle’s current position.

Vehicles without navigation function:
Press this button to display the compass mode screen.

B “MENU” button

Press this button to display the menu screen.

C Back button

Press this button to display the previous screen.

D Touchpad

Slide your finger on the touchpad and move the pointer to select a function, letter and screen button.

Press the touchpad to enter the selected

function, letter or screen button. Certain finger movements on the touchpad can perform functions, such as changing map scalings and scrolling list screens.

E Sub function button

When  is displayed on the screen, a function screen assigned to the screen can be displayed.

■ Using the touchpad

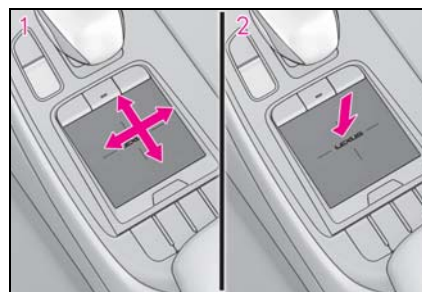

- 1 Select: Touch the touchpad to select the desired button on the screen.
- 2 Enter: Buttons on the screen can be selected by either depressing or double tapping the touchpad. Once a button has been selected, the screen will change.

■ Touch operation

Operations are performed by touching the touchpad with your finger.

● Trace

Trace the pad surface while maintaining contact with the touchpad. Moving the cursor and the pointer.

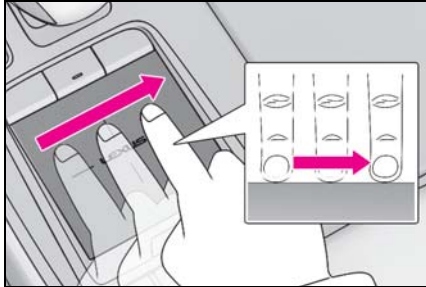

● Double tap

Tap the touchpad twice, quickly. Select the button on the screen.

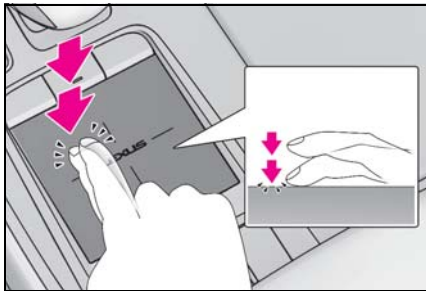

● Flick

Quick and short movement along the touchpad with you finger. Move the list screen.

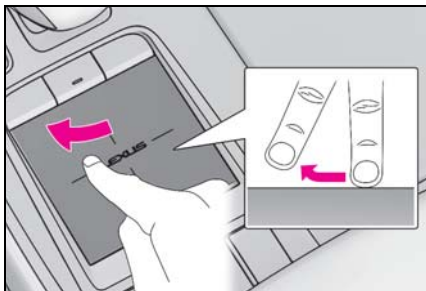

● Pinch in/Pinch out

Slide fingers toward each other or apart on the touchpad. Change the scale of the map.

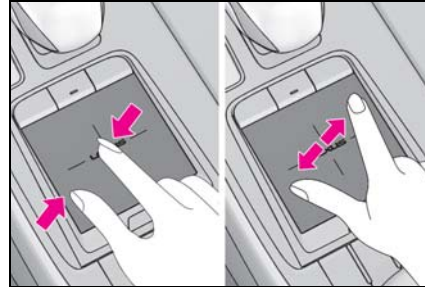

 NOTICE

■ To prevent damage to the Remote Touch

Observe the following precautions. Failure to do so may cause damage to the Remote Touch.

- Do not allow food, liquid, stickers or lit cigarettes to contact the Remote Touch.
- Do not subject the Remote Touch to excessive pressure or strong impact.
- Do not push the touchpad with a strong force or use a sharp pointed object to operate the pad.

Center Display



Center Display overview

■ Menu screen

Press the "MENU" button on the Remote Touch to display the menu screen.

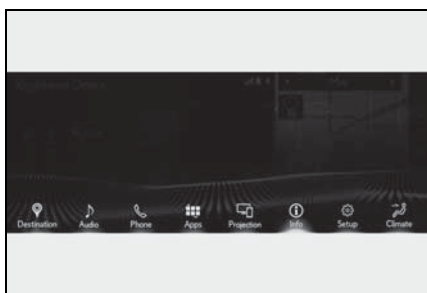



The displays shown in the illustrations are used for example only and may differ from the actual vehicle.



Switch	Function
	Select to display the "Destination" screen. ^{*1}
	Select to display the media control screen or the audio control screen. ^{*1}
	Select to display the hands-free control screen. ^{*1}

■ Split-screen display

Different information can be displayed on the left and right sides of the screen. For example, air conditioning system screen can be displayed and operated while the fuel consumption information screen is being displayed. The large screen on the

Switch	Function
	Select to display the "Apps" screen. ^{*1,2}
	When an Apple CarPlay connection is established and button displays "Apple CarPlay", select to display the home screen of Apple CarPlay. ^{*1,2}
	Select to display the information screen. ^{*1} (→P.91)
	Select to display the setup screen. ^{*1}
	Select to display the air conditioning control screen. (→P.316)

^{*1}: Refer to the "NAVIGATION AND MULTIMEDIA SYSTEM OWNER'S MANUAL".

^{*2}: This function is not available on some models.

left of the display is called the main display, and the small screen to the right is called the side display.

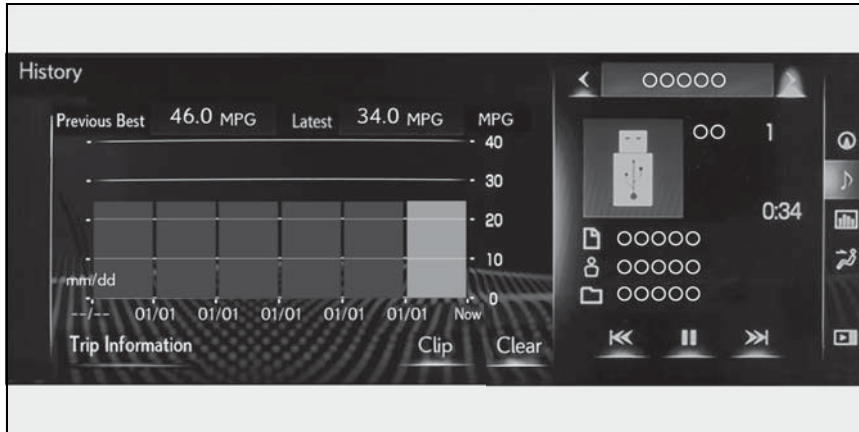

■ **Main display**

For details about the functions and operation of the main display, refer to the respective section and “NAVIGATION AND MULTIMEDIA SYSTEM OWNER’S MANUAL”.

■ **Side display**

The following functions can be displayed and operated on the side display.

Select **<** or **>** to display the desired screen.

C Vehicle information (→P.93)

D Air conditioning system (→P.319)

E Show/hide the side display*

*: Refer to the “NAVIGATION AND MULTIMEDIA SYSTEM OWNER’S MANUAL”.

■ **Screen display during low temperatures**

When the ambient temperature is extremely low, screen response may be delayed even if the Remote Touch is operated.

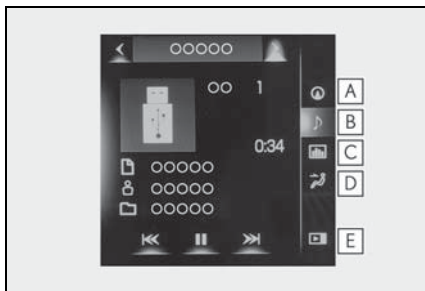

A Navigation system*

B Audio*

Rear Multi Operation Panel*

*: If equipped

The Rear Multi Operation Panel built-into the rear armrest can be used to operate the rear audio system, air conditioning system, seat, relaxation, shade or lamp.

Rear Multi Operation Panel overview

■ Home screen

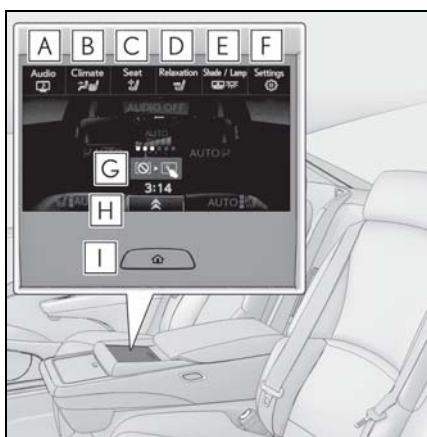

- A** Touch to display the audio control screen.
Refer to "NAVIGATION AND MULTIMEDIA SYSTEM OWNER'S MANUAL".
- B** Touch to display the rear air conditioning control screen. (→P.324)
- C** Touch to display the rear seat adjustment screen. (→P.126)
- D** Touch to display the relaxation seat (if equipped) control screen. (→P.129)

E Touch to display the rear sunshade (if equipped)/rear interior light control screen. (→P.347)

F Touch to display the Rear Multi Operation Panel settings screen. (→P.308)

G Rear Multi Operation Panel unlock button
Touch and hold until the unlock status indicators are completely illuminated to unlock the Rear Multi Operation Panel.
Touch "Screen Lock" to lock the Rear Multi Operation Panel system. (→P.308)

H Shortcut button
Shortcut screen is displayed. Touch to display/hide commonly used buttons for a selected mode on the bottom portion of the screen.

I  button
Press to display the home screen. When the screen is on, press and hold to turn the screen off.

■ Rear Multi Operation Panel settings screen

Screen operation settings and the brightness of the screen can be changed.

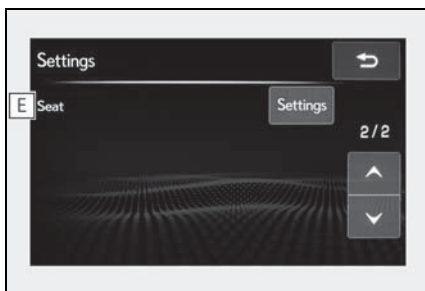
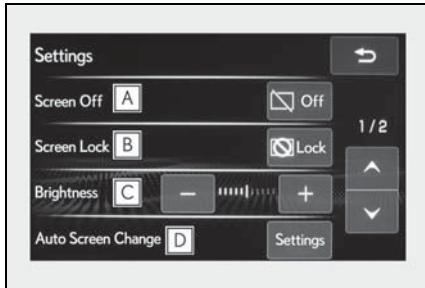

- A** Touch to turn the screen off.
- Press the  button to display the home screen.
- B** Touch to lock the Rear Multi Operation Panel.
 - C** Touch to adjust the brightness of the screen.
 - D** Touch to display the automatic screen transition settings screen. (→P.309)
 - E** Touch to display the rear seat settings screen.
 - Touch to set the seat return function linked to the door opening operation/shift-linked rear seat reclining function (→P.128) on/off.
 - For the rear seat with an ottoman (if equipped): Touch to set the position the seatback will move to when the seat is occupied and the door-linked rear seat return function operates. (→P.128)

■ **Auto screen change settings screen**

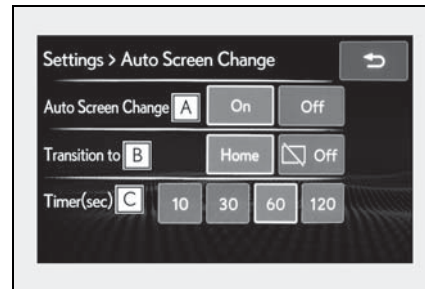



- A** Touch to turn the automatic screen transition function on/off.
- B** Touch to set whether the screen will transition to the home screen or turn off when the automatic screen transition function operates.
- C** Touch to set the amount of time (10/30/60/120 seconds) the Rear Multi Operation Panel must be idle before the automatic screen transition function operates.

When the screen is off, press the  button to turn the screen on and display the previously displayed screen. Press again to display the home screen.

■ **Operating the Rear Multi Operation Panel**

- When operating the Rear Multi Operation Panel, only use the tip of a finger. The Rear Multi Operation Panel cannot be operated with a fingernail, pen, etc.
- Use only one finger when operating the Rear Multi Operation Panel. The Rear Multi Operation Panel cannot be operated with multiple fingers.
- When the engine switch is changed to ACCESSORY or IGNITION ON mode, if a hand object, liquid or foreign matter is touching the Rear Multi Operation Panel,

it may not operate correctly. In this case, remove anything touching the Rear Multi Operation Panel and wait for approximately 30 seconds before operating it again.

If the Rear Multi Operation Panel still cannot be operated normally, press and hold the  button to turn the Rear Multi Operation Panel off, and then press the  button again to turn it back on and operate it.

- In the following situations, the Rear Multi Operation Panel may not operate properly:
 - If wearing gloves during operation, non response may occur.
 - If a wet hand is used to operate the Rear Multi Operation Panel.
 - If a screen cover or coating is applied to on the Rear Multi Operation Panel.
 - If the Rear Multi Operation Panel is dirty or has liquid attached to it, incorrect operation or non-response may occur.
 - If the Rear Multi Operation Panel receives electro magnetic waves, incorrect operation or non-response may occur.
 - If a mobile phone or other wireless communication device brought near the Rear Multi Operation Panel.
- If the a metal object, such as the following, is touching or covering the Rear Multi Operation Panel:
 - Coins
 - Keys
 - Metallic wallets or bags
 - Magnetic isolation cards
 - Metallic foil, such as the inner packaging of a cigarette box
 - Disposable heat packs
 - Discs, such as a CD or DVD, Cables, such as a USB cable
 - Mobile devices, such as smartphones, mobile phones, tablets, etc.
- Make sure to keep the Rear Multi Operation Panel clean. If the Rear Multi Operation Panel is dirty, it may not operate correctly. (When cleaning the Rear Multi Operation Panel, turn the screen off to

avoid unexpected operation.)



NOTICE



■ To prevent damage to the Rear Multi Operation Panel

Observe the following precautions. Failure to do so may cause damage to the Rear Multi Operation Panel.

- Keep the Rear Multi Operation Panel free of liquids, such as drinks or rain, as they may cause a short circuit.
- Do not sit on or set heavy objects on the Rear Multi Operation Panel.
- Do not push the Rear Multi Operation Panel with a strong force or use a sharp pointed object to operate the panel.

Lexus Climate Concierge

The seat heaters (if equipped), seat ventilators (if equipped) and heated steering wheel (if equipped) are each automatically controlled according to the set temperature of the air conditioning system, the outside and cabin temperature, etc. Lexus Climate Concierge allows a comfortable condition to be maintained without adjusting each system.

Press the "MENU" button on the Remote Touch to display the main menu and move the cursor to  to display the climate control shortcut buttons. Then, select  to display the Lexus Climate Concierge control screen.

Turning on Lexus Climate Concierge

Select .

The indicator on the Lexus Climate Concierge control screen illuminates, and the automatic air conditioning system, seat heaters and ventilators, and heated steering wheel operate in automatic mode.

If any of the system is operated manually, the indicator turns off. However, all other functions continue to operate in automatic mode.



■ Changing Lexus Climate Concierge control screen between front/rear (vehicles with 4-ZONE climate control)

Select "Rear" to display the rear air conditioning system screen.

Select "Front" to display the front air conditioning system screen.

■ When using the Lexus Climate Concierge

Lexus Climate Concierge can be operated on the sub function menu or option control screen. (→P.316)

Operation of each system

■ Automatic air conditioning system (→P.313, 323)

The temperature can be adjusted independently for each seat.

■ Seat heaters and ventilators (if equipped) (→P.326)

Heating or ventilation is automatically selected according to the set temperature of the air conditioning system, the outside temperature, etc.

■ Heated steering wheel (if equipped) (→P.326)

Heated steering wheel operates automatically according to the set tempera-

ture of the air conditioning system, the outside temperature, etc.

■ **Passenger detection functions**

- When a passenger is detected in the front passenger seat, the seat heater and ventilator will operate automatically.
- When a passenger is detected in a rear seat, the seat heater and ventilator will operate automatically. (vehicles with 4-ZONE climate control)

■ **Seat heater/ventilator operation**



When automatic mode is selected using the seat heater/ventilator switch, passenger detection is not performed.

■ **Rear seat heater operation (vehicles with power rear seat)**

The rear seat heaters are not controlled by the Lexus Climate Concierge.

Front automatic air conditioning system

Air outlets and fan speed are automatically adjusted according to the temperature setting.

Press the “MENU” button on the Remote Touch to display the main menu and move the cursor to  to display the climate control shortcut buttons. Then, select  to display the air conditioning control screen.

The air conditioning system can be displayed and operated on the side display.

Air conditioning controls

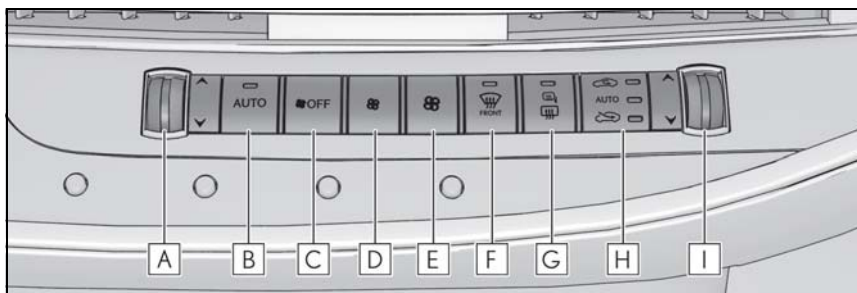



- A** Left-hand side temperature control switch
- B** Automatic mode switch
- C** Off switch
- D** Fan speed decreases switch
- E** Fan speed increases switch
- F** Windshield defogger switch
- G** Rear window defogger and outside rear view mirror defoggers switch
- H** Outside/recirculated air mode switch
- I** Right-hand side temperature control switch

■ Adjusting the temperature

Operate the temperature control switch upwards to increase the temperature and downwards to decrease the temperature.

■ Setting the fan speed

Operate the  switch to increase the fan speed and the  switch to decrease the fan speed.

Press the off switch to turn the fan off.



■ Changing the air flow mode

→P.316

■ Switching between outside air and recirculated air modes

Press the outside/recirculated air mode switch.

The mode changes as follows each time the switch is pressed.

automatic mode →  (outside air mode) →  (recirculated air mode) → automatic mode

When the system is switched to automatic mode, the air conditioning system operates automatically.

■ Defogging the windshield

Defoggers are used to defog the windshield and front side windows.

Press the windshield defogger switch.

Set the outside/recirculated air mode switch to outside air mode if the recirculated air mode is used. (It may switch automatically.)

To defog the windshield and the side windows quickly, turn the air flow and temperature up.

To return to the previous mode, press the windshield defogger switch again when the windshield is defogged.

■ Defogging the rear window and outside rear view mirrors

Defoggers are used to defog the rear window, and to remove raindrops, dew and frost from the outside rear view mirrors.

Press the rear window and outside rear view mirror defoggers switch.

The defoggers will automatically turn off

after a while. The operation time changes according to the ambient temperature and vehicle speed.

■ Windshield wiper de-icer (if equipped)

→P.319

■ When the outside temperature exceeds 75°F (24°C) and the air conditioning system is on

- In order to reduce the air conditioning power consumption, the air conditioning system may switch to recirculated air mode automatically. This may also reduce fuel consumption.
- It is possible to switch to outside air mode at any time by pressing the outside/recirculated air mode switch.

■ Fogging up of the windows

The windows will easily fog up when the humidity in the vehicle is high. Turning "A/C" on will dehumidify the air from the outlets and defog the windshield effectively.

- If you turn "A/C" off, the windows may fog up more easily.
- The windows may fog up if the recirculated air mode is used.

■ Outside/recirculated air mode

- When driving on dusty roads such as tunnels or in heavy traffic, set the outside/recirculated air mode switch to the recirculated air mode. This is effective in preventing outside air from entering the vehicle interior. During cooling operation, setting the recirculated air mode will also cool the vehicle interior effectively.
- Outside/recirculated air mode may automatically switch depending on the temperature setting or the inside temperature.

■ Registering air conditioning settings to electronic keys

- Unlocking the vehicle using an electronic key and turning the engine switch to IGNITION ON mode will recall that key's registered air conditioning settings.

- When the engine switch is turned off, the current air conditioning settings will automatically be registered to the electronic key that was used to unlock the vehicle.
- The system may not operate correctly if more than one electronic key is in the vicinity or if the smart access system with push-button start is used to unlock a passenger door.
- The doors that can recall the air conditioning setting* when unlocked using the smart access system with push-button start can be changed. For details, contact your Lexus dealer.

*: The doors that can recall the driving position memory are changed at the same time.

■ Operation of the air conditioning system in Eco drive mode

In Eco drive mode, the air conditioning system is controlled as follows to prioritize fuel efficiency:

- Engine speed and compressor operation controlled to restrict heating/cooling capacity
- Fan speed restricted when automatic mode is selected

To improve air conditioning performance, perform the following operations:

- Turn off eco air conditioning mode (→P.316)
- Adjust the fan speed
- Turn off Eco drive mode (→P.289)

■ When the outside temperature falls to nearly 32°F (0°C)

The dehumidification function may not operate even when "A/C" is selected.

■ Ventilation and air conditioning odors

- To let fresh air in, set the air conditioning system to the outside air mode.
- During use, various odors from inside and outside the vehicle may enter into and accumulate in the air conditioning system. This may then cause odor to be emitted from the vents.
- To reduce potential odors from occur-

ring:

- It is recommended that the air conditioning system be set to outside air mode prior to turning the vehicle off.
- The start timing of the blower may be delayed for a short period of time immediately after the air conditioning system is started in automatic mode or with the micro dust and pollen filter on.
- When parking, the system automatically switches to outside air mode to encourage better air circulation throughout the vehicle, helping to reduce odors that occur when starting the vehicle.

■ Using the voice command system

Air conditioning system can be operated using voice commands. For details, refer to the "NAVIGATION AND MULTIMEDIA SYSTEM OWNER'S MANUAL".

■ Air conditioning filter

→P.398

■ Customization

Some functions can be customized. (→P.466)

⚠ WARNING

■ To prevent the windshield from fogging up

Do not use the windshield defogger switch during cool air operation in extremely humid weather. The difference between the temperature of the outside air and that of the windshield can cause the outer surface of the windshield to fog up, blocking your vision.

■ When the outside rear view mirror defoggers are operating

Do not touch the outside rear view mirror surfaces, as they can become very hot and burn you.

 **NOTICE**

■ To prevent battery discharge

Do not leave the air conditioning system on longer than necessary when the engine is off.

Air conditioning control screen

■ Main control screen

Using the touchpad of the Remote Touch, select the button on the screen.

B to **E** and **H** can be adjusted by performing the following operations.

Flick operation: Move the pointer to the desired item and flick the touchpad up or down.

The item can be adjusted by one level.

Trace operation: After selecting the desired item, trace the pad surface.

The item can be adjusted by the amount that you trace.

Trace operation cannot be used while driving.

- ▶ Vehicles with DUAL-ZONE climate control

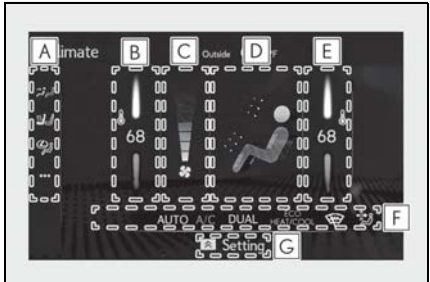



A Sub menu

Selecting the sub menu item to switch the main screen.

: Display the air conditioning control

screen

: Display the heated steering wheel/front seat heater/front seat ventilator control screen (if equipped)

: Display the rear seat heater/rear seat ventilator control screen (if equipped)

: Display the Lexus Climate Concierge control screen

: Display the option control screen

B Adjust the left side seat temperature setting

C Adjust the fan speed setting

D Select the air flow mode

: Air flows to the upper body

: Air flows to the upper body and feet

: Air flows to the feet

: Air flows to the feet and the windshield defogger operates

E Adjust the right side seat temperature setting

F Function on/off indicators

When the function is on, the indicator illuminates on the control screen.

G Sub function menu

When the sub function button on the Remote Touch is pressed, the following functions can be switched on and off.

: Set Lexus Climate Concierge (→P.311)

“AUTO”: Set automatic mode on/off (→P.320)

“OFF”: Turn the fan off

“A/C”: Set cooling and dehumidification function
If the “A/C” display is turned off, the system will blow ambient temperature air or heated air.

“DUAL”: Adjust the temperature for driver and passenger seats separately (“DUAL” mode) (→P.322)

ECO HEAT/COOL: Set eco air conditioning mode

▶ Vehicles with 4-ZONE climate control

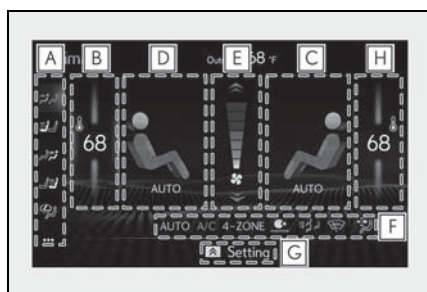

A Sub menu

Selecting the sub menu item to switch the main screen.

: Display the front air conditioning control screen

: Display the heated steering wheel/front seat heater/front seat ventilator control screen

: Display the rear air conditioning control screen

: Display the rear seat heater/rear seat ventilator control screen

: Display the Lexus Climate Concierge control screen

: Display the option control screen

B Adjust the left side seat temperature setting

C Select the right side seat air flow mode

: Air flows to the upper body

: Air flows to the upper body and feet

: Air flows to the feet

: Air flows to the feet and the windshield defogger operates

D Select the left side seat air flow mode

E Adjust the fan speed setting

F Function on/off indicators

When the function is on, the indicator illuminates on the control screen.

G Sub function menu

When the sub function button on the Remote Touch is pressed, the following functions can be switched on and off.

: Set Lexus Climate Concierge (→P.311)

“AUTO”: Set automatic mode on/off (→P.320)

“OFF”: Turn the fan off

“A/C”: Set cooling and dehumidification function

If the “A/C” display is turned off, the system will blow ambient temperature air or heated air.

“4-ZONE”: Adjust the temperature for the driver, front passenger and left and right rear passenger seats separately (“4-ZONE” mode) (→P.322)

ECO HEAT/COOL: Set eco air conditioning mode

H Adjust the right side seat temperature setting

■ Option control screen

Select  on the sub menu to display the option control screen.

The functions can be switched on and off.

When the function is on, the indicator illuminates on the screen.

- ▶ Vehicles with DUAL-ZONE climate control

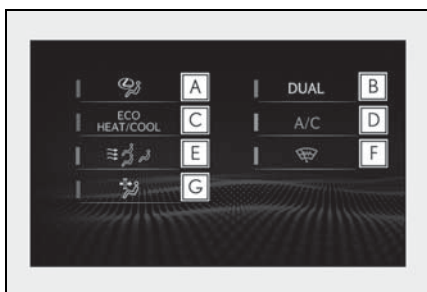

- A** Set Lexus Climate Concierge (→P.311)
- B** Adjusting the temperature for driver and passenger seats separately (“DUAL” mode) (→P.322)
- C** Set eco air conditioning mode
Air conditioning and heater output is limited to prioritize fuel economy.
- D** Cooling and dehumidification function
If the “A/C” indicator is turned off, the system will blow ambient temperature air or heated air.
- E** Select the S-FLOW mode (→P.320)
- F** Prevent ice from building up on the windshield and wiper blades (Windshield wiper de-icer) (if equipped)
- G** Removing pollen from the air

(Micro dust and pollen filter)

- ▶ Vehicles with 4-ZONE climate control

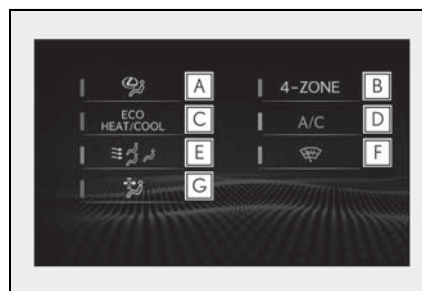

- A** Set Lexus Climate Concierge (→P.311)
- B** Adjust the temperature for driver, passenger and rear seats separately (“4-ZONE” mode) (→P.322)
- C** Set eco air conditioning mode
Air conditioning and heater output is limited to prioritize fuel economy.
- D** Cooling and dehumidification function
If the “A/C” indicator is turned off, the system will blow ambient temperature air or heated air.
- E** Select the S-FLOW mode (→P.320)
- F** Prevent ice from building up on the windshield and wiper blades (Windshield wiper de-icer) (if equipped)
- G** Removing pollen from the air (Micro dust and pollen filter)

■ Side display

- ▶ Vehicles with DUAL-ZONE climate control

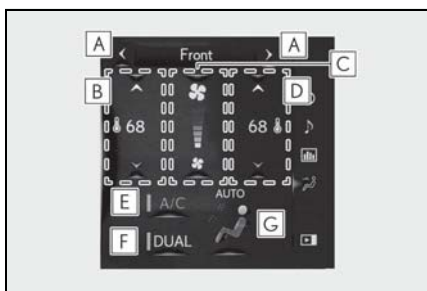

- A** Display the front seat heaters/front seat ventilators control screen (→P.327)
- B** Adjust the left side seat temperature setting
- C** Adjust the fan speed setting
- D** Adjust the right side seat temperature setting
- E** Set cooling and dehumidification function on/off
- F** Adjusting the temperature for driver and passenger seats separately ("DUAL" mode) (→P.322)
- G** Select the air flow mode
- ▶ Vehicles with 4-ZONE climate control

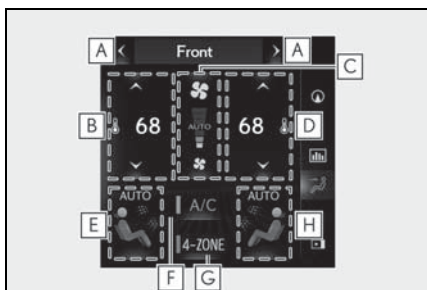

- A** Display the front seat heaters/front

seat ventilators control screen (→P.327)

- B** Adjust the left side seat temperature setting
 - C** Adjust the fan speed setting
 - D** Adjust the right side seat temperature setting
 - E** Select the left side seat air flow mode
 - F** Set cooling and dehumidification function on/off
- If the "A/C" indicator is turned off, the system will blow ambient temperature air or heated air.
- G** Adjust the temperature for driver, passenger and rear seats separately ("4-ZONE" mode) (→P.322)
 - H** Select the right side seat air flow mode

■ Windshield wiper de-icer (if equipped)

This feature is used to prevent ice from building up on the windshield and wiper blades.

The windshield de-icer will automatically turn off after a while.

■ Eco air conditioning mode

When Eco drive mode is selected using the driving mode select switch, eco air conditioning mode turns on.

When a drive mode other than Eco drive mode is selected, eco air conditioning mode may turn off.

■ Micro dust and pollen filter

Outside air mode switches to  (recirculated air) mode. Pollen is removed from the air and the air flows to the upper part of the body.

Usually the system will automatically turn

off after a while.

In order to prevent the windshield from fogging up when the outside air is cold, the dehumidification function may operate or the outside/recirculated air mode may not switch to  (recirculated air) mode.

Pollen is filtered even if the micro dust and pollen filter is turned off.



WARNING

■ To prevent burns (vehicles with windshield wiper de-icer)

Do not touch the glass at lower part of the windshield or to the side of the front pillars when the windshield wiper de-icer is on.

Using automatic mode

- 1 Press the automatic mode switch or select "AUTO" on the sub function menu. (→P.316)
 - 2 Press the outside/recirculated air mode switch to switch to automatic air intake mode.
- The air conditioning system automatically switches between outside air and recirculated air modes.
- 3 Adjust the temperature setting.
 - 4 To stop the operation, press the off switch or select "OFF" on the sub function menu. (→P.316)

If the fan speed setting or air flow modes are operated, the automatic mode indicator goes off. However, automatic mode for functions other than that operated is maintained.

■ Using automatic mode

Fan speed is adjusted automatically according to the temperature setting and the ambient conditions.

Therefore, the fan may stop for a while until

warm or cool air is ready to flow immediately after the automatic mode switch is pressed or "AUTO" is selected.

Cool air may blow around the upper body even when the heater is on due to sunlight.

■ Automatic mode for air intake control

In automatic mode, the system detects exhaust gas and other pollutants and automatically switches between outside air and recirculated air modes.

When the dehumidification function is off, and the fan is operating, turning automatic mode on will activate the dehumidification function.

S-FLOW mode

In S-FLOW mode, priority for the airflow is given to the front seats, reducing the airflow and air conditioning effect on the rear seats. When in S-FLOW mode, airflow from the rear air conditioning system is stopped.

Operation in S-FLOW mode differs according to the following conditions:

- Priority is given to the driver's seat only when:
 - Manual S-FLOW mode: When no passenger is judged to be in the front passenger seat.
 - Automatic S-FLOW mode: When no passengers are judged to be in the front passenger seat or rear seats.
- Priority is given to the front seats when: Manual S-FLOW mode is selected or no passengers are judged to be in the rear seats when in automatic S-FLOW mode.
- S-FLOW mode will be disabled when: A passenger is judged to be

in a rear seat when in automatic S-FLOW mode.

Depending on the set temperature, operation in S-FLOW mode may not change as described above.

When certain conditions are met and priority is given to the driver's seat only, the temperature indicator for the front passenger side will turn off.

How the system judges if a passenger is in the vehicle: P.321

The following S-FLOW modes are available:

► Automatic S-FLOW mode

In this mode, when a passenger is judged to be in a rear seat, S-FLOW mode will be automatically disabled. (→P.321)

The indicator will illuminate on the air conditioning control screen when S-FLOW mode is enabled.

To enable/disable S-FLOW mode and enter manual S-FLOW mode, select the S-FLOW mode switch.

How the system judges if a passenger is in the vehicle: P.321

► Manual S-FLOW mode

When the S-FLOW mode switch is selected, S-FLOW mode will be manually enabled/ disabled.

The indicator will illuminate on the air conditioning control screen when S-FLOW mode is enabled.

In manual S-FLOW mode, as the system does not judge if a passenger is in a rear seat.

If the rear air conditioning control screen on the Rear Multi Operation Panel (if equipped) is operated, S-FLOW mode will

automatically be disabled

■ How the system judges if a passenger is in the vehicle when in S-FLOW mode

In S-FLOW mode, the system judges if a passenger is in the vehicle as follows:

- Front passenger seat: A passenger is judged to be in the front passenger seat when the system detects an object on the front passenger seat, fastening of the front passenger seat belt, changing of the set temperature for the front passenger seat, changing of the air outlets for the front passenger seat or the opening and closing of the front passenger door. (However, when only opening and closing of the front passenger door is detected, the system will judge that a passenger is not in the front passenger seat after the vehicle speed reaches approximately 12 mph (20 km/h) or more.)
- Rear seats: A passenger is judged to be in a rear seat when the system detects the opening and closing of a rear door (automatic S-FLOW mode only) or the operation of the rear air conditioning control screen on the Rear Multi Operation Panel.

■ Operation of automatic S-FLOW mode

When the system is operating in automatic S-FLOW mode, if the system detects the opening and closing of a rear door or the operation of the rear air conditioning control screen on the Rear Multi Operation Panel, S-FLOW mode will be disabled. To enable S-FLOW mode, select the S-FLOW mode switch. (In this case, the system will operate in manual S-FLOW mode.)

■ Changing from manual S-FLOW mode to automatic S-FLOW mode

- 1 Select the S-FLOW mode switch to disable S-FLOW mode.
- 2 Turn the engine switch off.
- 3 After 60 minutes have elapsed, change the engine switch to ON mode.

Adjusting the temperature for the driver and passenger seats separately

- ▶ Vehicles with DUAL-ZONE climate control

To turn on the “DUAL” mode, perform any of the following procedures:

- Select “DUAL” on the sub function menu. (→P.316)
- Select “DUAL” on the option control screen.
- Adjust the passenger’s side temperature setting.

The indicator on the main control screen comes on when the “DUAL” mode is on.

- ▶ Vehicles with 4-ZONE climate control

To turn on the “4-ZONE” mode, perform any of the following procedures:

- Select “4-ZONE” on the sub function menu. (→P.316)
- Select “4-ZONE” on the option control screen.
- Adjust a passenger seat temperature setting.

The indicator on the main control screen comes on when the “4-ZONE” mode is on.

Air outlet layout and operations

■ Location of air outlets

The air outlets and air volume changes according to the selected air flow mode.

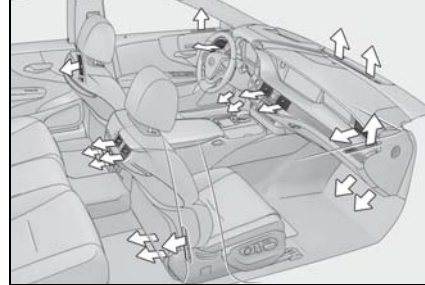

■ Adjusting the position of and opening and closing the air outlets

- ▶ Front center/front side

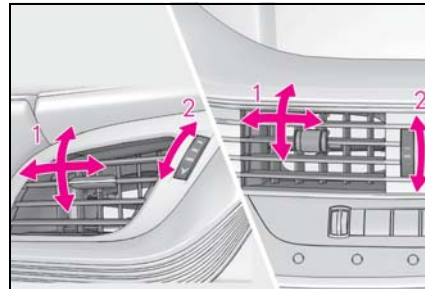

- 1 Direct air flow to the left or right, up or down
- 2 Turn the knob to open or close the vent

- ▶ Rear center/rear side

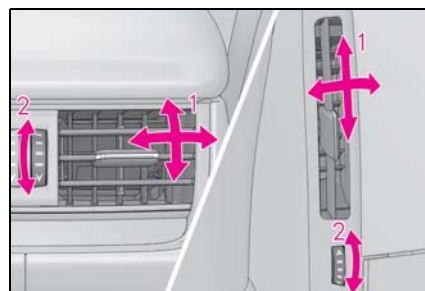

- 1 Direct air flow to the left or right, up or down
- 2 Turn the knob to open or close the vent

⚠ WARNING**■ To prevent the windshield defogger from operating improperly**

Do not place anything on the instrument panel which may cover the air outlets. Otherwise, air flow may be obstructed, preventing the windshield defoggers from defogging.

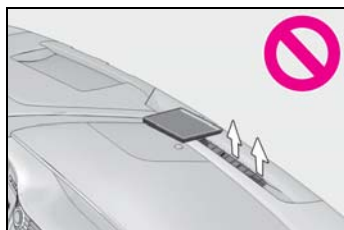

**Rear automatic air conditioning system***

*: If equipped

The air outlets and fan speed are automatically adjusted according to the temperature setting.

The rear air conditioning system can be operated using the Center Display and Rear Multi Operation Panel.

- Center Display

Press the "MENU" button on the Remote Touch to display the main menu and move the cursor to  to display the climate control shortcut buttons. Then, select  to display the rear air conditioning control screen.

- Rear Multi Operation Panel*

Touch "Climate" on the home screen to display the rear air conditioning control screen.(→P.308)

Touching the shortcut button on the home screen will also display operation buttons for some of the rear air conditioning system functions.

*: The Rear Multi Operation Panel cannot be used to operate the rear air conditioning system if the function is disabled.(→P.324)

Rear air conditioning control screen

■ **Center Display**

Using the touchpad of the Remote Touch, select the button on the screen.

A to **E** can be adjusted by performing the following operations.

Flick operation: Move the pointer to the desired item and flick the touchpad up or down.

The item can be adjusted by one level.

Trace operation: After selecting the desired item, trace the pad surface.

The item can be adjusted by the amount that you trace.

Trace operation cannot be used while driving.

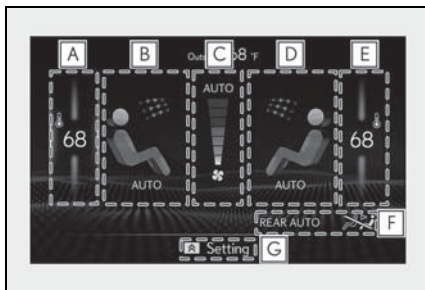

- A** Adjust the left side rear seat temperature setting
- B** Select the left side rear seat air flow mode
 - : Air flows to the upper body
 - : Air flows to the upper body and feet
 - : Air flows to the feet
- C** Adjust the rear seats fan speed set-

ting

- D** Select the right side rear seat air flow mode
- E** Adjust the right side rear seat temperature setting
- F** Function on/off indicators

When the function is on, the indicator illuminates on the control screen.
- G** Sub function menu

When the sub function button on the Remote Touch is pressed, the following functions can be switched on and off.

 - “Rear off”: Turn the rear seats fan off
 - “Rear AUTO”: Set the rear seats automatic mode on/off (→P.325)

: Disables operation of the rear air conditioning system using the Rear Multi Operation Panel

■ **Rear Multi Operation Panel***

Various functions can be operated by touching the displayed buttons on the Rear Multi Operation Panel.

* : The Rear Multi Operation Panel cannot be used to operate the rear air conditioning system if the function is disabled. (→P.324)

► Rear air conditioning control screen

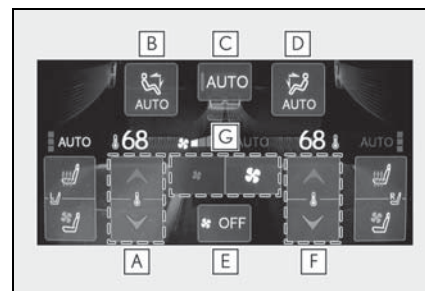

- A** Adjust the left side rear seat temperature setting

- B** Select the left side rear seat air flow mode



: Air flows to the upper body



: Air flows to the upper body and feet



: Air flows to the feet

- C** Set the rear seats automatic mode on/off (→P.325)

- D** Select the right side rear seat air flow mode

- E** Turn the rear seats fan off

- F** Adjust the right side rear seat temperature setting

- G** Adjust the rear seats fan speed setting

- ▶ Shortcut screen



- A** Adjust the left side rear seat temperature setting

- B** Adjust the right side rear seat temperature setting

Using automatic mode

- ▶ Center Display

- 1** Select "Rear AUTO" on the sub function menu. (→P.324)

- 2** To stop the operation, select "Rear off" on the sub function menu. (→P.324)

If the fan speed setting or air flow modes are operated, the automatic mode indicator goes off. However, automatic mode for functions other than that operated is maintained.

- ▶ Rear Multi Operation Panel

- 1** Select "AUTO" on the rear air conditioning control screen. (→P.324)

- 2** To stop the operation, select "OFF" on the rear air conditioning control screen. (→P.324)

If the fan speed setting or air flow modes are operated, the automatic mode indicator goes off. However, automatic mode for functions other than that operated is maintained.

Using automatic mode

Fan speed is adjusted automatically according to the temperature setting and the ambient conditions.

Therefore, the fan may stop for a while until warm or cool air is ready to flow immediately after "Rear AUTO" is selected or "AUTO" is touched.

Cool air may blow around the upper body even when the heater is on due to sunlight.

Adjusting the temperature setting of the rear seats

The temperature setting of the rear seats can be adjusted using the following methods:

- When the "4-ZONE" indicator is off: Adjust the driver's seat temperature.

Adjust the temperature setting of each rear seat using the Center Display or Rear Multi Operation Panel.

- Adjust the temperature setting of each rear seat using the Center Display (rear air conditioning control screen) or Rear Multi Operation Panel.

The temperature setting of each rear seat can be changed independently.

Air outlet layout and operations

■ Rear center outlets and rear side outlets

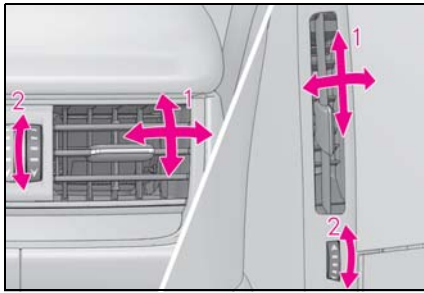

- 1 Direct air flow to the left or right, up or down
- 2 Turn the knob to open or close the vent



NOTICE

■ To prevent battery discharge

Do not leave the air conditioning system on longer than necessary when the engine is off.

Heated steering wheel* / seat heaters* / seat ventilators*

*: If equipped

- Heated steering wheel

Warms up the grip of the steering wheel

- Front seat heaters/Rear seat heaters



Warm up the seat upholstery

- Front seat ventilators/Rear seat ventilators

Maintain good ventilation by pulling air through the seat upholstery

The Center Display and Rear Multi Operation Panel/rear control panel can be used to operate the heated steering wheel, seat heaters and seat ventilators as follows:

● Center Display

Press the "MENU" button on the Remote Touch to display the main menu and move the cursor to  to display the shortcut buttons. Then, select  to display the heated steering wheel/front seat heater/front seat ventilator control screen.

To display the rear seat heater/rear seat ventilator control screen, select  (if equipped)

● Rear Multi Operation Panel

Touch "Climate" on the home screen to display the air conditioning control screen.(→P.308)

Touching the shortcut button on the home screen will display operation buttons for the rear seat heaters and rear seat ventilators.

● Rear control panel

The rear seat heaters can be operated.

● Persons who have taken alcohol or drugs that induce sleep (sleeping drugs, cold remedies, etc.)

 NOTICE

■ To prevent damage to the seat heaters and seat ventilators

Do not put heavy objects that have an uneven surface on the seat and do not stick sharp objects (needles, nails, etc.) into the seat.

■ To prevent battery discharge

Do not use the functions when the engine is off.

Control screen

■ Center Display

▶ Main screen

Using the touchpad of the Remote Touch, select the button on the screen.

A to **C** can be adjusted by performing the following operations.

Flick operation: Move the pointer to the desired item and flick the touchpad up or down.

The item can be adjusted by one level.

Trace operation: After selecting the desired item, trace the touchpad surface.

The item can be adjusted by the amount that you trace.

Trace operation cannot be used while driving.

 WARNING

■ To prevent minor burn injuries

Care should be taken if anyone in the following categories comes in contact with the steering wheel or seats when the heater is on:

- Babies, small children, the elderly, the sick and the physically challenged
- Persons with sensitive skin
- Persons who are fatigued

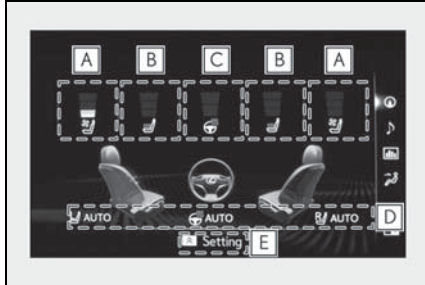

- A** Adjust the seat ventilator fan speed level

The seat ventilator can be adjusted in 3 levels. (Low, Mid or Hi)

- B** Adjust the seat heater temperature level

The seat heater can be adjusted in 3 levels. (Low, Mid or Hi)

- C** Adjust the heated steering wheel temperature level*

The heated steering wheel can be adjusted in 2 levels. (Low or Hi)

- D** Automatic mode on/off indicators

When the automatic mode is on, the indicator illuminates on the screen.

- E** Sub function menu

When the sub function button on the Remote Touch is pressed, the following functions can be set to automatic mode.

AUTO : Left-hand side seat heater/seat ventilator

AUTO : Heated steering wheel*

AUTO : Right-hand side seat heater/seat ventilator

* : Available on the front seat control screen only

► Side screen

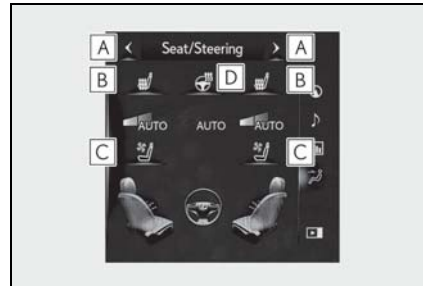

- A** Display the air conditioning control screen: →P.319

- B** Adjust the front seat heater temperature level

Each time the switch is selected, the temperature level and level indicator (orange) change as follows:

AUTO→Hi→Mid→Lo→OFF

- C** Adjust the front seat ventilator fan speed level

Each time the switch is selected, the fan speed level and level indicator (blue) change as follows:

AUTO→Hi→Mid→Lo→OFF

- D** Adjust the heated steering wheel temperature level

Each time the switch is selected, the temperature level and level indicator change as follows:

AUTO→Hi→Lo→OFF

■ **Rear Multi Operation Panel (if equipped)**

▶ Rear air conditioning control screen



A Adjust the rear seat heater temperature level

Each time the switch is selected, the temperature level and level indicator (orange) change as follows:

AUTO→Hi→Mid→Lo→OFF

B Adjust the rear seat ventilator fan speed level

Each time the switch is selected, the fan speed level and level indicator (blue) change as follows:

AUTO→Hi→Mid→Lo→OFF

▶ Shortcut screen



A Adjust the rear seat heater temperature level

Each time the switch is selected, the temperature level and level indicator (orange) change as follows:

AUTO→Hi→Mid→Lo→OFF

B Adjust the rear seat ventilator fan speed level

Each time the switch is selected, the fan speed level and level indicator (blue) change as follows:

AUTO→Hi→Mid→Lo→OFF

■ **Rear control panel (if equipped)**

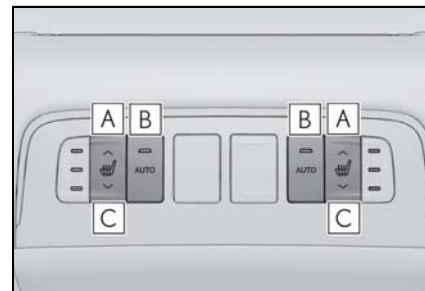

A Increases the rear seat heater temperature level

The seat ventilator can be adjusted in 3 levels. (Low, Mid or Hi)

B Enables/Disables the automatic mode of the rear seat heaters

C Decreases the rear seat heater temperature level

If this switch is selected when the rear seat heater temperature level is set to Lo, the rear seat heater will turn off.

■ **The heated steering wheel, seat heaters and seat ventilators can be used when**

The engine switch is in IGNITION ON mode.

■ **Air conditioning system-linked control mode**

When the seat ventilator fan speed level is Hi, the seat ventilator fan speed becomes higher according to the fan speed of the air conditioning system.

■ **When the air conditioning system is operating in S-FLOW mode**

If a passenger is not detected in the front

passenger seat, the seat ventilator and seat heater of the front passenger's seat will be turned off if on. (→P.320)

■ **Customization**

Some functions can be customized.
(→P.466)



WARNING

■ **To prevent overheating and minor burn injuries**

Observe the following precautions when using the seat heaters.

- Do not cover the seat with a blanket or cushion when using the seat heater.
- Do not use seat heater more than necessary.

Interior lights list

Location of the interior lights

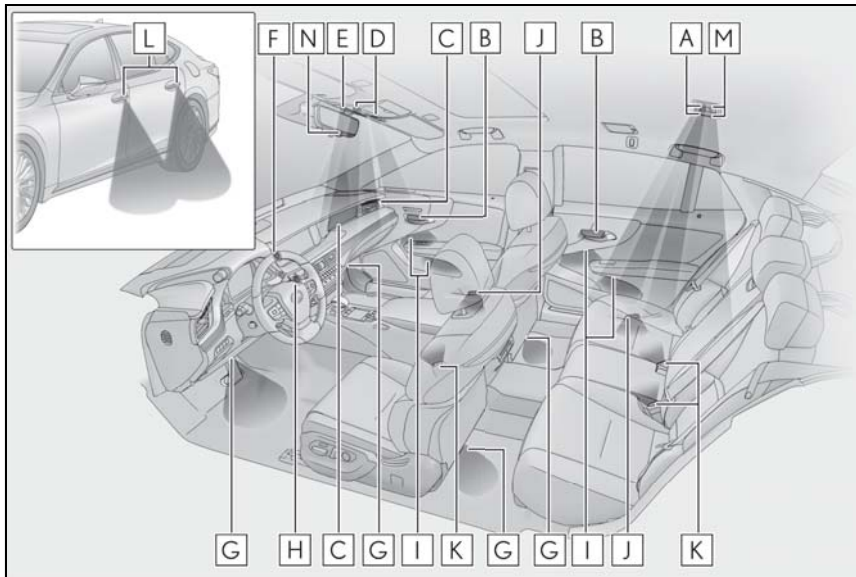

- A** Rear personal lights (→P.333)
- B** Inside door handle lights
- C** Instrument panel ornament lights (if equipped)
- D** Front personal lights (→P.333)
- E** Front interior lights (→P.332)
- F** Clock light
- G** Footwell lights
- H** Engine switch light
- I** Door trim ornament lights
- J** Door courtesy lights
- K** Seat belt buckle lights
- L** Outer foot lights
- M** Rear interior light (→P.332)
- N** Shift lever lights

Operating the interior lights

■ **Turning the door position on**

Press the door-linked interior light switch

The lights are turned on and off according to whether the doors are opened/closed.

When the door position is on, the indicator **A** illuminates.

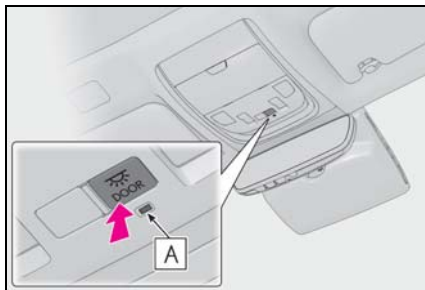

■ **Turning the lights on/off**

▶ **Front**

Turns the lights on/off (touch the light)

When a door is opened while the door position is on, the lights turn on.

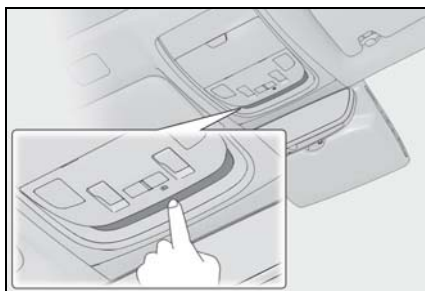

▶ **Rear (vehicles without a panoramic moon roof)**

On/off

The rear interior light turns on/off together the front interior lights.

When a door is opened while the door position is on, the lights turn on.

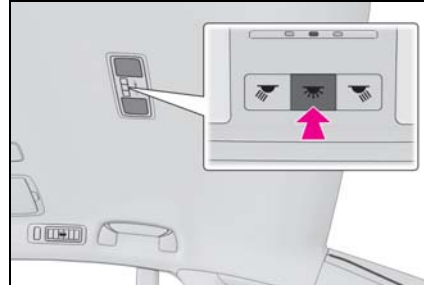

▶ **Rear (vehicles with a panoramic moon roof)**

On/off

The rear interior light turns on/off together the front interior lights.

When a door is opened while the door position is on, the lights turn on.

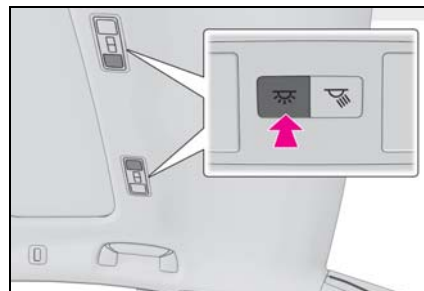

■ **Using the Rear Multi Operation Panel (if equipped)**

- 1 Display the home screen and then touch "Rear Shade/Lamp". (→P.308)

- 2 To turn on/off the rear interior lights, touch the respective button.



Operating the personal lights

■ **Turning the lights on/off**

- ▶ Front

Turns the lights on/off (touch the light)

When a door is opened while the door position is on, the lights turn on.

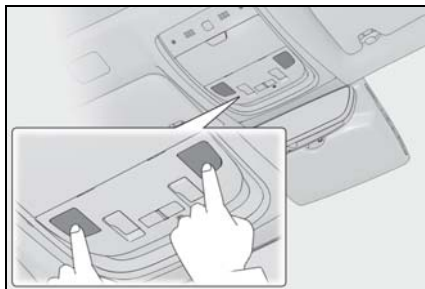

- ▶ Rear (vehicles without a panoramic moon roof)

On/dimmed/off

When a door is opened while the door position is on, the lights turn on.

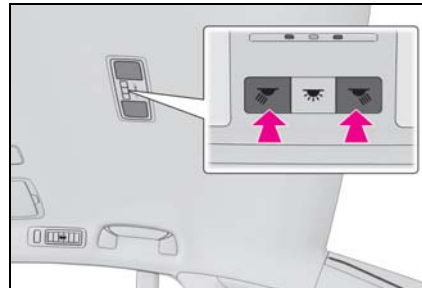

- ▶ Rear (vehicles with a panoramic moon roof)

On/dimmed/off

When a door is opened while the door position is on, the lights turn on.

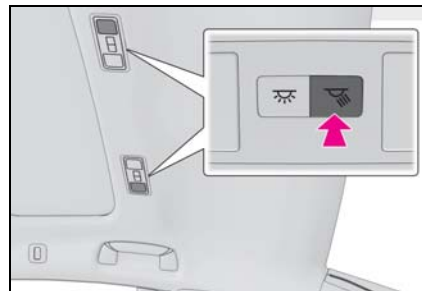

■ **Using the Rear Multi Operation Panel (if equipped)**

- 1 Display the home screen and then touch "Rear Shade/Lamp". (→P.308)
- 2 To turn on/dimmed/off the rear personal lights, touch the respective button.



■ **Illuminated entry system**

The lights automatically turn on/off according to the engine switch mode, the presence of the electronic key, whether the doors are locked/unlocked, and whether the doors are opened/closed.

■ **To prevent the battery from being discharged**

If the interior lights remain on when the engine switch is turned off, the lights will go off automatically after 20 minutes.

■ **When front interior light or front personal lights do not respond as normal**

- When water, dirt, etc., have adhered to the lens surface
- When operated with a wet hand
- When wearing gloves, etc.

■ **The interior lights may turn on automatically when**

If any of the SRS airbags deploy (inflate) or in the event of a strong rear impact, the interior lights will turn on automatically.

The interior lights will turn off automatically after approximately 20minutes.

The interior lights can be turned off manually. However, in order to help prevent further collisions, it is recommended that they be left on until safety can be ensured.

(The interior lights may not turn on automatically depending on the force of the impact and conditions of the collision.)

■ **Customization**

Some functions can be customized.
(→P.466)

■ **Removing light lenses**

Never remove the lens for the front interior light and front personal lights. Otherwise, the lights will be damaged. If a lens needs to be removed, contact your Lexus dealer.

 **NOTICE**

■ **To prevent battery discharge**

Do not leave the lights on longer than necessary when the engine is not running.

List of storage features**Location of the storage features**

- Vehicles without power rear seat

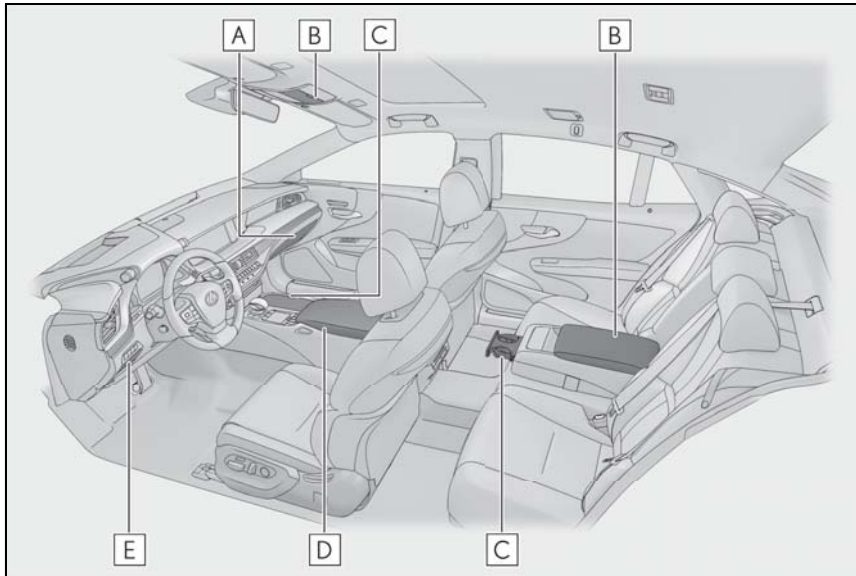

- A** Glove box (→P.336)
- B** Auxiliary boxes (→P.339)
- C** Cup holders (→P.337)
- D** Console box (→P.338)
- E** Coin holder (→P.337)

► Vehicles with power rear seat

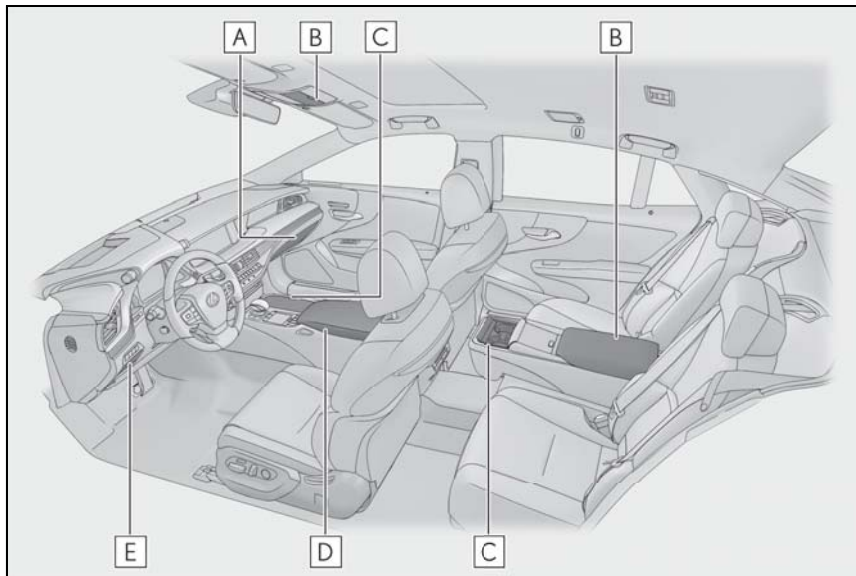

- A** Glove box (→P.336)
- B** Auxiliary boxes (→P.339)
- C** Cup holders (→P.337)
- D** Console box (→P.338)
- E** Coin holder (→P.337)

⚠ WARNING

■ **Items that should not be left in the storage spaces**

Do not leave glasses, lighters or spray cans in the storage spaces, as this may cause the following when cabin temperature becomes high:

- Glasses may be deformed by heat or cracked if they come into contact with other stored items.
- Lighters or spray cans may explode. If they come into contact with other stored items, the lighter may catch fire or the spray can may release gas, causing a fire hazard.

Glove box

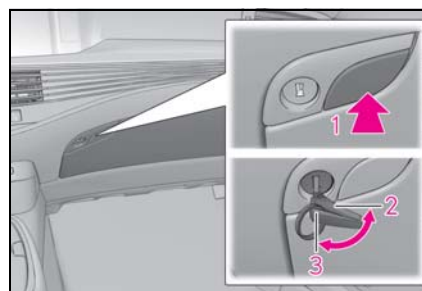

- 1** Open (push button)
- 2** Unlock with the mechanical key
- 3** Lock with the mechanical key

■ **Glove box light**

The glove box light turns on when the tail lights are on.

■ **Trunk opener main switch**

The trunk opener main switch is located in the glove box. (→P.110)

■ **Removing the partition**

The partition inside the glove box can be removed by pulling it.

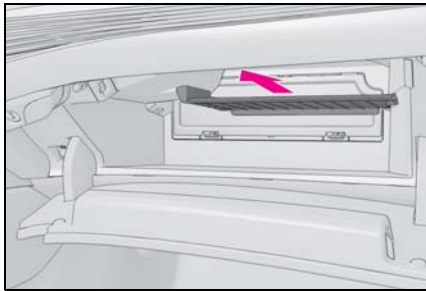

! WARNING

■ **Caution while driving**

Keep the glove box closed. In the event of sudden braking or sudden swerving, an accident may occur due to an occupant being struck by the open glove box or the items stored inside.

Coin holder

Push the button.

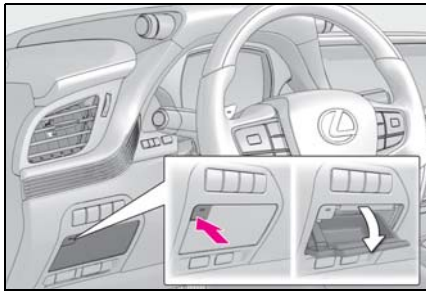

! WARNING

■ **Caution while driving**

Keep the coin holder closed. Injuries may result in the event of an accident or sudden braking.

Cup holders

▶ **Front**

Press in and release the button.

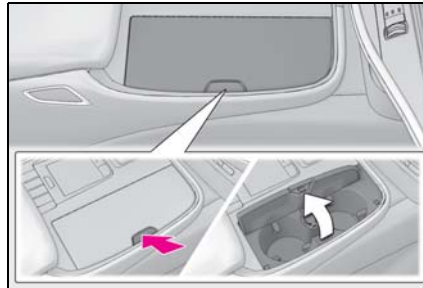

▶ **Rear (vehicles without power rear seat)**

Pull the armrest down then push in the cup holder trim to extend the cup holders.

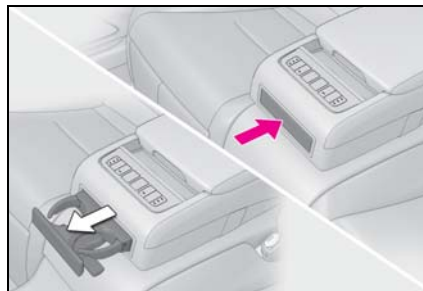

▶ **Rear (vehicles with power rear seat)**

Press in and release the button.

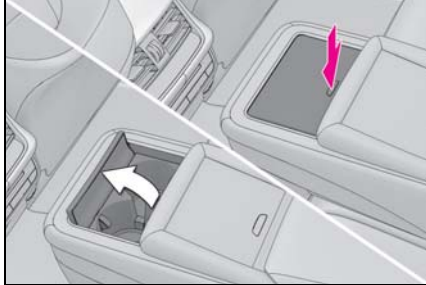

■ **When stowing the rear cup holders (vehicles without power rear seat)**

Stow the cup holder with the armrest down. The cup holder cannot be stowed if the armrest is not down.

⚠ WARNING

■ **Items unsuitable for the cup holder**

Do not place anything other than cups or beverage cans in the cup holders. Inappropriate items must not be stored in the cup holders even if the lid is closed. Other items may be thrown out of the holders in the event of an accident or sudden braking and cause injury. If possible, cover hot drinks to prevent burns.

■ **When not in use**

Keep the cup holders closed. Injuries may result in the event of an accident or sudden braking.

⚠ NOTICE

■ **To prevent damage to the rear cup holder (vehicles without power rear seat)**

Stow the cup holder before stowing the armrest.

■ **To avoid damaging the power outlet**

Close the lid of the power outlet in the front cup holder when the power outlet is not in use. Foreign objects or liquids that enter the power outlet may cause a short circuit.

Console box

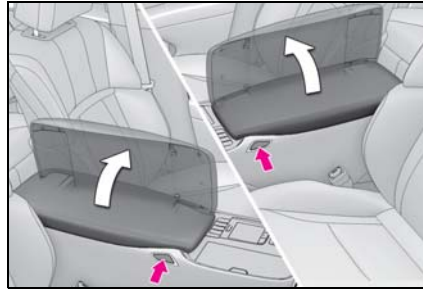

Press a button to open the console box.

The console box can be opened from either side.

■ **Tray in the console box**

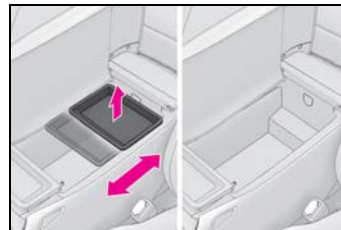

The tray can be slid and removed.

■ **Console box light**

The console box light turns on when the tail lights are on.

⚠ WARNING

■ **Caution while driving**

Keep the console box closed. Injuries may result in the event of an accident or sudden braking.

⚠ NOTICE

■ **Tray**

Do not insert items exceeding the height of the tray. Doing so may prevent opening and closing of the lid.

Auxiliary boxes

► Overhead

Press in the button.

This box is useful for temporarily storing sunglasses and similar small items.

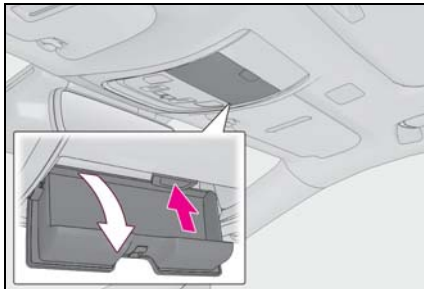

► Rear seat (vehicles without power rear seat)

Pull the armrest down then push the knob and lift the lid to open it.

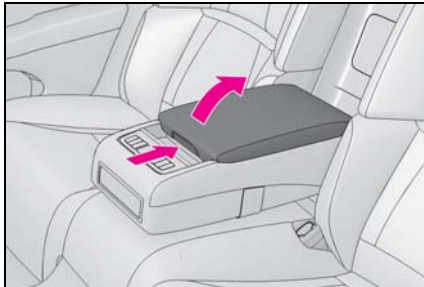

► Rear seat (vehicles with power rear seat)

Pull the armrest down then press the button to open the lid.

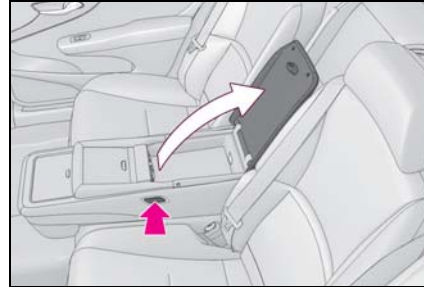

⚠ WARNING

■ Caution while driving

Do not leave the auxiliary box open while driving.

Items may fall out and cause death or serious injury in case of an accident or sudden stop.

■ Items unsuitable for storing (overhead)

Do not store items heavier than 0.4 lb. (0.2 kg).

Doing so may cause the auxiliary box to open and the items inside may fall out, resulting in an accident.

Trunk features

Cargo net (if equipped)

The cargo net is provided for securing loose items on the floor or items inside the trunk.

Raise the cargo hooks on the floor.
Hook the net on the cargo hooks.

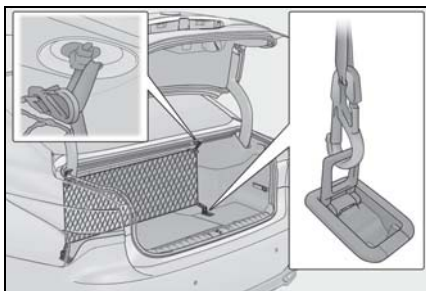
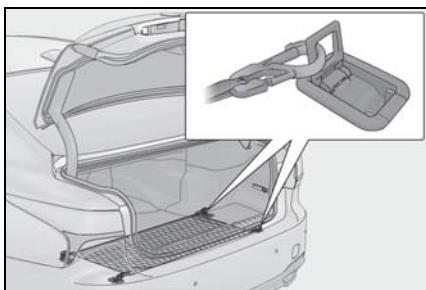

⚠ WARNING

■ When the cargo net is not in use

To avoid injury, always return the cargo hooks on the floor to their stowed positions.

Shopping bag hooks

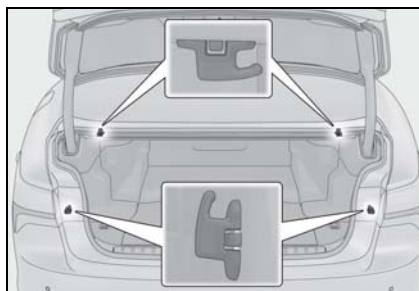

⚠ NOTICE

■ To prevent damage to the grocery bag hooks

Do not hang any object heavier than 11 lb. (5 kg) on the grocery bag hooks.

Luggage mats

► Side

Pull the strap upwards to lift the luggage mat and remove it.

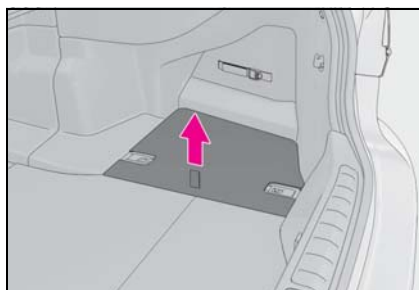

► Front

- 1 Pull the strap upwards and lift up the luggage mat.

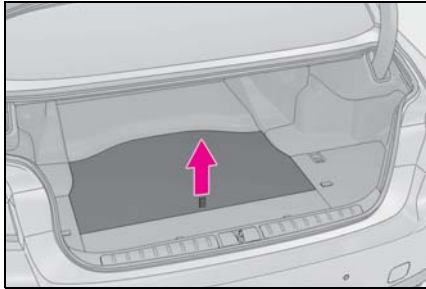

- 2 Lift the luggage mat until it engages with the hook.

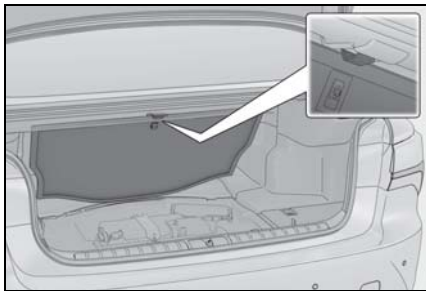

To return the luggage mat to its original position, push the hook and lower the luggage mat.

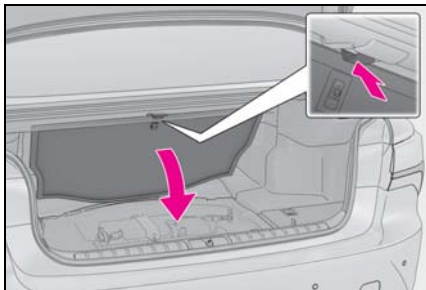

 NOTICE

■ To prevent damage to the hook for the front luggage mat

Do not hang a grocery bag or any other object from the hook.

Auxiliary boxes

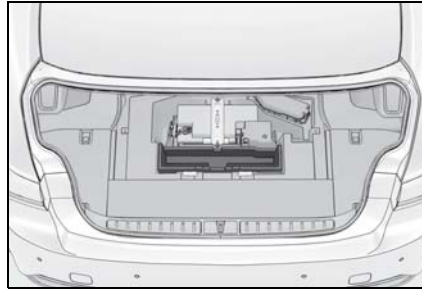

Auxiliary boxes are under the luggage mats.

First-aid kit storage belt

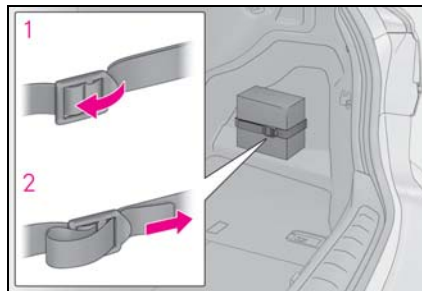

- 1 Loosen the belt
- 2 Tighten the belt

Warning reflector storage belt

■ Using a belt to hold an object

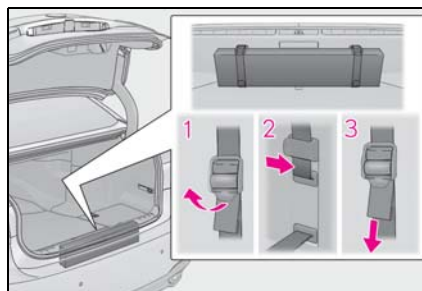

- 1 Loosen the belt

2 Pass the belt through the clip

3 Tighten the belt

Depending on the size and shape of an object, such as the case of a warning reflector, the object may not be able to be secured with the belts or stowed in an auxiliary box.

■ **Stowing the belt**

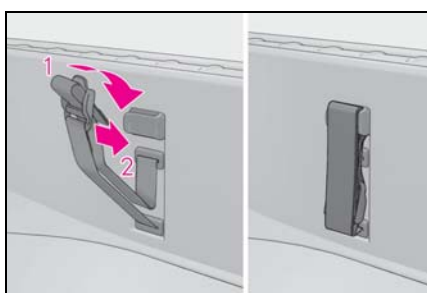

1 Fold the belt

2 Secure the belt with the clip

To prevent damage to the warning reflector storage belt when it is not in use, stow the belt.

Other interior features

USB charging ports

The USB charging ports are used to supply 2.1 A of electricity at 5 V to external devices.

The USB charging ports are for charging only. They are not designed for data transfer or other purposes.

Depending on the external device, it may not charge properly. Refer to the manual included with the device before using a USB charging port.

Using the USB charging ports

Open the console box lid and open the lid.

- ▶ Vehicles without power rear seat

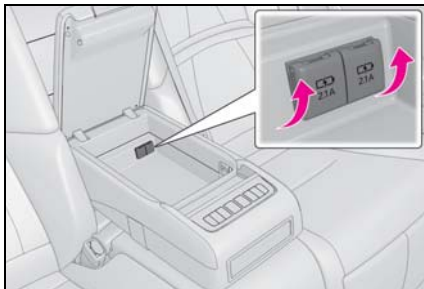

- ▶ Vehicles with power rear seat

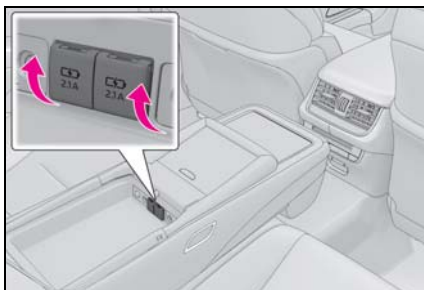

The USB charging ports can be used when

The engine switch is in ACCESSORY or IGNITION ON mode.

Situations in which the USB charging ports may not operate correctly

- If a device which consumes more than 2.1 A at 5 V is connected
- If a device designed to communicate with a personal computer, such as a USB memory device, is connected
- If the connected external device is turned off (depending on device)
- If the temperature inside the vehicle is high, such as after the vehicle has been parked in the sun

About connected external devices

Depending on the connected external device, charging may occasionally be suspended and then start again. This is not a malfunction.

NOTICE

To prevent damage to the USB charging ports

- Do not insert foreign objects into the ports.
- Do not spill water or other liquids into the ports.
- When the USB charging ports are not in use, close the lids. If a foreign object or liquid enters a port may cause a short circuit.

- Do not apply excessive force to or impact the USB charging ports.

- Do not disassemble or modify the USB charging ports.

To prevent damage to external devices

- Do not leave external devices in the vehicle. The temperature inside the vehicle may become high, resulting in damage to an external device.

 **NOTICE**

- Do not push down on or apply unnecessary force to an external device or the cable of an external device while it is connected.
- **To prevent battery discharge**
Do not use the USB charging ports for a long period of time with the engine stopped.

Armrest

- ▶ Vehicle without power rear seat
Pull the armrest down for use.

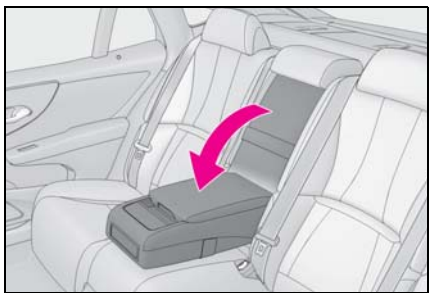

- ▶ Vehicle with power rear seat
Pull the lock release lever and fold the rear seatback down.

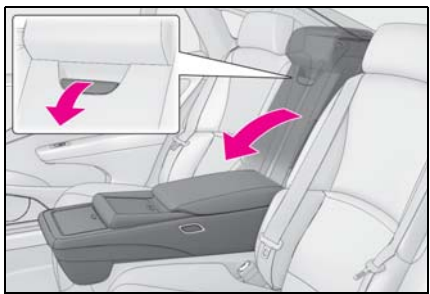



 **NOTICE**

- **To prevent damage to the armrest**
Do not place too much strain on the armrest.

Assist grips

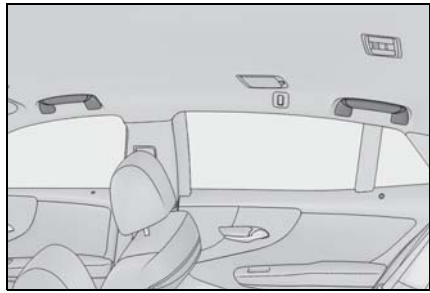
An assist grip installed on the ceiling can be used to support your body while sitting on the seat.



 **WARNING**

- **Assist grip**
Do not use the assist grip when getting in or out of the vehicle or rising from your seat. Doing so could damage the assist grip, or could cause you to injure yourself by falling over.

 **NOTICE**

- **To prevent damage to the assist grip**
Do not hang any heavy object or put a heavy load on the assist grip.

Coat hooks

To use the coat hook, push it on.

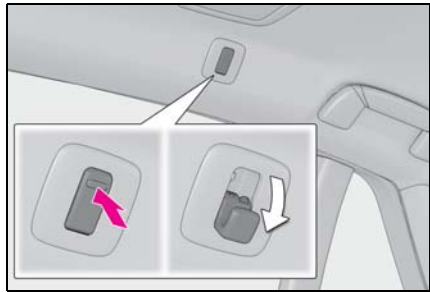

⚠ WARNING**■ Items that must not be hung on the hook**

Do not hang a coat hanger or other hard or sharp object on the hook. If the SRS curtain shield airbags deploy, these items may become projectiles that cause death or serious injury.

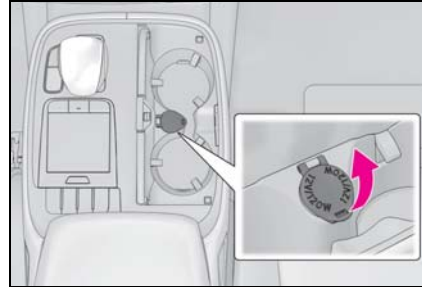
**Clock**

The GPS clock's time is automatically adjusted by utilizing GPS time information. For details, refer to "NAVIGATION AND MULTIMEDIA SYSTEM OWNER'S MANUAL".

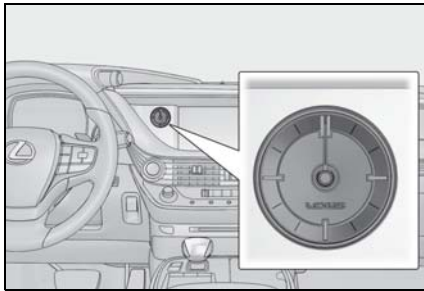
**▶ Console box**

Open the console box and open the lid.

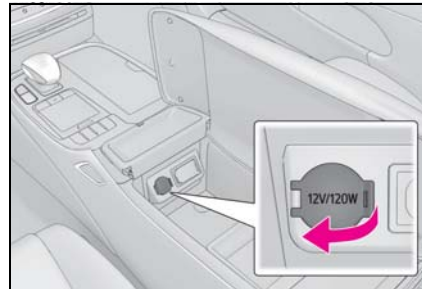
**▶ Rear (if equipped)**

Open the lid.

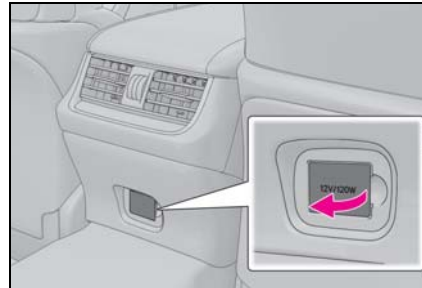
**■ 120 VAC (if equipped)**

Open the lid.

Power outlets

The power outlet can be used for the following components:

12 V: Accessories that run on less than 10 A.

120 VAC: Accessories that use less than 100 W.

■ 12 V**▶ Front**

Open the cup holder, and open the lid.

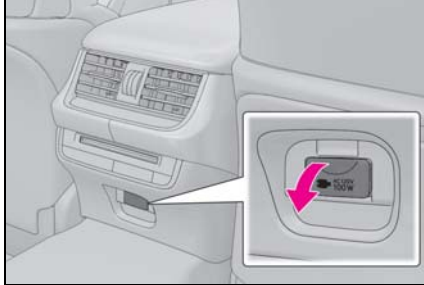

■ **The power outlet can be used when**

● 12 V

The engine switch is in ACCESSORY or IGNITION ON mode.

● 120 VAC

The engine switch is in IGNITION ON mode.



NOTICE

■ **To avoid damaging the power outlet**

Close the power outlet lid when the power outlet is not in use. Foreign objects or liquids that enter the power outlet may cause a short circuit.

■ **To prevent the fuse from being blown**

● 12 V

Do not use an accessory that uses more than 12 V 10 A.

● 120 VAC

Do not use a 120 VAC appliance that requires more than 100 W. If a 120 VAC appliance that consumes more than 100 W is used, the protection circuit will cut the power supply.

■ **To prevent incorrect operation of the vehicle**

When turning the engine switch off, make sure to disconnect accessories designed for charging, such as portable chargers, power banks, etc. from the power outlets.

If such an accessory is left connected, the following may occur:

● The doors cannot be locked using the smart access system with push-button start or wireless remote control.

● The opening screen will be displayed on the multi-information display.

● The interior lights, instrument panel lights, etc. will illuminate.

■ **To prevent the battery from being discharged**

Do not use the power outlet longer than necessary when the engine is not running.

■ **Appliances that may not operate properly (120 VAC)**

The following 120 VAC appliances may not operate properly even if their power consumption is under 100 W.

● Appliances with high initial peak wattage

● Measuring devices that process precise data

● Other appliances that require an extremely stable power supply

Sun visors

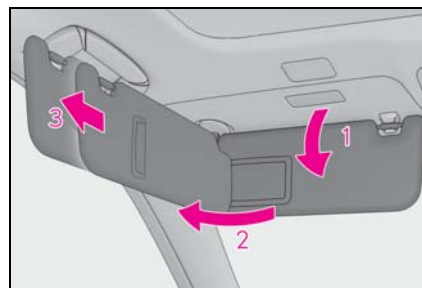

- 1** To set the visor in the forward position, flip it down.
- 2** To set the visor in the side position, flip down, unhook, and swing it to the side.
- 3** To use the side extender, place the visor in the side position, then slide it backward.

 **NOTICE**

- When not in use**
Keep the rear vanity mirror closed.
- To prevent the battery from being discharged**
Do not leave the vanity lights on for extended periods while the engine is stopped.

Vanity mirrors

► **Front**

Slide the cover to open.

The vanity light turns on.

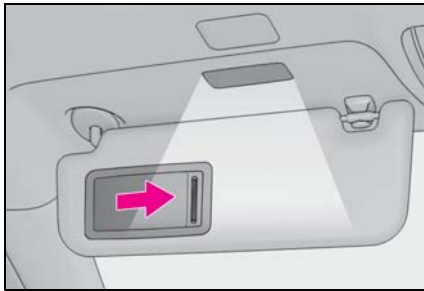

► **Rear**

Press the button to open.

The vanity light turns on.

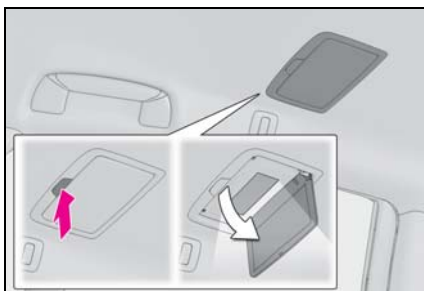

■ **To prevent battery discharge**

If the vanity lights remain on when the engine switch is turned off, the lights will go off automatically after 20 minutes.

Rear door/rear quarter sunshades (if equipped)

The rear door/rear quarter sunshades can be extended and retracted using the driver's power window switch and Rear Multi Operation Panel.

■ **From driver's seat**

Operate the driver's power window switch.

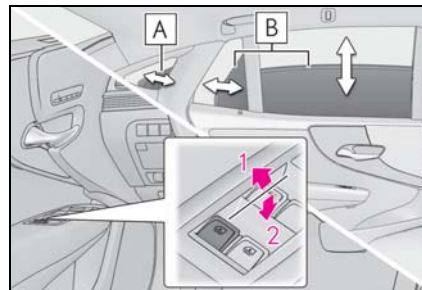

A Rear quarter sunshade (if equipped)

B Rear door sunshade

1 Extend

2 Retract*

*: If the driver's power window switch is operated when a rear door sunshade/rear quarter sunshade is retracted or being retracted, the rear window will open.

■ **From rear seat**

The rear seat power window switches cannot be used to extend the rear door sunshades/rear quarter sunshades.

- 1 Display the home screen and then touch “Rear Shade/Lamp”. (→P.308)
- 2 To fully extend/retract a rear door/rear quarter sunshade, touch the respective button.

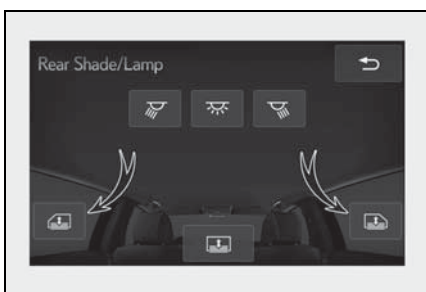

■ **Operating conditions**

- The engine switch is in IGNITION ON mode.
- The rear side windows are fully closed.

■ **Operation of rear door sunshades/rear quarter sunshades when extended**

If a rear door power window switch is operated when the rear door sunshade/rear quarter sunshade is extended, the rear door sunshade/rear quarter sunshade will retract while the rear window is opening.

■ **Operating the rear door/rear quarter sunshades after turning the engine switch off**

The rear door/rear quarter sunshades can be operated for a while even after the engine switch is turned to ACCESSORY mode or off.

However, they cannot be operated using the driver's power window switch after either front door is opened.

■ **Jam protection function**

If an object becomes caught between a rear

door sunshade and the window frame, the rear door sunshade will stop and then extend/retract slightly.

■ **When reconnecting the battery**

The rear door/rear quarter sunshades will always be retracted the first time the button is pressed.

WARNING

■ **When the rear door/rear quarter sunshades are being extended or retracted**

Do not place fingers or other objects in the shade mechanism or in the opening as injury may result.

■ **Jam protection function**

Never use any part of your body to intentionally activate the jam protection function.

NOTICE

■ **To ensure normal operation of the sunshades**

Observe the following precautions:

- Do not place excessive load on the motor or other components.
- Do not place objects where they may hinder opening and closing operations.
- Do not attach items to the rear door/rear quarter sunshades.
- Keep the opening clean and clear of obstructions.
- Do not operate the rear door/rear quarter sunshades continuously for long periods of time.

Rear sunshade (if equipped)

The rear sunshade can be raised and lowered by operating any of the switches shown below.

■ **From front seat**

Extend/retract

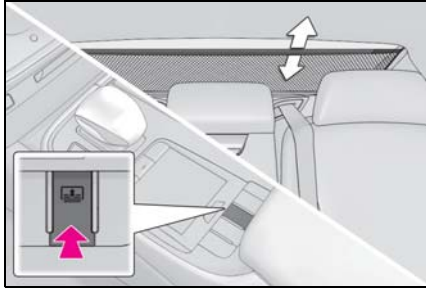

■ **From rear seat**

▶ Vehicles without power rear seat

Extend/retract

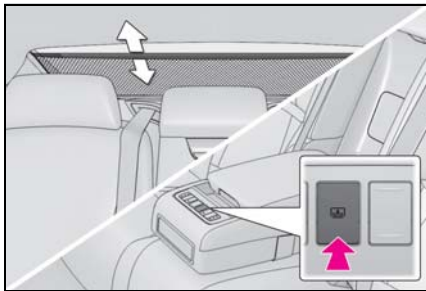

▶ Vehicles with power rear seat

- 1 Display the home screen and then touch "Rear Shade/Lamp". (→P.308)
- 2 To fully extend/retract a rear door sunshade, touch the respective button.



■ **The rear sunshade can be used when**

The engine switch is in IGNITION ON mode.

■ **Operating the rear sunshade after turning the engine switch off**

The rear sunshade can be operated for a while even after the engine switch is switched to ACCESSORY mode or turned off.

■ **Reverse operation feature**

To ensure adequate rear visibility, the rear sunshade automatically lowers when the shift position is shifted to R.

However, the rear sunshade is raised again if any of the following occurs:

- The switch is pressed again.
- The shift position is shifted to P.
- The shift position is shifted out of P and R, and the vehicle reaches a speed of 9 mph (15 km/h).

If the engine is turned off when the rear sunshade has been lowered due to the reverse operation feature, it will not be raised even when the engine is turned on again and the vehicle reaches a speed of 9 mph (15 km/h). To raise the sunshade again, press the switch.

⚠ WARNING

■ **When the rear sunshade is being raised or lowered**

Do not place fingers or other objects in the shade mechanism or in the opening as injury may result.

⚠ NOTICE

■ **To ensure normal operation of the sunshade**

Observe the following precautions:

- Do not place excessive load on the motor or other components.
- Do not place objects where they may hinder opening and closing operations.

**NOTICE**

- Do not attach items to the rear sunshade.
- Keep the opening clean and clear of obstructions.
- Do not operate the rear sunshade continuously for long periods of time.

Garage door opener

The garage door opener can be programmed using the HomeLink[®] to operate garage doors, gates, entry doors, door locks, home lighting systems, security systems, and other devices.

System components

The HomeLink[®] wireless control system in your vehicle has 3 buttons which can be programmed to operate 3 different devices. Refer to the programming methods on the following pages to determine the method which is appropriate for the device.

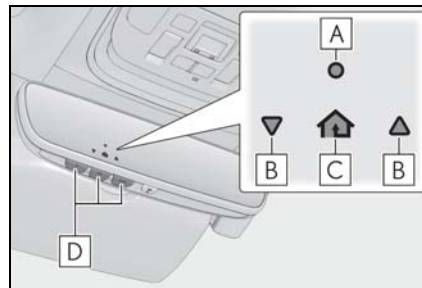

- A** HomeLink[®] indicator light
- B** Garage door operation indicators
- C** HomeLink[®] icon

Illuminates while HomeLink[®] is operating.

- D** Buttons

■ Codes stored in the HomeLink[®] memory

- The registered codes are not erased even if the battery cable is disconnected.
- If learning failed when registering a dif-

ferent code to a HomeLink® button that already has a code registered to it, the already registered code will not be erased.

■ **Certification for the garage door opener**

- ▶ For vehicles sold in the U.S.A., Hawaii, Guam and Puerto Rico

This device complies with FCC rules part 15 and Innovation, Science, and Economic Development Canada RSS-210. Operation is subject to the following two conditions: (1) This device may not cause harmful interference, and (2) This device must accept any interference that may be received including interference that may cause undesired operation. WARNING: The transmitter has been tested and complies with FCC and ISDE rules. Changes or modifications not expressly approved by the party responsible for compliance could void the user's authority to operate the device.

This equipment complies with FCC and ISDE radiation exposure limits set forth for an uncontrolled environment. End Users must follow the specific operating instructions for satisfying RF exposure compliance. This transmitter must be at least 20 cm from the user and must not be co-located or operating in conjunction with any other antenna or transmitter.

- ▶ For vehicles sold in Canada

This device complies with FCC rules part 15 and Innovation, Science, and Economic Development Canada RSS-210. Operation is subject to the following two conditions: (1) This device may not cause harmful interference, and (2) This device must accept any interference that may be received including interference that may cause undesired operation. WARNING: The transmitter has been tested and complies with FCC and ISDE rules. Changes or modifications not expressly approved by the party responsible for compliance could void the user's authority to operate the device.

This equipment complies with FCC and ISDE radiation exposure limits set forth for an uncontrolled environment. End Users must follow the specific operating instructions for satisfying RF exposure compliance. This transmitter must be at least 20 cm from the user and must not be co-located or operating in conjunction with any other antenna or transmitter.

Cet appareil est conforme aux règlements de la FCC, section 15, et au CNR-210 d'Innovation, Sciences et Développement économique Canada. Le fonctionnement est assujéti aux deux conditions suivantes : (1) cet appareil ne doit pas causer d'interférences nuisibles et (2) cet appareil doit accepter toute interférence reçue, y compris celle qui pourrait entraîner un dysfonctionnement. MISE EN GARDE : L'émetteur a subi des tests et est conforme aux règlements de la FCC et d'ISDE. Les changements ou modifications non approuvés explicitement par la partie responsable de la conformité pourraient rendre caduque l'autorisation de l'utilisateur de se servir du dispositif.

Cet appareil est conforme aux limites d'exposition aux radiations de la FCC et d'ISDE établies pour un environnement non contrôlé. Les utilisateurs finaux doivent respecter les instructions d'utilisation spécifiques pour satisfaire aux exigences de conformité aux expositions de RF. L'émetteur doit se trouver à 20 cm au minimum de l'utilisateur et ne doit pas être situé au même endroit que tout autre émetteur ou antenne ni fonctionner avec un autre émetteur ou antenne.

■ **When support is necessary**

Visit on the web at www.home-link.com/lexus or call 1-800-355-3515.

⚠ WARNING

■ **When programming a garage door or other remote control device**

The garage door or other device may operate, so ensure people and objects are out of danger to prevent potential harm.

■ **Conforming to federal safety standards**

Do not use the HomeLink® compatible transceiver with any garage door opener or device that lacks safety stop and reverse features as required by federal safety standards.

This includes any garage door that cannot detect an interfering object. A door or device without these features increases the risk of death or serious injury.

⚠ WARNING**■ When operating or programming HomeLink®**

Never allow a child to operate or play with the HomeLink® buttons.

Programming the HomeLink®**■ Before programming HomeLink®**

- During programming, it is possible that garage doors, gates, or other devices may operate. For this reason, make sure that people and objects are clear of the garage door or other devices to prevent injury or other potential harm.
- It is recommended that a new battery be placed in the remote control transmitter for more accurate programming.
- Garage door opener motors manufactured after 1995 may be equipped with rolling code protection. If this is the case, you may need a stepladder or other sturdy, safe device to reach the “Learn” or “Smart” button on the garage door opener motor.

■ Programming HomeLink®

Steps **1** through **3** must be performed within 60 seconds, otherwise the indicator light will stop flashing and programming will not be able to be completed.

- 1** Press and release the HomeLink® button you want to program and

check that the HomeLink® indicator light flashes (orange).

- 2** Point the remote control transmitter for the device at the rear view mirror, 1 to 3 in. (25 to 75 mm) from the HomeLink® buttons.

Keep the HomeLink® indicator light in view while programming.

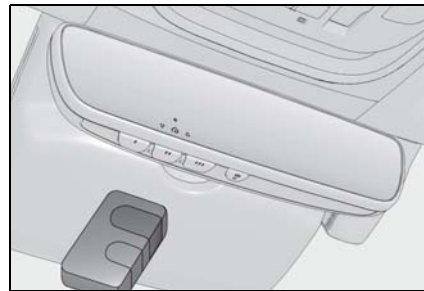

- 3** Program a device.

- ▶ Programming a device other than an entry gate (for U.S.A. owners)

Press and hold the handheld transmitter button until the HomeLink® indicator light changes from slowly flashing orange to rapidly flashing green (rolling code) or continuously lit green (fixed code), then release the button.

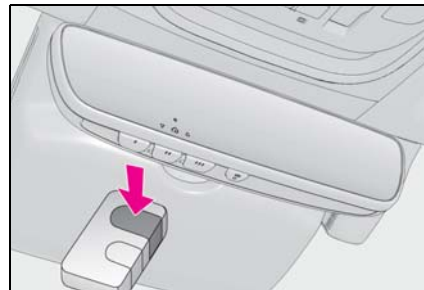

- ▶ Programming an entry gate (for U.S.A. owners)/Programming a device in the Canadian market

Press and release the remote control

transmitter button at 2 second intervals, repeatedly, until the HomeLink[®] indicator light changes from slowly flashing (orange) to rapidly flashing (green) (rolling code) or continuously lit (green) (fixed code).

4 Test the HomeLink[®] operation by pressing the newly programmed button and observing the indicator light:

- Indicator light illuminates: Programming of a fixed code device has completed. The garage door or other device should operate when a HomeLink[®] button is pressed and released.
- Indicator light flashes rapidly: The garage door opener motor or other device is equipped with a rolling code. To complete programming, firmly press and hold the HomeLink[®] button for 2 seconds then release it.
- If the garage door or other device does not operate, proceed to "Programming a rolling code system".

5 Repeat the steps above to program another device for any of the remaining HomeLink[®] buttons.

■ **Programming a rolling code system**

2 or more people may be necessary to complete rolling code programming.

1 Locate the "Learn" or "Smart" button on the garage door opener motor in the garage.

This button can usually be found where the

hanging antenna wire is attached to the unit. The name and color of the button may vary by manufacturer. Refer to the owner's manual supplied with the garage door opener motor for details.

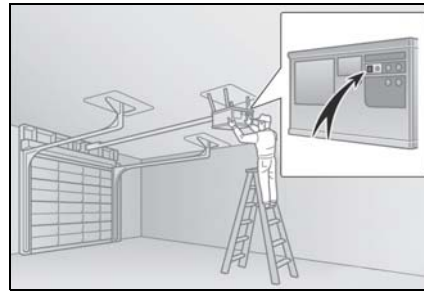

2 Press and release the "Learn" or "Smart" button.

Perform **3** within 30 seconds after performing **2**.

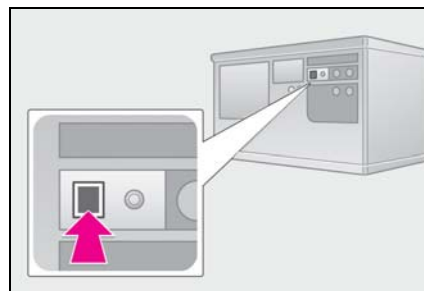

3 Press and hold the desired HomeLink[®] button (inside the vehicle) for 2 seconds and release it. Repeat this sequence (press/hold/release) up to 3 times to complete programming.

If the garage door opener motor operates when the HomeLink[®] button is pressed, the garage door

opener motor recognizes the HomeLink[®] signal.



■ **Enabling 2-way communication with a garage door (only available for compatible devices)**

When enabled, 2-way communication allows you to check the status of the opening and closing of a garage door through indicators in your vehicle.

2-way communication is only available if the garage door opener motor used is a compatible device. (To check device compatibility, refer to www.homelink.com.)

- 1 Within 5 seconds after programming the garage door opener has been completed, if the garage door opener motor is trained to HomeLink[®], both garage door operation indicators will flash rapidly (green) and the light on the garage door opener motor will blink twice, indicating that 2-way communication is enabled.

If the indicators do not flash, perform **2** and **3** within the first 10 presses of the HomeLink[®] button after programming has been completed.

- 2 Press a programmed HomeLink[®] button to operate a garage door.

- 3 Within 1 minute of pressing the HomeLink[®] button, after the garage door operation has stopped, press the “Learn” or “Smart” button on the garage door opener motor. Within 5 seconds of the establishment of 2-way communication with the garage door opener, both garage door operation indicators in the vehicle will flash rapidly (green) and the light on the garage door opener motor will blink twice, indicating that 2-way communication is enabled.

■ **Reprogramming a single HomeLink[®] button**

When the following procedure is performed, buttons which already have devices registered to them can be overwritten:

- 1 With one hand, press and hold the desired HomeLink[®] button.
- 2 When the HomeLink[®] indicator starts flashing (orange), continue to hold the HomeLink[®] button and perform “Programming HomeLink[®]” **1** (it takes 20 seconds for the HomeLink[®] indicator to start flashing).

■ **Before programming**

- Install a new battery in the transmitter.
- The battery side of the transmitter must be pointed away from the HomeLink[®].

Operating HomeLink®

Press the appropriate HomeLink® button. The HomeLink® indicator light should turn on.

The status of the opening and closing of a garage door is shown by the indicators.

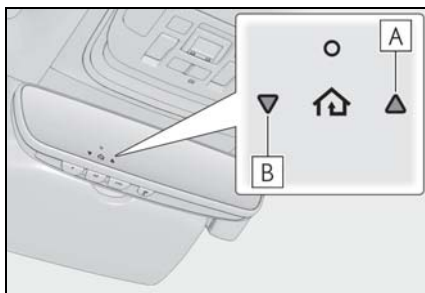

A Opening

B Closing



This function is only available if the garage door opener motor used is a compatible device. (To check device compatibility, refer to www.homelink.com.)

Color	Status
Orange (flashing)	Currently opening/closing
Green	Opening/closing has completed
Red (flashing)	Feedback signals cannot be received

The indicators can operate within approximately 820 ft. (250 m) of the garage door. However, if there are obstructions between the garage door and the vehicle, such as houses and trees, feedback signals from the garage door may not be received.

To recall the previous door operation status, press and release either Home-

Link® buttons  and  or

 and  simultaneously. The last recorded status will be displayed for 3 seconds.

Erasing the entire HomeLink® memory (all three codes)

Press and hold the 2 outside buttons for 10 seconds until the HomeLink® indicator light changes from continuously lit (orange) to rapidly flashing (green).

If you sell your vehicle, be sure to erase the programs stored in the HomeLink® memory.



Maintenance and care

6

6-1. Maintenance and care

Cleaning and protecting the vehicle exterior **358**

Cleaning and protecting the vehicle interior **361**

6-2. Maintenance

Maintenance requirements **364**

General maintenance **365**

Emission inspection and maintenance (I/M) programs **368**

6-3. Do-it-yourself maintenance

Do-it-yourself service precautions **369**

Hood..... **371**

Positioning a floor jack..... **371**

Engine compartment..... **373**

Battery **380**

Tires **382**

Replacing the tire **391**

Tire inflation pressure..... **395**

Wheels..... **396**

Air conditioning filter **398**

Electronic key battery **399**

Checking and replacing fuses **401**

Light bulbs **404**

Cleaning and protecting the vehicle exterior

Perform cleaning in a manner appropriate to each component and its material.

Cleaning instructions

- Working from top to bottom, liberally apply water to the vehicle body, wheel wells and underside of the vehicle to remove any dirt and dust.
- Wash the vehicle body using a sponge or soft cloth, such as a chamois.
- For hard-to-remove marks, use car wash soap and rinse thoroughly with water.
- Wipe away any water.
- Wax the vehicle when the water-proof coating deteriorates.

If water does not bead on a clean surface, apply wax when the vehicle body is cool.

■ Self-restoring coat

The vehicle body has a self-restoring coating that is resistant to small surface scratches caused in a car wash etc.

- The coating lasts for 5 to 8 years from when the vehicle is delivered from the plant.
- The restoration time differs depending on the depth of the scratch and outside temperature. The restoration time may become shorter when the coating is warmed by applying warm water.
- Deep scratches caused by keys, coins, etc. cannot be restored.
- Do not use wax that contains abrasives.

■ Automatic car washes

- Before washing the vehicle:
 - Fold the mirrors
 - Turn off the power trunk opener and closer (if equipped)

Start washing from the front of the vehicle. Extend the mirrors before driving.

- Brushes used in automatic car washes may scratch the vehicle surface and harm your vehicle's paint.

■ High pressure car washes

- Do not allow the nozzles of the car wash to come within close proximity of the windows and the air suspension unit (if equipped).
- Before using the car wash, check that the fuel filler door on your vehicle is closed properly.

■ When using a car wash

If the door handle becomes wet while the electronic key is within the effective range, the door may lock and unlock repeatedly. In that case, follow the following correction procedures to wash the vehicle:

- Place the key in a position 6 ft. (2 m) or more separate from the vehicle while the vehicle is being washed. (Take care to ensure that the key is not stolen.)
- Set the electronic key to battery-saving mode to disable the smart access system with push-button start. (→P.112)

■ Aluminum wheels

- Remove any dirt immediately by using a neutral detergent.
- Wash detergent off with water immediately after use.
- To protect the paint from damage, make sure to observe the following precautions.
 - Do not use acidic, alkaline or abrasive detergent
 - Do not use hard brushes
 - Do not use detergent on the wheels when they are hot, such as after driving or parking in hot weather

■ Brake caliper coating (F SPORT models)

- When using detergent, use neutral detergent. Do not use hard brushes or abrasive cleaners, as they will damage the coating.
- Do not use detergent on the brake calipers when they are hot.
- Wash detergent off immediately after use.

■ Bumpers and side moldings

Do not scrub with abrasive cleaners.

■ Front side windows water-repellent coating (if equipped)

- The following precautions can extend the effectiveness of the water-repellent coating.
 - Remove any dirt, etc. from the front side windows regularly.
 - Do not allow dirt and dust to accumulate on the windows for a long period. Clean the windows with a soft, damp cloth as soon as possible.
 - Do not use wax or glass cleaners that contain abrasives when cleaning the windows.
 - Do not use any metallic objects to remove condensation build up.
- When the water-repellent performance has become insufficient, the coating can be repaired. Contact your Lexus dealer.

■ Plated portions

If dirt cannot be removed, clean the parts as follows:

- Use a soft cloth dampened with an approximately 5% solution of neutral detergent and water to clean the dirt off.
- Wipe the surface with a dry, soft cloth to remove any remaining moisture.
- To remove oily deposits, use alcohol wet wipes or a similar product.

⚠ WARNING

■ When washing the vehicle

Do not apply water to the inside of the engine compartment. Doing so may cause the electrical components, etc. to catch fire.

■ When cleaning the windshield

Set the wiper switch to off. If the wiper switch is in "AUTO", the wipers may operate unexpectedly in the following situations, and may result in hands being caught or other serious injuries and cause damage to the wiper blades.

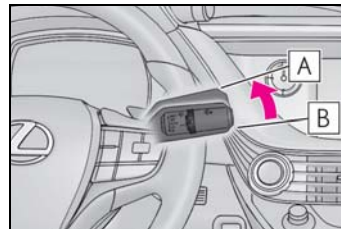

A Off

B AUTO

- When the upper part of the windshield where the raindrop sensor is located is touched by hand
- When a wet rag or similar is held close to the raindrop sensor
- If something bumps against the windshield
- If you directly touch the raindrop sensor body or if something bumps into the raindrop sensor

■ Precautions regarding the exhaust pipes and rear bumper diffusers

Exhaust gases cause the exhaust pipes and rear bumper diffusers to become quite hot.

When washing the vehicle, be careful not to touch the pipes and diffusers until they have cooled sufficiently, as touching hot exhaust pipes and rear bumper diffusers can cause burns.

**WARNING****■ Precaution regarding the front bumper (vehicles with Lexus Safety System + A)**

If the paint of the front bumper is chipped or scratched, the Lexus Safety System + A may not function correctly. If this occurs, consult your Lexus dealer.

■ Precaution regarding the rear bumper

If the paint of the rear bumper is chipped or scratched, the following systems may not function correctly. If this occurs, consult your Lexus dealer.

- Lexus Safety System + A (if equipped)
- BSM (if equipped)
- RCTA (if equipped)
- PKSB (if equipped)

**NOTICE****■ To prevent paint deterioration and corrosion on the body and components (aluminum wheels, etc.)**

- Wash the vehicle immediately in the following cases:
 - After driving near the sea coast
 - After driving on salted roads
 - If coal tar or tree sap is present on the paint surface
 - If dead insects, insect droppings or bird droppings are present on the paint surface
 - After driving in an area contaminated with soot, oily smoke, mine dust, iron powder or chemical substances
 - If the vehicle becomes heavily soiled with dust or mud
 - If liquids such as benzene and gasoline are spilled on the paint surface

- If the paint is chipped or scratched, have it repaired immediately.

- To prevent the wheels from corroding, remove any dirt and store in a place with low humidity when storing the wheels.

■ Cleaning the exterior lights

- Wash carefully. Do not use organic substances or scrub with a hard brush. This may damage the surfaces of the lights.

- Do not apply wax to the surfaces of the lights. Wax may cause damage to the lenses.

■ When using an automatic car wash

Set the wiper switch to the off position. If the wiper switch is in "AUTO", the wipers may operate and the wiper blades may be damaged.

■ When using a high pressure car wash

- When washing the vehicle, do not spray the camera or its surrounding area directly with a high pressure washer. Shock applied from high pressure water may cause the device to not operate normally.

- Do not bring the nozzle tip close to boots (rubber or resin manufactured cover), connectors or the following parts. The parts may be damaged if they come into contact with high-pressure water.

- Traction related parts
- Steering parts
- Suspension parts
- Brake parts

Cleaning and protecting the vehicle interior

Perform cleaning in a manner appropriate to each component and its material.

Protecting the vehicle interior

- Remove dirt and dust using a vacuum cleaner. Wipe dirty surfaces with a cloth dampened with lukewarm water.
- If dirt cannot be removed, wipe it off with a soft cloth dampened with neutral detergent diluted to approximately 1%.
Wring out any excess water from the cloth and thoroughly wipe off remaining traces of detergent and water.

■ Shampooing the carpets

There are several commercial foaming-type cleaners available. Use a sponge or brush to apply the foam. Rub in overlapping circles. Do not use water. Wipe dirty surfaces and let them dry. Excellent results are obtained by keeping the carpet as dry as possible.

■ Handling the seat belts

Clean with mild soap and lukewarm water using a cloth or sponge. Also check the belts periodically for excessive wear, fraying or cuts.

■ When cleaning the carpeted portions of the glove box, console box, etc.

If a strong adhesive tape is used, there is a possibility that the surface of the carpet could be damaged.

WARNING

■ Water in the vehicle

- Do not splash or spill liquid in the vehicle.
Doing so may cause electrical components, etc. to malfunction or catch fire.
- Do not get any of the SRS components or wiring in the vehicle interior wet. (→P.29)
An electrical malfunction may cause the airbags to deploy or not function properly, resulting in death or serious injury.

■ Cleaning the interior (especially instrument panel)

Do not use polish wax or polish cleaner. The instrument panel may reflect off the windshield, obstructing the driver's view and leading to an accident, resulting in death or serious injury.

NOTICE

■ Cleaning detergents

- Do not use the following types of detergent, as they may discolor the vehicle interior or cause streaks or damage to painted surfaces:
 - Areas other than the seats and steering wheel: Organic substances such as benzene or gasoline, alkaline or acidic solutions, dye, and bleach
 - Seats: Alkaline or acidic solutions, such as thinner, benzene, and alcohol
 - Steering wheel: Organic substances, such as thinner, and cleaner that contains alcohol
- Do not use polish wax or polish cleaner. The instrument panel's or other interior part's painted surface may be damaged.

 NOTICE

■ Preventing damage to leather surfaces

Observe the following precautions to avoid damage to and deterioration of leather surfaces:

- Remove any dust or dirt from leather surfaces immediately.
- Do not expose the vehicle to direct sunlight for extended periods of time. Park the vehicle in the shade, especially during summer.
- Do not place items made of vinyl, plastic, or containing wax on the upholstery, as they may stick to the leather surface if the vehicle interior heats up significantly.

■ Water on the floor

Do not wash the vehicle floor with water. Vehicle systems such as the audio system may be damaged if water comes into contact with electrical components such as the audio system above or under the floor of the vehicle. Water may also cause the body to rust.

■ When cleaning the inside of the windshield

Do not allow glass cleaner to contact the lens. Also, do not touch the lens. (→P.191, 198)

■ Cleaning the inside of the rear window

- Do not use glass cleaner to clean the rear window, as this may cause damage to the rear window defogger heater wires or antenna. Use a cloth dampened with lukewarm water to gently wipe the window clean. Wipe the window in strokes running parallel to the heater wires or antenna.
- Be careful not to scratch or damage the heater wires or antenna.

Cleaning the areas with satin-finish metal accents

- Remove dirt using a water-dampened soft cloth or synthetic chamois.
- Wipe the surface with a dry, soft cloth to remove any remaining moisture.

■ Cleaning the areas with satin-finish metal accents

The metal areas use a layer of real metal for the surface. It is necessary to clean them regularly. If dirty areas are left uncleaned for long periods of time, they may be difficult to clean.

Cleaning the leather areas

- Remove dirt and dust using a vacuum cleaner.
- Wipe off any excess dirt and dust with a soft cloth dampened with diluted detergent.

Use a diluted water solution of approximately 5% neutral wool detergent.

- Wring out any excess water from the cloth and thoroughly wipe off all remaining traces of detergent.
- Wipe the surface with a dry, soft cloth to remove any remaining moisture. Allow the leather to dry in a shaded and ventilated area.

■ Caring for leather areas

Lexus recommends cleaning the interior of the vehicle at least twice a year to maintain the quality of the vehicle's interior.

Cleaning the synthetic leather areas

- Remove dirt and dust using a vacuum cleaner.
- Wipe it off with a soft cloth dampened with neutral detergent diluted to approximately 1%.
- Wring out any excess water from the cloth and thoroughly wipe off remaining traces of detergent and water.

Cleaning fabric portions of the instrument panel

- To remove dust from the fabric, use a vacuum cleaner or adhesive tape.
- Use a cloth dampened with water to gently wipe the fabric clean.

Do not use detergents to clean the fabric.

Maintenance requirements

To ensure safe and economical driving, day-to-day care and regular maintenance are essential. It is the owner's responsibility to perform regular checks. Lexus recommends the maintenance below.

■ Repair and replacement

It is recommended that genuine Lexus parts be used for repairs to ensure performance of each system. If non-Lexus parts are used in replacement or if a repair shop other than a Lexus dealer performs repairs, confirm the warranty coverage.

■ Allow inspection and repairs to be performed by a Lexus dealer

- Lexus technicians are well-trained specialists and are kept up to date with the latest service information. They are well informed about the operation of all systems on your vehicle.
- Keep a copy of the repair order. It proves that the maintenance that has been performed is under warranty coverage. If any problem should arise while your vehicle is under warranty, your Lexus dealer will promptly take care of it.

⚠ WARNING

■ If your vehicle is not properly maintained

Improper maintenance could result in serious damage to the vehicle and possible death or serious injury.

■ Handling of the battery

- Engine exhaust, some of its constituents, and a wide variety of automobile components contain or emit chemicals known to the State of California to cause cancer and birth defects and other reproductive harm. Work in a well ventilated area.

- Oils, fuels and fluids contained in vehicles as well as waste produced by component wear contain or emit chemicals known to the State of California to cause cancer and birth defects or other reproductive harm. Avoid exposure and wash any affected area immediately.

- Battery posts, terminals and related accessories contain lead and lead compounds which are known to cause brain damage. Wash your hands after handling. (→P.380)

General maintenance

General maintenance should be performed on a daily basis. This can be done by yourself or by a Lexus dealer.

Scheduled maintenance

Scheduled maintenance should be performed at specified intervals according to the maintenance schedule.

For details about maintenance items and schedules, refer to the "Warranty and Service Guide", "Owner's Manual Supplement" or "Scheduled Maintenance".

■ Resetting the message indicating maintenance is required

After the required maintenance is performed according to the maintenance schedule, please reset the message. To reset the message, follow the procedure described below:

- 1 Press **<** or **>** of the meter control switch to select .
- 2 Press **▲** or **▼** to select "Vehicle Settings" and then press **OK**.

- 3 Press **▲** or **▼** to select "Scheduled Maintenance" and then press **OK**.
- 4 Press **▲** or **▼** to select "Yes" and then press **OK**.

A message will be displayed on the multi-information display when the reset procedure has been completed.

Do-it-yourself maintenance

You can perform some maintenance procedures by yourself. Please be aware that do-it-yourself maintenance may affect warranty coverage. The use of Lexus repair manuals is recommended.

For details about warranty coverage, refer to the separate "Owner's Guide", "Warranty and Service Guide", "Owner's Manual Supplement" or "Warranty Booklet".

General maintenance

Listed below are the general maintenance items that should be performed at the intervals specified in the "Warranty and Service Guide" or "Owner's Manual Supplement". It is recommended that any problem you notice should be brought to the attention of your Lexus dealer or qualified service shop for advice.

WARNING

■ If the engine is running
Turn the engine off and ensure that there is adequate ventilation before performing maintenance checks.

Engine compartment

Items	Check points
Brake fluid	Is the brake fluid at the correct level? (→P.379)
Engine/inter-cooler coolant	Is the engine/inter-cooler coolant at the correct level? (→P.377)
Engine oil	Is the engine oil at the correct level? (→P.375)
Exhaust system	There should not be any fumes or strange sounds.

Items	Check points
Radiator, condenser, intercooler radiator and intercooler sub radiator	The radiator, condenser, intercooler radiator and intercooler sub radiator should be free from foreign objects. (→P.378)
Washer fluid	Is there sufficient washer fluid? (→P.379)

Trunk

Items	Check points
Battery	Check the connections. (→P.380)

Vehicle interior

Items	Check points
Accelerator pedal	<ul style="list-style-type: none"> The accelerator pedal should move smoothly (without uneven pedal effort or catching).
Automatic transmission "Park" mechanism	<ul style="list-style-type: none"> When parked on a slope and the shift position is in P, is the vehicle securely stopped?

Items	Check points
Brake pedal	<ul style="list-style-type: none"> Does the brake pedal move smoothly? Does the brake pedal have appropriate clearance from the floor? Does the brake pedal have the correct amount of free play?
Brakes	<ul style="list-style-type: none"> The vehicle should not pull to one side when the brakes are applied. The brakes should work effectively. The brake pedal should not feel spongy. The brake pedal should not get too close to the floor when the brakes are applied.
Head restraints	<ul style="list-style-type: none"> Do the head restraints move smoothly and lock securely?
Indicators/buzzers	<ul style="list-style-type: none"> Do the indicators and buzzers function properly?
Lights	<ul style="list-style-type: none"> Do all the lights come on?

Items	Check points
Parking brake	<ul style="list-style-type: none"> • Does the parking brake operate normally? • When parked on a slope and the parking brake is on, is the vehicle securely stopped?
Seat belts	<ul style="list-style-type: none"> • Do the seat belts operate smoothly? • The seat belts should not be damaged.
Seats	<ul style="list-style-type: none"> • Do the seat controls operate properly?
Steering wheel	<ul style="list-style-type: none"> • Does the steering wheel rotate smoothly? • Does the steering wheel have the correct amount of free play? • There should not be any strange sounds coming from the steering wheel.

Items	Check points
Tires	<ul style="list-style-type: none"> • Is the tire inflation pressure correct? • The tires should not be damaged or excessively worn. • Have the tires been rotated according to the maintenance schedule? • The wheel nuts should not be loose.
Windshield wipers	<ul style="list-style-type: none"> • The wiper blades should not show any signs of cracking, splitting, wear, contamination or deformation. • The wiper blades should clear the windshield without streaking or skipping.

Vehicle exterior

Items	Check points
Doors/trunk	<ul style="list-style-type: none"> • Do the doors/trunk operate smoothly?
Engine hood	<ul style="list-style-type: none"> • Does the engine hood lock system work properly?
Fluid leaks	<ul style="list-style-type: none"> • There should not be any signs of fluid leakage after the vehicle has been parked.

Emission inspection and maintenance (I/M) programs

Some states have vehicle emission inspection programs which include OBD (On Board Diagnostics) checks. The OBD system monitors the operation of the emission control system.

If the malfunction indicator lamp comes on

The OBD system determines that a problem exists somewhere in the emission control system. Your vehicle may not pass the I/M test and may need to be repaired. Contact your Lexus dealer to service the vehicle.

Your vehicle may not pass the I/M test in the following situations:

- When the battery is disconnected or discharged

Readiness codes that are set during ordinary driving are erased.

Also, depending on your driving habits, the readiness codes may not be completely set.

- When the fuel tank cap is loose

The malfunction indicator lamp comes on indicating a temporary malfunction and your vehicle may not pass the I/M test.

When the malfunction indicator lamp still remains on after several driving trips

The error code in the OBD system will not be cleared unless the vehicle is driven 40 or more times.

If your vehicle does not pass the I/M test

Contact your Lexus dealer to prepare the vehicle for re-testing.

Do-it-yourself service precautions

If you perform maintenance by yourself, be sure to follow the correct procedure as given in these sections.

Maintenance

Items	Parts and tools
Battery condition (→P.380)	<ul style="list-style-type: none"> • Grease • Conventional wrench (for terminal clamp bolts)
Brake fluid level (→P.379)	<ul style="list-style-type: none"> • FMVSSNo.116 DOT 3 or SAE J1703 brake fluid • FMVSSNo.116 DOT 4 or SAE J1704 brake fluid • Rag or paper towel • Funnel (used only for adding brake fluid)

Items	Parts and tools
Engine/inter-cooler coolant level (→P.377)	<ul style="list-style-type: none"> • "Toyota Super Long Life Coolant" or a similar high quality ethylene glycol-based non-silicate, non-amine, non-nitrite and non-borate coolant with long-life hybrid organic acid technology <p>For the U.S.A.: "Toyota Super Long Life Coolant" is pre-mixed with 50% coolant and 50% deionized water.</p> <p>For Canada: "Toyota Super Long Life Coolant" is pre-mixed with 55% coolant and 45% deionized water.</p> <ul style="list-style-type: none"> • Funnel (used only for adding coolant)
Engine oil level (→P.375)	<ul style="list-style-type: none"> • "Toyota Genuine Motor Oil" or equivalent • Rag or paper towel • Funnel (used only for adding engine oil)
Fuses (→P.401)	<ul style="list-style-type: none"> • Fuse with same amperage rating as original
Radiator, condenser, inter-cooler radiator and intercooler sub radiator (→P.378)	—

Items	Parts and tools
Tire inflation pressure (→P.395)	<ul style="list-style-type: none"> • Tire pressure gauge • Compressed air source
Washer fluid (→P.379)	<ul style="list-style-type: none"> • Water or washer fluid containing anti-freeze (for winter use) • Funnel (used only for adding water or washer fluid)

■ Safety glasses

Wear safety glasses to prevent flying or falling material, fluid spray, etc. from getting in your eyes.



NOTICE

■ If you remove the air cleaner filter

Driving with the air cleaner filter removed may cause excessive engine wear due to dirt in the air.



WARNING

The engine compartment contains many mechanisms and fluids that may move suddenly, become hot, or become electrically energized. To avoid death or serious injury, observe the following precautions.

■ When working on the engine compartment

- Keep hands, clothing and tools away from the moving fan and engine drive belt.
- Be careful not to touch the engine, radiator, exhaust manifold, etc. right after driving as they may be hot. Oil and other fluids may also be hot.
- Do not leave anything that may burn easily, such as paper and rags, in the engine compartment.
- Do not smoke, cause sparks or expose an open flame to fuel. Fuel fumes are flammable.

■ When working near the electric cooling fan or radiator grille

Be sure the engine switch is off. With the engine switch in IGNITION ON mode, the electric cooling fan may automatically start to run if the air conditioning is on and/or the coolant temperature is high. (→P.378)

Hood

Opening the hood

- 1 Pull the hood lock release lever.
The hood will pop up slightly.

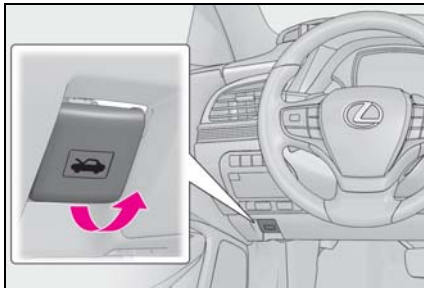

- 2 Pull up the auxiliary catch lever and lift the hood.

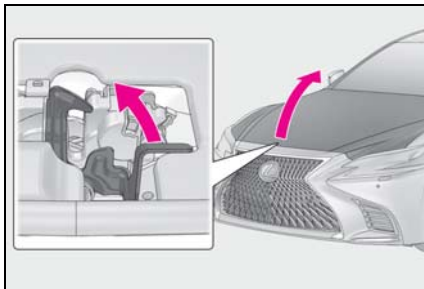

WARNING

Pre-driving check

Check that the hood is fully closed and locked.
If the hood is not locked properly, it may open while the vehicle is in motion and cause an accident, which may result in death or serious injury.

Positioning a floor jack

When using a floor jack, follow the instructions in the manual provided with the jack and perform the operation safely.

When raising your vehicle with a floor jack, position the jack correctly. Improper placement may damage your vehicle or cause injury.

Location of the jack point

■ Front

- ▶ 2WD models

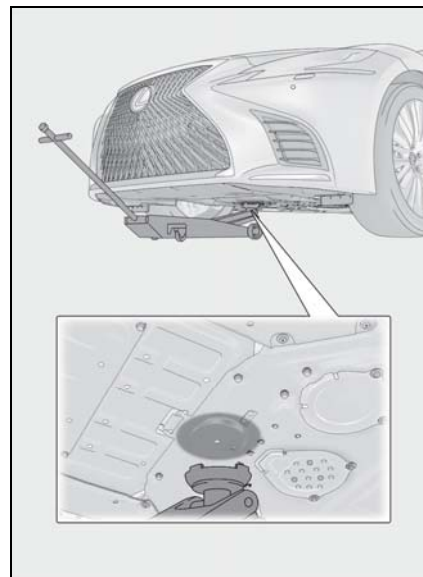

▶ AWD models

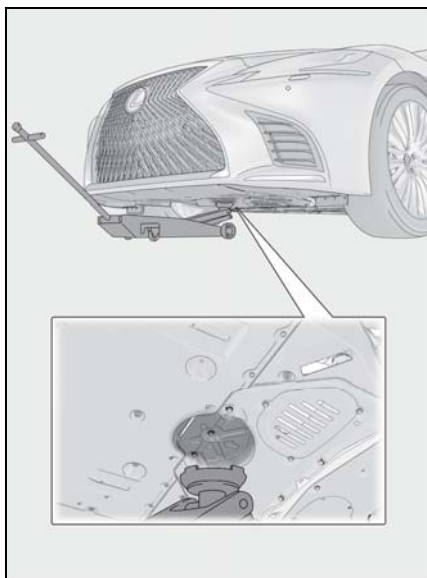

■ Rear



Engine compartment

Components

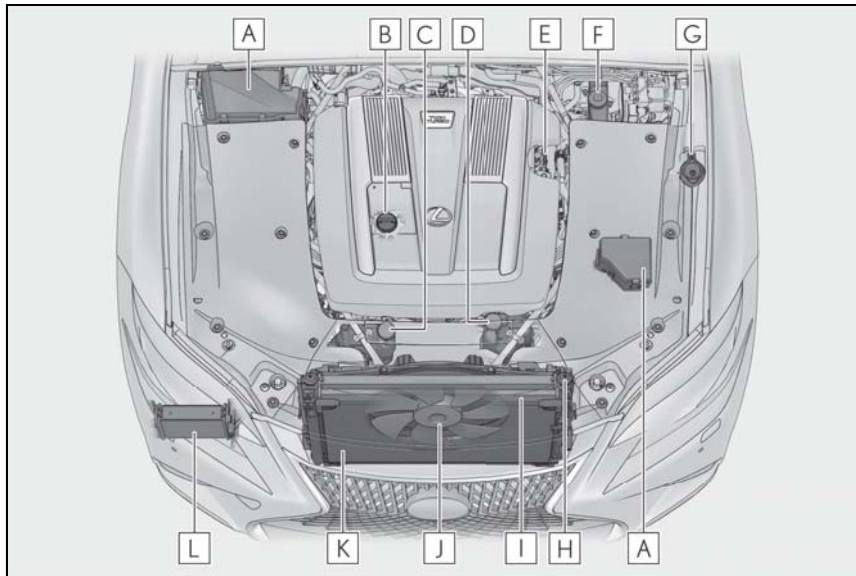

- A** Fuse boxes (→P.401)
- B** Engine oil filler cap (→P.376)
- C** Engine coolant reservoir (→P.377)
- D** Intercooler coolant reservoir (→P.377)
- E** Engine oil level dipstick (→P.375)
- F** Brake fluid reservoir (→P.379)
- G** Washer fluid tank (→P.379)
- H** Radiator (→P.378)
- I** Intercooler radiator (→P.378)
- J** Electric cooling fan
- K** Condenser (→P.378)
- L** Intercooler sub radiator (→P.378)

For AWD models:

The engine oil level dipstick is located on the opposite side of the engine.

- Battery
→P.380

Engine compartment cover

- Removing the engine compartment cover

- ▶ Outside

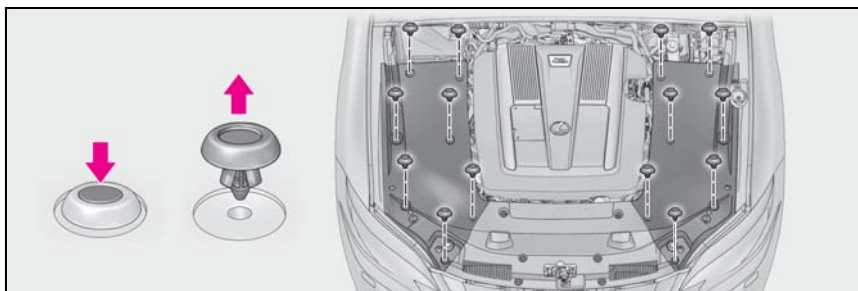

- ▶ Front

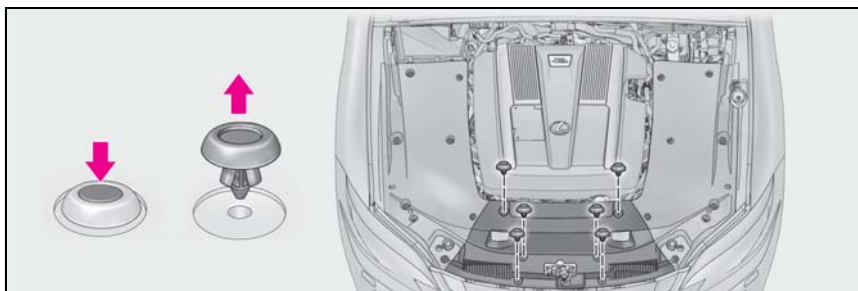

- Installing the clips

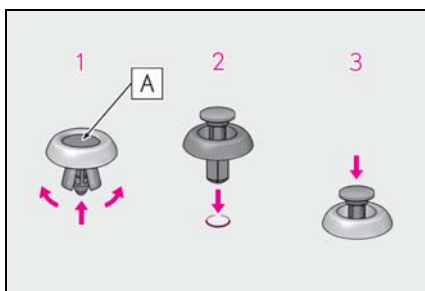

- 1 Push up center portion **A**
- 2 Insert
- 3 Press

 NOTICE

■ Checking the engine compartment cover after installation

Make sure that the cover is securely installed in its original position.

Service cover

■ **Removing the service cover**

- 1 Pull up the passenger side end of the rubber strip to disengage it from the vehicle body.

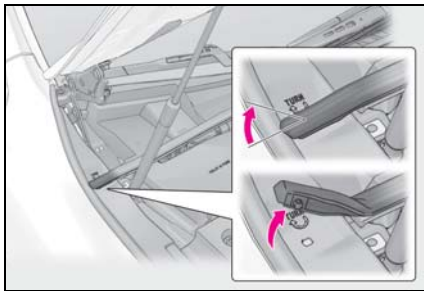

- 2 Remove the service cover.

Push the tabs and lift away the service cover.

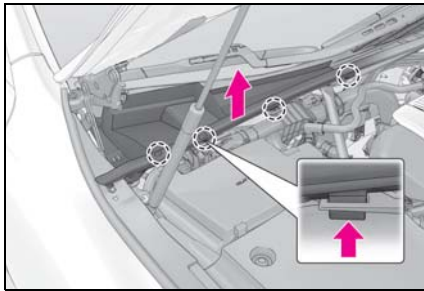

■ **Installing the service cover**

- 1 Install the service cover.

Make sure to engage the claws on the windshield side of the service cover when installing the service cover.

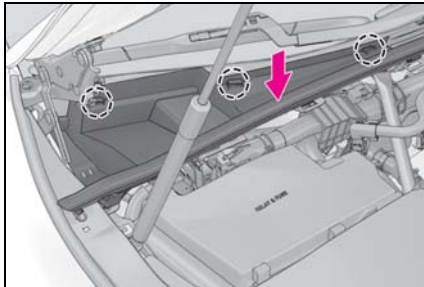

- 2 Engage the rubber strip to the vehicle body.

 **NOTICE**

■ **Checking the service cover after installation**

Make sure that the cover is securely installed in its original position.

Checking and adding the engine oil

With the engine at operating temperature and turned off, check the oil level on the dipstick.

■ **Checking the engine oil**

- 1 Park the vehicle on level ground. After warming up the engine and turning it off, wait more than 5 minutes for the oil to drain back into the bottom of the engine.
- 2 Holding a rag under the end, pull the dipstick out.

- 2WD models

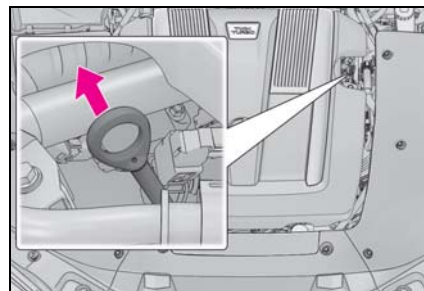

- AWD models

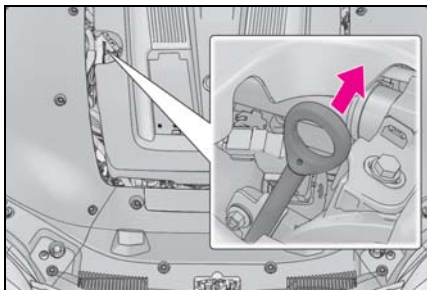

- 3 Wipe the dipstick clean.
- 4 Reinsert the dipstick fully.
- 5 Holding a rag under the end, pull the dipstick out and check the oil level.

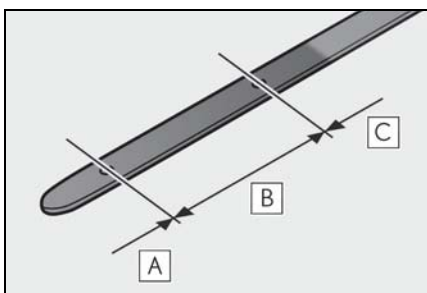

- A** Low
- B** Normal
- C** Excessive

The shape of the dipstick may differ depending on the type of vehicle or engine.

- 6 Wipe the dipstick and reinsert it fully.

■ **Checking the oil type and preparing the item needed**

Make sure to check the oil type and prepare the items needed before adding oil.

- Engine oil selection
→P.448

- Oil quantity (Low → Full)
1.6 qt. (1.5 L, 1.3 Imp. qt.)
- Item
Clean funnel

■ **Adding engine oil**

If the oil level is below or near the low level mark, add engine oil of the same type as that already in the engine.

- 2WD models

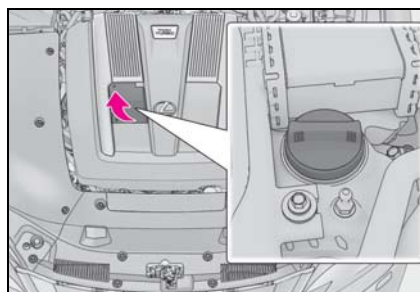

- AWD models

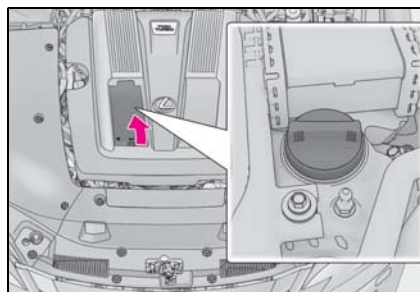

- 1 Remove the oil filler cap by turning it counterclockwise.
- 2 Add engine oil slowly, checking the dipstick.
- 3 Install the oil filler cap by turning it clockwise.

■ **Engine oil consumption**

A certain amount of engine oil will be consumed while driving. In the following situations, oil consumption may increase, and

engine oil may need to be refilled in between oil maintenance intervals.

- When the engine is new, for example directly after purchasing the vehicle or after replacing the engine
- If low quality oil or oil of an inappropriate viscosity is used
- When driving at high engine speeds or with a heavy load, or when driving while accelerating or decelerating frequently
- When leaving the engine idling for a long time, or when driving frequently through heavy traffic

■ **After changing the engine oil**

The engine oil maintenance data should be reset. Perform the following procedures:

- 1 Press **<** or **>** of the meter control switch to select .
- 2 Press **▲** or **▼** to select "Vehicle Settings" and then press **OK**.
- 3 Press **▲** or **▼** to select "Oil Maintenance" and then press **OK**.
- 4 Press **▲** or **▼** to select "Yes" and then press **OK**.

A message will be displayed on the multi-information display when the reset procedure has been completed.

 **WARNING**

- **Used engine oil**
- Used engine oil contains potentially harmful contaminants which may cause skin disorders such as inflammation and skin cancer, so care should be taken to avoid prolonged and repeated contact. To remove used engine oil from your skin, wash thoroughly with soap and water.

- Dispose of used oil and filters only in a safe and acceptable manner. Do not dispose of used oil and filters in household trash, in sewers or onto the ground. Call your Lexus dealer, service station or auto parts store for information concerning recycling or disposal.
- Do not leave used engine oil within the reach of children.

 **NOTICE**

■ **To prevent serious engine damage**

Check the oil level on a regular basis.

■ **When replacing the engine oil**

- Be careful not to spill engine oil on the vehicle components.
- Avoid overfilling, or the engine could be damaged.
- Check the oil level on the dipstick every time you refill the vehicle.
- Be sure the engine oil filler cap is properly tightened.

Checking the coolant

The coolant level is satisfactory if it is between the "F" and "L" lines on the reservoir when the engine is cold.

■ **Engine coolant reservoir**

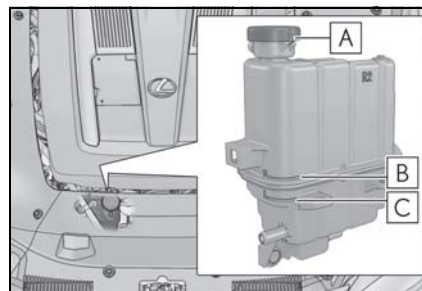

A Reservoir cap

B "F" line

C "L" line

If the level is on or below the "L" line, add coolant up to the "F" line. (→P.440)

■ **Intercooler coolant reservoir**

The coolant level is satisfactory if it is between the "F" and "L" lines on the reservoir when the engine is cold.

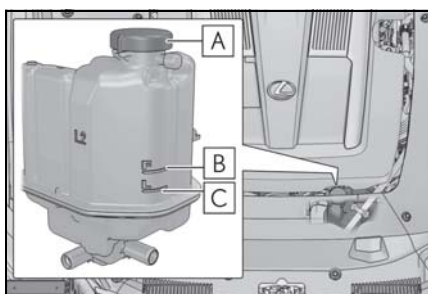

A Reservoir cap

B "F" line

C "L" line

If the level is on or below the "L" line, add coolant up to the "F" line. (→P.440)

■ **Coolant selection**

Only use "Toyota Super Long Life Coolant" or a similar high quality ethylene glycol based non-silicate, non-amine, non-nitrite, and non-borate coolant with long-life hybrid organic acid technology.

U.S.A.:

"Toyota Super Long Life Coolant" is a mixture of 50% coolant and 50% deionized water. (Minimum temperature: -31°F [-35°C])

Canada:

"Toyota Super Long Life Coolant" is a mixture of 55% coolant and 45% deionized water. (Minimum temperature: -44°F [-42°C])

For more details about coolant, contact your Lexus dealer.

■ **If the coolant level drops within a short time of replenishing**

Visually check the radiator, hoses, engine coolant reservoir caps, drain cock and water pump.

If you cannot find a leak, have your Lexus dealer test the cap and check for leaks in the cooling system.

WARNING

■ **When the engine is hot**

Do not remove the engine coolant reservoir cap, the intercooler coolant reservoir cap and the coolant inlet cap. (→P.442)

The cooling system may be under pressure and may spray hot coolant if the cap is removed, causing serious injuries, such as burns.

NOTICE

■ **When adding coolant**

Coolant is neither plain water nor straight antifreeze. The correct mixture of water and antifreeze must be used to provide proper lubrication, corrosion protection and cooling. Be sure to read the antifreeze or coolant label.

■ **If you spill coolant**

Be sure to wash it off with water to prevent it from damaging parts or paint.

Checking the radiator, condenser, intercooler radiator (if equipped) and intercooler sub radiator (if equipped)

Check the radiator, condenser, intercooler radiator and intercooler sub radiator and clear away any foreign objects. If either of the above parts is extremely dirty or you are not sure of their condition, have your vehicle inspected by your Lexus dealer.

⚠ WARNING**■ When the engine is hot**

Do not touch the radiator, condenser, intercooler radiator or intercooler sub radiator as they may be hot and cause serious injuries, such as burns.

Checking and adding the brake fluid**■ Checking fluid level**

The brake fluid level should be between the "MAX" and "MIN" lines on the tank.

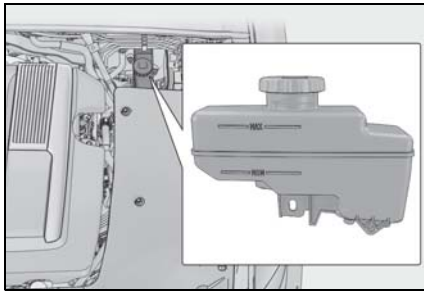
**■ Adding fluid**

Make sure to check the fluid type and prepare the necessary item.

● Fluid type

FMVSS No.116 DOT 3 or SAE J1703 brake fluid

FMVSS No.116 DOT 4 or SAE J1704 brake fluid

● Item

Clean funnel

■ Brake fluid can absorb moisture from the air

Excess moisture in the brake fluid can cause a dangerous loss of braking efficiency. Use only newly opened brake fluid.

⚠ WARNING**■ When filling the reservoir**

Take care as brake fluid can harm your hands and eyes and damage painted surfaces.

If fluid gets on your hands or in your eyes, flush the affected area with clean water immediately.

If you still experience discomfort, see a doctor.

⚠ NOTICE**■ If the fluid level is low or high**

It is normal for the brake fluid level to go down slightly as the brake pads wear out or when the fluid level in the accumulator is high.

If the reservoir needs frequent refilling, there may be a serious problem.

Adding the washer fluid

If any washer does not work or the warning message appears on the multi-information display, the washer tank may be empty. Add washer fluid.

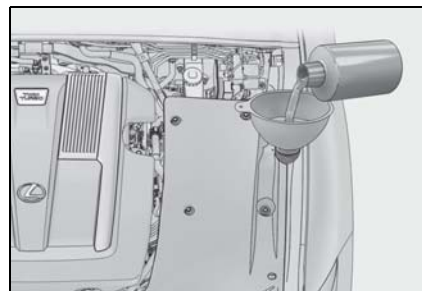
**⚠ WARNING****■ When adding washer fluid**

Do not add washer fluid when the engine is hot or running as washer fluid contains alcohol and may catch fire if spilled on the engine, etc.

 NOTICE

■ Do not use any fluid other than washer fluid

Do not use soapy water or engine anti-freeze instead of washer fluid. Doing so may cause streaking on the vehicle's painted surfaces, as well as damaging the pump leading to problems of the washer fluid not spraying.

■ Diluting washer fluid

Dilute washer fluid with water as necessary. Refer to the freezing temperatures listed on the label of the washer fluid bottle.

Battery

Location

The battery is located in the trunk under the luggage mat.

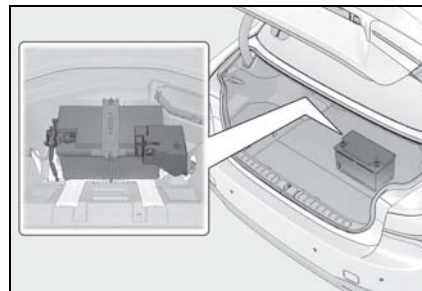

Removing the luggage mat: →P.340

■ Before recharging

When recharging, the battery produces hydrogen gas which is flammable and explosive. Therefore, observe the following precautions before recharging:

- If recharging with the battery installed on the vehicle, be sure to disconnect the ground cable.
- Make sure the engine switch on the charger is off when connecting and disconnecting the charger cables to the battery.

■ After recharging/reconnecting the battery

- Unlocking the doors using the smart access system with push-button start may not be possible immediately after reconnecting the battery. If this happens, use the wireless remote control or the mechanical key to lock/unlock the doors.
- Start the engine with the engine switch in ACCESSORY mode. The engine may not start with the engine switch turned off. However, the engine will operate normally from the second attempt.
- The engine switch mode is recorded by the vehicle. If the battery is reconnected, the vehicle will return the engine switch mode to the status it was in before the

battery was disconnected. Make sure to turn off the engine before disconnecting the battery. Take extra care when connecting the battery if the engine switch mode prior to discharge is unknown.

If the system will not start even after multiple attempts, contact your Lexus dealer.

WARNING

■ Chemicals in the battery

The battery contains poisonous and corrosive sulfuric acid and may produce hydrogen gas which is flammable and explosive. To reduce the risk of death or serious injury, take the following precautions while working on or near the battery:

- Do not cause sparks by touching the battery terminals with tools.
- Do not smoke or light a match near the battery.
- Avoid contact with eyes, skin and clothes.
- Never inhale or swallow electrolyte.
- Wear protective safety glasses when working near the battery.
- Keep children away from the battery.

■ Where to safely charge the battery

Always charge the battery in an open area. Do not charge the battery in a garage or closed room where there is insufficient ventilation.

■ Emergency measures regarding electrolyte

- If electrolyte gets in your eyes
Flush your eyes with clean water for at least 15 minutes and get immediate medical attention. If possible, continue to apply water with a sponge or cloth while traveling to the nearest medical facility.

- If electrolyte gets on your skin
Wash the affected area thoroughly. If you feel pain or burning, get medical attention immediately.
- If electrolyte gets on your clothes
It can soak through clothing on to your skin. Immediately take off the clothing and follow the procedure above if necessary.
- If you accidentally swallow electrolyte
Drink a large quantity of water or milk. Get emergency medical attention immediately.

■ When replacing the battery

Use a battery designed for this vehicle. Failure to do so may cause gas (hydrogen) to enter the passenger compartment, causing a fire or explosion.

For replacement of the battery, contact your Lexus dealer.

NOTICE

■ When recharging the battery

Never recharge the battery while the engine is running. Also, be sure all accessories are turned off.

Exterior

Make sure that the battery terminals are not corroded and that there are no loose connections, cracks, or loose clamps.

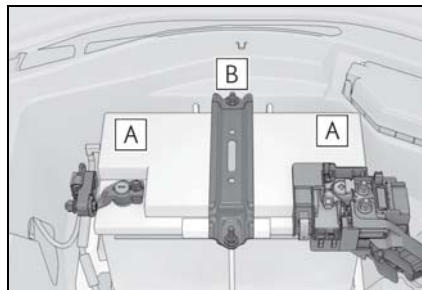

- A** Terminals
- B** Hold-down clamp

Checking the battery condition

Check the battery condition by indicator color.

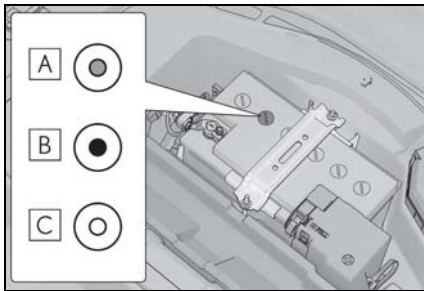

- A** Blue: Good condition
- B** Red: Charging is necessary. Have the vehicle inspected by your Lexus dealer.
- C** Clear: Replacement is necessary. Have the battery checked by your Lexus dealer.

Tires

Replace or rotate tires in accordance with maintenance schedules and treadwear.

Checking tires

Check if the treadwear indicators are showing on the tires. Also check the tires for uneven wear, such as excessive wear on one side of the tread.

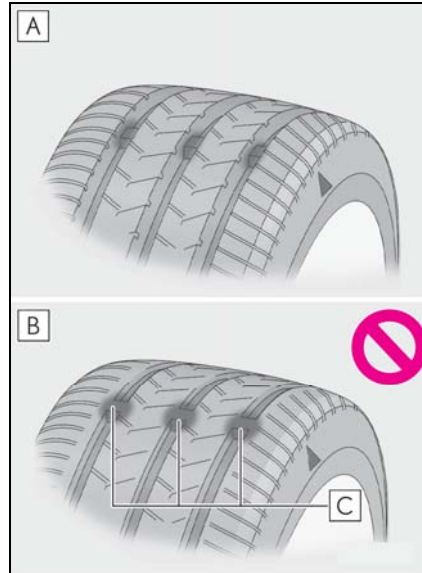

- A** New tread
- B** Worn tread
- C** Treadwear indicator

The location of treadwear indicators is shown by a "TWI" or "△" mark, etc., molded into the sidewall of each tire. Replace the tires if the treadwear indicators are showing on a tire.

■ When to replace your vehicle's tires

Tires should be replaced if:

- The treadwear indicators are showing on a tire.
- You have tire damage such as cuts, splits, cracks deep enough to expose the fabric, and bulges indicating internal damage
- A tire goes flat repeatedly or cannot be properly repaired due to the size or location of a cut or other damage

If you are not sure, consult with your Lexus dealer.

■ Tire life

Any tire over 6 years old must be checked by a qualified technician even if it has seldom or never been used or damage is not obvious.

■ Maximum load of tire

Check that the maximum load of the replacement tire is greater than 1/2 of the Gross Axle Weight Ratings (GAWR) of either the front axle or the rear axle, whichever is greater.

For the GAWR, see the Certification Label. For the maximum load of the tire, see the load limit at maximum cold tire inflation pressure mentioned on the sidewall of the tire. (→P.457)

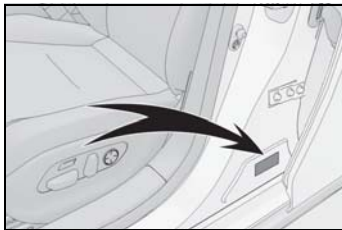

■ Tire types

- Summer tires

Summer tires are high-speed performance tires best suited to highway driving under dry conditions. Since summer tires do not have the same traction performance as snow tires, summer tires are inadequate for driving on snow-covered or icy roads. For driving on snow-covered roads or icy

roads, the use of snow tires is recommended. When installing snow tires, be sure to replace all four tires.

- All season tires

All season tires are designed to provide better traction in snow and to be adequate for driving in most winter conditions as well as for use year-round. All season tires, however, do not have adequate traction performance compared with snow tires in heavy or loose snow. Also, all season tires fall short in acceleration and handling performance compared with summer tires in highway driving.

- Snow tires

For driving on snow-covered roads or icy roads, we recommend using snow tires. If you need snow tires, select tires of the same size, construction and load capacity as the originally installed tires. Since your vehicle has radial tires as original equipment, make sure your snow tires also have radial construction. Do not install studded tires without first checking local regulations for possible restrictions. Snow tires should be installed on all wheels. (→P.300)

■ If the tread on snow tires wears down below 0.16 in. (4 mm)

The effectiveness of the tires as snow tires is lost.

⚠ WARNING

■ When inspecting or replacing tires

Observe the following precautions to prevent accidents. Failure to do so may cause damage to parts of the drive train as well as dangerous handling characteristics, which may lead to an accident resulting in death or serious injury.

⚠ WARNING

- Do not mix tires of different makes, models or tread patterns. Also, do not mix tires of remarkably different treadwear.
- Do not use tire sizes other than those recommended by Lexus.
- Do not mix differently constructed tires (radial, bias-belted or bias-ply tires).
- Do not mix summer, all season and snow tires.
- Do not use tires that have been used on another vehicle. Do not use tires if you do not know how they were used previously.

⚠ NOTICE

■ Driving on rough roads
 Take particular care when driving on roads with loose surfaces or potholes. These conditions may cause losses in tire inflation pressure, reducing the cushioning ability of the tires. In addition, driving on rough roads may cause damage to the tires themselves, as well as the vehicle's wheels and body.

Tire rotation

- ▶ Vehicles with front and rear tires of the same size

Rotate the tires in the order shown.

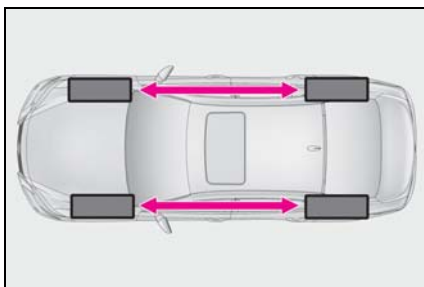

To equalize tire wear and extend tire life, Lexus recommends that tire rotation is carried out at the same interval as tire inspection.

Do not fail to initialize the tire pressure warning system after tire rotation.

- ▶ Vehicles with front and rear tires of differing sizes

Tires cannot be rotated.

Run-flat tires

When run-flat tires are installed, the vehicle can be driven for a maximum of 100 miles (160 km) at a speed below 50 mph (80 km/h) after any tire goes flat. (However, the vehicle speed may not increase to near 50 mph [80 km/h] depending on weather or driving conditions.)

A run-flat tire has a  mark on the side wall.

Make sure to replace the flat tire before the vehicle has been driven for near 100 miles (160 km). Also, do not use a repaired tire.

■ Run-flat tires

- The run-flat tires are for only this vehicle. Do not use the tires on other vehicles.
- Do not mix run-flat tires and normal tires.
- If non-genuine Lexus wheels are used, it may be impossible to sufficiently demonstrate the performance of run-flat tires.

Tire pressure warning system

Your vehicle is equipped with a tire pressure warning system that uses tire pressure warning valves and transmitters to detect low tire inflation pressure

before serious problems arise.

- The tire pressure detected by the tire pressure warning system can be displayed on the multi-information display. (→P.80)

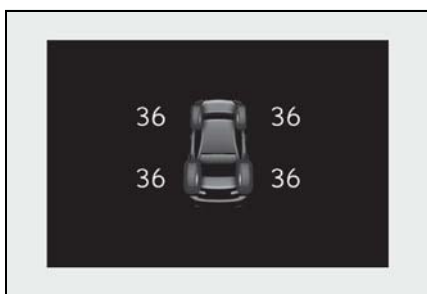

- If the tire pressure drops below a predetermined level, the driver is warned by a screen display and a warning light. (→P.419)

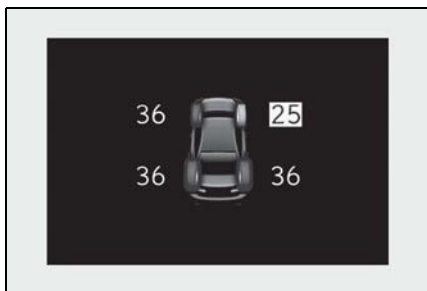

■ Routine tire inflation pressure checks

The tire pressure warning system does not replace routine tire inflation pressure checks. Make sure to check tire inflation pressure as part of your routine of daily vehicle checks.

■ Tire inflation pressure

- It may take a few minutes to display the tire inflation pressure after the engine switch is turned to IGNITION ON mode. It may also take a few minutes to display the tire inflation pressure after inflation pressure has been adjusted.
- Tire inflation pressure changes with temperature. The displayed values may also

be different from the values measured using a tire pressure gauge.

■ Situations in which the tire pressure warning system may not operate properly

- In the following cases, the tire pressure warning system may not operate properly.
 - If non-genuine Lexus wheels are used.
 - If a tire has been replaced with a tire that is not an OE (Original Equipment) tire.
 - If a tire has been replaced with a tire that is not of the specified size.
 - If tire chains, etc. are installed.
 - An auxiliary-supported run-flat tire is equipped.
 - If a window tint that affects the radio wave signals is installed.
 - If there is a lot of snow or ice on the vehicle, particularly around the wheels or wheel housings.
 - If the tire inflation pressure is much higher than the specified level.
 - If wheels not equipped with tire pressure warning valves and transmitter are used.
 - If the ID code on the tire pressure warning valves and transmitters is not registered in the tire pressure warning computer.
 - Performance may be affected in the following situations.
 - When driving near a TV tower, electric power plant, gas station, radio station, large display, airport or other facility that generates strong radio waves or electrical noise
 - When carrying a portable radio, cellular phone, cordless phone or other wireless communication device
- If tire position information is not correctly displayed due to the radio wave conditions, the display may be corrected by changing the location of the vehicle as the radio wave conditions may change.
- When the vehicle is stopped, the time taken for the warning to start or turn off may be longer.
 - When the inflation pressure of a tire drops rapidly, for example when a tire has burst, the warning may not operate.

■ **Warning performance of the tire pressure warning system**

The warning of the tire pressure warning system will change in accordance with driving conditions. For this reason, the system

may give a warning even if the tire pressure does not reach a low enough level, or if the pressure is higher than the pressure that was adjusted to when the system was initialized.

■ **Tire pressure warning system certification**

- ▶ For vehicles sold in the U.S.A., Hawaii, Guam and Puerto Rico

FCC ID: PAXPMVC015

NOTE

This device complies with part 15 of the FCC Rules.

Operation is subject to the following two conditions:

(1) This device may not cause harmful interference, and (2) this device must accept any interference received, including interference that may cause undesired operation.

FCC WARNING

Changes or modifications not expressly approved by the party responsible for compliance could void the user's authority to operate the equipment.

► For vehicles sold in Canada

[英語]

Model:PMV-C015

NOTE

This device complies with Industry Canada licence-exempt RSS standard(s). Operation is subject to the following two conditions: (1) this device may not cause interference, and (2) this device must accept any interference, including interference that may cause undesired operation of the device.

[フランス語]

NOTE

Le présent appareil est conforme aux CNR d'Industrie Canada applicables aux appareils radio exempts de licence. L'exploitation est autorisée aux deux conditions suivantes : (1) l'appareil ne doit pas produire de brouillage, et (2) l'utilisateur de l'appareil doit accepter tout brouillage radioélectrique subi, même si le brouillage est susceptible d'en compromettre le fonctionnement.

Installing tire pressure warning valves and transmitters

When replacing the tires or wheels, the tire pressure warning valve and transmitters must be installed to the wheels which will be installed to the vehicle.

When new tire pressure warning valves and transmitters are installed, new ID codes must be registered in the tire pressure warning computer and the tire pressure warning system must be initialized. (→P.389)

■ Replacing tires and wheels

If the ID codes of the tire pressure warning valve and transmitters are not registered, the tire pressure warning system will not work properly. In this case, after driving for about 20 minutes, the tire pressure warning

light will blink for approximately 1 minute and then illuminate to indicate a system malfunction.



NOTICE

■ Repairing or replacing tires, wheels, tire pressure warning valves, transmitters and tire valve caps

- When removing or fitting the wheels, tires or the tire pressure warning valves and transmitters, contact your Lexus dealer as the tire pressure warning valves and transmitters may be damaged if not handled correctly.
- Make sure to install the tire valve caps. If the tire valve caps are not installed, water may enter the valves of the tire pressure warning valve and transmitters and the valves may become stuck.
- When replacing tire valve caps, do not use tire valve caps other than those specified. The cap may become stuck.

Initializing the tire pressure warning system

■ The tire pressure warning system must be initialized in the following circumstances:

- When the tire inflation pressure is changed such as when changing traveling speed or load weight.
- When the tire inflation pressure is changed such as when the tire size is changed.
- When rotating the tires.
- After performing the transmitter ID code registration procedure. (→P.389)

When the tire pressure warning system is initialized, the current tire inflation pressure is set as the benchmark pressure.



■ How to initialize the tire pressure warning system



- 1 Park the vehicle in a safe place, turn the engine switch off and wait 20 minutes or more.

The initialization procedure cannot be started while the vehicle is moving.



- 2 Adjust the tire inflation pressure to the specified cold tire inflation pressure level.

Make sure to adjust the tire pressure to the specified cold tire inflation pressure level. The tire pressure warning system will operate based on this pressure level.

- 3 Start the engine.
- 4 Press  or  of the meter control switch to select .

- 5 Press  or  to select "Vehicle Settings" and then press .

- 6 Press  or  to select "TPWS" and then press .

- 7 Press  or  to select "Set Pressure". Then press and hold  until the tire pressure warning light blinks 3 times.

Then a message will be displayed on the multi-information display.

"---" will be displayed on the multi-information display for the inflation pressure of each tire while initialization is being performed.

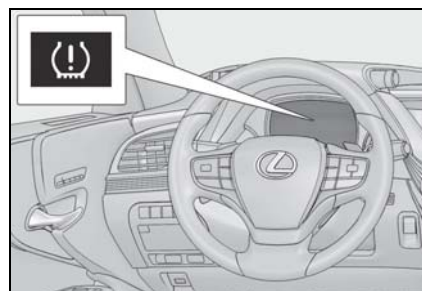

- 8 Drive straight (with occasional left and right turns) at approximately 25 mph (40 km/h) or more for approximately 10 to 30 minutes.

Initialization is complete when the position of each tire is determined and the inflation pressure of each tire is displayed on the multi-information display.

Initialization may take longer than normal to complete if the vehicle speed cannot be maintained at approximately 25 mph (40 km/h) or more. If initialization cannot be completed after driving for 1 hour or more, park the vehicle in a safe place, turn the engine switch off and wait 20 minutes or more before performing the driving procedure again. (→P.389)

Initialization procedure

- Make sure to perform the initialization procedure after adjusting the tire inflation pressure. Also, make sure the tires are cold before performing the initialization procedure or adjusting the tire inflation pressure.
- If the engine switch is turned off during initialization, it is not necessary to restart the initialization procedure from the beginning as it will begin automatically when the engine switch is turned back to IGNITION ON mode.
- If initialization has accidentally been started when it is not necessary, adjust the tire inflation pressure to the specified level when the tires are cold and then perform the initialization procedure again.
- While the position of each tire is being determined and the inflation pressures are not being displayed on the multi-information display, if the inflation pressure of a tire drops, the tire pressure warning light will come on.

If the tire pressure warning system is not initialized properly

- In the following situations, initialization may take longer than usual to be completed or may not be possible. (Usually, the vehicle will need to be driven for approximately 10 to 30 minutes to complete initialization.) If initialization is not complete after driving approximately 30 minutes, continue driving for a while.
 - If the vehicle is driven on an unpaved road, it may take longer to complete initialization.
 - If the vehicle is backed up while performing initialization, data collected during initialization will be cleared and it will take longer than normal to complete.
 - If the vehicle is driven in heavy traffic or another situation where other vehicles are driven close by, it may take time for the system to recognize the tire pressure warning valve and transmitters of your vehicle over those of other vehicles.

If initialization is not complete after driving for approximately 1 hour, park the vehicle in

a safe place for approximately 20 minutes and then drive the vehicle again.

- In the following situations, initialization will not be started or was not completed properly and the system will not operate properly. Perform the initialization procedure again.
 - If, when attempting to start initialization, the tire pressure warning light does not blink 3 times.
 - If, when the vehicle has been driven for about 20 minutes after performing initialization, the tire pressure warning light blinks for approximately 1 minute and then illuminates.
- If initialization cannot be completed after performing the above procedure, contact your Lexus dealer.

**WARNING****When initializing the tire pressure warning system**

Do not initialize the tire pressure warning system without first adjusting the tire inflation pressure to the specified level. Otherwise, the tire pressure warning light may not come on even if the tire inflation pressure is low, or it may come on when the tire inflation pressure is actually normal.

Registering ID codes

Every tire pressure warning valve and transmitter has a unique ID code. When replacing a tire pressure warning valve and transmitter, it is necessary to register the ID codes.

The ID codes can be registered on  of the multi-information display.

- 1 Park the vehicle in a safe place, turn the engine switch off, wait 20 minutes or more, and then start the engine.

- 2 Press **<** or **>** of the meter control switch to select .
- 3 Press **▲** or **▼** to select "Vehicle Settings" and then press **OK**.
- 4 Press **▲** or **▼** to select "TPWS" and then press **OK**.
- 5 Press **▲** or **▼** to select "Change Wheel Set". Then press and hold **OK** until the tire pressure warning light blinks slowly 3 times.

Then a message will be displayed on the multi-information display.

When registration is being performed, the tire pressure warning light will blink for approximately 1 minute then illuminate and "---" will be displayed for the inflation pressure of each tire on the multi-information display.

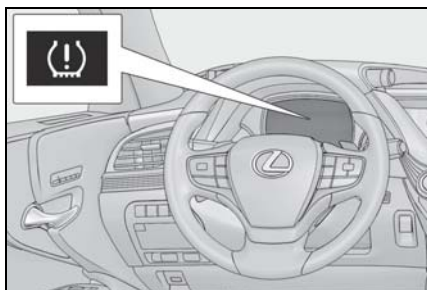

- 6 Drive straight (with occasional left and right turns) at approximately 25 mph (40 km/h) or more for approximately 10 to 30 minutes.

Registration is complete when the tire pressure warning light turns off and the inflation pressure of each tire is displayed on the multi-information display.

Registration may take longer than normal to complete if the vehicle speed cannot be maintained at approximately 25 mph (40 km/h) or more. If registration cannot be completed after driving for 1 hour or more,

perform the registration procedure again from the beginning. (→P.390)

After registering the ID codes, make sure to initialize the tire pressure warning system. (→P.388)

■ When registering ID codes

- Before performing ID code registration, make sure that no wheels with tire pressure warning valve and transmitters installed are near the vehicle.
- Make sure to initialize the tire pressure warning system after registering the ID codes. If the system is initialized before registering the ID codes, the initialized values will be invalid.
- As the tires will be warm when registration is completed, make sure to allow the tires to cool before performing initialization.

■ Canceling ID code registration

- To cancel ID code registration after it has been started, turn the engine switch off before driving the vehicle. If the vehicle is driven after ID code registration is started, to cancel registration, perform the ID code registration start procedure again and turn the engine switch off before driving.
- If ID code registration has been canceled, the tire pressure warning light will blink for approximately 1 minute when the engine switch is turned to IGNITION ON mode and then illuminate. The tire pressure warning system will be operational when the tire pressure warning light turns off.
- If the warning light does not turn off even after several minutes have elapsed, ID code registration may not have been cancelled correctly. To cancel registration, perform the ID code registration start procedure again and then turn the engine switch off before driving.

■ If ID codes are not registered properly

- In the following situations, ID code registration may take longer than usual to be completed or may not be possible. (Usually, the vehicle will need to be driven for

approximately 10 to 30 minutes to complete ID code registration.)

If ID code registration is not complete after driving for approximately 30 minutes, continue driving for a while.

- If the vehicle is driven on an unpaved road, it may take longer than normal to complete registration.
- If the vehicle is backed up while performing registration, data collected during registration will be cleared, and it will take longer than normal to complete.
- If the vehicle is driven in heavy traffic or another situation where other vehicles are driven close by, it may take time for the system to recognize the tire pressure warning valve and transmitters of your vehicle over those of other vehicles.
- If a wheel with a tire pressure warning valve and transmitter installed is inside or near the vehicle, registration of the ID codes for the installed wheels may not be possible.

If ID registration is not complete after driving for approximately 1 hour, park the vehicle in a safe place for approximately 20 minutes and then perform the ID code registration procedure again.

- In the following situations, ID code registration will not be started or was not completed properly and the system will not operate properly. Perform the ID code registration procedure again.
 - If, when attempting to start ID code registration, the tire pressure warning light does not blink slowly 3 times.
 - If, when the vehicle has been driven for about 20 minutes after performing ID code registration, the tire pressure warning light blinks for approximately 1 minute and then illuminates.
- If ID code registration cannot be completed after performing the above procedure, contact your Lexus dealer.

Replacing the tire

When raising your vehicle with a jack, position the jack correctly. Improper placement may damage your vehicle or cause injury. If necessary tire replacement seems difficult to perform, contact your Lexus dealer.

Before jacking up the vehicle

- Stop the vehicle in a safe place on a hard, flat surface.
- Set the parking brake.
- Shift the shift position to P.
- Disabling the height control. (if equipped) (→P.293)
- Stop the engine.

Jack and tools

As your vehicle is equipped with run-flat tires, the following tools for replacing a tire are not included with your vehicle. They can be purchased at your Lexus dealer.

- Wheel nut wrench
- Jack
- Jack handle

WARNING

■ Using the tire jack

Observe the following precautions. Improper use of the tire jack may cause the vehicle to suddenly fall off the jack, leading to death or serious injury.

- Do not use the tire jack for any purpose other than replacing tires or installing and removing tire chains.
- Do not use other tire jacks for replacing tires on this vehicle.
- Put the jack properly in its jack point.
- Do not put any part of your body under the vehicle while it is supported by the jack.
- Do not start the engine or drive the vehicle while the vehicle is supported by the jack.
- Do not raise the vehicle while someone is inside.
- When raising the vehicle, do not put an object on or under the jack.
- Do not raise the vehicle to a height greater than that required to replace the tire.
- Use a jack stand if it is necessary to get under the vehicle.
- Make sure to disable all functions of the vehicle height control of the electronically modulated air suspension and then stopping the engine. (→P.293)
- When lowering the vehicle, make sure that there is no-one near the vehicle. If there are people nearby, warn them vocally before lowering.

■ Replacing a flat tire for vehicles with power trunk opener and closer (if equipped)

In cases such as when replacing tires, make sure to turn off the trunk opener main switch (→P.110). Failure to do so may cause the trunk lid to operate unintentionally if the power trunk opener and closer switch is accidentally touched, resulting in hands and fingers being caught and injured.

Removing a tire

1 Chock the tires.

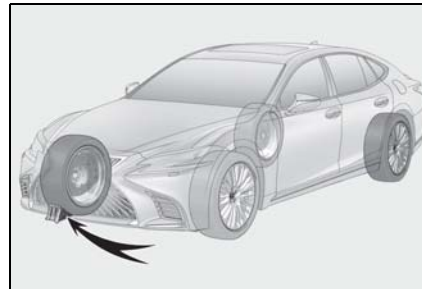

Tire	Wheel chock positions
Front left-hand side	Behind the rear right-hand side tire
Front right-hand side	Behind the rear left-hand side tire
Rear left-hand side	In front of the front right-hand side tire
Rear right-hand side	In front of the front left-hand side tire

- 2** Slightly loosen the wheel nuts (one turn).

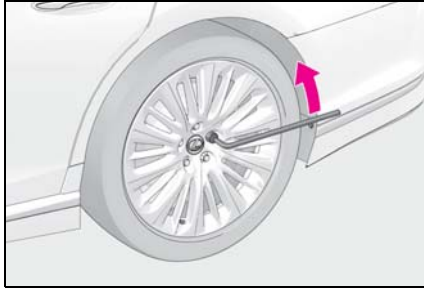

- 3** Turn the tire jack portion **A** by hand until the notch of the jack is in contact with the jack point.

The jack point guides are located under the rocker panel. They indicate the jack point positions.

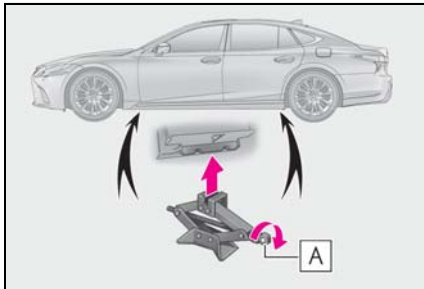

- 4** Raise the vehicle until the tire is slightly raised off the ground.

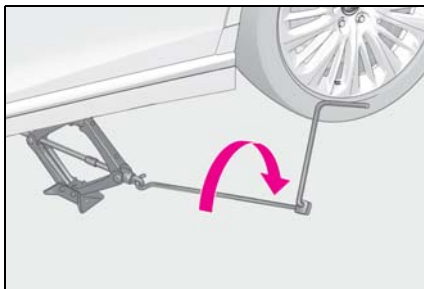

- 5** Remove all the wheel nuts and the tire.

When resting the tire on the ground, place the tire so that the wheel design faces up to

avoid scratching the wheel surface.

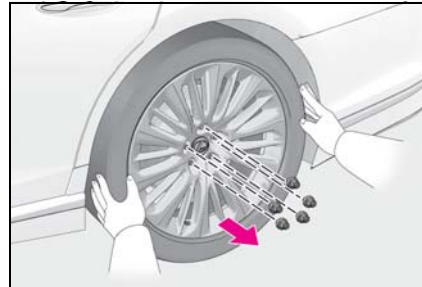

⚠ WARNING

■ Replacing a tire

Do not touch the disc wheels or the area around the brakes immediately after the vehicle has been driven.

After the vehicle has been driven the disc wheels and the area around the brakes will be extremely hot. Touching these areas with hands, feet or other body parts while changing a tire, etc. may result in burns.

Installing the tire

- 1** Remove any dirt or foreign matter from the wheel contact surface.

If foreign matter is on the wheel contact surface, the wheel nuts may loosen while the vehicle is in motion, causing the tire to come off.

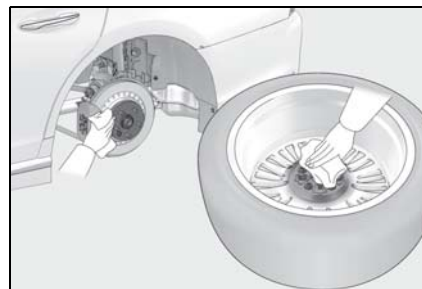

- 2** Install the tire and loosely tighten each wheel nut by hand by approximately the same amount.

Turn the wheel nuts until the washers come

into contact with the disc wheel.

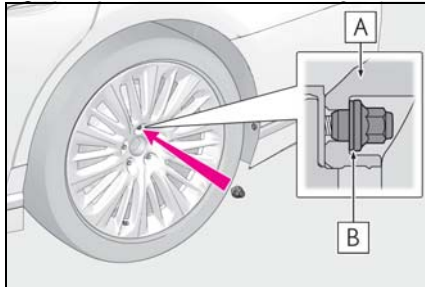

A Disc wheel

B Washer

3 Lower the vehicle.

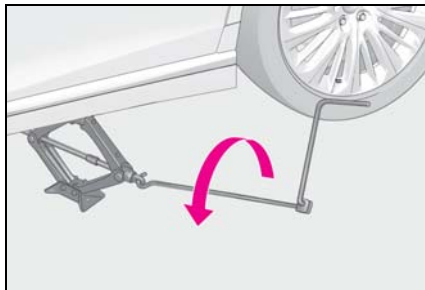

4 Firmly tighten each wheel nut two or three times in the order shown in the illustration.

Tightening torque:
103 ft•lbf (140 N•m, 14.3 kgf•m)

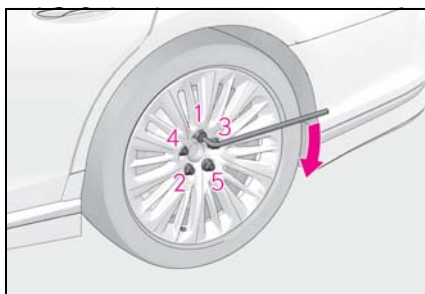

⚠ WARNING

■ When installing the tire

Failure to follow these precautions could cause the wheel nuts to loosen and the tire to fall off, resulting in death or serious injury.

- Never use oil or grease on the wheel bolts or wheel nuts. Oil and grease may cause the wheel nuts to be excessively tightened, leading to bolt or disc wheel damage. In addition, the oil or grease can cause the wheel nuts to loosen and the wheel may fall off, causing a serious accident. Remove any oil or grease from the wheel bolts or wheel nuts.
- Have the wheel nuts tightened with a torque wrench to 103 ft•lbf (140 N•m, 14.3 kgf•m) as soon as possible after changing wheels.
- Do not attach a heavily damaged wheel ornament, as it may fly off the wheel while the vehicle is moving.
- When installing a tire, only use wheel nuts that have been specifically designed for that wheel.
- If there are any cracks or deformations in the bolt screws, nut threads or bolt holes of the wheel, have the vehicle inspected by your Lexus dealer.

⚠ NOTICE

■ Repairing or replacing tires, wheels, tire pressure warning valves, transmitters and tire valve caps

→P.387

Tire inflation pressure

Checking the specified tire inflation pressure

The recommended cold tire inflation pressure and tire size are displayed on the tire and loading information label. (→P.452)

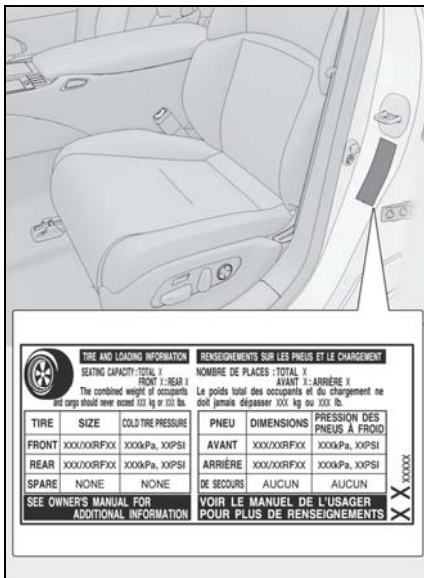

Inspection and adjustment procedure

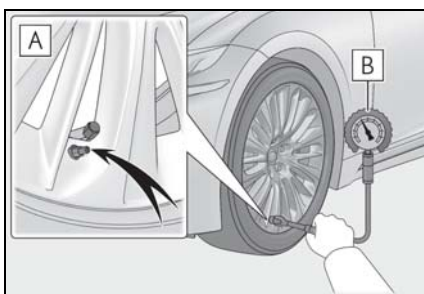

- A** Tire valve
- B** Tire pressure gauge

- 1** Remove the tire valve cap.
- 2** Press the tip of the tire pressure gauge onto the tire valve.
- 3** Read the pressure using the gauge gradations.
- 4** If the tire inflation pressure is not at the recommended level, adjust the pressure.
If you add too much air, press the center of the valve to deflate.
- 5** After completing the tire inflation pressure measurement and adjustment, apply soapy water to the valve and check for leakage.
- 6** Put the tire valve cap back on.

■ Tire inflation pressure check interval

You should check tire inflation pressure every two weeks, or at least once a month. Do not forget to check the spare.

■ Effects of incorrect tire inflation pressure

Driving with incorrect tire inflation pressure may result in the following:

- Reduced fuel economy
- Reduced driving comfort and poor handling
- Reduced tire life due to wear
- Reduced safety
- Damage to the drive train

If a tire needs frequent inflating, have it checked by your Lexus dealer.

■ Instructions for checking tire inflation pressure

When checking tire inflation pressure, observe the following:

- Check only when the tires are cold.
If your vehicle has been parked for at least 3 hours or has not been driven for more than 1 mile or 1.5 km, you will get an accurate cold tire inflation pressure read-

ing.

- Always use a tire pressure gauge. It is difficult to judge if a tire is properly inflated based only on its appearance.
- It is normal for the tire inflation pressure to be higher after driving as heat is generated in the tire. Do not reduce tire inflation pressure after driving.
- Never exceed the vehicle capacity weight. Passengers and luggage weight should be placed so that the vehicle is balanced.

 **WARNING**

■ **Proper inflation is critical to save tire performance**

Keep your tires properly inflated. If the tires are not properly inflated, the following conditions may occur which could lead to an accident resulting in death or serious injury:

- Excessive wear
- Uneven wear
- Poor handling
- Possibility of blowouts resulting from overheated tires
- Air leaking from between tire and wheel
- Wheel deformation and/or tire damage
- Greater possibility of tire damage while driving (due to road hazards, expansion joints, sharp edges in the road, etc.)

 **NOTICE**

■ **When inspecting and adjusting tire inflation pressure**

Be sure to put the tire valve caps back on. If a valve cap is not installed, dirt or moisture may get into the valve and cause an air leak, resulting in decreased tire inflation pressure.

Wheels

If a wheel is bent, cracked or heavily corroded, it should be replaced. Otherwise, the tire may separate from the wheel or cause a loss of handling control.

Wheel selection

When replacing wheels, care should be taken to ensure that they are equivalent to those removed in load capacity, diameter, rim width and inset*.

Replacement wheels are available at your Lexus dealer.

*: Conventionally referred to as offset.

Lexus does not recommend using the following:

- Wheels of different sizes or types
- Used wheels
- Bent wheels that have been straightened

■ **When replacing wheels**

The wheels of your vehicle are equipped with tire pressure warning valves and transmitters that allow the tire pressure warning system to provide advance warning in the event of a loss in tire inflation pressure. Whenever wheels are replaced, the tire pressure warning valves and transmitters must be installed. (→P.387)

 **WARNING**

■ **When replacing wheels**

- Do not use wheels that are a different size from those recommended in the Owner's Manual, as this may result in a loss of handling control.

⚠ WARNING

- Never use an inner tube in a leaking wheel which is designed for a tubeless tire. Doing so may result in an accident, causing death or serious injury.

■ Use of defective wheels prohibited

Do not use cracked or deformed wheels. Doing so could cause the tire to leak air during driving, possibly causing an accident.

⚠ NOTICE**■ Replacing tire pressure warning valves and transmitters**

- Because tire repair or replacement may affect the tire pressure warning valves and transmitters, make sure to have tires serviced by your Lexus dealer or other qualified service shop. In addition, make sure to purchase your tire pressure warning valves and transmitters at your Lexus dealer.
- Ensure that only genuine Lexus wheels are used on your vehicle. Tire pressure warning valves and transmitters may not work properly with non-genuine wheels.

Aluminum wheel precautions

- Use only Lexus wheel nuts and wheel nut wrenches designed for use with your aluminum wheels.
- When rotating, repairing or changing your tires, check that the wheel nuts are still tight after driving 1000 miles (1600 km).
- Be careful not to damage the aluminum wheels when using tire chains.
- Use only Lexus genuine balance weights or equivalent and a plastic

or rubber hammer when balancing your wheels.

Air conditioning filter

The air conditioning filter must be changed regularly to maintain air conditioning efficiency.

Removing the air conditioning filter

- 1 Turn the engine switch off.
- 2 Open the glove box. Remove the partition. (→P.337)
- 3 Remove the panel.

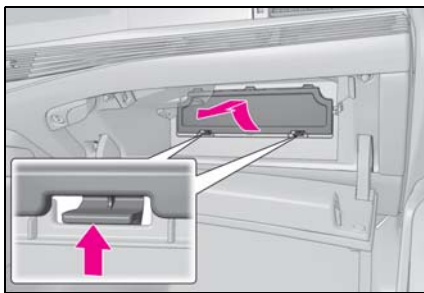

- 4 Unlock the filter cover (A), pull the filter cover out of the claws (B), and remove the filter cover.

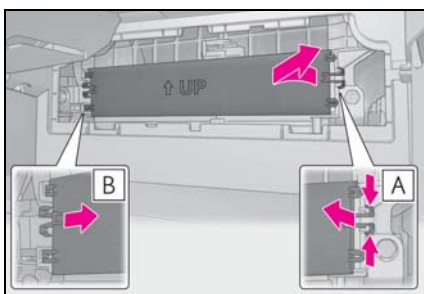

- 5 Remove the filter case.

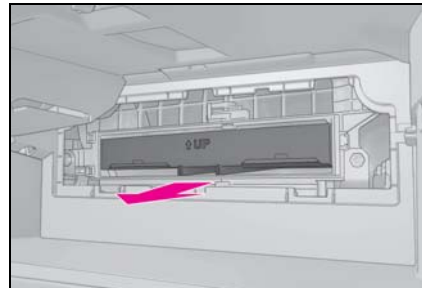

- 6 Remove the air conditioning filter from the filter case and replace it with a new one.

The “↑ UP” marks shown on the filter and the filter case should be pointing up.

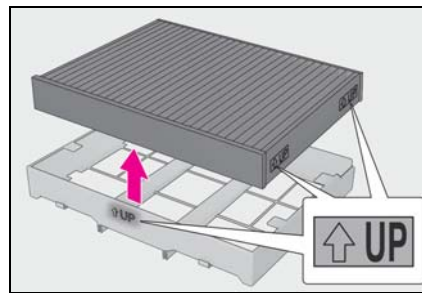

■ Checking interval

Inspect and replace the air conditioning filter according to the maintenance schedule. In dusty areas or areas with heavy traffic flow, early replacement may be required. (For scheduled maintenance information, please refer to the “Owner’s Manual Supplement” or “Scheduled Maintenance”.)

■ If air flow from the vents decreases dramatically

The filter may be clogged. Check the filter and replace if necessary.

■ Air conditioning filter with deodorizing function

When fragrances are placed in your vehicle, the deodorizing effect may become significantly weakened in a short period. When an air conditioning odor comes out continuously, replace the air conditioning

filter.



NOTICE

■ When using the air conditioning system

Make sure that a filter is always installed. Using the air conditioning system without a filter may cause damage to the system.

■ To prevent damage to the filter cover

When moving the filter cover in the direction of arrow to release the fitting, pay attention not to apply excessive force to the claws. Otherwise, the claws may be damaged.

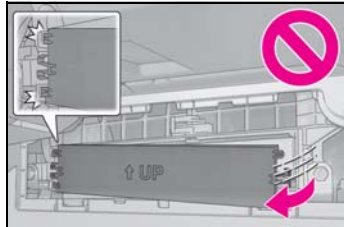

Electronic key battery

Replace the battery with a new one if it is depleted.

As the key may be damaged if the following procedure is not performed properly, it is recommended that key battery replacement be performed by your Lexus dealer.

■ If the electronic key battery is depleted

The following symptoms may occur:

- The smart access system with push-button start and wireless remote control will not function properly.
- The operational range will be reduced.

■ When the card key battery needs to be replaced (if equipped)

The battery for the card key is available only at Lexus dealers. Your Lexus dealer can replace the battery for you.

Items to prepare

- Flathead screwdriver
- Small flathead screwdriver
- Lithium battery CR2032

■ Use a CR2032 lithium battery

- Batteries can be purchased at your Lexus dealer, local electrical appliance shops or camera stores.
- Replace only with the same or equivalent type recommended by the manufacturer.
- Dispose of used batteries according to local laws.

Replacing the battery

- 1 Take out the mechanical key.

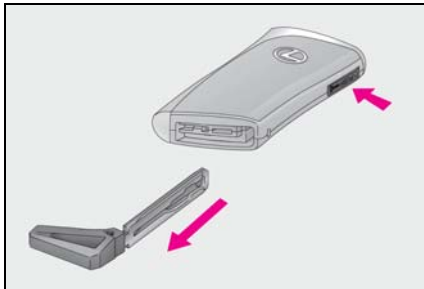

- 2 Remove the cover.

To prevent damage to the key, cover the tip of the flathead screwdriver with a tape.

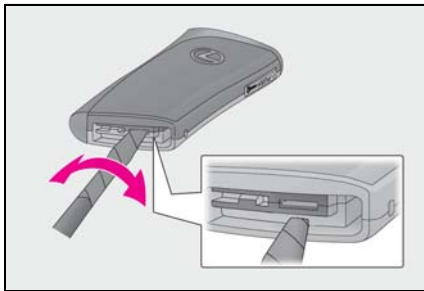

- 3 Remove the depleted battery.

Insert a new battery with the “+” terminal facing up.

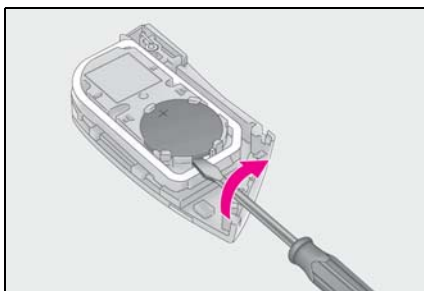

⚠ WARNING

■ Removed battery and other parts

These parts are small and if swallowed by a child, they can cause choking. Keep away from children. Failure to do so could result in death or serious injury.

⚠ NOTICE

■ When replacing the battery

Use a flathead screwdriver of appropriate size. Applying excessive force may deform or damage the cover.

■ For normal operation after replacing the battery

Observe the following precautions to prevent accidents:

- Always work with dry hands. Moisture may cause the battery to rust.
- Do not touch or move any other component inside the remote control.
- Do not bend either of the battery terminals.

Checking and replacing fuses

If any of the electrical components do not operate, a fuse may have blown. If this happens, check and replace the fuses as necessary.

Checking and replacing fuses

- 1 Turn the engine switch off.
 - 2 Open the fuse box cover.
 - ▶ Engine compartment: type A fuse box
- Remove the service cover (→P.375) and push the tabs in and lift the lid off.

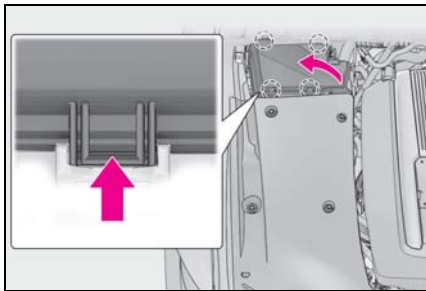

- ▶ Engine compartment: type B fuse box
- Remove the engine compartment cover (→P.374) and push the tabs in and lift the lid off.

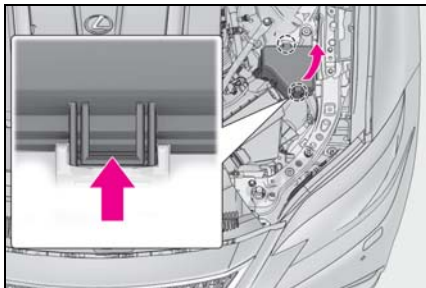

- ▶ Driver's side instrument panel
- Push the tab in and remove the lid.
Make sure to push the tab in during removal or installation.

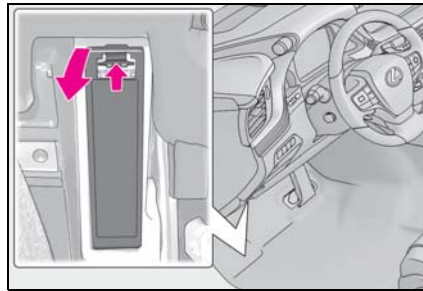

- ▶ Passenger's side instrument panel
- Push the tab in and remove the lid.
Make sure to push the tab in during removal or installation.

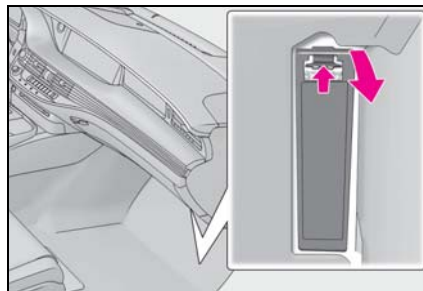

- ▶ Trunk
- Remove the luggage mat. (→P.340)

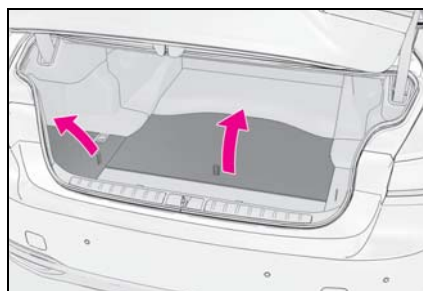

Push the tab in and lift the lid off.

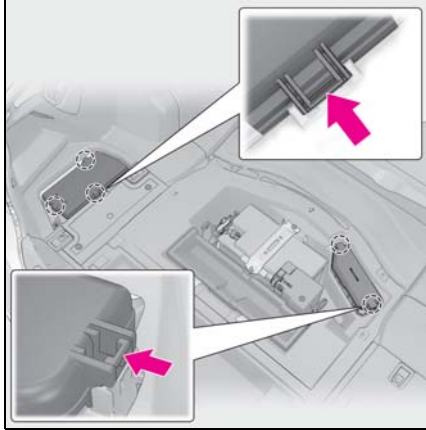

- 3** Remove the fuse with the pullout tool.
Only type A fuse can be removed using the pullout tool.

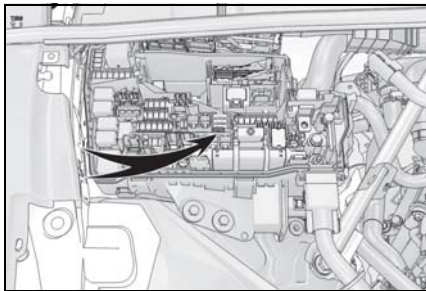

- 4** Check if the fuse is blown.

Type A and B:
Replace the blown fuse with a new fuse of an appropriate amperage rating. The amperage rating can be found on the fuse box lid.

Type C and D:
Contact your Lexus dealer.

► Type A

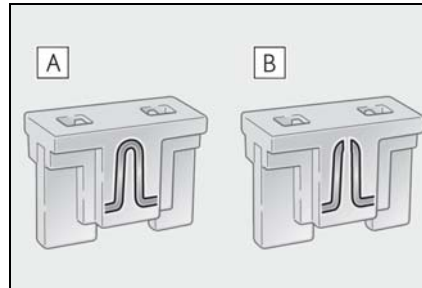

- A** Normal fuse
B Blown fuse

► Type B

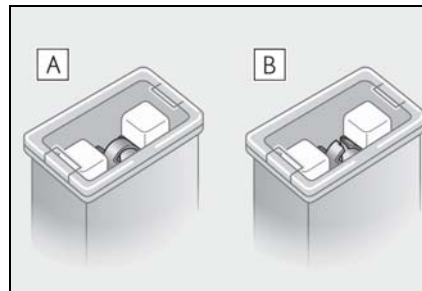

- A** Normal fuse
B Blown fuse

► Type C

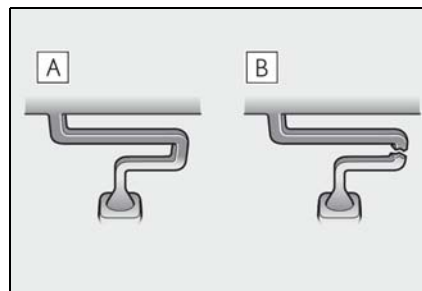

- A** Normal fuse
B Blown fuse

▶ Type D

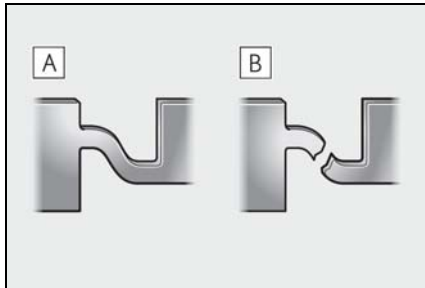

A Normal fuse

B Blown fuse

■ After a fuse is replaced

- When installing the lid, make sure that the tab is installed securely.
- If the lights do not turn on even after the fuse has been replaced, a bulb may need replacement.
- If the replaced fuse blows again, have the vehicle inspected by your Lexus dealer.

■ If there is an overload in a circuit

The fuses are designed to blow, protecting the wiring harness from damage.

⚠ WARNING

■ To prevent system breakdowns and vehicle fire

Observe the following precautions. Failure to do so may cause damage to the vehicle, and possibly a fire or injury.

- Never use a fuse of a higher amperage rating than that indicated, or use any other object in place of a fuse.
- Always use a genuine Lexus fuse or equivalent. Never replace a fuse with a wire, even as a temporary fix.
- Do not modify the fuses or fuse boxes.

⚠ NOTICE

■ Before replacing fuses

Have the cause of electrical overload determined and repaired by your Lexus dealer as soon as possible.

Light bulbs

If any lights burn out, have it replaced by your Lexus dealer.

■ LED Lights

The lights consist of a number of LEDs. If any of the LEDs burn out, take your vehicle to your Lexus dealer to have the light replaced.

■ Condensation build-up on the inside of the lens

Temporary condensation build-up on the inside of the headlight lens does not indicate a malfunction. Contact your Lexus dealer for more information in the following situations:

- Large drops of water have built up on the inside of the lens.
- Water has built up inside the headlight.

When trouble arises

7

7-1. Essential information

Emergency flashers..... 406

If your vehicle has to be stopped in
an emergency..... 406

If the vehicle is trapped in rising
water..... 407

7-2. Steps to take in an emergency

If your vehicle needs to be towed
..... 409

If you think something is wrong
..... 413

Fuel pump shut off system 414

If a warning light turns on or a
warning buzzer sounds 415

If a warning message is displayed
..... 425

If you have a flat tire..... 429

If the engine will not start 430

If you lose your keys..... 432

If the fuel filler door cannot be
opened..... 432

If the electronic key does not
operate properly 433

If the vehicle battery is discharged
..... 435

If your vehicle overheats 440

If the vehicle becomes stuck
..... 443

Emergency flashers

The emergency flashers are used to warn other drivers when the vehicle has to be stopped on the road due to a breakdown, etc.

Operating instructions

Press the switch to flash all of the turn signal lights.

To turn them off, press the switch once again.

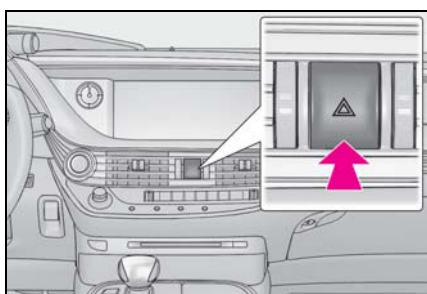

Emergency flashers

- If the emergency flashers are used for a long time while the engine is not running, the battery may discharge.
- If any of the SRS airbags deploy (inflate) or in the event of a strong rear impact, the emergency flashers will turn on automatically. The emergency flashers will turn off automatically after operating for approximately 20 minutes. To manually turn the emergency flashers off, press the switch twice. (The emergency flashers may not turn on automatically depending on the force of the impact and conditions of the collision.)

If your vehicle has to be stopped in an emergency

Only in an emergency, such as if it becomes impossible to stop the vehicle in the normal way, stop the vehicle using the following procedure:

Stopping the vehicle

- 1 Steadily step on the brake pedal with both feet and firmly depress it.

Do not pump the brake pedal repeatedly as this will increase the effort required to slow the vehicle.

- 2 Shift the shift position to N.
 - ▶ If the shift position is shifted to N
- 3 After slowing down, stop the vehicle in a safe place by the road.
- 4 Stop the engine.
 - ▶ If the shift position cannot be shifted to N
- 3 Keep depressing the brake pedal with both feet to reduce vehicle speed as much as possible.
- 4 To stop the engine, press and hold the engine switch for 2 consecutive

seconds or more, or press it briefly 3 times or more in succession.

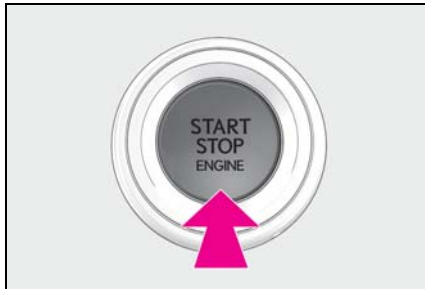

- 5 Stop the vehicle in a safe place by the road.

⚠ WARNING

■ If the engine has to be turned off while driving

Power assist for the steering wheel will be lost, making the steering wheel heavier to turn. Decelerate as much as possible before turning off the engine.

If the vehicle is trapped in rising water

In the event the vehicle is submerged in water, remain calm and perform the following.

- Remove the seat belt first.
- If the door can be opened, open the door and exit the vehicle.
- If the door can not be opened, open the window using the power window switch and exit the vehicle through the window.
- If the window can not be opened using the power window switch, remain calm, wait until the water level inside the vehicle rises to the point that the water pressure inside of the vehicle equals the water pressure outside of the vehicle, and then open the door and exit the vehicle.



WARNING

■ **Using an emergency hammer* for emergency escape**

The rear window of this vehicle can be shattered by an emergency hammer used for emergency escape, however, since the windshield, front side windows and rear side windows are laminated glass they can not be shattered by an emergency hammer.

*: Contact your Lexus dealer or after-market accessory manufacturer for further information about an emergency hammer.

■ **Escaping the vehicle from the window**

There are cases where escaping the vehicle from the window is not possible due to seating position, passenger body type, etc.

When using an emergency hammer, consider your seat location and the size of the window opening to ensure that the opening is accessible and large enough to escape.

If your vehicle needs to be towed

If towing is necessary, we recommend having your vehicle towed by your Lexus dealer or commercial towing service, using a wheel-lift type truck or flatbed truck.

Use a safety chain system for all towing, and abide by all state/provincial and local laws.

WARNING

Observe the following precautions. Failure to do so may result in death or serious injury.

■ When towing the vehicle

▶ 2WD models

Be sure to transport the vehicle with all four wheels raised off the ground. If the vehicle is towed with the tires contacting the ground, the drivetrain and related parts may be damaged or an accident may occur due to a change in direction of the vehicle.

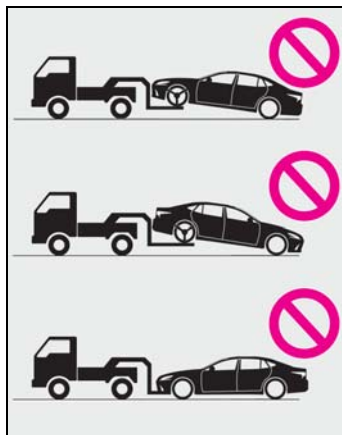

▶ AWD models

Be sure to transport the vehicle with all four wheels raised off the ground. If the vehicle is towed with the tires contacting the ground, the drivetrain or related parts may be damaged, the vehicle may fly off the truck.

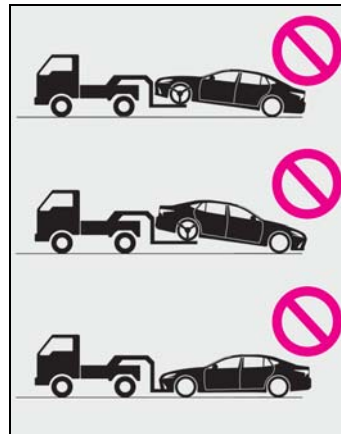

■ While towing

- When towing using cables or chains, avoid sudden starts, etc. which place excessive stress on the towing eyelets, cables or chains. The towing eyelets, cables or chains may become damaged, broken debris may hit people, and cause serious damage.
- Make sure to disable all functions of the vehicle height control of the electronically modulated air suspension. Otherwise, the vehicle height may change and part of your body may be caught under the vehicle, possibly causing injury. (→P.293)
- Do not turn the engine switch off. This may lead to an accident as the rear wheels will be locked by the parking lock. Also, there is a possibility that the steering wheel is locked and cannot be operated.

⚠ WARNING

■ **Installing towing eyelets to the vehicle**

Make sure that towing eyelets are installed securely. If not securely installed, towing eyelets may come loose during towing.

⚠ NOTICE

■ **To prevent damage to the vehicle when towing using a wheel-lift type truck**

- Do not tow the vehicle from the rear when the engine switch is off. The steering lock mechanism is not strong enough to hold the front wheels straight.
- When raising the vehicle, ensure adequate ground clearance for towing at the opposite end of the raised vehicle. Without adequate clearance, the vehicle could be damaged while being towed.

■ **To prevent damage to the vehicle when towing with a sling-type truck**

Do not tow with a sling-type truck, either from the front or rear.

■ **To prevent damage to the vehicle during emergency towing**

Do not secure cables or chains to the suspension components.

Situations when it is not possible to be towed by another vehicle

In the following situations, it is not possible to be towed by another vehicle using cables or chains, as the rear wheels may be locked due to the parking lock. Contact your Lexus dealer or commercial towing service.

- There is a malfunction in the shift

control system. (→P.167, 425)

- There is a malfunction in the engine immobilizer system. (→P.63)
- There is a malfunction in the smart access system with push-button start. (→P.433)
- The battery is discharged. (→P.435)

Situations when it is necessary to contact dealers before towing

The following may indicate a problem with your transmission. Contact your Lexus dealer or commercial towing service before towing.

- The engine is running but the vehicle does not move.
- The vehicle makes an abnormal sound.

Towing with a sling-type truck

Do not tow with a sling-type truck to prevent body damage.

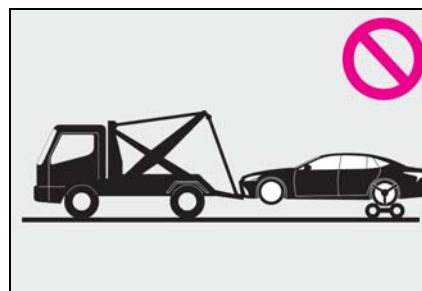

Towing with a wheel-lift type truck

- From the front

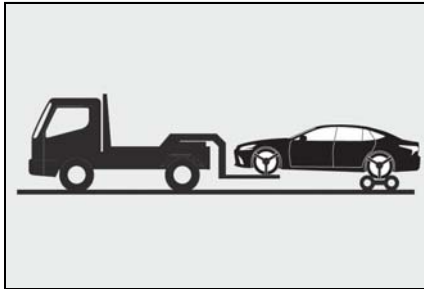

Use a towing dolly under the rear wheels.

- From the rear

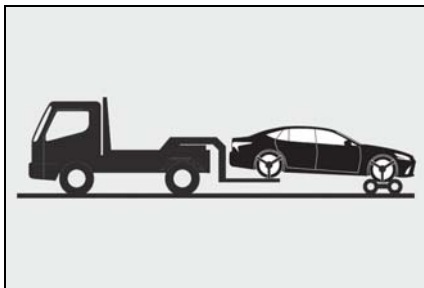

Use a towing dolly under the front wheels.

Using a flatbed truck

If your vehicle is transported by a flatbed truck, it should be tied down at the locations shown in the illustration.

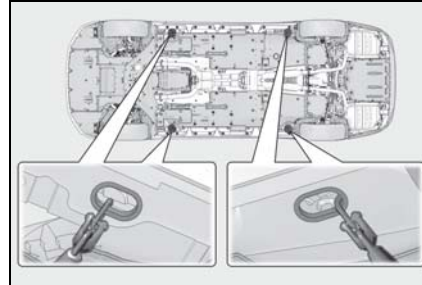

If you use chains or cables to tie down your vehicle, the angles shaded in black must be 45°.

Do not overly tighten the tie downs or the vehicle may be damaged.

Make sure to disable all functions of the vehicle height control of the electronically modulated air suspension. Otherwise, the vehicle height may change and the vehicle may be damaged. (→P.293)

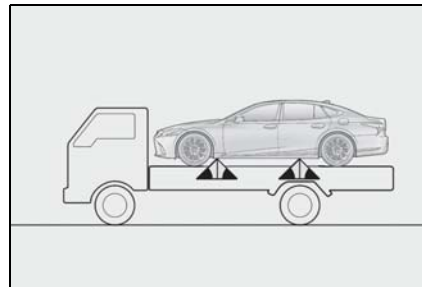

Emergency towing

If a tow truck is not available in an emergency, your vehicle may be temporarily towed using cables or chains secured to the emergency towing eyelets. This should only be attempted on hard surfaced roads for short distances at under 18 mph (30 km/h).

A driver must be in the vehicle to steer and operate the brakes. The vehicle's

wheels, drive train, axles, steering and brakes must be in good condition.

Emergency towing procedure

To have your vehicle towed by another vehicle, the towing eyelet must be installed to your vehicle. Install the towing eyelet using the following procedure.

- 1 Take out the phillips-head screwdriver and towing eyelet.

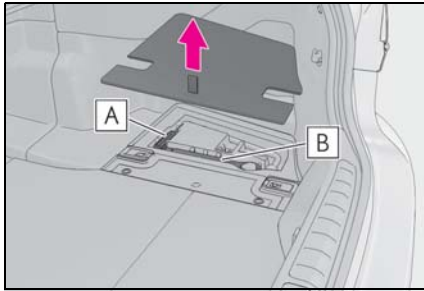

- A** Phillips-head screwdriver
- B** Towing eyelet

- 2 Remove the eyelet cover using a flathead screwdriver.

To protect the bodywork, place a rag between the screwdriver and the vehicle body as shown in the illustration.

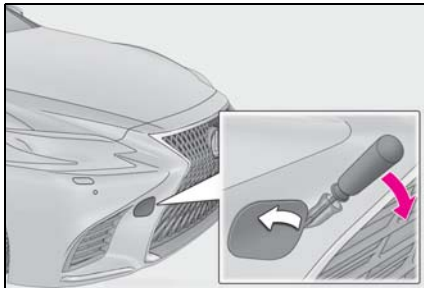

- 3 Insert the towing eyelet into the hole and tighten partially by hand.

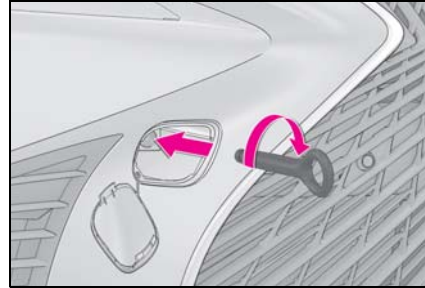

- 4 Tighten down the towing eyelet securely using a phillips-head screwdriver or hard metal bar.

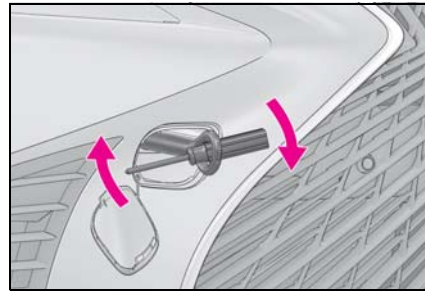

- 5 Securely attach cables or chains to the towing eyelet.

Take care not to damage the vehicle body.

- 6 Enter the vehicle being towed and start the engine.

If the engine does not start, turn the engine switch to IGNITION ON mode.

- 7 Shift the shift position to N and release the parking brake.

■ While towing

If the engine is not running, the power assist for the brakes and steering will not function, making steering and braking more difficult.

If you think something is wrong

If you notice any of the following symptoms, your vehicle probably needs adjustment or repair. Contact your Lexus dealer as soon as possible.

Visible symptoms

- Fluid leaks under the vehicle. (Water dripping from the air conditioning after use is normal.)
- Flat-looking tires or uneven tire wear
- Engine coolant temperature gauge needle continually points higher than normal.

Audible symptoms

- Changes in exhaust sound
- Excessive tire squeal when cornering
- Strange noises related to the suspension system
- Pinging or other noises related to the engine

Operational symptoms

- Engine missing, stumbling or running roughly
- Appreciable loss of power
- Vehicle pulls heavily to one side when braking

- Vehicle pulls heavily to one side when driving on a level road
- Loss of brake effectiveness, spongy feeling, pedal almost touches the floor

Fuel pump shut off system

To minimize the risk of fuel leakage when the engine stalls or when an airbag inflates upon collision, the fuel pump shut off system stops the supply of fuel to the engine.

Restarting the engine

Follow the procedure below to restart the engine after the system is activated.

- 1 Turn the engine switch to ACCESSORY mode or turn it off.
- 2 Restart the engine.

 NOTICE

■ **Before starting the engine**



Inspect the ground under the vehicle. If you find that fuel has leaked onto the ground, the fuel system has been damaged and is in need of repair. Do not restart the engine.

If a warning light turns on or a warning buzzer sounds



Calmly perform the following actions if any of the warning lights comes on or flashes. If a light comes on or flashes, but then goes off, this does not necessarily indicate a malfunction in the system. However, if this continues to occur, have the vehicle inspected by your Lexus dealer.

Actions to the warning lights or warning buzzers

■ Brake system warning light (warning buzzer)

Warning light	Details/Actions
 <p>BRAKE (U.S.A.) or  (red) (Canada)</p>	<p>Indicates that:</p> <ul style="list-style-type: none"> ● The brake fluid level is low; or ● The brake system is malfunctioning <p>→ Immediately stop the vehicle in a safe place and contact your Lexus dealer. Continuing to drive the vehicle may be dangerous.</p> <p>Indicates that the brake pads are worn out (only the right-side pads can be detected)</p> <p>→ Have the vehicle inspected by your Lexus dealer.</p>

■ Brake system warning light (warning buzzer)

Warning light	Details/Actions
 <p> (yellow)</p>	<p>Indicates a malfunction in:</p> <ul style="list-style-type: none"> ● The electronically controlled brake system (vehicles with Lexus Safety System + A); or ● The parking brake system <p>→ Have the vehicle inspected by your Lexus dealer immediately.</p>

■ High coolant temperature warning light* (warning buzzer)

Warning light	Details/Actions
	<p>Indicates that the engine coolant temperature is too high</p> <p>→ Immediately stop the vehicle in a safe place. Handling method (→P.440)</p>

*: This light illuminates on the multi-information display.

■ **Charging system warning light* (warning buzzer)**

Warning light	Details/Actions
	Indicates a malfunction in the vehicle's charging system → Immediately stop the vehicle in a safe place and contact your Lexus dealer.



* : This light illuminates on the multi-information display.

■ **Low engine oil pressure warning light* (warning buzzer)**

Warning light	Details/Actions
	Indicates that the engine oil pressure is too low → Immediately stop the vehicle in a safe place and contact your Lexus dealer.

* : This light illuminates on the multi-information display.

■ **Malfunction indicator lamp (warning buzzer)**

Warning light	Details/Actions
 (U.S.A.) or  (Canada)	Indicates a malfunction in: <ul style="list-style-type: none"> ● The electronic engine control system; ● The electronic throttle control system; or ● The electronic automatic transmission control system → Immediately stop the vehicle in a safe place and contact your Lexus dealer.



■ **SRS warning light (warning buzzer)**

Warning light	Details/Actions
	Indicates a malfunction in: <ul style="list-style-type: none"> ● The SRS airbag system; ● The front passenger occupant classification system; or ● The seat belt pretensioner system → Have the vehicle inspected by your Lexus dealer immediately.

■ **Pop Up Hood warning light (warning buzzer)**

Warning light	Details/Actions
	<p>Indicates that the Pop Up Hood system has operated → The Pop Up Hood system cannot be reused once it has operated. Have it replaced by your Lexus dealer.</p> <p>Indicates a malfunction in the Pop Up Hood system → Have the vehicle inspected by your Lexus dealer immediately.</p>

■ **ABS warning light (warning buzzer)**



Warning light	Details/Actions
 (U.S.A.) or  (Canada)	<p>Indicates a malfunction in:</p> <ul style="list-style-type: none"> ● The ABS; or ● The brake assist system <p>→ Have the vehicle inspected by your Lexus dealer immediately.</p>

■ **Brake Override System warning light/Drive-Start Control warning light* (warning buzzer)**

Warning light	Details/Actions
	<p>When a buzzer sounds:</p> <ul style="list-style-type: none"> ● Brake Override System is malfunctioning; ● Drive-Start Control is operating; ● Drive-Start Control is malfunctioning; or ● Parking Support Brake function (for static objects) is operating <p>→ Follow the instructions displayed on the multi-information display.</p> <p>When a buzzer does not sound: Brake Override System is operating → Release the accelerator pedal and depress the brake pedal.</p>

* : This light illuminates on the multi-information display.

■ Electric power steering system warning light (warning buzzer)

Warning light	Details/Actions
 (red) or  (yellow)	Indicates a malfunction in the EPS (Electric Power Steering) system → Have the vehicle inspected by your Lexus dealer immediately.

■ Low fuel level warning light

Warning light	Details/Actions
	Indicates that remaining fuel is approximately 3.4 gal. (13 L, 2.8 Imp. gal.) or less → Refuel the vehicle.

■ Driver's and front passenger's seat belt reminder light (warning buzzer)*

Warning light	Details/Actions
	Warns the driver and/or front passenger to fasten their seat belts → Fasten the seat belt. If the front passenger's seat is occupied, the front passenger's seat belt also needs to be fastened to make the warning light (warning buzzer) turn off.

* : Driver's seat belt warning buzzer:

The driver's seat belt warning buzzer sounds to alert the driver that his or her seat belt is not fastened. Once the engine switch is turned to IGNITION ON mode, the buzzer sounds for 6 seconds. If the vehicle reaches a speed of 12 mph (20 km/h), the buzzer sounds once. If the seat belt is still unfastened after 24 seconds, the buzzer will sound intermittently for 6 seconds. Then, if the seat belt is still unfastened, the buzzer will sound in a different tone for 90 more seconds.

Front passenger's seat belt warning buzzer:

The front passenger's seat belt warning buzzer sounds to alert the front passenger that his or her seat belt is not fastened. The buzzer sounds once if the vehicle reaches a speed of 12 mph (20 km/h). If the seat belt is still unfastened after 24 seconds, the buzzer will sound intermittently for 6 seconds. Then, if the seat belt is still unfastened, the buzzer will sound in a different tone for 90 more seconds.

■ Rear passengers' seat belt reminder lights^{*1} (warning buzzer)^{*2}

Warning light	Details/Actions
	Warns the rear passengers to fasten their seat belts → Fasten the seat belt.

^{*1}: This light illuminates on the center panel.

^{*2}: Rear passengers' seat belt warning buzzer:

The rear passengers' seat belt warning buzzer sounds to alert the rear passengers that his or her seat belt is not fastened. The buzzer sounds once if the vehicle reaches a speed of 12 mph (20 km/h). If the seat belt is still unfastened after 24 seconds, the buzzer will sound intermittently for 6 seconds. Then, if the seat belt is still unfastened, the buzzer will sound in a different tone for 30 more seconds.

■ Tire pressure warning light

Warning light	Details/Actions
	When the light comes on after blinking for approximately 1 minute: Malfunction in the tire pressure warning system → Have the system checked by your Lexus dealer. When the light comes on: Low tire inflation pressure such as <ul style="list-style-type: none"> ● Natural causes ● Flat tire → Immediately stop the vehicle in a safe place. Handling method (→P.423)

■ LTA indicator (warning buzzer)

Warning light	Details/Actions
 (orange)	Indicates a malfunction in the LTA (Lane Tracing Assist) → Follow the instructions displayed on the multi-information display. (→P.237)

■ Intuitive parking assist OFF indicator (warning buzzer)

Warning light	Details/Actions
 <p>(flashes) (if equipped)</p>	<p>Indicates a malfunction in the intuitive parking assist function → Have the vehicle inspected by your Lexus dealer immediately.</p> <p>Indicates that the system is temporarily unavailable, possibly due to a sensor being dirty or covered with ice, etc. → Follow the instructions displayed on the multi-information display. (→P.259)</p>

■ RCTA OFF indicator (warning buzzer)

Warning light	Details/Actions
 <p>(flashes) (if equipped)</p>	<p>Indicates a malfunction in the RCTA (Rear Cross Traffic Alert) function → Have the vehicle inspected by your Lexus dealer immediately.</p> <p>Indicates that the rear bumper around the radar sensor is covered with dirt, etc. (→P.251) → Follow the instructions displayed on the multi-information display. (→P.264)</p>

■ RCD OFF indicator (warning buzzer)

Warning light	Details/Actions
 <p>(flashes) (if equipped)</p>	<p>When a buzzer sounds: Indicates a malfunction in the RCD (Rear Camera Detection) function → Have the vehicle inspected by your Lexus dealer immediately.</p> <p>When a buzzer does not sound: Indicates that the function temporarily cannot be used due to the camera being dirty, etc. → Follow the instructions displayed on the multi-information display. (→P.268, 425)</p>

■ PKSB OFF indicator (warning buzzer)

Warning light	Details/Actions
 (flashes) (if equipped)	<p>When a buzzer sounds:</p> <p>Indicates a malfunction in the PKSB (Parking Support Brake) system → Have the vehicle inspected by your Lexus dealer immediately.</p> <p>When a buzzer does not sound:</p> <p>Indicates that the system is temporarily unavailable, possibly due to a sensor being dirty or covered with ice, etc. → Follow the instructions displayed on the multi-information display. (→P.274, 425)</p>

■ PCS warning light

Warning light	Details/Actions
 (flashes or illuminates)	<p>When a buzzer sounds simultaneously:</p> <p>Indicates a malfunction has occurred in the PCS (Pre-Collision System). → Have the vehicle inspected by your Lexus dealer immediately.</p> <p>If a buzzer does not sound:</p> <p>The PCS (Pre-Collision System) has become temporarily unavailable, corrective action may be necessary. → Follow the instructions displayed on the multi-information display. (→P.196, 202, 428)</p> <p>If the PCS (Pre-Collision System) or VSC (Vehicle Stability Control) system is disabled, the PCS warning light will illuminate. → P.214, 222</p>

■ Slip indicator

Warning light	Details/Actions
	<p>Indicates a malfunction in:</p> <ul style="list-style-type: none"> ● The VSC system; ● The TRAC system; ● The hill-start assist control system; ● The VGRS system (if equipped); or ● The DRS system (if equipped) <p>→ Have the vehicle inspected by your Lexus dealer immediately.</p>

■ Parking brake indicator (warning buzzer)

Warning light	Details/Actions
	Indicates a malfunction in the parking brake system → Have the vehicle inspected by your Lexus dealer immediately.

■ Brake hold operated indicator (warning buzzer)

Warning light	Details/Actions
	Indicates a malfunction in the brake hold system → Have the vehicle inspected by your Lexus dealer immediately.

■ Master warning light (warning buzzer)

Warning light	Details/Actions
	A buzzer sounds and the warning light comes on and flashes to indicate that the master warning system has detected a malfunction. → P.425

■ Warning buzzer

In some cases, the buzzer may not be heard due to being in a noisy location or audio sound.

■ Front passenger detection sensor, seat belt reminder and warning buzzer

- If luggage is placed on the front passenger seat, the front passenger detection sensor may cause the warning light to flash and the warning buzzer to sound even if a passenger is not sitting in the seat.
- If a cushion is placed on the seat, the sensor may not detect a passenger, and the warning light may not operate properly.

■ SRS warning light

This warning light system monitors the air-

bag sensor assembly, Pop Up Hood computer assembly, front impact sensors, side impact sensors (front door), side impact sensors (front), side impact sensors (rear), driver's seat position sensor, driver's seat belt buckle switch, front passenger occupant classification system (ECU and sensors), rear seat belt buckle switches (if equipped), "AIR BAG ON" indicator light, "AIR BAG OFF" indicator light, front passenger's seat belt buckle switch, seat belt pretensioners, airbags, interconnecting wiring and power sources. (→P.29)

■ If the malfunction indicator lamp comes on while driving

First check the following:

- Is the fuel tank empty?
If it is, fill the fuel tank immediately.
- Is the fuel tank cap loose?

If it is, tighten it securely.

The light will go off after several driving trips.

If the light does not go off even after several trips, contact your Lexus dealer as soon as possible.

■ **Electric power steering system warning light (warning buzzer)**

When the battery charge becomes insufficient or the voltage temporarily drops, the electric power steering system warning light may come on and the warning buzzer may sound.

■ **When the tire pressure warning light comes on**

Inspect the tires to check if a tire is punctured.

If a tire is punctured: →P.429

If none of the tires are punctured:
Turn the engine switch off then turn it to IGNITION ON mode. Check if the tire pressure warning light comes on or blinks.

- ▶ If the tire pressure warning light blinks for approximately 1 minute then stays on

There may be a malfunction in the tire pressure warning system. Have the vehicle inspected by your Lexus dealer immediately.

- ▶ If the tire pressure warning light comes on

- 1 After the temperature of the tires has lowered sufficiently, check the inflation pressure of each tire and adjust them to the specified level.
- 2 If the warning light does not turn off even after several minutes have elapsed, check that the inflation pressure of each tire is at the specified level and perform initialization. (→P.388)

■ **The tire pressure warning light may come on due to natural causes**

The tire pressure warning light may come on due to natural causes such as natural air leaks and tire inflation pressure changes caused by temperature. In this case, adjusting the tire inflation pressure will turn off the warning light (after a few minutes).

- **Conditions that the tire pressure warning system may not function properly**
→P.385

 **WARNING**

■ **If both the ABS and the brake system warning lights remain on**

Stop your vehicle in a safe place immediately and contact your Lexus dealer. The vehicle will become extremely unstable during braking, and the ABS system may fail, which could cause an accident resulting in death or serious injury.

■ **When the electric power steering system warning light comes on**

When the light comes on yellow, the assist to the power steering is restricted. When the light comes on red, the assist to the power steering is lost and handling operations of the steering wheel become extremely heavy.

When steering wheel operations are heavier than usual, grip the steering wheel firmly and operate it using more force than usual.

■ **If the tire pressure warning light comes on**

Be sure to observe the following precautions.

Failure to do so could cause a loss of vehicle control and result in death or serious injury.

- Decelerate to the lowest appropriate speed as soon as possible. Do not drive over 50 mph (80 km/h).
- Check and adjust the tire inflation pressure immediately.
- If the tire pressure warning light comes on even after tire inflation pressure adjustment, it is probable that you have a flat tire. Have the flat tire replaced by the nearest Lexus dealer.

 **WARNING**

- **Avoid abrupt maneuvering and braking.**
If the vehicle tires deteriorate, you could lose control of the steering wheel or the brakes.

- **If a blowout or sudden air leakage should occur**

The tire pressure warning system may not activate immediately.

- **Maintenance of the tires**

Each tire, including the spare (if provided), should be checked monthly when cold and inflated to the inflation pressure recommended by the vehicle manufacturer on the vehicle placard or tire inflation pressure label (tire and load information label). (If your vehicle has tires of a different size than the size indicated on the vehicle placard or tire inflation pressure label [tire and load information label], you should determine the proper tire inflation pressure for those tires.)

As an added safety feature, your vehicle has been equipped with a tire pressure monitoring system (TPMS-tire pressure warning system) that illuminates a low tire pressure telltale (tire pressure warning light) when one or more of your tires is significantly under-inflated. Accordingly, when the low tire pressure telltale (tire pressure warning light) illuminates, you should stop and check your tires as soon as possible, and inflate them to the proper pressure. Driving on a significantly under-inflated tire causes the tire to overheat and can lead to tire failure. Under-inflation also reduces fuel efficiency and tire tread life, and may affect the vehicle's handling and stopping ability.

Please note that the TPMS (tire pressure warning system) is not a substitute for proper tire maintenance, and it is the driver's responsibility to maintain correct tire pressure, even if under-inflation has not reached the level to trigger illumination of the TPMS low tire pressure telltale (tire pressure warning light).

Your vehicle has also been equipped with a TPMS (tire pressure warning system) malfunction indicator to indicate when the system is not operating properly. The TPMS (tire pressure warning system) malfunction indicator is combined with the low tire pressure telltale (tire pressure warning light). When the system detects a malfunction, the telltale will flash for approximately one minute and then remain continuously illuminated. This sequence will continue upon subsequent vehicle start-ups as long as the malfunction exists. When the malfunction indicator is illuminated, the system may not be able to detect or signal low tire pressure as intended.

TPMS (tire pressure warning system) malfunctions may occur for a variety of reasons, including the installation of replacement or alternate tires or wheels on the vehicle that prevent the TPMS (tire pressure warning system) from functioning properly. Always check the TPMS (tire pressure warning system) malfunction telltale after replacing one or more tires or wheels on your vehicle to ensure that the replacement or alternate tires and wheels allow the TPMS (tire pressure warning system) to continue to function properly.

 **NOTICE**

- **To ensure the tire pressure warning system operates properly**

Do not install tires with different specifications or makers, as the tire pressure warning system may not operate properly.

If a warning message is displayed

The multi-information display shows warnings of system malfunctions, incorrectly performed operations, and messages that indicate a need for maintenance. When a message is shown, perform the correction procedure appropriate to the message.

Except F SPORT models:

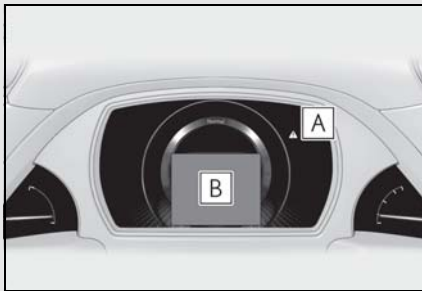

A Master warning light

The master warning light also comes on or flashes in order to indicate that a message is currently being displayed on the multi-information display.

B Multi-information display

Follow the instructions of the message on the multi-information display.

If any of the warning messages are shown again after the appropriate actions have been performed, contact your Lexus dealer.

F SPORT models (main meter in center position):

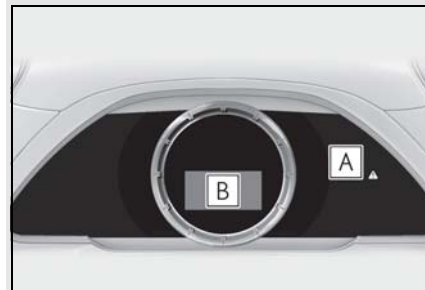

A Master warning light

The master warning light also comes on or flashes in order to indicate that a message is currently being displayed on the multi-information display.

B Multi-information display

Follow the instructions of the message on the multi-information display.

If any of the warning messages are shown again after the appropriate actions have been performed, contact your Lexus dealer.

F SPORT models (main meter moved to the right):

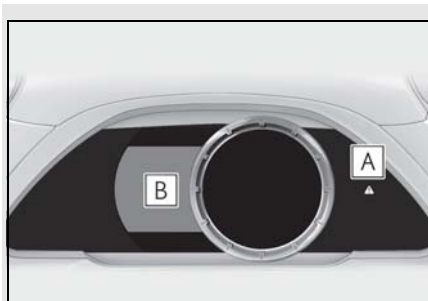

A Master warning light

The master warning light also comes on or flashes in order to indicate that a message is currently being displayed on the multi-information display.

B Multi-information display

Follow the instructions of the message on the multi-information display.

If any of the warning messages are shown again after the appropriate actions have been performed, contact your Lexus dealer.

Messages and warnings

The master warning light and warning buzzers operate as follows depending on the content of the message. If a message indicates the need for inspection by a dealer, have the vehicle inspected by your Lexus dealer immediately.

	Warning buzzer *	Warning
Comes on	Sounds	Indicates an important situation, such as when a system related to driving is malfunctioning or that danger may result if the correction procedure is not performed
Flashes	Sounds	Indicates a situation, such as when damage to the vehicle or danger may result

	Warning buzzer *	Warning
Comes on	Does not sound	Indicates a condition, such as malfunction of electrical components, their condition, or indicates the need for maintenance
Flashes	Does not sound	Indicates a situation, such as when an operation has been performed incorrectly, or indicates how to perform an operation correctly

- In some situations, the master warning light and warning buzzer may not operate as specified. In this case, follow the instructions displayed in the warning message.
- If a warning light comes on or flashes at the same time that a warning message is displayed, take corrective action according to the warning light. (→P.415)

* : A buzzer sounds the first time a message is shown on the multi-information display.

■ **Warning messages**

The warning messages explained below may differ from the actual messages according to operation conditions and vehicle specifications.

■ **Warning buzzer**

In some cases, the buzzer may not be heard due to being in a noisy location or audio sound.

■ **If “Engine Oil Level Low Add or Replace” is displayed**

The engine oil level is low. Check the level of the engine oil, and add if necessary.

This message may appear if the vehicle is stopped on a slope. Move the vehicle to a level surface and check to see if the message disappears.

■ **If “Engine Stopped Steering Power Low” is displayed**

This message is displayed if the engine is stopped while driving.

When steering wheel operations are heavier than usual, grip the steering wheel firmly and operate it using more force than usual.

■ **If “Auto Power Off to Conserve Battery” is displayed**

Power was turned off due to the automatic power off function. Next time when starting the engine, increase the engine speed slightly and maintain that level for approximately 5 minutes to recharge the battery.

■ **If “Headlight System Malfunction Visit Your Dealer” is displayed**

The following systems may be malfunctioning. Have the vehicle inspected by your Lexus dealer immediately.

- The LED headlight system
- AFS (Adaptive Front-lighting System)
- The automatic headlight leveling system
- AHB (Automatic High Beam)

■ **If “Radar Cruise Control Unavailable See Owner’s Manual” is displayed**

The dynamic radar cruise control with full-speed range system is suspended temporarily or until the problem shown in the message is resolved. (causes and coping methods: →P.196, 202)

■ **If “Radar Cruise Control Unavailable” is displayed**

The dynamic radar cruise control with full-speed range system cannot be used temporarily. Use the system when it

becomes available again.

■ If “Front Camera Unavailable” or “Front Camera Unavailable See Owner’s Manual” is displayed

The following systems may be suspended until the problem shown in the message is resolved. (→P.196, 202, 421)

- PCS (Pre-Collision system)
- LTA (Lane Tracing Assist)
- Dynamic radar cruise control with full-speed range
- RSA (Road Sign Assist) (if equipped)
- AHB (Automatic High Beam)

■ If “Maintenance Required Soon” is displayed

Indicates that all maintenance according to the driven distance on the maintenance schedule* should be performed soon.

Comes on approximately 4500 miles (7200 km) after the message has been reset. If necessary, perform maintenance. Please reset the message after the maintenance is performed. (→P.364)

*: Refer to the separate “Scheduled Maintenance” or “Owner’s Manual Supplement” for the maintenance interval applicable to your vehicle.

■ If “Maintenance Required Visit Your Dealer” is displayed

Indicates that all maintenance is required to correspond to the driven distance on the maintenance schedule*.

Comes on approximately 5000 miles (8000 km) after the message has been reset. (The indicator will not work properly unless the message has been reset.) Perform the necessary maintenance. Please reset the message after the maintenance is performed. (→P.364)

*: Refer to the separate “Scheduled Maintenance” or “Owner’s Manual Supplement” for the maintenance interval applicable to your vehicle.

■ If “Oil Maintenance Required Soon” is displayed

Indicates that the engine oil should be scheduled to be changed.

Check the engine oil and change it if necessary. After changing the engine oil, make sure to reset the message. (→P.377)

■ If “Oil Maintenance Required” is displayed

Indicates that the engine oil should be changed.

Check and change the engine oil, and oil filter by your Lexus dealer. After changing the engine oil, make sure to reset the message. (→P.377)

■ If “Shift System Malfunction Driving Unavailable” is displayed

There is a malfunction in the shift control system. Have the vehicle inspected by your Lexus dealer immediately.

■ If a message that indicates the need for the shift lever operation is displayed

To prevent the shift lever from being operated incorrectly or the vehicle from moving unexpectedly, a message that requires shifting the shift position may be displayed on the multi-information display. In that case, follow the instruction of the message and shift the shift position.

■ If a message that indicates the need for visiting your Lexus dealer is displayed

The system or part shown on the multi-information display is malfunctioning. Have the vehicle inspected by your Lexus dealer immediately.

■ If a message that indicates the need for referring to Owner’s Manual is displayed

- If any of the following messages are shown on the multi-information display, follow the instructions.
 - “Engine Coolant Temp High” (→P.440)
 - “Battery Low” (→P.435)
 - “Transmission Fluid Temp High” (→P.168)
- If any of the following messages are shown on the multi-information display, it may indicate a malfunction. Have the vehicle inspected by your Lexus dealer

- immediately.
- “Access System with Elec. Key Malfunction”
 - “Shift System Malfunction”
 - “P Switch Malfunction”
 - “Shift System Unavailable”
- If any of the following messages are shown on the multi-information display, it may indicate a malfunction. Immediately stop the vehicle and contact your Lexus dealer.
- “Braking Power Low”
 - “Charging System Malfunction”
 - “Oil Pressure Low”



NOTICE

■ If “High Power Consumption Partial Limit On AC/Heater Operation” is displayed frequently

There is a possible malfunction relating to the charging system or the battery may be deteriorating. Have the vehicle inspected by your Lexus dealer.

If you have a flat tire

Your vehicle is not equipped with a spare tire, but instead you can continue driving the vehicle with run-flat tires even if any tire goes flat.

In this case, slow down and drive with extra caution.

Run-flat tires

Take your vehicle to the nearest Lexus dealer or authorized tire dealer as soon as possible if any tire goes flat.

The vehicle can be driven for a maximum of 100 miles (160 km) at a speed below 50 mph (80 km/h) after the tire pressure warning light comes on. (→P.419)

A run-flat tire has a  mark on the side wall.



■ In some conditions (such as at high temperatures)

You cannot continue driving for up to 160 miles (100 km).

■ For the detailed information on run-flat tires

See the tire warranty booklet.

 NOTICE

■ **When replacing the tires**
 When removing or fitting the wheels, tires or the tire pressure warning valve and transmitter, contact your Lexus dealer as the tire pressure warning valve and transmitter may be damaged if not handled correctly.

■ **When driving over bumps**
 If a vehicle has a flat tire, the vehicle height will be lower than usual. Ensure that nothing strikes the bottom of the vehicle.

■ **To avoid damage to the tire pressure warning valves and transmitters**
 When a tire is repaired with liquid sealants, the tire pressure warning valve and transmitter may not operate properly. If a liquid sealant is used, contact your Lexus dealer or other qualified service shop as soon as possible. Make sure to replace the tire pressure warning valve and transmitter when replacing the tire. (→P.387)

If the engine will not start

If the engine will not start even though correct starting procedures are being followed (→P.164), consider each of the following points:

The engine will not start even though the starter motor operates normally.

- One of the following may be the cause of the problem:
- There may not be sufficient fuel in the vehicle's tank.
 Refuel the vehicle.
 - The engine may be flooded.
 Try to restart the engine again following correct starting procedures. (→P.164)
 - There may be a malfunction in the engine immobilizer system. (→P.63)
 - There may be a malfunction in the shift control system. * (→P.167, 428)
- * : It may not be possible to shift the shift position from P.

The starter motor turns over slowly, the interior lights and headlights are dim, or the horn does not sound or sounds at a low volume.

- One of the following may be the cause of the problem:
- The battery may be discharged.

(→P.435)

- The battery terminal connections may be loose or corroded. (→P.380)

The starter motor does not turn over

The engine starting system may be malfunctioning due to an electrical problem such as electronic key battery depletion or a blown fuse. However, an interim measure is available to start the engine. (→P.431)

The starter motor does not turn over, the interior lights and headlights do not turn on, or the horn does not sound.

One of the following may be the cause of the problem:

- One or both of the battery terminals may be disconnected. (→P.380)
- The battery may be discharged. (→P.435)
- There may be a malfunction in the steering lock system.

Contact your Lexus dealer if the problem cannot be repaired, or if repair procedures are unknown.

Starting the engine in an emergency

When the engine does not start, the following steps can be used as an interim measure to start the engine if the engine switch is functioning nor-

mally.

Do not use this starting procedure except in cases of emergency.

- 1 Press the parking brake switch to check that the parking brake is set. (→P.174)

Parking brake indicator will come on.

- 2 Turn the engine switch to ACCESSORY mode.
- 3 Press and hold the engine switch for about 15 seconds while depressing the brake pedal firmly.

Even if the engine can be started using the above steps, the system may be malfunctioning. Have the vehicle inspected by your Lexus dealer.

If you lose your keys

New genuine mechanical keys can be made by your Lexus dealer using another mechanical key and the key number stamped on your key number plate.

Keep the plate in a safe place such as your wallet, not in the vehicle.

 NOTICE

■ **When an electronic key is lost**

If the electronic key remains lost, the risk of vehicle theft increases significantly. Visit your Lexus dealer immediately with all remaining electronic keys and the card key (if equipped) that were provided with your vehicle.

If the fuel filler door cannot be opened

If the fuel filler door opener switch cannot be operated, contact your Lexus dealer to service the vehicle. In case where refueling is urgently necessary, the following procedure can be used to open the fuel filler door.

Opening the fuel filler door

Remove the cover inside the trunk and pull the lever.

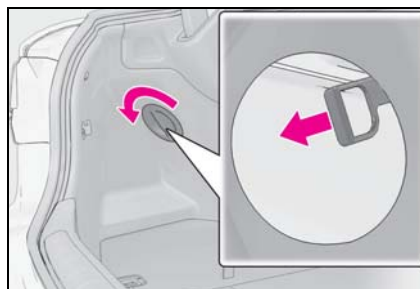

If the electronic key does not operate properly

If communication between the electronic key and vehicle is interrupted (→P.113) or the electronic key cannot be used because the battery is depleted, the smart access system with push-button start and wireless remote control cannot be used. In such cases, the doors and trunk can be opened and the engine can be started by following the procedure below.

■ When the electronic key does not work properly

- Make sure that the smart access system with push-button start has not been disabled at your Lexus dealer. If it has been disabled, re-enable it.
- Check if battery-saving mode is set. If it is set, cancel the function. (→P.113)

⚠ NOTICE

■ In case of a smart access system with push-button start malfunction or other key-related problems

Take your vehicle with all the electronic keys provided with your vehicle to your Lexus dealer.

Locking and unlocking the doors, unlocking the trunk

■ Unlocking the door

Use the mechanical key (→P.98) in order to perform the following operations:

- 1 Pull the driver's door handle and insert the mechanical key.

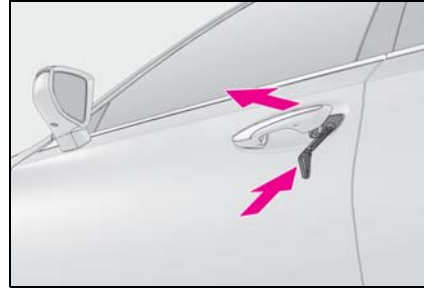

- 2 Unlock the door.

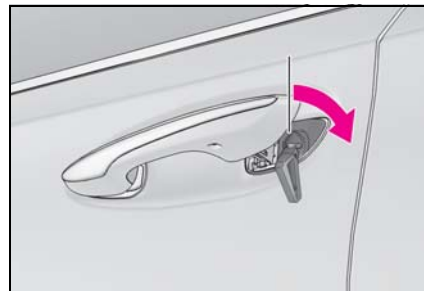

- 3 Remove the key, return the handle, and then pull the handle again.

■ Locking the door

- 1 With the door open, push down the inside lock button.

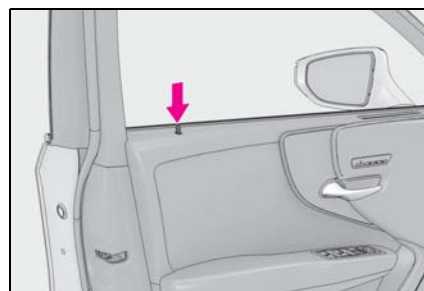

- 2 Close the door.

■ Trunk

Turn the mechanical key clockwise to open. (→P.65)

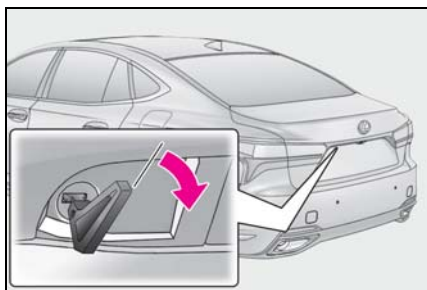

■ Key linked functions

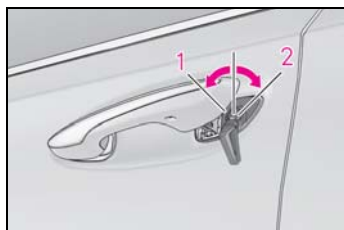

- 1 Closes the windows and the moon roof* or panoramic moon roof* (turn and hold)
- 2 Opens the windows and the moon roof* or panoramic moon roof* (turn and hold)

These settings must be customized at your Lexus dealer.

* : If equipped

⚠ WARNING

■ When using the mechanical key and operating the power windows or the moon roof or panoramic moon roof

Operate the power window or the moon roof or panoramic moon roof after checking to make sure that there is no possibility of any passenger having any of their body parts caught in the window or the moon roof or panoramic moon roof. Also, do not allow children to operate the mechanical key. It is possible for children and other passengers to get caught in the power window or the moon roof or panoramic moon roof.

Starting the engine

- 1 Depress the brake pedal.
- 2 Touch the Lexus emblem side of the electronic key to the engine switch.

When the electronic key is detected, a buzzer sounds and the engine switch will turn to IGNITION ON mode.

When the smart access system with push-button start is deactivated in customization setting, the engine switch will turn to ACCESSORY mode.

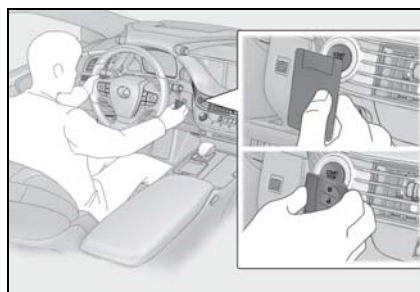

- 3 Firmly depress the brake pedal and check that  is shown on the multi-information display.
- 4 Press the engine switch.

In the event that the engine still cannot be started, contact your Lexus dealer.

■ Stopping the engine

Set the parking brake, shift the shift position to P and press the engine switch as you normally do when stopping the engine.

■ Electronic key battery

As the above procedure is a temporary measure, it is recommended that the electronic key battery be replaced immediately when the battery is depleted. (→P.399)

■ Changing engine switch modes

Release the brake pedal and press the engine switch in step 3 above. The engine does not start and modes will be changed each time the switch is pressed. (→P.166)

If the vehicle battery is discharged

The following procedures may be used to start the engine if the vehicle's battery is discharged. You can also call your Lexus dealer or a qualified repair shop.

Restarting the engine

If you have a set of jumper (or booster) cables and a second vehicle with a 12-volt battery, you can jump start your vehicle by following the steps below.

► Method connecting jumper (or booster) cables to the battery

- 1 Confirm that the electronic key is being carried.
- 2 Open the trunk lid and remove the luggage mat. (→P.340)
- 3 Connect a positive jumper cable clamp to **A** on your vehicle and connect the clamp on the other end of the positive cable to **B** on the second vehicle. Then, connect a negative cable clamp to **C** on the second vehicle and connect the clamp at the other end of the negative cable to **D**.

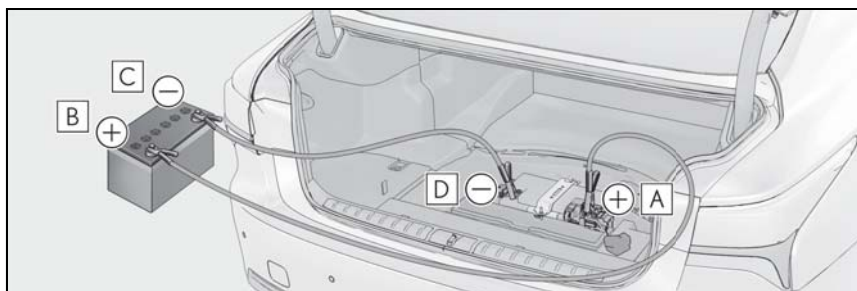

- A** Positive (+) battery terminal (your vehicle)
- B** Positive (+) battery terminal (second vehicle)
- C** Negative (-) battery terminal (second vehicle)
- D** Negative (-) battery terminal (your vehicle)

When connecting the jumper (or booster) cables, depending on the situation, the alarm may activate and doors locked. (→P.66)

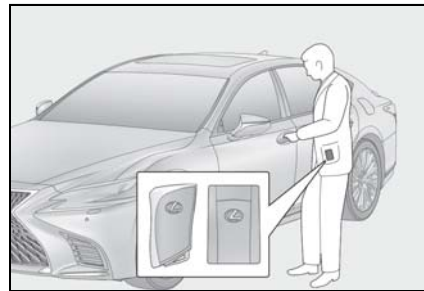

- 2 Open the trunk lid and remove the luggage mat. (→P.340)

In the event that the trunk opener cannot be used, use the mechanical key to open the trunk. (→P.433)

436 7-2. Steps to take in an emergency

- 4** Start the engine of the second vehicle. Increase the engine speed slightly and maintain at that level for approximately 5 minutes to recharge the battery of your vehicle.
 - 5** Open and close any of the doors of your vehicle with the engine switch off.
 - 6** Maintain the engine speed of the second vehicle and start the engine of your vehicle by turning the engine switch to IGNITION ON mode.
 - 7** Once the vehicle's engine has started, remove the jumper cables in the exact reverse order from which they were connected.
- ▶ Method connecting jumper (or booster) cables to the exclusive jump starting terminal
- 1** Confirm that the electronic key is being carried.

When connecting the jumper (or booster) cables, depending on the situation, the alarm may activate and doors locked. (→P.66)

- 2** Open the hood. Remove the passenger side engine compartment cover. (→P.371, 374)
- 3** Remove the service cover. (→P.375)
- 4** Open the fuse box cover. Push the tab in and lift the lid off.

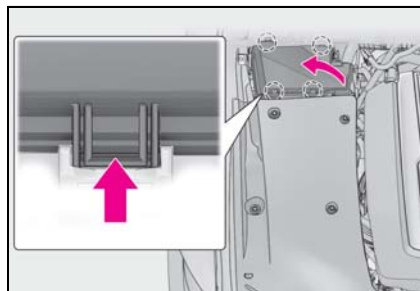

- 5** Open the exclusive jump starting terminal cover.

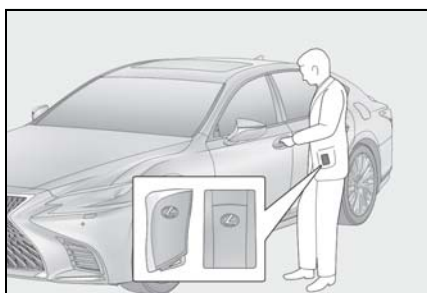
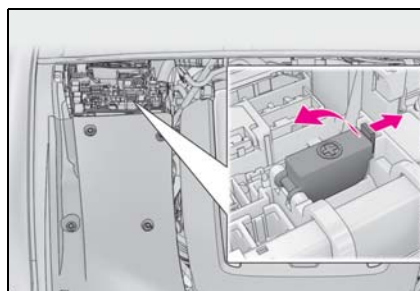

- 6** Connect a positive jumper cable clamp to **A** on your vehicle and connect the clamp on the other end of the positive cable to **B** on the second vehicle. Then,

connect a negative cable clamp to **C** on the second vehicle and connect the clamp at the other end of the negative cable to **D**.

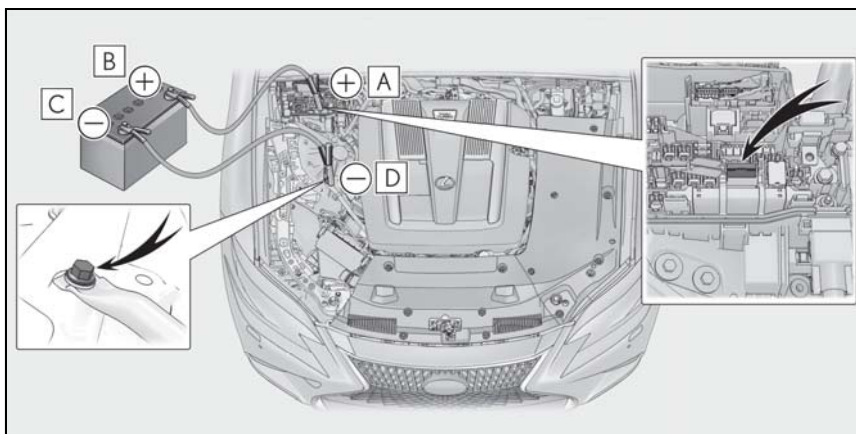

- A** Exclusive jump starting terminal (your vehicle)
 - B** Positive (+) battery terminal (second vehicle)
 - C** Negative (-) battery terminal (second vehicle)
 - D** Solid, stationary, unpainted metallic point away from the exclusive jump starting terminal and any moving parts as shown in the illustration
- 7** Start the engine of the second vehicle. Increase the engine speed slightly and maintain at that level for approximately 5 minutes to recharge the battery of your vehicle.
 - 8** Open and close any of the doors of your vehicle with the engine switch off.
 - 9** Maintain the engine speed of the second vehicle and start the engine of your vehicle by turning the engine switch to IGNITION ON mode.
 - 10** Once the vehicle's engine has started, remove the jumper cables in the exact reverse order from which they were connected.
 - 11** Close the exclusive jump starting terminal cover, and reinstall the fuse box cover to its original position.
 - 12** Install the service cover. (→P.375)
 - 13** Install the engine compartment cover.
- Once the engine starts, have the vehicle inspected at your Lexus dealer as soon as possible.
-
- **Starting the engine when the battery is discharged**
- The engine cannot be started by push-starting.
- **To prevent battery discharge**
- Turn off the headlights and the audio system while the engine is off.
 - Turn off any unnecessary electrical components when the vehicle is running at a

low speed for an extended period, such as in heavy traffic.

■ **When the battery is removed or discharged**

- Information stored in the ECU is cleared. When the battery is depleted, have the vehicle inspected at your Lexus dealer.
- Some systems may require initialization. (→P.481)

■ **When removing the battery terminals**

When the battery terminals are removed, the information stored in the ECU is cleared. Before removing the battery terminals, contact your Lexus dealer.

■ **Charging the battery**

The electricity stored in the battery will discharge gradually even when the vehicle is not in use, due to natural discharge and the draining effects of certain electrical appliances. If the vehicle is left for a long time, the battery may discharge, and the engine may be unable to start. (The battery recharges automatically during driving.)

■ **When recharging or replacing the battery**

- In some cases, it may not be possible to unlock the doors using the smart access system with push-button start when the battery is discharged. Use the wireless remote control or the mechanical key to lock or unlock the doors.
- The engine may not start on the first attempt after the battery has recharged but will start normally after the second attempt. This is not a malfunction.
- The engine switch mode is memorized by the vehicle. When the battery is reconnected, the system will return to the mode it was in before the battery was discharged. Before disconnecting the battery, turn the engine switch off. If you are unsure what mode the engine switch was in before the battery discharged, be especially careful when reconnecting the battery.

■ **When replacing the battery**

- Use a Central Degassing type battery (European Regulations).

- Use a battery with the same case size as the previous battery and an equivalent 20 hour rate capacity (20HR) or greater.
- If the sizes differ, the battery cannot be properly secured.
- If the 20 hour rate capacity is low, even if the time period where the vehicle is not used is a short time, the battery may discharge and the engine may not be able to start.
- Use a battery with a handle. If a battery without a handle is used, removal is more difficult.
- After replacing, firmly attach the following items to the exhaust hole of the battery.
- Use the exhaust hose that was attached to the battery before replacing and confirm that it is firmly connected to the hole section of the vehicle.
- Use the exhaust hole plug included with the battery replaced or the one installed on the battery prior to the replacement. (Depending on the battery to be replaced, the exhaust hole may be plugged.)

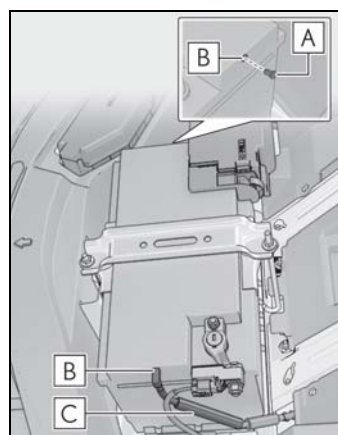

A Exhaust hole plug

B Exhaust hole

C Exhaust hose

For details, consult your Lexus dealer.

⚠ WARNING**■ When removing the battery terminals**

Always remove the negative (-) terminal first. If the positive (+) terminal contacts any metal in the surrounding area when the positive (+) terminal is removed, a spark may occur, leading to a fire in addition to electrical shocks and death or serious injury.

■ Avoiding battery fires or explosions

Observe the following precautions to prevent accidentally igniting the flammable gas that may be emitted from the battery:

- Make sure each jumper cable is connected to the correct terminal and that it is not unintentionally in contact with any other than the intended terminal.
- Do not allow the other end of the jumper cable connected to the "+" terminal to come into contact with any other parts or metal surfaces in the area, such as brackets or unpainted metal.
- Do not allow the + and - clamps of the jumper cables to come into contact with each other.
- Do not smoke, use matches, cigarette lighters or allow open flame near the battery.

■ Battery precautions

The battery contains poisonous and corrosive acidic electrolyte, while related parts contain lead and lead compounds. Observe the following precautions when handling the battery:

- When working with the battery, always wear safety glasses and take care not to allow any battery fluids (acid) to come into contact with skin, clothing or the vehicle body.
- Do not lean over the battery.

- In the event that battery fluid comes into contact with the skin or eyes, immediately wash the affected area with water and seek medical attention. Place a wet sponge or cloth over the affected area until medical attention can be received.

- Always wash your hands after handling the battery support, terminals, and other battery-related parts.

- Do not allow children near the battery.

■ After recharging the battery

Have the battery inspected at your Lexus dealer as soon as possible.

If the battery is deteriorating, continued use may cause the battery to emit a malodorous gas, which may be detrimental to the health of passengers.

■ When replacing the battery

- When the vent plug and indicator are close to the hold down clamp, the battery fluid (sulfuric acid) may leak.
- For information regarding battery replacement, contact your Lexus dealer.
- After replacing, securely attach the exhaust hose and exhaust hole plug to the exhaust hole of the replaced battery. If not properly installed, gases (hydrogen) may leak into the vehicle interior, and there is the possible danger of the gas igniting and exploding.

⚠ NOTICE**■ When handling jumper cables**

When connecting the jumper cables, ensure that they do not become entangled in the cooling fan or engine drive belt.

■ To prevent damaging the vehicle

The exclusive jump starting terminal is to be used when charging the battery from another vehicle in an emergency. It cannot be used to jump start another vehicle.

If your vehicle overheats

The following may indicate that your vehicle is overheating.

- The engine coolant temperature gauge (→P.73, 76) is in the red zone or a loss of engine power is experienced. (For example, the vehicle speed does not increase.)
- “Engine Coolant Temp High Stop in a Safe Place See Owner’s Manual” is shown on the multi-information display.
- Steam comes out from under the hood.

Correction procedures

- 1 Stop the vehicle in a safe place and turn off the air conditioning system, and then stop the engine.
- 2 If you see steam: Carefully lift the hood after the steam subsides.
If you do not see steam: Carefully lift the hood.
- 3 After the engine has cooled down sufficiently, inspect the hoses and

radiator core (radiator) for any leaks.

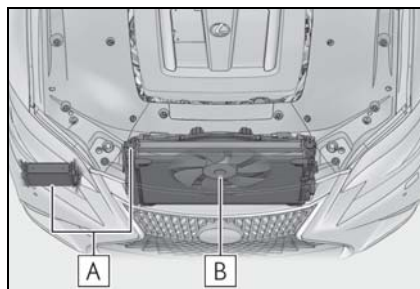

- A** Radiators
- B** Cooling fan

If a large amount of coolant leaks, immediately contact your Lexus dealer.

- 4 The coolant level is satisfactory if it is between the “F” and “L” lines on the reservoir.

- Engine

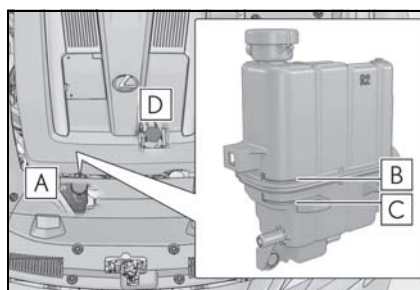

- A** Reservoir
- B** “F” line
- C** “L” line
- D** Coolant inlet cap

- Intercooler

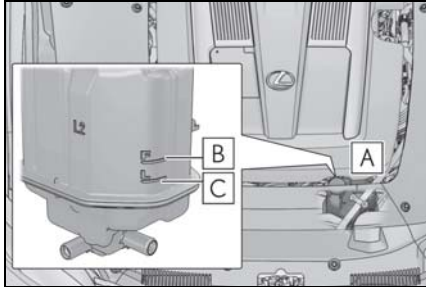

A Reservoir

B "F" line

C "L" line

5 Add coolant if necessary.

Water can be used in an emergency if coolant is unavailable.

● Engine

→P.441

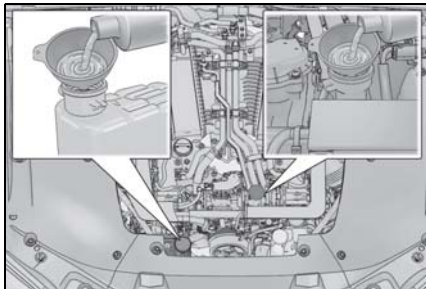

● Intercooler

Remove the engine compartment cover and add coolant.

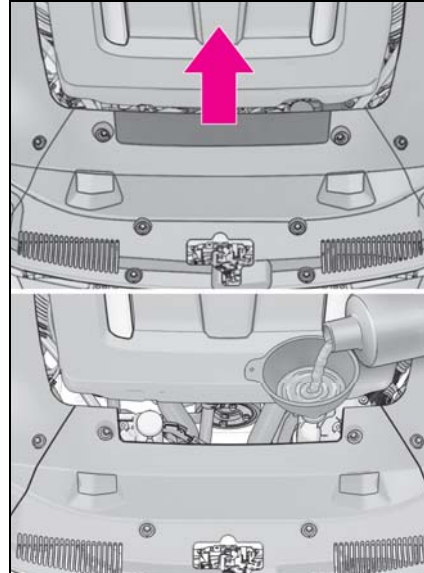

6 Start the engine and turn the air conditioning system on to check that the radiator cooling fan operates and to check for coolant leaks from the radiator or hoses.

The fan operates when the air conditioning system is turned on immediately after a cold start. Confirm that the fan is operating by checking the fan sound and air flow. If it is difficult to check these, turn the air conditioning system on and off repeatedly. (The fan may not operate in freezing temperatures.)

7 If the fan is not operating:
Stop the engine immediately and contact your Lexus dealer.
If the fan is operating:
Have the vehicle inspected at the nearest Lexus dealer.

■ When adding engine coolant

Add coolant in accordance with the following procedure.

- 1 Remove the engine compartment cover.

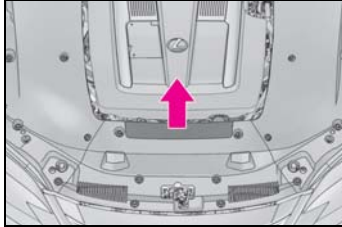

- 2 Remove the engine cover.
Lift the front of the engine cover straight up and then pull it forward.

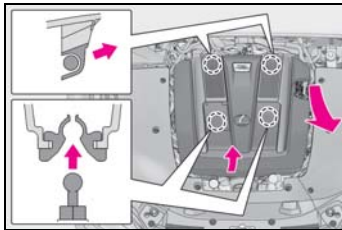

- 3 Remove the caps **A** and **B**.

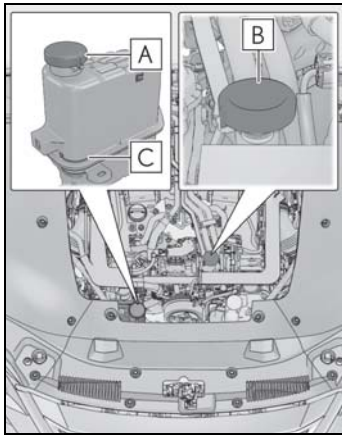

- 4 Add coolant through the inlet of the cap **A** up to the "F" line **C**, and then replace the cap **A**.
- 5 Add coolant through the inlet of the cap **B** until it is full, and then replace the cap **B**.
- 6 Install the engine compartment cover and engine cover.

Engage the claws of the engine cover to

install it.

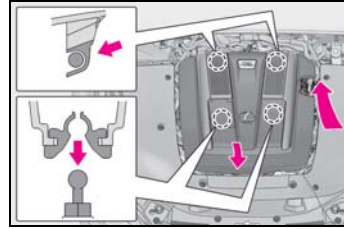

WARNING

When inspecting under the hood of your vehicle

Observe the following precautions. Failure to do so may result in serious injury such as burns.

- If steam is seen coming from under the hood, do not open the hood until the steam has subsided. The engine compartment may be very hot.
- Keep hands and clothing (especially a tie, a scarf or a muffler) away from the fan and belts. Failure to do so may cause the hands or clothing to be caught, resulting in serious injury.
- Do not loosen the coolant inlet cap, the engine coolant reservoir cap or the intercooler coolant reservoir cap while the engine and radiator are hot. High temperature steam or coolant could spray out.

NOTICE

When adding engine coolant

Add coolant slowly after the engine has cooled down sufficiently. Adding cool coolant to a hot engine too quickly can cause damage to the engine.

To prevent damage to the cooling system

Observe the following precautions:

- Avoid contaminating the coolant with foreign matter (such as sand or dust etc.).

**NOTICE**

● Do not use any coolant additive.

If the vehicle becomes stuck

Carry out the following procedures if the tires spin or the vehicle becomes stuck in mud, dirt or snow:

Recovering procedure

- 1 Stop the engine. Set the parking brake and shift the shift position to P.
- 2 Remove the mud, snow or sand from around the rear wheels.
- 3 Place wood, stones or some other material under the rear wheels to help provide traction.
- 4 Restart the engine.
- 5 Shift the shift position to D or R and release the parking brake. Then, while exercising caution, depress the accelerator pedal.

■ When it is difficult to free the vehicle

Press the  switch to turn off TRAC.

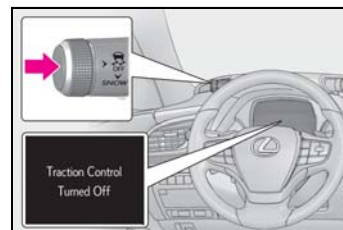



WARNING

■ **When attempting to free a stuck vehicle**

If you choose to push the vehicle back and forth to free it, make sure the surrounding area is clear to avoid striking other vehicles, objects or people. The vehicle may also lunge forward or lunge back suddenly as it becomes free. Use extreme caution.

■ **When shifting the shift position**

Be careful not to shift the shift position with the accelerator pedal depressed. This may lead to unexpected rapid acceleration of the vehicle that may cause an accident resulting in death or serious injury.



NOTICE

■ **To avoid damaging the transmission and other components**

- Avoid spinning the rear wheels and depressing the accelerator pedal more than necessary.
- If the vehicle remains stuck even after these procedures are performed, the vehicle may require towing to be freed.

Vehicle specifications

8

445

8-1. Specifications

Maintenance data (fuel, oil level,
etc.) 446

Fuel information 455

Tire information 457

8-2. Customization

Customizable features 466

8-3. Initialization

Items to initialize 481

8

Vehicle specifications

Maintenance data (fuel, oil level, etc.)

Dimensions and weight

Overall length		206.1 in. (5235 mm)	
Overall width		74.8 in. (1900 mm)	
Overall height* ¹	2WD models	57.5 in. (1460 mm) ^{*2} 57.1 in. (1450 mm) ^{*3}	
	AWD models	57.9 in. (1470 mm) ^{*2} 57.5 in. (1460 mm) ^{*3}	
Wheelbase		123.0 in. (3125 mm)	
Tread* ¹	Front	2WD models	64.2 in. (1630 mm)
		AWD models	64.2 in. (1630 mm) ^{*2} 64.4 in. (1635 mm) ^{*3}
	Rear	64.4 in. (1635 mm) ^{*4} 63.6 in. (1615 mm) ^{*5}	
Vehicle capacity weight (Occupants + luggage)		870 lb. (395 kg)	

*¹: Unladen vehicles

*²: Without electronically modulated air suspension

*³: With electronically modulated air suspension

*⁴: Except F SPORT models

*⁵: F SPORT models

Vehicle identification

■ **Vehicle identification number** of the instrument panel.

The vehicle identification number (VIN) is the legal identifier for your vehicle. This is the primary identification number for your Lexus. It is used in registering the ownership of your vehicle.

This number is stamped on the top left

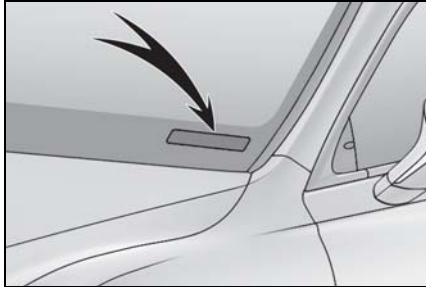

This number is also stamped under the right-hand front seat.

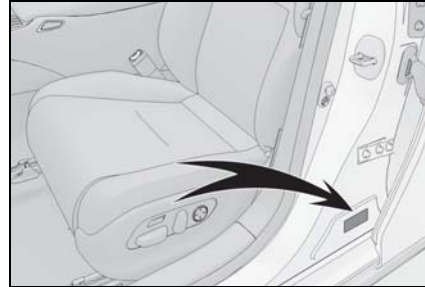

■ **Engine number**

The engine number is stamped on the engine block as shown.

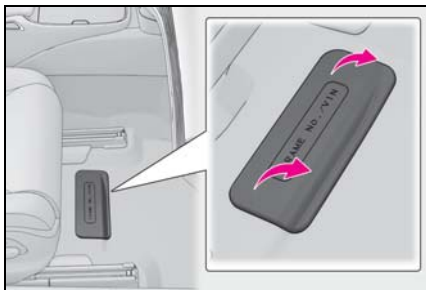

This number is also on the Certification Label.

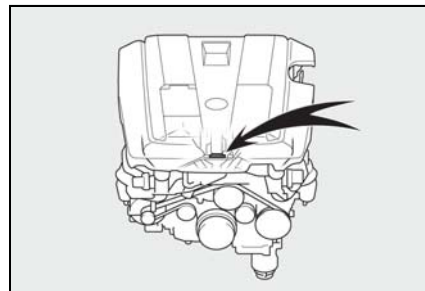

Engine

Model	3.5 L 6-cylinder (V35A-FTS)
Type	6-cylinder V type, 4-cycle, gasoline (with turbocharger)
Bore and stroke	3.37 × 3.94 in. (85.5 × 100.0 mm)
Displacement	210.2 cu. in. (3445 cm ³)
Valve clearance	Automatic adjustment
Drive belt tension	Automatic adjustment

Fuel

Fuel type	Unleaded gasoline only
-----------	------------------------

Octane Rating	91 (Research Octane Number 96) or higher
Fuel tank capacity (Reference)	21.7 gal. (82.0 L, 18.0 Imp. gal.)

Lubrication system

Oil capacity (Drain and refill [Reference*])

With filter	<ul style="list-style-type: none"> ▶ 2WD models 6.7 qt. (6.3 L, 5.5 Imp. qt.) ▶ AWD models 7.5 qt. (7.1 L, 6.2 Imp. qt.)
Without filter	<ul style="list-style-type: none"> ▶ 2WD models 6.1 qt. (5.8 L, 5.1 Imp. qt.) ▶ AWD models 7.0 qt. (6.6 L, 5.8 Imp. qt.)

*: The engine oil capacity is a reference quantity to be used when changing the engine oil. Warm up and turn off the engine, wait more than 5 minutes, and check the oil level on the dipstick.

Engine oil selection

“Toyota Genuine Motor Oil” is used in your Lexus vehicle. Use Lexus approved “Toyota Genuine Motor Oil” or equivalent to satisfy the following grade and viscosity.

Oil grade: ILSAC GF-5 multigrade engine oil

Recommended viscosity: SAE OW-20

SAE OW-20 is the best choice for good fuel economy and good starting in cold weather.

If SAE OW-20 is not available, SAE 5W-20 oil may be used. However, it must be replaced with SAE OW-20 at

the next oil change.

Recommended viscosity (SAE):

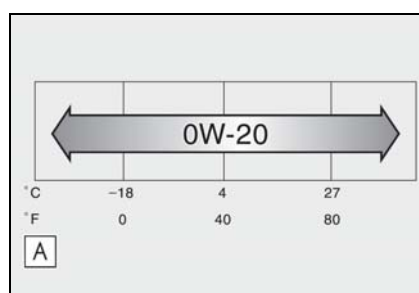

A Outside temperature

Oil viscosity (OW-20 is explained here as an example):

- The OW in OW-20 indicates the characteristic of the oil which allows cold startability. Oils with a lower value before the W allow for easier starting of the engine in cold weather.
- The 20 in OW-20 indicates the viscosity characteristic of the oil when the oil is at high temperature. An oil with a higher viscosity (one with a higher value) may be better suited if the vehicle is operated at high speeds, or under extreme load conditions.

How to read oil container label:

The International Lubricant Specification Advisory Committee (ILSAC) Certification Mark is added to some oil

containers to help you select the oil you should use.



Cooling system

Capacity	▶ Engine 2WD models: 11.2 qt. (10.6 L, 9.3 Imp. qt.) AWD models: 11.1 qt. (10.5 L, 9.2 Imp. qt.) ▶ Intercooler 4.5 qt. (4.3 L, 3.8 Imp. qt.)
Coolant type	Use either of the following: <ul style="list-style-type: none"> • “Toyota Super Long Life Coolant” • Similar high-quality ethylene glycol-based non-silicate, non-amine, non-nitrite, and non-borate coolant with long-life hybrid organic acid technology Do not use plain water alone.

Ignition system (spark plug)

Make	DENSO EC22HPR-D7
Gap	0.028 in. (0.7 mm)

 **NOTICE**

■ Iridium-tipped spark plugs

Use only iridium-tipped spark plugs. Do not adjust the spark plug gap.

Electrical system (battery)

Open voltage at 68°F (20°C):	12.3 V or higher (Turn the engine switch off and turn on the headlights for 20 to 30 seconds.)
Charging rates	
Quick charge	15 A max.
Slow charge	5 A max.

Automatic transmission

Fluid capacity *	9.5 qt. (9.0 L, 7.9 Imp. qt.)
Fluid type	Toyota Genuine ATF WS

*: The fluid capacity is a reference quantity.
If replacement is necessary, contact your Lexus dealer.

 NOTICE

Automatic transmission fluid type

Using transmission fluid other than "Toyota Genuine ATF WS" may cause deterioration in shift quality, locking up of your transmission accompanied by vibration, and ultimately damage the transmission of your vehicle.

Transfer (AWD models)

Oil capacity	0.74 qt. (0.70 L, 0.62 Imp. qt.)
Oil type and viscosity *	Toyota Genuine Transfer gear oil LL 80 or equivalent

*: Your Lexus vehicle is filled with Toyota genuine gear oil at the factory. Use Lexus approved Toyota genuine gear oil or an equivalent of matching quality to satisfy the above specification. Please contact your Lexus dealer for further details.

Front differential (AWD models)

Oil capacity	0.69 qt. (0.65 L, 0.57 Imp. qt.)
Oil type and viscosity *	Toyota Genuine Differential gear oil LT 75W-85 GL-5 or equivalent

*: Your Lexus vehicle is filled with "Toyota Genuine Differential Gear Oil" at the factory. Use Lexus approved "Toyota Genuine Differential Gear Oil" or an equivalent oil of

matching quality to satisfy the above specification. Please contact your Lexus dealer for further details.

Rear differential

► 2WD models

Oil capacity	0.90 qt. (0.85 L, 0.75 Imp. qt.)
Oil type and viscosity *	Toyota Genuine Differential gear oil LT 75W-85 GL-5 or equivalent

► AWD models

Oil capacity	1.42 qt. (1.35 L, 1.19 Imp. qt.)
Oil type and viscosity *	Toyota Genuine Differential gear oil LT 75W-85 GL-5 or equivalent

*: Your Lexus vehicle is filled with "Toyota Genuine Differential Gear Oil" at the factory. Use Lexus approved "Toyota Genuine Differential Gear Oil" or an equivalent oil of matching quality to satisfy the above specification. Please contact your Lexus dealer for further details.

Brakes

Pedal clearance ^{*1}	4.8 in. (121 mm) Min. ^{*3} 4.8 in. (122 mm) Min. ^{*4}
Pedal free play	0.04 — 0.24 in. (1 — 6 mm)
Brake pad wear limit	0.04 in. (1 mm)
Parking brake lining wear limit	0.04 in. (1 mm)
Parking brake indicator ^{*2}	When pushing the parking brake switch for 1 to 2 seconds: comes on When pulling the parking brake switch for 1 to 2 seconds: turns off
Fluid type	FMVSS No.116 DOT 3 or SAE J1703 FMVSS No.116 DOT 4 or SAE J1704

^{*1}: Minimum pedal clearance when depressed with a force of 112 lbf (500 N, 51 kgf) while the engine is running.
When performing the brake pedal inspection, also be sure to check that the brake system warning light is not illuminated when the engine is running. (If the brake system

warning light is illuminated, refer to P.415.)

*2: Make sure to confirm that the brake warning light (yellow) does not illuminate. (If the brake warning light illuminates, refer to P.415.)

*3: Vehicles without Lexus Safety System + A

*4: Vehicles with Lexus Safety System + A

Steering

Free play	Less than 1.2 in. (30 mm)
-----------	---------------------------

Tires and wheels

► 19-inch tires (type A)

Tire size	245/50RF19 101W
Tire inflation pressure (Recommended cold tire inflation pressure)	<p>Driving under normal conditions</p> <p>Front: 36 psi (250 kPa, 2.5 kgf/cm² or bar)</p> <p>Rear: 36 psi (250 kPa, 2.5 kgf/cm² or bar)</p> <p>Driving at high speeds above 118 mph (190 km/h) (in countries where such speeds are permitted by law)</p> <p>Add 9 psi (60 kPa, 0.6 kgf/cm² or bar) to the front tires and rear tires. Never exceed the maximum cold tire inflation pressure indicated on the tire sidewall.</p>
Wheel size	19 × 8J
Wheel nut torque	103 ft•lbf (140 N•m, 14.3 kgf•m)

► 19-inch tires (type B)

Tire size	245/50RF19 101V
Tire inflation pressure (Recommended cold tire inflation pressure)	<p>Driving under normal conditions</p> <p>Front: 36 psi (250 kPa, 2.5 kgf/cm² or bar)</p> <p>Rear: 36 psi (250 kPa, 2.5 kgf/cm² or bar)</p> <p>Driving at high speeds above 100 mph (160 km/h) (in countries where such speeds are permitted by law)</p> <p>Add 9 psi (60 kPa, 0.6 kgf/cm² or bar) to the front tires and rear tires. Never exceed the maximum cold tire inflation pressure indicated on the tire sidewall.</p>

Wheel size	19 × 8J
Wheel nut torque	103 ft•lbf (140 N•m, 14.3 kgf•m)

▶ 20-inch tires (type A)

Tire size	245/45RF20 99Y
Tire inflation pressure (Recommended cold tire inflation pressure)	<p>Driving under normal conditions</p> <p>Front: 35 psi (240 kPa, 2.4 kgf/cm² or bar)</p> <p>Rear: 35 psi (240 kPa, 2.4 kgf/cm² or bar)</p> <p>Driving at high speeds above 137 mph (220 km/h) (in countries where such speeds are permitted by law)</p> <p>Add 9 psi (60 kPa, 0.6 kgf/cm² or bar) to the front tires and rear tires. Never exceed the maximum cold tire inflation pressure indicated on the tire sidewall.</p>
Wheel size	20 × 8 1/2J
Wheel nut torque	103 ft•lbf (140 N•m, 14.3 kgf•m)

▶ 20-inch tires (type B)

Tire size	<p>Front tires: 245/45RF20 99Y</p> <p>Rear tires: 275/40RF20 102Y</p>
Tire inflation pressure (Recommended cold tire inflation pressure)	<p>Driving under normal conditions</p> <p>Front: 36 psi (250 kPa, 2.5 kgf/cm² or bar)</p> <p>Rear: 36 psi (250 kPa, 2.5 kgf/cm² or bar)</p> <p>Driving at high speeds above 137 mph (220 km/h) (in countries where such speeds are permitted by law)</p> <p>Add 9 psi (60 kPa, 0.6 kgf/cm² or bar) to the front tires and rear tires. Never exceed the maximum cold tire inflation pressure indicated on the tire sidewall.</p>
Wheel size	<p>Front wheels: 20 × 8 1/2J</p> <p>Rear wheels: 20 × 9 1/2J</p>
Wheel nut torque	103 ft•lbf (140 N•m, 14.3 kgf•m)

► 20-inch tires (type C)

Tire size	245/45RF20 99V
Tire inflation pressure (Recommended cold tire inflation pressure)	<p>Driving under normal conditions</p> <p>Front: 35 psi (240 kPa, 2.4 kgf/cm² or bar)</p> <p>Rear: 35 psi (240 kPa, 2.4 kgf/cm² or bar)</p> <p>Driving at high speeds above 100 mph (160 km/h) (in countries where such speeds are permitted by law)</p> <p>Add 9 psi (60 kPa, 0.6 kgf/cm² or bar) to the front tires and rear tires. Never exceed the maximum cold tire inflation pressure indicated on the tire sidewall.</p>
Wheel size	20 × 8 1/2J
Wheel nut torque	103 ft•lbf (140 N•m, 14.3 kgf•m)

► 20-inch tires (type D)

Tire size	<p>Front tires: 245/45RF20 99V</p> <p>Rear tires: 275/40RF20 102V</p>
Tire inflation pressure (Recommended cold tire inflation pressure)	<p>Driving under normal conditions</p> <p>Front: 36 psi (250 kPa, 2.5 kgf/cm² or bar)</p> <p>Rear: 36 psi (250 kPa, 2.5 kgf/cm² or bar)</p> <p>Driving at high speeds above 100 mph (160 km/h) (in countries where such speeds are permitted by law)</p> <p>Add 9 psi (60 kPa, 0.6 kgf/cm² or bar) to the front tires and rear tires. Never exceed the maximum cold tire inflation pressure indicated on the tire sidewall.</p>
Wheel size	<p>Front wheels: 20 × 8 1/2J</p> <p>Rear wheels: 20 × 9 1/2J</p>
Wheel nut torque	103 ft•lbf (140 N•m, 14.3 kgf•m)

Fuel information

You must only use unleaded gasoline.
Select premium unleaded gasoline with an octane rating of 91 (Research Octane Number 96) or higher required for optimum engine performance and fuel economy.

If the octane rating is less than 91, damage to the engine may occur and may void the vehicle warranty.

At minimum, the gasoline you use should meet the specifications of ASTM D4814 in the U.S.A.

Gasoline quality

In very few cases, driveability problems may be caused by the brand of gasoline you are using. If driveability problems persist, try changing the brand of gasoline. If this does not correct the problem, consult your Lexus dealer.

Recommendation of the use of gasoline containing detergent additives

- Lexus recommends the use of gasoline that contains detergent additives to avoid the build-up of engine deposits.
- All gasoline sold in the U.S.A. contains minimum detergent additives to clean and/or keep clean intake systems, per EPA's lowest additives concentration program.
- Lexus strongly recommends the use of Top Tier Detergent Gasoline. For more information on Top Tier Detergent Gasoline and a list of marketers, please go to the official website www.toptiergas.com.

Recommendation of the use of low emissions gasoline

Gasolines containing oxygenates such as ethers and ethanol, as well as reformulated

gasolines, are available in some cities. These fuels are typically acceptable for use, providing they meet other fuel requirements.

Lexus recommends these fuels, since the formulations allow for reduced vehicle emissions.

Non-recommendation of the use of blended gasoline

- Use only gasoline containing up to 15% ethanol.
 DO NOT use any flex-fuel or gasoline that could contain more than 15% ethanol, including from any pump labeled E30 (30% ethanol [A]), E50 (50% ethanol [B]), E85 (85% ethanol [C]) (which are only some examples of fuel containing more than 15% ethanol).

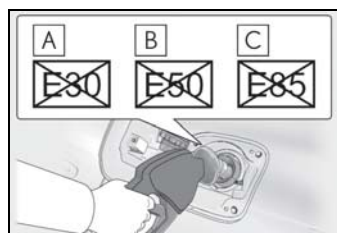

- If you use gasohol in your vehicle, be sure that it has an octane rating no lower than 91.
- Lexus does not recommend the use of gasoline containing methanol.

Non-recommendation of the use of gasoline containing MMT

Some gasoline contains an octane enhancing additive called MMT (Methylcyclopentadienyl Manganese Tricarbonyl).

Lexus does not recommend the use of gasoline that contains MMT. If fuel containing MMT is used, your emission control system may be adversely affected.

The malfunction indicator lamp on the instrument cluster may come on. If this happens, contact your Lexus dealer for service.

If your engine knocks

- Consult your Lexus dealer.
- You may occasionally notice light knocking for a short time while accelerating or

driving uphill. This is normal and there is no need for concern.

 NOTICE

■ **Notice on fuel quality**

- Do not use improper fuels. If improper fuels are used, the engine will be damaged.
- Do not use leaded gasoline. Leaded gasoline can cause damage to your vehicle's three-way catalytic converters causing the emission control system to malfunction.
- Do not use gasohol other than the type previously stated. Other gasohol may cause fuel system damage or vehicle performance problems.
- Using unleaded gasoline with an octane number or rating lower than the level previously stated may cause persistent heavy knocking. At worst, this may lead to engine damage and will void the vehicle warranty.

■ **When refueling with gasohol**

Take care not to spill gasohol. It can damage your vehicle's paint.

■ **Fuel-related poor driveability**

If poor driveability is encountered after using a different type of fuel (poor hot starting, vaporization, engine knocking, etc.), discontinue the use of that type of fuel.

Tire information

Typical tire symbols

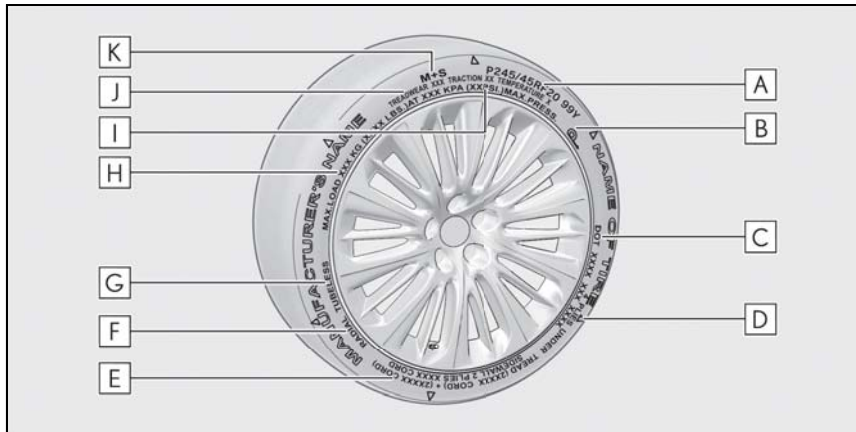

A Tire size (→P.458)

B Run-flat tire (RFT) or standard tire (→P.429)

This vehicle can be equipped with either run-flat tires (RFT) or standard tires. A  mark is molded on the sidewall of the run-flat tire.

C DOT and Tire Identification Number (TIN) (→P.458)

D Location of treadwear indicators (→P.382)

E Tire ply composition and materials

Ply is a layer of rubber-coated parallel cords. Cords are the strands which form the ply in a tire.

F Radial tires or bias-ply tires

A radial tire has "RADIAL" on the sidewall. A tire not marked "RADIAL" is a bias-ply tire.

G TUBELESS or TUBE TYPE

A tubeless tire does not have a tube and air is directly put into the tire. A tube type tire has a tube inside the tire and the tube maintains the air pressure.

H Load limit at maximum cold tire inflation pressure (→P.383)

I Maximum cold tire inflation pressure (→P.452)

This means the pressure to which a tire may be inflated.

J Uniform tire quality grading

For details, see "Uniform Tire Quality Grading" that follows.

K Summer tires or all season tires (→P.383)

An all season tire has "M+S" on the sidewall. A tire not marked "M+S" is a summer tire.

Typical DOT and Tire Identification Number (TIN)

► Type A

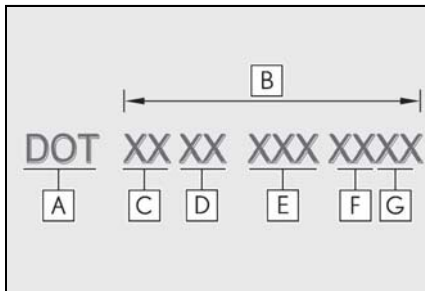

- A** DOT symbol*
- B** Tire Identification Number (TIN)
- C** Tire manufacturer's identification mark
- D** Tire size code
- E** Manufacturer's optional tire type code (3 or 4 letters)
- F** Manufacturing week
- G** Manufacturing year

*: The DOT symbol certifies that the tire conforms to applicable Federal Motor Vehicle Safety Standards.

► Type B

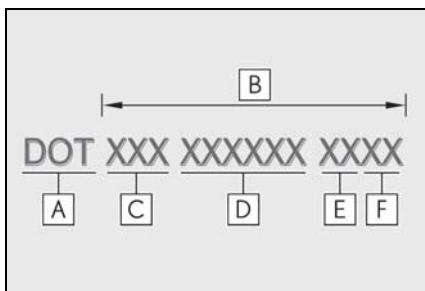

- A** DOT symbol*

- B** Tire Identification Number (TIN)
- C** Tire manufacturer's identification mark
- D** Manufacturer's code
- E** Manufacturing week
- F** Manufacturing year

*: The DOT symbol certifies that the tire conforms to applicable Federal Motor Vehicle Safety Standards.

Tire size

■ Typical tire size information

The illustration indicates typical tire size.

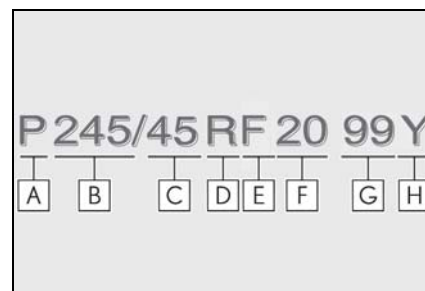

- A** Tire use (P = Passenger car, T = Temporary use)
- B** Section width (millimeters)
- C** Aspect ratio (tire height to section width)
- D** Tire construction code (R = Radial, D = Diagonal)
- E** Run-flat tire code
- F** Wheel diameter (inches)
- G** Load index (2 digits or 3 digits)
- H** Speed symbol (alphabet with one)

letter)

■ **Tire dimensions**

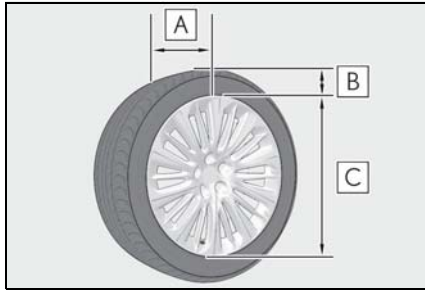

- A** Section width
- B** Tire height
- C** Wheel diameter

Tire section names

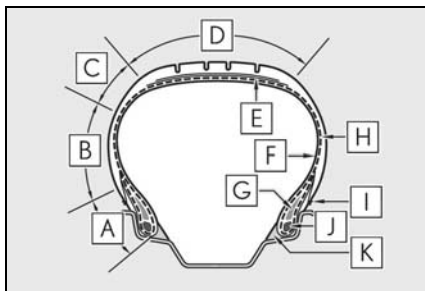

- A** Bead
- B** Sidewall
- C** Shoulder
- D** Tread
- E** Belt
- F** Inner liner
- G** Reinforcing rubber
- H** Carcass
- I** Rim lines
- J** Bead wires
- K** Chafer

Uniform Tire Quality Grading

This information has been prepared in accordance with regulations issued by the National Highway Traffic Safety Administration of the U.S. Department of Transportation.

It provides the purchasers and/or prospective purchasers of Lexus vehicles with information on uniform tire quality grading.

Your Lexus dealer will help answer any questions you may have as you read this information.

■ **DOT quality grades**

All passenger vehicle tires must conform to Federal Safety Requirements in addition to these grades. Quality grades can be found where applicable on the tire sidewall between tread shoulder and maximum section width.

For example: Treadwear 200 Traction AA Temperature A

■ **Treadwear**

The treadwear grade is a comparative rating based on the wear rate of the tire when tested under controlled conditions on a specified government test course.

For example, a tire graded 150 would wear one and a half (1 - 1/2) times as well on the government course as a tire graded 100. The relative performance of tires depends upon the actual conditions of their use. Performance may differ significantly from the norm due to variations in driving habits, service practices and differences in road characteristics and climate.

■ **Traction AA, A, B, C**

The traction grades, from highest to lowest, are AA, A, B and C, and they represent the tire's ability to stop on wet pavement as measured under controlled conditions on specified government test surfaces of asphalt and concrete.

A tire marked C may have poor traction performance.

Warning: The traction grade assigned to this tire is based on braking (straight ahead) traction tests and does not include cornering (turning) traction.

■ **Temperature A, B, C**

The temperature grades are A (the highest), B, and C, representing the tire's resistance to the generation of heat and its ability to dissipate heat

when tested under controlled conditions on a specified indoor laboratory test wheel.

Sustained high temperature can cause the material of the tire to degenerate and reduce tire life, and excessive temperature can lead to sudden tire failure.

Grade C corresponds to a level of performance which all passenger car tires must meet under the Federal Motor Vehicle Safety Standard No. 109.

Grades B and A represent higher levels of performance on the laboratory test wheel than the minimum required by law.

Warning: The temperature grades of a tire assume that it is properly inflated and not overloaded.

Excessive speed, underinflation, or excessive loading, either separately or in combination, can cause heat buildup and possible tire failure.

Glossary of tire terminology

Tire related term	Meaning
Cold tire inflation pressure	Tire pressure when the vehicle has been parked for three hours or more, or has not been driven more than 1 mile or 1.5 km under that condition
Maximum inflation pressure	The maximum cold inflated pressure to which a tire may be inflated, shown on the sidewall of the tire
Recommended inflation pressure	Cold tire inflation pressure recommended by a manufacturer
Accessory weight	The combined weight (in excess of those standard items which may be replaced) of automatic transmission, power steering, power brakes, power windows, power seats, radio and heater, to the extent that these items are available as factory-installed equipment (whether installed or not)

Tire related term	Meaning
Curb weight	The weight of a motor vehicle with standard equipment, including the maximum capacity of fuel, oil and coolant, and if so equipped, air conditioning and additional weight optional engine
Maximum loaded vehicle weight	The sum of: (a) Curb weight (b) Accessory weight (c) Vehicle capacity weight (d) Production options weight
Normal occupant weight	150 lb. (68 kg) times the number of occupants specified in the second column of Table 1* that follows
Occupant distribution	Distribution of occupants in a vehicle as specified in the third column of Table 1* below
Production options weight	The combined weight of installed regular production options weighing over 5 lb. (2.3 kg) in excess of the standard items which they replace, not previously considered in curb weight or accessory weight, including heavy duty brakes, ride levelers, roof rack, heavy duty battery, and special trim
Rim	A metal support for a tire or a tire and tube assembly upon which the tire beads are seated
Rim diameter (Wheel diameter)	Nominal diameter of the bead seat
Rim size designation	Rim diameter and width
Rim type designation	The industry manufacturer's designation for a rim by style or code
Rim width	Nominal distance between rim flanges
Vehicle capacity weight (Total load capacity)	The rated cargo and luggage load plus 150 lb. (68 kg) times the vehicle's designated seating capacity
Vehicle maximum load on the tire	The load on an individual tire that is determined by distributing to each axle its share of the maximum loaded vehicle weight, and dividing by two

Tire related term	Meaning
Vehicle normal load on the tire	The load on an individual tire that is determined by distributing to each axle its share of curb weight, accessory weight, and normal occupant weight (distributed in accordance with Table 1* below), and dividing by two
Weather side	The surface area of the rim not covered by the inflated tire
Bead	The part of the tire that is made of steel wires, wrapped or reinforced by ply cords and that is shaped to fit the rim
Bead separation	A breakdown of the bond between components in the bead
Bias ply tire	A pneumatic tire in which the ply cords that extend to the beads are laid at alternate angles substantially less than 90 degrees to the centerline of the tread
Carcass	The tire structure, except tread and sidewall rubber which, when inflated, bears the load
Chunking	The breaking away of pieces of the tread or sidewall
Cord	The strands forming the plies in the tire
Cord separation	The parting of cords from adjacent rubber compounds
Cracking	Any parting within the tread, sidewall, or innerliner of the tire extending to cord material
CT	A pneumatic tire with an inverted flange tire and rim system in which the rim is designed with rim flanges pointed radially inward and the tire is designed to fit on the underside of the rim in a manner that encloses the rim flanges inside the air cavity of the tire
Extra load tire	A tire designed to operate at higher loads and at higher inflation pressures than the corresponding standard tire
Groove	The space between two adjacent tread ribs
Innerliner	The layer(s) forming the inside surface of a tubeless tire that contains the inflating medium within the tire

Tire related term	Meaning
Innerliner separation	The parting of the innerliner from cord material in the carcass
Intended outboard sidewall	(a) The sidewall that contains a whitewall, bears white lettering, or bears manufacturer, brand, and/or model name molding that is higher or deeper than the same molding on the other sidewall of the tire, or (b) The outward facing sidewall of an asymmetrical tire that has a particular side that must always face outward when mounted on a vehicle
Light truck (LT) tire	A tire designated by its manufacturer as primarily intended for use on lightweight trucks or multipurpose passenger vehicles
Load rating	The maximum load that a tire is rated to carry for a given inflation pressure
Maximum load rating	The load rating for a tire at the maximum permissible inflation pressure for that tire
Maximum permissible inflation pressure	The maximum cold inflation pressure to which a tire may be inflated
Measuring rim	The rim on which a tire is fitted for physical dimension requirements
Open splice	Any parting at any junction of tread, sidewall, or innerliner that extends to cord material
Outer diameter	The overall diameter of an inflated new tire
Overall width	The linear distance between the exteriors of the sidewalls of an inflated tire, including elevations due to labeling, decorations, or protective bands or ribs
Passenger car tire	A tire intended for use on passenger cars, multipurpose passenger vehicles, and trucks, that have a gross vehicle weight rating (GVWR) of 10,000 lb. or less.
Ply	A layer of rubber-coated parallel cords
Ply separation	A parting of rubber compound between adjacent plies

Tire related term	Meaning
Pneumatic tire	A mechanical device made of rubber, chemicals, fabric and steel or other materials, that, when mounted on an automotive wheel, provides the traction and contains the gas or fluid that sustains the load
Radial ply tire	A pneumatic tire in which the ply cords that extend to the beads are laid at substantially 90 degrees to the centerline of the tread
Reinforced tire	A tire designed to operate at higher loads and at higher inflation pressures than the corresponding standard tire
Section width	The linear distance between the exteriors of the sidewalls of an inflated tire, excluding elevations due to labeling, decoration, or protective bands
Sidewall	That portion of a tire between the tread and bead
Sidewall separation	The parting of the rubber compound from the cord material in the sidewall
Snow tire	A tire that attains a traction index equal to or greater than 110, compared to the ASTM E-1136 Standard Reference Test Tire, when using the snow traction test as described in ASTM F-1805-00, Standard Test Method for Single Wheel Driving Traction in a Straight Line on Snow-and Ice-Covered Surfaces, and which is marked with an Alpine Symbol () on at least one sidewall
Test rim	The rim on which a tire is fitted for testing, and may be any rim listed as appropriate for use with that tire
Tread	That portion of a tire that comes into contact with the road
Tread rib	A tread section running circumferentially around a tire
Tread separation	Pulling away of the tread from the tire carcass

Tire related term	Meaning
Treadwear indicators (TWI)	The projections within the principal grooves designed to give a visual indication of the degrees of wear of the tread
Wheel-holding fixture	The fixture used to hold the wheel and tire assembly securely during testing

*: Table 1 -Occupant loading and distribution for vehicle normal load for various designated seating capacities





Designated seating capacity, Number of occupants	Vehicle normal load, Number of occupants	Occupant distribution in a normally loaded vehicle
2 through 4	2	2 in front
5 through 10	3	2 in front, 1 in second seat
11 through 15	5	2 in front, 1 in second seat, 1 in third seat, 1 in fourth seat
16 through 20	7	2 in front, 2 in second seat, 2 in third seat, 1 in fourth seat

Customizable features

Your vehicle includes a variety of electronic features that can be personalized to your preferences. The settings of these features can be changed by using the meter control switches, the Remote Touch, Rear Multi Operation Panel or at your Lexus dealer.

Customizing vehicle features

■ Changing by using the meter control switches

- 1 Press  or  to select .
- 2 Operate the meter control switches to select the desired item to be customized.
- 3 According to the display, select the desired setting and then press .

To go back to the previous screen or exit the customize mode, press .

■ Changing by using the Remote Touch

- 1 Press the "MENU" button on the Remote Touch.
- 2 Select "Setup" on the menu screen and select "Vehicle".
- 3 Select "Vehicle Customization" or "Drive Mode Customization".

Various setting can be changed. Refer to the list of settings that can be changed for details.

For details on the Remote Touch, refer to the "NAVIGATION AND MULTI-MEDIA SYSTEM OWNER'S MAN-

UAL".

■ Changing by using the Rear Multi Operation Panel (if equipped)

- 1 Display the home screen on the Rear Multi Operation Panel and then touch "Settings".
- 2 Touch "Seat".
- 3 Select the desired setting.

■ When customizing using the Remote Touch

Stop the vehicle in a safe place, apply the parking brake, and shift the shift position to P. Also, to prevent battery discharge, leave the engine running while customizing the features.

WARNING

■ During customization

As the engine needs to be running during customization, ensure that the vehicle is parked in a place with adequate ventilation. In a closed area such as a garage, exhaust gases including harmful carbon monoxide (CO) may collect and enter the vehicle. This may lead to death or a serious health hazard.

NOTICE

■ During customization

To prevent battery discharge, ensure that the engine is running while customizing features.

Customizable features

Some function settings are changed simultaneously with other functions being customized. Contact your Lexus dealer for further details.

- A** Settings that can be changed using the Remote Touch
- B** Settings that can be changed using the meter control switches
- C** Settings that can be changed using the Rear Multi Operation Panel (if equipped)
- D** Settings that can be changed by your Lexus dealer

Definition of symbols: O = Available, – = Not available

■ **Seat belts (→P.24)**

Function	Default setting	Customized setting	A	B	C	D
Easy Access Buckle *1	On	Off	–	–	–	O
Retraction of front seat belts when vehicle speed reaches approximately 12 mph (20 km/h)*2	On	Off	–	–	–	O
Retraction of front seat belt when corresponding front door is opened or seat belt is released *2	On	Off	–	–	–	O

*1: If equipped

*2: Vehicles with pre-collision seat belts with comfort function

■ **Gauges, meters and multi-information display (→P.68, 73, 76, 80)**

Function *1	Default setting	Customized setting	A	B	C	D
Language	English	French	O	O	–	–
		Spanish				
Units *2	miles (MPG)	km (km/L)				
		km (L/100 km)	O	O	–	–
		miles (MPG Imperial)				

Function ^{*1}	Default setting	Customized setting	A	B	C	D
Drive information 1	Current fuel consumption	Customizable items: →P.82	-	○	-	-
	Average fuel economy (after reset)					
Drive information 2	Distance (driving range)					
	Average vehicle speed (after reset)					
Clock	12-hour display	24-hour display	-	○	-	-
Pop-up display	On	Off	-	○	-	-
Accent color	Color 1	Color 2	○	○	-	-
Rev indicator ^{*3}	5000 r/min.	2000 - 6400 r/min.	-	○	-	-
		Off				
Rev peak ^{*3}	On	Off	-	○	-	-
Eco Driving Indicator Light	On	Off	-	○	-	-
Suggestion function	On	On (when the vehicle is stopped)	○	-	-	○
		Off				

*1: For details about each function: →P.85

*2: The default setting varies according to country.

*3: F SPORT models

■ Head-up Display* (→P.87)

Function	Default setting	Customized setting	A	B	C	D
Gauge information	Tachometer	Eco Driving Indicator	-	○	-	-
		No content				

Function	Default setting	Customized setting	Customized setting			
			A	B	C	D
Route guidance to destination/street name *	On	Off	-	○	-	-
Driving support system display	On	Off	-	○	-	-
Compass *	On	Off	-	○	-	-
Audio system operation status	On	Off	-	○	-	-

*: If equipped

■ Door lock (→P.100, 104, 433)

Function	Default setting	Customized setting	Customized setting			
			A	B	C	D
Unlocking using a mechanical key	Driver's door unlocked in one step, all doors unlocked in two step	All doors unlocked in one step	-	-	-	○
Automatic door locking function	Shift position linked door locking operation	Off	-	-	-	○
		Speed linked door locking operation	○	-	-	○
Automatic door unlocking function	Shift position linked door unlocking operation	Off	-	-	-	○
		Driver's door linked door unlocking operation	○	-	-	○
Locking/unlocking of the trunk when all doors are locked/unlocked	On	Off	-	-	-	○

■ Smart access system with push-button start and wireless remote control (→P.100, 111)

Function	Default setting	Customized setting	A	B	C	D
			<input type="checkbox"/>	<input type="checkbox"/>	<input type="checkbox"/>	<input type="checkbox"/>
Operating signal (Buzzers)	5	Off	<input type="checkbox"/>	<input type="checkbox"/>	<input type="checkbox"/>	<input type="checkbox"/>
		1 to 7	<input type="checkbox"/>	<input type="checkbox"/>	<input type="checkbox"/>	<input type="checkbox"/>
Operation signal (Emergency flashers)	On	Off	<input type="checkbox"/>	<input type="checkbox"/>	<input type="checkbox"/>	<input type="checkbox"/>
Time elapsed before automatic door lock function is activated if door is not opened after being unlocked	60 seconds	Off	<input type="checkbox"/>	<input type="checkbox"/>	<input type="checkbox"/>	<input type="checkbox"/>
		30 seconds	<input type="checkbox"/>	<input type="checkbox"/>	<input type="checkbox"/>	<input type="checkbox"/>
		120 seconds	<input type="checkbox"/>	<input type="checkbox"/>	<input type="checkbox"/>	<input type="checkbox"/>
Open door warning buzzer	On	Off	<input type="checkbox"/>	<input type="checkbox"/>	<input type="checkbox"/>	<input type="checkbox"/>

■ Smart access system with push-button start (→P.100, 111)

Function	Default setting	Customized setting	A	B	C	D
			<input type="checkbox"/>	<input type="checkbox"/>	<input type="checkbox"/>	<input type="checkbox"/>
Smart access system with push-button start	On	Off	<input type="checkbox"/>	<input type="checkbox"/>	<input type="checkbox"/>	<input type="checkbox"/>
Smart door unlocking	Driver's door	All the doors	<input type="checkbox"/>	<input type="checkbox"/>	<input type="checkbox"/>	<input type="checkbox"/>
Time elapsed before unlocking all the door when gripping and holding the driver's door handle	2 seconds	Off	<input type="checkbox"/>	<input type="checkbox"/>	<input type="checkbox"/>	<input type="checkbox"/>
		1.5 seconds	<input type="checkbox"/>	<input type="checkbox"/>	<input type="checkbox"/>	<input type="checkbox"/>
		2.5 seconds	<input type="checkbox"/>	<input type="checkbox"/>	<input type="checkbox"/>	<input type="checkbox"/>
Number of consecutive door lock operations	2 times	As many as desired	<input type="checkbox"/>	<input type="checkbox"/>	<input type="checkbox"/>	<input type="checkbox"/>

■ Wireless remote control (→P.98, 100, 104)

Function	Default setting	Customized setting	A	B	C	D
			<input type="checkbox"/>	<input type="checkbox"/>	<input type="checkbox"/>	<input type="checkbox"/>
Wireless remote control	On	Off	<input type="checkbox"/>	<input type="checkbox"/>	<input type="checkbox"/>	<input type="checkbox"/>
Unlocking operation	Driver's door unlocked in one step, all doors unlocked in two step	All doors unlocked in one step	<input type="checkbox"/>	<input type="checkbox"/>	<input type="checkbox"/>	<input type="checkbox"/>

Function	Default setting	Customized setting	A	B	C	D
Trunk unlocking operation	Press and hold (short)	One short press				
		Push twice				
		Press and hold (long)	-	-	-	○
		Off				
Theft deterrent panic mode	On	Off	-	-	-	○
Reservation lock	On	Off	○	-	-	○

■ **Trunk (→P.104)**

Function	Default setting	Customized setting	A	B	C	D
Hands Free Power Trunk Lid (kick sensor)*	On	Off	-	○	-	-

* : If equipped

■ **Front seats (→P.119)**

Function	Default setting	Customized setting	A	B	C	D
Driver's seat position linked head restraint height operation*	Off	On	-	-	-	○

* : If equipped

■ **Power rear seats* (→P.126)**

Function	Default setting	Customized setting	A	B	C	D
Automatic rear seat operation (door-linked rear seat return function and shift-linked rear seat reclining function)	On	Off	-	-	○	-

Function	Default setting	Customized setting	A	B	C	D
Door linked rear seat with ottoman seatback position for exiting*	More upright than upright position	Upright position	-	-	○	-
Shift-linked rear seat reclining function	On	Off	-	-	-	○

* : If equipped

■ Driving position memory (→P.130)

Function	Default setting	Customized setting	A	B	C	D
Selecting doors linked to the memory recall function	Driver's door	All doors	-	-	-	○
Driver's seat slide movement when exiting the vehicle	Full	Off	○	-	-	○
		Partial				
Driver's seat height movement when exiting the vehicle	Off	Full	○	-	-	○
		Partial				
Steering wheel movement	Tilt only	Off				
		Telescopic only	○	-	-	○
		Tilt and telescopic				

■ Outside rear view mirrors (→P.140)

Function	Default setting	Customized setting	A	B	C	D
Automatic mirror folding and extending operation	Linked to the locking/ unlocking of the doors	Off				
		Linked to operation of the engine switch	-	-	-	○

■ Power windows, and moon roof* or panoramic moon roof* (→P.142,145,147)

Function	Default setting	Customized setting	A	B	C	D
Mechanical key linked operation	Off	On	-	-	-	○
Wireless remote control linked operation	Off	On (open only)	-	-	-	○
Wireless remote control linked operation signal (buzzer)	On	Off	-	-	-	○

* : If equipped

■ Reverse warning buzzer (→P.168)

Function	Default setting	Customized setting	A	B	C	D
Signal (buzzer) when the shift position is in R	Single	Intermittent	-	-	-	○

■ Automatic light control system (→P.179)

Function	Default setting	Customized setting	A	B	C	D
Light sensor sensitivity	Standard	-2 to 2	○	-	-	○
Time elapsed before headlights automatically turn off after doors are closed	30 seconds	Off	○	-	-	○
		60 seconds				
		90 seconds				
Windshield wiper linked headlight illumination	On	Off	-	-	-	○

■ Lights (→P.179)

Function	Default setting	Customized setting	A	B	C	D
Daytime running lights	On	Off*1	○	-	-	○
Welcome lighting	On	Off	-	-	-	○
AFS (Adaptive Front-lighting System)*2	On	Off	-	-	-	○

*1: Except for Canada

*2: If equipped

■ PCS (Pre-Collision System) and FCTA (Front Cross Traffic Alert)* (→P.204, 215, 222)

Function	Default setting	Customized setting	A	B	C	D
PCS (Pre-Collision System) and FCTA function	On	Off	-	<input type="radio"/>	-	-
Adjust alert timing	Middle	Far	-	<input type="radio"/>	-	-
		Near	-	<input type="radio"/>	-	-
Pedestrian alert* and FCTA function	On	Off	-	<input type="radio"/>	-	-

*: If equipped

■ LTA (Lane Tracing Assist) (vehicles with Lexus Safety System + A) (→P.225)

Function	Default setting	Customized setting	A	B	C	D
Lane centering function	On	Off	-	<input type="radio"/>	-	-
Steering assist function	On	Off	-	<input type="radio"/>	-	-
Lane change assist function	On	Off	-	<input type="radio"/>	-	-
Alert type	Steering wheel vibration	Buzzer	-	<input type="radio"/>	-	-
Alert sensitivity	High	Standard	-	<input type="radio"/>	-	-
Vehicle sway warning function	On	Off	-	<input type="radio"/>	-	-
Vehicle sway warning sensitivity	Standard	High	-	<input type="radio"/>	-	-
		Low	-	<input type="radio"/>	-	-

■ LTA (Lane Tracing Assist) (vehicles with Lexus Safety System + 2.0) (→P.225)

Function	Default setting	Customized setting	A	B	C	D
Lane centering function	On	Off	-	<input type="radio"/>	-	-
Steering assist function	On	Off	-	<input type="radio"/>	-	-

Function	Default setting	Customized setting	A	B	C	D
Alert type	Steering wheel vibration	Buzzer	-	<input type="radio"/>	-	-
Alert sensitivity	High	Standard	-	<input type="radio"/>	-	-
Vehicle sway warning function	On	Off	-	<input type="radio"/>	-	-
Vehicle sway warning sensitivity	Standard	High	-	<input type="radio"/>	-	-
		Low	-	<input type="radio"/>	-	-

■ **RSA (Road Sign Assist)*** (→P.247)

Function	Default setting	Customized setting	A	B	C	D
RSA (Road Sign Assist)	On	Off	-	<input type="radio"/>	-	-
Excess speed notification method	Display only	No notification	-	<input type="radio"/>	-	-
		Display and buzzer	-	<input type="radio"/>	-	-
Excess speed notification level	1 mph (2 km/h)	3 mph (5 km/h)	-	<input type="radio"/>	-	-
		5 mph (10 km/h)	-	<input type="radio"/>	-	-
Other notifications method (No-entry notification)	Display only	No notification	-	<input type="radio"/>	-	-
		Display and buzzer	-	<input type="radio"/>	-	-

* : If equipped

■ **BSM (Blind Spot Monitor)*** (→P.250)

Function	Default setting	Customized setting	A	B	C	D
BSM (Blind Spot Monitor)	On	Off	-	<input type="radio"/>	-	-
Outside rear view mirror indicator brightness	Bright	Dim	-	<input type="radio"/>	-	-

Function	Default setting	Customized setting	A	B	C	D
Alert timing for presence of approaching vehicle (sensitivity)	Intermediate	Early				
		Late				
		Only when vehicle detected in blind spot	-	○	-	-

*: If equipped

■ PKSA (Parking Support Alert)* (→P.255)

Function	Default setting	Customized setting	A	B	C	D
Buzzer volume	Level2	Level1	-	○	-	-
		Level3				

*: If equipped

■ Intuitive parking assist* (→P.257)

Function	Default setting	Customized setting	A	B	C	D
Intuitive parking assist	On	Off	-	○	-	-

*: If equipped

■ RCTA (Rear cross traffic alert) function* (→P.263)

Function	Default setting	Customized setting	A	B	C	D
RCTA (Rear cross traffic alert) function	On	Off	-	○	-	-

*: If equipped

■ RCD (Rear camera detection) function* (→P.267)

Function	Default setting	Customized setting	A	B	C	D
RCD (Rear camera detection) function	On	Off	-	○	-	-

*: If equipped

■ PKSB (Parking Support Brake)* (→P.270)

Function	Default setting	Customized setting	A	B	C	D
PKSB (Parking Support Brake) function	On	Off	-	○	-	-

* : If equipped

■ Driving mode select switch (→P.289)

Function	Default setting	Customized setting	A	B	C	D
Powertrain control in custom mode*	Normal	Power	○	-	-	-
		Eco				
Chassis control in custom mode*	Normal	Sport	○	-	-	-
		Comfort				
Air conditioning operation in custom mode*	Normal	Eco	○	-	-	-

* : If equipped

■ Electronically modulated air suspension* (→P.291)

Function	Default setting	Customized setting	A	B	C	D
Vehicle height control	On	Off	-	○	-	-
Ingress/egress height control function	On	Off	-	○	-	-
Vehicle height when parked	Normal	High	-	○	-	-

* : If equipped

■ Automatic air conditioning system (→P.313)

Function	Default setting	Customized setting	A	B	C	D
A/C auto switch operation	On	Off	○	-	-	○
Exhaust gas sensor sensitivity	Standard	-3 to 3	○	-	-	○

■ Seat heater/seat ventilators ^{*1}(→P.326)

Function	Default setting	Customized setting	A	B	C	D
Driver's seat temperature preference in automatic mode	Standard	-2 (cooler) to 2 (warmer)	<input type="radio"/>	-	-	<input type="radio"/>
Passenger's seat temperature preference in automatic mode	Standard	-2 (cooler) to 2 (warmer)	<input type="radio"/>	-	-	<input type="radio"/>
Left-hand rear seat temperature preference in automatic mode ^{*1}	Standard	-2 (cooler) to 2 (warmer)	<input type="radio"/>	-	-	<input type="radio"/>
Right-hand rear seat temperature preference in automatic mode ^{*1}	Standard	-2 (cooler) to 2 (warmer)	<input type="radio"/>	-	-	<input type="radio"/>
Engine switch linked automatic activation of the left-hand rear seat heater/ventilator ^{*2}	Off	On	<input type="radio"/>	-	-	<input type="radio"/>
Engine switch linked automatic activation of the right-hand rear seat heater/ventilator ^{*2}	Off	On	<input type="radio"/>	-	-	<input type="radio"/>

^{*1}: If equipped

^{*2}: Vehicles without power rear seat

■ Heated steering wheel ^{*}(→P.326)

Function	Default setting	Customized setting	A	B	C	D
Steering wheel heating preference in automatic mode	Standard	-2 (low) to 2 (high)	<input type="radio"/>	-	-	<input type="radio"/>

^{*}: If equipped

■ **Illumination (→P.331)**

Function	Default setting	Customized setting	A	B	C	D
Time elapsed before the interior lights turn off	15 seconds	Off				
		7.5 seconds	○	-	-	○
		30 seconds				
Operation after the engine switch is turned off	On	Off	-	-	-	○
Operation when the doors are unlocked	On	Off	-	-	-	○
Operation when you approach the vehicle with the electronic key on your person	On	Off	-	-	-	○
Footwell lights	On	Off	-	-	-	○
Instrument panel ornament light and door trim ornament lights	On	Off	-	-	-	○
Time elapsed before the outer foot lights turn off	15 seconds	Off				
		7.5 seconds	○	-	-	○
		30 seconds				
Operation of the outer foot lights when you approach the vehicle with the electronic key on your person	On	Off	-	-	-	○
Operation of the outer foot lights when the doors are unlocked	On	Off	-	-	-	○
Operation of the outer foot lights when a door is opened	On	Off	-	-	-	○
Fading out of the outer foot lights when they turn off	Long	Short	-	-	-	○

■ **Vehicle customization**

- When the smart access system with push-button start is off, the entry unlock function cannot be customized.

- When the doors remain closed after unlocking the doors and the timer activated automatic door lock function activates, signals will be generated in accordance with the operation buzzer volume and operational signal (Emer-



Vehicle specifications

gency flashers) function settings.

- Some settings can be changed using a switch or the audio system screen. If a setting is changed using a switch, the changed setting will not be reflected on the audio system screen until the engine switch is turned off and then to IGNITION ON mode.

■ **Clock settings screen**

If the clock adjustment screen is displayed continuously when attempting to change the clock settings, the system may be malfunctioning. Have the vehicle inspected by your Lexus dealer.

Items to initialize

The following items must be initialized for normal system operation after such cases as the battery being reconnected, or maintenance being performed on the vehicle:

List of items to initialize

Item	When to initialize	Reference
PKSB (Parking Support Brake)*	<ul style="list-style-type: none"> After reconnecting or changing the battery 	P.274
Message indicating maintenance is required	<ul style="list-style-type: none"> After maintenance is performed 	P.364
Oil maintenance	<ul style="list-style-type: none"> After maintenance is performed 	P.377
Tire pressure warning system	<ul style="list-style-type: none"> When the tire inflation pressure is changed, such as when changing traveling speed or load weight. When the tire inflation pressure is changed, such as when the tire size is changed. When rotating the tires. After performing the transmitter ID code registration procedure. 	P.388
Lexus parking assist monitor*	<ul style="list-style-type: none"> Battery has been reinstalled. The steering wheel has been moved while the battery was being reinstalled. Battery power is low. 	Refer to the "NAVIGATION AND MULTIMEDIA SYSTEM OWNER'S MANUAL".
Panoramic view monitor*	<ul style="list-style-type: none"> Battery has been reinstalled. The steering wheel has been moved while the battery was being reinstalled. Battery power is low. 	Refer to the "NAVIGATION AND MULTIMEDIA SYSTEM OWNER'S MANUAL".

*: If equipped

For owners

9

483

9-1. For owners

Reporting safety defects for U.S. owners484

Seat belt instructions for Canadian owners (in French).....484

SRS airbag instructions for Canadian owners (in French).....486

9

For owners

Reporting safety defects for U.S. owners

If you believe that your vehicle has a defect which could cause a crash or could cause injury or death, you should immediately inform the National Highway Traffic Safety Administration (NHTSA) in addition to notifying the Lexus Division of Toyota Motor Sales, U.S.A., Inc. (Toll-free: 1-800-25-LEXUS).

If NHTSA receives similar complaints, it may open an investigation, and if it finds that a safety defect exists in a group of vehicles, it may order a recall and remedy campaign. However, NHTSA cannot become involved in individual problems between you, your dealer, or Lexus Division of Toyota Motor Sales, U.S.A., Inc.

To contact NHTSA, you may call the Vehicle Safety Hotline toll-free at 1-888-327-4236 (TTY: 1-800-424-9153); go to <http://www.safercar.gov>; or write to: Administrator, NHTSA, 1200 New Jersey Ave, S.E., Washington, DC 20590. You can also obtain other information about motor vehicle safety from <http://www.safercar.gov>.

Seat belt instructions for Canadian owners (in French)

The following is a French explanation of seat belt instructions extracted from the seat belt section in this manual.

See the seat belt section for more detailed seat belt instructions in English.

Utilisation correcte des ceintures de sécurité

- Déroulez la sangle diagonale de telle sorte qu'elle passe bien sur l'épaule, sans pour autant être en contact avec le cou ou glisser de l'épaule.



- Placez la sangle abdominale le plus bas possible sur les hanches.
- Réglez la position du dossier de siège. Asseyez-vous le dos droit et calez-vous bien dans le siège.
- Ne vrillez pas la ceinture de sécurité.

Entretien et soin

■ Traitement des ceintures de sécurité

Nettoyez avec un chiffon ou une éponge humidifiés avec de l'eau savonneuse tiède. Vérifiez régulièrement que les ceintures ne sont pas usées, effilochées ou entaillées excessivement.



ATTENTION

■ Détérioration et usure des ceintures de sécurité

Inspectez le système de ceintures de sécurité régulièrement. Contrôlez l'absence de coupures, d'effilochages et de pièces desserrées. N'utilisez pas une ceinture de sécurité endommagée avant qu'elle ne soit remplacée. Une ceinture de sécurité endommagée ne permet pas de protéger un occupant de blessures graves ou mortelles.

SRS airbag instructions for Canadian owners (in French)

The following is a French explanation of SRS airbag instructions extracted from the SRS airbag section in this manual.

See the SRS airbag section for more detailed SRS airbag instructions in English.

Système de coussins gonflables SRS

■ Emplacement des coussins gonflables SRS

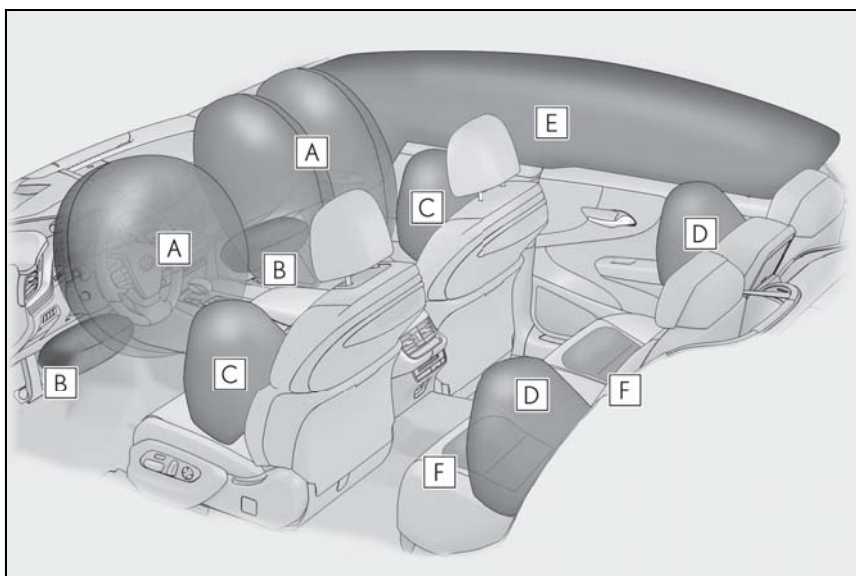

► Coussins gonflables frontaux SRS

A Coussin gonflable conducteur/coussin gonflable du passager avant SRS
Participe à la protection de la tête et du thorax du conducteur et du passager avant contre les chocs contre les éléments de l'habitacle

B Coussins gonflables de genoux SRS
Participent à la protection du conducteur et du passager avant

► Coussins gonflables latéraux et rideaux SRS

C Coussins gonflables latéraux avant SRS
Participent à la protection du torse des occupants de siège avant

D Coussins gonflables latéraux arrière SRS
Participent à la protection du torse des occupants des sièges latéraux arrière

- E** Coussins gonflables rideaux SRS
 - Participent principalement à la protection de la tête des occupants des sièges latéraux
 - Peut contribuer à empêcher les occupants d'être éjectés du véhicule en cas de tonneau
- F** Coussins gonflables de coussin de siège SRS (sur modèles équipés)
Contribue à retenir les occupants des sièges arrière électriques

■ **Composants du système de coussins gonflables SRS**

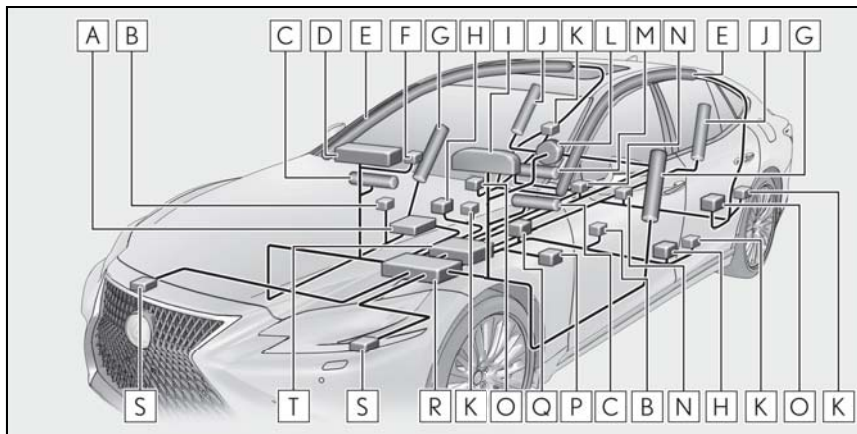

- A** Système de classification de l'occupant du siège passager avant (ECU et capteurs)
- B** Capteurs d'impact latéral (porte avant)
- C** Coussins gonflables de genoux
- D** Coussin gonflable passager avant
- E** Coussins gonflables rideaux
- F** Témoins indicateurs "AIR BAG ON" et "AIR BAG OFF"
- G** Coussins gonflables latéraux avant
- H** Capteurs d'impact latéral (avant)
- I** Témoin d'avertissement SRS
- J** Coussins gonflables latéraux arrière
- K** Prétensionneurs de ceinture de sécurité
- L** Coussin gonflable conducteur
- M** Coussins gonflables de coussin de siège (sur modèles équipés)
- N** Contacts de boucle de ceinture de sécurité de siège arrière (sur modèles équipés)

- O** Capteurs d'impact latéral (arrière)
- P** Capteur de position du siège conducteur
- Q** Contact de boucle de ceinture de sécurité conducteur
- R** Ensemble de capteurs de coussins gonflables
- S** Capteurs d'impact avant
- T** Ensemble informatique du capot actif

Votre véhicule est équipé de COUSSINS GONFLABLES INTELLIGENTS conçus selon les normes de sécurité américaines applicables aux véhicules à moteur (FMVSS208). L'ensemble de capteurs de coussins gonflables (ECU) régule le déploiement des coussins gonflables sur la base des informations qu'il reçoit des capteurs, etc., indiqués ci-dessus dans le schéma illustrant les composants du système. Parmi ces informations figurent la gravité du choc et l'occupation du véhicule par les passagers. Le déploiement rapide des coussins gonflables est obtenu au moyen d'une réaction chimique dans les dispositifs pyrotechniques, qui produit un gaz inoffensif permettant d'amortir le mouvement des occupants.

**ATTENTION****■ Précautions relatives aux coussins gonflables SRS**

Respectez les précautions suivantes concernant les coussins gonflables SRS. Le non-respect de ces précautions peut occasionner des blessures graves, voire mortelles.

- Le conducteur et tous les passagers du véhicule doivent porter correctement leur ceinture de sécurité. Les coussins gonflables SRS sont des dispositifs supplémentaires à utiliser avec les ceintures de sécurité.

- Le coussin gonflable conducteur SRS se déploie avec une force considérable, pouvant occasionner des blessures graves, voire mortelles, si le conducteur se trouve très près du coussin gonflable.

L'autorité fédérale chargée de la sécurité routière aux États-Unis (NHTSA) conseille: La zone à risque du coussin gonflable conducteur se situant dans les premiers 2 à 3 in. (50 à 75 mm) de déploiement, vous placer à 10 in. (250 mm) de votre coussin gonflable conducteur vous garantit une marge de sécurité suffisante. Cette distance est à mesurer entre le centre du volant et le sternum. Si vous êtes assis à moins de 10 in. (250 mm), vous pouvez changer votre position de conduite de plusieurs façons:

- Reculez votre siège le plus possible, de manière à pouvoir encore atteindre confortablement les pédales.

⚠ ATTENTION

- Inclinez légèrement le dossier du siège.
Bien que les véhicules aient une conception différente, un grand nombre de conducteurs peuvent s'asseoir à une distance de 10 in. (250 mm), même avec le siège conducteur complètement avancé, simplement en inclinant un peu le dossier de siège. Si vous avez des difficultés à voir la route après avoir incliné le dossier de votre siège, utilisez un coussin ferme et antidérapant pour vous rehausser ou remontez le siège si votre véhicule est équipé de cette fonction.
- Si votre volant est réglable, inclinez-le vers le bas. Cela a pour effet d'orienter le coussin gonflable en direction de votre poitrine plutôt que de votre tête et de votre cou.

Réglez votre siège selon les recommandations de la NHTSA ci-dessus, tout en conservant le contrôle des pédales, du volant et la vue des commandes du tableau de bord.

- Si vous attachez une rallonge de ceinture de sécurité aux boucles de ceinture de sécurité avant, sans l'attacher au pêne de la ceinture de sécurité, les coussins gonflables frontaux SRS déterminent que le conducteur et le passager avant ont attaché leur ceinture de sécurité, bien que la ceinture de sécurité ne soit pas attachée. Dans ce cas, les coussins gonflables frontaux SRS peuvent ne pas se déployer correctement en cas de collision, pouvant occasionner des blessures graves, voire mortelles. Veillez à porter la ceinture de sécurité avec la rallonge de ceinture de sécurité.



- Le coussin gonflable passager avant SRS se déploie également avec une force considérable, pouvant occasionner des blessures graves, voire mortelles, si le passager avant se trouve très près du coussin gonflable. Le siège du passager avant doit être éloigné le plus possible du coussin gonflable en réglant le dossier de siège de façon à ce que le passager avant soit assis bien droit dans le siège.

⚠ ATTENTION

● Les nourrissons et les enfants qui ne sont pas correctement assis et/ou attachés peuvent être grièvement blessés ou tués par le déploiement d'un coussin gonflable. Un nourrisson ou un enfant trop petit pour utiliser une ceinture de sécurité doit être correctement attaché au moyen d'un siège de sécurité enfant. Lexus recommande vivement d'installer tous les nourrissons et enfants sur les sièges arrière du véhicule et de prévoir pour eux des systèmes de retenue adaptés. Les sièges arrière sont plus sûrs pour les nourrissons et les enfants que le siège du passager avant.

● N'installez jamais un siège de sécurité enfant type dos à la route sur le siège passager avant, même si le témoin indicateur "AIR BAG OFF" est allumé. En cas d'accident, la force engendrée par le déploiement rapide du coussin gonflable du passager avant peut blesser grièvement, voire tuer l'enfant si le siège de sécurité enfant type dos à la route est installé sur le siège du passager avant.

● Ne vous asseyez pas sur le bord du siège et ne vous appuyez pas contre la planche de bord.

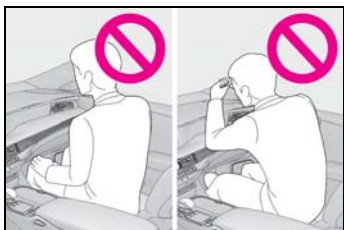

● Ne laissez pas un enfant rester debout devant le coussin gonflable passager avant SRS ou s'asseoir sur les genoux du passager avant.

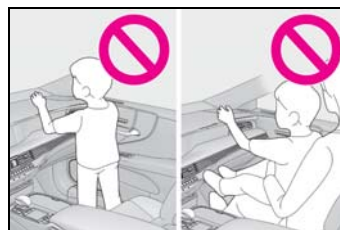

● Ne laissez pas les occupants des sièges avant voyager avec un objet sur les genoux.

● Ne vous appuyez pas contre la porte, le rail latéral de toit ou les montants avant, latéraux et arrière.



● Ne laissez personne s'agenouiller sur les sièges passagers en appui contre la porte ou sortir la tête ou les mains à l'extérieur du véhicule.



⚠ ATTENTION

- Ne fixez rien et ne posez rien sur des emplacements tels que la planche de bord, la garniture du volant et la partie inférieure du tableau de bord. Ces éléments peuvent se transformer en projectiles lorsque les coussins gonflables conducteur, passager avant et genoux SRS se déploient.

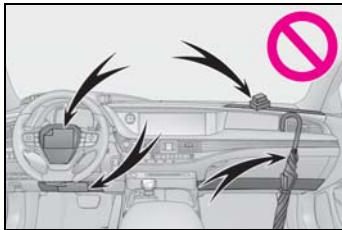

- Ne fixez rien aux portes, à la vitre du pare-brise, aux vitres latérales, aux montants avant et arrière, au rail latéral de toit et à la poignée de maintien.

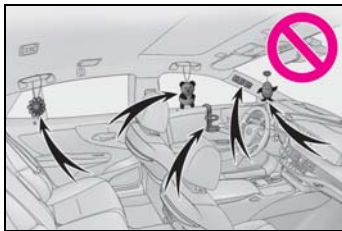

- Ne suspendez aucun cintre ou objet dur aux crochets à vêtements. Tous ces objets pourraient se transformer en projectiles et causer des blessures graves, voire mortelles en cas de déploiement des coussins gonflables rideaux SRS.
- Si un cache en vinyle est placé sur la zone où le coussin gonflable de genoux SRS se déploie, assurez-vous de le retirer.

- N'utilisez aucun accessoire de siège recouvrant les zones de déploiement des coussins gonflables latéraux SRS, car il risque de gêner le déploiement des coussins gonflables SRS. De tels accessoires peuvent empêcher les coussins gonflables latéraux de fonctionner correctement, désactiver le système ou entraîner le déploiement accidentel des coussins gonflables latéraux, occasionnant des blessures graves, voire mortelles.

- Évitez de faire subir des chocs ou des pressions excessives aux parties renfermant les composants de coussins gonflables SRS ou aux portes avant. En effet, cela pourrait entraîner un dysfonctionnement des coussins gonflables SRS.

- Ne touchez aucun composant immédiatement après le déploiement (gonflage) des coussins gonflables SRS, car ils peuvent être chauds.

- Si vous avez des difficultés à respirer après le déploiement des coussins gonflables SRS, ouvrez une porte ou une vitre pour faire entrer de l'air frais, ou bien descendez du véhicule si cela ne présente pas de danger. Essayez tout résidu dès que possible afin d'éviter d'éventuelles irritations de la peau.

- Si les parties renfermant les coussins gonflables SRS, comme les garnitures du volant et des montants avant et arrière, sont endommagées ou craquelées, faites-les remplacer par votre concessionnaire Lexus.

- Ne placez rien sur le siège du passager avant, comme un coussin par exemple. Cela a pour conséquence de répartir le poids du passager sur toute la surface du siège, ce qui empêche le capteur de détecter correctement le poids du passager. En conséquence, les coussins gonflables frontaux SRS du passager avant risquent de ne pas se déployer en cas de collision.

**ATTENTION****■ Modification et mise au rebut des composants du système de coussins gonflables SRS**

Ne mettez pas votre véhicule au rebut et ne procédez à aucune des modifications suivantes sans consulter votre concessionnaire Lexus. Les coussins gonflables SRS peuvent ne pas fonctionner correctement ou se déployer (se gonfler) accidentellement, provoquant la mort ou de graves blessures.

- Installation, dépose, démontage et réparation des coussins gonflables SRS
- Réparations, modifications, démontage ou remplacement du volant, du tableau de bord, de la planche de bord, des sièges ou de leur garnissage, des montants avant, latéraux et arrière, des rails latéraux de toit, des panneaux de porte avant, des garnitures de porte avant ou des haut-parleurs de porte avant
- Modifications du panneau de porte avant (par exemple, perçage d'un trou dans le panneau)
- Réparations ou modifications des ailes avant, du pare-chocs avant ou des flancs de l'habitacle
- Installation d'un protège-calandre (pare-buffle, pare-kangourou, etc.), de chasse-neige, de treuils ou d'un porte-bagages de toit
- Modifications du système de suspension du véhicule
- Installation d'appareils électroniques tels que les émetteurs/récepteurs radios mobiles et les lecteurs CD
- Modifications de votre véhicule pour une personne atteinte d'un handicap physique

Index

493

What to do if... (Troubleshooting)

.....**494**

Alphabetical Index.....**497**

What to do if... (Troubleshooting)

If you have a problem, check the following before contacting your Lexus dealer.

The doors cannot be locked, unlocked, opened or closed



You lose your keys

- If you lose your mechanical keys, new genuine mechanical keys can be made by your Lexus dealer. (→P.432)
- If you lose your electronic keys, the risk of vehicle theft increases significantly. Contact your Lexus dealer immediately. (→P.432)



The electronic key does not operate properly

- Is the electronic key battery weak or depleted? (→P.399)



The doors cannot be locked or unlocked

- Is the engine switch in IGNITION ON mode?

When locking the doors, turn the engine switch off. (→P.166)

- Is the electronic key left inside the vehicle?

When locking the doors, make sure that you have the electronic key on your person.

- The function may not operate properly due to the condition of the radio wave. (→P.113)



The rear door cannot be opened

- Is the child-protector lock set?

The rear door cannot be opened from inside the vehicle when the lock is set.

Open the rear door from outside and then unlock the child-protector lock. (→P.103)



The trunk lid is closed with the electronic key left inside

- The function to prevent the electronic key from being left inside the trunk will operate and you can open the trunk as usual. Take the key out from the trunk. (→P.109)

If you think something is wrong



The engine does not start

- Did you press the engine switch while firmly depressing the brake pedal? (→P.164)
- Is the electronic key anywhere detectable inside the vehicle? (→P.112)
- Is the steering wheel unlocked? (→P.164)
- Is the electronic key battery weak or depleted?

In this case, the engine can be started in a temporary way. (→P.434)

- Is the battery discharged?
(→P.435)



The steering wheel cannot be turned after the engine is stopped

- It is locked automatically to prevent theft of the vehicle. (→P.164)



The windows do not open or close by operating the power window switches

- Is the window lock switch pressed?

The power window except for the one at the driver's seat cannot be operated if the window lock switch is pressed. (→P.144)



The engine switch is turned off automatically

- The auto power off function will be operated if the vehicle is left in ACCESSORY mode for a period of time. (→P.166)



A warning buzzer sounds during driving

- The seat belt reminder light is flashing

Are the driver and the front passenger wearing the seat belts? (→P.418)

- The parking brake indicator is on
Is the parking brake released? (→P.174)

Depending on the situation, other types of warning buzzer may also

sound. (→P.415, 425)



An alarm is activated and the horn sounds

- Did anyone inside the vehicle open a door during setting the alarm?

The sensor detects it and the alarm sounds. (→P.65)

Do one of the following to deactivate or stop the alarms:

- Unlock the doors.
- Turn the engine switch to ACCESSORY or IGNITION ON mode, or start the engine. (The alarm will be deactivated or stopped after a few seconds.)



A warning buzzer sounds when leaving the vehicle

- Is the message displayed on the multi-information display?

Check the message on the multi-information display. (→P.425)



A warning light turns on or a warning message is displayed

- When a warning light turns on or a warning message is displayed, refer to P.415, 425.

When a problem has occurred



If you have a flat tire

- Slow down the vehicle, drive with extra caution, and take your vehicle to the nearest Lexus dealer or authorized tire dealer as soon as possible to have the tire replaced. (→P.429)



The vehicle becomes stuck

- Try the procedure for when the vehicle becomes stuck in mud, dirt, or snow. (→P.443)

Alphabetical Index

A

A/C	
Air conditioning filter	398
Front automatic air conditioning system	313
Micro dust and pollen filter	319
Rear automatic air conditioning system	323
ABS (Anti-lock Brake System)	294
Warning light	417
Active stabilizer suspension system	295
Adaptive Front-lighting System (AFS) ..	181
Adaptive Variable Suspension System	295
AFS (Adaptive Front-lighting System) ..	181
Air conditioning filter	398
Air conditioning system	
Air conditioning filter	398
Front automatic air conditioning system	313
Micro dust and pollen filter	319
Rear automatic air conditioning system	323
Airbags	
Airbag operating conditions.....	31
Airbag precautions for your child.....	34
Correct driving posture	23
Curtain shield airbag operating conditions.....	32
Curtain shield airbag precautions	34
Front passenger occupant classification system	40
General airbag precautions	34
Locations of airbags.....	29
Modification and disposal of airbags..	37
Side airbag operating conditions.....	32
Side airbag precautions	34
Side and curtain shield airbags operating conditions.....	32
Side and curtain shield airbags precautions.....	34
SRS airbags	29

SRS warning light.....	416
Alarm	65
Warning buzzer	415
Anchor brackets	46, 55
Antennas (smart access system with push-button start)	111
Anti-lock Brake System (ABS)	294
Warning light	417
Approach warning	243
Armrest	344
Assist grips	344
Audio system-linked display	85
Automatic headlight leveling system ...	180
Automatic High Beam	182
Automatic light control system	179
Automatic transmission	167
M mode	172
Paddle shift switches	171, 172
Snow mode.....	171
Auxiliary boxes	339, 341
Average fuel economy	82
Average vehicle speed	82

B

Back-up lights	
Replacing light bulbs.....	404
Battery	
Battery checking	380
If the battery is discharged	435
Preparing and checking before winter	300
Warning light	416
Blind Spot Monitor (BSM)	250
Boost gauge	83
Brake	
Brake hold	177
Fluid.....	379, 451
Parking brake	174
Warning light	415
Brake assist	294
Break-in tips	155

Brightness control
 Instrument panel light control75, 79
 BSM (Blind Spot Monitor).....250
 Buzzer
 Hands off steering wheel alert (LTA)
 236, 236

C

Card key 96
 Care
 Aluminum wheels.....358
 Exterior358
 Interior361
 Seat belts.....361
 Cargo capacity.....162
 Cargo net340
 Center Display306
 Chains301
 Child restraint system
 Fixed with a LATCH system53
 Fixed with a seat belt.....49
 Front passenger occupant classification
 system40
 Points to remember45
 Riding with children.....45
 Types of child restraint system installation
 method46
 Using an anchor bracket.....55
 Child safety
 Airbag precautions.....34
 Battery precautions.....381, 439
 Child restraint system.....46
 Heated steering wheel and seat heater
 precautions.....327
 How your child should wear the seat belt
 25
 Moon roof precautions146
 Panoramic moon roof precautions...150
 Power window lock switch.....144
 Power window precautions143
 Rear door child-protectors103

Removed electronic key battery precau-
 tions400
 Seat belt extender precautions.....25
 Seat belt precautions45
 Trunk precautions.....104
 Child-protectors.....103
 Cleaning
 Aluminum wheels358
 Exterior.....358
 Interior361
 Radar sensor192, 198
 Seat belts.....361
 Clock73, 76, 345
 Clock light331
 Coat hooks.....344
 Coin holder337
 Condenser378
 Console box338
 Consumption screen91
 Cooling system.....377
 Engine overheating.....440
 Cornering lights181
 Cruise control
 Dynamic radar cruise control with
 full-speed range237, 247
 Cup holders337
 Current fuel consumption82
 Curtain shield airbags29
 Customizable features.....466

D

Daytime running light system179
 Defogger
 Outside rear view mirrors.....314
 Rear window314
 Windshield.....314
 Differential
 Front differential oil.....450
 Rear differential oil.....451
 Dimension446
 Dinghy towing.....163

Display	
Center Display.....	306
Dynamic radar cruise control with full-speed range.....	237
Head-up display	87
Intuitive parking assist.....	257
LTA (Lane Tracing Assist).....	231
Multi-information display.....	80
Parking Support Brake function (rear pedestrians).....	286
RCD (Rear Camera Detection).....	267
RCTA.....	263
Warning message.....	425
Distance until next engine oil	
change	74, 79
Do-it-yourself maintenance.....	365
Door courtesy lights.....	331
Door lock	
Doors.....	100
Smart access system with push-button start.....	111
Wireless remote control.....	98
Doors	
Automatic door locking and unlocking system	104
Door closer	103
Door glasses.....	142
Door lock.....	100
Open door warning buzzer	101, 103
Outside rear view mirrors	140
Rear door child-protectors	103
Drive distance.....	82
Drive info 1/Drive info 2	82
Driver's seat position memory	
Driving position memory.....	130
Memory recall function	133
Power easy access system.....	130
Drive-start control	155
Driving	
Break-in tips.....	155
Correct driving posture.....	23
Driving mode select switch.....	289
Procedures	154
Winter drive tips.....	300
Driving information display	82
Driving position memory.....	130
Memory recall function.....	133
Power easy access system	130
Driving range	82
Driving support system information display	85
DRS (Dynamic Rear Steering)	295
Dynamic radar cruise control with full-speed range.....	237, 247
Warning message.....	245
Dynamic Rear Steering (DRS)	295
E	
ECB (Electronically Controlled Brake Sys- tem).....	294
Eco Driving Indicator.....	83, 91
Eco Driving Indicator Light.....	83
EDR (Event data recorder).....	7
Elapsed time	82
Electric Power Steering (EPS)	295
Warning light	418
Electronic key	96
Battery-saving function.....	112
If the electronic key does not operate properly	433
Replacing the battery.....	399
Electronic roof sunshade	
Jam protection function.....	149
Operation.....	147
Electronically Controlled Brake System (ECB).....	294
Electronically modulated air suspension	291
Emergency flashers.....	406
Emergency, in case of	
If a warning buzzer sounds.....	415
If a warning light turns on.....	415
If a warning message is displayed....	425
If the battery is discharged.....	435

If the electronic key does not operate properly.....	433
If the engine will not start	430
If the fuel filler door cannot be opened	432
If the vehicle is trapped in rising water	407
If you have a flat tire.....	429
If you lose your keys.....	432
If you think something is wrong	413
If your vehicle becomes stuck.....	443
If your vehicle has to be stopped in an emergency	406
If your vehicle needs to be towed....	409
If your vehicle overheats.....	440
Engine	
ACCESSORY mode	166
Compartment	373
Engine compartment cover	374
Engine switch.....	164
Fuel pump shut off system	414
Hood.....	371
How to start the engine.....	164
Identification number.....	447
If the engine will not start	430
If your vehicle has to be stopped in an emergency	406
Ignition switch (engine switch)	164
Overheating.....	440
Tachometer	73, 76
Engine compartment cover	374
Engine coolant	
Capacity.....	449
Checking	377
Preparing and checking before winter	300
Engine coolant temperature gauge 73, 76	
Engine immobilizer system	63
Engine oil	
Capacity.....	448
Checking	375
Preparing and checking before winter	300
Warning light	416
Engine oil maintenance data	377
Engine switch	164
Auto power off function.....	166
Changing the engine switch modes	166
If your vehicle has to be stopped in an emergency.....	406
EPS (Electric Power Steering)	295
Warning light	418
Event data recorder (EDR).....	7
F	
FCTA (Front Cross Traffic Alert).....	222
First-aid kit storage belt	341
Flat tire	
Tire pressure warning system	384
Floor mats	22
Fluid	
Automatic transmission	450
Brake.....	451
Washer	379
Footwell light	331
Front automatic air conditioning system	313
Front Cross Traffic Alert (FCTA).....	222
Front passenger occupant classification system	40
Front seats	
Adjustment.....	119
Cleaning.....	361
Correct driving posture	23
Driving position memory	130
Head restraints.....	135
Memory recall function.....	133
Power easy access system	130
Refresh system	124
Seat heaters	326
Seat position memory	130
Seat ventilators.....	326

Front side marker light
 Light switch.....179
 Replacing light bulbs.....404

Front turn signal lights
 Replacing light bulbs.....404
 Turn signal lever.....173

Fuel
 Capacity.....447
 Fuel gauge.....73, 76
 Fuel pump shut off system.....414
 Information.....455
 Refueling.....189
 Type.....447
 Warning light.....418

Fuel consumption
 Average fuel economy.....82
 Current fuel consumption.....82

Fuel filler door
 If the fuel filler door cannot be opened
432
 Refueling.....189

Fuel gauge.....73, 76

Fuel pump shut off system.....414

Fuses.....401

G

Garage door opener.....350

Gauges.....73, 76

Gear Position.....84

G-force.....84

Glove box.....336

Glove box light.....337

H

Hands Free Power Trunk Lid.....107

Head restraints.....135

Headlights
 Adaptive Front-lighting System (AFS)
181
 Automatic High Beam system.....182
 Light switch.....179

Replacing light bulbs.....404

Head-up display.....87
 Driving information display area.....87
 Driving support system display area..90
 Eco Driving Indicator.....91
 HUD (Head-up display) switch.....89
 Navigation system-linked display.....87
 Pop-up display.....90
 Settings.....89

Heated steering wheel.....326

Heaters
 Front automatic air conditioning system
313
 Heated steering wheel.....326
 Outside rear view mirrors.....314
 Rear automatic air conditioning system
323
 Seat heaters.....326

Height control
 Electronically modulated air suspension
292

Hill-start assist control.....295

Hood
 Open.....371
 Pop Up Hood.....38

Hooks
 Coat hooks.....344
 Retaining hooks (floor mat).....22

Horn.....138

HUD (Head-up display) switch.....89

I

I/M test.....368

Identification
 Engine.....447
 Vehicle.....446

Ignition switch (engine switch).....164
 Auto power off function.....166
 Changing the engine switch modes.166
 If your vehicle has to be stopped in an
 emergency.....406

Indicators.....70

Initialization
 Items to initialize 481
 Maintenance 364, 377
 Power windows 142
 Tire pressure warning system 388
Inside door handle lights 331
Inside rear view mirror 139
Instrument panel light control 75, 79
Intercooler 378
Intercooler coolant
 Capacity 449
 Checking 377
Interior lights 331
 Front interior light 331
 Rear interior light 331
Intuitive parking assist 255, 257
 Function 257
 Warning message 259

J

Jack
 Positioning a floor jack 371
Jam protection function
 Electronic roof sunshade 149
 Moon roof 145
 Panoramic moon roof 149
 Power trunk opener and closer 109
 Power windows 142
 Rear door sunshade 347

K

Keyless entry
 Smart access system with push-button
 start 111
 Wireless remote control 98
Keys
 Battery-saving function 112
 Electronic key 96
 Engine switch 164
 If the electronic key does not operate
 properly 433

If you lose your keys 432
 Key number plate 96
 Keyless entry 100, 111
 Mechanical key 96
 Replacing the battery 399
 Warning buzzer 112
 Wireless remote control 98
Knee airbags 29

L

Lane change assist function 225
Lane Tracing Assist (LTA)
 Operation 225
 Warning messages 237
Language (multi-information display) ... 85
LATCH anchors 53
LDH (Lexus Dynamic Handling system)
 295
Lever
 Auxiliary catch lever 371
 Hood lock release lever 371
 Internal trunk release lever 109
 Shift lever 167
 Turn signal lever 173
 Wiper lever 184
Lexus climate concierge 311
Lexus Dynamic Handling system (LDH)
 295
Lexus Enform Safety Connect 58
Lexus Safety System + 2.0
 Automatic High Beam 182
 Dynamic radar cruise control with
 full-speed range 237
 LTA (Lane Tracing Assist) 225
 PCS (Pre-Collision System) 215
 RSA (Road Sign Assist) 247
Lexus Safety System + A 191
 Automatic High Beam 182
 Dynamic radar cruise control with
 full-speed range 237, 247
 FCTA (Front Cross Traffic Alert) 222
 LTA (Lane Tracing Assist) 225

PCS (Pre-Collision System).....204
 RSA (Road Sign Assist) 247
License plate lights
 Light switch.....179
 Replacing light bulbs.....404
Light bulbs
 Replacing.....404
Lights
 Automatic High Beam system.....182
 Front interior lights.....332
 Front personal lights.....333
 Headlight switch179
 Interior lights.....331
 Interior lights list.....331
 Rear interior lights.....332
 Rear personal lights.....333
 Replacing light bulbs.....404
 Trunk lid light.....108
 Trunk light.....108
 Turn signal lever173
 Vanity lights347
 Welcome light illumination control...180
Lock steering column164
LTA (Lane Tracing Assist)
 Operation.....225
 Warning messages237
Luggage mats340

M

Maintenance
 Do-it-yourself maintenance369
 General maintenance365
 Maintenance data.....446
 Maintenance requirements364
Malfunction indicator lamp416
Master warning light422
Menu icons.....81
Meter
 Changing the main meter location80
 Clock.....73, 76
 Indicators70
 Instrument panel light control75, 79

Meter control switches81
 Meters.....73, 76
 Multi-information display80
 Settings.....85
 Units.....84
 Warning lights.....415
 Warning message.....425
Micro dust and pollen filter319
Mirrors
 Inside rear view mirror139
 Outside rear view mirror defoggers
314
 Outside rear view mirrors.....140
 Vanity mirrors.....347
Moon roof
 Door lock linked moon roof operation
145, 149
 Jam protection function.....145
 Operation.....145
Multi-information display80
 Audio system-linked display85
 Boost gauge.....83
 Drive information 1/Drive information 2
82
 Driving information display.....82
 Driving support system information display.....85
 Dynamic radar cruise control with
 full-speed range237
 Eco Driving Indicator.....83
 Gear Position84
 G-force.....84
 LTA (Lane Tracing Assist).....231
 Menu icons81
 Meter control switches81
 Navigation system-linked display84
 Pop-up display80
 Settings.....85
 Suggestion function.....86
 Tire pressure384
 Units.....84
 Warning message.....425

N

Navigation system-linked display....84, 87
 Noise from under vehicle6

O

“ODO TRIP” switch74, 79
 Odometer74, 79
 Odometer and trip meter display
 Display items..... 74, 79
 “ODO TRIP” switch..... 74, 79
 Pop-up display.....75, 79
 Oil
 Engine oil..... 448
 Front differential oil450
 Rear differential oil451
 Opener
 Fuel filler door..... 189
 Hood.....371
 Trunk106
 Outer foot lights
 Location.....331
 Outside door handle lights.....331
 Outside rear view mirrors
 Adjustment..... 140
 BSM (Blind Spot Monitor)250
 Folding141
 Linked mirror function when reversing
 140
 Mirror position memory..... 130
 Outside rear view mirror defoggers
 314
 RCTA function.....263
 Outside temperature.....73, 76
 Overheating 440

P

Paddle shift switches171, 172
 Panic mode 98
 Panoramic moon roof
 Jam protection function.....149

 Operation.....147
 Parking assist sensors (intuitive parking assist)..... 257
 Parking brake
 Operation.....174
 Parking brake engaged warning buzzer
 176
 Warning light422
 Warning message.....176
 Parking lights
 Light switch179
 Replacing light bulbs..... 404
 Parking Support Brake function (for rear-crossing vehicles)282
 Function282
 Parking Support Brake function (rear pedestrians).....270, 286
 Function286
 Parking Support Brake function (rear-crossing vehicles)..... 270
 Parking Support Brake function (static objects).....270, 276
 Function276
 PCS (Pre-Collision System)
 Function 204, 215
 PCS OFF switch207, 217
 Warning light421
 Personal lights.....331
 PKSA (Parking Support Alert)..... 255
 PKSB (Parking Support Brake)..... 270
 Warning message..... 274
 Pop Up Hood.....38
 Power easy access system 130
 Power outlets345
 Power rear seat.....126
 Power steering (Electric power steering system).....295
 Warning light 418
 Power trunk opener and closer 106
 Power windows
 Door lock linked window operation..143
 Jam protection function.....142

Operation.....142
 Window lock switch144
Pre-Collision System (PCS)
 Function.....204, 215
 PCS OFF switch.....207, 217
 Warning light.....421

R

Radar cruise control (dynamic radar cruise control with full-speed range).. 237, 247
Radiator378
RCD (Rear camera detection).....255
 Warning message.....268
RCD (Rear Camera Detection)
 Function.....267
RCTA
 Function.....263
 Warning message.....264
RCTA (Rear Cross Traffic Alert)255
RCTA function264
Rear automatic air conditioning system323
Rear Cross Traffic Alert (RCTA)263
Rear door sunshades347
Rear Multi Operation Panel308
Rear seat position memory134
Rear seats126
 Adjustment.....126
 Head restraints135
 Rear seat position memory134
 Relaxation system.....129
 Seat heaters326
 Seat ventilators.....326
Rear side marker lights
 Light switch.....179
 Replacing light bulbs.....404
Rear sunshades348
Rear turn signal lights
 Replacing light bulbs.....404
 Turn signal lever.....173
Rear view mirror
 Inside rear view mirror.....139

Outside rear view mirrors.....140
Rear window defogger314
Refueling
 Capacity.....447
 Fuel types447
 If the fuel filler door cannot be opened432
 Opening the fuel tank cap189
Remote Touch304
Replacing
 Electronic key battery399
 Fuses.....401
 Light bulbs.....404
 Tires391
Resetting the message indicating maintenance is required.....364
Rev indicator78
Rev peak.....78
Road Sign Assist.....247
RSA (Road Sign Assist).....247
Run-flat tires.....384, 429

S

Seat belt buckle lights.....331
Seat belt reminder light.....418, 419
Seat belts.....24
 Automatic Locking Retractor.....26
 Child restraint system installation.....46
 Cleaning and maintaining the seat belt361
 Easy Access Buckle26
 Emergency Locking Retractor26
 How to wear your seat belt25
 How your child should wear the seat belt25
 Pregnant women, proper seat belt use24
 Reminder light and buzzer418, 419
 Seat belt extender.....25
 SRS warning light.....416
Seat heaters.....326
Seat position memory.....130, 134

Seat ventilators.....	326
Seating capacity.....	162
Seats	
Adjustment.....	119, 126
Adjustment precautions.....	119
Child seats/child restraint system installation.....	45
Cleaning.....	361
Driving position memory.....	130
Front seat refresh system.....	124
Head restraints.....	135
Power easy access system.....	130
Properly sitting in the seat.....	23
Rear seat relaxation system.....	129
Seat heaters.....	326
Seat position memory.....	130, 134
Seat ventilators.....	326
Secondary Collision Brake	294
Sensor	
Automatic headlight system.....	179
Automatic High Beam system.....	182
Inside rear view mirror.....	139
Intuitive parking assist.....	257
LTA (Lane Tracing Assist).....	225
Parking Support Brake function (rear-crossing vehicles).....	282
Parking Support Brake function (static objects).....	277
Radar sensor.....	191, 198, 251
Rain-sensing windshield wipers.....	185
RCTA.....	264
Service reminder message	364
Shift lever	
Automatic transmission.....	167
Shift lever light	331
Shopping bag hooks	340
Side airbags	29
Side marker lights	
Light switch.....	179
Replacing light bulbs.....	404
Side mirrors	
Adjustment.....	140
BSM (Blind Spot Monitor).....	250
Folding.....	141
Linked mirror function when reversing.....	140
Mirror position memory.....	130
RCTA function.....	263
Side turn signal lights	
Replacing light bulbs.....	404
Turn signal lever.....	173
Side windows	142
Smart access system with push-button start	
Antenna location.....	111
Entry functions.....	100
Starting the engine.....	164
Snow mode	171
Snow tires	300
Spark plug	449
Specifications	446
Speedometer	73, 76
Steering lock	
Column lock release.....	164
Steering lock system warning message.....	164
Steering wheel	
Adjustment.....	138
Heated steering wheel.....	326
Meter control switches.....	81
Power easy access system.....	130
Steering wheel position memory.....	130
Stop lights	
Replacing light bulbs.....	404
Storage features	335
Stuck	
If the vehicle becomes stuck.....	443
Suggestion function	86
Sun visors	346
Sunshade	
Roof.....	145
Switches	
Activating the Automatic High Beam.....	182
Automatic High Beam system.....	182

Brake Hold switch 177
 Door lock switches 102
 Driving mode select switch 289
 Driving position memory switches... 130
 Dynamic radar cruise control with
 full-speed range switch 238
 Electronic roof sunshade switches... 147
 Emergency flashers switch 406
 Engine switch 164
 Garage door opener switches 350
 Heated steering wheel switch 326
 HUD (Head-up display) switch 89
 Ignition switch 164
 Instrument panel light control switches
 75, 79
 Intuitive parking assist switch 258
 Light switches 179
 LTA (Lane-Tracing Assist) switch 231
 Meter control switches 81
 Moon roof switches 145
 "ODO TRIP" switch 74, 79
 Outside rear view mirror switches... 140
 Paddle shift switches 171, 172
 Panoramic moon roof switches 147
 Parking brake switch 174
 PCS OFF switch 207, 217
 PKSB (Parking Support Brake) switch
 271
 Power door lock switch 102
 Power window switches 142
 RCD (Rear camera detection) switch
 267
 RCTA switch 264
 Rear door sunshade switch 347
 Rear seat heater 324
 Rear seat position memory switches. 134
 Rear seat ventilator 324
 Rear sunshades switch 348
 Rear window and outside rear view mir-
 ror defoggers switch 313
 Seat heater switches 326
 Seat ventilator switches 326

Snow mode switch 171
 "SOS" button 58
 Tilt and telescopic steering control switch
 138
 Tire pressure warning reset switch.. 388
 Trunk closer switch 108
 Trunk opener main switch 110
 Trunk opener switch 106
 Vehicle-to-vehicle distance switch... 238
 VSC OFF switch 296
 Window lock switch 144
 Windshield wiper and washer switch 184
 Windshield wiper de-icer switch 318

T

Tachometer 73, 76
 Rev indicator 78
 Rev peak 78
Tail lights
 Light switch 179
 Replacing light bulbs 404
Theft deterrent system
 Alarm 65
 Engine immobilizer system 63
Tire inflation pressure
 Maintenance data 452
 Tire inflation pressure display function
 384
 Warning light 419
Tire information 457
 Glossary 460
 Size 458
 Tire identification number 458
 Uniform Tire Quality Grading 459
Tire pressure display 384
Tire pressure warning system
 Function 384
 Initializing 388
 Installing tire pressure warning valves
 and transmitters 387
 Registering ID codes 389
 Warning light 419

Tires	
Chains	301
Checking	382
If you have a flat tire	429
Inflation pressure	395
Information	457
Replacing	391
Rotating tires	384
Run-flat tires	384, 429
Size	452
Snow tires	300
Tire inflation pressure display function	384
Tire pressure warning system	384
Warning light	419
Top tether strap	55
Total load capacity	446
Towing	
Dinghy towing	163
Emergency towing	409
Towing eyelet	412
Trailer towing	163
TRAC (Traction Control)	295
Traction Control (TRAC)	295
Trailer towing	163
Transmission	
Automatic transmission	167
Driving mode select switch	289
M mode	172
Paddle shift switches	171, 172
Snow mode	171
Trip meters	74, 79
Trunk	104
Hands Free Power Trunk Lid	107
Internal trunk release lever	109
Power trunk opener and closer	106
Smart access system with push-button start	107
Trunk closer switch	108
Trunk easy closer	108
Trunk features	340
Trunk grip	108
Trunk lid light	108
Trunk light	108
Trunk opener main switch	110
Trunk opener switch	106
Wireless remote control	107
Trunk lid light	108
Trunk light	108
Turn signal lights	
Replacing light bulbs	404
Turn signal lever	173
U	
USB charging ports	343
V	
Vanity lights	347
Vanity mirrors	347
Variable Gear Ratio Steering (VGRS)	295
VDIM (Vehicle Dynamics Integrated Management)	295
Vehicle data recordings	6
Vehicle Dynamics Integrated Management (VDIM)	295
Vehicle identification number	446
Vehicle Stability Control (VSC)	294
Ventilators (seat ventilators)	326
VGRS (Variable Gear Ratio Steering)	295
VSC (Vehicle Stability Control)	294
W	
Warning buzzer	
Hands off steering wheel alert (LTA)	236
LTA (Lane-Tracing Assist)	228
Warning buzzers	
ABS	417
Airbags	416
Approach warning	243
Brake hold	422
Brake Override System	417
Brake system	415

Charging system	416	SRS.....	416
Downshifting.....	172, 173	Tire pressure	419
Drive-Start Control.....	417	Warning messages.....	425
Electric power steering.....	418	Warning reflector storage belt.....	341
Engine	416	Washer	
High coolant temperature	415	Adding.....	379
Intuitive parking assist.....	263, 420	Preparing and checking before winter	
Low engine oil pressure.....	416	300
LTA (Lane Tracing Assist).....	225, 419	Switch.....	184
Open door.....	101, 103	Washing and waxing.....	358
Open window.....	143	Weight	
PKSA (Parking Support Alert).....	256	Cargo capacity.....	162
PKSB (Parking Support Brake).....	421	Load limits	162
Pop Up Hood.....	417	Weight.....	446
Pre-collision braking.....	204, 216	Wheels	
RCD (Rear Camera Detection).....	420	Replacing wheels.....	391
RCTA (Rear Cross Traffic Alert).....	420	Size.....	452
Seat belt.....	418, 419	Window lock switch.....	144
Warning lights.....	415	Windows	
ABS.....	417	Power windows.....	142
Brake hold operated indicator	422	Rear window defogger.....	314
Brake Override System.....	417	Washer	184
Brake system	415	Windshield wiper de-icer	319
Charging system	416	Windshield wipers	
Drive-Start Control.....	417	Position.....	187
Electric power steering	418	Rain-sensing windshield wipers.....	184
High coolant temperature	415	Winter driving tips.....	300
Intuitive parking assist OFF indicator		Wireless remote control	
.....	420	Battery-Saving Function.....	112
Low engine oil pressure.....	416	Locking/Unlocking	98
Low fuel level.....	418	Replacing the battery.....	399
LTA indicator.....	419		
Malfunction indicator lamp.....	416		
Master warning light	422		
Parking brake indicator	422		
PKSB OFF indicator.....	421		
Pop Up Hood.....	417		
Pre-collision system	421		
RCD OFF indicator	420		
RCTA OFF indicator.....	420		
Seat belt reminder light	418, 419		
Slip indicator	421		

For information regarding the equipment listed below, refer to the “NAVIGATION AND MULTI-MEDIA SYSTEM OWNER’S MANUAL”.

- Navigation system
- Audio/visual system

510 Alphabetical Index

- Rear seat entertainment system
- Lexus parking assist monitor

GAS STATION INFORMATION

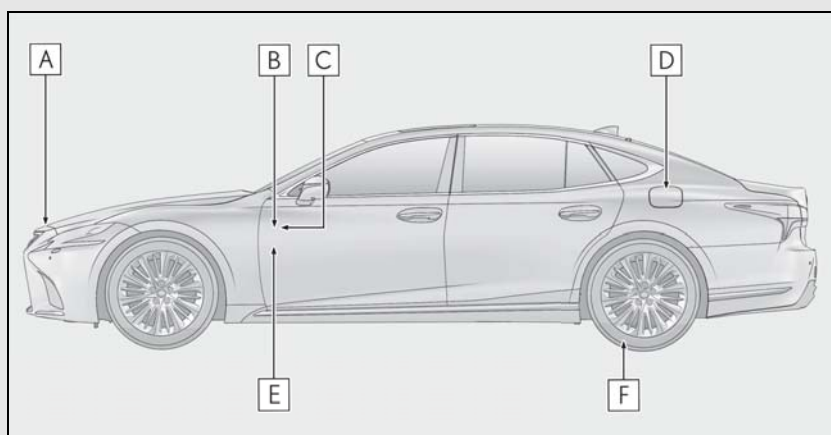

- A** Auxiliary catch lever (→P.371)
- B** Trunk opener (→P.106)
- C** Fuel filler door opener (→P.190)
- D** Fuel filler door (→P.190)
- E** Hood lock release lever (→P.371)
- F** Tire inflation pressure (→P.452)

Fuel tank capacity (Reference)	21.7 gal. (82.0 L, 18.0 Imp. gal.)	
Fuel type	Unleaded gasoline only	P.447 P.455
Cold tire inflation pressure		P.452
Engine oil capacity (Drain and refill — reference)		P.448
Engine oil type		P.448