

<b>Pictorial index</b>	Search by illustration	
<b>For safety and security</b>	Make sure to read through them (Main topics: Child seat, theft deterrent system)	1
<b>Vehicle status information and indicators</b>	Reading driving-related information (Main topics: Meters, multi-information display)	2
<b>Before driving</b>	Opening and closing the doors and windows, adjustment before driving (Main topics: Keys, doors, seats)	3
<b>Driving</b>	Operations and advice which are necessary for driving (Main topics: Starting engine <hybrid system>, refueling)	4
<b>Interior features</b>	Usage of the interior features (Main topics: Air conditioner, storage features)	5
<b>Maintenance and care</b>	Caring for your vehicle and maintenance procedures (Main topics: Interior and exterior, light bulbs)	6
<b>When trouble arises</b>	What to do in case of malfunction and emergency (Main topics: Battery discharge, flat tire)	7
<b>Vehicle specifications</b>	Vehicle specifications, customizable features (Main topics: Fuel, oil, tire inflation pressure)	8
<b>For owners</b>	Reporting safety defects for U.S. owners, and seat belt, SRS airbag and headlight aim instructions for Canadian owners	9
<b>Index</b>	Search by symptom	
	Search alphabetically	

## 2 TABLE OF CONTENTS

For your information .....	6
Reading this manual .....	10
How to search .....	11
Pictorial index .....	12

### 1 For safety and security

<b>1-1. For safe use</b>	
Before driving .....	22
For safe driving .....	23
Seat belts .....	24
SRS airbags .....	28
Pop Up Hood .....	36
Front passenger occupant classification system .....	38
Exhaust gas precautions .....	42
<b>1-2. Child safety</b>	
Riding with children .....	43
Child restraint systems .....	43
<b>1-3. Lexus Enform</b>	
Lexus Enform Safety Connect ..	54
Lexus Enform Remote .....	59
Lexus Enform Service Connect	60
<b>1-4. Hybrid system</b>	
Hybrid system features (LC500h) .....	61
Hybrid system precautions (LC500h) .....	64
<b>1-5. Theft deterrent system</b>	
Engine immobilizer system <Immobilizer system> .....	69
Alarm .....	71
Theft prevention labels (U.S.A.)	72

### 2 Vehicle status information and indicators

<b>2-1. Instrument cluster</b>	
Warning lights and indicators .....	74
Gauges and meters .....	80
Multi-information display .....	84
Head-up display .....	90
Energy monitor/consumption screen .....	95

### 3 Before driving

<b>3-1. Key information</b>	
Keys .....	102
<b>3-2. Opening, closing and locking the doors and trunk</b>	
Doors .....	106
Trunk .....	110
Smart access system with push-button start .....	113
<b>3-3. Adjusting the seats</b>	
Front seats .....	120
Driving position memory .....	122
Head restraints .....	125
<b>3-4. Adjusting the steering wheel and mirrors</b>	
Steering wheel .....	127
Inside rear view mirror .....	128
Outside rear view mirrors .....	129
<b>3-5. Opening and closing the windows</b>	
Power windows .....	132

**4 Driving**

**4-1. Before driving**

- Driving the vehicle..... **136**
- Cargo and luggage..... **142**
- Vehicle load limits..... **144**
- Trailer towing..... **145**
- Dinghy towing ..... **145**

**4-2. Driving procedures**

- Engine (ignition) switch (LC500)  
..... **146**
- Power (ignition) switch (LC500h)  
..... **149**
- EV drive mode (LC500h)..... **153**
- Automatic transmission (LC500)  
..... **155**
- Hybrid transmission (LC500h) **161**
- Turn signal lever..... **167**
- Parking brake ..... **168**
- Brake Hold..... **171**

**4-3. Operating the lights and wipers**

- Headlight switch..... **173**
- Automatic High Beam ..... **176**
- Windshield wipers and washer **178**

**4-4. Refueling**

- Opening the fuel tank cap..... **182**

**4-5. Using the driving support systems**

- Lexus Safety System + ..... **184**
- PCS (Pre-Collision System)..... **189**
- LKA (Lane-Keeping Assist) ..... **196**
- Dynamic radar cruise control with  
full-speed range..... **203**
- Driving mode select switch..... **213**
- Intuitive parking assist ..... **214**
- BSM (Blind Spot Monitor)..... **220**

- Active rear wing ..... **229**
- Driving assist systems ..... **231**

**4-6. Driving tips**

- Hybrid vehicle driving tips  
(LC500h)..... **236**
- Winter driving tips ..... **238**

**5 Interior features**

**5-1. Remote Touch**

- Remote Touch..... **242**

**5-2. Lexus Climate Concierge**

- Lexus Climate Concierge..... **246**

**5-3. Using the air conditioning system**

- Automatic air conditioning system  
..... **248**
- Heated steering wheel/seat heat-  
ers/seat ventilators..... **255**

**5-4. Using the interior lights**

- Interior lights list ..... **258**

**5-5. Using the storage features**

- List of storage features ..... **260**
- Trunk features ..... **262**

**5-6. Using the other interior features**

- Other interior features ..... **264**
- Garage door opener ..... **266**

**6 Maintenance and care**

**6-1. Maintenance and care**

- Cleaning and protecting the vehi-  
cle exterior..... **274**
- Cleaning and protecting the vehi-  
cle interior ..... **277**

**6-2. Maintenance**

- Maintenance requirements..... **283**



## 4 TABLE OF CONTENTS

General maintenance .....	284	If a warning message is displayed .....	344
Emission inspection and maintenance (I/M) programs .....	287	If you have a flat tire .....	350
<b>6-3. Do-it-yourself maintenance</b>		If the engine will not start (LC500) .....	351
Do-it-yourself service precautions .....	288	If the hybrid system will not start (LC500h) .....	352
Hood.....	290	If you lose your keys.....	354
Positioning a floor jack.....	290	If the fuel filler door cannot be opened .....	354
Engine compartment.....	292	If the electronic key does not operate properly .....	355
12-volt battery.....	299	If the 12-volt battery is discharged .....	357
Tires .....	301	If your vehicle overheats (LC500) .....	364
Replacing the tire .....	309	If your vehicle overheats (LC500h) .....	366
Tire inflation pressure.....	313	If the vehicle becomes stuck ...	370
Wheels.....	315		
Air conditioning filter .....	316		
Electronic key battery .....	318		
Checking and replacing fuses. ....	319		
Headlight aim.....	323		
Light bulbs.....	324		
<b>7 When trouble arises</b>			
<b>7-1. Essential information</b>			
Emergency flashers.....	326		
If your vehicle has to be stopped in an emergency.....	326		
If the vehicle is trapped in rising water.....	327		
<b>7-2. Steps to take in an emergency</b>			
If your vehicle needs to be towed .....	329		
If you think something is wrong .....	333		
Fuel pump shut off system (LC500).....	334		
If a warning light turns on or a warning buzzer sounds.....	335		
		<b>8 Vehicle specifications</b>	
		<b>8-1. Specifications</b>	
		Maintenance data (fuel, oil level, etc.).....	372
		Fuel information.....	381
		Tire information .....	383
		<b>8-2. Customization</b>	
		Customizable features .....	391
		<b>8-3. Items to initialize</b>	
		Items to initialize.....	403
		<b>9 For owners</b>	
		<b>9-1. For owners</b>	
		Reporting safety defects for U.S. owners.....	406



Seat belt instructions for Canadian owners (in French).....	406	
SRS airbag instructions for Canadian owners (in French).....	408	
Headlight aim instructions for Canadian owners (in French)	414	
<b>Index</b>		<b>1</b>
What to do if... (Troubleshooting) .....	418	2
Alphabetical index .....	420	3
		4
		5
		6
		<b>7</b>
		8
		9

## For your information

### Main Owner's Manual

Please note that this manual applies to all models and explains all equipment, including options. Therefore, you may find some explanations for equipment not installed on your vehicle.

All specifications provided in this manual are current at the time of printing. However, because of the Lexus policy of continual product improvement, we reserve the right to make changes at any time without notice.

Depending on specifications, the vehicle shown in the illustrations may differ from your vehicle in terms of color and equipment.

### Noise from under vehicle after turning off the engine <hybrid system>

Approximately five hours after the engine <hybrid system> is turned off, you may hear sound coming from under the vehicle for several minutes. This is the sound of a fuel evaporation leakage check and, it does not indicate a malfunction.

### Accessories, spare parts and modification of your Lexus

A wide variety of non-genuine spare parts and accessories for Lexus vehicles are currently available in the market. You should know that Toyota does

not warrant these products and is not responsible for their performance, repair, or replacement, or for any damage they may cause to, or adverse effect they may have on, your Lexus vehicle.

This vehicle should not be modified with non-genuine Lexus products. Modification with non-genuine Lexus products could affect its performance, safety or durability, and may even violate governmental regulations. In addition, damage or performance problems resulting from the modification may not be covered under warranty.

### Installation of a mobile two-way radio system

The installation of a mobile two-way radio system in your vehicle could affect electronic systems such as:

- Hybrid system
- Multiport fuel injection system/sequential multiport fuel injection system
- Lexus Safety System +
- Anti-lock brake system
- Vehicle dynamics integrated management
- SRS airbag system
- Seat belt pretensioner system

Be sure to check with your Lexus dealer for precautionary measures or special instructions regarding installation of a mobile two-way radio system.

LC500h: High voltage parts and cables on the hybrid vehicles emit approximately the same amount of electromagnetic waves as the conventional gasoline powered vehicles or home electronic appliances despite of their electromagnetic shielding.

LC500h: Unwanted noise may occur in the reception of the mobile two-way radio.

### Vehicle data recording

The vehicle is equipped with sophisticated computers that will record certain data, such as:

The recorded data varies according to the vehicle grade level and options with which it is equipped.

These computers do not record conversations or sounds, and only record images outside of the vehicle in certain situations.

- Engine speed / Electric motor speed (traction motor speed)
- Accelerator status
- Brake status
- Vehicle speed
- Operation status of the driving assist systems, such as the ABS and pre-collision system
- Images from the front camera (available only when certain safety systems are activated, which varies depending on the vehicle specifications).

#### ● Data Transmission

Your vehicle may transmit the data recorded in these computers to Lexus

without notification to you.

#### ● Data usage

Lexus may use the data recorded in these computers to diagnose malfunctions, conduct research and development, and improve quality.

Lexus will not disclose the recorded data to a third party except:

- With the consent of the vehicle owner or with the consent of the lessee if the vehicle is leased
  - In response to an official request by the police, a court of law or a government agency
  - For use by Lexus in a lawsuit
  - For research purposes where the data is not tied to a specific vehicle or vehicle owner
- Recorded image information can be erased by your Lexus dealer.

The image recording function can be disabled. However, if the function is disabled, data from when the pre-collision system operates will not be available.

- To learn more about the vehicle data collected, used and shared by Lexus, please visit [www.lexus.com/privacyvts/](http://www.lexus.com/privacyvts/).

### Usage of data collected through Lexus Enform (U.S. mainland only)

If your Lexus has Lexus Enform and if you have subscribed to those services, please refer to the Lexus Enform Telematics Subscription Service Agreement for information on data collected and its usage.

To learn more about the vehicle data collected, used and shared by Lexus, please visit [www.lexus.com/privacyvts/](http://www.lexus.com/privacyvts/)

### Event data recorder

This vehicle is equipped with an event data recorder (EDR). The main purpose of an EDR is to record, in certain crash or near crash-like situations, such as an air bag deployment or hitting a road obstacle, data that will assist in understanding how a vehicle's systems performed. The EDR is designed to record data related to vehicle dynamics and safety systems for a short period of time, typically 30 seconds or less.

The EDR in this vehicle is designed to record such data as:

- How various systems in your vehicle were operating;
- Whether or not the driver and passenger safety belts were buckled/fastened;
- How far (if at all) the driver was depressing the accelerator and/or brake pedal; and,
- How fast the vehicle was traveling.

These data can help provide a better understanding of the circumstances in which crashes and injuries occur.

NOTE: EDR data are recorded by your vehicle only if a non-trivial crash situation occurs; no data are recorded by the EDR under normal driving conditions and no personal data (e.g., name, gender, age, and crash location) are

recorded. However, other parties, such as law enforcement, could combine the EDR data with the type of personally identifying data routinely acquired during a crash investigation.

To read data recorded by an EDR, special equipment is required, and access to the vehicle or the EDR is needed. In addition to the vehicle manufacturer, other parties, such as law enforcement, that have the special equipment, can read the information if they have access to the vehicle or the EDR.

#### ● Disclosure of the EDR data

Lexus will not disclose the data recorded in an EDR to a third party except when:

- An agreement from the vehicle's owner (or the lessee for a leased vehicle) is obtained
- In response to an official request by the police, a court of law or a government agency
- For use by Lexus in a lawsuit

However, if necessary, Lexus may:

- Use the data for research on vehicle safety performance
- Disclose the data to a third party for research purposes without disclosing information about the specific vehicle or vehicle owner

### Scrapping of your Lexus

The SRS airbag, seat belt pretensioner devices and Pop Up Hood system in your Lexus contain explosive chemicals. If the vehicle is scrapped with the airbags, seat belt pretensioners and Pop Up Hood micro gas generators

left as they are, this may cause an accident such as fire. Be sure to have the systems of the SRS airbag, seat belt pretensioner and Pop Up Hood micro gas generator system removed and disposed of by a qualified service shop or by your Lexus dealer before you scrap your vehicle.

### Perchlorate Material

Special handling may apply, See [www.dtsc.ca.gov/hazardouswaste/perchlorate](http://www.dtsc.ca.gov/hazardouswaste/perchlorate).

Your vehicle has components that may contain perchlorate. These components may include airbag, seat belt pretensioners, Pop Up Hood system, and wireless remote control batteries.

### WARNING

#### ■ General precautions while driving

**Driving under the influence:** Never drive your vehicle when under the influence of alcohol or drugs that have impaired your ability to operate your vehicle. Alcohol and certain drugs delay reaction time, impair judgment and reduce coordination, which could lead to an accident that could result in death or serious injury.

**Defensive driving:** Always drive defensively. Anticipate mistakes that other drivers or pedestrians might make and be ready to avoid accidents.

**Driver distraction:** Always give your full attention to driving. Anything that distracts the driver, such as adjusting controls, talking on a cellular phone or reading can result in a collision with resulting death or serious injury to you, your occupants or others.

#### ■ General precaution regarding children's safety



Never leave children unattended in the vehicle, and never allow children to have or use the key.

Children may be able to start the vehicle or shift the vehicle into neutral. There is also a danger that children may injure themselves by playing with the windows or other features of the vehicle. In addition, heat build-up or extremely cold temperatures inside the vehicle can be fatal to children.

### Reading this manual



Explains symbols used in this manual

### Symbols in this manual

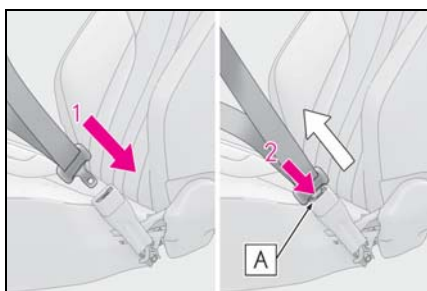

Symbols	Meanings
	<b>WARNING:</b> Explains something that, if not obeyed, could cause death or serious injury to people.
	<b>NOTICE:</b> Explains something that, if not obeyed, could cause damage to or a malfunction in the vehicle or its equipment.
	Indicates operating or working procedures. Follow the steps in numerical order.

### Symbols in illustrations

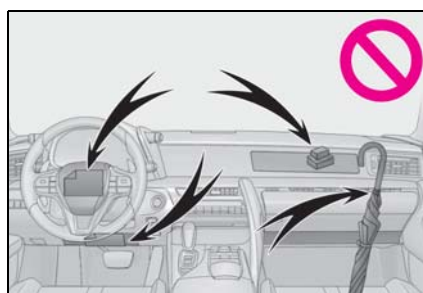

Symbols	Meanings
	Indicates the action (pushing, turning, etc.) used to operate switches and other devices.
	Indicates the outcome of an operation (e.g. a lid opens).



Symbols	Meanings
	Indicates the component or position being explained.
	Means <b>Do not</b> , <b>Do not do this</b> , or <b>Do not let this happen</b> .

### Different writing styles for gasoline and hybrid vehicles

Information for hybrid vehicles is written in brackets next to the information for gasoline vehicles

Example

Turn the engine switch<sup>\*1</sup> <power switch><sup>\*2</sup> to IGNITION ON mode<sup>\*1</sup> <ON mode><sup>\*2</sup> mode.

\*1: LC500

\*2: LC500h

## How to search

### ■ Searching by name

- Alphabetical index: →P.420

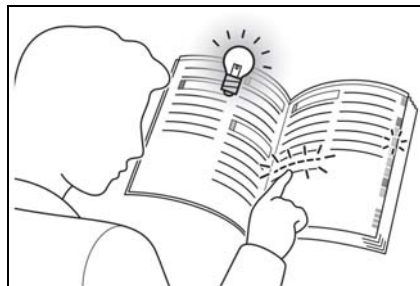
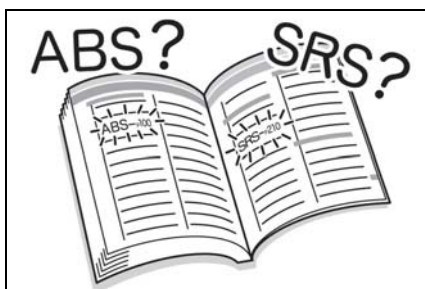

### ■ Searching by installation position

- Pictorial index: →P.12

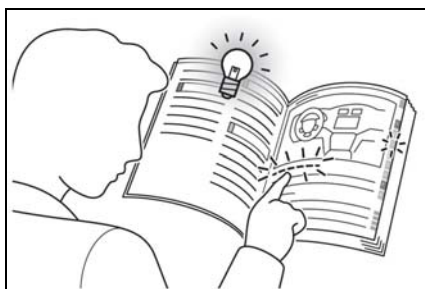

### ■ Searching by symptom or sound

- What to do if... (Troubleshooting):  
→P.418



### ■ Searching by title

- Table of contents: →P.2

## Pictorial index

### ■ Exterior

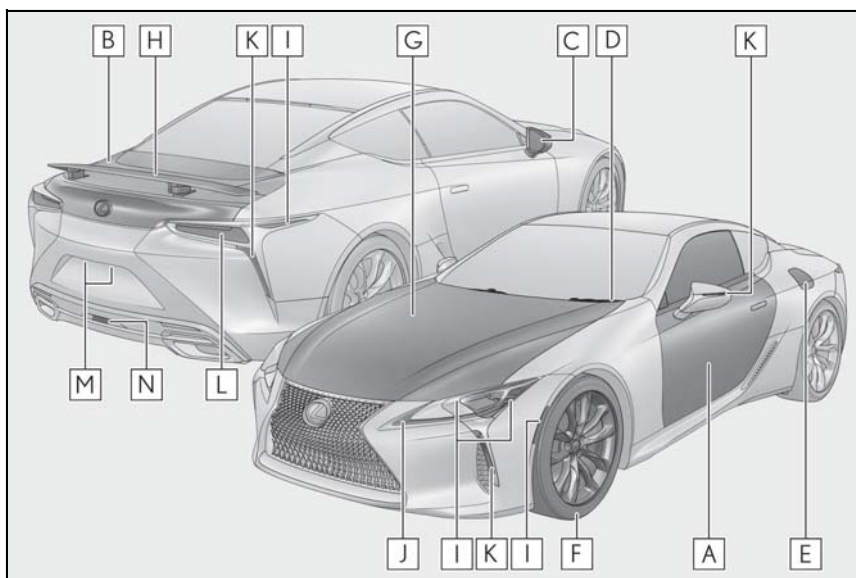

<b>A</b>	<b>Doors</b> .....	<b>P.106</b>
	Locking/unlocking .....	P.106
	Opening/closing the side window .....	P.132
	Locking/unlocking by using the mechanical key .....	P.356
	Warning messages .....	P.109
<b>B</b>	<b>Trunk</b> .....	<b>P.110</b>
	Opening from inside the cabin .....	P.111
	Opening from outside .....	P.111
	Opening by using the mechanical key .....	P.357
	Warning messages .....	P.109
<b>C</b>	<b>Outside rear view mirrors</b> .....	<b>P.129</b>
	Adjusting the mirror angle .....	P.129
	Folding the mirrors.....	P.130
	Driving position memory .....	P.122
	Defogging the mirrors .....	P.249
<b>D</b>	<b>Windshield wipers</b> .....	<b>P.178</b>



	Precautions against winter season .....	P.239
	To prevent freezing (windshield wiper de-icer)* .....	P.253
	Precautions against car wash .....	P.275
<b>E</b>	<b>Fuel filler door</b> .....	<b>P.182</b>
	Refueling method .....	P.182
	Fuel type/fuel tank capacity .....	P.373
<b>F</b>	<b>Tires</b> .....	<b>P.301</b>
	Tire size/inflation pressure .....	P.379
	Winter tires.....	P.238
	Checking/rotation/tire pressure warning system.....	P.301
	Coping with flat tires.....	P.350
<b>G</b>	<b>Hood</b> .....	<b>P.290</b>
	Opening .....	P.290
	Engine oil.....	P.374
	Coping with overheating.....	P.364, 366
	Warning messages .....	P.344
<b>H</b>	<b>Active rear wing</b> * .....	<b>P.229</b>

**Light bulbs of the exterior lights for driving**  
(Replacing method: P.324, Watts: P.380)

<b>I</b>	<b>Headlights/side marker lights/cornering lights</b> .....	<b>P.173</b>
<b>J</b>	<b>Parking lights/daytime running lights</b> .....	<b>P.173</b>
<b>K</b>	<b>Turn signal lights</b> .....	<b>P.167</b>
<b>L</b>	<b>Tail lights</b> .....	<b>P.173</b>
<b>M</b>	<b>License plate lights</b> .....	<b>P.173</b>
<b>N</b>	<b>Back up lights</b>	
	Shifting the shift lever to R.....	P.157, 163

\* : If equipped

■ Instrument panel

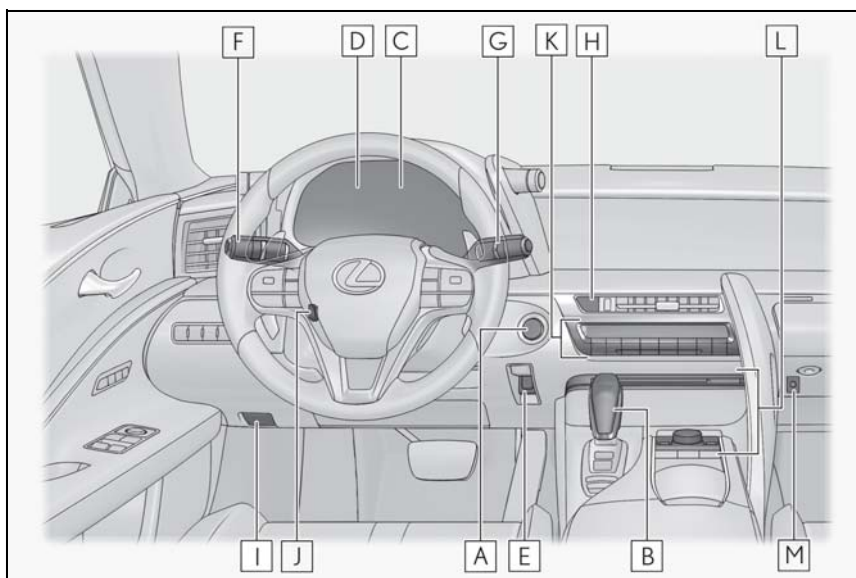

- A Engine switch <Power switch>**.....P.146, 149
  - Starting the engine <hybrid system>/changing the mode .....P.146, 149
  - Emergency stop of the engine <hybrid system>..... P.326
  - When the engine <hybrid system> will not start .....P.351, 352
  - Warning messages ..... P.344
- B Shift lever**.....P.155, 161
  - Changing the shift position .....P.157, 163
  - Precautions against towing..... P.329
- C Meters**..... P.80
  - Reading the meters/adjusting the instrument panel lights.....P.80
  - Warning lights/indicator lights ..... P.74
  - When the warning lights come on.....P.335
- D Multi-information display** ..... P.84
  - Display .....P.84
  - When the warning messages are displayed.....P.344
- E Parking brake switch** .....P.168

	Applying/releasing .....	P.168
	Precautions against winter season .....	P.239
	Warning buzzer/message.....	P.338, 345
<b>F</b>	<b>Turn signal lever</b> .....	P.167
	<b>Headlight switch</b> .....	P.173
	Headlights/parking lights/tail lights/daytime running lights .....	P.173
<b>G</b>	<b>Windshield wiper and washer switch</b> .....	P.178
	Usage.....	P.178
	Adding washer fluid.....	P.298
	Warning messages .....	P.345
<b>H</b>	<b>Emergency flasher switch</b> .....	P.326
<b>I</b>	<b>Hood lock release lever</b> .....	P.290
<b>J</b>	<b>Tilt and telescopic steering control switch</b> .....	P.127
	Adjustment .....	P.127
	Driving position memory .....	P.122
<b>K</b>	<b>Air conditioning system</b> .....	P.248
	Usage.....	P.248
	Rear window defogger.....	P.249
<b>L</b>	<b>Audio system</b> *	
<b>M</b>	<b>Trunk opener main switch</b> .....	P.113

\* : Refer to "NAVIGATION SYSTEM OWNER'S MANUAL".

■ Switches

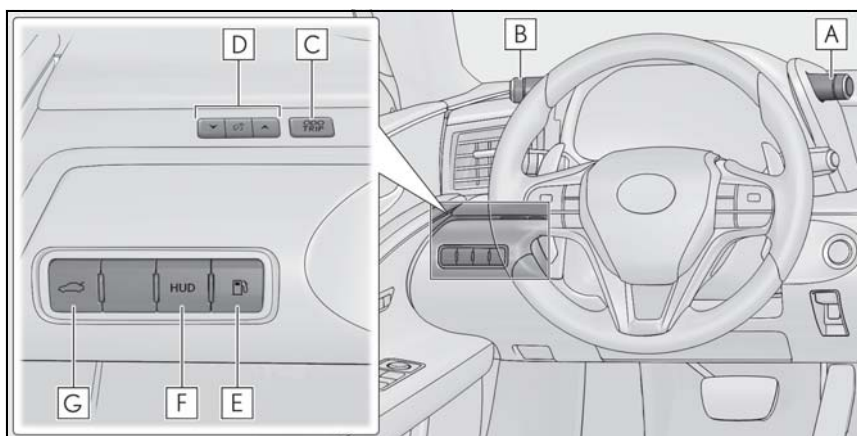

- A** Driving mode select switch ..... P.213
- B** VSC OFF/snow mode switch ..... P.159, 165, 233
- C** Odometer/trip meter/trip meter reset button ..... P.83
- D** Instrument panel light control switches ..... P.83
- E** Fuel filler door opener switch ..... P.183
- F** HUD (Head-up display) switch \* ..... P.90
- G** Trunk opener switch ..... P.111

\* : If equipped

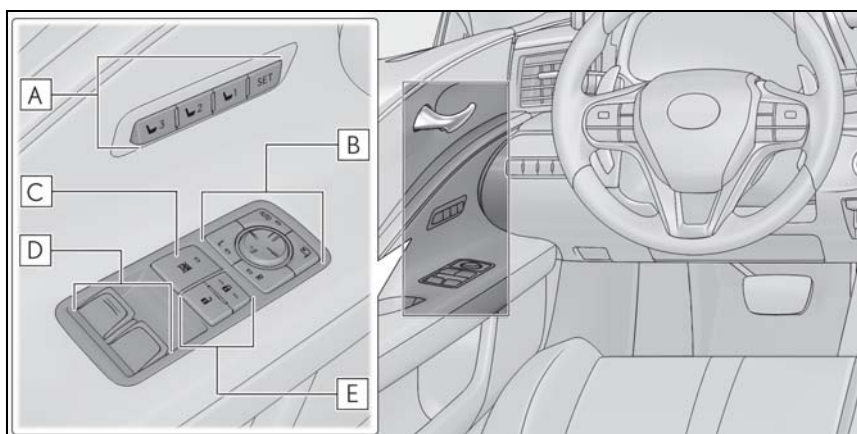

- A** Driving position memory switches.....P.122
- B** Outside rear view mirror switches.....P.129
- C** Window lock switch .....P.133
- D** Power window switches .....P.132
- E** Door lock switches ..... P.108

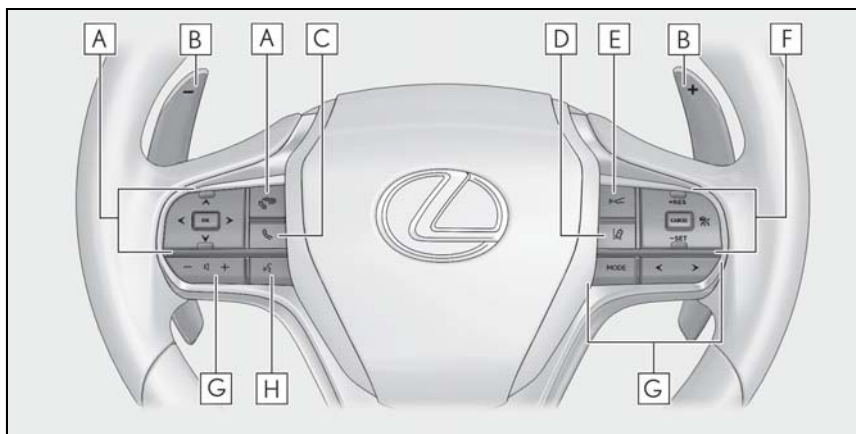

- A** Meter control switches..... P.85
- B** Paddle shift switches.....P.159,165
- C** Telephone switch\*
- D** LKA (Lane-Keeping Assist) switch..... P.196
- E** Vehicle-to-vehicle distance switch ..... P.208
- F** Cruise control switches  
Dynamic radar cruise control with full-speed range .....P.203
- G** Audio remote control switches\*
- H** Talk switch\*

\*: Refer to "NAVIGATION SYSTEM OWNER'S MANUAL".

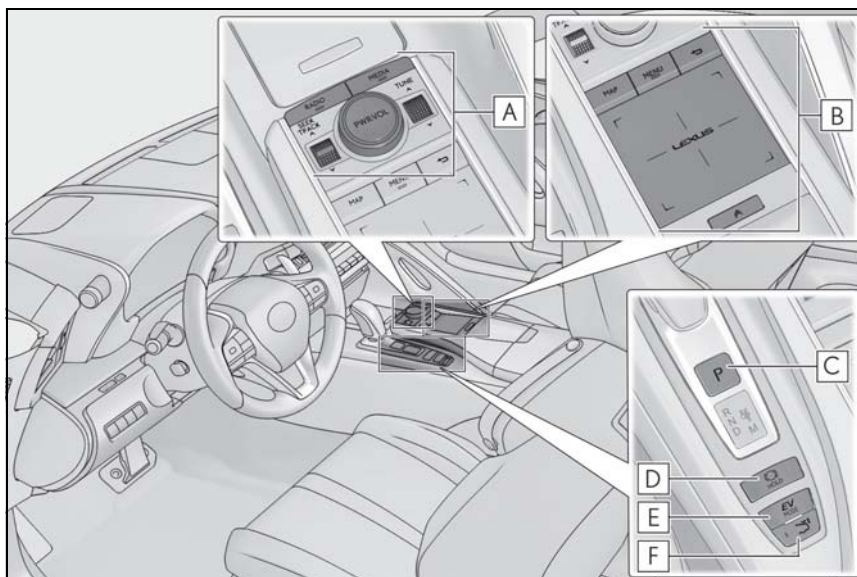

- A** Audio control switches <sup>\*1</sup>
- B** Remote Touch.....P.242
- C** P position switch..... P.158, 164
- D** Brake hold switch..... P.171
- E** EV drive mode switch <sup>\*2</sup> .....P.153
- F** Active rear wing switch <sup>\*2</sup> .....P.229

<sup>\*1</sup>: Refer to "NAVIGATION SYSTEM OWNER'S MANUAL".

<sup>\*2</sup>: If equipped

## ■ Interior

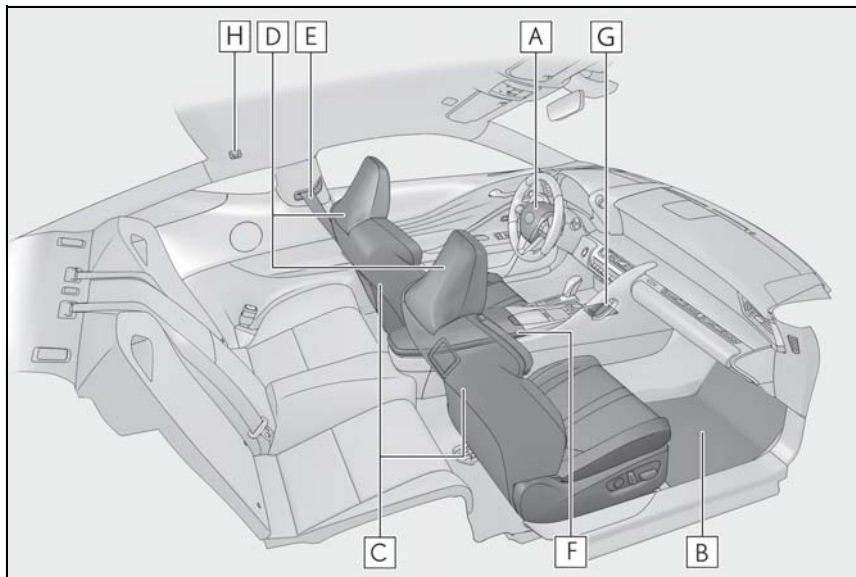

<b>A</b>	SRS airbags.....	P.28
<b>B</b>	Floor mats.....	P.22
<b>C</b>	Front seats.....	P.120
<b>D</b>	Head restraints.....	P.125
<b>E</b>	Seat belts.....	P.24
<b>F</b>	Console box/auxiliary box.....	P.261
<b>G</b>	Cup holder.....	P.261
<b>H</b>	Coat hooks.....	P.265

■ Ceiling

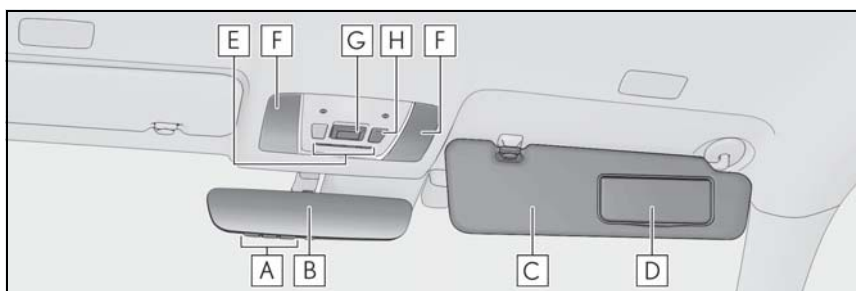

<b>A</b>	Garage door opener buttons.....	P.266
<b>B</b>	Inside rear view mirror.....	P.128
<b>C</b>	Sun visors.....	P.264
<b>D</b>	Vanity mirrors.....	P.264
<b>E</b>	Seat lights.....	P.258
	Shift lever light.....	P.258
<b>F</b>	Personal lights.....	P.259
<b>G</b>	“SOS” button *.....	P.54
<b>H</b>	Door-linked personal light switch.....	P.259

\* : If equipped



## For safety and security

1

- 1-1. For safe use**
  - Before driving ..... 22
  - For safe driving..... 23
  - Seat belts ..... 24
  - SRS airbags ..... 28
  - Pop Up Hood ..... 36
  - Front passenger occupant classification system ..... 38
  - Exhaust gas precautions ..... 42
- 1-2. Child safety**
  - Riding with children..... 43
  - Child restraint systems ..... 43
- 1-3. Lexus Enform**
  - Lexus Enform Safety Connect 54
  - Lexus Enform Remote ..... 59
  - Lexus Enform Service Connect ..... 60
- 1-4. Hybrid system**
  - Hybrid system features (LC500h)..... 61
  - Hybrid system precautions (LC500h)..... 64
- 1-5. Theft deterrent system**
  - Engine immobilizer system <Immobilizer system> ..... 69
  - Alarm..... 71
  - Theft prevention labels (U.S.A.) ..... 72

1

For safety and security

### Before driving

Observe the following before starting off in the vehicle to ensure safety of driving.

### Installing floor mats

Use only floor mats designed specifically for vehicles of the same model and model year as your vehicle. Fix them securely in place onto the carpet.

- 1 Insert the retaining hooks (clips) into the floor mat eyelets.

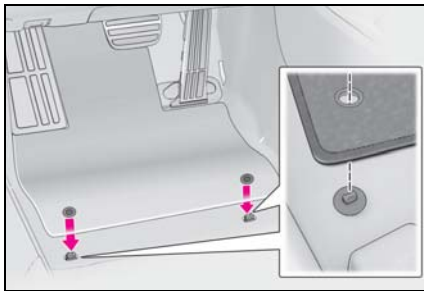

- 2 Turn the upper knob of each retaining hook (clip) to secure the floor mats in place.

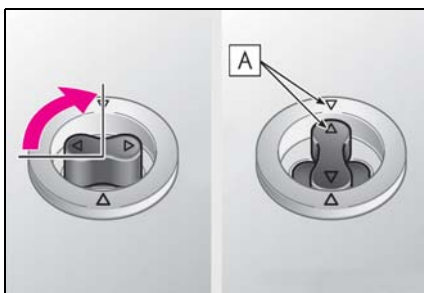

Always align the  $\triangle$  marks **A**.

The shape of the retaining hooks (clips) may differ from that shown in the illustration.

### ⚠ WARNING

Observe the following precautions. Failure to do so may cause the driver's floor mat to slip, possibly interfering with the pedals while driving. An unexpectedly high speed may result or it may become difficult to stop the vehicle. This could lead to an accident, resulting in death or serious injury.

#### ■ When installing the driver's floor mat

- Do not use floor mats designed for other models or different model year vehicles, even if they are Lexus Genuine floor mats.
- Only use floor mats designed for the driver's seat.
- Always install the floor mat securely using the retaining hooks (clips) provided.
- Do not use two or more floor mats on top of each other.
- Do not place the floor mat bottom-side up or upside-down.

#### ■ Before driving

- Check that the floor mat is securely fixed in the correct place with all the provided retaining hooks (clips). Be especially careful to perform this check after cleaning the floor.

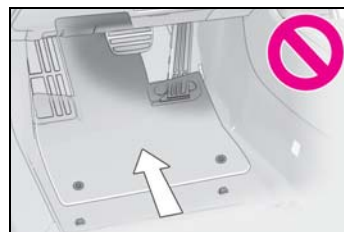

- With the engine <hybrid system> stopped and the shift position in P, fully depress each pedal to the floor to make sure it does not interfere with the floor mat.

### For safe driving

For safe driving, adjust the seat and mirror to an appropriate position before driving.

### Correct driving posture

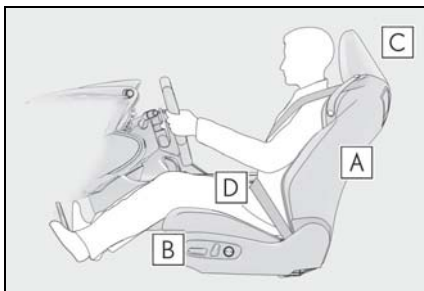

- A** Adjust the angle of the seatback so that you are sitting straight up and so that you do not have to lean forward to steer. (→P.120)
- B** Adjust the seat so that you can depress the pedals fully and so that your arms bend slightly at the elbow when gripping the steering wheel. (→P.120)
- C** Lock the head restraint in place with the center of the head restraint closest to the top of your ears. (→P.125)
- D** Wear the seat belt correctly. (→P.25)

### **!** WARNING

Observe the following precautions. Failure to do so may result in death or serious injury.

- Do not adjust the position of the driver's seat while driving. Doing so could cause the driver to lose control of the vehicle.
- Do not place a cushion between the driver or passenger and the seatback. A cushion may prevent correct posture from being achieved, and reduce the effectiveness of the seat belt and head restraint.
- Do not place anything under the front seats. Objects placed under the front seats may become jammed in the seat tracks and stop the seat from locking in place. This may lead to an accident and the adjustment mechanism may also be damaged.
- Always observe the legal speed limit when driving on public roads.
- When driving over long distances, take regular breaks before you start to feel tired. Also, if you feel tired or sleepy while driving, do not force yourself to continue driving and take a break immediately.

### Correct use of the seat belts

Make sure that all occupants are wearing their seat belts before driving the vehicle. (→P.25)

Use a child restraint system appropriate for the child until the child becomes large enough to properly wear the vehicle's seat belt. (→P.43)

### Adjusting the mirrors

Make sure that you can see backward clearly by adjusting the inside and outside rear view mirrors properly. (→P.128, 129)

## Seat belts

**Make sure that all occupants are wearing their seat belts before driving the vehicle.**

### WARNING

Observe the following precautions to reduce the risk of injury in the event of sudden braking, sudden swerving or an accident. Failure to do so may cause death or serious injury.

#### ■ Wearing a seat belt

- Ensure that all passengers wear a seat belt.
- Always wear a seat belt properly.
- Each seat belt should be used by one person only. Do not use a seat belt for more than one person at once, including children.
- Lexus recommends that children be seated in the rear seat and always use a seat belt and/or an appropriate child restraint system.
- To achieve a proper seating position, do not recline the seat more than necessary. The seat belt is most effective when the occupants are sitting up straight and well back in the seats.
- Do not wear the shoulder belt under your arm.
- Always wear your seat belt low and snug across your hips.

#### ■ Pregnant women

Obtain medical advice and wear the seat belt in the proper way. (→P.25)

Women who are pregnant should position the lap belt as low as possible over the hips in the same manner as other occupants, extending the shoulder belt completely over the shoulder and avoiding belt contact with the rounding of the abdominal area.

If the seat belt is not worn properly, not only the pregnant woman, but also the fetus could suffer death or serious injury as a result of sudden braking or a collision.

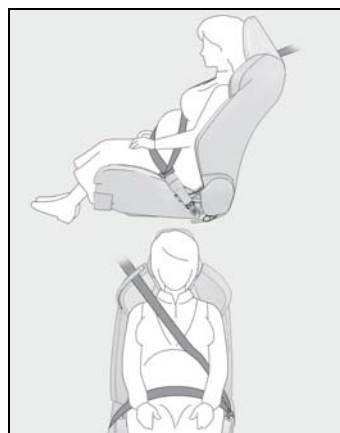

#### ■ People suffering illness

Obtain medical advice and wear the seat belt in the proper way. (→P.25)

#### ■ When children are in the vehicle

→P.43

#### ■ Seat belt damage and wear

- Do not damage the seat belts by allowing the belt, plate, or buckle to be jammed in the door.
- Inspect the seat belt system periodically. Check for cuts, fraying, and loose parts. Do not use a damaged seat belt until it is replaced. Damaged seat belts cannot protect an occupant from death or serious injury.

**! WARNING**

- Ensure that the belt and plate are locked and the belt is not twisted. If the seat belt does not function correctly, immediately contact your Lexus dealer.
- Replace the seat assembly, including the belts, if your vehicle has been involved in a serious accident, even if there is no obvious damage.
- Do not attempt to install, remove, modify, disassemble or dispose of the seat belts. Have any necessary repairs carried out by your Lexus dealer. Inappropriate handling may lead to incorrect operation.

**Correct use of the seat belts**

- Extend the shoulder belt so that it comes fully over the shoulder, but does not come into contact with the neck or slide off the shoulder.
- Position the lap belt as low as possible over the hips.
- Adjust the position of the seatback. Sit up straight and well back in the seat.

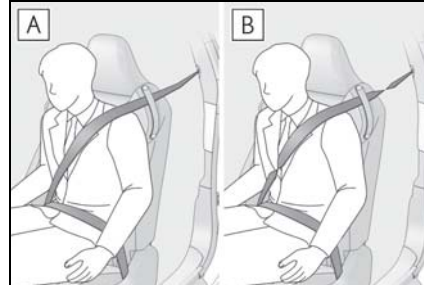

- Do not twist the seat belt.

**A** Not twisted**B** Twisted**Child seat belt usage**

The seat belts of your vehicle were principally designed for persons of adult size.

- Use a child restraint system appropriate for the child, until the child becomes large enough to properly wear the vehicle's seat belt. (→P.43)
- When the child becomes large enough to properly wear the vehicle's seat belt, follow the instructions regarding seat belt usage. (→P.24)

**Seat belt extender**

If your seat belts cannot be fastened securely because they are not long enough, a personalized seat belt extender is available from your Lexus dealer free of charge.

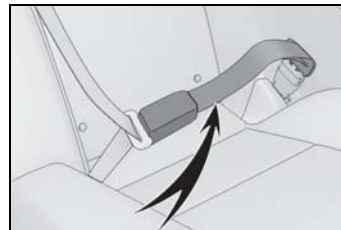
**! WARNING****Using a seat belt extender**

Observe the following precautions to reduce the risk of injury in the event of sudden braking, sudden swerving or an accident. Failure to do so may cause death or serious injury.

**⚠ WARNING**

- Do not wear the seat belt extender if you can fasten the seat belt without the extender.
- Do not use the seat belt extender when installing a child restraint system because the belt will not securely hold the child restraint system, increasing the risk of death or serious injury in the event of an accident.
- The personalized extender may not be safe on another vehicle, when used by another person, or at a different seating position other than the one originally intended.

**⚠ NOTICE****■ When using a seat belt extender**

When releasing the seat belt, press on the buckle release button on the extender, not on the seat belt. This helps prevent damage to the vehicle interior and the extender itself.

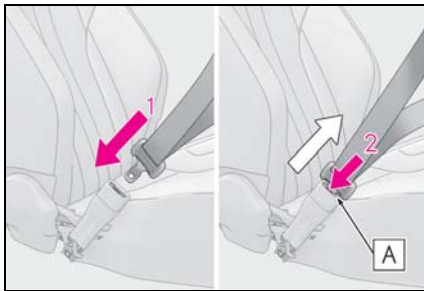
**Fastening and releasing the seat belt**

- 1 To fasten the seat belt, push the plate into the buckle until a click sound is heard.
- 2 To release the seat belt, press the release button **A**.

**■ Emergency locking retractor (ELR)**

The retractor will lock the belt during a sudden stop or on impact. It may also lock if you lean forward too quickly. A slow, easy motion will allow the belt to extend so that you can move around fully.

**■ Automatic locking retractor (ALR)**

When a passenger's shoulder belt is completely extended and then retracted even slightly, the belt is locked in that position and cannot be extended. This feature is used to hold a child restraint system (CRS) firmly. To free the belt again, fully retract the belt and then pull the belt out once more.

**Seat belt guide**

The front seats are equipped with guides to allow the seat belt to be extended easily. When it is difficult to extend the seat belt, pass the seat belt through the guide.

When getting into or out of a rear seat, release the seat belt from the guide.

- ▶ Vehicles with manual type head restraint

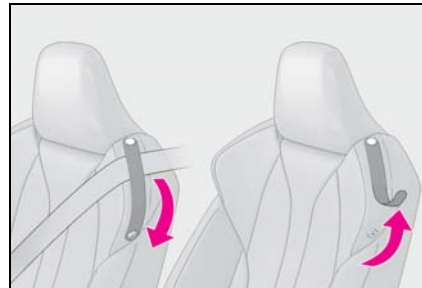

- ▶ Vehicles with power type head restraint

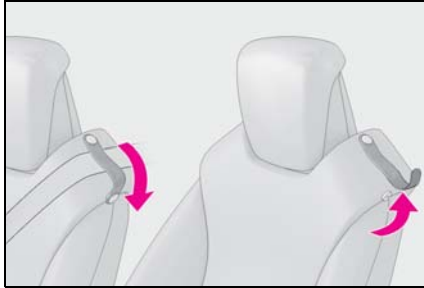

### ⚠ WARNING

#### ■ When using the seat belt guide

Observe the following precautions to reduce the risk of injury in the event of sudden braking, sudden swerving or an accident. Failure to do so may cause death or serious injury.

- Always make sure that the belt is not twisted, and runs freely through the guide.
- Regardless of whether the guide is used or not, always secure the seat belt guide button.
- Do not hang from or pull the guide forcefully.

### Seat belt pretensioners

The pretensioners help the seat belts to quickly restrain the occupants by retracting the seat belts when the vehicle is subjected to certain types of severe frontal or side collision or a vehicle rollover.

The pretensioners do not activate in the event of a minor frontal impact, a minor side impact or a rear impact.

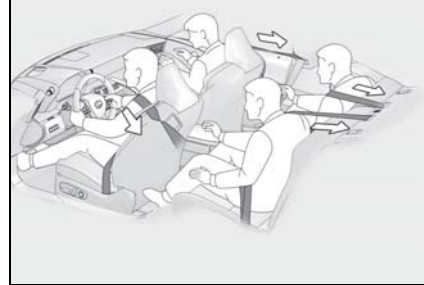

#### ■ Replacing the belt after the pretensioner has been activated

If the vehicle is involved in multiple collisions, the pretensioner will activate for the first collision, but will not activate for the second or subsequent collisions.

### ⚠ WARNING

#### ■ Seat belt pretensioners

Observe the following precautions to reduce the risk of injury in the event of sudden braking, sudden swerving or an accident. Failure to do so may cause death or serious injury.

- Do not place anything, such as a cushion, on the front passenger's seat. Doing so will disperse the passenger's weight, which prevents the sensor from detecting the passenger's weight properly. As a result, the seat belt pretensioner for the front passenger's seat may not activate in the event of a collision.
- If the pretensioner has activated, the SRS warning light will come on. In that case, the seat belt cannot be used again and must be replaced at your Lexus dealer.

## SRS airbags

The SRS airbags inflate when the vehicle is subjected to certain types of severe impacts that may cause significant injury to the occupants. They work together with the seat belts to help reduce the risk of death or serious injury.

### SRS airbag system

#### ■ Location of the SRS airbags

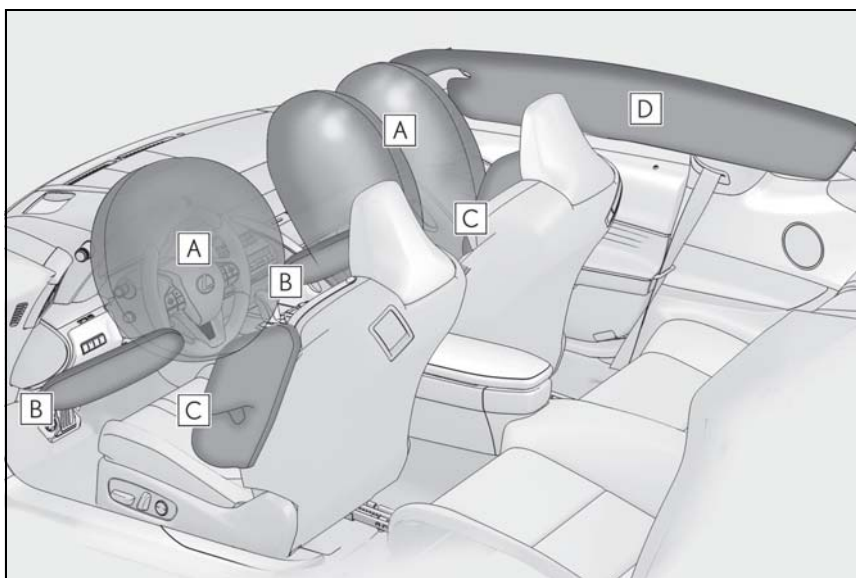

#### ► SRS front airbags

##### **A** SRS driver airbag/front passenger airbag

Can help protect the head and chest of the driver and front passenger from impact with interior components

##### **B** SRS knee airbags

Can help provide driver and front passenger protection

#### ► SRS side and curtain shield airbags

##### **C** SRS side airbags

Can help protect the torso of the front seat occupants

##### **D** SRS curtain shield airbags

- Can help protect primarily the head of occupants
- Can help prevent the occupants from being thrown from the vehicle in the event of vehi-



cle rollover

### ■ SRS airbag system components

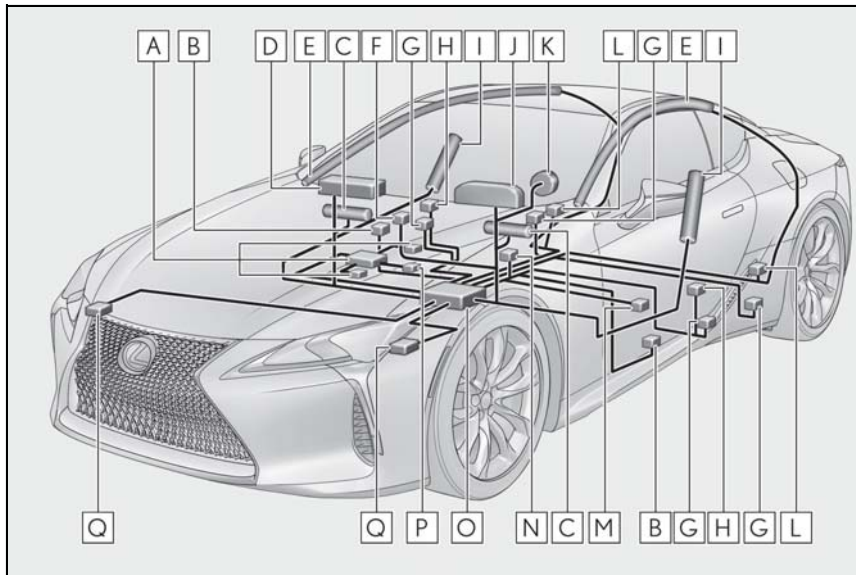

- A** Front passenger occupant classification system (ECU and sensors)
- B** Side impact sensors (door)
- C** Knee airbags
- D** Front passenger airbag
- E** Curtain shield airbags
- F** "AIR BAG ON" and "AIR BAG OFF" indicator lights
- G** Seat belt pretensioners and force limiters
- H** Side impact sensors (front)
- I** Front side airbags
- J** SRS warning light
- K** Driver airbag
- L** Side impact sensors (rear)
- M** Driver's seat position sensor
- N** Driver's seat belt buckle switch
- O** Airbag sensor assembly

**P** Front passenger's seat belt buckle switch

**Q** Front impact sensors

Your vehicle is equipped with ADVANCED AIRBAGS designed based on the US motor vehicle safety standards (FMVSS208). The airbag sensor assembly (ECU) controls airbag deployment based on information obtained from the sensors etc. shown in the system components diagram above. This information includes crash severity and occupant information. As the airbags deploy, a chemical reaction in the inflators quickly fills the airbags with non-toxic gas to help restrain the motion of the occupants.

#### ■ If the SRS airbags deploy (inflate)

- Slight abrasions, burns, bruising etc., may be sustained from SRS airbags, due to the extremely high speed deployment (inflation) by hot gases.
- A loud noise and white powder will be emitted.
- Parts of the airbag module (steering wheel hub, airbag cover and inflator) as well as the front seats, parts of the front and rear pillars, and roof side rails may be hot for several minutes. The airbag itself may also be hot.
- The windshield may crack.
- For Lexus Enform Safety Connect subscribers, if any of the following situations occur, the system is designed to send an emergency call to the response center, notifying them of the vehicle's location (without needing to push the "SOS" button) and an agent will attempt to speak with the occupants to ascertain the level of emergency and assistance required. If the occupants are unable to communicate, the agent automatically treats the call as an emergency and helps to dispatch the necessary emergency services. (→P.54)
  - An SRS airbag is deployed.
  - A seat belt pretensioner is activated.
  - The vehicle is involved in a severe rear-end collision.

#### ■ SRS airbag deployment conditions (SRS front airbags)

- The SRS front airbags will deploy in the event of an impact that exceeds the set

threshold level (the level of force corresponding to an approximately 12 - 18 mph [20 - 30 km/h] frontal collision with a fixed wall that does not move or deform).

However, this threshold velocity will be considerably higher in the following situations:

- If the vehicle strikes an object, such as a parked vehicle or sign pole, which can move or deform on impact
- If the vehicle is involved in an underride collision, such as a collision in which the front of the vehicle underrides, or goes under, the bed of a truck
- Depending on the type of collision, it is possible that only the seat belt pretensioners will activate.
- The SRS front airbags for the front passenger will not activate if there is no passenger sitting in the front passenger seat. However, the SRS front airbags for the front passenger may deploy if luggage is put in the seat, even if the seat is unoccupied.

#### ■ SRS airbag deployment conditions (SRS side and curtain shield airbags)

- The SRS side and curtain shield airbags will deploy in the event of an impact that exceeds the set threshold level (the level of force corresponding to the impact force produced by an approximately 3300 lb. [1500 kg] vehicle colliding with the vehicle cabin from a direction perpendicular to the vehicle orientation at an approximate speed of 12 - 18 mph [20 - 30 km/h]).
- Both SRS curtain shield airbags may

deploy in the event of a severe side collision.

- Both SRS curtain shield airbags will deploy in the event of vehicle rollover.
- Both SRS curtain shield airbags may also deploy in the event of a severe frontal collision.

#### ■ Conditions under which the SRS airbags may deploy (inflate), other than a collision

The SRS front airbags and SRS curtain shield airbags may also deploy if a serious impact occurs to the underside of your vehicle. Some examples are shown in the illustration.

- Hitting a curb, edge of pavement or hard surface
- Falling into or jumping over a deep hole
- Landing hard or falling

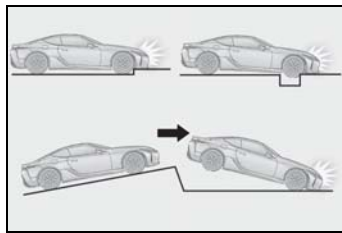

The SRS curtain shield airbags may also deploy under the situations shown in the illustration.

- The angle of vehicle tip-up is marginal.
- The vehicle skids and hits a curb stone.

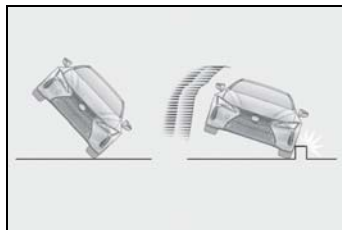

#### ■ Types of collisions that may not deploy the SRS airbags (SRS front airbags)

The SRS front airbags do not generally inflate if the vehicle is involved in a side or rear collision, if it rolls over, or if it is involved in a low-speed frontal collision. But, whenever a collision of any type causes sufficient

forward deceleration of the vehicle, deployment of the SRS front airbags may occur.

- Collision from the side
- Collision from the rear
- Vehicle rollover

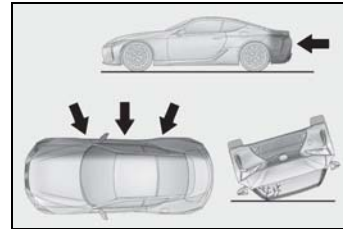

#### ■ Types of collisions that may not deploy the SRS airbags (SRS side and curtain shield airbags)

The SRS side and curtain shield airbags may not activate if the vehicle is subjected to a collision from the side at certain angles, or a collision to the side of the vehicle body other than the passenger compartment.

- Collision from the side to the vehicle body other than the passenger compartment
- Collision from the side at an angle

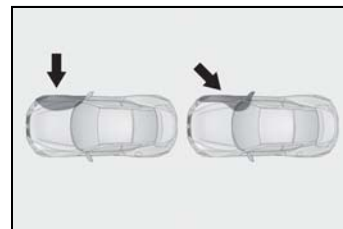

The SRS side airbags do not generally inflate if the vehicle is involved in a frontal or rear collision, if it rolls over, or if it is involved in a low-speed side collision.

- Collision from the front
- Collision from the rear
- Vehicle rollover

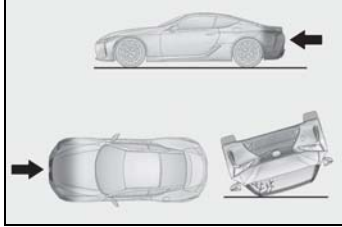

The SRS curtain shield airbags do not generally inflate if the vehicle is involved in a rear collision, if it pitches end over end, or if it is involved in a low-speed side or low-speed frontal collision.

- Collision from the rear
- Pitching end over end

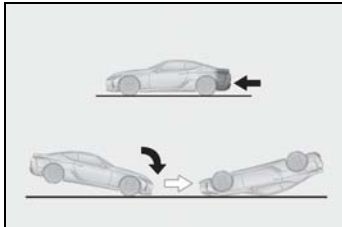

#### ■ When to contact your Lexus dealer

In the following cases, the vehicle will require inspection and/or repair. Contact your Lexus dealer as soon as possible.

- Any of the SRS airbags have been inflated.
- The front of the vehicle is damaged or deformed, or was involved in an accident that was not severe enough to cause the SRS front airbags to inflate.

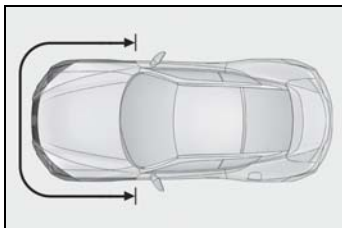

- A portion of a door or its surrounding area is damaged, deformed or has had a hole made in it, or the vehicle was involved in an accident that was not severe enough to cause the SRS side and curtain shield airbags to inflate.

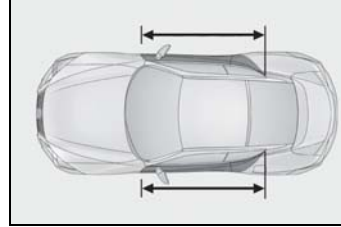

- The pad section of the steering wheel, dashboard near the front passenger airbag or lower portion of the instrument panel is scratched, cracked, or otherwise damaged.

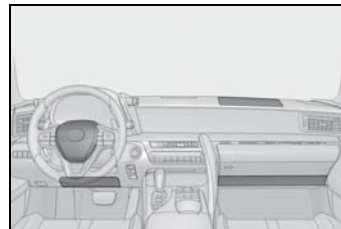

- The surface of the seats with the SRS side airbag is scratched, cracked, or otherwise damaged.

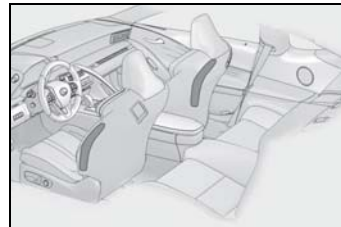

- The portion of the front pillars, rear pillars or roof side rail garnishes (padding) containing the SRS curtain shield airbags inside is scratched, cracked, or otherwise damaged.

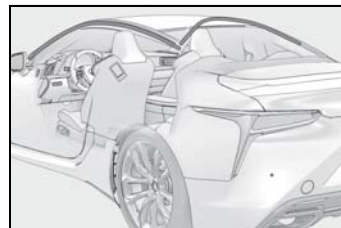

**⚠ WARNING****■ SRS airbag precautions**

Observe the following precautions regarding the SRS airbags. Failure to do so may cause death or serious injury.

- The driver and all passengers in the vehicle must wear their seat belts properly. The SRS airbags are supplemental devices to be used with the seat belts.
- The SRS driver airbag deploys with considerable force, and can cause death or serious injury especially if the driver is very close to the airbag. The National Highway Traffic Safety Administration (NHTSA) advises: Since the risk zone for the driver's airbag is the first 2 - 3 in. (50 - 75 mm) of inflation, placing yourself 10 in. (250 mm) from your driver airbag provides you with a clear margin of safety. This distance is measured from the center of the steering wheel to your breastbone. If you sit less than 10 in. (250 mm) away now, you can change your driving position in several ways:
  - Move your seat to the rear as far as you can while still reaching the pedals comfortably.
  - Slightly recline the back of the seat. Although vehicle designs vary, many drivers can achieve the 10 in. (250 mm) distance, even with the driver seat all the way forward, simply by reclining the back of the seat somewhat. If reclining the back of your seat makes it hard to see the road, raise yourself by using a firm, non-slippery cushion, or raise the seat if your vehicle has that feature.
  - If your steering wheel is adjustable, tilt it downward. This points the airbag toward your chest instead of your head and neck.

The seat should be adjusted as recommended by NHTSA above, while still maintaining control of the foot pedals, steering wheel, and your view of the instrument panel controls.

- If the seat belt extender has been connected to the front seat belt buckles but the seat belt extender has not also been fastened to the latch plate of the seat belt, the SRS front airbags will judge that the driver and front passenger are wearing the seat belt even though the seat belt has not been connected. In this case, the SRS front airbags may not activate correctly in a collision, resulting in death or serious injury in the event of a collision. Be sure to wear the seat belt with the seat belt extender.

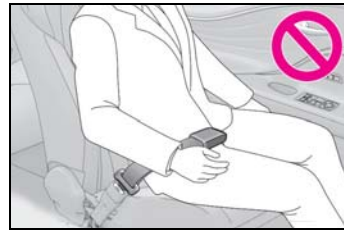

- The SRS front passenger airbag also deploys with considerable force, and can cause death or serious injury especially if the front passenger is very close to the airbag. The front passenger seat should be as far from the airbag as possible with the seatback adjusted, so the front passenger sits upright.
- Improperly seated and/or restrained infants and children can be killed or seriously injured by a deploying airbag. An infant or child who is too small to use a seat belt should be properly secured using a child restraint system. Lexus strongly recommends that all infants and children be placed in the rear seats of the vehicle and properly restrained. The rear seats are safer for infants and children than the front passenger seat. (→P.43)

**⚠ WARNING**

- Do not sit on the edge of the seat or lean against the dashboard.

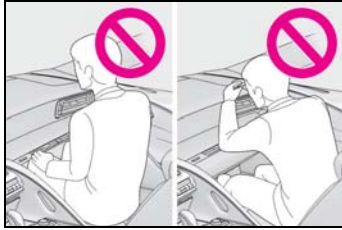

- Do not allow a child to stand in front of the SRS front passenger airbag unit or sit on the knees of a front passenger.

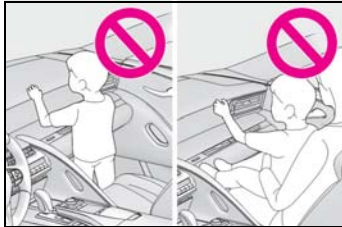

- Do not allow the front seat occupants to hold items on their knees.
- Do not lean against the door, the roof side rail or the front, side and rear pillars.



- Do not allow anyone to kneel on the passenger seat toward the door or put their head or hands outside the vehicle.



- Do not attach anything to or lean anything against areas such as the dashboard, steering wheel pad and lower portion of the instrument panel. These items can become projectiles when the SRS driver, front passenger and knee airbags deploy.

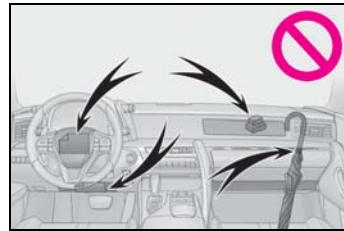

- Do not attach anything to areas such as a door, windshield, side window, front or rear pillar and roof side rail.

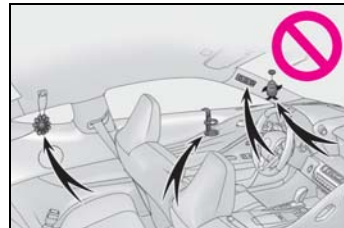

- Do not hang coat hangers or other hard objects on the coat hooks. All of these items could become projectiles and may cause death or serious injury, should the SRS curtain shield airbags deploy.
- If a vinyl cover is put on the area where the SRS knee airbag will deploy, be sure to remove it.

**WARNING**

- Do not use seat accessories which cover the parts where the SRS side airbags inflate as they may interfere with inflation of the SRS airbags. Such accessories may prevent the side airbags from activating correctly, disable the system or cause the side airbags to inflate accidentally, resulting in death or serious injury.
- Do not strike or apply significant levels of force to the area of the SRS airbag components or the doors. Doing so can cause the SRS airbags to malfunction.
- Do not touch any of the component parts immediately after the SRS airbags have deployed (inflated) as they may be hot.
- If breathing becomes difficult after the SRS airbags have deployed, open a door or window to allow fresh air in, or leave the vehicle if it is safe to do so. Wash off any residue as soon as possible to prevent skin irritation.
- If the areas where the SRS airbags are stored, such as the steering wheel pad and front and rear pillar garnishes are damaged or cracked, have them replaced by your Lexus dealer.
- Do not place anything, such as a cushion, on the front passenger's seat. Doing so will disperse the passenger's weight, which prevents the sensor from detecting the passenger's weight properly. As a result, the SRS front airbags for the front passenger may not deploy in the event of a collision.

■ **Modification and disposal of SRS airbag system components**

Do not dispose of your vehicle or perform any of the following modifications without consulting your Lexus dealer. The SRS airbags may malfunction or deploy (inflate) accidentally, causing death or serious injury.

- Installation, removal, disassembly and repair of the SRS airbags
- Repairs, modifications, removal or replacement of the steering wheel, instrument panel, dashboard, seats or seat upholstery, front, side and rear pillars, roof side rails, door panels, door trims or door speakers
- Modifications to the door panel (such as making a hole in it)
- Repairs or modifications of the front fender, front bumper, or side of the occupant compartment
- Installation of a grille guard (bull bars, kangaroo bar, etc.), snow plows, winches or roof luggage carrier
- Modifications to the vehicle's suspension system
- Installation of electronic devices such as mobile two-way radios and CD players
- Modifications to your vehicle for a person with a physical disability



## Pop Up Hood

In the event of a frontal collision with a body, such as a pedestrian, the Pop Up Hood system raises the hood to reduce the possibility of a serious impact to the pedestrian's head area by adding clearance to the engine compartment.

When the sensors located at the back of the front bumper detect a frontal impact with a body, such as a pedestrian, which meets or exceeds the threshold level while the vehicle is being driven within the operational speed range, the system operates.

### System components

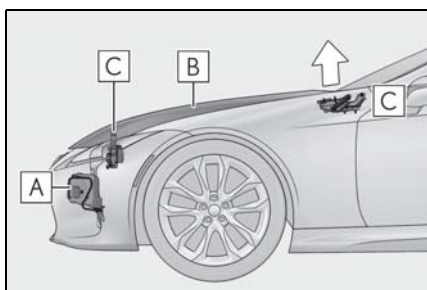

**A** Sensors

**B** Hood

**C** Lifters

### Pop Up Hood precautions

- Before scrapping your vehicle, make sure to contact your Lexus dealer.
- The Pop Up Hood system cannot be reused once it has operated. Have it replaced by your Lexus dealer.

### Pop Up Hood operational conditions

The Pop Up Hood will operate when the vehicle detects an impact such as the following:

- The front bumper detects a frontal impact equivalent to or greater than that of a pedestrian while the vehicle being driven within the operational speed range of approximately 16 to 34 mph (25 to 55 km/h). (The system is operated by an impact of threshold level or greater, even in the case of a minor collision that may not leave a trace on the front bumper. Also, depending on the impact conditions or vehicle speed, the system may operate by a collision with a light or small object or a small animal.)
- In other situations such as the following, the system may operate when an impact is applied to the lower part of the vehicle or front bumper:
  - Colliding with a curb
  - Falling into a deep hole
  - Landing hard
  - Hitting the slope of a parking lot, an undulating road, a protruding object or falling object

### Conditions under which the Pop Up Hood may not operate properly

- If a pedestrian collides with the right or left corner of the front bumper or the side of the vehicle. As such impacts may be difficult to detect, the system may not operate.
- If the vehicle speed is not detected correctly, such as if the vehicle is sliding sideways, the system may not operate properly.

### Conditions under which the Pop Up Hood will not operate

The Pop Up Hood will not operate in the following situations:

- Colliding with a lying person
- A frontal impact applied to the front bumper while driving at speeds outside of the operational speed range
- A side impact or rear impact
- A vehicle rollover (In some accident situations, the Pop Up Hood may operate.)



**WARNING****■ When the Pop Up Hood is operated**

- Do not pull the hood lock release lever. Doing so after the Pop Up Hood has operated will further raise the hood and may cause an injury. Do not drive with the hood raised, as doing so may block the driver's vision, possibly causing an accident.
- Do not forcibly push down the hood. As the popped up hood cannot be lowered by hand, doing so may deform the hood or cause an injury.
- If the Pop Up Hood has operated, have it replaced by your Lexus dealer. If the Pop Up Hood has operated, stop the vehicle in a safe place and contact your Lexus dealer.
- Do not touch the lifters immediately after the Pop Up Hood has operated, as the lifters may be hot and burn you.

- Do not remove such components as the front bumper, hood or suspension, or replace them with non-genuine parts, as doing so may prevent the system from operating properly.
- Do not install anything to the front bumper or hood, as doing so may prevent the sensors from detecting an impact correctly and prevent the system from operating properly.
- Do not close the hood with force or apply load to the lifters, as doing so may damage the lifters and prevent the system from operating properly.
- Do not modify the suspension, as changes made to the vehicle height may prevent the system from operating properly.

**NOTICE****■ Pop Up Hood precautions**

- Make sure to close the hood before driving, as the system may not operate properly if the hood is not fully closed.
- Make sure that all 4 tires are of the specified size and inflated to the specified tire pressure. If tires of a different size are used, the system may not operate properly.
- If something has hit the area around the front bumper, the sensors may be damaged even if the Pop Up Hood has not operated. Have the vehicle inspected by your Lexus dealer.
- Do not remove or repair the parts or wiring of the Pop Up Hood, as doing so may cause accidental operation or prevent the system from operating properly. If repair or replacement is necessary, contact your Lexus dealer.

## Front passenger occupant classification system

Your vehicle is equipped with a front passenger occupant classification system. This system detects the conditions of the front passenger seat and activates or deactivates the front passenger airbag, and front passenger knee airbag.

### System components

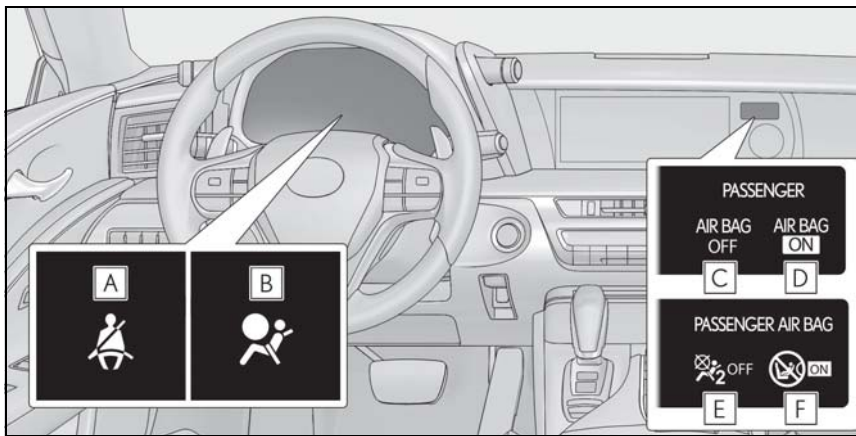

- A** Driver's and front passenger's seat belt reminder light
- B** SRS warning light
  - ▶ For the U.S.A.
- C** "AIR BAG OFF" indicator light
- D** "AIR BAG ON" indicator light
  - ▶ For Canada
- E** "AIR BAG OFF" indicator light
- F** "AIR BAG ON" indicator light

#### **⚠ WARNING**

##### **■ Front passenger occupant classification system precautions**

Observe the following precautions regarding the front passenger occupant classification system. Failure to do so may cause death or serious injury.

- Wear the seat belt properly.
- Make sure the front passenger's seat belt plate has not been left inserted into the buckle before someone sits in the front passenger seat.

**WARNING**

- Make sure the "AIR BAG OFF" indicator light is not illuminated when using the seat belt extender for the front passenger seat. If the "AIR BAG OFF" indicator light is illuminated, disconnect the extender tongue from the seat belt buckle, and reconnect the seat belt. Reconnect the seat belt extender after making sure the "AIR BAG ON" indicator light is illuminated. If you use the seat belt extender while the "AIR BAG OFF" indicator light is illuminated, the SRS airbags for the front passenger will not activate, which could cause death or serious injury in the event of a collision.
- Do not apply a heavy load to the front passenger seat or equipment (e.g. seatback pocket or armrest).
- Do not put weight on the front passenger seat by putting your hands or feet on the front passenger seat seatback from the rear passenger seat.
- Do not let a rear passenger lift the front passenger seat with their feet or press on the seatback with their legs.
- Do not put objects under the front passenger seat.
- Do not recline the front passenger seatback so far that it touches a rear seat. This may cause the "AIR BAG OFF" indicator light to be illuminated, which indicates that the SRS airbags for the front passenger will not activate in the event of a severe accident. If the seatback touches the rear seat, return the seatback to a position where it does not touch the rear seat. Keep the front passenger seatback as upright as possible when the vehicle is moving. Reclining the seatback excessively may lessen the effectiveness of the seat belt system.
- If an adult sits in the front passenger seat, the "AIR BAG ON" indicator light is illuminated. If the "AIR BAG OFF" indicator is illuminated, ask the passenger to sit up straight, well back in the seat, feet on the floor, and with the seat belt worn correctly. If the "AIR BAG OFF" indicator still remains illuminated, either ask the passenger to move to the rear seat, or if that is not possible, move the front passenger seat fully rearward.
- When it is unavoidable to install a forward-facing child restraint system on the front passenger seat, install the child restraint system on the front passenger seat in the proper order. (→P.45)
- Do not modify or remove the front seats.
- Do not kick the front passenger seat or subject it to severe impact. Otherwise, the SRS warning light may come on to indicate a malfunction of the front passenger occupant classification system. In this case, contact your Lexus dealer immediately.
- Child restraint systems installed on the rear seat should not contact the front seatbacks.
- Do not use a seat accessory, such as a cushion and seat cover, that covers the seat cushion surface.
- Do not modify or replace the upholstery of the front seat.

### Condition and operation in the front passenger occupant classification system

#### ■ Adult<sup>\*1</sup>

Indicator/warning light	"AIR BAG ON" and "AIR BAG OFF" indicator lights	"AIR BAG ON"
	SRS warning light	Off
	Driver's and front passenger's seat belt reminder light	Off <sup>*2</sup> or flashing <sup>*3</sup>
Devices	Front passenger airbag	Activated
	Front passenger knee airbag	

#### ■ Child<sup>\*4</sup>

Indicator/warning light	"AIR BAG ON" and "AIR BAG OFF" indicator lights	"AIR BAG OFF" or "AIR BAG ON" <sup>*4</sup>
	SRS warning light	Off
	Driver's and front passenger's seat belt reminder light	Off <sup>*2</sup> or flashing <sup>*3</sup>
Devices	Front passenger airbag	Deactivated or activated <sup>*4</sup>
	Front passenger knee airbag	

#### ■ Child restraint system with infant<sup>\*5</sup>

Indicator/warning light	"AIR BAG ON" and "AIR BAG OFF" indicator lights	"AIR BAG OFF" <sup>*6</sup>
	SRS warning light	Off
	Driver's and front passenger's seat belt reminder light	Off <sup>*2</sup> or flashing <sup>*3</sup>
Devices	Front passenger airbag	Deactivated
	Front passenger knee airbag	

### ■ Unoccupied

Indicator/warning light	"AIR BAG ON" and "AIR BAG OFF" indicator lights	"AIR BAG OFF"
	SRS warning light	Off
	Driver's and front passenger's seat belt reminder light	
Devices	Front passenger airbag	Deactivated
	Front passenger knee airbag	

### ■ There is a malfunction in the system

Indicator/warning light	"AIR BAG ON" and "AIR BAG OFF" indicator lights	"AIR BAG OFF"
	SRS warning light	On
	Driver's and front passenger's seat belt reminder light	
Devices	Front passenger airbag	Deactivated
	Front passenger knee airbag	

\*1: The system judges a person of adult size as an adult. When a smaller adult sits in the front passenger seat, the system may not recognize him/her as an adult depending on his/her physique and posture.

\*2: In the event the front passenger is wearing a seat belt.

\*3: In the event the front passenger does not wear a seat belt

\*4: For some children, child in seat, child in booster seat or child in convertible seat, the system may not recognize him/her as a child. Factors which may affect this can be the physique or posture.

\*5: Never install a rear-facing child restraint system on the front passenger seat. A forward-facing child restraint system should only be installed on the front passenger seat when it is unavoidable. (→P.45)

\*6: In case the indicator light is not illuminated, consult this manual on how to install the child restraint system properly. (→P.43)

### Exhaust gas precautions

**Harmful substance to the human body is included in exhaust gases if inhaled.**

#### WARNING

Exhaust gases include harmful carbon monoxide (CO), which is colorless and odorless. Observe the following precautions.

Failure to do so may cause exhaust gases enter the vehicle and may lead to an accident caused by light-headedness, or may lead to death or a serious health hazard.

#### ■ Important points while driving

- Keep the trunk lid closed.
- If you smell exhaust gases in the vehicle even when the trunk lid is closed, open the windows and have the vehicle inspected at your Lexus dealer as soon as possible.

#### ■ When parking

- If the vehicle is in a poorly ventilated area or a closed area, such as a garage, stop the engine <hybrid system>.
- Do not leave the vehicle with the engine running <hybrid system operating> for a long time. If such a situation cannot be avoided, park the vehicle in an open space and ensure that exhaust fumes do not enter the vehicle interior.
- Do not leave the engine running <hybrid system operating> in an area with snow build-up, or where it is snowing. If snowbanks build up around the vehicle while the engine is running <hybrid system is operating>, exhaust gases may collect and enter the vehicle.

#### ■ Exhaust pipe

The exhaust system needs to be checked periodically. If there is a hole or crack caused by corrosion, damage to a joint or abnormal exhaust noise, be sure to have the vehicle inspected and repaired by your Lexus dealer.

### Riding with children

Observe the following precautions when children are in the vehicle. Use a child restraint system appropriate for the child, until the child becomes large enough to properly wear the vehicle's seat belt.

- It is recommended that children sit in the rear seats to avoid accidental contact with the shift lever, wiper switch, etc.
- Use the window lock switch to avoid children operating the power window accidentally.
- Do not let small children operate equipment which may catch or pinch body parts, such as the power window, hood, trunk, seats etc.

### WARNING

#### ■ When children are in the vehicle

Never leave children unattended in the vehicle, and never allow children to have or use the key.

Children may be able to start the vehicle or shift the vehicle into neutral. There is also a danger that children may injure themselves by playing with the windows or other features of the vehicle. In addition, heat build-up or extremely cold temperatures inside the vehicle can be fatal to children.

### Child restraint systems

Before installing a child restraint system in the vehicle, there are precautions that need to be observed, different types of child restraint systems, as well as installation methods, etc., written in this manual.

Use a child restraint system when riding with a small child that cannot properly use a seat belt. For the child's safety, install the child restraint system to a rear seat. Be sure to follow the installation method that is in the operation manual enclosed with the restraint system.

### Table of contents

Points to remember: →P.43

Child restraint system: →P.44

When using a child restraint system: →P.45

Child restraint system installation method

- Fixed with a seat belt: →P.47
- Fixed with a child restraint LATCH anchor: →P.50
- Using an anchor bracket (for top tether strap): →P.52

### Points to remember

The laws of all 50 states of the U.S.A. as well as Canada now require the use of child restraint systems.

- Prioritize and observe the warnings, as well as the laws and regula-

tions for child restraint systems.

- Use a child restraint system until the child becomes large enough to properly wear the vehicle's seat belt.
- Choose a child restraint system that suits your vehicle and is appropriate to the age and size of the child.

**⚠ WARNING**

■ **When a child is riding**

Observe the following precautions. Failure to do so may result in death or serious injury.

- For effective protection in automobile accidents and sudden stops, a child must be properly restrained, using a seat belt or child restraint system which is correctly installed. For installation details, refer to the operation manual enclosed with the child restraint system. General installation instruction is provided in this manual.
- Lexus strongly urges the use of a proper child restraint system that conforms to the weight and size of the child, installed on the rear seat. According to accident statistics, the child is safer when properly restrained in the rear seat than in the front seat.
- Holding a child in your or someone else's arms is not a substitute for a child restraint system. In an accident, the child can be crushed against the windshield or between the holder and the interior of the vehicle.

■ **Handling the child restraint system**

If the child restraint system is not properly fixed in place, the child or other passengers may be seriously injured or even killed in the event of sudden braking, sudden swerving, or an accident.

- If the vehicle were to receive a strong impact from an accident, etc., it is possible that the child restraint system has damage that is not readily visible. In such cases, do not reuse the restraint system.
- Make sure you have complied with all installation instructions provided with the child restraint system manufacturer and that the system is properly secured.
- Keep the child restraint system properly secured on the seat even if it is not in use. Do not store the child restraint system unsecured in the passenger compartment.
- If it is necessary to detach the child restraint system, remove it from the vehicle.

**Child restraint system**

■ **Types of child restraint system installation methods**

Confirm with the operation manual enclosed with the child restraint system about the installation of the child restraint system.

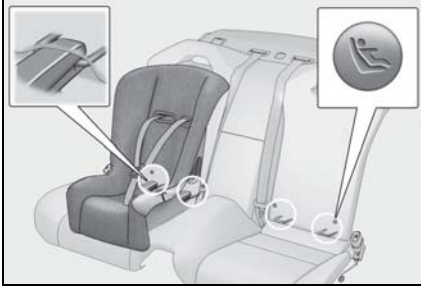
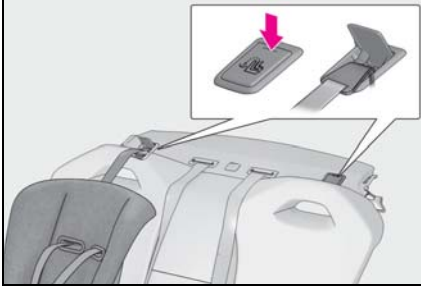

	Installation method	Page
Seat belt attachment		P.47
Child restraint LATCH anchors attachment		P.50
Anchor brackets (for top tether strap) attachment		P.52

### When using a child restraint system

#### ■ When installing a child restraint system to a front passenger seat

For the safety of a child, install child restraint systems to a rear seats. When installing child restraint system to a front passenger seat is unavoidable, adjust the seat as follows and install the child restraint system.

- Raise the seatback as much as possible
- Move the seat to the rearmost position
- Raise the seat to the highest position
- If the head restraint interferes with the child restraint system installation and the head restraint can be removed, remove the head restraint. Otherwise, put the head restraint in the upper most position.



**⚠ WARNING**

■ **When installing a child restraint system**

Observe the following precautions. Failure to do so may result in death or serious injury.

- Never install a rear-facing child restraint system on the front passenger seat even if the "AIR BAG OFF" indicator light is illuminated. In the event of an accident, the force of the rapid inflation of the front passenger airbag can cause death or serious injury to the child if the rear-facing child restraint system is installed on the front passenger seat.
- A forward-facing child restraint system may be installed on the front passenger seat only when it is unavoidable. A child restraint system that requires a top tether strap should not be used in the front passenger seat since there is no top tether strap anchor for the front passenger seat.

- A forward-facing child restraint system may be installed on the front passenger seat only when it is unavoidable. When installing a forward-facing child restraint system on the front passenger seat, adjust the seatback to the most upright position, move the seat as far back as possible, and raise the seat to the highest position, even if the "AIR BAG OFF" indicator light is illuminated.

If the head restraint interferes with the installation of the child restraint system, and the head restraint can be removed, remove the head restraint. Otherwise, put the head restraint in the upper most position.



- Do not allow the child to lean his/her head or any part of his/her body against the door or the area of the seat, front or rear pillars or roof side rails from which the SRS side airbags or SRS curtain shield airbags deploy even if the child is seated in the child restraint system. It is dangerous if the SRS side and curtain shield airbags inflate, and the impact could cause death or serious injury to the child.



**⚠ WARNING**

- When a booster seat is installed, always ensure that the shoulder belt is positioned across the center of the child's shoulder. The belt should be kept away from the child's neck, but not so that it could fall off the child's shoulder.
- Use child restraint system suitable to the age and size of the child and install it to the rear seat.
- If the driver's seat interferes with the child restraint system and prevents it from being attached correctly, attach the child restraint system to the right-hand rear seat.

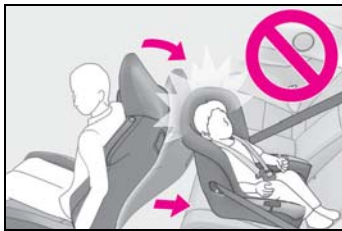

- Adjust the front passenger seat so that it does not interfere with the child restraint system.

**Child restraint system fixed with a seat belt****■ Installing child restraint system using a seat belt (child restraint lock function belt)**

A child restraint system for a small child or baby must itself be properly restrained on the seat with the lap portion of the lap/shoulder belt.

Install the child restraint system in accordance to the operation manual enclosed with the child restraint system.

**■ Rear-facing — Infant seat/convertible seat**

- 1 Place the child restraint system on the rear seat facing the rear of the vehicle.



- 2 Run the seat belt through the child restraint system and insert the plate into the buckle. Make sure that the belt is not twisted.



- 3 Fully extend the shoulder belt and allow it to retract to put it in lock mode. In lock mode, the belt cannot be extended.

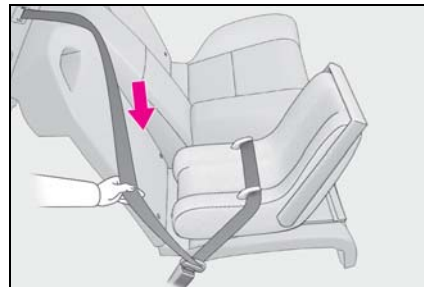

- 4 While pushing the child restraint system down into the rear seat, allow the shoulder belt to retract until the child restraint system is securely in place.

After the shoulder belt has retracted to a point where there is no slack in the belt, pull the belt to check that it cannot be extended.

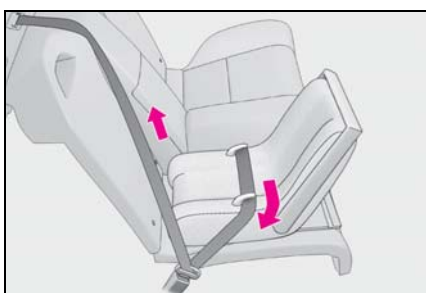

- 5 After installing the child restraint system, rock it back and forth to ensure that it is installed securely. (→P.50)

■ **Forward-facing — Convertible seat**

- 1 If installing the child restraint system to the front passenger seat is unavoidable, refer to P.45 for front passenger seat adjustment.
- 2 If the head restraint interferes with the child restraint system installation and the head restraint can be removed, remove the head restraint. Otherwise, put the head restraint in the upper most position. (→P.125)

- 3 Place the child restraint system on the seat facing the front of the vehicle.



- 4 Run the seat belt through the child restraint system and insert the plate into the buckle. Make sure that the belt is not twisted.

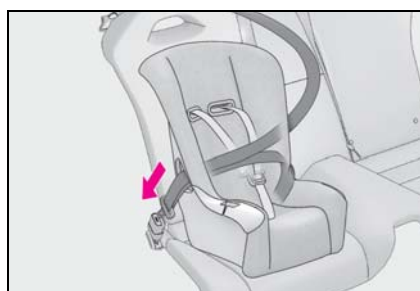

- 5 Fully extend the shoulder belt and allow it to retract to put it in lock mode. In lock mode, the belt cannot be extended.

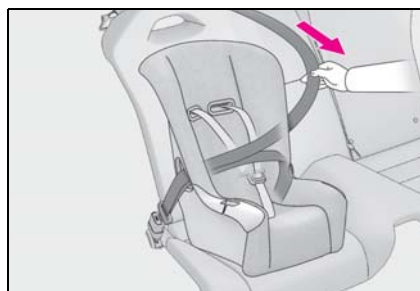

- 6 While pushing the child restraint system into the rear seat, allow the shoulder belt to retract until the

child restraint system is securely in place.

After the shoulder belt has retracted to a point where there is no slack in the belt, pull the belt to check that it cannot be extended.

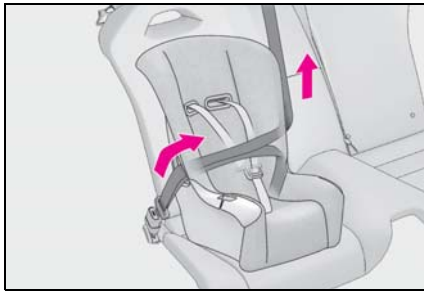

- 7 If the child restraint has a top tether strap, follow the child restraint manufacturer's operation manual regarding the installation, using the top tether strap to latch onto the top tether strap anchor. (→P.52)
- 8 After installing the child restraint system, rock it back and forth to ensure that it is installed securely. (→P.50)

#### ■ Booster seat

- 1 If installing the child restraint system to the front passenger seat is unavoidable, refer to P.45 for front passenger seat adjustment.
- 2 High back type: If the head restraint interferes with your child restraint system, and the head restraint can be removed, remove the head restraint. Otherwise, put the head restraint in the upper most position. (→P.125)
- 3 Place the child restraint system on the seat facing the front of the vehicle.

#### ▶ Booster type

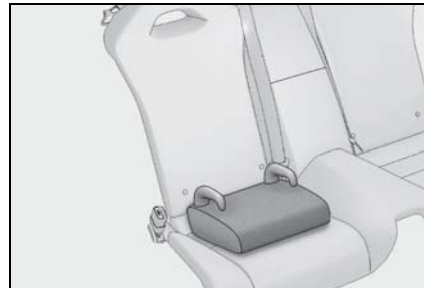

#### ▶ High back type



- 4 Sit the child in the child restraint system. Fit the seat belt to the child restraint system according to the manufacturer's instructions and insert the plate into the buckle. Make sure that the belt is not twisted.

Check that the shoulder belt is correctly positioned over the child's shoulder and that the lap belt is as low as possible. (→P.25)



### ■ Removing a child restraint system installed with a seat belt

Press the buckle release button and fully retract the seat belt.

When releasing the buckle, the child restraint system may spring up due to the rebound of the seat cushion. Release the buckle while holding down the child restraint system.

Since the seat belt automatically reels itself, slowly return it to the stowing position.

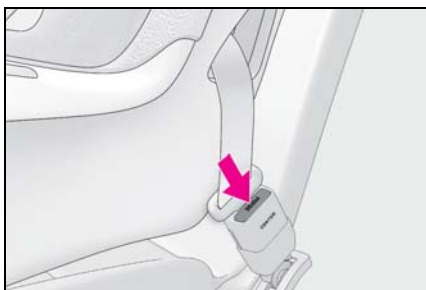

### ⚠ WARNING

#### ■ When installing a child restraint system

Observe the following precautions. Failure to do so may result in death or serious injury.

- Do not allow children to play with the seat belt. If the seat belt becomes twisted around a child's neck, it may lead to choking or other serious injuries that could result in death. If this occurs and the buckle cannot be unfastened, scissors should be used to cut the belt.
- Ensure that the belt and plate are securely locked and the seat belt is not twisted.
- Shake the child restraint system left and right, and forward and backward to ensure that it has been securely installed.

- After securing a child restraint system, never adjust the seat.

- When a booster seat is installed, always ensure that the shoulder belt is positioned across the center of the child's shoulder. The belt should be kept away from the child's neck, but not so that it could fall off the child's shoulder.

- Follow all installation instructions provided by the child restraint system manufacturer.

#### ■ When installing a booster seat

To prevent the belt from going into ALR lock mode, do not fully extend the shoulder belt. ALR mode causes the belt to tighten only. This could cause injury or discomfort to the child. (→P.26)

#### ■ Do not use a seat belt extender

If a seat belt extender is used when installing a child restraint system, the seat belt will not securely hold the child restraint system, which could cause death or serious injury to the child or other passengers in the event of sudden braking, sudden swerving or an accident.

### Child restraint system fixed with a child restraint LATCH anchor

#### ■ Child restraint LATCH anchors

LATCH anchors are provided for the each rear seat. (Buttons displaying the location of the anchors are attached to the seats.)



### ■ Installation with LATCH system

Install the child restraint system in accordance to the operation manual enclosed with the child restraint system.

#### ► Type A

- 1 Latch the hooks of the lower straps onto the LATCH anchors.  
For owners in Canada:  
The symbol on a child restraint system indicates **A** the presence of a lower connector system.

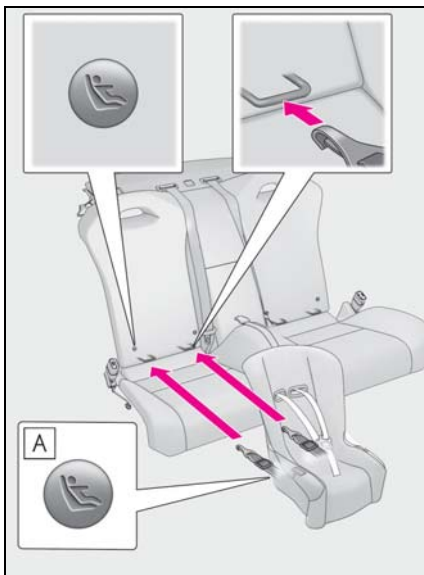

#### ► Type B

- 1 Latch the buckles onto the LATCH anchors.  
For owners in Canada:  
The symbol on a child restraint system indicates **A** the presence of a lower connector system.

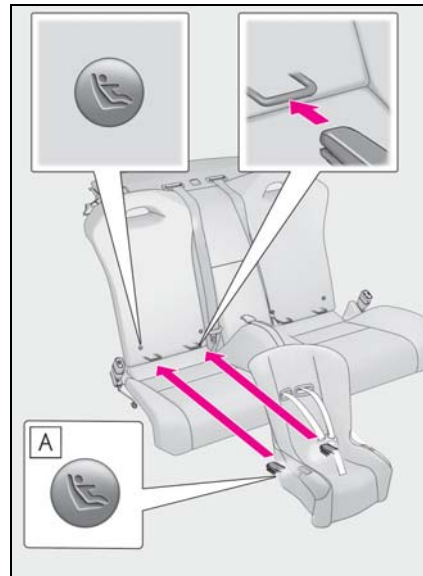

- 2 If the child restraint has a top tether strap, follow the child restraint manufacturer's operation manual regarding the installation, using the top tether strap to latch onto the top tether strap anchor. (→P.52)
- 3 After installing the child restraint system, rock it back and forth to ensure that it is installed securely. (→P.50)

### ■ Laws and regulations pertaining to anchors

The LATCH system conforms to FMVSS225 or CMVSS210.2.  
Child restraint systems conforming to FMVSS213 or CMVSS213 specifications



can be used.  
This vehicle is designed to conform to SAE J1819.

### **⚠ WARNING**

#### ■ When installing a child restraint system

Observe the following precautions. Failure to do so may result in death or serious injury.

- After securing a child restraint system, never adjust the seat.
- When using the LATCH anchors, be sure that there are no foreign objects around the anchors and that the seat belt is not caught behind the child restraint system.
- Follow all installation instructions provided by the child restraint system manufacturer.

### Using an anchor bracket (for top tether strap)

#### ■ Anchor brackets (for top tether strap)

Anchor brackets are provided for each rear seat.

Use anchor brackets when fixing the top tether strap.

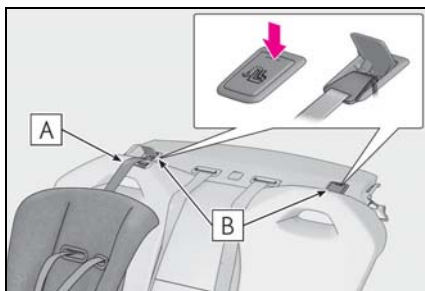

**A** Top tether strap

**B** Anchor brackets

#### ■ Fixing the top tether strap to the anchor bracket

Install the child restraint system in accordance to the operation manual enclosed with the child restraint system.

Open the anchor bracket cover, latch the hook onto the anchor bracket and tighten the top tether strap.

Make sure the top tether strap is securely latched. (→P.50)

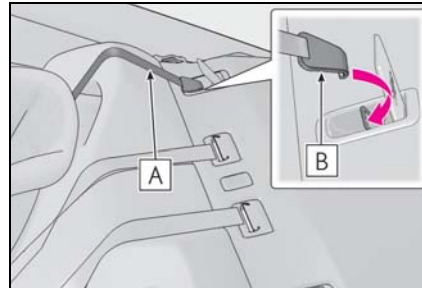

**A** Top tether strap

**B** Hook

#### ■ Laws and regulations pertaining to anchors

The LATCH system conforms to FMVSS225 or CMVSS210.2.

Child restraint systems conforming to FMVSS213 or CMVSS213 specifications can be used.

This vehicle is designed to conform to SAE J1819.

### **⚠ WARNING**

#### ■ When installing a child restraint system

Observe the following precautions. Failure to do so may result in death or serious injury.

- Firmly attach the top tether strap and make sure that the belt is not twisted.



**WARNING**

- Do not attach the top tether strap to anything other than the anchor bracket.
- After securing a child restraint system, never adjust the seat.
- Follow all installation instructions provided by the child restraint system manufacturer.

**NOTICE****■ Anchor brackets (for top tether strap)**

When not in use, make certain to close the lid. If it remains open, the lid may be damaged.

## Lexus Enform Safety Connect\*

\*: If equipped

Safety Connect is a subscription-based telematics service that uses Global Positioning System (GPS) data and embedded cellular technology to provide safety and security features to subscribers. Safety Connect is supported by Lexus' designated response center, which operates 24 hours per day, 7 days per week.

Safety Connect service is available by subscription on select, telematics hardware-equipped vehicles.

By using the Safety Connect service, you are agreeing to be bound by the Telematics Subscription Service Agreement and its Terms and Conditions, as in effect and amended from time to time, a current copy of which is available at [Lexus.com](http://Lexus.com). All use of the Safety Connect service is subject to such then-applicable Terms and Conditions.

## System components

### ► Vehicles without sunshade

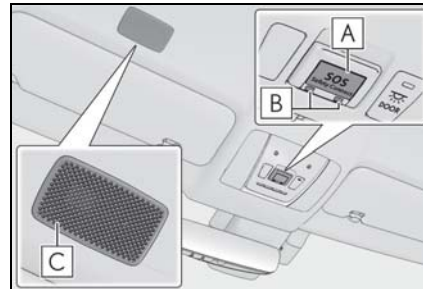

**A** "SOS" button

**B** LED light indicators

**C** Microphone

### ► Vehicles with sunshade

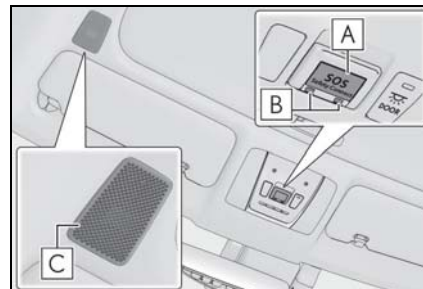

**A** "SOS" button

**B** LED light indicators

**C** Microphone

### ■ Certification for Lexus Enform

FCC ID: JOYJ79  
IC: 574B-J79

#### FCC/IC WARNING:

Changes or modifications not expressly approved by the manufacture could void the user's authority to operate the equipment. This device complies with Part 15 of the FCC Rules and Industry Canada license-exempt RSS standards. Operation is subject to the following two conditions:

- (1) this device may not cause harmful interference, and
- (2) this device must accept any interference, including interference that may cause undesired operation of the device.

This equipment complies with IC RSS-102 radiation exposure limits set forth for uncontrolled environment.

The antennas used for this transmitter must be installed to provide a separation distance of least 20cm from all persons.

#### FCC/IC AVERTISSEMENT:

L'utilisateur est averti que les changements ou modifications non expressément approuvés par le fabricant pourraient annuler l'autorité de l'utilisateur à utiliser l'équipement.

Ce appareil est compatible avec la Partie 15 du règlement FCC et de la Licence de l'industrie canadienne et des normes exemptes de RSS. Opération soumise aux deux conditions suivantes :

- (1) ce appareil ne doit pas causer des interférences nuisibles, et
- (2) cet appareil doit accepté toutes les interférences, y compris les interférences qui peuvent entraîner un fonctionnement indésirable de l'appareil.

Cet appareil est compatible aux limites d'exposition aux radiation IC RSS-102 définies pour un environnement non contrôlé.

Les antennes utilisées pour cet émetteur doivent être installées à une distance d'au moins 20 cm de toutes les personnes.

### Services

Subscribers have the following Safety Connect services available:

#### ● Automatic Collision Notification\*

Helps drivers receive necessary response from emergency service providers. (→P.57)

\*: U.S. Patent No. 7,508,298 B2

- Stolen Vehicle Location

Helps drivers in the event of vehicle theft. (→P.57)

- Emergency Assistance Button (“SOS”)

Connects drivers to response-center support. (→P.57)

- Enhanced Roadside Assistance

Provides drivers various on-road assistance. (→P.57)

### Subscription

After you have signed the Telematics Subscription Service Agreement and are enrolled, you can begin receiving services.

A variety of subscription terms is available for purchase. Contact your Lexus dealer, call the following or push the “SOS” button in your vehicle for further subscription details.

- The United States  
1-800-25-LEXUS (1-800-255-3987)
- Canada  
1-800-26-LEXUS (1-800-265-3987)
- Puerto Rico  
1-877-539-8777

### ■ Safety Connect Services Information

- Phone calls using the vehicles Bluetooth® technology will not be possible during Safety Connect.
- Safety Connect is available beginning Fall 2009 on select Lexus models (in the contiguous United States only). Contact with the Safety Connect response center is dependent upon the telematics device being in operative condition, cellular con-

nection availability, and GPS satellite signal reception, which can limit the ability to reach the response center or receive emergency service support. Enrollment and Telematics Subscription Service Agreement required. A variety of subscription terms is available; charges vary by subscription term selected and location.

- Automatic Collision Notification, Emergency Assistance and Stolen Vehicle Location will function in the United States, including Hawaii and Alaska, Puerto Rico and in Canada, and Enhanced Roadside Assistance will function in the United States, Puerto Rico and in Canada.
- Automatic Collision Notification, Emergency Assistance, Stolen Vehicle and Enhanced Road Assistance will not function in the United States Virgin Islands. For vehicles first sold in the USVI, no Safety Connect services will function in and outside the United States Virgin Islands.
- Safety Connect services are not subject to section 255 of the Telecommunications Act and the device is not TTY compatible.

### ■ Languages

The Safety Connect response center will offer support in multiple languages. The Safety Connect system will offer voice prompts in English, Spanish, and French. Please indicate your language of choice when enrolling.

### ■ When contacting the response center

You may be unable to contact the response center if the network is busy.

### Safety Connect LED light Indicators

When the engine switch <power switch> is turned to IGNITION ON mode <ON mode>, the red indicator light comes on for 2 seconds then turns off. Afterward, the green indicator light

comes on, indicating that the service is active.

The following indicator light patterns indicate specific system usage conditions:

- Green indicator light on = Active service
- Green indicator light flashing = Safety Connect call in process
- Red indicator light (except at vehicle start-up) = System malfunction (contact your Lexus dealer)
- No indicator light (off) = Safety Connect service not active

### Safety Connect services

#### ■ Automatic Collision Notification

In case of either airbag deployment or severe rear-end collision, the system is designed to automatically call the response center. The responding agent receives the vehicle's location and attempts to speak with the vehicle occupants to assess the level of emergency. If the occupants are unable to communicate, the agent automatically treats the call as an emergency, contacts the nearest emergency services provider to describe the situation, and requests that assistance be sent to the location.

#### ■ Stolen Vehicle Location

If your vehicle is stolen, Safety Connect can work with local authorities to assist them in locating and recovering the vehicle. After filing a police report, call the Safety Connect response center at

1-800-25-LEXUS (1-800-255-3987) in the United States, 1-877-539-8777 in Puerto Rico or 1-800-265-3987 in Canada, and follow the prompts for Safety Connect to initiate this service.

In addition to assisting law enforcement with recovery of a stolen vehicle, Safety-Connect-equipped vehicle location data may, under certain circumstances, be shared with third parties to locate your vehicle. Further information is available at [Lexus.com](http://Lexus.com).

#### ■ Emergency Assistance Button ("SOS")

In the event of an emergency on the road, push the "SOS" button to reach the Safety Connect response center. The answering agent will determine your vehicle's location, assess the emergency, and dispatch the necessary assistance required.

If you accidentally press the "SOS" button, tell the response-center agent that you are not experiencing an emergency.

#### ■ Enhanced Roadside Assistance

Enhanced Roadside Assistance adds GPS data to the already included warranty-based Lexus roadside service.

Subscribers can press the "SOS" button to reach a Safety Connect response-center agent, who can help with a wide range of needs, such as: towing, flat tire, fuel delivery, etc. For a description of the Roadside Assistance services and their limitations, please see the Safety Connect Terms and Conditions, which are available at

Lexus.com.

### Safety information for Safety Connect

Important! Read this information about exposure to radio frequency signals before using Safety Connect;

The Safety Connect system installed in your vehicle is a low-power radio transmitter and receiver. It receives and also sends out radio frequency (RF) signals.

In August 1996, the Federal Communications Commission (FCC) adopted RF exposure guidelines with safety levels for mobile wireless phones. Those guidelines are consistent with the safety standards previously set by the following U.S. and international standards bodies.

- ANSI (American National Standards Institute) C95.1 [1992]
- NCRP (National Council on Radiation Protection and Measurement) Report 86 [1986]
- ICNIRP (International Commission on Non-Ionizing Radiation Protection) [1996]

Those standards were based on comprehensive and periodic evaluations of the relevant scientific literature. Over 120 scientists, engineers, and physicians from universities, and government health agencies and industries reviewed the available body of research to develop the ANSI Standard (C95.1).

The design of Safety Connect com-

plies with the FCC guidelines in addition to those standards.

## Lexus Enform Remote\*

\*: If equipped

**Lexus Enform Remote is a cellular phone application that lets you view and remotely control certain aspects of your vehicle.**

**For details about the functions and services of this application, refer to <http://www.lexus.com/enform/>.**

**Function of the Lexus Enform Remote is achieved by using DCM (Data Communication Module).**

## Subscription

After you sign the Telematics Subscription Service Agreement, download the Lexus Enform Remote app from your cellular phone's app store, and register within the app (or enroll and complete registration at the dealer), you can begin using these services. (→P.54)

A variety of subscription terms are available. Contact your Lexus dealer, or call 1-800-25-LEXUS (1-800-255-3987) for further subscription details.

### ■ Availability of service

Lexus Enform Remote is available in the contiguous United States, Washington D.C. and Alaska.

Lexus Enform Remote is not available in some countries or areas.

### ■ Lexus Enform Remote Information

- Lexus Enform Remote should only be used by authorized users.
- Laws in some communities may require that the vehicle be within view of the user

when operating Lexus Enform Remote. In some states, use of Lexus Enform Remote may violate state or local laws. Before using Lexus Enform Remote, check your state and local laws.

- Any malfunction of the Lexus should be repaired by your Lexus dealer.
- Lexus Enform Remote is designed to work at temperatures above -22°F (-30°C). This specification is related to the Lexus Enform Remote operation, but is dependent on the vehicle's operating temperature range which may be different.
- Content is subject to change without notice.
- Some features of the Lexus Enform Remote may not be available on some models.
- Additional information can be found at [www.lexus.com/enform/](http://www.lexus.com/enform/).
- Availability of functions of the Lexus Enform service is dependent on network reception level.

### ■ Safety information for Lexus Enform Remote

Refer to the safety information for Safety Connect: →P.58

## Lexus Enform Service Connect\*

\*: If equipped

**Lexus Enform Service Connect uses DCM (Data Communication Module) to collect and transmit vehicle data that allows Lexus to provide:**

- Vehicle Health Report (VHR) (Safety Recalls, Service Campaigns, Current Vehicle Alerts, Required Maintenance, and Vehicle Condition Status)
- Maintenance Notifications
- Vehicle Alert Notifications

**For details about this service and how to register, refer to <http://www.lexus.com/enform/>.**

**The Lexus Enform Service Connect is achieved by using a DCM built in the vehicle.**

### ■ Availability of service

Lexus Enform Service Connect is not available in some countries or areas.

### ■ Lexus Enform Service Connect Information

Availability of functions of the Lexus Enform Service Connect is dependent on network reception level.

### ■ Safety information for Lexus Enform Service Connect

Refer to the safety information for Safety Connect: →P.58



### Hybrid system features (LC500h)

Your vehicle is a hybrid vehicle. It has characteristics different from conventional vehicles. Be sure you are closely familiar with the characteristics of your vehicle, and operate it with care.

The hybrid system combines the use of a gasoline engine and an electric motor (traction motor) according to driving conditions, improving fuel efficiency and reducing exhaust emissions.

In addition to the conventional system, exclusive control is performed for four driving conditions (starting off, accelerating, low-speed driving and high-speed cruising) to optimize the drive force and fuel efficiency, allowing for a more powerful drive and a higher fuel efficiency.

### System components

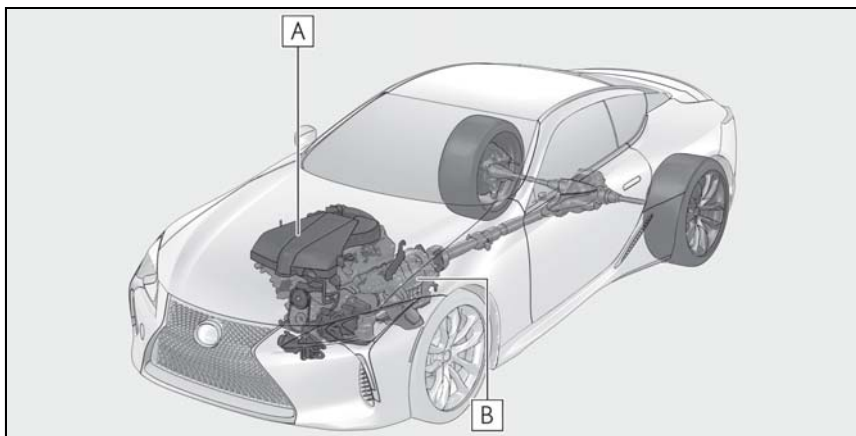

The illustration is an example for explanation and may differ from the actual item.

- A** Gasoline engine
- B** Electric motor (traction motor)

#### ■ When stopped/during start off

The gasoline engine stops\* when the vehicle is stopped. During start off, the electric motor (traction motor) drives the vehicle. When the accelerator pedal is only lightly depressed, such as when traveling on a level surface or

down a gentle slope, the engine is stopped\* and the electric motor (traction motor) is used.

When the shift position is in N, the hybrid battery (traction battery) is not being charged.

\*: When the hybrid battery (traction battery) requires charging or the engine is warming up, etc., the gasoline engine will not automatically stop.

■ **During normal driving**

The gasoline engine is predominantly used. The electric motor (traction motor) charges the hybrid battery (traction battery) as necessary.

■ **When accelerating sharply**

When the accelerator pedal is depressed heavily, the power of the hybrid battery (traction battery) is added to that of the gasoline engine via the electric motor (traction motor).

■ **When braking (regenerative braking)**

The wheels operate the electric motor (traction motor) as a power generator, and the hybrid battery (traction battery) is charged.

■ **Regenerative braking**

In the following situations, kinetic energy is converted to electric energy and deceleration force can be obtained in conjunction with the recharging of the hybrid battery (traction battery).

- The accelerator pedal is released while driving with the shift position in D or M.
- The brake pedal is depressed while driving with the shift position in D or M.

■ **EV indicator**

The EV indicator comes on when the vehicle is driven using only the electric motor (traction motor) or the gasoline engine is stopped.

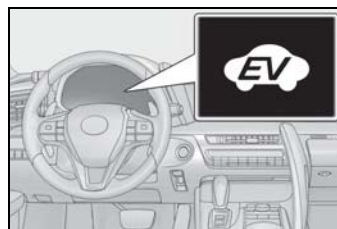

■ **Conditions in which the gasoline engine may not stop**

The gasoline engine starts and stops automatically. However, it may not stop automatically in the following conditions\*:

- During gasoline engine warm-up
- During hybrid battery (traction battery) charging
- When the temperature of the hybrid battery (traction battery) is high or low
- When the heater is switched on
- When the shift position is in M

\*: Depending on the circumstances, the gasoline engine may also not stop automatically in other situations.

■ **Charging the hybrid battery (traction battery)**

As the gasoline engine charges the hybrid battery (traction battery), the battery does not need to be charged from an outside source. However, if the vehicle is left parked for a long time the hybrid battery (traction battery) will slowly discharge. For this reason, be sure to drive the vehicle at least once every few months for at least 30 minutes or 10 miles (16 km). If the hybrid battery (traction battery) becomes fully discharged and you are unable to start the hybrid system, contact your Lexus dealer.

■ **Charging the 12-volt battery**

→P.361

■ **After the 12-volt battery has discharged or when the terminal has been removed and installed during exchange, etc.**

The gasoline engine may not stop even if the vehicle is being driven by the hybrid battery (traction battery). If this continues for a few days, contact your Lexus dealer.

### ■ Sounds and vibrations specific to a hybrid vehicle

There may be no engine sound or vibration even though the vehicle is able to move with the "READY" indicator is illuminated. For safety, apply the parking brake and make sure to shift the shift position to P when parked.

The following sounds or vibrations may occur when the hybrid system is operating and are not a malfunction:

- Motor sounds may be heard from the engine compartment.
- Sounds may be heard from the hybrid battery (traction battery) behind the rear seats when the hybrid system starts or stops.
- Relay operating sounds such as a snap or soft clank will be emitted from the hybrid battery (traction battery), behind the rear seats, when the hybrid system is started or stopped.
- Sounds from the hybrid system may be heard when the trunk lid is open.
- Sounds may be heard from the transmission when the gasoline engine starts or stops, when driving at low speeds, or during idling.
- Engine sounds may be heard when accelerating sharply.
- Sounds may be heard due to regenerative braking when the brake pedal is depressed or as the accelerator pedal is released.
- Vibration may be felt when the gasoline engine starts or stops.
- Cooling fan sounds may be heard from the air intake vents under the rear seats.

### ■ Maintenance, repair, recycling, and disposal

Contact your Lexus dealer regarding maintenance, repair, recycling and disposal. Do not dispose of the vehicle yourself.

### ■ Customization

Settings (e.g. on/off operation of the EV indicator) can be changed.  
(Customizable features: →P.391)

### Vehicle proximity notification system

When driving with the gasoline engine stopped, a sound, which changes in accordance with the driving speed, will be played in order to warn people nearby of the vehicle's approach. The sound will stop when the vehicle speed exceeds approximately 15 mph (25 km/h).

### ■ Vehicle proximity notification system

In the following cases, the vehicle proximity notification system may be difficult for surrounding people to hear.

- In very noisy areas
- In the wind or the rain

Also, as the vehicle proximity notification system is installed on the front of the vehicle, it may be more difficult to hear from the rear of the vehicle compared to the front.

### ■ If "Proximity Notification System Malfunction Visit Your Dealer" is displayed on the multi-information display

The system may be malfunctioning. Have the vehicle inspected by your Lexus dealer.

### ■ Customization

The volume of vehicle proximity notification system sound can be changed.  
(Customizable features: →P.391)

### Hybrid system precautions (LC500h)

Take care when handling the hybrid system, as it is a high voltage system (about 650 V at maximum) as well as contains parts that become extremely hot when the hybrid system is operating. Obey the warning labels attached to the vehicle.

### System components

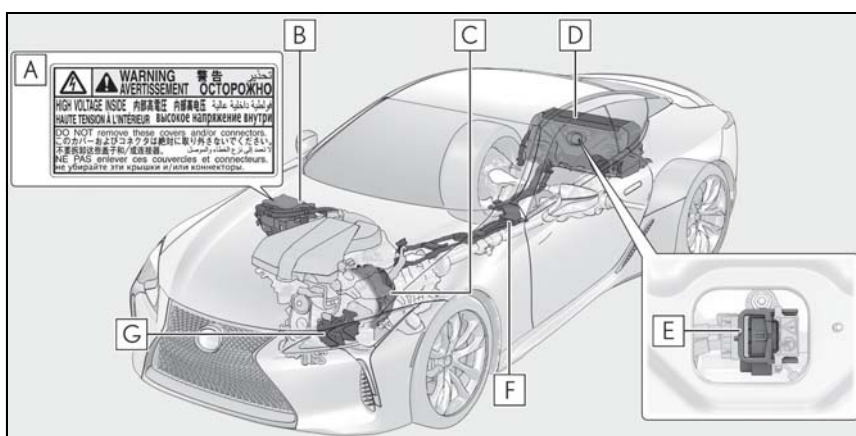

The illustration is an example for explanation and may differ from the actual item.

- A** Warning label
- B** Power control unit
- C** Electric motor (traction motor)
- D** Hybrid battery (traction battery)
- E** Service plug
- F** High voltage cables (orange)
- G** Air conditioning compressor

#### ■ Running out of fuel

When the vehicle has run out of fuel and the hybrid system cannot be started, refuel the vehicle with at least enough gasoline to make the low fuel level warning light (→P.339) go off. If there is only a small amount of fuel, the hybrid system may not be able to start. (The standard amount of

fuel is about 3.3 gal. [12.6 L, 2.8 Imp.gal.], when the vehicle is on a level surface. This value may vary when the vehicle is on a slope. Add extra fuel when the vehicle is inclined.)

#### ■ Electromagnetic waves

- High voltage parts and cables on hybrid vehicles incorporate electromagnetic

shielding, and therefore emit approximately the same amount of electromagnetic waves as conventional gasoline powered vehicles or home electronic appliances.

- Your vehicle may cause sound interference in some third party-produced radio parts.

#### ■ Hybrid battery (traction battery)

The hybrid battery (traction battery) has a limited service life. The lifespan of the hybrid battery (traction battery) can change in accordance with driving style and driving conditions.

#### ■ Starting the hybrid system in an extremely cold environment

When the hybrid battery (traction battery) is extremely cold (below approximately -22°F [-30°C]) under the influence of the outside temperature, it may not be possible to start the hybrid system. In this case, try to start the hybrid system again after the temperature of the hybrid battery increases due to the outside temperature increase etc.

### ⚠ WARNING

#### ■ High voltage precautions

This vehicle has high voltage DC and AC systems as well as a 12-volt system. DC and AC high voltage is very dangerous and can cause severe burns and electric shock that may result in death or serious injury.

- Never touch, disassemble, remove or replace the high voltage parts, cables or their connectors.
- The hybrid system will become hot after starting as the system uses high voltage. Be careful of both the high voltage and the high temperature, and always obey the warning labels attached to the vehicle.

- Never try to open the service plug access hole located behind the rear seats. The service plug is used only when the vehicle is serviced and is subject to high voltage.

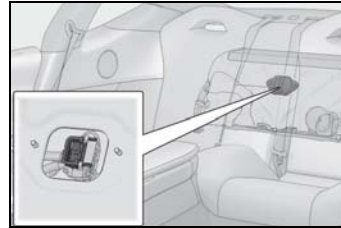

#### ■ Road accident cautions

Observe the following precautions to reduce the risk of death or serious injury:

- Stop the vehicle in a safe place to prevent subsequent accidents. While depressing the brake pedal, apply the parking brake and shift the shift position to P to stop the hybrid system. Then, slowly release the brake pedal.
- Do not touch the high voltage parts, cables and connectors.
- If electric wires are exposed inside or outside your vehicle, an electric shock may occur. Never touch exposed electric wires.
- Do not touch the battery if liquid is leaking from or adhering to it. If electrolyte (carbonic-based organic electrolyte) from the hybrid battery (traction battery) comes into contact with the eyes or skin, it could cause blindness or skin wounds. In the unlikely event that it comes into contact with the eyes or skin, wash it off immediately with a large amount of water, and seek immediate medical attention.

**WARNING**

- If electrolyte is leaking from the hybrid battery (traction battery), do not approach the vehicle. Even in the unlikely event that the hybrid battery (traction battery) is damaged, the internal construction of the battery will prevent a large amount of electrolyte from leaking out. However, any electrolyte that does leak out will give off a vapor. This vapor is an irritant to skin and eyes and could cause acute poisoning if inhaled.
- Do not bring burning or high-temperature items close to the electrolyte. The electrolyte may ignite and cause a fire.
- If a fire occurs in the hybrid vehicle, leave the vehicle as soon as possible. Never use a fire extinguisher that is not meant for electric fires. Using even a small amount of water may be dangerous.
- If your vehicle needs to be towed, do so with rear wheels raised. If the wheels connected to the electric motor (traction motor) are on the ground when towing, the motor may continue to generate electricity. This may cause a fire. (→P.329)
- Carefully inspect the ground under the vehicle. If you find that liquid has leaked onto the ground, the fuel system may have been damaged. Leave the vehicle as soon as possible.
- **Hybrid battery (traction battery)**
- Your vehicle contains a sealed lithium-ion battery

- Never resell, hand over or modify the hybrid battery. To prevent accidents, hybrid batteries that have been removed from a disposed vehicle are collected through Lexus dealer. Do not dispose of the battery yourself. Unless the battery is properly collected, the following may occur, resulting in death or serious injury:
  - The hybrid battery may be illegally disposed of or dumped, and it is hazardous to the environment or someone may touch a high voltage part, resulting in an electric shock.
  - The hybrid battery is intended to be used exclusively with your hybrid vehicle. If the hybrid battery is used outside of your vehicle or modified in any way, accidents such as electric shock, heat generation, smoke generation, an explosion and electrolyte leakage may occur.

When reselling or handing over your vehicle, the possibility of an accident is extremely high because the person receiving the vehicle may not be aware of these dangers.

- If your vehicle is disposed of without the hybrid battery having been removed, there is a danger of serious electric shock if high voltage parts, cables and their connectors are touched. In the event that your vehicle must be disposed of, the hybrid battery must be disposed of by your Lexus dealer or a qualified service shop. If the hybrid battery is not disposed of properly, it may cause electric shock that can result in death or serious injury.

 NOTICE

■ **Hybrid battery (traction battery)**

Do not carry large amounts of water such as water cooler bottles in the vehicle. If water spills onto the hybrid battery (traction battery), the battery may be damaged. Have the vehicle inspected by your Lexus dealer.

**Hybrid battery (traction battery) air intake vents**

There are air intake vents under the rear seats for the purpose of cooling the hybrid battery (traction battery). If the vents become blocked, the hybrid battery input and output may be restricted, leading to a reduction in hybrid battery (traction battery) output.

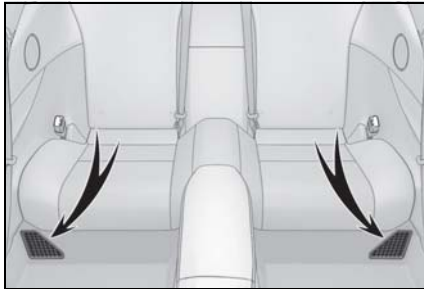

 NOTICE

■ **Hybrid battery (traction battery) air intake vents**

- Make sure not to block the air intake vent with anything, such as a seat cover, plastic cover, or luggage. If the vents become blocked, the hybrid battery (traction battery) input and output may be restricted, leading to a reduction in hybrid battery (traction battery) output and a malfunction.

- When dust etc. has accumulated in the air intake vent, periodically clean it with a vacuum cleaner to prevent the vent from clogging.
- Filters are installed to the air intake vent. When the filters remain noticeably dirty even after cleaning the air intake vent, filter cleaning or replacement is recommended. When cleaning or replacing the filters, contact your Lexus dealer. Refer to P.279 for details on how to clean the filters.
- Do not get water or foreign materials in the air intake vents as this may cause a short circuit and damage the hybrid battery (traction battery).

**Emergency shut off system**

When a certain level of impact is detected by the impact sensor, the emergency shut off system blocks the high voltage current and stops the fuel pump to minimize the risk of electrocution and fuel leakage. If the emergency shut off system activates, your vehicle will not restart. To restart the hybrid system, contact your Lexus dealer.

**Hybrid warning message**

A message is automatically displayed when a malfunction occurs in the hybrid system or an improper operation is attempted.

If a warning message is shown on the multi-information display, read the message and follow the instructions.

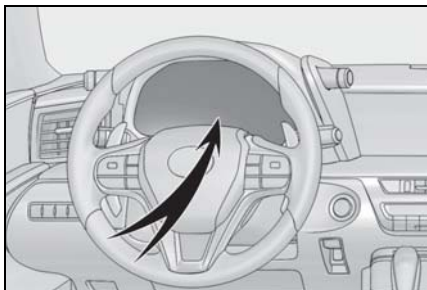

- **If a warning light comes on, a warning message is displayed, or the 12-volt battery is disconnected**

The hybrid system may not start. In this case, try to start the system again. If the "READY" indicator does not come on, contact your Lexus dealer.



### Engine immobilizer system <Immobilizer system>

The vehicle's keys have built-in transponder chips that prevent the engine <hybrid system> from starting if a key has not been previously registered in the vehicle's on-board computer.

Never leave the keys inside the vehicle when you leave the vehicle.

This system is designed to help prevent vehicle theft but does not guarantee absolute security against all vehicle thefts.

### Operating the system

The indicator light flashes after the engine switch <power switch> has been turned off to indicate that the system is operating.

The indicator light stops flashing after

#### ■ Certifications for the engine immobilizer system <immobilizer system>

- ▶ For vehicles sold in the U.S.A., Hawaii and Puerto Rico

FCC ID: NI4TMIMB-3

This device complies with part 15 of the FCC Rules. Operation is subject to the following two conditions: (1) This device may not cause harmful interference, and (2) this device must accept any interference received, including interference that may cause undesired operation.

Changes or modifications not expressly approved by the party responsible for compliance could void the user's authority to operate the equipment.

the engine switch <power switch> has been turned to ACCESSORY or IGNITION ON mode <ON mode> to indicate that the system has been canceled.

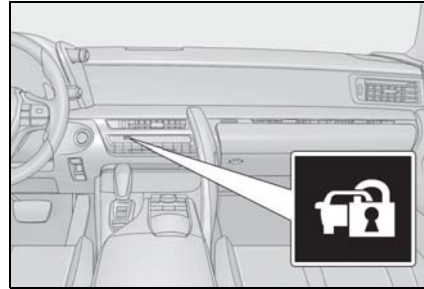

#### ■ System maintenance

The vehicle has a maintenance-free type engine immobilizer system <immobilizer system>.

#### ■ Conditions that may cause the system to malfunction

- If the grip portion of the key is in contact with a metallic object
- If the key is in close proximity to or touching a key registered to the security system (key with a built-in transponder chip) of another vehicle

## 70 1-5. Theft deterrent system

---

- ▶ For vehicles sold in Canada

This device complies with Industry Canada's licence-exempt RSSs. Operation is subject to the following two conditions: (1) This device may not cause interference; and (2) This device must accept any interference, including interference that may cause undesired operation of the device.

Le présent appareil est conforme aux CNR d'Industrie Canada applicables aux appareils radio exempts de licence. L'exploitation est autorisée aux deux conditions suivantes : 1) l'appareil ne doit pas produire de brouillage; 2) l'utilisateur de l'appareil doit accepter tout brouillage radioélectrique subi, même si le brouillage est susceptible d'en compromettre le fonctionnement.

 NOTICE

■ **To ensure the system operates correctly**

Do not modify or remove the system. If modified or removed, the proper operation of the system cannot be guaranteed.

## Alarm

The alarm uses light and sound to give an alert when an intrusion is detected.

The alarm is triggered in the following situations when the alarm is set:

- A locked door or trunk is unlocked or opened in any way other than using the entry function, wireless remote control or mechanical key. (The doors will lock again automatically.)
- The hood is opened.

## Setting/canceling/stopping the alarm system

### ■ Items to check before locking the vehicle

To prevent unexpected triggering of the alarm and vehicle theft, make sure of the following:

- Nobody is in the vehicle.
- The windows are closed before the alarm is set.
- No valuables or other personal items are left in the vehicle.

### ■ Setting

Close the doors, trunk and hood, and lock both side doors. The system will be set automatically after 30 seconds.

The indicator light changes from being on to flashing when the system is set.

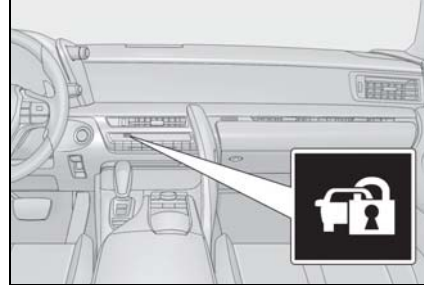

### ■ Canceling or stopping

Do one of the following to deactivate or stop the alarms:

- Unlock the doors or open the trunk.
- Turn the engine switch <power switch> to ACCESSORY or IGNITION ON mode <ON mode>, or start the engine <hybrid system>. (The alarm will be deactivated or stopped after a few seconds.)

### ■ System maintenance

The vehicle has a maintenance-free type alarm system.

### ■ Triggering of the alarm

The alarm may be triggered in the following situations:

(Stopping the alarm deactivates the alarm system.)

- A person inside the vehicle opens a door, the trunk or hood, or unlocks the vehicle using a door lock switch.

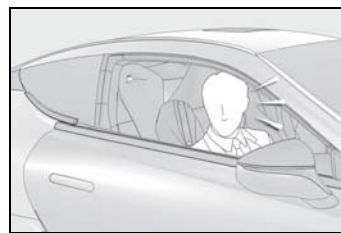

- The 12-volt battery is recharged or replaced when the vehicle is locked. (→P.361)

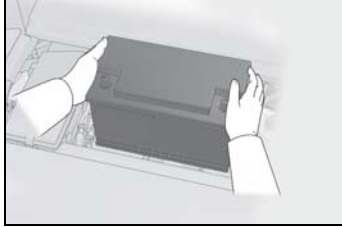

#### ■ Alarm-operated door lock

In the following cases, depending on the situation, the door may automatically lock to prevent improper entry into the vehicle:

- When a person remaining in the vehicle unlocks the door and the alarm is activated.
- While the alarm is activated, a person remaining in the vehicle unlocks the door.
- When recharging or replacing the 12-volt battery



#### NOTICE

#### ■ To ensure the system operates correctly

Do not modify or remove the system. If modified or removed, the proper operation of the system cannot be guaranteed.

### Theft prevention labels (U.S.A.)

These labels are attached to the vehicle to reduce vehicle theft by facilitating the tracing and recovery of parts from stolen vehicles. Do not remove under penalty of law.



**Vehicle status information  
and indicators**

**2**

**73**

**2-1. Instrument cluster**

Warning lights and indicators. **74**

Gauges and meters ..... **80**

Multi-information display..... **84**

Head-up display ..... **90**

Energy monitor/consumption  
screen ..... **95**

**2**

Vehicle status information and indicators

### Warning lights and indicators

The warning lights and indicators on the instrument cluster, center panel and outside rear view mirrors inform the driver of the status of the vehicle's various systems.

### Instrument cluster

For the purpose of explanation, the following illustrations display all warning lights and indicators illuminated.

► LC500













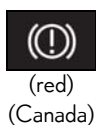

► LC500h













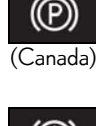

The units used on the meters and some indicators may differ depending on the target region.

**Warning lights**

Warning lights inform the driver of malfunctions in the indicated vehicle systems.

-  Brake system warning light<sup>\*1</sup> (→P.335)
-  Brake system warning light<sup>\*1</sup> (red) (→P.335) (Canada)
-  Charging system warning light<sup>\*2</sup> (→P.335)
-  Low engine oil pressure warning light<sup>\*2</sup> (→P.335)
-  Malfunction indicator lamp<sup>\*1</sup> (→P.336) (U.S.A.)
-  Malfunction indicator lamp<sup>\*1</sup> (→P.336) (Canada)
-  SRS warning light<sup>\*1</sup> (→P.336)
-  ABS warning light<sup>\*1</sup> (→P.336) (U.S.A.)
-  ABS warning light<sup>\*1</sup> (→P.336) (Canada)
-  Electric power steering system warning light<sup>\*1</sup> (red) (→P.336)
-  Electric power steering system warning light<sup>\*1</sup> (yellow) (→P.336)
-  PCS warning light<sup>\*1,3</sup> (→P.337)
-  LKA indicator<sup>\*2</sup> (→P.337) (orange)

-  Slip indicator<sup>\*1</sup> (→P.337)
-  Brake Override System warning light (→P.338)/Drive-Start Control warning light<sup>\*2</sup> (→P.338)
-  Brake hold operated indicator<sup>\*1,3</sup> (→P.338)
-  Parking brake indicator<sup>\*3</sup> (→P.338) (U.S.A.)
-  Parking brake indicator<sup>\*3</sup> (→P.338) (Canada)
-  Brake system warning light<sup>\*1</sup> (yellow) (→P.339)
-  Low fuel level warning light (→P.339)
-  Driver's and front passenger's seat belt reminder light (→P.339)
-  Rear passengers' seat belt reminder lights<sup>\*4</sup> (→P.340)
-  Master warning light<sup>\*1</sup> (→P.340)
-  Tire pressure warning light<sup>\*1,3</sup> (→P.340)
-  High coolant temperature warning light<sup>\*2</sup> (→P.340)
-  Hybrid system overheat warning light<sup>\*2</sup> (→P.341) (if equipped)

<sup>\*1</sup>: These lights turn on when the engine switch <power switch> is turned to IGNITION ON mode <ON mode> to indicate that a system check is being performed. They will turn off after the engine <hybrid system> is started, or

after a few seconds. There may be a malfunction in a system if a light does not come on, or turn off. Have the vehicle inspected by your Lexus dealer.

\*2: This light illuminates on the multi-information display.

\*3: The light flashes to indicate a malfunction.

\*4: This light illuminates on the center panel.

### WARNING





#### If a safety system warning light does not come on

Should a safety system light such as the ABS and SRS warning light not come on when you start the engine <hybrid system>, this could mean that these systems are not available to help protect you in an accident, which could result in death or serious injury. Have the vehicle inspected by your Lexus dealer immediately if this occurs.

## Indicators

The indicators inform the driver of the operating state of the vehicle's various systems.

### ■ Operation indicators

	Turnsignal indicator (→P.167)
	Headlight indicator (→P.173) (U.S.A.)
	Tail light indicator (→P.173) (Canada)
	Headlight high beam indicator (→P.175)
	Automatic High Beam indicator <sup>*1</sup> (→P.176)



Cruise control indicator<sup>\*2</sup>  
(→P.203)



Dynamic radar cruise control indicator<sup>\*2</sup> (→P.203)



Cruise control "SET" indicator<sup>\*2</sup> (→P.203)



(white)

LKA indicator<sup>\*2</sup> (→P.196)



(green)

LKA indicator<sup>\*2</sup> (→P.196)



(orange)

LKA indicator<sup>\*2,3</sup> (→P.196)



(if equipped)

Intuitive parking assist indicator (→P.214)



Slip indicator<sup>\*1,3</sup> (→P.232)



VSC OFF indicator<sup>\*1</sup>  
(→P.233)



OFF

PCS warning light<sup>\*1,4</sup>  
(→P.191)



BSM (Blind Spot Monitor) outside rear view mirror indicators<sup>\*5,6</sup> (→P.220)



BSM (Blind Spot Monitor) indicator (→P.220)



RCTA (Rear Cross Traffic Alert) indicator (→P.220)



HOLD

Brake hold standby indicator<sup>\*1</sup> (→P.171)



HOLD

Brake hold operated indicator<sup>\*1</sup> (→P.171)





Security indicator<sup>\*7</sup> (→P.69, 71)



Smart access system with push-button start indicator<sup>\*2</sup> (→P.146, 149)





 "READY" indicator (→P.149)  
(if equipped)

 Low outside temperature indicator \*2,8 (→P.80)

 Eco Driving Indicator Light \*1  
(if equipped) (→P.78)

 EV indicator (→P.62)  
(if equipped)

 Parking brake indicator  
(U.S.A.) (→P.168)

 Parking brake indicator  
(Canada) (→P.168)

 Snow mode indicator  
(→P.159, 165)

 EV drive mode indicator  
(if equipped) (→P.153)

 "Normal" indicator \*2  
(→P.213)

 "Eco" indicator \*2 (→P.213)

 "Sport S" indicator \*2  
(→P.213)

 "Sport S+" indicator \*2  
(→P.213)

 "Comfort" indicator \*2  
(→P.213)

 "Custom" indicator \*2  
(→P.213)

 "AIR BAG ON/OFF" indicator \*7 (→P.38)  
(U.S.A.)

 "AIR BAG ON/OFF" indicator \*7 (→P.38)  
(Canada)

\*1: These lights turn on when the engine switch <power switch> is turned to IGNITION ON mode <ON mode> to indicate that a system check is being performed. They will turn off after the engine <hybrid system> is started, or after a few seconds. There may be a malfunction in a system if a light does not come on, or turn off. Have the vehicle inspected by your Lexus dealer.

\*2: This light illuminates on the multi-information display.

\*3: The light flashes to indicate that the system is operating.

\*4: The light comes on when the system is turned off.

\*5: In order to confirm operation, the BSM outside rear view mirror indicators illuminate in the following situations:  
When the engine switch <power switch> is turned to IGNITION ON mode <ON mode> while the BSM main switch is turned on.

When the BSM main switch is turned on while the engine switch <power switch> is in IGNITION ON mode <ON mode>.

If the system is functioning correctly, the BSM outside rear view mirror indicators will turn off after a few seconds.

If the BSM outside rear view mirror indicators do not illuminate or do not turn off, there may be a malfunction in the system.

If this occurs, have the vehicle inspected by your Lexus dealer.

- \*6: This light illuminates on the outside rear view mirrors.
- \*7: This light illuminates on the center panel.
- \*8: When the outside temperature is approximately 37°F (3°C) or lower, the indicator will flash for approximately 10 seconds, then stay on.

■ Eco Driving Indicator (LC500)

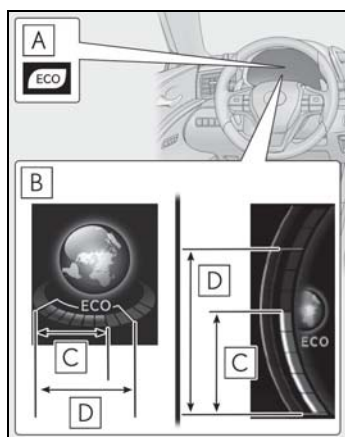

**A** Eco Driving Indicator Light

During Eco-friendly acceleration (Eco driving), the Eco Driving Indicator Light will turn on. When the acceleration exceeds the Zone of Eco driving, or when the vehicle is stopped, the light turns off.

Eco Driving Indicator can be enabled on the multi-information display. (→P.84)

**B** Eco Driving Indicator Zone Display

Suggests the Zone of Eco driving with current Eco driving ratio based on acceleration.

**C** Eco driving ratio based on acceleration

The part that exceeds the Zone of Eco driving illuminates in white.

**D** Zone of Eco driving

Eco Driving Indicator will not operate under the following conditions:

- The shift position is in any position other than D.
- A paddle shift switch is operated.
- Eco Driving Indicator Light: Neither normal mode nor Eco drive mode is selected.  
Eco Driving Indicator Zone Display: Eco drive mode is not selected.
- The vehicle speed is approximately 80 mph (130 km/h) or higher.

■ Hybrid System Indicator (LC500h)



**A** Charge area

Shows regeneration\* status. Regenerated energy will be used to charge the hybrid battery (traction battery).

**B** Hybrid Eco area

Shows that gasoline engine power is not being used very often.

The gasoline engine will automatically stop and restart under various conditions.

**C** Eco area

Shows that the vehicle is being driven in an Eco-friendly manner.

By keeping the indicator needle within Eco area, more Eco-friendly driving can be

achieved.

#### **D** Power area

Shows that an Eco-friendly driving range is being exceeded (during full power driving etc.)

In the following situation, the Hybrid System Indicator does not operate.

\*: When used in this manual, "regeneration" refers to the conversion of energy created by the movement of the vehicle into electrical energy.

- The shift position is in other than D or M.
- The driving mode is other than Eco mode.

#### **■** Motor power display (LC500h)

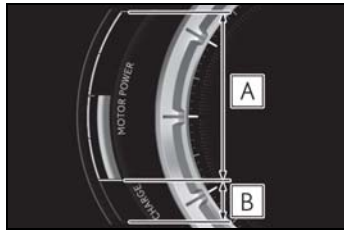

#### **A** Motor power area

Shows that the power of the motor assists the engine.

#### **B** Charge area

Shows regeneration\* status. Regenerated energy will be used to charge the hybrid battery (traction battery).

\*: When used in this manual, "regeneration" refers to the conversion of energy created by the movement of the vehicle into electrical energy.

### Gauges and meters

When the main meter is in the side position, some of the meter displays and the gauge layout will be changed.

### Meter display

► LC500

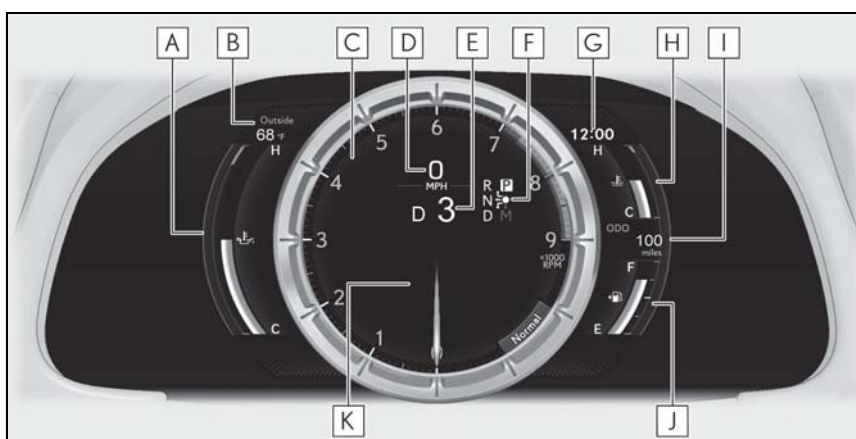

► LC500h

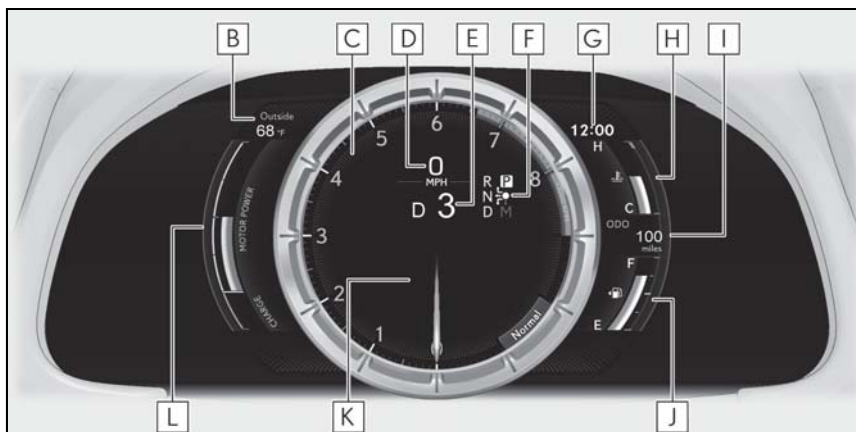

The units used on the meters may differ depending on the target region.

**A** Engine oil temperature gauge/Eco Driving Indicator (LC500)

Displays the engine oil temperature or Eco Driving Indicator (→P.78)

**B** Outside temperature

Displays the outside temperature within the range of -40°F (-40°C) to 122°F (50°C)  
Low outside temperature indicator comes on when the ambient temperature is 37°F (3°C) or lower

**C** Tachometer

Displays the engine speed in revolutions per minute

**D** Speedometer

**E** Shift position/shift range/gear position (→P.155, 161)

**F** Shift position indicator (→P.157, 163)

**G** Clock

Time displayed is linked to the analog clock on the instrument panel. (→P.264)

**H** Engine coolant temperature gauge

Displays the engine coolant temperature

If the engine coolant temperature gauge indicator enters the red zone, a buzzer sounds and the high coolant temperature warning light comes on

**I** Odometer and trip meter display

Odometer:

Displays the total distance the vehicle has been driven

Trip meter:

Displays the distance the vehicle has been driven since the meter was last reset

Trip meters "A" and "B" can be used to record and display different distances independently

**J** Fuel gauge

Displays the quantity of fuel remaining in the tank

**K** Multi-information display

Presents the driver with a variety of vehicle data (→P.84)

Displays warning messages in case of a malfunction (→P.344)

**L** Motor power display/Hybrid System Indicator (LC500h)

Displays the motor power display (→P.79) or Hybrid System Indicator (→P.78)

■ **Rev indicator**

When the engine speed reaches a set speed or the red zone, a ring-shaped indicator will be displayed on the tachometer.

The indicators will be displayed in amber (**A**) when the engine speed reaches a set speed, and in red (**B**)

when the engine speed reaches the red zone. This setting can be enabled on the multi-information display. (→P.89)



#### ■ Rev peak

When the engine speed reaches or exceeds the following, an afterimage of the tachometer will be displayed at the highest engine speed for approximately 1 second.

LC500: 3600 r/min

LC500h: 4000 r/min



#### ■ The meters and display illuminate when

The engine switch <power switch> is in IGNITION ON mode <ON mode>.

#### ■ Variable red zone (LC500)

To help protect the engine, the engine speed is controlled by starting the red zone of the tachometer at different engine speeds ranging from 3700 rpm to 7300 rpm depending on the engine coolant temperature.

Before driving under extremely high load conditions, make sure to sufficiently warm up the engine.



#### ■ Instrument panel brightness adjustment

The brightness of the instrument panel lights is automatically adjusted based on the light sensor detecting how bright the surroundings are.

#### ■ Outside temperature display

- In the following situations, the correct outside temperature may not be displayed, or the display may take longer than normal to change.
  - When stopped, or driving at low speeds (less than 12 mph [20 km/h])
  - When the outside temperature has changed suddenly (at the entrance/exit of a garage, tunnel, etc.)
- When “-” or “E” is displayed, the system may be malfunctioning. Take your vehicle to your Lexus dealer.

#### ■ Speed unit setting for the speedometer

When the speed unit has been changed from the default setting, the vehicle speed in the default unit is also displayed in the meter.



#### ■ Pop-up display

- In some situations, such as when a switch operation is performed, a pop-up display will be temporarily displayed on the multi-information display.
- Some pop-up displays can be set on/off. (→P.88)

### ■ Liquid crystal display

Small spots or light spots may appear on the display. This phenomenon is characteristic of liquid crystal displays, and there is no problem continuing to use the display.

### ■ Customization

The meter display can be customized on the multi-information display. (→P.391)

#### ⚠ NOTICE

#### ■ To prevent damage to the engine and its components

- Do not let the indicator of the tachometer enter the red zone, as it represents the engine speed range which exceeds the maximum safe engine speed.
- In the following situations, the engine may be overheating. In this case, immediately stop the vehicle in a safe place, and check the engine after it has cooled completely. (→P.364, 366)
  - The engine coolant temperature gauge is in the red zone (H).
  - LC500: The engine oil temperature gauge is in the red zone (H).

### Changing between the odometer and trip meter

The odometer and trip meter displays can be switched. When the trip meter is displayed, pressing and holding the button will reset the trip meter.

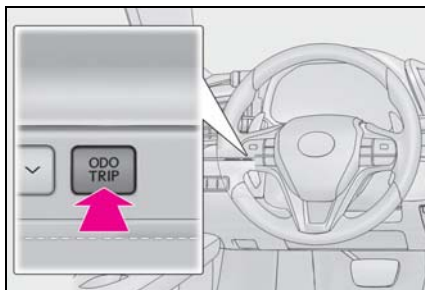

### Changing the Instrument panel light brightness

The brightness of the instrument panel lights can be adjusted.

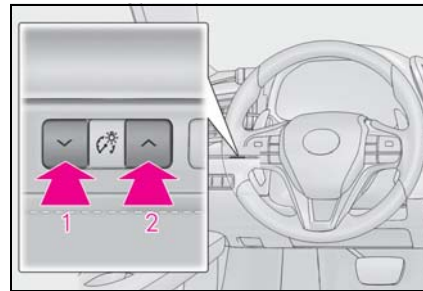

- 1 Darker
- 2 Brighter

### ■ Instrument panel brightness adjustment

The instrument panel brightness levels when the tail lights are on and off can be adjusted individually. However, when the surroundings are bright (daytime, etc.), turning on the tail lights will not change the instrument panel brightness.

### Changing the display

The display can be switched between the center and side positions.

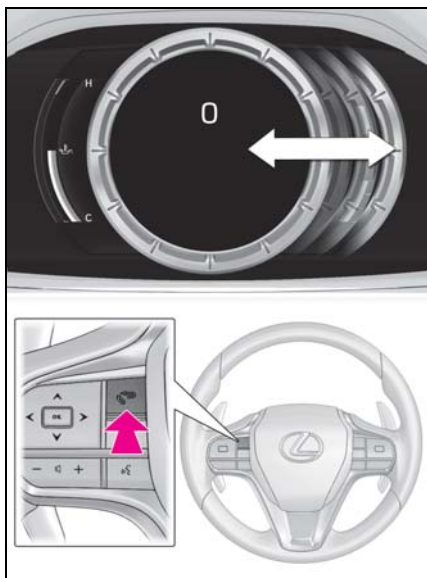

## Multi-information display

### Display and menu icons

#### ■ Display

- ▶ When the main meter is in the center position

Displays various drive information on the main meter.





Some of the contents which are displayed when the main meter is in the side position cannot be displayed. (→P.85)

- ▶ When the main meter is in the side position

Selecting a menu icon displays a variety of vehicle data or allows vehicle settings to be customized.



#### ■ Menu icons

-  Drive information
-  Navigation system-linked display
-  Audio system-linked display
-  Driving assist system information





Warning message display



Settings display

### ■ Opening image display

When the engine switch <power switch> is in ACCESSORY mode or IGNITION ON mode <ON mode>, the opening image is displayed on the multi-information display. While the opening image is being displayed, the meter display cannot be changed even if the drive mode is changed. When the start-up display is finished, the meter display for the currently selected mode will be displayed.

### ■ When disconnecting and reconnecting 12-volt battery terminals

Record of the maximum G-forces will be reset.

### ■ Liquid crystal display

→P.83



## WARNING

### ■ Caution for use while driving

- When operating the multi-information display while driving, pay extra attention to the safety of the area around the vehicle.
- Do not look continuously at the multi-information display while driving as you may fail to see pedestrians, objects on the road, etc. ahead of the vehicle.

### ■ The information display at low temperatures

Allow the interior of the vehicle to warm up before using the liquid crystal information display. At extremely low temperatures, the information display monitor may respond slowly, and display changes may be delayed.

For example, there is a lag between the driver's shifting and the new gear number appearing on the display. This lag could cause the driver to downshift again, causing rapid and excessive engine braking and possibly an accident resulting in death or injury.

### Changing the meter display

The multi-information display is operated using the meter control switches.

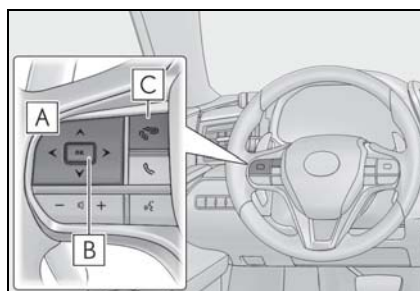





- A** < / > : Switch menu  
 ▲ / ▼ : Change displayed content, scroll up/down the screen and move the cursor up/down
- B** Press: Enter/Set  
 Press and hold: Reset
- C** Return to the previous screen and move the main meter

### Drive information

#### ■ Content of drive information

Select to display various drive data.

Up to 2 of the following items can be selected.

Items displayed can be switched by pressing  or  of the meter control switches to select  and pressing  or .

- **Current fuel consumption**<sup>\*1</sup>

Displays the current rate of fuel consumption

- **Average fuel economy (after reset<sup>\*2</sup>/after start/after refuel)**<sup>\*1</sup>

Displays the average fuel consumption since the function was reset, the engine <hybrid system> was started, and the vehicle was refueled, respectively

Use the displayed average fuel consumption as a reference.

- **Average speed (after reset<sup>\*2</sup>/after start)**<sup>\*1</sup>

Displays the average vehicle speed since the function was reset and the engine <hybrid system> was started, respectively

- **Elapsed time (after reset<sup>\*2</sup>/after start)**<sup>\*1</sup>

Displays the elapsed time since the function was reset and the engine <hybrid system> was started, respectively

- **Distance (range/after start)**<sup>\*1</sup>

Displays the estimated maximum distance that can be driven with the quantity of fuel remaining and the distance driven after the engine <hybrid system> was started respectively.

- This distance is computed based on your average fuel consumption. As a result, the actual distance that can be driven

may differ from that displayed.

- When only a small amount of fuel is added to the tank, the display may not be updated.  
When refueling, turn the engine switch <power switch> off. If the vehicle is refueled without turning the engine switch <power switch> off, the display may not be updated.

<sup>\*1</sup>: Displayed when the item is set in "Drive Info 1" and "Drive Info 2".

<sup>\*2</sup>: The function can be reset by pressing "OK" of the meter control switches for longer than 1 second when the item to reset is displayed.

If there is more than one item that can be reset, the item selection screen will appear.

- **Eco Driving Indicator/engine oil temperature gauge (LC500)**

→P.78, 80

- **Hybrid System Indicator/motor power display (LC500h)**

→P.78

- **Energy monitor (LC500h)**

→P.95

- **Tire pressure**

→P.303

- **Gear positions**

Displays the current shift range or gear position when the shift position is in D or M.

- **Units**

The units of measure used can be changed while driving.

Unlike the units setting performed on the settings display, the units setting performed on the drive information menu can

be changed while driving.

■ **G-force**

Displays lateral G-forces on the vehicle

● **Reading the display**

- Normal display

Displays the following on the multi-information display

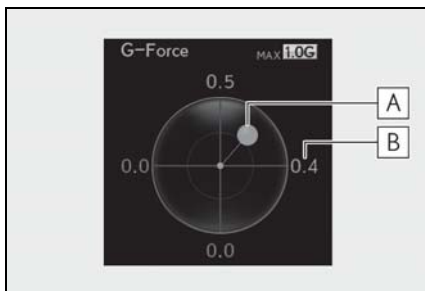

- A** Acceleration G-force on the vehicle
- B** Current G-force value (analyzed value of front/rear and left/right G-forces)

- Advanced display

Displays the following on the main meter and multi-information display

Multi-information display:

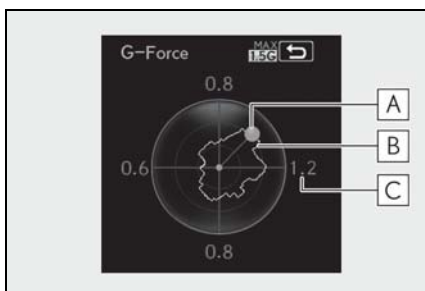

- A** Acceleration G-force on the vehicle
- B** Record of the maximum G-forces
- C** Value of the maximum G-force since display reset (analyzed value of

front/rear and left/right G-forces)

This display is intended for use as a guideline. Depending on factors such as the road surface condition, temperature and vehicle speed, the display may not show the actual condition of the vehicle.

Main meter:

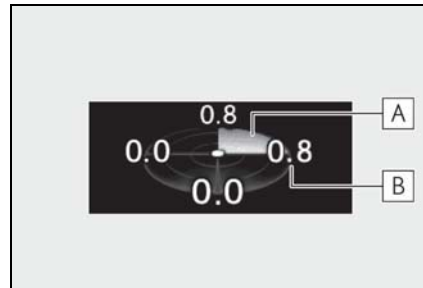

- A** G-force direction
- B** Current G-force value (analyzed value of front/rear and left/right G-forces)

This display is intended for use as a guideline. Depending on factors such as the road surface condition, temperature and vehicle speed, the display may not show the actual condition of the vehicle.

● **Switching the display**

To switch to advanced display, press "OK".

To return to normal display, press "OK".

- **Resetting the record of maximum G-forces**

With the record of maximum G-forces displayed, press and hold "OK" to reset the display.

- **Peak hold function (advanced display only)**

If lateral G-forces of 0.5 G or greater are generated, the G-force value displayed on the main meter will turn yellow and be held for 3 seconds.

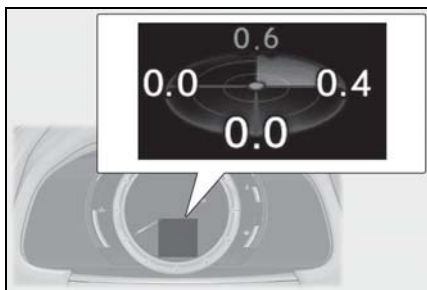

#### ■ Rear wing position (if equipped)

Displays the raised/retracted state of the active rear wing

#### ■ LKA (Lane-Keeping Assist) vehicle sway warning

→P.197

#### ■ Display off

A blank screen is displayed

### Navigation system-linked display

Select to display the following navigation system-linked information.

- Route guidance
- Compass display

### Audio system-linked display

Select to enable selection of an audio source or track on the meter using the meter control switches.

### Driving assist system information

Select to display the dynamic radar cruise control with full-speed range/LKA (Lane-Keeping Assist) information, when the system is used.

### Warning message display

Select to display warning messages and measures to be taken if a malfunction is detected. (→P.344)

### Settings display

Select to change the meter display settings.

#### ■ Language

Select to change the language on the display.

#### ■ Units

Select to change the unit of measure for fuel consumption.

#### ■ Eco Driving Indicator Light (LC500)

Select to activate/deactivate the Eco Driving Indicator Light.

#### ■ EV indicator (LC500h)

Select to activate/deactivate the EV indicator.

#### ■ Drive information 1/Drive information 2

Select to select up to 2 items that will be displayed on the "Drive Info 1" screen and "Drive Info 2" screen respectively. (→P.85)

#### ■ Pop-up display

Select to set the following pop-up displays, which may appear in some situations, on/off.

- Route guidance display of the navigation system-linked system
- Making call display of the hands-free phone system

- Audio system operation display
- Voice recognition display
- Instrument panel brightness adjustment display

#### ■ Ring position memory

Select to change the meter ring position when the engine <hybrid system> is started.

The position before the engine <hybrid system> is stopped or the center position can be selected.

#### ■ Accent color

Select to change the accent color on the screen, such as the cursor color.

#### ■ Rev indicator

Select to set the rev indicator on/off.

When set to on, proceed to select the engine speed at which the rev indicator will be displayed.

#### ■ Rev peak

Select to set the rev peak on/off.

#### ■ Clock

Select to switch between 12-hour display and 24-hour display.

#### ■ Initialization

Select to reset the meter display settings.

#### ■ Suspension of the settings display

In the following situations, operation of the settings display will be temporarily suspended.

- When a warning message appears on the multi-information display
- When the vehicle begins to move

#### ■ Customization

The settings can be changed on  of the multi-information display.

- Settings of the driving assist systems (→P.391)
- Vehicle settings (→P.91, 283, 306, 308, 391)

#### ⚠ WARNING

##### ■ Cautions during setting up the display

As the engine <hybrid system> needs to be running <operating> during setting up the display, ensure that the vehicle is parked in a place with adequate ventilation. In a closed area such as a garage, exhaust gases including harmful carbon monoxide (CO) may collect and enter the vehicle. This may lead to death or a serious health hazard.

#### ⚠ NOTICE

##### ■ While setting up the display

To prevent 12-volt battery discharge, ensure that the engine is running <hybrid system is operating> while setting up the display features.

#### Suggestion function

Displays suggestions to the driver in the following situations. For some suggestions, a response to a displayed suggestion can be selected. To select a response, use the meter control switches.

#### ■ Suggestion to turn on the headlights

If the headlight switch is in other than  or AUTO position, and the vehicle speed is 3 mph (5 km/h) or higher for a certain amount of time when the sur-

roundings are dark, a suggestion message will be displayed.

#### ■ Suggestion to turn off the headlights

If the headlights are left on for a certain amount of time after the engine switch <power switch> has been turned off, a suggestion message will be displayed asking if you wish to turn the headlights off.

When the headlight switch is in the "AUTO" position: To turn the headlights off, select "Yes".

If a front door is opened after the engine switch <power switch> is turned off, this suggestion message will not be displayed.

#### ■ Suggestion to unlock the power windows

If it is attempt to close the passenger's side window using the power window switch on the driver's door, a suggestion message will be displayed.

#### ■ Customization

The suggestion function can be turned on/off. (Customizable features: →P.391)

## Head-up display\*

\*: If equipped

The head-up display is linked to the meters and navigation system and projects a variety of information in front of the driver, such as the current vehicle speed and route guidance to a set destination.

## System components

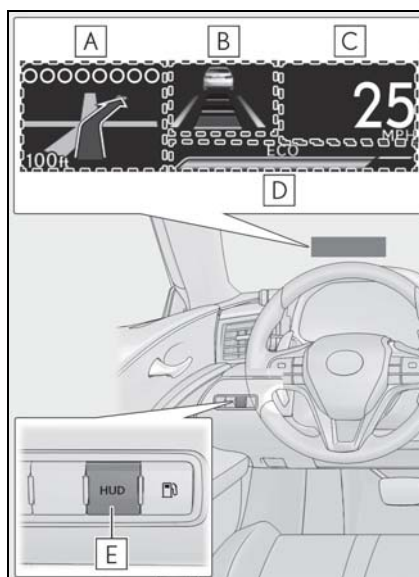

### A Navigation system-linked display area

Displays the following items, which are linked to the navigation system:

- Speed limit
- Street name
- Route guidance to destination
- Compass

### B Driving assist system status display area

Displays the current shift position, and shift

range/gear position, or the operational status of the following systems:



- Pre-collision warning (Pre-Collision System) (→P.189)
- Dynamic radar cruise control with full-speed range (→P.203)
- LKA (Lane-Keeping Assist) (→P.196)
- Intuitive parking assist (→P.214)

Displayed content is the same as that displayed on the multi-information display. For details, refer to the explanations of each system.

#### **C** Vehicle speed display

#### **D** Information display area (→P.93)

Displays the following items:

- Warning/message
-   icon (→P.93)
- Audio system operation status
- Dynamic radar cruise control with full-speed range status (→P.203)
- Hands-free system status (→P.93)
- Eco Driving Indicator/tachometer (→P.94) (LC500)
- Hybrid System Indicator/motor power display/tachometer (→P.94) (LC500h)

#### **E** HUD (Head-up display) switch

### Using the head-up display

#### ■ Enabling/Disabling the head-up display

Pressing the switch turns the head-up display on/off.

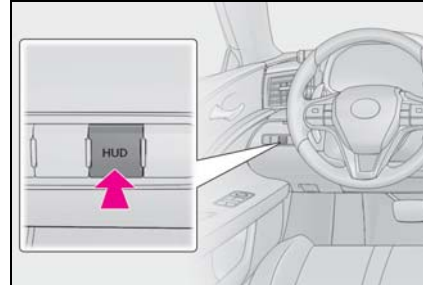

#### ■ Changing settings of the head-up display

Select  on the multi-information display (→P.84) to change the following settings:

- Display brightness/position

Select to adjust the brightness and position of the head-up display.

- Eco Driving Indicator/tachometer (LC500)

Select to display Eco Driving Indicator, tachometer or no content.

- Hybrid System Indicator/motor power display/tachometer (LC500h)

Select to display Hybrid System Indicator, tachometer or no content.

Motor power display can be displayed when Hybrid System Indicator is selected while the driving mode (→P.213) is other than the Eco drive mode.

- Display content

Select to enable/disable the following items:

- Route guidance to destination
- Driving assist system status
- Compass
- Audio system operation status
- Display angle

Select to adjust the angle of the head-up display.

#### ■ Head-up display

- The head-up display may seem dark and hard to see when viewed through sunglasses, especially polarized sunglasses. Adjust the brightness of the head-up display or remove your sunglasses.
- When the head-up display is turned off, it will remain off even if the engine switch <power switch> is turned to ACCESSORY mode or IGNITION ON mode <ON mode> after the engine switch <power switch> has been turned off.
- The startup image will be displayed on the head-up display after the engine switch <power switch> has been turned to IGNITION ON mode <ON mode> while the head-up display switch is set to on.

#### ■ Display brightness

The brightness of the head-up display can be adjusted on  of the multi-information display. Also, it is automatically adjusted according to the ambient brightness.

#### ■ Head-up display automatic position adjustment

If the display position is recorded into memory, the head-up display will be automatically adjusted to the desired position. (→P.122)

#### ■ When the 12-volt battery is disconnected

The customize settings of the head-up display will be reset.

#### ■ Customization

Settings (e.g. display) can be changed. (Customizable features: →P.391)

### ⚠ WARNING

#### ■ Before using the head-up display

- Check that the position and brightness of the head-up display image does not interfere with safe driving. Incorrect adjustment of the image's position or brightness may obstruct the driver's view and lead to an accident, resulting in death or serious injury.
- Do not continuously look at the head-up display while driving as you may fail to see pedestrians, objects on the road, etc. ahead of the vehicle.

#### ■ Caution for changing settings of the head-up display

As the engine needs to be running <hybrid system needs to be operating> while changing the settings of the head-up display, ensure that the vehicle is parked in a place with adequate ventilation. In a closed area such as a garage, exhaust gases including harmful carbon monoxide (CO) may collect and enter the vehicle. This may lead to death or a serious health hazard.

### ⚠ NOTICE

#### ■ To prevent damage to components

- Do not place any drinks near the head-up display projector. If the projector gets wet, electrical malfunctions may result.



- Do not place anything on or put stickers onto the head-up display projector. Doing so could interrupt head-up display indications.



 **NOTICE**

- Do not touch the inside of the head-up display projector or thrust sharp edges or the like into the projector. Doing so could cause mechanical malfunctions.

**When changing the settings of the head-up display**

To prevent battery discharge, ensure that the engine is running while changing the settings of the head-up display.

### Information display area

Displays the following items in the appropriate situation:

#### ■ Warning/message

Displays the following warning/messages:

- Master warning message
- Notification message (Dynamic radar cruise control with full-speed range)
- Other messages

#### ■ icons

Displays the following multi-information display linked icons:

: Master warning icon

Displayed when a warning message is displayed on the multi-information display. (→P.344)

: Information icon

Displayed when a suggestion/advice pop-up display is displayed on the multi-information display. (→P.89)

#### ■ Hands-free system status

Displayed when the hands-free system is operated.

#### ■ Audio system operation status

Displayed when the audio system is operated.

#### ■ Eco Driving Indicator/tachometer (LC500)

Displays either of Eco Driving Indicator or the tachometer.

#### ■ Hybrid System Indicator/motor power display/tachometer (LC500h)

Displays either of Hybrid System Indicator or the tachometer.

Motor power display can be displayed when Hybrid System Indicator is selected while the driving mode (→P.213) is other than the Eco drive mode.

### Navigation system-linked display area

Displays the following items which are linked to the navigation system:

#### ■ Speed limit

Displays the speed limit on the current road.

#### ■ Street name

When the navigation system is performing route guidance, the name of the next street will be displayed on the top of the display area.

#### ■ Route guidance to destination

Displayed when the navigation system is performing route guidance. When approaching an intersection, an arrow will be displayed to indicate the sug-

gested direction of travel.

■ **Compass**

Displays the direction of travel.

■ **Street name display**

Only street names which are included in the map data will be displayed.

**Eco Driving Indicator/tachometer (LC500)**

■ **Eco Driving Indicator**

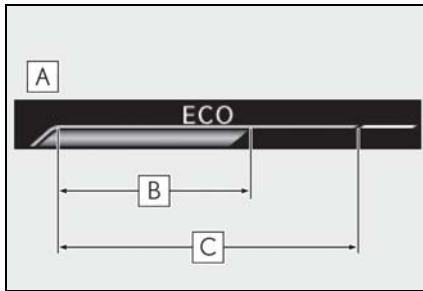

**A** Eco Driving Indicator Zone Display

**B** Eco driving ratio based on acceleration

**C** Zone of Eco driving

Displayed content is the same as that displayed on the multi-information display (Eco Driving Indicator). For details, refer to P.78.

■ **Tachometer**

Displays the engine speed in revolutions per minute.

**Hybrid System Indicator/motor power display/tachometer (LC500h)**

■ **Hybrid System Indicator**

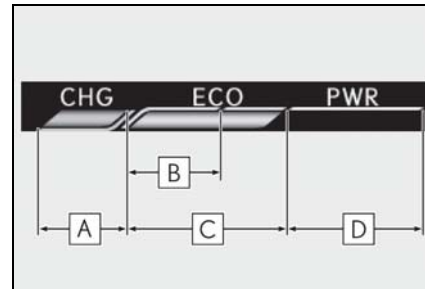

**A** Charge area

**B** Hybrid Eco area

**C** Eco area

**D** Power area

Displayed content is the same as that displayed on the meter (Hybrid System Indicator). For details, refer to P.78.

■ **Motor power display**

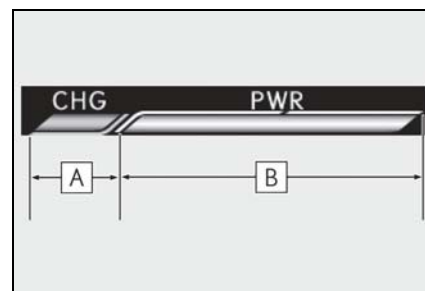

**A** Charge area

**B** Power area

Displayed content is the same as that displayed on the meter (Motor power display). For details, refer to P.79.

Motor power display can be displayed when Hybrid System Indicator is selected

while the driving mode (→P.213) is other than the Eco drive mode.

#### ■ Tachometer

Displays the engine speed in revolutions per minute.

### Energy monitor\* /consumption screen

\*: If equipped

You can view the status of your hybrid system (LC500h) and fuel consumption information on the multi-information display and Center Display.

The energy monitor or consumption screen can be displayed on the side display.

2

Vehicle status information and indicators

### System components

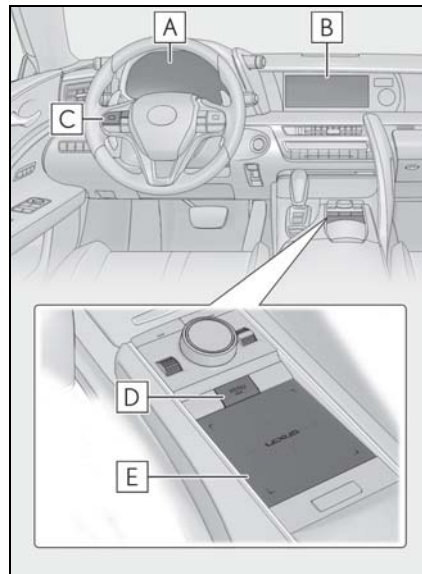

- A** Multi-information display
- B** Center Display
- C** Meter control switches
- D** "MENU" button
- E** Touchpad





**Energy monitor (LC500h)**

▶ Center Display



Press the “MENU” button on the Remote Touch, and then select  on the menu screen.

If the “Trip Information” or “History” screen is displayed, select “Energy”.



▶ Multi-information display

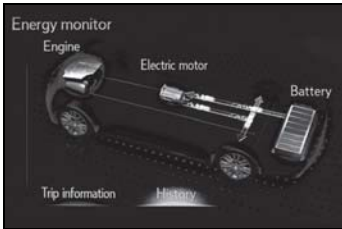





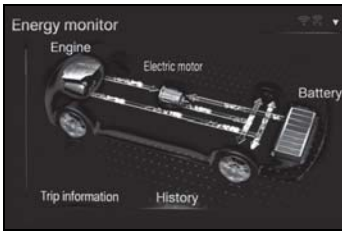

Press  or  of the meter control switches and select , and then press  or  to select the energy monitor display.

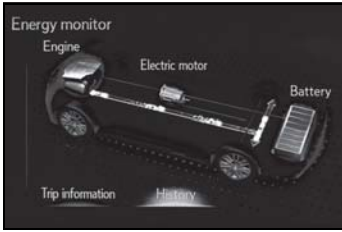
When the vehicle is powered by the electric motor (traction motor)

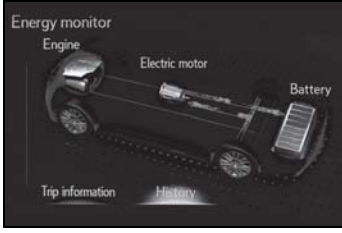
<p>Center Display</p> 	<p>Multi-information display</p> 
--	--

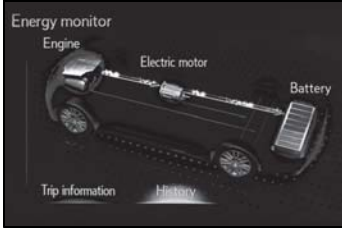
When the vehicle is powered by both the gasoline engine and the electric motor (traction motor)

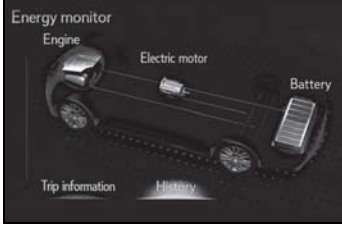
<p>Center Display</p> 	<p>Multi-information display</p> 
---	---

When the vehicle is powered by the gasoline engine	
<p>Center Display</p> 	<p>Multi-information display</p> 
When the vehicle is charging the hybrid battery (traction battery)	
<p>Center Display</p> 	<p>Multi-information display</p> 
<p>Center Display</p> 	<p>Multi-information display</p> 
When there is no energy flow	
<p>Center Display</p> 	<p>Multi-information display</p> 

These images are examples only, and may vary slightly from actual conditions.

### ■ Hybrid battery (traction battery) status

#### ► Center Display

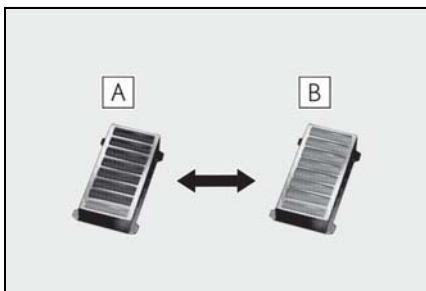

**A** Low

**B** High

#### ► Multi-information display

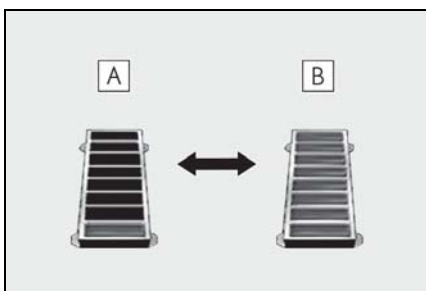

**A** Low

**B** High

These images are examples only, and may vary slightly from actual conditions.

### Consumption

Press the “MENU” button on the Remote Touch, then select **i** on the screen, and then select “Trip Information” or “History”.

#### ■ Trip information

If a screen other than “Trip Information” is displayed, select “Trip Information”.

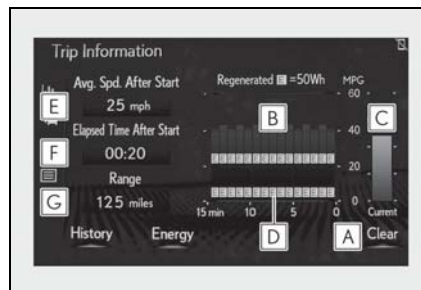

**A** Resetting the consumption data

**B** Fuel consumption in the past 15 minutes

**C** Current fuel consumption

**D** Regenerated energy in the past 15 minutes (LC500h)

One symbol indicates 50 Wh. Up to 5 symbols are shown.

**E** Average vehicle speed since the engine <hybrid system> was started.

**F** Elapsed time since the engine <hybrid system> was started.

**G** Cruising range

Average fuel consumption for the past 15 minutes is divided by color into past averages and averages attained since the engine switch <power switch> was last turned to IGNITION ON mode <ON mode>. Use the displayed average fuel consumption as a reference.

The image is an example only, and may vary slightly from actual conditions.

#### ■ History

If a screen other than “History” is displayed, select “History”.

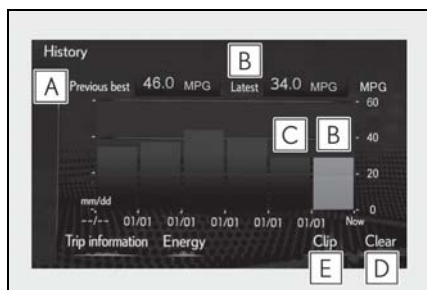

- A** Best recorded fuel consumption
- B** Latest fuel consumption
- C** Previous fuel consumption record
- D** Resetting the history data
- E** Updating the latest fuel consumption data

The average fuel consumption history is divided by color into past averages and the average fuel consumption since the last updated. Use the displayed average fuel consumption as a reference.

The image is an example only, and may vary slightly from actual conditions.

#### ■ Updating the history data

Update the latest fuel consumption by selecting "Clip" to measure the current fuel consumption again.

#### ■ Resetting the data

The fuel consumption data can be deleted by selecting "Clear".

#### ■ Cruising range

Displays the estimated maximum distance that can be driven with the quantity of fuel remaining.

This distance is computed based on your average fuel consumption. As a result, the actual distance that can be driven may differ from that displayed.

### Using the side display

Display the vehicle information on the side display (→P.244), and then select **<** or **>** to display the desired screen.

#### ■ Trip information (type A)

Displays the average fuel consumption and regenerated energy for the past 10 minutes in 1 minute intervals (LC500h), as well as the cruising range.



The image is an example only, and may vary slightly from actual conditions.

Use the displayed average fuel consumption as a reference.

#### ■ Trip information (type B)

Displays the cruising range, latest fuel consumption and the amount of time elapsed since the engine <hybrid system> was started.

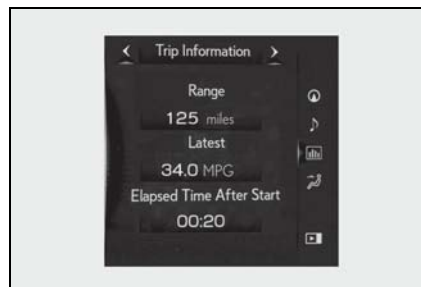

The image is an example only, and may vary slightly from actual conditions.

Use the displayed average fuel consumption as a reference.

■ **History**

Displays the average fuel consumption, last average fuel consumption and highest fuel consumption.



The image is an example only, and may vary slightly from actual conditions.

Use the displayed average fuel consumption as a reference.

■ **Energy monitor (LC500h)**

Displays the hybrid system operation and energy recovery states.

Displayed content is the same as that displayed on the multi-information display. (→P.96)



The image is an example only, and may vary slightly from actual conditions.



- 3-1. Key information
  - Keys ..... 102
- 3-2. Opening, closing and locking the doors and trunk
  - Doors..... 106
  - Trunk..... 110
  - Smart access system with push-button start..... 113
- 3-3. Adjusting the seats
  - Front seats..... 120
  - Driving position memory ..... 122
  - Head restraints..... 125
- 3-4. Adjusting the steering wheel and mirrors
  - Steering wheel..... 127
  - Inside rear view mirror..... 128
  - Outside rear view mirrors..... 129
- 3-5. Opening and closing the windows
  - Power windows..... 132

## Keys

### Key types

The following keys are provided with the vehicle.

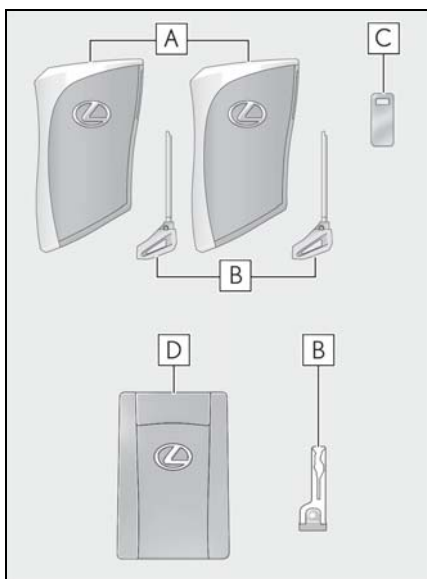

#### A Electronic keys

- Operating the smart access system with push-button start (→P.113)
- Operating the wireless remote control function

#### B Mechanical keys

#### C Key number plate

#### D Card key (electronic key) (if equipped)

Operating the smart entry & start system (→P.113)

#### ■ Card key (if equipped)

- The card key is not waterproof.
- The mechanical key that is stored inside the card key should be used only if a problem arises, such as when the card

key does not operate properly.

- If it is difficult to take out the mechanical key, push down the release button using a pen tip etc. If it is still difficult to pull it out, use a coin etc. (→P.104)
- To store the mechanical key in the card key, insert it while pressing the release button.

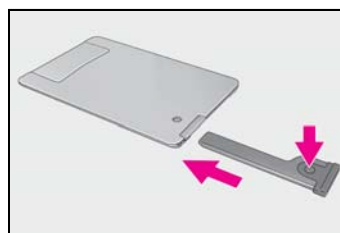

- If the battery cover is not installed and the battery falls out or if the battery was removed because the key got wet, reinstall the battery with the positive terminal facing the Lexus emblem.

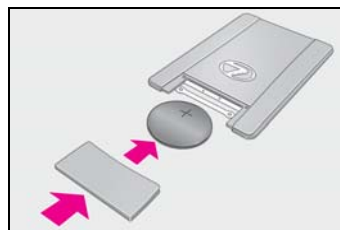

#### ■ When riding in an aircraft

When bringing an electronic key onto an aircraft, make sure you do not press any buttons on the electronic key while inside the aircraft cabin. If you are carrying an electronic key in your bag etc., ensure that the buttons are not likely to be pressed accidentally. Pressing a button may cause the electronic key to emit radio waves that could interfere with the operation of the aircraft.

#### ■ Electronic key battery depletion

- The standard battery life is 1 to 2 years. (The card key battery life is about a year and a half.)
- If the battery becomes low, an alarm will sound in the cabin when the engine <hybrid system> is stopped.
- As the electronic key always receives

radio waves, the battery will become depleted even if the electronic key is not used. The following symptoms indicate that the electronic key battery may be depleted. Replace the battery when necessary. (→P.318)

- The smart access system with push-button start or the wireless remote control does not operate.
- The detection area becomes smaller.
- The LED indicator on the key surface does not turn on.
- To avoid serious deterioration, do not leave the electronic key within 3 ft. (1 m) of the following electrical appliances that produce a magnetic field:
  - TVs
  - Personal computers
  - Cellular phones, cordless phones and battery chargers
  - Recharging cellular phones or cordless phones
  - Table lamps
  - Induction cookers

■ **Replacing the battery**

→P.318

■ **Confirmation of the registered key number**

The number of keys already registered to the vehicle can be confirmed. Ask your Lexus dealer for details.

■ **If “A New Key has been Registered Contact Your Dealer for Details” is shown on the multi-information display**

This message will be displayed each time the driver’s door is opened when the doors are unlocked from the outside for approximately 10 days after a new electronic key has been registered.

If this message is displayed but you have not had a new electronic key registered, ask your Lexus dealer to check if an unknown electronic key (other than those in your possession) has been registered.

 <b>NOTICE</b>
<p>■ <b>To prevent key damage</b></p> <ul style="list-style-type: none"> <li>● Do not drop the keys, subject them to strong shocks or bend them.</li> </ul>

- Do not expose the keys to high temperatures for long periods of time.
- Do not get the keys wet or wash them in an ultrasonic washer etc.
- Do not attach metallic or magnetic materials to the keys or place the keys close to such materials.
- Do not disassemble the keys.
- Do not attach a sticker or anything else to the surface of the electronic key.
- Do not place the keys near objects that produce magnetic fields, such as TVs, audio systems and induction cookers.
- Do not place the keys near medical electrical equipment such as low-frequency therapy equipment or microwave therapy equipment, and do not receive medical attention with the keys on your person.

■ **Carrying the electronic key on your person**

Carry the electronic key 3.9 in. (10 cm) or more away from electric appliances that are turned on. Radio waves emitted from electric appliances within 3.9 in. (10 cm) of the electronic key may interfere with the key, causing the key to not function properly.

■ **In case of a smart access system with push-button start malfunction or other key-related problems**

→P.355

■ **When an electronic key is lost**

→P.354

■ **Handling the card key (if equipped)**

- Do not apply excess force when inserting the mechanical key into the card key. Doing so may damage the card key.

 NOTICE

- If the battery or card key terminals get wet, the battery may corrode and the card key may stop working. If the key is dropped into water, or if drinking water, etc. is spilled on the key, immediately remove the battery cover and wipe the battery and terminals. (To remove the battery cover, lightly grasp and pull it.) If the battery is corroded, have your Lexus dealer replace the battery.
- Do not crush the battery cover or use a screwdriver to remove the battery cover. Forcibly removing the battery cover may bend or damage the key.
- If the battery cover is frequently removed, the battery cover may become loose.
- When installing the battery, make sure to check the direction of the battery. Installing the battery in the wrong direction may cause the battery to deplete rapidly.
- The surface of the card key may be damaged, or its coating may peel off in the following situations:
  - The card key is carried together with hard objects, such as coins and keys.
  - The card key is scraped with a sharp object, such as the tip of a mechanical pencil.
  - The surface of the card key is wiped with thinner or benzene.

**Wireless remote control**

The electronic keys are equipped with the following wireless remote control:

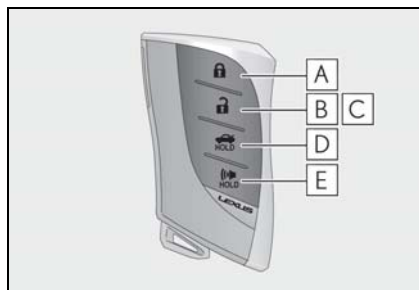

- A** Locks the doors (→P.106)
- B** Unlocks the doors (→P.106)
- C** Opens the windows\* (→P.106)
- D** Opens the trunk (→P.111)
- E** Sounds the alarm (→P.104)

\* : This setting must be customized at your Lexus dealer.

**■ Theft deterrent panic mode**

When  is pressed for longer than about one second, an alarm will sound intermittently and the vehicle lights will flash to deter any person from trying to break into or damage your vehicle.

To stop the alarm, press any button on the electronic key.

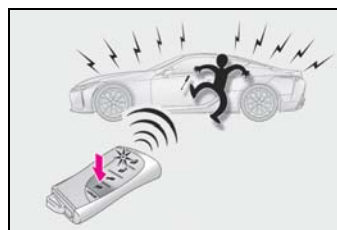

**Using the mechanical key**

To take out the mechanical key, push the release button and take the key out.

The mechanical key can only be inserted in one direction, as the key only has grooves on one side. If the key cannot be inserted in

a lock cylinder, turn it over and re-attempt to insert it.

After using the mechanical key, store it in the electronic key. Carry the mechanical key together with the electronic key. If the electronic key battery is depleted or the entry function does not operate properly, you will need the mechanical key. (→P.355)

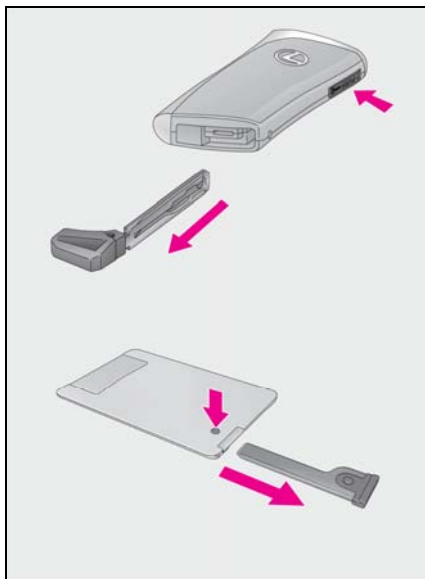

■ **When required to leave the vehicle's key with a parking attendant**

Turn the trunk opener main switch off and lock the glove box (→P.260) as circumstances demand.

Remove the mechanical key for your own use and provide the attendant with the electronic key only.

■ **If you lose your mechanical keys**

→P.354

■ **If a wrong key is used**

The key cylinder rotates freely, isolated from the internal mechanism.

## Doors

### Unlocking and locking the doors from the outside

#### ■ Smart access system with push-button start

Carry the electronic key to enable this function.

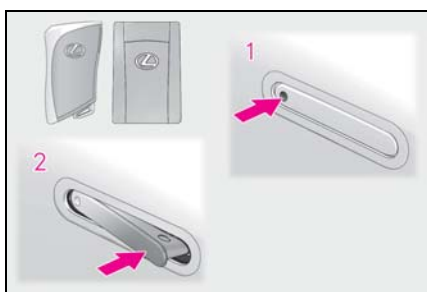

- 1 Push the depression on the front edge of the driver's door handle to unlock the door. Push the depression on the front edge of the passenger's door handle to unlock both side doors.\*

The outside door handles will be extended. The extended outside door handles are automatically retracted in approximately 60 seconds.

The doors cannot be unlocked for 3 seconds after the doors are locked.

\*: The door unlock settings can be changed.

- 2 Push the rear edge of the extended door handle to lock the doors.

If the outside door handles are extended, they will be retracted.

After locking the doors, check that the door is securely locked with the door lock indicator (→P.108).

#### ■ Wireless remote control

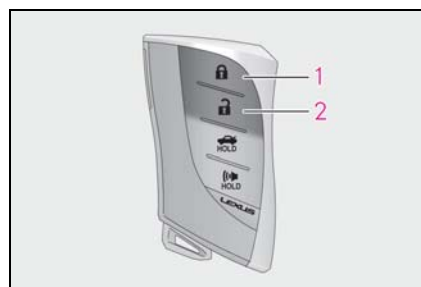

- 1 Locks both side doors

The outside door handles will be retracted if they have been extended. After locking the doors, check that the door is securely locked with the door lock indicator (→P.108).

- 2 Unlocks both side doors

Pressing the button unlocks the driver's door. Pressing the button again within 5 seconds unlocks the other door. The outside door handles will be extended.

Press and hold to open the windows.\*

\*: This setting must be customized at your Lexus dealer.

#### ■ Side window open/close function linked to door operation

When a door is opened, its window opens slightly. When a door is closed, its window closes completely.

#### ■ Speed-linked outside door handle retracting function





When the vehicle speed reaches 6 mph (10 km/h), the outside door handles will be retracted.

#### ■ To extend the outside door handles retracted automatically



The outside door handle can be extended by pushing the depression on the front edge of it. To lock the doors, push the rear edge of the outside door handle after extending it once.

■ **Switching the door unlock function**

It is possible to set which doors the entry function unlocks using the wireless remote control.

- 1 Turn the engine switch <power switch> off.
- 2 When the indicator light on the key surface is not on, press and hold ,  or  for approximately 5 seconds while pressing and holding .

The setting changes each time an operation is performed, as shown below. (When changing the setting continuously, release the buttons, wait for at least 5 seconds, and repeat step 2.)

Multi-information display/Beep	Unlocking function
 Exterior: Beeps 3 times Interior: Pings once	Pushing the depression on the front edge of the driver's door handle unlocks only the driver's door.  Pushing the depression on the front edge of the passenger's door handle unlocks both side doors.
 Exterior: Beeps twice Interior: Pings once	Pushing the depression on the front edge of either door handle unlocks both side doors.

To prevent unintended triggering of the alarm, unlock the doors using the wireless remote control and open and close a door once after the settings have been changed. (If a door is not opened within 60 seconds after  is pressed, the doors will be locked again and the alarm will automati-

cally be set.)

In a case that the alarm is triggered, immediately stop the alarm. (→P.71)

■ **Impact detection door lock release system**

In the event that the vehicle is subject to a strong impact, both side doors are unlocked. Depending on the force of the impact or the type of accident, however, the system may not operate.

■ **Operation signals**

A buzzer sounds and the emergency flashers flash to indicate that the doors have been locked/unlocked. (Locked: once; Unlocked: twice)

A buzzer sounds to indicate that the windows are operating.

■ **Security feature**

If a door is not opened within approximately 60 seconds after the vehicle is unlocked, the security feature automatically locks the vehicle again.

■ **Open door warning buzzer**

If an attempt to lock the doors is made when a door is not fully closed, a buzzer sounds continuously for 5 seconds. Fully close the door to stop the buzzer, and lock the vehicle once more.

■ **Setting the alarm**

Locking the doors will set the alarm system. (→P.71)

■ **Conditions affecting the operation of the smart access system with push-button start or wireless remote control**

→P.115

■ **If the smart access system with push-button start or the wireless remote control does not operate properly**

Use the mechanical key to lock and unlock the doors. (→P.355)

Replace the key battery with a new one if it is depleted. (→P.318)

■ **If the 12-volt battery is discharged**

The doors cannot be locked and unlocked using the smart access system with push-button start or wireless remote control.

3 Before driving

Lock or unlock the doors using the mechanical key. (→P.355)

#### ■ Customization

Settings (e.g. unlocking function using a key) can be changed.  
(Customizable features: →P.391)

### ⚠ WARNING

#### ■ To prevent an accident

Observe the following precautions while driving the vehicle.

Failure to do so may result in a door opening and an occupant being thrown out of the vehicle, resulting in death or serious injury.

- Ensure that both side doors are properly closed and locked.
- Do not pull the inside handle of the doors while driving. The doors may be opened even if they are locked.

#### ■ Side window open/close function linked to door operation

Do not hold the upper edge of the side window when you close the door. Otherwise, your fingers or hand may be caught in the window.

#### ■ When entering and exiting the vehicle

Do not step on the scuff plate. Slipping on the surface may result in injury.

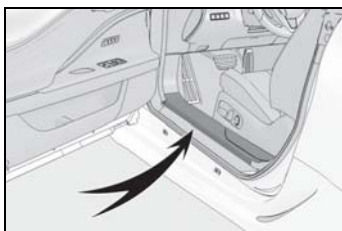

## Unlocking and locking the doors from the inside

### ■ Door lock switches

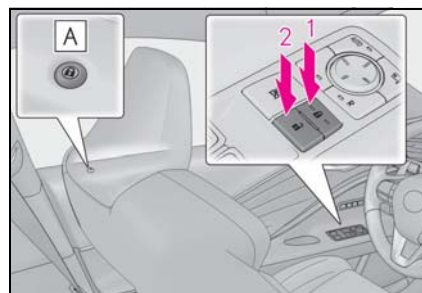

#### 1 Locks both side doors

The indicator **A** comes on.

#### 2 Unlocks both side doors

The indicator **A** turns off.

### ■ Inside door handles

Pull the inside door handle to unlock the door.

The door lock indicator **A** turns off.

The doors can be opened by pulling the inside door handle even if the door lock indicator **A** illuminates.

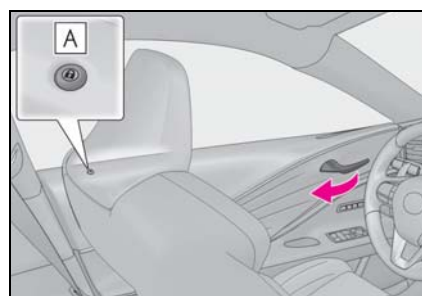

### ■ Door lock indicator

The door lock indicator turns on when the door is locked. If the door lock indicator illuminates for more than 30 seconds while the engine switch <power switch> is off, the door lock indicator will automatically turn



off.

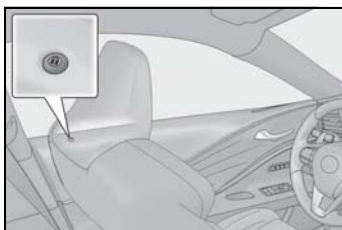

■ **If a symbol indicating one or both side doors open is shown on the multi-information display**

The hood, one or both side of the doors, or trunk are not fully closed. If the vehicle reaches a speed of 3 mph (5 km/h), the master warning light flashes and a buzzer sounds to indicate that the door(s) are not fully closed. Make sure to close hood, both side doors and trunk.

■ **Customization**

The time elapsed before the door lock indicator turns off can be changed. (Customizable features: →P.391)

### Automatic door locking and unlocking systems

The following functions can be set or canceled:

For instructions on customizing, refer to P.391.

Function	Operation
Speed linked door locking function	Both side doors are automatically locked when vehicle speed is approximately 12 mph (20 km/h) or higher.
Shift position linked door locking function	Both side doors are automatically locked when the shift position is shifted to a position other than P.

Function	Operation
Shift position linked door unlocking function	Both side doors are automatically unlocked when the shift position is shifted to P.
Driver's door linked door unlocking function	Both side doors are automatically unlocked when driver's door is opened within approximately 45 seconds after turning the engine switch <power switch> off.

3

Before driving

## Trunk

The trunk can be opened using the trunk opener switch, entry function or wireless remote control.

### ⚠ WARNING

Observe the following precautions. Failure to do so may result in death or serious injury.

#### ■ Before driving

- Make sure that the trunk lid is fully closed. If the trunk lid is not fully closed, it may open unexpectedly while driving and hit near-by objects or luggage in the trunk may be thrown out, causing an accident.
- Do not allow children to play in the trunk. If a child is accidentally locked in the trunk, they could suffer from heat exhaustion, suffocation or other injuries.
- Do not allow a child to open or close the trunk lid. Doing so may cause the trunk lid to open unexpectedly, or cause the child's hands, head, or neck to be caught by the closing trunk lid.

#### ■ Important points while driving

Never let anyone sit in the trunk. In the event of sudden braking or a collision, they are susceptible to death or serious injury.

#### ■ Using the trunk

Observe the following precautions. Failure to do so may cause parts of the body to be caught, resulting in serious injury.

- Remove any heavy loads, such as snow and ice, from the trunk lid before opening it. Failure to do so may cause the trunk lid to suddenly shut again after it is opened.

- When opening or closing the trunk lid, thoroughly check to make sure the surrounding area is safe.
- If anyone is in the vicinity, make sure they are safe and let them know that the trunk is about to open or close.
- Use caution when opening or closing the trunk lid in windy weather as it may move abruptly in strong wind.
- On an incline it is more difficult to open or close the trunk lid than on a level surface, so beware of the trunk lid unexpectedly opening or closing by itself. Make sure that the trunk lid is fully open and secure before using the trunk.
- When opening the trunk lid, take care so that it does not hit anyone in the face or any other part of the body.

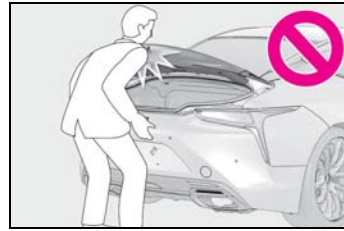

- When closing the trunk lid, take extra care to prevent your fingers etc. from being caught.

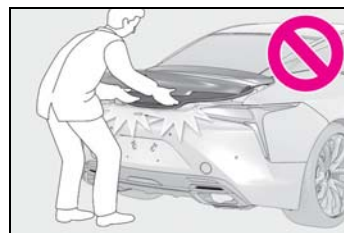

- When closing the trunk lid, make sure to press it lightly on its outer surface. If the trunk grip is used to fully close the trunk lid, it may result in hands or arms being caught.

**⚠ WARNING**

- Do not pull on the trunk damper stay to close the trunk lid, and do not hang on the trunk damper stay. Doing so may cause hands to be caught or the trunk damper stay to break, causing an accident.
- Do not attach any accessories other than genuine Lexus parts to the trunk lid. Such additional weight on the trunk lid may cause the lid to suddenly shut again after it is opened.

**⚠ NOTICE****■ Trunk damper stays**

The trunk is equipped with damper stays **A** that hold the trunk lid in place.

Observe the following precautions. Failure to do so may cause damage to the trunk damper stay **A**, resulting in malfunction.

- Do not attach any foreign objects, such as stickers, plastic sheets, or adhesives to the damper stay rod.
- Do not touch the damper stay rod with gloves or other fabric items.
- Do not attach any accessories other than genuine Lexus parts to the trunk lid.
- Do not place your hand on the damper stay or apply lateral forces to it.

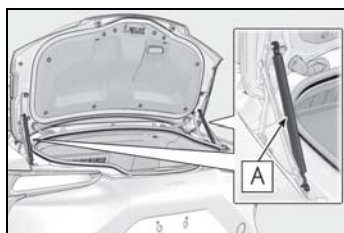
**Opening the trunk****■ Trunk opener switch**

Press the trunk opener switch.

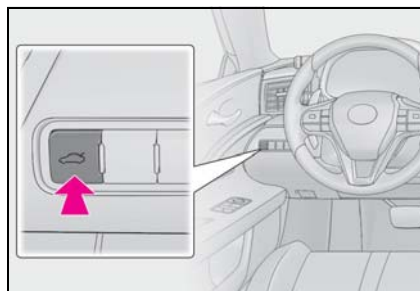
**■ Smart access system with push-button start**

While carrying the electronic key, press the button.

When both side doors are unlocked using one of the following methods, the trunk can be opened without the electronic key:

- Entry function
- Wireless remote control
- Door lock switches
- Automatic door unlocking system
- Mechanical key

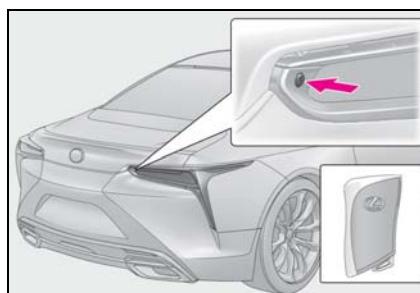
**■ Wireless remote control**

Press and hold the switch.

A buzzer sounds.

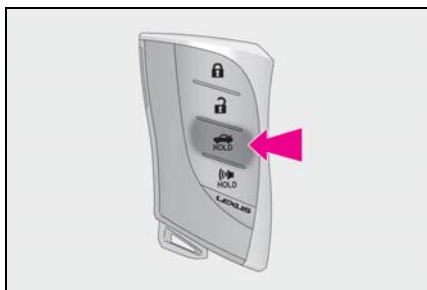

#### ■ Trunk light

The trunk light turns on when the trunk is opened.

#### ■ Function to prevent the trunk being locked with the electronic key inside

- When both side doors are locked, closing the trunk lid with the electronic key left inside the trunk will sound an alarm. In this case, the trunk lid can be opened by pressing the trunk release button on the trunk lid.
- If the spare electronic key is put in the trunk with both side doors locked, the key confinement prevention function is activated so the trunk can be opened. In order to prevent theft, take all electronic keys with you when leaving the vehicle.
- If the electronic key is put in the trunk with both side doors locked, the key may not be detected depending on the location of the key and the surrounding radio wave conditions. In this case, the key confinement prevention function cannot be activated, causing the trunk to be locked when the trunk lid is closed. Make sure to check where the key is before closing the trunk.
- The key confinement prevention function cannot be activated if either door is unlocked. In this case, open the trunk using the trunk opener switch.
- If the trunk lid is closed by a hand having the electronic key when the both side doors are locked, a warning buzzer may sound. In this case, the trunk is not locked. Do not close the trunk lid by a hand having the electronic key.

#### ■ Internal trunk release lever

The trunk lid can be opened by pulling the glow-in-the-dark lever located on the inside of the trunk to the side.

The lever will continue to glow for some time after the trunk lid is closed.

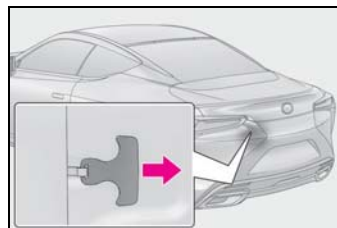

#### ■ If the smart access system with push-button start or the wireless remote control does not operate properly

Use the trunk opener switch to unlock the trunk. (→P.355)

Replace the key battery with a new one if it is depleted. (→P.318)

#### ■ If a symbol indicating the trunk opens is shown on the multi-information display

→P.109

#### ■ If the 12-volt battery is discharged

The trunk cannot be locked and unlocked using the smart access system with push-button start or wireless remote control. Lock or unlock the trunk using the mechanical key. (→P.357)

#### ■ Customization

The trunk unlocking operation can be changed. (Customizable features: →P.391)

### Closing the trunk

Using the trunk grip, lower the trunk without applying force to the side and push the trunk down from the outside to close it.

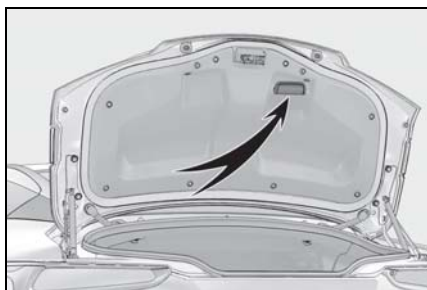

### Protecting luggage against theft

The trunk opener switch can be temporarily disabled to protect luggage stored in the trunk against theft.

Turn the trunk opener main switch in the glove box off to disable the trunk opener.

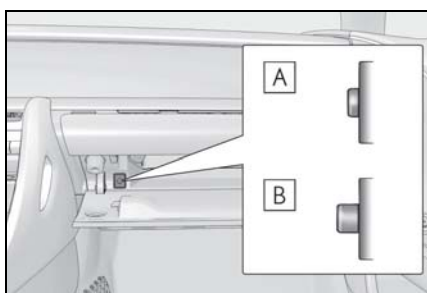

**A** On

**B** Off

When the trunk opener main switch is off, the trunk lid cannot be opened even with the wireless remote control or entry function.

### ■ When leaving a key to the vehicle with a parking attendant

→P.105

### Smart access system with push-button start

The following operations can be performed simply by carrying the electronic key (including the card key) on your person, for example in your pocket. The driver should always carry the electronic key.

- Locks and unlocks the doors (→P.106)
- Opens the trunk (→P.111)
- Starts the engine <hybrid system> (→P.146, 149)

### ■ Antenna location

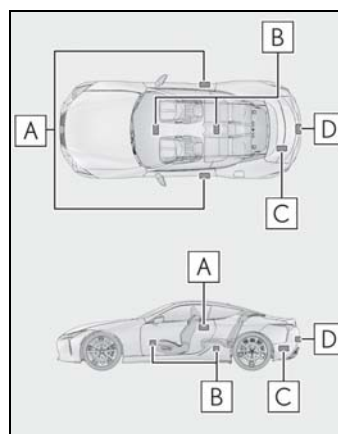

**A** Antennas outside the cabin

**B** Antennas inside the cabin

**C** Antenna inside the trunk

**D** Antenna outside the trunk

■ **Effective range (areas within which the electronic key is detected)**

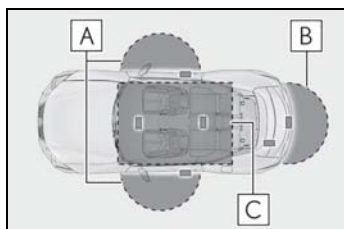

**A** When locking or unlocking the doors  
The system can be operated when the electronic key is within about 2.3 ft. (0.7 m) of an outside door handle. (Only the doors detecting the key can be operated.)

**B** When opening the trunk  
The system can be operated when the electronic key is within about 2.3 ft. (0.7 m) of the trunk release button.

**C** When starting the engine <hybrid system> or changing engine switch <power switch> modes  
The system can be operated when the electronic key is inside the vehicle.

■ **If an alarm sounds or a warning message is displayed**

An alarm sounds and warning messages are displayed on the multi-information display to protect against unexpected accidents or theft of the vehicle resulting from erroneous operation. When a warning message is displayed, take appropriate measures based on the displayed message.

When only an alarm sounds, circumstances and correction procedures are as follows.

- When an exterior alarm sounds once for 5 seconds

Situation	Correction procedure
The trunk was closed while the electronic key was still inside the trunk and both side doors were locked.	Retrieve the electronic key from the trunk and close the trunk lid.
An attempt was made to lock the vehicle while a door was open.	Close both side doors and lock the doors again.

- When an interior alarm sounds continuously

Situation	Correction procedure
The engine switch <power switch> was turned to ACCESSORY mode while the driver's door was open (or the driver's door was opened while the engine switch <power switch> was in ACCESSORY mode).	Turn the engine switch <power switch> off and close the driver's door.
The engine switch <power switch> was turned off while the driver's door was open.	Close the driver's door.

■ **If "Key Detected in Vehicle" is shown on the multi-information display**

An attempt was made to lock the doors using the smart access system with push-button start while the electronic key was still inside the vehicle. Retrieve the electronic key from the vehicle and lock the doors again.



### ■ Battery-saving function

The battery-saving function will be activated in order to prevent the electronic key battery and the 12-volt battery from being discharged while the vehicle is not in operation for a long time.

- In the following situations, the smart access system with push-button start may take some time to unlock the doors.
  - The electronic key has been left within approximately 6 ft. (2 m) of the outside of the vehicle for 10 minutes or longer.
  - The smart access system with push-button start has not been used for 5 days or longer.
- If the smart access system with push-button start has not been used for 14 days or longer, the doors cannot be unlocked at the passenger door. In this case, push the depression on the front edge the driver's door handle, or use the wireless remote control or mechanical key, to unlock the doors.

### ■ Turning an electronic key to battery-saving mode

When battery-saving mode is set, battery depletion is minimized by stopping the electronic key from receiving radio waves.

Press  twice while pressing and holding . Confirm that the electronic key indicator flashes 4 times. While the battery-saving mode is set, the smart access system with push-button start cannot be used. To cancel the function, press any of the electronic key buttons.

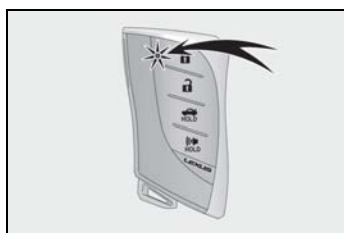

### ■ Conditions affecting operation

The smart access system with push-button start uses weak radio waves. In the following situations, the communication between the electronic key and the vehicle may be

affected, preventing the smart access system with push-button start, wireless remote control and engine immobilizer system <immobilizer system> from operating properly.

(Ways of coping: →P.355)

- When the electronic key battery is depleted
- Near a TV tower, electric power plant, gas station, radio station, large display, airport or other facility that generates strong radio waves or electrical noise
- When carrying a portable radio, cellular phone, cordless phone or other wireless communication device
- When the electronic key is in contact with, or is covered by the following metallic objects
  - Cards to which aluminum foil is attached
  - Cigarette boxes that have aluminum foil inside
  - Metallic wallets or bags
  - Coins
  - Hand warmers made of metal
  - Media such as CDs and DVDs
- When other wireless keys (that emit radio waves) are being used nearby
- When carrying the electronic key together with the following devices that emit radio waves
  - Another vehicle's electronic key or a wireless key that emits radio waves
  - Personal computers or personal digital assistants (PDAs)
  - Digital audio players
  - Portable game systems
- If window tint with a metallic content or metallic objects are attached to the rear window
- When the electronic key is placed near a battery charger or electronic devices

### ■ Note for the entry function

- Even when the electronic key is within the effective range (detection areas), the system may not operate properly in the following cases:
  - The electronic key is too close to the window or outside door handle, near the ground, or in a high place when the doors are locked or unlocked.

- The electronic key is near the ground or in a high place, or too close to the rear bumper center when the trunk is opened.
- The electronic key is on the instrument panel, rear package tray or floor, or in the door pockets or glove box when the engine <hybrid system> is started or engine switch <power switch> modes are changed.
- Do not leave the electronic key on top of the instrument panel or near the door pockets when exiting the vehicle. Depending on the radio wave reception conditions, it may be detected by the antenna outside the cabin and the doors will become lockable from the outside, possibly trapping the electronic key inside the vehicle.
- As long as the electronic key is within the effective range, the doors may be locked or unlocked by anyone. However, only the doors detecting the electronic key can be used to unlock the vehicle.
- Even if the electronic key is not inside the vehicle, it may be possible to start the engine <hybrid system> if the electronic key is near the window.
- The doors may unlock or lock if a large amount of water splashes on the door handle, such as in the rain or in a car wash, when the electronic key is within the effective range. (The doors will automatically be locked after approximately 60 seconds if the doors are not opened and closed.)
- If the wireless remote control is used to lock the doors when the electronic key is near the vehicle, there is a possibility that the door may not be unlocked by the entry function. (Use the wireless remote control to unlock the doors.)
- When the lock operation is performed using the lock sensor, recognition signals will be shown up to two consecutive times. After this, no recognition signals will be given.
- If the door handle becomes wet while the electronic key is within the effective range, the door may lock and unlock repeatedly. In this case, follow the following correction procedures to wash the vehicle:
  - Place the electronic key in a location 6 ft. (2 m) or more away from the vehicle. (Take care to ensure that the key is not stolen.)
  - Set the electronic key to battery-saving mode to disable the smart access system with push-button start. (→P.115)
- If the electronic key is inside the vehicle and a door handle becomes wet during a car wash, a message may be shown on the multi-information display and a buzzer will sound outside the vehicle. To turn off the alarm, lock both side doors.
- If an outside door handle is not retracted during a car wash, a door may be opened or an outside door handle may be damaged. Make sure that the outside door handles are retracted before using the car wash.
- A sudden handle operation or a handle operation immediately after entering the effective range may prevent the doors from being unlocked. Touch the door unlock sensor and check that the doors are unlocked before pulling the door handle again.
- Unlocking the vehicle may take more time if another electronic key is within the effective range.
- **When the vehicle is not driven for extended periods**
  - To prevent theft of the vehicle, do not leave the electronic key within 6 ft. (2 m) of the vehicle.
  - The smart access system with push-button start can be deactivated in advance.
- **To operate the system properly**
  - Make sure to carry the electronic key when operating the system. Do not get the electronic key too close to the vehicle when operating the system from the outside of the vehicle. Depending on the position and holding condition of the electronic key, the key may not be detected correctly and the system may not operate properly. (The alarm may go off accidentally, or the door lock prevention function may not operate.)



- Do not leave the electronic key inside the trunk.  
The key confinement prevention function may not operate, depending on the location of the key (the inside edge of the trunk), conditions (inside a metal bag, close to metallic objects) and the radio waves in the surrounding area. (→P.112)
- **If an electronic key does not work properly**
- Locking and unlocking the doors and opening the trunk: →P.355
- Starting the engine <hybrid system>: →P.356
- **Customization**  
Settings (e. g. smart access system with
- **Certification for the smart access system with push-button start**
- ▶ For vehicles sold in the U.S.A., Hawaii and Puerto Rico

push-button start) can be changed.  
(Customizable features: →P.391)

If the smart access system with push-button start has been deactivated in a customized setting, refer to the explanations for the following operations.

- Locking and unlocking the doors and opening the trunk:  
Use the wireless remote control or mechanical key. (→P.106, 111, 355)
- Starting the engine <hybrid system> and changing engine switch <power switch> modes: →P.356
- Stopping the engine <hybrid system>: →P.148, 151

FCC ID: HYQ23AAY
FCC ID: HYQ14FBF
FCC ID: HYQ14CBG

**NOTE:**

This device complies with part 15 of the FCC Rules. Operation is subject to the following two conditions: (1) This device may not cause harmful interference, and (2) this device must accept any interference received, including interference that may cause undesired operation.

**FCC WARNING:**

Changes or modifications not expressly approved by the party responsible for compliance could void the user's authority to operate the equipment.

<For 14FBF>

The FCC ID/IC Certification number is affixed inside the equipment. You can find the ID/number when replacing the battery.

FCC ID: NI4TMLF15-1

This device complies with part 15 of the FCC Rules. Operation is subject to the following two conditions: (1) This device may not cause harmful interference, and (2) this device must accept any interference received, including interference that may cause undesired operation.

Changes or modifications not expressly approved by the party responsible for compliance could void the user's authority to operate the equipment.

► For vehicles sold in Canada

**NOTE:**

This device complies with Industry Canada's licence-exempt RSSs. Operation is subject to the following two conditions:

- (1) This device may not cause interference; and
- (2) This device must accept any interference, including interference that may cause undesired operation of the device.

<For 14FBF>

The FCC ID/IC Certification number is affixed inside the equipment. You can find the ID/number when replacing the battery.

**NOTE:**

Le présent appareil est conforme aux CNR d'Industrie Canada applicables aux appareils radio exempts de licence. L'exploitation est autorisée aux deux conditions suivantes:

- (1) l'appareil ne doit pas produire de brouillage;
- (2) l'utilisateur de l'appareil doit accepter tout brouillage radioélectrique subi, même si le brouillage est susceptible d'en compromettre le fonctionnement.

<Pour 14FBF>

L'identification FCC/le numéro d'accréditation IC est apposé(e) à l'intérieur de l'appareil. Cette identification/ce numéro est visible au remplacement de la pile.

This device complies with Industry Canada's licence-exempt RSSs. Operation is subject to the following two conditions: (1) This device may not cause interference; and (2) This device must accept any interference, including interference that may cause undesired operation of the device.

Le présent appareil est conforme aux CNR d'Industrie Canada applicables aux appareils radio exempts de licence. L'exploitation est autorisée aux deux conditions suivantes : 1) l'appareil ne doit pas produire de brouillage; 2) l'utilisateur de l'appareil doit accepter tout brouillage radioélectrique subi, même si le brouillage est susceptible d'en compromettre le fonctionnement.

 **WARNING**

■ **Caution regarding interference with electronic devices**

- People with implantable cardiac pacemakers, cardiac resynchronization therapy-pacemakers or implantable cardioverter defibrillators should keep away from the smart access system with push-button start antennas. (→P.113)

The radio waves may affect the operation of such devices. If necessary, the entry function can be disabled. Ask your Lexus dealer for details, such as the frequency of radio waves and timing of the emitted radio waves. Then, consult your doctor to see if you should disable the entry function.

- Users of any electrical medical device other than implantable cardiac pacemakers, cardiac resynchronization therapy-pacemakers or implantable cardioverter defibrillators should consult the manufacturer of the device for information about its operation under the influence of radio waves. Radio waves could have unexpected effects on the operation of such medical devices.

Ask your Lexus dealer for details on disabling the entry function.

### Front seats

The seats can be adjusted (longitudinally, vertically, etc.). Adjust the seat to ensure the correct driving posture.

### Adjustment procedure

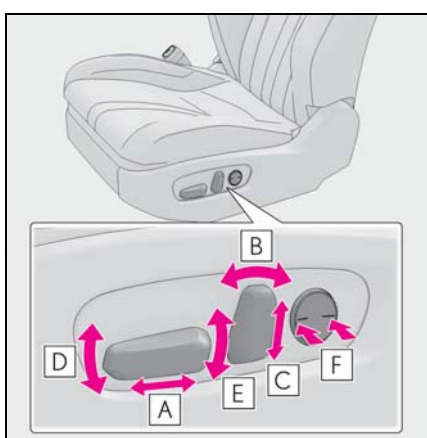

- A** Seat position adjustment
- B** Seatback angle adjustment
- C** Head restraint height adjustment (if equipped) (→P.125)
- D** Seat cushion (front) angle adjustment
- E** Vertical height adjustment
- F** Lumbar support adjustment (if equipped)

#### ■ When adjusting the seat

- Make sure that any surrounding passengers or objects are not contact the seat.
- Take care when adjusting the seat so that the head restraint does not touch the ceiling.

#### ■ Seat-linked function

- This function operates when the seat is moved forward, backward or in the reclining direction a certain distance or more.
- Vehicles with power head restraint: When the seat is adjusted forward a certain distance or more, the head restraint moves down.
- Vehicles with power head restraint: When the seat is raised a certain distance or more, the seat stops and the head restraint moves down.

#### ⚠ WARNING

##### ■ When adjusting the seat position

- Take care when adjusting the seat position to ensure that other passengers are not injured by the moving seat.
- Do not put your hands under the seat or near the moving parts to avoid injury. Fingers or hands may become jammed in the seat mechanism.
- Make sure to leave enough space around the feet so they do not get stuck.

##### ■ Seat adjustment

To reduce the risk of sliding under the lap belt during a collision, do not recline the seat more than necessary. If the seat is too reclined, the lap belt may slide past the hips and apply restraint forces directly to the abdomen, or your neck may contact the shoulder belt, increasing the risk of death or serious injury in the event of an accident. Adjustments should not be made while driving as the seat may unexpectedly move and cause the driver to lose control of the vehicle.

### Entering/exiting the rear seats (lever-operated "Front, Fold & Return" seat)

#### ■ Before entering/exiting the rear seats

- Remove the seat belt from the seat belt guide. (→P.26)
- Stow the sun visor.

#### ■ Entering/exiting the rear seat

##### 1 Pull the lever.

The front seat will lower automatically.

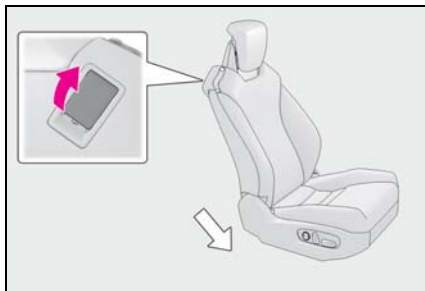

##### 2 Fold the seatback completely forward.

The front seat will move forward and the head restraint will move downward\* automatically.



\*: Power type only

#### ■ Returning the front seat to its original position

Move the seatback backward until it

locks. The front seat will return to its original position automatically.

#### ■ Lever-operated "Front, Fold & Return" seat

- After the front seat is moved forward by operating the "Front, Fold & Return" seat lever, if a power seat adjusting switch or a driving position memory switch is pressed, the front seat will not return to its original position even if the front seatback is moved backward until it locks.
- The lever-operated "Front, Fold & Return" seat will not operate in the following situations:
  - The seat belt of the seat to be operated is fastened.
  - The engine switch <power switch> is in IGNITION ON mode <ON mode> and the shift position is in a position other than P.
- Operation of the lever-operated "Front, Fold & Return" seat will stop in the following situations:
  - A power seat adjusting switch or a driving position memory switch is pressed.
  - The seat belt of the seat which is operating is fastened.
  - The engine switch <power switch> is in IGNITION ON mode <ON mode> and the shift position is changed to a position other than P.

#### ■ Jam protection function

While the driving position is recalling or the lever-operated "Front, Fold & Return" seat is operating, if an object is stuck either in front of or behind the front seat, the front seat will stop and then move in the opposite direction slightly.

When the jam protection function operates, the seat stops at a position other than the set seat position. Check the seat position.

**⚠ WARNING****■ Lever-operated “Front, Fold & Return” seat**

- Before operating the lever-operated “Front, Fold & Return” seat, ensure that any surrounding passengers or objects will not contact the seat.
- Make sure the seatback is locked securely before driving.
- Never operate the lever-operated “Front, Fold & Return” seat while the vehicle is moving.

**■ Jam protection function**

Do not use a hand, foot, or any other part of your body to intentionally activate the jam protection function.

**Driving position memory**

This feature automatically adjusts the positions of the driver’s seat, steering wheel, outside rear view mirrors and head-up display (if equipped) to suit your preferences.

Up to 3 different driving positions can be recorded.

Each electronic key (including a card key) can be registered to recall your preferred driving position.

**Recording a driving position into memory**

- 1** Turn the engine switch <power switch> to IGNITION ON mode <ON mode>.
- 2** Check that the shift position is in P.
- 3** Adjust the driver’s seat, steering wheel, outside rear view mirrors and head-up display to the desired positions.
- 4** While pressing the “SET” button, or within 3 seconds after the “SET” button is pressed, press button “1”, “2” or “3” until the buzzer sounds.

If the selected button has already been preset, the previously recorded position

will be overwritten.

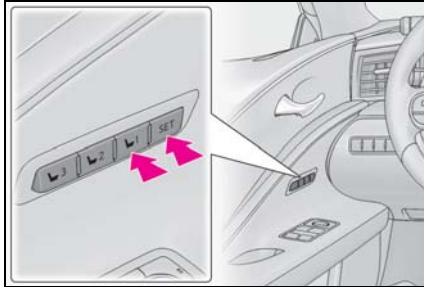

■ **Seat positions that can be memorized** (→P.120)

The adjusted positions other than the position adjusted by lumbar support switch can be recorded.

■ **In order to correctly use the driving position memory function**

If a seat position is already in the furthest possible position and the seat is operated in the same direction, the recorded position may be slightly different when it is recalled.

**⚠ WARNING**

■ **Seat adjustment caution**

Take care during seat adjustment so that the seat does not strike the rear passenger or squeeze your body against the steering wheel.

**Recalling a driving position**

- 1** Turn the engine switch <power switch> to IGNITION ON mode <ON mode>.
- 2** Check that the shift position is in P.

- 3** Press one of the buttons for the driving position you want to recall until the buzzer sounds.

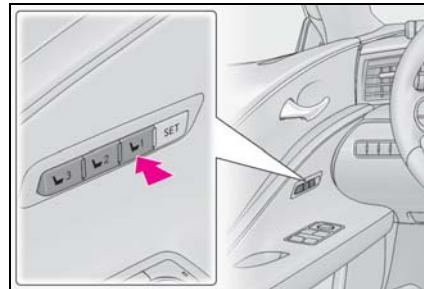

■ **To stop the position recall operation part-way through**

Perform any of the following:

- Press the "SET" button.
- Press button "1", "2" or "3".
- Operate any of the seat adjustment switches (only cancels seat position recall).
- Operate the tilt and telescopic steering control switch (only cancels steering wheel position recall).

■ **Operating the driving position memory after turning the engine switch <power switch> off**

Recorded seat positions can be activated up to 180 seconds after the driver's door is opened and another 60 seconds after it is closed again.

**Registering/canceling/recall a driving position to an electronic key (including a card key) (memory recall function)**

■ **Registering procedure**

Record your driving position to button "1", "2" or "3" before performing the following:

Carry only the key you want to register,

**3**

Before driving



and then close the driver's door.

If 2 or more keys are in the vehicle, the driving position cannot be recorded properly.

- 1 Turn the engine switch <power switch> to IGNITION ON mode <ON mode>.
- 2 Check that the shift position is in P.
- 3 Recall the driving position that you want to record.
- 4 While pressing the recalled button, press and hold the door lock switch (either lock or unlock) until the buzzer sounds.

If the button could not be registered, the buzzer sounds continuously for approximately 3 seconds.

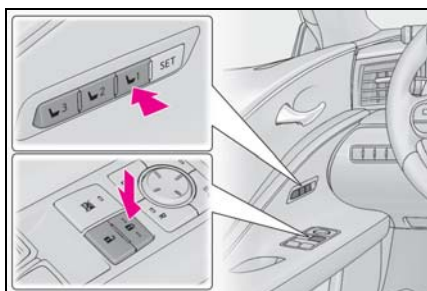

#### ■ Cancellation procedure

- 1 Carry only the key you want to cancel and then close the driver's door.
- If 2 or more keys are in the vehicle, the driving position cannot be canceled properly.
- 2 Turn the engine switch <power switch> to IGNITION ON mode <ON mode>.
  - 3 While pressing the "SET" button, press and hold the door lock switch (either lock or unlock) until the buzzer sounds twice.

If the button could not be canceled, the buzzer sounds continuously for approximately 3 seconds.

#### ■ Recall procedure

- 1 Make sure that the doors are locked before recalling the driving position. Carry the electronic key that has been registered to the driving position, and then unlock and open the driver's door using the smart access system with push-button start or wireless remote control.

The driving position will move to the recorded position (not including the steering wheel and head-up display).

If the driving position is in a position that has already been recorded, the seat and outside rear view mirrors will not move.

- 2 Turn the engine switch <power switch> to ACCESSORY mode or IGNITION ON mode <ON mode>.

The steering wheel and head-up display will move to the recorded position.

#### ■ Recalling the driving position using the memory recall function

- Different driving positions can be registered for each electronic key. Therefore, the driving position that is recalled may be different depending on the key being carried.
- If the passenger's door is unlocked with the smart access system with push-button start, the driving position cannot be recalled. In this case, press the driving position button which has been set.

#### ■ Customization

The unlock door settings of the memory recall function can be changed. (Customizable features: →P.391)



## Head restraints

Head restraints are provided for front seats.

### ⚠ WARNING

#### ■ Head restraint precautions

Observe the following precautions regarding the head restraints. Failure to do so may result in death or serious injury.

- Adjust the head restraints to the correct position at all times.
- Manual type: After adjusting the head restraints, push down on them and make sure they are locked in position.
- Manual type: Do not drive with the head restraints removed.

## Vertical adjustment

### ▶ Manual type

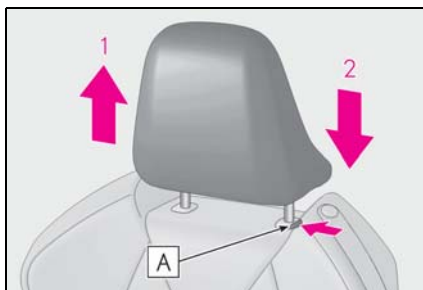

#### 1 Up

Pull the head restraints up.

#### 2 Down

Push the head restraint down while pressing the lock release button **A**.

### ▶ Power type

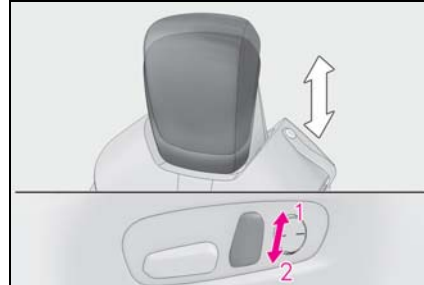

#### 1 Up

#### 2 Down

### ■ Adjusting the height of the head restraints

Make sure that the head restraints are adjusted so that the center of the head restraint is closest to the top of your ears.

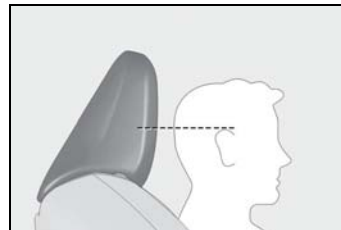

### Removing the head restraints (manual type only)

Pull the head restraint up while pressing the lock release button **A**.

If the head restraint touches the ceiling, making the removal difficult, change the seat height or angle. (→P.120)

3

Before driving

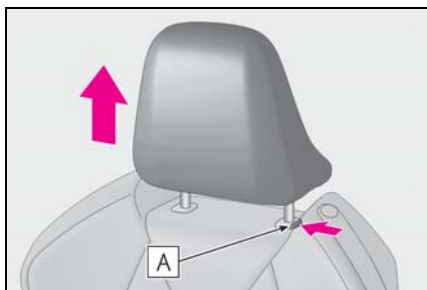

#### ■ Removing the head restraints (power type only)

For removing and installation of the head restraint, contact your Lexus dealer.

#### Installing the head restraints (manual type only)

Align the head restraint with the installation holes and push it down to the lock position.

Press and hold the lock release button

**A** when lowering the head restraint.

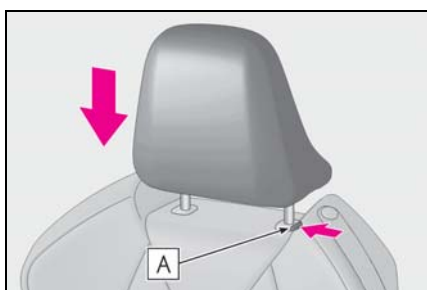

## Steering wheel

### Adjustment procedure

Operating the switch moves the steering wheel in the following directions:

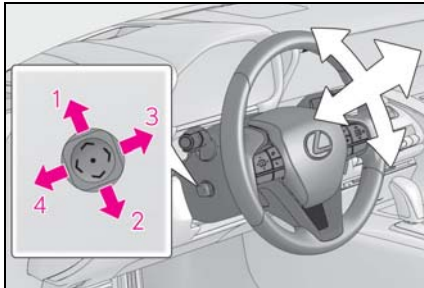

- 1 Up
- 2 Down
- 3 Toward the driver
- 4 Away from the driver

#### ■ The steering wheel can be adjusted when

The engine switch <power switch> is in ACCESSORY or IGNITION ON mode <ON mode>.

#### ■ Automatic adjustment of the steering position

A desired steering position can be entered to memory and recalled automatically by the driving position memory system. (→P.122)

#### ■ Enabling easier driver entry and exit (auto tilt away)

When the engine switch <power switch> is turned off, the steering wheel returns to its stowed position by moving up and away.

Turning the engine switch <power switch> to ACCESSORY or IGNITION ON mode <ON mode> will return the steering wheel to the original position.

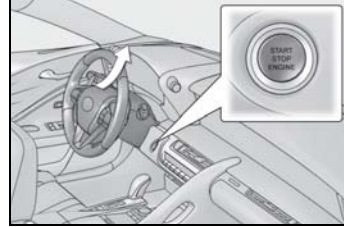

#### ■ Customization

The auto tilt away function can be changed. (Customizable features: →P.391)

### ⚠ WARNING

#### ■ Caution while driving

Do not adjust the steering wheel while driving. Doing so may cause the driver to mishandle the vehicle and cause an accident, resulting in death or serious injury.

### Sounding the horn

Press on or close to the  mark.

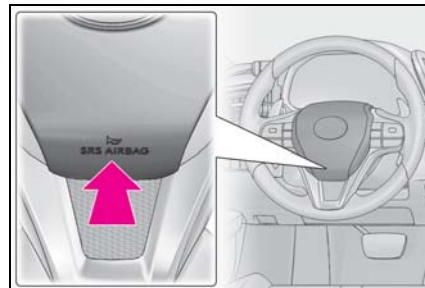

3

Before driving

### Inside rear view mirror

The rear view mirror's position can be adjusted to enable sufficient confirmation of the rear view.

### Adjusting the height of rear view mirror

The height of the rear view mirror can be adjusted to suit your driving posture.

Adjust the height of the rear view mirror by moving it up and down.

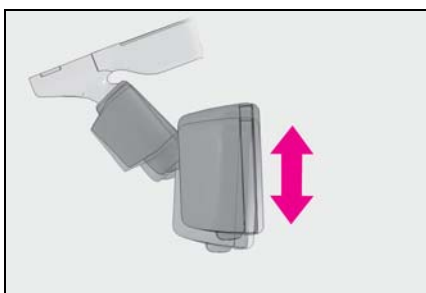

### ⚠ WARNING

#### ■ Caution while driving

Do not adjust the position of the mirror while driving. Doing so may lead to mishandling of the vehicle and cause an accident, resulting in death or serious injury.

### Anti-glare function

Responding to the level of brightness of the headlights of vehicles behind, the reflected light is automatically reduced.

Turn the automatic anti-glare function mode on/off

When the automatic anti-glare function is in ON mode, the indicator **A** illuminates. The function will set to ON mode each time the engine switch <power switch> is turned to IGNITION ON mode <ON mode>.

Pressing the button turns the function to OFF mode. (The indicator **A** also turns off.)

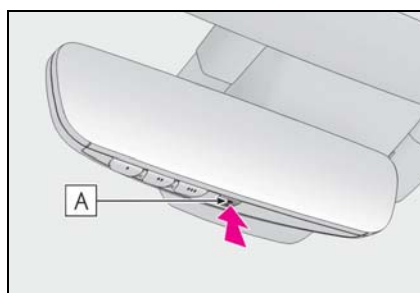

### ■ To prevent sensor error

To ensure that the sensors operate properly, do not touch or cover them.



### Outside rear view mirrors

The rear view mirror's position can be adjusted to enable sufficient confirmation of the rear view.

#### ⚠ WARNING

##### ■ Important points while driving

Observe the following precautions while driving.

Failure to do so may result in loss of control of the vehicle and cause an accident, resulting in death or serious injury.

- Do not adjust the mirrors while driving.
- Do not drive with the mirrors folded.
- Both the driver and passenger side mirrors must be extended and properly adjusted before driving.

### Adjustment procedure

- 1 To select a mirror to adjust, press the switch.

The indicator comes on.

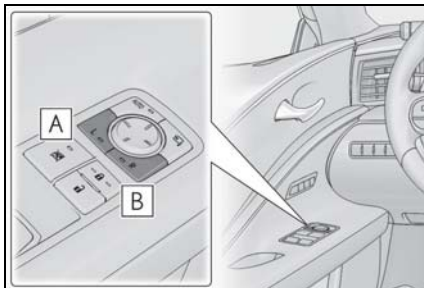

- A** Left
- B** Right

Pressing the same switch again will put the switch in neutral.

- 2 To adjust the mirror, press the switch.

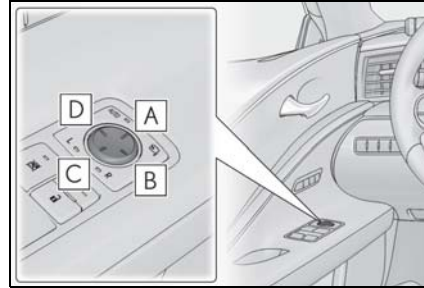

- A** Up
- B** Right
- C** Down
- D** Left

#### ■ Mirror angle can be adjusted when

The engine switch <power switch> is in ACCESSORY or IGNITION ON mode <ON mode>.

#### ■ Defogging the mirrors

The outside rear view mirrors can be cleared using the mirror defoggers. Turn on the rear window defogger to turn on the outside rear view mirror defoggers. (→P.249)

#### ■ Auto anti-glare function

When the anti-glare inside rear view mirror is set to automatic mode, the outside rear view mirrors will activate in conjunction with the anti-glare inside rear view mirror to reduce reflected light. (→P.128)

#### ■ Automatic adjustment of the mirror angle

A desired mirror face angle can be entered to memory and recalled automatically by the driving position memory. (→P.122)

**⚠ WARNING****■ When the outside rear view mirror defoggers are operating**

Do not touch the outside rear view mirror surfaces, as they can become very hot and burn you.

**Folding and extending the mirrors****■ Using the switch**

Press the switch to fold the mirrors.

Press it again to extend them to the original position.

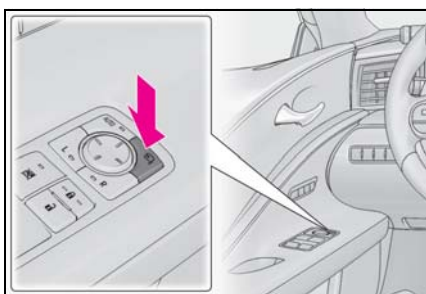
**■ Setting automatic mode**

Automatic mode allows the folding or extending of the mirrors to be linked to locking/unlocking of the doors.

Press the "AUTO" switch to set automatic mode.

The indicator **A** will come on.

Pressing the switch once more will return to manual mode.

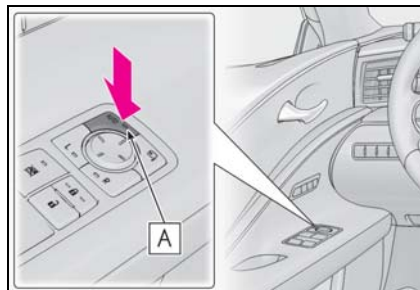
**■ When disconnecting and reconnecting 12-volt battery terminals**

The automatic folding/extending mirror function will return to off as default. To turn the function on, press the switch again to select on.

**■ Using automatic mode in cold weather**

When automatic mode is used in cold weather, the door mirror could freeze up and automatic stowing and return may not be possible. In this case, remove any ice and snow from the door mirror, then either operate the mirror using manual mode or move the mirror by hand.

**■ Customization**

The automatic mirror folding and extending operation can be changed.  
(Customizable features: →P.391)

**⚠ WARNING****■ When a mirror is moving**

To avoid personal injury and mirror malfunction, be careful not to get your hand caught by the moving mirror.

**Linked mirror function when reversing**

When either "L" or "R" of the mirror select switch is selected, the outside rear view mirrors will automatically angle downwards when the vehicle is reversing in order to give a better view of the ground.

To disable this function, select neither "L" nor "R".

■ **Adjusting the mirror angle when the vehicle is reversing**

With the shift position in R, adjust the mirror angle at a desired position.

The adjusted angle will be memorized and the mirror will automatically tilt to the memorized angle whenever the shift position is shifted to R from next time.

The memorized downward tilt position of the mirror is linked to the normal position (angle adjusted with the shift position in other than R). Therefore, if the normal position is changed after adjustment, the tilt position will also change.

When the normal position is changed, readjust the angle in reversing.

## Power windows

### Opening and closing the power windows

The power windows can be opened and closed by one-touch operation of the switches.

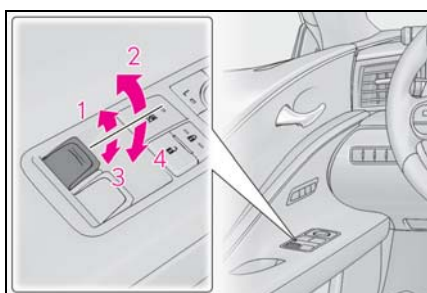

- 1 Closing
- 2 One-touch closing \*
- 3 Opening
- 4 One-touch opening \*

\*: To stop the window partway, operate the switch in the opposite direction.

#### ■ The power windows can be operated when

The engine switch <power switch> is in IGNITION ON mode <ON mode>.

#### ■ Operating the power windows after turning the engine <hybrid system> off

The power windows can be operated for approximately 45 seconds after the engine switch <power switch> is turned to ACCESSORY mode or turned off. They cannot, however, be operated once either door is opened.

#### ■ Jam protection function

If an object becomes jammed between the window and the window frame while the window is closing, window movement is stopped and the window is opened slightly.

#### ■ Catch protection function

If an object becomes caught between the door and window while the window is opening, window movement is stopped.

#### ■ When the window cannot be opened or closed

When the jam protection function or catch protection function operates unusually and the door window cannot be opened or closed, perform the following operations with the power window switch of that door.

- Stop the vehicle. With the engine switch <power switch> in IGNITION ON mode <ON mode>, within 4 seconds of the jam protection function or catch protection function activating, continuously operate the power window switch in the one-touch closing direction or one-touch opening direction so that the door window can be opened and closed.

- If the door window cannot be opened and closed even when performing the above operations, perform the following procedure for function initialization.

- 1 Close both side doors.
- 2 Turn the engine switch <power switch> to IGNITION ON mode <ON mode>.
- 3 Pull and hold the power window switch in the one-touch closing direction and completely close the door window.
- 4 Release the power window switch for a moment, resume pulling the switch in the one-touch closing direction, and hold it there for approximately 6 seconds or more.
- 5 Press and hold the power window switch in the one-touch opening direction. After the door window is completely opened, continue holding the switch for an additional 1 second or more.
- 6 Release the power window switch for a moment, resume pushing the switch in the one-touch opening direction, and hold it there for approximately 4 seconds or more.
- 7 Pull and hold the power window switch in the one-touch closing direction again. After the door window is com-



pletely closed, continue holding the switch for a further 1 second or more.

If you release the switch while the window is moving, start again from the beginning. If the window reverses and cannot be fully closed or opened, have the vehicle inspected by your Lexus dealer.

#### ■ Door lock linked window operation

- The power windows can be opened and closed using the mechanical key. \* (→P.355)
- The power windows can be opened using the wireless remote control. \* (→P.106)

\*: These settings must be customized at your Lexus dealer.

#### ■ Power windows open warning buzzer

The buzzer sounds and “Window Open” is shown on the multi-information display in the instrument cluster when the engine switch <power switch> is turned off and the driver’s door is opened with the power windows open.

#### ■ Customization

Settings (e.g. linked door lock operation) can be changed.  
(Customizable features: →P.391)

### ⚠ WARNING

Observe the following precautions. Failure to do so may result in death or serious injury.

#### ■ Closing the windows

- The driver is responsible for all the power window operations, including the operation for the passengers. In order to prevent accidental operation, especially by a child, do not let a child operate the power windows. It is possible for children and other passengers to have body parts caught in the power window. Also, when riding with a child, it is recommended to use the window lock switch. (→P.133)

- Check to make sure that all passengers do not have any part of their body in a position where it could be caught when a window is being operated.

- When using the wireless remote control or mechanical key and operating the power windows, operate the power window after checking to make sure that there is no possibility of any passenger having any of their body parts caught in the window. Also do not let a child operate window by the wireless remote control or mechanical key. It is possible for children and other passengers to get caught in the power window.

- When exiting the vehicle, turn the engine switch <power switch> off, carry the key and exit the vehicle along with the child. There may be accidental operation, due to mischief, etc., that may possibly lead to an accident.

#### ■ Jam protection function

- Never use any part of your body to intentionally activate the jam protection function.
- The jam protection function may not work if something gets jammed just before the window is fully closed. Be careful not to get any part of your body jammed in the window.

#### ■ Catch protection function

- Never use any part of your body or clothing to intentionally activate the catch protection function.
- The catch protection function may not work if something gets caught just before the window is fully opened. Be careful not to get any part of your body or clothing caught in the window.

### Preventing accidental operation (window lock switch)

This function can be used to prevent children from accidentally opening or

closing a passenger window.

Press the switch.

The indicator **A** will come on and the passenger window will be locked.

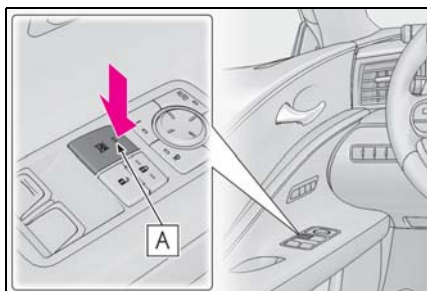

■ **The power windows can be operated when**

The engine switch <power switch> is in IGNITION ON mode <ON mode>.

■ **When the 12-volt battery is disconnected**

The window lock switch is disabled. If necessary, press the window lock switch after reconnecting the 12-volt battery.

- 4-1. Before driving**
- Driving the vehicle..... **136**
  - Cargo and luggage..... **142**
  - Vehicle load limits..... **144**
  - Trailer towing..... **145**
  - Dinghy towing ..... **145**
- 4-2. Driving procedures**
- Engine (ignition) switch (LC500)  
..... **146**
  - Power (ignition) switch (LC500h)  
..... **149**
  - EV drive mode (LC500h)..... **153**
  - Automatic transmission (LC500)  
..... **155**
  - Hybrid transmission (LC500h)  
..... **161**
  - Turn signal lever..... **167**
  - Parking brake ..... **168**
  - Brake Hold..... **171**
- 4-3. Operating the lights and wipers**
- Headlight switch..... **173**
  - Automatic High Beam..... **176**
  - Windshield wipers and washer  
..... **178**
- 4-4. Refueling**
- Opening the fuel tank cap..... **182**
- 4-5. Using the driving support systems**
- Lexus Safety System + ..... **184**
  - PCS (Pre-Collision System).. **189**
  - LKA (Lane-Keeping Assist).. **196**
- 4-6. Driving tips**
- Dynamic radar cruise control with  
full-speed range..... **203**
  - Driving mode select switch ... **213**
  - Intuitive parking assist..... **214**
  - BSM (Blind Spot Monitor).... **220**
  - Active rear wing..... **229**
  - Driving assist systems..... **231**
  - Hybrid vehicle driving tips  
(LC500h)..... **236**
  - Winter driving tips ..... **238**

## Driving the vehicle

The following procedures should be observed to ensure safe driving:

### Driving procedure

#### ■ Starting the engine <hybrid system>

→P.146, 149

#### ■ Driving

- 1 With the brake pedal depressed, shift the shift position to D. (→P.157, 163)

Check that the shift position indicator shows D.

- 2 If the parking brake is in manual mode, release the parking brake. (→P.168)
- 3 Gradually release the brake pedal and gently depress the accelerator pedal to accelerate the vehicle.

#### ■ Stopping

- 1 With the shift position in D, depress the brake pedal.
- 2 If necessary, set the parking brake.

If the vehicle is to be stopped for an extended period of time, shift the shift position to P. (→P.157, 163)

#### ■ Parking the vehicle

- 1 Stop the vehicle completely.
- 2 If the parking brake is in manual mode, set the parking brake. (→P.168)
- 3 Shift the shift position to P. (→P.158, 164)

Check that the shift position indicator

shows P.

- 4 Press the engine switch <power switch> to stop the engine <hybrid system>.
- 5 Slowly release the brake pedal.
- 6 Lock the door, making sure that you have the electronic key on your person.

If parking on a hill, block the wheels as needed.

#### ■ Starting off on a steep uphill

- 1 Make sure that the parking brake is set with the brake pedal depressed, and then shift the shift position to D.

The hill-start assist control will be activated. (→P.232)

- 2 Release the brake pedal and gently depress the accelerator pedal.
- 3 Release the parking brake.

#### ■ For fuel-efficient driving (LC500h)

Keep in mind that hybrid vehicles are similar to conventional vehicles, and it is necessary to refrain from activities such as sudden acceleration. (→P.236)

#### ■ Driving in the rain

- Drive carefully when it is raining, because visibility will be reduced, the windows may become fogged-up, and the road will be slippery.
- Drive carefully when it starts to rain, because the road surface will be especially slippery.
- Refrain from high speeds when driving on an expressway in the rain, because there may be a layer of water between the tires and the road surface, preventing the steering and brakes from operating properly.

#### ■ Engine speed while driving

In the following conditions, the engine speed may become high while driving. This

is due to automatic up-shifting control or down-shifting implementation to meet driving conditions. It does not indicate sudden acceleration.

- The vehicle is judged to be driving uphill or downhill
- When the accelerator pedal is released
- When the brake pedal is firmly or quickly depressed

#### ■ Restraining the engine <hybrid system> output (Brake Override System)

- When the accelerator and brake pedals are depressed at the same time, the engine <hybrid system> output may be restrained.
- A warning message is displayed on the multi-information display while the system is operating. If a warning message is shown on the multi-information display, read the message and follow the instructions.

#### ■ Restraining sudden start (Drive-Start Control)

- When the following unusual operation is performed, the engine <hybrid system> output may be restrained.
  - When the shift position is shifted from R to D, D or M to R, N to R, P to D\*, P to R\* with the accelerator pedal depressed, a warning message appears on the multi-information display. If a warning message is shown on the multi-information display, read the message and follow the instructions.
  - When the accelerator pedal is depressed too much while the vehicle is in reverse.

\* : Depending on the situation, the shift position may not be changed.

- While Drive-Start Control is being activated, your vehicle may have trouble escaping from the mud or fresh snow. In such case, deactivate TRAC (→P.233) to cancel Drive-Start Control so that the vehicle may become able to escape from the mud or fresh snow.

#### ■ Breaking in your new Lexus

To extend the life of the vehicle, observing the following precautions is recommended:

- For the first 186 miles (300 km):  
Avoid sudden stops.
- For the first 621 miles (1000 km):
  - Do not drive at extremely high speeds.
  - Avoid sudden acceleration.
  - Do not drive continuously in low gears.
  - Do not drive at a constant speed for extended periods.

#### ■ Drum-in-disc type parking brake system

Your vehicle has a drum-in-disc type parking brake system. This type of brake system needs bedding-down of the brake shoes periodically or whenever the parking brake shoes and/or drum are replaced. Have your Lexus dealer perform the bedding down operation.

#### ■ Operating your vehicle in a foreign country

Comply with the relevant vehicle registration laws and confirm the availability of the correct fuel. (→P.373)

#### ■ Brake pads and discs

The brake pads and discs are designed for use under high load conditions. Therefore, brake noise may be generated depending on the vehicle speed, braking force and vehicle environment (temperature, humidity, etc.).

#### WARNING

Observe the following precautions. Failure to do so may result in death or serious injury.

##### ■ When starting the vehicle

LC500: Always keep your foot on the brake pedal while stopped with the engine running. This prevents the vehicle from creeping.

LC500h: Always keep your foot on the brake pedal while stopped with the "READY" indicator is illuminated. This prevents the vehicle from creeping.

**WARNING****■ When driving the vehicle**

- Do not drive if you are unfamiliar with the location of the brake and accelerator pedals to avoid depressing the wrong pedal.
- Accidentally depressing the accelerator pedal instead of the brake pedal will result in sudden acceleration that may lead to an accident.
- When backing up, you may twist your body around, leading to a difficulty in operating the pedals. Make sure to operate the pedals properly.
- Make sure to keep a correct driving posture even when moving the vehicle only slightly. This allows you to depress the brake and accelerator pedals properly.
- Depress the brake pedal using your right foot. Depressing the brake pedal using your left foot may delay response in an emergency, resulting in an accident.
- LC500h: The driver should pay extra attention to pedestrians when the vehicle is powered only by the electric motor (traction motor). As there is no engine noise, the pedestrians may misjudge the vehicle's movement. Even though the vehicle is equipped with the vehicle proximity notification system, drive with care as pedestrians in the vicinity may still not notice the vehicle if the surrounding area is noisy.
- Do not drive the vehicle over or stop the vehicle near flammable materials. The exhaust system and exhaust gases can be extremely hot. These hot parts may cause a fire if there is any flammable material nearby.

- During normal driving, do not turn off the engine <hybrid system>. Turning the engine <hybrid system> off while driving will not cause loss of steering or braking control, however, power assist to the steering will be lost. This will make it more difficult to steer smoothly, so you should pull over and stop the vehicle as soon as it is safe to do so.

In the event of an emergency, such as if it becomes impossible to stop the vehicle in the normal way: →P.326

- Use engine braking (downshift) to maintain a safe speed when driving down a steep hill. Using the brakes continuously may cause the brakes to overheat and lose effectiveness. (→P.155, 161)
- Do not adjust the positions of the steering wheel, the seat, or the inside or outside rear view mirrors while driving. Doing so may result in a loss of vehicle control.
- Always check that all passengers' arms, heads or other parts of their body are not outside the vehicle.
- Do not drive in excess of the speed limit. Even if the legal speed limit permits it, do not drive over 85 mph (140 km/h) unless your vehicle has high-speed capability tires. Driving over 85 mph (140 km/h) may result in tire failure, loss of control and possible injury. Be sure to consult a tire dealer to determine whether the tires on your vehicle are high-speed capability tires or not before driving at such speeds.
- When driving on slippery road surfaces**
- Sudden braking, acceleration and steering may cause tire slippage and reduce your ability to control the vehicle.

**⚠ WARNING**

- Sudden acceleration, engine braking due to shifting, or changes in engine speed could cause the vehicle to skid, resulting in an accident.
  - After driving through a puddle, lightly depress the brake pedal to make sure that the brakes are functioning properly. Wet brake pads may prevent the brakes from functioning properly. If the brakes on only one side are wet and not functioning properly, steering control may be affected.
- **When shifting the shift position**
- **LC500:** Do not let the vehicle roll backward while a forward driving position is selected, or roll forward while the shift position is in R. Doing so may cause the engine to stall or lead to poor brake and steering performance, resulting in an accident or damage to the vehicle.  
**LC500h:** Do not let the vehicle roll backward while a forward driving position is selected, or roll forward while the shift position is in R. Doing so may result in an accident or damage to the vehicle.
  - Do not shift the shift position to P while the vehicle is moving. Doing so can damage the transmission and may result in a loss of vehicle control.
  - Do not shift the shift position to R while the vehicle is moving forward. Doing so can damage the transmission and may result in a loss of vehicle control.
  - Do not shift the shift position to a driving position while the vehicle is moving backward. Doing so can damage the transmission and may result in a loss of vehicle control.

- **LC500:** Changing the shift position to N while the vehicle is moving will disengage the engine from the transmission. Engine braking is not available when N is selected.  
**LC500h:** Changing the shift position to N while the vehicle is moving will disengage the hybrid system. Engine braking is not available with the hybrid system disengaged.
- Be careful not to change the shift position with the accelerator pedal depressed. Changing the shift position to any positions other than P or N may lead to unexpected rapid acceleration of the vehicle that may cause an accident and result in death or serious injury.  
After changing the shift position, make sure to confirm the current shift position displayed on the shift position indicator inside the meter.

■ **Brake pad wear**

If any of the following situations occurs, have the brake pads visually checked and replaced by your Lexus dealer as soon as possible.

- If the thickness of the brake pads exceeds the brake pad wear limit when visually checking all four brake pads (for the brake pad wear limit, refer to P.378)
- If "Brake Pad Wear Visit Your Dealer" is displayed (only the right-side pads can be detected)

Rotor damage may result if the pads are not replaced when needed. Moderate levels of the brake pad and disc wear allow enhanced braking power. As a result, the discs may wear more quickly than conventional brake discs. Therefore, when replacing the brake pads, Lexus recommends that you also have the thickness of the discs measured. It is dangerous to drive the vehicle when the wear limits of the brake pads and/or those of the brake discs are exceeded.

**WARNING****■ When the vehicle is stopped**

- LC500: Do not race the engine. If the shift position is any position other than P or N, the vehicle may accelerate suddenly and unexpectedly, causing an accident.  
LC500h: Do not depress the accelerator pedal unnecessarily. If the shift position is any position other than P or N, the vehicle may accelerate suddenly and unexpectedly, causing an accident.
- LC500: In order to prevent accidents due to the vehicle rolling away, always keep depressing the brake pedal while the engine is running, and apply the parking brake as necessary.  
LC500h: In order to prevent accidents due to the vehicle rolling away, always keep depressing the brake pedal while stopped with the "READY" indicator is illuminated, and apply the parking brake as necessary.
- If the vehicle is stopped on an incline, in order to prevent accidents caused by the vehicle rolling forward or backward, always depress the brake pedal and securely apply the parking brake as needed.
- Avoid revving or racing the engine. Running the engine at high speed while the vehicle is stopped may cause the exhaust system to overheat, which could result in a fire if combustible material is nearby.

**■ When the vehicle is parked**

- Do not leave glasses, cigarette lighters, spray cans, or soft drink cans in the vehicle when it is in the sun. Doing so may result in the following:
  - Gas may leak from a cigarette lighter or spray can, and may lead to a fire.
  - The temperature inside the vehicle may cause the plastic lenses and plastic material of glasses to deform or crack.
  - Soft drink cans may fracture, causing the contents to spray over the interior of the vehicle, and may also cause a short circuit in the vehicle's electrical components.
- Do not leave cigarette lighters in the vehicle. If a cigarette lighter is in a place such as the glove box or on the floor, it may be lit accidentally when luggage is loaded or the seat is adjusted, causing a fire.
- Do not attach adhesive discs to the windshield or windows. Do not place containers such as air fresheners on the instrument panel or dashboard. Adhesive discs or containers may act as lenses, causing a fire in the vehicle.
- Do not leave a door or window open if the curved glass is coated with a metallized film such as a silver-colored one. Reflected sunlight may cause the glass to act as a lens, causing a fire.



**⚠ WARNING**

- LC500: Always apply the parking brake, shift the shift position to P, stop the engine and lock the vehicle. Do not leave the vehicle unattended while the engine is running. If the vehicle is parked with the shift position in P but the parking brake is not set, the vehicle may start to move, possibly leading to an accident.  
LC500h: Always apply the parking brake, shift the shift position to P, stop the hybrid system and lock the vehicle. Do not leave the vehicle unattended while the "READY" indicator is illuminated. If the vehicle is parked with the shift position in P but the parking brake is not set, the vehicle may start to move, possibly leading to an accident.
- LC500: Do not touch the exhaust pipes while the engine is running or immediately after turning the engine off. Doing so may cause burns.  
LC500h: Do not touch the exhaust pipes while the "READY" indicator is illuminated or immediately after turning the hybrid system off. Doing so may cause burns.
- **When taking a nap in the vehicle**  
Always turn the engine <hybrid system> off. Otherwise, if you accidentally move the shift lever or depress the accelerator pedal, this could cause an accident or fire due to engine <hybrid system> overheating. Additionally, if the vehicle is parked in a poorly ventilated area, exhaust gases may collect and enter the vehicle, leading to death or a serious health hazard.
- **When braking**
  - When the brakes are wet, drive more cautiously. Braking distance increases when the brakes are wet, and this may cause one side of the vehicle to brake differently than the other side. Also, the parking brake may not securely hold the vehicle.

- If the electronically controlled brake system does not operate, do not follow other vehicles closely and avoid hills or sharp turns that require braking. In this case, braking is still possible, but the brake pedal should be depressed more firmly than usual. Also, the braking distance will increase. Have your brakes fixed immediately.
- The brake system consists of 2 or more individual hydraulic systems; if one of the systems fails, the other(s) will still operate. In this case, the brake pedal should be depressed more firmly than usual and the braking distance will increase. Have your brakes fixed immediately.

**⚠ NOTICE**

- **When driving the vehicle**
  - Do not depress the accelerator and brake pedals at the same time while driving, as this may restrain the engine <hybrid system> output.
  - Do not use the accelerator pedal or depress the accelerator and brake pedals at the same time to hold the vehicle on a hill.
- **Avoiding damage to vehicle parts**
  - Do not turn the steering wheel fully in either direction and hold it there for an extended period of time. Doing so may damage the power steering motor.
  - When driving over bumps in the road, drive as slowly as possible to avoid damaging the wheels, underside of the vehicle, etc.
- **If you get a flat tire while driving**  
A flat or damaged tire may cause the following situations. Hold the steering wheel firmly and gradually depress the brake pedal to slow down the vehicle.
  - It may be difficult to control your vehicle.

 NOTICE

- The vehicle will make abnormal sounds or vibrations.
- The vehicle will lean abnormally.

Information on what to do in case of a flat tire (→P.350)

■ **When encountering flooded roads**

Do not drive on a road that has flooded after heavy rain etc. Doing so may cause the following serious damage to the vehicle:

- Engine stalling
- Short in electrical components
- Engine damage caused by water immersion

In the event that you drive on a flooded road and the vehicle is flooded, be sure to have your Lexus dealer check the following:

- Brake function
- Changes in quantity and quality of oil and fluid used for the engine, transmission, differential, etc.
- Lubricant condition for the propeller shaft, bearings and suspension joints (where possible), and the function of all joints, bearings, etc.

If the shift control system is damaged by flooding, it may not be possible to shift the shift position to P, or from P to other positions. In this case, contact your Lexus dealer.

■ **When parking the vehicle**

Always set the parking brake, and shift the shift position to P. Failure to do so may cause the vehicle to move or the vehicle may accelerate suddenly if the accelerator pedal is accidentally depressed.

## Cargo and luggage

Take notice of the following information about storage precautions, cargo capacity and load:

 WARNING

■ **Things that must not be carried in the trunk**

The following things may cause a fire if loaded in the trunk:

- Receptacles containing gasoline
- Aerosol cans

■ **Storage precautions**

Observe the following precautions. Failure to do so may prevent the pedals from being depressed properly, may block the driver's vision, or may result in items hitting the driver or passengers, possibly causing an accident.

- Stow cargo and luggage in the trunk whenever possible.
- Do not place cargo or luggage in or on the following locations.
  - At the feet of the driver
  - On the front passenger or rear seats (when stacking items)
  - On the package tray
  - On the instrument panel
  - On the dashboard
  - In front of the Center Display
- Secure all items in the occupant compartment.

## Capacity and distribution

Cargo capacity depends on the total weight of the occupants.

(Cargo capacity) = (Total load capacity) — (Total weight of occupants)

### Steps for Determining Correct Load Limit —

- (1) Locate the statement “The combined weight of occupants and cargo should never exceed XXX kg or XXX lbs.” on your vehicle’s placard.
- (2) Determine the combined weight of the driver and passengers that will be riding in your vehicle.
- (3) Subtract the combined weight of the driver and passengers from XXX kg or XXX lbs.
- (4) The resulting figure equals the available amount of cargo and luggage load capacity.

For example, if the “XXX” amount equals 1400 lbs. and there will be five 150 lb passengers in your vehicle, the amount of available cargo and luggage load capacity is 650 lbs. (1400 – 750 (5 × 150) = 650 lbs.)

- (5) Determine the combined weight of luggage and cargo being loaded on the vehicle. That weight may not safely exceed the available cargo and luggage load capacity calculated in Step 4.

- (6) If your vehicle will be towing a trailer, load from your trailer will be transferred to your vehicle. Consult this manual to determine how this reduces the available cargo and luggage load capacity of your vehicle. (→P.144)

Lexus does not recommend towing a trailer with your vehicle. Your vehicle is not designed for trailer towing.

### ⚠ WARNING

#### ■ Capacity and distribution

- Do not exceed the maximum axle weight rating or the total vehicle weight rating.
- Even if the total load of occupant’s weight and the cargo load is less than the total load capacity, do not apply the load unevenly. Improper loading may cause deterioration of steering or braking control which may cause death or serious injury.

### Calculation formula for your vehicle

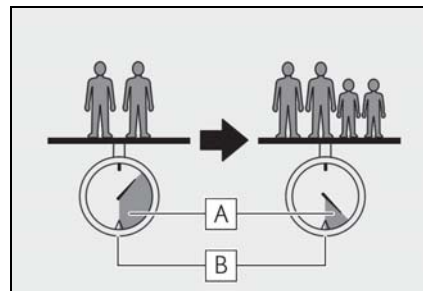

**A** Cargo capacity

**B** Total load capacity (vehicle capacity weight) (→P.372)

When 2 people with the combined weight of A lb. (kg) are riding in your vehicle, which has a total load capacity (vehicle capacity weight) of B lb. (kg), the available amount of cargo and luggage load capacity will be C lb. (kg) as follows:

$$B^{*2} \text{ lb. (kg)} - A^{*1} \text{ lb. (kg)} = C^{*3} \text{ lb. (kg)}$$

\*1: A = Weight of people

\*2: B = Total load capacity

\*3: C = Available cargo and luggage load

In this condition, if 2 more passengers with the combined weight of D lb. (kg) get on, the available cargo and luggage load will be reduced E lb. (kg) as follows:

$$C \text{ lb. (kg)} - D^{*4} \text{ lb. (kg)} = E^{*5} \text{ lb. (kg)}$$

\*4: D = Additional weight of people

\*5: E = Available cargo and luggage load

As shown in the example above, if the number of occupants increases, the cargo and luggage load will be reduced by an amount that equals the increased weight due to the additional occupants. In other words, if an increase in the number of occupants causes an excess of the total load capacity (combined weight of occupants plus cargo and luggage load), you must reduce the cargo and luggage on your vehicle.

## Vehicle load limits

Vehicle load limits include total load capacity, seating capacity, towing capacity and cargo capacity.

- Total load capacity (vehicle capacity weight): →P.372

Total load capacity means the combined weight of occupants, cargo and luggage.

- Seating capacity: 4 occupants (Front 2, Rear 2)

Seating capacity means the maximum number of occupants whose estimated average weight is 150 lb. (68 kg) per person.

- Towing capacity

Lexus does not recommend towing a trailer with your vehicle.

- Cargo capacity

Cargo capacity may increase or decrease depending on the weight and the number of occupants.

### ■ Total load capacity and seating capacity

These details are also described on the tire and loading information label. (→P.313)

### WARNING

#### ■ Overloading the vehicle

Do not overload the vehicle. It may not only cause damage to the tires, but also degrade steering and braking ability, resulting in an accident.

### Trailer towing

Lexus does not recommend towing a trailer with your vehicle. Lexus also does not recommend the installation of a tow hitch or the use of a tow hitch carrier for a wheelchair, scooter, bicycle, etc. Your vehicle is not designed for trailer towing or for the use of tow hitch mounted carriers.

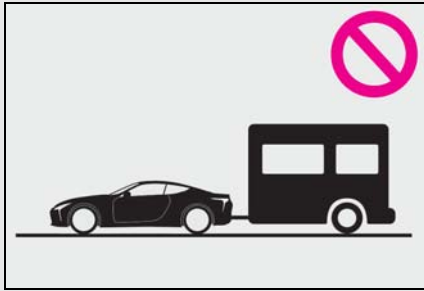

### Dinghy towing

Your vehicle is not designed to be dinghy towed (with 4 wheels on the ground) behind a motor home.

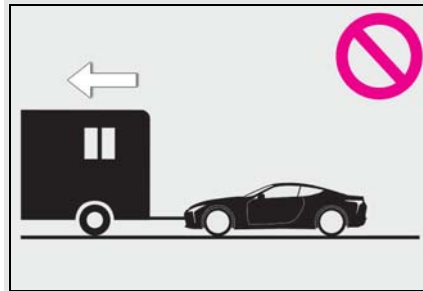

#### NOTICE

■ To avoid serious damage to your vehicle

Do not tow your vehicle with the four wheels on the ground.

## Engine (ignition) switch (LC500)

Performing the following operations when carrying the electronic key on your person starts the engine or changes engine switch modes.

### Starting the engine

- 1 Press the parking brake switch to check that the parking brake is set. (→P.168)

Parking brake indicator will come on.

- 2 Firmly depress the brake pedal.

 and a message will be displayed on the multi-information display. If it is not displayed, the engine cannot be started.

- 3 Press the engine switch shortly and firmly.

When operating the engine switch, one short, firm press is enough. It is not necessary to press and hold the switch.

The engine will crank until it starts or for up to 30 seconds, whichever is less.

Continue depressing the brake pedal until the engine is completely started.

The engine can be started from any engine

switch mode.

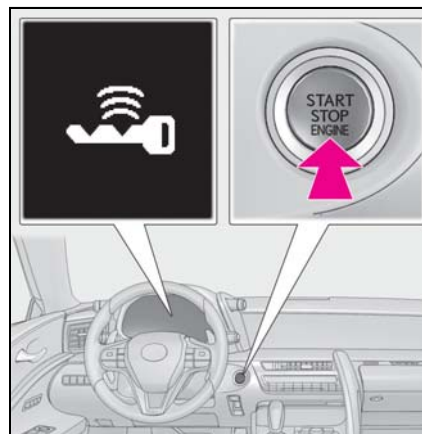

### ■ Engine switch illumination

According to the situation, the engine switch illumination operates as follows.

- When a door is opened, or the engine switch mode is changed from ACCESSORY or IGNITION ON mode to off, the engine switch illumination slowly blinks.
- When depressing the brake pedal with carrying the electronic key on your person, the engine switch illumination rapidly blinks.
- When the engine switch is in ACCESSORY or IGNITION ON mode, the engine switch illumination illuminates.

### ■ If the engine does not start

- The engine immobilizer system may not have been deactivated. (→P.69) Contact your Lexus dealer.
- If a message related to start-up is shown on the multi-information display, read the message and follow the instructions.

### ■ If the 12-volt battery is discharged

The engine cannot be started using the smart access system with push-button start. Refer to P.358 to restart the engine.

### ■ Electronic key battery depletion

→P.102

■ **Conditions affecting operation**

→P.115

■ **Notes for the entry function**

→P.115

■ **Steering lock function**

- After turning the engine switch off and opening and closing the doors, the steering wheel will be locked due to the steering lock function. Operating the engine switch again automatically cancels the steering lock.
- When the steering lock cannot be released, “Push engine switch while turning the steering wheel in either direction” will be displayed on the multi-information display. Press the engine switch shortly and firmly while turning the steering wheel left and right.

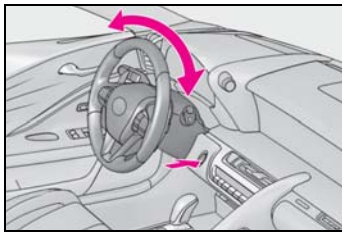

- To prevent the steering lock motor from overheating, operation of the motor may be suspended if the engine is turned on and off repeatedly in a short period of time. In this case, refrain from operating the engine switch. After about 10 seconds, the steering lock motor will resume functioning.

■ **If there is a malfunction in the smart access system with push-button start**

If “Access System with Elec. Key Malfunction” is displayed on the multi-information display, the system may be malfunctioning. Have the vehicle inspected by your Lexus dealer immediately.

■ **Electronic key battery**

→P.318

■ **Operation of the engine switch**

- If the switch is not pressed shortly and firmly, the engine switch mode may not

change or the engine may not start.

- If attempting to restart the engine immediately after turning the engine switch off, the engine may not start in some cases. After turning the engine switch off, please wait a few seconds before restarting the engine.

■ **Customization**

If the smart access system with push-button start has been deactivated in a customized setting, refer to P.355.

**! WARNING**

■ **When starting the engine**

Always start the engine while sitting in the driver’s seat. Do not depress the accelerator pedal while starting the engine under any circumstances. Doing so may cause an accident resulting in death or serious injury.

■ **Caution while driving**

If engine failure occurs while the vehicle is moving, do not lock or open the doors until the vehicle reaches a safe and complete stop. Activation of the steering lock in this circumstance may lead to an accident, resulting in death or serious injury.

**! NOTICE**

■ **When starting the engine**

- Do not race a cold engine.
- If the engine becomes difficult to start or stalls frequently, have your vehicle checked by your Lexus dealer immediately.

■ **Symptoms indicating a malfunction with the engine switch**

If the engine switch seems to be operating somewhat differently than usual, such as the switch sticking slightly, there may be a malfunction. Contact your Lexus dealer immediately.

### Stopping the engine

- 1 Stop the vehicle completely.
- 2 If the parking brake is in manual mode, set the parking brake. (→P.168)
- 3 Shift the shift position to P. (→P.158)

Check that the shift position indicator shows P. (→P.157)

- 4 Press the engine switch.

The engine will stop, and the meter display will be extinguished (the shift position indicator will be extinguished a few seconds after the meter display).

- 5 Check that "ACCESSORY" or "IGNITION ON" is not shown on the meter.

■ Automatic P position selection function  
→P.158

### ⚠ WARNING

#### ■ Stopping the engine in an emergency

- If you want to stop the engine in an emergency while driving the vehicle, press and hold the engine switch for more than 2 seconds, or press it briefly 3 times or more in succession. (→P.326)

However, do not touch the engine switch while driving except in an emergency. Turning the engine off while driving will not cause loss of steering or braking control, however, power assist to the steering will be lost. This will make it more difficult to steer smoothly, so you should pull over and stop the vehicle as soon as it is safe to do so.

- If the engine switch is operated while the vehicle is running, a warning message will be shown on the multi-information display and a buzzer sounds.
- When restarting the engine after an emergency shutdown, press the engine switch.

### Changing engine switch modes

Modes can be changed by pressing the engine switch with the brake pedal released. (The mode changes each time the switch is pressed.)

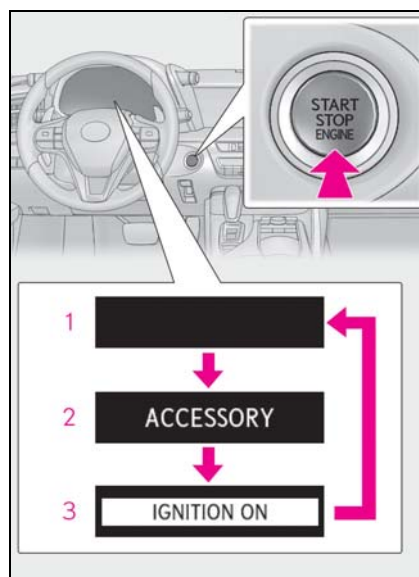

#### 1 Off

The emergency flashers can be used.

#### 2 ACCESSORY mode

Some electrical components such as the audio system can be used.

"ACCESSORY" will be displayed on the meter.

#### 3 IGNITION ON mode

All electrical components can be used.

"IGNITION ON" will be displayed on the



meter.

#### ■ Auto power off function

If the vehicle is left in ACCESSORY mode for more than 20 minutes or IGNITION ON mode (the engine is not running) for more than an hour with the shift position in P, the engine switch will automatically turn off. However, this function cannot entirely prevent the 12-volt battery discharge. Do not leave the vehicle with the engine switch in ACCESSORY or IGNITION ON mode for long periods of time when the engine is not running.

#### ■ When the shift control system malfunctions

When attempting to turn the engine switch off while there is a malfunction in the shift control system, the engine switch mode may change to ACCESSORY mode. In this case, ACCESSORY mode may be turned off by applying the parking brake and pressing the engine switch again. If there is a malfunction in the system, have the vehicle inspected by your Lexus dealer immediately.



#### NOTICE

##### ■ To prevent 12-volt battery discharge

- Do not leave the engine switch in ACCESSORY or IGNITION ON mode for long periods of time without the engine running.
- If "ACCESSORY" or "IGNITION ON" is displayed on the meter, the engine switch is not off. Exit the vehicle after turning the engine switch off.

## Power (ignition) switch (LC500h)

Performing the following operations when carrying the electronic key on your person starts the hybrid system or changes power switch modes.

### Starting the hybrid system

- 1 Press the parking brake switch to check that the parking brake is set. (→P.168)

Parking brake indicator will come on.

- 2 Firmly depress the brake pedal.



and a message will be displayed on the multi-information display.

If it is not displayed, the hybrid system cannot be started.

When the shift position is N, the hybrid system cannot start. Shift the shift position to P when starting the hybrid system. (→P.164)

- 3 Press the power switch shortly and firmly.

When operating the power switch, one short, firm press is enough. It is not necessary to press and hold the switch.

If the "READY" indicator turns on, the hybrid system will operate normally.

Continue depressing the brake pedal until the "READY" indicator is illuminated.

The hybrid system can be started from any

power switch mode.

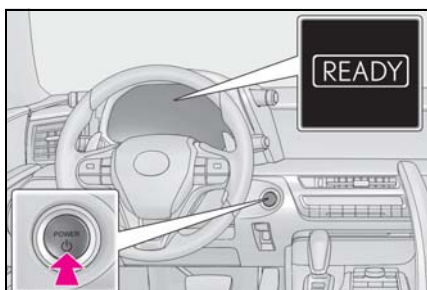

#### 4 Check that the "READY" indicator is illuminated.

If the "READY" indicator changes from a flashing light to a solid light and the buzzer sounds, the hybrid system is starting normally.

The vehicle will not move when the "READY" indicator is off.

The vehicle can move when the "READY" indicator is on even if the engine is stopped. (The gasoline engine starts or stops automatically in accordance with the state of the vehicle.)

#### ■ Power switch illumination

According to the situation, the power switch illumination operates as follows.

- When a door is opened, or the power switch mode is changed from ACCESSORY or ON mode to off, the power switch illumination slowly blinks.
- When depressing the brake pedal with carrying the electronic key on your person, the power switch illumination rapidly blinks.
- When the power switch is in ACCESSORY or ON mode, the power switch illumination illuminates.

#### ■ If the hybrid system does not start

- The immobilizer system may not have been deactivated. (→P.69)  
Contact your Lexus dealer.
- If a message related to start-up is shown on the multi-information display, read the message and follow the instructions.

#### ■ When the ambient temperature is low, such as during winter driving conditions

- When starting the hybrid system, the flashing time of the "READY" indicator may be long. Leave the vehicle as it is until the "READY" indicator is steady on, as steady means the vehicle is able to move.
- When the hybrid battery (traction battery) is extremely cold (below approximately  $-22^{\circ}\text{F}$  [ $-30^{\circ}\text{C}$ ]) under the influence of the outside temperature, it may not be possible to start the hybrid system. In this case, try to start the hybrid system again after the temperature of the hybrid battery increases due to the outside temperature increase etc.

#### ■ Sounds and vibrations specific to a hybrid vehicle

→P.63

#### ■ If the 12-volt battery is discharged

The hybrid system cannot be started using the smart access system with push-button start. Refer to P.358 to restart the hybrid system.

#### ■ Electronic key battery depletion

→P.102

#### ■ Conditions affecting operation

→P.115

#### ■ Notes for the entry function

→P.115

#### ■ Steering lock function

- After turning the power switch off and opening and closing the doors, the steering wheel will be locked due to the steering lock function. Operating the power switch again automatically cancels the steering lock.
- When the steering lock cannot be released, "Push power switch while turning the steering wheel in either direction" will be displayed on the multi-information display.  
Press the power switch shortly and firmly while turning the steering wheel left and right.

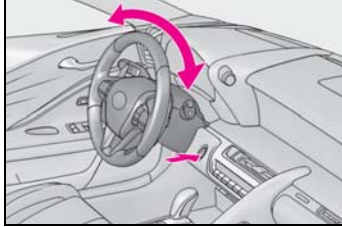

- To prevent the steering lock motor from overheating, the motor may be suspended if the hybrid system is turned on and off repeatedly in a short period of time. In this case, refrain from operating the power switch. After about 10 seconds, the steering lock motor will resume functioning.

#### ■ If there is a malfunction in the smart access system with push-button start

If "Access System with Elec. Key Malfunction" is displayed on the multi-information display, the system may be malfunctioning. Have the vehicle inspected by your Lexus dealer immediately.

#### ■ If the "READY" indicator does not come on

In the event that the "READY" indicator does not come on even after performing the proper procedures for starting the vehicle, contact your Lexus dealer immediately.

#### ■ If the hybrid system is malfunctioning

→P.67

#### ■ Electronic key battery

→P.318

#### ■ Operation of the power switch

- If the switch is not pressed shortly and firmly, the power switch mode may not change or the hybrid system may not start.
- If attempting to restart the hybrid system immediately after turning the power switch off, the hybrid system may not start in some cases. After turning the power switch off, please wait a few seconds before restarting the hybrid system.

#### ■ Customization

If the smart access system with push-button start has been deactivated in a customized

setting, refer to P.355.

### ⚠ WARNING

#### ■ When starting the hybrid system

Always start the hybrid system while sitting in the driver's seat. Do not depress the accelerator pedal while starting the hybrid system under any circumstances. Doing so may cause an accident resulting in death or serious injury.

#### ■ Caution while driving

If hybrid system failure occurs while the vehicle is moving, do not lock or open the doors until the vehicle reaches a safe and complete stop. Activation of the steering lock in this circumstance may lead to an accident, resulting in death or serious injury.

### ⚠ NOTICE

#### ■ When starting the hybrid system

If the hybrid system becomes difficult to start, have your vehicle checked by your Lexus dealer immediately.

#### ■ Symptoms indicating a malfunction with the power switch

If the power switch seems to be operating somewhat differently than usual, such as the switch sticking slightly, there may be a malfunction. Contact your Lexus dealer immediately.

### Stopping the hybrid system

- 1 Stop the vehicle completely.
- 2 If the parking brake is in manual mode, set the parking brake. (→P.168)
- 3 Shift the shift position to P. (→P.164)

Check that the shift position indicator shows P. (→P.163)

- 4 Press the power switch.

The hybrid system will stop, and the meter display will be extinguished (the shift position indicator will be extinguished a few seconds after the meter display).

- 5 Check that "ACCESSORY" or "IGNITION ON" is not shown on the meter.

■ Automatic P position selection function

→P.164

**⚠ WARNING**

■ Stopping the hybrid system in an emergency

- If you want to stop the hybrid system in an emergency while driving the vehicle, press and hold the power switch for more than 2 seconds, or press it briefly 3 times or more in succession. (→P.326)

However, do not touch the power switch while driving except in an emergency. Turning the hybrid system off while driving will not cause loss of steering or braking control, however, power assist to the steering will be lost. This will make it more difficult to steer smoothly, so you should pull over and stop the vehicle as soon as it is safe to do so.

- If the power switch is operated while the vehicle is running, a warning message will be shown on the multi-information display and a buzzer sounds.

- When restarting the hybrid system after an emergency shutdown, press the power switch.

**Changing power switch modes**

Modes can be changed by pressing the power switch with the brake pedal released. (The mode changes each time the switch is pressed.)

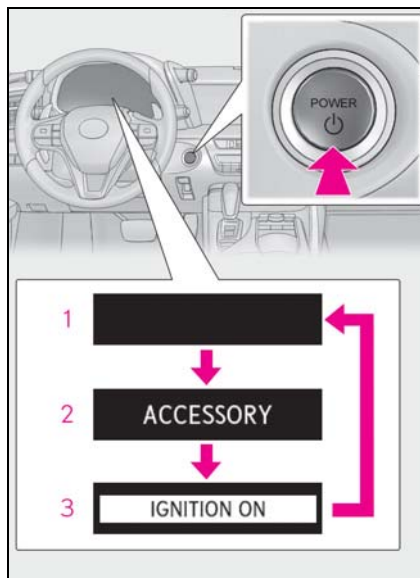

**1 Off**

The emergency flashers can be used.

**2 ACCESSORY mode**

Some electrical components such as the audio system can be used.

"ACCESSORY" will be displayed on the meter.

**3 ON mode**

All electrical components can be used.

"IGNITION ON" will be displayed on the meter.

■ Auto power off function

If the vehicle is left in ACCESSORY mode for more than 20 minutes or ON mode (the hybrid system is not operating) for more than an hour with the shift position in P, the power switch will automatically turn off.

However, this function cannot entirely prevent the 12-volt battery discharge. Do not leave the vehicle with the power switch in ACCESSORY or ON mode for long periods of time when the hybrid system is not operating.

#### ■ When the shift control system malfunctions

When attempting to turn the power switch off while there is a malfunction in the shift control system, the power switch mode may change to ACCESSORY mode. In this case, ACCESSORY mode may be turned off by applying the parking brake and pressing the power switch again. If there is a malfunction in the system, have the vehicle inspected by your Lexus dealer immediately.



#### NOTICE

##### ■ To prevent 12-volt battery discharge

- Do not leave the power switch in ACCESSORY or ON mode for long periods of time without the hybrid system on.
- If "ACCESSORY" or "IGNITION ON" is displayed on the meter, the power switch is not off. Exit the vehicle after turning the power switch off.

### EV drive mode (LC500h)

In EV drive mode, electric power is supplied by the hybrid battery (traction battery), and only the electric motor (traction motor) is used to drive the vehicle.

This mode allows you to drive in residential areas early in the morning and late at night, or in indoor parking lots etc. without concern for noises and gas emissions.

However, when the vehicle proximity notification system is active, the vehicle may produce sound.

#### Operating instructions

Turns EV drive mode on/off

When EV drive mode is turned on, the EV drive mode indicator will come on. Pressing the switch when in EV drive mode will return the vehicle to normal driving (using the gasoline engine and electric motor [traction motor]).



#### ■ Situations in which EV drive mode cannot be turned on

It may not be possible to turn EV drive mode on in the following situations. If it cannot be turned on, a buzzer will sound and a message will be shown on the multi-infor-

mation display.

- The temperature of the hybrid system is high.  
The vehicle has been left in the sun, driven on a hill, driven at high speeds, etc.
- The temperature of the hybrid system is low.  
The vehicle has been left in temperatures lower than about 32°F (0°C) for a long period of time etc.
- The gasoline engine is warming up.
- The hybrid battery (traction battery) is low.  
The remaining battery level indicated in the "Energy monitor" display is low. (→P.96)
- Vehicle speed is high.
- The accelerator pedal is depressed firmly or the vehicle is on a hill etc.
- The windshield defogger is in use.
- When the shift position is in M.

#### ■ Switching to EV drive mode when the gasoline engine is cold

If the hybrid system is started while the gasoline engine is cold, the gasoline engine will start automatically in order to warm up. In this case, you will become unable to switch to EV drive mode.

To prevent gasoline engine warm up in order to reduce noises, start the hybrid system without starting the gasoline engine, pressing the power switch with fully depressing the brake pedal and pressing the EV drive mode switch.

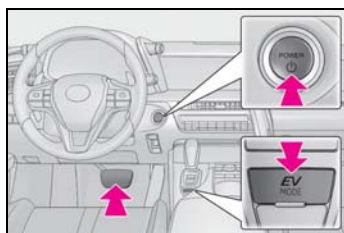

#### ■ Automatic cancelation of EV drive mode

When driving in EV drive mode, the gasoline engine may automatically restart in the following situations. When EV drive mode

is canceled, a buzzer will sound and the EV drive mode indicator will flash and go off.

- The hybrid battery (traction battery) becomes low.  
The remaining battery level indicated in the "Energy monitor" display is low. (→P.96)
- Vehicle speed is high.
- The accelerator pedal is depressed firmly or the vehicle is on a hill etc.

When it is possible to inform the driver of automatic cancelation in advance, a prior notice screen will appear on the multi-information display.

#### ■ Possible driving distance when driving in EV drive mode

EV drive mode's possible driving distance ranges from a few hundred meters to approximately 0.6 mile (1 km). However, depending on vehicle conditions, there are situations when EV drive mode cannot be used.

(The distance that is possible depends on the hybrid battery [traction battery] level and driving conditions.)

#### ■ Fuel economy

The hybrid system is designed to achieve the best possible fuel economy during normal driving (using the gasoline engine and electric motor [traction motor]). Driving in EV drive mode more than necessary may lower fuel economy.

#### ■ If "EV Mode Unavailable" is shown on the multi-information display

The EV drive mode is not available. The reason the EV drive mode is not available (the vehicle is idling, battery charge is low, vehicle speed is higher than the EV drive mode operating speed range or accelerator pedal is depressed too much) may be displayed. Use the EV drive mode when it becomes available.

#### ■ If "EV Mode Deactivated" is shown on the multi-information display

The EV drive mode has been automatically canceled. The reason the EV drive mode is not available (the battery charge is low, vehicle speed is higher than the EV drive mode operating speed range or accelera-

tor pedal is depressed too much) may be displayed. Drive the vehicle for a while before attempting to turn on the EV drive mode again.

### WARNING

#### ■ Caution while driving

When driving in EV drive mode, pay special attention to the area around the vehicle. Because there is no engine noise, pedestrians, people riding bicycles or other people and vehicles in the area may not be aware of the vehicle starting off or approaching them, so take extra care while driving. Therefore, take extra care while driving even if the vehicle proximity notification system is active.

## Automatic transmission (LC500)

Select the shift position depending on your purpose and situation.

### Shift position purpose and functions

Shift position	Objective or function
P	Parking the vehicle/starting the engine
R	Reversing
N	Neutral (Condition in which the power is not transmitted)
D	Normal driving <sup>*1</sup>
M	M mode driving <sup>*2</sup> (→P.160)

<sup>\*1</sup>: To improve fuel efficiency and reduce noise, set the shift position in D for normal driving. You can choose gear range suitable for your driving situation by operating the paddle shift switches.

<sup>\*2</sup>: Any gear range can be fixed when driving in M mode.

#### ■ For the shift positions

- When the engine switch is off or in ACCESSORY mode, the shift position cannot be changed.
- When the engine switch is in IGNITION ON mode, the shift position can only be changed to N.
- When the engine is running, the shift position can be changed from P to D, N or R.
- The shift position can only be changed to M directly from D.

In addition, if an attempt is made to change the shift position by moving the shift lever or by pressing the P position switch in any of the following situations, the buzzer will sound and the shifting operation will be disabled or the shift position will automatically change to N. When this happens, select an appropriate shift position.

- Situations where the shifting operation will be disabled:
  - When an attempt is made to change the shift position from P to another position by moving the shift lever without depressing the brake pedal.
  - When an attempt is made to change the shift position from P or N to M by moving the shift lever.
  - When the P position switch is pressed while the vehicle is running.<sup>\*1</sup>
- Situations where the shift position will automatically change to N:
  - When an attempt is made to select the R position by moving the shift lever when the vehicle is moving forward.<sup>\*2</sup>
  - When an attempt is made to select the D position by moving the shift lever when the vehicle is moving in reverse.<sup>\*3</sup>
  - When the shift position is changed from R to M
- If N is selected while driving at a certain speed, even if the shift lever is not held in the N position, the shift position changes to N. In this situation, the buzzer sounds and a confirmation message is displayed on the multi-information display to inform the driver that the shift position has changed to N.

<sup>\*1</sup>: Shift position may be changed to P when driving at extremely low speeds.

<sup>\*2</sup>: Shift position may be changed to R when driving at low speeds.

<sup>\*3</sup>: Shift position may be changed to D when driving at low speeds.

#### ■ Reverse warning buzzer

When shifting into R, a buzzer will sound to inform the driver that the shift position is in R.

#### ■ To protect the automatic transmission

If the automatic transmission fluid temperature is high, "Transmission Fluid Temp High See Owner's Manual" will be displayed on the multi-information display and the vehicle will go into transmission protection mode automatically. Have the vehicle inspected by your Lexus dealer.

#### ■ When driving with dynamic radar cruise control with full-speed range activated

Even when performing the following actions with the intent of enabling engine braking, engine braking will not be activated because dynamic radar cruise control with full-speed range will not be canceled.

- While driving in the D position, downshifting to 9, 8, 7, 6, 5 or 4.
- When switching the driving mode to sport mode while driving in D position. (→P.213)

#### ■ Restraining sudden start (Drive-Start Control)

→P.137

#### ■ AI-SHIFT

The AI-SHIFT automatically selects the suitable gear according to driver performance and driving conditions.

The AI-SHIFT automatically operates when the shift position is in D. (Shifting the shift position to M cancels the function.)

#### ■ If a message about a shift operation is shown

To prevent the shift position from being selected incorrectly or the vehicle from moving unexpectedly, the shift position may be changed automatically or operating the shift lever may be required. In this case, change the shift position following the messages on the multi-information display.

#### ■ After recharging/reconnecting the 12-volt battery

→P.299

#### ■ Customization

Settings (e.g. reverse warning buzzer) can be changed. (Customizable features: →P.391)



**⚠ WARNING****■ When driving on slippery road surfaces**

Do not accelerate or shift the shift position suddenly.  
Sudden changes in engine braking may cause the vehicle to spin or skid, resulting in an accident.

**⚠ NOTICE****■ Situations where shift control system malfunctions are possible**

If any of the following situations occurs, shift control system malfunctions are possible.  
Immediately stop the vehicle in a safe place on level ground, apply the parking brake, and then contact your Lexus dealer.

- When the warning message indicating the shift control system appears on the multi-information display.
- The display indicates that no shift position is selected for more than a few seconds.

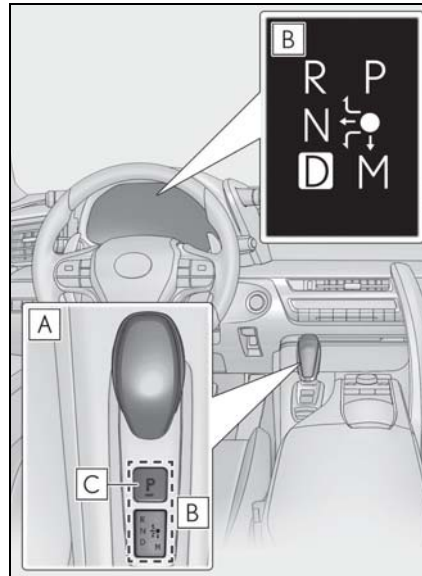
**Shifting the shift lever****A** Shift lever

Operate the shift lever gently and securely in the direction of the arrow on the shift position indicator.

To shift to N, slide the shift lever in the direction of the arrow and hold it.

Release the shift lever after each shifting operation to allow it to return to its regular position (●).

Shifting to M is only possible when the shift position is in D.

When shifting from P to N, D or R, from N, D, M or R to P, from D or M to R, or from R to D, ensure that the brake pedal is being depressed and the vehicle is stationary.

**B** Shift position indicator

Meter display:

The current shift position is highlighted.  
When any shift position other than D or M is selected, the arrow toward M and M position indicator are displayed in gray.

Shift lever display:

The current shift position is illuminated.

When selecting the shift position, make sure that the shift position has been changed to the desired position by checking the shift position indicator provided on the instrument cluster.

**C** P position switch

**⚠ WARNING**

**■ For the shift lever**

- Do not remove the shift lever knob or use anything but a genuine Lexus shift lever knob. Also, do not hang anything on the shift lever. Doing so could prevent the shift lever from returning to position, causing unexpected accidents to occur when the vehicle is in motion.
- In order to prevent the shift position from accidentally being changed, do not touch the shift lever when not using them.

**P position switch**

**■ When shifting the shift position to P**

Fully stop the vehicle and set the parking brake, and then press the P position switch.

When the shift position is changed to P, the switch illuminates.

Check that the shift position indicator shows P.

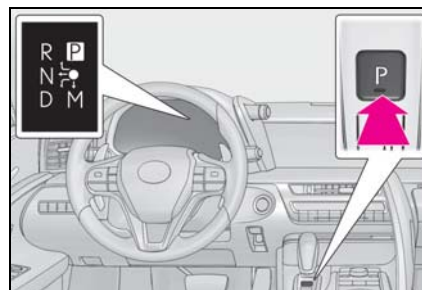

**■ Shifting the shift position from P to other positions**

- While depressing the brake pedal firmly, operate the shift lever. If the shift lever is operated without depressing the brake pedal, the buzzer will sound and the shifting operation will be disabled.
- When selecting the shift position, make sure that the shift position has been changed to the desired position by checking the shift position indicator provided on the instrument cluster.
- The shift position cannot be changed from P to M directly.

**■ Automatic P position selection function**

In the following situations, the shift position is automatically changed to P.

- When pressing the engine switch with the vehicle stopped while the engine switch is in IGNITION ON mode and the shift position is in a position other than P (after the shift position has changed to P, the engine switch will turn off)\*
- When the vehicle is stopped after the engine has been stopped in an emergency while driving
- When voltage of the 12-volt battery drops while the shift position is in a position other than P

\*: When the engine switch is pressed while

driving at extremely slow speeds, such as immediately before stopping the vehicle, the shift position may automatically change to P. Make sure that the vehicle is completely stopped before pressing the engine switch.

**■ If the shift position cannot be shifted from P**

There is a possibility that the 12-volt battery is discharged. Check the 12-volt battery in this situation. (→P.357)

**⚠ WARNING**

**■ P position switch**

- Do not press the P position switch while the vehicle is moving. If the P position switch is pressed when driving at very low speeds (for example, directly before stopping the vehicle), the vehicle may stop suddenly when the shift position switches to P, which could lead to an accident.
- In order to prevent the shift position from accidentally being changed, do not touch the P position switch or shift lever when not using them.

**⚠ NOTICE**

**■ Notes regarding shift lever and P position switch operation**

Avoid repeatedly operating the shift lever and P position switch in quick succession. The system protection function may activate and it will not be temporarily possible to shift the shift position other than P. If this happens, please wait for a while before attempting to change the shift position again.

**Selecting the driving mode**

**■ Driving mode**

→P.213

**■ Snow mode**

Snow mode can be selected to suit the conditions when driving on slippery road surfaces, such as on snow.

Turn the  switch backward.

The snow mode indicator comes on.

Turn the  switch backward again to return to normal mode.

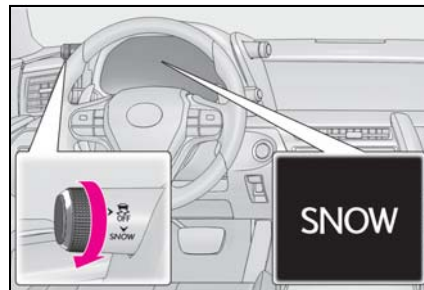

**■ Snow mode automatic deactivation**

Snow mode is automatically deactivated if the engine switch is turned off after driving in snow mode.

**Selecting shift ranges in the D position**

To drive using temporary shift range selection, operate the “-” or “+” paddle shift switch.

When the “-” paddle shift switch is operated, the shift range switches to a range that enables engine braking force that is suitable to driving conditions. When the “+” paddle shift switch is operated, the shift range switches to a range that is one range higher than the current range.

Changing the shift range allows restriction of the highest gear, prevent-

ing unnecessary upshifting and enabling the level of engine braking force to be selected.

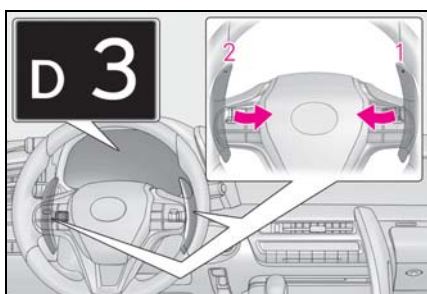

- 1 Upshifting
- 2 Downshifting

The selected shift range, from D1 to D10, will be displayed in the meter.

To return to normal D position driving, the “+” paddle shift switch must be held down for a period of time.

Meter display	Function
D2 - D10	A gear in the range between D1 and the selected shift range is automatically chosen depending on vehicle speed and driving conditions
D1	Setting the shift range at D1

A lower shift range will provide greater engine braking forces than a higher shift range.

**Automatic deactivation of shift range selection in the D position**

Shift range selection in the D position will be deactivated in the following situations:

- When the vehicle comes to a stop
- If the accelerator pedal is depressed for more than a certain period of time
- When the shift lever is moved to D again
- When pressing and holding the “+” pad-

dle shift switch

**Downshifting restriction warning buzzer**

To help ensure safety and driving performance, downshifting operation may sometimes be restricted. In some circumstances, downshifting may not be possible even when the paddle shift switch is operated. (A buzzer will sound twice.)

**Selecting gears in the M position**

To enter M mode, shift the shift position to M. Gears can be selected by operating the paddle shift switches, allowing you to drive in the gear of your choosing.

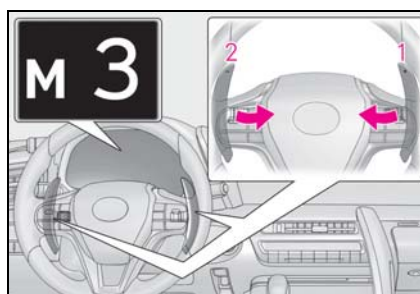

- 1 Upshifting
- 2 Downshifting

The gear changes once every time the paddle shift switch is operated.

The selected gear, from M1 to M10, will be fixed and displayed in the meter.

When in the M position, the gear will not change unless the paddle shift switches are operated.

However, even when in the M position, the gears will be automatically changed in the following situation:

- When vehicle speed drops (downshift only).
- When it is necessary to protect the

engine or automatic transmission when the engine coolant temperature is low, the automatic transmission fluid temperature is high or low, or other reasons.

Also, the gear will not shift when the vehicle speed is low, even if an upshift operation is performed.

#### ■ Downshifting restriction warning buzzer

To help ensure safety and driving performance, downshifting operation may sometimes be restricted. In some circumstances, downshifting may not be possible even when the paddle shift switch is operated. (A buzzer will sound twice.)

### Hybrid transmission (LC500h)

Select the shift position depending on your purpose and situation.

#### Shift position purpose and functions

Shift position	Objective or function
P	Parking the vehicle/starting the hybrid system
R	Reversing
N	Neutral (Condition in which the power is not transmitted)
D	Normal driving <sup>*1</sup>
M	M mode driving <sup>*2</sup> (→P.166)

<sup>\*1</sup>: To improve fuel efficiency and reduce noise, set the shift position in D for normal driving. You can choose gear range suitable for your driving situation by operating the paddle shift switches.

<sup>\*2</sup>: Any gear range can be fixed when driving in M mode.

#### ■ For the shift positions

- When the power switch is off, the shift position cannot be changed.
- When the power switch is in ON mode (the hybrid system is not operating), the shift position can only be changed to N.
- When the "READY" indicator is on, the shift position can be changed from P to D, N or R.
- When the "READY" indicator is flashing, the shift position cannot be changed from P to another position even if the shift lever is operated. Wait until the "READY" indi-

cator changes from a flashing to a solid light, and then operate the shift lever again.

- The shift position can only be changed to M directly from D.

In addition, if an attempt is made to change the shift position by moving the shift lever or by pressing the P position switch in any of the following situations, the buzzer will sound and the shifting operation will be disabled or the shift position will automatically change to N. When this happens, select an appropriate shift position.

- Situations where the shifting operation will be disabled:
  - When an attempt is made to change the shift position from P to another position by moving the shift lever without depressing the brake pedal.
  - When an attempt is made to change the shift position from P or N to M by moving the shift lever.
  - When the P position switch is pressed while the vehicle is running.<sup>\*1</sup>
- Situations where the shift position will automatically change to N:
  - When an attempt is made to select the R position by moving the shift lever when the vehicle is moving forward.<sup>\*2</sup>
  - When an attempt is made to select the D position by moving the shift lever when the vehicle is moving in reverse.<sup>\*3</sup>
  - When the shift position is changed from R to M
- If N is selected while driving at a certain speed, even if the shift lever is not held in the N position, the shift position changes to N. In this situation, the buzzer sounds and a confirmation message is displayed on the multi-information display to inform the driver that the shift position has changed to N.

<sup>\*1</sup>: Shift position may be changed to P when driving at extremely low speeds.

<sup>\*2</sup>: Shift position may be changed to R when driving at low speeds.

<sup>\*3</sup>: Shift position may be changed to D when driving at low speeds.

#### ■ Reverse warning buzzer

When shifting into R, a buzzer will sound to inform the driver that the shift position is in R.

#### ■ To protect the hybrid transmission

If the transmission fluid temperature is high, "Transmission Fluid Temp High See Owner's Manual" will be displayed on the multi-information display and the vehicle will go into transmission protection mode automatically. Have the vehicle inspected by your Lexus dealer.

#### ■ When driving with dynamic radar cruise control with full-speed range activated

- When dynamic radar cruise control with full-speed range is operating, the system does not respond to paddle shift switch operations.
- Even when the driving mode is switched to sport mode with the intent of enabling engine braking, dynamic radar cruise control with full-speed range is not canceled and engine braking is not activated.

#### ■ Restraining sudden start (Drive-Start Control)

→P.137

#### ■ AI-SHIFT

The AI-SHIFT automatically selects the suitable gear according to driver performance and driving conditions.

The AI-SHIFT automatically operates when the shift position is in D. (Shifting the shift position to the M position cancels the function.)

#### ■ If a message about a shift operation is shown

To prevent the shift position from being selected incorrectly or the vehicle from moving unexpectedly, the shift position may be changed automatically or operating the shift lever may be required. In this case, change the shift position following the messages on the multi-information display.

#### ■ After recharging/reconnecting the 12-volt battery

→P.299

### ■ Customization

Settings (e.g. reverse warning buzzer) can be changed.  
(Customizable features: →P.391)

### ⚠ WARNING

#### ■ When driving on slippery road surfaces

Do not accelerate or shift the shift position suddenly.  
Sudden changes in engine braking may cause the vehicle to spin or skid, resulting in an accident.

### ⚠ NOTICE

#### ■ Hybrid battery (traction battery) charge

If the shift position is in N, the hybrid battery (traction battery) will not be charged. To help prevent the battery from discharging, avoid leaving the N position selected for an extended period of time.

#### ■ Situations where shift control system malfunctions are possible

If any of the following situations occurs, shift control system malfunctions are possible.  
Immediately stop the vehicle in a safe place on level ground, apply the parking brake, and then contact your Lexus dealer.

- When the warning message indicating the shift control system appears on the multi-information display.
- The display indicates that no shift position is selected for more than a few seconds.

## Shifting the shift lever

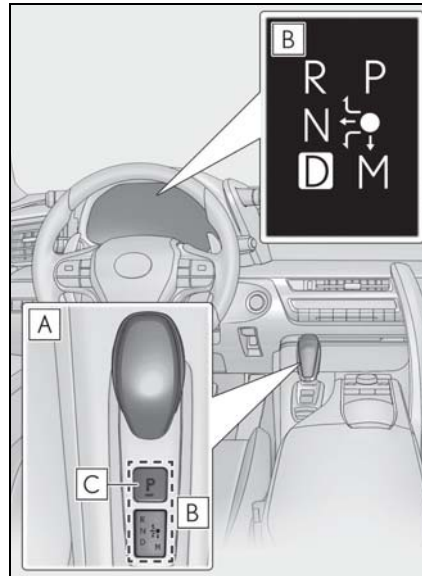

### A Shift lever

Operate the shift lever gently and securely in the direction of the arrow on the shift position indicator.

To shift to N, slide the shift lever in the direction of the arrow and hold it.

Release the shift lever after each shifting operation to allow it to return to its regular position (●).

Shifting to M is only possible when the shift position is in D.

When shifting from P to N, D or R, from N, D, M or R to P, from D or M to R, or from R to D, ensure that the brake pedal is being depressed and the vehicle is stationary.

### B Shift position indicator

Meter display:

The current shift position is highlighted.  
When any shift position other than D or M is selected, the arrow toward M and M position indicator are displayed in gray.

Shift lever display:

The current shift position is illuminated.

When selecting the shift position, make sure that the shift position has been changed to the desired position by checking the shift position indicator provided on the instrument cluster.

**C** P position switch

**⚠ WARNING**

**■ For the shift lever**

- Do not remove the shift lever knob or use anything but a genuine Lexus shift lever knob. Also, do not hang anything on the shift lever. Doing so could prevent the shift lever from returning to position, causing unexpected accidents to occur when the vehicle is in motion.
- In order to prevent the shift position from accidentally being changed, do not touch the shift lever when not using them.

**P position switch**

**■ When shifting the shift position to P**

Fully stop the vehicle and set the parking brake, and then press the P position switch.

When the shift position is changed to P, the switch illuminates.

Check that the shift position indicator shows P.

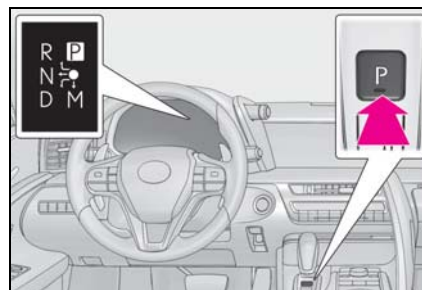

**■ Shifting the shift position from P to other positions**

- While depressing the brake pedal firmly, operate the shift lever. If the shift lever is operated without depressing the brake pedal, the buzzer will sound and the shifting operation will be disabled.
- When selecting the shift position, make sure that the shift position has been changed to the desired position by checking the shift position indicator provided on the instrument cluster.
- The shift position cannot be changed from P to M directly.

**■ Automatic P position selection function**

In the following situations, the shift position is automatically changed to P.

- When pressing the power switch with the vehicle stopped while the power switch is in ON mode and the shift position is in a position other than P (after the shift position has changed to P, the power switch will turn off)\*
- When the vehicle is stopped after the hybrid system has been stopped in an emergency while driving
- When voltage of the 12-volt battery drops while the shift position is in a position other than P

\*: When the power switch is pressed while



driving at extremely slow speeds, such as immediately before stopping the vehicle, the shift position may automatically change to P. Make sure that the vehicle is completely stopped before pressing the power switch.

■ **If the shift position cannot be shifted from P**

There is a possibility that the 12-volt battery is discharged. Check the 12-volt battery in this situation. (→P.357)

**⚠ WARNING**

■ **P position switch**

- Do not press the P position switch while the vehicle is moving. If the P position switch is pressed when driving at very low speeds (for example, directly before stopping the vehicle), the vehicle may stop suddenly when the shift position switches to P, which could lead to an accident.
- In order to prevent the shift position from accidentally being changed, do not touch the P position switch or shift lever when not using them.

**⚠ NOTICE**

■ **Notes regarding shift lever and P position switch operation**

Avoid repeatedly operating the shift lever and P position switch in quick succession. The system protection function may activate and it will not be temporarily possible to shift the shift position other than P. If this happens, please wait for a while before attempting to change the shift position again.

**Selecting the driving mode**

■ **Driving mode**

→P.213

■ **Snow mode**

Snow mode can be selected to suit the conditions when driving on slippery road surfaces, such as on snow.

Turn the  switch backward.

The snow mode indicator comes on.

Turn the  switch backward again to return to normal mode.

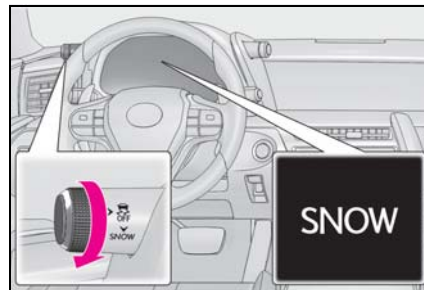

■ **Snow mode automatic deactivation**

Snow mode is automatically deactivated if the power switch is turned off after driving in snow mode.

**Selecting shift ranges in the D position**

To drive using temporary shift range selection, operate the “-” or “+” paddle shift switch.

When the “-” paddle shift switch is operated, the shift range switches to a range that enables engine braking force that is suitable to driving conditions. When the “+” paddle shift switch is operated, the shift range switches to a range that is one range higher than the current range.

Changing the shift range allows restriction of the highest shift range,

preventing unnecessary upshifting and enabling the level of engine braking force to be selected.

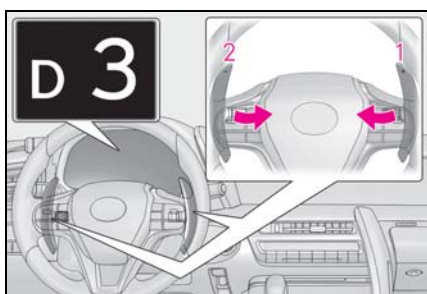

1 Upshifting

2 Downshifting

The selected shift range, from D1 to D10, will be displayed in the meter.

To return to normal D position driving, the “+” paddle shift switch must be held down for a period of time.

Meter display	Function
D2 - D10	A gear in the range between D1 and the selected shift range is automatically chosen depending on vehicle speed and driving conditions
D1	Setting the shift range at D1

A lower shift range will provide greater engine braking forces than a higher shift range.

■ **Automatic deactivation of shift range selection in the D position**

Shift range selection in the D position will be deactivated in the following situations:

- When the vehicle comes to a stop
- If the accelerator pedal is depressed for more than a certain period of time
- When the shift lever is moved to D again
- When the “+” paddle shift switch is

pressed and held

- When dynamic radar cruise control with full-speed range is operating

■ **Downshifting restriction warning buzzer**

To help ensure safety and driving performance, downshifting operation may sometimes be restricted. In some circumstances, downshifting may not be possible even when the paddle shift switch is operated. (A buzzer will sound twice.)

**Selecting gears in the M position**

To enter M mode, shift the shift position to M. Gears can be selected by operating the paddle shift switches, allowing you to drive in the gear of your choosing.

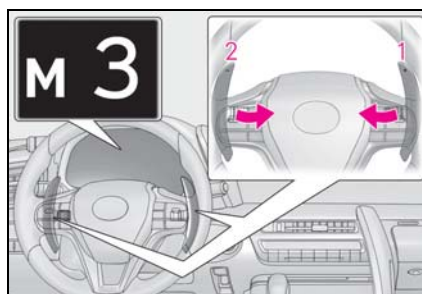

1 Upshifting

2 Downshifting

The gear changes once every time the paddle shift switch is operated.

The selected gear, from M1 to M10, will be fixed and displayed in the meter.

When in the M position, the gear will not change unless the paddle shift switches are operated.

However, even when in the M position, the gears will be automatically changed in the following situation:

- When vehicle speed drops (down-

shift only).

- When vehicle speed increases (upshift only).
- When the accelerator pedal is firmly depressed.
- When it is necessary to protect the transmission fluid temperature is high or low, or other reasons.

Also, the gear will not shift when the vehicle speed is low, even if an upshift operation is performed.

#### ■ Downshifting restrictions warning buzzer

To help ensure safety and driving performance, downshifting operation may sometimes be restricted. In some circumstances, downshifting may not be possible even when the paddle shift switch is operated. (A buzzer will sound twice.)

### Turn signal lever

#### Operating instructions

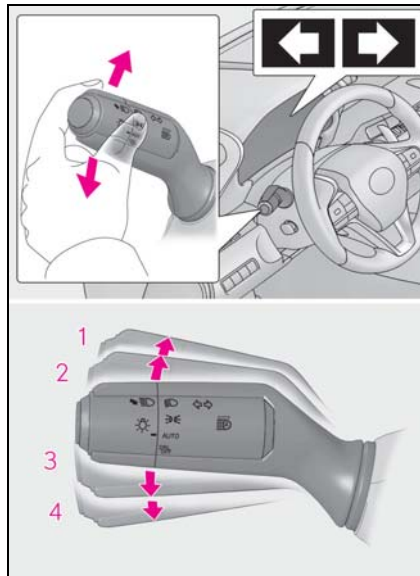

- 1 Right turn
- 2 Lane change to the right (move the lever partway and release it)  
The right hand signals will flash 3 times.
- 3 Lane change to the left (move the lever partway and release it)  
The left hand signals will flash 3 times.
- 4 Left turn

#### ■ Turn signals can be operated when

The engine switch <power switch> is in IGNITION ON mode <ON mode>.

#### ■ If the indicator flashes faster than usual

Check that a light bulb in the front or rear turn signal lights has not burned out.

#### ■ If the turn signals stop flashing before a lane change has been performed

Operate the lever again.

■ Customization

→P.391

## Parking brake

The parking brake can be set or released automatically or manually.

In automatic mode, the parking brake can be set or released automatically according to shift lever operation. Also, even in automatic mode, the parking brake can be set or released manually.

## Operating instructions

### ■ Using the manual mode

The parking brake can be set and released manually.

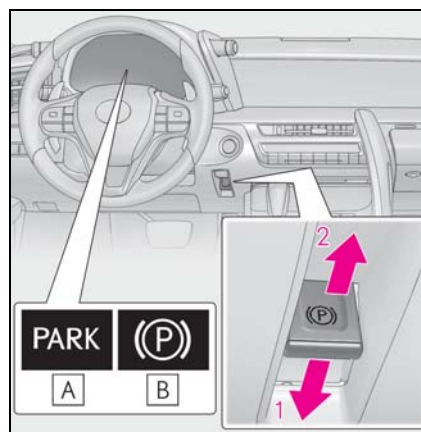

**A** U.S.A.

**B** Canada

- 1** Push the switch to set the parking brake

The parking brake indicator light will turn on.

Press and hold the parking brake switch if an emergency occurs and it is necessary to operate the parking brake while driving.

## 2 Pull the switch to release the parking brake

- Operate the parking brake switch while depressing the brake pedal.
- Using the parking brake automatic release function, the parking brake can be released by depressing the accelerator pedal. When using this function, slowly depress the accelerator pedal.

Make sure that the parking brake indicator light turn off.

### ■ Turning the automatic mode on

While the vehicle is stopped, press and hold the parking brake switch until a message is shown on the multi-information display

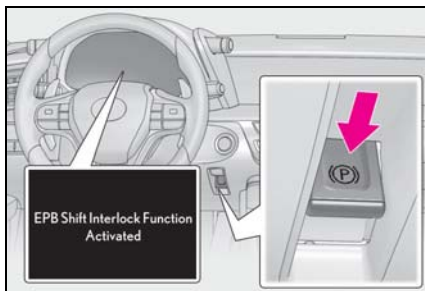

When the automatic mode is turned on, the parking brake operates as follows.

- When the shift position is shifted from P, the parking brake will be released, and the parking brake indicator light turn off.
- When the shift position is shifted to P, the parking brake will be set, and the parking brake indicator light turn on.

Operate the shift lever and P position switch with the vehicle stopped and the brake pedal depressed.

### ■ Turning the automatic mode off

While the vehicle is stopped, pull and hold the parking brake switch until a message is shown on the multi-information display

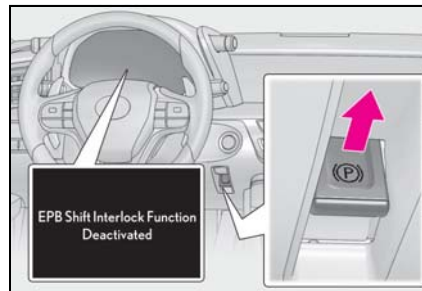

### ■ Parking brake operation

- When the engine switch <power switch> is not in IGNITION ON mode <ON mode>, the parking brake cannot be released using the parking brake switch.
- When the engine switch <power switch> is not in IGNITION ON mode <ON mode>, automatic mode (automatic brake setting and releasing) is not available.

### ■ Parking brake automatic release function

- When the shift position is shifted from P, the parking brake will be released in automatic mode.
- When all of the following conditions are met in manual mode, the parking brake can be released by depressing the accelerator pedal.
  - The driver's door is closed
  - The driver is wearing the seat belt
  - The shift position is in D, M or R

### ■ If "EPB frequently operated Wait a minute" is displayed on the multi-information display

If the parking brake is operated repeatedly over a short period of time, the system may restrict operation to prevent overheating. If this happens, refrain from operating the parking brake. Normal operation will return after about 1 minute.

■ **If “EPB Activation Stopped Incompletely” or “EPB unavailable” is displayed on the multi-information display**

Operate the parking brake switch. If the message does not disappear after operating the switch several times, the system may be malfunctioning. Have the vehicle inspected by your Lexus dealer.

■ **Parking brake operation sound**

When the parking brake operates, a motor sound (whirring sound) may be heard. This does not indicate a malfunction.

■ **Parking brake indicator light**

- Depending on the engine switch <power switch> mode, the parking brake indicator light will turn on and stay on as described below:

IGNITION ON mode <ON mode>:  
Comes on until the parking brake is released.

Not in IGNITION ON mode <ON mode>: Stays on for approximately 15 seconds.

- When the engine switch <power switch> is turned off with the parking brake set, the parking brake indicator light will stay on for about 15 seconds. This does not indicate a malfunction.

■ **When the parking brake switch malfunctions**

Automatic mode (automatic brake setting and releasing) will be turned on automatically.

■ **Parking the vehicle**

→P.136

■ **Parking brake engaged warning buzzer**

A buzzer will sound if the vehicle is driven with the parking brake engaged. “EPB applied” is displayed on the multi-information display (with the vehicle reached a speed of 3 mph [5 km/h]).

■ **If the brake system warning light comes on**

→P.335

■ **Usage in winter time**

→P.238

 **WARNING**

■ **When parking the vehicle**

Do not leave a child in the vehicle alone. The parking brake may be released unintentionally and there is the danger of the vehicle moving that may lead to an accident resulting in death or serious injury.

 **NOTICE**

■ **When parking the vehicle**

Before you leave the vehicle, shift the shift position to P, set the parking brake and make sure that the vehicle does not move.

■ **When the system malfunctions**

Stop the vehicle in a safe place and check the warning messages.

■ **When the parking brake cannot be released due to a malfunction**

Driving the vehicle with the parking brake set will lead to brake components overheating, which may affect braking performance and increase brake wear.

Have the vehicle inspected by your Lexus dealer immediately if this occurs.

## Brake Hold

The brake hold system keeps the brakes applied when the vehicle is stopped by depressing the brake pedal. You may want this system when you are caught in a traffic congestion or waiting for a traffic light to change.

This system keeps the brake applied when the shift position is in D, M or N with the system on and the brake pedal has been depressed to stop the vehicle. The system releases the brake when the accelerator pedal is depressed with the shift position in D or M to allow smooth start off.

### Enabling the system

Press the brake hold switch to turn the system on

The brake hold standby indicator **A** comes on. While the system is holding the brake, the brake hold operated indicator

**B** comes on.

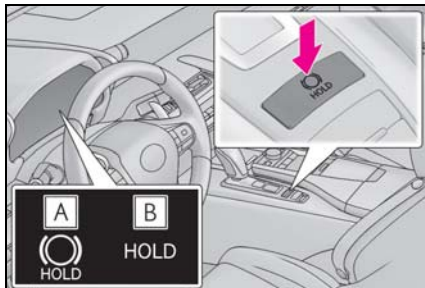

### Brake hold system operating conditions

The brake hold system cannot be turned on in the following conditions:

- The driver's door is not closed.
- The driver is not wearing the seat belt.
- "EPB Activation Stopped Incompletely" or "EPB Malfunction Visit Your dealer" is displayed on the multi-information display.

If any of the conditions above are detected when the brake hold system is enabled, the system will turn off and the brake hold standby indicator light will go off. In addition, if any of the conditions are detected while the system is holding the brake, a warning buzzer will sound and a message will be shown on the multi-information display. The parking brake will then be set automatically.

### Brake hold function

- If the brake pedal is left released for a period of about 3 minutes after the system has started holding the brake, the parking brake will be set automatically. In this case, a warning buzzer sounds and a message is shown on the multi-information display.
- To turn the system off while the system is holding the brake, firmly depress the brake pedal and press the button again.
- The brake hold function may not hold the vehicle when the vehicle is on a steep incline. In this situation, it may be necessary for the driver to apply the brakes. A warning buzzer will sound and the multi-information display will inform the driver of this situation. (→P.344)

### When the parking brake is set automatically while the system is holding the brakes

The parking brake will not be released automatically. Perform one of the following procedures to release the parking brake and confirm that the parking brake indicator light turns off. (→P.168)

- With the brake pedal depressed, operate the parking brake switch.
- Fasten your seat belt, check that the shift position is in either D or R and slowly depress the accelerator pedal.

**■ When an inspection at your Lexus dealer is necessary**

When the brake hold standby indicator (green) does not illuminate even when the brake hold switch is pressed with the brake hold system operating conditions met, the system may be malfunctioning. Have the vehicle inspected at your Lexus dealer.

**■ If “Brake Hold Unavailable” is shown on the multi-information display**

The brake hold system cannot be used. The reason the brake hold system is not available (the driver’s door opens, the driver’s seat belt is unfasten, or the hood or trunk opens) is displayed. Use the brake hold system when it becomes available.

**■ Warning message and buzzers**

Warning messages and buzzers are used to indicate a system malfunction or to inform the driver of the need for caution.  
(→P.344)

**WARNING****■ When the vehicle is on a steep incline**

When using the brake hold system on a steep incline exercise caution. The brake hold function may not hold the vehicle in such a situation.

**■ When stopped on a slippery road**

The system cannot stop the vehicle when the gripping ability of the tires has been exceeded. Do not use the system when stopped on a slippery road.

**NOTICE****■ When parking the vehicle**

The brake hold system is not designed for use when parking the vehicle for a long period of time. Turning the engine switch <power switch> off while the system is holding the brake may release the brake, which would cause the vehicle to move. When operating the engine switch <power switch>, depress the brake pedal, set the parking brake and shift the shift position to P.



## Headlight switch

The headlights can be operated manually or automatically.

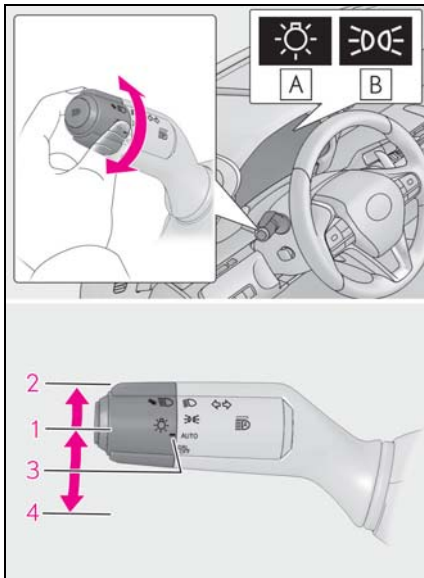

### Turning on the headlights

Operating the  switch turns on the lights as follows:



**A** U.S.A.

**B** Canada

- 1**  The side marker, parking, tail, license plate, instrument panel lights, and daytime running lights turn on.
- 2**  The headlights and all the lights listed above (except daytime running lights) turn on.
- 3** **AUTO** The headlights, daytime running lights and all the lights listed

above turn on and off automatically.

**4**  (U.S.A.) Off

○ (Canada) The daytime running lights turn on.

### ■ AUTO mode can be used when

The engine switch <power switch> is in IGNITION ON mode <ON mode>.

### ■ Daytime running light system

- The daytime running lights illuminate using the same lights as the parking lights and illuminate brighter than the parking lights.
- To make your vehicle more visible to other drivers during daytime driving, the daytime running lights turn on automatically when all of the following conditions are met. (The daytime running lights are not designed for use at night.)
  - The engine is running <hybrid system is operating>
  - The parking brake is released
  - The headlight switch is in the ○ (Canada only),  or **AUTO**\* position

\* : When the surroundings are bright

The daytime running lights remain on after they illuminate, even if the parking brake is set again.

- For the U.S.A.: Daytime running lights can be turned off by operating the headlight switch to  position.
- Compared to turning on the headlights, the daytime running light system offers greater durability and consumes less electricity, so it can help improve fuel economy.

### ■ Headlight control sensor

The sensor may not function properly if an object is placed on the sensor, or anything that blocks the sensor is affixed to the windshield.

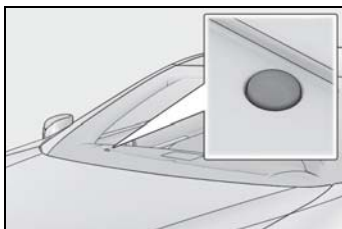

Doing so interferes with the sensor detecting the level of ambient light and may cause

the automatic headlight system to malfunction.



■ **Automatic light off system**

- When the headlights come on: The headlights and tail lights turn off 30 seconds after the driver's door is opened and closed if the engine switch <power switch> is turned to ACCESSORY mode or turned off. (The lights turn off immediately if  on the key is pressed after all the doors are locked.)
- When only the tail lights come on: The tail lights turn off automatically if the engine switch <power switch> is turned to ACCESSORY mode or turned off and the driver's door is opened.

To turn the lights on again, turn the engine switch <power switch> to IGNITION ON mode <ON mode>, or turn the light switch off once and then back to  or .

■ **Light reminder buzzer**

A buzzer sounds when the engine switch <power switch> is turned off or turned to ACCESSORY mode and the driver's door is opened while the lights are turned on.

■ **Automatic headlight leveling system**

The level of the headlights is automatically adjusted according to the number of passengers and the loading condition of the vehicle to ensure that the headlights do not interfere with other road users.

■ **Windshield wiper linked headlight illumination**

When driving during daytime with the headlight switch turned to AUTO, if the windshield wipers are used, the headlights will turn on automatically after several seconds

to help enhance the visibility of your vehicle.

■ **12-volt battery-saving function**

In order to prevent the 12-volt battery of the vehicle from discharging, if the headlights and/or tail lights are on when the engine switch <power switch> is turned off the 12-volt battery saving function will operate and automatically turn off all the lights after approximately 20 minutes.

When the engine switch <power switch> is turned to IGNITION ON mode <ON mode>, the 12-volt battery-saving function will be disabled.

When any of the following are performed, the 12-volt battery-saving function is canceled once and then reactivated. All the lights will turn off automatically 20 minutes after the 12-volt battery-saving function has been reactivated:

- When the headlight switch is operated
- When a door is opened or closed

■ **Welcome light illumination control**

The side marker, parking, tail and license plate lights automatically turn on at night when the doors are unlocked using the entry function or wireless remote control if the light switch is in the AUTO position.

■ **Customization**

Settings (e.g. light sensor sensitivity) can be changed.  
(Customizable features: →P.391)

 NOTICE

■ **To prevent 12-volt battery discharge**

Do not leave the lights on longer than necessary when the engine is not running <hybrid system is not operating>.

### Turning on the high beam headlights

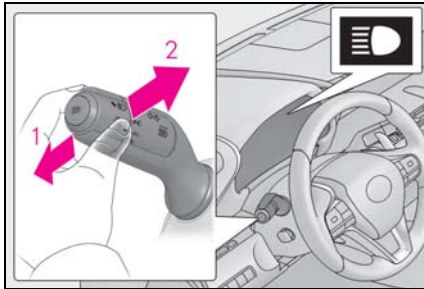

- 1 With the headlights on, push the lever away from you to turn on the high beams.

Pull the lever toward you to the center position to turn the high beams off.

- 2 Pull the lever toward you and release it to flash the high beams once.

You can flash the high beams with the headlights on or off.

speed is approximately 19 mph (30 km/h) or less. However, the lights turn off when the vehicle speed increases to approximately 22 mph (35 km/h) or more.

- After the lights remain illuminated for 30 minutes, they automatically turn off.

### Cornering lights

When any of the following conditions is met, while the headlights (low beam) are on, the cornering lights will additionally turn on and light up the direction of movement for the vehicle. This is to ensure excellent visibility when either driving at intersections or parking at night.

- The steering wheel is operated
- The turn signal lever is operated
- The shift position is in R (both left and right side cornering lights)

#### ■ Cornering light control

- The lights illuminate when the vehicle

### Automatic High Beam

The Automatic High Beam uses an in-vehicle camera sensor to assess the brightness of streetlights, the lights of vehicle ahead, etc., and automatically turns the high beam on or off as necessary.

#### WARNING

##### ■ Limitations of the Automatic High Beam

Do not rely on the Automatic High Beam. Always drive safely, taking care to observe your surroundings and turning the high beam on or off manually if necessary.

##### ■ To prevent incorrect operation of the Automatic High Beam system

Do not overload the vehicle.

### Activating the Automatic High Beam system

- 1 Push the lever away from you with the headlight switch in the **AUTO** or  position.

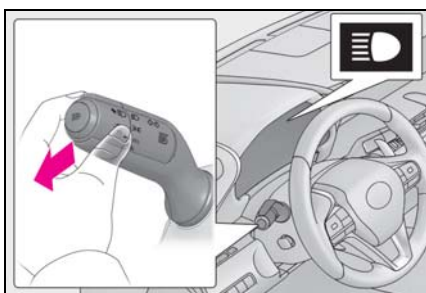

- 2 Press the Automatic High Beam switch.

The Automatic High Beam indicator will come on when the headlights are turned

on automatically to indicate that the system is active.

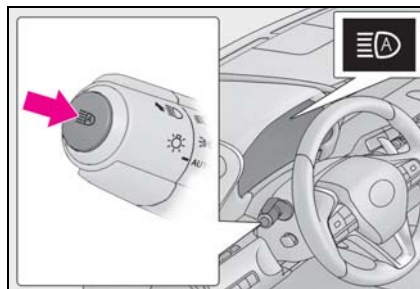

#### ■ High beam automatic turning on or off conditions

- When all of the following conditions are met, the high beam will be automatically turned on (after approximately 1 second):
  - Vehicle speed is above approximately 21 mph (34 km/h).
  - The area ahead of the vehicle is dark.
  - There are no vehicles ahead with headlights or tail lights turned on.
  - There are few streetlights on the road ahead.
- If any of the following conditions are met, the high beam will be automatically turned off:
  - Vehicle speed drops below approximately 17 mph (27 km/h).
  - The area ahead of the vehicle is not dark.
  - Vehicles ahead have headlights or tail lights turned on.
  - There are many streetlights on the road ahead.

#### ■ Camera sensor detection information

- The high beam may not be automatically turned off in the following situations:
  - When oncoming vehicles suddenly appear from a curve
  - When the vehicle is cut in front of by another vehicle
  - When vehicles ahead are hidden from sight due to repeated curves, road dividers or roadside trees
  - When vehicles ahead appear from the faraway lane on wide road
  - When vehicles ahead have no lights
- The high beam may be turned off if a vehicle ahead that is using fog lights with-

out using the headlights is detected.

- House lights, street lights, traffic signals, and illuminated billboards or signs may cause the high beam to switch to the low beams, or the low beams to remain on.
- The following factors may affect the amount of time taken to turn the high beam on or off:
  - The brightness of headlights, fog lights, and tail lights of vehicles ahead
  - The movement and direction of vehicles ahead
  - When a vehicle ahead only has operational lights on one side
  - When a vehicle ahead is a two-wheeled vehicle
  - The condition of the road (gradient, curve, condition of the road surface etc.)
  - The number of passengers and amount of luggage
- The high beam may be turned on or off when the driver does not expect it.
- Bicycles or similar objects may not be detected.
- In the situations shown below, the system may not be able to accurately detect surrounding brightness levels. This may cause the low beams to remain on or the high beams to cause problems for pedestrians, vehicles ahead or other parties. In these cases, manually switch between the high and low beams.
  - In bad weather (rain, snow, fog, sandstorms etc.)
  - The windshield is obscured by fog, mist, ice, dirt etc.
  - The windshield is cracked or damaged.
  - The camera sensor is deformed or dirty.
  - Surrounding brightness levels are equal to those of headlights, tail lights or fog lights.
  - Vehicles ahead have headlights or tail lights that are either switched off, dirty, changing color, or have improperly adjusted aim.
  - When driving through an area of intermittently changing brightness and darkness.
  - When frequently and repeatedly driving ascending/descending roads, or roads with rough, bumpy or uneven surfaces (such as stone-paved roads, gravel tracks

etc.).

- When frequently and repeatedly taking curves or driving on a winding road.
- There is a highly reflective object ahead of the vehicle, such as a sign or a mirror.
- The vehicle's headlights are damaged or dirty.
- The vehicle is listing or tilting, due to a flat tire, a trailer being towed etc.
- The driver believes that the high beam may be causing problems or distress to other drivers or pedestrians nearby.

#### ■ Temporarily lowering sensor sensitivity

The sensitivity of the sensor can be temporarily lowered.

- 1 Turn the engine switch <power switch> off while the following conditions are met.

- The headlight switch is in  or AUTO.
  - The headlight switch lever is in high beam position.
  - Automatic High Beam switch is on.
- 2 Turn the engine switch <power switch> to IGNITION ON mode <ON mode>.
  - 3 Within 30 seconds after 2, repeat pulling the headlight switch lever to the original position then pushing it to the high beam position quickly 10 times, then leave the lever in high beam position.
  - 4 If the sensitivity is changed, the Automatic High Beam indicator turns on and off 3 times.

Automatic High Beam (headlights) may turn on even the vehicle is stopped.

### Turning the high beam on/off manually

#### ■ Switching to low beam

Pull the lever to the original position.

The Automatic High Beam indicator will turn off.

Push the lever away from you to activate the Automatic High Beam system again.

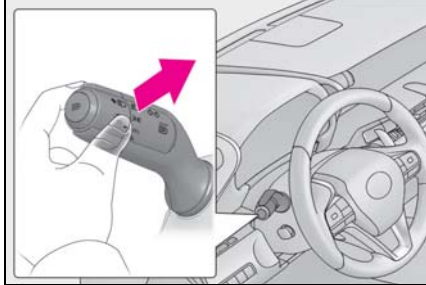

■ Switching to high beam

Press the Automatic High Beam switch.

The Automatic High Beam indicator will turn off and the high beam indicator will turn on.

Press the switch to activate the Automatic High Beam system again.

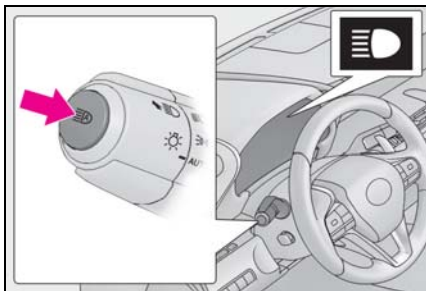

**Windshield wipers and washer**

Operating the lever can switch between automatic operation and manual operation, or can use the washer.

⚠ NOTICE

■ When the windshield is dry

Do not use the wipers, as they may damage the windshield.

**Operating the wiper lever**

Operating the  lever operates the wipers or washer as follows. When "AUTO" is selected, the wipers will operate automatically when the sensor detects falling rain. The system automatically adjusts wiper timing in accordance with rain volume and vehicle speed.

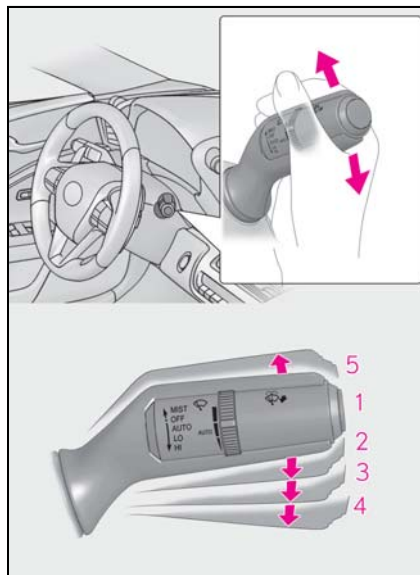

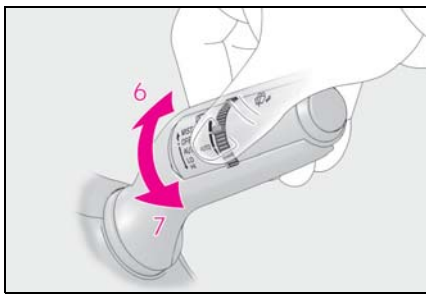

- 1** OFF (U.S.A.) or ○ (Canada)  
Off
- 2** AUTO Rain-sensing wiper operation
- 3** LO (U.S.A.) or ▼ (Canada)  
Low speed wiper operation
- 4** HI (U.S.A.) or ▼ (Canada)  
High speed wiper operation
- 5** MIST (U.S.A.) or △ (Canada)  
Temporary operation

When "AUTO" is selected, the sensor sensitivity can be adjusted by turning the switch ring.

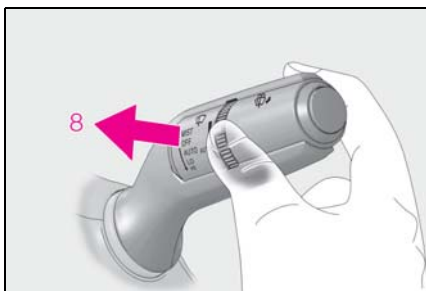

- 6** Increases the sensitivity
- 7** Decreases the sensitivity



- 8**  Washer/wiper dual operation

Pulling the lever operates the wipers and washer.

The wipers will automatically operate a

couple of times after the washer squirts. (After operating several times, the wipers operate once more time after a short delay to prevent dripping. However, the dripping prevention does not operate while the vehicle is moving.)

■ **The windshield wiper and washer can be operated when**

The engine switch <power switch> is in IGNITION ON mode <ON mode>.

■ **Raindrop sensor**

- The raindrop sensor judges the amount of raindrops.

An optical sensor is adopted. It may not operate properly when sunlight from the rising or setting of the sun intermittently strikes the windshield, or if bugs etc. are present on the windshield.

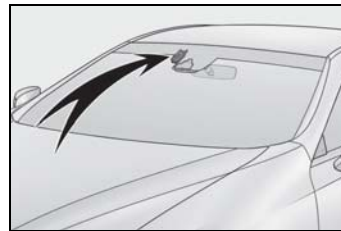

- If the wiper is turned to "AUTO" position while the engine switch <power switch> is in IGNITION ON mode <ON mode>, the wipers will operate once to show that "AUTO" mode is activated.
- If the temperature of the raindrop sensor is 185°F (85°C) or higher, or -22°F (-30°C) or lower, automatic operation may not occur. In this case, operate the wipers in any mode other than "AUTO".

■ **If no windshield washer fluid sprays**

Check that the washer nozzles are not blocked if there is washer fluid in the windshield washer fluid reservoir.



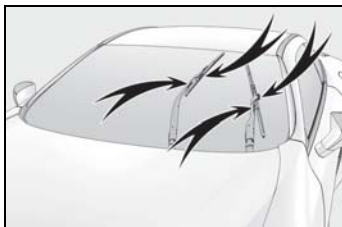

#### ■ Front door opening linked windshield wiper stop function

When "AUTO" is selected and the windshield wipers are operating, if a front door is opened, the operation of the windshield wipers will be stopped to prevent anyone near the vehicle from being sprayed by water from the wipers, provided the vehicle is stopped. When the front door is closed, wiper operation will resume.

#### ■ To protect the windshield wipers

If movement of the windshield wipers is largely restricted by a foreign object such as snow, the operation of the windshield wipers may be stopped automatically to protect the windshield wipers. In this case, turn the windshield wiper switch off and remove the foreign object, and then use the windshield wipers.

#### ■ When stopping the engine <hybrid system> in an emergency while driving

If the windshield wipers are operating when the engine <hybrid system> is stopped, the windshield wipers will operate in high speed operation. After the vehicle is stopped, operation will return to normal when the engine switch <power switch> is turned to IGNITION ON mode <ON mode>, or operation will stop when the driver's door is opened.

#### ■ Customization

The rain-sensing operation setting can be changed.  
(Customizable features: →P.391)

#### ⚠ WARNING

##### ■ Caution regarding the use of windshield wipers in "AUTO" mode

The windshield wipers may operate unexpectedly if the sensor is touched or the windshield is subject to vibration in "AUTO" mode. Take care that your fingers or anything else do not become caught in the windshield wipers.

##### ■ Caution regarding the use of washer fluid

When it is cold, do not use the washer fluid until the windshield becomes warm. The fluid may freeze on the windshield and cause low visibility. This may lead to an accident, resulting in death or serious injury.

#### ⚠ NOTICE

##### ■ When there is no washer fluid spray from the nozzle

Damage to the washer fluid pump may be caused if the lever is pulled toward you and held continually.

##### ■ When a nozzle becomes blocked

In this case, contact your Lexus dealer. Do not try to clear it with a pin or other object. The nozzle will be damaged.

#### Changing the windshield wiper rest position/Lifting the windshield wipers

When the windshield wipers are not being used, they retract to below the hood. To enable the windshield wipers to be lifted when parking in cold conditions or when replacing a windshield wiper insert, change the rest position of the windshield wipers to the service position using the wiper lever.



### ■ Raising the wipers to the service position

Within approximately 45 seconds of turning the engine switch <power switch> off, move the wiper lever to the **MIST** position and hold it for approximately 2 seconds or more.

The wipers will move to the service position.

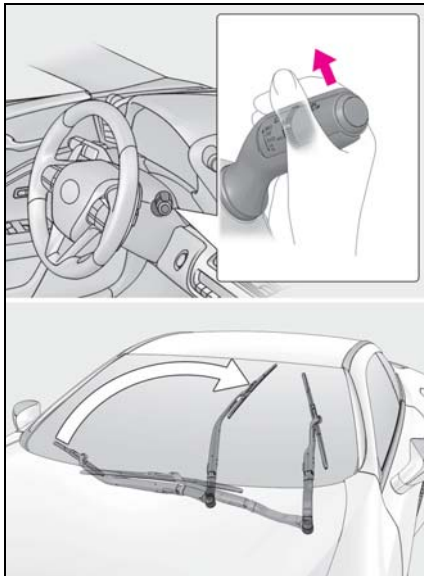

### ■ Lifting the windshield wipers

While holding the hook portion **A** of the wiper arm, lift the windshield wiper from the windshield.

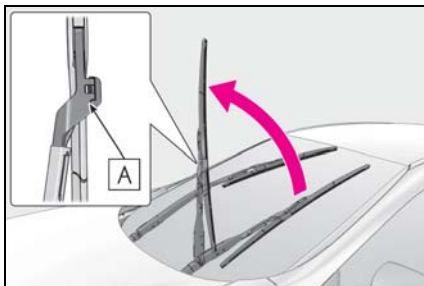

### ■ Lowering the windshield wipers to the retracted position

With the windshield wipers placed on the windshield, turn the engine switch <power switch> to IGNITION ON mode <ON mode> and then move the wiper lever to an operating position. When the wiper switch is turned off, the windshield wipers will stop at the retracted position. Even if the wipers deviate while the engine switch <power switch> is off, the wipers will return to the normal position.

#### ⚠ NOTICE

##### ■ When lifting the windshield wipers

- Do not lift the windshield wipers when they are in the retracted position below the hood. Otherwise, they may contact the hood, possibly resulting in damage to a windshield wiper and/or the hood.
- Do not lift a windshield wiper by the wiper blade. Otherwise, the wiper blade may be deformed.

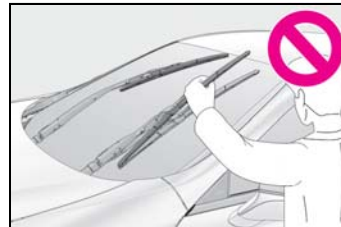

- Do not operate the wiper lever when the windshield wipers are lifted. Otherwise, the windshield wipers may contact the hood, possibly resulting in damage to the windshield wipers and/or hood.
- Make sure that the wiper arms do not overlap each other when returning them. Failure to do so may cause damage to the windshield wipers.

### Opening the fuel tank cap

**LC500h:** The fuel tank of your vehicle has a special structure, which requires a reduction in fuel tank pressure before refueling. After the opener switch has been pressed, it will take several seconds until the vehicle is ready for refueling.

### Before refueling the vehicle

- Turn the engine switch <power switch> off and ensure that both side doors and windows are closed.
- Confirm the type of fuel.

#### ■ Fuel types

→P.381

#### ■ Fuel tank opening for unleaded gasoline

To help prevent incorrect fueling, your vehicle has a fuel tank opening that only accommodates the special nozzle on unleaded fuel pumps.



### WARNING

#### ■ When refueling the vehicle

Observe the following precautions while refueling the vehicle. Failure to do so may result in death or serious injury.

- After exiting the vehicle and before opening the fuel door, touch an unpainted metal surface to discharge any static electricity. It is important to discharge static electricity before refueling because sparks resulting from static electricity can cause fuel vapors to ignite while refueling.

- Always hold the grips on the fuel tank cap and turn it slowly to remove it. A whooshing sound may be heard when the fuel tank cap is loosened. Wait until the sound cannot be heard before fully removing the cap. In hot weather, pressurized fuel may spray out the filler neck and cause injury.

- Do not allow anyone that has not discharged static electricity from their body to come close to an open fuel tank.

- Do not inhale vaporized fuel. Fuel contains substances that are harmful if inhaled.

- Do not smoke while refueling the vehicle. Doing so may cause the fuel to ignite and cause a fire.

- Do not return to the vehicle or touch any person or object that is statically charged. This may cause static electricity to build up, resulting in a possible ignition hazard.

#### ■ When refueling

Observe the following precautions to prevent fuel overflowing from the fuel tank:

- Securely insert the fuel nozzle into the fuel filler neck.
- Stop filling the tank after the fuel nozzle automatically clicks off.
- Do not top off the fuel tank.



### NOTICE

#### ■ Refueling

- **LC500h:** Finish refueling within 30 minutes. If more than 30 minutes passes, the internal valve closes. In this condition, fuel may overflow during the refueling process. Press the fuel filler door opener switch again.

 **NOTICE**  
 ● Do not spill fuel during refueling. Doing so may damage the vehicle, such as causing the emission control system to operate abnormally or damaging fuel system components or the vehicle's painted surface.

**Opening the fuel tank cap**

**1** Press the opener.  
 LC500h: The fuel filler door will open within about 10 seconds of the switch being pressed. Before refueling is possible, a message will be shown on the multi-information display in the instrument cluster to indicate the progress of the fuel filler door opener.

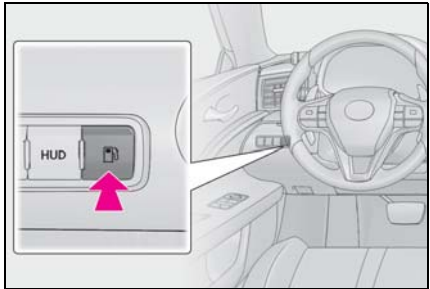

**2** Open the fuel filler door until it is securely locked.  
 The fuel filler door will be locked when it is opened until it becomes perpendicular to the base.



**3** Turn the fuel tank cap slowly and remove it, then put it into the holder on the fuel filler door.

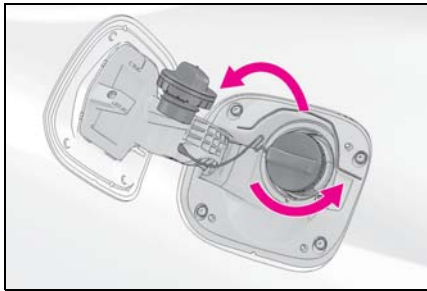

■ If the fuel filler door cannot be opened →P.354

**Closing the fuel tank cap**

After refueling, turn the fuel tank cap until you hear a click. Once the cap is released, it will turn slightly in the opposite direction.

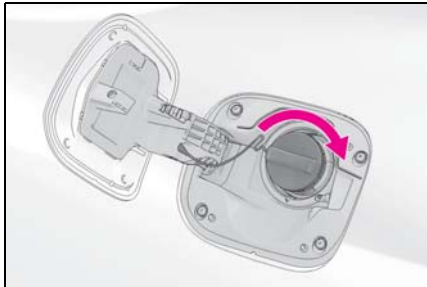

 **WARNING**  
 ■ **When replacing the fuel tank cap**  
 Do not use anything but a genuine Lexus fuel tank cap designed for your vehicle. Doing so may cause a fire or other incident which may result in death or serious injury.

4

Driving

### Lexus Safety System +

The Lexus Safety System + consists of the following drive assist systems and contributes to a safe and comfortable driving experience:

#### Drive assist systems of Lexus Safety System +

- PCS (Pre-Collision System)

→P.189

- LKA (Lane-Keeping Assist)

→P.196

- Automatic High Beam

→P.176

- Dynamic radar cruise control with full-speed range

→P.203

#### WARNING

- Lexus Safety System +

The Lexus Safety System + is designed to operate under the assumption that the driver will drive safely, and is designed to help reduce the impact to the occupants and the vehicle in the case of a collision or assist the driver in normal driving conditions.

As there is a limit to the degree of recognition accuracy and control performance that this system can provide, do not overly rely on this system. The driver is always responsible for paying attention to the vehicle's surroundings and driving safely.

### Vehicle data recording

The pre-collision system is equipped with a sophisticated computer that will

record certain data, such as:

- Accelerator status
- Brake status
- Vehicle speed
- Operation status of the pre-collision system functions
- Information (such as the distance and relative speed between your vehicle and the vehicle ahead or other objects)
- Images from the camera sensor (available only when the pre-collision braking function or the pre-collision brake assist function was operating)

The pre-collision system does not record conversations, sounds or images of the inside of the vehicle.

- Data usage

Lexus may use the data recorded in this computer to diagnose malfunctions, conduct research and development, and improve quality.

Lexus will not disclose the recorded data to a third party except:

- With the consent of the vehicle owner or with the consent of the lessee if the vehicle is leased
- In response to an official request by the police, a court of law or a government agency
- For use by Lexus in a lawsuit
- For research purposes where the data is not tied to a specific vehicle or vehicle owner
- Recorded images can be erased using a specialized device.

The image recording function can be disabled. However, if the function is disabled,

data from when the pre-collision system operates will not be available.

### Sensors

Two types of sensors, located behind the front grille and windshield, detect information necessary to operate the drive assist systems.

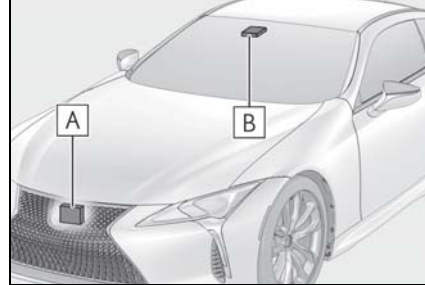

**A** Radar sensor

**B** Camera sensor

### ■ Certification

► For vehicles sold in the U.S.A., Hawaii and Puerto Rico

**FCC ID: HYQDNMWR008**

#### NOTE:

This device complies with part 15 of the FCC Rules. Operation is subject to the following two conditions: (1) This device may not cause harmful interference, and (2) this device must accept any interference received, including interference that may cause undesired operation.

#### FCC WARNING:

Changes or modifications not expressly approved by the party responsible for compliance could void the user's authority to operate the equipment.

#### Radiofrequency radiation exposure Information:

This equipment complies with FCC radiation exposure limits set forth for an uncontrolled environment. This equipment should be installed and operated with minimum distance of 20 cm between the radiator (antenna) and your body. This transmitter must not be co-located or operating in conjunction with any other antenna or transmitter.

- For vehicles sold in Canada

**NOTE:**

This device complies with Industry Canada's licence-exempt RSSs. Operation is subject to the following two conditions: (1) This device may not cause interference; and (2) This device must accept any interference, including interference that may cause undesired operation of the device.

This equipment complies with IC radiation exposure limits set forth for an uncontrolled environment and meets RSS-102 of the IC radio frequency (RF) Exposure rules. This equipment should be installed and operated keeping the radiator at least 20 cm or more away from person's body.

**NOTE:**

Le présent appareil est conforme aux CNR d'Industrie Canada applicables aux appareils radio exempts de licence. L'exploitation est autorisée aux deux conditions suivantes: (1) l'appareil ne doit pas produire de brouillage; (2) l'utilisateur de l'appareil doit accepter tout brouillage radioélectrique subi, même si le brouillage est susceptible d'en compromettre le fonctionnement.

Cet équipement est conforme aux limites d'exposition aux rayonnements énoncées pour un environnement non contrôlé et respecte les règles d'exposition aux fréquences radioélectriques (RF) CNR-102 de l'IC. Cet équipement doit être installé et utilisé en gardant une distance de 20 cm ou plus entre le dispositif rayonnant et le corps.



**WARNING**

■ **To avoid malfunction of the radar sensor**

Observe the following precautions.

Otherwise, the radar sensor may not operate properly, possibly leading to an accident resulting in death or serious injury.



**⚠ WARNING**

- Keep the radar sensor and front grille emblem clean at all times.

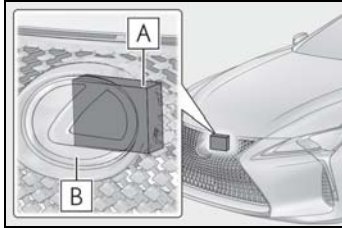

**A** Radar sensor

**B** Front grille emblem

If the front of the radar sensor or the front or back of the front grille emblem is dirty or covered with water droplets, snow, etc., clean it.

Clean the radar sensor and front grille emblem with a soft cloth so you do not mark or damage them.

- Do not attach accessories, stickers (including transparent stickers) or other items to the radar sensor, front grille emblem or surrounding area.
- Do not subject the radar sensor or surrounding area to a strong impact. If the radar sensor, front grille, or front bumper has been subjected to a strong impact, have the vehicle inspected by your Lexus dealer.
- Do not disassemble the radar sensor.
- Do not modify or paint the radar sensor, front grille emblem or surrounding area.
- If the radar sensor, front grille, or front bumper needs to be removed and installed, or replaced, contact your Lexus dealer.

**■ To avoid malfunction of the camera sensor**

Observe the following precautions.

Otherwise, the camera sensor may not operate properly, possibly leading to an accident resulting in death or serious injury.

- Keep the windshield clean at all times.
  - If the windshield is dirty or covered with an oily film, water droplets, snow, etc., clear the windshield.
  - If a glass coating agent is applied to the windshield, it will still be necessary to use the windshield wipers to remove water droplets, etc. from the area of the windshield in front of the camera sensor.
  - If the inner side of the windshield where the camera sensor is installed is dirty, contact your Lexus dealer.
- Do not attach objects, such as stickers, transparent stickers, and so forth, to the outer side of the windshield in front of the camera sensor (shaded area in the illustration).

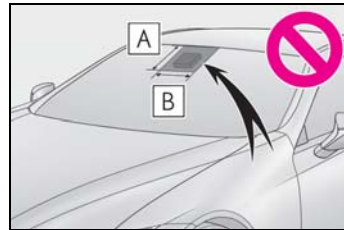

**A** From the top of the windshield to approximately 0.4 in. (1 cm) below the bottom of the camera sensor

**B** Approximately 7.9 in. (20 cm) (Approximately 4.0 in. (10 cm) to the right and left from the center of the camera sensor)

**WARNING**

- If the part of the windshield in front of the camera sensor is fogged up or covered with condensation or ice, use the windshield defogger to remove the fog, condensation or ice. (→P.249)
  - If water droplets cannot be properly removed from the area of the windshield in front of the camera sensor by the windshield wipers, replace the wiper insert or wiper blade. If the wiper inserts or wiper blades need to be replaced, contact your Lexus dealer.
  - Do not attach window tinting to the windshield.
  - Replace the windshield if it is damaged or cracked. If the windshield needs to be replaced, contact your Lexus dealer.
  - Do not get the camera sensor wet.
  - Do not allow bright lights to shine into the camera sensor.
  - Do not dirty or damage the camera sensor. When cleaning the inside of the windshield, do not allow glass cleaner to contact the lens. Also, do not touch the lens. If the lens is dirty or damaged, contact your Lexus dealer.
  - Do not subject the camera sensor to a strong impact.
  - Do not change the installation position or direction of the camera sensor or remove it.
  - Do not disassemble the camera sensor.
  - Do not modify any components of the vehicle around the camera sensor (inside rear view mirror, etc.) or ceiling.
- Do not attach any accessories that may obstruct the camera sensor to the hood, front grille or front bumper. Contact your Lexus dealer for details.
  - If a surfboard or other long object is to be mounted on the roof, make sure that it will not obstruct the camera sensor.
  - Do not modify the headlights or other lights.



## PCS (Pre-Collision System)

The pre-collision system uses a radar sensor and camera sensor to detect vehicles and pedestrians in front of your vehicle. When the system determines that the possibility of a frontal collision with a vehicle or pedestrian is high, a warning operates to urge the driver to take evasive action and the potential brake pressure is increased to help the driver avoid the collision. If the system determines that the possibility of a frontal collision with a vehicle or pedestrian is extremely high, the brakes are automatically applied to help avoid the collision or help reduce the impact of the collision.

The pre-collision system can be disabled/enabled and the warning timing can be changed. (→P.191)

### System functions

#### ■ Pre-collision warning

When the system determines that the possibility of a frontal collision is high, a buzzer will sound and a warning message will be displayed on the multi-information display to urge the driver to take evasive action.

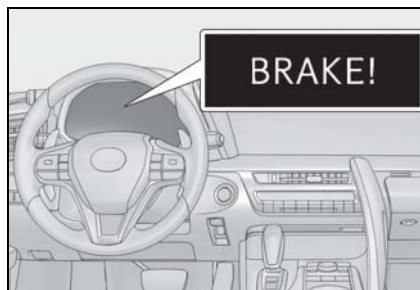

#### ■ Pre-collision brake assist

When the system determines that the possibility of a frontal collision is high, the system applies greater braking force in relation to how strongly the brake pedal is depressed.

#### ■ Pre-collision braking

When the system determines that the possibility of a frontal collision is high, the system warns the driver. If the system determines that the possibility of a frontal collision is extremely high, the brakes are automatically applied to help avoid the collision or reduce the collision speed.

#### ■ Suspension control

When the system determines that the possibility of a frontal collision is high, the Adaptive Variable Suspension System (→P.232) will control the damping force of the shock absorbers to help maintain an appropriate vehicle posture.

#### ■ Steering control (if equipped)

When the system determines that the possibility of a frontal collision is high and the driver is operating the steering wheel, the LDH system (→P.232) will control the turning angle of the front

and rear wheels and effort necessary to turn the steering wheel to help enhance steering responsiveness.



### WARNING

#### ■ Limitations of the pre-collision system

- The driver is solely responsible for safe driving. Always drive safely, taking care to observe your surroundings. Do not use the pre-collision system instead of normal braking operations under any circumstances. This system will not prevent collisions or lessen collision damage or injury in every situation. Do not overly rely on this system. Failure to do so may lead to an accident, resulting in death or serious injury.
- Although this system is designed to help avoid a collision or help reduce the impact of the collision, its effectiveness may change according to various conditions, therefore the system may not always be able to achieve the same level of performance. Read the following conditions carefully. Do not overly rely on this system and always drive carefully.
  - Conditions under which the system may operate even if there is no possibility of a collision: →P.192
  - Conditions under which the system may not operate properly: →P.194
- Do not attempt to test the operation of the pre-collision system yourself, as the system may not operate properly, possibly leading to an accident.

#### ■ Pre-collision braking

- When the pre-collision braking function is operating, a large amount of braking force will be applied.

- If the vehicle is stopped by the operation of the pre-collision braking function, the pre-collision braking function operation will be canceled after approximately 2 seconds. Depress the brake pedal as necessary.

- The pre-collision braking function may not operate if certain operations are performed by the driver. If the accelerator pedal is being depressed strongly or the steering wheel is being turned, the system may determine that the driver is taking evasive action and possibly prevent the pre-collision braking function from operating.

- In some situations, while the pre-collision braking function is operating, operation of the function may be canceled if the accelerator pedal is depressed strongly or the steering wheel is turned and the system determines that the driver is taking evasive action.

- If the brake pedal is being depressed, the system may determine that the driver is taking evasive action and possibly delay the operation timing of the pre-collision braking function.

#### ■ When to disable the pre-collision system

In the following situations, disable the system, as it may not operate properly, possibly leading to an accident resulting in death or serious injury:

- When the vehicle is being towed
- When your vehicle is towing another vehicle
- When transporting the vehicle via truck, boat, train or similar means of transportation
- When the vehicle is raised on a lift with the engine running <hybrid system on> and the tires are allowed to rotate freely

**⚠ WARNING**

- When inspecting the vehicle using a drum tester such as a chassis dynamometer or speedometer tester, or when using an on vehicle wheel balancer
- When a strong impact is applied to the front bumper or front grille, due to an accident or other reasons
- If the vehicle cannot be driven in a stable manner, such as when the vehicle has been in an accident or is malfunctioning
- When the vehicle is driven in a sporty manner or off-road
- When the tires are not properly inflated
- When the tires are very worn
- When tires of a size other than specified are installed
- When tire chains are installed
- When a compact spare tire or an emergency tire puncture repair kit is used
- If equipment (snow plow, etc.) that may obstruct the radar sensor or camera sensor is temporarily installed to the vehicle

**Changing settings of the pre-collision system****■ Enabling/disabling the pre-collision system**

The pre-collision system can be enabled/disabled on  (→P.84) of the multi-information display.

The system is automatically enabled each time the engine switch <power switch> is turned to IGNITION ON mode <ON

mode>.

If the system is disabled, the PCS warning light will turn on and a message will be displayed on the multi-information display.

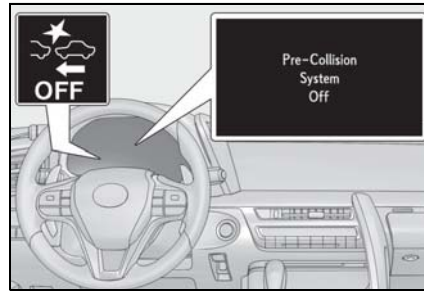
**■ Changing the pre-collision warning timing**

The pre-collision warning timing can be changed on  (→P.84) of the multi-information display.

The operation timing setting is retained when the engine switch <power switch> is turned off.

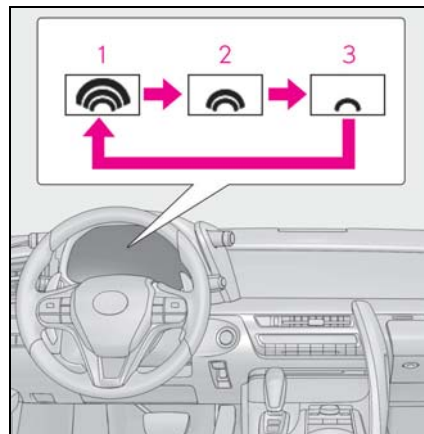
**1 Far**

The warning will begin to operate earlier than with the default timing.

**2 Middle**

This is the default setting.

### 3 Near

The warning will begin to operate later than with the default timing.

#### ■ Operational conditions

The pre-collision system is enabled and the system determines that the possibility of a frontal collision with a vehicle or pedestrian is high.

Each function is operational at the following speeds:

- Pre-collision warning:
  - Vehicle speed is between approximately 7 and 110 mph (10 and 180 km/h). (For detecting a pedestrian, vehicle speed is between approximately 7 and 50 mph [10 and 80 km/h].)
  - The relative speed between your vehicle and the vehicle or pedestrian ahead is approximately 7 mph (10 km/h) or more.
- Pre-collision brake assist:
  - Vehicle speed is between approximately 20 and 110 mph (30 and 180 km/h). (For detecting a pedestrian, vehicle speed is between approximately 20 and 50 mph [30 and 80 km/h].)
  - The relative speed between your vehicle and the vehicle or pedestrian ahead is approximately 20 mph (30 km/h) or more.
- Pre-collision braking:
  - Vehicle speed is between approximately 7 and 110 mph (10 and 180 km/h). (For detecting a pedestrian, vehicle speed is between approximately 7 and 50 mph [10 and 80 km/h].)
  - The relative speed between your vehicle and the vehicle or pedestrian ahead is approximately 7 mph (10 km/h) or more.

The system may not operate in the following situations:

- If a 12-volt battery terminal has been disconnected and reconnected and then the vehicle has not been driven for a certain amount of time
- If the shift position is in R
- If VSC is disabled (only the pre-collision warning function will be operational)

#### ■ Pedestrian detection function

The pre-collision system detects pedestrians based on the size, profile, and motion of a detected object. However, a pedestrian may not be detected depending on the surrounding brightness and the motion, posture, and angle of the detected object, preventing the system from operating properly. (→P.194)

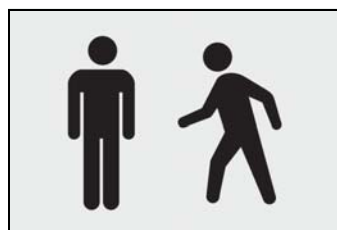

#### ■ Cancellation of the pre-collision braking

If either of the following occur while the pre-collision braking function is operating, it will be canceled:

- The accelerator pedal is depressed strongly.
- The steering wheel is turned sharply or abruptly.

#### ■ Conditions under which the system may operate even if there is no possibility of a collision

- In some situations such as the following, the system may determine that there is a possibility of a frontal collision and operate.
  - When passing a vehicle or pedestrian
  - When changing lanes while overtaking a preceding vehicle
  - When overtaking a preceding vehicle that is changing lanes
  - When overtaking a preceding vehicle that is making a left/right turn

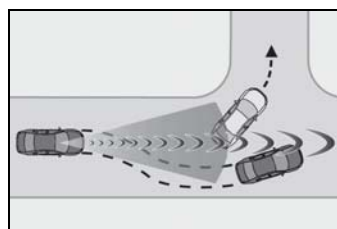

- When passing a vehicle in an oncoming

lane that is stopped to make a right/left turn

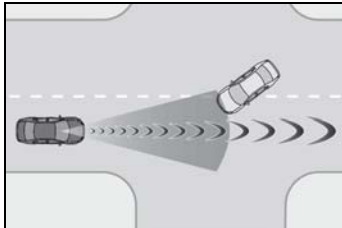

- When driving on a road where relative location to vehicle ahead in an adjacent lane may change, such as on a winding road

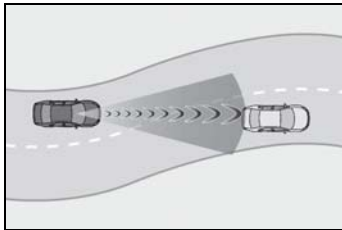

- When rapidly closing on a vehicle ahead
- If the front of the vehicle is raised or lowered, such as when the road surface is uneven or undulating
- When approaching objects on the roadside, such as guardrails, utility poles, trees, or walls
- When there is a vehicle, pedestrian, or object by the roadside at the entrance of a curve

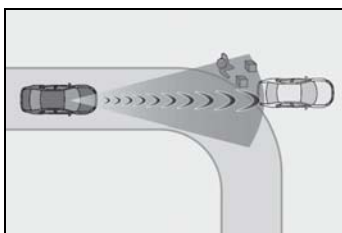

- When driving on a narrow path surrounded by a structure, such as in a tunnel or on an iron bridge
- When there is a metal object (manhole cover, steel plate, etc.), steps, or a protrusion on the road surface or roadside
- When a crossing pedestrian approaches very close to the vehicle

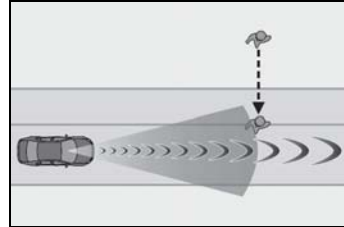

- When passing through a place with a low structure above the road (low ceiling, traffic sign, etc.)

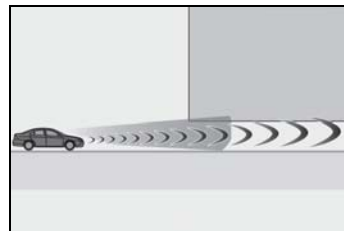

- When passing under an object (billboard, etc.) at the top of an uphill road

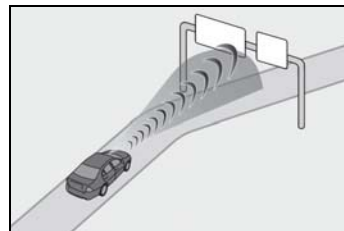

- When rapidly closing on an electric toll gate barrier, parking area barrier, or other barrier that opens and closes
- When using an automatic car wash
- When driving through or under objects that may contact the vehicle, such as thick grass, tree branches, or a banner

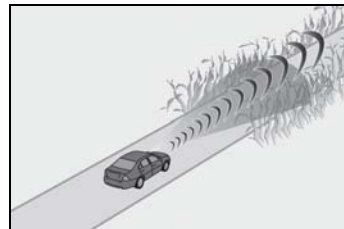

- When the vehicle is hit by water, snow, dust, etc. from a vehicle ahead
- When driving through steam or smoke
- When there are patterns or paint on the

road or a wall that may be mistaken for a vehicle or pedestrian

- When driving near an object that reflects radio waves, such as a large truck or guardrail
- When driving near a TV tower, broadcasting station, electric power plant, or other location where strong radio waves or electrical noise may be present

#### ■ Situations in which the system may not operate properly

- In some situations such as the following, a vehicle may not be detected by the radar sensor and camera sensor, preventing the system from operating properly:
  - If an oncoming vehicle is approaching your vehicle
  - If a vehicle ahead is a motorcycle or bicycle
  - When approaching the side or front of a vehicle
  - If a preceding vehicle has a small rear end, such as an unloaded truck
  - If a preceding vehicle has a low rear end, such as a low bed trailer

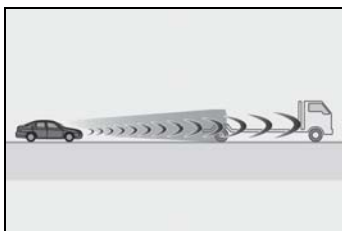

- If a vehicle ahead is carrying a load which protrudes past its rear bumper
- If a vehicle ahead has extremely high ground clearance

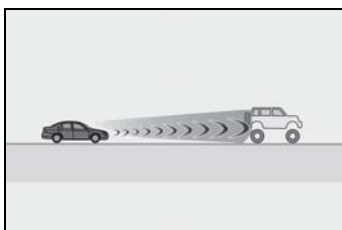

- If a vehicle ahead is irregularly shaped, such as a tractor or side car
- If the sun or other light is shining directly on a vehicle ahead
- If a vehicle cuts in front of your vehicle or

emerges from beside a vehicle

- If a vehicle ahead makes an abrupt maneuver (such as sudden swerving, acceleration or deceleration)
- When suddenly cutting behind a preceding vehicle
- When a vehicle ahead is not directly in front of your vehicle

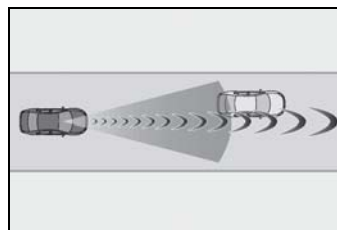

- When driving in inclement weather such as heavy rain, fog, snow or a sandstorm
- When the vehicle is hit by water, snow, dust, etc. from a vehicle ahead
- When driving through steam or smoke
- When driving in a place where the surrounding brightness changes suddenly, such as at the entrance or exit of a tunnel
- When a very bright light, such as the sun or the headlights of oncoming traffic, shines directly into the camera sensor
- When the surrounding area is dim, such as at dawn or dusk, or while at night or in a tunnel
- After the engine <hybrid system> has started the vehicle has not been driven for a certain amount of time
- While making a left/right turn and for a few seconds after making a left/right turn
- While driving on a curve and for a few seconds after driving on a curve
- If your vehicle is skidding
- If the front of the vehicle is raised or lowered

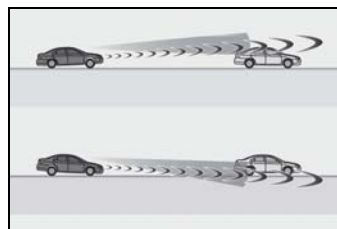

- If the wheels are misaligned
- If a wiper blade is blocking the camera sensor

- The vehicle is wobbling.
- The vehicle is being driven at extremely high speeds.
- When driving on a hill
- If the radar sensor or camera sensor is misaligned
- In some situations such as the following, sufficient braking force may not be obtained, preventing the system from performing properly:
  - If the braking functions cannot operate to their full extent, such as when the brake parts are extremely cold, extremely hot, or wet
  - If the vehicle is not properly maintained (brakes or tires are excessively worn, improper tire inflation pressure, etc.)
  - When the vehicle is being driven on a gravel road or other slippery surface
- Some pedestrians such as the following may not be detected by the radar sensor and camera sensor, preventing the system from operating properly:
  - Pedestrians shorter than approximately 3.2 ft. (1 m) or taller than approximately 6.5 ft. (2 m)
  - Pedestrians wearing oversized clothing (a rain coat, long skirt, etc.), making their silhouette obscure
  - Pedestrians who are carrying large baggage, holding an umbrella, etc., hiding part of their body
  - Pedestrians who are bending forward or squatting
  - Pedestrians who are pushing a stroller, wheelchair, bicycle or other vehicle
  - Groups of pedestrians which are close together
  - Pedestrians who are wearing white and look extremely bright
  - Pedestrians in the dark, such as at night or while in a tunnel
  - Pedestrians whose clothing appears to be nearly the same color or brightness as their surroundings
  - Pedestrians near walls, fences, guardrails, or large objects
  - Pedestrians who are on a metal object (manhole cover, steel plate, etc.) on the road
  - Pedestrians who are walking fast
  - Pedestrians who are changing speed abruptly
- Pedestrians running out from behind a vehicle or a large object
- Pedestrians who are extremely close to the side of the vehicle (outside rear view mirror, etc.)
- **If the PCS warning light flashes or illuminates and a warning message is displayed on the multi-information display**

The pre-collision system may be temporarily unavailable or there may be a malfunction in the system.

  - In the following situations, the warning light will turn off, the message will disappear and the system will become operational when normal operating conditions return:
    - When the radar sensor or camera sensor or the area around either sensor is hot, such as in the sun
    - When the radar sensor or camera sensor or the area around either sensor is cold, such as in an extremely cold environment
    - When a front sensor is dirty or covered with snow, etc.
    - When the part of the windshield in front of the camera sensor is fogged up or covered with condensation or ice (Defogging the windshield: →P.249)
    - If the camera sensor is obstructed, such as when the hood is open or a sticker is attached to the windshield near the camera sensor
  - If the PCS warning light continues to flash or remains illuminated or the warning message does not disappear even though the vehicle has returned to normal, the system may be malfunctioning. Have the vehicle inspected by your Lexus dealer immediately.
- **If VSC is disabled**
  - If VSC is disabled (→P.233), the pre-collision brake assist and pre-collision braking functions are also disabled.
  - The PCS warning light will turn on and “VSC Turned Off Pre-Collision Brake System Unavailable” will be displayed on the multi-information display.

### LKA (Lane-Keeping Assist)

When driving on highways and freeways with white or yellow lines, this function alerts the driver when the vehicle might depart from its lane and provides assistance by operating the steering wheel to keep the vehicle in its lane. Furthermore, the system also provides steering assistance when dynamic radar cruise control with full-speed range is operating to keep the vehicle in its lane.

The LKA system recognizes visible white or yellow lines with the camera sensor on the upper portion of the front windshield.

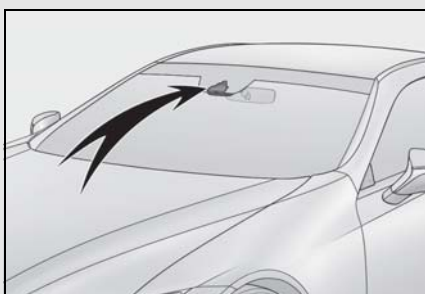

#### Functions included in LKA system

##### ■ Lane departure alert function

When the system determines that the vehicle might depart from its lane, a warning is displayed on the multi-information display, and either the warning buzzer sounds to alert the driver.

When the warning buzzer sounds, check the surrounding road situation and care-

fully operate the steering wheel to move the vehicle back to the center of the lane.

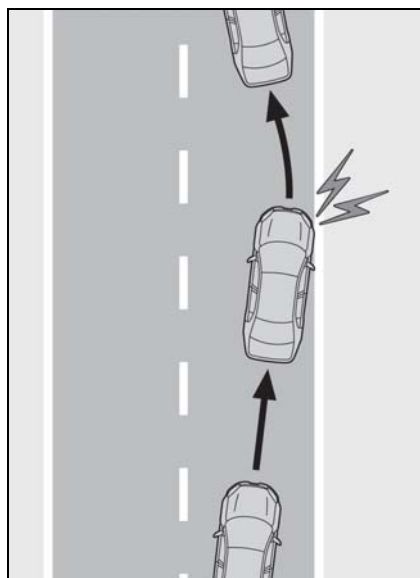

##### ■ Steering assist function

When the system determines that the vehicle might depart from its lane, the system provides assistance as necessary by operating the steering wheel in small amounts for a short period of time to keep the vehicle in its lane.

If the system detects that the steering wheel has not been operated for a fixed amount of time or the steering wheel is not being firmly gripped, a warning is displayed on the multi-information display and the warning buzzer sounds.



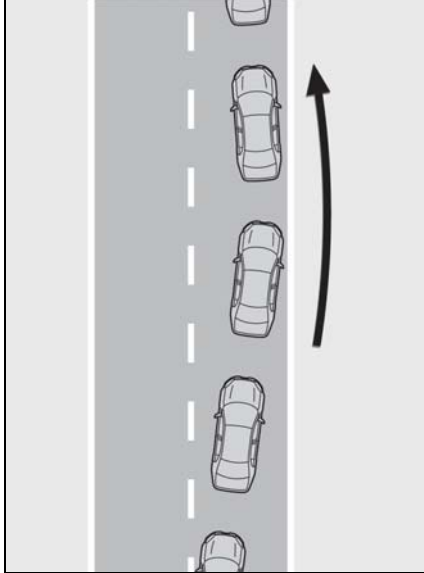

#### ■ Lane centering function

This function is linked with radar cruise control and provides the required assistance by operating the steering wheel to keep the vehicle in its current lane.

When radar cruise control is not operating, the lane centering function does not operate.

If the system detects that the steering wheel has not been operated for a fixed amount of time or the steering wheel is not being firmly gripped, a warning is displayed on the multi-information display and the warning buzzer sounds.

#### ■ Vehicle sway warning function

When the vehicle is swaying or appears as if it may depart from its lane multiple times, the warning buzzer sounds and a message is displayed on the multi-information display to alert the driver.

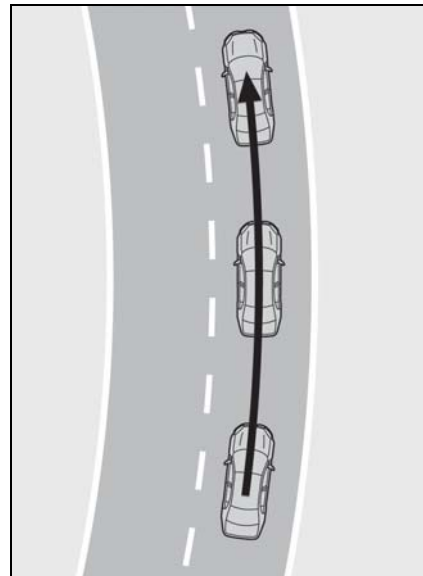
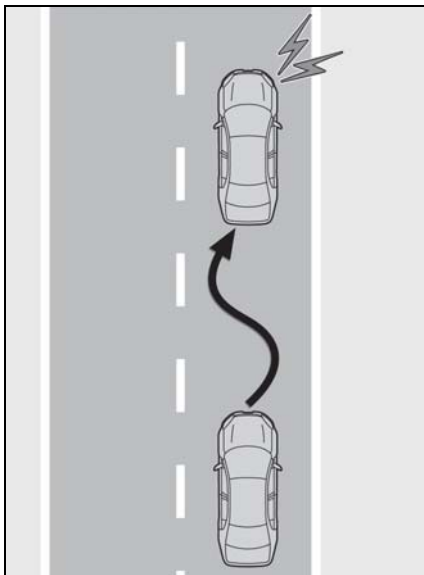

**⚠ WARNING****■ Before using LKA system**

Do not rely solely upon the LKA system. The LKA system does not automatically drive the vehicle or reduce the amount of attention that must be paid to the area in front of the vehicle. The driver must always assume full responsibility for driving safely by paying careful attention to the surrounding conditions and operating the steering wheel to correct the path of the vehicle. Also, the driver must take adequate breaks when fatigued, such as from driving for a long period of time.

Failure to perform appropriate driving operations and pay careful attention may lead to an accident, resulting in death or serious injury.

**■ To avoid operating LKA system by mistake**

When not using the LKA system, use the LKA switch to turn the system off.

**■ Situations unsuitable for LKA system**

Do not use the LKA system in the following situations.

The system may not operate properly and lead to an accident, resulting in death or serious injury.

- A spare tire, tire chains, etc. are equipped.
- When the tires have been excessively worn, or when the tire inflation pressure is low.
- Tires which differ by structure, manufacturer, brand or tread pattern are used.
- Objects or patterns that could be mistaken for white (yellow) lines are present on the side of the road (guardrails, curbs, reflective poles, etc.).
- Vehicle is driven on a snow-covered road.
- White (yellow) lines are difficult to see due to rain, snow, fog, dust, etc.

- Asphalt repair marks, white (yellow) line marks, etc. are present due to road repair.

- Vehicle is driven in a temporary lane or restricted lane due to construction work.

- Vehicle is driven on a road surface which is slippery due to rainy weather, fallen snow, freezing, etc.

- Vehicle is driven in traffic lanes other than on highways and freeways.

- Vehicle is driven in a construction zone.

**■ Preventing LKA system malfunctions and operations performed by mistake**

- Do not modify the headlights or place stickers, etc. on the surface of the lights.

- Do not modify the suspension etc. If the suspension etc. needs to be replaced, contact your Lexus dealer.

- Do not install or place anything on the hood or grille. Also, do not install a grille guard (bull bars, kangaroo bar, etc.).

- If your windshield needs repairs, contact your Lexus dealer.

**Turning LKA system on**

Press the LKA switch to turn the LKA system on.

The LKA indicator illuminates and a message is displayed on the multi-information display.

Press the LKA switch again to turn the LKA system off.

When the LKA system is turned on or off, operation of the LKA system continues in the same condition the next time the engine <hybrid system> is started.



**B** Operation display of steering wheel operation support

Indicates that steering wheel assistance of the steering assist function or lane centering function is operating.

**C** Lane departure alert function display

Displayed when the multi-information display is switched to the driving assist system information screen.

- ▶ Inside of displayed white lines is white

**Indications on multi-information display**

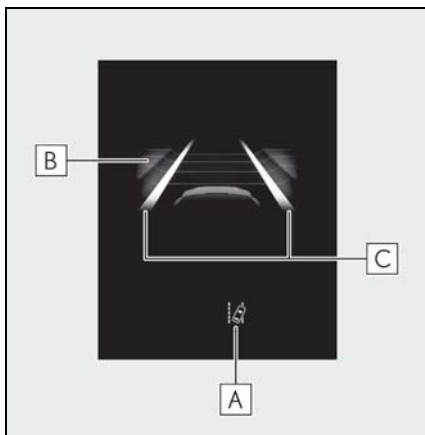

**A** LKA indicator

The illumination condition of the indicator informs the driver of the system operation status.

Illuminated in white:  
LKA system is operating.

Illuminated in green:  
Steering wheel assistance of the steering assist function or lane centering function is operating.

Flashing in orange:  
Lane departure alert function is operating.



Indicates that the system is recognizing white (yellow) lines. When the vehicle departs from its lane, the white line displayed on the side the vehicle departs from flashes orange.

- ▶ Inside of displayed white lines is black



Indicates that the system is not able to recognize white (yellow) lines or is temporarily canceled.

### ■ Operation conditions of each function

#### ● Lane departure alert function

This function operates when all of the following conditions are met.

- LKA is turned on.
- Vehicle speed is approximately 32 mph (50 km/h) or more.
- System recognizes white (yellow) lines.
- Width of traffic lane is approximately 9.8 ft. (3 m) or more.
- Turn signal lever is not operated.
- Vehicle is driven on a straight road or around a gentle curve with a radius of more than approximately 492 ft. (150 m).
- No system malfunctions are detected. (→P.202)

#### ● Steering assist function

This function operates when all of the following conditions are met in addition to the operation conditions for the lane departure alert function.

- Setting for "Steering Assist" in  of the multi-information display is set to "On". (→P.84)
- Vehicle is not accelerated or decelerated by a certain amount or more.
- Steering wheel is not operated with a steering force level suitable for changing lanes.
- ABS, VSC, TRAC and PCS are not operating.
- TRAC or VSC is not turned off.

#### ● Vehicle sway warning function

This function operates when all of the following conditions are met.

- Setting for "Sway Warning" in  of the multi-information display is set to "On". (→P.84)
- Vehicle speed is approximately 32 mph (50 km/h) or more.
- Width of traffic lane is approximately 9.8 ft. (3 m) or more.
- No system malfunctions are detected. (→P.202)

#### ● Lane centering function

This function operates when all of the following conditions are met.

- LKA is turned on.
- Setting for "Steering Assist" and "Lane Center" in  of the multi-information display are set to "On". (→P.84)
- System recognizes white (yellow) lines.
- Dynamic radar cruise control with full-speed range is operating.
- Width of traffic lane is approximately 8.2 to 13.5 ft. (2.5 to 4.1 m).
- Turn signal lever is not operated.
- Vehicle is driven on a straight road or around a gentle curve with a radius of more than approximately 656 ft. (200 m).
- No system malfunctions are detected. (→P.202)
- Vehicle does not accelerate or decelerate by a certain amount or more.
- Steering wheel is not operated with a steering force level suitable for changing lanes.
- ABS, VSC, TRAC and PCS are not operating.
- TRAC or VSC is not turned off.
- Steering assist function is not operating.

### ■ Temporary cancellation of functions

When the operation conditions are no longer met, a function may be temporarily canceled. However, when the operation conditions are met again, operation of the function is automatically restored. (→P.200)

### ■ Steering assist function/lane centering function

Depending on the vehicle speed, lane departure situation, road conditions, etc., the driver may not feel the function is operating or the function may not operate at all.

### ■ Lane departure alert function

The warning buzzer may be difficult to hear due to external noise, audio playback, etc.

### ■ Hands off steering wheel warning

When the system determines that the driver has removed their hands from the steering wheel while the steering assist function or lane centering function is operating, a warning message urging the driver to hold the steering wheel and the symbol shown in the illustration are displayed on the multi-information display.

If the driver continues to keep their hands off of the steering wheel, a buzzer sounds and a warning message and the symbol shown in the illustration are displayed on the multi-information display. This warning also operates in the same way when the driver continuously operates the steering wheel only a small amount. Always keep your hands on the steering wheel when using this system, regardless of warnings.



Depending on the vehicle and road conditions, the warning may not operate.

#### ■ Vehicle sway warning function

When the system determines that the vehicle is swaying while the vehicle sway warning function is operating, a buzzer sounds and a warning message urging the driver to rest and the symbol shown in the illustration are simultaneously displayed on the multi-information display.

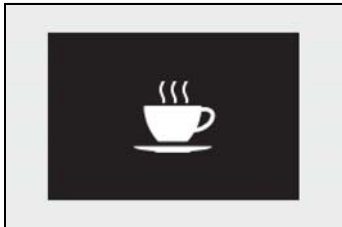

Depending on the vehicle and road conditions, the warning may not operate.

#### ■ White (yellow) lines are only on one side of road

The LKA system will not operate for the side on which white (yellow) lines could not be recognized.

#### ■ Conditions in which functions may not operate properly

In the following situations, the camera sensor may not detect white (yellow) lines and various functions may not operate normally.

- There are shadows on the road that run parallel with, or cover, the white (yellow) lines.
- The vehicle is driven in an area without white (yellow) lines, such as in front of a tollgate or checkpoint, or at an intersection, etc.
- The white (yellow) lines are cracked, "Botts' dots", "Raised pavement marker" or stones are present.
- The white (yellow) lines cannot be seen or are difficult to see due to sand, etc.
- The vehicle is driven on a road surface that is wet due to rain, puddles, etc.
- The traffic lines are yellow (which may be more difficult to recognize than lines that are white).
- The white (yellow) lines cross over a curb, etc.
- The vehicle is driven on a bright surface, such as concrete.
- The vehicle is driven on a surface that is bright due to reflected light, etc.
- The vehicle is driven in an area where the brightness changes suddenly, such as at the entrances and exits of tunnels, etc.
- Light from the headlights of an oncoming vehicle, the sun, etc. enters the camera.
- The vehicle is driven where the road diverges, merges, etc.
- The vehicle is driven on a slope.
- The vehicle is driven on a road which tilts left or right, or a winding road.
- The vehicle is driven on an unpaved or rough road.
- The vehicle is driven around a sharp curve.
- The traffic lane is excessively narrow or wide.
- The vehicle is extremely tilted due to carrying heavy luggage or having improper tire pressure.
- The distance to the preceding vehicle is extremely short.
- The vehicle is moving up and down a large amount due to road conditions

during driving (poor roads or road seams).

- The headlight lenses are dirty and emit a faint amount of light at night, or the beam axis has deviated.
- The vehicle is struck by a crosswind.
- The vehicle has just changed lanes or crossed an intersection.
- Snow tires, etc. are equipped.

■ **Warning message**

If the following warning message is displayed on the multi-information display and the LKA indicator illuminates in orange, follow the appropriate troubleshooting procedure.

Warning message	Details/Actions
"Lane Keeping Assist Malfunction Visit Your Dealer"	The system may not be operating properly. → Have the vehicle inspected at your Lexus dealer.
"Front Camera Unavailable Remove Debris On Windshield"	Dirt, rain, condensation, ice, snow, etc., are present on the windshield in front of the camera sensor. → Turn the LKA system off, remove any dirt, rain, condensation, ice, snow, etc., from the windshield, and then turn the LKA system back on.

Warning message	Details/Actions
"Front Camera Unavailable"	The operation conditions of the camera sensor (temperature, etc.) are not met. → When the operation conditions of the camera sensor (temperature, etc.) are met, the LKA system will become available. Turn the LKA system off, wait for a little while, and then turn the LKA system back on.
"Lane Keeping Assist Unavailable"	The LKA system is temporarily canceled due to a malfunction in a sensor other than the camera sensor. → Turn the LKA system off and follow the appropriate troubleshooting procedures for the warning message. Afterward, drive the vehicle for a short time, and then turn the LKA system back on.

Warning message	Details/Actions
"Lane Keeping Assist Unavailable Below Approx 32MPH"	The LKA system cannot be used as the vehicle speed is less than approximately 32 mph (50 km/h). → Drive the vehicle at approximately 32 mph (50 km/h) or more.
"Lane Keeping Assist Unavailable at Current Speed"	The LKA system cannot be used as the vehicle speed is too high. → Slow down.

If a different warning message is displayed, follow the instructions displayed on the screen.

■ Customization

The following settings can be changed.

Function	Setting details
Lane departure alert function	Adjust alert sensitivity
Steering assist function	Turn steering wheel assistance on and off
Vehicle sway warning function	Turn function on and off
	Adjust alert sensitivity
Lane centering function	Turn function on and off

For how to change settings, refer to P.391.

**Dynamic radar cruise control with full-speed range**

In vehicle-to-vehicle distance control mode, the vehicle automatically accelerates, decelerates and stops to match the speed changes of the preceding vehicle even if the accelerator pedal is not depressed. In constant speed control mode, the vehicle runs at a fixed speed.

Use the dynamic radar cruise control with full-speed range on freeways and highways.

- Vehicle-to-vehicle distance control mode (→P.206)
- Constant speed control mode (→P.210)

4  
Driving

**System Components**

■ Meter display

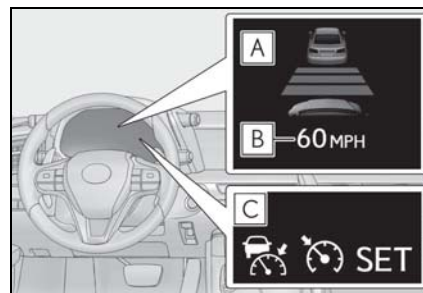

- A** Display
- B** Set speed
- C** Indicators

■ Operation switches

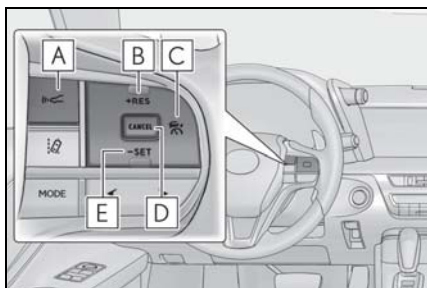

- A** Vehicle-to-vehicle distance switch
- B** "+RES" switch
- C** Cruise control main switch
- D** Cancel switch
- E** "-SET" switch

**⚠ WARNING**

■ Before using dynamic radar cruise control with full-speed range

- Driving safely is the sole responsibility of the driver. Do not rely solely on the system, and drive safely by always paying careful attention to your surroundings.
- The dynamic radar cruise control with full-speed range provides driving assistance to reduce the driver's burden. However, there are limitations to the assistance provided. Read the following conditions carefully. Do not overly rely on this system and always drive carefully.
  - When the sensor may not be correctly detecting the vehicle ahead: →P.211
  - Conditions under which the vehicle-to-vehicle distance control mode may not function correctly: →P.212
- Set the speed appropriately depending on the speed limit, traffic flow, road conditions, weather conditions, etc. The driver is responsible for checking the set speed.

● Even when the system is functioning normally, the condition of the preceding vehicle as detected by the system may differ from the condition observed by the driver. Therefore, the driver must always remain alert, assess the danger of each situation and drive safely. Relying on this system or assuming the system ensures safety while driving can lead to an accident, resulting in death or serious injury.

● Switch the dynamic radar cruise control with full-speed range off using the cruise control main switch when not in use.

■ Cautions regarding the driving assist systems

Observe the following precautions, as there are limitations to the assistance provided by the system.

Failure to do so may cause an accident resulting in death or serious injury.

● Assisting the driver to measure following distance

The dynamic radar cruise control with full-speed range is only intended to help the driver in determining the following distance between the driver's own vehicle and a designated vehicle traveling ahead. It is not a mechanism that allows careless or inattentive driving, and it is not a system that can assist the driver in low-visibility conditions. It is still necessary for driver to pay close attention to the vehicle's surroundings.

● Assisting the driver to judge proper following distance

The dynamic radar cruise control with full-speed range determines whether the following distance between the driver's own vehicle and a designated vehicle traveling ahead is within a set range. It is not capable of making any other type of judgement. Therefore, it is absolutely necessary for the driver to remain vigilant and to determine whether or not there is a possibility of danger in any given situation.



 **WARNING**

- Assisting the driver to operate the vehicle  
The dynamic radar cruise control with full-speed range has limited capability to prevent or avoid a collision with a vehicle traveling ahead. Therefore, if there is ever any danger, the driver must take immediate and direct control of the vehicle and act appropriately in order to ensure the safety of all involved.

**■ Situations unsuitable for dynamic radar cruise control with full-speed range**

Do not use dynamic radar cruise control with full-speed range in any of the following situations.

Doing so may result in inappropriate speed control and could cause an accident resulting in death or serious injury.

- Roads where there are pedestrians, cyclists, etc.
- In heavy traffic
- On roads with sharp bends
- On winding roads
- On slippery roads, such as those covered with rain, ice or snow
- On steep downhills, or where there are sudden changes between sharp up and down gradients  
Vehicle speed may exceed the set speed when driving down a steep hill.
- At entrances to freeways and highways
- When weather conditions are bad enough that they may prevent the sensors from detecting correctly (fog, snow, sandstorm, heavy rain, etc.)
- When there is rain, snow, etc. on the front surface of the radar sensor or camera sensor

- In traffic conditions that require frequent repeated acceleration and deceleration
- During emergency towing
- When an approach warning buzzer is heard often

### Driving in vehicle-to-vehicle distance control mode

This mode employs a radar sensor to detect the presence of vehicles up to approximately 328 ft. (100 m) ahead, determines the current vehicle-to-vehicle following distance, and operates to maintain a suitable following distance from the vehicle ahead.

Note that vehicle-to-vehicle distance will close in when traveling on downhill slopes.

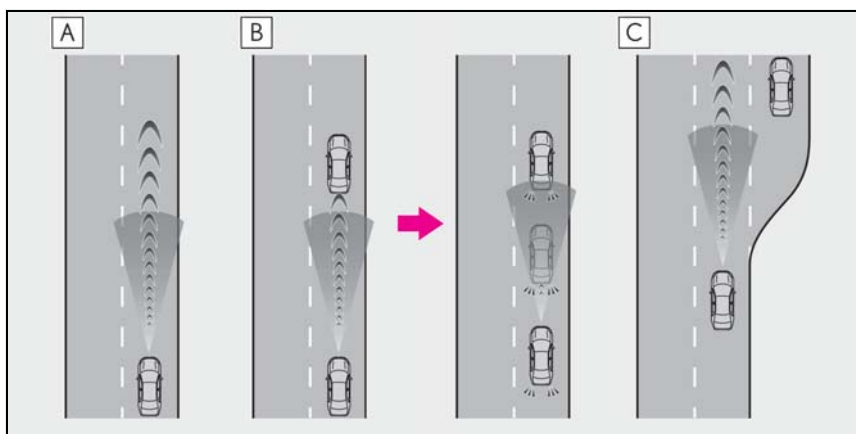

- A** Example of constant speed cruising  
When there are no vehicles ahead

The vehicle travels at the speed set by the driver. The desired vehicle-to-vehicle distance can also be set by operating the vehicle-to-vehicle distance switch.

- B** Example of deceleration cruising and follow-up cruising

When a preceding vehicle driving slower than the set speed appears

When a vehicle is detected running ahead of you, the system automatically decelerates your vehicle. When a greater reduction in vehicle speed is necessary, the system applies the brakes (the stop lights will come on at this time). The system will respond to changes in the speed of the vehicle ahead in order to maintain the vehicle-to-vehicle distance set by the driver. Approach warning warns you when the system cannot decelerate sufficiently to prevent your vehicle from closing in on the vehicle ahead.

When the vehicle ahead of you stops, your vehicle will also stop (vehicle is stopped by system control). After the vehicle ahead starts off, pressing the "+RES" switch or depressing the accelerator pedal will resume follow-up cruising.

- C** Example of acceleration

When there are no longer any preceding vehicles driving slower than the set speed

The system accelerates until the set speed is reached. The system then returns to constant speed cruising.

**Setting the vehicle speed (vehicle-to-vehicle distance control mode)**

- 1 Press the cruise control main switch to activate the cruise control.

Radar cruise control indicator will come on and a message will be displayed on the multi-information display.

Press the switch again to deactivate the cruise control.

If the cruise control main switch is pressed and held for 1.5 seconds or more, the system turns on in constant speed control mode. (→P.210)



- 2 Accelerate or decelerate, with accelerator pedal operation, to the desired vehicle speed (at or above approximately 30 mph [50 km/h]) and press the “-SET” switch to set the speed.

Cruise control “SET” indicator will come on.

The vehicle speed at the moment the switch is released becomes the set speed.

If the switch is operated while the vehicle speed is below approximately 30 mph (50 km/h) and a preceding vehicle is present, the set speed will be adjusted to approxi-

mately 30 mph (50 km/h).

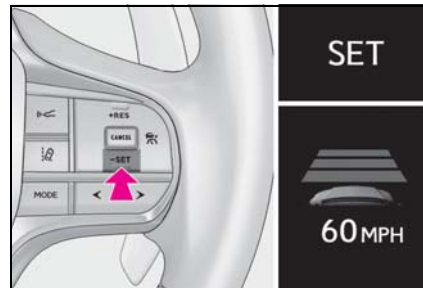

**Adjusting the set speed**

To change the set speed, operate the “+RES” or “-SET” switch until the desired set speed is displayed.

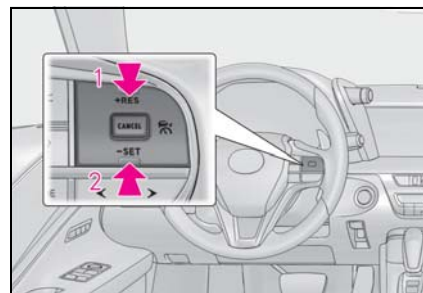

- 1 Increases the speed  
(Except when the vehicle has been stopped by system control in vehicle-to-vehicle distance control mode)
- 2 Decreases the speed

Fine adjustment: Press the switch.

Large adjustment: Press and hold the switch to change the speed, and release when the desired speed is reached.

In the vehicle-to-vehicle distance control mode, the set speed will be increased or decreased as follows:

- For the U.S. mainland and Hawaii  
Fine adjustment: By 1 mph (1.6 km/h)<sup>\*1</sup> or 1

km/h (0.6mph)<sup>\*2</sup> each time the switch is pressed

Large adjustment: Increases or decreases in 1mph (1.6 km/h)<sup>\*1</sup> or 1 km/h (0.6 mph)<sup>\*2</sup> increments for as long as the switch is held

► For Canada and Puerto Rico

Fine adjustment: By 1 mph (1.6 km/h)<sup>\*1</sup> or 1 km/h (0.6mph)<sup>\*2</sup> each time the switch is pressed

Large adjustment: Increases or decreases in 5 mph (8 km/h)<sup>\*1</sup> or 5 km/h (3.1 mph)<sup>\*2</sup> increments for as long as the switch is held

In the constant speed control mode (→P.210), the set speed will be increased or decreased as follows:

Fine adjustment: By 1 mph (1.6 km/h)<sup>\*1</sup> or 1 km/h (0.6 mph)<sup>\*2</sup> each time the switch is pressed

Large adjustment: The speed will continue to change while the switch is held.

\*1: When the set speed is shown in "MPH"

\*2: When the set speed is shown in "km/h"

### Changing the vehicle-to-vehicle distance (vehicle-to-vehicle distance control mode)

Pressing the switch changes the vehicle-to-vehicle distance as follows:

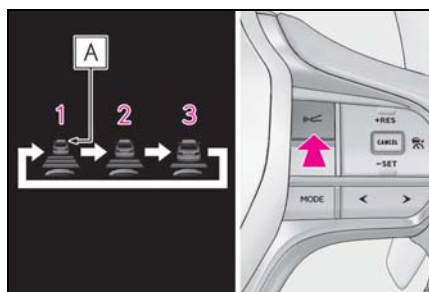

1 Long

2 Medium

3 Short

The vehicle-to-vehicle distance is set automatically to long mode when the engine switch <power switch> is turned to IGNITION ON mode <ON mode>.

If a vehicle is running ahead of you, the preceding vehicle mark **A** will also be displayed.

### Vehicle-to-vehicle distance settings (vehicle-to-vehicle distance control mode)

Select a distance from the table below. Note that the distances shown correspond to a vehicle speed of 50 mph (80 km/h). Vehicle-to-vehicle distance increases/decreases in accordance with vehicle speed. When the vehicle is stopped by system control, the vehicle stops at a certain vehicle-to-vehicle distance depending on the situation.

Distance options	Vehicle-to-vehicle distance
Long	Approximately 160 ft. (50 m)
Medium	Approximately 130 ft. (40 m)
Short	Approximately 100 ft. (30 m)

### Resuming follow-up cruising when the vehicle has been stopped by system control (vehicle-to-vehicle distance control mode)

After the vehicle ahead of you starts

off, press the “+RES” switch.

Your vehicle will also resume follow-up cruising if the accelerator pedal is depressed after the vehicle ahead of you starts off.

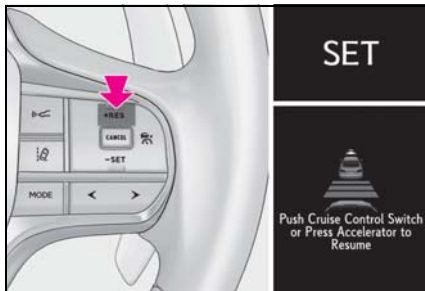

**Canceling and resuming the speed control**

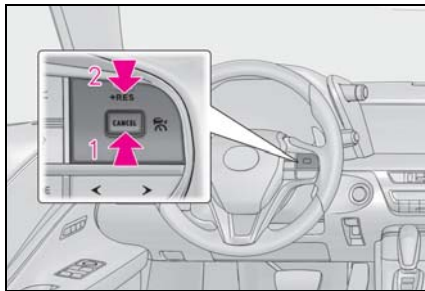

**1** Pressing the cancel switch cancels the speed control.

The speed control is also canceled when the brake pedal is depressed. (When the vehicle has been stopped by system control, depressing the brake pedal does not cancel the setting.)

**2** Pressing the “+RES” switch resumes the cruise control and returns vehicle speed to the set speed.

However, when a vehicle ahead is not detected, cruise control does not resume when the vehicle speed is approximately

25 mph (40 km/h) or less.

**Approach warning (vehicle-to-vehicle distance control mode)**

When your vehicle is too close to a vehicle ahead, and sufficient automatic deceleration via the cruise control is not possible, the display will flash and the buzzer will sound to alert the driver. An example of this would be if another driver cuts in front of you while you are following a vehicle. Depress the brake pedal to ensure an appropriate vehicle-to-vehicle distance.

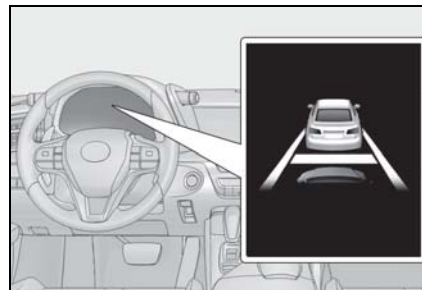

**Warnings may not occur when**

In the following instances, warnings may not occur even when the vehicle-to-vehicle distance is small.

- When the speed of the preceding vehicle matches or exceeds your vehicle speed
- When the preceding vehicle is traveling at an extremely slow speed
- Immediately after the cruise control speed was set
- When depressing the accelerator pedal

**Selecting constant speed control mode**

When constant speed control mode is selected, your vehicle will maintain a set speed without controlling the vehicle-to-vehicle distance. Select this mode only when vehicle-to-vehicle distance control mode does not function correctly due to a dirty radar sensor, etc.

- 1 With the cruise control off, press and hold the cruise control main switch for 1.5 seconds or more.

Immediately after the switch is pressed, the radar cruise control indicator will come on. Afterwards, it switches to the cruise control indicator.

Switching to constant speed control mode is only possible when operating the switch with the cruise control off.

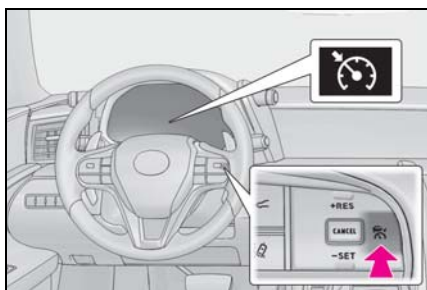

- 2 Accelerate or decelerate, with accelerator pedal operation, to the desired vehicle speed (at or above approximately 25 mph [40 km/h]) and press the "-SET" switch to set the speed.

Cruise control "SET" indicator will come on.

The vehicle speed at the moment the switch is released becomes the set speed.

Adjusting the speed setting: →P.207

Canceling and resuming the speed setting:  
→P.209

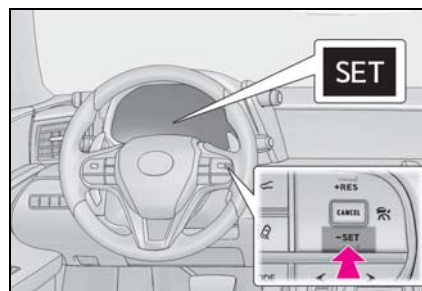

■ **Dynamic radar cruise control with full-speed range can be set when**

- The shift position is in D.
- LC500: Range 4 or higher of D has been selected by using the paddle shift switch.
- Vehicle speed is at or above approximately 30 mph (50 km/h). However, when a preceding vehicle is detected, the dynamic radar cruise control with full-speed range can be set even if the vehicle speed is below approximately 30 mph (50 km/h).

■ **Accelerating after setting the vehicle speed**

The vehicle can accelerate by operating the accelerator pedal. After accelerating, the set speed resumes. However, during vehicle-to-vehicle distance control mode, the vehicle speed may decrease below the set speed in order to maintain the distance to the preceding vehicle.

■ **When the vehicle stops while follow-up cruising**

- Pressing the "+RES" switch while the vehicle ahead stops will resume follow-up cruising if the vehicle ahead starts off within approximately 3 seconds after the switch is pressed.
- If the vehicle ahead starts off within 3 seconds after your vehicle stops, follow-up cruising will be resumed.

■ **Automatic cancelation of vehicle-to-vehicle distance control mode**

Vehicle-to-vehicle distance control mode is automatically canceled in the following situ-

ations.

- Actual vehicle speed falls at or below approximately 25 mph (40 km/h) when there are no vehicles ahead.
- The preceding vehicle leaves the lane when your vehicle is following at a vehicle speed at or below approximately 25 mph (40 km/h). Otherwise, the sensor can not properly detect the vehicle. ("CRUISE NOT AVAILABLE No Preceding Vehicles" is displayed on the multi-information display)
- VSC is activated.
- TRAC is activated for a period of time.
- When the VSC or TRAC system is turned off.
- When snow mode is set.
- The sensor cannot detect correctly because it is covered in some way.
- Pre-collision braking is activated.
- The parking brake is operated.
- The vehicle is stopped by system control on a steep incline.
- The following are detected when the vehicle has been stopped by system control:
  - The driver is not wearing a seat belt.
  - The driver's door is opened.
  - The vehicle has been stopped for about 3 minutes

If vehicle-to-vehicle distance control mode is automatically canceled for any other reason, there may be a malfunction in the system. Contact your Lexus dealer.

#### ■ Automatic cancellation of constant speed control mode

Constant speed control mode is automatically canceled in the following situations:

- Actual vehicle speed is more than approximately 10 mph (16 km/h) below the set vehicle speed.
- Actual vehicle speed falls below approximately 25 mph (40 km/h).
- VSC is activated.
- TRAC is activated for a period of time.
- When the VSC or TRAC system is

turned off.

- Pre-collision braking is activated.

If constant speed control mode is automatically canceled for any other reason, there may be a malfunction in the system. Contact your Lexus dealer.

#### ■ Brake system operation sound

If the brakes are applied automatically while the vehicle is in vehicle-to-vehicle distance control mode, a brake system operation sound may be heard. This does not indicate a malfunction.

#### ■ If "Radar Cruise Control Unavailable" is shown on the multi-information display

The radar cruise control system cannot be used temporarily. Use the system when it becomes available again.

#### ■ Warning messages and buzzers for dynamic radar cruise control with full-speed range

Warning messages and buzzers are used to indicate a system malfunction or to inform the driver of the need for caution while driving. If a warning message is shown on the multi-information display, read the message and follow the instructions.

#### ■ When the sensor may not be correctly detecting the vehicle ahead

In the case of the following and depending on the conditions, operate the brake pedal when deceleration of the system is insufficient or operate the accelerator pedal when acceleration is required.

As the sensor may not be able to correctly detect these types of vehicles, the approach warning (→P.209) may not be activated.

- Vehicles that cut in suddenly
- Vehicles traveling at low speeds
- Vehicles that are not moving in the same lane
- Vehicles with small rear ends (trailers with no load on board, etc.)

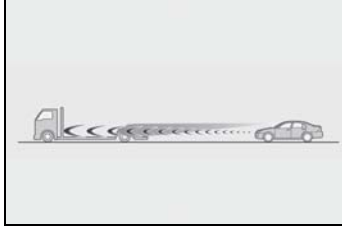

- Motorcycles traveling in the same lane
- When water or snow thrown up by the surrounding vehicles hinders the detecting of the sensor
- When your vehicle is pointing upwards (caused by a heavy load in the luggage compartment, etc.)

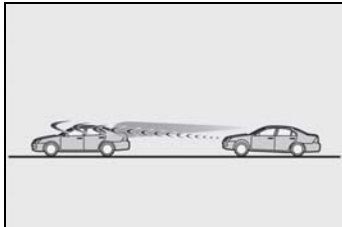

- Preceding vehicle has an extremely high ground clearance

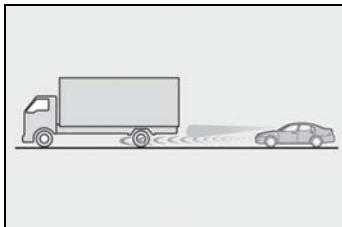

■ **Conditions under which the vehicle-to-vehicle distance control mode may not function correctly**

In the case of the following conditions, operate the brake pedal (or accelerator pedal, depending on the situation) as necessary.

As the sensor may not be able to correctly detect vehicles ahead, the system may not operate properly.

- When the road curves or when the lanes are narrow

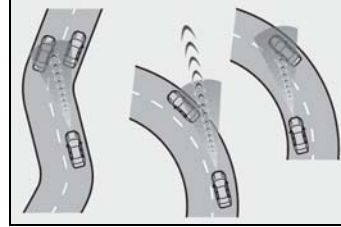

- When steering wheel operation or your position in the lane is unstable

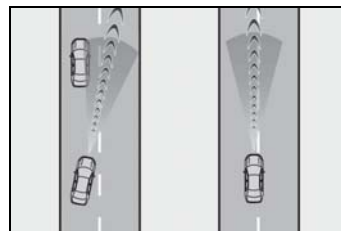

- When the vehicle ahead of you decelerates suddenly
- When driving on a road surrounded by a structure, such as in a tunnel or on a bridge
- While the vehicle speed is decreasing to the set speed after the vehicle accelerates by depressing the accelerator pedal



## Driving mode select switch

The driving modes can be selected to suit driving condition.

### Selecting the driving mode

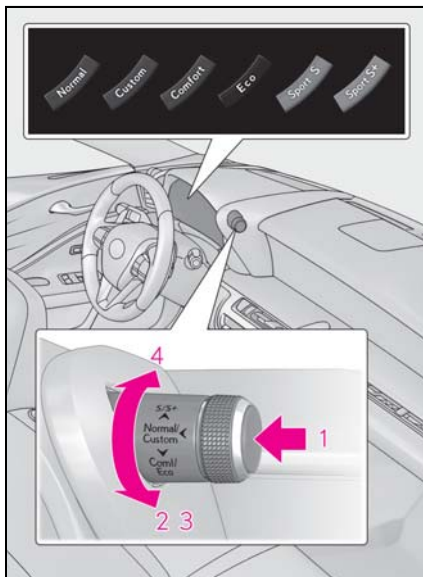

#### 1 Normal mode/Custom mode

Normal mode and custom mode are selected by pressing the driving mode select switch. Each time the switch is pressed, the driving mode changes between normal mode and custom mode. When custom mode is selected, the "Custom" indicator comes on.

Press the switch to change the driving mode to normal mode when not in normal mode.

- Normal mode

Provides an optimal balance of fuel economy, quietness, and dynamic performance. Suitable for city driving.

When the shift position is in D, an appropriate gear for sporty driving may automati-

cally be selected according to driver performance and driving conditions.

- Custom mode

Allows you to drive with the power train, chassis and air conditioning system functions set to your preferred settings.

Custom mode settings can only be changed on the drive mode customization display of the Center Display. (→P.243)

#### 2 Comfort mode

By controlling the suspension, riding comfort is further enhanced. Suitable for city driving.

When not in comfort mode and the driving mode select switch is turned forward, the "Comfort" indicator comes on.

#### 3 Eco drive mode

Helps the driver accelerate in an eco-friendly manner and improve fuel economy through moderate throttle characteristics and by controlling the operation of the air conditioning system (heating/cooling).

When in comfort mode, if the driving mode select switch is turned forward, the "Eco" indicator comes on.

#### 4 Sport mode

- SPORT S mode

Controls the transmission and engine to provide quick, powerful acceleration. This mode is suitable for when agile driving response is desired, such as when driving on roads with many curves.

When not in SPORT S mode, if the driving mode select switch is turned backward, the "Sport S" indicator comes on.

- SPORT S+ mode

Provides earlier downshift timing than SPORT S mode in order to maintain a high engine speed and provides faster gear changes. This mode also changes the steering feel, suspension control and VDIM control, making it suitable for pow-

erful sporty driving.

When in SPORT S mode, if the driving mode select switch is turned backward, the "Sport S+" indicator comes on.

■ **Operation of the air conditioning system in Eco drive mode**

Eco drive mode controls the heating/cooling operations and fan speed of the air conditioning system to enhance fuel efficiency. To improve air conditioning performance, perform the following operations:

- Turn off eco air conditioning mode (→P.253)
- Adjust the fan speed (→P.251)
- Turn off Eco drive mode (→P.213)

■ **Automatic deactivation of sport mode and custom mode**

If the engine switch <power switch> is turned off after driving in sport mode or custom mode, the drive mode will be changed to normal mode.

■ **Driving mode pop-up display**

When the driving mode is changed, the selected driving mode will be temporarily displayed on the side display. (→P.244)

For custom mode, select "Setting" on the display to customize the driving mode.

**Intuitive parking assist\***

\*: If equipped

The distance from your vehicle to nearby obstacles when parallel parking or maneuvering into a garage is measured by the sensors and communicated via the multi-information display, head-up display (if equipped), Center Display and a buzzer. Always check the surrounding area when using this system.

**System components**

■ **Types of sensors**

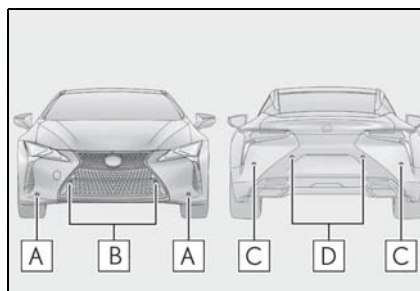

- A** Front corner sensors
- B** Front center sensors
- C** Rear corner sensors
- D** Rear center sensors

■ **Display**

When the sensors detect an obstacle, a graphic is shown on the multi-information display, head-up display and Center Display depending on the position and distance to the obstacle.

- Multi-information display and head-

up display



- A** Front corner sensor detection
- B** Front center sensor detection
- C** Rear corner sensor detection
- D** Rear center sensor detection

- Center Display

A graphic is shown when the Lexus parking assist monitor is displayed (insert display)

A simplified image is displayed on the upper right corner of the Center Display when an obstacle is detected.

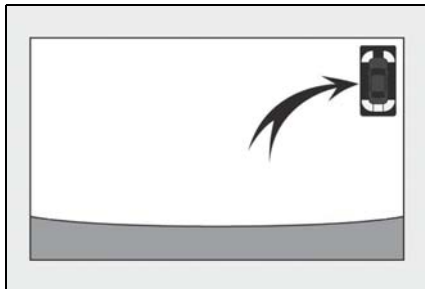

### Turning intuitive parking assist on/off

- 1 Press **<** or **>** of the meter control switches, and select

- 2 Press **▲** or **▼** of the meter control switches, and select "Parking Assist", and press "OK".

When the intuitive parking assist turn on, the intuitive parking assist indicator comes on to inform the driver that the system is operational.

#### ■ The intuitive parking assist can be operated when

- Front center sensors:
  - The engine switch <power switch> is in IGNITION ON mode <ON mode>.
  - The shift position is in a position other than P or R.
  - The vehicle speed is less than about 6 mph (10 km/h).
- Front corner sensors:
  - The engine switch <power switch> is in IGNITION ON mode <ON mode>.
  - The shift position is in a position other than P.
  - The vehicle speed is less than about 6 mph (10 km/h).  
(At any speed when the shift position is in R)
- Rear corner and rear center sensors:
  - The engine switch <power switch> is in IGNITION ON mode <ON mode>.
  - The shift position is in R.

#### ■ Muting the buzzer sound

- To mute the buzzer sound:

The buzzer can be temporarily muted by pressing "OK" of the meter control switches while an obstacle detection display is shown on the multi-information display.

- To cancel the mute:

Mute will be automatically canceled in the following situations.

- When the shift position is changed (except shifting from D to N, or N to D)
- When the vehicle speed has reached or exceeded 6 mph (10 km/h) with the shift position in D
- When the intuitive parking assist is turned off once and turned on again

- When the engine switch <power switch> is turned off once and turned to IGNITION ON mode <ON mode> again

■ **If “Clean Parking Assist Sensor” is displayed on the multi-information display**

A sensor may be dirty or covered with snow or ice. In such cases, if it is removed from the sensor, the system should return to normal.

Also, due to the sensor being frozen at low temperatures, a malfunction display may appear or an obstacle may not be detected. If the sensor thaws out, the system should return to normal.

■ **If “Parking Assist Malfunction” or “Parking Assist Malfunction Visit Your Dealer” is displayed on the multi-information display**

There is a malfunction and the device may not be working properly.

Have the vehicle inspected by your Lexus dealer.

■ **Sensor detection information**

- The sensor’s detection areas are limited to the areas around the vehicle’s front and rear bumpers.
- Certain vehicle conditions and the surrounding environment may affect the ability of the sensor to correctly detect obstacles. Particular instances where this may occur are listed below.
  - There is dirt, snow or ice on the sensor. (Wiping the sensors will resolve this problem.)
  - The sensor is frozen. (Thawing the area will resolve this problem.)  
In especially cold weather, if a sensor is frozen the screen may show an abnormal display, or obstacles may not be detected.
  - The sensor is covered in any way.
  - The vehicle is leaning considerably to one side.
  - On an extremely bumpy road, on an incline, on gravel, or on grass.
  - The vicinity of the vehicle is noisy due to vehicle horns, motorcycle engines, air brakes of large vehicles, or other loud noises producing ultrasonic waves.
  - There is another vehicle equipped with

- parking assist sensor in the vicinity.
- The sensor is coated with a sheet of spray or heavy rain.
- The vehicle is equipped with a fender pole or wireless antenna.
- Towing eyelets are installed.
- The bumper or sensor receives a strong impact.
- The vehicle is approaching a tall or curved curb.
- In harsh sunlight or intense cold weather.
- The area directly under the bumpers is not detected.
- If obstacles draw too close to the sensor.
- A non-genuine Lexus suspension (lowered suspension etc.) is installed.
- People may not be detected if they are wearing certain types of clothing.

In addition to the examples above, there are instances in which, because of their shape, signs and other objects may be judged by the sensor to be closer than they are.

- The shape of the obstacle may prevent the sensor from detecting it. Pay particular attention to the following obstacles:
  - Wires, fences, ropes, etc.
  - Cotton, snow and other materials that absorb sound waves
  - Sharply-angled objects
  - Low obstacles
  - Tall obstacles with upper sections projecting outwards in the direction of your vehicle
- The following situations may occur during use.
  - Depending on the shape of the obstacle and other factors, the detection distance may shorten, or detection may be impossible.
  - Obstacles may not be detected if they are too close to the sensor.
  - There will be a short delay between obstacle detection and display. Even at slow speeds, there is a possibility that the obstacle will come within the sensor’s detection areas before the display is shown and the warning beep sounds.
  - Thin posts or objects lower than the sensor may not be detected when approached, even if they have been detected once.
  - It might be difficult to hear beeps due to

the volume of the audio system or air flow noise of the air conditioning system.

- It might be difficult to hear beeps due to the sounds of other systems.

#### ■ Certification

- ▶ For vehicles sold in the U.S.A.

This device complies with Part 15 of the FCC Rules. Operation is subject to the following two conditions; (1) This device may not cause harmful interference, and (2) this device must accept any interference received, including interference that may cause undesired operation.

#### ■ Customization

Some functions can be customized. (→P.391)

- ▶ For vehicles sold in Canada

This ISM device complies with Canadian ICES-001.

Cet appareil ISM est conforme à la norme NMB-001 du Canada.



#### WARNING

##### ■ When using the intuitive parking assist

Observe the following precautions. Failing to do so may result in the vehicle being unable to be driven safely and possibly cause an accident.

- Do not use the sensor at speeds in excess of 6 mph (10 km/h).
- The sensors' detection areas and reaction times are limited. When moving forward or reversing, check the areas surrounding the vehicle (especially the sides of the vehicle) for safety, and drive slowly, using the brake to control the vehicle's speed.
- Do not install accessories within the sensors' detection areas.



#### NOTICE

##### ■ When using intuitive parking assist

In the following situations, the system may not function correctly due to a sensor malfunction etc. Have the vehicle checked by your Lexus dealer.

- The intuitive parking assist operation display flashes or shows continuously, and a beep sounds when no obstacles are detected.
- If the area around a sensor collides with something, or is subjected to strong impact.
- If the bumper or grille collides with something.

 **NOTICE**

- If the display flashes or shows continuously without beeping, except when the mute function has been turned on.
- If a display error occurs, first check the sensor.  
If the error occurs even when there is no ice, snow or mud on the sensor, it is likely that the sensor is malfunctioning.

■ **Notes when washing the vehicle**

Do not apply intensive bursts of water or steam to the sensor area.

Doing so may result in the sensor malfunctioning.

**Sensor detection display, obstacle distance**

■ **Detection range of the sensors**

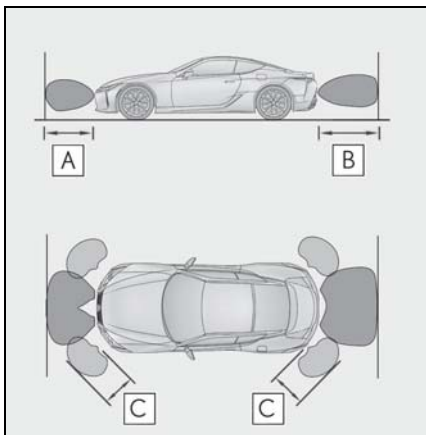

- A** Approximately 3.3 ft. (100 cm)
- B** Approximately 4.9 ft. (150 cm)
- C** Approximately 2.0 ft. (60 cm)



The diagram shows the detection range of the sensors. Note that the sensors cannot detect obstacles that are extremely close to the vehicle.



The range of the sensors may change

depending on the shape of the object etc.

■ **Multi-information display, head-up display and Center Display**

Sensors that detect an obstacle will illuminate continuously or blink.

Display <sup>*1</sup>	Approximate distance to obstacle
 (continuous <sup>*2</sup> or blinking slowly <sup>*3</sup> )	Front center sensor: 3.3 ft. (100 cm) to 1.6 ft. (50 cm) Rear center sensor: 4.9 ft. (150 cm) to 2.0 ft. (60 cm)
 (continuous <sup>*2</sup> or blinking <sup>*3</sup> )	Front center sensor: 1.6 ft. (50 cm) to 1.3 ft. (40 cm) Rear center sensor: 2.0 ft. (60 cm) to 1.5 ft. (45 cm) Front and rear corner sensor: 2.0 ft. (60 cm) to 1.5 ft. (45 cm)

Display <sup>*1</sup>	Approximate distance to obstacle
 (continuous <sup>*2</sup> or blinking rapidly <sup>*3</sup> )	Front center sensor: 1.3 ft. (40 cm) to 1.0 ft. (30 cm) Rear center sensor: 1.5 ft. (45 cm) to 1.1 ft. (35 cm) Front and rear corner sensor: 1.5 ft. (45 cm) to 1.0 ft. (30 cm)
 (blinking <sup>*2</sup> or continuous <sup>*3</sup> )	Front center sensor: Less than 1.0 ft. (30 cm) Rear center sensor: Less than 1.1 ft. (35 cm) Front and rear corner sensor: Less than 1.0 ft. (30 cm)

- Front center sensors: Approximately 1.0 ft. (30 cm)
- Corner sensors: Approximately 1.0 ft. (30 cm)
- Rear center sensors: Approximately 1.1 ft. (35 cm)
- When 2 or more obstacles are detected simultaneously, the buzzer system responds to the nearest obstacle. If one or both come within the above distances, the beep will repeat a long tone, followed by fast beeps.

<sup>\*1</sup>: The illustrations show the graphics on the Multi-information display, and differ from the graphics on the head-up display and Center Display. Depending on the distance of the obstacle, the sensor display on the Center Display illuminates or blinks in various cycles, although the width of it does not change.

<sup>\*2</sup>: Multi-information display and head-up display

<sup>\*3</sup>: Center Display

■ **Buzzer operation and distance to an obstacle**

A buzzer sounds when the sensors are operating.

- The buzzer beeps faster as the vehicle approaches an obstacle. When the vehicle comes within the following distance of the obstacle, the buzzer sounds continuously:

**BSM (Blind Spot Monitor)\***

\*: If equipped

The Blind Spot Monitor uses the sensors installed behind the rear bumper. The system is intended to assist the driver check areas that are not easily visible. The system has the following 2 functions:

- The BSM (Blind Spot Monitor) function

Assists the driver in making a decision when changing lanes

- The RCTA (Rear Cross Traffic Alert) function

Assists the driver when backing up

**These functions use same sensors.**

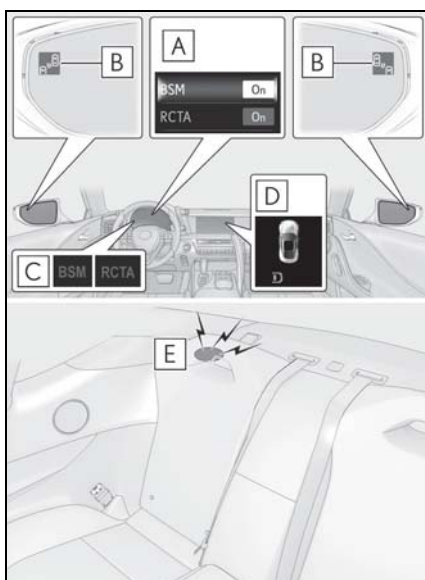
**System components**

**A** Multi-information display

Turning the BSM function/RCTA function on/off.

The RCTA function is available when the BSM function is on.

**B** Outside rear view mirror indicators BSM function:

When a vehicle is detected in a blind spot of the outside rear view mirrors or approaching rapidly from behind into a blind spot, the outside rear view mirror indicator on the detected side will illuminate. If the turn signal lever is operated toward the detected side, the outside rear view mirror indicator will flash.

RCTA function:

When a vehicle approaching from the right or left at the rear of the vehicle is detected, both outside rear view mirror indicators will flash.

**C** BSM indicator/RCTA indicator

When the BSM function/RCTA function is turned on, the indicator comes on.

**D** Monitor screen display (RCTA function only)

If a vehicle approaching from the right or left at the rear of the vehicle is detected, the RCTA icon (→P.226) for the detected side will be displayed on the monitor screen. This illustration shows an example of a vehicle approaching from the left at the rear of the vehicle.

**E** RCTA buzzer (RCTA function only)

If a vehicle approaching from the right or left at the rear of the vehicle is detected, a buzzer will sound. The buzzer also sounds for approximately 1 second immediately after the BSM function is operated to turn the system on.



### Turning the BSM function/RCTA function on/off

- 1 Press **<** or **>** of the meter control switches, select .
- 2 Press **▲** or **▼** of the meter control switches, select "BSM", and then press "OK".
- 3 Press **▲** or **▼** of the meter control switches, select "BSM" or "RCTA", and press "OK".

#### ■ Outside rear view mirror indicator visibility

In strong sunlight, the outside rear view mirror indicator may be difficult to see.

#### ■ Hearing the RCTA buzzer

The RCTA buzzer may be difficult to hear

#### ■ Certification for the Blind Spot Monitor

- ▶ For vehicles sold in the U.S.A., Hawaii and Puerto Rico

FCC ID : OAYSRR3A

This device complies with part 15 of the FCC Rules. Operation is subject to the following two conditions:  
 (1) This device may not cause harmful interference, and  
 (2) this device must accept any interference received, including interference that may cause undesired operation.

#### FCC Warning

Changes or modifications not expressly approved by the party responsible for compliance could void the user's authority to operate the equipment.

over loud noises, such as if the audio system volume is high.

#### ■ When "Blind Spot Monitor Unavailable" is shown on the multi-information display

Water, snow, mud, etc., may be built up in the vicinity of the sensor area of bumper. (→P.222) Removing the water, snow, mud, etc., from the vicinity of the sensor area bumper should return it to normal.

Also, the sensor may not function normally when used in extremely hot or cold weather.

#### ■ When "Blind Spot Monitor System Malfunction" is shown on the multi-information display

There may be a sensor malfunction or voltage abnormality. Have the vehicle inspected at your Lexus dealer.

#### ■ Customization

Some functions can be customized. (Customizable features: →P.391)

► For vehicles sold in Canada

Applicable law : Canada 310

This device complies with Industry Canada licence-exempt RSS standard(s). Operation is subject to the following two conditions: (1) this device may not cause interference, and (2) this device must accept any interference, including interference that may cause undesired operation of the device.

Frequency bands : 24.05 - 24.25GHz

Output power : less than 20 milliwatts

Droit applicable : Canada 310

Le présent appareil est conforme aux CNR d'Industrie Canada applicables aux appareils radio exempts de licence. L'exploitation est autorisée aux deux conditions suivantes : (1) l'appareil ne doit pas produire de brouillage, et (2) l'utilisateur de l'appareil doit accepter tout brouillage radioélectrique subi, même si le brouillage est susceptible d'en compromettre le fonctionnement.

Bandes de fréquences : 24.05 - 24.25GHz

Puissance émise : Moins de 20 milliwatts

**⚠ WARNING**

■ **Handling the radar sensor**

Blind Spot Monitor sensors are installed behind the left and right sides of the rear bumper respectively. Observe the following to ensure the Blind Spot Monitor can function correctly.

● Keep the sensors and the surrounding areas on the rear bumper clean at all times.

If a sensor or its surrounding area on the rear bumper is dirty or covered with snow, the Blind Spot Monitor may not operate and a warning message (→P.221) will be displayed. In this situation, clear off the dirt or snow and drive the vehicle with the operation conditions of the BSM function (→P.224) satisfied for approximately 10 minutes. If the warning message does not disappear, have the vehicle inspected by your Lexus dealer.

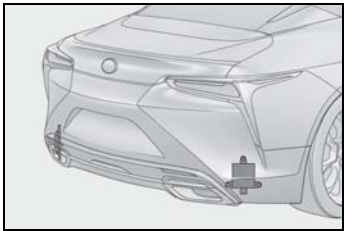

**⚠ WARNING**

- Do not subject a sensor or its surrounding area on the rear bumper to a strong impact.  
If a sensor is moved even slightly off position, the system may malfunction and vehicles may not be detected correctly.  
In the following situations, have your vehicle inspected by your Lexus dealer.
- A sensor or its surrounding area is subject to a strong impact.
- If the surrounding area of a sensor is scratched or dented, or part of them has become disconnected.
- Do not disassemble the sensor.
- Do not attach stickers to the sensor or surrounding area on the rear bumper.
- Do not modify the sensor or surrounding area on the rear bumper.
- Do not paint the rear bumper any color other than an official Lexus color.

4

Driving

**BSM function****■ Operation of the BSM function**

The BSM function uses radar sensors to detect the following vehicles traveling in adjacent lanes and advises the driver of the presence of such vehicles via the indicators on the outside rear view mirrors.

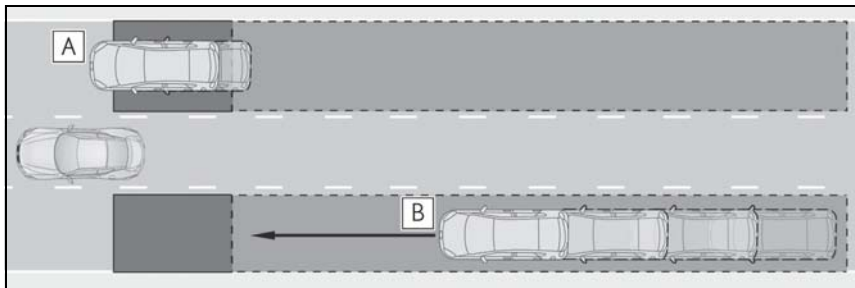

- A** Vehicles that are traveling in areas that are not visible using the outside rear view mirrors (the blind spots)

- B** Vehicles that are approaching rapidly from behind in areas that are not visible using the outside rear view mirrors (the blind spots)

■ **BSM function detection areas**

The areas that vehicles can be detected in are outlined below.

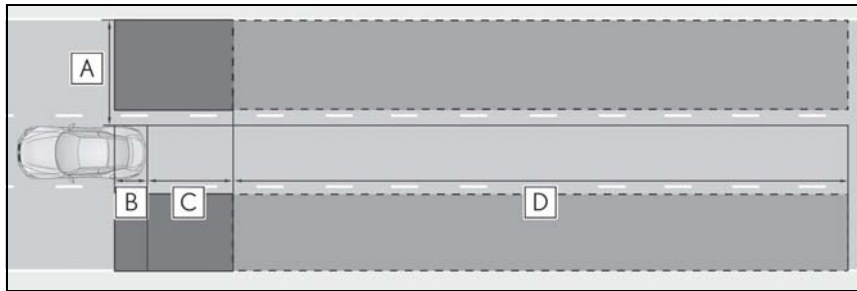

The range of each detection area is:

- A** Approximately 1.6 ft. (0.5 m) to 11.5 ft. (3.5 m) from either side of the vehicle<sup>\*1</sup>
- B** Approximately 3.3 ft. (1 m) forward of the rear bumper
- C** Approximately 9.8 ft. (3 m) from the rear bumper
- D** Approximately 9.8 ft. (3 m) to 197 ft. (60 m) from the rear bumper<sup>\*2</sup>

<sup>\*1</sup>: The area between the side of the vehicle and 1.6 ft. (0.5 m) from the side of the vehicle cannot be detected.

<sup>\*2</sup>: The greater the difference in speed between your vehicle and the detected vehicle is, the farther away the vehicle will be detected, causing the outside rear view mirror indicator to illuminate or flash.

■ **The BSM function is operational when**

The BSM function is operational when all of the following conditions are met:

- The BSM function is on.
- The shift position is in a position other than R.
- The vehicle speed is greater than approximately 10 mph (16 km/h).

■ **The BSM function will detect a vehicle when**

The BSM function will detect a vehicle present in the detection area in the following situations:

- A vehicle in an adjacent lane overtakes your vehicle.

- You overtake a vehicle in adjacent lane slowly.
- Another vehicle enters the detection area when it changes lanes.

■ **Conditions under which the BSM function will not detect a vehicle**

The BSM function is not designed to detect the following types of vehicles and/or objects:

- Small motorcycles, bicycles, pedestrians, etc.\*
- Vehicles traveling in the opposite direction
- Guardrails, walls, signs, parked vehicles and similar stationary objects\*
- Following vehicles that are in the same

lane\*

- Vehicles traveling 2 lanes away from your vehicle\*
- Vehicles which are being overtaken rapidly by your vehicle.\*

\* : Depending on the conditions, detection of a vehicle and/or object may occur.

#### ■ Conditions under which the BSM function may not function correctly

- The BSM function may not detect vehicles correctly in the following situations:
  - When the sensor is misaligned due to a strong impact to the sensor or its surrounding area
  - When mud, snow, ice, a sticker, etc. is covering the sensor or surrounding area on the rear bumper
  - When driving on a road surface that is wet with standing water during bad weather, such as heavy rain, snow, or fog
  - When multiple vehicles are approaching with only a small gap between each vehicle
  - When the distance between your vehicle and a following vehicle is short
  - When there is a significant difference in speed between your vehicle and the vehicle that enters the detection area
  - When the difference in speed between your vehicle and another vehicle is changing
  - When a vehicle enters a detection area traveling at about the same speed as your vehicle
  - As your vehicle starts from a stop, a vehicle remains in the detection area
  - When driving up and down consecutive steep inclines, such as hills, dips in the road, etc.
  - When driving on roads with sharp bends, consecutive curves, or uneven surfaces
  - When vehicle lanes are wide, or when driving on the edge of a lane, and the vehicle in an adjacent lane is far away from your vehicle
  - When an accessory (such as a bicycle carrier) or towing eyelet is installed to the rear of the vehicle
  - When there is a significant difference in height between your vehicle and the vehicle that enters the detection area

- Immediately after the BSM function is turned on
- Instances of the BSM function unnecessarily detecting a vehicle and/or object may increase in the following situations:
  - When the sensor is misaligned due to a strong impact to the sensor or its surrounding area
  - When the distance between your vehicle and a guardrail, wall, etc. that enters the detection area is short
  - When driving up and down consecutive steep inclines, such as hills, dips in the road, etc.
  - When vehicle lanes are narrow, or when driving on the edge of a lane, and a vehicle traveling in a lane other than the adjacent lanes enters the detection area
  - When driving on roads with sharp bends, consecutive curves, or uneven surfaces
  - When the tires are slipping or spinning
  - When the distance between your vehicle and a following vehicle is short
  - When an accessory (such as a bicycle carrier) or towing eyelet is installed to the rear of the vehicle



#### WARNING

##### ■ Cautions regarding the use of the function

The driver is solely responsible for safe driving. Always drive safely, taking care to observe your surroundings.

The BSM function is a supplementary function which alerts the driver that a vehicle is in a blind spot of the outside rear view mirrors or is approaching rapidly from behind into a blind spot. Do not overly rely on the BSM function. As the function cannot judge if it is safe to change lanes, over reliance could lead to an accident resulting in death or serious injury.

As the system may not function correctly under certain conditions, the driver's own visual confirmation of safety is necessary.

**RCTA function**

■ **Operation of the RCTA function**

The RCTA function uses radar sensors to detect vehicles approaching from the right or left at the rear of the vehicle and alerts the driver of the presence of such vehicles by flashing the outside rear view mirror indicators and sounding a buzzer.

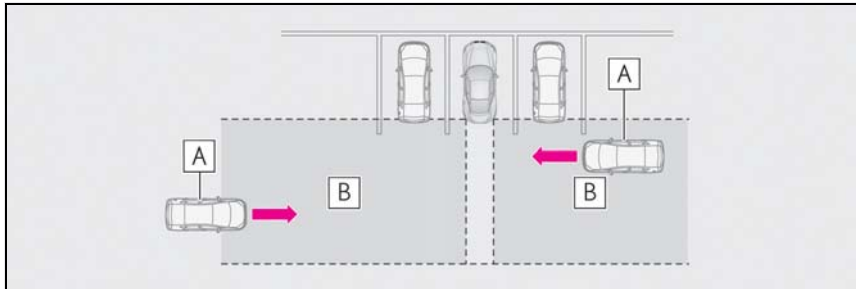

- A** Approaching vehicles
- B** Detection areas of approaching vehicles

■ **RCTA icon display**

When a vehicle approaching from the right or left at the rear of the vehicle is detected, the following will be displayed on the monitor screen.

Display	Content
	A vehicle is approaching from the left at the rear of the vehicle
	A vehicle is approaching from the right at the rear of the vehicle

Display	Content
	Vehicles are approaching from both sides of the vehicle
	The RCTA function is malfunctioning (→P.221)

■ **RCTA function detection areas**

The areas that vehicles can be detected in are outlined below.

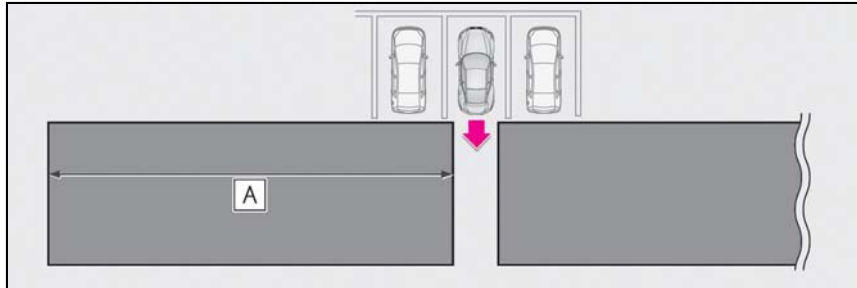

The buzzer can alert the driver of faster vehicles approaching from farther away.

Example:

Approaching vehicle speed	<b>A</b> Approximate alert distance
18 mph (28 km/h) (fast)	65 ft. (20 m)
5 mph (8 km/h) (slow)	18 ft. (5.5 m)

■ **The RCTA function is operational when**

The RCTA function operates when all of the following conditions are met:

- The RCTA function is on.
- The shift position is in R.
- The vehicle speed is less than approximately 5 mph (8 km/h).
- The approaching vehicle speed is between approximately 5 mph (8 km/h) and 18 mph (28 km/h).

■ **Conditions under which the RCTA function will not detect a vehicle**

The RCTA function is not designed to detect the following types of vehicles and/or objects:

- Vehicles approaching from directly behind
- Vehicles backing up in a parking space

next to your vehicle

- Vehicles that the sensors cannot detect due to obstructions

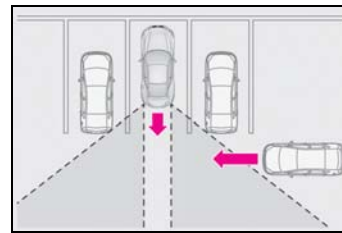

- Guardrails, walls, signs, parked vehicles and similar stationary objects\*
- Small motorcycles, bicycles, pedestrians, etc.\*
- Vehicles moving away from your vehicle
- Vehicles approaching from the parking spaces next to your vehicle\*

\*: Depending on the conditions, detection of a vehicle and/or object may occur.

■ **Conditions under which the RCTA function may not function correctly**

- The RCTA function may not detect vehicles correctly in the following situations:
  - When the sensor is misaligned due to a strong impact to the sensor or its surrounding area
  - When mud, snow, ice, a sticker, etc. is covering the sensor or surrounding area on the rear bumper
  - When driving on a road surface that is wet with standing water during bad weather, such as heavy rain, snow, or fog

- When multiple vehicles are approaching with only a small gap between each vehicle
- When a vehicle is approaching at high speed
- When a towing eyelet is installed to the rear of the vehicle.
- When backing up on a slope with a sharp change in grade

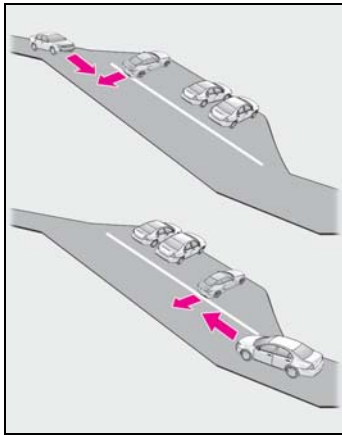

- When backing out of a shallow angle parking spot

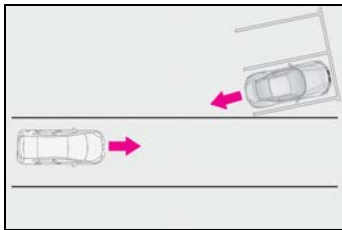

- Immediately after the RCTA function is turned on
- Immediately after the engine <hybrid system> is started with the RCTA function on
- When the sensors cannot detect a vehicle due to obstructions

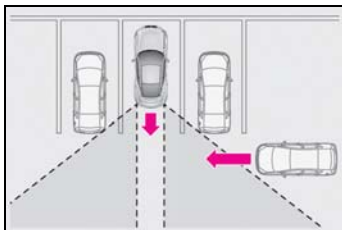

● Instances of the RCTA function unnecessarily detecting a vehicle and/or object may increase in the following situations:

- When a vehicle passes by the side of your vehicle
- When the parking space faces a street and vehicles are being driven on the street

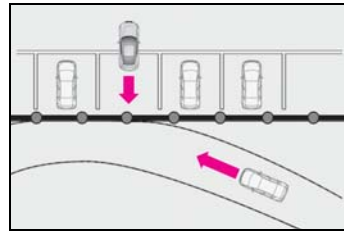

- When the distance between your vehicle and metal objects, such as a guardrail, wall, sign, or parked vehicle, which may reflect electrical waves toward the rear of the vehicle, is short
- When a towing eyelet is installed to the rear of the vehicle

**⚠ WARNING**

**■ Cautions regarding the use of the function**

The driver is solely responsible for safe driving. Always drive safely, taking care to observe your surroundings.

The RCTA function is only a supplementary function which alerts the driver that a vehicle is approaching from the right or left at the rear of the vehicle. As the RCTA function may not function correctly under certain conditions, the driver's own visual confirmation of safety is necessary. Over reliance on this function may lead to an accident resulting death or serious injury.



### Active rear wing\*

\*: If equipped

The vehicle is equipped with an active rear wing that operates automatically while the vehicle is being driven. This active rear wing enhances aerodynamic performance, especially at high speeds, contributing to a more stable ride.

The active rear wing can be controlled manually using a switch.

### System components

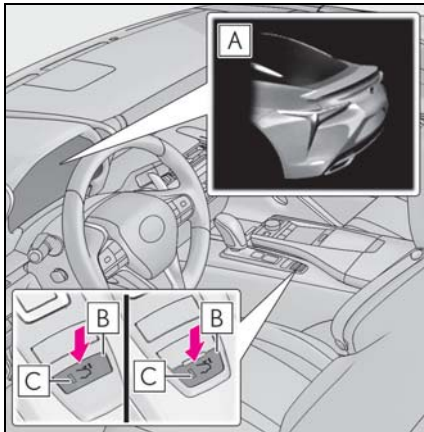

**A** Multi-information display (→P.84)

Displays the status of the active rear wing.

**B** Active rear wing switch

Operates the active rear wing manually.

**C** Indicator

Illuminates when the active rear wing is raised and turns off when it is retracted.

#### ■ The active rear wing can be operated when

- The engine switch <power switch> is in

IGNITION ON mode <ON mode>.

- The trunk is closed.
- The active rear wing has been activated in a customized setting.

#### ■ Conditions which stop the operation

In the following situations operation of the active rear wing will stop:

- The engine switch <power switch> is turned to ACCESSORY mode or off while the active rear wing is operating.
- The trunk is opened while the active rear wing is operating.
- The raising operation of the active rear wing is interrupted by an object, etc.
- The active rear wing is operated in an unusual manner causing it to stop at an irregular position.

In such cases, pressing the active rear wing switch will fully raise the active rear wing. Or, begin driving the vehicle and the active rear wing will raise automatically when the vehicle speed reaches 16 mph (25 km/h).

#### ■ When there is a malfunction in the system

A warning message will be displayed on the multi-information display. (→P.344)

#### ■ Customization

The active rear wing can be turned on/ off. (Customizable features: →P.391)

#### ⚠ NOTICE

##### ■ To prevent system damage

- Do not apply pressure to the active rear wing when pushing or pulling the vehicle.
- Do not lean on the active rear wing.
- Do not attach any accessories or other objects to the active rear wing.
- Do not modify or disassemble the active rear wing.
- Do not subject the active rear wing to severe impact.

 **NOTICE**

■ **To prevent 12-volt battery discharge**  
Do not operate the active rear wing repeatedly while the engine <hybrid system> is turned off.

**Automatic operation**

The active rear wing will operate automatically at the following speeds according to the selected driving mode (→P.213).

(Always observe the legal speed limit when driving on public roads.)

- When other than Eco drive mode is selected  
Up: Approximately 50 mph (80 km/h)  
Down: Approximately 25 mph (40 km/h)
- When Eco drive mode is selected  
Up: Approximately 80 mph (130 km/h)  
Down: Approximately 25 mph (40 km/h)

**Changing to manual operation**

Operate the active rear wing switch to raise/retract the active rear wing manually.

The active rear wing retracts when it is raised and raises when retracted.

However, the active rear wing does not respond to switch operations while the active rear wing is operating.

Vehicle speed	Up/Down
0 mph (0 km/h) (vehicle stopped)	Press/Press and hold*
Approximately 0 - 12 mph (0 - 20 km/h)	Operation not possible
Approximately 12 - 75 mph (20 - 120 km/h)	Press/Press
Approximately 75 mph (120 km/h) or more	Operation not possible

\*: Press and hold the switch until the indicator turns off. If the switch is released while the active rear wing is moving, it will return to the raised position automatically.

■ **Restoring automatic operation after the active rear wing is operated manually**

If the active rear wing is operated manually, automatic operation will resume according to the vehicle speed.

 **WARNING**

■ **When manually operating the active rear wing**  
Observe the following precautions before operating the active rear wing. Failure to do so may result in death or serious injury.

- Ensure that the surrounding area is free of any objects that may come into contact with or get caught on the active rear wing.

**! WARNING**

- If there are people near the active rear wing, make sure that there is no possibility of their clothing, personal belongings or body parts getting caught. Children especially should be warned not to touch the active rear wing while it is being operated.

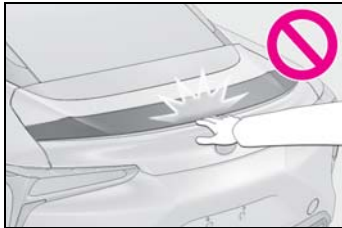

- If there is a risk that an object may become caught on the active rear wing during operation, stop operation immediately.

**Driving assist systems**

To keep safety and performance, the following systems operate automatically in response to various driving situations. Be aware, however, that these systems are supplementary and should not be relied upon too heavily when operating the vehicle.

**Summary of the driving assist systems**

- **ECB (Electronically Controlled Brake System)**

The electronically controlled system generates braking force corresponding to the brake operation

- **ABS (Anti-lock Brake System)**

Helps to prevent wheel lock when the brakes are applied suddenly, or if the brakes are applied while driving on a slippery road surface

- **Brake assist**

Generates an increased level of braking force after the brake pedal is depressed when the system detects a panic stop situation

- **VSC (Vehicle Stability Control)**

Helps the driver to control skidding when swerving suddenly or turning on slippery road surfaces

- **Secondary Collision Brake**

When the airbag sensor detects a collision, the brakes and brake lights are automatically controlled to reduce the

vehicle speed and that helps reduce the possibility of further damage due to a secondary collision

■ **TRAC (Traction Control)**

Helps to maintain drive power and prevent the drive wheels from spinning when starting the vehicle or accelerating on slippery roads

■ **Hill-start assist control**

Helps to reduce the backward movement of the vehicle when starting on an uphill

■ **VGRS (Variable Gear Ratio Steering) (if equipped)**

Adjusts the front wheel turning angle in accordance with the vehicle speed and steering wheel movement

■ **DRS (Dynamic Rear Steering) (if equipped)**

Contributes to the turning characteristics and responsiveness of the vehicle by slightly adjusting the rear wheel angle of the vehicle in accordance with steering wheel movement

■ **EPS (Electric Power Steering)**

Employs an electric motor to reduce the amount of effort needed to turn the steering wheel

■ **AVS (Adaptive Variable Suspension System)**

By independently controlling the damping force of the shock absorbers for each of the 4 wheels according to the road and driving conditions, this system helps riding comfort with superior vehicle stability, and helps good

vehicle posture.

Also, the damping force changes depending on the selected driving mode. (→P.213)

■ **LDH (Lexus Dynamic Handling system) (if equipped)**

Provides integrated control of the VGRS, DRS and EPS. Contributes to turning characteristics at low speeds, responsiveness at medium speeds and safety at high speeds by controlling the steering angle of the front and rear wheels in accordance with the steering wheel operation and vehicle speed

■ **VDIM (Vehicle Dynamics Integrated Management)**

Provides integrated control of the ABS, brake assist, TRAC, VSC, hill-start assist control, EPS, VGRS (if equipped) and DRS (if equipped) systems

Helps to maintain vehicle stability when swerving on slippery road surfaces by controlling the brakes, engine <hybrid system> output, steering assist (if equipped), and steering ratio (if equipped)

■ **When the TRAC/VSC/ABS systems are operating**

The slip indicator light will flash while the TRAC/VSC/ABS systems are operating.

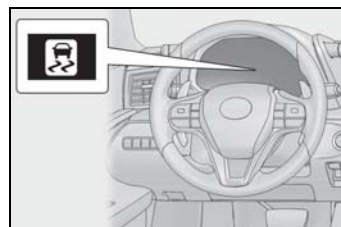

### ■ Disabling the TRAC system

If the vehicle gets stuck in mud, dirt or snow, the TRAC system may reduce power from the engine <hybrid system> to the wheels.

Pressing  to turn the system off may make it easier for you to rock the vehicle in order to free it.

To turn the TRAC system off, quickly press and release .

“Traction Control Turned Off” will be shown on the multi-information display.

Press  again to turn the system back on.

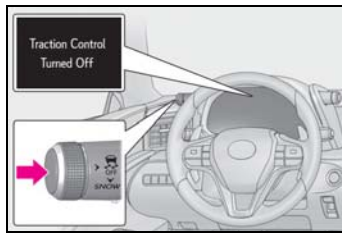

### ■ Disabling both TRAC and VSC systems

To turn the TRAC and VSC systems off, press and hold  for more than 3 seconds while the vehicle is stopped.

The VSC OFF indicator light will come on and the “Traction Control Turned Off” will be shown on the multi-information display.\*

Press  again to turn the systems back on.

\*: PCS (Pre-Collision System) will also be disabled (only Pre-Collision warning is available). The PCS warning light will come on and a message will be displayed on the multi-information display. (→P.195)

### ■ When the message is displayed on the multi-information display showing that TRAC has been disabled even if the

 has not been pressed

TRAC cannot be operated. Contact your Lexus dealer.

### ■ Operating conditions of hill-start assist control

When the following four conditions are met, the hill-start assist control will operate:

- The shift position is in a position other than P or N (when starting off forward/backward on an upward incline).
- The vehicle is stopped.
- The accelerator pedal is not depressed.
- The parking brake is not engaged.

### ■ Automatic system cancelation of hill-start assist control

The hill-start assist control will turn off in any of the following situations:

- The shift position is shifted to P or N.
- The accelerator pedal is depressed.
- The parking brake is engaged.
- 2 seconds at maximum elapsed after the brake pedal is released.

### ■ VGRS is disabled when

VGRS may stop operating in the following situations.

In this event, the steering wheel may move from its straight forward position, but it will return when the system restarts.

- When the steering wheel is operated for an extended period of time while the vehicle is stopped or is moving very slowly (on vehicles with LDH, DRS is disabled together with VGRS)
- When the steering wheel has been held fully to the left or right

The center position of the steering wheel may change when VGRS is disabled. However, the position will return to normal after VGRS is reactivated.

■ **When the 12-volt battery is disconnected (vehicles with VGRS)**

The steering wheel may move from its straight forward position, but this will be corrected automatically when driving.

■ **Sounds and vibrations caused by the ABS, brake assist, VSC, TRAC, hill-start assist control and VGRS systems**

- A sound may be heard from the engine compartment when the brake pedal is depressed repeatedly, when the engine is started or just after the vehicle begins to move. This sound does not indicate that a malfunction has occurred in any of these systems.
- Any of the following conditions may occur when the above systems are operating. None of these indicates that a malfunction has occurred.
  - Vibrations may be felt through the vehicle body and steering.
  - A motor sound may be heard after the vehicle comes to a stop.

■ **ECB operating sound**

ECB operating sound may be heard in the following cases, but it does not indicate that a malfunction has occurred.

- Operating sound heard from the engine compartment when the brake pedal is operated.
- Motor sound of the brake system heard from the front part of the vehicle when the driver's door is opened.
- Operating sound heard from the engine compartment when one or two minutes passed after the stop of the engine <hybrid system>.

■ **EPS, VGRS and DRS operation sound**

When the steering wheel is operated, a motor sound (whirring sound) may be heard. This does not indicate a malfunction.

■ **Automatic reactivation of TRAC and VSC systems**

After turning the TRAC and VSC systems off, the systems will be automatically re-enabled in the following situations:

- When the engine switch <power switch> is turned off

- If only the TRAC system is turned off, the TRAC will turn on when vehicle speed increases

If both the TRAC and VSC systems are turned off, automatic re-enabling will not occur when vehicle speed increases.

■ **Secondary Collision Brake operating conditions**

The vehicle speed is approximately 6 mph (10 km/h) or more and the airbag sensor detects a collision. (The Secondary Collision Brake will not operate when the vehicle speed is below approximately 6 mph [10 km/h].)

■ **Secondary Collision Brake automatic cancellation**

The Secondary Collision Brake is automatically canceled in the following situations.

- The vehicle speed drops below approximately 6 mph (10 km/h)
- A certain amount of time elapses during operation
- The accelerator pedal is depressed a large amount

■ **If "Secondary Collision Brake system Malfunction" is displayed on the multi-information display**

The system may be malfunctioning. Have the vehicle inspected at your Lexus dealer.

■ **Reduced effectiveness of the EPS system**

The effectiveness of the EPS system is reduced to prevent the system from overheating when there is frequent steering input over an extended period of time. The steering wheel may feel heavy as a result. Should this occur, refrain from excessive steering input or stop the vehicle and turn the engine <hybrid system> off. The EPS system should return to normal within 10 minutes.

**WARNING****■ The ABS does not operate effectively when**

- The limits of tire gripping performance have been exceeded (such as excessively worn tires on a snow covered road).
- The vehicle hydroplanes while driving at high speed on wet or slick roads.

**■ Stopping distance when the ABS is operating may exceed that of normal conditions**

The ABS is not designed to shorten the vehicle's stopping distance. Always maintain a safe distance from the vehicle in front of you, especially in the following situations:

- When driving on dirt, gravel or snow-covered roads
- When driving over bumps in the road
- When driving over roads with potholes or uneven surfaces

**■ TRAC/VSC may not operate effectively when**

Directional control and power may not be achievable while driving on slippery road surfaces, even if the TRAC/VSC system is operating.

Drive the vehicle carefully in conditions where stability and power may be lost.

**■ Hill-start assist control does not operate effectively when**

- Do not overly rely on hill-start assist control. Hill-start assist control may not operate effectively on steep inclines and roads covered with ice.
- Unlike the parking brake, hill-start assist control is not intended to hold the vehicle stationary for an extended period of time. Do not attempt to use hill-start assist control to hold the vehicle on an incline, as doing so may lead to an accident.

**■ When the TRAC/VSC/ABS is activated**

The slip indicator light flashes. Always drive carefully. Reckless driving may cause an accident. Exercise particular care when the indicator light flashes.

**■ When the TRAC/VSC systems are turned off**

Be especially careful and drive at a speed appropriate to the road conditions. As these are the systems to help ensure vehicle stability and driving force, do not turn the TRAC/VSC systems off unless necessary.

**■ Secondary Collision Brake**

Do not overly rely on the Secondary Collision Brake. This system is designed to help reduce the possibility of further damage due to a secondary collision, however, that effect changes according to various conditions. Overly relying on the system may result in death or serious injury.

**■ Replacing tires**

Make sure that all tires are of the specified size, brand, tread pattern and total load capacity. In addition, make sure that the tires are inflated to the recommended tire inflation pressure level.

The ABS, TRAC and VSC systems will not function correctly if different tires are installed on the vehicle.

Contact your Lexus dealer for further information when replacing tires or wheels.

**■ Handling of tires and the suspension**

Using tires with any kind of problem or modifying the suspension will affect the driving assist systems, and may cause a system to malfunction.

### Hybrid vehicle driving tips (LC500h)

For economical and ecological driving, pay attention to the following points:

#### Using Eco drive mode

When using Eco drive mode, the torque corresponding to the accelerator pedal depression amount can be generated more smoothly than it is in normal conditions. In addition, the operation of the air conditioning system (heating/cooling) will be minimized, improving the fuel economy. (→P.213)

#### Use of Hybrid System Indicator

The Eco-friendly driving is possible by keeping the indicate of Hybrid System Indicator within Eco area. (→P.78)

#### Changing the shift position

Shift the shift position to D when stopped at a traffic light, or driving in heavy traffic etc. Shift the shift position to P when parking. When using the N position, there is no positive effect on fuel consumption. In the N position, the gasoline engine operates but electricity cannot be generated. Also, when using the air conditioning system, etc., the hybrid battery (traction battery) power is consumed.

### Accelerator pedal/brake pedal operation

- Drive your vehicle smoothly. Avoid abrupt acceleration and deceleration. Gradual acceleration and deceleration will make more effective use of the electric motor (traction motor) without having to use gasoline engine power.
- Avoid repeated acceleration. Repeated acceleration consumes hybrid battery (traction battery) power, resulting in poor fuel consumption. Battery power can be restored by driving with the accelerator pedal slightly released.

#### When braking

Make sure to operate the brakes gently and in a timely manner. A greater amount of electrical energy can be regenerated when slowing down.

#### Delays

Repeated acceleration and deceleration, as well as long waits at traffic lights, will lead to bad fuel economy. Check traffic reports before leaving and avoid delays as much as possible. When driving in a traffic jam, gently release the brake pedal to allow the vehicle to move forward slightly while avoiding overuse of the accelerator pedal. Doing so can help control excessive gasoline consumption.



**Highway driving**

Control and maintain the vehicle at a constant speed. Before stopping at a toll booth or similar, allow plenty of time to release the accelerator and gently apply the brakes. A greater amount of electrical energy can be regenerated when slowing down.

**Air conditioning**

Use the air conditioning only when necessary. Doing so can help reduce excessive gasoline consumption.

In summer: When the ambient temperature is high, use the recirculated air mode. Doing so will help to reduce the burden on the air conditioning system and reduce fuel consumption as well.

In winter: Because the gasoline engine will not automatically cut out until it and the interior of the vehicle are warm, it will consume fuel. Also, fuel consumption can be improved by avoiding overuse of the heater.

**Checking tire inflation pressure**

Make sure to check the tire inflation pressure frequently. Improper tire inflation pressure can cause poor fuel economy.

Also, as snow tires can cause large amounts of friction, their use on dry roads can lead to poor fuel economy. Use tires that are appropriate for the season.

**Luggage**

Carrying heavy luggage will lead to poor fuel economy. Avoid carrying unnecessary luggage. Installing a large roof rack will also cause poor fuel economy.

**Warming up before driving**

Since the gasoline engine starts up and cuts out automatically when cold, warming up the engine is unnecessary. Moreover, frequently driving short distances will cause the engine to repeatedly warm up, which can lead to excess fuel consumption.

### Winter driving tips

Carry out the necessary preparations and inspections before driving the vehicle in winter. Always drive the vehicle in a manner appropriate to the prevailing weather conditions.

### Preparation for winter

- Use fluids that are appropriate to the prevailing outside temperatures.
  - Engine oil
  - Engine coolant
  - Power control unit coolant (LC500h)
  - Washer fluid
- Have a service technician inspect the condition of the 12-volt battery.
- Have the vehicle fitted with four snow tires.

Ensure that all tires are the specified size and the same brand.

### WARNING

#### ■ Driving with snow tires

Observe the following precautions to reduce the risk of accidents. Failure to do so may result in a loss of vehicle control and cause death or serious injury.

- Use tires of the specified size.
- Maintain the recommended level of air pressure.
- Do not drive in excess of 75 mph (120 km/h), regardless of the type of snow tires being used.
- Use snow tires on all, not just some wheels.

### NOTICE

#### ■ Driving with tire chains

Do not fit tire chains. Tire chains may damage the vehicle body and suspension, and adversely affect driving performance.

#### ■ Repairing or replacing snow tires

Request repairs or replacement of snow tires from Lexus dealers or legitimate tire retailers.

This is because the removal and attachment of snow tires affects the operation of the tire pressure warning valves and transmitters.

### Before driving the vehicle

Perform the following according to the driving conditions:

- Do not try to forcibly open a window or move a wiper that is frozen. Pour warm water over the frozen area to melt the ice. Wipe away the water immediately to prevent it from freezing.
- When the outside door handle is frozen, unlock the doors using the wireless remote control. If the outside door handles remain retracted and do not move even if the doors are unlocked using the wireless remote control, pour warm water over the frozen area to melt the ice and wipe away the water immediately to prevent it from freezing. The outside door handle may not retract due to ice, however, the outside door handle will return to the normal position after the ice melts.
- To ensure proper operation of the climate control system fan, remove

any snow that has accumulated on the air inlet vents in front of the windshield.

- Check for and remove any excess ice or snow that may have accumulated on the exterior lights, vehicle's roof, chassis, around the tires or on the brakes.
- Remove any snow or mud from the bottom of your shoes before getting in the vehicle.

■ **To protect the windshield wipers**

→P.180

### When driving the vehicle

Accelerate the vehicle slowly, keep a safe distance between you and the vehicle ahead, and drive at a reduced speed suitable to road conditions.

### When parking the vehicle

Park the vehicle and shift the shift position to P without setting the parking brake. The parking brake may freeze up, preventing it from being released. If the vehicle is parked without setting the parking brake, make sure to block the wheels.

Failure to do so may be dangerous because it may cause the vehicle to move unexpectedly, possibly leading to an accident.

### Selecting tire chains

Tire chains cannot be mounted.

Snow tires should be used instead.

### Windshield wipers

To enable the windshield wipers to be lifted when heavy snow or icy conditions are expected, change the rest position of the windshield wipers from the retracted position below the hood to the service position using the wiper lever. (→P.180)



Interior features

5

- 5-1. Remote Touch
  - Remote Touch..... 242
- 5-2. Lexus Climate Concierge
  - Lexus Climate Concierge..... 246
- 5-3. Using the air conditioning system
  - Automatic air conditioning system..... 248
  - Heated steering wheel/seat heaters/seat ventilators..... 255
- 5-4. Using the interior lights
  - Interior lights list..... 258
- 5-5. Using the storage features
  - List of storage features..... 260
  - Trunk features..... 262
- 5-6. Using the other interior features
  - Other interior features ..... 264
  - Garage door opener..... 266

### Remote Touch

The Remote Touch can be used to operate the Center Display.

For details on the Remote touch, refer to the “NAVIGATION SYSTEM OWNER’S MANUAL”.

### Remote Touch operation

#### ■ Switches

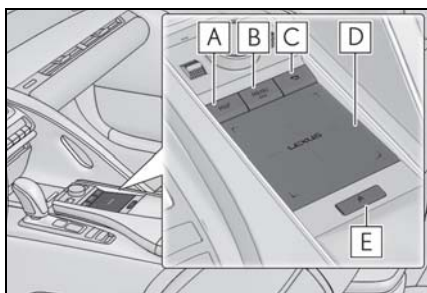

- A** “MAP” button  
Press to display the current location.
- B** “MENU” button  
Press to display the menu screen.
- C** Back button  
Press to display the previous screen.
- D** Touchpad  
Slide your finger on the touchpad and move the pointer to select a function, letter and screen button.  
Press the touchpad to enter the selected function, letter or screen button. Certain finger movements on the touchpad can perform functions, such as changing map scalings and scrolling list screens.
- E** Sub function button  
When  is displayed on the screen, a function screen assigned to the screen can

be displayed.

#### ■ Using the touchpad

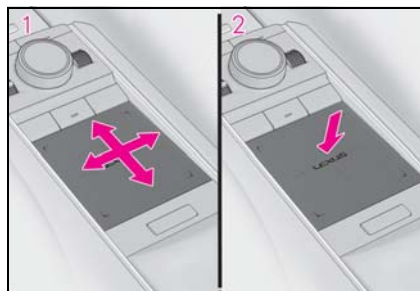

- 1** Select: Touch the touchpad to select the desired button on the screen.
- 2** Enter: The buttons on the screen can be selected by either depressing or double tapping on the touchpad. Once a button has been selected, the screen will change.

#### ■ Touch operation

Operations are performed by touching the touchpad with your finger.

##### ● Trace

Trace the pad surface while maintaining contact with the touchpad. Moving the cursor and the pointer.

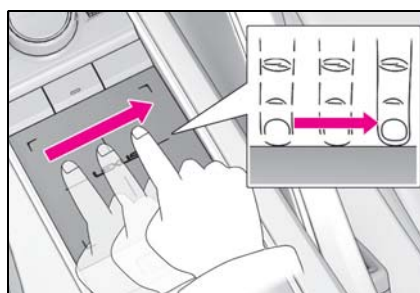

##### ● Double tap

Tap the touchpad twice, quickly. Select the button on the screen.

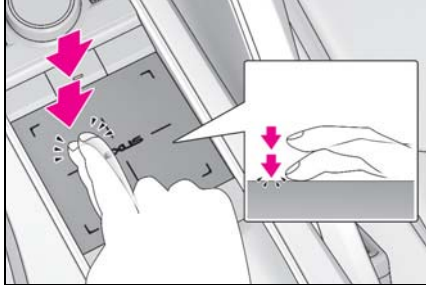

● Flick

Quick and long movement along the touchpad with your finger. Move the list screen.

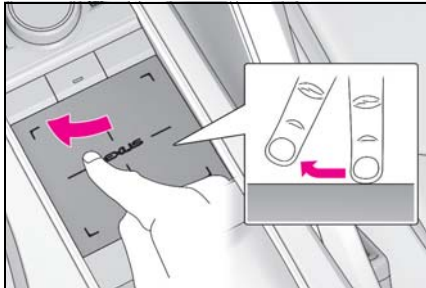

● Pinch in/Pinch out

Slide fingers toward each other or apart on the touchpad. Change the scale of the map.

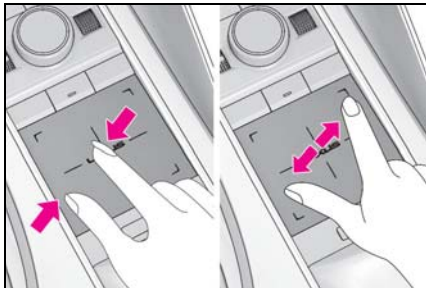

NOTICE

**To prevent damage to the Remote Touch**

Observe the following precautions. Failure to do so may cause damage to the Remote Touch.

- Do not allow the Remote Touch to come into contact with food, liquid, stickers or lit cigarettes.
- Do not subject the Remote Touch to excessive pressure or strong impact.
- Do not push the touchpad with a strong force or use a sharp pointed object to operate the pad.

**Center Display overview**





■ Menu screen

Press the "MENU" button on the Remote Touch to display the menu screen.

The display may differ depending on the type of the system.



Switch	Function
	Select to display the "Destination" screen.*1
	Select to display the audio control screen.*1
	Select to display the hands-free control screen.*1
	Select to display the "Apps" screen.*1,2

Switch	Function
	When an Apple CarPlay connection is established and this button displays "Apple CarPlay", select to display the home screen of Apple CarPlay. *1,2
	Select to display the information screen. *1 (→P.96, 98)
	Select to display the "Setup" screen. *1
	Select to display the air conditioning control screen. (→P.251)

\*1: Refer to the "NAVIGATION SYSTEM OWNER'S MANUAL".

\*2: This function is not made available on some models.

■ Split-screen display

Different information can be displayed on the left and right of the screen. For example, air conditioning system screen can be displayed and operated while the fuel consumption information screen is being displayed. The large screen on the left of the display is called the main display, and the small screen to the right is called the side display.

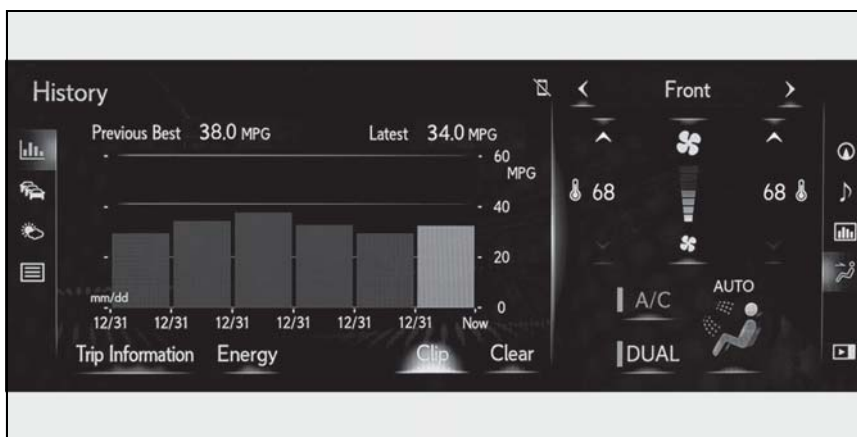



■ Main display

For details about the functions and operation of the main display, refer to the respective section and "NAVIGATION SYSTEM OWNER'S MANUAL".

■ Side display

The following functions can be displayed and operated on the side display.

Select  or  to display the desired screen.



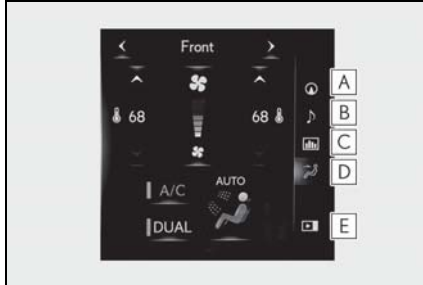

- A** Navigation system \*
- B** Audio \*
- C** Vehicle information (→P.99)
- D** Air conditioning system (→P.252)
- E** Show/hide the side display

\*: Refer to the "NAVIGATION SYSTEM OWNER'S MANUAL".

#### ■ Screen display during low temperatures

When the ambient temperature is extremely low, screen response may be delayed even if the Remote Touch is operated.

### Lexus Climate Concierge

The seat heaters (if equipped), seat ventilators (if equipped) and heated steering wheel (if equipped) are each automatically controlled according to the set temperature of the air conditioning system, the outside and cabin temperature, etc. Lexus Climate Concierge allows a comfortable condition to be maintained without adjusting each system.

Press the "MENU" button on the Remote Touch and select "Climate" to display the air conditioning control screen. Then, select  on the sub menu (→P.251) to display the Lexus Climate Concierge control screen.

### Turning on Lexus Climate Concierge

Select .

The indicator on the Lexus Climate Concierge control screen illuminates, and the automatic air conditioning system, seat heaters and ventilators, and heated steering wheel operate in automatic mode.

If any of the system is operated manually, the indicator turns off. However, all other functions continue to operate in automatic mode.



### ■ When using the Lexus Climate Concierge

Lexus Climate Concierge can be operated on the sub function menu or option control screen. (→P.251)

### Operation of each system

#### ■ Automatic air conditioning system (→P.248)

The temperature can be adjusted individually for the driver seat and passenger seat.

#### ■ Seat heaters and ventilators (if equipped) (→P.255)

Heating or ventilation is automatically selected according to the set temperature of the air conditioning system, the outside temperature, etc.

The seat heater and ventilator of the front passenger seat operate in automatic mode if a passenger is detected.

#### ■ Heated steering wheel (if equipped) (→P.255)

Heated steering wheel operates automatically according to the set temperature of the air conditioning system, the outside temperature, etc.

---

■ **Seat heater/ventilator operation**

When automatic mode is selected using the seat heater/ventilator switch, passenger detection is not performed.

### Automatic air conditioning system

Air outlets and fan speed are automatically adjusted according to the temperature setting.

Press the “MENU” button on the Remote Touch, then select “Climate” to display the air conditioning control screen. (→P.243)

The air conditioning system can be displayed and operated on the side display.

### Air conditioning controls

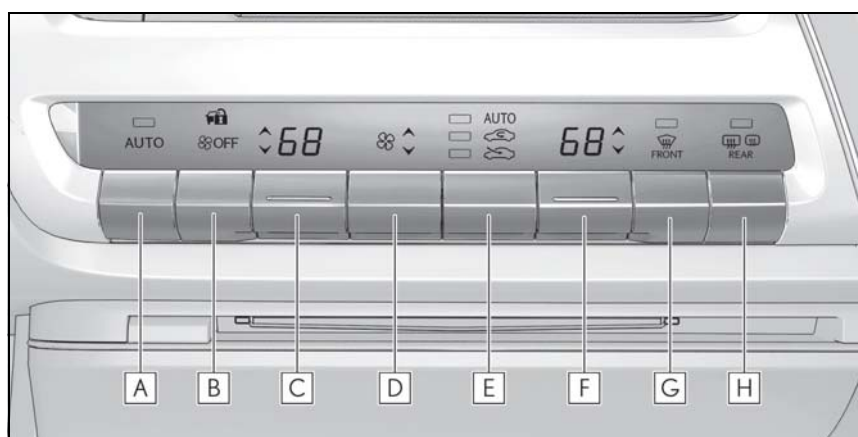

- A** Automatic mode switch
- B** Off switch
- C** Left-hand side temperature control switch
- D** Fan speed control switch
- E** Outside/recirculated air mode switch
- F** Right-hand side temperature control switch
- G** Windshield defogger switch
- H** Rear window and outside rear view mirror defoggers switch

■ **Adjusting the temperature**

Operate the temperature control switch upwards to increase the temperature and downwards to decrease

the temperature.

If the “A/C” indicator is turned off, the system will blow ambient temperature air or heated air.

**■ Setting the fan speed**

Operate the fan speed control switch upwards to increase the fan speed and downwards to decrease the fan speed.

Press the off switch to turn the fan off.



**■ Changing the air flow mode**

→P.251

**■ Switching between outside air and recirculated air modes**

Operate the outside/recirculated air mode switch upwards or downwards.

The mode changes as follows each time the switch is operated.

automatic mode →  (outside air mode) →  (recirculated air mode) → automatic mode

When the system is switched to automatic mode, the air conditioning system operates automatically.

**■ Defogging the windshield**

Defoggers are used to defog the windshield and front side windows.

Press the windshield defogger switch.

Set the outside/recirculated air mode switch to outside air mode if the recirculated air mode is used. (It may switch automatically.)

To defog the windshield and the side windows early, turn the air flow and temperature up.

To return to the previous mode, press the windshield defogger switch again when the windshield is defogged.

**■ Defogging the rear window and outside rear view mirrors**

Defoggers are used to defog the rear

window, and to remove raindrops, dew and frost from the outside rear view mirrors.

Press the rear window and outside rear view mirror defoggers switch.

The defoggers will automatically turn off after 15 to 60 minutes. The operation time changes according to the ambient temperature and vehicle speed.

**■ Windshield wiper de-icer (if equipped)**

→P.253

**■ When the outside temperature exceeds 75°F (24°C) and the air conditioning system is on**

- In order to reduce the air conditioning power consumption, the air conditioning system may switch to recirculated air mode automatically. This may also reduce fuel consumption.

- Recirculated air mode is selected as a default mode when the engine switch <power switch> is turned to IGNITION ON mode <ON mode>.

- It is possible to switch to outside air mode at any time by pressing the outside/recirculated air mode switch.

**■ Fogging up of the windows**

The windows will easily fog up when the humidity in the vehicle is high. Turning "A/C" on will dehumidify the air from the outlets and defog the windshield effectively.

- If you turn "A/C" off, the windows may fog up more easily.

- The windows may fog up if the recirculated air mode is used.

**■ Outside/recirculated air mode**

- When driving on dusty roads such as tunnels or in heavy traffic, set the outside/recirculated air mode switch to the recirculated air mode. This is effective in preventing outside air from entering the vehicle interior. During cooling operation, setting the recirculated air mode will

also cool the vehicle interior effectively.

- Outside/recirculated air mode may automatically switch depending on the temperature setting or the inside temperature.

#### ■ Registering air conditioning settings to electronic keys

- Unlocking the vehicle using an electronic key and turning the engine switch <power switch> to IGNITION ON mode <ON mode> will recall that key's registered air conditioning settings.
- When the engine switch <power switch> is turned off, the current air conditioning settings will automatically be registered to the electronic key that was used to unlock the vehicle.
- The system may not operate correctly if more than one electronic key is in the vicinity or if the smart access system with push-button start is used to unlock the passenger door.
- The doors that can recall the air conditioning setting\* when unlocked using the smart access system with push-button start can be changed. For details, contact your Lexus dealer.

\*: The doors that can recall the driving position memory are changed at the same time.

#### ■ Operation of the air conditioning system in Eco drive mode

In Eco drive mode, the air conditioning system is controlled as follows to prioritize fuel efficiency:

- Engine speed and compressor operation controlled to restrict heating/cooling capacity
- Fan speed restricted when automatic mode is selected

To improve air conditioning performance, perform the following operations:

- Turn off eco air conditioning mode (→P.251)
- Adjust the fan speed
- Turn off Eco drive mode (→P.213)

#### ■ When the outside temperature falls to nearly 32°F (0°C)

The dehumidification function may not operate even when "A/C" is selected.

#### ■ Ventilation and air conditioning odors

- To let fresh air in, set the air conditioning system to the outside air mode.
- During use, various odors from inside and outside the vehicle may enter into and accumulate in the air conditioning system. This may then cause odor to be emitted from the vents.
- To reduce potential odors from occurring:
  - It is recommended that the air conditioning system be set to outside air mode prior to turning the vehicle off.
  - The start timing of the blower may be delayed for a short period of time immediately after the air conditioning system is started in automatic mode or with the micro dust and pollen filter on.
- When parking, the system automatically switches to fresh air intake mode to encourage better air circulation throughout the vehicle, helping to reduce odors that occur when starting the vehicle.

#### ■ Using the voice command system

Air conditioning system can be operated using voice commands. For details, refer to the "NAVIGATION SYSTEM OWNER'S MANUAL".

#### ■ Air conditioning filter

→P.316

#### ■ Customization

Settings (e.g. A/C Auto switch operation) can be changed.  
(Customizable features →P.391)

**⚠ WARNING**

■ **To prevent the windshield from fogging up**  
 Do not use the windshield defogger switch during cool air operation in extremely humid weather. The difference between the temperature of the outside air and that of the windshield can cause the outer surface of the windshield to fog up, blocking your vision.

■ **When the outside rear view mirror defoggers are operating**  
 Do not touch the outside rear view mirror surfaces, as they can become very hot and burn you.

**⚠ NOTICE**

■ **To prevent 12-volt battery discharge**  
 Do not leave the air conditioning system on longer than necessary when the engine <hybrid system> is off.

**Air conditioning control screen**

■ **Main control screen**

Using the touchpad of the Remote Touch, select the button on the screen.

**B** to **E** can be adjusted by performing the following operations.

Flick operation: Move the pointer to the desired item and flick the touchpad up or down.

The item can be adjusted by one level.

Trace operation: After selecting the desired item, trace the pad surface.

The item can be adjusted by the amount that you trace.

Trace operation cannot be used while driving.

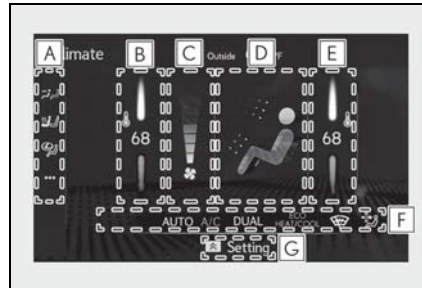

- A** Sub menu  
 Selecting the sub menu item to switch the main screen.
- : Display the air conditioning control screen
- : Display the heated steering wheel/seat heater/seat ventilator control screen (if equipped)
- : Display the Lexus Climate Concierge control screen
- : Display the option control screen
- B** Adjust the left-hand side temperature setting
- C** Adjust the fan speed setting
- D** Select the air flow mode
  - : Air flows to the upper body
  - : Air flows to the upper body and feet
  - : Air flows to the feet
  - : Air flows to the feet and the windshield defogger operates
- E** Adjust the right-hand side temperature setting
- F** Function on/off indicators  
 When the function is on, the indicator illu-

minates on the control screen.

**G** Sub function menu

When the sub function button on the Remote Touch is pressed, the following functions can be switched on and off.

- : Set Lexus Climate Concierge (→P.246)
- "AUTO": Set automatic mode on/off (→P.253)
- "Off": Turn the fan off
- "A/C": Set cooling and dehumidification function
- "DUAL": Adjust the temperature for driver and passenger seats separately ("DUAL" mode) (→P.254)

**ECO HEAT/COOL**: Set eco air conditioning mode

■ Option control screen

Select  on the sub menu to display the option control screen.

The functions can be switched on and off. When the function is on, the indicator illuminates on the screen.

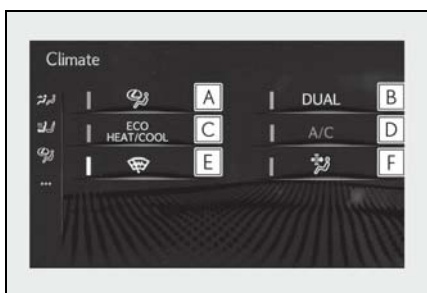

- A** Set Lexus Climate Concierge (→P.246)
- B** Adjusting the temperature for driver and passenger seats separately ("DUAL" mode) (→P.254)
- C** Set eco air conditioning mode

Air conditioning and heater output is limited to prioritize fuel economy.

- D** Cooling and dehumidification function
- E** Prevent ice from building up on the windshield and wiper blades (Windshield wiper de-icer) (if equipped)
- F** Removing pollen from the air (Micro dust and pollen filter)

■ Side display

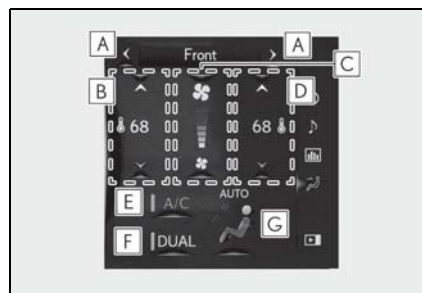

- A** Display the heated steering wheel/seat heaters/seat ventilators control screen (if equipped) (→P.256)
- B** Adjust the left-hand side temperature setting
- C** Adjust the fan speed setting
- D** Adjust the right-hand side temperature setting
- E** Set cooling and dehumidification function on/off
- F** Adjust the temperature for the driver's and front passenger's seats separately ("DUAL" mode) (→P.254)
- G** Select the air flow mode



#### ■ Windshield wiper de-icer (if equipped)

This feature is used to prevent ice from building up on the windshield and wiper blades.

The windshield de-icer will automatically turn off after approximately 15 minutes.

#### ■ Eco air conditioning mode

When Eco drive mode is selected using the driving mode select switch, eco air conditioning mode turns on.

When a drive mode other than Eco drive mode is selected, eco air conditioning mode may turn off.

#### ■ Micro dust and pollen filter

Outside air mode switches to  (recirculated air) mode. Pollen is removed from the air and the air flows to the upper part of the body.

Usually the system will automatically turn off after approximately 1 to 3 minutes.

In order to prevent the windshield from fogging up when the outside air is cold, the dehumidification function may operate or the outside/recirculated air mode may not switch to  (recirculated air) mode.

Pollen is filtered even if the micro dust and pollen filter is turned off.

#### WARNING

##### ■ To prevent burns (vehicles with windshield wiper de-icer)

Do not touch the glass at lower part of the windshield or to the side of the front pillars when the windshield wiper de-icer is on.

#### Using automatic mode

- 1 Press the automatic mode switch or select "AUTO" on the sub function menu. (→P.251)

- 2 Press the outside/recirculated air mode switch to switch to automatic air intake mode.

The air conditioning system automatically switches between outside air and recirculated air modes.

- 3 Adjust the temperature setting.
- 4 To stop the operation, press the off switch or select "Off" on the sub function menu. (→P.251)

If the fan speed setting or air flow modes are operated, the automatic mode indicator goes off. However, automatic mode for functions other than that operated is maintained.

#### ■ Using automatic mode

Fan speed is adjusted automatically according to the temperature setting and the ambient conditions.

Therefore, the fan may stop for a while until warm or cool air is ready to flow immediately after the automatic mode switch is pressed or "AUTO" is selected.

Cool air may blow around the upper body even when the heater is on due to sunlight.

#### ■ Windshield fog detection function

When automatic mode is set, the humidity sensor detects fog on the windshield and controls the air conditioning system to prevent fog.

#### ■ Automatic mode for air intake control

In automatic mode, the system detects exhaust gas and other pollutants and automatically switches between outside air and recirculated air modes.

When the dehumidification function is off, and the fan is operating, turning automatic mode on will activate the dehumidification function.

 NOTICE

**■ Humidity sensor**

In order to detect fog on the windshield, a sensor which monitors the temperature of the windshield, the surround humidity, etc. is installed.

Follow these points to avoid damaging the sensor:

- Do not disassemble the sensor
- Do not spray the glass cleaner on the sensor or subject it to strong impacts
- Do not stick anything on the sensor

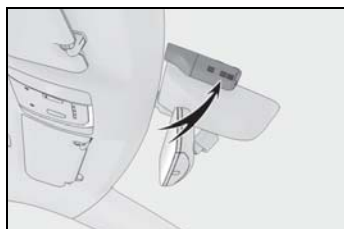
**Adjusting the temperature for driver and passenger seats separately ("DUAL" mode)**

To turn on the "DUAL" mode, perform any of the following procedures:

- Select "DUAL" on the sub function menu. (→P.251)
- Select "DUAL" on the option control screen.
- Adjust the passenger's side temperature setting.

The indicator on the main control screen comes on when the "DUAL" mode is on.

**Air outlet layout and operations**
**■ Location of air outlets**

The air outlets and air volume changes

according to the selected air flow mode.

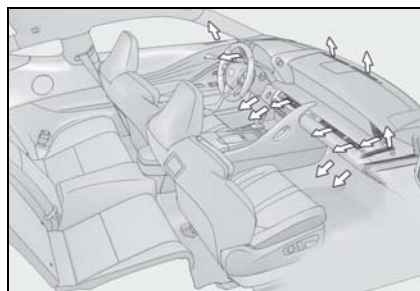
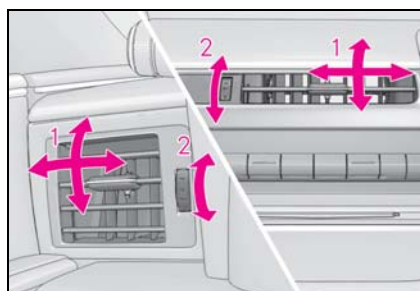
**■ Adjusting the air flow direction and opening/closing the air outlets**
**► Center/side**

- 1 Direct air flow to the left or right, up or down
- 2 Turn the knob to open or close the vent

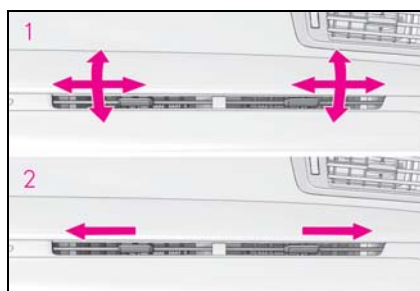
**► Above the glove box**

- 1 Direct air flow to the left or right, up or down
- 2 Move the knob to the most outside

position to close the vent

■ **If an object falls into the air outlet above the glove box**

Remove the panel inside the glove box to take out the object. (→P.316)

**! WARNING**

■ **To prevent the windshield defogger from operating improperly**

Do not place anything on the instrument panel which may cover the air outlets. Otherwise, air flow may be obstructed, preventing the windshield defoggers from defogging.

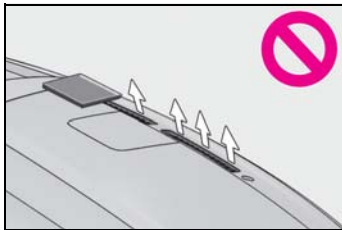

**Heated steering wheel\* / seat heaters\* / seat ventilators\***

\*: If equipped

● **Heated steering wheel**

Warms up the grip of the steering wheel

● **Seat heaters**

Warm up the seat upholstery

● **Seat ventilators**

Maintain good air flow on the seat upholstery by sucking air into the seats

Press the "MENU" button on the Remote Touch and select "Climate" to display the air conditioning control screen. Then, select  on the sub menu (→P.251) to display the heated steering wheel/seat heaters/seat ventilators control screen.

**! WARNING**

■ **To prevent minor burn injuries**

Care should be taken if anyone in the following categories comes in contact with the steering wheel or seats when the heater is on:

- Babies, small children, the elderly, the sick and the physically challenged
- Persons with sensitive skin
- Persons who are fatigued
- Persons who have taken alcohol or drugs that induce sleep (sleeping drugs, cold remedies, etc.)

 NOTICE

■ To prevent damage to the seat heaters and seat ventilators

Do not put heavy objects that have an uneven surface on the seat and do not stick sharp objects (needles, nails, etc.) into the seat.

■ To prevent 12-volt battery discharge

Do not use the functions when the engine <hybrid system> is off.

### Control screen

#### ■ Main display

Using the touchpad of the Remote Touch, select the button on the screen.

**A** to **C** can be adjusted by performing the following operations.

Flick operation: Move the pointer to the desired item and flick the touchpad up or down.

The item can be adjusted by one level.

Trace operation: After selecting the desired item, trace the pad surface.

The item can be adjusted by the amount that you trace.

Trace operation cannot be used while driving.

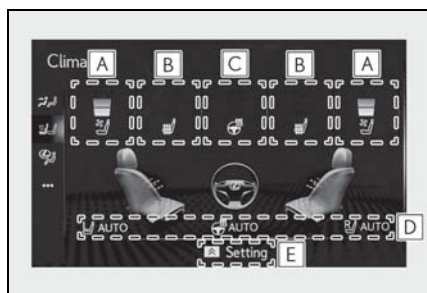

**A** Adjust the seat ventilator fan speed level

The seat ventilator can be adjusted in 3 levels.

When the seat ventilator is operated, the fan speed level is displayed on the screen.

**B** Adjust the seat heater temperature level

The seat heater can be adjusted in 3 levels. When the seat heater is operated, the temperature level is displayed on the screen.

**C** Adjust the heated steering wheel temperature level

The heated steering wheel can be adjusted in 2 levels.

When the heated steering wheel is operated, the temperature level is displayed on the screen.

**D** Automatic mode on/off indicators

When the automatic mode is on, the indicator illuminates on the screen.

**E** Sub function menu

When the sub function button on the Remote Touch is pressed, the following functions can be set to automatic mode.

 **AUTO**: Left-hand side seat heater/seat ventilator

 **AUTO**: Heated steering wheel

 **AUTO**: Right-hand side seat heater/seat ventilator

#### ■ Side display

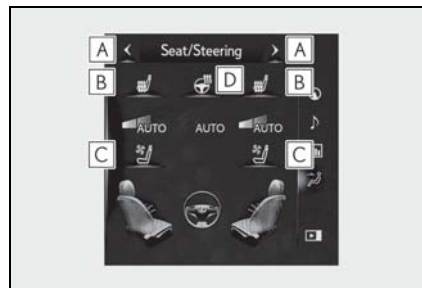

**A** Display the air conditioning control screen (→P.251)

**B** Adjust the seat heater temperature level

Each time the switch is selected, the temperature level and level indicator (orange) change as follows:

AUTO → Hi → Mid → Lo → Off

**C** Adjust the seat ventilator fan speed level

Each time the switch is selected, the fan speed level and level indicator (blue) change as follows:

AUTO → Hi → Mid → Lo → Off

**D** Adjust the heated steering wheel temperature level

Each time the switch is selected, the temperature level and level indicator change as follows:

AUTO → Hi → Lo → Off

■ **The heated steering wheel, seat heaters and seat ventilators wheel can be used when**

The engine switch <power switch> is in IGNITION ON mode <ON mode>.

■ **Air conditioning system-linked control mode**

When the seat ventilator fan speed level is Hi, the seat ventilator fan speed may become higher according to the fan speed of the air conditioning system.

■ **Customization**

Steering wheel heating preference in automatic mode and the automatic mode settings for the seat heaters and ventilators can be changed. (Customizable features: →P.391)



**WARNING**

■ **To prevent overheating and minor burn injuries**

Observe the following precautions when using the seat heaters.

- Do not cover the seat with a blanket or cushion when using the seat heater.
- Do not use seat heater more than necessary.

## Interior lights list

### Location of the interior lights

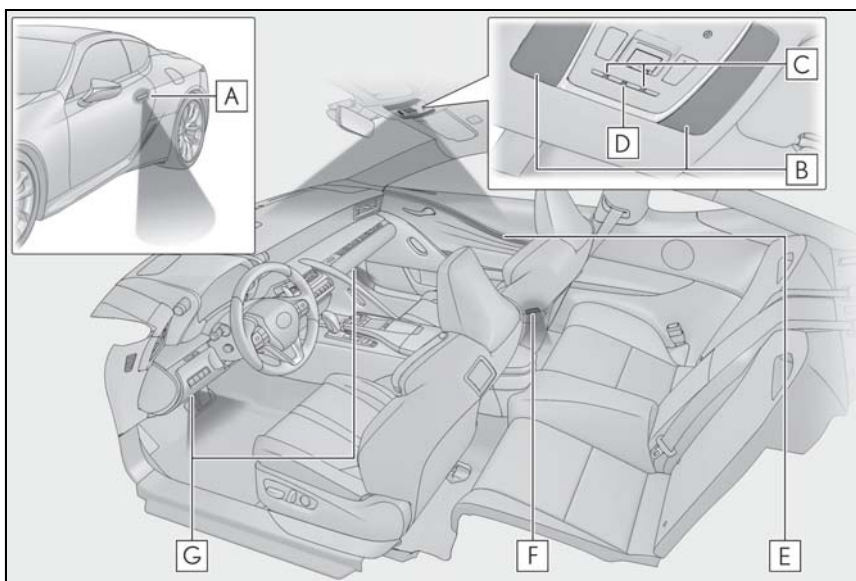

- A** Outside door handle lights
- B** Personal lights (→P.259)
- C** Seat lights
- D** Shift lever light
- E** Door trim ornament lights
- F** Door courtesy lights
- G** Footwell lights

#### ■ Personal lights automatic on/off

- Illuminated entry system: The lights automatically turn on/off according to engine switch <power switch> mode, the presence of the electronic key, whether the doors are locked/unlocked, and whether the doors are opened/closed.
- If the personal lights remain on when the engine switch <power switch> is turned off, the lights will go off automatically after 20 minutes.

#### ■ When personal lights do not respond as normal

- When water, dirt, etc., have adhered to the lens surface
- When operated with a wet hand
- When wearing gloves, etc.

#### ■ Customization

Setting (e.g. the time elapsed before lights turn off) can be changed.  
(Customizable features: →P.391)

 NOTICE

■ **Removing light lenses**

Never remove the lens for the personal lights. Otherwise, the lights will be damaged.

■ **To prevent 12-volt battery discharge**

Do not leave the lights on longer than necessary when the engine <hybrid system> is off.

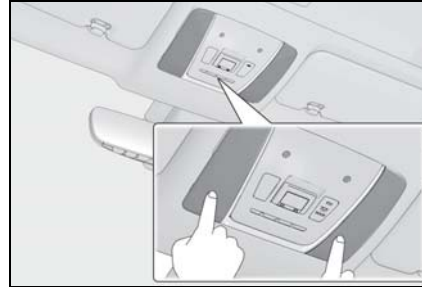

### Operating the personal lights

■ **Turning the door position on**

Press the door-linked personal light switch

The lights are turned on and off according to whether the doors are opened/closed.

When the door position is on, the indicator

**A** illuminates.

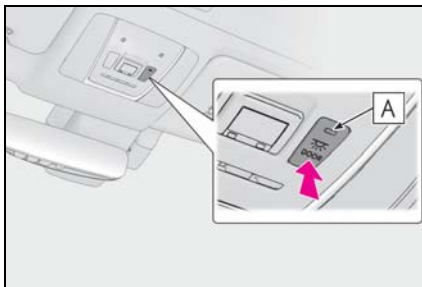

■ **Turning the lights on/off**

Touch the light

When a door is opened while the door position is on, the lights turn on.

### List of storage features

#### Location of the storage features

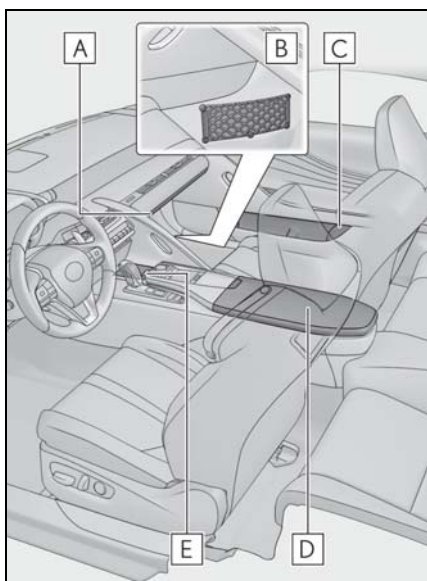

- A** Glove box (→P.260)
- B** Auxiliary net
- C** Door pockets
- D** Console box/auxiliary box (→P.261)
- E** Cup holder (→P.261)

#### **⚠** WARNING

##### ■ Items that should not be left in the vehicle

Do not leave glasses, lighters or spray cans in the storage spaces, as this may cause the following when cabin temperature becomes high:

- Glasses may be deformed by heat or cracked if they come into contact with other stored items.

- Lighters or spray cans may explode. If they come into contact with other stored items, the lighter may catch fire or the spray can may release gas, causing a fire hazard.

##### ■ When storage compartments are not in use

When driving or when the storage compartments are not in use, keep the lids closed.

In the event of sudden braking or sudden swerving, an accident may occur due to an occupant being struck by an open lid or the items stored inside.

### Glove box

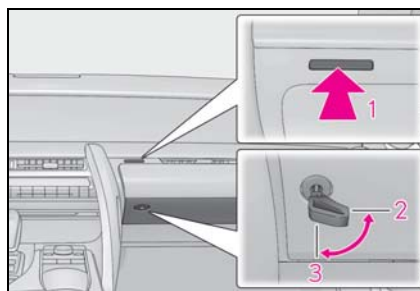

- 1** Open (press the glove box opener)
- 2** Unlock with the mechanical key
- 3** Lock with the mechanical key

#### ■ Glove box light

The glove box light turns on when the tail lights are on.

#### ■ Trunk opener main switch

→P.113

#### ■ If the 12-volt battery is discharged

The glove box cannot be opened as usual. Refer to P.358 to open the glove box.



**Console box/auxiliary box**

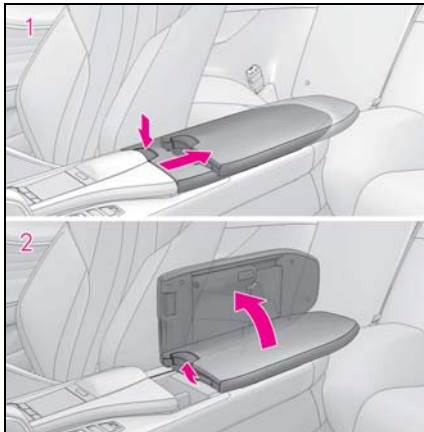

- 1 Using with half-open: Slide the armrest as far back while pressing the button.
- Press the button to close.
- 2 Using with fully open: Lift the armrest while pulling the knob.

**Console box light**

The console box light turns on when the tail lights are on.

**Using the auxiliary box**

Do not place cups, beverage cans, etc. in the auxiliary box.

**WARNING**

**When closing the console box**

Take care to prevent your fingers etc. from being caught.

**NOTICE**

**To prevent damage to the console box**

- Do not pull the knob while sliding the armrest.

- Do not apply excessive force to the armrest.

**Cup holder**

To open, press down and release the cup holder lid.

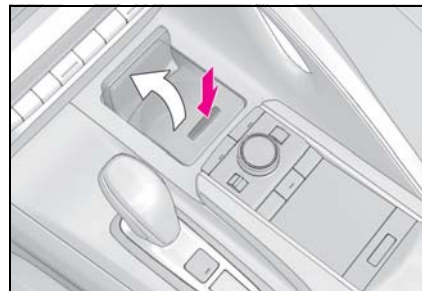

**WARNING**

**Items unsuitable for the cup holder**

Do not place anything other than a cup or beverage can in the cup holder. Even when the lid is closed, items must not be stored in the cup holder.

Other items may be thrown out of the holder in the event of an accident or sudden braking, causing injury. If possible, cover hot drinks to prevent burns.

**NOTICE**

**To prevent damage to the cup holder and air conditioning control switches**

- Do not apply excessive force to the cup holder.
- Take care when placing a tall bottle in the cup holder. When the bottle is taken out or the brakes are suddenly applied, the bottle may hit the air conditioning control switches, causing damage to the switches or parts of the air conditioning system.

### Trunk features

#### Cargo hooks

Raise the hooks when needed.  
The cargo hooks are provided for securing loose items.

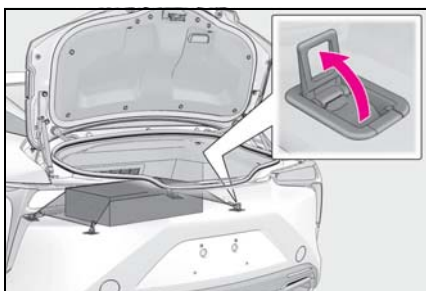

#### ⚠ WARNING

■ **When the cargo hooks are not in use**  
To avoid injury, always return the cargo hooks to their stowed positions when not in use.

#### Grocery bag hooks

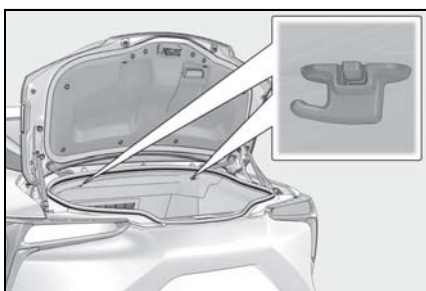

#### ⚠ NOTICE

■ **To prevent damage to the grocery bag hooks**  
Do not hang any object heavier than 4 lb. (2 kg) on the grocery bag hooks.

#### First-aid kit storage belt

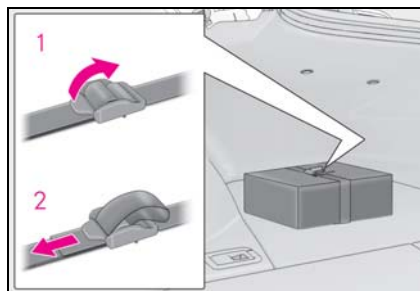

- 1 Loosen the belt
- 2 Tighten the belt

#### Warning reflector storage belt

##### ■ Loosening/tightening the belt

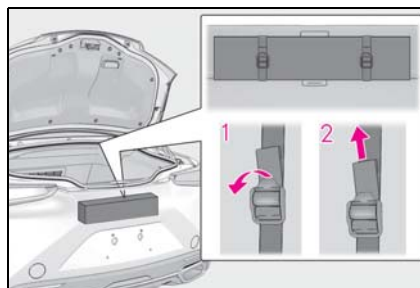

- 1 Loosen the belt
- 2 Tighten the belt

##### ■ Stowing the belt

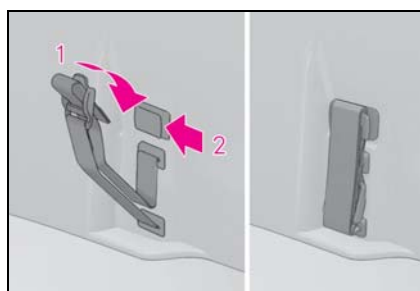

- 1 Fold the belt
- 2 Secure the belt with the clip

To prevent damage to the warning reflector storage belt when it is not in use, stow the belt.

## Other interior features

### Sun visors

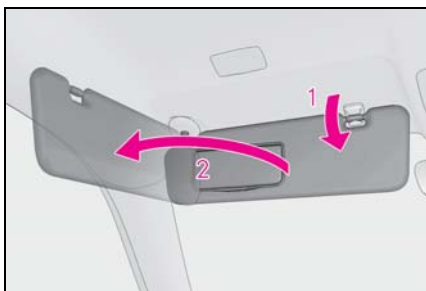

- 1** To set the visor in the forward position, flip it down.
- 2** To set the visor in the side position, flip down, unhook, and swing it to the side.

### Vanity mirrors

Open the cover.

The light turns on when the cover is opened.

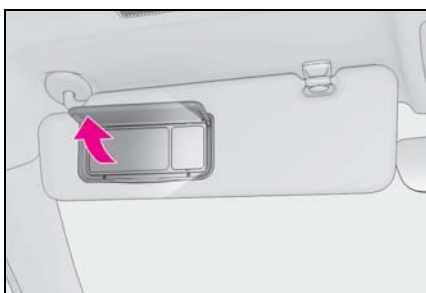

#### NOTICE

#### ■ To prevent 12-volt battery discharge

Do not leave the lights on longer than necessary when the engine <hybrid system> is off.

### Clock

The GPS clock's time is automatically adjusted by utilizing GPS time information.

For details, refer to the "NAVIGATION SYSTEM OWNER'S MANUAL".

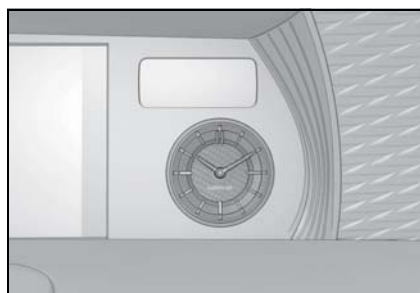

### Power outlet

Please use as a power supply for electronic goods that use less than 12 VDC/10 A (power consumption of 120 W).

Open the lid.

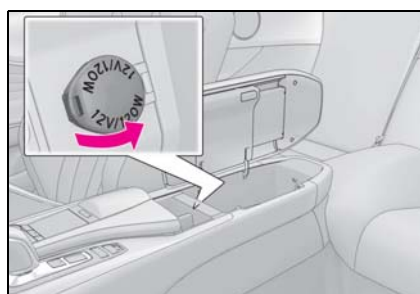

#### ■ The power outlet can be used when

The engine switch <power switch> is in ACCESSORY or IGNITION ON mode <ON mode>.

#### ■ Using the power outlet

The shape of the console box partition allows power cables to be passed through when the console box lid is partially closed.

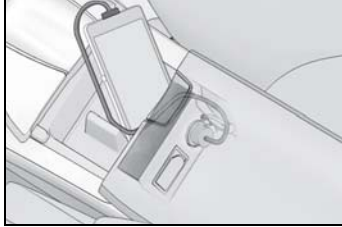

**NOTICE**

- **When the power outlet is not in use**  
To avoid damaging the power outlet, close the power outlet lid when the power outlet is not in use. Foreign objects or liquids that enter the power outlet may cause a short circuit.
- **To prevent 12-volt battery discharge**  
Do not use the power outlet longer than necessary when the engine <hybrid system> is off.

**Coat hooks**

To use the coat hook, push it in.

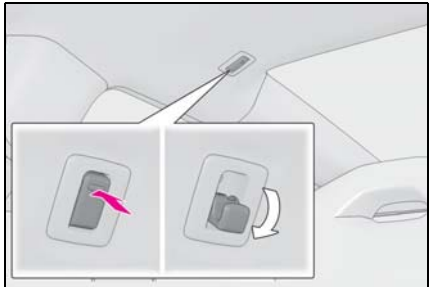

**WARNING**

- **Items that should not be hanged**  
Do not hang coat hangers or other hard or sharp objects on the hook. If the SRS curtain shield airbags deploy, these items may become projectiles, causing death or serious injury.

- **When the coat hooks are not in use**  
Store the coat hooks when they are not in use.  
When entering and exiting the rear seats, passengers may hit their heads on the coat hooks, resulting in injury.

**Sunshade (if equipped)**

Slide the sunshade to open.

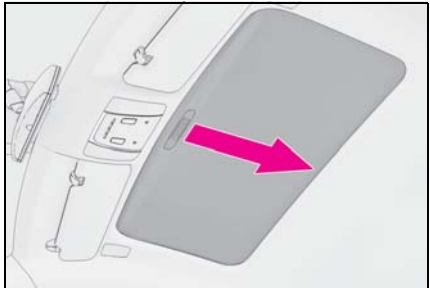

### Garage door opener

The garage door opener can be programmed using the HomeLink<sup>®</sup> to operate garage doors, gates, entry doors, door locks, home lighting systems, security systems, and other devices.

### System components

The HomeLink<sup>®</sup> wireless control system in your vehicle has 3 buttons which can be programmed to operate 3 different devices. Refer to the programming methods on the following pages to determine the method which is appropriate for the device.

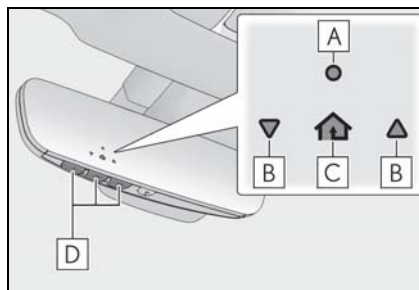

- A** HomeLink<sup>®</sup> indicator light
  - B** Garage door operation indicators
  - C** HomeLink<sup>®</sup> icon
- Illuminates while HomeLink<sup>®</sup> is operating.
- D** Buttons

#### Codes stored in the HomeLink<sup>®</sup> memory

- The registered codes are not erased even if the 12-volt battery cable is disconnected.
- If learning failed when registering a different code to a HomeLink<sup>®</sup> button that already has a code registered to it, the already registered code will not be erased.

#### Certification for the garage door opener

This device complies with FCC rules part 15 and Innovation, Science, and Economic Development Canada RSS-210. Operation is subject to the following two conditions: (1) This device may not cause harmful interference, and (2) This device must accept any interference that may be received including interference that may cause undesired operation. WARNING: The transmitter has been tested and complies with FCC and ISED rules. Changes or modifications not expressly approved by the party responsible for compliance could void the user's authority to operate the device.

This equipment complies with FCC and ISED radiation exposure limits set forth for an uncontrolled environment. End Users must follow the specific operating instructions for satisfying RF exposure compliance. This transmitter must be at least 20 cm from the user and must not be co-located or operating in conjunction with any other antenna or transmitter.

Cet appareil est conforme aux règlements de la FCC, section 15, et au CNR-210 d'Innovation, Sciences et Développement économique Canada. Le fonctionnement est assujéti aux deux conditions suivantes : (1) cet appareil ne doit pas causer d'interférences nuisibles et (2) cet appareil doit accepter toute interférence reçue, y compris celle qui pourrait entraîner un dysfonctionnement. MISE EN GARDE : L'émetteur a subi des tests et est conforme aux règlements de la FCC et d'ISDE. Les changements ou modifications non approuvés explicitement par la partie responsable de la conformité pourraient rendre caduque l'autorisation de l'utilisateur de se servir du dispositif.

Cet appareil est conforme aux limites d'exposition aux radiations de la FCC et d'ISDE établies pour un environnement non contrôlé. Les utilisateurs finaux doivent respecter les instructions d'utilisation spécifiques pour satisfaire aux exigences de conformité aux expositions de RF. L'émetteur doit se trouver à 20 cm au minimum de l'utilisateur et ne doit pas être situé au même endroit que tout autre émetteur ou antenne ni fonctionner avec un autre émetteur ou antenne.

■ **When support is necessary**

Visit on the web at [www.homelink.com/lexus](http://www.homelink.com/lexus) or call 1-800-355-3515.

**⚠ WARNING**

■ **When programming a garage door or other remote control device**

The garage door or other device may operate, so ensure people and objects are out of danger to prevent potential harm.

■ **Conforming to federal safety standards**

Do not use the HomeLink<sup>®</sup> compatible transceiver with any garage door opener or device that lacks safety stop and reverse features as required by federal safety standards.

This includes any garage door that cannot detect an interfering object. A door or device without these features increases the risk of death or serious injury.

■ **When operating or programming HomeLink<sup>®</sup>**

Never allow a child to operate or play with the HomeLink<sup>®</sup> buttons.

**Programming the HomeLink<sup>®</sup>**

- **Before programming HomeLink<sup>®</sup>**
  - During programming, it is possible that garage doors, gates, or other

devices may operate. For this reason, make sure that people and objects are clear of the garage door or other devices to prevent injury or other potential harm.

- It is recommended that a new battery be placed in the remote control transmitter for more accurate programming.
- Garage door opener motors manufactured after 1995 may be equipped with rolling code protection. If this is the case, you may need a stepladder or other sturdy, safe device to reach the "Learn" or "Smart" button on the garage door opener motor.

■ **Programming HomeLink<sup>®</sup>**

Steps **1** through **3** must be performed within 60 seconds, otherwise the indicator light will stop flashing and programming will not be able to be completed.

- 1** Press and release the HomeLink<sup>®</sup> button you want to program and check that the HomeLink<sup>®</sup> indicator light flashes (orange).
- 2** Point the remote control transmitter for the device at the rear view

mirror, 1 to 3 in. (25 to 75 mm) from the HomeLink® buttons.

Keep the HomeLink® indicator light in view while programming.

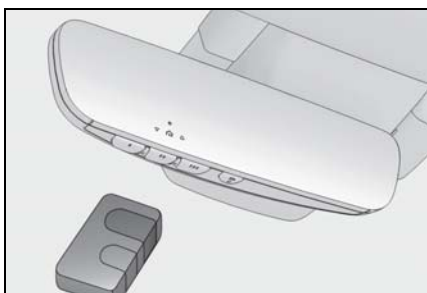

**3** Program a device.

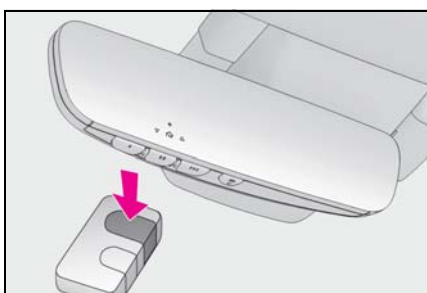

► Programming a device other than an entry gate (for U.S.A. owners)

Press and hold the remote control transmitter button until the HomeLink® indicator light changes from slowly flashing orange to rapidly flashing green (rolling code) or continuously lit green (fixed code), then release the button.

► Programming an entry gate (for U.S.A. owners)/Programming a device in the Canadian market

Press and release the remote control transmitter button at 2 second intervals, repeatedly, until the HomeLink® indicator light changes from slowly

flashing (orange) to rapidly flashing (green) (rolling code) or continuously lit (green) (fixed code).

**4** Test the HomeLink® operation by pressing the newly programmed button and observing the indicator light:

- Indicator light illuminates: Programming of a fixed code device has completed. The garage door or other device should operate when a HomeLink® button is pressed and released.
- Indicator light flashes rapidly: The garage door opener motor or other device is equipped with a rolling code. To complete programming, firmly press and hold the HomeLink® button for 2 seconds then release it.
- If the garage door or other device does not operate, proceed to “Programming a rolling code system”.

**5** Repeat the steps above to program another device for any of the remaining HomeLink® buttons.

■ **Programming a rolling code system**

2 or more people may be necessary to complete rolling code programming.

**1** Locate the “Learn” or “Smart” button on the garage door opener motor in the garage.

This button can usually be found where the hanging antenna wire is attached to the unit. The name and color of the button may vary by manufacturer. Refer to the owner’s manual supplied with the garage door



opener motor for details.

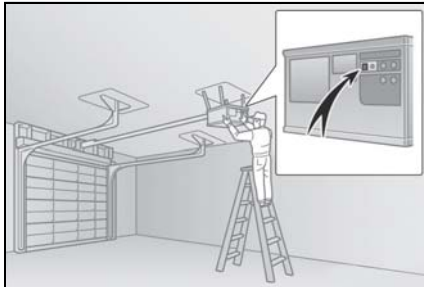

- 2** Press and release the “Learn” or “Smart” button.  
Perform **3** within 30 seconds after performing **2**.

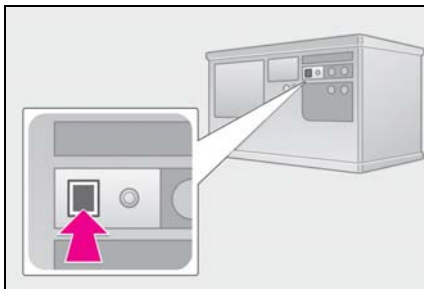

- 3** Press and hold the desired HomeLink<sup>®</sup> button (inside the vehicle) for 2 seconds and release it. Repeat this sequence (press/hold/release) up to 3 times to complete programming.  
If the garage door opener motor operates when the HomeLink<sup>®</sup> button is pressed, the garage door

opener motor recognizes the HomeLink<sup>®</sup> signal.

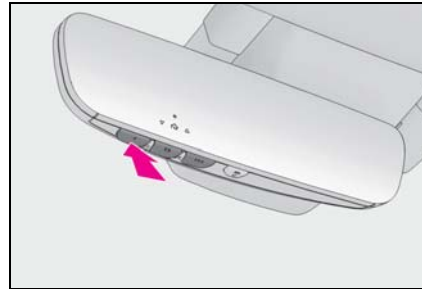

■ **Enabling 2-way communication with a garage door (only available for compatible devices)**

When enabled, 2-way communication allows you to check the status of the opening and closing of a garage door through indicators in your vehicle.

2-way communication is only available if the garage door opener motor used is a compatible device. (To check device compatibility, refer to [www.homelink.com](http://www.homelink.com).)

- 1** Within 5 seconds after programming the garage door opener has been completed, if the garage door opener motor is trained to HomeLink<sup>®</sup>, both garage door operation indicators will flash rapidly (green) and the light on the garage door opener motor will blink twice, indicating that 2-way communication is enabled.

If the indicators do not flash, perform **2** and **3** within the first 10 presses of the HomeLink<sup>®</sup> button after programming has been completed.

- 2** Press a programmed HomeLink<sup>®</sup> button to operate a garage door.

- 3 Within 1 minute of pressing the HomeLink<sup>®</sup> button, after the garage door operation has stopped, press the “Learn” or “Smart” button on the garage door opener motor. Within 5 seconds of the establishment of 2-way communication with the garage door opener, both garage door operation indicators in the vehicle will flash rapidly (green) and the light on the garage door opener motor will blink twice, indicating that 2-way communication is enabled.

■ **Reprogramming a single HomeLink<sup>®</sup> button**

When the following procedure is performed, buttons which already have devices registered to them can be overwritten:

- 1 With one hand, press and hold the desired HomeLink<sup>®</sup> button.
- 2 When the HomeLink<sup>®</sup> indicator starts flashing (orange), continue to hold the HomeLink<sup>®</sup> button and perform “Programming HomeLink<sup>®</sup>” 1 (it takes 20 seconds for the HomeLink<sup>®</sup> indicator to start flashing).

■ **Before programming**

- Install a new battery in the transmitter.
- The battery side of the transmitter must be pointed away from the HomeLink<sup>®</sup>.

**Operating HomeLink<sup>®</sup>**

Press the appropriate HomeLink<sup>®</sup> button. The HomeLink<sup>®</sup> indicator light should turn on.

The status of the opening and closing of a garage door is shown by the indicators.

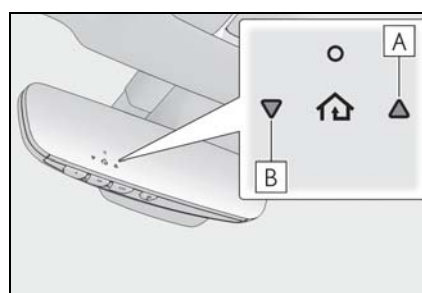

**A** Opening

**B** Closing

This function is only available if the garage door opener motor used is a compatible device. (To check device compatibility, refer to [www.homelink.com](http://www.homelink.com).)

Color	Status
Orange (flashing)	Currently opening/closing
Green	Opening/closing has completed
Red (flashing)	Feedback signals cannot be received

The indicators can operate within approximately 820 ft. (250 m) of the garage door. However, if there are obstructions between the garage door and the vehicle, such as houses and trees, feedback signals from the garage door may not be received.

To recall the previous door operation status, press and release either Home-

Link<sup>®</sup> buttons  and  or

 and  simultaneously. The

last recorded status will be displayed for 3 seconds.

### Erasing the entire HomeLink<sup>®</sup> memory (all three codes)

Press and hold the 2 outside buttons for 10 seconds until the HomeLink<sup>®</sup> indicator light changes from continuously lit (orange) to rapidly flashing (green).

If you sell your vehicle, be sure to erase the programs stored in the HomeLink<sup>®</sup> memory.

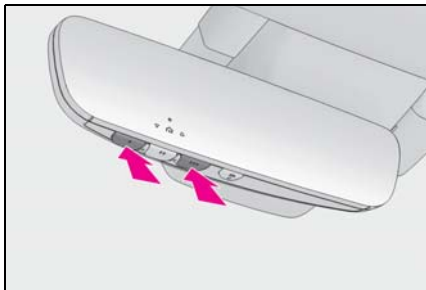



- 6-1. Maintenance and care**
- Cleaning and protecting the vehicle exterior ..... 274
  - Cleaning and protecting the vehicle interior ..... 277
- 6-2. Maintenance**
- Maintenance requirements.. 283
  - General maintenance ..... 284
  - Emission inspection and maintenance (I/M) programs ..... 287
- 6-3. Do-it-yourself maintenance**
- Do-it-yourself service precautions ..... 288
  - Hood..... 290
  - Positioning a floor jack..... 290
  - Engine compartment..... 292
  - 12-volt battery..... 299
  - Tires ..... 301
  - Replacing the tire ..... 309
  - Tire inflation pressure..... 313
  - Wheels..... 315
  - Air conditioning filter..... 316
  - Electronic key battery ..... 318
  - Checking and replacing fuses ..... 319
  - Headlight aim..... 323
  - Light bulbs..... 324

## Cleaning and protecting the vehicle exterior

Perform cleaning in a manner appropriate to each component and its material.

### Cleaning instructions

- Working from top to bottom, liberally apply water to the vehicle body, wheel wells and underside of the vehicle to remove any dirt and dust.
- Wash the vehicle body using a sponge or soft cloth, such as a chamois.
- For hard-to-remove marks, use car wash soap and rinse thoroughly with water.
- Wipe away any water.
- Wax the vehicle when the water-proof coating deteriorates.

If water does not bead on a clean surface, apply wax when the vehicle body is cool.

#### ■ CFRP (Carbon Fiber Reinforced Plastic) part (if equipped)

- As the CFRP parts may change color if they are exposed to ultraviolet rays for extended periods of time, Lexus recommends that your vehicle be stored in a place where it will not be exposed to direct sunlight.
- Do not use wax that contains abrasives.
- Do not use automatic car washes as they may scratch the CFRP parts and damage the paint.

#### ■ Self-restoring coat \*

The vehicle body has a self-restoring coating that is resistant to small surface

scratches caused in a car wash etc.

- The coating lasts for 5 to 8 years from when the vehicle is delivered from the plant.
  - The restoration time differs depending on the depth of the scratch and outside temperature. The restoration time may become shorter when the coating is warmed by applying warm water.
  - Deep scratches caused by keys, coins, etc. cannot be restored.
  - Do not use wax that contain abrasives.
- \*: CFRP parts (if equipped) do not have a self-restoring coat.

#### ■ Cleaning the areas with metal accents

Do not use baking soda (sodium bicarbonate) and wax that contains abrasives.

#### ■ Automatic car washes (vehicles without CFRP parts)

- Fold the mirrors before washing the vehicle. Start washing from the front of the vehicle. Make sure to extend the mirrors before driving.
  - Wash the vehicle with the active rear wing retracted. If the vehicle is washed with the active rear wing raised, depending on the type of automatic car wash, the brushes of the automatic car wash may become stuck on the active rear wing. In this case, the active rear wing may not be washed very well or may even be scratched or damaged.
  - Brushes used in automatic car washes may scratch the vehicle body and damage the paint.
- #### ■ High pressure car washes
- Do not allow the nozzles of the car wash to come within close proximity of the windows.
  - Before using the car wash, check that the fuel filler door on your vehicle is closed properly.

#### ■ Notes for the smart access system with push-button start

If the door handle becomes wet while the electronic key is within the effective range,

the door may lock and unlock repeatedly. In that case, follow the following correction procedures to wash the vehicle:

- Place the key in a position 6 ft. (2 m) or more separate from the vehicle while the vehicle is being washed. (Take care to ensure that the key is not stolen.)
- Set the electronic key to battery-saving mode to disable the smart access system with push-button start. (→P.115)

#### ■ Aluminum wheels

- Remove any dirt immediately by using a neutral detergent.
- Wash detergent off with water immediately after use.
- To protect the paint from damage, make sure to observe the following precautions.
  - Do not use acidic, alkaline or abrasive detergent
  - Do not use hard brushes
  - Do not use detergent on the wheels when they are hot, such as after driving or parking in hot weather

#### ■ Brake caliper coating

- When using detergent, use neutral detergent. Do not use hard brushes or abrasive cleaners, as they will damage the coating.
- Do not use detergent on the brake calipers when they are hot.
- Wash detergent off immediately after use.

#### ■ Bumpers

Do not scrub with abrasive cleaners.

#### ■ Front side windows water-repellent coating

- The following precautions can extend the effectiveness of the water-repellent coating.
  - Remove any dirt, etc. from the front side windows regularly.
  - Do not allow dirt and dust to accumulate on the windows for a long period. Clean the windows with a soft, damp cloth as soon as possible.
  - Do not use wax or glass cleaners that contain abrasives when cleaning the win-

dows.

- Do not use any metallic objects to remove condensation build up.
- When the water-repellent performance has become insufficient, the coating can be repaired. Contact your Lexus dealer.

### ⚠ WARNING

#### ■ When washing the vehicle

Do not apply water to the inside of the engine compartment. Doing so may cause the electrical components etc. to catch fire.

#### ■ When cleaning the windshield

Set the wiper switch to off.

If the wiper switch is in "AUTO", the wipers may operate unexpectedly in the following situations, and may result in hands being caught or other serious injuries and cause damage to the wiper blades.

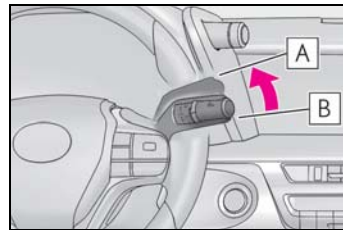

**A** Off

**B** AUTO

- When the upper part of the windshield where the raindrop sensor is located is touched by hand
- When a wet rag or similar is held close to the raindrop sensor
- If something bumps against the windshield
- If you directly touch the raindrop sensor body or if something bumps into the raindrop sensor

**WARNING****■ Precautions regarding the exhaust pipes and rear bumper diffusers**

As exhaust gases cause the exhaust pipes and rear bumper diffusers to become quite hot, do not touch the exhaust pipes and rear bumper diffusers while the engine is running <hybrid system is operating> or immediately after the engine <hybrid system> is turned off.

When washing the vehicle, be careful not to touch the exhaust pipes and rear bumper diffusers until they have cooled sufficiently, as touching hot exhaust pipes and rear bumper diffusers can cause burns.

**■ Precaution regarding the rear bumper with Blind Spot Monitor (if equipped)**

If the paint of the rear bumper is chipped or scratched, the system may malfunction. If this occurs, consult your Lexus dealer.

**NOTICE****■ Application of coatings to the vehicle body (vehicles with CFRP parts)**

Do not apply any kind of coating to the vehicle body as doing so may damage the paint or reduce its durability.

**■ To prevent paint deterioration and corrosion on the body and components (aluminum wheels etc.)**

- Wash the vehicle immediately in the following cases:
  - After driving near the sea coast
  - After driving on salted roads
  - If coal tar, pollen or tree sap is present on the paint surface
  - If dead insects, insect droppings or bird droppings are present on the paint surface
  - After driving in an area contaminated with soot, oily smoke, mine dust, iron powder or chemical substances
  - If the vehicle becomes heavily soiled with dust or mud
  - If liquids such as benzene and gasoline are spilled on the paint surface

- If the paint is chipped or scratched, have it repaired immediately.

- To prevent the wheels from corroding, remove any dirt and store in a place with low humidity when storing the wheels.

**■ Cleaning the exterior lights**

- Wash carefully. Do not use organic substances or scrub with a hard brush. This may damage the surfaces of the lights.
- Do not apply wax to the surfaces of the lights. Wax may cause damage to the lenses.

**■ When using an automatic car wash**

Set the wiper switch to the off position.

If the wiper switch is in "AUTO", the wipers may operate and the wiper blades may be damaged.



 NOTICE**■ When using a high-pressure car wash**

- When washing the vehicle, do not let water from the high-pressure washer directly hit the camera, the area around the camera or inside of the outside door handles. Due to the shock from high-pressure water, it is possible that the device may not operate normally.
- Do not bring the nozzle tip close to boots (rubber or resin manufactured cover), connectors or the following parts. The parts may be damaged if they come into contact with high-pressure water.
  - Traction related parts
  - Steering parts
  - Suspension parts
  - Brake parts
- LC500h: Do not wash the underside of the vehicle using a high pressure car washer.

**Cleaning and protecting the vehicle interior**

**Perform cleaning in a manner appropriate to each component and its material.**

**Protecting the vehicle interior**

- Remove dirt and dust using a vacuum cleaner. Wipe dirty surfaces with a cloth dampened with lukewarm water.
- If dirt cannot be removed, wipe it off with a soft cloth dampened with neutral detergent diluted to approximately 1%.  
Wring out any excess water from the cloth and thoroughly wipe off remaining traces of detergent and water.

**■ Shampooing the carpets**

There are several commercial foaming-type cleaners available. Use a sponge or brush to apply the foam. Rub in overlapping circles. Do not use water. Wipe dirty surfaces and let them dry. Excellent results are obtained by keeping the carpet as dry as possible.

**■ Handling the seat belts**

Clean with mild soap and lukewarm water using a cloth or sponge. Also check the belts periodically for excessive wear, fraying or cuts.

**■ When cleaning the carpeted portions of the glove box, console box, etc.**

If a strong adhesive tape is used, there is a possibility that the surface of the carpet could be damaged.

■ **CFRP (Carbon Fiber Reinforced Plastic) parts (if equipped)**

CFRP is used for the scuff plates. When cleaning the scuff plates, remove dirt using a water-dampened soft cloth or synthetic chamois, and then wipe the surface with a dry soft cloth to remove any remaining moisture.

 **WARNING**

■ **Water in the vehicle**

- **LC500:** Do not splash or spill liquid in the vehicle.

Doing so may cause electrical components etc. to malfunction or catch fire.  
**LC500h:** Do not splash or spill liquid in the vehicle, such as on the floor, on the rear seats, in the hybrid battery (traction battery) air vents, and in the trunk. (→P.67)

Doing so may cause the hybrid battery, electrical components, etc. to malfunction or catch fire.

- Do not get any of the SRS components or wiring in the vehicle interior wet. (→P.28)

An electrical malfunction may cause the airbags to deploy or not function properly, resulting in death or serious injury.

■ **Cleaning the interior (especially instrument panel)**

Do not use polish wax or polish cleaner. The instrument panel may reflect off the windshield, obstructing the driver's view and leading to an accident, resulting in death or serious injury.

 **NOTICE**

■ **Cleaning detergents**

- Do not use the following types of detergent, as they may discolor the vehicle interior or cause streaks or damage to painted surfaces:
  - Non-seat portions: Organic substances such as benzene or gasoline, alkaline or acidic solutions, dye, and bleach
  - Seats: Alkaline or acidic solutions, such as thinner, benzene, and alcohol
- Do not use polish wax or polish cleaner. The instrument panel's or other interior part's painted surface may be damaged.

■ **Preventing damage to leather surfaces**

Observe the following precautions to avoid damage to and deterioration of leather surfaces:

- Remove any dust or dirt from leather surfaces immediately.
- Do not expose the vehicle to direct sunlight for extended periods of time. Park the vehicle in the shade, especially during summer.
- Do not place items made of vinyl, plastic, or containing wax on the upholstery, as they may stick to the leather surface if the vehicle interior heats up significantly.

■ **Water on the floor**

Do not wash the vehicle floor with water. Vehicle systems such as the audio system may be damaged if water comes into contact with electrical components such as the audio system above or under the floor of the vehicle. Water may also cause the body to rust.

 **NOTICE**

■ **When cleaning the inside of the windshield**  
Do not allow glass cleaner to contact the lens. Also, do not touch the lens. (→P.185)

■ **Cleaning the inside of the rear window**

- Do not use glass cleaner to clean the rear window, as this may cause damage to the rear window defogger heater wires or antenna. Use a cloth dampened with lukewarm water to gently wipe the window clean. Wipe the window in strokes running parallel to the heater wires or antenna.
- Be careful not to scratch or damage the heater wires or antenna.

**Cleaning the hybrid battery (traction battery) air intake vents (LC500h)**

To prevent the hybrid battery (traction battery) air intake vents from becoming clogged, clean them periodically.

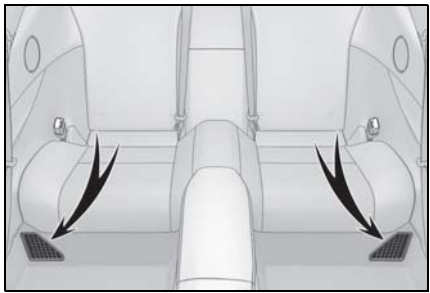

■ **Cleaning the air intake vents**  
Remove the dust from the air intake vents with a vacuum cleaner etc.  
Make sure to only use a vacuum to suck out dust and clogs. Attempting to blow out dust and clogs using a com-

pressed air blow gun, etc. may push it into the air intake vents. (→P.281)

If dust and clogs cannot be completely removed with the air intake vent covers installed, remove the covers and clean the filters.

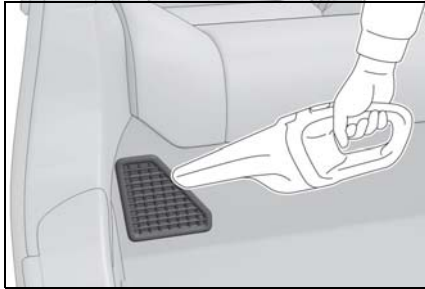

■ **Cleaning the filters**  
If dust and clogs cannot be completely removed with the air intake vent covers installed, remove the air intake vent covers and clean the filters.

1 Remove the grille.

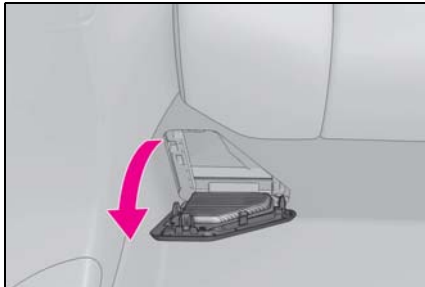

2 Remove the filter.

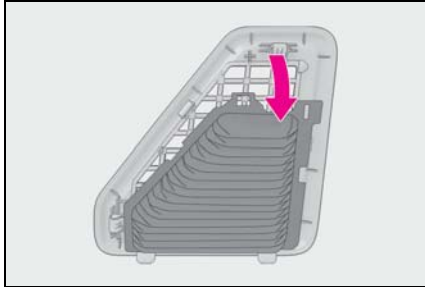

- 3** Remove dust using a vacuum cleaner etc. to clean the filter.

Also, remove dust on the grille as well as on the filter using a vacuum cleaner.



- 4** Install the filter in its original position, and then install the grille.
- 5** Start the hybrid system and check that the warning message on the multi-information display disappears.

It may take several minutes before the warning message disappears.

■ **Scheduled maintenance of the air intake filters is necessary when**

In some situations such as when the vehicle is used frequently or in heavy traffic or dusty areas, the air intake filters may need to be cleaned more regularly.

For details, refer to "Owner's Manual Supplement" or "Scheduled Maintenance".

■ **Air intake vents maintenance**

- If the vehicle is driven with the air intake vents clogged, charging / discharging of the hybrid battery (traction battery) may become limited and the fuel consumption may increase.
- Depending on the conditions under which the vehicle is used, the air intake vents may need to be cleaned more regularly.

■ **Cleaning the air intake vents**

- Dust in the air intake vents may interfere with the cooling of the hybrid battery (traction battery). If charging/discharging

of the hybrid battery (traction battery) becomes limited, the distance that the vehicle can be driven using the electric motor (traction motor) may be reduced and the fuel economy may be reduced. Inspect and clean the air intake vents periodically.

- Improper handling may result in damage to the air intake vent covers or filters. If you have any concerns about cleaning the filters, contact your Lexus dealer.
- The necessary cleaning interval of the air intake vents will differ according to the vehicle usage environment.
- If "Maintenance required for Traction battery cooling parts See owner's manual" is displayed on the multi-information display
  - If this warning message is displayed on the multi-information display, remove the air intake vent covers and clean the filters. (→P.279)
  - After cleaning the air intake vents, start the hybrid system and check that the warning message is no longer displayed. After the hybrid system is started, it may be necessary to drive the vehicle up to approximately 20 minutes before the warning message disappears. If the warning message does not disappear after driving for appropriately 20 minutes, have the vehicle inspected by your Lexus dealer.

**⚠ WARNING**

■ **When cleaning the hybrid battery (traction battery) air intake vents/filters**

- Do not use water or other liquids to clean the air intake vents/filters. If water is applied to the hybrid battery (traction battery) or other components, a malfunction or fire may occur.
- When the air intake vent covers (under the both sides of the rear seat) are to be removed, make sure to turn the power switch off to stop the hybrid system.

 NOTICE

■ **When cleaning the air intake vents**

When cleaning the air intake vents, make sure to only use a vacuum to suck out dust and clogs. If a compressed air blow gun, etc. is used to blow out dust and clogs, the dust or clogs may be pushed into the air intake vents, which may affect the performance of the hybrid battery (traction battery) and cause a malfunction.

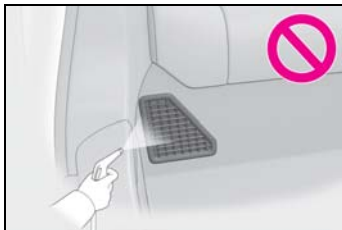

■ **To prevent damage to the vehicle**

- Do not allow water or foreign matter to enter the air intake vents when the cover is removed.
- Carefully handle the removed filters so that it will not be damaged. If the filters are damaged, have them replaced with new filters by your Lexus dealer.
- Make sure to reinstall the filters and cover to their original positions after cleaning.
- Do not install anything to the air intake vents other than the exclusive filters for this vehicle or use the vehicle without the filters installed.

■ **If “Maintenance required for traction battery cooling parts See owner’s manual” is displayed on the multi-information display**

If the vehicle is continuously driven with the warning message (indicating that charging/discharging of the hybrid battery [traction battery] may become limited) displayed, the hybrid battery (traction battery) may malfunction. If the warning message is displayed, clean the air intake vents immediately.

**Cleaning the areas with satin-finish metal accents**

- Remove dirt using a water-dampened soft cloth or synthetic chamois.
- Wipe the surface with a dry soft cloth to remove any remaining moisture.

■ **Cleaning the areas with satin-finish metal accents**

The metal areas use a layer of real metal for the surface. It is necessary to clean them regularly. If dirty areas are left uncleaned for long periods of time, they may be difficult to clean.

**Cleaning the leather areas**

- Remove dirt and dust using a vacuum cleaner.
- Wipe off any excess dirt and dust with a soft cloth dampened with diluted detergent.

Use a diluted water solution of approximately 5% neutral wool detergent.

- Wring out any excess water from the cloth and thoroughly wipe off all remaining traces of detergent.
- Wipe the surface with a dry soft

cloth to remove any remaining moisture. Allow the leather to dry in a shaded and ventilated area.

#### ■ Caring for leather areas

Lexus recommends cleaning the interior of the vehicle at least twice a year to maintain the quality of the vehicle's interior.

#### Cleaning the synthetic leather areas

- Remove dirt and dust using a vacuum cleaner.
- Wipe it off with a soft cloth dampened with neutral detergent diluted to approximately 1%.
- Wring out any excess water from the cloth and thoroughly wipe off remaining traces of detergent and water.

#### Cleaning the artificial leather (Alcantara®\*) areas

- Brush the surfaces using a soft brush.
- Do not brush hard as doing so may cause damage.
- Wipe the surfaces clean with a soft cloth that has been dampened in cold or lukewarm water and squeezed out.
  - Allow the artificial leather (Alcantara®\*) to dry in a shaded and ventilated area.

\*: "Alcantara®" is a registered trademark of Alcantara S.p.A.

**Maintenance requirements**

To ensure safe and economical driving, day-to-day care and regular maintenance are essential. It is the owner's responsibility to perform regular checks. Lexus recommends the following maintenance:

■ **Repair and replacement**

It is recommended that genuine Lexus parts be used for repairs to ensure performance of each system. If non-Lexus parts are used in replacement or if a repair shop other than a Lexus dealer performs repairs, confirm the warranty coverage.

■ **Allow inspection and repairs to be performed by a Lexus dealer**

- Lexus technicians are well-trained specialists and are kept up to date with the latest service information. They are well informed about the operations of all systems on your vehicle.
- Keep a copy of the repair order. It proves that the maintenance that has been performed is under warranty coverage. If any problem should arise while your vehicle is under warranty, your Lexus dealer will promptly take care of it.

**⚠ WARNING**

■ **If your vehicle is not properly maintained**

Improper maintenance could result in serious damage to the vehicle and possible death or serious injury.

■ **Handling of the 12-volt battery**

- Engine exhaust, some of its constituents, and a wide variety of automobile components contain or emit chemicals known to the State of California to cause cancer and birth defects and other reproductive harm. Work in a well ventilated area.

- Oils, fuels and fluids contained in vehicles as well as waste produced by component wear contain or emit chemicals known to the State of California to cause cancer and birth defects or other reproductive harm. Avoid exposure and wash any affected area immediately.

- 12-volt battery posts, terminals and related accessories contain lead and lead compounds which are known to cause brain damage. Wash your hands after handling. (→P.299)

**General maintenance**

General maintenance should be performed on a daily basis. This can be done by yourself or by a Lexus dealer.





**Scheduled maintenance**

Scheduled maintenance should be performed at specified intervals according to the maintenance schedule.

For details about maintenance items and schedules, refer to the "Warranty and Service Guide", "Owner's Manual Supplement" or "Scheduled Maintenance".

■ **Resetting the message indicating maintenance is required**

After the required maintenance is performed according to the maintenance schedule, please reset the message. To reset the message, follow the procedure described below:

- 1 Press  or  of the meter control switches and select .
- 2 Press  or  of the meter control switches and select "Vehicle Settings". Then press "OK".

- 3 Press **▲** or **▼** of the meter control switches and select "Scheduled Maintenance". Then press "OK".
- 4 Select "Yes" and press "OK".

A message will be displayed when the reset procedure has been completed.



### Do-it-yourself maintenance

You can perform some maintenance procedures by yourself.

Please be aware that do-it-yourself maintenance may affect warranty coverage.

The use of Lexus repair manuals is recommended.

For details about warranty coverage, refer to the separate "Owner's Guide", "Warranty and Service Guide", "Owner's Manual Supplement" or "Warranty Booklet".

### General maintenance

Listed below are the general maintenance items that should be performed at the intervals specified in the "Warranty and Service Guide" or "Owner's Manual Supplement". It is recommended that any problem you notice should be brought to the attention of your Lexus dealer or qualified service shop for advice.

#### **⚠** WARNING

**■** If the engine is running <hybrid system is operating>

Turn the engine <hybrid system> off and ensure that there is adequate ventilation before performing maintenance checks.

### Engine compartment

Items	Check points
Brake fluid	Is the brake fluid at the correct level? (→P.297)
Engine coolant (LC500)	Is the engine coolant at the correct level? (→P.296)
Engine/power control unit coolant (LC500h)	Is the engine/power control unit coolant at the correct level? (→P.296)
Engine oil	Is the engine oil at the correct level? (→P.293)
Exhaust system	There should not be any fumes or strange sounds.



Items	Check points
Radiator/con- denser	The radiator and con- denser should be free from foreign objects. (→P.297)
Washer fluid	Is there sufficient washer fluid? (→P.298)

**Trunk**

Items	Check points
12-volt battery	Check the battery fluid level and connections. (→P.299)

**Vehicle interior**

Items	Check points
Accelerator pedal	<ul style="list-style-type: none"> <li>The accelerator pedal should move smoothly (without uneven pedal effort or catching).</li> </ul>
Automatic trans- mission "Park" mechanism (LC500)/Hybrid transmission "Park" mecha- nism (LC500h)	<ul style="list-style-type: none"> <li>When parked on a slope and the shift position is in P, is the vehicle securely stopped?</li> </ul>

Items	Check points
Brake pedal	<ul style="list-style-type: none"> <li>Does the brake pedal move smoothly?</li> <li>Does the brake pedal have appro- priate clear- ance from the floor?</li> <li>Does the brake pedal have the cor- rect amount of free play?</li> </ul>
Brakes	<ul style="list-style-type: none"> <li>The vehicle should not pull to one side when the brakes are applied.</li> <li>The brakes should work effectively.</li> <li>The brake pedal should not feel spongy.</li> <li>The brake pedal should not get too close to the floor when the brakes are applied.</li> </ul>
Head restraints	<ul style="list-style-type: none"> <li>Do the head restraints move smoothly and lock securely?</li> </ul>
Indicators/buzz- ers	<ul style="list-style-type: none"> <li>Do the indicators and buzzers function properly?</li> </ul>
Lights	<ul style="list-style-type: none"> <li>Do all the lights come on?</li> <li>Are the headlights aimed correctly?</li> </ul>

Items	Check points
Parking brake	<ul style="list-style-type: none"> <li>• Move smoothly?</li> <li>• When parked on a slope and the parking brake is on, is the vehicle securely stopped?</li> </ul>
Seat belts	<ul style="list-style-type: none"> <li>• Do the seat belts operate smoothly?</li> <li>• The seat belts should not be damaged.</li> </ul>
Seats	<ul style="list-style-type: none"> <li>• Do the seat controls operate properly?</li> </ul>
Steering wheel	<ul style="list-style-type: none"> <li>• Does the steering wheel rotate smoothly?</li> <li>• Does the steering wheel have the correct amount of free play?</li> <li>• There should not be any strange sounds coming from the steering wheel.</li> </ul>

Items	Check points
Tires	<ul style="list-style-type: none"> <li>• Is the tire inflation pressure correct?</li> <li>• The tires should not be damaged or excessively worn.</li> <li>• Have the tires been rotated according to the maintenance schedule?</li> <li>• The wheel nuts should not be loose.</li> </ul>
Windshield wipers	<ul style="list-style-type: none"> <li>• The wiper blades should not show any signs of cracking, splitting, wear, contamination or deformation.</li> <li>• The wiper blades should clear the windshield without streaking or skipping.</li> </ul>

### Vehicle exterior

Items	Check points
Doors/trunk	<ul style="list-style-type: none"> <li>• Do the doors/trunk operate smoothly?</li> </ul>
Engine hood	<ul style="list-style-type: none"> <li>• Does the engine hood lock system work properly?</li> </ul>
Fluid leaks	<ul style="list-style-type: none"> <li>• There should not be any signs of fluid leakage after the vehicle has been parked.</li> </ul>

**Emission inspection and maintenance (I/M) programs**

Some states have vehicle emission inspection programs which include OBD (On Board Diagnostics) checks. The OBD system monitors the operation of the emission control system.

**If the malfunction indicator lamp comes on**

The OBD system determines that a problem exists somewhere in the emission control system. Your vehicle may not pass the I/M test and may need to be repaired. Contact your Lexus dealer to service the vehicle.

**Your vehicle may not pass the I/M test in the following situations:**

- When the 12-volt battery is disconnected or discharged  
Readiness codes that are set during ordinary driving are erased. Also, depending on your driving habits, the readiness codes may not be completely set.
- When the fuel tank cap is loose  
The malfunction indicator lamp comes on indicating a temporary malfunction and your vehicle may not pass the I/M test.

**When the malfunction indicator lamp still remains on after several driving trips**

The error code in the OBD system will not be cleared unless the vehicle is driven 40 or more times.

**If your vehicle does not pass the I/M test**

Contact your Lexus dealer to prepare the vehicle for re-testing.

### Do-it-yourself service precautions

If you perform maintenance by yourself, be sure to follow the correct procedure as given in these sections.

### Maintenance

Items	Parts and tools
12-volt battery condition (→P.299)	<ul style="list-style-type: none"> <li>• Grease</li> <li>• Conventional wrench (for terminal clamp bolts)</li> </ul>
Brake fluid level (→P.297)	<ul style="list-style-type: none"> <li>• SAE J1703 or FMVSS No.116 DOT 3 brake fluid</li> <li>• Rag or paper towel</li> <li>• Funnel (used only for adding brake fluid)</li> </ul>

Items	Parts and tools
Engine coolant level (LC500) (→P.296)	<ul style="list-style-type: none"> <li>• "Toyota Super Long Life Coolant" or a similar high quality ethylene glycol-based non-silicate, non-amine, non-nitrite and non-borate coolant with long-life hybrid organic acid technology</li> </ul> <p>For the U.S.A.: "Toyota Super Long Life Coolant" is pre-mixed with 50% coolant and 50% deionized water.</p> <p>For Canada: "Toyota Super Long Life Coolant" is pre-mixed with 55% coolant and 45% deionized water.</p> <ul style="list-style-type: none"> <li>• Funnel (used only for adding coolant)</li> </ul>
Engine/power control unit coolant level (LC500h) (→P.296)	<ul style="list-style-type: none"> <li>• "Toyota Super Long Life Coolant" or a similar high quality ethylene glycol-based non-silicate, non-amine, non-nitrite and non-borate coolant with long-life hybrid organic acid technology</li> </ul> <p>For the U.S.A.: "Toyota Super Long Life Coolant" is pre-mixed with 50% coolant and 50% deionized water.</p> <p>For Canada: "Toyota Super Long Life Coolant" is pre-mixed with 55% coolant and 45% deionized water.</p> <ul style="list-style-type: none"> <li>• Funnel (used only for adding coolant)</li> </ul>

Items	Parts and tools
Engine oil level (→P.293)	<ul style="list-style-type: none"> <li>• “Toyota Genuine Motor Oil” or equivalent</li> <li>• Rag or paper towel</li> <li>• Funnel (used only for adding engine oil)</li> </ul>
Fuses (→P.319)	<ul style="list-style-type: none"> <li>• Fuse with same amperage rating as original</li> </ul>
Headlight aim	<ul style="list-style-type: none"> <li>• Phillips-head screwdriver</li> </ul>
Light bulbs (→P.324)	—
Radiator and condenser (→P.297)	—
Tire inflation pressure (→P.313)	<ul style="list-style-type: none"> <li>• Tire pressure gauge</li> <li>• Compressed air source</li> </ul>
Washer fluid (→P.298)	<ul style="list-style-type: none"> <li>• Water or washer fluid containing antifreeze (for winter use)</li> <li>• Funnel (used only for adding water or washer fluid)</li> </ul>

**WARNING**

The engine compartment contains many mechanisms and fluids that may move suddenly, become hot, or become electrically energized. To avoid death or serious injury, observe the following precautions.

■ **When working on the engine compartment**

- LC500h: Make sure that the “IGNITION ON” on the multi-information display and the “READY” indicator are both off.
- Keep hands, clothing and tools away from the moving fan and engine drive belt.

● LC500: Be careful not to touch the engine, radiator, exhaust manifold, etc. right after driving as they may be hot. Oil and other fluids may also be hot. LC500h: Be careful not to touch the engine, power control unit, radiator, exhaust manifold, etc. right after driving as they may be hot. Oil and other fluids may also be hot.

● Do not leave anything that may burn easily, such as paper and rags, in the engine compartment.

● Do not smoke, cause sparks or expose an open flame to fuel. Fuel fumes are flammable.

■ **When working near the electric cooling fan or radiator grille**

Be sure the engine switch <power switch> is off.

With the engine switch <power switch> in IGNITION ON mode <ON mode>, the electric cooling fan may automatically start to run if the air conditioning is on and/or the coolant temperature is high. (→P.297)

■ **Safety glasses**

Wear safety glasses to prevent flying or falling material, fluid spray, etc. from getting in your eyes.

**NOTICE**

■ **If you remove the air cleaner filter**

Driving with the air cleaner filter removed may cause excessive engine wear due to dirt in the air.

## Hood

### Opening the hood

- 1 Pull the hood lock release lever.  
The hood will pop up slightly.

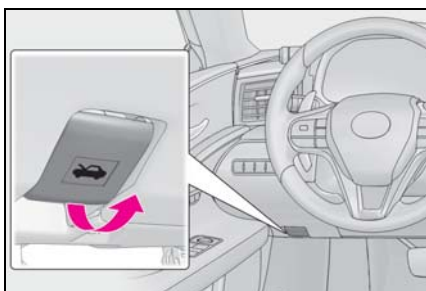

- 2 Pull up the auxiliary catch lever and lift the hood.

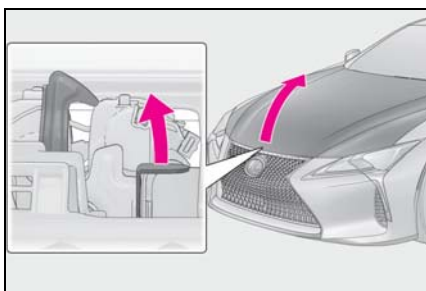

### WARNING

#### Pre-driving check

Check that the hood is fully closed and locked.  
If the hood is not locked properly, it may open while the vehicle is in motion and cause an accident, which may result in death or serious injury.

## Positioning a floor jack

When using a floor jack, follow the instructions in the manual provided with the jack and perform the operation safely.

When raising your vehicle with a floor jack, position the jack correctly. Improper placement may damage your vehicle or cause injury.

### Location of the jack point

#### ■ Front

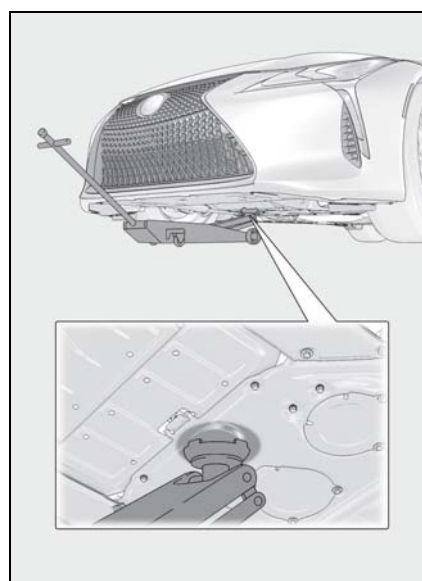

■ Rear

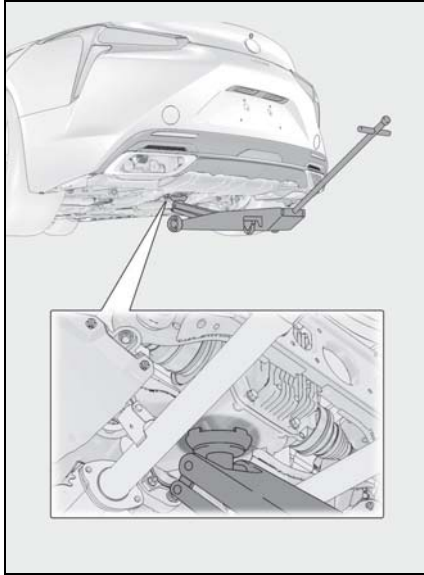

## Engine compartment

### Components

► LC500

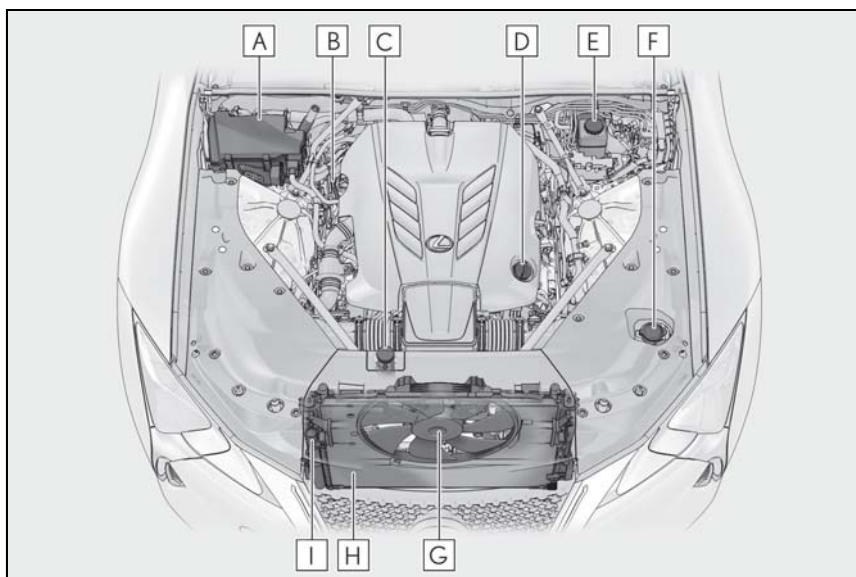

- A** Fuse box (→P.319)
- B** Engine oil level dipstick (→P.293)
- C** Engine coolant reservoir (→P.296)
- D** Engine oil filler cap (→P.294)
- E** Brake fluid reservoir (→P.297)
- F** Washer fluid tank (→P.298)
- G** Electric cooling fan
- H** Condenser (→P.297)
- I** Radiator (→P.297)



## ▶ LC500h

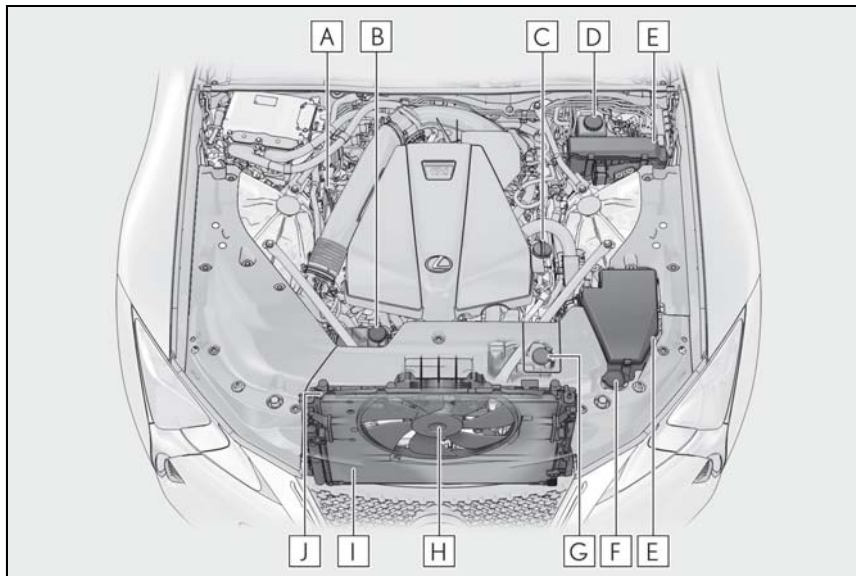

- A** Engine oil level dipstick (→P.293)
- B** Power control unit coolant reservoir (→P.296)
- C** Engine oil filler cap (→P.294)
- D** Brake fluid reservoir (→P.297)
- E** Fuse boxes (→P.319)
- F** Washer fluid tank (→P.298)
- G** Engine coolant reservoir (→P.296)
- H** Electric cooling fan
- I** Condenser (→P.297)
- J** Radiator (→P.297)

■ **12-volt battery**  
→P.299

### Checking and adding the engine oil

With the engine at operating temperature and turned off, check the oil level

on the dipstick.

#### ■ Checking the engine oil

- 1** Park the vehicle on level ground.

▶ LC500

After warming up the engine and turning it off, wait more than 5 minutes for the oil to drain back into the bottom of the engine.

▶ LC500h

After warming up the engine and turning off the hybrid system, wait more than 5 minutes for the oil to drain back into the bottom of the engine.

**2** Holding a rag under the end, pull the dipstick out.

▶ LC500

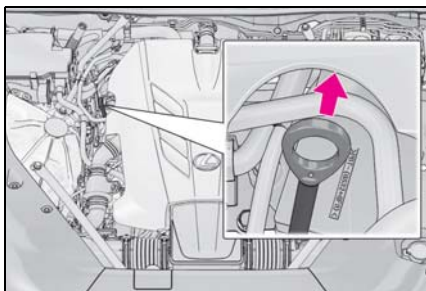

▶ LC500h

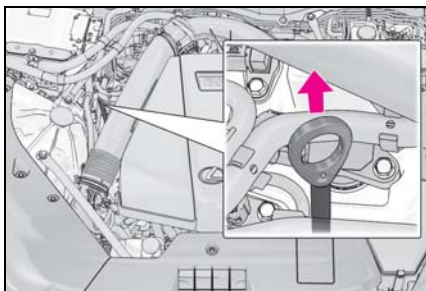

**3** Wipe the dipstick clean.

**4** Reinsert the dipstick fully.

**5** Holding a rag under the end, pull the dipstick out and check the oil level.

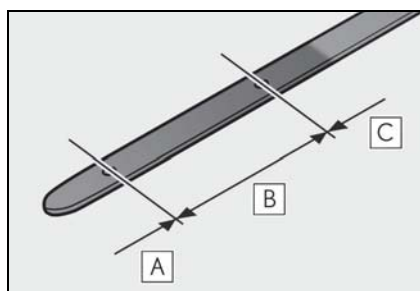

**A** Low

**B** Normal

**C** Excessive

The shape of the dipstick may differ depending on the type of vehicle or engine.

**6** Wipe the dipstick and reinsert it fully.

■ **Checking the oil type and preparing the items needed**

Make sure to check the oil type and prepare the items needed before adding oil.

- Engine oil selection

→P.374, 375

- Oil quantity (Low → Full)

1.6 qt. (1.5 L, 1.3 Imp.qt.)

- Item

Clean funnel

■ **Adding engine oil**

If the oil level is below or near the low level mark, add engine oil of the same type as that already in the engine.

▶ LC500

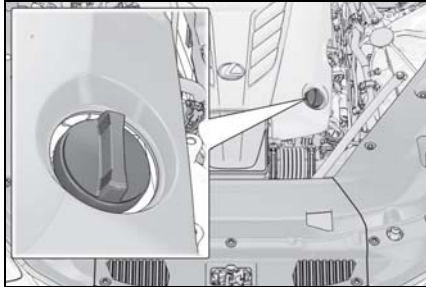

▶ LC500h

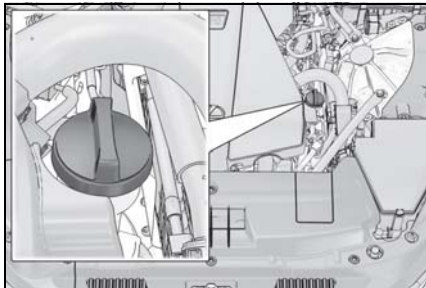

- 1 Remove the oil filler cap by turning it counterclockwise.
- 2 Add engine oil slowly, checking the dipstick.
- 3 Install the oil filler cap by turning it clockwise.

■ Engine oil consumption

A certain amount of engine oil will be consumed while driving. In the following situations, oil consumption may increase, and engine oil may need to be refilled in between oil maintenance intervals.

- When the engine is new, for example directly after purchasing the vehicle or after replacing the engine
- If low quality oil or oil of an inappropriate viscosity is used
- When driving at high engine speeds or with a heavy load, or when driving while accelerating or decelerating frequently
- When leaving the engine idling for a long

time, or when driving frequently through heavy traffic

■ After changing the engine oil (LC500h)

The engine oil maintenance data should be reset. Perform the following procedures:

- 1 While the vehicle is stopped, press of the meter control switches.
- 2 Press or of the meter control switches, and select .
- 3 Press or of the meter control switches, select "Vehicle Settings", and then press "OK".
- 4 Press or of the meter control switches, select "Oil Maintenance", and then press "OK".
- 5 Select "Yes" and then press "OK".

A message will be displayed on the multi-information display.



**WARNING**

■ Used engine oil

- Used engine oil contains potentially harmful contaminants which may cause skin disorders such as inflammation and skin cancer, so care should be taken to avoid prolonged and repeated contact. To remove used engine oil from your skin, wash thoroughly with soap and water.
- Dispose of used oil and filters only in a safe and acceptable manner. Do not dispose of used oil and filters in household trash, in sewers or onto the ground.  
Call your Lexus dealer, service station or auto parts store for information concerning recycling or disposal.

**⚠ WARNING**

- Do not leave used engine oil within the reach of children.

**⚠ NOTICE**

- **To prevent serious engine damage**  
Check the oil level on a regular basis.
- **When replacing the engine oil**
  - Be careful not to spill engine oil on the vehicle components.
  - Avoid overfilling, or the engine could be damaged.
  - Check the oil level on the dipstick every time you refill the vehicle.
  - Be sure the engine oil filler cap is properly tightened.

**Checking the coolant**

The coolant level is satisfactory if it is between the "F" and "L" lines on the reservoir when the engine <hybrid system> is cold.

■ **Engine coolant reservoir**

▶ LC500

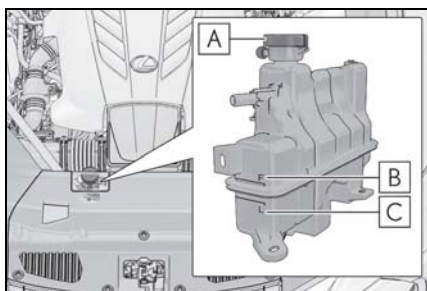

- A** Reservoir cap
- B** "F" line
- C** "L" line

If the level is on or below the "L" line, add coolant up to the "F" line. (→P.364)

▶ LC500h

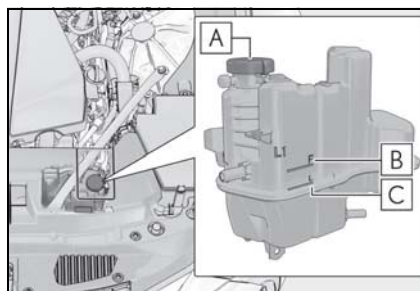

**A** Reservoir cap

**B** "F" line

**C** "L" line

If the level is on or below the "L" line, add coolant up to the "F" line. (→P.366)

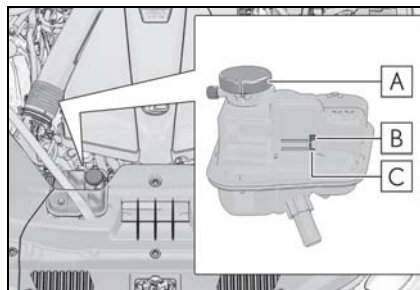
■ **Power control unit coolant reservoir (LC500h)**

**A** Reservoir cap

**B** "F"/"FULL" line

**C** "L"/"LOW" line

If the level is on or below the "L"/"LOW" line, add coolant up to the "F"/"FULL" line. (→P.367)

■ **Coolant selection**

Only use "Toyota Super Long Life Coolant" or a similar high quality ethylene glycol based non-silicate, non-amine, non-nitrite,

and non-borate coolant with long-life hybrid organic acid technology.

U.S.A.:

"Toyota Super Long Life Coolant" is a mixture of 50% coolant and 50% deionized water. (Minimum temperature: -31°F [-35°C])

Canada:

"Toyota Super Long Life Coolant" is a mixture of 55% coolant and 45% deionized water. (Minimum temperature: -44°F [-42°C])

For more details about engine coolant, contact your Lexus dealer.

■ **If the coolant level drops within a short time of replenishing**

Visually check the radiator, hoses, engine/power control unit coolant reservoir caps, drain cock and water pump. If you cannot find a leak, have your Lexus dealer test the cap and check for leaks in the cooling system.

 **WARNING**

■ **When the engine <hybrid system> is hot**

LC500: Do not remove the engine coolant reservoir cap or the coolant inlet cap. (→P.366)

The cooling system may be under pressure and may spray hot coolant if the cap is removed, causing serious injuries, such as burns.

LC500h: Do not remove the engine/power control unit coolant reservoir caps or the coolant inlet cap. (→P.369)

The cooling system may be under pressure and may spray hot coolant if the cap is removed, causing serious injuries, such as burns.

 **NOTICE**

■ **When adding coolant**

Coolant is neither plain water nor straight antifreeze. The correct mixture of water and antifreeze must be used to provide proper lubrication, corrosion protection and cooling. Be sure to read the antifreeze or coolant label.

■ **If you spill coolant**

Be sure to wash it off with water to prevent it from damaging parts or paint.

**Checking the radiator and condenser**

Check the radiator and condenser and clear away any foreign objects.

If either of the above parts is extremely dirty or you are not sure of their condition, have your vehicle inspected by your Lexus dealer.

 **WARNING**

■ **When the engine <hybrid system> is hot**

Do not touch the radiator or condenser as they may be hot and cause serious injuries, such as burns.

**Checking and adding the brake fluid**

■ **Checking fluid level**

The brake fluid level should be between the "MAX" and "MIN" lines on the tank.

▶ LC500

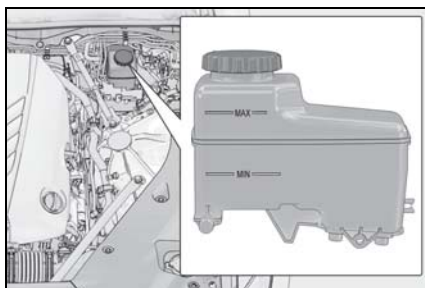

▶ LC500h

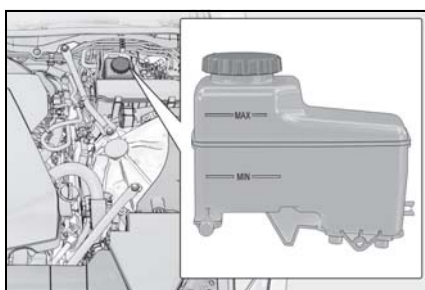

■ Adding fluid

Make sure to check the fluid type and prepare the necessary items.

- Fluid type  
SAE J1703 or FMVSS No.116 DOT 3 brake fluid
- Item  
Clean funnel

■ Brake fluid can absorb moisture from the air

Excess moisture in the brake fluid can cause a dangerous loss of braking efficiency. Use only newly opened brake fluid.

**! WARNING**

■ When filling the reservoir

Take care as brake fluid can harm your hands and eyes and damage painted surfaces.

If fluid gets on your hands or in your eyes, flush the affected area with clean water immediately.

If you still experience discomfort, see a doctor.

**! NOTICE**

■ If the fluid level is low or high

It is normal for the brake fluid level to go down slightly as the brake pads wear out or when the fluid level in the accumulator is high.

If the reservoir needs frequent refilling, there may be a serious problem.

**Checking and adding the washer fluid**

If any washer does not work or “Windshield Washer Fluid Low” is shown on the multi-information display, the washer tank may be empty. Add washer fluid.

▶ LC500

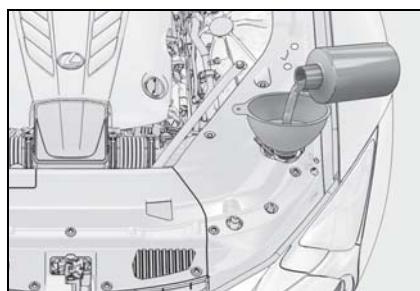

## ▶ LC500h

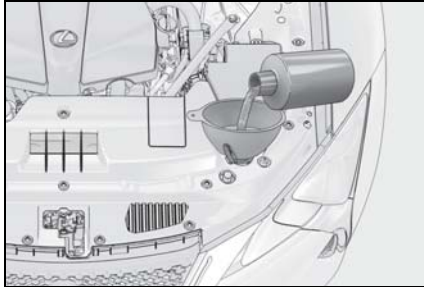

**⚠ WARNING**

■ **When adding washer fluid**

Do not add washer fluid when the engine <hybrid system> is hot or running <operating> as washer fluid contains alcohol and may catch fire if spilled on the engine etc.

**⚠ NOTICE**

■ **Do not use any fluid other than washer fluid**

Do not use soapy water or engine anti-freeze instead of washer fluid. Doing so may cause streaking on the vehicle's painted surfaces, as well as damaging the pump leading to problems of the washer fluid not spraying.

■ **Diluting washer fluid**

Dilute washer fluid with water as necessary. Refer to the freezing temperatures listed on the label of the washer fluid bottle.

## 12-volt battery

### Location

The 12-volt battery is located in the trunk.

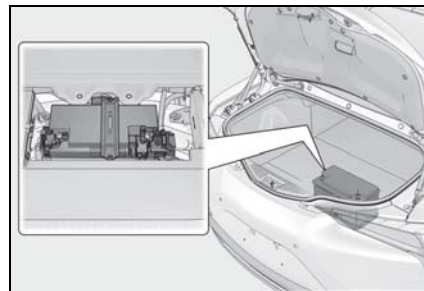

### ■ Before recharging

When recharging, the 12-volt battery produces hydrogen gas which is flammable and explosive. Therefore, observe the following precautions before recharging:

- If recharging with the 12-volt battery installed on the vehicle, be sure to disconnect the ground cable.
- Make sure the power switch on the charger is off when connecting and disconnecting the charger cables to the 12-volt battery.

### ■ After recharging/reconnecting the 12-volt battery

- Unlocking the doors using the smart access system with push-button start may not be possible immediately after reconnecting the 12-volt battery. If this happens, use the wireless remote control or the mechanical key to lock/unlock the doors.
- Start the engine <hybrid system> with the engine switch <power switch> in ACCESSORY mode. The engine <hybrid system> may not start with the engine switch <power switch> turned off. However, the engine <hybrid system> will operate normally from the second attempt.
- The engine switch <power switch> mode is recorded by the vehicle. If the 12-volt



battery is reconnected, the vehicle will return the engine switch <power switch> mode to the status it was in before the 12-volt battery was disconnected. Make sure to turn off the engine switch <power switch> before disconnect the 12-volt battery. Take extra care when connecting the 12-volt battery if the engine switch <power switch> mode prior to discharge is unknown.

If the engine <hybrid system> will not start even after multiple attempts at all methods above, contact your Lexus dealer.

**⚠ WARNING**

**■ Chemicals in the 12-volt battery**

The 12-volt battery contains poisonous and corrosive sulfuric acid and may produce hydrogen gas which is flammable and explosive. To reduce the risk of death or serious injury, take the following precautions while working on or near the 12-volt battery:

- Do not cause sparks by touching the 12-volt battery terminals with tools.
- Do not smoke or light a match near the 12-volt battery.
- Avoid contact with eyes, skin and clothes.
- Never inhale or swallow electrolyte.
- Wear protective safety glasses when working near the 12-volt battery.
- Keep children away from the 12-volt battery.

**■ Where to safely charge the 12-volt battery**

Always charge the 12-volt battery in an open area. Do not charge the 12-volt battery in a garage or closed room where there is insufficient ventilation.

**■ How to recharge the 12-volt battery**

Recharge at a current of 5 A or less and make sure that the recharging period does not exceed a total of 12 hours.

**■ Emergency measures regarding electrolyte**

- If electrolyte gets in your eyes  
Flush your eyes with clean water for at least 15 minutes and get immediate medical attention. If possible, continue to apply water with a sponge or cloth while traveling to the nearest medical facility.
- If electrolyte gets on your skin  
Wash the affected area thoroughly. If you feel pain or burning, get medical attention immediately.
- If electrolyte gets on your clothes  
It can soak through clothing on to your skin. Immediately take off the clothing and follow the procedure above if necessary.
- If you accidentally swallow electrolyte  
Drink a large quantity of water or milk. Get emergency medical attention immediately.

**⚠ NOTICE**

**■ When recharging the 12-volt battery**

Never recharge the 12-volt battery while the engine is running <hybrid system is operating>. Also, be sure all accessories are turned off.

**Removing the 12-volt battery cover**

Pull the strap upwards to lift up the luggage mat.

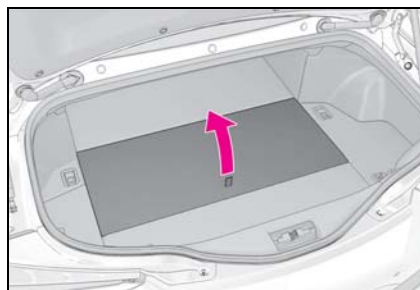



### Exterior

Make sure that the 12-volt battery terminals are not corroded and that there are no loose connections, cracks, or loose clamps.

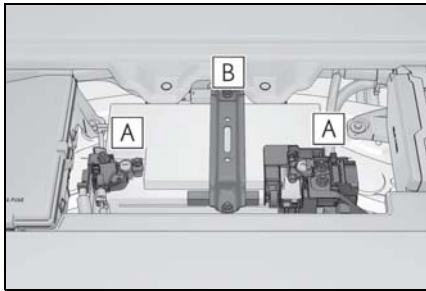

- A** Terminals
- B** Hold-down clamp

### Checking 12-volt battery fluid

Check that the level is upper than the center between the bottom of the battery lid and "LOWER LEVEL" line.

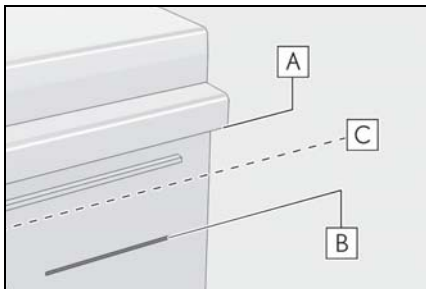

- A** Bottom of the battery lid
- B** "LOWER LEVEL" line
- C** Center of **A** and **B**

If the fluid level is below **C**, replace the 12-volt battery.

### Tires

Replace or rotate tires in accordance with maintenance schedules and treadwear.

### Checking tires

Check if the treadwear indicators are showing on the tires. Also check the tires for uneven wear, such as excessive wear on one side of the tread.

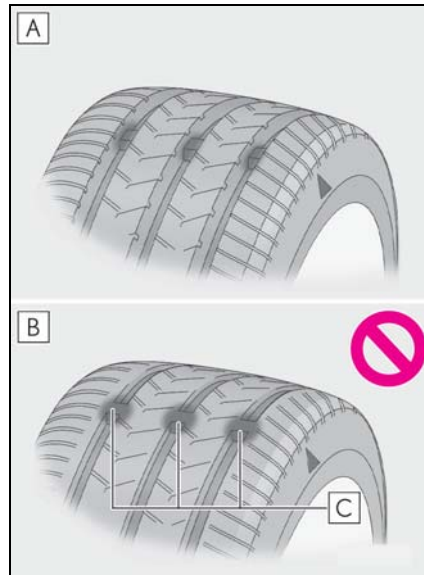

- A** New tread
- B** Worn tread
- C** Treadwear indicator

The location of treadwear indicators is shown by a "TWI" or "△" mark, etc., molded into the sidewall of each tire.

Replace the tires if the treadwear indicators are showing on a tire.

■ **When to replace your vehicle's tires**

Tires should be replaced if:

- The treadwear indicators are showing on a tire.
- You have tire damage such as cuts, splits, cracks deep enough to expose the fabric, and bulges indicating internal damage
- A tire goes flat repeatedly or cannot be properly repaired due to the size or location of a cut or other damage

If you are not sure, consult your Lexus dealer.

■ **Tire life**

Any tire over 6 years old must be checked by a qualified technician even if it has seldom or never been used or damage is not obvious.

■ **Low profile tires (21-inch tires)**

Generally, low profile tires will wear more rapidly and tire grip performance will be reduced on snowy and/or icy roads when compared to standard tires. Be sure to use snow tires on snowy and/or icy roads and drive carefully at a speed appropriate for road and weather conditions.

■ **Maximum load of tire**

Check that the maximum load of the replacement tire is greater than 1/2 of the Gross Axle Weight Ratings (GAWR) of either the front axle or the rear axle, whichever is greater.

For the GAWR, see the Certification Label. For the maximum load of the tire, see the load limit at maximum cold tire inflation pressure mentioned on the sidewall of the tire. (→P.383)



■ **Tire types**

- Summer tires

Summer tires are high-speed performance tires best suited to highway driving under dry conditions. Since summer tires do not have the same traction performance as snow tires, summer tires are inadequate for driving on snow-covered or icy roads. For driving on snow-covered roads or icy roads, the use of snow tires is recommended. When installing snow tires, be sure to replace all four tires.

● **All season tires**

All season tires are designed to provide better traction in snow and to be adequate for driving in most winter conditions as well as for use year-round. All season tires, however, do not have adequate traction performance compared with snow tires in heavy or loose snow. Also, all season tires fall short in acceleration and handling performance compared with summer tires in highway driving.

● **Snow tires**

For driving on snow-covered roads or icy roads, we recommend using snow tires. If you need snow tires, select tires of the same size, construction and load capacity as the originally installed tires. Since your vehicle has radial tires as original equipment, make sure your snow tires also have radial construction. Do not install studded tires without first checking local regulations for possible restrictions. Snow tires should be installed on all wheels. (→P.238)

■ **If the tread on snow tires wears down below 0.16 in. (4 mm)**

The effectiveness of the tires as snow tires is lost.

**⚠ WARNING**

■ **When inspecting or replacing tires**

Observe the following precautions to prevent accidents. Failure to do so may cause damage to parts of the drivetrain as well as dangerous handling characteristics, which may lead to an accident resulting in death or serious injury.

**⚠ WARNING**

- Do not mix tires of different makes, models or tread patterns. Also, do not mix tires of remarkably different treadwear.
- Do not use tire sizes other than those recommended by Lexus.
- Do not mix differently constructed tires (radial, bias-belted or bias-ply tires).
- Do not mix summer, all season and snow tires.
- Do not use tires that have been used on another vehicle. Do not use tires if you do not know how they were used previously.

**⚠ NOTICE****■ Driving on rough roads**

Take particular care when driving on roads with loose surfaces or potholes. These conditions may cause losses in tire inflation pressure, reducing the cushioning ability of the tires. In addition, driving on rough roads may cause damage to the tires themselves, as well as the vehicle's wheels and body.

**■ Low profile tires (21-inch tires)**

Low profile tires may cause greater damage than usual to the tire wheel when sustaining impact from the road surface. Therefore, pay attention to the following:

- Be sure to use proper tire inflation pressure. If tires are under-inflated, they may be damaged more severely.
- Avoid potholes, uneven pavement, curbs and other road hazards. Failure to do so may lead to severe tire and wheel damage.

**■ If tire inflation pressure of each tire becomes low while driving**

Do not continue driving, or your tires and/or wheels may be ruined.

**Tire rotation**

Tires cannot be rotated.

**Run-flat tires**

When run-flat tires are installed, the vehicle can be driven for a maximum of 100 miles (160 km) at a speed below 50 mph (80 km/h) after any tire goes flat. (However, the vehicle speed may not increase to near 50 mph [80 km/h] depending on weather or driving conditions.)

A run-flat tire has a  mark on the sidewall.

Make sure to replace the flat tire before the vehicle has been driven for near 100 miles (160 km). Also, do not use a repaired tire.

**■ Run-flat tires**

- The run-flat tires are for only this vehicle. Do not use the tires on other vehicles.
- Do not mix run-flat tires and normal tires.
- If non-genuine Lexus wheels are used, it may be impossible to sufficiently demonstrate the performance of run-flat tires.

**Tire pressure warning system**

Your vehicle is equipped with a tire pressure warning system that uses tire pressure warning valves and transmitters to detect low tire inflation pressure before serious problems arise.

- If the tire pressure drops below a predetermined level, the driver is warned by a screen display and a warning light. (→P.340)
- The tire pressure detected by the

tire pressure warning system can be displayed on the multi-information display. (→P.84)

The illustration used is intended as an example, and may differ from the image that is actually displayed on the multi-information display.



#### ■ Routine tire inflation pressure checks

The tire pressure warning system does not replace routine tire inflation pressure checks. Make sure to check tire inflation pressure as part of your routine of daily vehicle checks.

#### ■ Situations in which the tire pressure warning system may not operate properly

- In the following cases, the tire pressure warning system may not operate properly.
  - If non-genuine Lexus wheels are used.
  - A tire has been replaced with a tire that is not an OE (Original Equipment) tire.
  - A tire has been replaced with a tire that is not of the specified size.
  - Tire chains etc. are equipped.
  - An auxiliary-supported run-flat tire is equipped.
  - If a window tint that affects the radio wave signals is installed.
  - If there is a lot of snow or ice on the vehicle, particularly around the wheels or wheel housings.
  - If the tire inflation pressure is extremely higher than the specified level.
  - If wheel without tire pressure warning valves and transmitters are used.
  - If the ID code on the tire pressure warning valves and transmitters is not regis-

tered in the tire pressure warning computer.

- Performance may be affected in the following situations.
  - Near a TV tower, electric power plant, gas station, radio station, large display, airport or other facility that generates strong radio waves or electrical noise
  - When carrying a portable radio, cellular phone, cordless phone or other wireless communication device

If tire position information is not correctly displayed due to the radio wave conditions, the display may be corrected by driving and changing the radio wave conditions.

- When the vehicle is parked, the time taken for the warning to start or go off could be extended.
- When tire inflation pressure declines rapidly for example when a tire has burst, the warning may not function.

■ **Tire pressure warning system certification**

- For vehicles sold in the U.S.A., Hawaii and Puerto Rico

FCC ID: PAXPMVC015

**NOTE**

This device complies with part 15 of the FCC Rules. Operation is subject to the following two conditions: (1) This device may not cause harmful interference, and (2) this device must accept any interference received, including interference that may cause undesired operation.

**FCC WARNING**

Changes or modifications not expressly approved by the party responsible for compliance could void the user's authority to operate the equipment.

- For vehicles sold in Canada

**NOTE**

This device complies with Industry Canada licence-exempt RSS standard(s). Operation is subject to the following two conditions: (1) this device may not cause interference, and (2) this device must accept any interference, including interference that may cause undesired operation of the device.

**NOTE**

Le présent appareil est conforme aux CNR d'Industrie Canada applicables aux appareils radio exempts de licence. L'exploitation est autorisée aux deux conditions suivantes : (1) l'appareil ne doit pas produire de brouillage, et (2) l'utilisateur de l'appareil doit accepter tout brouillage radioélectrique subi, même si le brouillage est susceptible d'en compromettre le fonctionnement.

**Installing tire pressure warning valves and transmitters**

When replacing tires or wheels, tire pressure warning valves and transmitters must also be installed.

When new tire pressure warning valves and transmitters are installed,

new ID codes must be registered in the tire pressure warning computer and the tire pressure warning system must be initialized. (→P.308)

■ **When replacing the tires and wheels**

If the ID code of the tire pressure warning valve and transmitter is not registered, the tire pressure warning system will not work

properly. After driving for about 20 minutes, the tire pressure warning light blinks for 1 minute and stays on to indicate a system malfunction.

 NOTICE

■ **Repairing or replacing tires, wheels, tire pressure warning valves, transmitters and tire valve caps**

- When removing or fitting the wheels, tires or the tire pressure warning valves and transmitters, contact your Lexus dealer as the tire pressure warning valves and transmitters may be damaged if not handled correctly.
- Make sure to install the tire valve caps. If the tire valve caps are not installed, water could enter the tire pressure warning valves and the tire pressure warning valves could be bound.
- When replacing tire valve caps, do not use tire valve caps other than those specified. The cap may become stuck.

**Initializing the tire pressure warning system**

- **The tire pressure warning system must be initialized in the following circumstances:**
  - When rotating the tires.
  - When the tire inflation pressure is changed when changing traveling speed.
  - When the tire inflation pressure is changed such as when changing tire size. (When there are multiple specified pressures)
  - After registering the ID codes. (→P.308)

When the tire pressure warning system is initialized, the current tire inflation

pressure is set as the benchmark pressure.









■ **How to initialize the tire pressure warning system**

- 1 Park the vehicle in a safe place and turn the engine switch <power switch> off.

Initialization cannot be performed while the vehicle is moving.

- 2 Adjust the tire inflation pressure to the specified cold tire inflation pressure level.

Make sure to adjust the tire pressure to the specified cold tire inflation pressure level. The tire pressure warning system will operate based on this pressure level.

- 3 Turn the engine switch <power switch> to IGNITION ON mode <ON mode>.
- 4 Press  or  of the meter control switches and select .
- 5 Press  or  of the meter control switches and select "Vehicle Settings", then press "OK".
- 6 Press  or  of the meter control switches and select "TPWS SET", then press "OK".
- 7 Press  or  of the meter control switches and select "Set tire pressure". Then press and hold "OK" until the tire pressure warning light starts blinking.

A message is displayed on the multi-information display. Also, "--" is displayed for inflation pressure of each tire on the multi-information display while the tire pressure

warning system determines the position.

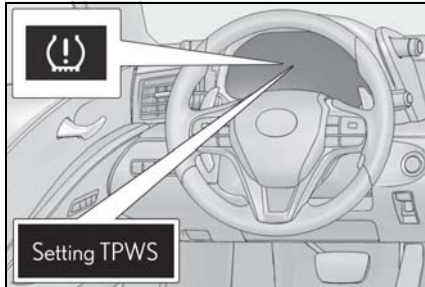

- 8 Drive the vehicle at approximately 25mph (40 km/h) or more for approximately 10 to 30 minutes.

When initialization is complete, the inflation pressure of each tire will be displayed on the multi-information display.

Depending on the vehicle and driving conditions, initialization may take up to approximately 1 hour to complete.

#### ■ The initialization operation

- Make sure to carry out initialization after adjusting the tire inflation pressure. Also, make sure the tires are cold before carrying out initialization or tire inflation pressure adjustment.
- If you have accidentally turned the engine switch <power switch> off during initialization, it is not necessary to manually restart the initialization again, as initialization will restart automatically the next time the engine switch <power switch> is turned to IGNITION ON mode <ON mode>.
- If you accidentally perform initialization when initialization is not necessary, adjust the tire inflation pressure to the specified level when the tires are cold, and conduct initialization again.
- While the position of each tire is being determined and the inflation pressures are not being displayed on the multi-information display, if the inflation pressure of a tire drops, the tire pressure warning light will come on.

#### ■ When initialization of the tire pressure warning system has failed

Initialization may take longer to complete if the vehicle is driven on an unpaved road. When performing initialization, drive on a paved road if possible. Depending on the driving environment and condition of the tires, initialization will be completed in approximately 10 to 30 minutes. If initialization is not complete after driving approximately 10 to 30 minutes, continue driving for a while. If the inflation of each tire is not displayed after driving for approximately 1 hour, perform the following procedure.

- Park the vehicle in a safe place for approximately 20 minutes. Then drive straight (with occasional left and right turns) at approximately 25 mph (40 km/h) or more for approximately 10 to 30 minutes.

However, in the following situations, the tire inflation pressure will not be recorded and the system will not operate properly. Perform initialization again.

- When performing initialization, the tire pressure warning light does not blink 3 times. (Initialization will not occur while driving)
- After performing initialization, the tire pressure warning light blinks for 1 minute then stays on after driving for about 20 minutes.

If the inflation pressure of each tire is still not displayed, have the vehicle inspected by your Lexus dealer.

#### ■ When registering ID codes

- Initialize the tire pressure warning system after ID code registration. Initialization is disabled if the system was initialized before registration.
- After ID code registration, the tires are hot by driving. Initialize the tire pressure warning system after the tires become cold.



**⚠ WARNING****■ When initializing the tire pressure warning system**

Do not initialize tire inflation pressure without first adjusting the tire inflation pressure to the specified level. Otherwise, the tire pressure warning light may not come on even if the tire inflation pressure is low, or it may come on when the tire inflation pressure is actually normal.

**Registering ID codes**

The tire pressure warning valve and transmitter is equipped with a unique ID code. When replacing a tire pressure warning valve and transmitter, it is necessary to register the ID code.

When registering the ID codes, perform the following procedure.

- 1 Turn the engine switch <power switch> to IGNITION ON mode <ON mode>.
- 2 Press **<** or **>** of the meter control switches and select **⚙**.
- 3 Press **▲** or **▼** of the meter control switches and select "Vehicle Settings", then press "OK".
- 4 Press **▲** or **▼** of the meter control switches and select "TPWS SET", then press "OK".
- 5 Press **▲** or **▼** of the meter control switches and select "Change wheel set". Then press and hold "OK" until the tire pressure warning light starts blinking.

The change wheel set mode is activated and registration is started.

A message is displayed on the multi-information display, and "--" is displayed for inflation pressure of each tire. Then, the tire pressure warning light blinks rapidly for approximately 1 minute and stays on.

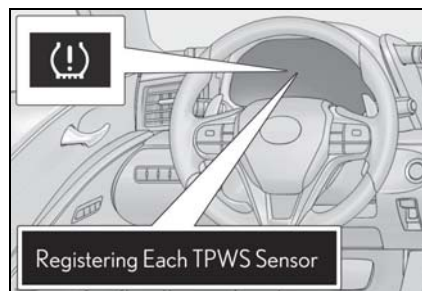

- 6 Drive the vehicle at 25mph (40 km/h) or more for approximately 10 to 30 minutes.

When registration is completed, the tire pressure warning light will go off and the inflation pressure of each tire will be displayed on the multi-information display.

The time elapsed before registration is completed differs according to the driving condition and environment.

**■ Canceling the change wheel set mode**

- If turning the engine switch <power switch> off when in the change wheel set mode before driving, the change wheel set mode is canceled.
- After driving when in the change wheel set mode, the change wheel set mode cannot be canceled. To cancel the mode, perform the procedure for ID code registration again and turn the engine switch <power switch> off before driving.
- If the change wheel set mode is canceled, the ID codes that have already been registered are communicated. When communication is finished, the tire pressure warning light will turn off.

**■ When ID code registration may not operate properly**

- Do not move the vehicle backward during registration. Registration is started again from the beginning and it may take longer than usual.



- When another vehicle is running the side of the vehicle such as in heavy traffic, it may take longer to detect the vehicle's tire pressure warning valves and transmitters.
- If tire pressure warning valves and transmitters are in the vehicle, the ID codes may not be registered.

If registration takes long time, perform the procedure for ID code registration again after parking the vehicle for 20 minutes.

If the ID codes cannot be registered even when performing the above procedure, contact your Lexus dealer.

### Replacing the tire

**When raising your vehicle with a jack, position the jack correctly. Improper placement may damage your vehicle or cause injury.**

**If necessary tire replacement seems difficult to perform, contact your Lexus dealer.**

### Before jacking up the vehicle

- Stop the vehicle in a safe place on a hard, flat surface.
- Set the parking brake.
- Shift the shift position to P.
- Stop the engine <hybrid system>.

#### ■ Tools

As your vehicle is equipped with run-flat tires, the following tools for replacing a tire are not included with your vehicle. They can be purchased at your Lexus dealer.

- Wheel nut wrench
- Jack
- Jack handle

Location of the tools

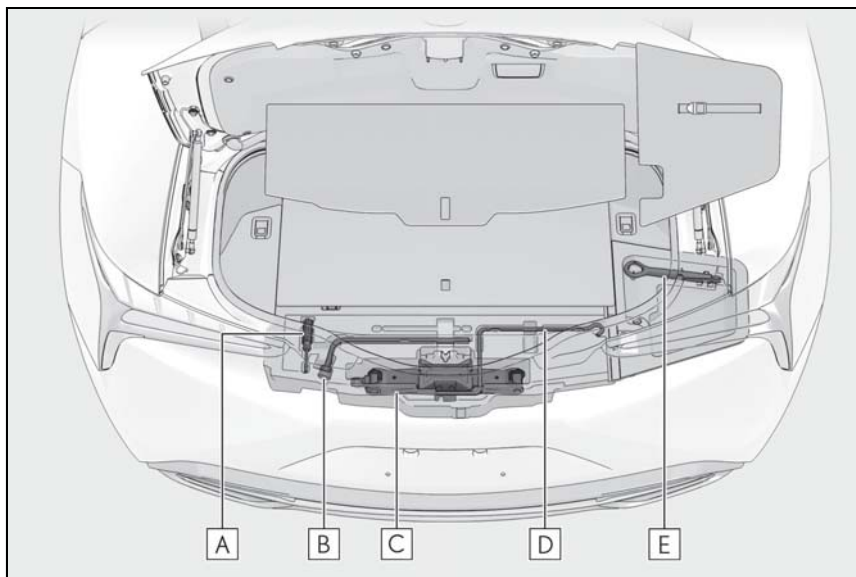

- A** Screwdriver
- B** Wheel nut wrench \*
- C** Jack \*
- D** Jack handle \*
- E** Towing eyelet

\* : They can be purchased at your Lexus dealer.

**⚠ WARNING**

**■ Using the tire jack**

Observe the following precautions. Improper use of the tire jack may cause the vehicle to suddenly fall off the jack, leading to death or serious injury.

- Do not use the tire jack for any purpose other than replacing tires.
- Do not use other tire jacks for replacing tires on this vehicle.
- Put the jack properly in its jack point.

- Do not put any part of your body under the vehicle while it is supported by the jack.
- Do not start the engine <hybrid system> or drive the vehicle while the vehicle is supported by the jack.
- Do not raise the vehicle while someone is inside.
- When raising the vehicle, do not put an object on or under the jack.
- Do not raise the vehicle to a height greater than that required to replace the tire.

**⚠ WARNING**

- Use a jack stand if it is necessary to get under the vehicle.
- When lowering the vehicle, make sure that there is no-one near the vehicle. If there are people nearby, warn them vocally before lowering.

**Removing a tire**

1 Check the tires.

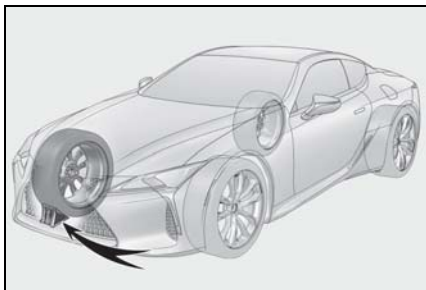

Tire	Wheel chock positions
Front left-hand side	Behind the rear right-hand side tire
Front right-hand side	Behind the rear left-hand side tire
Rear left-hand side	In front of the front right-hand side tire
Rear right-hand side	In front of the front left-hand side tire

2 Slightly loosen the wheel nuts (one turn).

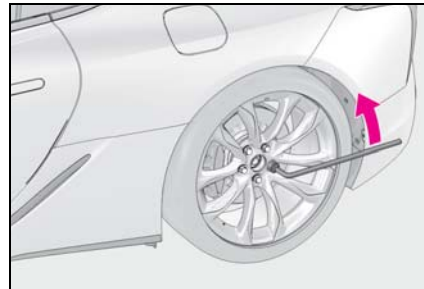

3 Turn the tire jack portion **A** by hand until the notch of the jack is in contact with the jack point.

The jack point guides are located under the rocker panel. They indicate the jack point positions.

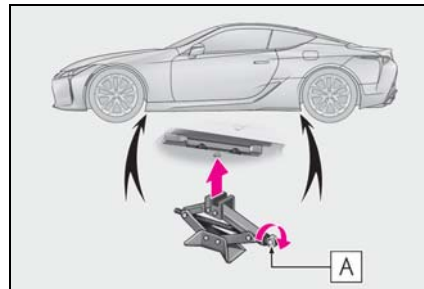

4 Raise the vehicle until the tire is slightly raised off the ground.

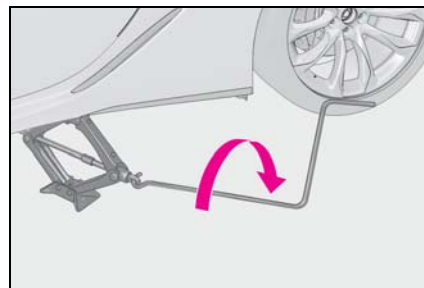

5 Remove all the wheel nuts and the tire.

When resting the tire on the ground, place the tire so that the wheel design faces up to

avoid scratching the wheel surface.

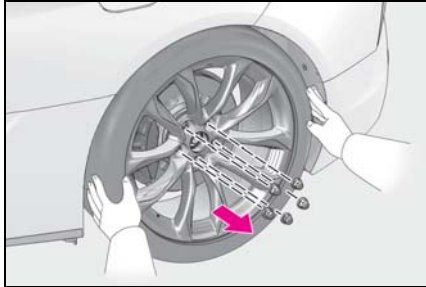

**⚠ WARNING**

**■ Replacing a tire**

Do not touch the disc wheels or the area around the brakes immediately after the vehicle has been driven.

After the vehicle has been driven the disc wheels and the area around the brakes will be extremely hot. Touching these areas with hands, feet or other body parts while changing a tire, etc. may result in burns.

**Installing the tire**

- 1 Remove any dirt or foreign matter from the wheel contact surface.

If foreign matter is on the wheel contact surface, the wheel nuts may loosen while the vehicle is in motion, causing the tire to come off.

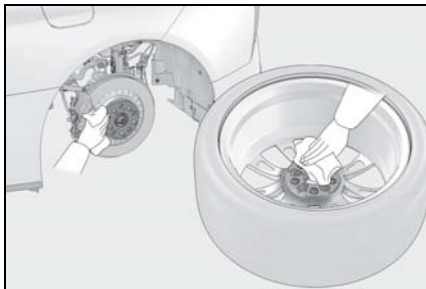

- 2 Install the tire and loosely tighten each wheel nut by hand by approximately the same amount.

Turn the wheel nuts until the washers come into contact with the disc wheel.

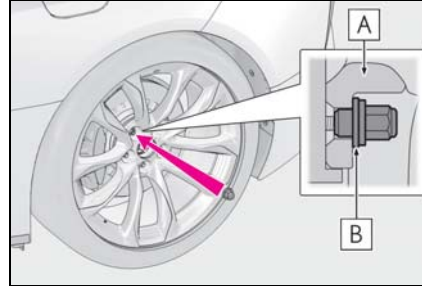

**A** Disc wheel

**B** Washer

- 3 Lower the vehicle.

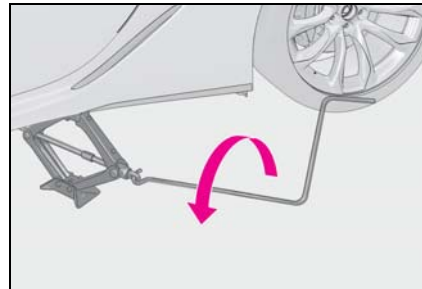

- 4 Firmly tighten each wheel nut two or three times in the order shown in the illustration.

**Tightening torque:**  
103.3 ft•lbf (140 N•m, 14.3 kgf•m)

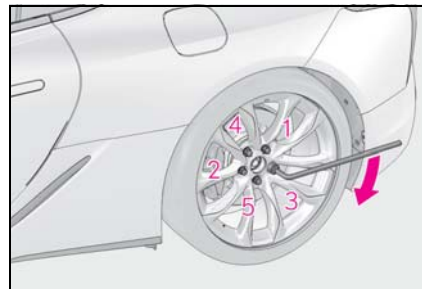

- 5 Stow all the tools.

**⚠ WARNING****■ When installing the tire**

Failure to follow these precautions could cause the wheel nuts to loosen and the tire to fall off, resulting in death or serious injury.

- Never use oil or grease on the wheel bolts or wheel nuts. Oil and grease may cause the wheel nuts to be excessively tightened, leading to bolt or disc wheel damage. In addition, the oil or grease can cause the wheel nuts to loosen and the wheel may fall off, causing a serious accident. Remove any oil or grease from the wheel bolts or wheel nuts.
- Have the wheel nuts tightened with a torque wrench to 103.3 ft•lbf (140 N•m, 14.3 kgf•m) soon as possible after changing wheels.
- Do not attach a heavily damaged wheel ornament, as it may fly off the wheel while the vehicle is moving.
- When installing a tire, only use wheel nuts that have been specifically designed for that wheel.
- If there are any cracks or deformations in the bolt screws, nut threads or bolt holes of the wheel, have the vehicle inspected by your Lexus dealer.

**■ After using the tools**

Before driving, make sure all the tools are stored securely in place. Failure to do so may cause injury in case of a collision or sudden braking.

**⚠ NOTICE**

- **Repairing or replacing tires, wheels, tire pressure warning valves, transmitters and tire valve caps**

→P.306

**Tire inflation pressure****Checking the specified tire inflation pressure**

The recommended cold tire inflation pressure and tire size are displayed on the tire and loading information label. (→P.379)

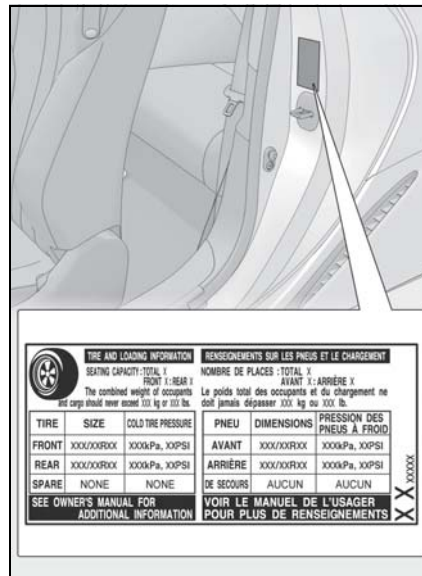
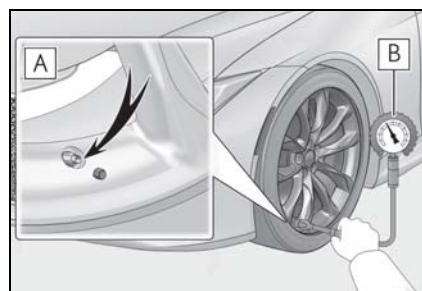
**Inspection and adjustment procedure**

**A** Tire valve

**B** Tire pressure gauge

- 1 Remove the tire valve cap.
- 2 Press the tip of the tire pressure gauge onto the tire valve.
- 3 Read the pressure using the gauge gradations.
- 4 If the tire inflation pressure is not at the recommended level, adjust the pressure.  
If you add too much air, press the center of the valve to deflate.
- 5 After completing the tire inflation pressure measurement and adjustment, apply soapy water to the valve and check for leakage.
- 6 Put the tire valve cap back on.

■ **Tire inflation pressure check interval**

You should check tire inflation pressure every two weeks, or at least once a month. Do not forget to check the spare.

■ **Effects of incorrect tire inflation pressure**

Driving with incorrect tire inflation pressure may result in the following:

- Reduced fuel economy
- Reduced driving comfort and poor handling
- Reduced tire life due to wear
- Reduced safety
- Damage to the drivetrain

If a tire needs frequent inflating, have it checked by your Lexus dealer.

■ **Instructions for checking tire inflation pressure**

When checking tire inflation pressure, observe the following:

- Check only when the tires are cold.  
If your vehicle has been parked for at least 3 hours or has not been driven for

more than 1 mile or 1.5 km, you will get an accurate cold tire inflation pressure reading.

- Always use a tire pressure gauge. It is difficult to judge if a tire is properly inflated based only on its appearance.
- It is normal for the tire inflation pressure to be higher after driving as heat is generated in the tire. Do not reduce tire inflation pressure after driving.
- Never exceed the vehicle capacity weight. Passengers and luggage weight should be placed so that the vehicle is balanced.

 **WARNING**

■ **Proper inflation is critical to save tire performance**

Keep your tires properly inflated. If the tires are not properly inflated, the following conditions may occur which could lead to an accident resulting in death or serious injury:

- Excessive wear
- Uneven wear
- Poor handling
- Possibility of blowouts resulting from overheated tires
- Air leaking from between tire and wheel
- Wheel deformation and/or tire damage
- Greater possibility of tire damage while driving (due to road hazards, expansion joints, sharp edges in the road, etc.)

**NOTICE****■ When inspecting and adjusting tire inflation pressure**

Be sure to put the tire valve caps back on. If a valve cap is not installed, dirt or moisture may get into the valve and cause an air leak, resulting in decreased tire inflation pressure.

**Wheels**

**If a wheel is bent, cracked or heavily corroded, it should be replaced. Otherwise, the tire may separate from the wheel or cause a loss of handling control.**

**Wheel selection**

When replacing wheels, care should be taken to ensure that they are equivalent to those removed in load capacity, diameter, rim width and inset\*. Replacement wheels are available at your Lexus dealer.

\*: Conventionally referred to as offset.

Lexus does not recommend using the following:

- Wheels of different sizes or types
- Used wheels
- Bent wheels that have been straightened

**■ When replacing wheels**

The wheels of your vehicle are equipped with tire pressure warning valves and transmitters that allow the tire pressure warning system to provide advance warning in the event of a loss in tire inflation pressure. Whenever wheels are replaced, tire pressure warning valves and transmitters must be installed. (→P.305)

**WARNING****■ When replacing wheels**

- Do not use wheels that are a different size from those recommended in the Owner's Manual, as this may result in a loss of handling control.

**⚠ WARNING**

- Never use an inner tube in a leaking wheel which is designed for a tubeless tire. Doing so may result in an accident, causing death or serious injury.

**■ Use of defective wheels prohibited**

Do not use cracked or deformed wheels. Doing so could cause the tire to leak air during driving, possibly causing an accident.

**⚠ NOTICE****■ Replacing tire pressure warning valves and transmitters**

- Because tire repair or replacement may affect the tire pressure warning valves and transmitters, make sure to have tires serviced by your Lexus dealer or other qualified service shop. In addition, make sure to purchase your tire pressure warning valves and transmitters at your Lexus dealer.
- Ensure that only genuine Lexus wheels are used on your vehicle. Tire pressure warning valves and transmitters may not work properly with non-genuine wheels.

**Aluminum wheel precautions**

- Use only Lexus wheel nuts and wrenches designed for use with your aluminum wheels.
- When rotating, repairing or changing your tires, check that the wheel nuts are still tight after driving 1000 miles (1600 km).
- Use only Lexus genuine balance weights or equivalent and a plastic or rubber hammer when balancing your wheels.

**Air conditioning filter**

The air conditioning filter must be changed regularly to maintain air conditioning efficiency.

**Removing the air conditioning filter**

- 1 Turn the engine switch <power switch> off.
- 2 Open the glove box.
- 3 Remove the panel.

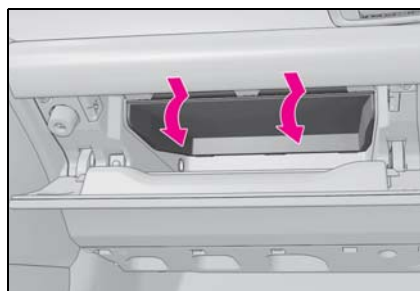

- 4 Unlock the filter cover (A), pull the filter cover out of the claws (B), and remove the filter cover.

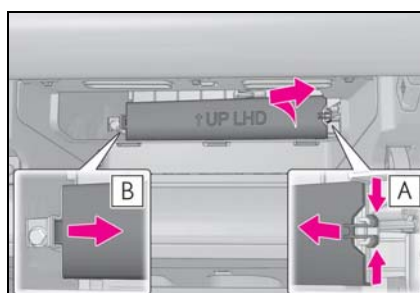



- 5 Remove the filter case.

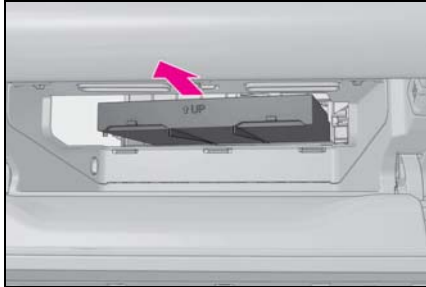

- 6 Remove the air conditioning filter from the filter case and replace it with a new one.

The “↑ UP” marks shown on the filter and the filter case should be pointing up.

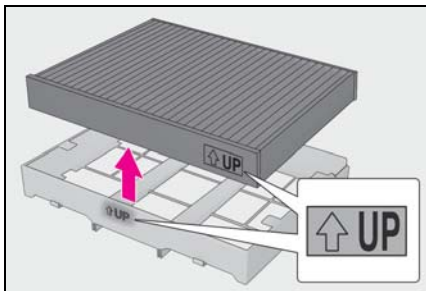

#### ■ Checking interval

Inspect and replace the air conditioning filter according to the maintenance schedule. In dusty areas or areas with heavy traffic flow, early replacement may be required. (For scheduled maintenance information, please refer to the “Owner’s Manual Supplement” or “Scheduled Maintenance”.)

#### ■ If air flow from the vents decreases dramatically

The filter may be clogged. Check the filter and replace if necessary.

#### ■ Air conditioning filter with deodorizing function

When fragrances are placed in your vehicle, the deodorizing effect may become significantly weakened in a short period. When an air conditioning odor comes out continuously, replace the air conditioning

filter.

#### ⚠ NOTICE

##### ■ When using the air conditioning system

Make sure that a filter is always installed. Using the air conditioning system without a filter may cause damage to the system.

##### ■ To prevent damage to the filter cover

When moving the filter cover in the direction of arrow to release the fitting, pay attention not to apply excessive force to the claws. Otherwise, the claws may be damaged.

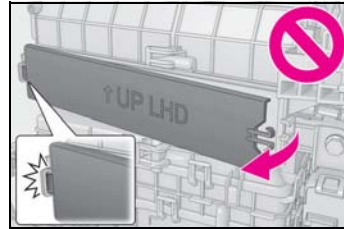

### Electronic key battery

Replace the battery with a new one if it is depleted.

#### ■ If the electronic key battery is depleted

The following symptoms may occur:

- The smart access system with push-button start and wireless remote control will not function properly.
- The operational range will be reduced.

#### ■ When the card key battery needs to be replaced (if equipped)

The battery for the card key is available only at Lexus dealers. Your Lexus dealer can replace the battery for you.

### Items to prepare

Prepare the following before replacing the battery:

- Flathead screwdriver
- Small flathead screwdriver
- Lithium battery CR2032

#### ■ Use a CR2032 lithium battery

- Batteries can be purchased at your Lexus dealer, local electrical appliance shops or camera stores.
- Replace only with the same or equivalent type recommended by the manufacturer.
- Dispose of used batteries according to the local laws.

### Replacing the battery

- 1 Take out the mechanical key.

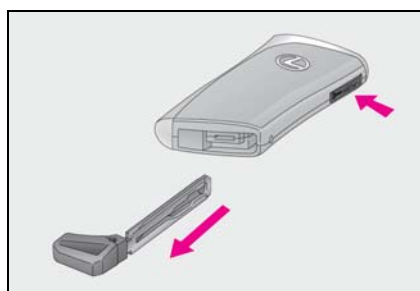

- 2 Remove the cover.

To prevent damage to the key, wrap the tip of the screwdriver with tape.

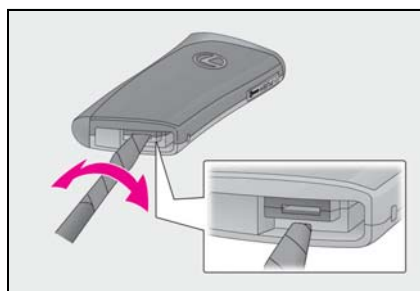

- 3 Remove the depleted battery using a small flathead screwdriver.

Insert a new battery with the "+" terminal facing up.

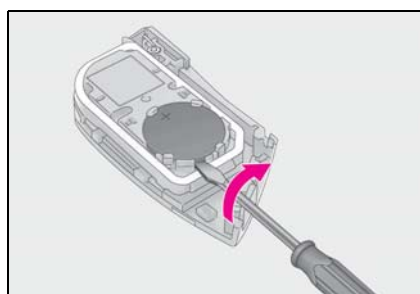

**⚠ WARNING****■ Removed battery and other parts**

These parts are small and if swallowed by a child, they can cause choking. Keep away from children. Failure to do so could result in death or serious injury.

**⚠ NOTICE****■ When replacing the battery**

Use a screwdriver of appropriate size. Applying excessive force may deform or damage the cover.

**■ For normal operation after replacing the battery**

Observe the following precautions to prevent accidents:

- Always work with dry hands. Moisture may cause the battery to rust.
- Do not touch or move any other component inside the remote control.
- Do not bend either of the battery terminals.

**Checking and replacing fuses**

**If any of the electrical components do not operate, a fuse may have blown. If this happens, check and replace the fuses as necessary.**

**Checking and replacing fuses**

- 1** Turn the engine switch <power switch> off.
- 2** Open the Fuse box cover.
  - ▶ Engine compartment: type A fuse box (LC500)

Push the tab in and lift the lid off.

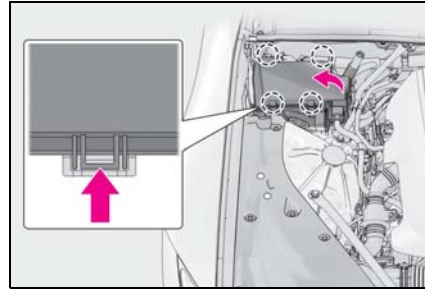

- ▶ Engine compartment: type B fuse box (LC500h)

Push the tab in and lift the lid off.

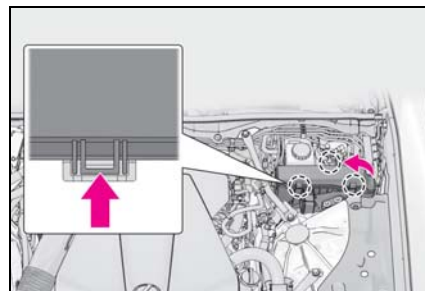

- ▶ Engine compartment: type C fuse box (LC500h)

Push the tab in and lift the lid off.

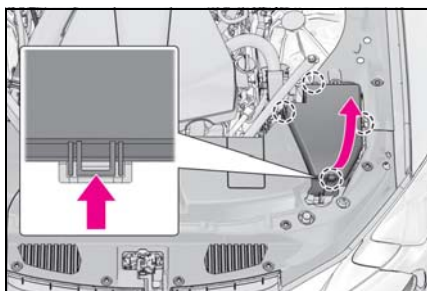

- ▶ Trunk

Remove the luggage mat.

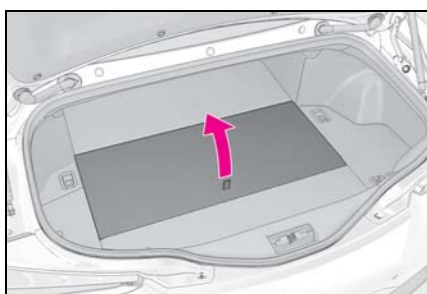

Push the tab in and lift the lid off.

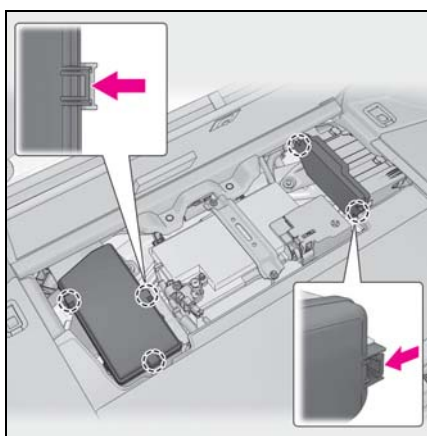

- ▶ Driver's side instrument panel

Push the tab in and remove the lid.

Make sure to push the tab in during

removal or installation.

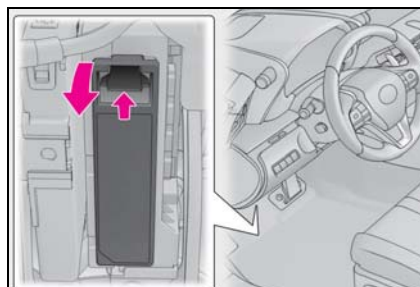

- ▶ Front passenger's side instrument panel

Remove the cover, and then remove the footwell light connector.

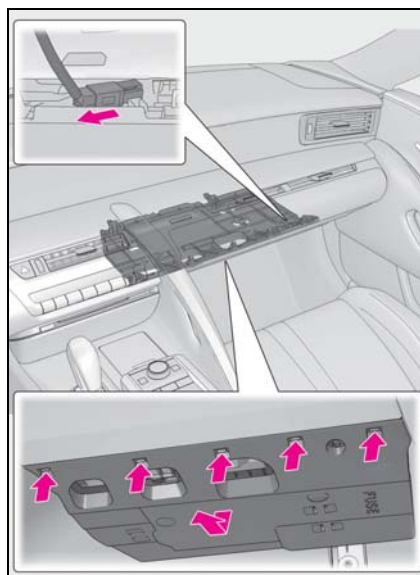

Push the tab in and remove the lid.

Make sure to push the tab in during removal or installation.

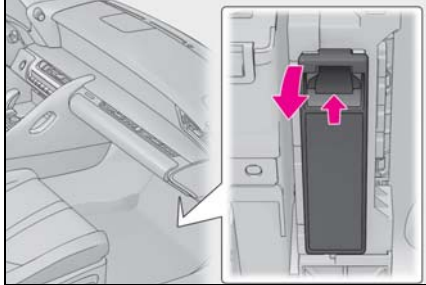

**3** Remove the fuse with the pullout tool.

Only type A fuses can be removed using the pullout tool.

▶ LC500

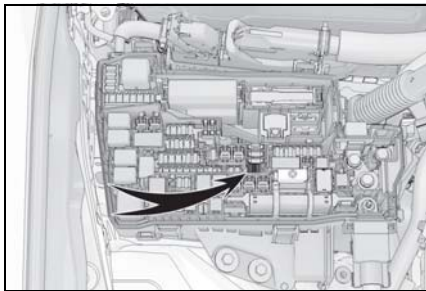

▶ LC500h

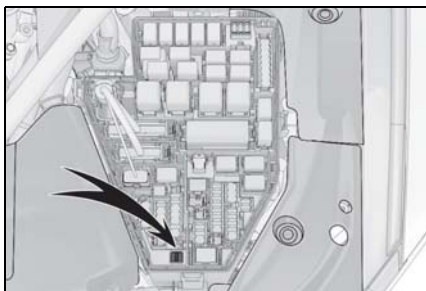

**4** Check if the fuse is blown.

Type A and B:  
Replace the blown fuse with a new fuse of an appropriate amperage rating. The amperage rating can be found on the fuse box lid.

Type C and D:  
Contact your Lexus dealer.

▶ Type A

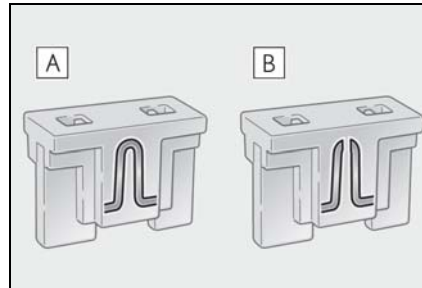

**A** Normal fuse

**B** Blown fuse

▶ Type B

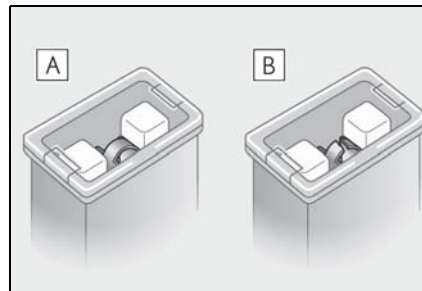

**A** Normal fuse

**B** Blown fuse

▶ Type C

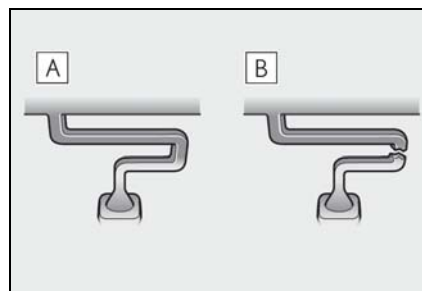

**A** Normal fuse

**B** Blown fuse

► Type D

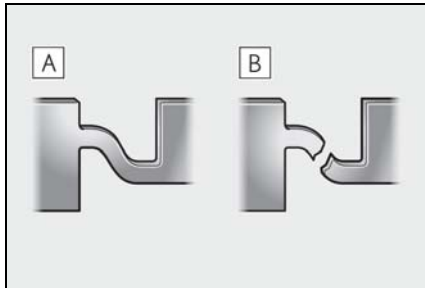

**A** Normal fuse

**B** Blown fuse

■ After a fuse is replaced

- When installing the lid, make sure that the tab is installed securely.
- If the lights do not turn on even after the fuse has been replaced, a bulb may need replacement. (→P.324)
- If the replaced fuse blows again, have the vehicle inspected by your Lexus dealer.

■ If there is an overload in a circuit

The fuses are designed to blow, protecting the wiring harness from damage.

■ When replacing light bulbs

Lexus recommends that you use genuine Lexus products designed for this vehicle. Because certain bulbs are connected to circuits designed to prevent overload, non-genuine parts or parts not designed for this vehicle may be unusable.

**! WARNING**

■ To prevent system breakdowns and vehicle fire

Observe the following precautions. Failure to do so may cause damage to the vehicle, and possibly a fire or injury.

- Never use a fuse of a higher amperage rating than that indicated, or use any other object in place of a fuse.

- Always use a genuine Lexus fuse or equivalent. Never replace a fuse with a wire, even as a temporary fix.
- Do not modify the fuses or fuse boxes.

**! NOTICE**

■ Before replacing fuses

Have the cause of electrical overload determined and repaired by your Lexus dealer as soon as possible.

## Headlight aim

### Vertical movement adjusting bolts

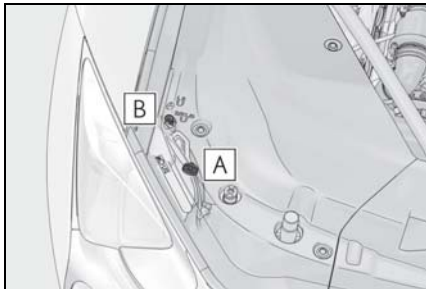

**A** Adjustment bolt A

**B** Adjustment bolt B

### Before checking the headlight aim

- Make sure the vehicle has a full tank of gasoline and the area around the headlight is not deformed.
- Park the vehicle on level ground.
- Make sure the tire inflation pressure is at the specified level.
- Have someone sit in the driver's seat.
- Bounce the vehicle several times.

### Adjusting the headlight aim

- 1** Using a Phillips-head screwdriver, turn bolt A in either direction.

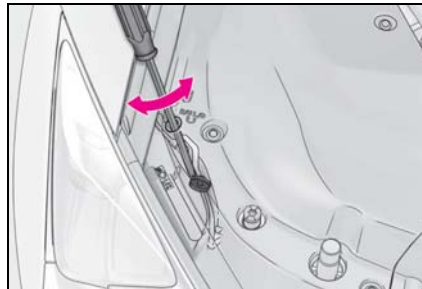

- 2** Turn bolt B in either direction as step 1.

If the headlight cannot be adjusted using this procedure, take the vehicle to your Lexus dealer to adjust the headlight aim.

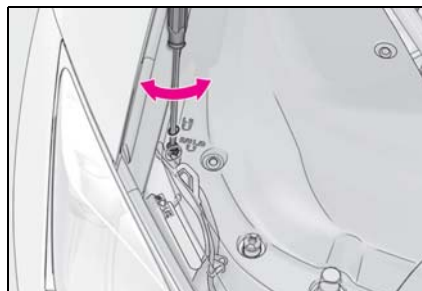

## Light bulbs

If any lights burn out, have it replaced by your Lexus dealer.

### ■ LED lights

The following lights consist of a number of LEDs. If any of the LEDs burn out, take your vehicle to your Lexus dealer to have the light replaced.

- Headlights
- Parking lights and daytime running lights
- Front side marker lights
- Front turn signal lights
- Cornering lights
- Side turn signal lights
- Tail lights
- Stop lights
- Rear side marker lights
- Rear turn signal lights
- Back-up lights
- High mounted stoplight
- License plate lights

### ■ Condensation build-up on the inside of the lens

Temporary condensation build-up on the inside of the headlight lens does not indicate a malfunction. Contact your Lexus dealer for more information in the following situations:

- Large drops of water have built up on the inside of the lens.
- Water has built up inside the headlight.

### WARNING

#### ■ Handling lights

Do not touch the lights while they are on or immediately after they have been turned off. Doing so may result in burns.



## When trouble arises

## 7

## 7-1. Essential information

Emergency flashers..... 326

If your vehicle has to be stopped in  
an emergency..... 326

If the vehicle is trapped in rising  
water..... 327

## 7-2. Steps to take in an emergency

If your vehicle needs to be towed  
..... 329

If you think something is wrong  
..... 333

Fuel pump shut off system  
(LC500)..... 334

If a warning light turns on or a  
warning buzzer sounds ..... 335

If a warning message is displayed  
..... 344

If you have a flat tire..... 350

If the engine will not start  
(LC500)..... 351

If the hybrid system will not start  
(LC500h)..... 352

If you lose your keys..... 354

If the fuel filler door cannot be  
opened..... 354

If the electronic key does not  
operate properly ..... 355

If the 12-volt battery is discharged  
..... 357

If your vehicle overheats  
(LC500)..... 364

If your vehicle overheats  
(LC500h)..... 366

If the vehicle becomes stuck 370

### Emergency flashers

The emergency flashers are used to warn other drivers when the vehicle has to be stopped in the road due to a breakdown, etc.

### Operating instructions

Press the switch to flash all of the turn signal lights.

To turn them off, press the switch once again.

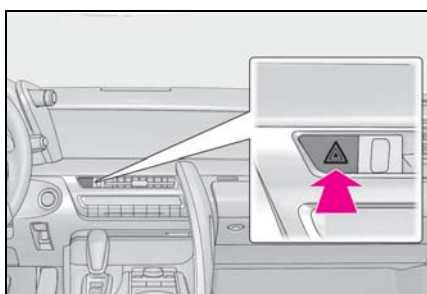

### Emergency flashers

LC500: If the emergency flashers are used for a long time while the engine is not running, the 12-volt battery may discharge.

LC500h: If the emergency flashers are used for a long time while the hybrid system is not operating (while the "READY" indicator is not illuminated), the 12-volt battery may discharge.

### If your vehicle has to be stopped in an emergency

Only in an emergency, such as if it becomes impossible to stop the vehicle in the normal way, stop the vehicle using the following procedure:

### Stopping the vehicle

- 1 Steadily step on the brake pedal with both feet and firmly depress it.

Do not pump the brake pedal repeatedly as this will increase the effort required to slow the vehicle.

- 2 Shift the shift position to N.
  - ▶ If the shift position is shifted to N
- 3 After slowing down, stop the vehicle in a safe place by the road.
- 4 Stop the engine <hybrid system>.
  - ▶ If the shift position cannot be shifted to N
- 3 Keep depressing the brake pedal with both feet to reduce vehicle speed as much as possible.
- 4 To stop the engine <hybrid system>, press and hold the engine switch <power switch> for 2 consecutive

seconds or more, or press it briefly 3 times or more in succession.

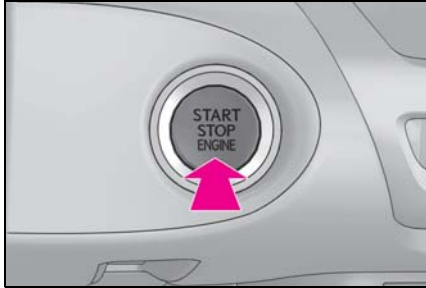

- 5 Stop the vehicle in a safe place by the road.

**! WARNING**

**■ If the engine <hybrid system> has to be turned off while driving**

Power assist for the steering wheel will be lost, making the steering wheel heavier to turn. Decelerate as much as possible before turning off the engine <hybrid system>.

**If the vehicle is trapped in rising water**

**In the event the vehicle is submerged in water, remain calm and perform the following.**

- Remove the seat belt first.
- If the door can be opened, open the door and exit the vehicle.
- If the door can not be opened, open the window using the power window switch and exit the vehicle through the window.
- If the window can not be opened using the power window switch, remain calm, wait until the water level inside the vehicle rises to the point that the water pressure inside of the vehicle equals the water pressure outside of the vehicle, and then open the door and exit the vehicle.

**! WARNING**

**■ Using an emergency hammer\* for emergency escape**

The front side windows and rear side windows, as well as the rear window can be shattered by an emergency hammer\* used for emergency escape.

However, an emergency hammer can not shatter the windshield as it is laminated glass.

\*: Contact your Lexus dealer or after-market accessory manufacturer for further information about an emergency hammer.

**WARNING****■ Escaping the vehicle from the window**

There are cases where escaping the vehicle from the window is not possible due to seating position, passenger body type, etc.

When using an emergency hammer, consider your seat location and the size of the window opening to ensure that the opening is accessible and large enough to escape.

### If your vehicle needs to be towed

If towing is necessary, we recommend having your vehicle towed by your Lexus dealer or commercial towing service, using a wheel-lift type truck or flatbed truck.

Use a safety chain system for all towing, and abide by all state/provincial and local laws.

#### WARNING

Observe the following precautions. Failure to do so may result in death or serious injury.

#### ■ When towing the vehicle

LC500: Be sure to transport the vehicle with all four wheels raised off the ground. If the vehicle is towed with the tires contacting the ground, the drivetrain and related parts may be damaged or an accident may occur due to a change in direction of the vehicle.

LC500h: Be sure to transport the vehicle with all four wheels raised off the ground. If the vehicle is towed with the tires contacting the ground, the drivetrain and related parts may be damaged, an accident may occur due to a change in direction of the vehicle or electricity generated by the operation of the motor may cause a fire to occur depending on the nature of the damage or malfunction.

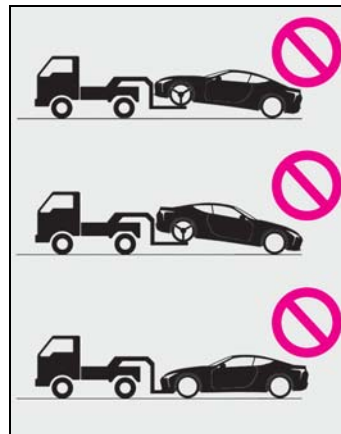

#### ■ While towing

- When towing using cables or chains, avoid sudden starts, etc. which place excessive stress on the towing eyelets, cables or chains. The towing eyelets, cables or chains may become damaged, broken debris may hit people, and cause serious damage.
- Do not turn the engine switch <power switch> off. This may lead to an accident as the rear wheels will be locked by the parking lock. Also, there is a possibility that the steering wheel is locked and cannot be operated.

**⚠ WARNING**

■ **Installing towing eyelets to the vehicle**

Make sure that towing eyelets are installed securely. If not securely installed, towing eyelets may come loose during towing.

**⚠ NOTICE**

■ **To prevent damage to the vehicle when towing using a wheel-lift type truck**

- Do not tow the vehicle from the rear when the engine switch <power switch> is off. The steering lock mechanism is not strong enough to hold the front wheels straight.
- When raising the vehicle, ensure adequate ground clearance for towing at the opposite end of the raised vehicle. Without adequate clearance, the vehicle could be damaged while being towed.

■ **To prevent damage to the vehicle when towing with a sling-type truck**

Do not tow with a sling-type truck, either from the front or rear.

■ **To prevent damage to the vehicle during emergency towing**

Do not secure cables or chains to the suspension components.

**Situations when it is not possible to be towed by another vehicle**

In the following situations, it is not possible to be towed by another vehicle using cables or chains, as the rear wheels may be locked due to the parking lock. Contact your Lexus dealer or commercial towing service.

- There is a malfunction in the shift

control system. (→P.149, 153, 347)

- There is a malfunction in the engine immobilizer system <immobilizer system>. (→P.69)
- There is a malfunction in the smart access system with push-button start. (→P.355)
- The 12-volt battery is discharged. (→P.357)

**Situations when it is necessary to contact dealers before towing**

The following may indicate a problem with your transmission. Contact your Lexus dealer or commercial towing service before towing.

- LC500: The engine is running but the vehicle does not move.
- LC500h: The hybrid system warning message is shown on the multi-information display and the vehicle does not move.
- The vehicle makes an abnormal sound.

**Towing with a sling-type truck**

Do not tow with a sling-type truck to prevent body damage.

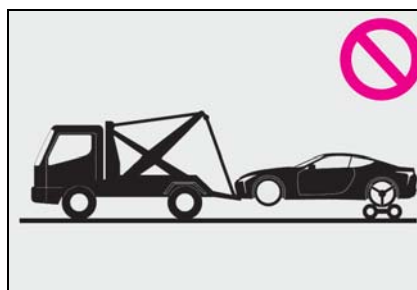

### Towing with a wheel-lift type truck

- From the front

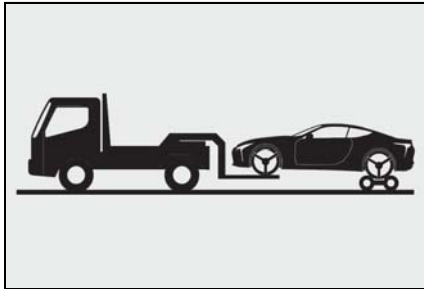

Use a towing dolly under the rear wheels.

- From the rear

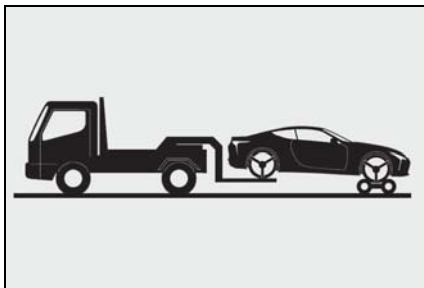

Use a towing dolly under the front wheels.

### Using a flatbed truck

If your vehicle is transported by a flatbed truck, it should be tied down at the locations shown in the illustration.

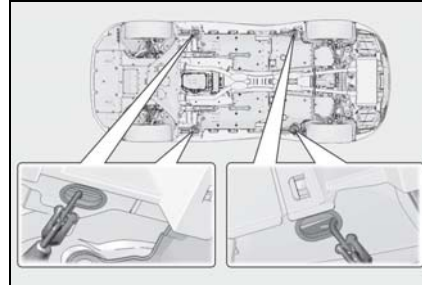

If you use chains or cables to tie down your vehicle, the angles shaded in black must be 45°.

Do not overly tighten the tie downs or the vehicle may be damaged.

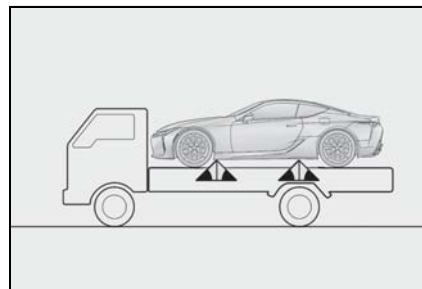

### Emergency towing

If a tow truck is not available in an emergency, your vehicle may be temporarily towed using cables or chains secured to the emergency towing eyelets. This should only be attempted on hard surfaced roads for short distances at under 18 mph (30 km/h).

A driver must be in the vehicle to steer and operate the brakes. The vehicle's wheels, drive train, axles, steering and brakes must be in good condition.

### Emergency towing procedure

To have your vehicle towed by another

vehicle, the towing eyelet must be installed to your vehicle. Install the towing eyelet using the following procedure.

- 1 Take out the screwdriver and the towing eyelet. (→P.310)
- 2 Remove the eyelet cover using a flathead screwdriver.

To protect the bodywork, place a rag between the screwdriver and the vehicle body as shown in the illustration.

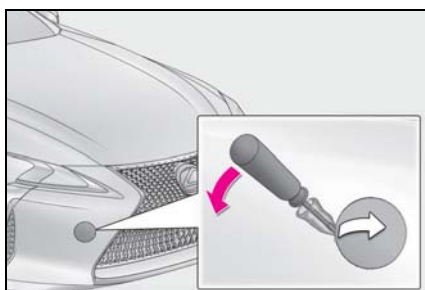

- 3 Insert the towing eyelet into the hole and tighten partially by hand.

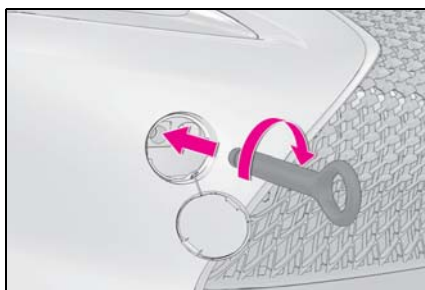

- 4 Tighten down the towing eyelet securely using the screwdriver or hard metal bar.

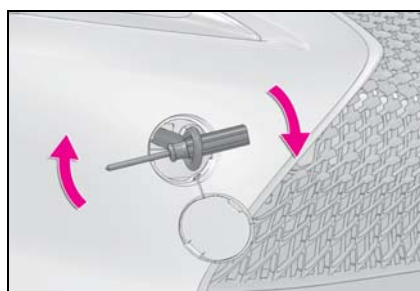

- 5 Securely attach cables or chains to the towing eyelet.

Take care not to damage the vehicle body.

- 6 Enter the vehicle being towed and start the engine <hybrid system>.

If the engine <hybrid system> does not start, turn the engine switch <power switch> to IGNITION ON mode <ON mode>.

- 7 Shift the shift position to N and release the parking brake.

#### ■ While towing

If the engine is not running <hybrid system is off>, the power assist for the brakes and steering will not function, making steering and braking more difficult.



**If you think something is wrong**

If you notice any of the following symptoms, your vehicle probably needs adjustment or repair. Contact your Lexus dealer as soon as possible.

**Visible symptoms**

- Fluid leaks under the vehicle. (Water dripping from the air conditioning after use is normal.)
- Flat-looking tires or uneven tire wear
- Engine coolant temperature gauge continually points higher than normal.

**Audible symptoms**

- Changes in exhaust sound
- Excessive tire squeal when cornering
- Strange noises related to the suspension system
- Pinging or other noises related to the engine <hybrid system>

**Operational symptoms**

- Engine missing, stumbling or running roughly
- Appreciable loss of power
- Vehicle pulls heavily to one side when braking

- Vehicle pulls heavily to one side when driving on a level road
- Loss of brake effectiveness, spongy feeling, pedal almost touches the floor

### Fuel pump shut off system (LC500)

To minimize the risk of fuel leakage when the engine stalls or when an airbag inflates upon collision, the fuel pump shut off system stops the supply of fuel to the engine.

#### Restarting the engine

Follow the procedure below to restart the engine after the system is activated.

- 1 Turn the engine switch to ACCESSORY mode or turn it off.
- 2 Restart the engine.



#### NOTICE

##### ■ Before starting the engine



Inspect the ground under the vehicle. If you find that fuel has leaked onto the ground, the fuel system has been damaged and is in need of repair. Do not restart the engine.

### If a warning light turns on or a warning buzzer sounds

Calmly perform the following actions if any of the warning lights comes on or flashes. If a light comes on or flashes, but then goes off, this does not necessarily indicate a malfunction in the system. However, if this continues to occur, have the vehicle inspected by your Lexus dealer.

#### Actions to the warning lights or warning buzzers

##### ■ Brake system warning light (warning buzzer)

Warning light	Warning light/Details/Actions
 (U.S.A.)  (red) (Canada)	Indicates that: <ul style="list-style-type: none"> <li>● The brake fluid level is low; or</li> <li>● The brake system is malfunctioning</li> </ul> This light also comes on when the parking brake is not released. If the light turns off after the parking brake is fully released the system is operating normally. <p>→ <b>Immediately stop the vehicle in a safe place and contact your Lexus dealer. Continuing to drive the vehicle may be dangerous.</b></p> <ul style="list-style-type: none"> <li>● Indicates that the brake pads are worn out (only the right-side pads can be detected)</li> </ul> <p>→ <b>Have the vehicle inspected by your Lexus dealer.</b></p>

##### ■ Charging system warning light\*

Warning light	Warning light/Details/Actions
	Indicates a malfunction in the vehicle's charging system <p>→ <b>Immediately stop the vehicle in a safe place and contact your Lexus dealer.</b></p>



\* : This light illuminates on the multi-information display.

##### ■ Low engine oil pressure warning light (warning buzzer)\*

Warning light	Warning light/Details/Actions
	Indicates that the engine oil pressure is too low <p>→ <b>Immediately stop the vehicle in a safe place and contact your Lexus dealer.</b></p>

\* : This light illuminates on the multi-information display.



■ **Malfunction indicator lamp (warning buzzer)**

Warning light	Warning light/Details/Actions
 (U.S.A.)  (Canada)	Indicates a malfunction in: <ul style="list-style-type: none"> <li>● The electronic engine control system;</li> <li>● The hybrid system (LC500h);</li> <li>● The electronic throttle control system;</li> <li>● The electronic automatic transmission control system (LC500); or</li> <li>● The electronic hybrid transmission control system (LC500h)</li> </ul> → <b>Have the vehicle inspected by your Lexus dealer immediately.</b>



■ **SRS warning light**

Warning light	Warning light/Details/Actions
	Indicates a malfunction in: <ul style="list-style-type: none"> <li>● The SRS airbag system;</li> <li>● The front passenger occupant classification system; or</li> <li>● The seat belt pretensioner system</li> </ul> → <b>Have the vehicle inspected by your Lexus dealer immediately.</b>

■ **ABS warning light (warning buzzer)**

Warning light	Warning light/Details/Actions
 (U.S.A.)  (Canada)	Indicates a malfunction in: <ul style="list-style-type: none"> <li>● The ABS; or</li> <li>● The brake assist system</li> </ul> → <b>Have the vehicle inspected by your Lexus dealer immediately.</b>

■ **Electric power steering system warning light (warning buzzer)**

Warning light	Warning light/Details/Actions
 (red) or  (yellow)	Indicates a malfunction in the EPS (Electric Power Steering) system → <b>Have the vehicle inspected by your Lexus dealer immediately.</b>

■ **PCS warning light (warning buzzer)**

Warning light	Warning light/Details/Actions
 (Flashes or illuminates)	Indicates a malfunction in the PCS (Pre-Collision System) or that the system is temporarily unavailable due to the vehicle being extremely hot/cold, or dirt around a front sensor, etc. (→ P.195, 344) → <b>Follow the instructions displayed on the multi-information display.</b> (→P.195, 344) If the PCS (Pre-Collision System) or VSC (Vehicle Stability Control) system is disabled, the PCS warning light will illuminate. → P.233

■ **LKA (Lane-Keeping Assist) indicator**\*

Warning light	Warning light/Details/Actions
 (orange)	Indicates a malfunction in the LKA (Lane-Keeping Assist) → <b>When “Lane Keeping Assist Unavailable” is displayed on the multi-information display, turn the LKA (Lane-Keeping Assist) system off, drive the vehicle for a short time, and then turn the LKA (Lane-Keeping Assist) system back on.</b> (→P.198) <b>When a message other than above is displayed, follow the instructions displayed in the message.</b>

\*: This light illuminates on the multi-information display.

■ **Slip indicator**

Warning light	Warning light/Details/Actions
	Indicates a malfunction in: <ul style="list-style-type: none"> <li>● The VSC (Vehicle Stability Control) system;</li> <li>● The TRAC (Traction Control) system; or</li> <li>● The hill-start assist control system</li> </ul> The light will flash when the VSC, TRAC or ABS system is operating. → <b>Have the vehicle inspected by your Lexus dealer immediately.</b>

■ Brake Override System warning light/Drive-Start Control warning light (warning buzzer)\*



Warning light	Warning light/Details/Actions
	<p>When the warning light flashes (and a buzzer sounds):</p> <p>Indicates a malfunction in the Brake Override System or Drive-Start Control</p> <p>→ <b>Have the vehicle inspected by your Lexus dealer immediately.</b></p> <p>Indicates that the shift position was changed while depressing the accelerator pedal and Drive-Start Control was operated</p> <p>→ <b>Momentarily release the accelerator pedal.</b></p> <p>When the warning light flashes (and a buzzer does not sound):</p> <p>Indicates that the accelerator and brake pedals are being depressed simultaneously</p> <p>→ <b>Release the accelerator pedal and depress the brake pedal.</b></p>

\*: This light illuminates on the multi-information display.

■ Brake hold operated indicator

Warning light	Warning light/Details/Actions
 <p>(flashes)</p>	<p>Indicates a malfunction in the brake hold system</p> <p>→ <b>Have the vehicle inspected by your Lexus dealer.</b></p>

■ Parking brake indicator

Warning light	Warning light/Details/Actions
 <p>(flashes) (U.S.A.) or</p>  <p>(flashes) (Canada)</p>	<p>Indicates a malfunction in the parking brake system</p> <p>→ <b>Have the vehicle inspected by your Lexus dealer immediately.</b></p>

### ■ Brake system warning light

Warning light	Warning light/Details/Actions
 (yellow)	Indicates a malfunction in: <ul style="list-style-type: none"> <li>● The electronically controlled brake system</li> <li>● The regenerated braking system (LC500h)</li> <li>● The parking brake system</li> </ul> → <b>Have the vehicle inspected by your Lexus dealer immediately.</b>

### ■ Low fuel level warning light

Warning light	Warning light/Details/Actions
	Indicates that remaining fuel is approximately 3.3 gal. [12.6 L, 2.8 Imp.gal.] or less → <b>Refuel the vehicle.</b>

### ■ Driver's and front passenger's seat belt reminder light (warning buzzer)\*

Warning light	Warning light/Details/Actions
	Warns the driver and/or front passenger to fasten their seat belts → <b>Fasten the seat belt.</b> <b>If the front passenger's seat is occupied, the front passenger's seat belt also needs to be fastened to make the warning light (warning buzzer) turn off.</b>

\* : Driver's seat belt buzzer:

The driver's seat belt buzzer sounds to alert the driver that his or her seat belt is not fastened. Once the engine switch <power switch> is turned to IGNITION ON mode <ON mode>, the buzzer sounds for 6 seconds. If the vehicle reaches a speed of 12 mph (20 km/h), the buzzer sounds once. If the seat belt is still unfastened after 24 seconds, the buzzer will sound intermittently for 6 seconds. Then, if the seat belt is still unfastened, the buzzer will sound in a different tone for 90 more seconds.

Front passenger's seat belt buzzer:

The front passenger's seat belt buzzer sounds to alert the front passenger that his or her seat belt is not fastened. The buzzer sounds once if the vehicle reaches a speed of 12 mph (20 km/h). If the seat belt is still unfastened after 24 seconds, the buzzer will sound intermittently for 6 seconds. Then, if the seat belt is still unfastened, the buzzer will sound in a different tone for 90 more seconds.

■ Rear passengers' seat belt reminder lights (warning buzzer<sup>\*1</sup>)\*<sup>2</sup>

Warning light	Warning light/Details/Actions
	Warns the rear passengers to fasten their seat belts → <b>Fasten the seat belt.</b>

\*1: Rear passenger's seat belt buzzer:

The rear passenger's seat belt buzzer sounds to alert the rear passenger that his or her seat belt is not fastened. The buzzer sounds for 6 seconds if the vehicle reaches a speed of 12 mph (20 km/h). Then, if the seat belt is still unfastened, the buzzer will sound in a different tone for 24 more seconds.

\*2: This light illuminates on the center panel.

■ Master warning light (warning buzzer)

Warning light	Warning light/Details/Actions
	A buzzer sounds and the warning light comes on and flashes to indicate that the master warning system has detected a malfunction. → P.344

■ Tire pressure warning light

Warning light	Warning light/Details/Actions
	When the light comes on: Low tire inflation pressure such as ● Natural causes (→P.342) ● Flat tire (→P.350) → <b>Adjust the tire inflation pressure to the specified level.</b> <b>The light will turn off after a few minutes. In case the light does not turn off even if the tire inflation pressure is adjusted, have the system checked by your Lexus dealer.</b>  When the light comes on after blinking for 1 minute: Malfunction in the tire pressure warning system → <b>Have the system checked by your Lexus dealer.</b>

■ High coolant temperature warning light (warning buzzer)<sup>\*</sup>

Warning light	Warning light/Details/Actions
	Changes from a flashing to a solid light when the engine coolant temperature increases → <b>Immediately stop the vehicle in a safe place.</b> <b>Handling method. (→P.364, 366)</b>



\*: This light illuminates on the multi-information display.

### ■ Hybrid system overheat warning light (warning buzzer)\* (LC500h)

Warning light	Warning light/Details/Actions
	<p>Indicates that the hybrid system has overheated</p> <p>This light may be displayed when driving under severe operating conditions. (For example, when driving up a long steep hill.)</p> <p>→ <b>Stop the vehicle in a safe place and the hybrid system.</b> (→P.366)</p>

\*: This light illuminates on the multi-information display.

### ■ SRS warning light

This warning light system monitors the airbag sensor assembly, front impact sensors, side impact sensors (door), side impact sensors (front), side impact sensors (rear), driver's seat position sensor, driver's seat belt buckle switch, front passenger occupant classification system (ECU and sensors), "AIR BAG ON" indicator light, "AIR BAG OFF" indicator light, front passenger's seat belt buckle switch, seat belt pretensioners, airbags, interconnecting wiring and power sources. (→P.29)

### ■ Front passenger detection sensor, seat belt reminder and warning buzzer

If luggage is placed on the front passenger seat, the front passenger detection sensor may cause the warning light to flash and the warning buzzer to sound even if a passenger is not sitting in the seat.

### ■ If the malfunction indicator lamp comes on while driving

First check the following:

- Is the fuel tank empty?  
If it is, fill the fuel tank immediately.
- Is the fuel tank cap loose?  
If it is, tighten it securely.

The light will go off after several driving trips.

If the light does not go off even after several trips, contact your Lexus dealer as soon as possible.

### ■ Electric power steering system warning light (warning buzzer)

When the 12-volt battery charge becomes insufficient or the voltage temporarily drops, the electric power steering system warning light may come on and the warning buzzer may sound.

### ■ Tire pressure warning light

When a malfunction occurs in the tire pressure warning system, the tire pressure warning light blinks to warn the driver. However, if the warning light blinks for 1 minute, and then remains illuminated, making it difficult to determine whether the warning light is blinking, turn the engine switch <power switch> from off to IGNITION ON mode <ON mode> and check if the warning light blinks.

### ■ When the tire pressure warning light comes on

Check the tire inflation pressure and adjust to the appropriate level. Pushing the tire pressure warning reset switch will not turn off the tire pressure warning light.

■ **The tire pressure warning light may come on due to natural causes**

The tire pressure warning light may come on due to natural causes such as natural air leaks and tire inflation pressure changes caused by temperature. In this case, adjusting the tire inflation pressure will turn off the warning light (after a few minutes).

■ **Conditions that the tire pressure warning system may not function properly**

→P.304

■ **If the tire pressure warning light frequently comes on after blinking for 1 minute**

If the tire pressure warning light frequently comes on after blinking for 1 minute when the engine switch <power switch> is turned to IGNITION ON mode <ON mode>, have it checked by your Lexus dealer.

■ **Warning buzzer**

In some cases, the buzzer may not be heard due to being in a noisy location or audio sound.

■ **Customization**

The vehicle speed linked seat belt reminder buzzer can be disabled.  
(Customizable features: →P.391)



**WARNING**

■ **If both the ABS and the brake system warning lights remain on**

Stop your vehicle in a safe place immediately and contact your Lexus dealer. The vehicle will become extremely unstable during braking, and the ABS system may fail, which could cause an accident resulting in death or serious injury.

■ **When the electric power steering system warning light comes on**

When the light comes on in yellow, the assist to the power steering is restricted. When the light comes on red, the assist to the power steering is lost and handling operations of the steering wheel become extremely heavy. When steering wheel operations are heavier than usual, grip the steering wheel firmly and operate it using more force than usual.

■ **If the tire pressure warning light comes on**

Be sure to observe the following precautions. Failure to do so could cause a loss of vehicle control and result in death or serious injury.

● Decelerate to the lowest appropriate speed as soon as possible. Do not drive over 50 mph (80 km/h).

● Check and adjust the tire inflation pressure immediately.

● If the tire pressure warning light comes on even after tire inflation pressure adjustment, it is probable that you have a flat tire. Have the flat tire replaced by the nearest Lexus dealer.

● Avoid abrupt maneuvering and braking. If the vehicle tires deteriorate, you could lose control of the steering wheel or the brakes.

■ **If a blowout or sudden air leakage should occur**

The tire pressure warning system may not activate immediately.

 **WARNING****■ Maintenance of the tires**

Each tire, including the spare (if provided), should be checked monthly when cold and inflated to the inflation pressure recommended by the vehicle manufacturer on the vehicle placard or tire inflation pressure label (tire and load information label). (If your vehicle has tires of a different size than the size indicated on the vehicle placard or tire inflation pressure label [tire and load information label], you should determine the proper tire inflation pressure for those tires.)

As an added safety feature, your vehicle has been equipped with a tire pressure monitoring system (TPMS-tire pressure warning system) that illuminates a low tire pressure telltale (tire pressure warning light) when one or more of your tires is significantly under-inflated. Accordingly, when the low tire pressure telltale (tire pressure warning light) illuminates, you should stop and check your tires as soon as possible, and inflate them to the proper pressure. Driving on a significantly under-inflated tire causes the tire to overheat and can lead to tire failure. Under-inflation also reduces fuel efficiency and tire tread life, and may affect the vehicle's handling and stopping ability.

Please note that the TPMS (tire pressure warning system) is not a substitute for proper tire maintenance, and it is the driver's responsibility to maintain correct tire pressure, even if under-inflation has not reached the level to trigger illumination of the TPMS low tire pressure telltale (tire pressure warning light).

Your vehicle has also been equipped with a TPMS (tire pressure warning system) malfunction indicator to indicate when the system is not operating properly. The TPMS (tire pressure warning system) malfunction indicator is combined with the low tire pressure telltale (tire pressure warning light). When the system detects a malfunction, the telltale will flash for approximately one minute and then remain continuously illuminated. This sequence will continue upon subsequent vehicle start-ups as long as the malfunction exists. When the malfunction indicator is illuminated, the system may not be able to detect or signal low tire pressure as intended.

TPMS (tire pressure warning system) malfunctions may occur for a variety of reasons, including the installation of replacement or alternate tires or wheels on the vehicle that prevent the TPMS (tire pressure warning system) from functioning properly. Always check the TPMS (tire pressure warning system) malfunction telltale after replacing one or more tires or wheels on your vehicle to ensure that the replacement or alternate tires and wheels allow the TPMS (tire pressure warning system) to continue to function properly.

 **NOTICE****■ To ensure the tire pressure warning system operates properly**

Do not install tires with different specifications or makers, as the tire pressure warning system may not operate properly.

**If a warning message is displayed**

The multi-information display shows warnings of system malfunctions, incorrectly performed operations, and messages that indicate a need for maintenance. When a message is shown, perform the correction procedure appropriate to the message.

When the main meter is in the center position:

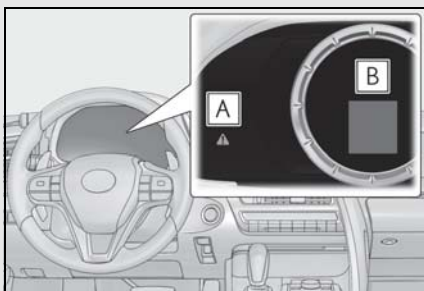

**A** Master warning light

The master warning light also comes on or flashes in order to indicate that a message is currently being displayed on the multi-information display.

**B** Multi-information display

Follow the instructions of the message on the multi-information display. If any of the warning message is shown again after the following actions have been performed, contact your Lexus dealer.

When the main meter is in the side position:

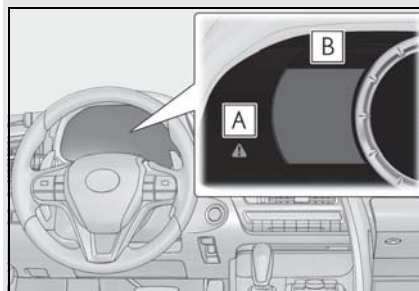

**A** Master warning light

The master warning light also comes on or flashes in order to indicate that a message is currently being displayed on the multi-information display.

**B** Multi-information display

Follow the instructions of the message on the multi-information display. If any of the warning message is shown again after the following actions have been performed, contact your Lexus dealer.

### Messages and warnings

The warning lights and warning buzzers operate as follows depending on the content of the message. If a message indicates the need for inspection by a dealer, have the vehicle inspected by your Lexus dealer immediately.

	System warning light	Warning buzzer *	Warning
Comes on	Comes on	Sounds	Indicates an important situation, such as when a system related to driving is malfunctioning or that danger may result if the correction procedure is not performed
Comes on	—	Sounds	
—	Comes on or flashes	Sounds	Indicates an important situation, such as when the systems shown on the multi-information display may be malfunctioning
Flashes	—	Sounds	Indicates a situation, such as when damage to the vehicle or danger may result
Comes on	—	Does not sound	Indicates a condition, such as malfunction of electrical components, their condition, or indicates the need for maintenance
Flashes	—	Does not sound	Indicates a situation, such as when an operation has been performed incorrectly, or indicates how to perform an operation correctly

\* : A buzzer sounds the first time a message is shown on the multi-information display.

#### ■ Warning messages

The warning messages explained below may differ from the actual messages according to operation conditions and vehicle specifications.

#### ■ System warning lights

The master warning light does not come on or flash in the following cases. Instead, a separate system warning light will come on along with a message or image shown on the multi-information display.

- Malfunction in the ABS

The ABS warning light comes on. (→P.336)

- Malfunction in the charging system

The charging system warning light comes on. (→P.335)

- Malfunction in the brake system

The brake system warning light comes on. (→P.335)

## 346 7-2. Steps to take in an emergency

---

- Malfunction in the EPS (Electric Power Steering) system

The electric power steering system warning light comes on. (→P.336)

- Malfunction in the tire pressure warning system

The tire pressure warning light comes on. (→P.340)

- Remaining fuel level is low

The low fuel level warning light comes on. (→P.339)

### ■ If “Hybrid System Overheated Reduced Output Power” is shown (LC500h)

This message may be displayed when driving under severe operating conditions. (For example, when driving up a long steep hill.) Stop and check. (→P.366)

### ■ If “Traction Battery Needs to be Protected Refrain from the Use of N Position” is shown (LC500h)

This message may be displayed when the shift position is in N.

As the hybrid battery (traction battery) cannot be charged when the shift position is in N, shift the shift position to P when the vehicle is stopped.

### ■ If “Traction Battery needs to be Protected Shift into P to Restart” is shown (LC500h)

This message is displayed when the hybrid battery (traction battery) charge has become extremely low because the vehicle has been left with the N shift position selected for a certain amount of time.

When operating the vehicle, shift to P and restart the hybrid system.

### ■ If “Shift to P Before Exiting Vehicle” is shown

The driver’s door is opened without turning the engine switch <power switch> to off with the shift lever in any position other than P. Shift the shift position to P.

### ■ If “Shift Is in N Release Accelerator Before Shifting” is shown

The accelerator pedal has been depressed when the shift position is in N. Release the accelerator pedal and shift the shift position to D or R.

### ■ If “Depress Brake when Vehicle Is Stopped Hybrid System May Overheat” is shown (LC500h)

The message may be displayed when the accelerator pedal is depressed to hold the vehicle while the vehicle is stopped on an uphill etc. The hybrid system may overheat. Release the accelerator pedal and depress the brake pedal.

### ■ If “Shift system malfunction Driving unavailable” is shown

There is a malfunction in the shift control system. Have the vehicle inspected by your Lexus dealer immediately.

### ■ If “Auto Power Off to Conserve Battery” is shown

LC500:

Power was turned off due to the automatic power off function. Next time when starting the engine, increase the engine speed slightly and maintain that level for approximately 5 minutes to recharge the battery.

LC500h:

Power was turned off due to the automatic power off function. Next time when starting the hybrid system, operate the hybrid system for approximately 5 minutes to recharge the 12-volt battery.

■ **If a message that indicates the need for the shift lever operation is shown**

To prevent the shift lever from being operated incorrectly or the vehicle from moving unexpectedly, a message that requires shifting the shift lever may be shown on the multi-information display. In that case, follow the instruction of the message and shift the shift lever.

■ **If “Front Camera Unavailable” or “Front Camera Unavailable Remove Debris On Windshield” is shown**

The following systems may be suspended until the problem shown in the message is resolved. (→P.195, 344)

- PCS (Pre-Collision system)
- LKA (Lane-Keeping Assist)
- Dynamic radar cruise control with full-speed range
- Automatic High Beam

■ **If “Engine Stopped Steering Power Low” (LC500) or “Hybrid System Stopped Steering Power Low” (LC500h) is shown**

The steering wheel may become extremely heavy. If the steering wheel becomes heavier than usual when operating, hold firmly and operate using more force than usual.

■ **If “Warming Up Maximum Vehicle Speed: 65MPH” is shown (LC500h)**

The transmission is being warmed up and the vehicle is unable to be driven over 65 mph (110 km/h). Wait until the transmission warms up.

■ **If “Stop the vehicle in a safe place Shift to P position” is shown (LC500h)**

There may be a malfunction in the hybrid system or the shift position may be shifted to N for a long time. Immediately stop the vehicle and contact your Lexus dealer.

■ **If “Oil Maintenance Required Soon” is shown (LC500h)**

The engine oil is scheduled to be changed. Check the engine oil, and change if necessary. After changing the engine oil, the message should be reset. (→P.283)

■ **If “Maintenance Required Soon” is shown**

Indicates that all maintenance according to the driven distance on the maintenance schedule\* should be performed soon. The message is shown approximately 4500 miles (7200 km) after the message has been reset. If necessary, perform maintenance.

\*: Refer to the separate “Scheduled Maintenance” or “Owner’s Manual Supplement” for the maintenance interval applicable to your vehicle.

■ **If “Engine Oil Level Low Add or Replace” is shown**

The engine oil level is low. Check the level of engine oil, and add if necessary. This message may appear if the vehicle is stopped on a slope. Move the vehicle to a level surface and check to see if the message disappears.

■ **If a message that indicates the need for referring to Owner’s Manual is shown**

- If any of the following messages is shown on the multi-information display, follow the instructions.
  - “Engine Coolant Temp High” (→P.364, 366)
  - “Battery low” (→P.357)
  - “Transmission Fluid Temp High” (→P.156, 162)
- If any of the following messages is shown on the multi-information display, it may indicate a malfunction. Have the vehicle inspected by your Lexus dealer immediately.

- “Access System with Elec. Key Malfunction”
- “Shift system malfunction”
- “P switch malfunction”
- “Shift system unavailable”
- If any of the following messages is shown on the multi-information display, it may indicate a malfunction in a system or part. Immediately have the vehicle inspected by your Lexus dealer.
  - “Hybrid System Malfunction” (LC500h)
  - “Check Engine”
  - “Hybrid Battery System Malfunction” (LC500h)
  - “Accelerator System Malfunction”
  - “Hybrid system stopped” (LC500h)
  - “Engine stopped”(LC500h)
- If any of the following messages is shown on the multi-information display, it may indicate a malfunction. Immediately stop the vehicle and contact your Lexus dealer.
  - “Braking Power Low”
  - “Charging System Malfunction”
  - “Oil Pressure Low”
- If “Aux Battery Low” is shown, observe the following. (LC500h)
  - If the message disappears in a few minutes<sup>\*</sup>  
Keep the hybrid system operating for more than approximately 15 minutes to charge the 12-volt battery.
  - If the message does not disappear  
Refer to “If the 12-volt battery is discharged” (→P.357) to start the hybrid system

\* : It is displayed for approximately 6 seconds.

- If “Battery low” is shown, the 12-volt battery charge is insufficient. Recharge or replace the 12-volt battery.
- If “Maintenance Required for Traction battery Cooling Parts” is shown, the filters may be clogged, the air intake vents may be blocked, or there may be a gap in the duct. Therefore, perform the following correction procedure. (LC500h)
  - If the air intake vents and filters of the hybrid battery (traction battery) are dirty, perform the procedure on P.279 to clean them.
  - If the warning message is shown when the air intake vents and filters of the hybrid battery (traction battery) are not dirty, have the vehicle inspected by your Lexus dealer.

■ **If a message that indicates the need for visiting your Lexus dealer is shown**

The system or part shown on the multi-information display is malfunctioning. Have the vehicle inspected by your Lexus dealer immediately.

■ **Warning buzzer**

In some cases, the buzzer may not be heard due to being in a noisy location or audio sound.

 NOTICE
<p>■ <b>While the engine oil level warning message is displayed</b> Continued engine operation with low engine oil will damage the engine.</p>





## NOTICE

**■ If “High Power Consumption Partial Limit On AC/Heater Operation” is shown frequently**

Air conditioning, heater and other operations are temporarily limited due to high power consumption. Turn off unnecessary electronic equipment to reduce power consumption, and wait until the power supply returns to normal. If this message is frequently displayed, have the vehicle inspected at your Lexus dealer.

**■ If “Aux Battery Low See Owner’s Manual” is shown frequently (LC500h)**

The 12-volt battery may deteriorate. As it may cause the 12-volt battery discharge, have the 12-volt battery inspected by your Lexus dealer.

### If you have a flat tire

Your vehicle is not equipped with a spare tire, but instead you can continue driving the vehicle with run-flat tires even if any tire goes flat.

In this case, slow down and drive with extra caution.

### Run-flat tires

Take your vehicle to the nearest Lexus dealer or authorized tire dealer as soon as possible if any tire goes flat.

The vehicle can be driven for a maximum of 100 miles (160 km) at a speed below 50 mph (80 km/h) after the tire pressure warning light comes on. (→P.340)

A run-flat tire has a  mark on the sidewall.

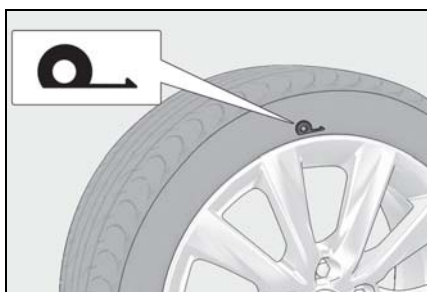

#### ■ In some condition (such as at high temperatures)

You cannot continue driving for up to 100 miles (160 km).

#### ■ For the detailed information on run-flat tires

See the tire warranty booklet.

### NOTICE

#### ■ When replacing the tires

When removing or fitting the wheels, tires or the tire pressure warning valve and transmitter, contact your Lexus dealer as the tire pressure warning valve and transmitter may be damaged if not handled correctly.

#### ■ When driving over bumps

If a vehicle has a flat tire, the vehicle height will be lower than usual. Ensure that nothing strikes the bottom of the vehicle.

#### ■ To avoid damaging the tire pressure warning valves and transmitters

When a tire is repaired with liquid sealants, the tire pressure warning valve and transmitter may not operate properly. If a liquid sealant is used, contact your Lexus dealer or other qualified service shop as soon as possible. Make sure to replace the tire pressure warning valve and transmitter when replacing the tire. (→P.305)

### If the engine will not start (LC500)

If the engine will not start even though correct starting procedures are being followed (→P.146), consider each of the following points:

#### The engine will not start even though the starter motor operates normally.

One of the following may be the cause of the problem:

- The electronic key may not be functioning properly. (→P.356)
- There may not be sufficient fuel in the vehicle's tank.  
Refuel the vehicle. (→P.182)
- The engine may be flooded.  
Try to restart the engine again following correct starting procedures. (→P.146)
- There may be a malfunction in the engine immobilizer system. (→P.69)
- There may be a malfunction in the shift control system.\* (→P.149)
- There may be a malfunction in the steering lock system.

\*: It may not be possible to shift the shift position other than P.

#### The starter motor turns over slowly, the interior lights and headlights are dim, or the horn does not sound or sounds at a low volume.

One of the following may be the cause of the problem:

- The 12-volt battery may be discharged. (→P.357)
- The 12-volt battery terminal connections may be loose or corroded. (→P.301)

#### The starter motor does not turn over

The engine starting system may be malfunctioning due to an electrical problem such as electronic key battery depletion or a blown fuse. However, an interim measure is available to start the engine.

#### The starter motor does not turn over, the interior lights and headlights do not turn on, or the horn does not sound.

One of the following may be the cause of the problem:

- One or both of the 12-volt battery terminals may be disconnected. (→P.301)
- The 12-volt battery may be discharged. (→P.357)
- There may be a malfunction in the steering lock system.

Contact your Lexus dealer if the problem cannot be repaired, or if repair procedures are unknown.

### Starting the engine in an emergency

When the engine does not start, the following steps can be used as an interim measure to start the engine if the engine switch is functioning normally:

- 1 Press the parking brake switch to check that the parking brake is set. (→P.168)

Parking brake indicator will come on.

- 2 Turn the engine switch to ACCESSORY mode.
- 3 Press and hold the engine switch for about 15 seconds while depressing the brake pedal firmly.

Even if the engine can be started using the above steps, the system may be malfunctioning. Have the vehicle inspected by your Lexus dealer.

### If the hybrid system will not start (LC500h)

Reasons for the hybrid system not starting vary depending on the situation. Check the following and perform the appropriate procedure:

### The hybrid system will not start even though the correct starting procedure is being followed. (→P.149)

One of the following may be the cause of the problem:

- The electronic key may not be functioning properly. (→P.356)
- There may not be sufficient fuel in the vehicle's tank. Refuel the vehicle. (→P.182)
- There may be a malfunction in the immobilizer system. (→P.69)
- There may be a malfunction in the shift control system. \* (→P.153)
- There may be a malfunction in the steering lock system.
- The hybrid system may be malfunctioning due to an electrical problem such as electronic key battery depletion or a blown fuse. However, depending on the type of malfunction, an interim measure is available to start the hybrid system.

\* : It may not be possible to shift the shift position other than P.

**The interior lights and headlights are dim, or the horn does not sound or sounds at a low volume.**

One of the following may be the cause of the problem:

- The 12-volt battery may be discharged. (→P.357)
- The 12-volt battery terminal connections may be loose or corroded. (→P.301)

**The interior lights and headlights do not turn on, or the horn does not sound.**

One of the following may be the cause of the problem:

- The 12-volt battery may be discharged. (→P.357)
- One or both of the 12-volt battery terminals may be disconnected. (→P.301)

Contact your Lexus dealer if the problem cannot be repaired, or if repair procedures are unknown.

**Starting the hybrid system in an emergency**

When the hybrid system does not start, the following steps can be used as an interim measure to start the hybrid system if the power switch is functioning normally.

Do not use this starting procedure except in cases of emergency.

- 1** Press the parking brake switch to check that the parking brake is set. (→P.168)

Parking brake indicator will come on.

- 2** Turn the power switch to ACCESSORY mode.
- 3** Press and hold the power switch for about 15 seconds while depressing the brake pedal firmly.

Even if the hybrid system can be started using the above steps, the system may be malfunctioning. Have the vehicle inspected by your Lexus dealer.

### If you lose your keys

New genuine mechanical keys can be made by your Lexus dealer using another mechanical key and the key number stamped on your key number plate. Keep the plate in a safe place such as your wallet, not in the vehicle.

 NOTICE

■ **When an electronic key is lost**

If the electronic key remains lost, the risk of vehicle theft increases significantly. Visit your Lexus dealer immediately with all remaining electronic keys and the card key that were provided with your vehicle.

### If the fuel filler door cannot be opened

#### LC500:

If the fuel filler door opener switch cannot be operated, the following procedure can be used to open the fuel filler door.

#### LC500h:

If the fuel filler door opener switch cannot be operated, contact your Lexus dealer to service the vehicle. In case where refueling is urgently necessary, the following procedure can be used to open the fuel filler door.

### Opening the fuel filler door

- 1 Remove the cover in the center of the rear seat. (→P.357)
- 2 Pull the tab.

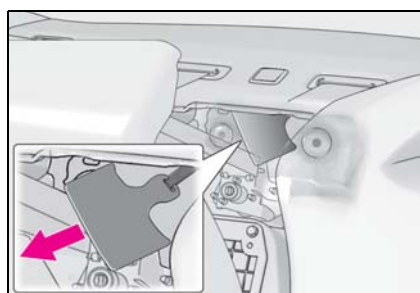

LC500h: Using the tab to open the fuel filler door may not allow for an adequate reduction in fuel tank pressure before refueling. To prevent fuel from spilling out, turn the cap slowly when removing it. During refueling, fuel may spill out from

the filler opening due to air being discharged from inside the fuel tank. Therefore, fill the fuel tank carefully and slowly.

### WARNING

#### ■ After opening the fuel filler door

Make sure to put back the cover to the center of the rear seat. Failure to do so may cause an accident.

### NOTICE

#### ■ After opening the fuel filler door

- Secure the tab in its original position.
- Install the tab so that it does not cover the clip installation position **A**. Failure to do so may cause damage to the clip and make it impossible to install the cover.

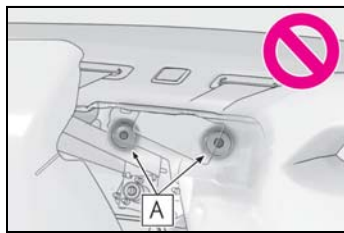

### If the electronic key does not operate properly

If communication between the electronic key and vehicle is interrupted (→P.115) or the electronic key cannot be used because the battery is depleted, the smart access system with push-button start and wireless remote control cannot be used. In such cases, the doors and trunk can be opened and the engine <hybrid system> can be started by following the procedure below.

#### ■ When the electronic key does not work properly

- Make sure that the smart access system with push-button start has not been deactivated using the Remote Touch or at your Lexus dealer. If it is off, turn the function on.
- Check if battery-saving mode is set. If it is set, cancel the function. (→P.115)

### NOTICE

#### ■ In case of a smart access system with push-button start malfunction or other key-related problems

Take your vehicle with all the electronic keys (including the card key) provided with your vehicle to your Lexus dealer as soon as possible.

### Locking and unlocking the doors, opening the trunk and using the key linked functions

Use the mechanical key (→P.104) in order to perform the following operations:

■ Locking and unlocking the door

- 1 Push in the depression on the front edge of the driver's door handle.
- 2 Insert the mechanical key while pulling on the driver's door handle.

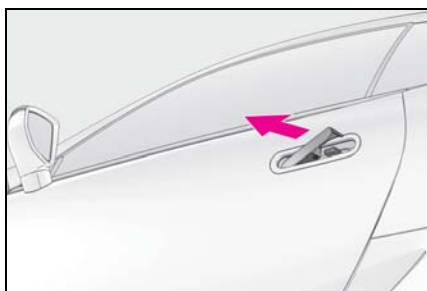

- 3 Turn the key in order to perform the following operations.

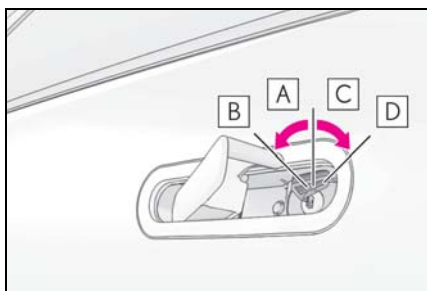

- A** Locks both side doors
- B** Closes the windows (turn and hold)\*
- C** Unlocks the door
- D** Opens the windows (turn and hold)\*

Turning the key rearward unlocks the driver's door. Turning the key once again within 5 seconds unlocks the other door.

- D** Opens the windows (turn and hold)\*

\*: These settings must be customized at your Lexus dealer.

■ Opening the trunk

Unlock the doors, and press the trunk opener switch.

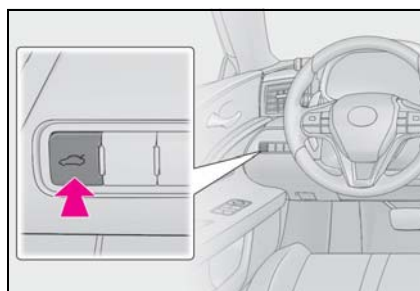

**! WARNING**

■ When using the mechanical key and operating the power windows

Operate the power window after checking to make sure that there is no possibility of any passenger having any of their body parts caught in the window. Also, do not allow children to operate the mechanical key. It is possible for children and other passengers to get caught in the power window.

**Starting the engine <hybrid system>**

- 1 Depress the brake pedal.
- 2 Touch the Lexus emblem side of the electronic key to the engine switch <power switch>.

When the electronic key is detected, a buzzer sounds and the engine switch <power switch> will turn to IGNITION ON mode <ON mode>.

When the smart access system with push-button start is deactivated in customization setting, the engine switch <power switch>



will turn to ACCESSORY mode.

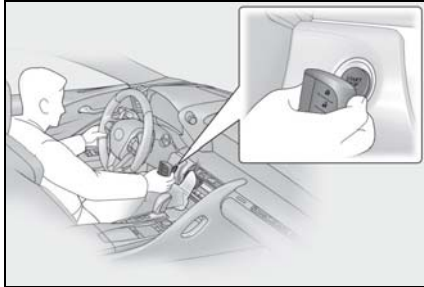

- 3 Firmly depress the brake pedal and check that  is shown on the multi-information display.
- 4 Press the engine switch <power switch>.

In the event that the engine <hybrid system> still cannot be started, contact your Lexus dealer.

#### ■ Stopping the engine <hybrid system>

Set the parking brake, shift the shift position to P and press the engine switch <power switch> as you normally do when stopping the engine <hybrid system>.

#### ■ Electronic key battery

As the above procedure is a temporary measure, it is recommended that the electronic key battery be replaced immediately when the battery is depleted. (→P.318)

#### ■ Changing engine switch <power switch> modes

Release the brake pedal and press the engine switch <power switch> in step 3 above.

The engine <hybrid system> does not start and modes will be changed each time the switch is pressed. (→P.148, 152)

### If the 12-volt battery is discharged

The following procedures may be used to start the engine <hybrid system> or opening the doors, trunk or glove box if the 12-volt battery is discharged.

You can also call your Lexus dealer or a qualified repair shop.

### Locking and unlocking the doors and opening the trunk

Use the mechanical key (→P.104) in order to perform the following operations:

#### ■ Locking and unlocking the doors

→P.355

#### ■ Opening the trunk

- 1 Slide the rear passengers' seat belts towards the outside.
- 2 Insert your fingers at the positions marked **A** and pull towards you to

remove the cover in the center of the rear seat.

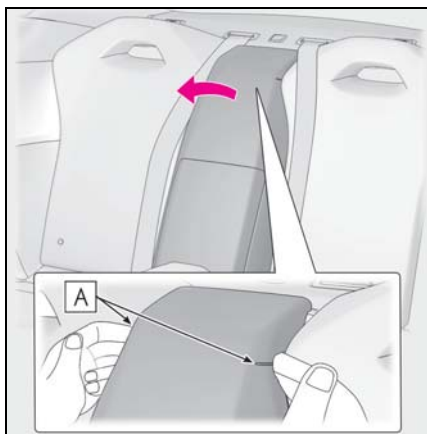

- 3** Insert the mechanical key into the cylinder and turn it clockwise to open.

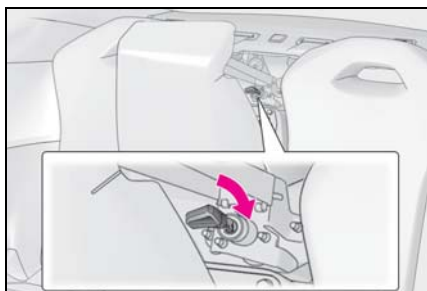

**⚠ WARNING**

■ **After unlocking the trunk**

Make sure to put back the cover to the center of the rear seat. Failure to do so may cause an accident.

**⚠ NOTICE**

■ **When installing the cover in the center of the rear seat**

Make sure that the seat belts are not caught in the cover. Failure to do so may cause damage to the cover installation clip and make it impossible to install the cover.

**Opening the glove box**

The glove box can be opened by performing the following operations after unlocking the doors.

If the glove box is locked, unlock it with the mechanical key. (→P.260)

- 1** Remove the cover using a flathead screwdriver.

To prevent damage to the cover, cover the tip of the screwdriver with a rag.

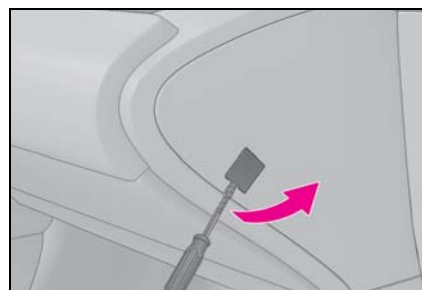

- 2** Push the flathead screwdriver into the part shown in the illustration to open the glove box.

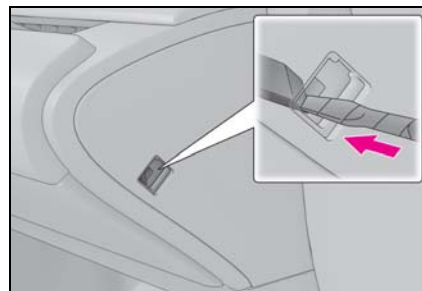

■ **After opening the glove box**

The glove box can be opened normally by closing the glove box after restarting the engine <hybrid system>.

**Restarting the engine <hybrid system>**

If you have a set of jumper (or booster)

cables and a second vehicle with a 12-volt battery, you can jump start your vehicle using the following procedure.

- 1 Confirm that the electronic key (including the card key) is being carried.

When connecting the jumper (or booster) cables, depending on the situation, the alarm may activate and doors locked. (→P.72)

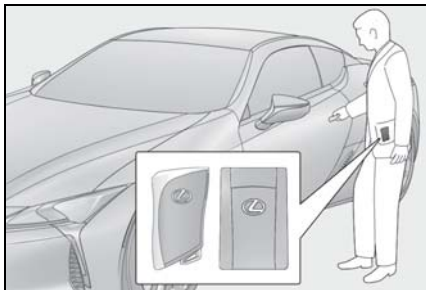

- 2 Open the hood (→P.290) and open the fuse box cover.

Push the tab in and lift the lid off.

- ▶ LC500

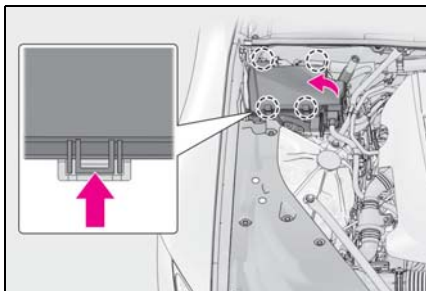

- ▶ LC500h

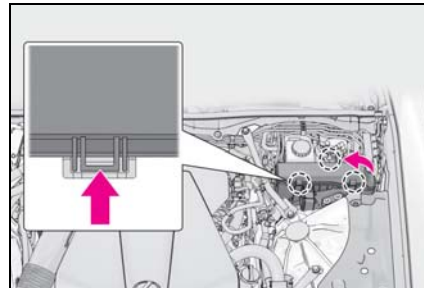

- 3 Open the exclusive jump starting terminal cover.

- ▶ LC500

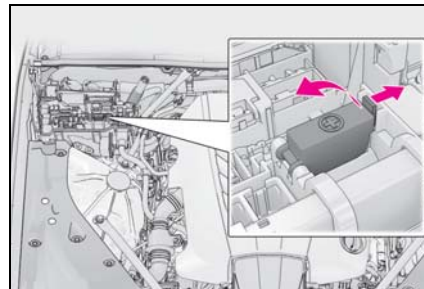

- ▶ LC500h

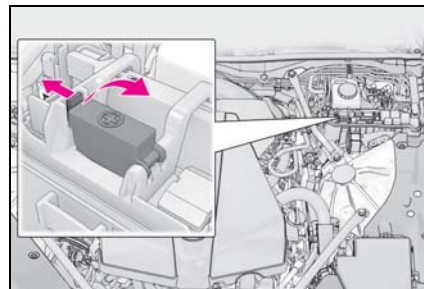

- 4 Connect a positive jumper cable clamp to **A** on your vehicle and connect the clamp on the other end of the positive cable to **B** on the second vehicle. Then, connect a negative cable clamp to **C** on the second vehicle and connect the clamp at the other end of the negative cable to **D**.

► LC500

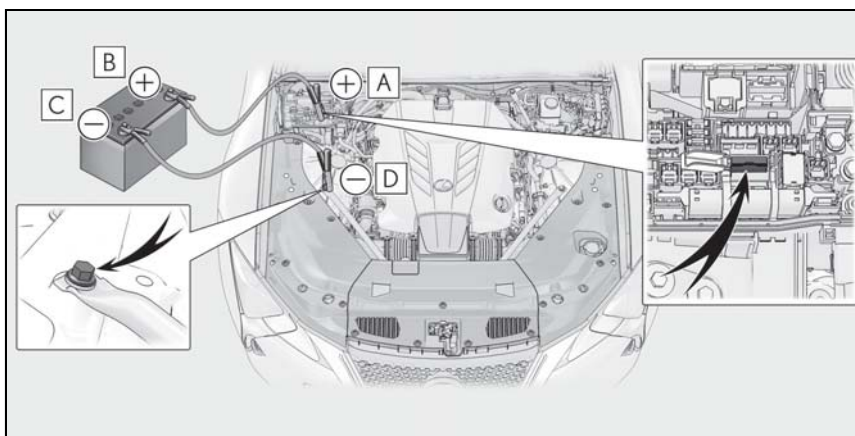

► LC500h

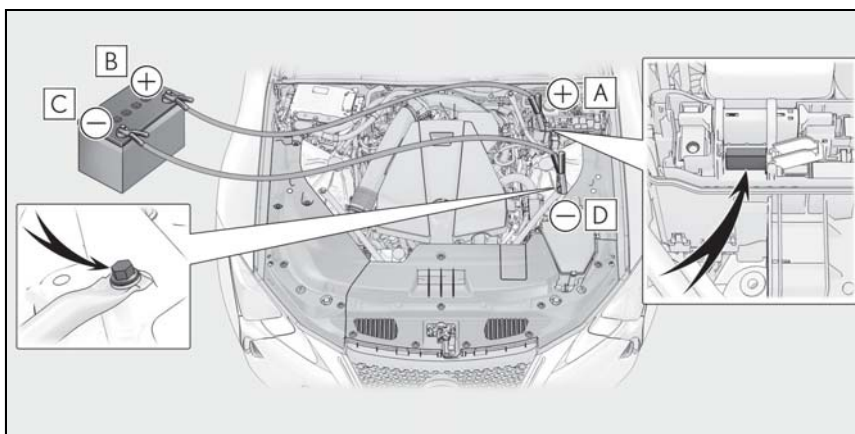

- A** Exclusive jump starting terminal (your vehicle)
  - B** Positive (+) battery terminal (second vehicle)
  - C** Negative (-) battery terminal (second vehicle)
  - D** Solid, stationary, unpainted metallic point away from the exclusive jump starting terminal and any moving parts as shown in the illustration
- 5** Start the engine of the second vehicle. Increase the engine speed slightly and maintain at that level for approximately 5 minutes to recharge the 12-volt battery of your vehicle.
  - 6** Open and close any of the door of your vehicle with the engine switch <power switch> off.
  - 7** Maintain the engine speed of the second vehicle and start the engine

<hybrid system> of your vehicle by turning the engine switch <power switch> to IGNITION ON mode <ON mode>.

- 8 Once the vehicle's engine <hybrid system> has started, remove the jumper cables in the exact reverse order from which they were connected.
- 9 Close the exclusive jump starting terminal cover, and reinstall the fuse box cover to its original position.

Once the engine <hybrid system> starts, have the vehicle inspected at your Lexus dealer as soon as possible.

#### ■ Starting the engine <hybrid system> when the 12-volt battery is discharged

The engine <hybrid system> cannot be started by push-starting.

#### ■ To prevent 12-volt battery discharge

- Turn off the headlights and the audio system while the engine <hybrid system> is stopped.
- Turn off any unnecessary electrical components when the vehicle is running at a low speed for an extended period, such as in heavy traffic.

#### ■ When the 12-volt battery is removed or discharged

- Information stored in the ECU is cleared. When the 12-volt battery is depleted, have the vehicle inspected at your Lexus dealer.
- Some systems may require initialization. (→P.403)

#### ■ When removing the 12-volt battery terminals

When the 12-volt battery terminals are removed, the information stored in the ECU is cleared. Before removing the 12-volt battery terminals, contact your Lexus dealer.

#### ■ Charging the 12-volt battery

The electricity stored in the 12-volt battery will discharge gradually even when the vehicle is not in use, due to natural discharge and the draining effects of certain electrical appliances. If the vehicle is left for a long time, the 12-volt battery may discharge, and the engine <hybrid system> may be unable to start. (The 12-volt battery recharges automatically during driving.)

#### ■ When recharging or replacing the 12-volt battery

- In some cases, it may not be possible to unlock the doors using the smart access system with push-button start when the 12-volt battery is discharged. Use the wireless remote control or the mechanical key to lock or unlock the doors.
  - The engine <hybrid system> may not start on the first attempt after the 12-volt battery has recharged but will start normally after the second attempt. This is not a malfunction.
  - The engine switch <power switch> mode is memorized by the vehicle. When the 12-volt battery is reconnected, the system will return to the mode it was in before the 12-volt battery was discharged. Before disconnecting the 12-volt battery, turn the engine switch <power switch> off. If you are unsure what mode the engine switch <power switch> was in before the 12-volt battery discharged, be especially careful when reconnecting the 12-volt battery.
  - If the 12-volt battery discharges, it may not be possible to shift the shift position to other positions. In this case, the vehicle cannot be towed without lifting both rear wheels because the rear wheels will be locked. (→P.330)
- #### ■ When replacing the 12-volt battery
- Use a Central Degassing type 12-volt battery (European Regulations).
  - Type A<sup>\*1</sup>: Use a 12-volt battery that the case size is same as the previous one (LN4), 20 hour rate capacity (20HR) is equivalent (80Ah) or greater, and performance rating (CCA) is equivalent (685A) or greater.

Type B\*<sup>2</sup>: Use a 12-volt battery that the case size is same as the previous one (LN3), 20 hour rate capacity (20HR) is equivalent (70Ah) or greater, and performance rating (CCA) is equivalent (600A) or greater.

- If the sizes differ, the 12-volt battery cannot be properly secured.
- If the 20 hour rate capacity is low, even if the time period where the vehicle is not used is a short time, the 12-volt battery may discharge and engine <hybrid system> may not be able to start.
- Use a 12-volt battery with a handle. If a 12-volt battery without a handle is used, removal is more difficult.
- After exchanging, firmly attach the following items to the exhaust hole of the 12-volt battery.
  - Use the exhaust hose that was attached to the 12-volt battery before exchanging.
  - Use the exhaust hole plug included with the 12-volt battery exchanged or the one installed on the battery prior to the exchange. (Depending on the 12-volt battery to be exchanged, the exhaust hole may be plugged.)

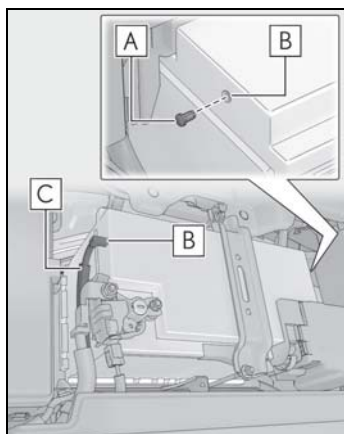

- A** Exhaust hole plug
- B** Exhaust hole
- C** Exhaust hose

For details, consult your Lexus dealer.

\*<sup>1</sup>: LC500 for Canada or LC500 with

heated steering wheel

\*<sup>2</sup>: LC500 except for Canada, LC500 without heated steering wheel or LC500h

**⚠ WARNING**

■ **When removing the 12-volt battery terminals**

Always remove the negative (-) terminal first. If the positive (+) terminal contacts any metal in the surrounding area when the positive (+) terminal is removed, a spark may occur, leading to a fire in addition to electrical shocks and death or serious injury.

■ **Avoiding 12-volt battery fires or explosions**

Observe the following precautions to prevent accidentally igniting the flammable gas that may be emitted from the 12-volt battery:

- Make sure each jumper cable is connected to the correct terminal and that it is not unintentionally in contact with any other than the intended terminal.
- Do not allow the other end of the jumper cable connected to the “+” terminal to come into contact with any other parts or metal surfaces in the area, such as brackets or unpainted metal.
- Do not allow the + and - clamps of the jumper cables to come into contact with each other.
- Do not smoke, use matches, cigarette lighters or allow open flame near the 12-volt battery.
- If the 12-volt battery fluid level is excessively low (→P.301), do not use the 12-volt battery.

 **WARNING****■ 12-volt battery precautions**

The 12-volt battery contains poisonous and corrosive acidic electrolyte, while related parts contain lead and lead compounds. Observe the following precautions when handling the 12-volt battery:

- When working with the 12-volt battery, always wear safety glasses and take care not to allow any 12-volt battery fluids (acid) to come into contact with skin, clothing or the vehicle body.
- Do not lean over the 12-volt battery.
- In the event that 12-volt battery fluid comes into contact with the skin or eyes, immediately wash the affected area with water and seek medical attention.  
Place a wet sponge or cloth over the affected area until medical attention can be received.
- Always wash your hands after handling the 12-volt battery support, terminals, and other battery-related parts.
- Do not allow children near the 12-volt battery.

**■ After recharging the 12-volt battery**

Have the 12-volt battery inspected at your Lexus dealer as soon as possible. If the 12-volt battery is deteriorating, continued use may cause the 12-volt battery to emit a malodorous gas, which may be detrimental to the health of passengers.

**■ When exchanging the 12-volt battery**

After exchanging, securely attach the exhaust hose and exhaust hole plug to the exhaust hole of the exchanged 12-volt battery. If not properly installed, gases (hydrogen) may leak into the vehicle interior, and there is the possible danger of the gas igniting and exploding.

 **NOTICE****■ When handling jumper cables**

When connecting the jumper cables, ensure that they do not become entangled in the cooling fan or engine drive belt.

**■ To prevent damaging the vehicle**

The exclusive jump starting terminal is to be used when charging the 12-volt battery from another vehicle in an emergency. It cannot be used to jump start another vehicle.



**If your vehicle overheats (LC500)**

The following may indicate that your vehicle is overheating.

- The engine coolant temperature gauge (→P.80) is in the red zone or a loss of engine power is experienced. (For example, the vehicle speed does not increase.)
- “Engine Coolant Temp High” is shown on the multi-information display.
- Steam comes out from under the hood.

**Correction procedures**

- 1 Stop the vehicle in a safe place and turn off the air conditioning system, and then stop the engine.
- 2 If you see steam: Carefully lift the hood after the steam subsides.  
If you do not see steam: Carefully lift the hood.
- 3 After the engine has cooled down sufficiently, inspect the hoses and

radiator core (radiator) for any leaks.

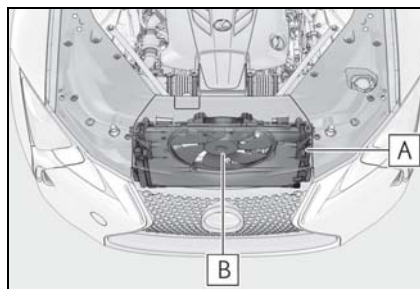

- A** Radiator
- B** Cooling fan

If a large amount of coolant leaks, immediately contact your Lexus dealer.

- 4 The coolant level is satisfactory if it is between the “F” and “L” lines on the reservoir.

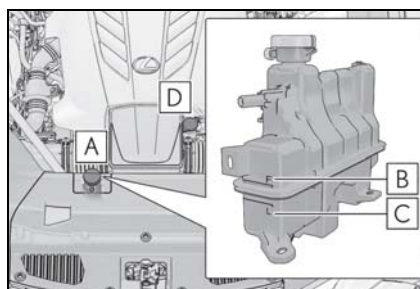

- A** Reservoir
- B** “F” line
- C** “L” line
- D** Coolant inlet cap

- 5 Add coolant if necessary.

Water can be used in an emergency if



coolant is unavailable.

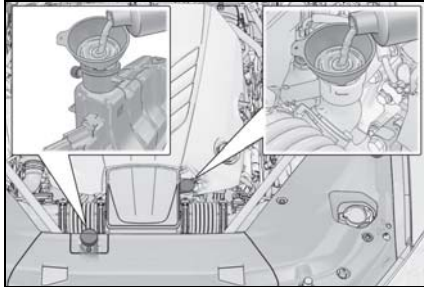

- 6 Start the engine and turn the air conditioning system on to check that the radiator cooling fan operates and to check for coolant leaks from the radiator or hoses.

The fan operates when the air conditioning system is turned on immediately after a cold start. Confirm that the fan is operating by checking the fan sound and air flow. If it is difficult to check these, turn the air conditioning system on and off repeatedly. (The fan may not operate in freezing temperatures.)

- 7 If the fan is not operating:  
Stop the engine immediately and contact your Lexus dealer.  
If the fan is operating:  
Have the vehicle inspected at the nearest Lexus dealer.

#### ■ When adding coolant

Add coolant in accordance with the following procedure.

- 1 Remove the service cover.

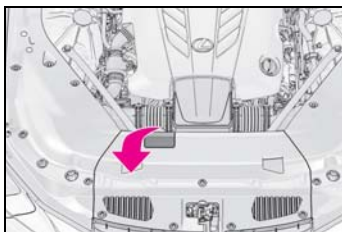

- 2 Remove the engine cover.

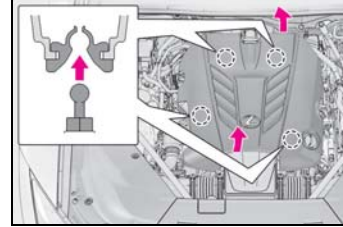

- 3 Remove the caps **A** and **B**.
- 4 Add coolant through the inlet of the cap **A** up to the "F" line **C**, and then replace the cap **A**.
- 5 Add coolant through the inlet of the cap **B** until it is full, and then replace the cap **B**.

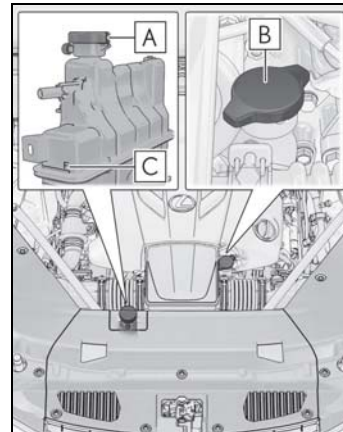

#### ⚠ WARNING

##### ■ When inspecting under the hood of your vehicle

Observe the following precautions. Failure to do so may result in serious injury such as burns.

- If steam is seen coming from under the hood, do not open the hood until the steam has subsided. The engine compartment may be very hot.

**⚠ WARNING**

- Keep hands and clothing (especially a tie, a scarf or a muffler) away from the fan and belts. Failure to do so may cause the hands or clothing to be caught, resulting in serious injury.
- While the engine and radiator are hot, do not loosen or remove the coolant inlet cap or coolant reservoir cap. High temperature steam or coolant could spray out.

**⚠ NOTICE****■ When adding engine coolant**

Add coolant slowly after the engine has cooled down sufficiently. Adding cool coolant to a hot engine too quickly can cause damage to the engine.

**■ To prevent damage to the cooling system**

Observe the following precautions:

- Avoid contaminating the coolant with foreign matter (such as sand or dust etc.).
- Do not use any coolant additive.

**If your vehicle overheats (LC500h)****The following may indicate that your vehicle is overheating.**

- The engine coolant temperature gauge (→P.80) is in the red zone or a loss of hybrid system power is experienced. (For example, the vehicle speed does not increase.)
- “Engine Coolant Temp High Stop in a Safe Place See Owner’s Manual” or “Hybrid System Overheated Reduced Output Power” is shown on the multi-information display.
- Steam comes out from under the hood.

**Correction procedures**

- ▶ If the engine coolant temperature gauge enters the red zone or “Engine Coolant Temp High Stop in a Safe Place See Owner’s Manual” is shown on the multi-information display
  - 1 Stop the vehicle in a safe place and turn off the air conditioning system, and then stop the hybrid system.
  - 2 If you see steam:
    - Carefully lift the hood after the steam subsides.
    - If you do not see steam:
      - Carefully lift the hood.

- 3** After the hybrid system has cooled down sufficiently, inspect the hoses and cooling system for leaks.

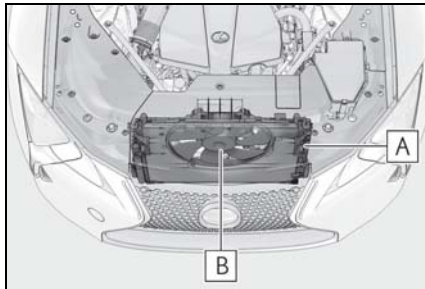

- A** Radiator  
**B** Cooling fan

If a large amount of coolant leaks, immediately contact your Lexus dealer.

- 4** The coolant level is satisfactory if it is between the "F" and "L" lines on the reservoir.

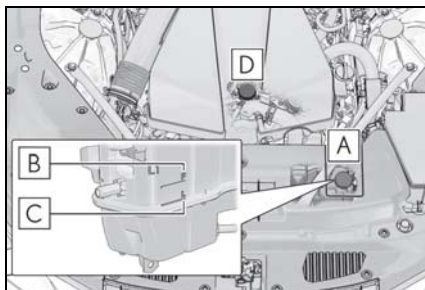

- A** Reservoir  
**B** "F" line  
**C** "L" line  
**D** Coolant inlet cap

- 5** Add coolant if necessary.

Water can be used in an emergency if

engine coolant is unavailable.

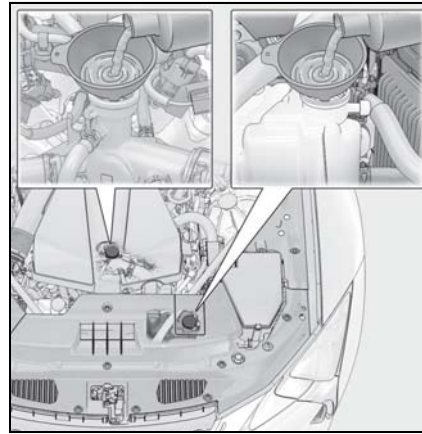

- 6** Start the hybrid system and turn the air conditioning system on to check that the radiator cooling fan operates and to check for coolant leaks from the radiator or hoses.

The fan operates when the air conditioning system is turned on immediately after a cold start. Confirm that the fan is operating by checking the fan sound and air flow. If it is difficult to check these, turn the air conditioning system on and off repeatedly. (The fan may not operate in freezing temperatures.)

- 7** If the fan is not operating:  
Stop the hybrid system immediately and contact your Lexus dealer.  
If the fan is operating:  
Have the vehicle inspected at the nearest Lexus dealer.

- ▶ If "Hybrid System Overheated Reduced Output Power" is shown on the multi-information display
- 1** Stop the vehicle in a safe place.
  - 2** Stop the hybrid system and carefully lift the hood.

- 3 After the hybrid system has cooled down, inspect the hoses and radiator core (radiator) for any leaks.

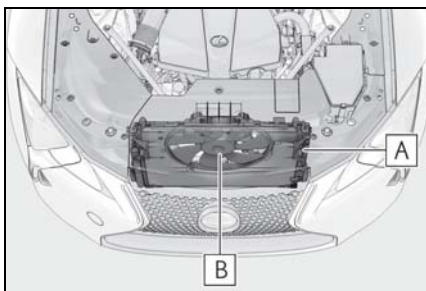

- A Radiator
- B Cooling fan

If a large amount of coolant leaks, immediately contact your Lexus dealer.

- 4 The coolant level is satisfactory if it is between the "F"/"FULL" and "L"/"LOW" lines on the reservoir.

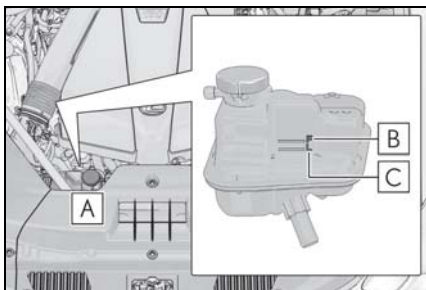

- A Reservoir
- B "F"/"FULL" line
- C "L"/"LOW" line

- 5 Add coolant if necessary.

Water can be used in an emergency if

power control unit coolant is unavailable.

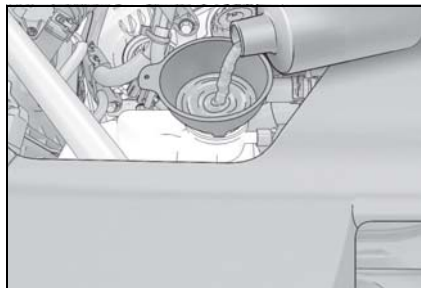

- 6 After stopping the hybrid system and waiting for 5 minutes or more, start the hybrid system again and check if "Hybrid System Overheated Reduced Output Power" is shown on the multi-information display.

If the message does not disappear: Stop the hybrid system and contact your Lexus dealer.

If the message is not displayed: The hybrid system temperature has dropped and the vehicle may be driven normally.

However, if the message appears again frequently, contact your Lexus dealer.

■ When adding engine coolant

Add coolant in accordance with the following procedure.

- 1 Remove the service cover.

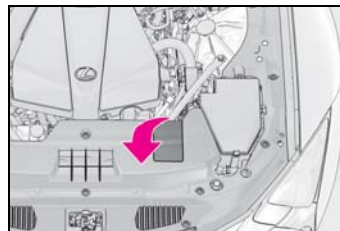

- 2 Remove the engine cover.

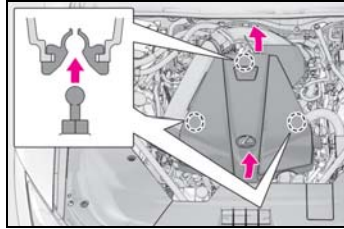

- 3 Remove the caps **A** and **B**.
- 4 Add coolant through the inlet of the cap **B** up to the "F" line **C**, and then replace the cap **B**.
- 5 Add coolant through the inlet of the cap **A** until it is full, and then replace the cap **A**.

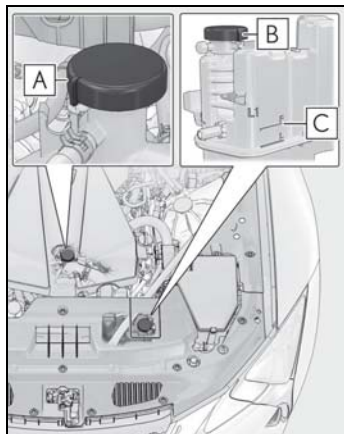

### WARNING

#### ■ When inspecting under the hood of your vehicle

Observe the following precautions. Failure to do so may result in serious injury such as burns.

- If steam is seen coming from under the hood, do not open the hood until the steam has subsided. The engine compartment may be very hot.

- After the hybrid system has been turned off, check that the indicator on the power switch and the "READY" indicator are off.

When the hybrid system is operating, the gasoline engine may automatically start, or the cooling fan may suddenly operate even if the gasoline engine stops. Do not touch or approach rotating parts such as the fan, which may lead to fingers or clothing (especially a tie, a scarf or a muffler) getting caught, resulting in serious injury.

- Do not loosen the coolant inlet cap or coolant reservoir caps while the hybrid system and radiator are hot. High temperature steam or coolant could spray out.

### NOTICE

#### ■ When adding engine/power control unit coolant

Add coolant slowly after the hybrid system has cooled down sufficiently. Adding cool coolant to a hot hybrid system too quickly can cause damage to the hybrid system.

#### ■ To prevent damage to the cooling system

Observe the following precautions:

- Avoid contaminating the coolant with foreign matter (such as sand or dust etc.).
- Do not use any coolant additive.

**If the vehicle becomes stuck**

Carry out the following procedures if the tires spin or the vehicle becomes stuck in mud, dirt or snow:

**Recovering procedure**

- 1 Stop the engine <hybrid system>. Set the parking brake and shift the shift position to P.
- 2 Remove the mud, snow or sand from around the rear wheels.
- 3 Place wood, stones or some other material under the rear wheels to help provide traction.
- 4 Restart the engine <hybrid system>.
- 5 Shift the shift position to D or R and release the parking brake. Then, while exercising caution, depress the accelerator pedal.

**When it is difficult to free the vehicle**

Press the  switch to turn off TRAC.

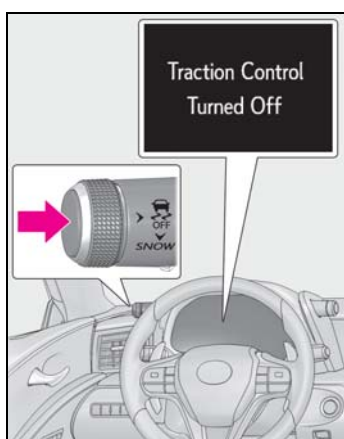

**WARNING**

**When attempting to free a stuck vehicle**

If you choose to push the vehicle back and forth to free it, make sure the surrounding area is clear to avoid striking other vehicles, objects or people. The vehicle may also lunge forward or lunge back suddenly as it becomes free. Use extreme caution.

**When shifting the shift position**

Be careful not to shift the shift position with the accelerator pedal depressed. This may lead to unexpected rapid acceleration of the vehicle that may cause an accident resulting in death or serious injury.

**NOTICE**

**To avoid damaging the transmission and other components**

- Avoid spinning the rear wheels and depressing the accelerator pedal more than necessary.
- If the vehicle remains stuck even after these procedures are performed, the vehicle may require towing to be freed.

## Vehicle specifications

8

371

### 8-1. Specifications

Maintenance data (fuel, oil level,  
etc.) ..... 372

Fuel information ..... 381

Tire information ..... 383

### 8-2. Customization

Customizable features ..... 391

### 8-3. Items to initialize

Items to initialize ..... 403

8

Vehicle specifications

**Maintenance data (fuel, oil level, etc.)**

**Dimensions and weight**

Overall length	187.4 in. (4760 mm)	
Overall width	75.6 in. (1920 mm)	
Overall height*	53.0 in. (1345 mm)	
Wheelbase	113.0 in. (2870 mm)	
Tread*	Front	64.2 in. (1630 mm)
	Rear	64.4 in. (1635 mm)
Vehicle capacity weight (Occupants + luggage)	720 lb. (325 kg)	

\*: Unladen vehicle

**Vehicle identification**

■ **Vehicle identification number**

The vehicle identification number (VIN) is the legal identifier for your vehicle. This is the primary identification number for your Lexus. It is used in registering the ownership of your vehicle.

This number is stamped on the top left of the instrument panel.

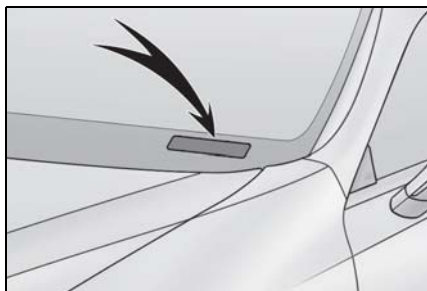

This number is also stamped under the right-hand front seat.

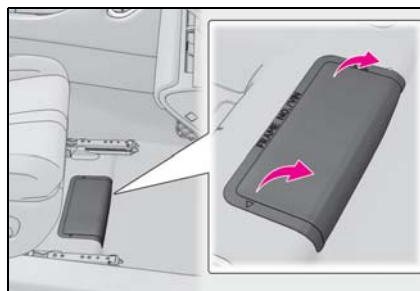

This number is also on the Certification Label.

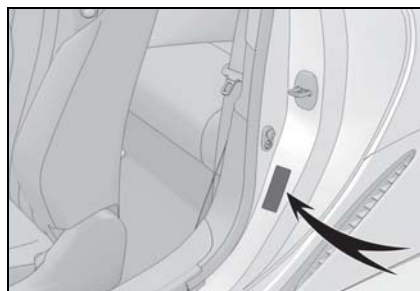

■ **Engine number**

The engine number is located as shown.



▶ LC500

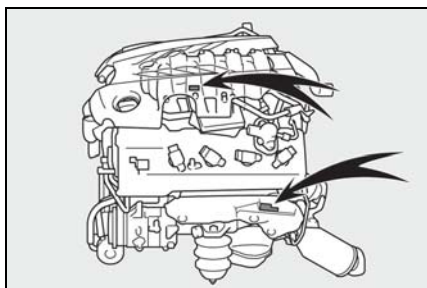

▶ LC500h

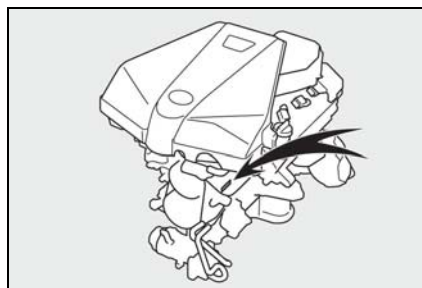

**Engine**

▶ LC500

Model	5.0 L 8-cylinder (2UR-GSE) engine
Type	8-cylinder V type, 4-cycle, gasoline
Bore and stroke	3.70 × 3.52 in. (94.0 × 89.5 mm)
Displacement	303.2 cu.in. (4969 cm <sup>3</sup> )
Drive belt tension	Automatic adjustment

▶ LC500h

Model	3.5 L 6-cylinder (8GR-FXS) engine
Type	6-cylinder V type, 4-cycle, gasoline
Bore and stroke	3.70 × 3.27 in. (94.0 × 83.0 mm)
Displacement	210.9 cu.in. (3456 cm <sup>3</sup> )
Drive belt tension	Automatic adjustment

**Fuel**

Fuel type	Unleaded gasoline only	
Octane Rating	91 (Research Octane Number 96) or higher	
Fuel tank capacity (Reference)	LC500	21.7 gal. (82.0 L, 18.0 Imp.gal.)
	LC500h	22.2 gal. (84.0 L, 18.5 Imp.gal.)

**Electric motor (traction motor) (LC500h)**

Type	Permanent magnet synchronous motor
Maximum output	131.9 kW
Maximum torque	221.3 ft•lbf (300 N•m, 30.6 kgf•m)

**Hybrid battery (traction battery) (LC500h)**

Type	Lithium-ion battery
Voltage	3.7 V/cell
Capacity	3.6 Ah
Quantity	84 cells
Overall voltage	310.8 V

**Lubrication system**

▶ LC500

■ **Oil capacity (Drain and refill [Reference\*])**

With filter	9.1 qt. (8.6 L, 7.6 Imp.qt.)
Without filter	8.4 qt. (7.9 L, 7.0 Imp.qt.)

\*: The engine oil capacity is a reference quantity to be used when changing the engine oil. Warm up and turn off the engine, wait more than 5 minutes, and check the oil level on the dipstick.

■ **Engine oil selection**

“Toyota Genuine Motor Oil” is used in your Lexus vehicle. Use Lexus approved “Toyota Genuine Motor Oil” or equivalent to satisfy the following grade and viscosity.

Oil grade: ILSAC GF-5 multigrade engine oil

Recommended viscosity: SAE 5W-30

SAE 5W-30 is the best choice for good fuel economy and good starting in cold weather.

If SAE 5W-30 is not available, SAE 10W-30 oil may be used. However, it should be replaced with SAE 5W-30 at the next oil change.

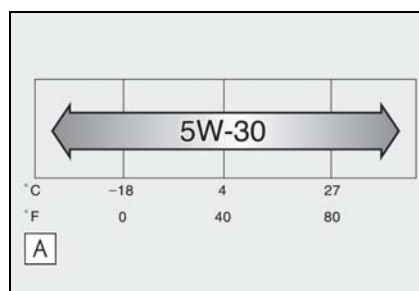

**A** Outside temperature

Oil viscosity (5W-30 is explained here as an example):

- The 5W in 5W-30 indicates the characteristic of the oil which allows

cold startability. Oils with a lower value before the W allow for easier starting of the engine in cold weather.

- The 30 in 5W-30 indicates the viscosity characteristic of the oil when the oil is at high temperature. An oil with a higher viscosity (one with a higher value) may be better suited if the vehicle is operated at high speeds, or under extreme load conditions.

How to read oil container label:

The International Lubricant Specification Advisory Committee (ILSAC) Certification Mark is added to some oil containers to help you select the oil you should use.



▶ LC500h

■ **Oil capacity (Drain and refill [Reference\*])**

With filter	6.0 qt. (5.7 L, 5.0 Imp.qt.)
Without filter	5.8 qt. (5.5 L, 4.8 Imp.qt.)

\*: The engine oil capacity is a reference quantity to be used when changing the engine oil. Warm up the engine and turn off the hybrid system, wait more than 5 minutes, and check the oil level on the dipstick.

■ **Engine oil selection**

“Toyota Genuine Motor Oil” is used in your Lexus vehicle. Use Lexus approved “Toyota Genuine Motor Oil” or equivalent to satisfy the following grade and viscosity.

Oil grade: ILSAC GF-5 multigrade engine oil

Recommended viscosity: SAE 0W-20

SAE 0W-20 is the best choice for good fuel economy and good starting in cold weather.

If SAE 0W-20 is not available, SAE 5W-20 oil may be used. However, it must be replaced with SAE 0W-20 at the next oil change.

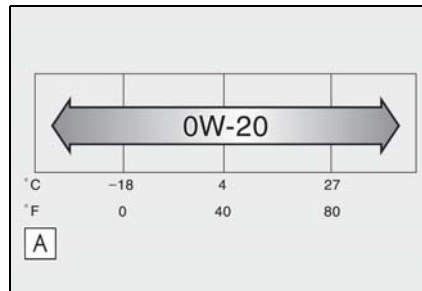

**A** Outside temperature

Oil viscosity (0W-20 is explained here as an example):

- The 0W in 0W-20 indicates the characteristic of the oil which allows cold startability. Oils with a lower value before the W allow for easier starting of the engine in cold weather.
- The 20 in 0W-20 indicates the viscosity characteristic of the oil when the oil is at high temperature. An oil with a higher viscosity (one with a

higher value) may be better suited if the vehicle is operated at high speeds, or under extreme load conditions.

How to read oil container label:

The International Lubricant Specification Advisory Committee (ILSAC) Certification Mark is added to some oil containers to help you select the oil you

should use.



### Cooling system

Capacity*	LC500	12.8 qt. (12.1 L, 10.6 Imp.qt.)
	LC500h	<ul style="list-style-type: none"> <li>▶ Gasoline engine 11.5 qt. (10.9 L, 9.6 Imp.qt.)</li> <li>▶ Power control unit 2.4 qt. (2.3 L, 2.0 Imp.qt.)</li> </ul>
Coolant type	Use either of the following: <ul style="list-style-type: none"> <li>• "Toyota Super Long Life Coolant"</li> <li>• Similar high-quality ethylene glycol-based non-silicate, non-amine, non-nitrite, and non-borate coolant with long-life hybrid organic acid technology</li> </ul> Do not use plain water alone.	

\*: The fluid capacity is a reference quantity.  
If replacement is necessary, contact your Lexus dealer.

### Ignition system

#### ■ Spark plug

	LC500	LC500h
Make	DENSO FK20HBR-J8	DENSO FK20HBR8
Gap	0.031 in. (0.8 mm)	0.031 in. (0.8 mm)

#### NOTICE

#### ■ Iridium-tipped spark plugs

Use only iridium-tipped spark plugs. Do not adjust the spark plug gap.

**Electrical system**■ **12-volt battery**

## ▶ LC500

Open voltage at 68°F (20°C):	12.3 V or higher (Turn the engine switch off and turn on the headlights for 20 to 30 seconds.)
Charging rates	
Quick charge	15 A max.
Slow charge	5 A max.

## ▶ LC500h

Open voltage at 68°F (20°C):	12.0 V or higher (Turn the power switch off and turn on the high beam headlights for 30 seconds.)
Charging rates	
Quick charge	15 A max.
Slow charge	5 A max.

**Automatic transmission (LC500)**

Fluid capacity*	9.3 qt. (8.8 L, 7.7 Imp.qt.)
Fluid type	Toyota Genuine ATF WS

\*: The fluid capacity is a reference quantity.  
If replacement is necessary, contact your Lexus dealer.

 **NOTICE**■ **Automatic transmission fluid type**

Using transmission fluid other than "Toyota Genuine ATF WS" may cause deterioration in shift quality, locking up of your transmission accompanied by vibration, and ultimately damage the transmission of your vehicle.

**Hybrid transmission (LC500h)**

Fluid capacity*	7.2 qt. (6.8 L, 6.0 Imp.qt.)
Fluid type	Toyota Genuine ATF WS

\*: The fluid capacity is a reference quantity.  
If replacement is necessary, contact your Lexus dealer.

 NOTICE
<p><b>Hybrid transmission fluid type</b></p> <p>Using transmission fluid other than “Toyota Genuine ATF WS” may cause deterioration in shift quality and ultimately damage the transmission of your vehicle.</p>

### Differential

Oil capacity	0.90 qt. (0.85 L, 0.75 Imp.qt.)
Oil type and viscosity	<p>▶ Without LSD (Limited Slip Differential)</p> <p>Toyota Genuine Differential gear oil LT 75W-85 GL-5 or equivalent*</p> <p>▶ With LSD (Limited Slip Differential)</p> <p>Toyota Genuine Differential gear oil LX 75W-85 GL-5 or equivalent*</p>

\*: Your Lexus vehicle is filled with “Toyota Genuine Differential Gear Oil” at the factory. Use Lexus approved “Toyota Genuine Differential Gear Oil” or an equivalent of matching quality to satisfy the above specification. Please contact your Lexus dealer for further details.

### Brakes

Pedal clearance* <sup>1</sup>	5.2 in. (132 mm) Min.
Pedal free play	0.04 — 0.24 in. (1.0 — 6.0 mm)
Brake pad wear limit	0.04 in. (1.0 mm)
Parking brake lining wear limit	0.04 in. (1.0 mm)
Parking brake indicator* <sup>2</sup>	<p>When pushing the parking brake switch for 1 to 4 seconds: comes on</p> <p>When pulling the parking brake switch for 1 to 4 seconds: turns off</p>
Fluid type	SAE J1703 or FMVSS No.116 DOT 3

\*<sup>1</sup>: Minimum pedal clearance when depressed with a force of 112.4 lbf (500 N, 51.0 kgf) while the engine is running <hybrid system is operating>.  
When performing the brake pedal inspection, also be sure to check that the brake system warning light is not illuminated when the engine is running <hybrid system is operating>. (If the brake system warning light is illuminated, refer to P.335.)

\*2: Make sure to confirm that the brake system warning light (yellow) does not illuminate. (If the brake system warning light illuminates, refer to P.339.)

### Steering

Free play	Less than 1.2 in. (30 mm)
-----------	---------------------------

### Tires and wheels

► 20-inch tires

Tire size	Front tires: 245/45RF20 99Y Rear tires: 275/40RF20 102Y
Tire inflation pressure (Recommended cold tire inflation pressure)	Driving under normal conditions: Front: 33 psi (230 kPa, 2.3 kgf/cm <sup>2</sup> or bar) Rear: 33 psi (230 kPa, 2.3 kgf/cm <sup>2</sup> or bar) Driving at high speeds (above 137 mph [220 km/h]) (in countries where such speeds are permitted by law): Add 10 psi (70 kPa, 0.7 kgf/cm <sup>2</sup> or bar) to the front tires and rear tires. Never exceed the maximum cold tire inflation pressure indicated on the tire sidewall.
Wheel size	Front wheels: 20 × 8 1/2J Rear wheels: 20 × 9 1/2J
Wheel nut torque	103.3 ft•lbf (140 N•m, 14.3 kgf•m)

► 21-inch tires

Tire size	Front tires: 245/40RF2196Y Rear tires: 275/35RF2199Y
Tire inflation pressure (Recommended cold tire inflation pressure)	Driving under normal conditions: Front: 33 psi (230 kPa, 2.3 kgf/cm <sup>2</sup> or bar) Rear: 33 psi (230 kPa, 2.3 kgf/cm <sup>2</sup> or bar) Driving at high speeds (above 137 mph [220 km/h]) (in countries where such speeds are permitted by law): Add 10 psi (70 kPa, 0.7 kgf/cm <sup>2</sup> or bar) to the front tires and rear tires. Never exceed the maximum cold tire inflation pressure indicated on the tire sidewall.
Wheel size	Front wheels: 21 × 8 1/2J Rear wheels: 21 × 9 1/2J
Wheel nut torque	103.3 ft•lbf (140 N•m, 14.3 kgf•m)

**Light bulbs**

Light bulbs	Bulb No.	W	Type
Vanity lights	—	2	Double end bulbs



**Fuel information**

**You must only use unleaded gasoline.**

**Select premium unleaded gasoline with an octane rating of 91 (Research Octane Number 96) or higher required for optimum engine performance and fuel economy. If the octane rating is less than 91, damage to the engine may occur and may void the vehicle warranty.**

At minimum, the gasoline you use should meet the specifications of ASTM D4814 in the U.S.A..

#### ■ Gasoline quality

In very few cases, driveability problems may be caused by the brand of gasoline you are using. If driveability problems persist, try changing the brand of gasoline. If this does not correct the problem, consult your Lexus dealer.

#### ■ Recommendation of the use of gasoline containing detergent additives

- Lexus recommends the use of gasoline that contains detergent additives to avoid the build-up of engine deposits.
- All gasoline sold in the U.S.A. contains minimum detergent additives to clean and/or keep clean intake systems, per EPA's lowest additives concentration program.
- Lexus strongly recommends the use of Top Tier Detergent Gasoline. For more information on Top Tier Detergent Gasoline and a list of marketers, please go to the official website [www.toptiergas.com](http://www.toptiergas.com).

#### ■ Recommendation of the use of low emissions gasoline

Gasolines containing oxygenates such as ethers and ethanol, as well as reformulated

gasolines, are available in some cities. These fuels are typically acceptable for use, providing they meet other fuel requirements.

Lexus recommends these fuels, since the formulations allow for reduced vehicle emissions.

#### ■ Non-recommendation of the use of blended gasoline

- Use only gasoline containing up to 15% ethanol.  
DO NOT use any flex-fuel or gasoline that could contain more than 15% ethanol, including from any pump labeled E30 (30% ethanol [A]), E50 (50% ethanol [B]), E85 (85% ethanol [C]) (which are only some examples of fuel containing more than 15% ethanol).

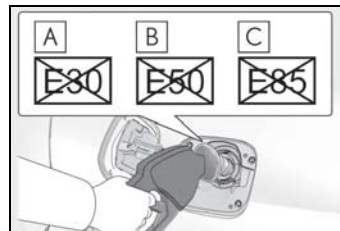

- If you use gasohol in your vehicle, be sure that it has an octane rating no lower than 91.
- Lexus does not recommend the use of gasoline containing methanol.
- **Non-recommendation of the use of gasoline containing MMT**

Some gasoline contains an octane enhancing additive called MMT (Methylcyclopentadienyl Manganese Tricarbonyl).

Lexus does not recommend the use of gasoline that contains MMT. If fuel containing MMT is used, your emission control system may be adversely affected.

The malfunction indicator lamp on the instrument cluster may come on. If this happens, contact your Lexus dealer for service.

#### ■ If your engine knocks

- Consult your Lexus dealer.
- You may occasionally notice light knock-

ing for a short time while accelerating or driving uphill. This is normal and there is no need for concern.

 NOTICE

■ **Notice on fuel quality**

- Do not use improper fuels. If improper fuels are used, the engine will be damaged.
- Do not use leaded gasoline. Leaded gasoline can cause damage to your vehicle's three-way catalytic converters causing the emission control system to malfunction.
- Do not use gasohol other than the type previously stated. Other gasohol may cause fuel system damage or vehicle performance problems.
- Using unleaded gasoline with an octane number or rating lower than the level previously stated may cause persistent heavy knocking. At worst, this may lead to engine damage and will void the vehicle warranty.

■ **Fuel-related poor driveability**

If poor driveability (poor hot starting, vaporization, engine knocking, etc.) is encountered after using a different type of fuel, discontinue the use of that type of fuel.

■ **When refueling with gasohol**

Take care not to spill gasohol. It can damage your vehicle's paint.

## Tire information

### Typical tire symbols

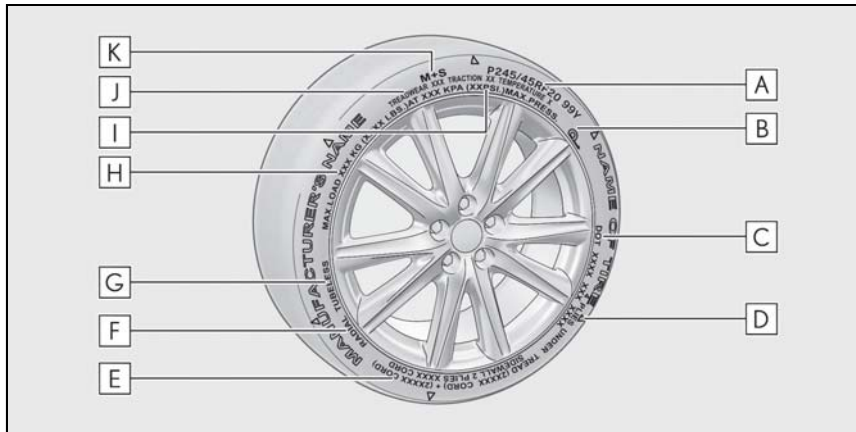

**A** Tire size (→P.384)

**B** Run-flat tire (RFT) or standard tire (→P.350)

This vehicle can be equipped with either run-flat tires (RFT) or standard tires. A  mark is molded on the sidewall of the run-flat tire.

**C** DOT and Tire Identification Number (TIN) (→P.384)

**D** Location of treadwear indicators (→P.301)

**E** Tire ply composition and materials

Plies are layers of rubber-coated parallel cords. Cords are the strands which form the plies in a tire.

**F** Radial tires or bias-ply tires

A radial tire has "RADIAL" on the sidewall. A tire not marked "RADIAL" is a bias-ply tire.

**G** TUBELESS or TUBE TYPE

A tubeless tire does not have a tube and air is directly put into the tire. A tube type tire has a tube inside the tire and the tube maintains the air pressure.

**H** Load limit at maximum cold tire inflation pressure (→P.386)

**I** Maximum cold tire inflation pressure (→P.386)

This means the pressure to which a tire may be inflated.

**J** Uniform tire quality grading

For details, see "Uniform Tire Quality Grading" that follows.

**K** Summer tires or all season tires (→P.302)

An all season tire has "M+S" on the sidewall. A tire not marked "M+S" is a summer tire.

**Typical DOT and Tire Identification Number (TIN)**

► Type A

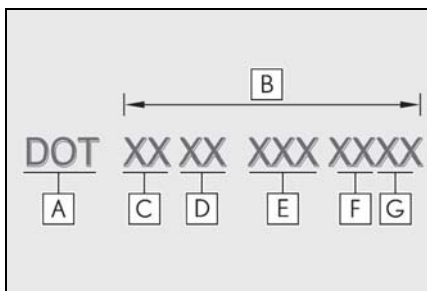

- A** DOT symbol\*
- B** Tire Identification Number (TIN)
- C** Tire manufacturer's identification mark
- D** Tire size code
- E** Manufacturer's optional tire type code (3 or 4 letters)
- F** Manufacturing week
- G** Manufacturing year

\*: The DOT symbol certifies that the tire conforms to applicable Federal Motor Vehicle Safety Standards.

► Type B

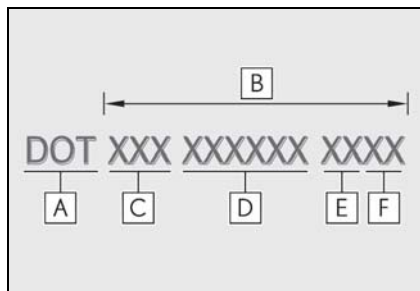

- A** DOT symbol\*
- B** Tire Identification Number (TIN)
- C** Tire manufacturer's identification mark
- D** Manufacture's code
- E** Manufacturing week
- F** Manufacturing year

\*: The DOT symbol certifies that the tire conforms to applicable Federal Motor Vehicle Safety Standards.

**Tire size**

■ **Typical tire size information**

The illustration indicates typical tire size.

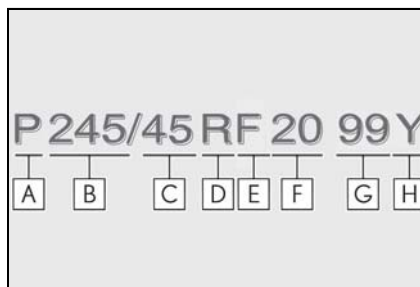

- A** Tire use (P = Passenger car, T = Temporary use)
- B** Section width (millimeters)
- C** Aspect ratio (tire height to section width)
- D** Tire construction code (R = Radial, D = Diagonal)
- E** Run-flat tire code
- F** Wheel diameter (inches)
- G** Load index (2 digits or 3 digits)
- H** Speed symbol (alphabet with one letter)

■ **Tire dimensions**

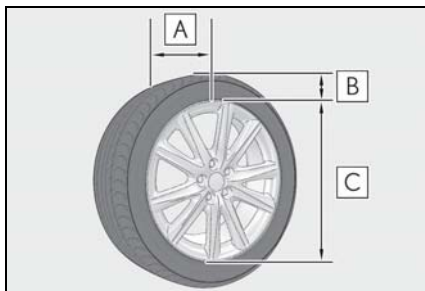

- A** Section width
- B** Tire height
- C** Wheel diameter

**Tire section names**

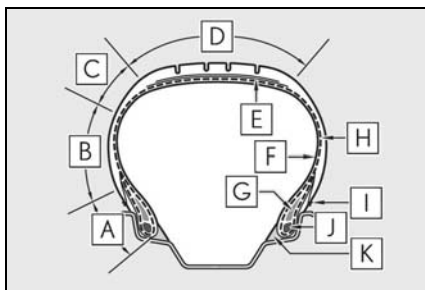

- A** Bead
- B** Sidewall
- C** Shoulder
- D** Tread
- E** Belt
- F** Inner liner
- G** Reinforcing rubber
- H** Carcass
- I** Rim lines
- J** Bead wires
- K** Chafer

**Uniform Tire Quality Grading**

This information has been prepared in accordance with regulations issued by the National Highway Traffic Safety Administration of the U.S. Department of Transportation.

It provides the purchasers and/or prospective purchasers of Lexus vehicles with information on uniform tire quality grading.

Your Lexus dealer will help answer any questions you may have as you read this information.

■ **DOT quality grades**

All passenger vehicle tires must conform to Federal Safety Requirements in addition to these grades. Quality grades can be found where applicable on the tire sidewall between tread shoulder and maximum section width.

For example: Treadwear 200 Traction AA Temperature A

■ **Treadwear**

The treadwear grade is a comparative rating based on the wear rate of the tire when tested under controlled conditions on a specified government test course.

For example, a tire graded 150 would wear one and a half (1 - 1/2) times as well on the government course as a tire graded 100.

The relative performance of tires depends upon the actual conditions of their use. Performance may differ significantly from the norm due to variations in driving habits, service practices and differences in road characteristics and climate.

■ **Traction AA, A, B, C**

The traction grades, from highest to lowest, are AA, A, B and C, and they represent the tire's ability to stop on wet pavement as measured under controlled conditions on specified government test surfaces of asphalt and concrete.

A tire marked C may have poor traction performance.

Warning: The traction grade assigned to this tire is based on braking (straight ahead) traction tests and does not include

cornering (turning) traction.

■ **Temperature A, B, C**

The temperature grades are A (the highest), B, and C, representing the tire's resistance to the generation of heat and its ability to dissipate heat when tested under controlled conditions on a specified indoor laboratory test wheel.

Sustained high temperature can cause the material of the tire to degenerate and reduce tire life, and excessive temperature can lead to sudden tire failure.

Grade C corresponds to a level of performance which all passenger car tires must meet under the Federal Motor Vehicle Safety Standard No. 109.

Grades B and A represent higher levels of performance on the laboratory test wheel than the minimum required by law.

Warning: The temperature grades of a tire assume that it is properly inflated and not overloaded.

Excessive speed, underinflation, or excessive loading, either separately or in combination, can cause heat buildup and possible tire failure.

**Glossary of tire terminology**

Tire related term	Meaning
Cold tire inflation pressure	Tire pressure when the vehicle has been parked for three hours or more, or has not been driven more than 1 mile or 1.5 km under that condition
Maximum inflation pressure	The maximum cold inflated pressure to which a tire may be inflated, shown on the sidewall of the tire
Recommended inflation pressure	Cold tire inflation pressure recommended by a manufacturer

Tire related term	Meaning
Accessory weight	The combined weight (in excess of those standard items which may be replaced) of automatic transmission <hybrid transmission>, power steering, power brakes, power windows, power seats, radio and heater, to the extent that these items are available as factory-installed equipment (whether installed or not)
Curb weight	The weight of a motor vehicle with standard equipment, including the maximum capacity of fuel, oil and coolant, and if so equipped, air conditioning and additional weight optional engine
Maximum loaded vehicle weight	The sum of: (a) Curb weight (b) Accessory weight (c) Vehicle capacity weight (d) Production options weight
Normal occupant weight	150 lb. (68 kg) times the number of occupants specified in the second column of Table 1* that follows
Occupant distribution	Distribution of occupants in a vehicle as specified in the third column of Table 1* below
Production options weight	The combined weight of installed regular production options weighing over 5 lb. (2.3 kg) in excess of the standard items which they replace, not previously considered in curb weight or accessory weight, including heavy duty brakes, ride levelers, roof rack, heavy duty 12-volt battery, and special trim
Rim	A metal support for a tire or a tire and tube assembly upon which the tire beads are seated
Rim diameter (Wheel diameter)	Nominal diameter of the bead seat
Rim size designation	Rim diameter and width
Rim type designation	The industry manufacturer's designation for a rim by style or code
Rim width	Nominal distance between rim flanges
Vehicle capacity weight (Total load capacity)	The rated cargo and luggage load plus 150 lb. (68 kg) times the vehicle's designated seating capacity

Tire related term	Meaning
Vehicle maximum load on the tire	The load on an individual tire that is determined by distributing to each axle its share of the maximum loaded vehicle weight, and dividing by two
Vehicle normal load on the tire	The load on an individual tire that is determined by distributing to each axle its share of curb weight, accessory weight, and normal occupant weight (distributed in accordance with Table 1* below), and dividing by two
Weather side	The surface area of the rim not covered by the inflated tire
Bead	The part of the tire that is made of steel wires, wrapped or reinforced by ply cords and that is shaped to fit the rim
Bead separation	A breakdown of the bond between components in the bead
Bias ply tire	A pneumatic tire in which the ply cords that extend to the beads are laid at alternate angles substantially less than 90 degrees to the centerline of the tread
Carcass	The tire structure, except tread and sidewall rubber which, when inflated, bears the load
Chunking	The breaking away of pieces of the tread or sidewall
Cord	The strands forming the plies in the tire
Cord separation	The parting of cords from adjacent rubber compounds
Cracking	Any parting within the tread, sidewall, or innerliner of the tire extending to cord material
CT	A pneumatic tire with an inverted flange tire and rim system in which the rim is designed with rim flanges pointed radially inward and the tire is designed to fit on the underside of the rim in a manner that encloses the rim flanges inside the air cavity of the tire
Extra load tire	A tire designed to operate at higher loads and at higher inflation pressures than the corresponding standard tire
Groove	The space between two adjacent tread ribs
Innerliner	The layer(s) forming the inside surface of a tubeless tire that contains the inflating medium within the tire
Innerliner separation	The parting of the innerliner from cord material in the carcass



Tire related term	Meaning
Intended outboard sidewall	(a) The sidewall that contains a whitewall, bears white lettering, or bears manufacturer, brand, and/or model name molding that is higher or deeper than the same molding on the other sidewall of the tire, or (b) The outward facing sidewall of an asymmetrical tire that has a particular side that must always face outward when mounted on a vehicle
Light truck (LT) tire	A tire designated by its manufacturer as primarily intended for use on lightweight trucks or multipurpose passenger vehicles
Load rating	The maximum load that a tire is rated to carry for a given inflation pressure
Maximum load rating	The load rating for a tire at the maximum permissible inflation pressure for that tire
Maximum permissible inflation pressure	The maximum cold inflation pressure to which a tire may be inflated
Measuring rim	The rim on which a tire is fitted for physical dimension requirements
Open splice	Any parting at any junction of tread, sidewall, or innerliner that extends to cord material
Outer diameter	The overall diameter of an inflated new tire
Overall width	The linear distance between the exteriors of the sidewalls of an inflated tire, including elevations due to labeling, decorations, or protective bands or ribs
Passenger car tire	A tire intended for use on passenger cars, multipurpose passenger vehicles, and trucks, that have a gross vehicle weight rating (GVWR) of 10,000 lb. or less.
Ply	A layer of rubber-coated parallel cords
Ply separation	A parting of rubber compound between adjacent plies
Pneumatic tire	A mechanical device made of rubber, chemicals, fabric and steel or other materials, that, when mounted on an automotive wheel, provides the traction and contains the gas or fluid that sustains the load
Radial ply tire	A pneumatic tire in which the ply cords that extend to the beads are laid at substantially 90 degrees to the centerline of the tread
Reinforced tire	A tire designed to operate at higher loads and at higher inflation pressures than the corresponding standard tire

Tire related term	Meaning
Section width	The linear distance between the exteriors of the sidewalls of an inflated tire, excluding elevations due to labeling, decoration, or protective bands
Sidewall	That portion of a tire between the tread and bead
Sidewall separation	The parting of the rubber compound from the cord material in the sidewall
Snow tire	A tire that attains a traction index equal to or greater than 110, compared to the ASTM E-1136 Standard Reference Test Tire, when using the snow traction test as described in ASTM F-1805-00, Standard Test Method for Single Wheel Driving Traction in a Straight Line on Snow-and Ice-Covered Surfaces, and which is marked with an Alpine Symbol (  ) on at least one sidewall
Test rim	The rim on which a tire is fitted for testing, and may be any rim listed as appropriate for use with that tire
Tread	That portion of a tire that comes into contact with the road
Tread rib	A tread section running circumferentially around a tire
Tread separation	Pulling away of the tread from the tire carcass
Treadwear indicators (TWI)	The projections within the principal grooves designed to give a visual indication of the degrees of wear of the tread
Wheel-holding fixture	The fixture used to hold the wheel and tire assembly securely during testing

\* : Table 1— Occupant loading and distribution for vehicle normal load for various designated seating capacities

Designated seating capacity, Number of occupants	Vehicle normal load, Number of occupants	Occupant distribution in a normally loaded vehicle
2 through 4	2	2 in front
5 through 10	3	2 in front, 1 in second seat
11 through 15	5	2 in front, 1 in second seat, 1 in third seat, 1 in fourth seat
16 through 20	7	2 in front, 2 in second seat, 2 in third seat, 1 in fourth seat

**Customizable features**

Your vehicle includes a variety of electronic features that can be personalized to your preferences. The settings of these features can be changed by using the meter control switches, the Remote Touch or at your Lexus dealer.

**Customizing vehicle features**

■ **Changing by using the meter control switches**

- 1 Press or of the meter control switches, and select .
- 2 Press or of the meter control switches, select the item, and press "OK".
- 3 Press or of the meter control switches, select the desired setting, and press "OK".

To go back to the previous screen or exit the customize mode, press .

■ **Changing by using the Remote Touch**

- 1 Press the "MENU" button on the Remote Touch.
- 2 Select "Setup" on the menu screen and select "Vehicle".

**Customizable features**

Some function settings are changed simultaneously with other functions being customized. Contact your Lexus dealer for further details.

- A** Settings that can be changed using the Remote Touch

- 3 Select "Vehicle Customization", "LEXUS Park Assist" or "Drive Mode Customization".

Various setting can be changed. Refer to the list of settings that can be changed for details.

For details on the Remote Touch, refer to the "NAVIGATION SYSTEM OWNER'S MANUAL".

■ **When customizing using the Remote Touch**

Stop the vehicle in a safe place, apply the parking brake, and shift the shift position to P. Also, to prevent 12-volt battery discharge, leave the engine running <hybrid system operating> while customizing the features.

**WARNING**

■ **During customization**

As the engine <hybrid system> needs to be running <operating> during customization, ensure that the vehicle is parked in a place with adequate ventilation. In a closed area such as a garage, exhaust gases including harmful carbon monoxide (CO) may collect and enter the vehicle. This may lead to death or a serious health hazard.

**NOTICE**

■ **During customization**

To prevent 12-volt battery discharge, ensure that the engine is running <hybrid system is operating> while customizing features.

**B** Settings that can be changed using the meter control switches

**C** Settings that can be changed by your Lexus dealer

Definition of symbols: ○ = Available, — = Not available

■ Gauges, meters and multi-information display (→P.74, 80, 84)

Function <sup>*1</sup>	Default setting	Customized setting	<b>A</b>	<b>B</b>	<b>C</b>
Language	English	French	○ <sup>*6</sup>	○	—
		Spanish			
Units <sup>*2</sup>	miles (MPG)	km (km/L)	○ <sup>*6</sup>	○	—
		km (L/100 km)			
		miles (MPG Imperial)			
Eco Driving Indicator Light <sup>*3</sup>	Off	On (Self-lighting)	—	○	—
EV indicator <sup>*4</sup>	On (Self-lighting)	Off	—	○	—
Drive information 1	Current fuel economy	<sup>*5</sup>	—	○	—
	Average fuel economy (after reset)				
Drive information 2	Distance (driving range)	<sup>*5</sup>	—	○	—
	Average vehicle speed (after reset)				
Pop-up display	On	Off	—	○	—
Ring position memory	On	Off	—	○	—
Accent color	Color 1	Color 2	○ <sup>*6</sup>	○	—
Rev indicator	Off	On	—	○	—
Rev indicator red zone setting	5000 r/min. <sup>*3</sup> 4000 r/min. <sup>*4</sup>	2000 - 7300 r/min. <sup>*3</sup> 2000 - 6600 r/min. <sup>*4</sup>	—	○	—

Function <sup>*1</sup>	Default setting	Customized setting	A	B	C
Rev peak	Off	On	—	○	—
Clock	12-hour display	24-hour display	—	○	—
Sensor sensitivity for darkening the brightness of the instrument cluster depending on the outside brightness	Standard	-2 to 2	—	—	○
Sensor sensitivity for returning the brightness of the instrument cluster to the original level depending on the outside brightness	Standard	-2 to 2	—	—	○
Suggestion function	On	On (when the vehicle is stopped)	○	—	○
		Off			

<sup>\*1</sup>: For details about each function: →P.80, 88

<sup>\*2</sup>: The default setting varies according to country.

<sup>\*3</sup>: LC500

<sup>\*4</sup>: LC500h

<sup>\*5</sup>: 2 of the following items: current fuel consumption, average fuel economy (after reset), average fuel economy (after start), average fuel economy (after refuel), average vehicle speed (after reset), average vehicle speed (after start), elapsed time (after reset), elapsed time (after start), distance (driving range), distance (after start), blank.

<sup>\*6</sup>: Refer to the “NAVIGATION SYSTEM OWNER’S MANUAL”.

■ **HUD (Head-up Display)<sup>\*1</sup>** (→P.90)

Function	Default setting	Customized setting	A	B	C
Gauge information	Tachometer	Eco Driving Indicator Light <sup>*2</sup>	—	○	—
		Hybrid System Indicator <sup>*3</sup>			
		No display			
Driving support display (Navigation system)	On	Off	—	○	—

Function	Default setting	Customized setting	A	B	C
Driving support display (Lane display)	On	Off	—	○	—
Driving support display (Driving assist)	On	Off	—	○	—
Driving support display (Compass)	On	Off	—	○	—
Driving support display (Audio)	On	Off	—	○	—

\*1: If equipped

\*2: LC500

\*3: LC500h

■ LKA (Lane-Keeping Assist) (→P.196)





Function	Default setting	Customized setting	A	B	C
Lane centering function	Off	On	—	○	—
Steering assist	On	Off	—	○	—
Alert sensitivity	Standard	High	—	○	—
Vehicle sway warning	On	Off	—	○	—
Vehicle sway warning sensitivity	Standard	Low	—	○	—
		High			

■ PCS (Pre-Collision System) (→P.189)

Function	Default setting	Customized setting	A	B	C
PCS (Pre-Collision System)	On	Off	—	○	—
Adjust alert timing	Middle	Far	—	○	—
		Near			

■ BSM (Blind Spot Monitor)\*1 (→P.220)

Function	Default setting	Customized setting	A	B	C
BSM (Blind Spot Monitor)	On	Off	—	○	—
RCTA (Rear Cross Traffic Alert)	On	Off	—	○	—
Outside rear view mirror indicator brightness	Bright	Dim	—	○	—

Function	Default setting	Customized setting	A	B	C
Alert timing for presence of approaching vehicle (sensitivity) <sup>*2</sup>	 (Intermediate)	 (Early)	—	○	—
		 (Late)			
		 (Only when in blind spot)			
RCTA buzzer volume	Level 2	Level 1	—	○	—
		Level 3			

\*1: If equipped

\*2: BSM function only

■ **Active rear wing** <sup>\*</sup> (→P.229)

Function	Default setting	Customized setting	A	B	C
Operation of the active rear wing	Off	On	—	○	○

\*: If equipped

■ **Door lock** (→P.106, 110, 355)

Function	Default setting	Customized setting	A	B	C
Unlocking using a mechanical key	Driver's door unlocked in one step, both side doors unlocked in two steps	Both side doors unlocked in one step	—	—	○
Automatic door lock	Shifting the shift position to position other than P	Off	○	—	○
		Vehicle speed is approximately 12 mph (20 km/h) or higher			

Function	Default setting	Customized setting	A	B	C
Automatic door unlock	Shifting the shift position to P	Off	○	—	○
		Driver's door is opened			
Locking/unlocking of the trunk when both side doors are locked/unlocked	On	Off	—	—	○
Time elapsed before the door lock indicator lights turn off	30 seconds	1 minute	—	—	○
		10 minutes			
		20 minutes			

■ Smart access system with push-button start and wireless remote control (→P.104, 113)

Function	Default setting	Customized setting	A	B	C
Operating signal (Buzzers)	5	Off	○	—	○
		1 to 7			
Operation signal (Emergency flashers)	On	Off	○	—	○
Time elapsed before automatic door lock function is activated if door is not opened after being unlocked	60 seconds	Off	○	—	○
		30 seconds			
		120 seconds			
Open door warning buzzer	On	Off	—	—	○

■ Smart access system with push-button start (→P.113)

Function	Default setting	Customized setting	A	B	C
Smart access system with push-button start	On	Off	—	—	○
Smart door unlocking	Driver's door	Both side doors	○	—	○
Number of consecutive door lock operations	2 times	As many as desired	—	—	○



■ **Wireless remote control (→P.104)**

Function	Default setting	Customized setting	A	B	C
Wireless remote control	On	Off	—	—	○
Unlocking operation	Driver's door unlocked in one step, both side doors unlocked in two steps	Both side doors unlocked in one step	○	—	○
Trunk unlocking operation	Press and hold (short)	One short press	—	—	○
		Push twice			
		Press and hold (long)			
		Off			
Alarm (panic mode)	On	Off	—	—	○
Reservation lock	On	Off	○	—	○

■ **Driving position memory (→P.122)**

Function	Default setting	Customized setting	A	B	C
Selecting the door linking driving position memory with door unlock operation	Driver's door	Both side doors	—	—	○

■ **Steering wheel (→P.127)**

Function	Default setting	Customized setting	A	B	C
Auto tilt away function	Tilt only	Telescopic only	○	—	○
		Tilt & telescopic			
		Off			

■ **Outside rear view mirrors (→P.129)**

Function	Default setting	Customized setting	A	B	C
Automatic mirror folding and extending operation	Linked to the locking/unlocking of the doors	Off	—	—	○
		Linked to operation of the engine switch <power switch>			

■ Power windows (→P.132)

Function	Default setting	Customized setting	A	B	C
Mechanical key linked operation	Off	On	—	—	○
Wireless remote control linked operation	Off	On (Open only)	—	—	○
Wireless remote control linked operation signal (buzzer)	On	Off	—	—	○

■ Turn signal lever (→P.167)

Function	Default setting	Customized setting	A	B	C
The number of times the turn signal lights flash automatically when the turn signal lever is moved to the first position during a lane change	3	5	—	—	○
		7			
		Off			

■ Automatic light control system (→P.173)

Function	Default setting	Customized setting	A	B	C
Light sensor sensitivity	Standard	-2 to 2	○	—	○
Time elapsed before headlights automatically turn off after doors are closed	30 seconds	Off	○	—	○
		60 seconds			
		90 seconds			
Windshield wiper linked headlight illumination	On	Off	—	—	○

■ Lights (→P.173)

Function	Default setting	Customized setting	A	B	C
Daytime running lights *	On	Off	○	—	○
Welcome light illumination control	On	Off	—	—	○

\*: U.S.A. only

■ Automatic air conditioning system (→P.248)

Function	Default setting	Customized setting	A	B	C
A/C auto switch operation	On	Off	<input type="radio"/>	—	<input type="radio"/>
Exhaust gas sensor sensitivity	Standard	-3 to 3	<input type="radio"/>	—	<input type="radio"/>

■ Seat heater<sup>\*</sup> / seat ventilators<sup>\*</sup> (→P.255)

Function	Default setting	Customized setting	A	B	C
Driver's seat temperature preference in automatic mode	Standard	-2 (cooler) to 2 (warmer)	<input type="radio"/>	—	<input type="radio"/>
Passenger's seat temperature preference in automatic mode	Standard	-2 (cooler) to 2 (warmer)	<input type="radio"/>	—	<input type="radio"/>

\* : If equipped

■ Heated steering wheel<sup>\*</sup> (→P.255)

Function	Default setting	Customized setting	A	B	C
Steering wheel heating preference in automatic mode	Standard	-2 (low) to 2 (high)	<input type="radio"/>	—	<input type="radio"/>

\* : If equipped

■ Illumination (→P.258)

Function	Default setting	Customized setting	A	B	C
Time elapsed before the interior lights turn off	15 seconds	Off	<input type="radio"/>	—	<input type="radio"/>
		7.5 seconds			
		30 seconds			
Operation after the engine switch <power switch> is turned off	On	Off	—	—	<input type="radio"/>
Operation when the doors are unlocked	On	Off	—	—	<input type="radio"/>
Operation when you approach the vehicle with the electronic key on your person	On	Off	—	—	<input type="radio"/>
Footwell lighting	On	Off	—	—	<input type="radio"/>
Door trim ornament lights	On	Off	—	—	<input type="radio"/>

Function	Default setting	Customized setting	A	B	C
Time elapsed before the outside door handle lights turn off	15 seconds	Off	○	—	○
		7.5 seconds			
		30 seconds			
Operation of the outside door handle lights when the doors are unlocked	On	Off	—	—	○
Operation of the outside door handle lights when a door is opened	On	Off	—	—	○
Fading out of the outside door handle lights when they turn off	Long	Short	—	—	○

■ Rain-sensing windshield wipers (→P.178)

Function	Default setting	Customized setting	A	B	C
Wiper operation when the wiper switch is in the AUTO position	Rain-sensing operation	Intermittent operation linked to vehicle speed (with interval adjuster)	—	—	○

■ Reverse warning buzzer (→P.156, 162)

Function	Default setting	Customized setting	A	B	C
Signal (buzzer) when the shift position is in R	Intermittent	Single	—	—	○

■ Seat belt reminder buzzer (→P.339)

Function	Default setting	Customized setting	A	B	C
Speed-linked seat belt reminder function	On	Off	—	—	○

■ **Outside door handle (→P.109)**

Function	Default setting	Customized setting	A	B	C
Vehicle speed at which the speed linked outside door handle retracting function operates	6 mph (10 km/h)	3 mph (5 km/h)	—	—	○
		9 mph (15 km/h)			
		12 mph (20 km/h)			
Time elapsed before the outside door handle are automatically retracted	60 seconds	20 minutes *	—	—	○

\*: After the engine switch <power switch> is turned off

■ **Vehicle proximity notification system (LC500h) (→P.63)**

Function	Default setting	Customized setting	A	B	C
The volume of vehicle proximity notification system sound	Level 1	Level 2	—	—	○
		Level 3			

■ **Intuitive parking assist\* (→P.214)**

Function	Default setting	Customized setting	A	B	C
Intuitive parking assist	On	Off	—	○	—
Detection distance of the front center sensor	Far	Near	○	—	○
Detection distance of the rear center sensor	Far	Near	○	—	○
Buzzer volume	Level 2	Level 1	○	—	○
		Level 3			

\*: If equipped

■ **Driving mode select switch (→P.213)**

Function	Default setting	Customized setting	A	B	C
Powertrain control in custom mode	Normal	Power	○	—	—
		Eco			

Function	Default setting	Customized setting	A	B	C
Chassis control in custom mode	Normal	Sport	○	—	—
		Comfort			
Air conditioning operation in custom mode	Normal	Eco	○	—	—

■ Vehicle customization

- When the Smart access system with push-button start is off, the entry unlock function cannot be customized.
- When the doors remain closed after unlocking the doors and the timer activated automatic door lock function activates, signals will be generated in accordance with the operation buzzer volume and operational signal (Emergency flashers) function setting.
- Some settings can be changed using a switch or the audio system screen. If a setting is changed using a switch, the changed setting will not be reflected on the audio system screen until the engine switch <power switch> is turned off and then to IGNITION ON mode <ON mode>.

**Items to initialize**

The following items must be initialized for normal system operation after such cases as the 12-volt battery being reconnected, or maintenance being performed on the vehicle:

**List of the items to initialize**

Item	When to initialize	Reference
Tire pressure warning system	<ul style="list-style-type: none"> <li>• When rotating the tires.</li> <li>• When the tire inflation pressure is changed by changing tire size. (When there are multiple specified pressures)</li> <li>• After registering the ID codes.</li> <li>• When the tire inflation pressure is changed such as when changing traveling speed.</li> </ul>	P.306
Power windows	<ul style="list-style-type: none"> <li>• When functioning abnormally</li> </ul>	P.132
Lexus parking assist monitor	<ul style="list-style-type: none"> <li>• The steering wheel has been moved while the 12-volt battery was being reinstalled.</li> <li>• 12-volt battery power is low.</li> </ul>	Refer to "NAVIGATION SYSTEM OWNER'S MANUAL".
Message indicating maintenance is required	<ul style="list-style-type: none"> <li>• After the maintenance is performed</li> </ul>	P.283
Oil maintenance (LC500h)	<ul style="list-style-type: none"> <li>• After the maintenance is performed</li> </ul>	P.295





9-1. For owners

- Reporting safety defects for U.S. owners ..... 406
- Seat belt instructions for Canadian owners (in French)..... 406
- SRS airbag instructions for Canadian owners (in French)..... 408
- Headlight aim instructions for Canadian owners (in French) ..... 414

### Reporting safety defects for U.S. owners

If you believe that your vehicle has a defect which could cause a crash or could cause injury or death, you should immediately inform the National Highway Traffic Safety Administration (NHTSA) in addition to notifying the Lexus Division of Toyota Motor Sales, U.S.A., Inc. (Toll-free: 1-800-25-LEXUS).

If NHTSA receives similar complaints, it may open an investigation, and if it finds that a safety defect exists in a group of vehicles, it may order a recall and remedy campaign. However, NHTSA cannot become involved in individual problems between you, your dealer, or Lexus Division of Toyota Motor Sales, U.S.A., Inc.

To contact NHTSA, you may call the Vehicle Safety Hotline toll-free at 1-888-327-4236 (TTY: 1-800-424-9153); go to <http://www.safercar.gov>; or write to: Administrator, NHTSA, 1200 New Jersey Ave, S.E., Washington, DC 20590. You can also obtain other information about motor vehicle safety from <http://www.safercar.gov>.

### Seat belt instructions for Canadian owners (in French)

The following is a French explanation of seat belt instructions extracted from the seat belt section in this manual.

See the seat belt section for more detailed seat belt instructions in English.

### Utilisation adéquate des ceintures de sécurité

- Tirez sur la ceinture épaulière jusqu'à ce qu'elle recouvre entièrement l'épaule; elle ne doit cependant pas toucher le cou ni glisser de l'épaule.
- Placez la ceinture abdominale le plus bas possible sur les hanches.
- Réglez la position du dossier. Tenez-vous assis bien au fond du siège, le dos droit.



- Ne vrillez pas la ceinture de sécurité.

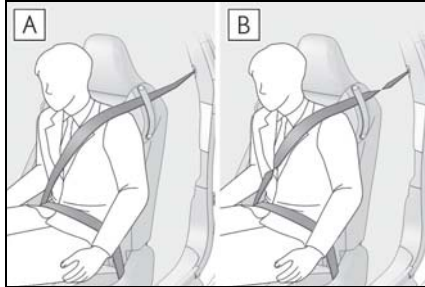

**A** Non vrillée

**B** Vrillée

### Guide de ceinture de sécurité

Les sièges avant sont dotés de guides pour permettre à la ceinture de sécurité de se dérouler facilement. Lorsque vous n'arrivez pas à dérouler facilement la ceinture de sécurité, faites-la passer dans le guide.

Lorsque vous vous asseyez sur un siège arrière ou que vous sortez du véhicule, retirez la ceinture de sécurité de son guide.

- ▶ Véhicules dotés d'appuis-tête de type manuel

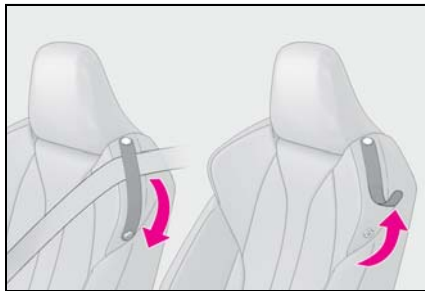

- ▶ Véhicules dotés d'appuis-tête de type assisté

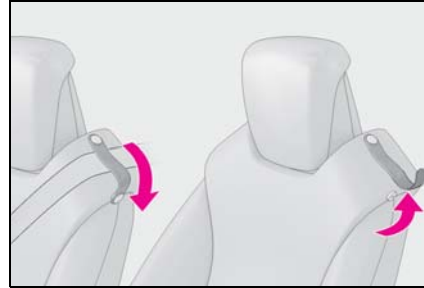

### Entretien et soin

#### ■ Manipulation des ceintures de sécurité

Avec un chiffon ou une éponge, nettoyez à l'aide d'un savon doux et de l'eau tiède. Vérifiez aussi les ceintures régulièrement pour vous assurer qu'elles ne présentent pas d'usure excessive, d'effilochage ou de coupures.

#### ⚠ AVERTISSEMENT

##### ■ Dommages et usure de la ceinture de sécurité

Vérifiez périodiquement le système de ceintures de sécurité. Vérifiez qu'il n'y a pas de coupures, d'effilochures ni de pièces desserrées. N'utilisez pas une ceinture de sécurité endommagée avant qu'elle ne soit remplacée. Les ceintures de sécurité endommagées ne peuvent pas protéger les occupants contre les blessures graves, voire mortelles.

### SRS airbag instructions for Canadian owners (in French)

The following is a French explanation of SRS airbag instructions extracted from the SRS airbag section in this manual.

See the SRS airbag section for more detailed SRS airbag instructions in English.

### Système de coussins gonflables SRS

#### ■ Emplacement des coussins gonflables SRS

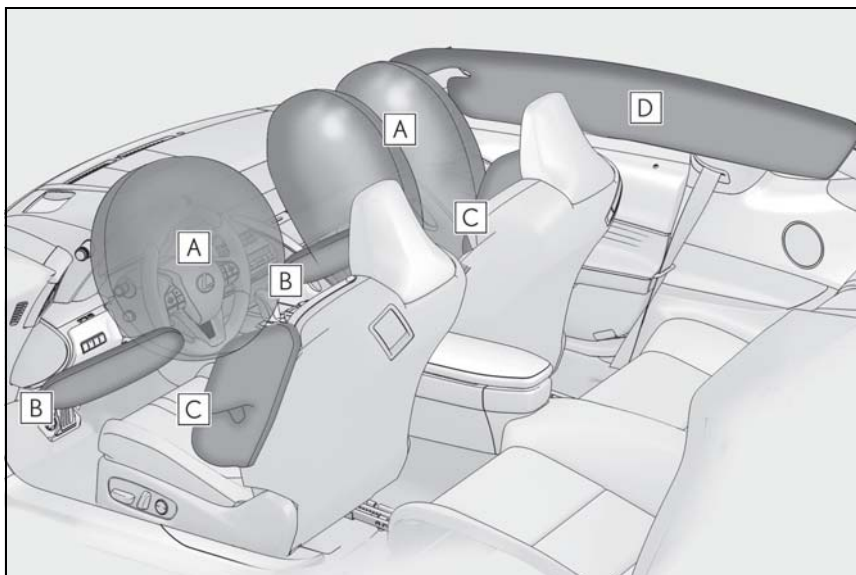

#### ► Coussins gonflables SRS avant

- A** Coussin gonflable SRS du conducteur/coussin gonflable SRS du passager avant

Peuvent aider à protéger la tête et la poitrine du conducteur et du passager avant contre les impacts avec des composants intérieurs

- B** Coussins gonflables SRS de protection des genoux  
Peuvent aider à protéger le conducteur et le passager avant

#### ► Coussins gonflables SRS latéraux et en rideau

- C** Coussins gonflables SRS latéraux  
Peuvent aider à protéger le torse des occupants des sièges avant

- D** Coussins gonflables SRS en rideau

- Peuvent aider à protéger principalement la tête des occupants
- Peuvent aider à empêcher les occupants d'être éjectés du véhicule en cas de tonneaux

### ■ Composants du système de coussins gonflables SRS

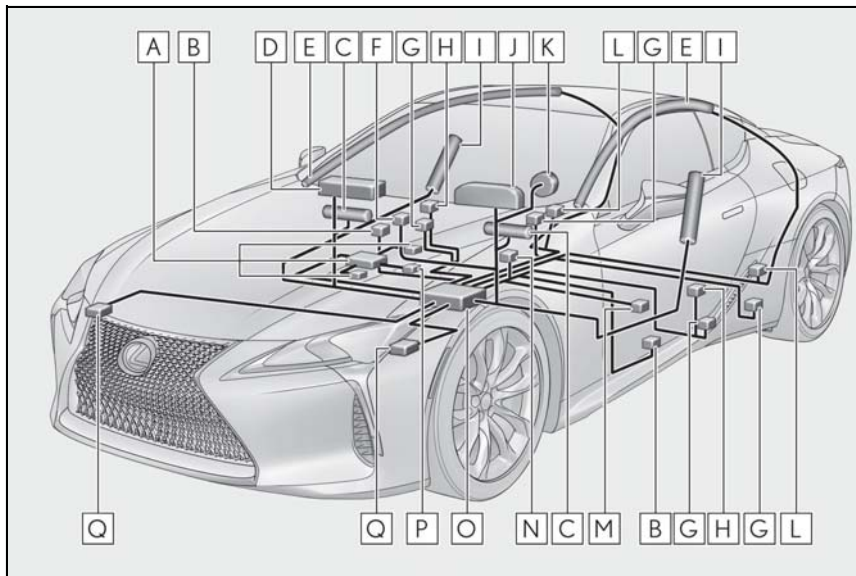

- A** Système de classification de l'occupant du siège du passager avant (ECU et capteurs)
- B** Capteurs d'impact latéral (portière)
- C** Coussins gonflables de protection des genoux
- D** Coussin gonflable du passager avant
- E** Coussins gonflables en rideau
- F** Voyants "AIR BAG ON" et "AIR BAG OFF"
- G** Limiteurs de force et dispositifs de tension des ceintures de sécurité
- H** Capteurs d'impact latéral (avant)
- I** Coussins gonflables latéraux avant
- J** Lampe témoin SRS
- K** Coussin gonflable du conducteur
- L** Capteurs d'impact latéral (arrière)
- M** Capteur de position du siège du conducteur
- N** Contacteur de boucle de ceinture de sécurité du conducteur

- O** Module de capteur de coussin gonflable
- P** Contacteur de boucle de ceinture de sécurité du passager avant
- Q** Capteurs d'impact avant

Votre véhicule est doté de COUSSINS GONFLABLES ÉVOLUÉS dont la conception s'appuie sur les normes de sécurité des véhicules à moteur américains (FMVSS208). Le module de capteur de coussin gonflable (ECU) contrôle le déploiement des coussins gonflables en fonction des informations obtenues des capteurs et d'autres éléments affichés dans le diagramme des composants du système ci-dessus. Ces informations comprennent des données relatives à la gravité de l'accident et aux occupants. Au moment du déploiement des coussins gonflables, une réaction chimique se produit dans les gonfleurs de coussin gonflable et les coussins gonflables se remplissent rapidement d'un gaz non toxique pour aider à limiter le mouvement des occupants.

**AVERTISSEMENT****■ Précautions relatives aux coussins gonflables SRS**

Observez les précautions suivantes en ce qui concerne les coussins gonflables SRS.

Les négliger pourrait occasionner des blessures graves, voire mortelles.

- Le conducteur et tous les passagers du véhicule doivent porter leur ceinture de sécurité de la manière appropriée. Les coussins gonflables SRS sont des dispositifs supplémentaires qui doivent être utilisés avec les ceintures de sécurité.

### ⚠ AVERTISSEMENT

- Le coussin gonflable SRS du conducteur se déploie avec une force considérable et peut occasionner des blessures graves, voire mortelles, notamment lorsque le conducteur se trouve très près du coussin gonflable. La National Highway Traffic Safety Administration (NHTSA), aux États-Unis, fait les recommandations suivantes :  
La zone à risque du coussin gonflable du conducteur couvre 2 à 3 in. (50 à 75 mm) de la zone de déploiement du coussin gonflable. Pour assurer une marge de sécurité suffisante, restez à 10 in. (250 mm) du coussin gonflable. Cette distance est mesurée depuis le centre du volant jusqu'à votre sternum. Si maintenant vous vous tenez assis à moins de 10 in. (250 mm), vous pouvez changer votre position de conduite de plusieurs manières :
  - Reculez votre siège à la position maximale vous permettant d'atteindre encore aisément les pédales.
  - Inclinez légèrement le dossier du siège. Bien que les véhicules soient conçus différemment, la plupart des conducteurs peuvent maintenir une distance de 10 in. (250 mm), même si leur siège se trouve complètement vers l'avant, simplement en inclinant un peu le dossier du siège vers l'arrière. Si la visibilité avant est moindre après avoir incliné le dossier de votre siège, utilisez un coussin ferme et non glissant pour être assis plus haut ou relevez le siège si cette option est disponible sur votre véhicule.
  - Si votre volant est réglable en hauteur, inclinez-le vers le bas. Cela vous permet d'orienter le coussin gonflable vers votre buste plutôt que vers votre tête et vers votre cou.

Le siège doit être réglé de la manière recommandée ci-dessus par la NHTSA, tout en gardant le contrôle des pédales et du volant, ainsi que la vue sur les commandes du tableau de bord.

- Si la rallonge de ceinture de sécurité a été reliée à la boucle des ceintures de sécurité des sièges avant sans avoir aussi été attachée à la plaque de blocage des ceintures de sécurité, les coussins gonflables SRS avant considéreront que le conducteur et le passager avant portent tout de même leur ceinture de sécurité même si les ceintures de sécurité ne sont pas attachées. Les coussins gonflables SRS avant peuvent alors ne pas s'activer correctement lors d'une collision, ce qui pourrait occasionner des blessures graves, voire mortelles, en cas de collision. Assurez-vous de toujours porter la ceinture de sécurité avec la rallonge de ceinture de sécurité.

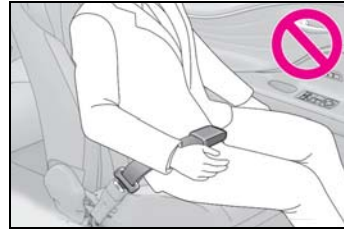

- Le coussin gonflable SRS du passager avant se déploie également avec une force considérable et peut occasionner des blessures graves, voire mortelles, notamment lorsque le passager avant se trouve très près du coussin gonflable. Le siège du passager avant doit se trouver le plus loin possible du coussin gonflable et le dossier doit être réglé de manière à ce que le passager avant soit assis bien droit.

### ⚠ AVERTISSEMENT

- Le déploiement d'un coussin gonflable risque d'infliger des blessures graves, voire mortelles, aux bébés et aux enfants mal assis et/ou mal attachés. Un bébé ou un enfant trop petit pour utiliser une ceinture de sécurité doit être correctement retenu à l'aide d'un dispositif de retenue pour enfants. Lexus recommande vivement de placer et d'attacher correctement tous les bébés et tous les enfants sur les sièges arrière du véhicule à l'aide de dispositifs de retenue adaptés. Les sièges arrière sont plus sécuritaires pour les bébés et les enfants que le siège du passager avant.
- N'installez jamais un dispositif de retenue pour enfants de type dos à la route sur le siège du passager avant, même si le voyant "AIR BAG OFF" est allumé. En cas d'accident, la force et la vitesse de déploiement du coussin gonflable du passager avant pourraient infliger à l'enfant des blessures graves, voire mortelles, si le dispositif de retenue pour enfants de type dos à la route était installé sur le siège du passager avant.
- Ne vous asseyez pas sur le bord du siège et ne vous appuyez pas sur la planche de bord.

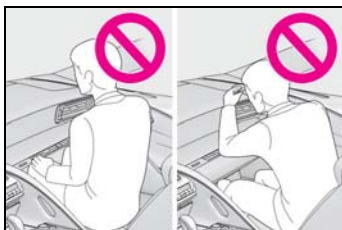

- Ne laissez pas un enfant se tenir face au coussin gonflable SRS du passager avant ni s'asseoir sur les genoux d'un passager avant.



- Ne laissez pas les occupants des sièges avant tenir des objets sur leurs genoux.
- Ne vous appuyez pas sur la portière ou sur le brancard de pavillon, ni sur les montants avant, latéraux ou arrière.



- Ne laissez personne s'agenouiller face à la portière sur le siège du passager ni sortir la tête ou les mains à l'extérieur du véhicule.





### ⚠ AVERTISSEMENT

- Ne fixez et n'appuyez rien sur des zones telles que la planche de bord, le tampon de volant ou encore la partie inférieure du tableau de bord. Ces objets peuvent se transformer en projectiles lorsque les coussins gonflables SRS du conducteur, du passager avant et de protection des genoux se déploient.

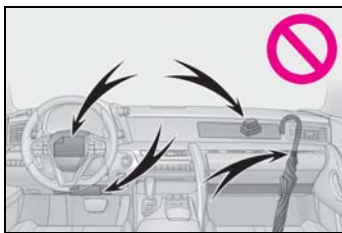

- Ne fixez rien sur des zones telles que les portières, le pare-brise, les glaces latérales, les montants avant ou arrière, et le brancard de pavillon.

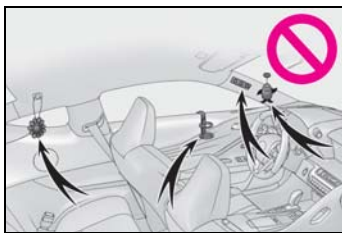

- N'accrochez pas de cintres ni d'autres objets rigides sur les crochets porte-vêtements. Tous ces objets pourraient se transformer en projectiles et vous occasionner des blessures graves, voire mortelles, en cas de déploiement des coussins gonflables SRS en rideau.
- Si un recouvrement de vinyle est placé sur la zone de déploiement du coussin gonflable SRS de protection des genoux, veuillez à le retirer.

- N'utilisez pas d'accessoires recouvrant les parties du siège où les coussins gonflables SRS latéraux se déploient, car ces accessoires pourraient entraver le déploiement des coussins gonflables SRS. De tels accessoires peuvent empêcher les coussins gonflables latéraux de se déployer correctement, rendre le système inopérant ou provoquer accidentellement le déploiement des coussins gonflables latéraux, occasionnant des blessures graves, voire mortelles.

- Ne frappez pas et n'appliquez pas une pression importante à l'emplacement des portières ou des composants des coussins gonflables SRS. Cela peut provoquer un mauvais fonctionnement des coussins gonflables SRS.

- Ne touchez à aucun composant des coussins gonflables SRS immédiatement après leur déploiement (gonflage), car ils pourraient être chauds.

- Si vous avez de la difficulté à respirer après le déploiement des coussins gonflables SRS, ouvrez une portière ou une glace pour laisser entrer l'air frais, ou quittez le véhicule si vous pouvez le faire en toute sécurité. Dès que possible, nettoyez tous les résidus afin d'éviter les irritations cutanées.

- Si les emplacements de stockage des coussins gonflables SRS, tels que le tampon de volant et les garnitures des montants avant et arrière, sont endommagés ou fissurés, faites-les remplacer par votre concessionnaire Lexus.

- Ne placez aucun objet, par exemple un coussin, sur le siège du passager avant. Cela disperserait le poids du passager, ce qui empêcherait le capteur de le détecter correctement. Cela pourrait empêcher le déploiement des coussins gonflables SRS du passager avant en cas de collision.

### ⚠ AVERTISSEMENT

#### ■ Modification et mise au rebut des composants du système de coussins gonflables SRS

Ne mettez pas votre véhicule au rebut et n'effectuez aucune des modifications suivantes sans d'abord consulter votre concessionnaire Lexus. Les coussins gonflables SRS pourraient fonctionner de manière incorrecte ou se déployer (gonfler) accidentellement, ce qui serait susceptible d'occasionner des blessures graves, voire mortelles.

- Installation, retrait, démontage et réparation des coussins gonflables SRS
- Réparations, modifications, retrait ou remplacement du volant, du tableau de bord, de la planche de bord, des sièges ou du capitonnage des sièges, des montants avant, latéraux et arrière, des brancards de pavillon, des panneaux des portières, des garnitures des portières ou des haut-parleurs des portières
- Modifications du panneau de la portière (comme le perforer)
- Réparations ou modifications de l'aile avant, du pare-chocs avant ou du côté de l'habitacle
- Installation d'une protection de calandre (barre safari, barre kangourou, etc.), de lames de déneigement, de treuils ou d'un porte-bagages de toit
- Modifications du système de suspension du véhicule
- Installation d'appareils électroniques tels qu'un émetteur-récepteur radio ou un lecteur de CD
- Modifications à votre véhicule pour une personne aux capacités physiques réduites

### Headlight aim instructions for Canadian owners (in French)

The following is a French explanation of headlight aim instructions from the headlight aim section in this manual.

#### Boulons de réglage vertical

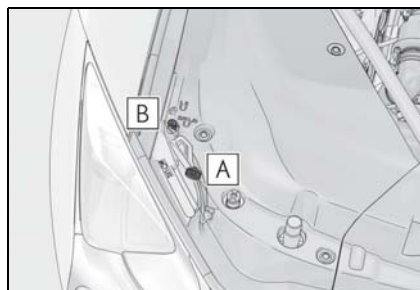

**A** Boulon de réglage A

**B** Boulon de réglage B

#### Avant de vérifier la portée des phares

- Assurez-vous que le réservoir de carburant du véhicule est plein et que la partie de carrosserie située autour des phares n'est pas déformée.
- Garez le véhicule sur un sol parfaitement horizontal.
- Assurez-vous que la pression de gonflage des pneus est au niveau prescrit.
- Demandez à quelqu'un de s'asseoir sur le siège du conducteur.

- Faites rebondir le véhicule à plusieurs reprises.

### Réglage de la portée des phares

- 1 Tournez le boulon A vers la droite ou vers la gauche à l'aide d'un tournevis cruciforme.

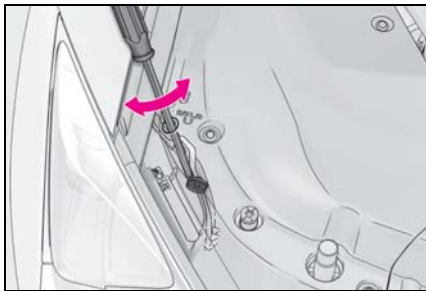

- 2 Tournez le boulon B vers la droite ou vers la gauche comme à l'étape 1.

Si vous n'arrivez pas à régler vos phares en suivant cette procédure, apportez le véhicule chez votre concessionnaire Lexus afin qu'il règle la portée des phares.

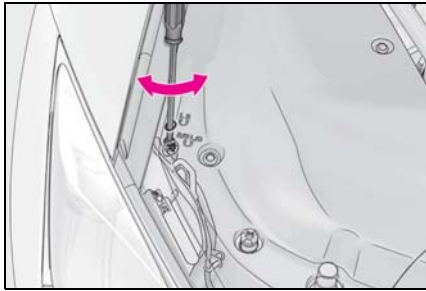



**Index**

**417**

What to do if... (Troubleshooting)

..... **418**

Alphabetical index ..... **420**

## What to do if... (Troubleshooting)

If you have a problem, check the following before contacting your Lexus dealer.

### The doors cannot be locked, unlocked, opened or closed



#### You lose your keys

- If you lose your mechanical keys, new genuine mechanical keys can be made by your Lexus dealer. (→P.354)
- If you lose your electronic keys, the risk of vehicle theft increases significantly. Contact your Lexus dealer immediately. (→P.354)



#### The doors cannot be locked or unlocked

- Is the electronic key battery weak or depleted? (→P.318)
- Is the engine switch <power switch> in IGNITION ON mode <ON mode>?

When locking the doors, turn the engine switch <power switch> off. (→P.148, 152)

- Is the electronic key left inside the vehicle?

When locking the doors, make sure that you have the electronic key on your person.

- The function may not operate properly due to the condition of the radio

wave. (→P.115)



#### The trunk lid is closed with the electronic key left inside

- The function to prevent the electronic key from being left inside the trunk will operate and you can open the trunk as usual. Take the key out from the trunk. (→P.112)

### If you think something is wrong



#### The engine <hybrid system> does not start

- Did you press the engine switch <power switch> while firmly depressing the brake pedal? (→P.146, 149)
- Is the shift position in P? (→P.155, 161)
- Is the electronic key anywhere detectable inside the vehicle? (→P.114)
- Is the steering wheel unlocked? (→P.147, 150)
- Is the electronic key battery weak or depleted?

In this case, the engine <hybrid system> can be started in a temporary way. (→P.356)

- Is the 12-volt battery discharged? (→P.357)



#### The steering wheel cannot be turned after the engine <hybrid system> is stopped

- It is locked automatically to prevent theft of the vehicle. (→P.147, 150)



**The windows do not open or close by operating the power window switches**

- Is the window lock switch pressed?

The power window at the passenger's seat cannot be operated if the window lock switch is pressed. (→P.133)



**The engine switch <power switch> is turned off automatically**

- The auto power off function will be operated if the vehicle is left in ACCESSORY or IGNITION ON mode <ON mode> (the engine is not running <hybrid system is not operating>) for a period of time. (→P.149, 152)



**A warning buzzer sounds during driving**

- The seat belt reminder light is flashing

Are the driver and the passengers wearing the seat belts? (→P.339)

- The parking brake indicator is on
- Is the parking brake released? (→P.168)

Depending on the situation, other types of warning buzzer may also sound. (→P.335, 344)



**An alarm is activated and the horn sounds**

- Did anyone inside the vehicle open

a door during setting the alarm?

The sensor detects it and the alarm sounds. (→P.71)

To stop the alarm, turn the engine switch <power switch> to IGNITION ON mode <ON mode>, or start the engine <hybrid system>.



**A warning buzzer sounds when leaving the vehicle**

- Is the electronic key left inside the vehicle?

Check the message on the multi-information display. (→P.344)



**A warning light turns on or a warning message is displayed**

- When a warning light turns on or a warning message is displayed, refer to P.335, 344.

## When a problem has occurred



**If you have a flat tire**

- Slow down the vehicle, drive with extra caution, and take your vehicle to the nearest Lexus dealer or authorized tire dealer as soon as possible to have the tire replaced. (→P.350)



**The vehicle becomes stuck**

- Try the procedure for when the vehicle becomes stuck in mud, dirt, or snow. (→P.370)

## Alphabetical index

### A

- A/C ..... 248
  - Air conditioning filter ..... 316
  - Automatic air conditioning system... 248
  - Micro dust and pollen filter ..... 253
- ABS (Anti-lock Brake System) ..... 231
  - Function ..... 231
  - Warning light ..... 336
- Active rear wing ..... 229
- Adaptive Variable Suspension System 232
- Airbags ..... 28
  - Airbag operating conditions ..... 30
  - Airbag precautions for your child ..... 33
  - Correct driving posture ..... 23
  - Curtain shield airbag operating conditions ..... 30
  - Curtain shield airbag precautions ..... 33
  - Front passenger occupant classification system ..... 38
  - General airbag precautions ..... 33
  - Locations of airbags ..... 28
  - Modification and disposal of airbags . 35
  - Side airbag operating conditions ..... 30
  - Side airbag precautions ..... 33
  - Side and curtain shield airbags operating conditions ..... 30
  - Side and curtain shield airbags precautions ..... 33
  - SRS airbags ..... 28
  - SRS warning light ..... 336
- Air conditioning filter ..... 316
- Air conditioning system ..... 248
  - Air conditioning filter ..... 316
  - Automatic air conditioning system... 248
  - Micro dust and pollen filter ..... 253
- Alarm ..... 71
  - Alarm ..... 71
  - Warning buzzer ..... 335
- Anchor brackets ..... 44, 52
- Antennas (smart access system with push-button start) ..... 113
- Anti-lock Brake System (ABS) ..... 231
  - Function ..... 231
  - Warning light ..... 336
- Approach warning ..... 209
- Automatic headlight leveling system ... 174
- Automatic High Beam ..... 176
- Automatic light control system ..... 173
- Automatic transmission ..... 155
  - M mode ..... 160
  - Paddle shift switches ..... 159, 160
  - Snow mode ..... 159
- Auxiliary net ..... 260
- Average fuel economy ..... 85
- Average vehicle speed ..... 85

### B

- Back-up lights
  - Replacing light bulbs ..... 324
- Battery (12-volt battery) ..... 299
  - Battery checking ..... 299
  - If the 12-volt battery is discharged ... 357
  - Preparing and checking before winter ..... 238
  - Replacing ..... 361
  - Warning light ..... 335
- Battery (traction battery) ..... 64
- Blind Spot Monitor (BSM) ..... 220
  - Blind Spot Monitor function ..... 223
  - Rear Cross Traffic Alert function ..... 226
- Brake
  - Brake hold ..... 171
  - Fluid ..... 378
  - Parking brake ..... 168
  - Regenerative braking ..... 62
  - Warning light ..... 335, 339
  - Warning message ..... 345
- Brake assist ..... 231
- Break-in tips ..... 137
- Brightness control
  - Instrument panel light control ..... 83
- BSM (Blind Spot Monitor) ..... 220
  - Blind Spot Monitor function ..... 223



Rear Cross Traffic Alert function..... 226

**C**

**Care**..... 274, 277  
 Aluminum wheels..... 275  
 Exterior..... 274  
 Interior..... 277  
 Seat belts..... 277  
**Cargo capacity**..... 144  
**Cargo hooks**..... 262  
**Center Display**..... 242  
**Chains**..... 239  
**Child restraint system**..... 43  
 Fixed with a LATCH system..... 50  
 Fixed with a seat belt..... 47  
 Front passenger occupant classification system..... 38  
 Points to remember..... 43  
 Riding with children..... 43  
 Types of child restraint system installation method..... 44  
 Using an anchor bracket..... 52  
**Child safety**..... 43  
 12-volt battery precautions..... 300, 363  
 Airbag precautions..... 33  
 Child restraint system..... 44  
 Heated steering wheel and seat heater precautions..... 255  
 How your child should wear the seat belt..... 25  
 Power window lock switch..... 133  
 Power window precautions..... 133  
 Removed electronic key battery precautions..... 319  
 Seat belt extender precautions..... 25  
 Seat belt precautions..... 43  
 Trunk precautions..... 110  
**Cleaning**..... 274, 277  
 Aluminum wheels..... 275  
 Exterior..... 274  
 Interior..... 277  
 Radar sensor..... 186, 222

Seat belts..... 277  
**Clock**..... 264  
**Coat hooks**..... 265  
**Condenser**..... 297  
**Console box**..... 261  
**Console box light**..... 261  
**Cooling system**..... 296  
 Engine overheating..... 364, 366  
 Hybrid system overheating..... 367  
**Cornering lights**..... 175  
**Cruise control**  
 Dynamic radar cruise control with full-speed range..... 203  
**Cup holder**..... 261  
**Current fuel consumption**..... 85  
**Curtain shield airbags**..... 28  
**Customizable features**..... 391

**D**

**Daytime running light system**..... 173  
**Defogger**  
 Outside rear view mirrors..... 249  
 Rear window..... 249  
 Windshield..... 249  
**Differential**..... 378  
**Dimension**..... 372  
**Dinghy towing**..... 145  
**Display**  
 BSM (Blind Spot Monitor)..... 220  
 Drive information..... 85  
 Dynamic radar cruise control with full-speed range..... 203  
 Energy monitor..... 95  
 Head-up display..... 90  
 Intuitive parking assist..... 214  
 LKA (Lane-Keeping Assist)..... 199  
 Multi-information display..... 84  
 Warning message..... 344  
**Distance**..... 85  
**Do-it-yourself maintenance**..... 284  
**Door courtesy lights**..... 258

Door lock  
 Doors..... 106  
   Smart access system with push-button start..... 113  
   Wireless remote control..... 104  
 Door pockets ..... 260  
 Doors..... 106  
   Automatic door locking and unlocking system ..... 109  
   Door glasses ..... 132  
   Door lock..... 106  
   Open door warning buzzer ..... 107, 109  
   Outside rear view mirrors ..... 129  
 Drive info 1/Drive info 2 ..... 85  
 Drive information ..... 85  
 Driver's seat position memory ..... 122  
   Driving position memory..... 122  
   Memory recall function ..... 123  
 Drive-start control ..... 137  
 Driving..... 136  
   Break-in tips..... 137  
   Correct driving posture ..... 23  
   Driving mode select switch ..... 213  
   Hybrid vehicle driving tips ..... 236  
   Procedures ..... 136  
   Winter drive tips..... 238  
 Driving mode select switch..... 213  
 DRS (Dynamic Rear Steering) ..... 232  
 Dynamic radar cruise control with full-speed range..... 203  
   Warning message..... 211  
 Dynamic Rear Steering (DRS) ..... 232

**E**

ECB (Electronically Controlled Brake System)..... 231  
 Eco drive mode ..... 213  
 Eco Driving Indicator..... 78  
 Eco Driving Indicator Light ..... 78  
 EDR (Event data recorder)..... 8  
 Elapsed time ..... 85  
 Electric motor (traction motor)..... 61

Electric Power Steering (EPS)  
   Function ..... 232  
   Warning light ..... 336  
 Electronically Controlled Brake System (ECB) ..... 231  
 Electronic key ..... 102  
   Battery-saving function..... 115  
   If the electronic key does not operate properly ..... 355  
   Replacing the battery..... 318  
 Emergency, in case of  
   If a warning buzzer sounds..... 335  
   If a warning light turns on..... 335  
   If a warning message is displayed ..... 344  
   If the 12-volt battery is discharged ..... 357  
   If the electronic key does not operate properly ..... 355  
   If the engine will not start..... 351  
   If the fuel filler door cannot be opened ..... 354  
   If the hybrid system will not start ..... 352  
   If the vehicle is trapped in rising water ..... 327  
   If you have a flat tire ..... 350  
   If you lose your keys ..... 354  
   If you think something is wrong..... 333  
   If your vehicle becomes stuck ..... 370  
   If your vehicle has to be stopped in an emergency..... 326  
   If your vehicle needs to be towed ..... 329  
   If your vehicle overheats ..... 364, 366  
 Emergency flashers ..... 326  
 Energy monitor ..... 95  
 Engine  
   ACCESSORY mode..... 148, 152  
   Compartment..... 292  
   Engine switch..... 146  
   Fuel pump shut off system..... 334  
   Hood..... 290  
   How to start the engine ..... 146  
   How to start the hybrid system..... 149  
   Identification number ..... 372

If the engine will not start .....	351
If the hybrid system will not start .....	352
If your vehicle has to be stopped in an emergency .....	326
Ignition switch (engine switch) .....	146
Ignition switch (power switch) .....	149
Overheating .....	364, 366
Power switch .....	149
<b>Engine coolant</b> .....	<b>296</b>
Capacity .....	376
Checking .....	296
Preparing and checking before winter .....	238
<b>Engine coolant temperature gauge</b> .....	<b>80</b>
<b>Engine immobilizer system</b> .....	<b>69</b>
<b>Engine oil</b> .....	<b>293</b>
Capacity .....	374
Checking .....	293
Preparing and checking before winter .....	238
Warning light .....	335
Warning message .....	347
<b>Engine oil maintenance data</b> .....	<b>295</b>
<b>Engine oil temperature gauge</b> .....	<b>80</b>
<b>Engine switch (power switch)</b> .....	<b>146, 149</b>
Auto power off function .....	149, 152
Changing the engine switch (power switch) modes .....	148, 152
If your vehicle has to be stopped in an emergency .....	326
Starting the engine (hybrid system) .....	146, 149
<b>EPS (Electric Power Steering)</b> .....	<b>232</b>
Function .....	232
Warning light .....	336
<b>EV drive mode</b> .....	<b>153</b>
<b>Event data recorder (EDR)</b> .....	<b>8</b>
<b>EV indicator</b> .....	<b>62</b>

## F

<b>First-aid kit storage belt</b> .....	<b>262</b>
<b>Flat tire</b> .....	<b>350</b>
Tire pressure warning system .....	303

<b>Floor mats</b> .....	<b>22</b>
<b>Fluid</b>	
Automatic transmission .....	377
Brake .....	378
Hybrid transmission .....	377
Washer .....	298
<b>Footwell light</b> .....	<b>258</b>
<b>Front passenger occupant classification   system</b> .....	<b>38</b>
<b>Front seats</b> .....	<b>120</b>
Adjustment .....	120
Cleaning .....	277
Correct driving posture .....	23
Driving position memory .....	122
Head restraints .....	125
Jam protection function .....	121
Memory recall function .....	123
Seat heaters .....	255
Seat position memory .....	122
Seat ventilators .....	255
<b>Front side marker light</b> .....	<b>173</b>
Light switch .....	173
Replacing light bulbs .....	324
<b>Front turn signal lights</b> .....	<b>167</b>
Replacing light bulbs .....	324
Turn signal lever .....	167
<b>Fuel</b> .....	<b>182</b>
Capacity .....	373
Fuel gauge .....	80
Fuel pump shut off system .....	334
Information .....	381
Refueling .....	182
Type .....	373
Warning light .....	339
<b>Fuel consumption</b>	
Average fuel consumption after refueling .....	85
Average fuel economy .....	85
Current fuel consumption .....	85
<b>Fuel filler door</b> .....	<b>182</b>
If the fuel filler door cannot be opened .....	354

Refueling .....182  
 Fuel gauge.....80  
 Fuel pump shut off system.....334  
 Fuses .....319

**G**

Garage door opener ..... 266  
 Gauges .....80  
 Glove box.....260  
 Glove box light.....260  
 Grocery bag hooks ..... 262

**H**

Headlights ..... 173  
     Automatic High Beam system.....176  
     Light switch.....173  
     Replacing light bulbs.....324  
 Headlights aim.....323  
 Head restraints.....125  
 Head-up display.....90  
 Heated steering wheel.....255  
 Heaters  
     Air conditioning system.....248  
     Heated steering wheel.....255  
     Outside rear view mirrors .....249  
     Seat heaters.....255  
 High-voltage components ..... 64  
 Hill-start assist control.....232  
 Hood.....290  
     Open .....290  
     Pop Up Hood.....36  
 Hooks  
     Cargo hooks.....262  
     Coat hooks.....265  
     Grocery bag hooks .....262  
     Retaining hooks (floor mat).....22  
 Horn.....127  
 Hybrid battery (traction battery)  
     Location.....64  
     Specification.....374  
     Warning message.....67

Hybrid battery (traction battery) air vents  
     .....67  
 Hybrid system.....61  
     Emergency shut off system.....67  
     Energy monitor/consumption screen95  
     EV drive mode.....153  
     High voltage components .....64  
     Hybrid System Indicator .....94  
     Hybrid system precautions.....64  
     Hybrid vehicle driving tips .....236  
     If the hybrid system will not start .....352  
     Overheating.....367  
     Power (ignition) switch.....149  
     Regenerative braking .....62  
     Starting the hybrid system.....149  
     Vehicle proximity notification system.63  
 Hybrid System Indicator.....94  
 Hybrid transmission.....161  
     M mode .....166  
     Paddle shift switches .....165,166  
     Snow mode.....165

**I**

I/M test .....287  
 Identification  
     Engine.....372  
     Vehicle .....372  
 Ignition switch (engine switch).....146  
     Auto power off function.....149  
     Changing the engine switch modes.148  
     If your vehicle has to be stopped in an  
         emergency.....326  
     Starting the engine .....146  
 Ignition switch (power switch) .....149  
     Auto power off function.....152  
     Changing the power switch modes .152  
     If your vehicle has to be stopped in an  
         emergency.....326  
     Starting the hybrid system.....149  
 Illuminated entry system .....258  
 Immobilizer system.....69  
 Indicators .....76

**Initialization**  
 Items to initialize ..... 403  
 Maintenance ..... 283, 295  
 Power windows ..... 132  
 Tire pressure warning system ..... 306  
**Inside rear view mirror** ..... 128  
**Instrument panel light control** ..... 83  
**Interior lights** ..... 258  
**Intuitive parking assist** ..... 214  
 Function ..... 214  
 Warning message ..... 216

**J**

**Jack**  
 Positioning a floor jack ..... 290  
 Vehicle-equipped jack ..... 310  
**Jack handle** ..... 310  
**Jam protection function**  
 Front seats ..... 121  
 Power windows ..... 132

**K**

**Keyless entry**  
 Smart access system with push-button  
 start ..... 113  
 Wireless remote control ..... 104  
**Keys** ..... 102  
 Battery-saving function ..... 115  
 Electronic key ..... 102  
 Engine switch ..... 146  
 If the electronic key does not operate  
 properly ..... 355  
 If you lose your keys ..... 354  
 Key number plate ..... 102  
 Keyless entry ..... 106, 113  
 Mechanical key ..... 102  
 Power switch ..... 149  
 Replacing the battery ..... 318  
 Warning buzzer ..... 114  
 Wireless remote control ..... 104  
**Knee airbags** ..... 28

**L**

**Lane-Keeping Assist (LKA)** ..... 196  
 Operation ..... 196  
 Warning messages ..... 202  
**Language (multi-information display)** ... 88  
**LATCH anchors** ..... 50  
**LDH (Lexus Dynamic Handling system)**  
 ..... 232  
**Lever**  
 Auxiliary catch lever ..... 290  
 Hood lock release lever ..... 290  
 Internal trunk release lever ..... 112  
 Shift lever ..... 155, 161  
 Turn signal lever ..... 167  
 Wiper lever ..... 178  
**Lexus climate concierge** ..... 246  
**Lexus Dynamic Handling system (LDH)**  
 ..... 232  
**Lexus Enform Safety Connect** ..... 54  
**Lexus Safety System +** ..... 184  
 Automatic High Beam ..... 176  
 Dynamic radar cruise control with full-  
 speed range ..... 203  
 LKA (Lane-Keeping Assist) ..... 196  
 PCS (Pre-Collision System) ..... 189  
**License plate lights** ..... 173  
 Light switch ..... 173  
 Replacing light bulbs ..... 324  
**Light bulbs**  
 Replacing ..... 324  
 Wattage ..... 380  
**Lights**  
 Automatic High Beam system ..... 176  
 Headlight switch ..... 173  
 Illuminated entry system ..... 258  
 Interior lights list ..... 258  
 Interior lights ..... 258  
 Personal lights ..... 259  
 Replacing light bulbs ..... 324  
 Trunk light ..... 112  
 Turn signal lever ..... 167

Vanity lights .....264  
 Wattage.....380  
 Welcome light illumination control...174  
**LKA (Lane-Keeping Assist).....196**  
     Operation.....196  
     Warning messages .....202  
**Lock steering column .....147, 150**  
**Low profile tire.....302**

**M**

**Maintenance**  
     Do-it-yourself maintenance .....288  
     General maintenance .....284  
     Maintenance data.....372  
     Maintenance requirements .....283  
**Malfunction indicator lamp .....336**  
**Master warning light .....340**  
**Meter**  
     Changing the display .....83  
     Head-up display .....90  
     Indicators .....76  
     Instrument panel light control .....83  
     Meters .....80  
     Multi-information display.....84  
     Operating the meter control switches85  
     Settings .....88  
     Warning lights.....335  
     Warning message.....344  
**Micro dust and pollen filter .....253**  
**Mirrors**  
     Inside rear view mirror.....128  
     Outside rear view mirror defoggers249  
     Outside rear view mirrors .....129  
     Vanity mirrors.....264  
**Multi-information display .....84**  
     Audio system-linked .....88  
     Drive information.....85  
     Dynamic radar cruise control with full-  
         speed range.....203  
     Eco Driving Indicator .....78  
     Energy monitor.....96  
     Gear positions .....86

G-force.....87  
 Hybrid System Indicator .....78  
 LKA (Lane-Keeping Assist).....199  
 Navigation system-linked.....88  
 Rear wing position .....88  
 Settings.....88  
 Switching the display.....85  
 Tire pressure .....303  
 Warning message.....344

**N**

**Noise from under vehicle .....6**

**O**

**Odometer .....80**  
**Oil**  
     Differential oil .....378  
     Engine oil.....374  
**Opener**  
     Fuel filler door.....182  
     Hood.....290  
     Trunk .....111  
**Outside door handle lights.....258**  
**Outside rear view mirrors .....129**  
     Adjustment.....129  
     BSM (Blind Spot Monitor).....220  
     Folding.....130  
     Linked mirror function when reversing  
         .....130  
     Mirror position memory .....122  
     Outside rear view mirror defoggers249  
**Outside temperature.....80**  
**Overheating .....364, 366**

**P**

**Paddle shift switches ..... 159, 160, 165, 166**  
**Panic mode ..... 104**  
**Parking assist sensors (intuitive parking  
 assist) ..... 214**  
**Parking brake..... 168**

Indicator .....	338
Operation.....	168
Parking brake engaged warning buzzer .....	170
Warning message.....	170
<b>Parking lights.....</b>	<b>173</b>
Light switch.....	173
Replacing light bulbs.....	324
<b>PCS (Pre-Collision System).....</b>	<b>189</b>
Function.....	189
PCS OFF switch.....	191
Warning light.....	337
Warning message.....	195
<b>Personal lights.....</b>	<b>258</b>
<b>Pop-up display.....</b>	<b>82</b>
<b>Pop Up Hood.....</b>	<b>36</b>
<b>Power control unit.....</b>	<b>64</b>
<b>Power control unit coolant.....</b>	<b>296</b>
Capacity.....	376
Checking.....	296
Preparing and checking before winter .....	238
<b>Power outlet.....</b>	<b>264</b>
<b>Power steering (Electric power steering system).....</b>	<b>232</b>
Warning light.....	336
Warning message.....	345
<b>Power switch (engine switch) .....</b>	<b>146, 149</b>
Auto power off function .....	149, 152
Changing the power switch (engine switch) modes.....	148, 152
If your vehicle has to be stopped in an emergency .....	326
Starting the hybrid system (engine) 146, 149	
<b>Power windows.....</b>	<b>132</b>
Door lock linked window operation..	133
Jam protection function.....	133
Operation.....	132
Window lock switch .....	133
<b>Pre-Collision System (PCS).....</b>	<b>189</b>
Function.....	189

PCS OFF switch.....	191
Warning light.....	337
Warning message.....	195

## R

<b>Radar cruise control (dynamic radar cruise control with full-speed range).....</b>	<b>203</b>
<b>Radiator.....</b>	<b>297</b>
<b>Rear side marker lights .....</b>	<b>173</b>
Light switch .....	173
Replacing light bulbs.....	324
<b>Rear turn signal lights .....</b>	<b>167</b>
Replacing light bulbs.....	324
Turn signal lever .....	167
<b>Rear view mirror</b>	
Inside rear view mirror.....	128
Outside rear view mirrors.....	129
<b>Rear window defogger .....</b>	<b>249</b>
<b>Refueling .....</b>	<b>182</b>
Capacity.....	373
Fuel types .....	373
If the fuel filler door cannot be opened .....	354
Opening the fuel tank cap .....	182
<b>Regenerative braking.....</b>	<b>62</b>
<b>Remote Touch.....</b>	<b>242</b>
<b>Replacing</b>	
Electronic key battery.....	318
Fuses.....	319
Light bulbs.....	324
Tires .....	309
<b>Resetting the message indicating maintenance is required.....</b>	<b>283</b>
<b>Rev indicator .....</b>	<b>81</b>
<b>Rev peak.....</b>	<b>82</b>
<b>Run-flat tires.....</b>	<b>303, 350</b>

## S

<b>Seat belt reminder light.....</b>	<b>339</b>
<b>Seat belts.....</b>	<b>24</b>
Automatic Locking Retractor.....	26

Child restraint system installation.....	44
Cleaning and maintaining the seat belt .....	277
Emergency Locking Retractor.....	26
How to wear your seat belt.....	25
How your child should wear the seat belt .....	25
Pregnant women, proper seat belt use .....	24
Reminder light and buzzer .....	339
Seat belt extender .....	25
Seat belt guide .....	26
Seat belt pretensioners.....	27
SRS warning light .....	336
<b>Seat heaters .....</b>	<b>255</b>
<b>Seating capacity .....</b>	<b>144</b>
<b>Seat lights.....</b>	<b>258</b>
<b>Seat position memory.....</b>	<b>122</b>
<b>Seats.....</b>	<b>120</b>
Adjustment precautions.....	120
Adjustment.....	120
Child seats/child restraint system installation .....	43
Cleaning.....	277
Driving position memory.....	122
Head restraints .....	125
Jam protection function.....	121
Properly sitting in the seat .....	23
Seat heaters.....	255
Seat position memory .....	122
Seat ventilators.....	255
<b>Seat ventilators .....</b>	<b>255</b>
<b>Sensor</b>	
Automatic headlight system.....	173
Automatic High Beam system.....	176
Inside rear view mirror.....	128
Intuitive parking assist.....	214
LKA (Lane-Keeping Assist).....	196
Radar sensor .....	185, 222
Rain-sensing windshield wipers.....	179
<b>Service plug .....</b>	<b>64</b>
<b>Service reminder message .....</b>	<b>283</b>
<b>Shift lever</b>	
Automatic transmission.....	155
Hybrid transmission.....	161
<b>Shift lever light .....</b>	<b>258</b>
<b>Shift position and gear position .....</b>	<b>80</b>
<b>Side airbags .....</b>	<b>28</b>
<b>Side marker lights.....</b>	<b>173</b>
Light switch .....	173
Replacing light bulbs.....	324
<b>Side mirrors .....</b>	<b>129</b>
Adjustment.....	129
BSM (Blind Spot Monitor).....	220
Folding.....	130
Linked mirror function when reversing .....	130
Mirror position memory.....	122
<b>Side turn signal lights .....</b>	<b>167</b>
Replacing light bulbs.....	324
Turn signal lever .....	167
<b>Side windows .....</b>	<b>132</b>
<b>Slip indicator .....</b>	<b>337</b>
<b>Smart access system with push-button start.....</b>	<b>113</b>
Antenna location.....	113
Entry functions.....	106
Starting the engine .....	146
Starting the hybrid system.....	149
<b>Snow mode .....</b>	<b>159, 165</b>
<b>Snow tires .....</b>	<b>238</b>
<b>Spark plug .....</b>	<b>376</b>
<b>Specifications.....</b>	<b>372</b>
<b>Speedometer .....</b>	<b>80</b>
<b>Sport mode .....</b>	<b>213</b>
<b>Steering lock</b>	
Column lock release.....	147, 150
Steering lock system warning message .....	147, 150
<b>Steering wheel.....</b>	<b>127</b>
Adjustment.....	127
Auto tilt away.....	127
Heated steering wheel.....	255
Steering wheel position memory.....	122



**Stop lights**  
 Replacing light bulbs.....324

**Storage feature** .....260

**Stuck**  
 If the vehicle becomes stuck.....370

**Sunshade**.....265

**Sun visors**.....264

**Switches**  
 “SOS” button.....54  
 Active rear wing switch.....229  
 Automatic High Beam system.....176  
 Brake Hold switch.....171  
 BSM (Blind spot monitor) switch.....221  
 Door lock switches.....108  
 Driving mode select switch.....213  
 Driving position memory switches.....122  
 Dynamic radar cruise control with full-  
 speed range switch.....204  
 Emergency flashers switch.....326  
 Engine switch.....146  
 EV drive mode switch.....153  
 Garage door opener switches.....266  
 Heated steering wheel switch.....255  
 HUD (Head-up display) switch.....90  
 Ignition switch.....146, 149  
 Instrument panel light control switch..83  
 Intuitive parking assist switch.....215  
 Light switches.....173  
 LKA (Lane-Keeping Assist) switch...198  
 Meter control switches.....85  
 Outside rear view mirror switches....129  
 Paddle shift switches. 159, 160, 165, 166  
 Parking brake switch.....168  
 PCS OFF switch.....191  
 Power door lock switch.....108  
 Power switch.....149  
 Power window switches.....132  
 Rear window and outside rear view mir-  
 ror defoggers switch.....248  
 Seat heater switches.....255  
 Seat ventilator switches.....255  
 Snow mode switch.....159, 165

Tilt and telescopic steering control switch  
 .....127

Tire pressure warning reset switch..306

Trunk opener main switch.....113

Trunk opener switch.....111

Vehicle-to-vehicle distance switch...204

VSC OFF switch.....233

Window lock switch.....133

Windshield wiper and washer switch178

Windshield wiper de-icer switch.....252

**T**

**Tachometer**.....80  
 Variable red zone.....82

**Tail lights**.....173  
 Light switch.....173  
 Replacing light bulbs.....324

**Theft deterrent system**  
 Alarm.....71  
 Engine immobilizer system.....69  
 Theft prevention labels.....72

**Tire inflation pressure**.....313  
 Maintenance data.....379  
 Tire inflation pressure display function  
 .....303  
 Warning light.....340

**Tire information**.....383  
 Glossary.....386  
 Size.....384  
 Tire identification number.....384  
 Uniform Tire Quality Grading.....385

**Tire pressure warning system**.....303  
 Function.....303  
 Initializing.....306  
 Installing tire pressure warning valves  
 and transmitters.....305  
 Registering ID codes.....308  
 Warning light.....340

**Tires**.....301  
 Chains.....239  
 Checking.....301  
 If you have a flat tire.....350

Inflation pressure.....313  
 Information.....383  
 Replacing.....309  
 Rotating tires.....303  
 Run-flat tires.....303, 350  
 Size.....379  
 Snow tires.....238  
 Tire inflation pressure display function  
     .....303  
 Tire pressure warning system.....303  
 Warning light.....340  
**Tools.....310**  
**Top tether strap.....52**  
**Total load capacity.....372**  
**Towing**  
     Dinghy towing.....145  
     Emergency towing.....329  
     Towing eyelet.....331  
     Trailer towing.....145  
**TRAC (Traction Control).....232**  
**Traction battery (hybrid battery).....64**  
     Hybrid battery (traction battery) air vents  
         .....67  
     Location.....64  
     Specification.....374  
     Warning message.....67  
**Traction Control (TRAC).....232**  
**Traction motor (electric motor).....61**  
**Trailer towing.....145**  
**Transmission**  
     Automatic transmission.....155  
     Driving mode select switch.....213  
     Hybrid transmission.....161  
     M mode.....160, 166  
     Paddle shift switches. 159, 160, 165, 166  
     Snow mode.....159, 165  
**Trip meters.....80**  
**Trunk.....110**  
     Internal trunk release lever.....112  
     Smart access system with push-button  
         start.....111  
     Trunk features.....262

Trunk grip.....112  
 Trunk light.....112  
 Trunk opener main switch.....113  
 Trunk opener switch.....111  
 Wireless remote control.....111  
**Trunk light.....112**  
**Turn signal lights.....167**  
     Replacing light bulbs.....324  
     Turn signal lever.....167

**U**

**Units.....86**

**V**

**Vanity lights.....264**  
     Wattage.....380  
**Vanity mirrors.....264**  
**Variable Gear Ratio Steering (VGRS)232**  
**VDIM (Vehicle Dynamics Integrated Man-  
 agement).....232**  
**Vehicle data recordings.....7**  
**Vehicle Dynamics Integrated Manage-  
 ment (VDIM).....232**  
**Vehicle identification number.....372**  
**Vehicle Stability Control (VSC).....231**  
**Ventilators (seat ventilators).....255**  
**VGRS (Variable Gear Ratio Steering)232**  
**VSC (Vehicle Stability Control).....231**

**W**

**Warning buzzers**  
     Approach warning.....209  
     Brake system.....335  
     Downshifting.....160, 161, 166, 167  
     Intuitive parking assist.....219  
     LKA (Lane-Keeping Assist).....196  
     Open door.....107, 109  
     Open hood.....109  
     Open trunk.....109  
     Open window.....133

Pre-collision braking.....	189	Windshield wiper de-icer .....	253
Seat belt reminder.....	339	Windshield wipers .....	178
<b>Warning label .....</b>	<b>64</b>	Position.....	180
<b>Warning lights.....</b>	<b>335</b>	Rain-sensing windshield wipers.....	178
ABS .....	336	<b>Winter driving tips.....</b>	<b>238</b>
Brake hold operated indicator .....	338	<b>Wireless remote control .....</b>	<b>104</b>
Brake Override System .....	338	Battery-Saving Function.....	115
Brake system .....	335, 339	Locking/Unlocking .....	104
Charging system .....	335	Replacing the battery.....	318
Electric power steering .....	336		
High coolant temperature .....	340		
LKA (Lane-Keeping Assist).....	337		
Low engine oil pressure.....	335		
Low fuel level.....	339		
Malfunction indicator lamp.....	336		
Master warning light .....	340		
Parking brake indicator.....	338		
Pre-collision system .....	337		
Seat belt reminder light .....	339		
Slip indicator .....	337		
SRS.....	336		
Tire pressure.....	340		
<b>Warning messages.....</b>	<b>344</b>		
<b>Warning reflector storage belt.....</b>	<b>262</b>		
<b>Washer .....</b>	<b>178</b>		
Checking .....	298		
Preparing and checking before winter .....	238		
Switch .....	178		
<b>Washing and waxing.....</b>	<b>274</b>		
<b>Weight</b>			
Cargo capacity.....	144		
Load limits .....	144		
Weight .....	372		
<b>Wheels.....</b>	<b>315</b>		
Replacing wheels.....	309		
Size.....	379		
<b>Window lock switch .....</b>	<b>133</b>		
<b>Windows .....</b>	<b>132</b>		
Power windows.....	132		
Rear window defogger .....	249		
Washer .....	178		

---

**For information regarding the equipment listed below, refer to the “NAVIGATION SYSTEM OWNER'S MANUAL”.**

- Audio/video system
- Navigation system
- Lexus parking assist monitor
- Lexus Enform

## GAS STATION INFORMATION

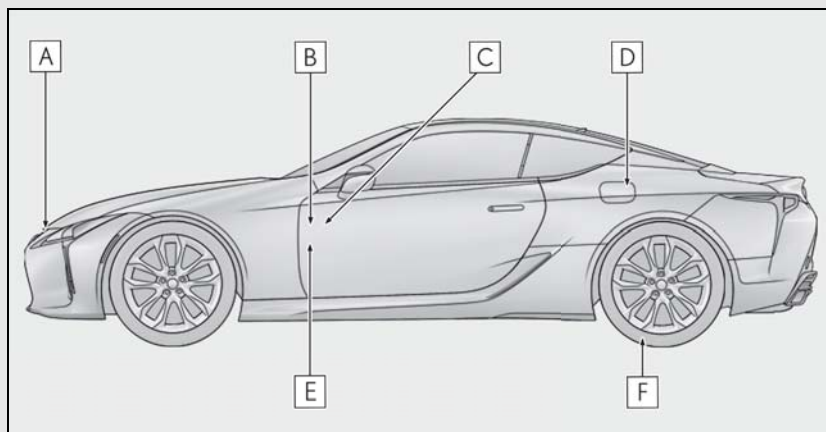

- A** Auxiliary catch lever (→P.290)
- B** Trunk opener (→P.111)
- C** Fuel filler door opener (→P.183)
- D** Fuel filler door (→P.183)
- E** Hood lock release lever (→P.290)
- F** Tire inflation pressure (→P.379)

Fuel tank capacity (Reference)	LC500	21.7 gal. (82.0 L, 18.0 Imp.gal.)	
	LC500h	22.2 gal. (84.0 L, 18.5 Imp.gal.)	
Fuel type	Unleaded gasoline only		P.373
Cold tire inflation pressure			P.379
Engine oil capacity (Drain and refill — reference)			P.374
Engine oil type			P.374, 375