

Pictorial index	Search by illustration
1 For safety and security	Make sure to read through them
2 Instrument cluster	How to read the gauges and meters, the variety of warning lights and indicators, etc.
3 Operation of each component	Opening and closing the doors and windows, adjustment before driving, etc.
4 Driving	Operations and advice which are necessary for driving
5 Interior features	Usage of the interior features, etc.
6 Maintenance and care	Caring for your vehicle and maintenance procedures
7 When trouble arises	What to do in case of malfunction or emergency
8 Vehicle specifications	Vehicle specifications, customizable features, etc.
9 For owners	Reporting safety defects for U.S. owners, and seat belt, SRS airbag and headlight aim instructions for Canadian owners
Index	Search by symptom
	Search alphabetically

2 TABLE OF CONTENTS

For your information.....	8
Reading this manual.....	12
How to search.....	13
Pictorial index.....	14

1 For safety and security

1-1. For safe use	
Before driving	26
For safe driving	28
Seat belts	30
SRS airbags	36
Front passenger occupant classification system	48
Safety information for children	54
Child restraint systems	55
Installing child restraints.....	59
Exhaust gas precautions.....	71
1-2. Theft deterrent system	
Engine immobilizer system.....	72
Alarm	74

2 Instrument cluster

2. Instrument cluster	
Warning and indicators lights	78
Gauges and meters	83
Multi-information display	86
Fuel consumption information	92

3 Operation of each component

3-1. Key information	
Keys.....	94
3-2. Opening, closing and locking the doors	
Side doors.....	98
Back door	105
Glass hatch	110
Smart access system with push-button start.....	115
3-3. Adjusting the seats	
Front seats	122
Rear seats	124
Driving position memory.....	135
Head restraints	140
3-4. Adjusting the steering wheel and mirrors	
Steering wheel.....	143
Inside rear view mirror	145
Outside rear view mirrors	147
3-5. Opening, closing the windows and moon roof	
Power windows	150
Moon roof.....	153

4 Driving

4-1. Before driving

Driving the vehicle	158
Cargo and luggage	165
Vehicle load limits	169
Trailer towing (with towing hitch)	170
Dinghy towing	188

4-2. Driving procedures

Engine (ignition) switch	189
Automatic transmission	194
Turn signal lever	200
Parking brake	201

4-3. Operating the lights and wipers

Headlight switch	202
Automatic High Beam	206
Fog light switch	211
Windshield wipers and washer	213
Rear window wiper and washer	218
Headlight cleaner switch	220

4-4. Refueling

Opening the fuel tank cap	221
---------------------------------	-----

4-5. Using the driving support systems

Cruise control	225
Dynamic radar cruise control	228
LDA (Lane Departure Alert)	239
Intuitive parking assist	245
Rear view monitor system	254
Lexus parking assist monitor	264
Wide view front & side monitor	290
Multi-terrain Select	308
Multi-terrain Monitor	313
Rear height control air suspension	337
AVS (Adaptive Variable Suspension System)	341
Four-wheel drive system	342
Crawl Control	346
Downhill assist control system	349
Driving assist systems	351
BSM (Blind Spot Monitor)	357
• The Blind Spot Monitor function	362
• The Rear Cross Traffic Alert function	365
PCS (Pre-Collision system)	368

4-6. Driving tips

Winter driving tips	377
Off-road precautions	380

5 Interior features

5-1. Using the air conditioning system and defogger

Front automatic air conditioning system.....386

Rear air conditioning system.....396

Heated steering wheel/seat heaters/seat ventilators 399

5-2. Using the interior lights

Interior lights list 402

- Personal/interior lights main switch..... 403

- Personal/interior lights 404

5-3. Using the storage features

List of storage features 405

- Glove box..... 406

- Console box 406

- Coin holder 408

- Cup holders/bottle holders/door pockets..... 408

- Auxiliary boxes 410

Luggage compartment features 412

5-4. Using the other interior features

Other interior features.....419

- Cool box.....419

- Sun visors 421

- Vanity mirror 421

- Conversation mirror 422

- Clock 422

- Power outlets 423

- Armrest..... 427

- Coat hooks..... 428

- Assist grips 428

- Compass..... 429

Garage door opener 433

LEXUS Enform Safety

Connect..... 439

6 Maintenance and care

6-1. Maintenance and care

- Cleaning and protecting the vehicle exterior 446
- Cleaning and protecting the vehicle interior 449

6-2. Maintenance

- Maintenance requirements 452
- General maintenance 455
- Emission inspection and maintenance (I/M) programs 458

6-3. Do-it-yourself maintenance

- Do-it-yourself service precautions 459
- Hood 462
- Engine compartment 463
- Tires 476
- Tire inflation pressure 483
- Wheels 487
- Air conditioning filter 489
- Electronic key battery 491
- Checking and replacing fuses 493
- Headlight aim 496
- Light bulbs 498

7 When trouble arises

7-1. Essential information

- Emergency flashers 510
- If your vehicle has to be stopped in an emergency 511

7-2. Steps to take in an emergency

- If your vehicle needs to be towed 512
- If you think something is wrong 518
- Fuel pump shut off system 519
- If a warning light turns on or a warning buzzer sounds 520
- If a warning message is displayed 528
- If you have a flat tire 542
- If the engine will not start 556
- If the electronic key does not operate properly 558
- If the vehicle battery is discharged 561
- If your vehicle overheats 564
- If the vehicle becomes stuck 567

8 Vehicle specifications

8-1. Specifications
 Maintenance data
 (fuel, oil level, etc.) 570
 Fuel information 580
 Tire information 583

8-2. Customization
 Customizable features 594
 Items to initialize 605

9 For owners

Reporting safety defects
 for U.S. owners 608

Seat belt instructions
 for Canadian owners
 (in French) 609

SRS airbag instructions
 for Canadian owners
 (in French) 611

Headlight aim instructions
 for Canadian owners
 (in French) 619

Index

What to do if...
 (Troubleshooting) 622
 Alphabetical index 626

For vehicles with a navigation system or a multimedia system, refer to the “NAVIGATION SYSTEM OWNER’S MANUAL” or “MULTIMEDIA OWNER’S MANUAL” for information regarding the equipment listed below.

- Navigation system
- Audio/video system
- Rear seat entertainment system
- Hands-free system (for cellular phone)
- Lexus Enform

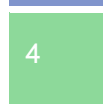

For your information

Main Owner's Manual

Please note that this manual applies to all models and explains all equipment, including options. Therefore, you may find some explanations for equipment not installed on your vehicle.

All specifications provided in this manual are current at the time of printing. However, because of the Lexus policy of continual product improvement, we reserve the right to make changes at any time without notice.

Depending on specifications, the vehicle shown in the illustrations may differ from your vehicle in terms of color and equipment.

Noise from under vehicle after turning off the engine

Approximately five hours after the engine is turned off, you may hear sound coming from under the vehicle for several minutes. This is the sound of a fuel evaporation leakage check and, it does not indicate a malfunction.

Accessories, spare parts and modification of your Lexus

A wide variety of non-genuine spare parts and accessories for Lexus vehicles are currently available in the market. You should know that Toyota does not warrant these products and is not responsible for their performance, repair, or replacement, or for any damage they may cause to, or adverse effect they may have on, your Lexus vehicle.

This vehicle should not be modified with non-genuine Lexus products. Modification with non-genuine Lexus products could affect its performance, safety or durability, and may even violate governmental regulations. In addition, damage or performance problems resulting from the modification may not be covered under warranty.

Installation of a mobile two-way radio system

The installation of a mobile two-way radio system in your vehicle could affect electronic systems such as:

- Multiport fuel injection system/sequential multiport fuel injection system
- Dynamic radar cruise control system
- Cruise control system
- Anti-lock brake system
- SRS airbag system
- Seat belt pretensioner system

Be sure to check with your Lexus dealer for precautionary measures or special instructions regarding installation of a mobile two-way radio system.

Vehicle data recordings

Your Lexus is equipped with several sophisticated computers that will record certain data, such as:

- Engine speed
- Accelerator status
- Brake status
- Vehicle speed
- Shift position

The recorded data varies according to the vehicle grade level and options with which it is equipped. These computers do not record conversations or sounds, and only record images outside of the vehicle in certain situations.

● Data Transmission

Your vehicle may transmit the data recorded in these computers to Lexus without notification to you.

● Data usage

Lexus may use the data recorded in these computers to diagnose malfunctions, conduct research and development, and improve quality.

Lexus will not disclose the recorded data to a third party except:

- With the consent of the vehicle owner or with the consent of the lessee if the vehicle is leased
- In response to an official request by the police, a court of law or a government agency
- For use by Lexus in a lawsuit
- For research purposes where the data is not tied to a specific vehicle or vehicle owner

● Usage of data collected through Lexus Enform (U.S. mainland only)

If your Lexus has Lexus Enform and if you have subscribed to those services, please refer to the Lexus Enform Telematics Subscription Service Agreement for information on data collected and its usage.

- To learn more about the vehicle data collected, used and shared by Lexus, please visit www.lexus.com/privacyvts/.

Event data recorder

This vehicle is equipped with an event data recorder (EDR). The main purpose of an EDR is to record, in certain crash or near crash-like situations, such as an air bag deployment or hitting a road obstacle, data that will assist in understanding how a vehicle's systems performed. The EDR is designed to record data related to vehicle dynamics and safety systems for a short period of time, typically 30 seconds or less.

The EDR in this vehicle is designed to record such data as:

- How various systems in your vehicle were operating;
- Whether or not the driver and passenger safety belts were buckled/fastened;
- How far (if at all) the driver was depressing the accelerator and/or brake pedal; and,
- How fast the vehicle was traveling.

These data can help provide a better understanding of the circumstances in which crashes and injuries occur.

NOTE: EDR data are recorded by your vehicle only if a non-trivial crash situation occurs; no data are recorded by the EDR under normal driving conditions and no personal data (e.g., name, gender, age, and crash location) are recorded. However, other parties, such as law enforcement, could combine the EDR data with the type of personally identifying data routinely acquired during a crash investigation.

To read data recorded by an EDR, special equipment is required, and access to the vehicle or the EDR is needed. In addition to the vehicle manufacturer, other parties, such as law enforcement, that have the special equipment, can read the information if they have access to the vehicle or the EDR.

● Disclosure of the EDR data

Lexus will not disclose the data recorded in an EDR to a third party except when:

- An agreement from the vehicle's owner (or the lessee for a leased vehicle) is obtained
- In response to an official request by the police, a court of law or a government agency
- For use by Lexus in a lawsuit

However, if necessary, Lexus may:

- Use the data for research on vehicle safety performance
- Disclose the data to a third party for research purposes without disclosing information about the specific vehicle or vehicle owner

Scrapping of your Lexus

The SRS airbag and seat belt pretensioner devices in your Lexus contain explosive chemicals. If the vehicle is scrapped with the airbags and seat belt pretensioners left as they are, this may cause an accident such as fire. Be sure to have the systems of the SRS airbag and seat belt pretensioner removed and disposed of by a qualified service shop or by your Lexus dealer before you scrap your vehicle.

Perchlorate Material

Special handling may apply, See www.dtsc.ca.gov/hazardouswaste/perchlorate. Your vehicle has components that may contain perchlorate. These components may include airbag, seat belt pretensioners, and wireless remote control batteries.

CAUTION

■ General precautions while driving

Driving under the influence: Never drive your vehicle when under the influence of alcohol or drugs that have impaired your ability to operate your vehicle. Alcohol and certain drugs delay reaction time, impair judgment and reduce coordination, which could lead to an accident that could result in death or serious injury.

Defensive driving: Always drive defensively. Anticipate mistakes that other drivers or pedestrians might make and be ready to avoid accidents.

Driver distraction: Always give your full attention to driving. Anything that distracts the driver, such as adjusting controls, talking on a cellular phone or reading can result in a collision with resulting death or serious injury to you, your occupants or others.

■ General precaution regarding children's safety

Never leave children unattended in the vehicle, and never allow children to have or use the key.

Children may be able to start the vehicle or shift the vehicle into neutral. There is also a danger that children may injure themselves by playing with the windows, the moon roof, or other features of the vehicle. In addition, heat build-up or extremely cold temperatures inside the vehicle can be fatal to children.

Reading this manual

 **CAUTION:**
Explains something that, if not obeyed, could cause death or serious injury to people.

 **NOTICE:**
Explains something that, if not obeyed, could cause damage to or a malfunction in the vehicle or its equipment.

1 2 3... Indicates operating or working procedures. Follow the steps in numerical order.

 Indicates the action (pushing, turning, etc.) used to operate switches and other devices.

 Indicates the outcome of an operation (e.g. a lid opens).

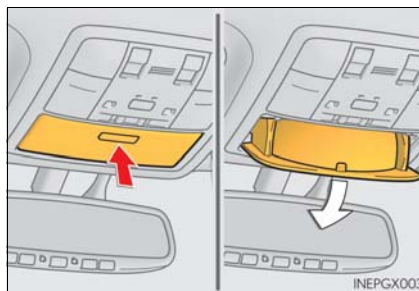

 Indicates the component or position being explained.

 Means "Do not", "Do not do this", or "Do not let this happen".

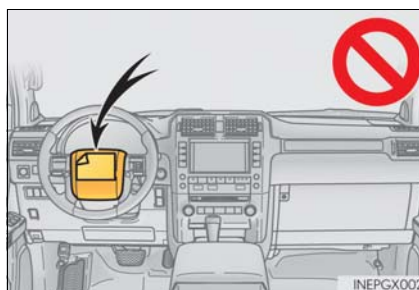

How to search

■ Searching by name

- Alphabetical index.....P. 626

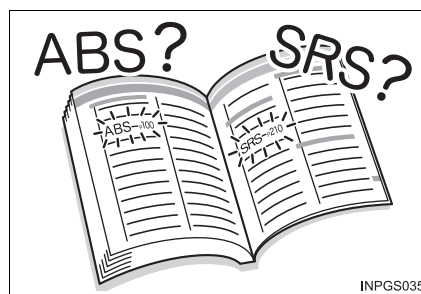

■ Searching by installation position

- Pictorial index.....P. 14

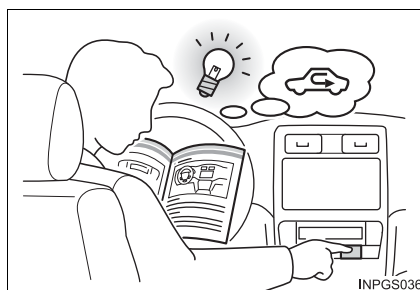

■ Searching by symptom or sound

- What to do if...
(Troubleshooting).....P. 622



■ Searching by title

- Table of contents.....P. 2

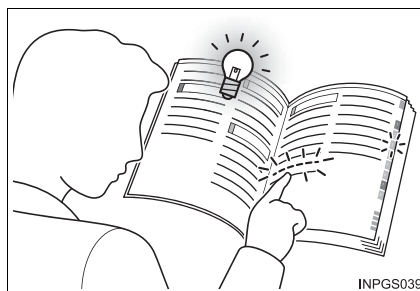

Pictorial index

Exterior

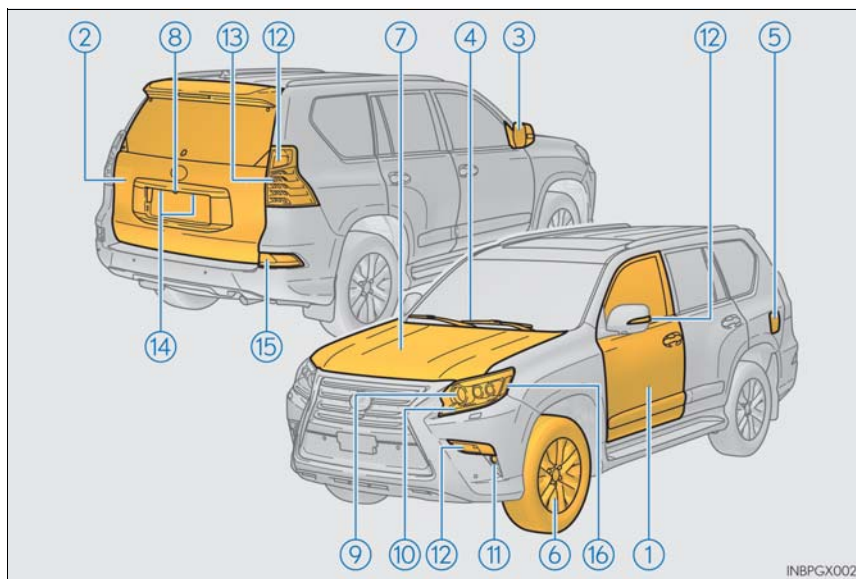

①	Side doors	P. 98
	Locking/unlocking	P. 98
	Opening/closing the door glasses	P. 150
	Locking/unlocking by using the mechanical key	P. 558
	Warning lights/warning messages	P. 522, 530
②	Back door	P. 105
	Opening from outside	P. 106
	Opening/closing the glass hatch	P. 110
	Warning lights/warning messages	P. 522, 530
③	Outside rear view mirrors	P. 147
	Adjusting the mirror angle	P. 147
	Folding the mirrors	P. 147
	Driving position memory	P. 135
	Defogging the mirrors	P. 391



④	Windshield wipers	P. 213
	Precautions against winter season	P. 377
	To prevent freezing (windshield wiper de-icer [*])	P. 391
	Precautions against car wash	P. 447
⑤	Fuel filler door	P. 221
	Refueling method	P. 221
	Fuel type/fuel tank capacity	P. 572
⑥	Tires	P. 476
	Tire size/inflation pressure	P. 578
	Winter tires/tire chain	P. 377
	Checking/rotation/tire pressure warning system	P. 476
	Coping with flat tires	P. 542
⑦	Hood	P. 462
	Opening	P. 462
	Engine oil	P. 572
	Coping with overheat	P. 564
⑧	Camera [*]	P. 254, 264

Light bulbs of the exterior lights for driving
(Replacing method: P. 498, Watts: P. 579)

⑨	Headlights	P. 202
⑩	Parking lights/daytime running lights	P. 202
⑪	Fog lights [*]	P. 211
⑫	Turn signal lights	P. 200
⑬	Stop/tail lights	
	Hill-start assist control [*]	P. 352
	Downhill assist control system [*]	P. 349
⑭	License plate lights	P. 202
⑮	Back-up lights	
	Shifting the shift lever to R	P. 194
⑯	Side marker lights	P. 202

^{*}: If equipped



■ Instrument panel

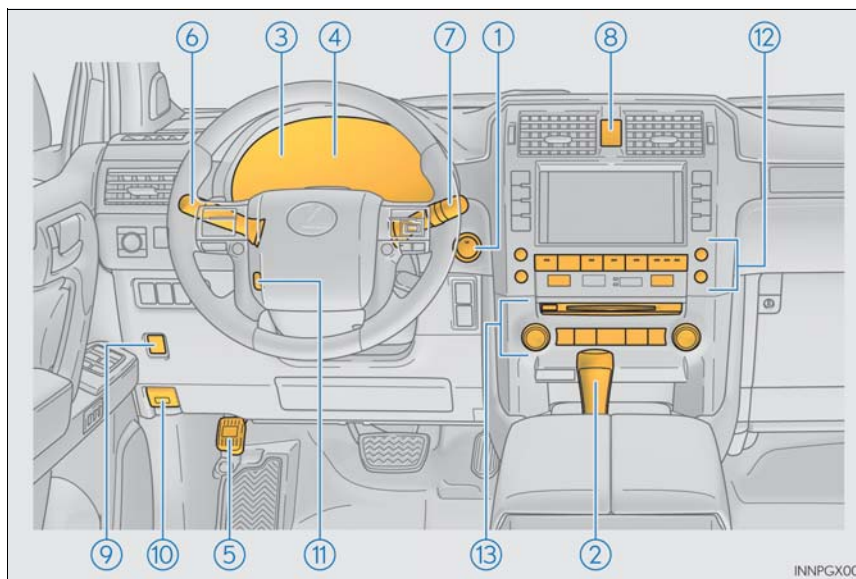

①	Engine switch	P. 189
	Starting the engine/changing the modes	P. 189
	Emergency stop of the engine	P. 511
	When the engine will not start	P. 556
	Warning messages	P. 528
②	Shift lever	P. 194
	Changing the shift position	P. 194
	Precautions against towing	P. 512
	When the shift lever does not move	P. 198
③	Meters	P. 83
	Reading the meters/adjusting the instrument panel light	P. 83
	Warning lights/indicators	P. 78
	When the warning lights come on	P. 520



④	Multi-information display	P. 86
	Display	P. 86
	When the warning messages are displayed	P. 528
⑤	Parking brake	P. 201
	Applying/releasing	P. 201
	Precautions against winter season	P. 378
	Warning buzzer/message	P. 530
⑥	Turn signal lever	P. 200
	Headlight switch	P. 202
	Headlights/parking lights/tail lights/daytime running lights	P. 202
	Fog lights ^{*1}	P. 211
⑦	Windshield wiper and washer switch	P. 213
	Usage	P. 213
	Adding washer fluid	P. 475
	Warning messages	P. 533
⑧	Emergency flasher switch	P. 510
⑨	Fuel filler door opener	P. 223
⑩	Hood lock release lever	P. 462
⑪	Tilt and telescopic steering control switch	P. 143
	Adjustment	P. 143
	Driving position memory	P. 135
⑫	Air conditioning system	P. 386
	Usage	P. 386
	Rear window defogger	P. 391
⑬	Audio system^{*2}	
	Hands-free system^{*2}	

^{*1}: If equipped

^{*2}: Refer to "NAVIGATION SYSTEM OWNER'S MANUAL" or
"MULTIMEDIA OWNER'S MANUAL".



■ Switches

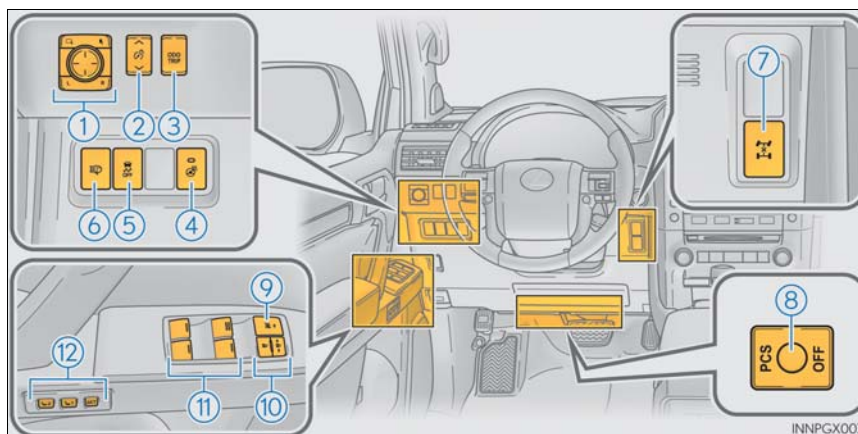

①	Outside rear view mirror switches.....	P. 147
②	Instrument cluster light control switch.....	P. 84
③	Odometer/trip meter and trip meter reset button.....	P. 84
④	Heated steering wheel switch *1	P. 399
⑤	VSC OFF switch.....	P. 353
⑥	Headlight cleaner switch *1	P. 220
⑦	Center differential lock/unlock switch	P. 343
⑧	Pre-collision braking off switch *1	P. 369
⑨	Window lock switch	P. 150
⑩	Door lock switches	P. 100
⑪	Power window switches	P. 150
⑫	Driving position memory buttons	P. 135



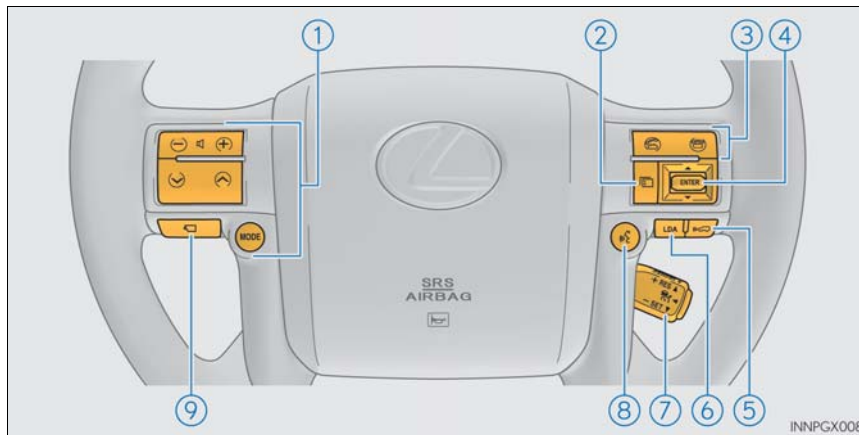

- ① Audio remote control switches *2
- ② Menu switch P. 87
- ③ Telephone switches *2
- ④ "ENTER" switch P. 87
- ⑤ Vehicle-to-vehicle distance button *1 P. 230
- ⑥ LDA (Lane Departure Alert) switch *1 P. 239
- ⑦ Cruise control switch
 Cruise control *1 P. 225
 Dynamic radar cruise control *1 P. 228
- ⑧ Talk switch *2
- ⑨ Wide view front & side monitor switch *1 P. 290
 Multi-terrain Monitor switch *1 P. 313

*1: If equipped

*2: Refer to "NAVIGATION SYSTEM OWNER'S MANUAL" or "MULTIMEDIA OWNER'S MANUAL".



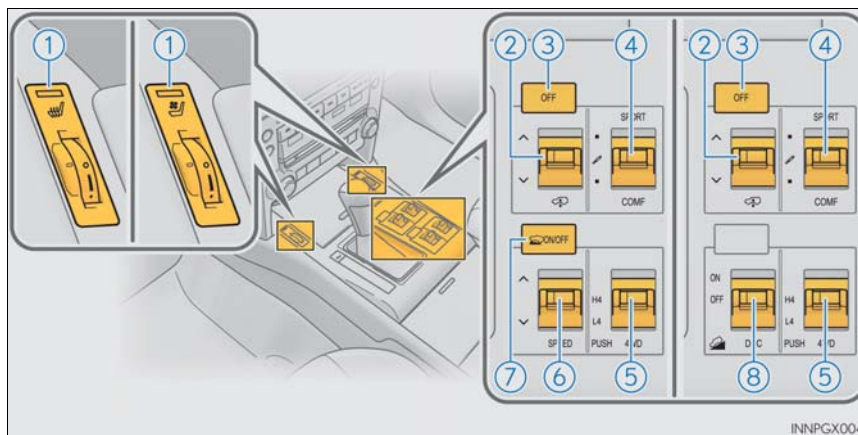

① Front seat heater/ventilator switches*	P. 399
② Height control switch*	P. 337
③ Height control OFF button*	P. 337
④ AVS switch*	P. 341
⑤ Four-wheel drive control switch	P. 342
⑥ Crawl Control speed selection switch*	P. 346
⑦ Crawl Control ON/OFF switch*	P. 346
⑧ "DAC" switch*	P. 349

■ Interior

► 7-passenger models

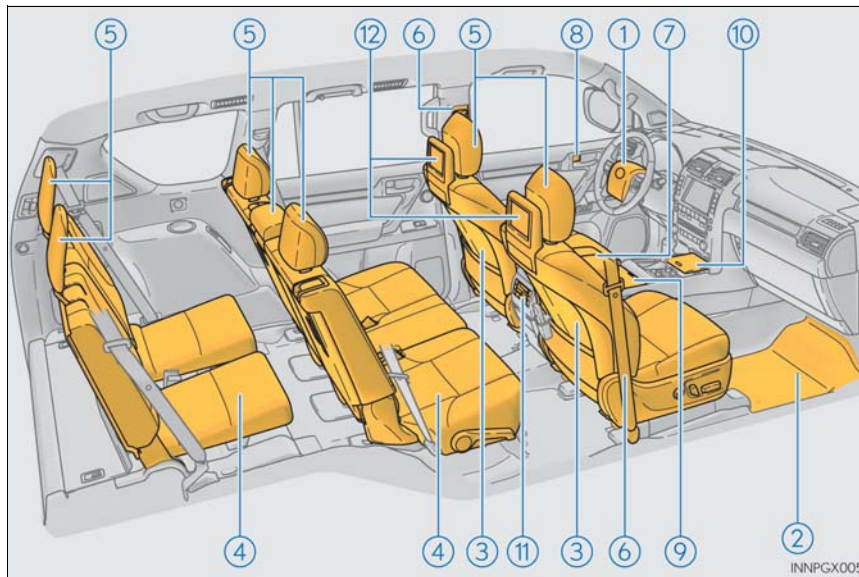

*: If equipped



► 6-passenger models

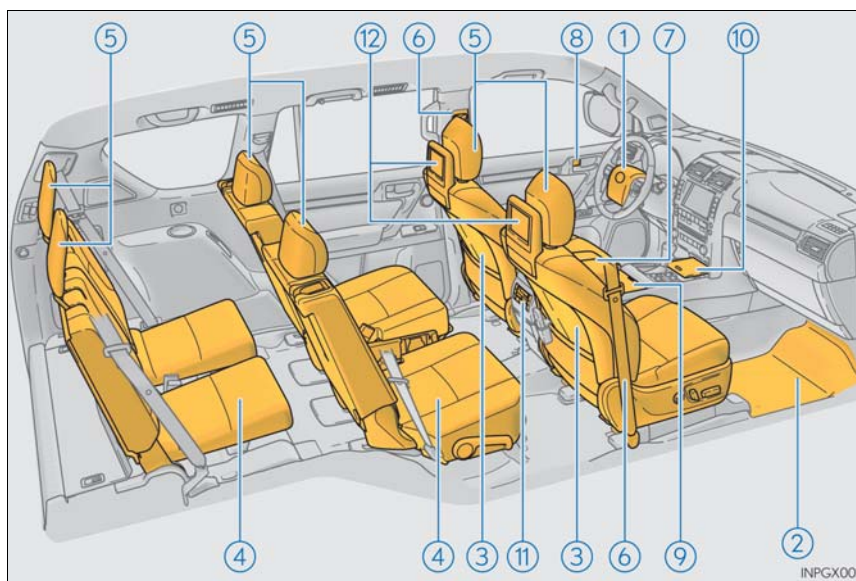

① SRS airbags.....	P. 36
② Floor mats.....	P. 26
③ Front seats.....	P. 122
④ Rear seats.....	P. 124
⑤ Head restraints.....	P. 140
⑥ Seat belts.....	P. 30
⑦ Console box* ¹	P. 406
Cool box* ¹	P. 419
⑧ Inside lock buttons.....	P. 100
⑨ Cup holders.....	P. 408
⑩ Auxiliary boxes.....	P. 410
⑪ Rear air conditioning system* ¹	P. 396
⑫ Rear seat entertainment system* ^{1,2}	



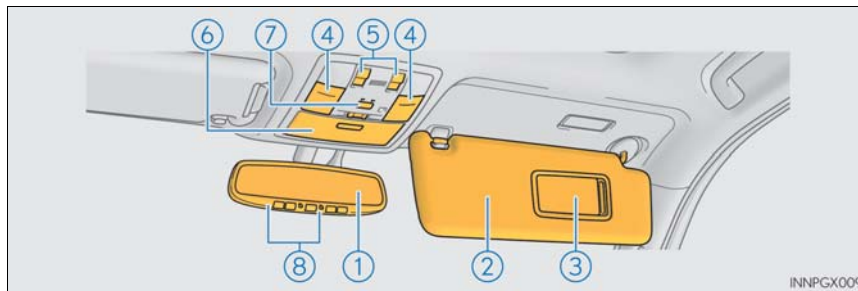

① Inside rear view mirror	P. 145
② Sun visors	P. 421
③ Vanity mirrors	P. 421
④ Personal/interior lights ^{*3}	P. 404
⑤ Moon roof switches	P. 153
⑥ Conversation mirror	P. 422
Auxiliary boxes	P. 410
⑦ "SOS" button ^{*1}	P. 439
⑧ Garage door opener buttons	P. 433

^{*1}: If equipped

^{*2}: Refer to "NAVIGATION SYSTEM OWNER'S MANUAL" or
"MULTIMEDIA OWNER'S MANUAL".

^{*3}: The illustration shows the front, but they are also equipped in the rear.





For safety and security

1

25

1-1. For safe use

Before driving..... 26

For safe driving28

Seat belts30

SRS airbags36

Front passenger occupant
classification system.....48

Safety information for
children54

Child restraint systems55

Installing child restraints.....59

Exhaust gas precautions71

1-2. Theft deterrent system

Engine immobilizer system..... 72

Alarm 74



Before driving

Floor mat

Use only floor mats designed specifically for vehicles of the same model and model year as your vehicle. Fix them securely in place onto the carpet.

- 1 Insert the retaining hooks (clips) into the floor mat eyelets.

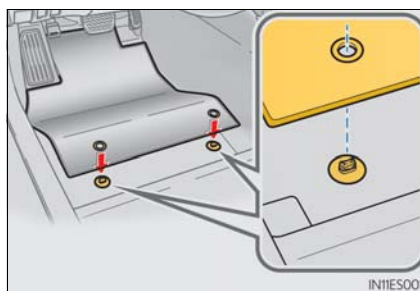

- 2 Turn the upper knob of each retaining hook (clip) to secure the floor mats in place.

*: Always align the Δ marks.

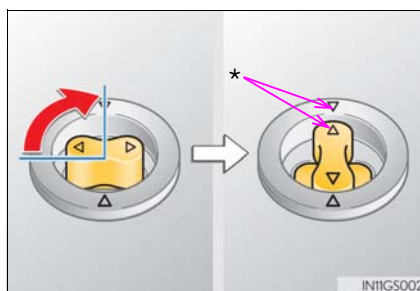

The shape of the retaining hooks (clips) may differ from that shown in the illustration.

⚠ CAUTION

Observe the following precautions.

Failure to do so may cause the driver's floor mat to slip, possibly interfering with the pedals while driving. An unexpectedly high speed may result or it may become difficult to stop the vehicle. This could lead to an accident, resulting in death or serious injury.

■ When installing the driver's floor mat

- Do not use floor mats designed for other models or different model year vehicles, even if they are Lexus Genuine floor mats.
- Only use floor mats designed for the driver's seat.
- Always install the floor mat securely using the retaining hooks (clips) provided.
- Do not use two or more floor mats on top of each other.
- Do not place the floor mat bottom-side up or upside-down.

■ Before driving

- Check that the floor mat is securely fixed in the correct place with all the provided retaining hooks (clips). Be especially careful to perform this check after cleaning the floor.
- With the engine stopped and the shift lever in P, fully depress each pedal to the floor to make sure it does not interfere with the floor mat.

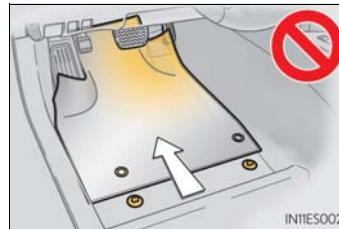

For safe driving

For safe driving, adjust the seat and mirror to an appropriate position before driving.

Correct driving posture

- ① Adjust the angle of the seatback so that you are sitting straight up and so that you do not have to lean forward to steer. (→P. 122)
- ② Adjust the seat so that you can depress the pedals fully and so that your arms bend slightly at the elbow when gripping the steering wheel. (→P. 122)
- ③ Lock the head restraint in place with the center of the head restraint closest to the top of your ears. (→P. 140)
- ④ Wear the seat belt correctly. (→P. 30)

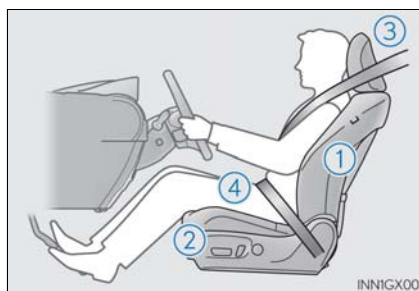

Correct use of the seat belts

Make sure that all occupants are wearing their seat belts before driving the vehicle. (→P. 30)

Use a child restraint system appropriate for the child until the child becomes large enough to properly wear the vehicle's seat belt. (→P. 55)

Adjusting the mirrors

Make sure that you can see backward clearly by adjusting the inside and outside rear view mirrors properly. (→P. 145, 147)

CAUTION

Observe the following precautions.

Failure to do so may result in death or serious injury.

- Do not adjust the position of the driver's seat while driving.
Doing so could cause the driver to lose control of the vehicle.
- Do not place a cushion between the driver or passenger and the seatback.
A cushion may prevent correct posture from being achieved, and reduce the effectiveness of the seat belt and head restraint.
- Do not place anything under the front seats.
Objects placed under the front seats may become jammed in the seat tracks and stop the seat from locking in place. This may lead to an accident and the adjustment mechanism may also be damaged.
- Always observe the legal speed limit when driving on public roads.
- When driving over long distances, take regular breaks before you start to feel tired.
Also, if you feel tired or sleepy while driving, do not force yourself to continue driving and take a break immediately.

1

For safety and security

Seat belts

Make sure that all occupants are wearing their seat belts before driving the vehicle.

Correct use of the seat belts

- Extend the shoulder belt so that it comes fully over the shoulder, but does not come into contact with the neck or slide off the shoulder.
- Position the lap belt as low as possible over the hips.
- Adjust the position of the seatback. Sit up straight and well back in the seat.
- Do not twist the seat belt.

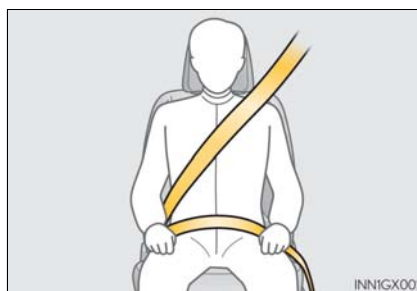

Fastening and releasing the seat belt

- ① To fasten the seat belt, push the plate into the buckle until a click sound is heard.
- ② To release the seat belt, press the release button.

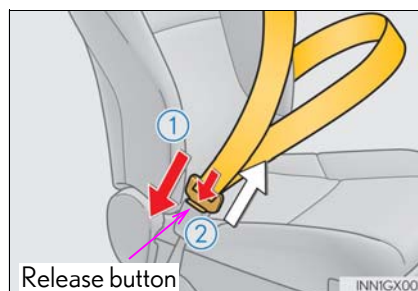

Adjusting the seat belt shoulder anchor height (front and outer second seats for 7-passenger models, front and second seats for 6-passenger models)

- ① Push the seat belt shoulder anchor down while pressing the release button.
- ② Push the seat belt shoulder anchor up.
Move the height adjuster up and down as needed until you hear a click.

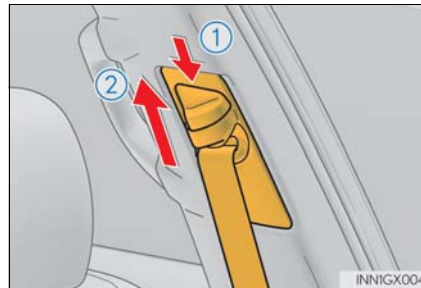

Seat belt pretensioners (front and outer second seats for 7-passenger models, front and second seats for 6-passenger models)

The pretensioners help the seat belts to quickly restrain the occupants by retracting the seat belts when the vehicle is subjected to certain types of severe frontal or side collision or a vehicle rollover.

The pretensioners do not activate in the event of a minor frontal or side impact, or a rear impact.

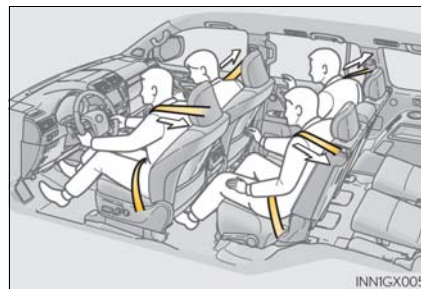

Pre-collision seat belts (front seats of vehicles with pre-collision system)

If the system determines that a collision is unavoidable, the front seat belts will retract before the collision. (→P. 368)

■ Emergency locking retractor (ELR)

The retractor will lock the belt during a sudden stop or on impact. It may also lock if you lean forward too quickly. A slow, easy motion will allow the belt to extend so that you can move around fully.

■ Automatic locking retractor (ALR)

When a passenger's shoulder belt is completely extended and then retracted even slightly, the belt is locked in that position and cannot be extended. This feature is used to hold the child restraint system (CRS) firmly. To free the belt again, fully retract the belt and then pull the belt out once more. (→P. 59)

■ Child seat belt usage

The seat belts of your vehicle were principally designed for persons of adult size.

- Use a child restraint system appropriate for the child, until the child becomes large enough to properly wear the vehicle's seat belt. (→P. 55)
- When the child becomes large enough to properly wear the vehicle's seat belt, follow the instructions on P. 30 regarding seat belt usage.

■ Replacing the belt after the pretensioner has been activated

If the vehicle is involved in multiple collisions, the pretensioner will activate for the first collision, but will not activate for the second or subsequent collisions.

■ Seat belt extender

If your seat belts cannot be fastened securely because they are not long enough, a personalized seat belt extender is available from your Lexus dealer free of charge.

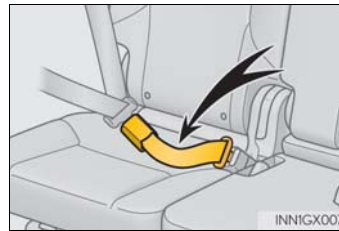

CAUTION

Observe the following precautions to reduce the risk of injury in the event of sudden braking, sudden swerving or an accident. Failure to do so may cause death or serious injury.

■ Wearing a seat belt

- Ensure that all passengers wear a seat belt.
- Always wear a seat belt properly.
- Each seat belt should be used by one person only. Do not use a seat belt for more than one person at once, including children.
- Lexus recommends that children be seated in the rear seat and always use a seat belt and/or an appropriate child restraint system.
- To achieve a proper seating position, do not recline the seat more than necessary. The seat belt is most effective when the occupants are sitting up straight and well back in the seats.
- Do not wear the shoulder belt under your arm.
- Always wear your seat belt low and snug across your hips.

■ Pregnant women

Obtain medical advice and wear the seat belt in the proper way. (→P. 30)

Women who are pregnant should position the lap belt as low as possible over the hips in the same manner as other occupants, extending the shoulder belt completely over the shoulder and avoiding belt contact with the rounding of the abdominal area.

If the seat belt is not worn properly, not only the pregnant woman, but also the fetus could suffer death or serious injury as a result of sudden braking, sudden swerving or a collision.

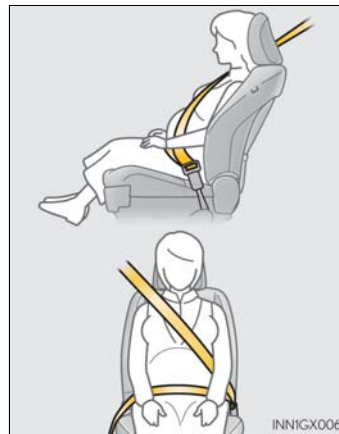

■ People suffering illness

Obtain medical advice and wear the seat belt in the proper way. (→P. 30)

 CAUTION**■ When the children are in the vehicle**

Do not allow children to play with the seat belt. If the seat belt becomes twisted around a child's neck, it may lead to choking or other serious injuries that could result in death. If this occurs and the buckle cannot be unfastened, scissors should be used to cut the belt.

■ Seat belt pretensioners

- Do not place anything, such as a cushion, on the front passenger's seat. Doing so will disperse the passenger's weight, which prevents the sensor from detecting the passenger's weight properly. As a result, the seat belt pretensioner for the front passenger's seat may not activate in the event of a collision.
- If the pretensioner has activated, the SRS warning light will come on. In that case, the seat belt cannot be used again and must be replaced at your Lexus dealer.

■ Adjustable shoulder anchor

Always make sure the shoulder belt is positioned across the center of your shoulder. The belt should be kept away from your neck, but not falling off your shoulder. Failure to do so could reduce the amount of protection in an accident and cause death or serious injuries in the event of a sudden stop, sudden swerve or accident. (→P. 31)

■ Seat belt damage and wear

- Do not damage the seat belts by allowing the belt, plate, or buckle to be jammed in the door.
- Inspect the seat belt system periodically. Check for cuts, fraying, and loose parts. Do not use a damaged seat belt until it is replaced. Damaged seat belt cannot protect an occupant from death or serious injury.
- Ensure that the belt and plate are locked and the belt is not twisted.
If the seat belt does not function correctly, immediately contact your Lexus dealer.
- Replace the seat assembly, including the belts, if your vehicle has been involved in a serious accident, even if there is no obvious damage.
- Do not attempt to install, remove, modify, disassemble or dispose of the seat belts. Have any necessary repairs carried out by your Lexus dealer. Inappropriate handling may lead to incorrect operation.

 CAUTION**■ Using a seat belt extender**

- Do not wear the seat belt extender if you can fasten the seat belt without the extender.
- Do not use the seat belt extender when installing a child restraint system because the belt will not securely hold the child restraint system, increasing the risk of death or serious injury in the event of an accident.
- The personalized extender may not be safe on another vehicle, when used by another person, or at a different seating position other than the one originally intended.

 NOTICE**■ Using a seat belt extender**

When releasing the seat belt, press on the buckle release button on the extender, not on the seat belt.
This helps prevent damage to the vehicle interior and the extender itself.

SRS airbags

The SRS airbags inflate when the vehicle is subjected to certain types of severe impacts that may cause significant injury to the occupants. They work together with the seat belts to help reduce the risk of death or serious injury.

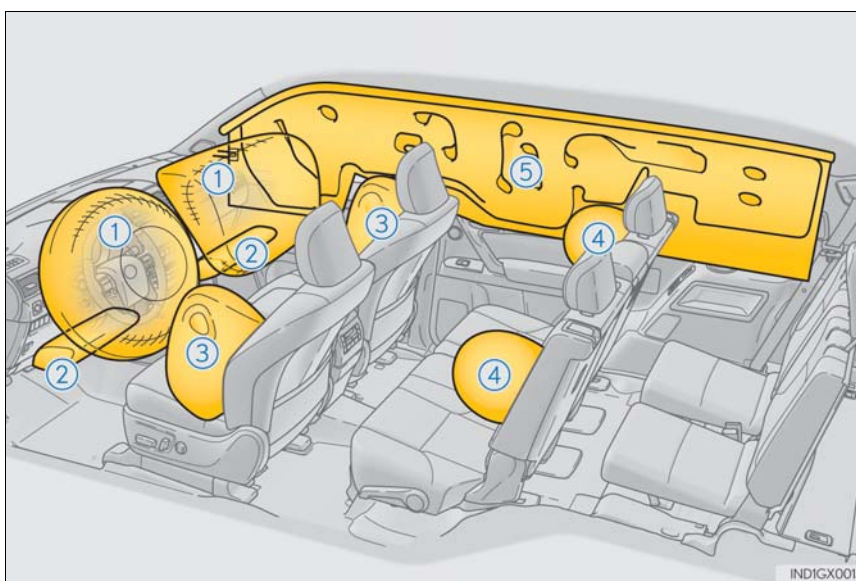

◆ SRS front airbags

- ① SRS driver airbag/front passenger airbag
Can help protect the head and chest of the driver and front passenger from impact with interior components
- ② SRS knee airbags
Can help provide driver and front passenger protection

◆ SRS side and curtain shield airbags

- ③ SRS front side airbags
 - Can help protect the torso of the front seat occupants
- ④ SRS rear side airbags
 - Can help protect the torso of occupants in the outer second seats (7-passenger models) or second seats (6-passenger models)
- ⑤ SRS curtain shield airbags
 - Can help protect primarily the head of occupants in the outer seats
 - Can prevent the occupants from being thrown from the vehicle in the event of vehicle rollover

1

For safety and security



Airbag system components

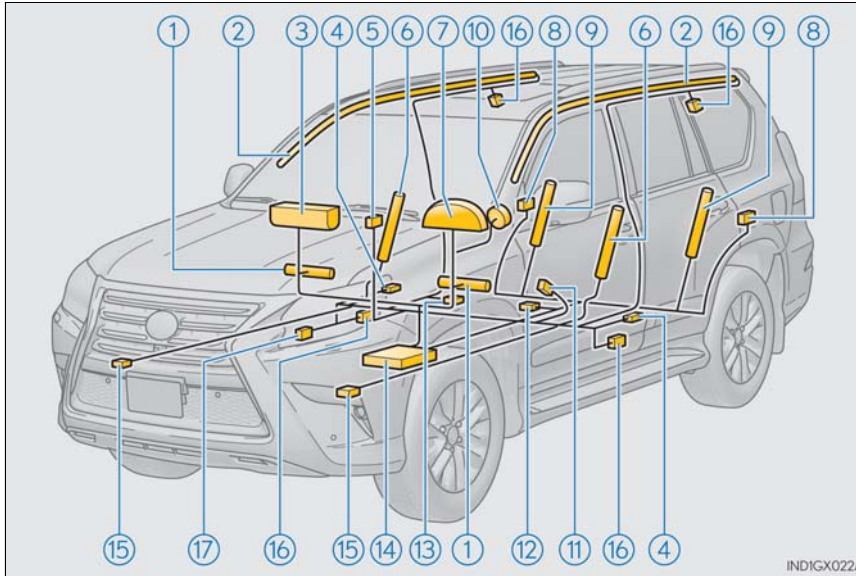

- | | |
|--|--|
| ① Knee airbags | ⑩ Driver airbag |
| ② Curtain shield airbags | ⑪ Driver's seat belt buckle switch |
| ③ Front passenger airbag | ⑫ Safing sensor (rear) |
| ④ Side impact sensors (front door) | ⑬ Front passenger's seat belt buckle switch |
| ⑤ "AIR BAG ON" and "AIR BAG OFF" indicator lights | ⑭ Airbag sensor assembly |
| ⑥ Front side airbags | ⑮ Front impact sensors |
| ⑦ SRS warning light | ⑯ Seat belt pretensioners and force limiters |
| ⑧ Side impact sensors (rear) | ⑰ Front passenger occupant classification system (ECU and sensors) |
| ⑨ Rear side airbags (outer second seats [7-passenger models] or second seats [6-passenger models]) | |

Your vehicle is equipped with ADVANCED AIRBAGS designed based on the US motor vehicle safety standards (FMVSS208). The airbag sensor assembly (ECU) controls airbag deployment based on information obtained from the sensors etc. shown in the system components diagram above. This information includes crash severity and occupant information. As the airbags deploy, a chemical reaction in the inflators quickly fills the airbags with non-toxic gas to help restrain the motion of the occupants.

 CAUTION

■ SRS airbag precautions

Observe the following precautions regarding the SRS airbags. Failure to do so may cause death or serious injury.

- The driver and all passengers in the vehicle must wear their seat belts properly. The SRS airbags are supplemental devices to be used with the seat belts.
- The SRS driver airbag deploys with considerable force, and can cause death or serious injury especially if the driver is very close to the airbag. The National Highway Traffic Safety Administration (NHTSA) advises:

Since the risk zone for the driver's airbag is the first 2 - 3 in. (50 - 75 mm) of inflation, placing yourself 10 in. (250 mm) from your driver airbag provides you with a clear margin of safety. This distance is measured from the center of the steering wheel to your breastbone. If you sit less than 10 in. (250 mm) away now, you can change your driving position in several ways:

- Move your seat to the rear as far as you can while still reaching the pedals comfortably.
- Slightly recline the back of the seat. Although vehicle designs vary, many drivers can achieve the 10 in. (250 mm) distance, even with the driver seat all the way forward, simply by reclining the back of the seat somewhat. If reclining the back of your seat makes it hard to see the road, raise yourself by using a firm, non-slippery cushion, or raise the seat if your vehicle has that feature.
- If your steering wheel is adjustable, tilt it downward. This points the airbag toward your chest instead of your head and neck.

The seat should be adjusted as recommended by NHTSA above, while still maintaining control of the foot pedals, steering wheel, and your view of the instrument panel controls.

CAUTION

■ **SRS airbag precautions**

- If the seat belt extender has been connected to the front seat belt buckles but the seat belt extender has not also been fastened to the latch plate of the seat belt, the SRS front airbags will judge that the driver and front passenger are wearing the seat belt even though the seat belt has not been connected. In this case, the SRS front airbags may not activate correctly in a collision, resulting in death or serious injury in the event of collision. Be sure to wear the seat belt with the seat belt extender.



- The SRS front passenger airbag also deploys with considerable force, and can cause death or serious injury especially if the front passenger is very close to the airbag. The front passenger seat should be as far from the airbag as possible with the seatback adjusted, so the front passenger sits upright.
- Improperly seated and/or restrained infants and children can be killed or seriously injured by a deploying airbag. An infant or child who is too small to use a seat belt should be properly secured using a child restraint system. Lexus strongly recommends that all infants and children be placed in the rear seats of the vehicle and properly restrained. The rear seats are safer for infants and children than the front passenger seat. (→P. 55)
- Do not sit on the edge of the seat or lean against the dashboard.



- Do not allow a child to stand in front of the SRS front passenger airbag unit or sit on the knees of a front passenger.
- Do not allow the front seat occupants to hold items on their knees.



CAUTION**■ SRS airbag precautions**

- Do not lean against the door, the roof side rail or the front, side and rear pillars.



- Do not allow anyone to kneel on the passenger seats toward the door or put their head or hands outside the vehicle.



- Do not attach anything to or lean anything against areas such as the dashboard, steering wheel pad and lower portion of the instrument panel. These items can become projectiles when the SRS driver, front passenger and knee airbags deploy.

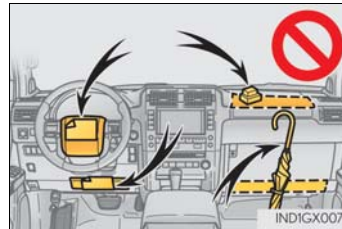

CAUTION

■ **SRS airbag precautions**

- Do not attach anything to areas such as a door, windshield glass, side door glass, front, side or rear pillars, roof side rail and assist grip.

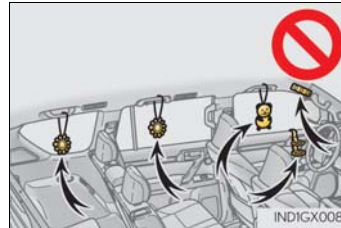

- Do not hang coat hangers or other hard objects on the coat hooks. All of these items could become projectiles and may cause death or serious injury, should the SRS curtain shield airbags deploy.
- If the vinyl cover is put on the area where the SRS knee airbag will deploy, be sure to remove it.
- Do not use seat accessories which cover the parts where the SRS side airbags inflate as they may interfere with inflation of the airbags. Such accessories may prevent the side airbags from activating correctly, disable the system or cause the side airbags to inflate accidentally, resulting in death or serious injury.
- Do not strike or apply significant levels of force to the area of the SRS airbag components.
Doing so can cause the SRS airbags to malfunction.
- Do not touch any of the component parts immediately after the SRS airbags have deployed (inflated) as they may be hot.
- If breathing becomes difficult after the SRS airbags have deployed, open a door or window to allow fresh air in, or leave the vehicle if it is safe to do so. Wash off any residue as soon as possible to prevent skin irritation.
- If the areas where the SRS airbags are stored, such as the steering wheel pad and front, side and rear pillar garnishes, are damaged or cracked, have them replaced by your Lexus dealer.
- Do not place anything such as a cushion on the front passenger's seat. Doing so will disperse the passenger's weight, which prevents the sensor from detecting the passenger's weight properly. As a result, the SRS front airbags for the front passenger may not deploy in the event of a collision.

 CAUTION**■ Modification and disposal of SRS airbag system components**

Do not dispose of your vehicle or perform any of the following modifications without consulting your Lexus dealer. The SRS airbags may malfunction or deploy (inflate) accidentally, causing death or serious injury.

- Installation, removal, disassembly and repair of the SRS airbags
- Repairs, modifications, removal or replacement of the steering wheel, instrument panel, dashboard, seats, seat upholstery, front, side and rear pillars or roof side rails
- Repairs or modifications of the front fender, front bumper, or side of the occupant compartment
- Installation of a grille guard (bull bars, kangaroo bar, etc.), snow plows, winches or roof luggage carrier
- Modifications to the vehicle's suspension system
- Installation of electronic devices such as mobile two-way radios and CD players
- Modifications to your vehicle for a person with a physical disability

■ If the SRS airbags deploy (inflate)

- Slight abrasions, burns, bruising etc., may be sustained from SRS airbags, due to the extremely high speed deployment (inflation) by hot gases.
- A loud noise and white powder will be emitted.
- Parts of the airbag module (steering wheel hub, airbag cover and inflator) as well as the front seats, parts of the front, side and rear pillars and roof side rails, may be hot for several minutes. The airbag itself may also be hot.
- The windshield may crack.
- For Lexus Enform Safety Connect subscribers, if the SRS airbags deploy or in the event of a severe rear-end collision, the system is designed to send an emergency call to the response center, notifying them of the vehicle's location (without needing to push the "SOS" button) and an agent will attempt to speak with the occupants to ascertain the level of emergency and assistance required. If the occupants are unable to communicate, the agent automatically treats the call as an emergency and helps to dispatch the necessary emergency services. (→P. 439)

■ SRS airbag deployment conditions (SRS front airbags)

- The SRS front airbags will deploy in the event of an impact that exceeds the set threshold level (the level of force corresponding to an approximately 12 - 18 mph [20 - 30 km/h] frontal collision with a fixed wall that does not move or deform).

However, this threshold velocity will be considerably higher in the following situations:

- If the vehicle strikes an object, such as a parked vehicle or sign pole, which can move or deform on impact
- If the vehicle is involved in an underride collision, such as a collision in which the front of the vehicle "underrides", or goes under, the bed of a truck
- Depending on the type of collision, it is possible that only the seat belt pretensioners will activate.
- The SRS front airbags for the front passenger will not activate if there is no passenger sitting in the front passenger seat. However, the SRS front airbags for the front passenger may deploy if luggage is put in the seat, even if the seat is unoccupied.

■ SRS airbag deployment conditions (SRS side and curtain shield airbags)

- The SRS side and curtain shield airbags will deploy in the event of an impact that exceeds the set threshold level (the level of force corresponding to the impact force produced by an approximately 3300 lb. [1500 kg] vehicle colliding with the vehicle cabin from a direction perpendicular to the vehicle orientation at an approximate speed of 12 - 18 mph [20 - 30 km/h]).
- The SRS curtain shield airbags will deploy in the event of vehicle rollover.
- The SRS side and curtain shield airbags may also deploy in the event of a severe frontal collision.

■ Conditions under which the SRS airbags may deploy (inflate), other than a collision

The SRS front airbags and SRS side and curtain shield airbags may also deploy if a serious impact occurs to the underside of your vehicle. Some examples are shown in the illustration.

- Hitting a curb, edge of pavement or hard surface
- Falling into or jumping over a deep hole
- Landing hard or falling

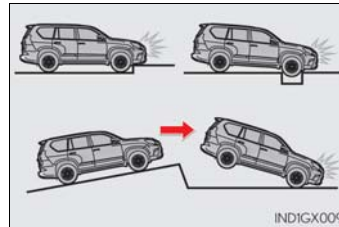

The SRS curtain shield airbags may also deploy under the situations shown in the illustration.

- The angle of vehicle tip-up is marginal
- The vehicle skids and hits a curb stone

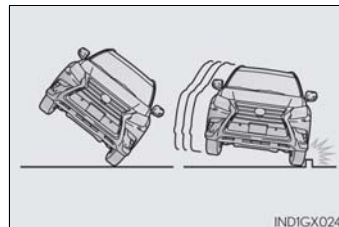

■ Types of collisions that may not deploy the SRS airbags (SRS front airbags)

The SRS front airbags do not generally inflate if the vehicle is involved in a side or rear collision, if it rolls over, or if it is involved in a low-speed frontal collision. But, whenever a collision of any type causes sufficient forward deceleration of the vehicle, deployment of the SRS front airbags may occur.

- Collision from the side
- Collision from the rear
- Vehicle rollover

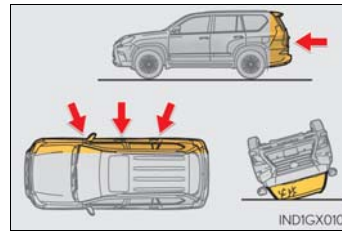

1

For safety and security

■ Types of collisions that may not deploy the SRS airbags (SRS side and curtain shield airbags)

The SRS side and curtain shield airbags may not activate if the vehicle is subjected to a collision from the side at certain angles, or a collision to the side of the vehicle body other than the passenger compartment.

- Collision from the side to the vehicle body other than the passenger compartment
- Collision from the side at an angle

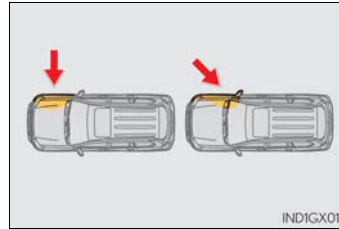

The SRS side airbags do not generally inflate if the vehicle is involved in a rear collision, if it rolls over, or if it is involved in a low-speed side or low-speed frontal collision.

- Collision from the rear
- Vehicle rollover

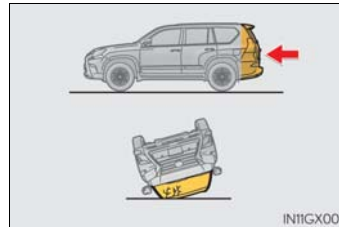

The SRS curtain shield airbags do not generally inflate if the vehicle is involved in a rear collision, if it pitches end over end, or if it is involved in a low-speed side or low-speed frontal collision.

- Collision from the rear
- Pitching end over end

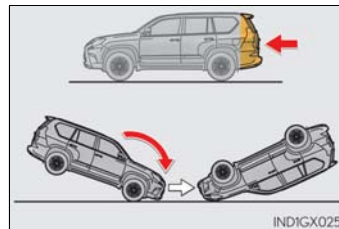

■ When to contact your Lexus dealer

In the following cases, the vehicle will require inspection and/or repair. Contact your Lexus dealer as soon as possible.

- Any of the SRS airbags have been inflated.
- The front of the vehicle is damaged or deformed, or was involved in an accident that was not severe enough to cause the SRS front airbags to inflate.
- A portion of a door or its surrounding area is damaged or deformed, or the vehicle was involved in an accident that was not severe enough to cause the SRS side and curtain shield airbags to inflate.
- The pad section of the steering wheel, dashboard near the front passenger airbag or lower portion of the instrument panel is scratched, cracked, or otherwise damaged.
- The surface of the seats with the side airbag is scratched, cracked or otherwise damaged.
- The portion of the front pillars, center pillars, rear pillars or roof side rail garnishes (padding) containing the curtain shield airbags inside is scratched, cracked or otherwise damaged.

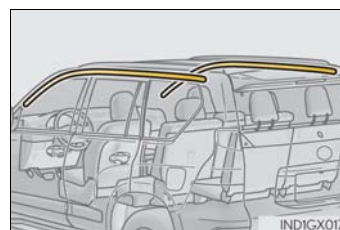
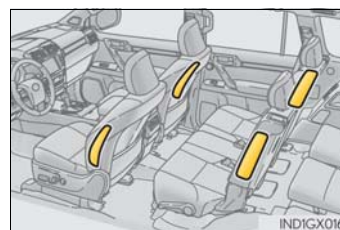
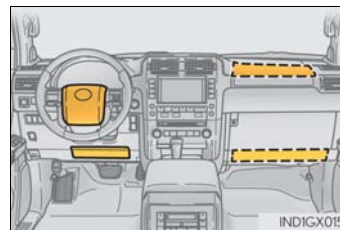
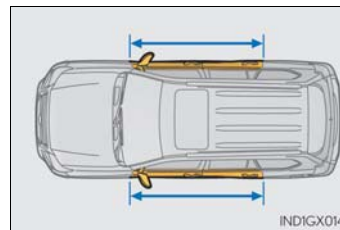
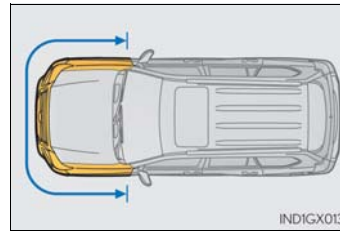

Front passenger occupant classification system

Your vehicle is equipped with a front passenger occupant classification system. This system detects the conditions of the front passenger seat and activates or deactivates the devices for the front passenger.

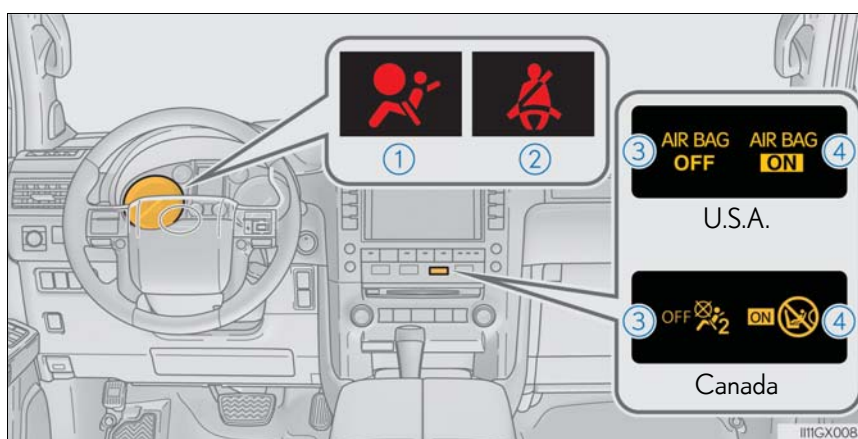

- ① SRS warning light
- ② Seat belt reminder light
- ③ "AIR BAG OFF" indicator light
- ④ "AIR BAG ON" indicator light

Condition and operation in the front passenger occupant classification system

■ Adult*¹

Indicator/ warning light	"AIR BAG ON" and "AIR BAG OFF" indicator lights	"AIR BAG ON"
	SRS warning light	Off
	Seat belt reminder light	Off* ² or flashing* ³
Devices	Front passenger airbag	Activated
	Side airbag on the front passenger seat	
	Curtain shield airbag in the front passenger side	
	Front passenger knee airbag	
	Front passenger's seat belt pretensioner	

■ Child*⁴ or child restraint system with infant*⁵

Indicator/ warning light	"AIR BAG ON" and "AIR BAG OFF" indicator lights	"AIR BAG OFF"* ⁶
	SRS warning light	Off
	Seat belt reminder light	Off* ² or flashing* ³
Devices	Front passenger airbag	Deactivated
	Side airbag on the front passenger seat	Activated
	Curtain shield airbag in the front passenger side	
	Front passenger knee airbag	Deactivated
	Front passenger's seat belt pretensioner	Activated

1

For safety and security



■ Unoccupied

Indicator/ warning light	"AIR BAG ON" and "AIR BAG OFF" indicator lights	Not illuminated
	SRS warning light	Off
	Seat belt reminder light	
Devices	Front passenger airbag	Deactivated
	Side airbag on the front passenger seat	Activated
	Curtain shield airbag in the front passenger side	
	Front passenger knee airbag	Deactivated
	Front passenger's seat belt pretensioner	Activated* ⁷ or deactivated* ⁸

■ There is a malfunction in the system

Indicator/ warning light	"AIR BAG ON" and "AIR BAG OFF" indicator lights	"AIR BAG OFF"
	SRS warning light	On
	Seat belt reminder light	
Devices	Front passenger airbag	Deactivated
	Side airbag on the front passenger seat	Activated
	Curtain shield airbag in the front passenger side	
	Front passenger knee airbag	Deactivated
	Front passenger's seat belt pretensioner	Activated



- *1: The system judges a person of adult size as an adult. When a smaller adult sits in the front passenger seat, the system may recognize him/her as a child depending on his/her physique and posture.
- *2: In the event the front passenger is wearing a seat belt.
- *3: In the event the front passenger does not wear a seat belt
- *4: When a larger child who has outgrown a child restraint system sits in the front passenger seat, the system may recognize him/her as an adult depending on his/her physique or posture.
- *5: Never install a rear-facing child restraint system on the front passenger seat. A forward-facing child restraint system should only be installed on the front passenger seat when it is unavoidable. (→P. 55)
- *6: In case the indicator light is not illuminated, consult this manual on how to install the child restraint system properly. (→P. 59)
- *7: In the event of a side collision.
- *8: In the event of a frontal collision or vehicle rollover.

 CAUTION**■ Front passenger occupant classification system precautions**

Observe the following precautions regarding the front passenger occupant classification system.

Failure to do so may cause death or serious injury.

- Wear the seat belt properly.
- Make sure the front passenger's seat belt plate has not been left inserted into the buckle before someone sits in the front passenger seat.
- Make sure the "AIR BAG OFF" indicator light is not illuminated when using the seat belt extender for the front passenger seat. If the "AIR BAG OFF" indicator light is illuminated, disconnect the extender tongue from the seat belt buckle, and reconnect the seat belt. Reconnect the seat belt extender after making sure the "AIR BAG ON" indicator light is illuminated. If you use the seat belt extender while the "AIR BAG OFF" indicator light is illuminated, the SRS airbags for the front passenger will not activate, which could cause death or serious injury in the event of a collision.
- Do not apply a heavy load to the front passenger seat or equipment (e.g. seatback pocket).
- Do not put weight on the front passenger seat by putting your hands or feet on the front passenger seat seatback from the rear passenger seat.
- Do not let a rear passenger lift the front passenger seat with their feet or press on the seatback with their legs.
- Do not put objects under the front passenger seat.

 CAUTION**■ Front passenger occupant classification system precautions**

- Do not recline the front passenger seatback so far that it touches the rear seat. This may cause the “AIR BAG OFF” indicator light to be illuminated, which indicates that the SRS airbags for the front passenger will not activate in the event of a severe accident. If the seatback touches the rear seat, return the seatback to a position where it does not touch the rear seat. Keep the front passenger seatback as upright as possible when the vehicle is moving. Reclining the seatback excessively may lessen the effectiveness of the seat belt system.
- If an adult sits in the front passenger seat, the “AIR BAG ON” indicator light is illuminated. If the “AIR BAG OFF” indicator is illuminated, ask the passenger to sit up straight, well back in the seat, feet on the floor, and with the seat belt worn correctly. If the “AIR BAG OFF” indicator still remains illuminated, either ask the passenger to move to the rear seat, or if that is not possible, move the front passenger seat fully rearward.
- When it is unavoidable to install a forward-facing child restraint system on the front passenger seat, install the child restraint system on the front passenger seat in the proper order. (→P. 59)
- Do not modify or remove the front seats.
- Do not kick the front passenger seat or subject it to severe impact. Otherwise, the SRS warning light may come on to indicate a malfunction of the front passenger occupant classification system. In this case, contact your Lexus dealer immediately.
- Child restraint systems installed on the rear seat should not contact the front seatbacks.
- Do not use a seat accessory, such as a cushion and seat cover, that covers the seat cushion surface.
- Do not modify or replace the upholstery of the front seat.

Safety information for children

Observe the following precautions when children are in the vehicle.

Use a child restraint system appropriate for the child, until the child becomes large enough to properly wear the vehicle's seat belt.

- It is recommended that children sit in the rear seats to avoid accidental contact with the shift lever, wiper switch etc.
- Use the rear door child-protector lock or the window lock switch to avoid children opening the door while driving or operating the power window accidentally.
- Do not let small children operate equipment which may catch or pinch body parts, such as the power window, hood, back door, seats etc.

CAUTION

Never leave children unattended in the vehicle, and never allow children to have or use the key.

Children may be able to start the vehicle or shift the vehicle into neutral. There is also a danger that children may injure themselves by playing with the windows, the moon roof (if equipped) or other features of the vehicle. In addition, heat build-up or extremely cold temperatures inside the vehicle can be fatal to children.

Child restraint systems

A child restraint system for a small child or baby must itself be properly restrained on the seat with the LATCH anchors or the lap portion of the lap/shoulder belt.

The laws of all 50 states of the U.S.A. and Canada now require the use of child restraint systems.

Points to remember

Studies have shown that installing a child restraint on a rear seat is much safer than installing one on the front passenger seat.

- Choose a child restraint system that suits your vehicle and is appropriate to the age and size of the child.
- For installation details, follow the instructions provided with the child restraint system.

General installation instructions are provided in this manual. (→P. 59)

1

For safety and security

Types of child restraints

Child restraint systems are classified into the following 3 types according to the age and size of the child:

- ▶ Rear facing — Infant seat/convertible seat
- ▶ Forward facing — Convertible seat



- ▶ Booster seat



■ Selecting an appropriate child restraint system

- Use a child restraint system appropriate for the child until the child becomes large enough to properly wear the vehicle's seat belt.
- If the child is too large for a child restraint system, sit the child on a rear seat and use the vehicle's seat belt. (→P. 30)

 CAUTION

■ Child restraint precautions

- For effective protection in automobile accidents and sudden stops, a child must be properly restrained, using a seat belt or child restraint system depending on the age and size of the child. Holding a child in your arms is not a substitute for a child restraint system. In an accident, the child can be crushed against the windshield, or between you and the vehicle's interior.
- Lexus strongly urges the use of a proper child restraint system that conforms to the size of the child, installed on the rear seat. According to accident statistics, the child is safer when properly restrained in the rear seat than in the front seat.
- Never install a rear-facing child restraint system on the front passenger seat even if the "AIR BAG OFF" indicator light is illuminated.
In the event of an accident, the force of the rapid inflation of the front passenger airbag can cause death or serious injury to the child if the rear-facing child restraint system is installed on the front passenger seat.
- A forward-facing child restraint system may be installed on the front passenger seat only when it is unavoidable. A child restraint system that requires a top tether strap should not be used in the front passenger seat since there is no top tether strap anchor for the front passenger seat. Adjust the seatback as upright as possible and always move the seat as far back as possible even if the "AIR BAG OFF" indicator light is illuminated, because the front passenger airbag could inflate with considerable speed and force. Otherwise, the child may be killed or seriously injured.
- Do not use the seat belt extender when installing a child restraint system on the front or rear passenger seat. If installing a child restraint system with the seat belt extender connected to the seat belt, the seat belt will not securely hold the child restraint system, which could cause death or serious injury to the child or other passengers in the event of a sudden stop, sudden swerve or accident.
- Do not allow the child to lean his/her head or any part of his/her body against the door or the area of the seat, front, center and rear pillars or roof side rails from which the SRS side airbags or SRS curtain shield airbags deploy even if the child is seated in the child restraint system. It is dangerous if the SRS side airbags and curtain shield airbags inflate, and the impact could cause death or serious injury to the child.
- Make sure you have complied with all installation instructions provided by the child restraint manufacturer and that the system is properly secured. If it is not secured properly, it may cause death or serious injury to the child in the event of a sudden stop, sudden swerve or accident.

 CAUTION**■ When children are in the vehicle**

Do not allow children to play with the seat belt. If the seat belt becomes twisted around a child's neck, it may lead to choking or other serious injuries that could result in death. If this occurs and the buckle cannot be unfastened, scissors should be used to cut the belt.

■ When the child restraint system is not in use

- Keep the child restraint system properly secured on the seat even if it is not in use. Do not store the child restraint system unsecured in the passenger compartment.
- If it is necessary to detach the child restraint system, remove it from the vehicle or store it securely in the luggage compartment. This will prevent it from injuring passengers in the event of a sudden stop, sudden swerve or accident.

Installing child restraints

Follow the child restraint system manufacturer's instructions. Firmly secure child restraints to the seats using the LATCH anchors or a seat belt. Attach the top tether strap when installing a child restraint.

The lap/shoulder belt can be used if your child restraint system is not compatible with the LATCH (Lower Anchors and Tethers for Children) system.

Child restraint LATCH anchors

► 7-passenger models

LATCH anchors are provided for the right side second seat and between the center and left side second seats. (Buttons displaying the location of the anchors are attached to the seats.)

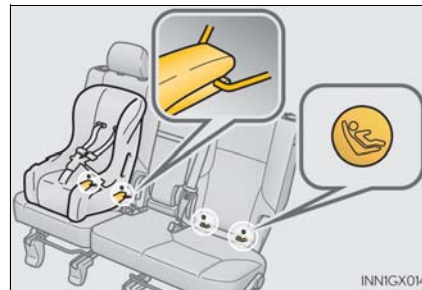

► 6-passenger models

LATCH anchors are provided for both second seats. (Buttons displaying the location of the anchors are attached to the seats.)



Seat belts equipped with a child restraint locking mechanism (ALR/ELR belts except driver's seat belt) (→P. 32)



1

For safety and security

Anchor brackets (for top tether strap)

▶ 7-passenger models

An anchor bracket is provided for each second seat.

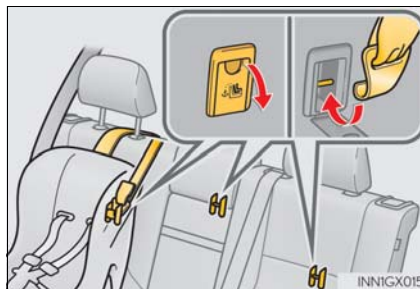

▶ 6-passenger models

Anchor brackets are provided for both second seats and right side third seat.



Installation with LATCH system

- 1 Fold the seatback forward. Then return the seatback and secure it at the first lock position (most upright position). (→P. 124)

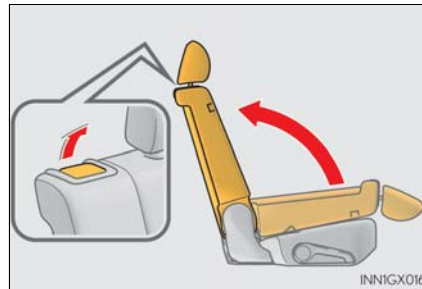

- ▶ Type A

- 2 Flip the cover, and latch the hooks of the lower straps onto the LATCH anchors. If the child restraint has a top tether strap, the top tether strap should be latched onto the top tether strap anchor. (→P. 67)

For owners in Canada:

The symbol on a child restraint system indicates the presence of a lower connector system.

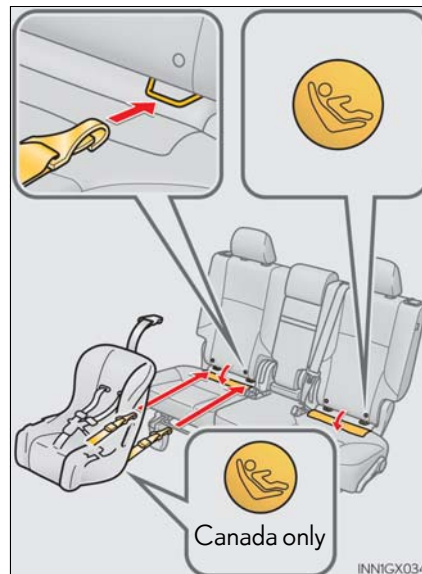

1

For safety and security

▶ Type B

- 2 Flip the cover, and latch the buckles onto the LATCH anchors. If the child restraint has a top tether strap, the top tether strap should be latched onto the top tether strap anchor. (→P. 67)

For owners in Canada:

The symbol on a child restraint system indicates the presence of a lower connector system.

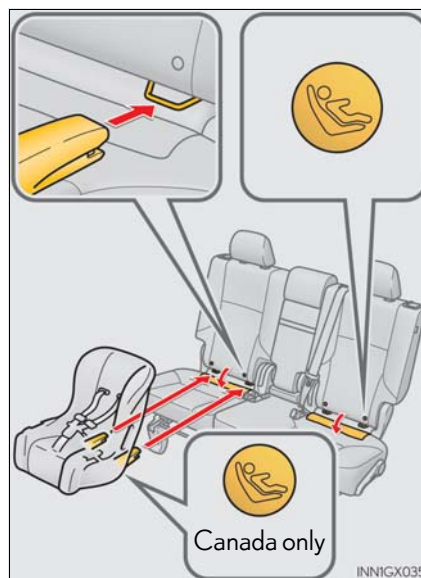

Installing child restraints using a seat belt (child restraint lock function belt)

■ Rear-facing— Infant seat/convertible seat

- 1 Fold the seatback forward. Then return the seatback and secure it at the first lock position (most upright position). (→P. 124)

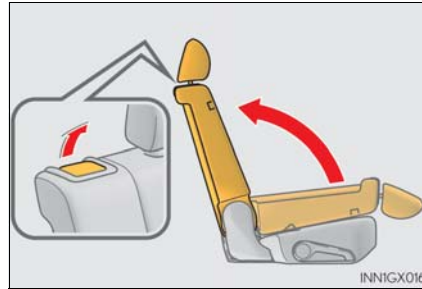

- 2 Place the child restraint system on the seat facing the rear of the vehicle.

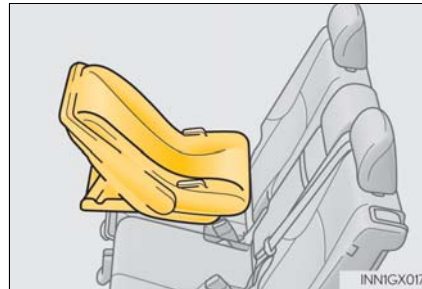

- 3 Run the seat belt through the child restraint system and insert the plate into the buckle. Make sure that the belt is not twisted.



- 4 Fully extend the shoulder belt and allow it to retract to put it in lock mode. In lock mode, the belt cannot be extended.

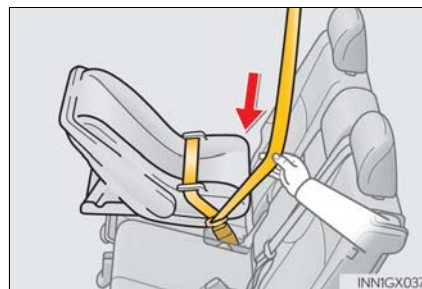

1

For safety and security

- 5 While pushing the child restraint system down into the seat, allow the shoulder belt to retract until the child restraint system is securely in place.

After the shoulder belt has retracted to a point where there is no slack in the belt, pull the belt to check that it cannot be extended.



■ Forward-facing— Convertible seat

- 1 Fold the seatback forward. Then return the seatback and secure it at the first lock position (most upright position). (→P. 124)

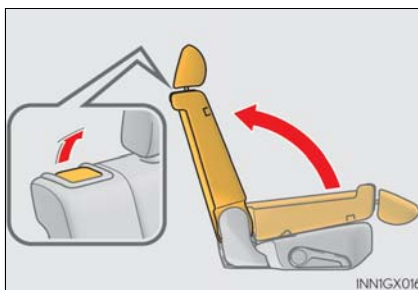

- 2 Place the child restraint system on the seat facing the front of the vehicle.



- 3 Run the seat belt through the child restraint system and insert the plate into the buckle. Make sure that the belt is not twisted.



- 4 Fully extend the shoulder belt and allow it to retract to put it in lock mode. In lock mode, the belt cannot be extended.



- 5 While pushing the child restraint system into the seat, allow the shoulder belt to retract until the child restraint system is securely in place.

After the shoulder belt has retracted to a point where there is no slack in the belt, pull the belt to check that it cannot be extended.



- 6 If the child restraint has a top tether strap, the top tether strap should be latched onto the top tether strap anchor. (→P. 67)

■ Booster seat

- 1 Fold the seatback forward. Then return the seatback and secure it at the first lock position (most upright position). (→P. 124)

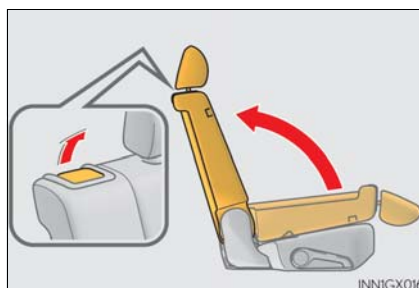

- 2 Place the child restraint system on the seat facing the front of the vehicle.



- 3 Sit the child in the child restraint system. Fit the seat belt to the child restraint system according to the manufacturer's instructions and insert the plate into the buckle. Make sure that the belt is not twisted.



Check that the shoulder belt is correctly positioned over the child's shoulder and that the lap belt is as low as possible. (→P. 30)

Removing a child restraint installed with a seat belt

Push the buckle release button and fully retract the seat belt.

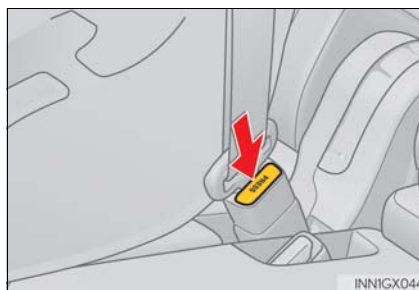

Child restraint systems with a top tether strap (second seats)

- 1 Secure the child restraint system using the seat belt or LATCH anchors and move the head restraint in place at the upmost position.

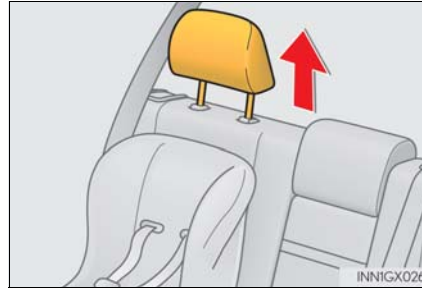

- ▶ 7-passenger models

- 2 Open the anchor bracket cover, latch the hook onto the anchor bracket and tighten the top tether strap.

Make sure the top tether strap is securely latched.

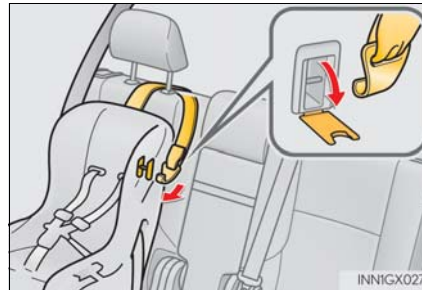

- ▶ 6-passenger models

- 2 Latch the hook onto the anchor bracket and tighten the top tether strap.

Make sure the top tether strap is securely latched.

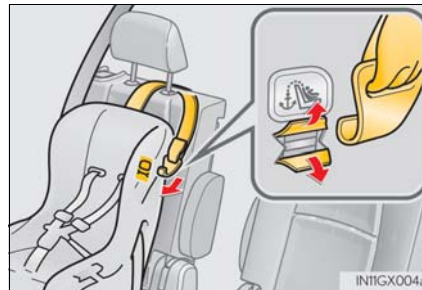

Child restraint systems with a top tether strap (right side third seat for 6-passenger models)

- 1 Lift up the head restraint system until it locks and secure the child restraint system using the seat belt.

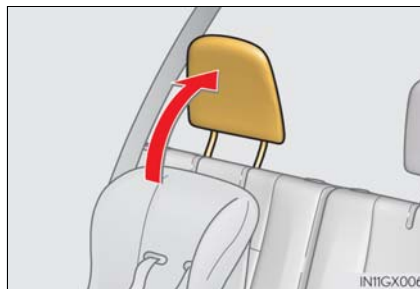

- 2 Latch the hook onto the anchor bracket and tighten the top tether strap.

Make sure the top tether strap is securely latched.



■ Laws and regulations pertaining to anchorages

The LATCH system conforms to FMVSS225 or CMVSS210.2.

Child restraint systems conforming to FMVSS213 or CMVSS213 specifications can be used.

This vehicle is designed to conform to the SAE J1819.

CAUTION

■ **When installing a booster seat**

To prevent the belt from going into ALR lock mode, do not fully extend the shoulder belt. ALR mode causes the belt to tighten only. This could cause injury or discomfort to the child. (→P. 32)

■ **When installing a child restraint system**

Follow the directions given in the child restraint system installation manual and fix the child restraint system securely in place.

If the child restraint system is not correctly fixed in place, the child or other passengers may be seriously injured or even killed in the event of sudden braking, sudden swerving or an accident.

- If the driver's seat interferes with the child restraint system and prevents it from being attached correctly, attach the child restraint system to the right-hand rear seat.
- Adjust the front passenger seat so that it does not interfere with the child restraint system.
- Child restraint system installed on the third seat should not contact the second seatbacks.



- Only put a forward-facing child restraint system on the front seat when unavoidable. When installing a forward-facing child restraint system on the front passenger seat, move the seat as far back as possible even if the "AIR BAG OFF" indicator light is illuminated. Failure to do so may result in death or serious injury if the airbags deploy (inflate).



- When installing a child restraint system in the center second seat, adjust both seatbacks at the same angle.
- When using the LATCH anchors for a child restraint system, move the seat as far back as possible (second seat only), with the seatback close to the child restraint system.

 CAUTION**■ When installing a child restraint system**

- When a booster seat is installed, always ensure that the shoulder belt is positioned across the center of the child's shoulder. The belt should be kept away from the child's neck, but not so that it could fall off the child's shoulder. Failing to do so may result in death or serious injury in the event of sudden braking, sudden swerving or an accident.
- Ensure that the belt and plate are securely locked and the seat belt is not twisted.
- Shake the child restraint system left and right, and forward and backward to ensure that it has been securely installed.
- After securing a child restraint system, never adjust the seat.
- Follow all installation instructions provided by the child restraint system manufacturer.
- When securing some types of child restraint systems in second or third row seats, it may not be possible to properly use the seat belts in positions next to the child restraint without interfering with it or affecting seat belt effectiveness. Be sure your seat belt fits snugly across your shoulder and low on your hips. If it does not, or if it interferes with the child restraint, move to a different position. Failure to do so may result in death or serious injury.

■ Do not use a seat belt extender

If a seat belt extender is used when installing a child restraint system, the seat belt will not securely hold the child restraint system, which could cause death or serious injury to the child or other passengers in the event of sudden braking, sudden swerving or an accident.

■ To correctly attach a child restraint system to the anchors

When using the LATCH anchors, be sure that there are no foreign objects around the anchors and that the seat belt is not caught behind the child restraint system. Make sure the child restraint system is securely attached, or it may cause death or serious injury to the child or other passengers in the event of a sudden stop, sudden swerve or accident.

Exhaust gas precautions

Harmful substance to the human body is included in exhaust gases if inhaled.

CAUTION

Exhaust gases include harmful carbon monoxide (CO), which is colorless and odorless. Observe the following precautions. Failure to do so may cause exhaust gases enter the vehicle and may lead to an accident caused by light-headedness, or may lead to death or a serious health hazard.

■ Important points while driving

- Keep the back door closed.
- If you smell exhaust gases in the vehicle even when the back door is closed, open the windows and have the vehicle inspected at your Lexus dealer as soon as possible.

■ When parking

- If the vehicle is in a poorly ventilated area or a closed area, such as a garage, stop the engine.
- Do not leave the vehicle with the engine running for a long time. If such a situation cannot be avoided, park the vehicle in an open space and ensure that exhaust fumes do not enter the vehicle interior.
- Do not leave the engine running in an area with snow build-up, or where it is snowing. If snowbanks build up around the vehicle while the engine is running, exhaust gases may collect and enter the vehicle.

■ Exhaust pipe

The exhaust system needs to be checked periodically. If there is a hole or crack caused by corrosion, damage to a joint or abnormal exhaust noise, be sure to have the vehicle inspected and repaired by your Lexus dealer.

1

For safety and security

Engine immobilizer system

The vehicle's keys have built-in transponder chips that prevent the engine from starting if a key has not been previously registered in the vehicle's on-board computer.

Never leave the keys inside the vehicle when you leave the vehicle.

This system is designed to help prevent vehicle theft but does not guarantee absolute security against all vehicle thefts.

The indicator light flashes after the engine switch has been turned off to indicate that the system is operating.

The indicator light stops flashing after the engine switch has been turned to ACCESSORY or IGNITION ON mode to indicate that the system has been canceled.

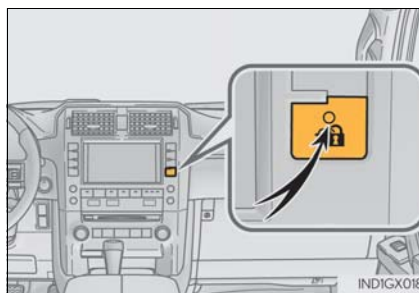

■ System maintenance

The vehicle has a maintenance-free type engine immobilizer system.

■ Conditions that may cause the system to malfunction

- If the grip portion of the key is in contact with a metallic object
- If the key is in close proximity to or touching a key to the security system (key with a built-in transponder chip) of another vehicle

■ Certifications for the engine immobilizer system

- ▶ For vehicles sold in the U.S.A., Hawaii, NATO Germany, Guam, Saipan and Puerto Rico

FCC ID: NI4TMIMB-2 ✓

This device complies with part 15 of the FCC Rules. Operation is subject to the following two conditions: (1) This device may not cause harmful interference, and (2) this device must accept any interference received, including interference that may cause undesired operation.

Changes or modifications not expressly approved by the party responsible for compliance could void the user's authority to operate the equipment.



- ▶ For vehicles sold in Canada

This device complies with Industry Canada's licence-exempt RSSs. Operation is subject to the following two conditions: (1) This device may not cause interference; and (2) This device must accept any interference, including interference that may cause undesired operation of the device.

Le présent appareil est conforme aux CNR d'Industrie Canada applicables aux appareils radio exempts de licence. L'exploitation est autorisée aux deux conditions suivantes : (1) l'appareil ne doit pas produire de brouillage; (2) l'utilisateur de l'appareil doit accepter tout brouillage radioélectrique subi, même si le brouillage est susceptible d'en compromettre le fonctionnement.

 NOTICE

■ **To ensure the system operates correctly**

Do not modify or remove the system. If modified or removed, the proper operation of the system cannot be guaranteed.

1

For safety and security

Alarm

The alarm

The alarm uses light and sound to give an alert when an intrusion is detected.

The alarm is triggered in the following situations when the alarm is set:

- A locked door or glass hatch is unlocked or opened in any way other than using the entry function, wireless remote control or mechanical key. (The doors will lock again automatically.)
- The hood is opened.

Setting the alarm system

Close the doors, glass hatch and hood, and lock all the doors. The system will be set automatically after 30 seconds.

The indicator light changes from being on to flashing when the system is set.

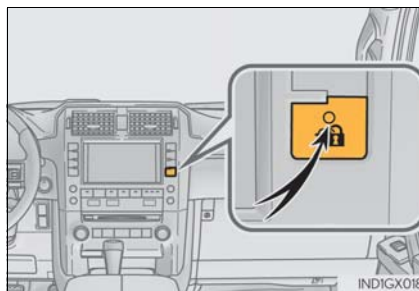

Deactivating or stopping the alarm

Do one of the following to deactivate or stop the alarms:

- Unlock the doors.
- Start the engine. (The alarm will be deactivated or stopped after a few seconds.)

■ System maintenance

The vehicle has a maintenance-free type alarm system.

■ Items to check before locking the vehicle

To prevent unexpected triggering of the alarm and vehicle theft, make sure of the following.

- Nobody is in the vehicle.
- The windows and moon roof are closed before the alarm is set.
- No valuables or other personal items are left in the vehicle.

■ Triggering of the alarm

The alarm may be triggered in the following situations:
(Stopping the alarm deactivates the alarm system.)

- A person inside the vehicle opens a door or hood.
- The battery is recharged or replaced when the vehicle is locked. (→P. 562)

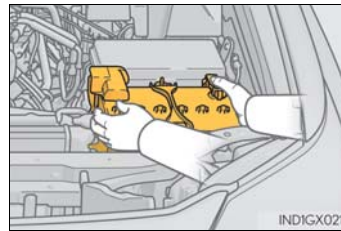

■ Alarm-operated door lock

In the following cases, depending on the situation, the door may automatically lock to prevent improper entry into the vehicle:

- When a person remaining in the vehicle unlocks the door and the alarm is activated.
- While the alarm is activated, a person remaining in the vehicle unlocks the door.
- When recharging or replacing the battery.

■ Alarm memory function

After the alarm is activated, when you unlock any door using a entry function, wireless remote control or mechanical key, the tail lights turn on for about 2 seconds to inform you that the system was activated.

⚠ NOTICE

■ To ensure the system operates correctly

Do not modify or remove the system. If modified or removed, the proper operation of the system cannot be guaranteed.



2. Instrument cluster

- Warning and indicators lights 78
- Gauges and meters 83
- Multi-information display 86
- Fuel consumption information 92



Warning and indicators lights

The warning and indicators lights on the instrument cluster and center panel inform the driver of the status of the vehicle's various systems.

For the purpose of explanation, the following illustrations display all warning lights and indicators illuminated.



The units used on the speedometer may differ depending on the target region.

Warning lights

Warning lights inform the driver of malfunctions in any of the vehicle's systems.

^{*1}  (U.S.A.)	Brake system warning light (→P. 520)	^{*1} 	LED headlight warning light (→P. 521)
^{*1}  (Canada)	Brake system warning light (→P. 520)	^{*1,2} 	Automatic headlight leveling system warning light (→P. 521)
^{*1} 	Charging system warning light (→P. 520)	^{*1} 	Kinetic dynamic suspension system warning light (→P. 521)
^{*1}  (U.S.A.)	Malfunction indicator lamp (→P. 520)	^{*2} 	Low speed four-wheel drive indicator light (→P. 522)
^{*1}  (Canada)	Malfunction indicator lamp (→P. 520)	^{*2} 	Center differential lock indicator light (→P. 522)
^{*1} 	SRS warning light (→P. 520)		Open door warning light (→P. 522)
^{*1}  (U.S.A.)	ABS warning light (→P. 520)		Low fuel level warning light (→P. 522)
^{*1}  (Canada)	ABS warning light (→P. 520)		Seat belt reminder light (→P. 522)
^{*1,2}  (if equipped)	Pre-collision system warning light (→P. 521)	^{*1} 	Master warning light (→P. 522)
^{*1} 	Slip indicator light (→P. 521)	^{*1} 	Tire pressure warning light (→P. 522)













*1: These lights turn on when the engine switch is turned to IGNITION ON mode to indicate that a system check is being performed. They will turn off after the engine is on, or after a few seconds. There may be a malfunction in a system if the lights do not turn on, or turn off. Have the vehicle inspected by your Lexus dealer.









*2: The light flashes to indicate a malfunction.

Indicators

The indicators inform the driver of the operating state of the vehicle's various systems.

	Turn signal indicator (→P. 200)		"SET" indicator (→P. 225, 228)
	Headlight indicator (→P. 202) (U.S.A.)		Dynamic radar cruise control indicator (→P. 228) (if equipped)
	Tail light indicator (→P. 202) (Canada)		"LDA" (Lane Departure Alert) indicator (→P. 239) (if equipped)
	Headlight high beam indicator (→P. 203)		*1, 2 Slip indicator (→P. 352)
	Automatic High Beam indicator (→P. 206) (if equipped)		*1 VSC OFF indicator (→P. 353)
	Fog light indicator (→P. 211) (if equipped)		Multi-terrain Select indicator (→P. 308) (if equipped)
	*1 Eco Driving Indicator Light (→P. 90)		*1 Crawl Control indicator (→P. 346) (if equipped)
	Cruise control indicator (→P. 225, 228)		*1 Downhill assist control system indicator (→P. 349) (if equipped)



	"2nd STRT" indicator (→P. 195)		"BSM" (Blind Spot Monitor) indicator (→P. 357)
	Low speed four-wheel drive indicator light (→P. 342)		BSM (Blind Spot Monitor) outside rear view mirror indicators (→P. 357)
	Center differential lock indicator (→P. 343)		"AIR BAG ON/OFF" indicator (→P. 48)
	Intuitive parking assist indicator (→P. 245)		"AIR BAG ON/OFF" indicator (→P. 48)
	"PCS" warning light (→P. 368)		

*1: These lights turn on when the engine switch is turned to IGNITION ON mode to indicate that a system check is being performed. They will turn off after the engine is on, or after a few seconds. There may be a malfunction in a system if the lights do not turn on, or turn off. Have the vehicle inspected by your Lexus dealer.

*2: The light flashes to indicate that the system is operating.

*3: The light turns on when the system is turned off. The light flashes quickly to indicate that the system is operating.

*4: In order to confirm operation, the BSM outside rear view mirror indicators illuminate in the following situations:

- When the engine switch is turned to IGNITION ON mode while the system is set to on.
- When the system is set to on while the engine switch is in IGNITION ON mode.

If the system is functioning correctly, the BSM outside rear view mirror indicators will turn off after a few seconds.

If the BSM outside rear view mirror indicators do not illuminate or do not turn off, there may be a malfunction with the system.

If this occurs, have the vehicle inspected by your Lexus dealer.

*5: This light illuminates on the outside rear view mirrors.

*6: This light illuminates on the center panel.

 CAUTION**■ If a safety system warning light does not come on**

Should a safety system light such as the ABS/Multi Terrain ABS and the SRS warning light not come on when you start the engine, this could mean that these systems are not available to help protect you in an accident, which could result in death or serious injury. Have the vehicle inspected by your Lexus dealer immediately if this occurs.

Gauges and meters



The units used on the speedometer may differ depending on the target region.

- ① Tachometer
Displays the engine speed in revolutions per minute
- ② Engine coolant temperature gauge
Displays the engine coolant temperature
- ③ Multi-information display
Presents the driver with a variety of driving-related data (→P. 86)
- ④ Fuel gauge
Displays the quantity of fuel remaining in the tank
- ⑤ Speedometer
Displays the vehicle speed
- ⑥ Rear height control air suspension display (if equipped)
Displays the rear height mode selected (→P. 337)
- ⑦ Shift position and shift range display
Displays the selected shift position or selected shift range (→P. 194)
- ⑧ Odometer and trip meter display
Odometer:
Displays the total distance the vehicle has been driven
Trip meter:
Displays the distance the vehicle has been driven since the meter was last reset. Trip meters A and B can be used to record and display different distances independently.

2

Instrument cluster

Changing the display

Switches between odometer and trip meter displays. When the trip meter is displayed, pressing and holding the button will reset the trip meter.

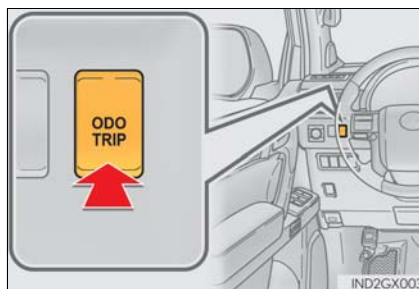

Instrument cluster light control switch

The brightness of the instrument cluster lights can be adjusted.

- ① Brighter
- ② Darker

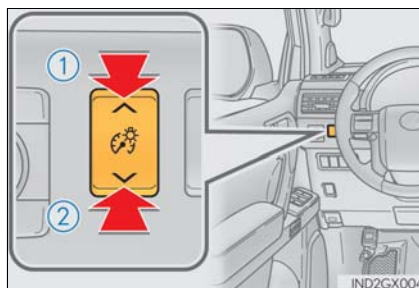

■ **The meters and display illuminate when**

The engine switch is in IGNITION ON mode.

■ **Instrument cluster brightness adjustment**

The instrument cluster brightness levels when the tail lights are on and off can be adjusted.

■ **The brightness of the instrument cluster lights**

When the tail lights are on, the brightness will change. However, when the surroundings are bright (daytime, etc.) turning on the tail lights will not change the instrument cluster brightness.

In addition, the brightness of the instrument cluster lights is automatically adjusted based on the light sensor detecting how bright the surroundings are.

■ **When disconnecting and reconnecting battery terminals**

The trip meter data will be reset.

If the trip meter was displayed last, the odometer will be displayed after resetting.

■ **Customization**

Setting of sensitivity of the ambient light sensor used for dimming the meter lights can be changed. (Customizable features: →P. 594)



NOTICE

■ **To prevent damage to the engine and its components**

- Do not let the indicator needle of the tachometer enter the red zone, which indicates the maximum engine speed.
- The engine may be overheating if the engine coolant temperature gauge is in the red zone (H). In this case, immediately stop the vehicle in a safe place, and check the engine after it has cooled completely. (→P. 564)

Multi-information display

Display contents

The multi-information display presents the driver with a variety of driving-related data.

- Trip information contents (→P. 87)
 - Displays driving range, fuel consumption and other cruising related information
- Electronic features control contents (→P. 88)
- Other contents (→P. 89)

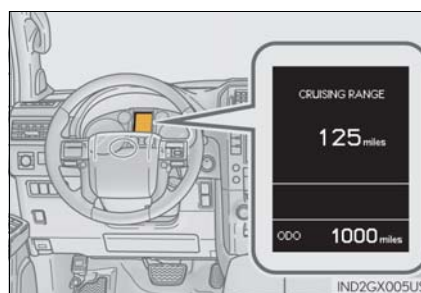

Switching the display

① Menu switch

Changes modes to electronic features control mode, customization mode or back to normal display mode.

② "ENTER" switch

Changes trip information items. This switch is also used to turn on/off electronic features controls and to change customization settings.

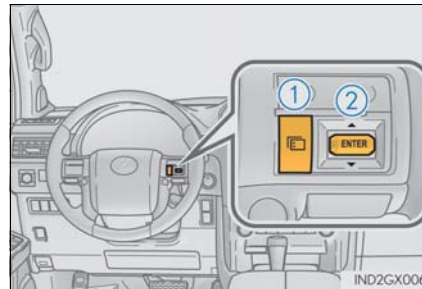

Trip information contents

Trip information items displayed can be switched by pressing the "ENTER" switch upwards or downwards.

■ Outside temperature

Displays the outside temperature

- The temperature range that can be displayed is from -40°F (-40°C) to 122°F (50°C).
- When the outside temperature drops below 37°F (3°C), the outside temperature display flashes several times.

■ Front tire angle

The direction of the front tires is displayed

The tire direction is displayed in 3 stages for both left and right, in accordance with the angle of the tire.

■ Driving range

Displays the estimated maximum distance that can be driven with the quantity of fuel remaining

- This distance is computed based on your average fuel consumption. As a result, the actual distance that can be driven may differ from that displayed.
- When only a small amount of fuel is added to the tank, the display may not be updated.
- When refueling, turn the engine switch off. If the vehicle is refueled without turning the engine switch off, the display may not be updated.

■ Average fuel consumption after refueling

Displays the average fuel consumption since the vehicle was last refueled

Use the displayed average fuel consumption as a reference.

■ Current fuel consumption

Displays the current rate of fuel consumption

■ Average fuel consumption and Eco Driving Indicator Zone Display
(→P. 90)

Displays the average fuel consumption since the function was reset

- The function can be reset by pressing the “ENTER” switch for longer than 1 second when the average fuel consumption is displayed.
- Use the displayed average fuel consumption as a reference.

■ Average vehicle speed

Displays the average vehicle speed since the engine was started or the function was reset

The function can be reset by pressing the “ENTER” switch for longer than 1 second when the average vehicle speed is displayed.

■ Elapsed time

Displays the elapsed time since the function was last reset

The function can be reset by pressing the “ENTER” switch for longer than 1 second when the elapsed time is displayed.

■ Display off

A blank screen is displayed

Electronic features control contents

- Multi-terrain Select (if equipped) (→P. 308)
- Intuitive parking assist (if equipped) (→P. 245)
- BSM (Blind Spot Monitor) (if equipped) (→P. 357)
- Second start mode (→P. 195)

Other contents

- **Dynamic radar cruise control display*** (if equipped) (→P. 228)
- **LDA (Lane Departure Alert) display*** (if equipped) (→P. 239)
- **Intuitive parking assist display*** (if equipped) (→P. 245)
- **Crawl Control display*** (if equipped) (→P. 346)
- **Warning messages** (→P. 528)

Automatically displayed when a malfunction occurs in one of the vehicles systems.

- **Customization**

Settings (e.g. available language) can be changed.
(Customizable features: →P. 594)

*: Automatically displayed when the system is used

- **Electronic features control can be turned on/off when**

Engine switch is in IGNITION ON mode.

- **System check display**

After turning the engine switch to IGNITION ON mode, "CHECKING" is displayed while system operation is checked. When the system check is complete, the normal screen will return.

- **Conditions for ending electronic features control**

In the following situations, the electronic features control will end automatically:

- The menu switch is pressed
- Intuitive parking assist display starts operating
- The Crawl Control is operated
- The dynamic radar cruise control is operated
- A warning message appears after the electronic features control screen is displayed

■ Eco Driving Indicator

- ① Eco Driving Indicator Light
During Eco-friendly acceleration (Eco driving), Eco Driving Indicator Light will turn on.
- ② Eco Driving Indicator Zone Display
Suggests Zone of Eco driving with current Eco driving ratio based on acceleration.
- ③ Zone of Eco driving
- ④ Eco driving ratio based on acceleration
If the vehicle exceeds Zone of Eco driving, the right side of Eco Driving Indicator Zone Display will blink and Eco Driving Indicator Light will turn off.

Eco Driving Indicator Light will not operate in the following conditions:

- The shift lever is in anything other than D.
- The vehicle is set to second start mode. (→P. 195)
- The vehicle speed is approximately 81 mph (130 km/h) or higher.

■ Outside temperature display

In the following situations, the correct outside temperature may not be displayed, or the display may take longer than normal to change:

- When stopped, or driving at low speeds (less than 12 mph [20 km/h])
- When the outside temperature has changed suddenly (at the entrance/exit of a garage, tunnel, etc.)

■ When "--" or "E" is displayed

The system may be malfunctioning. Take your vehicle to your Lexus dealer.

■ When disconnecting and reconnecting battery terminals

The following information data will be reset:

- Average fuel consumption after refueling
- Average fuel consumption
- Average vehicle speed
- Elapsed time

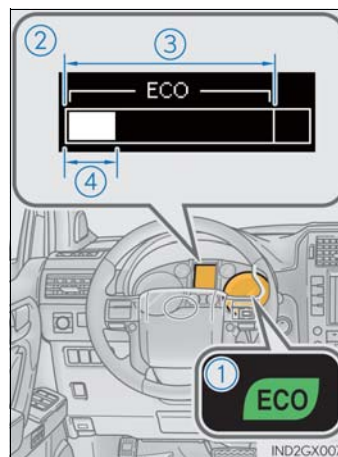

 CAUTION**■ The multi-information display at low temperatures**

Allow the interior of the vehicle to warm up before using the information display. At extremely low temperatures, the information display monitor may respond slowly, and display changes may be delayed.

For example, there is a lag between the driver's shifting and the new gear number appearing on the display. This lag could cause the driver to downshift again, causing rapid and excessive engine braking and possibly an accident resulting in death or serious injury.

■ Cautions during setting up the display

As the engine needs to be running during setting up the display, ensure that the vehicle is parked in a place with adequate ventilation. In a closed area such as a garage, exhaust gases including harmful carbon monoxide (CO) may collect and enter the vehicle. This may lead to death or a serious health hazard.

 NOTICE**■ During setting up the display**

To prevent battery discharge, ensure that the engine is running while setting up the display features.

Fuel consumption information

Fuel consumption information can be displayed on the multimedia screen or navigation system screen.

Press the “INFO”/“APPS” button, and then select “Fuel consumption”/“Eco” on the screen.

- ① Resetting the consumption data
- ② Fuel consumption in the past 30 minutes
- ③ Cruising range

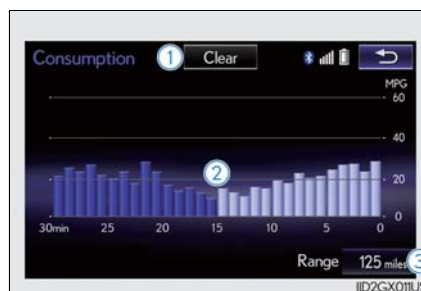

Average fuel consumption for the past 30 minutes is divided by color into past averages and averages attained since the engine switch was last turned to IGNITION ON mode. Use the displayed average fuel consumption as a reference.

The image is an example only.

■ Resetting the data

The data can be deleted by selecting “Clear”.

■ Cruising range

Displays the estimated maximum distance that can be driven with the quantity of fuel remaining.

This distance is computed based on your average fuel consumption. As a result, the actual distance that can be driven may differ from that displayed.

3-1. Key information	
Keys	94
3-2. Opening, closing and locking the doors	
Side doors	98
Back door	105
Glass hatch	110
Smart access system with push-button start	115
3-3. Adjusting the seats	
Front seats	122
Rear seats	124
Driving position memory	135
Head restraints	140
3-4. Adjusting the steering wheel and mirrors	
Steering wheel	143
Inside rear view mirror	145
Outside rear view mirrors	147
3-5. Opening, closing the windows and moon roof	
Power windows	150
Moon roof	153



Keys

The keys

The following keys are provided with the vehicle.

- ① Electronic keys
 - Operating the smart access system with push-button start (→P. 115)
 - Operating the wireless remote control function
- ② Mechanical keys
- ③ Key number plate

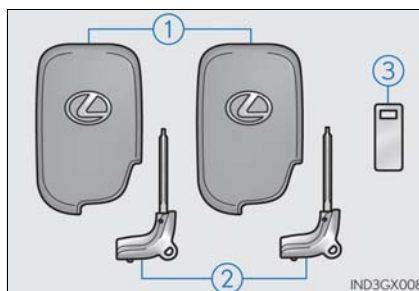

Wireless remote control

- ① Locks the doors (→P. 98)
- ② Unlocks the doors (→P. 98)
- ③ Opens the windows and moon roof* (→P. 98)
- ④ Opens the glass hatch (→P. 110)
- ⑤ Sounds the alarm (→P. 95)

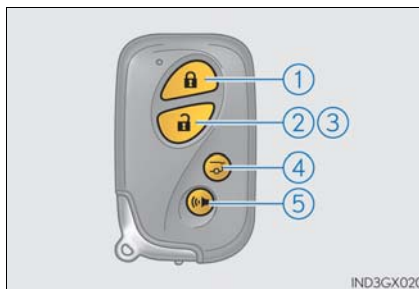

*: These settings must be customized at your Lexus dealer.

Using the mechanical key

To take out the mechanical key, slide the release lever and take the key out.

After using the mechanical key, store it in the electronic key. Carry the mechanical key together with the electronic key. If the electronic key battery is depleted or the entry function does not operate properly, you will need the mechanical key. (→P. 558)

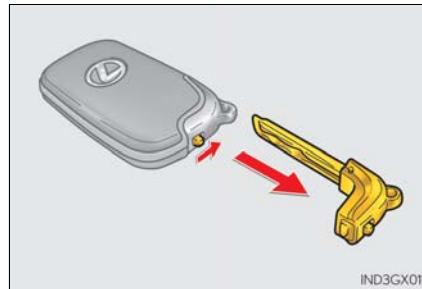

■ Panic mode

When  is pressed for longer than about one second, an alarm will sound intermittently and the vehicle lights will flash to deter any person from trying to break into or damage your vehicle.

To stop the alarm, press any button on the electronic key.



■ When required to leave the vehicle's key with a parking attendant

Lock the glove box as circumstances demand. (→P. 406)

Remove the mechanical key for your own use and provide the attendant with the electronic key only.

■ If you lose your mechanical keys

New genuine mechanical keys can be made by your Lexus dealer using another mechanical key and the key number stamped on your key number plate. Keep the plate in a safe place such as your wallet, not in the vehicle.

3

Operation of each component

■ When riding in an aircraft

When bringing an electronic key onto an aircraft, make sure you do not press any buttons on the electronic key while inside the aircraft cabin. If you are carrying an electronic key in your bag etc., ensure that the buttons are not likely to be pressed accidentally. Pressing a button may cause the electronic key to emit radio waves that could interfere with the operation of the aircraft.

■ Electronic key battery depletion

- The standard battery life is 1 to 2 years.
- If the battery becomes low, an alarm will sound in the cabin when the engine is stopped. (→P. 539)
- As the electronic key always receives radio waves, the battery will become depleted even if the electronic key is not used. The following symptoms indicate that the electronic key battery may be depleted. Replace the battery when necessary. (→P. 491)
 - The smart access system with push-button start or the wireless remote control does not operate.
 - The detection area becomes smaller.
 - The LED indicator on the key surface does not turn on.
- To avoid serious deterioration, do not leave the electronic key within 3 ft. (1 m) of the following electrical appliances that produce a magnetic field:
 - TVs
 - Personal computers
 - Cellular phones, cordless phones and battery chargers
 - Recharging cellular phones or cordless phones
 - Table lamps
 - Induction cookers

■ Replacing the battery

→P. 491

■ Certification for the wireless remote control

- ▶ For vehicles sold in the U.S.A., Hawaii, NATO Germany, Guam, Saipan and Puerto Rico

FCC ID: NI4TMLF8-21 ✓

This device complies with part 15 of the FCC Rules. Operation is subject to the following two conditions: (1) This device may not cause harmful interference, and (2) this device must accept any interference received, including interference that may cause undesired operation.

Changes or modifications not expressly approved by the party responsible for compliance could void the user's authority to operate the equipment.



- ▶ For vehicles sold in the Canada

This device complies with Industry Canada's licence-exempt RSSs. Operation is subject to the following two conditions: (1) This device may not cause interference; and (2) This device must accept any interference, including interference that may cause undesired operation of the device.

Le présent appareil est conforme aux CNR d'Industrie Canada applicables aux appareils radio exempts de licence. L'exploitation est autorisée aux deux conditions suivantes : (1) l'appareil ne doit pas produire de brouillage; (2) l'utilisateur de l'appareil doit accepter tout brouillage radioélectrique subi, même si le brouillage est susceptible d'en compromettre le fonctionnement.

 NOTICE

■ **To prevent key damage**

- Do not drop the keys, subject them to strong shocks or bend them.
- Do not expose the keys to high temperatures for long periods of time.
- Do not get the keys wet or wash them in an ultrasonic washer etc.
- Do not attach metallic or magnetic materials to the keys or place the keys close to such materials.
- Do not disassemble the keys.
- Do not attach a sticker or anything else to the surface of the electronic key.
- Do not place the keys near objects that produce magnetic fields, such as TVs, audio systems and induction cookers, or medical electrical equipment, such as low-frequency therapy equipment.

■ **Carrying the electronic key on your person**

Carry the electronic key 3.9 in. (10 cm) or more away from electric appliances that are turned on. Radio waves emitted from electric appliances within 3.9 in. (10 cm) of the electronic key may interfere with the key, causing the key to not function properly.

■ **In case of a smart access system with push-button start malfunction or other key-related problems**

Take your vehicle with all the electronic keys provided with your vehicle to your Lexus dealer.

■ **When an electronic key is lost**

If the electronic key remains lost, the risk of vehicle theft increases significantly. Visit your Lexus dealer immediately with all remaining electronic keys that were provided with your vehicle.



Side doors

The vehicle can be locked and unlocked using the entry function, wireless remote control, key or door lock switch.

Locking and unlocking the doors from the outside

◆ Smart access system with push-button start

Carry the electronic key to enable this function.

- ① Grip the driver's door handle to unlock the door. Grip the passenger's door handle to unlock all the doors.*

Make sure to touch the sensor on the back of the handle.

The doors cannot be unlocked for 3 seconds after the doors are locked.

*: The door unlock settings can be changed. (→P. 103)

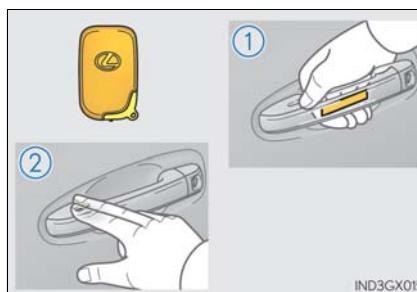

- ② Touch the lock sensor (the indentation on the upper part or lower part of the front door handle) to lock the doors.

Check that the door is securely locked.

◆ Wireless remote control

- ① Locks all the doors

Check that the door is securely locked.

- ② Unlocks all the doors

Pressing the button unlocks the driver's door. Pressing the button again within 3 seconds unlocks the other doors.

Press and hold to open the windows and moon roof.*

*: These settings must be customized at your Lexus dealer.

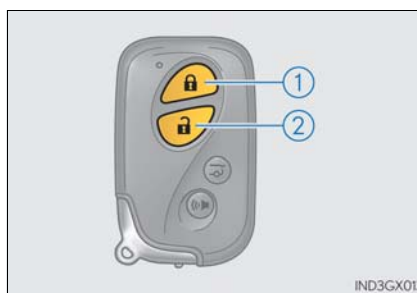

■ Operation signals

Doors: A buzzer sounds and the emergency flashers flash to indicate that the doors have been locked/unlocked. (Locked: once; Unlocked: twice)

Windows and moon roof: A buzzer sounds to indicate that the windows and moon roof are operating.

■ Security feature

If a door or the glass hatch is not opened within approximately 60 seconds after the vehicle is unlocked, the security feature automatically locks the vehicle again.

■ When the door cannot be locked by the lock sensor on the upper part of the door handle

If the door will not lock even when the topside sensor area is touched, try touching both the topside and underside sensor areas at the same time.



■ Door lock buzzer

If an attempt to lock the doors is made when a door and/or the glass hatch is not fully closed, a buzzer sounds continuously. Fully close the door and/or the glass hatch to stop the buzzer, and lock the vehicle once more.

■ Setting the alarm

Locking the doors will set the alarm system. (→P. 74)

■ If the smart access system with push-button start or the wireless remote control does not operate properly

Use the mechanical key to lock and unlock the doors. (→P. 558)

Replace the battery with a new one if it is depleted. (→P. 491)

⚠ CAUTION

■ When closing the windows or moon roof using wireless remote control

Observe the following precautions.
Failing to do so may result in death or serious injury.

- Check to make sure that all passengers do not have any part of their body in a position where it could be caught when a window or moon roof is being operated.
- To prevent inadvertent power windows and moon roof operation, never let a small child have and use the wireless remote control.

■ Jam protection function

- Never try jamming any part of your body to activate the jam protection function intentionally.
- The jam protection function may not work if something gets caught just before the window or moon roof fully closes.

Locking and unlocking the doors from the inside

◆ Door lock switches

- ① Locks all the doors
- ② Unlocks all the doors

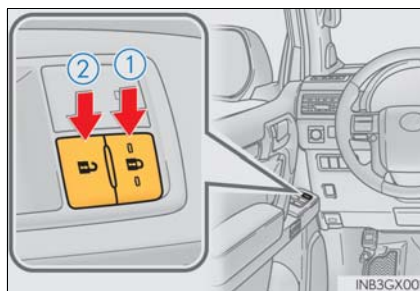

◆ Inside lock buttons

- ① Locks the door
- ② Unlocks the door

The front doors can be opened by pulling the inside handle even if the lock button is in the lock position.

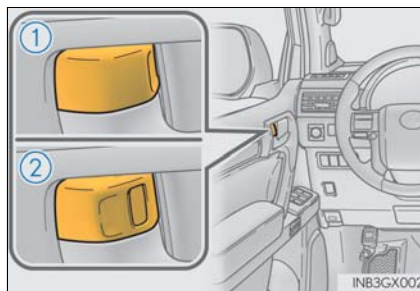

Locking the front doors from the outside without a key

- 1 Move the inside lock button to the lock position.
- 2 Close the door.

The door cannot be locked if the engine switch is in ACCESSORY or IGNITION ON mode, or the electronic key is left inside the vehicle. However, the key may not be detected correctly and the door may be locked.

Rear door child-protector lock

The door cannot be opened from inside the vehicle when the lock is set.

- 1 Unlock
- 2 Lock

These locks can be set to prevent children from opening the rear doors. Push down on each rear door switch to lock both rear doors.

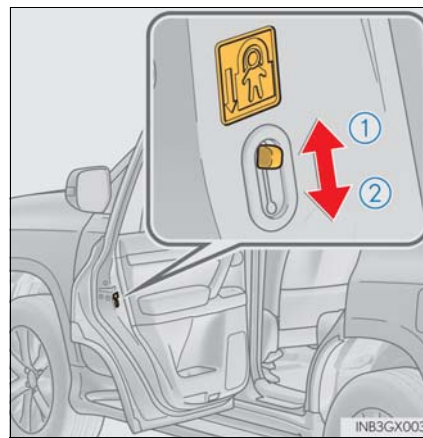

3

Operation of each component

Automatic door locking and unlocking systems

The following functions can be set or canceled:



For instructions on customizing, refer to P. 594.

Function	Operation
Shift position linked door locking function	Shifting the shift lever out of P locks all the doors.
Shift position linked door unlocking function	Shifting the shift lever to P unlocks all the doors.
Speed linked door locking function	All the doors are locked when the vehicle speed is approximately 12 mph (20 km/h) or higher.
Driver's door linked door unlocking function	All the doors are unlocked when the driver's door is opened within 43 seconds after turning the engine switch off.





■ Changing the door unlock function setting

It is possible to set which doors the entry function unlocks using the wireless remote control.

- 1 Turn the engine switch off.
- 2 When the indicator light on the key surface is not on, press and hold  or  for approximately 5 seconds while pressing and holding  .

The setting changes each time an operation is performed, as shown below. (When changing the setting continuously, release the buttons, wait for at least 5 seconds, and repeat step 2.)

Multi-information display	Unlocking function	Beep
	Holding the driver's door handle unlocks only the driver's door.	Exterior: Beeps 3 times Interior: Pings once
	Holding a passenger's door handle unlocks all the doors.	
	Holding a door handle unlocks all the doors.	Exterior: Beeps twice Interior: Pings once

To prevent unintended triggering of the alarm, unlock the doors using the wireless remote control and open and close a door once after the settings have been changed. (If a door or the glass hatch is not opened within 60 seconds after  is pressed, the doors will be locked again and the alarm will automatically be set.)
In a case that the alarm is triggered, immediately stop the alarm. (→P. 74)

3

Operation of each component

■ **Impact detection door lock release system**

In the event that the vehicle is subject to a strong impact, all the doors are unlocked. Depending on the force of the impact or the type of accident, however, the system may not operate.

■ **Using the mechanical key**

The doors can also be locked and unlocked with the mechanical key. (→P. 558)

■ **Conditions affecting the operation of the smart access system with push-button start or wireless remote control**

→P. 117

■ **Customization**

Settings (e.g. unlocking function using a key) can be changed.
(Customizable features: →P. 594)

 **CAUTION**

■ **To prevent an accident**

Observe the following precautions while driving the vehicle. Failure to do so may result in a door opening and an occupant being thrown out of the vehicle, resulting in death or serious injury.

- Ensure that all doors are properly closed and locked.
- Do not pull the inside handle of the doors while driving.
Be especially careful for the front doors, as the doors may be opened even if the inside lock buttons are in locked position.
- Set the rear door child-protector locks when children are seated in the rear seats.

■ **When using the wireless remote control and operating the power windows or moon roof**

Operate the power window or moon roof after checking to make sure that there is no possibility of any passenger having any of their body parts caught in the window or moon roof. Also, do not allow children to operate the wireless remote control. It is possible for children and other passengers to get caught in the power window or moon roof.

Back door

The back door can be locked/unlocked and opened by the following procedures.

Locking and unlocking the back door from the outside

◆ Smart access system with push-button start

Carry the electronic key to enable this function.

- ① Locks all the doors
Check that the door is securely locked.
- ② Unlocks all the doors
The doors cannot be unlocked for 3 seconds after the doors are locked.

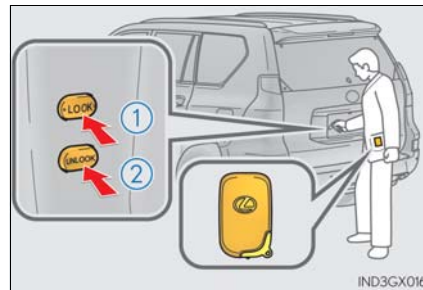

◆ Wireless remote control

→P. 98

Locking and unlocking the back door from the inside

◆ Door lock switch

- ① Locks all the doors
- ② Unlocks all the doors

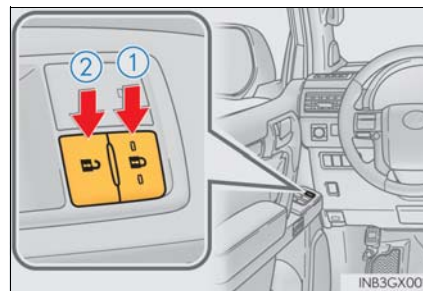

3

Operation of each component

Opening the back door from the outside

- ① Pull the handle
- ② Open the back door

The back door can be kept open at a desired position.

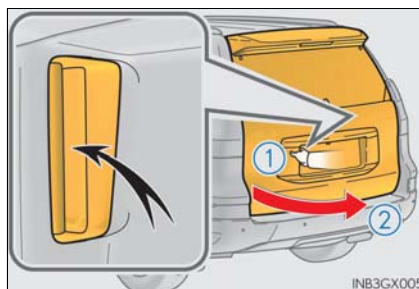

Keeping the back door open

- ① Unlocks the back door stopper
- ② Locks the back door stopper

The back door stopper can only be operated when the back door is fully open.

When closing the back door, check that the back door stopper is unlocked.

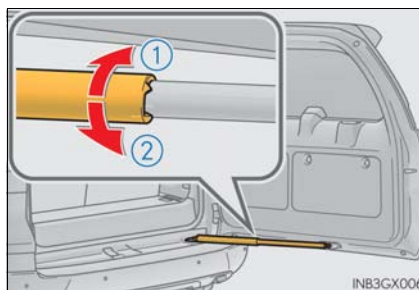

When closing the back door

Close the back door using the back door handle, and make sure to push the back door from the outside to close it.

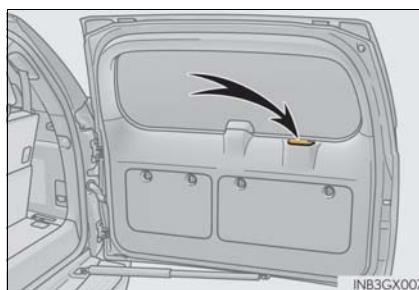

Rear step bumper

The rear step bumper is for rear end protection and easier step-up loading.

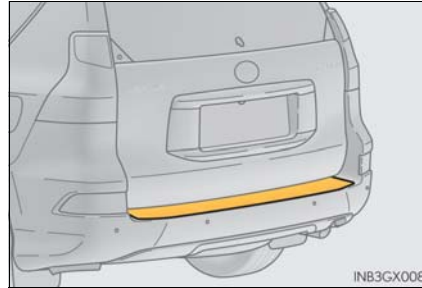

⚠ CAUTION

■ While driving

- Keep the back door closed while driving.
If the back door is left open, it may hit near-by objects while driving or luggage may be unexpectedly thrown out, causing an accident.
In addition, exhaust gases may enter the vehicle, causing death or a serious health hazard. Make sure to close the back door before driving.
- Before driving the vehicle, make sure that the back door is fully closed. If the back door is not fully closed, it may open unexpectedly while driving, causing an accident.
- Never let anyone sit in the luggage compartment. In the event of sudden braking, sudden swerving or a collision, they are susceptible to death or serious injury.

■ When children are in the vehicle

Observe the following precautions.

Failure to do so may result in death or serious injury.

- Do not allow children to play in the luggage compartment.
If a child is accidentally locked in the luggage compartment, they could have heat exhaustion or other injuries.
- Do not allow a child to open or close the back door.
Doing so may cause the back door to move unexpectedly, or cause the child's hands, head, or neck to be caught by the closing back door.

3

Operation of each component

CAUTION

■ **Operating the back door**

Observe the following precautions.

Failure to do so may cause parts of the body to be caught, resulting in death or serious injury.

- When opening or closing the back door, thoroughly check to make sure the surrounding area is safe.
- If anyone is in the vicinity, make sure they are safe and let them know that the back door is about to open or close.
- Use caution when opening or closing the back door in windy weather as it may move abruptly in strong wind.
- The back door may suddenly shut if the back door stopper is not locked. It is more difficult to open or close the back door on an incline than on a level surface, so beware of the back door unexpectedly opening or closing by itself. Make sure that the back door stopper is locked and secure before using the luggage compartment.
- Even with the back door stopper locked, the back door stopper may unlock and the back door may close when excessive force such as a strong wind is applied to the back door. Take extra care to prevent any part of your body from being caught.
- When closing the back door, take extra care to prevent your fingers etc. from being caught. Also pay attention to your personal belongings such as bags and ties.
- When closing the back door, make sure to press it lightly on its outer surface. If the back door handle is used to fully close the back door, it may result in hands or arms being caught.



⚠ CAUTION

- Do not pull on the back door damper stay to close the back door, and do not hang on the back door damper stay. Doing so may cause hands to be caught or the back door damper stay to break, causing an accident.
- If a bicycle carrier or similar heavy object is attached to the back door, it may suddenly shut again after being opened, causing someone's hands, head or neck to be caught and injured. When installing an accessory part to the back door, using a genuine Lexus part is recommended.

⚠ NOTICE**■ Back door damper stay**

The back door is equipped with damper stay that hold the back door in place. Observe the following precautions. Failure to do so may cause damage to the back door damper stay, resulting in malfunction.

- Do not attach any accessories other than genuine Lexus parts to the back door.
- Do not lean against, climb on or place luggage on the damper stay, or apply lateral forces to it.

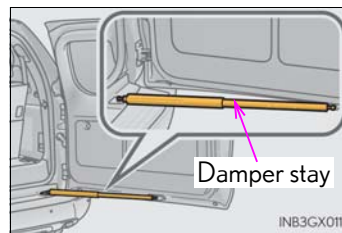

3

Operation of each component

Glass hatch

The glass hatch can be opened using the glass hatch opener or wireless remote control.

Opening the glass hatch

◆ Glass hatch opener

- ① Press the button to pop up the glass hatch.
- ② Raise
The glass hatch cannot be opened when the back door is locked. Unlock the back door to open the glass hatch. (→P.105)

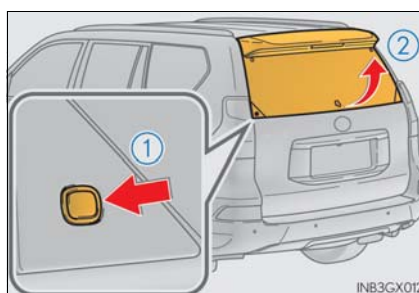

◆ Smart access system with push-button start

- ① While carrying the electronic key, press the button to pop up the glass hatch.
- ② Raise
The glass hatch can be opened even when the back door is locked.

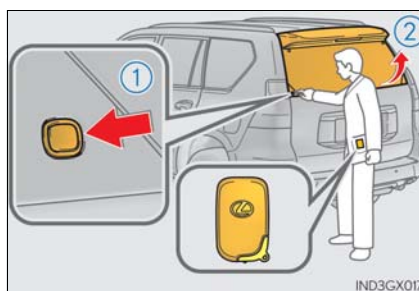

◆ Wireless remote control

Press and hold the button to open the glass hatch. The glass hatch will pop up.



■ When opening the glass hatch

- Open the glass hatch slowly and carefully.
- Use the glass hatch opener or wireless remote control when the back door is closed.

■ Operation signals (when opening with the wireless remote control)

A buzzer sounds once to indicate that the glass hatch have been opened.

■ Opening the glass hatch while the rear window wiper is in operation

Rear window wiper operation will stop moving. Operation will recommence after the glass hatch has been closed.

■ Function to prevent the glass hatch being locked with the electronic key inside

- When all doors are being locked, closing the glass hatch with the electronic key left inside the luggage compartment will sound an alarm.
In this case, the glass hatch can be opened using the entry function.
- Even when the spare electronic key is put in the luggage compartment with all the doors locked, the key confinement prevention function can be activated so the glass hatch can be opened. In order to prevent theft, take all electronic keys with you when leaving the vehicle.
- Even when the electronic key is put in the luggage compartment with all the doors are locked, the key may not be detected depending on the places and the surrounding radio wave conditions. In this case, the key confinement prevention function cannot be activated, causing the doors to lock when the glass hatch is closed. Make sure to check where the key is before closing the glass hatch.

■ After closing the glass hatch

Check that the glass hatch is firmly locked. If it is not firmly locked, the rear window wiper and washer will not operate correctly.

■ Customization

The glass hatch opening operation can be changed. (Customizable features: →P. 594)

 CAUTION

■ While driving

- Keep the glass hatch closed while driving.
If the glass hatch is left open, it may hit near-by objects while driving or luggage may be unexpectedly thrown out, causing an accident.
In addition, exhaust gases may enter the vehicle, causing death or a serious health hazard. Make sure to close the glass hatch before driving.
- Before driving the vehicle, make sure that the glass hatch is fully closed. If the glass hatch is not fully closed, it may open unexpectedly while driving, causing an accident.

■ When children are in the vehicle

Do not allow a child to open or close the glass hatch.
Doing so may cause the glass hatch to move unexpectedly, or cause the child's hands, head, or neck to be caught by the closing glass hatch.

CAUTION**■ Operating the glass hatch**

Observe the following precautions.

Failure to do so may cause parts of the body to be caught, resulting in death or serious injury.

- Remove any heavy loads, such as snow and ice, from the glass hatch before opening it. Failure to do so may cause the glass hatch suddenly shut again after it is opened.
- When opening or closing the glass hatch, thoroughly check to make sure the surrounding area is safe.
- If anyone is in the vicinity, make sure they are safe and let them know that the glass hatch is about to open or close.
- Use caution when opening or closing the glass hatch in windy weather as it may move abruptly in strong wind.

- The glass hatch may close if it is not opened fully. It is more difficult to open or close the glass hatch on an incline than on a level surface, so beware of the glass hatch unexpectedly opening or closing by itself. Make sure that the glass hatch is fully open and secure before using the luggage compartment. Also pay attention to your personal belongings such as bags and ties.



- When closing the glass hatch, take extra care to prevent your fingers etc. from being caught. Also pay attention to your personal belongings such as bags and ties.
- When closing the glass hatch, make sure to press it lightly on its outer surface.



- Do not pull on the glass hatch damper stay to close the glass hatch, and do not hang on the glass hatch damper stay. Doing so may cause hands to be caught or the glass hatch damper stay to break, causing an accident.
- Do not attach any accessories other than genuine Lexus parts to the glass hatch. Such additional weight on the glass hatch may cause the glass hatch to suddenly shut again after it is opened, resulting in death or serious injury.

 NOTICE

■ Glass hatch damper stays

The glass hatch is equipped with damper stays that hold the glass hatch in place. Observe the following precautions.

Failure to do so may cause damage to the glass hatch damper stay, resulting in malfunction.

- Do not attach any foreign objects, such as stickers, plastic sheets, or adhesives to the damper stay rod.
- Do not touch the damper stay rod with gloves or other fabric items.
- Do not attach any accessories other than genuine Lexus parts to the glass hatch.
- Do not place your hand or foot on the damper stay or apply lateral forces to it.

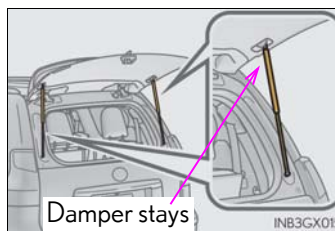

Smart access system with push-button start

The following operations can be performed simply by carrying the electronic key on your person, for example in your pocket. The driver should always carry the electronic key.

- Locks and unlocks the side doors (→P. 98)
- Locks and unlocks the back door (→P. 105)
- Opens the glass hatch (→P. 110)
- Starts the engine (→P. 189)

■ Antenna location

- ① Antennas outside the cabin
- ② Antennas inside the cabin
- ③ Antenna outside the luggage compartment

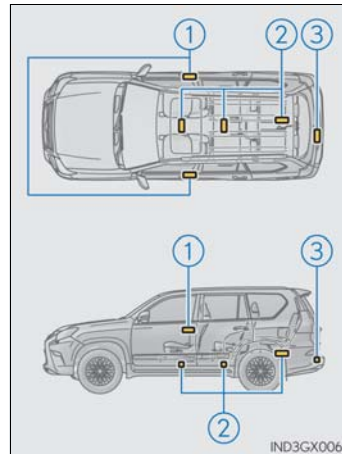

3

Operation of each component

■ **Effective range (areas within which the electronic key is detected)**

● When locking or unlocking the doors
 The system can be operated when the electronic key is within about 2.3 ft. (0.7 m) of either of the outside front door handle. (Only the doors detecting the key can be operated.)

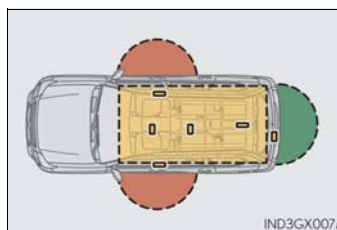

● When opening the glass hatch and locking or unlocking the back door
 The system can be operated when the electronic key is within about 2.3 ft. (0.7 m) of the back door handle.

● When starting the engine or changing engine switch modes
 The system can be operated when the electronic key is inside the vehicle.

■ **Alarms and warning indicators**

A combination of exterior and interior alarms as well as warning messages shown on the multi-information display are used to prevent theft of the vehicle and accidents resulting from erroneous operation. Take appropriate measures in response to any warning message on the multi-information display. (→P. 528)

Alarm	Situation	Correction procedure
Exterior alarm sounds once for 5 seconds	An attempt was made to lock the vehicle while a door and/or the glass hatch was open.	Close all of the doors and/or the glass hatch, and lock the doors again.
	An attempt was made to close the glass hatch while the electronic key was still inside the vehicle.	Open the glass hatch again and retrieve the electronic key from the vehicle.
Interior alarm pings continuously	The engine switch was turned to ACCESSORY mode while the driver's door was open (or the driver's door was opened while the engine switch was in ACCESSORY mode).	Turn the engine switch off and close the driver's door.



■ Battery-saving function

The battery-saving function will be activated in order to prevent the electronic key battery and the vehicle battery from being discharged while the vehicle is not in operation for a long time.

- In the following situations, the smart access system with push-button start may take some time to unlock the doors.
 - The electronic key has been left in an area of approximately 6 ft. (2 m) of the outside of the vehicle for 10 minutes or longer.
 - The smart access system with push-button start has not been used for 5 days or longer.
- If the smart access system with push-button start has not been used for 14 days or longer, the doors cannot be unlocked at any doors except the driver's door. In this case, take hold of the driver's door handle, or use the wireless remote control or the mechanical key, to unlock the doors.

■ Conditions affecting operation

The smart access system with push-button start uses weak radio waves. In the following situations, the communication between the electronic key and the vehicle may be affected, preventing the smart access system with push-button start, wireless remote control and engine immobilizer system from operating properly. (Ways of coping: →P. 558)

- When the electronic key battery is depleted
- Near a TV tower, electric power plant, gas station, radio station, large display, airport or other facility that generates strong radio waves or electrical noise
- When carrying a portable radio, cellular phone, cordless phone or other wireless communication device
- When the electronic key is in contact with, or is covered by the following metallic objects
 - Cards to which aluminum foil is attached
 - Cigarette boxes that have aluminum foil inside
 - Metallic wallets or bags
 - Coins
 - Hand warmers made of metal
 - Media such as CDs and DVDs
- When other wireless keys (that emit radio waves) are being used nearby
- When carrying the electronic key together with the following devices that emit radio waves
 - Another vehicle's electronic key or a wireless key that emits radio waves
 - Personal computers or personal digital assistants (PDAs)
 - Digital audio players
 - Portable game systems
- If window tint with a metallic content or metallic objects are attached to the rear window



■ Note for the entry function

- Even when the electronic key is within the effective range (detection areas), the system may not operate properly in the following cases:
 - The electronic key is too close to the window or outside door handle, near the ground, or in a high place when the doors are locked or unlocked.
 - The electronic key is near the ground or in a high place, or too close to the rear bumper center when the glass hatch is opened.
 - The electronic key is on the instrument panel, luggage cover or floor, or in the door pockets or glove box when the engine is started or engine switch modes are changed.
- Do not leave the electronic key on top of the instrument panel or near the door pockets when exiting the vehicle. Depending on the radio wave reception conditions, it may be detected by the antenna outside the cabin and the doors will become lockable from the outside, possibly trapping the electronic key inside the vehicle.
- As long as the electronic key is within the effective range, the doors may be locked or unlocked by anyone. However, only the doors detecting the electronic key can be used to unlock the vehicle.
- Even if the electronic key is not inside the vehicle, it may be possible to start the engine if the electronic key is near the window.
- The doors may lock or unlock if a large amount of water splashes on the door handle, such as in the rain or in a car wash, when the electronic key is within the effective range. (The doors will automatically be locked after approximately 60 seconds if the doors or the glass hatch are not opened and closed.)
- If the wireless remote control is used to lock the doors when the electronic key is near the vehicle, there is a possibility that the door may not be unlocked by the entry function. (Use the wireless remote control to unlock the doors.)
- Touching the door lock sensor while wearing gloves may prevent lock operation.
- If the door handle becomes wet while the electronic key is within the effective range, the door may lock and unlock repeatedly. Place the electronic key in a location 6 ft. (2 m) or more away from the vehicle. (Take care to ensure that the key is not stolen.)
- If the electronic key is inside the vehicle and a door handle becomes wet during a car wash, a message may be shown on the multi-information display and a buzzer will sound outside the vehicle. To turn off the alarm, lock all the doors.
- The lock sensor may not work properly if it comes into contact with ice, snow, mud, etc. Clean the lock sensor and attempt to operate it again, or use the lock sensor on the lower part of the door handle.
- Fingernails may scrape against the door during operation of the door handle. Be careful not to injure fingernails or damage the surface of the door.
- A sudden approach to the effective range or door handle may prevent the doors from being unlocked. In this case, return the door handle to the original position and check that the doors unlock before pulling the door handle again.
- Unlocking the vehicle may take more time if another electronic key is within the effective range.



■ When the vehicle is not driven for extended periods

- To prevent theft of the vehicle, do not leave the electronic key within 6 ft. (2 m) of the vehicle.
- The smart access system with push-button start can be deactivated in advance. (→P. 594)

■ To operate the system properly

Make sure to carry the electronic key when operating the system. Do not get the electronic key too close to the vehicle when operating the system from the outside of the vehicle.

Depending on the position and holding condition of the electronic key, the key may not be detected correctly and the system may not operate properly. (The alarm may go off accidentally, or the door lock prevention function may not operate.)

■ If the smart access system with push-button start does not operate properly

- Locking and unlocking the doors: Use the mechanical key. (→P. 558)
- Starting the engine: →P. 559

■ Customization

Settings (e. g. smart access system with push-button start) can be changed. (Customizable features: →P. 594)

■ If the smart access system with push-button start has been deactivated in a customized setting

- Locking and unlocking the doors:
Use the wireless remote control or mechanical key. (→P. 98, 558)
- Starting the engine and changing engine switch modes: →P. 559
- Stopping the engine: →P. 190

■ Certification for the smart access system with push-button start

- ▶ For vehicles sold in the U.S.A., Hawaii, NATO Germany, Guam, Saipan and Puerto Rico

FCC ID: HYQ13CZM
FCC ID: HYQ14ACX

FCC ID: HYQ13CZN
FCC ID: HYQ14ADF

NOTE:

This device complies with part 15 of the FCC Rules. Operation is subject to the following two conditions: (1) This device may not cause harmful interference, and (2) this device must accept any interference received, including interference that may cause undesired operation.

FCC WARNING:

Changes or modifications not expressly approved by the party responsible for compliance could void the user's authority to operate the equipment.

- ▶ For vehicles sold in Canada

NOTE:

This device complies with Industry Canada's licence-exempt RSSs. Operation is subject to the following two conditions:

- (1) This device may not cause interference; and
- (2) This device must accept any interference, including interference that may cause undesired operation of the device.

NOTE:

Le présent appareil est conforme aux CNR d'Industrie Canada applicables aux appareils radio exempts de licence. L'exploitation est autorisée aux deux conditions suivantes:

- (1) l'appareil ne doit pas produire de brouillage;
- (2) l'utilisateur de l'appareil doit accepter tout brouillage radioélectrique subi, même si le brouillage est susceptible d'en compromettre le fonctionnement.



 CAUTION**■ Caution regarding interference with electronic devices**

- People with implantable cardiac pacemakers, cardiac resynchronization therapy-pacemakers or implantable cardioverter defibrillators should keep away from the smart access system antennas. (→P. 115)

The radio waves may affect the operation of such devices. If necessary, the entry function can be disabled. Ask your Lexus dealer for details, such as the frequency of radio waves and timing of the emitted radio waves. Then, consult your doctor to see if you should disable the entry function.

- Users of any electrical medical device other than implantable cardiac pacemakers, cardiac resynchronization therapy-pacemakers or implantable cardioverter defibrillators should consult the manufacturer of the device for information about its operation under the influence of radio waves.

Radio waves could have unexpected effects on the operation of such medical devices.

Ask your Lexus dealer for details on disabling the entry function.

3

Operation of each component

Front seats

Adjustment procedure

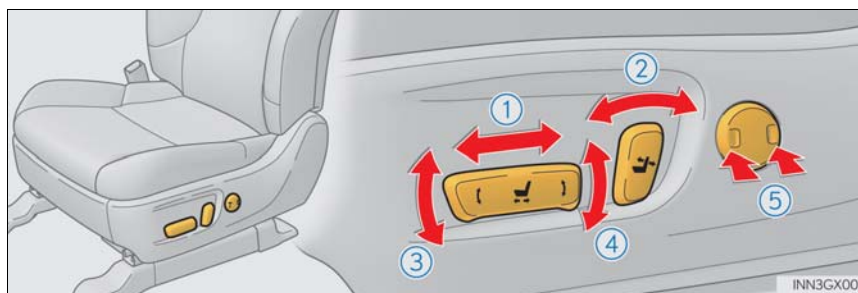

- ① Seat position adjustment switch
- ② Seatback angle adjustment switch
- ③ Seat cushion (front) angle adjustment switch
- ④ Vertical height adjustment switch
- ⑤ Lumber support adjustment switch

Active head restraints

When the occupant's lower back presses against the seatback during a rear-end collision, the head restraint moves slightly forward and upward to help reduce the risk of whiplash on the seat occupant.

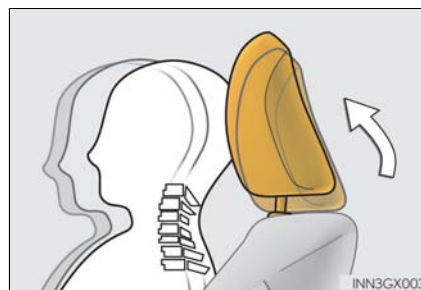

■ Active head restraints

Even small forces applied to the seatback may cause the head restraint to move. Pushing up a locked head restraint forcibly may appear the head restraint inner structure. These do not indicate problems.

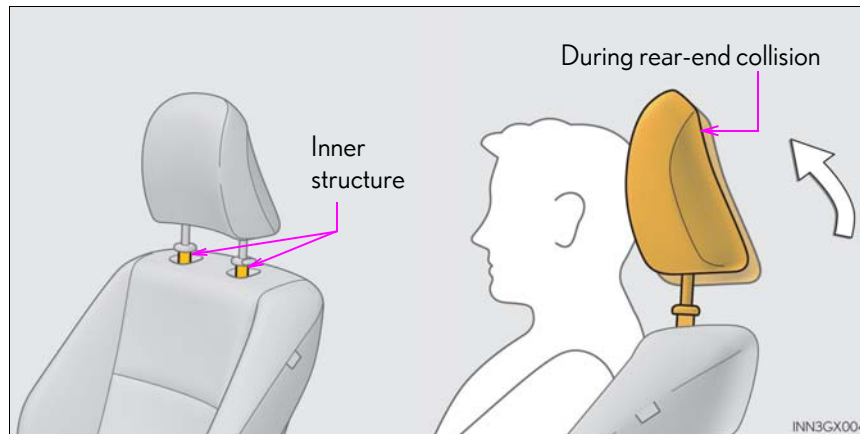

⚠ CAUTION

■ When adjusting the seat position

- Take care when adjusting the seat position to ensure that other passengers are not injured by the moving seat.
- Do not put your hands under the seat or near the moving parts to avoid injury. Fingers or hands may become jammed in the seat mechanism.

■ Seat adjustment

To reduce the risk of sliding under the lap belt during a collision, do not recline the seat more than necessary.

If the seat is too reclined, the lap belt may slide past the hips and apply restraint forces directly to the abdomen, or your neck may contact the shoulder belt, increasing the risk of death or serious injury in the event of an accident.

Adjustments should not be made while driving as the seat may unexpectedly move and cause the driver to lose control of the vehicle.

Rear seats

Adjustment procedure

■ Second seats

- ① Seatback angle adjustment lever
- ② Seat position adjustment lever



■ Third seats (power seat)

Seatback angle adjustment switch

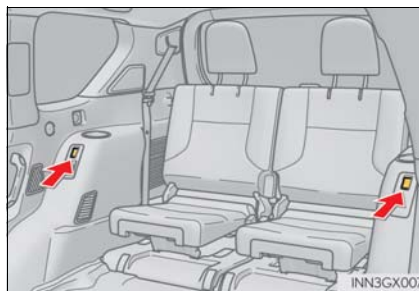

Moving a second seat for third seat access (right side only for 7-passenger models, both side for 6-passenger models)

■ Getting in the vehicle

Pull the seatback angle adjustment lever and fold down the seatback. The seat will slide forward.

Move the seat to the front-most position



■ Getting out of the vehicle

Pull the release lever and fold down the seatback. The seat will slide forward.

Move the seat to the front-most position

Make sure that no passenger is seated on the second seat before pulling the release lever.



■ After passengers have entered/exited the vehicle

Lift up the seatback and slide the seat backward until it locks.

3

Operation of each component

Folding down the second seatbacks

■ Before folding down the second seatbacks

Lower the head restraints to the lowest position.

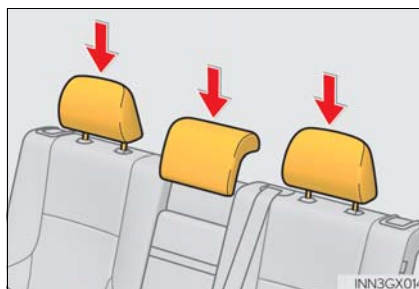

■ Folding down second seatbacks

Pull the seatback lock release lever and fold them down.

To return the second seatbacks to their original positions, lift them up until they lock.

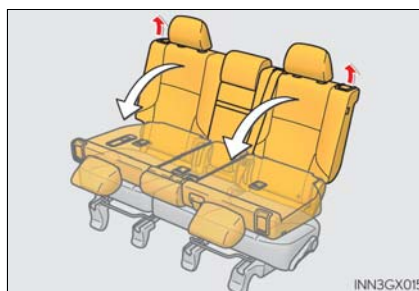

■ Folding down second center seatback only (for 7-passenger models)

Pull the center seatback lock release lever behind the seatback and fold it down.

To return the center seatback to its original position, lift it up until it locks.

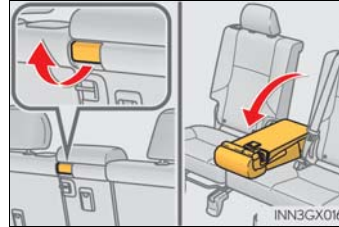
**■ If you cannot raise the second seatback**

Release the seat belt lock by:

- ① Pushing on the lower front edge of the seatback to slacken the seat belt.
- ② Let the seat belt retract a little.

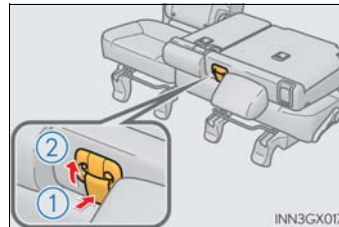

3

Operation of each component

Folding down the third seats (manual seat)

■ **Before folding down the third seats**

Use the seat belt hanger to prevent the belt from being tangled.

Make sure that the seat belts are removed from the hangers before using them.



■ **Folding down the third seats**

▶ From rear door side

- 1 Pull the strap to fold the head restraint.

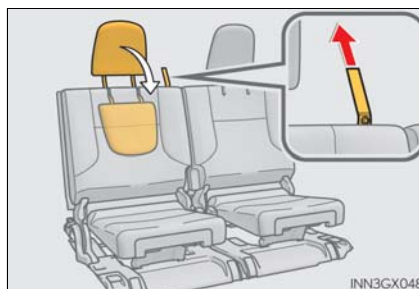

- 2 Pull the seat cushion lock release lever.

The seat cushion is stowed automatically.

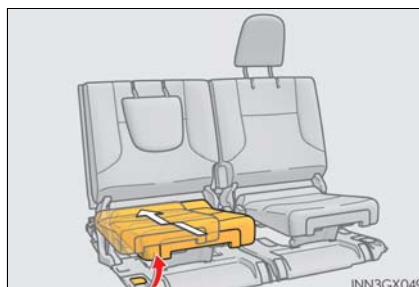

- 3 Pull the seatback lock release lever and fold the seatback down.

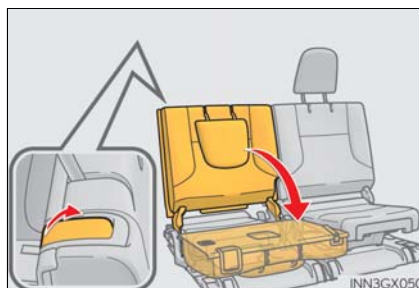

► From back door side

- 1 Pull the strap to fold the head restraint.

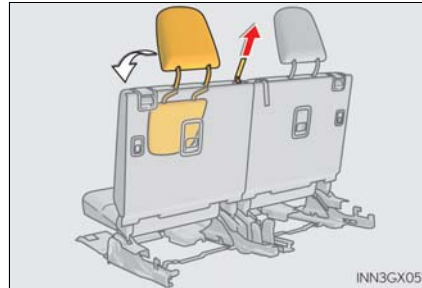

- 2 Pull the seat cushion/seatback lock release lever.

The seat cushion is stowed automatically.

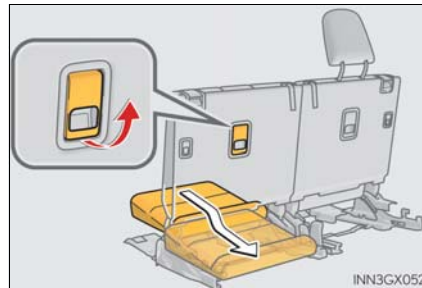

- 3 Fold the seatback down.

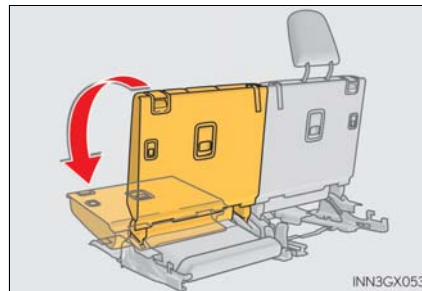

■ Returning the third seats

- 1 From rear door side, unlock the seatbacks by pulling the lock release lever, and lift them up until they lock.

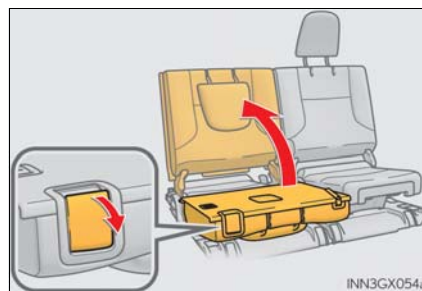

3

Operation of each component

130 3-3. Adjusting the seats

- 2 Pull the grip and carry the seat cushion out.

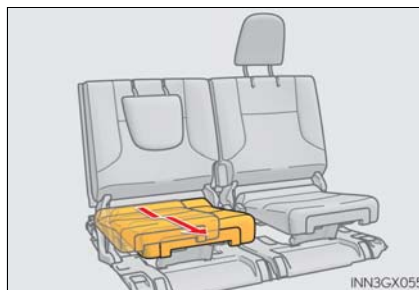

- 3 Lift the head restraint up until it locks.



Folding down the third seats (power seat)

- 1 Right seat return switch
- 2 Right seat fold switch
- 3 Left seat return switch
- 4 Left seat fold switch

The switches can be operated from both the rear door side and the back door side.

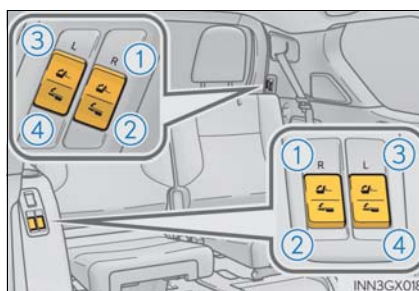

■ Before folding down the third seats

Use the seat belt hangers to prevent the belts from being tangled.

Make sure that the seat belts are removed from the hangers before using them.

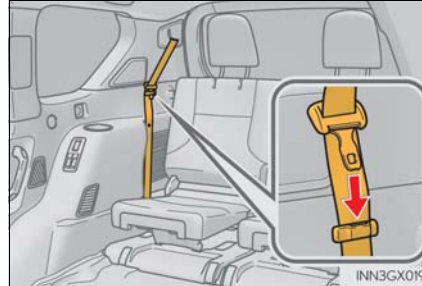

■ Folding down the third seats

- 1** Press and hold . Two beeps sound and the seatback will rise.

When operating is completed, two beeps sound again.



- 2** Press and hold  again. Two beeps sound, the head restraints will fold forward, and the seat will be stowed.

When operating is completed, two beeps sound again.



3

Operation of each component

■ Returning the third seats

- 1 Press and hold .

Two beeps sound and seatback and seat cushion begin to move. When operating is completed, two beeps sound again.



- 2 Lift the head restraints up until they lock.

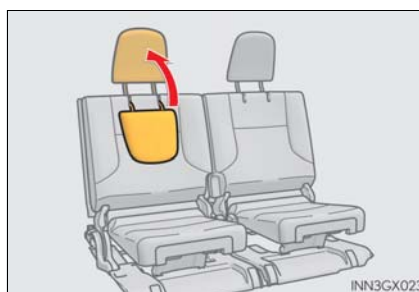

■ The third power seats can be operated when

- The engine switch is off.
- The shift lever is in P position with the engine switch in IGNITION ON mode.

■ During third power seat stowing operation

Do not remove your hand from the switch until the operation stops automatically. If you remove your hand from the switch, the operation will stop and the buzzer will sound continuously. The seat cannot be used in this state. The buzzer will stop when the switch is pressed again.

■ Enlarging the luggage compartment

The third seat can be used for sitting when it is in the position shown in step **2** of the folding down the third seats. (→P. 130)

This can be convenient for enlarging the luggage compartment, for instance when the luggage is against the back of the seatback.

■ If the warning buzzer sounds continuously

If there is an abnormality in the system, the warning buzzer will sound continuously while the engine switch is in IGNITION ON mode. In this case, take the following operations:

1 Press and hold .

2 Press and hold  to stow the seat.

For each step, wait until the seat movement stops automatically and the two beeps sound twice before removing your hand from the switch.

If the warning buzzer does not stop even after performing the above procedure correctly, perform the following operations:

3 Press and hold  on the rear door side.

4 While holding , press forward on  5 times within 10 seconds and keep

holding  until 3 beeps sound. The beep will then sound continuously again.

5 Repeat step **1** and **2**.

3

Operation of each component

 CAUTION**■ When folding the seatbacks down**

Observe the following precautions. Failure to do so may result in death or serious injury.

- Do not fold the seatbacks down while driving.
- Stop the vehicle on level ground, set the parking brake and shift the shift lever to P.
- Do not allow anyone to sit on a folded seatback or in the luggage compartment while driving.
- Do not allow children to enter the luggage compartment.

■ Seat adjustment

Observe the following precautions. Failure to do so may result in death or serious injury.

- To reduce the risk of sliding under the lap belt during a collision, do not recline the seat more than necessary.
If the seat is too reclined, the lap belt may slide past the hips and apply restraint forces directly to the abdomen, or your neck may contact the shoulder belt, increasing the risk of death or serious injury in the event of an accident.
Adjustments should not be made while driving as the seat may unexpectedly move and cause the driver to lose control of the vehicle.
- Be careful not to get hands or feet pinched between the rear console box and the second seat when folding down the rear seatback.

■ When stowing the third seats

Observe the following precautions. Failure to do so may result in death or serious injury.

- Check that there is no luggage and that there are no other people around the seat before stowing operation.
- Do not insert hands or feet into the moving parts of the seat.
- Do not allow children to operate the seat.

■ After returning the seatbacks to the upright position

Observe the following precautions. Failure to do so may result in death or serious injury.

- Make sure the seatback is securely locked by pushing it forward and rearward on the top.
- Check that the seat belts are not twisted or caught in the seatback.

 NOTICE**■ When returning the third seat (vehicles with a luggage cover)**

If the luggage cover is installed in the luggage compartment, make sure you remove it before returning the third seat. (→P. 414) The luggage cover may be damaged by the seat.



Driving position memory

This feature automatically adjusts the driver's seats, steering wheel and outside rear view mirrors to make entering and exiting the vehicle easier or to suit your preferences.

Power easy access system

The seat and steering wheel are automatically adjusted to allow the driver to enter and exit the vehicle easily.

When all of the following have been performed, the driver's seat and steering wheel are automatically adjusted to a position that allows driver to enter and exit the vehicle easily.

- The shift lever has been shifted to P.
- The engine switch has been turned off.
- The driver's seat belt has been unfastened.

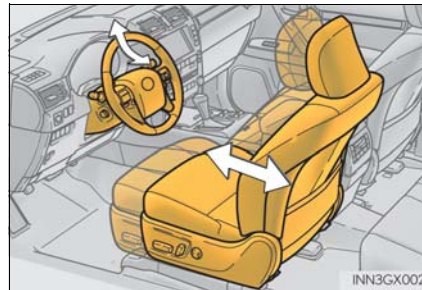

When any of the following has been performed, the driver's seat and steering wheel automatically return to their original positions.

- The engine switch has been turned to ACCESSORY mode or IGNITION ON mode.
- The driver's seat belt has been fastened.

■ Operation of the power easy access system

When exiting the vehicle, the power easy access system may not operate if the seat is already close to the rearmost position, etc.

■ Customization

The seat movement amount settings of the power easy access system can be customized. (Customizable features: →P. 594)

3

Operation of each component

Driving position memory

Your preferred driving position (the position of the driver’s seat, steering wheel and outside rear view mirrors) can be recorded and recalled by pressing a button.

Two different driving positions can be recorded into memory.

■ Recording procedure

- 1 Check that the shift lever is in P.
- 2 Turn the engine switch to IGNITION ON mode.
- 3 Adjust the driver’s seat, steering wheel, and outside rear view mirrors to the desired positions.
- 4 While pressing the “SET” button, or within 3 seconds after the “SET” button is pressed, press button “1” or “2” until the buzzer sounds.

If the selected button has already been preset, the previously recorded position will be overwritten.

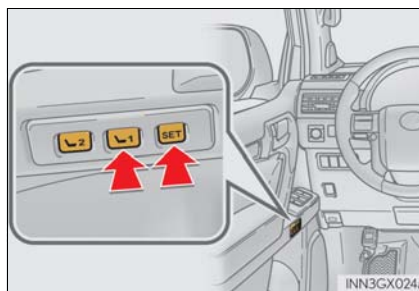

■ Recall procedure

- 1 Check that the shift lever is in P.
- 2 Turn the engine switch to IGNITION ON mode.
- 3 Press one of the buttons for the driving position you want to recall until the buzzer sounds.

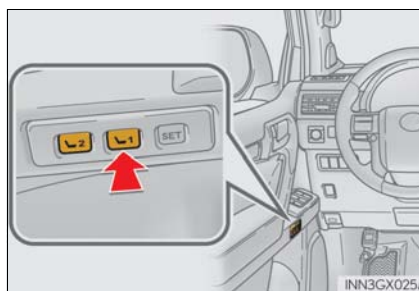

■ To stop the position recall operation part-way through

Perform any of the following:

- Press the "SET" button.
- Press button "1" or "2".
- Operate any of the seat adjustment switches (only cancels seat position recall).
- Operate the tilt and telescopic steering control switch (only cancels steering wheel position recall).

■ Seat positions that can be memorized (→ P. 122)

The adjusted positions other than the position adjusted by lumbar support switch can be recorded.

■ Operating the driving position memory after turning the engine switch off

Recorded seat positions can be activated up to 180 seconds after the driver's door is opened and another 60 seconds after it is closed again.

■ In order to correctly use the driving position memory function

If a seat position is already in the furthest possible position and the seat is operated in the same direction, the recorded position may be slightly different when it is recalled.

Memory recall function

Each electronic key can be registered to recall your preferred driving position.

■ Registering procedure

Record your driving position to button "1" or "2" before performing the following:

Carry only the key you want to register, and then close the driver's door.

If 2 or more keys are in the vehicle, the driving position cannot be recorded properly.

- 1** Check that the shift lever is in P.
- 2** Turn the engine switch to IGNITION ON mode.
- 3** Recall the driving position that you want to record.

3

Operation of each component



- 4 While pressing the recalled button, press and hold the door lock switch (either lock or unlock) until the buzzer sounds.

If the button could not be registered, the buzzer sounds continuously for approximately 3 seconds.

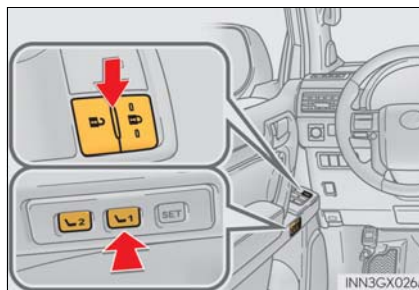

■ **Recall procedure**

- 1 Make sure that the doors are locked before recalling the driving position. Carry the electronic key that has been registered to the driving position, and then unlock and open the driver's door using the smart access system with push-button start or wireless remote control.

The driving position will move to the recorded position (not including the steering wheel). However, the seat will move to a position slightly behind the recorded position in order to make entering the vehicle easier.

If the driving position is in a position that has already been recorded, the seat and outside rear view mirrors will not move.

- 2 Turn the engine switch to ACCESSORY mode or IGNITION ON mode, or fasten a seat belt.

The seat and steering wheel will move to the recorded position.

■ **Cancellation procedure**

Carry only the key you want to cancel and then close the driver's door.

If 2 or more keys are in the vehicle, the driving position cannot be canceled properly.

- 1 Turn the engine switch to IGNITION ON mode.
- 2 While pressing the "SET" button, press and hold the door lock switch (either lock or unlock) until the buzzer sounds twice.

If the button could not be canceled, the buzzer sounds continuously for approximately 3 seconds.



■ Recalling the driving position using the memory recall function

- Different driving positions can be registered for each electronic key. Therefore, the driving position that is recalled may be different depending on the key being carried.
- If a door other than the driver's door is unlocked with the smart access system with push-button start, the driving position cannot be recalled. In this case, press the driving position button which has been set.

■ Customization

The unlock door settings of the memory recall function can be customized.
(Customizable features: →P. 594)

⚠ CAUTION**■ Seat adjustment caution**

Take care during seat adjustment so that the seat does not strike the rear passenger or squeeze your body against the steering wheel.

3

Operation of each component

Head restraints

Head restraints are provided for all seats.

Front and second seats

Vertical adjustment

- ① Up
Pull the head restraints up.
- ② Down
Push the head restraint down while pushing the lock release button.

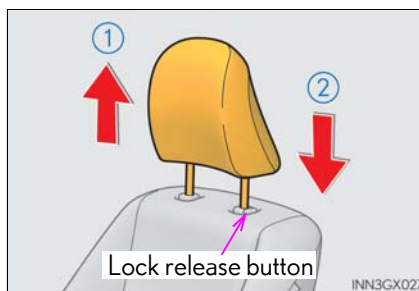

Angle adjustment (front seats only) (if equipped)

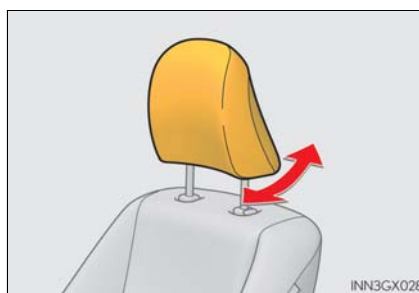

Third seats

To fold the head restraints, pull the lock release strap.

To return the head restraints, lift them up until they lock.

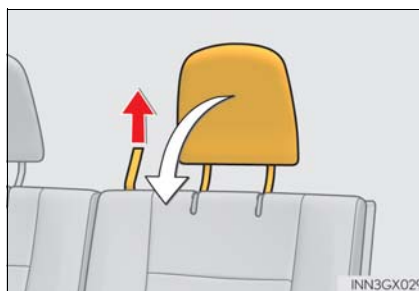

■ Removing the head restraints

▶ Front and second seats

Pull the head restraint up while pressing the lock release button.

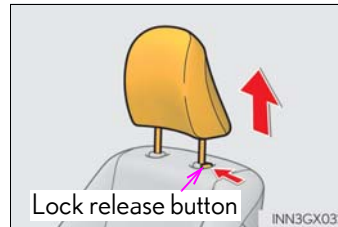

▶ Third seats

The head restraint cannot be removed.

■ Installing the head restraints (front and second seats)

Align the head restraint with the installation holes and push it down to the lock position.

Press and hold lock release button when lowering the head restraint.

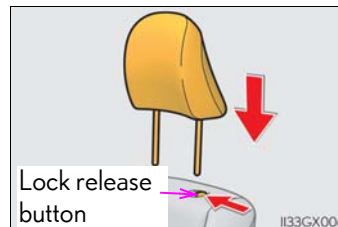

■ Adjusting the height of the head restraints (front and second seats)

Make sure that the head restraints are adjusted so that the center of the head restraint is closest to the top of your ears.

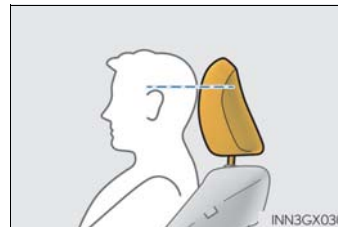

■ Using the second center seat head restraint (for 7-passenger models)

Always raise the head restraint one level from the stowed position when using.



■ Using the third seats

Always lift the head restraints up until they lock when using.

 CAUTION**■ Head restraint precautions**

Observe the following precautions regarding the head restraints. Failure to do so may result in death or serious injury.

- Use the head restraints designed for each respective seat.
- Adjust the head restraints to the correct position at all times.
- After adjusting the head restraints, push down on them and make sure they are locked in position.
- Do not drive with the head restraints removed.

Steering wheel

Adjustment procedure

- ① Up
- ② Down
- ③ Toward the driver
- ④ Away from the driver

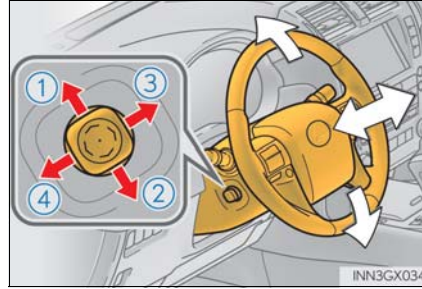

Horn

To sound the horn, press on or close to the  mark.

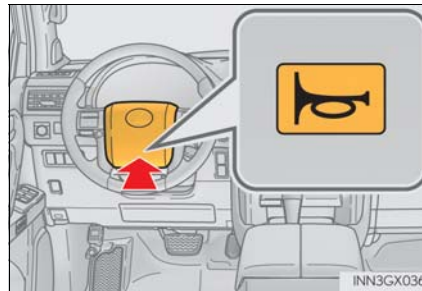

3

Operation of each component

■ The steering wheel can be adjusted when

The engine switch is in ACCESSORY or IGNITION ON mode*.

*: If the driver's seat belt is fastened, the steering wheel can be adjusted regardless of engine switch mode.

■ Automatic adjustment of the steering position

A desired steering position can be entered to memory and recalled automatically by the driving position memory system. (→P. 135)

⚠ CAUTION

Do not adjust the steering wheel while driving.
Doing so may cause the driver to mishandle the vehicle and cause an accident, resulting in death or serious injury.

Inside rear view mirror

The rear view mirror's position can be adjusted to enable sufficient confirmation of the rear view.

Adjusting the height of rear view mirror

The height of the rear view mirror can be adjusted to suit your driving posture.

Adjust the height of the rear view mirror by moving it up and down.

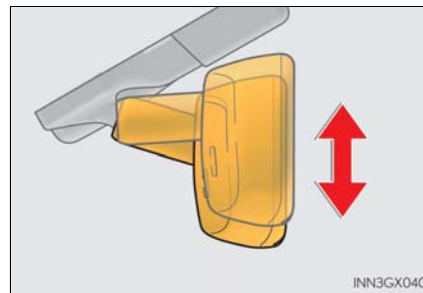

Anti-glare function

Responding to the level of brightness of the headlights of vehicles behind, the reflected light is automatically reduced.

► Without compass

- ① Turns automatic mode on
- ② Turns automatic mode off

The indicator comes on when automatic mode is turned on.

The mirror reverts to automatic mode each time the engine switch is turned to IGNITION ON mode.

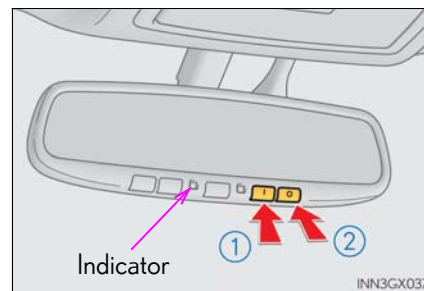

3

Operation of each component

▶ With compass

Changing automatic anti-glare function mode On/off

When the automatic anti-glare function is in ON mode, the indicator illuminates. The function will set to ON mode each time the engine switch is turned to IGNITION ON mode. Pressing the button turns the function to OFF mode. (The indicator also turns off.)

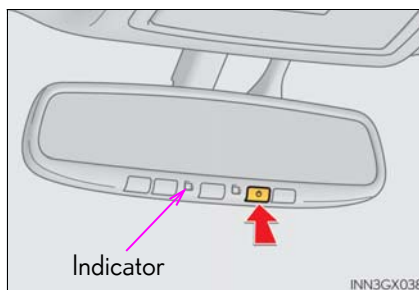

■ To prevent sensor error

To ensure that the sensors operate properly, do not touch or cover them.

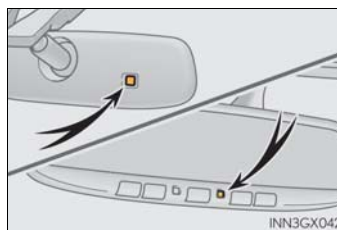

⚠ CAUTION

Do not adjust the position of the mirror while driving. Doing so may lead to mishandling of the vehicle and an accident, resulting in death or serious injury.

Outside rear view mirrors

Adjustment procedure

1 To select a mirror to adjust, press the switch.

- ① Left
- ② Right

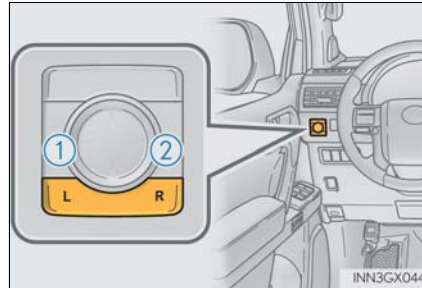

2 To adjust the mirror, press the switch.

- ① Up
- ② Right
- ③ Down
- ④ Left

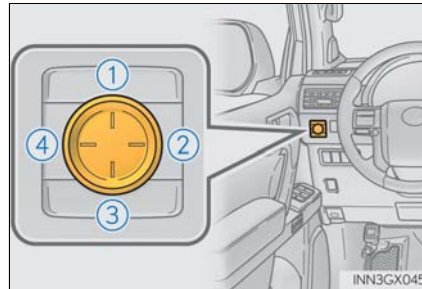

Folding and extending the mirrors

► Manual type

Push the mirror back in the direction of the vehicle's rear.

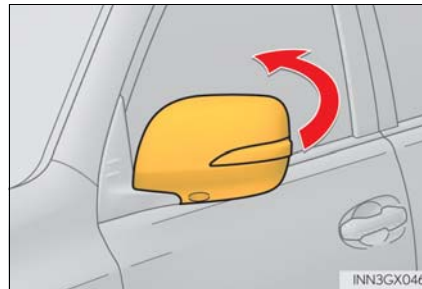

3

Operation of each component

- ▶ Power type
- ① Extends the mirrors
- ② Folds the mirrors

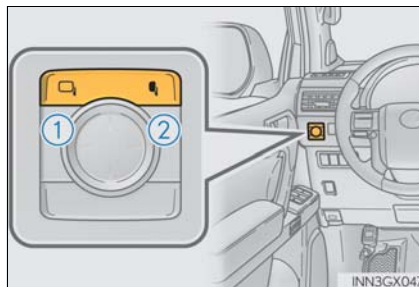

Linked mirror function when reversing

When the mirror select switch is in the L or R position, the outside rear view mirrors will automatically angle downwards when the vehicle is reversing in order to give a better view of the ground.

To disable this function, move the mirror select switch to the neutral position (between L and R).

■ Mirror angle can be adjusted when

The engine switch is in ACCESSORY or IGNITION ON mode.

■ When the mirrors are fogged up

Turn on the mirror defoggers to defog the mirrors. (→P. 391)

■ Automatic adjustment of the mirror angle

A desired mirror face angle can be entered to memory and recalled automatically by the driving position memory. (→P. 135)

■ Auto anti-glare function

When the anti-glare inside rear view mirror is set to automatic mode, the outside rear view mirrors will activate in conjunction with the anti-glare inside rear view mirror to reduce reflected light. (→P. 145)

 CAUTION**■ Important points while driving**

Observe the following precautions while driving. Failing to do so may result in loss of control of the vehicle and cause an accident, resulting in death or serious injury.

- Do not adjust the mirrors while driving.
- Do not drive with the mirrors folded.
- Both the driver and passenger side mirrors must be extended and properly adjusted before driving.

■ When a mirror is moving

To avoid personal injury and mirror malfunction, be careful not to get your hand caught by the moving mirror.

■ When the mirror defoggers are operating

Do not touch the rear view mirror surfaces, as they can become very hot and burn you.

 NOTICE**■ If ice should jam the mirror**

Do not operate the control or scrape the mirror face. Use a spray de-icer to free the mirror.

3

Operation of each component

Power windows

Opening and closing procedures

The power windows can be opened and closed using the switches.

Operating the switch moves the windows as follows:

- ① Closing
- ② One-touch closing*
- ③ Opening
- ④ One-touch opening*

*: To stop the window partway, operate the switch in the opposite direction.

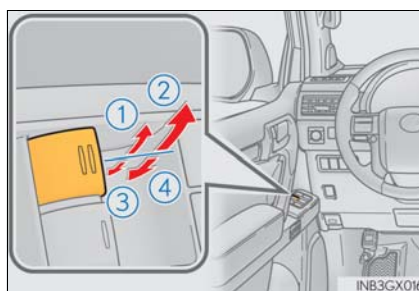

Window lock switch

Press the switch down to lock the passenger window switches.

The indicator will come on.

Use this switch to prevent children from accidentally opening or closing a passenger window.

The passenger windows can still be opened and closed using the power window switches on the driver's side even if the lock switch is on.

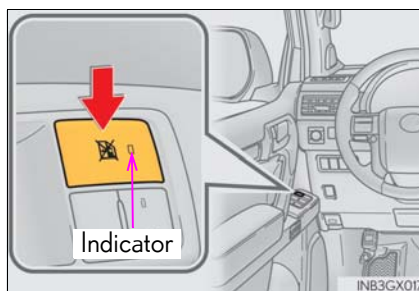

■ The power windows can be operated when

The engine switch is in IGNITION ON mode.

■ Operating the power windows after turning the engine off

The power windows can be operated for approximately 45 seconds even after the engine switch is turned to ACCESSORY mode or turned off. They cannot, however, be operated once either front door is opened.

■ Jam protection function

If an object becomes jammed between the window and the window frame while the window is closing, window movement is stopped and the window is opened slightly.

■ Catch protection function

If an object becomes caught between the door and window while the window is opening, window movement is stopped.

■ When the window cannot be opened or closed

When the jam protection function or catch protection function operates unusually and the door window cannot be opened and closed, perform the following operations with the power window switch of that door.

- Stop the vehicle. With the engine switch in IGNITION ON mode, within 4 seconds of the jam protection function or catch protection function activating, continuously operate the power window switch in the one-touch closing direction or one-touch opening direction so that the door window can be opened and closed.
- If the door window can not be opened and closed even when performing the above operations, perform the following procedure for function initialization.
 - 1 Turn the engine switch to IGNITION ON mode.
 - 2 Pull and hold the power window switch in the one-touch closing direction and completely close the door window.
 - 3 Release the power window switch for a moment, resume pulling the switch in the one-touch closing direction, and hold it there for approximately 6 seconds or more.
 - 4 Press and hold the power window switch in the one-touch opening direction. After the door window is completely opened, continue holding the switch for an additional 1 second or more.
 - 5 Release the power window switch for a moment, resume pushing the switch in the one-touch opening direction, and hold it there for approximately 4 seconds or more.
 - 6 Pull and hold the power window switch in the one-touch closing direction. After the door window is completely closed, continue holding the switch for a further 1 second or more.

If you release the switch while the window is moving, start again from the beginning.

If the window reverses and cannot be fully closed or opened, have the vehicle inspected by your Lexus dealer.

■ Door lock linked window operation

- The power windows can be opened and closed using the mechanical key. (→P. 558)
- The power windows can be opened using the wireless remote control. (→P. 98)

■ Customization

Settings (e.g. linked door lock operation) can be changed.
(Customizable features: →P. 594)



⚠ CAUTION

Observe the following precautions.
Failing to do so may result in death or serious injury.

■ Closing the windows

- The driver is responsible for all the power window operations, including the operation for the passengers. In order to prevent accidental operation, especially by a child, do not let a child operate the power windows. It is possible for children and other passengers to have body parts caught in the power window. Also, when riding with a child, it is recommended to use the window lock switch. (→P. 150)
- Check to make sure that all passengers do not have any part of their body in a position where it could be caught when a window is being operated.
- When using the wireless remote control or mechanical key and operating the power windows, operate the power window after checking to make sure that there is no possibility of any passenger having any of their body parts caught in the window. Also, do not let a child operate window by the wireless remote control or mechanical key. It is possible for children and other passengers to get caught in the power window.
- When exiting the vehicle, turn the engine switch off, carry the key and exit the vehicle along with the child. There may be accidental operation, due to mischief, etc., that may possibly lead to an accident.

■ Jam protection function

- Never use any part of your body to intentionally activate the jam protection function.
- The jam protection function may not work if something gets jammed just before the window is fully closed. Be careful not to get any part of your body jammed in the window.

■ Catch protection function

- Never use any part of your body or clothing to intentionally activate the catch protection function.
- The catch protection function may not work if something gets caught just before the window is fully opened. Be careful not to get any part of your body or clothing caught in the window.

Moon roof

Use the overhead switches to open and close the moon roof and tilt it up and down.

Opening and closing

- ① Opens the moon roof*
The moon roof stops slightly before the fully open position to reduce wind noise. Press the switch again to fully open the moon roof.
- ② Closes the moon roof*
*: Lightly press either end of the moon roof switch to stop the moon roof partway.

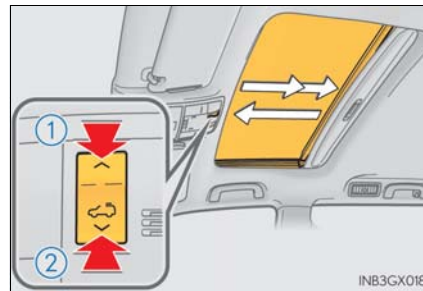

Tilting up and down

- ① Tilts the moon roof up*
- ② Tilts the moon roof down*
*: Lightly press either end of the moon roof switch to stop the moon roof partway.

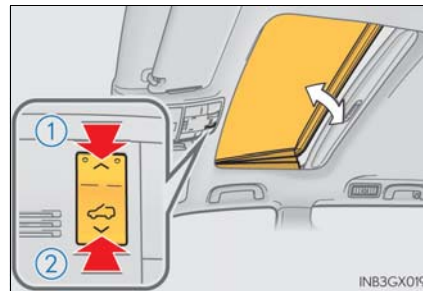

3

Operation of each component

■ **The moon roof can be operated when**

The engine switch is in IGNITION ON mode.

■ **Operating the moon roof after turning the engine off**

The moon roof can be operated for approximately 45 seconds after the engine switch is turned to ACCESSORY mode or turned off. It cannot, however, be operated once either front door is opened.

■ **Jam protection function**

If an object is detected between the moon roof and the frame while the moon roof is closing or tilting down, travel is stopped and the moon roof opens slightly.

■ **Sunshade**

The sunshade can be opened and closed manually. However, the sunshade will open automatically when the moon roof is opened.

■ **Door lock linked moon roof operation**

- The moon roof can be opened and closed using the mechanical key. (→P. 558)
- The moon roof can be opened using the wireless remote control. (→P. 98)

■ **Moon roof open reminder function**

An alarm will sound and a message will be shown on the multi-information display when the driver's door is opened with the moon roof not fully closed and the engine switch off.

■ **When the moon roof does not close normally**

Perform the following procedure:

- If the moon roof closes but then re-opens slightly

1 Stop the vehicle.

2 Press and hold "v" on the .*1



The moon roof will close, re-open and pause for approximately 10 seconds.*2 Then it will close again, tilt up and pause for approximately 1 second. Finally, it will tilt down, open and close.

3 Check to make sure that the moon roof is completely closed and then release the switch.

- If the moon roof tilts down but then tilts back up

1 Stop the vehicle.

2 Press and hold “^” on the  *1 until the moon roof moves into the tilt up position and stops.

3 Release “^” on the  once and then press and hold “^” on the  again. *1

The moon roof will pause for approximately 10 seconds in the tilt up position. *2
Then it will adjust slightly and pause for approximately 1 second.
Finally, it will tilt down, open and close.

4 Check to make sure that the moon roof is completely closed and then release the switch.

*1: If the switch is released at the incorrect time, the procedure will have to be performed again from the beginning.

*2: If the switch is released after the above mentioned 10 second pause, automatic

operation will be disabled. In that case, press and hold “v” on the  or “^” on the

 and the moon roof will tilt up and pause for approximately 1 second. Then it will tilt down, open and close. Check to make sure that the moon roof is completely closed and then release the switch.

If the moon roof does not fully close even after performing the above procedure correctly, have the vehicle inspected by your Lexus dealer.

■ Customization

Settings (e.g. linked door lock operation) can be changed.
(Customizable features: →P. 594)

3

Operation of each component

⚠ CAUTION

Observe the following precautions.
Failing to do so may cause death or serious injury.

■ Opening the moon roof

- Do not allow any passengers to put their hands or heads outside the vehicle while it is moving.
- Do not sit on top of the moon roof.

■ Closing the moon roof

- The driver is responsible for moon roof opening and closing operations.
In order to prevent accidental operation, especially by a child, do not let a child operate the moon roof. It is possible for children and other passengers to have body parts caught in the moon roof.
- Check to make sure that all passengers do not have any part of their bodies in a position where it could be caught when the moon roof is being operated.
- When using the wireless remote control or mechanical key and operating the moon roof, operate the moon roof after checking to make sure that there is no possibility of any passenger having any of their body parts caught in the moon roof. Also, do not let a child operate moon roof by the wireless remote control or mechanical key. It is possible for children and other passengers to get caught in the moon roof.
- When exiting the vehicle, turn the engine switch off, carry the key and exit the vehicle along with the child. There may be accidental operation, due to mischief, etc., that may possibly lead to an accident.

■ Jam protection function

- Never use any part of your body to intentionally activate the jam protection function.
- The jam protection function may not work if something gets caught just before the moon roof fully closes.



- 4-1. Before driving**
- Driving the vehicle.....158
 - Cargo and luggage.....165
 - Vehicle load limits.....169
 - Trailer towing
(with towing hitch)170
 - Dinghy towing188
- 4-2. Driving procedures**
- Engine (ignition) switch189
 - Automatic transmission.....194
 - Turn signal lever.....200
 - Parking brake201
- 4-3. Operating the lights and wipers**
- Headlight switch.....202
 - Automatic High Beam.....206
 - Fog light switch211
 - Windshield wipers and washer.....213
 - Rear window wiper and washer.....218
 - Headlight cleaner switch220
- 4-4. Refueling**
- Opening the fuel tank cap.....221
- 4-5. Using the driving support systems**
- Cruise control225
 - Dynamic radar cruise control228
 - LDA
(Lane Departure Alert).....239
 - Intuitive parking assist.....245
 - Rear view monitor system.....254
 - Lexus parking assist monitor.....264
 - Wide view front & side monitor290
 - Multi-terrain Select.....308
 - Multi-terrain Monitor313
 - Rear height control air suspension337
 - AVS (Adaptive Variable Suspension System).....341
 - Four-wheel drive system342
 - Crawl Control.....346
 - Downhill assist control system.....349
 - Driving assist systems351
 - BSM (Blind Spot Monitor).....357
 - The Blind Spot Monitor function362
 - The Rear Cross Traffic Alert function.....365
 - PCS
(Pre-Collision system).....368
- 4-6. Driving tips**
- Winter driving tips.....377
 - Off-road precautions.....380



Driving the vehicle

The following procedures should be observed to ensure safe driving:

Starting the engine

→P. 189

Driving

- 1 With the brake pedal depressed, shift the shift lever to D. (→P. 194)
- 2 Release the parking brake. (→P. 201)
- 3 Gradually release the brake pedal and gently depress the accelerator pedal to accelerate the vehicle.

Stopping

- 1 With the shift lever in D, depress the brake pedal.
- 2 If necessary, set the parking brake.
If the vehicle is to be stopped for an extended period of time, shift the shift lever to P or N. (→P. 194)

Parking the vehicle

- 1 With the shift lever in D, depress the brake pedal.
- 2 Set the parking brake (→P. 201), and shift the shift lever to P (→P. 194).
- 3 Press the engine switch to stop the engine.
- 4 Lock the door, making sure that you have the key on your person.
If parking on a hill, block the wheels as needed.

Starting off on a steep uphill

- 1 Make sure that the parking brake is set and shift the shift lever to D.
- 2 Gently depress the accelerator pedal.
- 3 Release the parking brake.



■ When starting off on a uphill (vehicles with hill-start assist control system)

The hill-start assist control is available. (→P. 352)

■ Driving in the rain

- Drive carefully when it is raining, because visibility will be reduced, the windows may become fogged-up, and the road will be slippery.
- Drive carefully when it starts to rain, because the road surface will be especially slippery.
- Refrain from high speeds when driving on an expressway in the rain, because there may be a layer of water between the tires and the road surface, preventing the steering and brakes from operating properly.

■ Engine speed while driving

In the following conditions, the engine speed may become high while driving. This is due to automatic up-shifting control or down-shifting implementation to meet driving conditions. It does not indicate sudden acceleration.

- The vehicle is judged to be driving uphill or downhill
- When the accelerator pedal is released

■ Breaking in your new Lexus

To extend the life of the vehicle, observing the following precautions is recommended:

- For the first 200 miles (300 km):
Avoid sudden stops.
- For the first 500 miles (800 km):
Do not tow a trailer.
- For the first 600 miles (1000 km):
 - Do not drive at extremely high speeds.
 - Avoid sudden acceleration.
 - Do not drive continuously in the low gears.
 - Do not drive at a constant speed for extended periods.

■ Drum-in-disc type parking brake system

Your vehicle has a drum-in-disc type parking brake system. This type of brake system needs bedding-down of the brake shoes periodically or whenever the parking brake shoes and/or drum are replaced. Have your Lexus dealer, perform the bedding-down operation.

■ Operating your vehicle in a foreign country

Comply with the relevant vehicle registration laws and confirm the availability of the correct fuel. (→P. 572)

■ When turning off the engine

Emission system operating sounds may continue for a short time after the engine is turned off. This is not a malfunction, and helps to ensure optimal performance of the emission system.



 CAUTION

Observe the following precautions.
Failure to do so may result in death or serious injury.

■ When starting the vehicle

Always keep your foot on the brake pedal while stopped with the engine running. This prevents the vehicle from creeping.

■ When driving the vehicle

- Do not drive if you are unfamiliar with the location of the brake and accelerator pedals to avoid depressing the wrong pedal.
 - Accidentally depressing the accelerator pedal instead of the brake pedal will result in sudden acceleration that may lead to an accident.
 - When backing up, you may twist your body around, leading to a difficulty in operating the pedals. Make sure to operate the pedals properly.
 - Make sure to keep a correct driving posture even when moving the vehicle only slightly. This allows you to depress the brake and accelerator pedals properly.
 - Depress the brake pedal using your right foot. Depressing the brake pedal using your left foot may delay response in an emergency, resulting in an accident.
- Do not drive the vehicle over or stop the vehicle near flammable materials. The exhaust system and exhaust gases can be extremely hot. These hot parts may cause a fire if there is any flammable material nearby.
- During normal driving, do not turn off the engine. Turning the engine off while driving will not cause loss of steering or braking control, but the power assist to these systems will be lost. This will make it more difficult to steer and brake, so you should pull over and stop the vehicle as soon as it is safe to do so. However, in the event of an emergency, such as if it becomes impossible to stop the vehicle in the normal way: →P. 511
- Use engine braking (downshift) to maintain a safe speed when driving down a steep hill. Using the brakes continuously may cause the brakes to overheat and lose effectiveness. (→P. 194)
- Do not adjust the positions of the steering wheel, the seat, or the inside or outside rear view mirrors while driving. Doing so may result in a loss of vehicle control.
- Always check that all passengers' arms, heads or other parts of their body are not outside the vehicle.
- Do not drive in excess of the speed limit. Even if the legal speed limit permits it, do not drive over 85 mph (140 km/h) unless your vehicle has high-speed capability tires. Driving over 85 mph (140 km/h) may result in tire failure, loss of control and possible injury. Be sure to consult a tire dealer to determine whether the tires on your vehicle are high-speed capability tires or not before driving at such speeds.



⚠ CAUTION

Observe the following precautions.
Failure to do so may result in death or serious injury.

■ When driving on slippery road surfaces

- Sudden braking, acceleration and steering may cause tire slippage and reduce your ability to control the vehicle.
- Sudden acceleration, engine braking due to shifting, or changes in engine speed could cause the vehicle to skid.
- After driving through a puddle, lightly depress the brake pedal to make sure that the brakes are functioning properly. Wet brake pads may prevent the brakes from functioning properly. If the brakes on only one side are wet and not functioning properly, steering control may be affected.

■ When shifting the shift lever

- Do not let the vehicle roll backwards while the shift lever is in a driving position, or roll forward while the shift lever is in R.
Doing so may cause the engine to stall or lead to poor brake and steering performance, resulting in an accident or damage to the vehicle.
- Do not shift the shift lever to P while the vehicle is moving.
Doing so can damage the transmission and may result in a loss of vehicle control.
- Do not shift the shift lever to R while the vehicle is moving forward.
Doing so can damage the transmission and may result in a loss of vehicle control.
- Do not shift the shift lever to a driving position while the vehicle is moving backward.
Doing so can damage the transmission and may result in a loss of vehicle control.
- Moving the shift lever to N while the vehicle is moving will disengage the engine from the transmission. Engine braking is not available when N is selected.
- Be careful not to shift the shift lever with the accelerator pedal depressed. Shifting the shift lever to a gear other than P or N may lead to unexpected rapid acceleration of the vehicle that may cause an accident.

■ If you hear a squealing or scraping noise (brake pad wear limit indicators)

Have the brake pads checked and replaced by your Lexus dealer as soon as possible. Rotor damage may result if the pads are not replaced when needed.
It is dangerous to drive the vehicle when the wear limits of the brake pads and/or those of the brake discs are exceeded.

⚠ CAUTION

Observe the following precautions.
Failure to do so may result in death or serious injury.

■ When the vehicle is stopped

- Do not race the engine.
If the vehicle is in any gear other than P or N, the vehicle may accelerate suddenly and unexpectedly, causing an accident.
- In order to prevent accidents due to the vehicle rolling away, always keep depressing the brake pedal while the engine is running, and apply the parking brake as necessary.
- If the vehicle is stopped on an incline, in order to prevent accidents caused by the vehicle rolling forward or backward, always depress the brake pedal and securely apply the parking brake as needed.
- Avoid revving or racing the engine. Running the engine at high speed while the vehicle is stopped may cause the exhaust system to overheat, which could result in a fire if combustible material is nearby.

■ When the vehicle is parked

- Do not leave glasses, cigarette lighters, spray cans, or soft drink cans in the vehicle when it is in the sun.
Doing so may result in the following:
 - Gas may leak from a cigarette lighter or spray can, and may lead to a fire.
 - The temperature inside the vehicle may cause the plastic lenses and plastic material of glasses to deform or crack.
 - Soft drink cans may fracture, causing the contents to spray over the interior of the vehicle, and may also cause a short circuit in the vehicle's electrical components.
- Do not leave cigarette lighters in the vehicle. If a cigarette lighter is in a place such as the glove box or on the floor, it may be lit accidentally when luggage is loaded or the seat is adjusted, causing a fire.
- Do not attach adhesive discs to the windshield or windows. Do not place containers such as air fresheners on the instrument panel or dashboard. Adhesive discs or containers may act as lenses, causing a fire in the vehicle.
- Do not leave a door or window open if the curved glass is coated with a metallized film such as a silver-colored one. Reflected sunlight may cause the glass to act as a lens, causing a fire.
- Always apply the parking brake, shift the shift lever to P, stop the engine and lock the vehicle.
Do not leave the vehicle unattended while the engine is running.
If the vehicle is parked with the shift lever in P but the parking brake is not set, the vehicle may start to move, possibly leading to an accident.
- Do not touch the exhaust pipes while the engine is running or immediately after turning the engine off.
Doing so may cause burns.



 CAUTION

Observe the following precautions.
Failure to do so may result in death or serious injury.

■ **When taking a nap in the vehicle**

Always turn the engine off. Otherwise, if you accidentally move the shift lever or depress the accelerator pedal, this could cause an accident or fire due to engine overheating. Additionally, if the vehicle is parked in a poorly ventilated area, exhaust gases may collect and enter the vehicle, leading to death or a serious health hazard.

■ **When braking**

- When the brakes are wet, drive more cautiously.
Braking distance increases when the brakes are wet, and this may cause one side of the vehicle to brake differently than the other side. Also, the parking brake may not securely hold the vehicle.
- If the power brake assist function does not operate, do not follow other vehicles closely and avoid hills or sharp turns that require braking. In this case, braking is still possible, but the brake pedal should be depressed more firmly than usual. Also, the braking distance will increase. Have your brakes fixed immediately.
- Do not pump the brake pedal if the engine stalls.
Each push on the brake pedal uses up the reserve for the power-assisted brakes.
- The brake system consists of 2 individual hydraulic systems: If one of the systems fails, the other will still operate. In this case, the brake pedal should be depressed more firmly than usual and the braking distance will increase.
Have your brakes fixed immediately.

■ **If the vehicle becomes stuck**

Do not spin the wheels excessively when any of the tires is up in the air, or the vehicle is stuck in sand, mud, etc. This may damage the driveline components or propel the vehicle forward or backward, causing an accident.

 NOTICE

■ **When driving the vehicle**

- Do not depress the accelerator and brake pedals at the same time during driving, as this may restrain the engine output.
- Do not use the accelerator pedal or depress the accelerator and brake pedals at the same time to hold the vehicle on a hill.

■ **When parking the vehicle**

Always set the parking brake, and shift the shift lever to P. Failure to do so may cause the vehicle to move or the vehicle may accelerate suddenly if the accelerator pedal is accidentally depressed.

■ **Avoiding damage to vehicle parts**

- Do not turn the steering wheel fully in either direction and hold it there for an extended period of time.
Doing so may damage the power steering pump.
- When driving over bumps in the road, drive as slowly as possible to avoid damaging the wheels, underside of the vehicle, etc.

■ **If you get a flat tire while driving**

A flat or damaged tire may cause the following situations. Hold the steering wheel firmly and gradually depress the brake pedal to slow down the vehicle.

- It may be difficult to control your vehicle.
- The vehicle will make abnormal sounds or vibrations.
- The vehicle will lean abnormally.

Information on what to do in case of a flat tire. (→P. 542)

■ **When encountering flooded roads**

Do not drive on a road that has flooded after heavy rain etc. Doing so may cause the following serious damage to the vehicle:

- Engine stalling
- Short in electrical components
- Engine damage caused by water immersion

In the event that you drive on a flooded road and the vehicle is flooded, be sure to have your Lexus dealer check the following:

- Brake function
- Changes in quantity and quality of oil and fluid used for the engine, transmission, transfer, differentials, etc.
- Lubricant condition for the propeller shaft, bearings and suspension joints (where possible), and the function of all joints, bearings, etc.



Cargo and luggage

Take notice of the following information about storage precautions, cargo capacity and load:

Capacity and distribution

Cargo capacity depends on the total weight of the occupants.

(Cargo capacity) = (Total load capacity) – (Total weight of occupants)

Steps for Determining Correct Load Limit—

- (1) Locate the statement “The combined weight of occupants and cargo should never exceed XXX kg or XXX lbs.” on your vehicle’s placard.
- (2) Determine the combined weight of the driver and passengers that will be riding in your vehicle.
- (3) Subtract the combined weight of the driver and passengers from XXX kg or XXX lbs.
- (4) The resulting figure equals the available amount of cargo and luggage load capacity.
For example, if the “XXX” amount equals 1400 lbs. and there will be five 150 lb passengers in your vehicle, the amount of available cargo and luggage load capacity is 650 lbs. $(1400 - 750 (5 \times 150) = 650 \text{ lbs.})$
- (5) Determine the combined weight of luggage and cargo being loaded on the vehicle. That weight may not safely exceed the available cargo and luggage load capacity calculated in Step 4.
- (6) If your vehicle will be towing a trailer, load from your trailer will be transferred to your vehicle. Consult this manual to determine how this reduces the available cargo and luggage load capacity of your vehicle. (→P. 169)



Calculation formula for your vehicle

- ① Cargo capacity
- ② Total load capacity (vehicle capacity weight) (→P. 570)

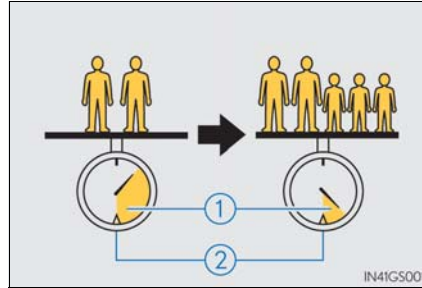

When 2 people with the combined weight of A lb. (kg) are riding in your vehicle, which has a total load capacity (vehicle capacity weight) of B lb. (kg), the available amount of cargo and luggage load capacity will be C lb. (kg) as follows:

$$B^{*2} \text{ lb. (kg)} - A^{*1} \text{ lb. (kg)} = C^{*3} \text{ lb. (kg)}$$

- *1: A = Weight of people
- *2: B = Total load capacity
- *3: C = Available cargo and luggage load

In this condition, if 3 more passengers with the combined weight of D lb. (kg) get on, the available cargo and luggage load will be reduced E lb. (kg) as follows:

$$C \text{ lb. (kg)} - D^{*4} \text{ lb. (kg)} = E^{*5} \text{ lb. (kg)}$$

- *4: D = Additional weight of people
- *5: E = Available cargo and luggage load

As shown in the example above, if the number of occupants increases, the cargo and luggage load will be reduced by an amount that equals the increased weight due to the additional occupants. In other words, if an increase in the number of occupants causes an excess of the total load capacity (combined weight of occupants plus cargo and luggage load), you must reduce the cargo and luggage on your vehicle.



 CAUTION**■ Things that must not be carried in the luggage compartment**

The following things may cause a fire if loaded in the luggage compartment:

- Receptacles containing gasoline
- Aerosol cans

■ Storage precautions

Observe the following precautions.

Failure to do so may prevent the pedals from being depressed properly, may block the driver's vision, or may result in items hitting the driver or passengers, possibly causing an accident.

- Stow cargo and luggage in the luggage compartment whenever possible.
- Do not stack cargo and luggage in the luggage compartment higher than the seat-backs.
- Do not place cargo or luggage in or on the following locations.
 - At the feet of the driver
 - On the front passenger or rear seats (when stacking items)
 - On the luggage cover (if equipped)
 - On the instrument panel
 - On the dashboard
- Secure all items in the occupant compartment.
- When you fold down the rear seats, long items should not be placed directly behind the front seats.
- Never allow anyone to ride in the luggage compartment. It is not designed for passengers. They should ride in their seats with their seat belts properly fastened. Otherwise, they are much more likely to suffer death or serious bodily injury, in the event of sudden braking, sudden swerving or an accident.

 CAUTION**■ Capacity and distribution**

- Do not exceed the maximum axle weight rating or the total vehicle weight rating.
- Even if the total load of occupant's weight and the cargo load is less than the total load capacity, do not apply the load unevenly. Improper loading may cause deterioration of steering or braking control which may cause death or serious injury.

■ Roof luggage carrier precautions (if equipped)

To use the roof rails as a roof luggage carrier, you must fit the roof rails with two or more genuine Lexus cross rails or their equivalent.

Follow the manufacturer's instructions and precautions when installing the cross rails or their equivalent.

When you load cargo on the roof luggage carrier, observe the following:

- Place the cargo so that its weight is distributed evenly between the front and rear axles.
- If loading long or wide cargo, never exceed the vehicle overall length or width. (→P. 570)
- Before driving, make sure the cargo is securely fastened on the roof luggage carrier.
- Loading cargo on the roof luggage carrier will make the center of gravity of the vehicle higher. Avoid high speeds, sudden starts, sharp turns, sudden braking or abrupt maneuvers, otherwise it may result in loss of control or vehicle rollover due to failure to operate this vehicle correctly and result in death or serious injury.
- If driving for a long distance, on rough roads, or at high speeds, stop the vehicle now and then during the trip to make sure the cargo remains in its place.
- Do not exceed 176 lb. (80 kg) cargo weight on the roof luggage carrier.

 NOTICE**■ When loading cargo on the roof luggage carrier (if equipped)**

Be careful not to scratch the surface of the moon roof.

Vehicle load limits

Vehicle load limits include total load capacity, seating capacity, TWR (Trailer Weight Rating) and cargo capacity.

◆ **Total load capacity (vehicle capacity weight): →P. 570**

Total load capacity means the combined weight of occupants, cargo and luggage.

◆ **Seating capacity**

7-passenger models: 7 occupants (Front 2, Rear 5)

6-passenger models: 6 occupants (Front 2, Rear 4)

Seating capacity means the maximum number of occupants whose estimated average weight is 150 lb. (68 kg) per person.

◆ **TWR (Trailer Weight Rating): →P. 174, 570**

TWR means the maximum gross trailer weight (trailer weight plus its cargo weight) that your vehicle is able to tow.

◆ **Cargo capacity**

Cargo capacity may increase or decrease depending on the weight and the number of occupants.

■ **Total load capacity and seating capacity**

These details are also described on the tire and loading information label. (→P. 483)

⚠ CAUTION

■ **Overloading the vehicle**

Do not overload the vehicle. It may not only cause damage to the tires, but also degrade steering and braking ability, resulting in an accident.



Trailer towing (with towing hitch)

Your vehicle is designed primarily as a passenger-and-load-carrying vehicle. Towing a trailer can have an adverse impact on handling, performance, braking, durability, and fuel consumption. For your safety and the safety of others, you must not overload your vehicle or trailer. You must also ensure that you are using appropriate towing equipment, that the towing equipment has been installed correctly and used properly, and that you employ the requisite driving habits.

Vehicle-trailer stability and braking performance are affected by trailer stability, brake performance and setting, trailer brakes, the hitch and hitch systems (if equipped).

To tow a trailer safely, use extreme care and drive the vehicle in accordance with your trailer's characteristics and operating conditions.

Lexus warranties do not apply to damage or malfunction caused by towing a trailer for commercial purposes.

Contact your Lexus dealer for further information about additional requirements such as towing kits, etc.



Towing related terms

■ GCWR (Gross Combination Weight Rating)

The maximum allowable gross combination weight. The gross combination weight is the sum of the total vehicle weight (including the occupants, cargo and any optional equipment installed on the vehicle) and the weight of the trailer being towed (including the cargo in the trailer).

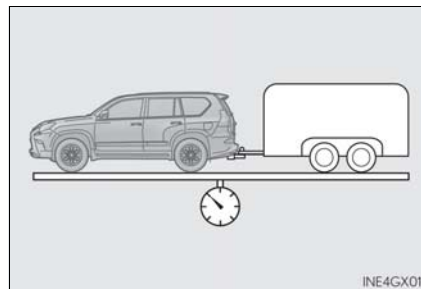

■ GVWR (Gross Vehicle Weight Rating)

The maximum allowable gross vehicle weight. The gross vehicle weight is the total weight of the vehicle. When towing a trailer, it is the sum of the vehicle weight (including the occupants, cargo and any optional equipment installed on the vehicle) and the tongue weight.

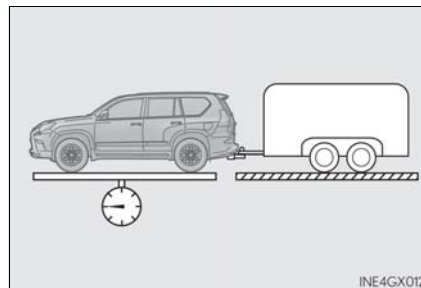

■ **GAWR (Gross Axle Weight Rating)**

The maximum allowable gross axle weight. The gross axle weight is the load placed on each axle (front and rear).

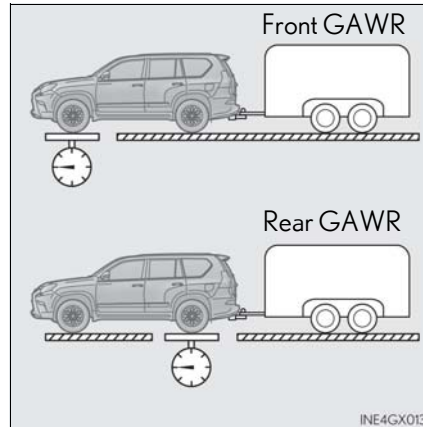

■ **TWR (Trailer Weight Rating)**

The maximum allowable gross trailer weight. The gross trailer weight is the sum of the trailer weight and the weight of the cargo in the trailer.

TWR is calculated assuming base vehicle with one driver, one front passenger, towing package (if available), hitch and hitch systems (if required).

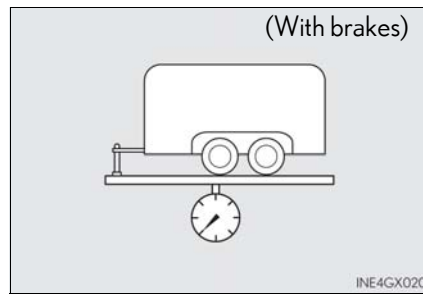

Additional optional equipment, passengers and cargo in the vehicle will reduce the trailer weight rating so as not to exceed GCWR, GVWR and GAWR.

If the gross trailer weight exceeds 3000 lb. (1360 kg), it is recommended to use a trailer with 2 or more axles.

■ **Unbraked TWR (Unbraked Trailer Weight Rating)**

The trailer weight rating for towing a trailer without a trailer service brake system.

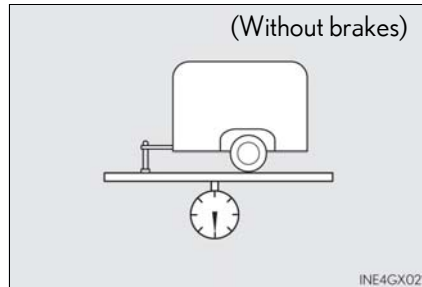

■ **Tongue Weight**

The load placed on the trailer hitch ball. (→P. 175)

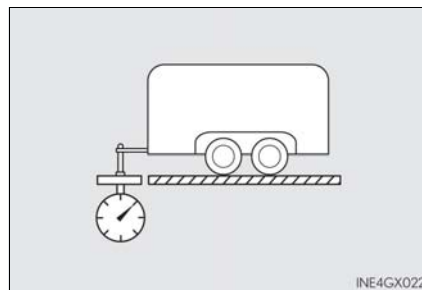

Weight limits

- The gross trailer weight must never exceed 6500 lb. (2950 kg).
- The gross combination weight must never exceed 13100 lb. (5940 kg).
- The gross vehicle weight must never exceed the GVWR indicated on the Certification Label.
- The gross axle weight on each axle must never exceed the GAWR indicated on the Certification Label.

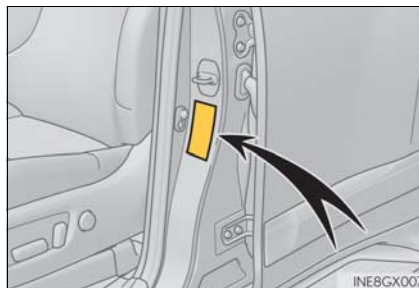

- If the gross trailer weight is over the unbraked TWR, trailer service brakes are required.
- If the gross trailer weight is over 2000 lb. (907 kg), a sway control device with sufficient capacity is required.
- If the gross trailer weight is over 5000 lb. (2268 kg), a weight distributing hitch with sufficient capacity is required.

Confirm that the gross trailer weight, gross combination weight, gross vehicle weight, gross axle weight and tongue weight are all within the limits.

- **GCWR***
13100 lb. (5940 kg)
- **TWR***
6500 lb. (2950 kg)
- **Unbraked TWR***
1000 lb. (453 kg)

*: This model meets the tow-vehicle trailering requirement of SAE International per SAE J2807.



Trailer Tongue Weight

- A recommended tongue weight varies in accordance with the types of trailers or towing as described below.
- To ensure the recommended values shown below, the trailer must be loaded by referring to the following instructions.

- Tongue Weight

The gross trailer weight should be distributed so that the tongue weight is 9 % to 11 %. (Tongue weight/Gross trailer weight \times 100 = 9 % to 11 %)

- ① Gross trailer weight
- ② Tongue weight

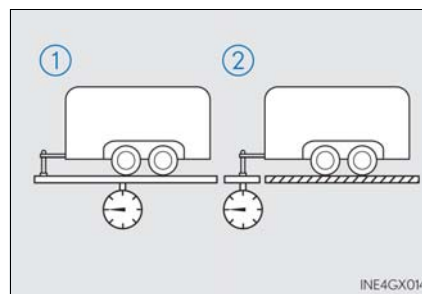

If using a weight distributing hitch when towing, return the front axle to the same weight as before the trailer connection.

If front axle weight cannot be measured directly, measure the front fender height above the front axle before connection. Adjust weight distributing hitch torque until front fender is returned to the same height as before connection.

The gross trailer weight, gross axle weight and tongue weight can be measured with platform scales found at a highway weighing station, building supply company, trucking company, junk yard, etc.

Hitch

Trailer hitch assemblies have different weight capacities. Lexus recommends the use of Lexus hitch/bracket for your vehicle. For details, contact your Lexus dealer.

- If you wish to install a trailer hitch, contact your Lexus dealer.
- Use only a hitch that conforms to the gross trailer weight requirement of your vehicle.
- Follow the directions supplied by the hitch manufacturer.
- Lubricate the hitch ball with a light coating of grease.
- Remove the trailer hitch whenever you are not towing a trailer. After removing the hitch, seal any mounting hole in the vehicle body to prevent entry of any substances into the vehicle.



Selecting trailer ball

Use the correct trailer ball for your application.

- ① Trailer ball load rating
Matches or exceeds the gross trailer weight rating of the trailer.
- ② Ball diameter
Matches the size of the trailer coupler. Most couplers are stamped with the required trailer ball size.

Trailer class	Typical trailer ball size
IV	2 5/16 in.
II and III	2 in.
I	1 7/8 in.

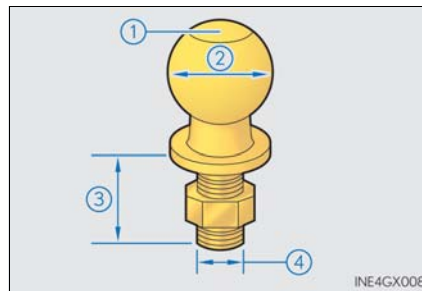

- ③ Shank length
Protrudes beyond the bottom of the lock washer and nut by at least 2 threads.
- ④ Shank diameter
Matches the ball mount hole diameter size.



Positions for towing hitch receiver and hitch ball

- ① Weight carrying ball position:
50.5 in. (1282.9 mm)
- ② Hitch receiver pin hole position:
44.1 in. (1120.4 mm)

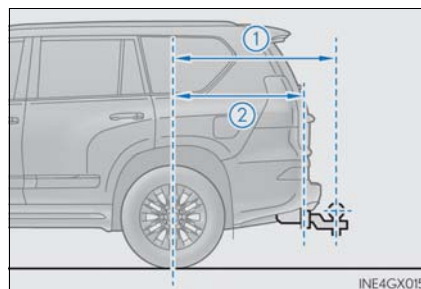

Connecting trailer lights

Use the wire harness stored in the rear end under the vehicle body.

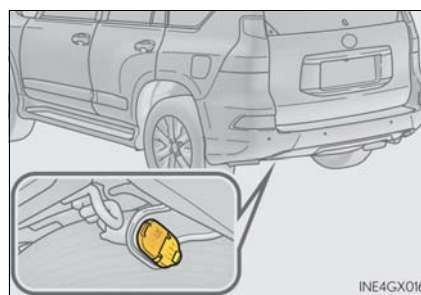

Please consult your dealer when installing trailer lights, as incorrect installation may cause damage to the vehicle's lights. Please take care to comply with your state's laws when installing trailer lights.

Connecting and disconnecting a trailer

Stop your vehicle and a trailer in line and perform the following:

● Connecting a trailer

- 1 Set the rear height control air suspension to N mode.
- 2 Turn off the engine switch or the rear height control air suspension.
- 3 Connect the trailer.
- 4 Turn on the switch that was turned off on step 2.

● Disconnecting a trailer

- 1 Set the rear height control air suspension to N mode.
- 2 Turn off the rear height control air suspension.
- 3 Turn off the engine switch.
- 4 Set the supporting leg of the trailer on the ground and raise the hitch by 4 in. (100 mm)
- 5 Turn on the engine switch.
- 6 Turn on the rear height control air suspension.
- 7 Wait until vehicle height is stabilized.

Make sure the hitch is disconnected. If the hitch does not disconnect, raise the hitch higher and repeat steps 2 through 7.

Trailer towing tips

Your vehicle will handle differently when towing a trailer. Help to avoid an accident, death or serious injury, keep the following in mind when towing:

- Speed limits for towing a trailer vary by state or province. Do not exceed the posted towing speed limit.
- Lexus recommends that the vehicle-trailer speed limit is 65 mph (104 km/h) on a flat, straight, dry road. Do not exceed this limit, the posted towing speed limit or the speed limit for your trailer as set forth in your trailer owner's manual, whichever is lowest. Instability of the towing vehicle-trailer combination (trailer sway) increases as speed increases. Exceeding speed limits may cause loss of control.
- Before starting out, check the trailer lights, tires and the vehicle-trailer connections. Recheck after driving a short distance.
- Practice turning, stopping and reversing with the trailer attached in an area away from traffic until you become accustomed to the feel of the vehicle-trailer combination.
- Reversing with a trailer attached is difficult and requires practice. Grip the bottom of the steering wheel and move your hand to the left to move the trailer to the left. Move your hand to the right to move the trailer to the right. (This is generally opposite to reversing without a trailer attached.) Avoid sharp or prolonged turning. Have someone guide you when reversing to reduce the risk of an accident.
- As stopping distance is increased when towing a trailer, vehicle-to-vehicle distance should be increased. For each 10 mph (16 km/h) of speed, allow at least one vehicle and trailer length.
- Avoid sudden braking as you may skid, resulting in the trailer jackknifing and loss of vehicle control. This is especially true on wet or slippery surfaces.



- Avoid jerky starts or sudden acceleration.
- Avoid jerky steering and sharp turns, and slow down before making a turn.
- Note that when making a turn, the trailer wheels will be closer than the vehicle wheels to the inside of the turn. Compensate by making a wider than normal turning radius.
- Slow down before making a turn, in crosswinds, on wet or slippery surfaces, etc.
Increasing vehicle speed can destabilize the trailer.
- Take care when passing other vehicles. Passing requires considerable distance. After passing a vehicle, do not forget the length of your trailer, and be sure you have plenty of room before changing lanes.
- To maintain engine braking efficiency and charging system performance when using engine braking, do not put the transmission in D.
If in the S mode, the transmission shift range position must be in 5 or lower.
- Instability happens more frequently when descending steep or long downhill grades. Before descending, slow down and downshift. Do not make sudden downshifts while descending steep or long downhill grades.
- Avoid holding the brake pedal down too long or applying the brakes too frequently. This could cause the brakes to overheat and result in reduced braking efficiency.
- Due to the added load of the trailer, your vehicle's engine may overheat on hot days (at temperatures over 85°F [30°C]) when driving up a long or steep grade. If the engine coolant temperature gauge indicates overheating, immediately turn off the air conditioning (if in use), pull your vehicle off the road and stop in a safe spot. (→P. 564)



- Always place wheel blocks under both the vehicle's and the trailer's wheels when parking. Apply the parking brake firmly, and put the transmission in P. Avoid parking on a slope, but if unavoidable, do so only after performing the following:
 - 1 Apply the brakes and keep them applied.
 - 2 Have someone place wheel blocks under both the vehicle's and trailer's wheels.
 - 3 When the wheel blocks are in place, release the brakes slowly until the blocks absorb the load.
 - 4 Apply the parking brake firmly.
 - 5 Shift into P and turn off the engine.
- When restarting after parking on a slope:
 - 1 With the transmission in P, start the engine. Be sure to keep the brake pedal pressed.
 - 2 Shift into 3, 2, L, or R (if reversing).
 - 3 Release the parking brake and brake pedal, and slowly pull or back away from the wheel blocks. Stop and apply the brakes.
 - 4 Have someone retrieve the blocks.



■ Matching trailer ball height to trailer coupler height

No matter which class of tow hitch applies, for a more safe trailer hookup, the trailer ball setup must be the proper height for the coupler on the trailer.

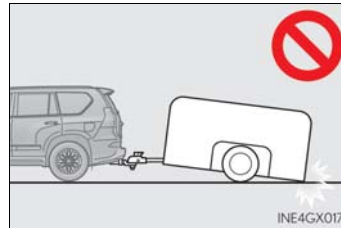

- ① Trailer ball
- ② Coupler

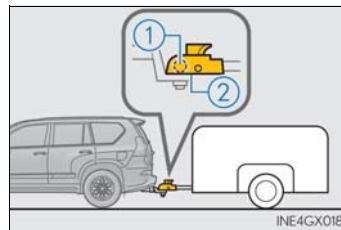

■ Before towing

Check that the following conditions are met:

- Ensure that your vehicle's tires are properly inflated. (→P. 578)
- Trailer tires are inflated according to the trailer manufacturer's recommendation.
- All trailer lights work as required by law.
- All lights work each time you connect them.
- The trailer ball is set at the proper height for the coupler on the trailer.
- The trailer is level when it is hitched.
Do not drive if the trailer is not level, and check for improper tongue weight, overloading, worn suspension, or other possible causes.
- The trailer cargo is securely loaded.
- The rear view mirrors conform to all applicable federal, state/provincial or local regulations. If they do not, install rear view mirrors appropriate for towing purposes.

■ **AVS (adaptive variable suspension system)**

The suspension can be switched for improvement in driveability. (→P. 341)

■ **Break-in schedule**

If your vehicle is new or equipped with any new power train components (such as an engine, transmission, differential or wheel bearing), Lexus recommends that you do not tow a trailer until the vehicle has been driven for over 500 miles (800 km).

After the vehicle has been driven for over 500 miles (800 km), you can start towing. However, for the next 500 miles (800 km), drive the vehicle at a speed of less than 50 mph (80 km/h) when towing a trailer, and avoid full throttle acceleration.

■ **Maintenance**

- If you tow a trailer, your vehicle will require more frequent maintenance due to the additional load. (See "Owner's Guide", "Warranty and Services Guide", "Owner's Manual Supplement" or "Warranty Booklet".)
- Retighten the fixing bolts of the towing ball and bracket after approximately 600 miles (1000 km) of trailer towing.

■ **If trailer sway occurs**

One or more factors (crosswinds, passing vehicles, rough roads, etc.) can adversely affect handling of your vehicle and trailer, causing instability.

- If trailer swaying occurs:
 - Firmly grip the steering wheel. Steer straight ahead.
Do not try to control trailer swaying by turning the steering wheel.
 - Begin releasing the accelerator pedal immediately but very gradually to reduce speed.
Do not increase speed. Do not apply vehicle brakes.

If you make no extreme correction with the steering or brakes, your vehicle and trailer should stabilize.



- After the trailer swaying has stopped:
 - Stop in a safe place. Get all occupants out of the vehicle.
 - Check the tires of the vehicle and the trailer.
 - Check the load in the trailer.
 - Make sure the load has not shifted.
 - Make sure the tongue weight is appropriate, if possible.
 - Check the load in the vehicle.
 - Make sure the vehicle is not overloaded after occupants get in.

If you cannot find any problems, the speed at which trailer swaying occurred is beyond the limit of your particular vehicle-trailer combination.

Drive at a lower speed to prevent instability. Remember that swaying of the towing vehicle-trailer increases as speed increases.

 **CAUTION**

■ **Trailer towing precautions**

- To tow a trailer safely, use extreme care and drive the vehicle in accordance with the trailer's characteristics and operating conditions. Failure to do so could cause an accident resulting in death or serious injury. Vehicle stability and braking performance are affected by trailer stability, brake setting and performance, and the hitch. Your vehicle will handle differently when towing a trailer.
- Set the vehicle height to the LO mode and turn off the rear height control air suspension when you connect a trailer, otherwise the vehicle height may change due to the automatic leveling function, and you may catch part of your body in the vehicle, resulting in an accident.

 CAUTION**■ To avoid accident or injury**

- Do not exceed the TWR, unbraked TWR, GCWR, GVWR or GAWR.
- If the gross trailer weight is over 2000 lb. (907 kg), a sway control device with sufficient capacity is required.
- If the gross trailer weight is over 5000 lb. (2268 kg), a weight distributing hitch with sufficient capacity is required.
- Adjust the tongue weight within the appropriate range. Place heavier loads as close to the trailer axle as possible.
- Do not exceed 65 mph (104 km/h), the posted towing speed limit or the speed limit for your trailer as set forth in your trailer owner's manual, whichever is lowest. Slow down sufficiently before making a turn, in crosswinds, on wet or slippery surface, etc. to help avoid an accident. If you experience a vehicle-trailer instability from reducing a certain speed, slow down and make sure you keep your vehicle speed under the speed of which you experience the instability.
- Do not make jerky, abrupt or sharp turns.
- Do not apply the brakes suddenly as you may skid, resulting in jackknifing and loss of vehicle control. This is especially true on wet or slippery surfaces.
- Do not exceed the trailer hitch assembly weight, gross vehicle weight, gross axle weight and trailer tongue weight capacities.
- Do not use cruise control when towing.
- Slow down and downshift before descending steep or long downhill grades. Do not make sudden downshifts while descending steep or long downhill grades.
- Vehicle-trailer instability is more likely on steep long down hills. Before descending steep or long downhill grades, slow down and downshift. Do not make sudden downshifts when descending steep or long downhill grades. Avoid holding the brake pedal down too long or applying the brakes too frequently. This could cause the brakes to overheat and result in reduced braking efficiency.



 CAUTION**■ Hitch**

Trailer hitch assemblies have different weight capacities established by the hitch manufacturer. Even though the vehicle may be physically capable of towing a higher weight, the operator must determine the maximum weight rating of the particular hitch assembly and never exceed the maximum weight rating specified for the trailer-hitch. Exceeding the maximum weight rating set by the trailer-hitch manufacturer can cause an accident resulting in death or serious personal injuries.

■ When towing a trailer

Lexus recommends trailers with brakes that conform to any applicable federal and state/provincial regulations.

- If the gross trailer weight exceeds unbraked TWR, trailer brakes are required. Lexus recommends trailers with brakes that conform to all applicable federal and state/provincial regulations.
- Never tap into your vehicle's hydraulic system, as this will lower the vehicle's braking effectiveness.
- Never tow a trailer without using a safety chain securely attached to both the trailer and the vehicle. If damage occurs to the coupling unit or hitch ball, there is danger of the trailer wandering into another lane.

 NOTICE**■ When installing a trailer hitch**

Use only the position recommended by your Lexus dealer. Do not install the trailer hitch on the bumper; this may cause body damage.

■ Do not directly splice trailer lights

Do not directly splice trailer lights. Directly splicing trailer lights may damage your vehicle's electrical system and cause a malfunction.

Dinghy towing

Your vehicle is not designed to be dinghy towed (with 4 wheels on the ground) behind a motor home.

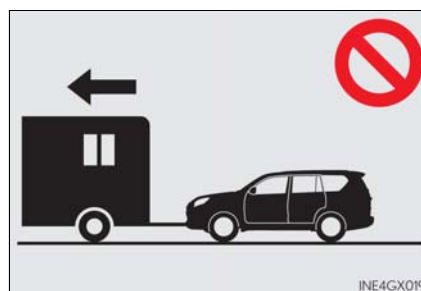

 NOTICE

- **To avoid serious damage to your vehicle**
Do not tow your vehicle with four wheels on the ground.

Engine (ignition) switch

Performing the following operations when carrying the electronic key on your person starts the engine or changes engine switch modes.

Starting the engine

- 1 Check that the parking brake is set.
- 2 Check that the shift lever is set in P.
- 3 Firmly depress the brake pedal.

The engine switch indicator will turn green.
If the indicator does not turn green, the engine cannot be started.

- 4 Press the engine switch shortly and firmly.

When operating the engine switch, one short, firm press is enough.

It is not necessary to press and hold the switch.

The engine will crank until it starts or for up to 30 seconds, whichever is less.

Continue depressing the brake pedal until the engine is completely started.

The engine can be started from any engine switch mode.

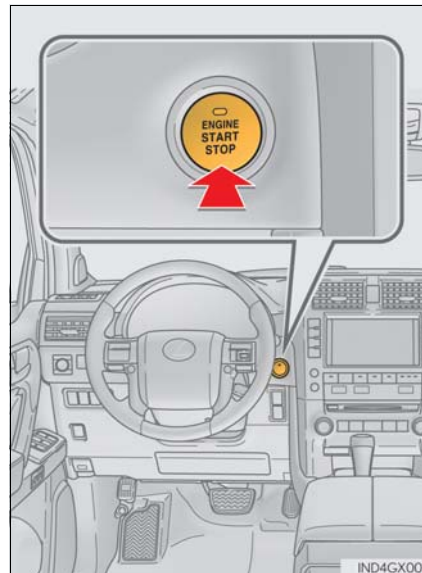

4

Driving

Stopping the engine

- 1 Stop the vehicle.
- 2 Set the parking brake (→P. 201), and shift the shift lever to P.
- 3 Press the engine switch.
- 4 Release the brake pedal and check that the indicator on the engine switch is off.

Changing engine switch modes

Modes can be changed by pressing the engine switch with brake pedal released. (The mode changes each time the switch is pressed.)

- 1 Off*
The emergency flashers can be used.
 - 2 ACCESSORY mode
Some electrical components such as the audio system can be used.
The engine switch indicator turns amber.
 - 3 IGNITION ON mode
All electrical components can be used.
The engine switch indicator turns amber.
- *: If the shift lever is in a position other than P when turning off the engine, the engine switch will be turned to ACCESSORY mode, not to OFF.

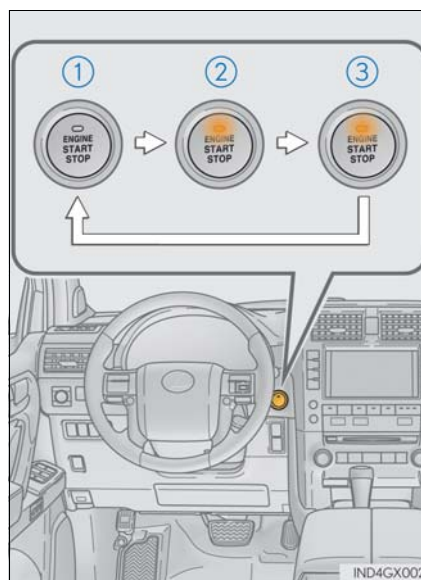

When stopping the engine with the shift lever in a position other than P

If the engine is stopped with the shift lever in a position other than P, the engine switch will not be turned off but instead be turned to ACCESSORY mode. Perform the following procedure to turn the switch off:

- 1** Check that the parking brake is set.
- 2** Shift the shift lever to P.
- 3** Check that the indicator on the engine switch is illuminated in amber and then press the engine switch once.
- 4** Check that the indicator on the engine switch is off.

■ Auto power off function

When the shift lever is in P, if the vehicle is left in ACCESSORY or IGNITION ON mode with the engine not running for more than 20 minutes (ACCESSORY mode) or one hour (IGNITION ON mode), the engine switch will automatically turn off. However, this function cannot entirely prevent battery discharge. Do not leave the vehicle with the engine switch in ACCESSORY or IGNITION ON mode for long periods of time when the engine is not running.

■ Electronic key battery depletion

→P. 96

■ Conditions affecting operation

→P. 117

■ Note for the entry function

→P. 118

■ If the engine does not start

The engine immobilizer system may not have been deactivated. (→P. 72)

Contact your Lexus dealer.

■ Steering lock

After turning the engine switch off and opening and closing the doors, the steering wheel will be locked due to the steering lock function. Operating the engine switch again automatically cancels the steering lock.

■ **When the steering lock cannot be released**

The green indicator light on the engine switch will flash and a message will be shown on the multi-information display. Press the engine switch again while turning the steering wheel left and right.

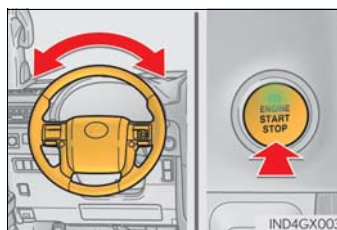

■ **Steering lock motor overheating prevention**

To prevent the steering lock motor from overheating, the motor may be suspended if the engine is turned on and off repeatedly in a short period of time. In this case, refrain from running the engine. After about 10 seconds, the steering lock motor will resume functioning.

■ **When the engine switch indicator flashes in amber**

The system may be malfunctioning. Have the vehicle inspected by your Lexus dealer, immediately.

■ **If the electronic key battery is depleted**

→P. 491

■ **Operation of the engine switch**

- If the switch is not pressed shortly and firmly, the engine switch mode may not change or the engine may not start.
- If attempting to restart the engine immediately after turning the engine switch off, the engine may not start in some cases. After turning the engine switch off, please wait a few seconds before restarting the engine.

■ **If the smart access system with push-button start has been deactivated in a customized setting**

→P. 558

⚠ CAUTION**■ When starting the engine**

Always start the engine while sitting in the driver's seat. Do not depress the accelerator pedal while starting the engine under any circumstances.
Doing so may cause an accident resulting in death or serious injury.

■ Caution while driving

If engine failure occurs while the vehicle is moving, do not lock or open the doors until the vehicle reaches a safe and complete stop. Activation of the steering lock in this circumstance may lead to an accident, resulting in death or serious injury.

■ Stopping the engine in an emergency

If you want to stop the engine in an emergency while driving the vehicle, press and hold the engine switch for more than 2 seconds, or press it briefly 3 times or more in succession. (→P. 511)

However, do not touch the engine switch while driving except in an emergency. Turning the engine off while driving will not cause loss of steering or braking control, but the power assist to these systems will be lost. This will make it more difficult to steer and brake, so you should pull over and stop the vehicle as soon as it is safe to do so.

⚠ NOTICE**■ To prevent battery discharge**

- Do not leave the engine switch in ACCESSORY or IGNITION ON mode for long periods of time without the engine running.
- If the indicator on the engine switch is illuminated, the engine switch is not off. When exiting the vehicle, always check that the engine switch is off.
- Do not stop the engine when the shift lever is in a position other than P. If the engine is stopped in another shift lever position, the engine switch will not be turned off but instead be turned to ACCESSORY mode. If the vehicle is left in ACCESSORY mode, battery discharge may occur.

■ When starting the engine

- Do not race a cold engine.
- If the engine becomes difficult to start or stalls frequently, have your vehicle checked by your Lexus dealer immediately.

■ Symptoms indicating a malfunction with the engine switch

If the engine switch seems to be operating somewhat differently than usual, such as the switch sticking slightly, there may be a malfunction. Contact your Lexus dealer immediately.

Automatic transmission

Shifting the shift lever

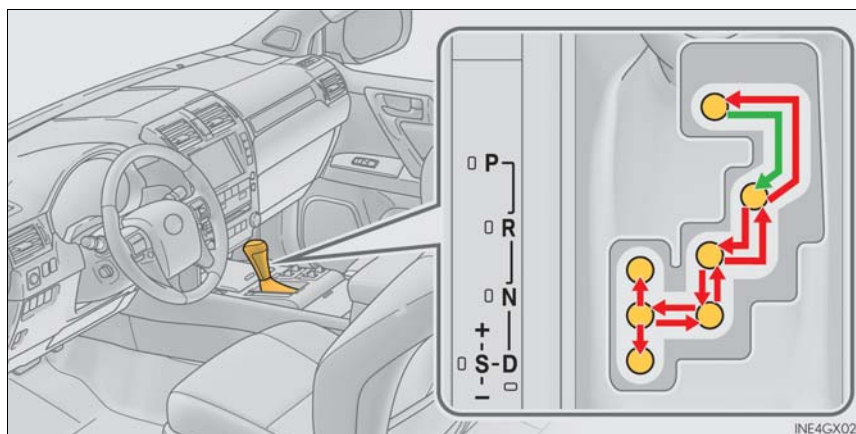

- ← While the engine switch is in IGNITION ON mode, move the shift lever with the brake pedal depressed.

When shifting the shift lever between P and D, make sure that the vehicle is completely stopped.

Shift position purpose

Shift position	Purpose and condition
P	Parking the vehicle/starting the engine
R	Reversing
N	Neutral (Condition in which the power is not transmitted)
D	Normal driving ^{*1}
S	S mode driving ^{*2} (→P. 196)

^{*1}: Shifting to the D position allows the system to select a gear suitable for the driving conditions. Setting the shift lever to the D position is recommended for normal driving.

^{*2}: Selecting shift ranges using S mode restricts the upper limit of the possible gear ranges, controls engine braking forces, and prevents unnecessary upshifting.



Selecting the second start mode

Use second start mode for accelerating and driving on slippery road surfaces such as snow.

- 1 Press the menu switch.

The multi-information display will change modes to electronic features control mode.

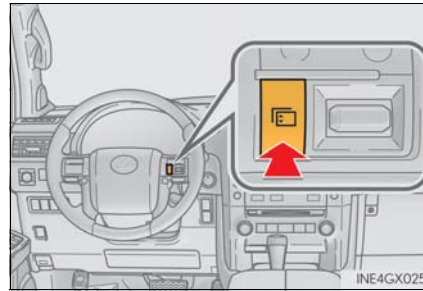

- 2 Press the "ENTER" switch upwards or downwards until "2ND START" appears.

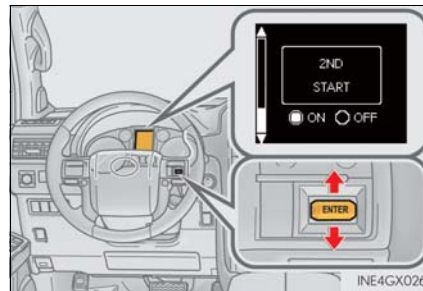

- 3 Press the "ENTER" switch to change to "ON".
The "2nd STRT" indicator will be displayed.

Each pressing of the switch turns second start mode on and off.

Press the menu switch to change to the normal display.

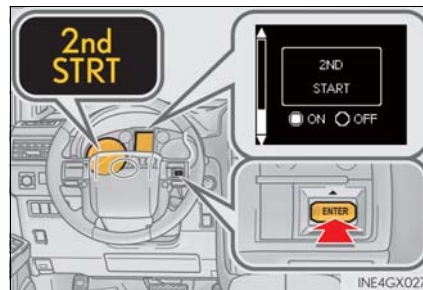

Changing shift ranges in S mode

When the shift lever is in the S position, the shift lever can be operated as follows:

① Upshifting

② Downshifting

The selected shift range, from 1 to 6, will be displayed in the meter.

The initial shift range in S mode is set automatically to 5 or 4 according to vehicle speed. However, the initial shift range may be set to 3 or 2 if AI-SHIFT has operated while the shift lever was in the D position. (→P. 197)

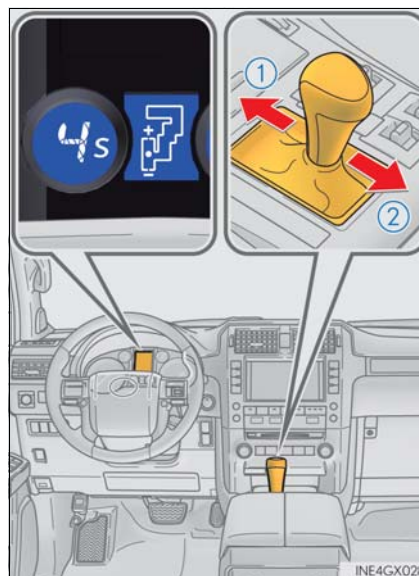

■ Shift ranges and their functions

- You can choose from 6 levels of engine braking force.
- A lower shift range will provide greater engine braking force than a higher shift range, and the engine speed will also increase.

■ Driving on a downhill

On declines, there may be case where the vehicle shifts down automatically to obtain engine braking. As a result of the downshifting, the engine speed may increase.

■ Second start mode automatic deactivation

Second start mode is automatically deactivated if the engine is turned off after driving in second start mode.

■ S mode

When the shift range is 5 or lower, holding the shift lever toward "+" sets the shift range to 6.

■ AI-SHIFT

AI-SHIFT automatically shifts the gear to the suitable position according to driver performance and driving conditions.

AI-SHIFT automatically operates when the shift lever is in the D position. (Shifting the shift lever to the S position cancels the function.)

■ When driving with the cruise control or dynamic radar cruise control

Engine braking will not occur in S mode, even when downshifting to 5 or 4.
(→P. 225, 228)

■ Shift lock system

The shift lock system is a system to prevent accidental operation of the shift lever in starting.

The shift lever can be shifted from P only when the engine switch is in the IGNITION ON mode and the brake pedal is being depressed.

■ **If the shift lever cannot be shifted from P**

First, check whether the brake pedal is being depressed.

If the shift lever cannot be shifted with your foot on the brake pedal, there may be a problem with the shift lock system. Have the vehicle inspected by your Lexus dealer, immediately.

The following steps may be used as an emergency measure to ensure that the shift lever can be shifted.

Releasing the shift lock:

- 1 Set the parking brake.
- 2 Turn the engine switch off.
- 3 Depress the brake pedal.
- 4 Pry the cover up with a flathead screwdriver or tool.

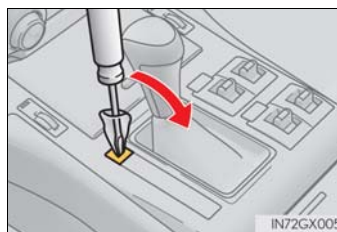

- 5 Press the shift lock override button.
The shift lever can be shifted while the button is pressed.

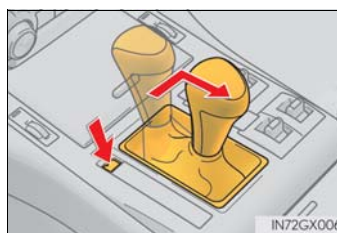

■ **If the “S” indicator does not come on even after shifting the shift lever to S**

This may indicate a malfunction in the automatic transmission system. Have the vehicle inspected by your Lexus dealer immediately.

(In this situation, the transmission will operate in the same manner as when the shift lever is in D.)

■ **Downshift restriction warning buzzer (S mode)**

To help ensure safety and driving performance, downshifting operation may sometimes be restricted. In some circumstances, downshifting may not be possible even when the shift lever is operated. (A buzzer will sound twice.)



 CAUTION**■ When driving on slippery road surfaces**

Do not accelerate or shift gears suddenly.

Sudden changes in engine braking may cause the vehicle to spin or skid, resulting in an accident.

■ To prevent an accident when releasing the shift lock

Before pressing the shift lock override button, make sure to set the parking brake and depress the brake pedal.

If the accelerator pedal is accidentally depressed instead of the brake pedal when the shift lock override button is pressed and the shift lever is shifted out of P, the vehicle may suddenly start, possibly leading to an accident resulting in death or serious injury.

Turn signal lever

Operating instructions

The turn signal lever can be used to show the following intentions of the driver:

- ① Right turn
The right hand signals will flash until you release the lever.
- ② Lane change to the right (push and hold the lever partway)
The right hand signals will flash until you release the lever.
- ③ Lane change to the left (push and hold the lever partway)
The left hand signals will flash until you release the lever.
- ④ Left turn

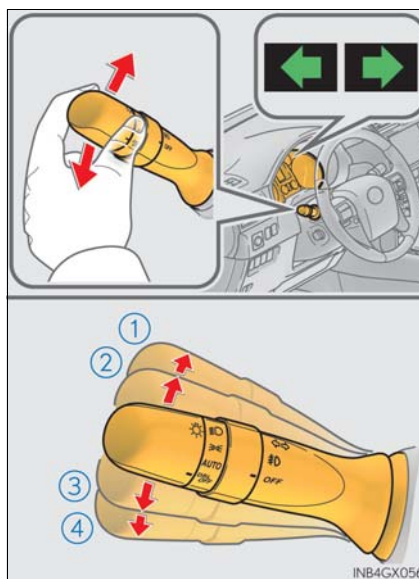

■ **Turn signals can be operated when**

The engine switch is in IGNITION ON mode.

■ **If the indicator flashes faster than usual**

Check that a light bulb in the front or rear turn signal lights has not burned out.

Parking brake

To set the parking brake, fully depress the parking brake pedal with your left foot while depressing the brake pedal with your right foot. (Depressing the pedal again releases the parking brake.)

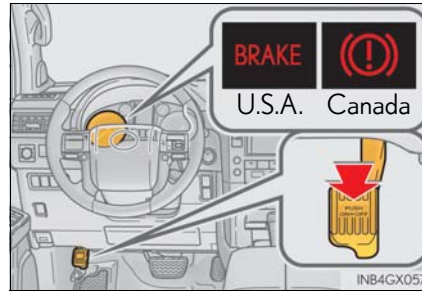

- **Parking the vehicle**
→P. 158
- **Parking brake engaged warning buzzer**
→P. 530
- **Usage in winter time**
→P. 377

NOTICE

■ **Before driving**

Fully release the parking brake.
Driving the vehicle with the parking brake set will lead to brake components overheating, which may affect braking performance and increase brake wear.



Headlight switch

The headlights can be operated manually or automatically.

Operating instructions



Turning the end of the lever turns on the lights as follows:

► Type A

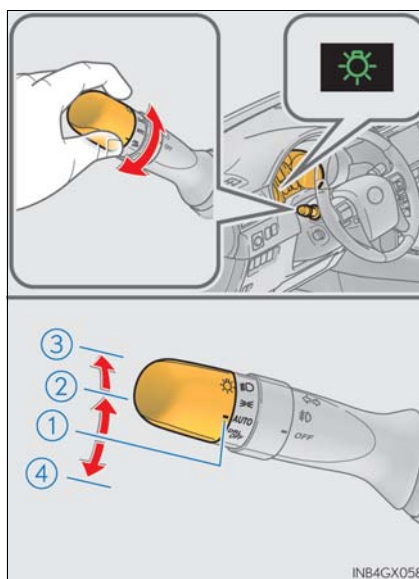
- ① AUTO The headlights, parking lights, daytime running lights (→P. 204) and so on turn on and off automatically (when the engine switch is in IGNITION ON mode).
- ②  The side marker, parking, tail, license plate, instrument panel lights, and daytime running lights (→P. 204) turn on.
- ③  The headlights and all the lights listed above (except daytime running lights) turn on.
- ④  The daytime running lights turn off.



▶ Type B

- ①  The daytime running lights turn on. (→P. 204)
- ②  The side marker, parking, tail, license plate, instrument panel lights, and daytime running lights (→P. 204) turn on.
- ③  The headlights and all lights listed above (except daytime running lights) turn on.
- ④ **AUTO** The headlights, parking lights, daytime running lights (→P. 204) and so on turn on and off automatically (when the engine switch is in IGNITION ON mode).

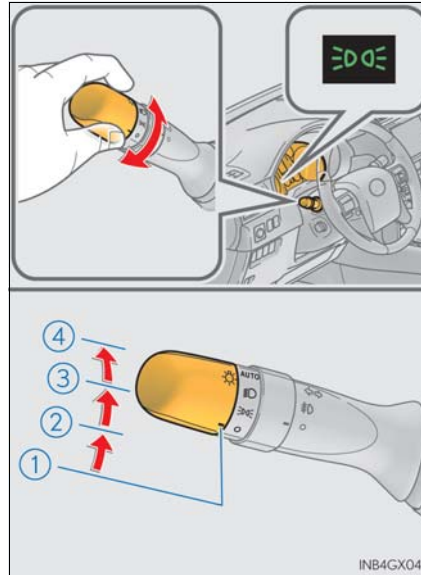

4

Driving

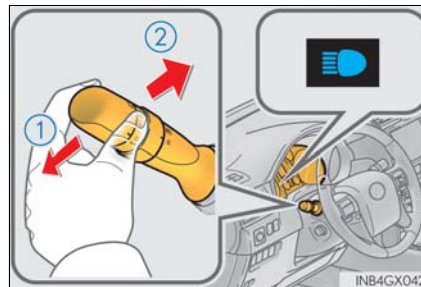

Turning on the high beam headlights

- ① With the headlights on, push the lever away from you to turn on the high beams.
When the light switch is in "AUTO" position, the Automatic High Beam system will be activated. (→P. 206)
Pull the lever toward you to the center position to turn the high beams off.
- ② Pull the lever toward you and release it to flash the high beams once.



You can flash the high beams with the headlights on or off.

■ Daytime running light system

- The daytime running lights illuminate using the same lights as the parking lights and illuminate brighter than the parking lights.
- To make your vehicle more visible to other drivers during daytime driving, the daytime running lights turn on automatically when all of the following conditions are met. (The daytime running lights are not designed for use at night.)
 - The engine is running
 - The parking brake is released
 - The headlight switch is in the  (type B only),  or "AUTO"* position

*: When the surroundings are bright

The daytime running lights remain on after they illuminate even if the parking brake is set again.

- For the U.S.A.: Daytime running lights can be turned off by operating the switch.
- Compared to turning on the headlights, the daytime running light system offers greater durability and consumes less electricity, so it can help improve fuel economy.

■ Headlight control sensor

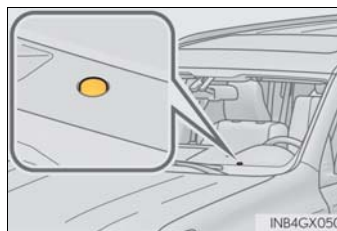

The sensor may not function properly if an object is placed on the sensor, or anything that blocks the sensor is affixed to the windshield.

Doing so interferes with the sensor detecting the level of ambient light and may cause the automatic headlight system to malfunction.



■ Automatic light off system

- When only the tail lights are on: All lights turn off if the engine switch is turned to ACCESSORY mode or turned off and the driver's door is opened.
- When the headlights are on: All lights turn off 30 seconds after a door or the glass hatch is opened and closed.

To turn the lights on again, turn the engine switch to IGNITION ON mode, or turn the light switch  once and then back to  or .



■ Automatic headlight leveling system

The level of the headlights is automatically adjusted according to the number of passengers and the loading condition of the vehicle to ensure that the headlights do not interfere with other road users.

■ If the automatic headlight leveling system warning light flashes

It may indicate a malfunction in the system. Contact your Lexus dealer.

■ Welcome lighting

If the headlight switch is turned to AUTO and the surrounding area is dark, unlocking the doors using the smart access system with push-button start or wireless remote control will turn the parking lights and tail lights on automatically.

■ Customization

Settings (e.g. light sensor sensitivity) can be changed.
(Customizable features: →P. 594)

 **NOTICE****■ To prevent battery discharge**

Do not leave the lights on longer than necessary when the engine is not running.

Automatic High Beam*

The Automatic High Beam uses an in-vehicle camera sensor to assess the brightness of streetlights, the lights of oncoming and preceding vehicles, etc., and automatically turns high beam on or off as necessary.

Activating the Automatic High Beam system

- 1 Turn the headlight switch to the "AUTO" position.

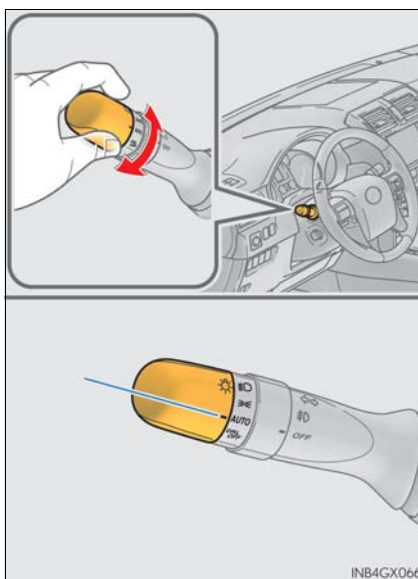

- 2 Push the lever away from you.
The Automatic High Beam indicator will come on when the headlights are turned on automatically to indicate that the system is active.

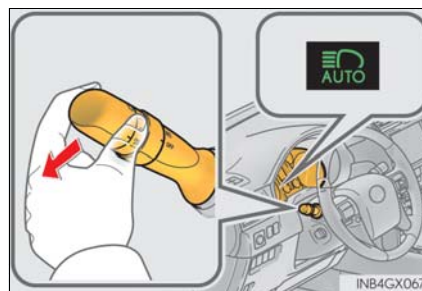

*: If equipped



Turning the high beam on/off manually

■ **Switching to low beam**

Pull the lever to original position.

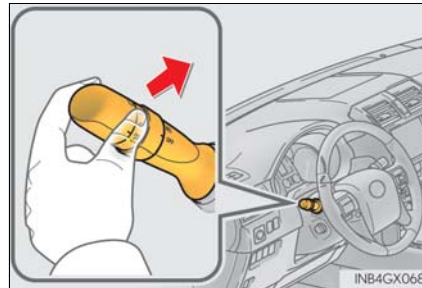

■ **Switching to high beam**

Turn the light switch to  position.

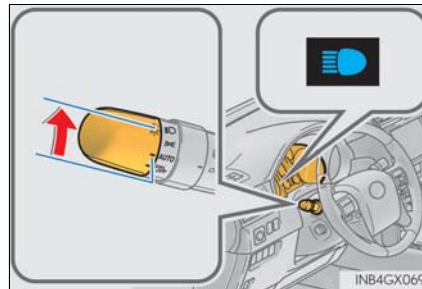

4

Driving

High beam automatic turning on or off conditions

When all of the following conditions are fulfilled, high beam will be automatically turned on (after approximately 1 second):

- Vehicle speed is above approximately 20 mph (32 km/h).
- The area ahead of the vehicle is dark.
- There are no oncoming or preceding vehicles with headlights or tail lights turned on.

If any of the following conditions are fulfilled, high beam will be automatically turned off:

- Vehicle speed drops below approximately 20 mph (32 km/h).
- The area ahead of the vehicle is not dark.
- Oncoming or preceding vehicles have headlights or tail lights turned on.

■ Limitations of the Automatic High Beam

Do not rely on the Automatic High Beam. Always drive safely, taking care to observe your surroundings and turning high beam on or off manually if necessary.

■ Camera sensor detection information

- High beam may not be automatically turned off in the following situations:
 - When oncoming vehicles suddenly appear from a curve.
 - When another vehicle cuts across in front of you.
- High beam may be turned off if an oncoming vehicle that is using fog lights without using the headlights is detected.
- Houselights, streetlights, red traffic signals, and illuminated billboards or signs may cause the high beam to turn off.
- The following factors may affect the amount of time taken to turn high beam on or off:
 - The brightness of headlights, fog lights, and tail lights of oncoming and preceding vehicles
 - Road conditions (wetness, ice, snow etc.)
 - The number of passengers and amount of baggage
- High beam may be turned on or off when unexpected by the driver.



- In the situations below, the system may not be able to correctly detect the surrounding brightness levels, and may flash or expose nearby pedestrians to the high beam. Therefore, you should consider turning the high beam on or off manually rather than relying on the Automatic High Beam system.
 - In bad weather (rain, snow, fog, sandstorms etc.)
 - The windshield is obscured by fog, mist, ice, dirt etc.
 - The windshield is cracked or damaged.
 - The inside rear view mirror or camera sensor is deformed or dirty.
 - The camera sensor temperature is extremely high.
 - Surrounding brightness levels are equal to those of headlights, tail lights or fog lights.
 - Vehicles ahead have headlights that are either switched off, dirty, are changing color, or are not aimed properly.
 - When driving through an area of intermittently changing brightness and darkness
 - When frequently and repeatedly driving ascending/descending roads, or roads with rough, bumpy or uneven surfaces (such as stone-paved roads, gravel tracks etc.)
 - When frequently and repeatedly taking curves or driving on a winding road
 - There is a highly reflective object ahead of the vehicle, such as a sign or a mirror.
 - The back of a vehicle ahead is highly reflective, such as a container on a truck.
 - The vehicle's headlights are damaged or dirty.
 - The vehicle is listing or tilting, due to a flat tire, a trailer being towed etc.
 - The Automatic High Beam indicator is flashing.
 - The high beam and low beam are repeatedly being switched between in an abnormal manner.
 - The driver believes that the high beam may be causing problems or distress to other drivers or pedestrians nearby.

■ **If the Automatic High Beam indicator flashes...**

It may indicate a malfunction in the system. Contact your Lexus dealer.

■ **Temporary lowering sensor sensitivity**

The sensitivity of the sensor can be temporarily lowered.

To lower the sensitivity, push and hold the "AUTO" button on the inside rear view mirror for 15 to 20 seconds, and release. The indicator light on the inside rear view mirror will flash to indicate that the sensitivity has been lowered.

When the engine switch is turned off, the sensitivity will be returned to its normal level.

■ **Customization that can be configured at your Lexus dealer**

The Automatic High Beam can be turned off.



 NOTICE

■ Camera sensor

Observe the following to ensure that the Automatic High Beam functions correctly.

- Do not touch the camera sensor.
- Do not subject the inside rear view mirror or the camera sensor to a strong impact.
- Do not disassemble the camera sensor.
- Do not spill liquid onto the inside rear view mirror or the camera sensor.
- Do not apply window tinting or stickers to the camera sensor or the area of windshield near the camera sensor.
- Do not place items on the dashboard. There is a possibility that the camera sensor will mistake items reflected in the windshield for streetlights, the headlights of other vehicles, etc.
- Do not install a parking tag or any other accessories near or around the inside rear view mirror and the camera sensor.
- Do not overload the vehicle.
- Do not modify the vehicle.
- Do not replace windshield with a non-genuine windshield. Contact your Lexus dealer.

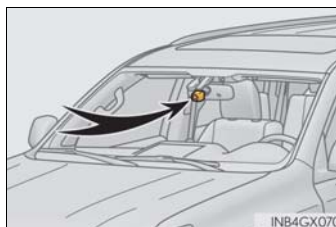

Fog light switch *

The fog lights secure excellent visibility in difficult driving conditions, such as in rain and fog.

► Type A

- ① OFF Turns the fog lights off
- ② 霧 Turns the fog lights on

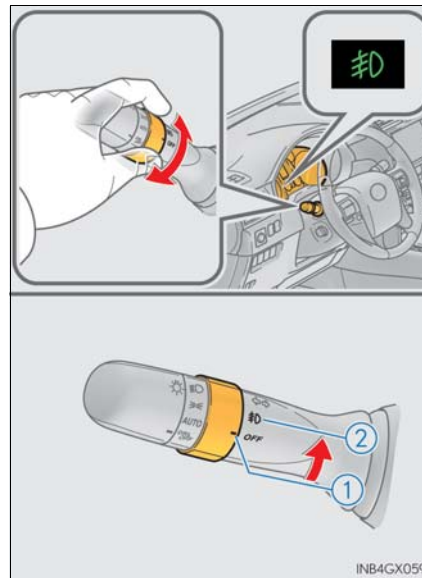

4

Driving

*: If equipped

212 4-3. Operating the lights and wipers

▶ Type B

- ① ○ Turns the fog light off
- ②  Turns the fog light on

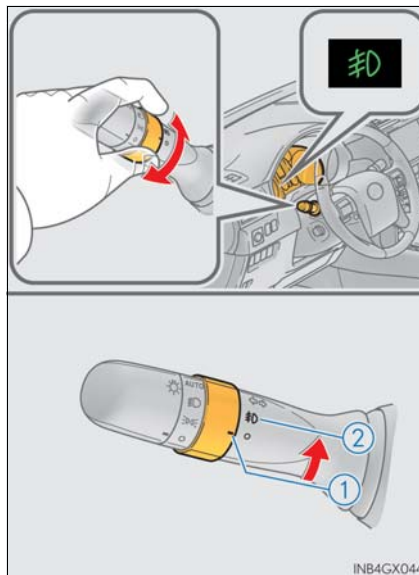

■ **Fog lights can be used when**

The headlights are on in low beam.

 **NOTICE**

■ **To prevent battery discharge**

Do not leave the lights on longer than necessary when the engine is not running.

Windshield wipers and washer

Operating the wiper lever

The wiper operation is selected by moving the lever as follows.

■ Intermittent windshield wipers with interval adjuster

- ① Intermittent operation
- ② Low speed operation
- ③ High speed operation
- ④ Temporary operation

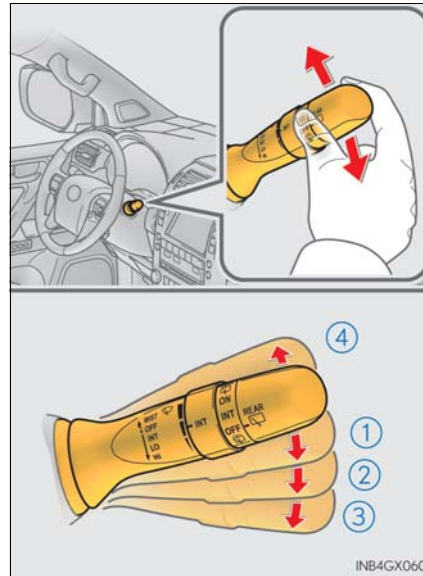

Wiper intervals can be adjusted when intermittent operation is selected.

- ⑤ Increases the intermittent windshield wiper frequency
- ⑥ Decreases the intermittent windshield wiper frequency



⑦ Washer/wiper dual operation

The wipers will automatically operate a couple of times after the washer squirts.

Vehicles with headlight cleaners: If the headlights are on, the headlight cleaners will operate once.

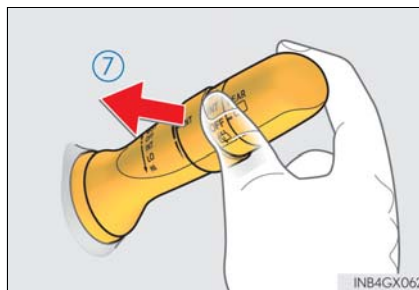

■ Rain-sensing windshield wipers

▶ Type A

- ① Rain-sensing operation ("AUTO")
- ② Low speed operation
- ③ High speed operation
- ④ Temporary operation

When "AUTO" is selected, the wipers will operate automatically when the sensor detects falling rain. The system automatically adjusts wiper timing in accordance with rain volume and vehicle speed.

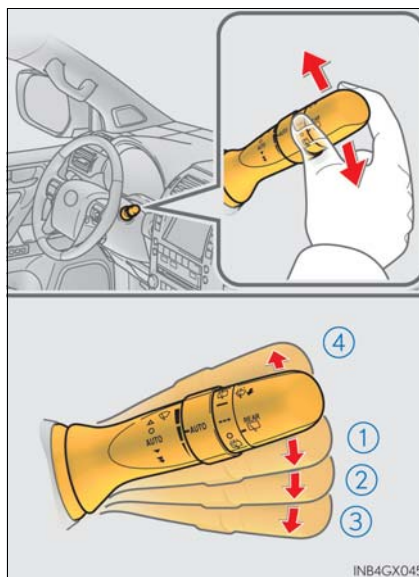

The sensor sensitivity can be adjusted when "AUTO" is selected.

- ⑤ Increases the sensitivity
- ⑥ Decreases the sensitivity

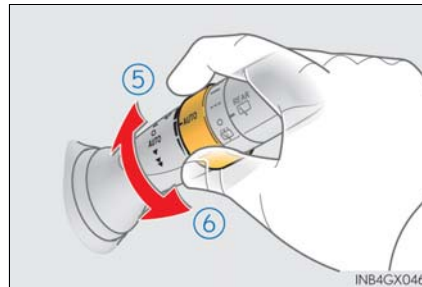

- ⑦ Washer/wiper dual operation

The wipers operate automatically. (After operating several times, the wipers operate one more time after a short delay to prevent dripping.)
Vehicles with headlight cleaners: If the headlights are on, the headlight cleaners will operate once.

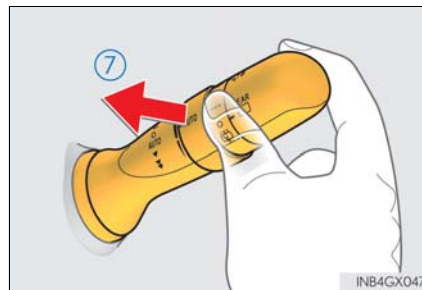

► Type B

- ① Rain-sensing operation ("AUTO")
- ② Low speed operation
- ③ High speed operation
- ④ Temporary operation

When "AUTO" is selected, the wipers will operate automatically when the sensor detects falling rain. The system automatically adjusts wiper timing in accordance with rain volume and vehicle speed.

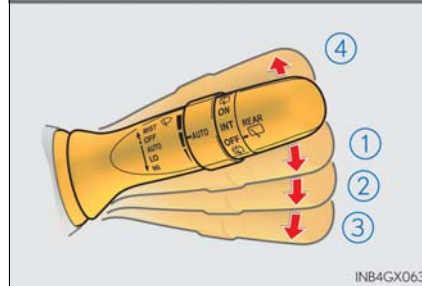
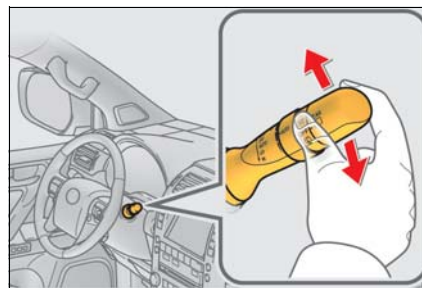

The sensor sensitivity can be adjusted when "AUTO" is selected.

- ⑤ Increases the sensitivity
- ⑥ Decreases the sensitivity

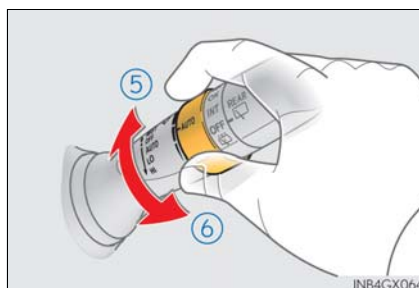

- ⑦ Washer/wiper dual operation

The wipers operate automatically. (After operating several times, the wipers operate one more time after a short delay to prevent dripping.)
 Vehicles with headlight cleaners: If the headlights are on, the headlight cleaners will operate once.

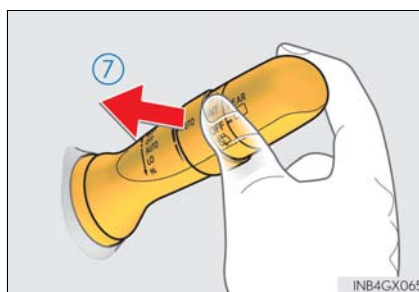

■ The windshield wiper and washer can be operated when

The engine switch is in IGNITION ON mode.

■ Raindrop sensor (vehicles with rain-sensing windshield wipers)

- The raindrop sensor judges the amount of raindrops.

An optical sensor is adopted. It may not operate properly when sunlight from the rising or setting of the sun intermittently strikes the windshield, or if bugs etc. are present on the windshield.

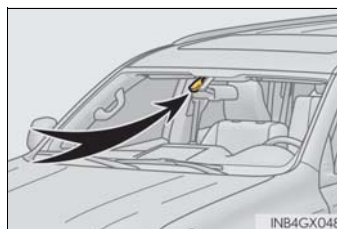

- If the wiper switch is turned to the "AUTO" position while the engine switch is in IGNITION ON mode, the wipers will operate once to show that "AUTO" mode is activated.
- When the sensor sensitivity ring is turned toward high while in "AUTO" mode, the wipers will operate once to indicate that the sensor sensitivity is enhanced.
- If the temperature of the rain drop sensor is 194°F (90°C) or higher, or 5°F (-15°C) or lower, the automatic operation may not occur. In this case, operate the wipers in any mode other than "AUTO".

■ **Effects of vehicle speed on wiper operation (vehicles with rain-sensing windshield wipers)**

With the settings other than "AUTO" also, the time until drip prevention wiper sweep occurs is changed depending on vehicle speed.

With the low speed wiper operation selected, wiper operation will be switched from low speed to intermittent wiper operation only when the vehicle is stationary. (However, when the sensor sensitivity is adjusted to the highest level, the mode cannot be switched.)

■ **If no windshield washer fluid sprays**

Check that the washer nozzles are not blocked if there is washer fluid in the windshield washer fluid reservoir.

 **CAUTION**

■ **Caution regarding the use of windshield wipers in "AUTO" mode (vehicles with rain-sensing windshield wipers)**

The windshield wipers may operate unexpectedly if the sensor is touched or the windshield is subject to vibration in "AUTO" mode. Take care that your fingers etc. anything else does not become caught in the windshield wipers.

■ **Caution regarding the use of washer fluid**

When it is cold, do not use the washer fluid until the windshield becomes warm. The fluid may freeze on the windshield and cause low visibility. This may lead to an accident, resulting in death or serious injury.

 **NOTICE**

■ **When the windshield is dry**

Do not use the wipers, as they may damage the windshield.

■ **When the washer fluid tank is empty**

Do not operate the switch continually as the washer fluid pump may overheat.

■ **When there is no washer fluid spray from the nozzle**

Damage to the washer fluid pump may be caused if the lever is pulled toward you and held continually.

■ **When a nozzle becomes blocked**



Do not try to clear it with a pin or other object. The nozzle will be damaged.



Rear window wiper and washer



Turning the end of the lever turns on the rear window wiper and washer.

► Type A

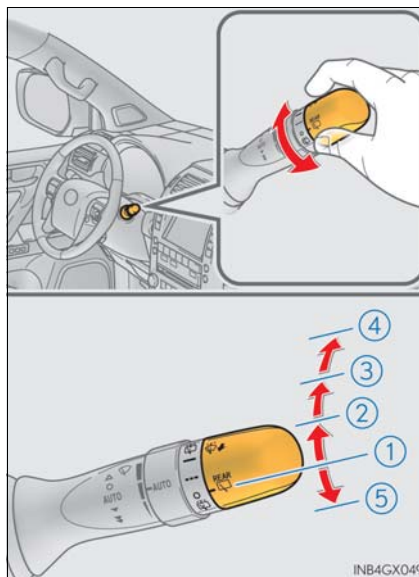
- ① ○ Off
- ② - - - Intermittent operation
- ③ — Normal operation
- ④  Washer/wiper dual operation
- ⑤  Washer/wiper dual operation



► Type B

- ① **OFF** Off
- ② **INT** Intermittent operation
- ③ **ON** Normal operation
- ④  Washer/wiper dual operation
- ⑤  Washer/wiper dual operation

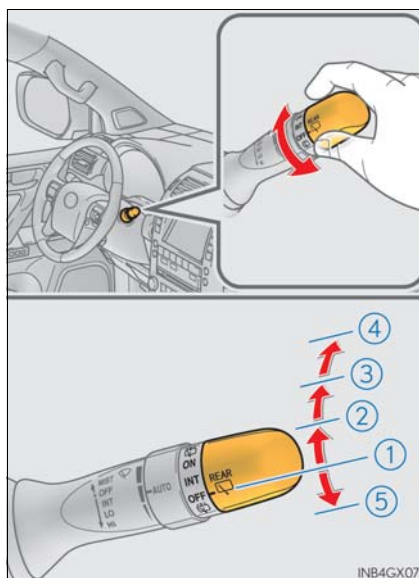

■ The rear window wiper and washer can be operated when

- The engine switch is in IGNITION ON mode.
- The glass hatch is closed.

■ If no windshield washer fluid sprays

Check that the washer nozzles are not blocked if there is washer fluid in the windshield washer fluid reservoir.

**NOTICE****■ When the rear window is dry**

Do not use the wiper, as it may damage the rear window.

■ When the washer fluid tank is empty

Do not operate the switch continually as the washer fluid pump may overheat.

Headlight cleaner switch*

Washer fluid can be sprayed on the headlights.

Press the switch to clean the headlights.

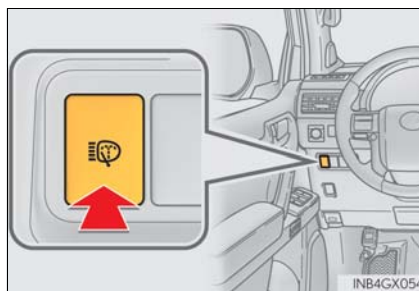

■ The headlight cleaners can be operated when

The engine switch is in IGNITION ON mode and the headlight switch is turned on.

■ Windshield washer linked operation

When the windshield washer is operated with the engine switch in IGNITION ON mode and the headlights on, the headlight cleaners will operate once. (→P. 213)

⚠ NOTICE

■ When the washer fluid tank is empty

Do not press the switch continually as the washer fluid pump may overheat.

*: If equipped

Opening the fuel tank cap

Perform the following steps to open the fuel tank cap.

Before refueling the vehicle

- Turn the engine switch off and ensure that all the doors and windows are closed.
- Confirm the type of fuel. (→P. 580)

■ Fuel types

→P. 580

■ Fuel tank opening for unleaded gasoline

To help prevent incorrect fueling, your Lexus has a fuel tank opening that only accommodates the special nozzle on unleaded fuel pumps.

CAUTION



■ When refueling the vehicle

Observe the following precautions while refueling the vehicle. Failure to do so may result in death or serious injury.

- After exiting the vehicle and before opening the fuel door, touch an unpainted metal surface to discharge any static electricity. It is important to discharge static electricity before refueling because sparks resulting from static electricity can cause fuel vapors to ignite while refueling.
- Always hold the grips on the fuel tank cap and turn it slowly to remove it.
A whooshing sound may be heard when the fuel tank cap is loosened. Wait until the sound cannot be heard before fully removing the cap. In hot weather, pressurized fuel may spray out of the filler neck and cause injury.
- Do not allow anyone that has not discharged static electricity from their body to come close to an open fuel tank.
- Do not inhale vaporized fuel.
Fuel contains substances that are harmful if inhaled.
- Do not smoke while refueling the vehicle.
Doing so may cause the fuel to ignite and cause a fire.
- Do not return to the vehicle or touch any person or object that is statically charged.
This may cause static electricity to build up, resulting in a possible ignition hazard.

 CAUTION **When refueling**

Observe the following precautions to prevent fuel overflowing from the fuel tank:

-  Securely insert the fuel nozzle into the fuel filler neck.
-  Stop filling the tank after the fuel nozzle automatically clicks off.
-  Do not top off the fuel tank.

 NOTICE **Refueling**

Do not spill fuel during refueling.

Doing so may damage the vehicle, such as causing the emission control systems to operate abnormally or damaging fuel system components or the vehicle's painted surface.

Opening the fuel tank cap

- 1** Press the opener to open the fuel filler door.

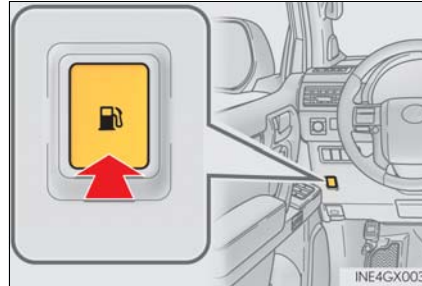

- 2** Turn the fuel tank cap slowly to open, and hang the fuel tank cap on the back of the fuel filler door.

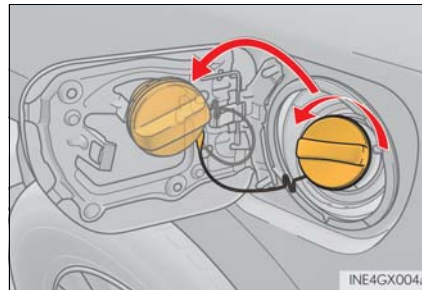

■ When the fuel filler door cannot be opened by pressing the inside switch

Remove the cover inside the luggage compartment and pull the lever.

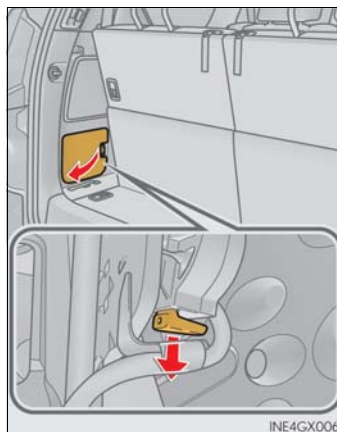

Closing the fuel tank cap

After refueling, turn the fuel tank cap until you hear a click. Once the cap is released, it will turn slightly in the opposite direction.

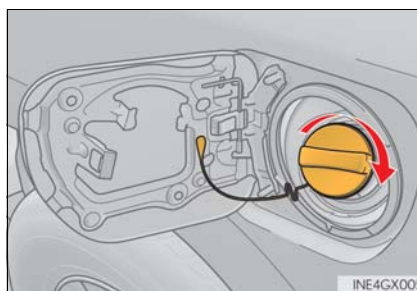

CAUTION

■ When replacing the fuel tank cap

Do not use anything but a genuine Lexus fuel tank cap designed for your vehicle. Doing so may cause a fire or other incident which may result in death or serious injury.



Cruise control*

Summary of functions

Use the cruise control to maintain a set speed without depressing the accelerator pedal.

- ① Indicators
- ② Cruise control switch

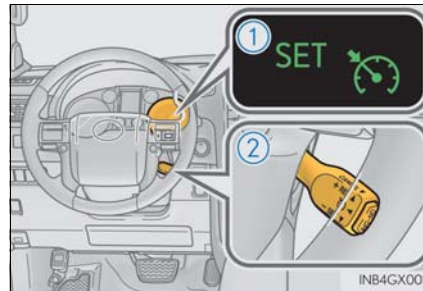

Setting the vehicle speed

- 1 Press the "ON-OFF" button to activate the cruise control.

Cruise control indicator will come on.
Press the button again to deactivate the cruise control.

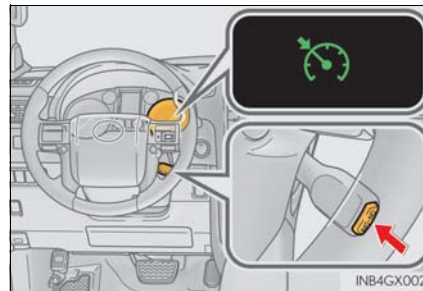

- 2 Accelerate or decelerate the vehicle to the desired speed, and push the lever down to set the speed.

"SET" indicator will come on.
The vehicle speed at the moment the lever is released becomes the set speed.

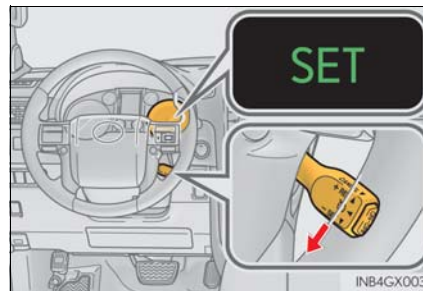

4

Driving

*: If equipped

Adjusting the set speed

To change the set speed, operate the lever until the desired set speed is obtained.

- ① Increases the speed
- ② Decreases the speed

Fine adjustment: Momentarily move the lever in the desired direction.

Large adjustment: Hold the lever in the desired direction.

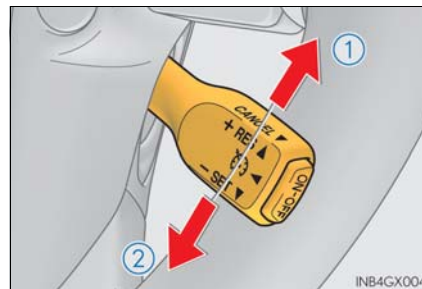

The set speed will be increased or decreased as follows:

Fine adjustment: By approximately 1 mph (1.6 km/h) each time the lever is operated.

Large adjustment: The set speed can be increased or decreased continually until the lever is released.

Canceling and resuming the constant speed control

- ① Pulling the lever toward you cancels the constant speed control.

The speed setting is also canceled when the brakes are applied.

- ② Pushing the lever up resumes the constant speed control.

Resuming is available when the vehicle speed is more than approximately 25 mph (40 km/h).

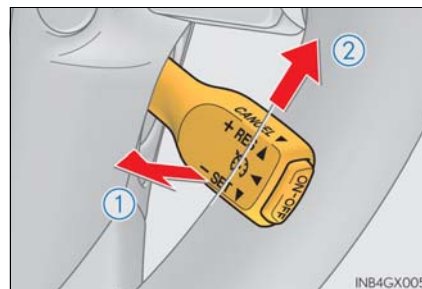

■ Cruise control can be set when

- The shift lever is in the D or range 4 or higher of S has been selected.
- Vehicle speed is above approximately 25 mph (40 km/h).

■ Accelerating after setting the vehicle speed

- The vehicle can be accelerated normally. After acceleration, the set speed resumes.
- Even without canceling the cruise control, the set speed can be increased by first accelerating the vehicle to the desired speed and then pushing the lever down to set the new speed.



■ **Automatic cruise control cancelation**

Cruise control will stop maintaining the vehicle speed in any of the following situations:

- Actual vehicle speed falls more than approximately 10 mph (16 km/h) below the preset vehicle speed.
At this time, the memorized set speed is not retained.
- Actual vehicle speed is below approximately 25 mph (40 km/h).
- VSC is activated.
- The center differential lock/unlock is not completed within 5 seconds while the cruise control system is on.

■ **If the warning message for the cruise control is shown on the multi-information display**

Press the "ON-OFF" button once to deactivate the system, and then press the button again to reactivate the system.

If the cruise control speed cannot be set or if the cruise control cancels immediately after being activated, there may be a malfunction in the cruise control system. Have the vehicle inspected by your Lexus dealer.

 CAUTION
<p>■ To avoid operating the cruise control by mistake Switch the cruise control off using the "ON-OFF" button when not in use.</p> <p>■ Situations unsuitable for cruise control Do not use cruise control in any of the following situations. Doing so may result in loss of control and could cause an accident resulting in death or serious injury.</p> <ul style="list-style-type: none"> ● In heavy traffic ● On roads with sharp bends ● On winding roads ● On slippery roads, such as those covered with rain, ice or snow ● On steep hills Vehicle speed may exceed the set speed when driving down a steep hill. ● When your vehicle is towing a trailer (with towing hitch) or during emergency towing



Dynamic radar cruise control*

Summary of functions

Dynamic radar cruise control supplements conventional cruise control with a vehicle-to-vehicle distance control. In vehicle-to-vehicle distance control mode, the vehicle automatically accelerates or decelerates in order to maintain a set following distance from vehicles ahead.

- ① Display
- ② Set speed
- ③ Indicators
- ④ Vehicle-to-vehicle distance button
- ⑤ Cruise control switch

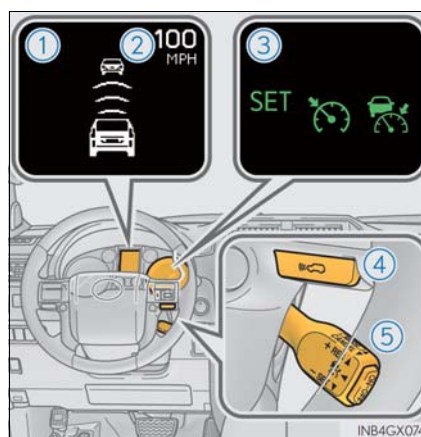

Setting the vehicle speed (vehicle-to-vehicle distance control mode)

- ① Press the “ON-OFF” button to activate the cruise control.

Dynamic radar cruise control indicator will come on.

Press the button again to deactivate the cruise control.



*: If equipped

- ② Accelerate or decelerate the vehicle to the desired speed, and push the lever down to set the speed.
 “SET” indicator will come on.
 The vehicle speed at the moment the lever is released becomes the set speed.

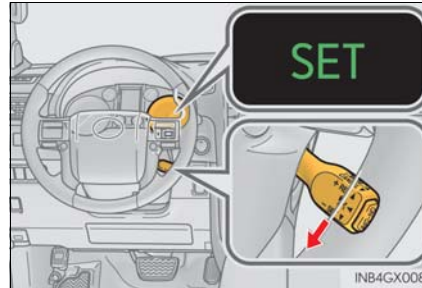

Adjusting the set speed

To change the set speed, operate the lever until the desired set speed is displayed.

- ① Increases the speed
 ② Decreases the speed
 Fine adjustment: Momentarily move the lever in the desired direction.
 Large adjustment: Hold the lever in the desired direction.

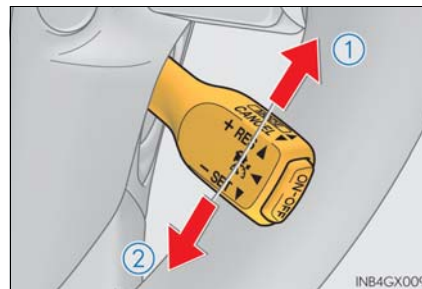

In the vehicle-to-vehicle distance control mode, the set speed will be increased or decreased as follows:

- When the set speed is shown in “MPH”
 - Fine adjustment: By approximately 1 mph (1.6 km/h) each time the lever is operated
 - Large adjustment: By approximately 5 mph (8 km/h) for each 0.75 seconds the lever is held
- When the set speed is shown in “km/h”
 - Fine adjustment: By approximately 0.6 mph (1 km/h) each time the lever is operated
 - Large adjustment: By approximately 3.1 mph (5 km/h) for each 0.75 seconds the lever is held

In the constant speed control mode (→P. 233), the set speed will be increased or decreased as follows:

- Fine adjustment: By approximately 1 mph (1.6 km/h) each time the lever is operated
 Large adjustment: The set speed can be increased or decreased continually until the lever is released.

Changing the vehicle-to-vehicle distance

Pressing the button changes the vehicle-to-vehicle distance as follows:

- ① Long
- ② Medium
- ③ Short

The vehicle-to-vehicle distance is set automatically to long mode when the engine switch is turned to IGNITION ON mode.

If a vehicle is running ahead of you, the preceding vehicle mark will be also displayed.

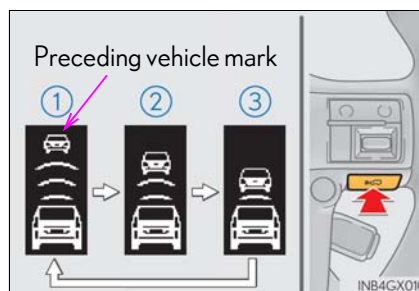

Vehicle-to-vehicle distance settings

Select a distance from the table below. Note that the distances shown correspond to a vehicle speed of 50 mph (80 km/h). Vehicle-to-vehicle distance increases/decreases in accordance with vehicle speed.

Distance options	Vehicle-to-vehicle distance
Long	Approximately 160 ft. (50 m)
Medium	Approximately 130 ft. (40 m)
Short	Approximately 100 ft. (30 m)



Canceling and resuming the speed control

- ① Pulling the lever toward you cancels the cruise control.
The speed setting is also canceled when the brakes are applied.
- ② Pushing the lever up resumes the cruise control and returns vehicle speed to the set speed.

Resuming is available when the vehicle speed is more than approximately 25 mph (40 km/h).

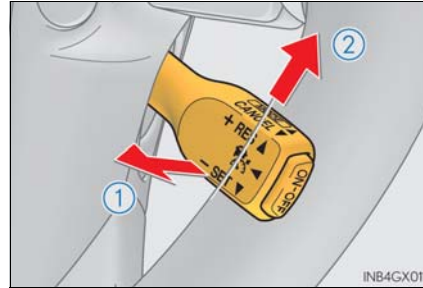

Driving in vehicle-to-vehicle distance control mode

This mode employs a radar sensor to detect the presence of vehicles up to approximately 400 ft. (120 m) ahead, determines the current vehicle-to-vehicle following distance, and operates to maintain a suitable following distance from the vehicle ahead.

Note that vehicle-to-vehicle distance will close in when traveling on long downhill slopes.

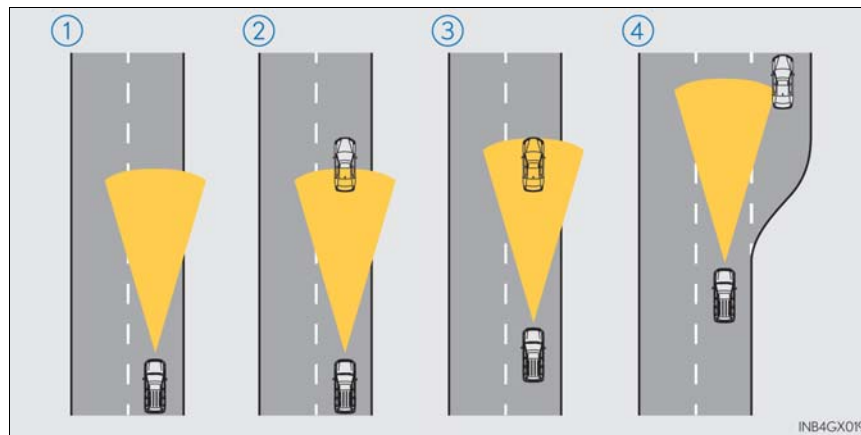

4

Driving

- ① Example of constant speed cruising
When there are no vehicles ahead
The vehicle travels at the speed set by the driver. The desired vehicle-to-vehicle distance can also be set by operating the vehicle-to-vehicle distance control.
- ② Example of deceleration cruising
When the vehicle ahead is driving slower than the set speed
When a vehicle is detected running ahead of you, the system automatically decelerates your vehicle. When a greater reduction in vehicle speed is necessary, the system applies the brakes. A warning tone warns you when the system cannot decelerate sufficiently to prevent your vehicle from closing in on the vehicle ahead.
- ③ Example of follow-up cruising
When following a vehicle driving slower than the set speed
The system continues follow-up cruising while adjusting for changes in the speed of the vehicle ahead in order to maintain the vehicle-to-vehicle distance set by the driver.
- ④ Example of acceleration
When there are no longer any vehicles ahead driving slower than the set speed
The system accelerates until the set speed is reached. The system then returns to constant speed cruising.

Approach warning

When your vehicle is too close to a vehicle ahead, and sufficient automatic deceleration via the cruise control is not possible, the display will flash and the buzzer will sound to alert the driver. An example of this would be if another driver cuts in front of you while you are following a vehicle. Apply the brakes to ensure an appropriate vehicle-to-vehicle distance.

■ Warnings may not occur when

In the following instances, there is a possibility that the warnings will not occur:

- When the speed of the vehicle ahead matches or exceeds your vehicle speed
- When the vehicle ahead is traveling at an extremely slow speed
- Immediately after the cruise control speed was set
- As the instant the accelerator is applied



Selecting conventional constant speed control mode

Constant speed control mode differs from vehicle-to-vehicle distance control mode. When constant speed control mode is selected, your vehicle will maintain a set speed regardless of whether or not there are other vehicles in the lane ahead.

- ① Press the “ON-OFF” button to activate the cruise control.

Press the button again to deactivate the cruise control.

- ② Switch to constant speed control mode. (Push the lever forward and hold for approximately 1 second.)

Constant speed control mode indicator will come on.

When in constant speed control mode, to return to vehicle-to-vehicle distance control mode, push the lever forward again and hold for approximately 1 second.

After the desired speed has been set, it is not possible to return to vehicle-to-vehicle distance control mode.

If the engine switch is turned off and then turned to IGNITION ON mode again, the vehicle will automatically return to vehicle-to-vehicle distance control mode.

Adjusting the speed setting: →P. 229

Canceling and resuming the speed setting: →P. 231

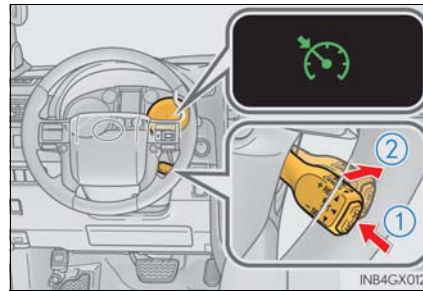

■ Dynamic radar cruise control can be set when

- The shift lever is in the D or range 4 or higher of S has been selected.
- Vehicle speed is above approximately 30 mph (50 km/h).

■ Switching modes

The mode cannot be switched to constant speed control mode if vehicle-to-vehicle distance control mode has been used. The mode also cannot be switched from constant speed control to vehicle-to-vehicle distance control mode. Turn the system off by pressing the "ON-OFF" button, and turn it on again.

■ Accelerating after setting the vehicle speed

The vehicle can accelerate normally. After acceleration, the set speed resumes. However, during vehicle-to-vehicle distance control mode, the vehicle speed may decrease below the set speed in order to maintain the distance to the vehicle ahead.

■ Automatic cancelation of vehicle-to-vehicle distance control

Vehicle-to-vehicle distance control driving is automatically canceled in the following situations:

- Actual vehicle speed falls below approximately 25 mph (40 km/h).
- VSC is activated.
- The sensor cannot operate correctly because it is covered in some way.
- The windshield wipers are operating at high speed (when the wiper switch is set to the "AUTO" mode or the high speed wiper operation position).
- When second start mode is set.
- Bad weather causes the detection function to become extremely unstable.
- Multi-terrain mode is selected other than OFF.
- The center differential lock/unlock is not completed within 5 seconds while the dynamic radar cruise control system is on.

If vehicle-to-vehicle distance control driving is automatically canceled for any other reason, there may be a malfunction in the system. Contact your Lexus dealer.

■ Automatic cancelation of constant speed control

The cruise control will stop maintaining the vehicle speed in the following situations:

- Actual vehicle speed is more than approximately 10 mph (16 km/h) below the set vehicle speed.
At this time, the memorized set speed is not retained.
- Actual vehicle speed falls below approximately 25 mph (40 km/h).
- VSC is activated.
- The center differential lock/unlock is not completed within 5 seconds while the dynamic radar cruise control system is on.



■ **Radar sensor and grille cover**

Always keep the sensor and grille cover clean to ensure that the vehicle-to-vehicle distance control operates properly. (Some obstructions, such as snow, ice or plastic objects, cannot be detected by the obstruction sensor.)

Dynamic radar cruise control is canceled if an obstruction is detected.

- ① Grille cover
- ② Radar sensor

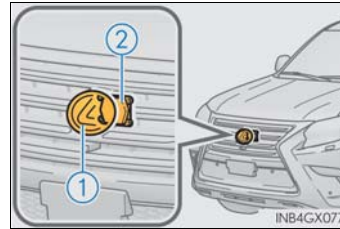

■ **Warning messages and buzzers for dynamic radar cruise control**

Warning messages and buzzers are used to indicate a system malfunction or to inform the driver of the need for caution while driving. (→P. 531)

■ **Certification**

- ▶ For vehicles sold in the U.S.A., Hawaii, Guam, Saipan and Puerto Rico

FCC ID : HYQDNMWR004

This device complies with part 15 of the FCC Rules. Operation is subject to the following two conditions : (1) This device may not cause harmful interference, and (2) this device must accept any interference received, including interference that may cause undesired operation.

FCC WARNING

Changes or modifications not expressly approved by the party responsible for compliance could void the user's authority to operate the equipment.

Radiofrequency radiation exposure Information:

This equipment complies with FCC radiation exposure limits set forth for an uncontrolled environment. This equipment should be installed and operated with minimum distance of 20 cm between the radiator (antenna) and your body. This transmitter must not be co-located or operating in conjunction with any other antenna or transmitter.

- ▶ For vehicles sold in Canada

This device complies with Industry Canada licence-exempt RSS standard(s).

Operation is subject to the following two conditions:

- (1) this device may not cause interference, and
- (2) this device must accept any interference, including interference that may cause undesired operation of the device.



 CAUTION**■ Before using dynamic radar cruise control**

Do not overly rely on vehicle-to-vehicle distance control.

Be aware of the set speed. If automatic deceleration/acceleration is not appropriate, adjust the vehicle speed, as well as the distance between your vehicle and vehicles ahead by applying the brakes etc.

■ Cautions regarding the driving assist systems

Observe the following precautions.

Failure to do so may cause an accident resulting in death or serious injury.

● Assisting the driver to measure following distance

The dynamic radar cruise control is only intended to help the driver in determining the following distance between the driver's own vehicle and a designated vehicle traveling ahead. It is not a mechanism that allows careless or inattentive driving, and it is not a system that can assist the driver in low-visibility conditions. It is still necessary for driver to pay close attention to the vehicle's surroundings.

● Assisting the driver to judge proper following distance

The dynamic radar cruise control determines whether the following distance between the driver's own vehicle and a designated vehicle traveling ahead is appropriate or not. It is not capable of making any other type of judgement. Therefore, it is absolutely necessary for the driver to remain vigilant and to determine whether or not there is a possibility of danger in any given situation.

● Assisting the driver to operate the vehicle

The dynamic radar cruise control has no capability to prevent or avoid a collision with a vehicle traveling ahead. Therefore, if there is ever any danger, the driver must take immediate and direct control of the vehicle and act appropriately in order to ensure the safety of all involved.

⚠ CAUTION**■ To avoid inadvertent cruise control activation**

Switch the cruise control off using the "ON-OFF" button when not in use.

■ Situations unsuitable for dynamic radar cruise control

Do not use dynamic radar cruise control in any of the following situations.

Doing so may result in inappropriate speed control and could cause an accident resulting in death or serious injury.

- In heavy traffic
- On roads with sharp bends
- On winding roads
- On slippery roads, such as those covered with rain, ice or snow
- On steep downhills, or where there are sudden changes between sharp up and down gradients
Vehicle speed may exceed the set speed when driving down a steep hill.
- At entrances to expressways
- When weather conditions are bad enough that they may prevent the sensors from functioning correctly (fog, snow, sandstorm, heavy rain, etc.)
- When an approach warning buzzer is heard often
- When your vehicle is towing a trailer (with towing hitch) or during emergency towing

■ When the sensor may not be correctly detecting the vehicle ahead

Apply the brakes as necessary when any of the following types of vehicles are in front of you.

As the sensor may not be able to correctly detect these types of vehicles, the approach warning (→P. 232) will not be activated, and a fatal or serious accident may result.

- Vehicles that cut in suddenly
- Vehicles traveling at low speeds
- Vehicles that are not moving
- Vehicles with small rear ends (trailers with no load on board etc.)
- Motorcycles traveling in the same lane

 CAUTION**■ Conditions under which the vehicle-to-vehicle distance control may not function correctly**

Apply the brakes as necessary in the following conditions as the radar sensor may not be able to correctly detect vehicles ahead, and a fatal or serious accident may result:

- When water or snow thrown up by the surrounding vehicles hinders the functioning of the sensor
- When your vehicle is pointing upwards (caused by a heavy load in the luggage compartment etc.)
- When the road curves or when the lanes are narrow
- When steering wheel operation or your position in the lane is unstable
- When the vehicle ahead of you decelerates suddenly

■ To ensure the sensor functions correctly

Do not do the following to the sensor or grille as doing so may cause the sensor not to function correctly and could result in an accident:

- Sticking or attaching anything to them
- Leaving them dirty
- Disassembling or subjecting them to strong shocks
- Modifying or painting them
- Replacing them with non-genuine parts

■ Handling the radar sensor

Observe the following to ensure the cruise control system can function effectively. Otherwise, the system may not function correctly and could result in an accident.

- Keep the sensor and grille cover clean at all times.
Clean the sensor and grille cover with a soft cloth so you do not mark or damage them.
- Do not subject the sensor or surrounding area to a strong impact.
If the sensor moves even slightly off position, the system may malfunction. If the sensor or surrounding area is subject to a strong impact, always have the area inspected and adjusted by your Lexus dealer.
- Do not disassemble the sensor.
- Do not attach accessories or stickers to the sensor, grille cover or surrounding area.
- Do not modify or paint the sensor and grille cover.
- If the sensor needs to be replaced, contact your Lexus dealer.

LDA (Lane Departure Alert)*

Summary of function

While driving on a road that has lane markers, this system recognizes the white lane markers using a camera as a sensor to alert the driver when the vehicle deviates from its lane.

If the system judges that the vehicle may deviate from its lane, it alerts the driver using beeping and indications on the multi-information display.

Camera sensor

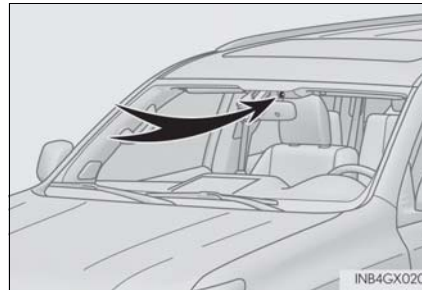

Turning the LDA system on

Press the "LDA" switch to activate the system.

"LDA" indicator and the lane lines will come on.

Press the switch again to turn the LDA system off.

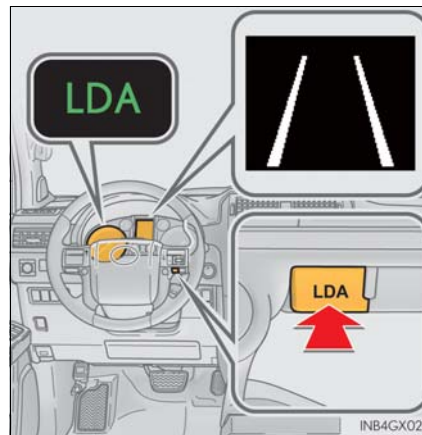

4

Driving

*: If equipped

Operating conditions

- When the vehicle speed is approximately 30 mph (48 km/h) or more
- When the lane width is between approximately 9.8 and 13.1 ft. (3 and 4 m)
- When driving on a straight road or through a curve with a radius of more than approximately 656 ft. (200 m)

Indication on the multi-information display

When the LDA system is on, the lane lines are shown.

When thin lines are shown:

Lane markers are not recognized by the system, or the LDA system is temporarily canceled.



When solid lane lines are shown:

The LDA system is active.

If the vehicle deviates from the lane, the lane line will flash.



■ Temporary cancelation of the LDA system

If any of the following occurs, the LDA system will be temporarily canceled. The functions will resume after the necessary operating conditions have returned.

- The turn signal lever is operated.
- The brake pedal is depressed.
- The vehicle speed deviates from the operating range of the LDA system.
- The lane lines cannot be recognized while driving.
- The wiper operates continuously.
- When the lane departure warning function is activated.
Once the lane departure warning function is activated, it will be temporarily canceled and resume a few seconds later.

■ The lane departure warning

Depending on the audio system sound level or air conditioning fan noise while the audio system or air conditioning system is in use, it may be difficult to hear the warning sound.

■ After the vehicle has been parked in the sun

The LDA system may not be available and a warning message (→P. 531) will be displayed for a while after driving has started. When the temperature in the cabin decreases and the temperature around the camera sensor (→P. 239) becomes suitable for its operation, the functions will begin to operate.

■ Conditions in which the function may not operate correctly

In the following conditions, the camera sensor may be unable to recognize lane markers causing the lane departure warning function to operate incorrectly. However, this does not indicate a malfunction.

- When driving through an area with no lane markers, such as a tollbooth, a crossing or before a ticket checkpoint
- When driving on a sharp curve
- When lane markers are extremely narrow or extremely wide
- When the vehicle leans to one side an unusual amount due to a heavy load or improper tire inflation pressure
- When the following distance between your vehicle and the vehicle ahead is extremely short
- When the lane markers are yellow (These may be more difficult for the system to recognize compared to white markers.)
- When the lane markers are broken, "Botts' dots", "Raised pavement marker" or stones
- When the lane markers are on a curb etc.
- When lane markers are obscured or partially obscured by sand, dirt, etc.
- When there are shadows on the road running parallel with lane markers, or if a shadow covers the lane markers
- When driving on a particularly bright road surface, such as concrete
- When driving on a road surface that is bright due to reflected light
- When driving in a location where the light level changes rapidly, such as the entrance to or exit from a tunnel
- When sunlight or the headlights of oncoming vehicles are shining directly into the camera lens
- When driving on roads that are branching or merging
- When driving on a road surface that is wet due to rain, previous rainfall, standing water, etc.
- When the vehicle experiences strong up-and-down motion such as when driving on an extremely rough road or on a seam in the pavement
- When headlight brightness at nighttime is reduced due to dirt on the lenses, or when the headlights are misaligned
- When driving on winding roads or roads that are uneven
- When driving on rough or unpaved roads

■ When changing the tires

Depending on the tires used, such as snow tire, etc., sufficient performance may not be maintainable.

■ Warning messages and buzzers for LDA system

Warning messages and buzzers are used to indicate a system malfunction or to inform the driver of the need for caution while driving. (→P. 531, 532)



 CAUTION**■ Before using the LDA system**

Do not rely solely on the LDA system. The LDA system does not drive the vehicle automatically, nor does it reduce the amount of care you need to take. As such, the driver must always assume full responsibility for understanding his/her surroundings, for operating the steering wheel to correct the driving line, and for driving safely. Inappropriate or negligent driving could lead to an accident.

■ To avoid operating the LDA by mistake

Switch the LDA system off using the "LDA" switch when not in use.

■ Situations unsuitable for LDA system

Do not use LDA system in any of the following situations. Otherwise, the system may not function correctly and could result in an accident.

- When driving with tire chains, a spare tire, or similar equipment
- When driving with non-standard parts or aftermarket equipment installed (including modified tires and suspensions, etc.).
- When there are objects or structures along the roadside that might be misinterpreted as lane markers (such as guardrails, curb, reflector posts, etc.)
- When driving on snowy roads
- When pavement lane markers are difficult to see due to rain, snow, fog, sand, dirt, etc.
- When there are visible lines on the pavement from road repairs, or if the remains of old lane markers are still visible on the road
- When driving in a lane other than the driving or passing lanes on a freeway or highway.
- When driving on a road with lane closures due to maintenance, or when driving in a temporary lane

 NOTICE

■ To prevent damage to or incorrect operation of the LDA system

- Do not modify the headlights or attach stickers to the surface of the lights.
- Do not modify the suspension or replace it with non-genuine parts.
- Do not install or place anything on the hood or the grille. Also, do not install a grille guard (bull bars, kangaroo bar etc.).
- If your windshield needs repairs, contact your Lexus dealer.

■ Camera sensor (→P. 239)

Observe the following to ensure that the LDA system functions correctly.

- Keep the windshield clean at all times.
Performance could be affected if the windshield is dirty, or if raindrops, condensation or ice are adhering to the windshield.
- Do not attach a sticker or other items to the windshield near the camera sensor.

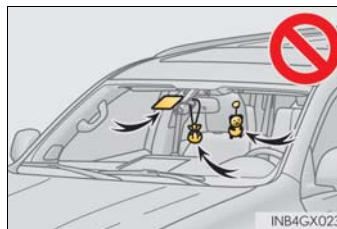

- Do not spill liquid onto the camera sensor.
- Do not attach window tinting to the windshield.
- Do not install an antenna in front of the camera lens.
- If the windshield is fogged up, use the windshield defogger to remove fog from the windshield.
When it is cold, using the heater with air blowing to the feet may allow the upper part of the windshield to fog up. This will have a negative effect on the images.
- Do not scratch the camera lens, or let it get dirty.
When cleaning the inside of the windshield, be careful not to get any glass cleaner etc. on the lens. Also, do not touch the lens.
For lens repair, contact your Lexus dealer.
- Do not change the installation position or direction of the camera sensor or remove it.
The direction of the camera sensor is precisely adjusted.
- Do not subject the camera sensor to strong impact or force, and do not disassemble the camera sensor.
- Do not replace windshield with non-genuine windshield.
Contact your Lexus dealer.



Intuitive parking assist*

The distance from your vehicle to nearby obstacles when parallel parking or maneuvering into a garage is measured by the sensors and communicated via the multi-information display, the multimedia screen (if equipped), the navigation system screen (if equipped), and a buzzer. Always check the surrounding area when using this system.

Types of sensors

- ① Front center sensors
- ② Front corner sensors
- ③ Rear corner sensors
- ④ Rear center sensors

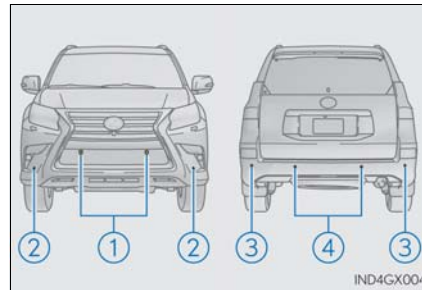

4

Driving

*: If equipped

Intuitive parking assist switch

- 1 Display the intuitive parking assist on/off screen.

- 1 Press the menu switch.
The multi-information display will change modes to electronic features control mode.

- 2 Press the "ENTER" switch upwards or downwards until the intuitive parking assist mark appears in the multi-information display.

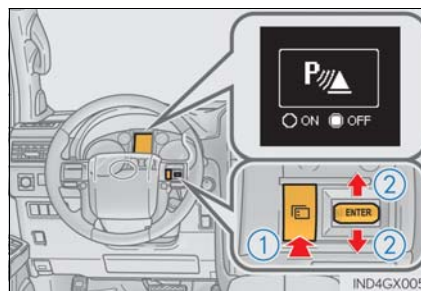

- 2 Press the "ENTER" switch to change to "ON".

The intuitive parking assist indicator will be displayed.

Each pressing of the switch turns the intuitive parking assist on and off.

When on, the buzzer sounds to inform the driver that the system is operational.

Press the menu switch to change to the normal display.

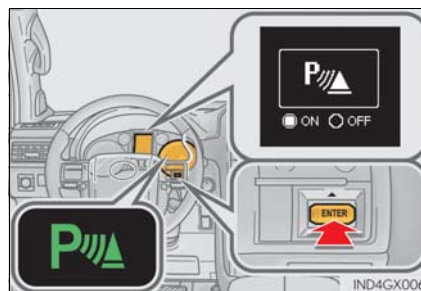

Display

When the sensors detect an obstacle, a graphic is shown on the multi-information display, multimedia screen (if equipped) and navigation system screen (if equipped) depending on the position and distance to the obstacle.

► Multi-information display

- ① Front corner sensor operation
- ② Front center sensor operation
- ③ Rear corner sensor operation
- ④ Rear center sensor operation

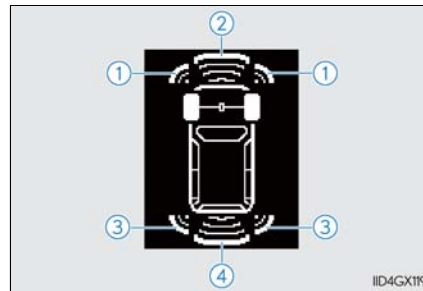

► Multimedia screen or navigation system screen

- ① Intuitive parking assist display

When the rear view monitor system*, Lexus parking assist monitor* or Multi-terrain Monitor* is not displayed.

A graphic is automatically displayed when an obstacle is detected. The screen can be set so that the graphic is not displayed. (→P. 250)

- ② Insert display

When the rear view monitor system*, Lexus parking assist monitor* or Multi-terrain Monitor* is displayed.

A simplified image is displayed on the upper corner of the screen when an obstacle is detected.



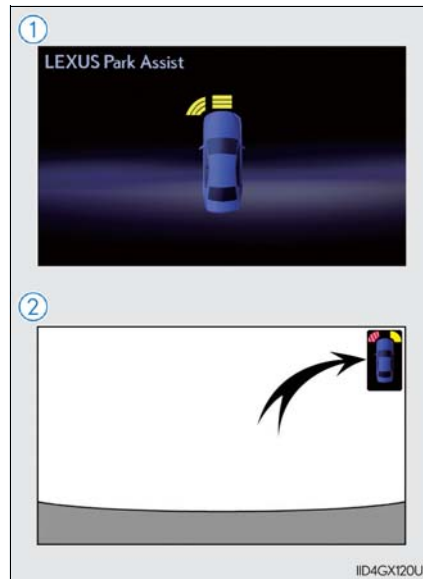









*: If equipped



Sensor detection display, obstacle distance

■ Distance display

Sensors that detect an obstacle will illuminate continuously or blink.

Multi-information display	Multimedia screen or navigation system screen	Insert display	Approximate distance to obstacle	
			Front corner sensor/front center sensor	Rear corner sensor/rear center sensor
 (continuous)	 (continuous)	 (blinking slowly)	Front center sensor: 3.3 ft. (100 cm) to 2.0 ft. (60 cm)	Rear center sensor: 4.9 ft. (150 cm) to 2.1 ft. (65 cm)
 (continuous)	 (continuous)	 (blinking)	Front corner sensor: 1.6 ft. (50 cm) to 1.3 ft. (40 cm) Front center sensor: 2.0 ft. (60 cm) to 1.5 ft. (45 cm)	Rear corner sensor: 1.8 ft. (55 cm) to 1.2 ft. (37.5 cm) Rear center sensor: 2.1 ft. (65 cm) to 1.6 ft. (50 cm)
 (continuous)	 (continuous)	 (blinking rapidly)	Front corner sensor: 1.3 ft. (40 cm) to 1.0 ft. (30 cm) Front center sensor: 1.5 ft. (45 cm) to 1.0 ft. (30 cm)	Rear corner sensor: 1.2 ft. (37.5 cm) to 0.8 ft. (25 cm) Rear center sensor: 1.6 ft. (50 cm) to 1.3 ft. (40 cm)
 (blinking)	 (continuous)	 (continuous)	Less than 1.0 ft. (30 cm)	Rear corner sensor: Less than 0.8 ft. (25 cm) Rear center sensor: Less than 1.3 ft. (40 cm)



■ Buzzer operation and distance to an obstacle

A buzzer sounds when the sensors are operating.

- The buzzer sounds faster as the vehicle approaches an obstacle.
 - When the vehicle comes within the following distance of the obstacle, the buzzer sounds continuously.
 - Front corner sensors: Approximately 1.0 ft. (30 cm)
 - Front center sensors: Approximately 1.0 ft. (30 cm)
 - Rear corner sensors: Approximately 0.8 ft. (25 cm)
 - Rear center sensors: Approximately 1.3 ft. (40 cm)
- When 2 or more obstacles are detected simultaneously, the buzzer system responds to the nearest obstacle. If one or both come within the above distances, the beep will repeat a long tone, followed by fast beeps.

Detection range of the sensors

- ① Approximately 3.3 ft. (100 cm)
- ② Approximately 4.9 ft. (150 cm)
- ③ Approximately 1.6 ft. (50 cm)
- ④ Approximately 1.8 ft. (55 cm)

The diagram shows the detection range of the sensors. Note that the sensors may not be able to detect obstacles that are extremely close to the vehicle.

The range of the sensors may change depending on the shape of the object etc.

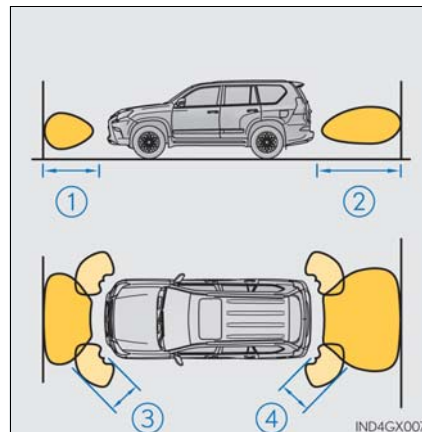

4

Driving

Setting up intuitive parking assist

You can change the buzzer sounds volume and the screen operating conditions.

- 1 Press the "SETUP" button.
- 2 Select "Vehicle", and then select "LEXUS Park Assist"/"LEXUS Park Assist Settings" on the screen.
- 3 Select the desired item.

▶ Multimedia screen



▶ Navigation system screen



- 1 The buzzer sounds volume can be adjusted.
- 2 On or off can be selected for intuitive parking assist display.
- 3 Front or rear center sensors display and tone indication can be set.

■ The intuitive parking assist can be operated when

- Front corner sensors:
 - The engine switch is in IGNITION ON mode.
 - The shift lever is in a position other than P.
 - The vehicle speed is less than approximately 6 mph (10 km/h).
(At any speed when the shift lever is in R)
- Front center sensors:
 - The engine switch is in IGNITION ON mode.
 - The shift lever is in a position other than P or R.
 - The vehicle speed is less than about 6 mph (10 km/h).
- Rear corner and rear center sensors:
 - The engine switch is in IGNITION ON mode.
 - The shift lever is in R.

■ Intuitive parking assist display

When an obstacle is detected while the rear view monitor system, Lexus parking assist monitor or Multi-terrain Monitor is in use, the warning indicator will appear in the upper corner of the screen even if the display setting has been set to off.

■ Sensor detection information

- The sensor's detection areas are limited to the areas around the vehicle's bumper.
 - Certain vehicle conditions and the surrounding environment may affect the ability of a sensor to correctly detect an obstacle. Particular instances where this may occur are listed below.
 - There is dirt, snow or ice on the sensor. (Wiping the sensors will resolve this problem.)
 - The sensor is frozen. (Thawing the area will resolve this problem.)
In especially cold weather, if a sensor is frozen the screen may show an abnormal display, or obstacles may not be detected.
 - The sensor is covered in any way.
 - The vehicle is leaning considerably to one side.
 - On an extremely bumpy road, on an incline, on gravel, or on grass.
 - The vicinity of the vehicle is noisy due to vehicle horns, motorcycle engines, air brakes of large vehicles, or other loud noises producing ultrasonic waves.
 - There is another vehicle equipped with parking assist sensors in the vicinity.
 - The sensor is coated with a sheet of spray or heavy rain.
 - The vehicle is equipped with a fender pole or wireless antenna.
 - The bumper or sensor receives a strong impact.
 - The vehicle is approaching a tall or curved curb.
 - In harsh sunlight or intense cold weather.
 - The area directly under the bumpers is not detected.
 - If obstacles draw too close to the sensor.
 - A non-genuine Lexus suspension (lowered suspension etc.) is installed.
 - People may not be detected if they are wearing certain types of clothing.
- In addition to the examples above, there are instances in which, because of their shape, signs and other objects may be judged by a sensor to be closer than they are.



- The shape of the obstacle may prevent a sensor from detecting it. Pay particular attention to the following obstacles:
 - Wires, fences, ropes, etc.
 - Cotton, snow and other materials that absorb sound waves
 - Sharply-angled objects
 - Low obstacles
 - Tall obstacles with upper sections projecting outwards in the direction of your vehicle
- The following situations may occur during use.
 - Depending on the shape of the obstacle and other factors, the detection distance may shorten, or detection may be impossible.
 - Obstacles may not be detected if they are too close to the sensor.
 - There will be a short delay between obstacle detection and display. Even at slow speeds, there is a possibility that the obstacle will come within the sensor's detection areas before the display is shown and the buzzer sounds.
 - Thin posts or objects lower than the sensor may not be detected when approached, even if they have been detected once.
 - It might be difficult to hear beeps due to the volume of audio system or air flow noise of the air conditioning system.
- **If a message is displayed on the multi-information display**
→P. 530
- **Certification for the intuitive parking assist (Canada only)**
This ISM device complies with Canadian ICES-001.
- **Customization**
Settings (e.g. buzzer sounds volume) can be changed.
(Customizable features: →P. 594)



 CAUTION**■ When using the intuitive parking assist**

Observe the following precautions.

Failing to do so may result in the vehicle being unable to be driven safely and possibly cause an accident.

- Do not use the sensor at speeds in excess of 6 mph (10 km/h).
- The sensors' detection areas and reaction times are limited. When moving forward or reversing, check the areas surrounding the vehicle (especially the sides of the vehicle) for safety, and drive slowly, using the brake to control the vehicle's speed.
- Do not install accessories within the sensors' detection areas.

 NOTICE**■ When using intuitive parking assist**

In the following situations, the system may not function correctly due to a sensor malfunction etc. Have the vehicle checked by your Lexus dealer.

- A buzzer does not sound when you turn the intuitive parking assist on.
- The intuitive parking assist operation display flashes, and a buzzer sounds when no obstacles are detected.
- If the area around a sensor collides with something, or is subjected to strong impact.
- If the bumper collides with something.
- If the display shows continuously without a beep.
- If a display error occurs, first check the sensor.
If the error occurs even if there is no ice, snow or mud on the sensor, it is likely that the sensor is malfunctioning.

■ Notes when washing the vehicle

Do not apply intensive bursts of water or steam to the sensor area.

Doing so may result in the sensor malfunctioning.

Rear view monitor system*

The rear view monitor system assists the driver by displaying guide lines and an image of the view behind the vehicle while backing up, for example while parking.

The screen illustrations used in this text are intended as examples, and may differ from the image that is actually displayed on the screen.

The rear view image is displayed when the shift lever is in R and the engine switch is in IGNITION ON mode.

The rear view monitor system will be deactivated when the shift lever is in any position other than R.

When the shift lever is shifted to R and any mode button (such as "SETUP") is pressed, the rear view monitor system is canceled, and the screen is switched to the mode of the button that was pressed.

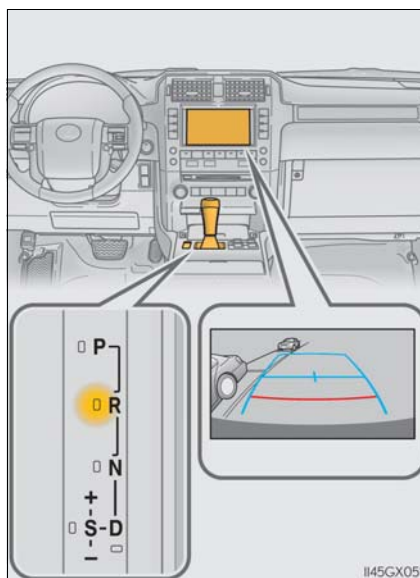

*: If equipped

Using the rear view monitor system

■ Screen description

The rear view monitor system screen will be displayed if the shift lever is shifted to R while the engine switch is in IGNITION ON mode.

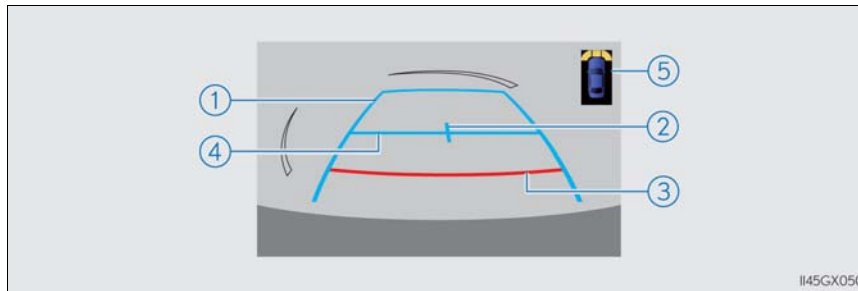

- ① Vehicle width extension guide line
The line indicates a guide path when the vehicle is being backed straight up. The displayed width is wider than the actual vehicle width.
- ② Vehicle center guide line
The line indicates the estimated vehicle center on the ground.
- ③ Distance guide line (red)
The line shows distance behind the vehicle, a point approximately 1.5 ft. (0.5 m) from the edge of the bumper.
- ④ Distance guide line (blue)
The line shows distance behind the vehicle, a point approximately 3 ft. (1 m) from the edge of the bumper.
- ⑤ Intuitive parking assist display (if equipped)
If an obstacle is detected while the intuitive parking assist is on, a display is shown at the top right corner of the screen.

Rear view monitor system precautions

■ Area displayed on screen

The rear view monitor system displays an image of the view from the bumper of the rear area of the vehicle.

The image on the rear view monitor system screen can be adjusted, refer to the "MULTIMEDIA OWNER'S MANUAL" or "NAVIGATION SYSTEM OWNER'S MANUAL".

- The area displayed on the screen may vary according to vehicle orientation conditions.
- Objects which are close to either corner of the bumper or under the bumper cannot be displayed.
- The camera uses a special lens. The distance of the image that appears on the screen differs from the actual distance.
- Items which are located higher than the camera may not be displayed on the monitor.
- If your vehicle is equipped with a backlit license plate, it may interfere with the display.

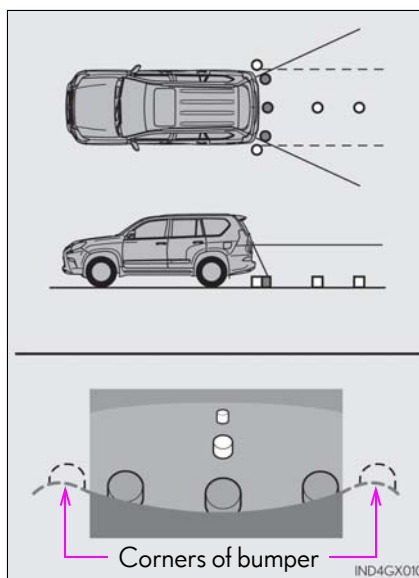

■ Rear view monitor system camera

The camera for the rear view monitor system is located above the license plate.

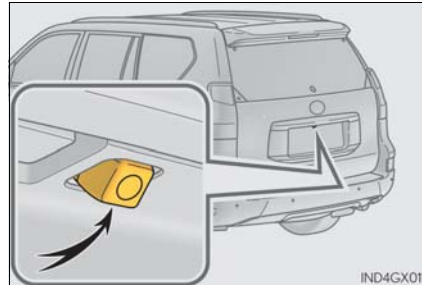
**● Using the camera**

If dirt or foreign matter (such as water droplets, snow, mud etc.) is adhering to the camera, it cannot transmit a clear image. In this case, flush it with a large quantity of water and wipe the camera lens clean with a soft and wet cloth.

■ Differences between the screen and the actual road

The distance guide lines and the vehicle width extension guide lines may not actually be parallel with the dividing lines of the parking space, even when they appear to be so. Be sure to check visually.

The distances between the vehicle width extension guide lines and the left and right dividing lines of the parking space may not be equal, even when they appear to be so. Be sure to check visually.

The distance guide lines give a distance guide for flat road surfaces. In any of the following situations, there is a margin of error between the fixation guide lines on the screen and the actual distance/course on the road.

● When the ground behind the vehicle slopes up sharply

The distance guide lines will appear to be closer to the vehicle than the actual distance. Because of this, objects will appear to be farther away than they actually are. In the same way, there will be a margin of error between the guide lines and the actual distance/course on the road.

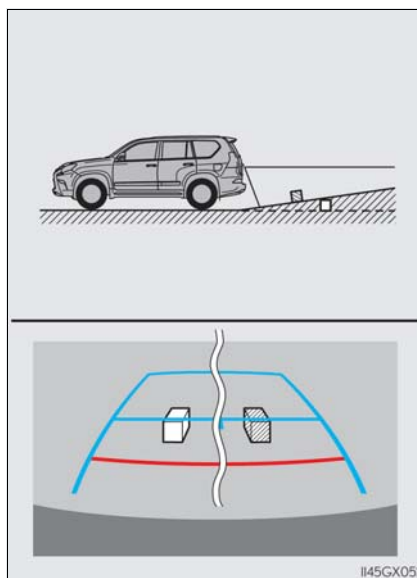

● When the ground behind the vehicle slopes down sharply

The distance guide lines will appear to be further from the vehicle than the actual distance. Because of this, objects will appear to be closer than they actually are. In the same way, there will be a margin of error between the guide lines and the actual distance/course on the road.

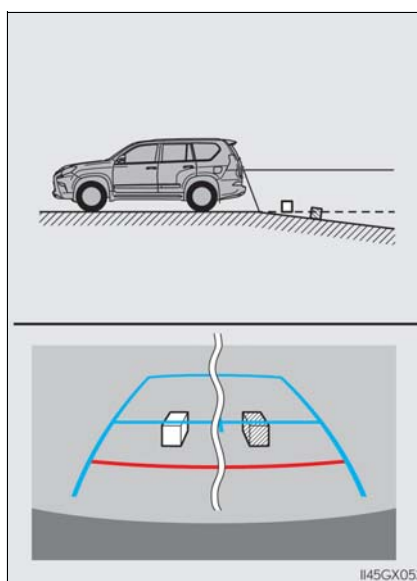

- When any part of the vehicle sags

When any part of the vehicle sags due to the number of passengers or the distribution of the load, there is a margin of error between the fixation guide lines on the screen and the actual distance/course on the road.

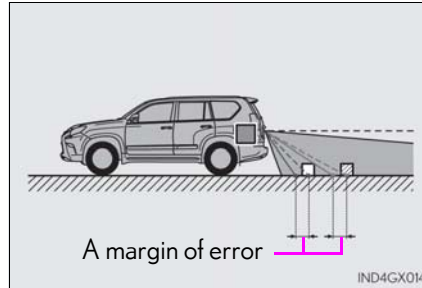

- When approaching three-dimensional objects

The distance guide lines are displayed according to flat surfaced objects (such as the road). It is not possible to determine the position of three-dimensional objects (such as vehicles) using the distance guide lines. When approaching a three-dimensional object that extends outward (such as the flatbed of a truck), be careful of the following.

- Vehicle width extension guide lines

Visually check the surroundings and the area behind the vehicle. In the case shown in the illustration, the truck appears to be outside of the vehicle width extension guide lines and the vehicle does not look as if it hits the truck. However, the rear body of the truck may actually cross over the vehicle width extension guide lines. In reality if you back up as guided by the vehicle width extension guide lines, the vehicle may hit the truck.

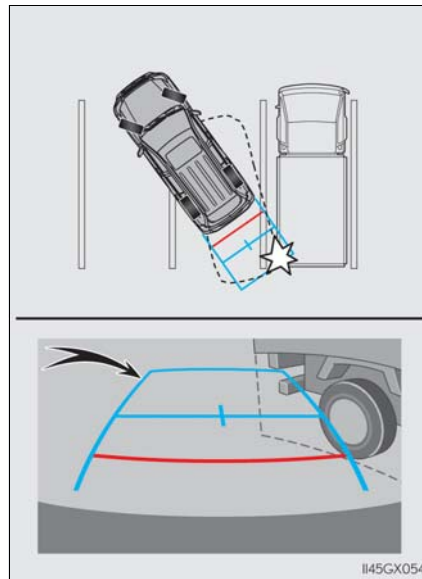

● Distance guide lines

Visually check the surroundings and the area behind the vehicle. On the screen, it appears that a truck is parking at point ②. However, in reality if you back up to point ①, you will hit the truck. On the screen, it appears that ① is closest and ③ is farthest away. However, in reality, the distance to ① and ③ is the same, and ② is farther than ① and ③.

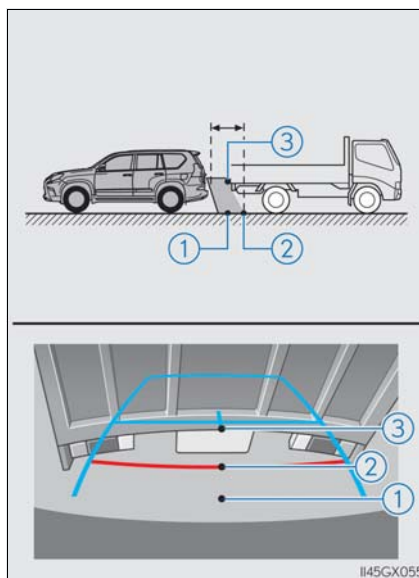

Things you should know

■ If you notice any symptoms

If you notice any of the following symptoms, refer to the likely cause and the solution, and re-check.

If the symptom is not resolved by the solution, have the vehicle inspected by your Lexus dealer.

Likely cause	Solution
□ The image is difficult to see	
<ul style="list-style-type: none"> • The vehicle is in a dark area • The temperature around the lens is either high or low • The outside temperature is low • There are water droplets on the camera • It is raining or humid • Foreign matter (mud etc.) is adhering to the camera • There are scratches on the camera • Sunlight or headlights are shining directly into the camera • The vehicle is under fluorescent lights, sodium lights, mercury lights etc. 	<p>If this happens due to these causes, it does not indicate a malfunction. Back up while visually checking the vehicle's surroundings. (Use the monitor again once conditions have been improved.)</p> <p>The image on the rear view monitor system screen can be adjusted, refer to the "MULTIMEDIA OWNER'S MANUAL" or "NAVIGATION SYSTEM OWNER'S MANUAL".</p>
□ The image is blurry	
Dirt or foreign matter (such as water droplets, snow, mud etc.) is adhering to the camera.	Flush the camera with a large quantity of water and wipe the camera lens clean with a soft and wet cloth.
□ The image is out of alignment	
The camera or surrounding area has received a strong impact.	Have the vehicle inspected by your Lexus dealer.
□ The fixed guide lines are very far out of alignment	
The camera position is out of alignment.	Have the vehicle inspected by your Lexus dealer.
<ul style="list-style-type: none"> • The vehicle is tilted (there is a heavy load on the vehicle, tire pressure is low due to a tire puncture, etc.) • The vehicle is used on an incline. 	<p>If this happens due to these causes, it does not indicate a malfunction. Back up while visually checking the vehicle's surroundings.</p>

⚠ CAUTION**■ When using the rear view monitor system**

The rear view monitor system is a supplemental device intended to assist the driver when backing up. When backing up, be sure to check visually behind and all around the vehicle before proceeding.

Observe the following precautions to avoid an accident that could result in death or serious injuries.

- Never depend on the rear view monitor system entirely when backing up. The image and the position of the guide lines displayed on the screen may differ from the actual state.
Use caution, just as you would when backing up any vehicle.
- Be sure to back up slowly, depressing the brake pedal to control vehicle speed.
- The instructions given are only guide lines.
When and how much to turn the steering wheel will vary according to traffic conditions, road surface conditions, vehicle condition, etc. when parking. It is necessary to be fully aware of this before using the rear view monitor system.
- When parking, be sure to check that the parking space will accommodate your vehicle before maneuvering into it.
- Do not use the rear view monitor system in the following cases:
 - On icy or slick road surfaces, or in snow
 - When using tire chains
 - When the back door is not closed completely
 - On roads that are not flat or straight, such as curves or slopes.
- In low temperatures, the screen may darken or the image may become faint. The image could distort when the vehicle is moving, or you may become unable to see the image on the screen. Be sure to check direct visually and with the mirrors all around the vehicle before proceeding.
- If the tire sizes are changed, the position of the fixed guide lines displayed on the screen may change.
- The camera uses a special lens. The distances between objects and pedestrians that appear in the image displayed on the screen will differ from the actual distances.
(→P. 257)

 NOTICE

■ How to use the camera

- The rear view monitor system may not operate properly in the following cases.
 - If the back of the vehicle is hit, the position and mounting angle of the camera may change.
 - As the camera has a water proof construction, do not detach, disassemble or modify it. This may cause incorrect operation.
 - When cleaning the camera lens, flush the camera with a large quantity of water and wipe it with a soft and wet cloth. Strongly rubbing the camera lens may cause the camera lens to be scratched and unable to transmit a clear image.
 - Do not allow organic solvent, car wax, window cleaner or glass coat to adhere to the camera. If this happens, wipe it off as soon as possible.
 - If the temperature changes rapidly, such as when hot water is poured on the vehicle in cold weather, the system may not operate normally.
 - When washing the vehicle, do not apply intensive bursts of water to the camera or camera area. Doing so may result in the camera malfunctioning.
 - When the camera is used under fluorescent lights, sodium light or mercury light etc., the lights and the illuminated areas may appear to flicker.
- Do not expose the camera to strong impact as this could cause a malfunction. If this happens, have the vehicle inspected by your Lexus dealer as soon as possible.

Lexus parking assist monitor*

The parking assist monitor assists the driver by displaying an image of the view behind the vehicle while backing up, for example while parking.

The parking assist monitor assists with the following 2 backing-up operations:

- Perpendicular parking (parking in a garage, etc.)
- Parallel parking (parking at the side of the road, etc.)

The screen illustrations used in this text are intended as examples, and may differ from the image that is actually displayed on the screen.

The rear view image is displayed when the shift lever is in R and the engine switch is in IGNITION ON mode.

The parking assist monitor system will be deactivated when the shift lever is in any position other than R.

When the shift lever is shifted to R and any mode button (such as "SETUP") is pressed, the parking assist monitor is canceled, and the screen is switched to the mode of the button that was pressed.

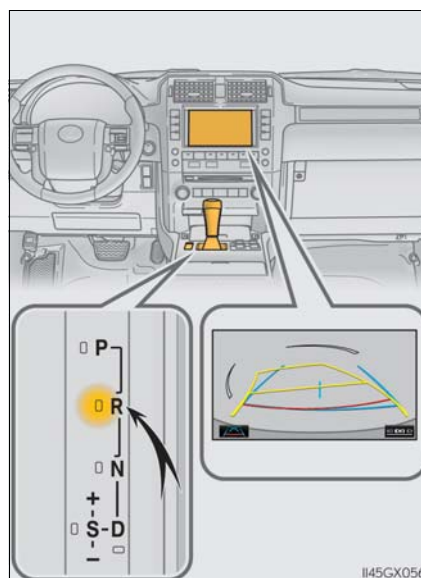

*: If equipped



Using the Lexus parking assist monitor

■ Screen display

The parking assist monitor screen will be displayed if the shift lever is shifted to R while the engine switch is in IGNITION ON mode.

The parking assist monitor displays the last-used parking mode first.

▶ Perpendicular parking

▶ Parallel parking

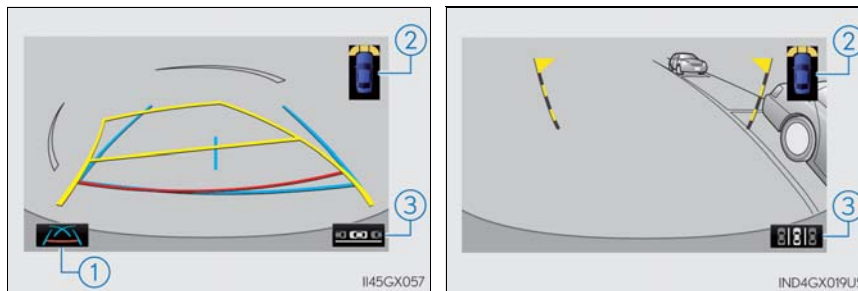

① Display mode switch screen button

Switches the display mode. (→P. 266)

② Intuitive parking assist display

If an obstacle is detected while the intuitive parking assist is on, a display is shown in the top right corner of the screen.

③ Parking mode switch screen button

Switches the parking mode (between perpendicular parking and parallel parking assist screens)

■ Using the system when perpendicular parking

Use any of the following modes when perpendicular parking (for example, when parking in a garage).

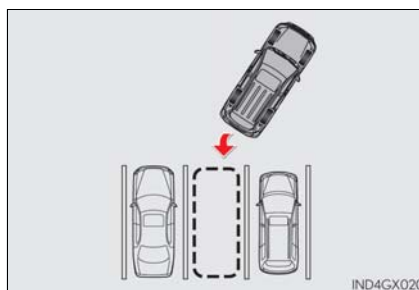

Each time you select the display mode switch screen button, the display mode switches in the following order:

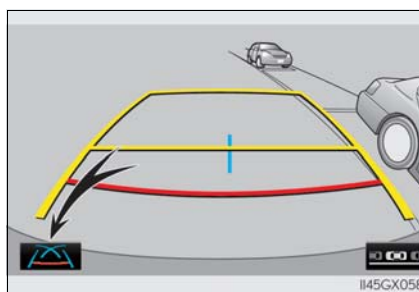
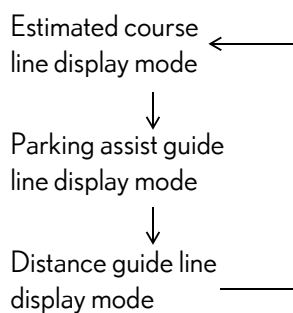

- Estimated course line display mode (→P. 269)

Estimated course lines are displayed which move in accordance with the operation of the steering wheel.

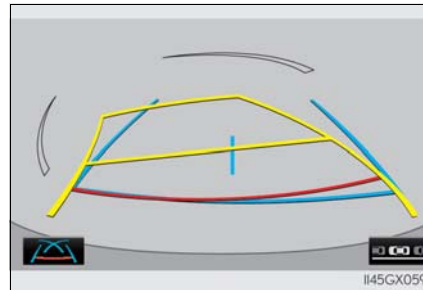

- Parking assist guide line display mode (→P. 271)

The steering wheel return points (parking assist guide lines) are displayed.

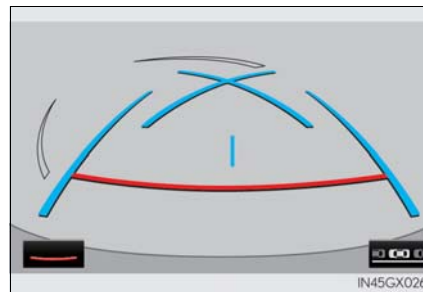

- Distance guide line display mode

Distance guide lines only are displayed.

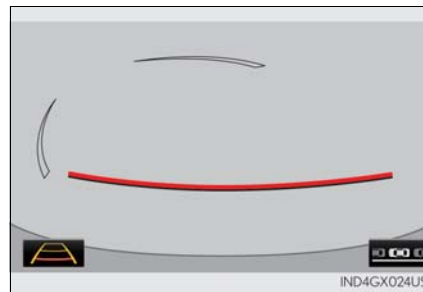

4
Driving

■ Using the system when parallel parking

Screen display and beep sounds provide an estimation of the point at which you should turn the steering wheel when parallel parking. If the position the vehicle is to be parked in is narrower than usual, narrow mode can be used.

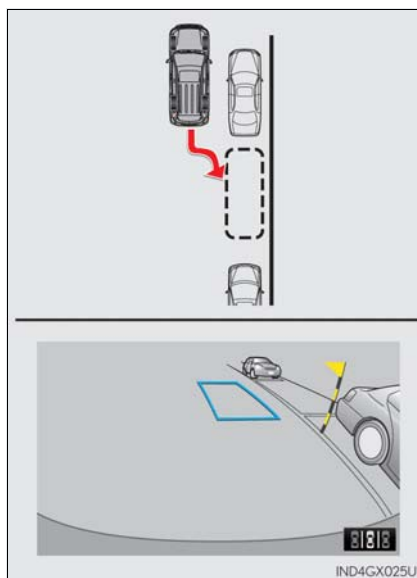

■ Switching the parking mode screen

Each time you select the parking mode switch screen button, the perpendicular parking mode and parallel parking mode are switched.

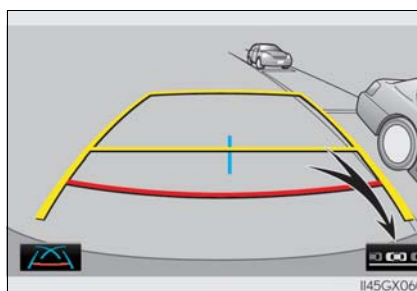

Perpendicular parking (estimated course line display mode)

■ Screen description

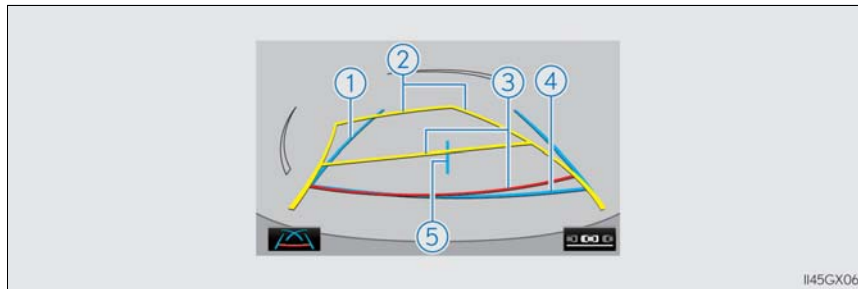

- ① Vehicle width guide line
The line indicates a guide path when the vehicle is being backed straight up. The displayed width is wider than the actual vehicle width. The line aligns with the estimated course lines when the steering wheel is straight.
- ② Estimated course lines
The lines show an estimated course when the steering wheel is turned.
- ③ Distance guide lines
The line moves, together with the estimated course lines, in sync with the steering wheel. The line shows points approximately 1.5 ft. (0.5 m) (red) and approximately 3 ft. (1 m) (yellow) from the center of the edge of the bumper.
- ④ Distance guide line
The line shows distance behind the vehicle, a point approximately 1.5 ft. (0.5 m) (blue) from the edge of the bumper.
- ⑤ Vehicle center guide line
The line indicates the estimated vehicle center on the ground.

■ Parking operation

When parking in a space which is in the reverse direction to the space described in the procedure below, the steering directions will be reversed.

- 1 Shift the shift lever to R.
- 2 Turn the steering wheel so that the estimated course lines are within the parking space, and back up slowly.

- ① Parking space
- ② Estimated course lines

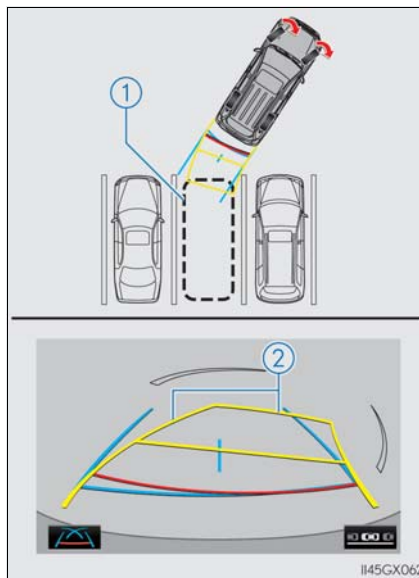

- 3 When the rear position of the vehicle has entered the parking space, turn the steering wheel so that the vehicle width guide lines are within the left and right dividing lines of the parking space.

- ③ Vehicle width guide line

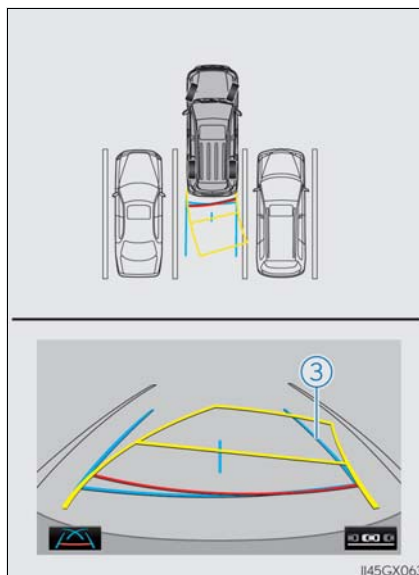

- 4 Once the vehicle width guide lines and the parking space lines are parallel, straighten the steering wheel and back up slowly until the vehicle has completely entered the parking space.
- 5 Stop the vehicle in an appropriate place, and finish parking.

Perpendicular parking (parking assist guide line display mode)

■ Screen description

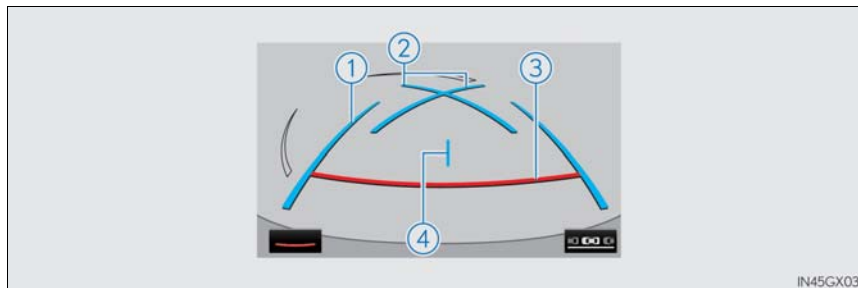

- ① Vehicle width guide lines
These lines indicate a guide path when the vehicle is being backed straight up. The displayed width is wider than the actual vehicle width.
- ② Parking assist guide lines
These lines indicate the path of the smallest turn possible behind the vehicle.
These lines also indicate the approximate position of the steering wheel when parking.
- ③ Distance guide line
This line (red) indicates points approximately 1.5 ft. (0.5 m) behind the rear bumper of your vehicle.
- ④ Vehicle center guide line
The line indicates the estimated vehicle center on the ground.

■ **Parking operation**

When parking in a space which is in the reverse direction to the space described in the procedure below, the steering directions will be reversed.

- 1 Shift the shift lever to R.
- 2 Back up until the parking assist guide line meets the edge of the left-hand dividing line of the parking space.
 - ① Parking assist guide line
 - ② Parking space dividing line

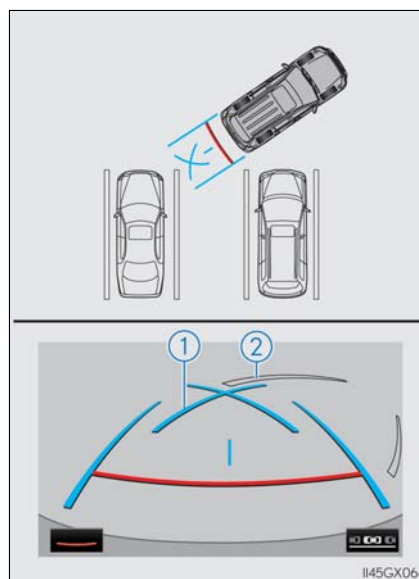

- 3 Turn the steering wheel all the way to the right, and back up slowly.
- 4 Once the vehicle is parallel with the parking space, straighten the steering wheel and back up slowly until the vehicle has completely entered the parking space.
- 5 Stop the vehicle in an appropriate place, and finish parking.

Parallel parking

■ Vehicle movement procedure

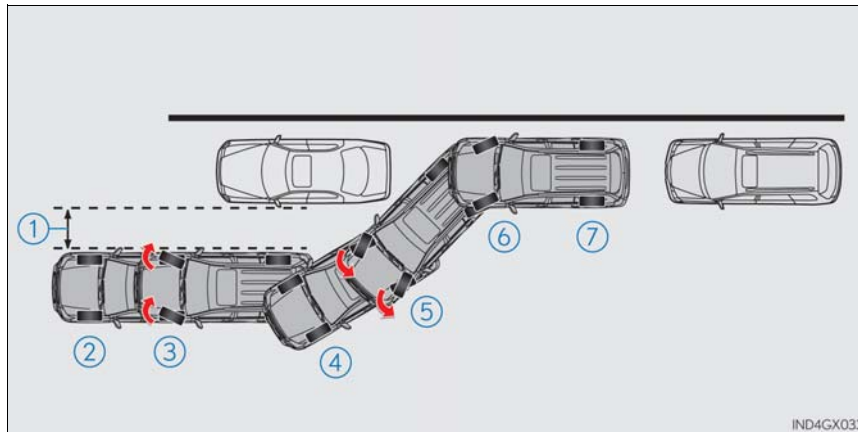

- ① Approx. 3 ft. (1 m)
- ② Keeping parallel with the road, stop the vehicle leaving a gap of approximately 3 ft. (1 m) between your vehicle and the parked vehicle (Step ① in "Parking operation").
- ③ Back up until the black and yellow vertical pole just overlaps the rear end of the parked vehicle. Then stop the vehicle (Step ④ in "Parking operation").
Leaving the vehicle stopped, move the steering wheel until the blue outline meets the desired parking space, and back up while keeping the steering wheel in that position (Step ⑤ in "Parking operation").
- ④ A curved blue line is displayed. Keep the steering wheel in the same position and back up until the curved blue line meets the left corner of the parking space (Step ⑦ in "Parking operation").
- ⑤ When it meets the left corner of the parking space, turn the steering wheel in the opposite direction as far as it will go (Step ⑧ in "Parking operation").
- ⑥ Keeping the steering wheel in that position, check your surroundings visually and using mirrors, and back up using the distance guide lines etc. as a reference (Step ⑨ in "Parking operation").
- ⑦ When the vehicle is approximately in the desired parking location, parallel parking assist is complete (Step ⑩ in "Parking operation").

■ **Parking operation**

The following example describes the procedure for pulling into a parking space on the left. For pulling into a parking space on the right, substitute right for left and vice versa in all steps.

1 Stop the vehicle in the position as described below, and straighten the steering wheel.

- ① Roughly half a vehicle's length
- ② Desired parking space
- ③ Approx. 3 ft. (1 m)
- ④ Parked vehicle
- ⑤ Your vehicle

A position in which you are parallel with the road (or the side of the road), and in which there is approximately 3 ft. (1 m) of space between your vehicle and the parked vehicle

A position in which you are half a vehicle's length ahead of the parked vehicle

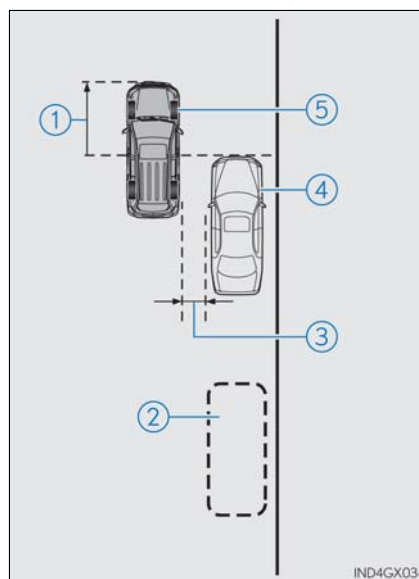

- 2 Shift the shift lever to R.
- 3 Make sure the monitor displays the part behind the rear tires of the parked vehicle, and select .

If the area is not displayed, move the vehicle to forward.

- 4 With the steering wheel straight, back up slowly to a position at which the black and yellow vertical pole just overlaps the rear end of the parked vehicle. Then stop the vehicle.

- ① Black and yellow vertical pole
- ② Back the vehicle up to here

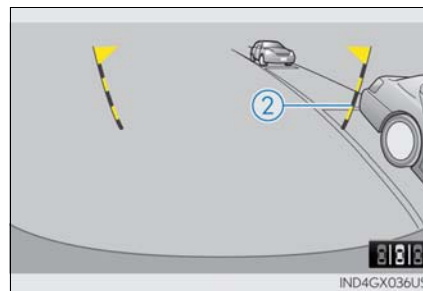
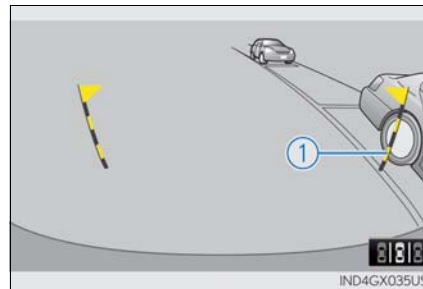

4

Driving

- 5 Turn the steering wheel with the vehicle stopped until the blue outline meets the desired parking space.

- ① Blue outline
- ② Black and yellow vertical pole
- ③ Extended line

If the extended line from the blue outline is displayed, the parallel parking assist is operational.

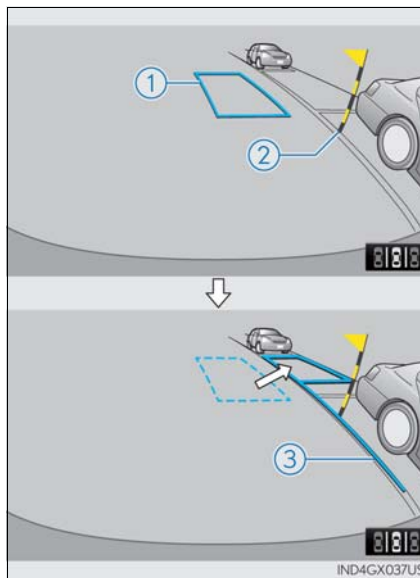

- ④ Turn the steering wheel right
- ⑤ Black and yellow vertical pole
- ⑥ Blue outline

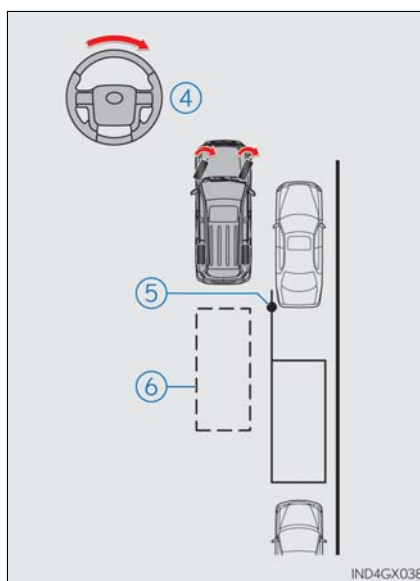

- 6** Keep the steering wheel in its current position and backing up.
 When backing up, be careful not to hit any obstacles with the left front corner of your vehicle. Back the vehicle up slowly.
 The parallel parking assist will be canceled if the steering wheel is moved while backing up. Shift the shift lever out of R, and restart from procedure 1.
- 7** A curved blue line will appear on the screen. Keep the steering wheel in its current position and back up slowly. Stop when the curved blue line meets the corner of the desired parking space.

① Curved blue line

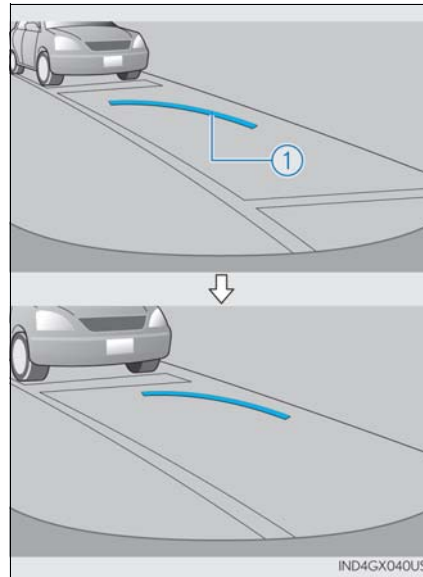

4
Driving

- ② Back up keeping the steering wheel in its current position
- ③ Curved blue line
- ④ Curved blue line meets the corner here

If you back up too quickly, you may lose synchronization with the parallel parking assist.

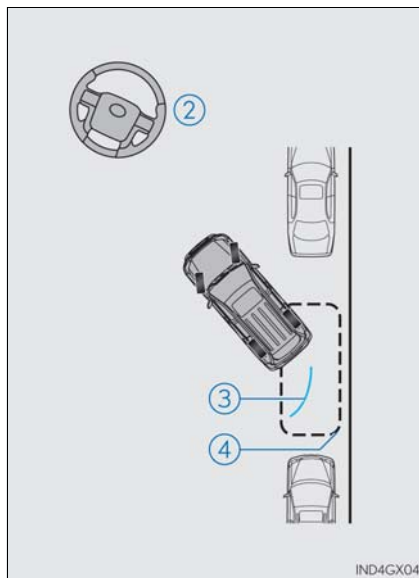

- ⑧ Leaving the vehicle stopped, turn the steering wheel all the way to the left.
Be sure to turn the steering wheel only when the vehicle is stopped.
- ⑨ When the screen changes, keep the steering wheel in its current position and back up.
When backing up, be careful not to hit any obstacles with the left front corner of your vehicle. Back the vehicle up slowly.
- ⑩ When the vehicle is parallel with the road or the shoulder, straighten the steering wheel.
Check your surroundings visually and with the mirrors, then back up using the distance guide lines as a reference, and stop.
When the vehicle is approximately in the desired parking location, the parallel parking assist is complete.
- Parallel parking assist mode information
 - There is a possibility that parallel parking guidance may not be given when backing up at a very slow speed.
 - If the back door is opened during parallel parking guidance, the parallel parking assist will be interrupted and canceled. Stop the vehicle, shift the shift lever out of the R position, and restart the operation from the step ①.

- Canceling parallel parking assist

Select .

- Vehicles with intuitive parking assist

If intuitive parking assist detects an object while you attempt to park in a parking space on the right, the black and yellow vertical pole could be obscured by intuitive parking assist display. In this event, turn intuitive parking assist switch off (→P. 246), and operate the vehicle while checking the safety of the surrounding area direct visually and with mirror. After the operation, turn the switch on.

- If the message “Steering wheel turned too far, please return.” is displayed

The steering wheel has been turned too far, and the system cannot function. Return the steering wheel to its original position.

If the message is displayed before the outline is positioned over the desired parking space, it is likely that the vehicle is too far away from the shoulder. Check that there is a gap of approximately 3 ft. (1 m) between your vehicle and the parked vehicle.

Lexus parking assist monitor precautions

■ Area displayed on screen

The parking assist monitor displays an image of the view from the bumper of the rear area of the vehicle.

The image on the rear view monitor system screen can be adjusted, refer to the “MULTIMEDIA OWNER’S MANUAL” or “NAVIGATION SYSTEM OWNER’S MANUAL”.

- The area displayed on the screen may vary according to vehicle orientation conditions.
- Objects which are close to either corner of the bumper or under the bumper cannot be seen on the screen.
- The camera uses a special lens. The distance of the image that appears on the screen differs from the actual distance.
- Items which are located higher than the camera may not be displayed on the monitor.
- If your vehicle is equipped with a backlit license plate, it may interfere with the display.

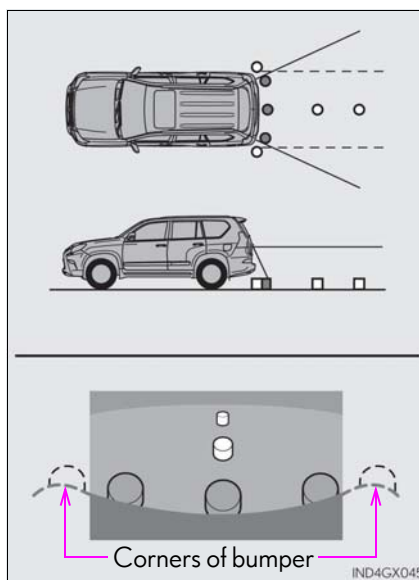

■ Lexus parking assist monitor camera

The camera for the parking assist monitor is located above the license plate.

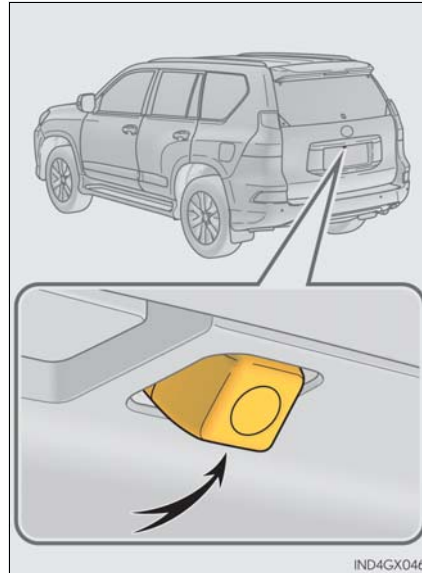

● Using the camera

If dirt or foreign matter (such as water droplets, snow, mud etc.) is adhering to the camera, it cannot transmit a clear image. In this case, flush it with a large quantity of water and wipe the camera lens clean with a soft and wet cloth.

■ Differences between the screen and the actual road

The distance guide lines and the vehicle width guide lines may not actually be parallel with the dividing lines of the parking space, even when they appear to be so. Be sure to check visually.

The distances between the vehicle width guide lines and the left and right dividing lines of the parking space may not be equal, even when they appear to be so. Be sure to check visually.

The distance guide lines give a distance guide for flat road surfaces. In any of the following situations, there is a margin of error between the guide lines on the screen and the actual distance/course on the road.

- When the ground behind the vehicle slopes up sharply

The distance guide lines will appear to be closer to the vehicle than the actual distance. Because of this, objects will appear to be farther away than they actually are. In the same way, there will be a margin of error between the guidelines and the actual distance/course on the road.

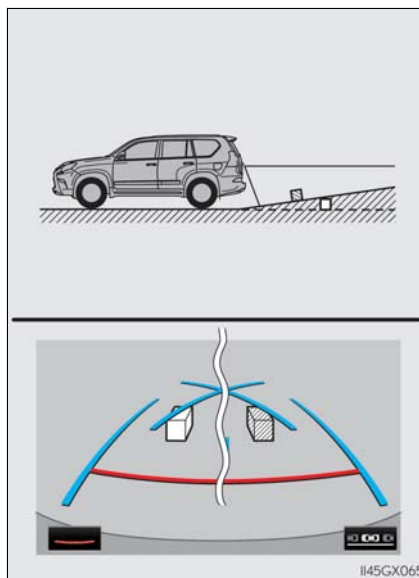

- When the ground behind the vehicle slopes down sharply

The distance guide lines will appear to be further from the vehicle than the actual distance. Because of this, objects will appear to be closer than they actually are. In the same way, there will be a margin of error between the guidelines and the actual distance/course on the road.

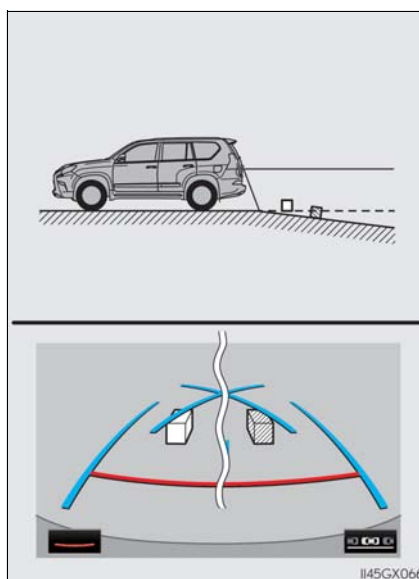

- When any part of the vehicle sags

When any part of the vehicle sags due to the number of passengers or the distribution of the load, there is a margin of error between the guide lines on the screen and the actual distance/course on the road.

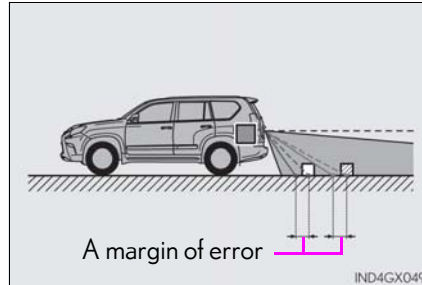

- When approaching three-dimensional objects

The estimated course lines target a flat surfaced objects (such as the road). It is not possible to determine the position of three-dimensional objects (such as vehicles) using the estimated course lines and distance guide lines. When approaching a three-dimensional object that extends outward (such as the flatbed of a truck), be careful of the following.

- Estimated course lines

Visually check the surroundings and the area behind the vehicle. In the case shown in the illustration, the truck appears to be outside of the estimated course lines and the vehicle does not look as if it will hit the truck. However, the rear body of the truck may actually cross over the estimated course lines. In reality if you back up as guided by the estimated course lines, the vehicle may hit the truck.

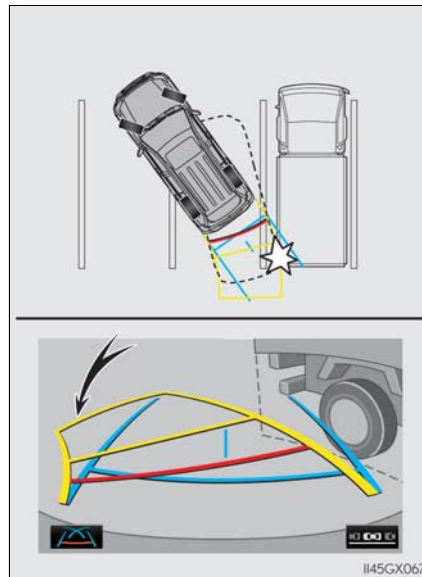

● Distance guidelines

Visually check the surroundings and the area behind the vehicle. On the screen, it appears that a truck is parking at point ②. However, in reality if you back up to point ①, you will hit the truck. On the screen, it appears that ① is closest and ③ is farthest away. However, in reality, the distance to ① and ③ is the same and ② is farther than ① and ③.

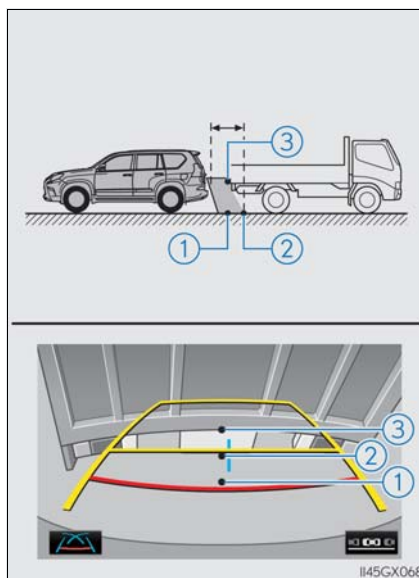

Things you should know

■ If you notice any symptoms

If you notice any of the following symptoms, refer to the likely cause and the solution, and re-check.

If the symptom is not resolved by the solution, have the vehicle inspected by your Lexus dealer.

Likely cause	Solution
☐ The image is difficult to see	
<ul style="list-style-type: none"> • The vehicle is in a dark area • The temperature around the lens is either high or low • The outside temperature is low • There are water droplets on the camera • It is raining or humid • Foreign matter (mud etc.) is adhering to the camera • Sunlight or headlights are shining directly into the camera • The vehicle is under fluorescent lights, sodium lights, mercury lights etc. 	<p>If this happens due to these causes, it does not indicate a malfunction. Back up while visually checking the vehicle's surroundings. (Use the monitor again once conditions have been improved.)</p> <p>The image on the rear view monitor system screen can be adjusted, refer to the "MULTIMEDIA OWNER'S MANUAL" or "NAVIGATION SYSTEM OWNER'S MANUAL".</p>
☐ The image is blurry	
Dirt or foreign matter (such as water droplets, snow, mud etc.) is adhering to the camera.	Flush the camera with a large quantity of water and wipe the camera lens clean with a soft and wet cloth.
☐ The image is out of alignment	
The camera or surrounding area has received a strong impact.	Have the vehicle inspected by your Lexus dealer.
☐ The guide lines are very far out of alignment	
The camera position is out of alignment.	Have the vehicle inspected by your Lexus dealer.
<ul style="list-style-type: none"> • The vehicle is tilted (there is a heavy load on the vehicle, tire pressure is low due to a tire puncture, etc.) • The vehicle is used on an incline. 	<p>If this happens due to these causes, it does not indicate a malfunction. Back up while visually checking the vehicle's surroundings.</p>

Likely cause	Solution
❑ The estimated course lines move even though the steering wheel is straight	
There is a malfunction in the signals being output by the steering sensor.	Have the vehicle inspected by your Lexus dealer.
❑ Guide lines are not displayed	
The back door is open.	Close the back door. If this does not resolve the symptom, have the vehicle inspected by your Lexus dealer.
❑ "System is initializing." is displayed	
<ul style="list-style-type: none"> • The battery has been reinstalled. • The steering wheel has been moved while the battery was being reinstalled. • Battery power is low. • The steering sensor has been reinstalled. • There is a malfunction in the signals being output by the steering sensor. 	<p>Stop the vehicle, and turn the steering wheel as far as it will go to the left and right. (Selecting "?" on the screen displays the operating procedure above.)</p> <p>If this does not resolve the symptom, have the vehicle inspected by your Lexus dealer.</p>



CAUTION**■ When using the Lexus parking assist monitor system**

The parking assist monitor is a supplemental device intended to assist the driver when backing up. When backing up, be sure to check visually behind and all around the vehicle before proceeding.

Observe the following precautions to avoid an accident that could result in death or serious injuries.

- Never depend on the parking assist monitor entirely when backing up. The image and the position of the guide lines displayed on the screen may differ from the actual state.
Use caution, just as you would when backing up any vehicle.
- Be sure to back up slowly, depressing the brake pedal to control vehicle speed.
- If you seem likely to hit nearby vehicles, obstacles, people or mount the shoulder, depress the brake pedal to stop the vehicle, then disable the assist system by select  on the screen to cancel the system.
- The instructions given are only guidelines.
When and how much to turn the steering wheel will vary according to traffic conditions, road surface conditions, vehicle condition, etc. when parking. It is necessary to be fully aware of this before using the parking assist system.
- When parking, be sure to check that the parking space will accommodate your vehicle before maneuvering into it.
- Do not use the parking assist monitor in the following cases:
 - On icy or slick road surfaces, or in snow
 - When using tire chains
 - When the back door is not closed completely
 - On roads that are not flat or straight, such as curves or slopes.
- In low temperatures, the screen may darken or the image may become faint. The image could distort when the vehicle is moving, or you may become unable to see the image on the screen. Be sure to check direct visually and with the mirrors all around the vehicle before proceeding.
- If the tire sizes are changed, the position of the guide lines displayed on the screen may change.
- The camera uses a special lens. The distances between objects and pedestrians that appear in the image displayed on the screen will differ from the actual distances. (→P. 281)

CAUTION**■ When using the perpendicular parking assist screen**

Estimated course line display mode: If the steering wheel is straight and the vehicle width guide lines and the estimated course lines are not in alignment, have the vehicle inspected by your Lexus dealer.

■ When using the parallel parking assist screen

- Do not use the system if the display is incorrect due to an uneven (curvy/hilly) road or a non-straight road.
- Make sure to operate the steering wheel only when the vehicle is stopped.
- Be sure to check that there are no obstacles inside the blue outline.
If there are any obstacles inside the blue outline, do not use the parallel parking assist.
- When positioning the blue outline over the parking space, be sure to position it so that the extended blue line may not cross the tire of the vehicle parked in front of the empty space.
- If the extended line of the blue outline may be crossing the parked vehicle, your vehicle is too close. Check that there is a gap of approximately 3 ft. (1 m) between your vehicle and the parked vehicle.

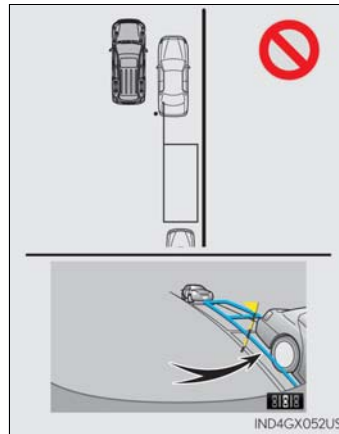

 NOTICE■ **How to use the camera**

- The parking assist monitor may not operate properly in the following cases.
 - If the back of the vehicle is hit, the position and mounting angle of the camera may change.
 - As the camera has a water proof construction, do not detach, disassemble or modify it. This may cause incorrect operation.
 - When cleaning the camera lens, flush the camera with a large quantity of water and wipe it with a soft and wet cloth. Strongly rubbing the camera lens may cause the camera lens to be scratched and unable to transmit a clear image.
 - Do not allow organic solvent, car wax, window cleaner or glass coat to adhere to the camera. If this happens, wipe it off as soon as possible.
 - If the temperature changes rapidly, such as when hot water is poured on the vehicle in cold weather, the system may not operate normally.
 - When washing the vehicle, do not apply intensive bursts of water to the camera or camera area. Doing so may result in the camera malfunctioning.
 - When the camera is used under fluorescent lights, sodium light or mercury light etc., the lights and the illuminated areas may appear to flicker.
- Do not expose the camera to strong impact as this could cause a malfunction. If this happens, have the vehicle inspected by your Lexus dealer as soon as possible.

Wide view front & side monitor*

The wide view front & side monitor provides support when checking the areas to the left and right side of the vehicle and the area in front of the vehicle during take-off at T-intersections or other intersections with poor visibility. This system also helps the driver avoid obstacles and when moving the vehicle to the side of the road.

The wide view front monitor camera displays the areas to the front left and right sides and the area directly in front of the vehicle on the multimedia screen (if equipped) or navigation system screen (if equipped). The side monitor camera displays the area to the front left of the vehicle on the screen.

This system can display the wide view front monitor and the side monitor separately or at the same time.

Pressing the wide view front & side monitor switch turns the monitor on/off

The simultaneous display screen is displayed when the wide view front & side monitor switch is pressed.

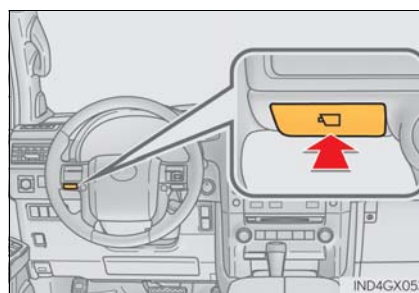

*: If equipped

Display

■ Wide view front & side monitor simultaneous display

Both the wide view front monitor and the side monitor are displayed on one screen. When switching to the wide view front & side monitors this screen is displayed first, regardless of the screen mode.

- ① Wide view front monitor
- ② Side monitor

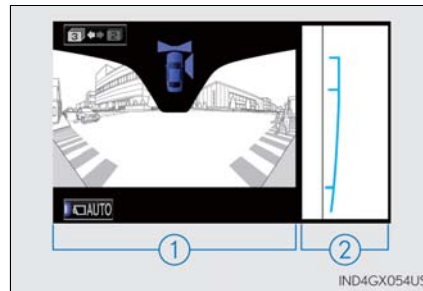

■ Wide view front monitor

The image from the front camera is displayed. Use this monitor to help check the area in front of the vehicle for safety, for example in intersections with poor visibility.

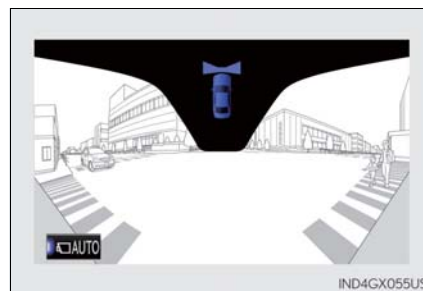

4

Driving

■ Side monitor

The image from the side camera is displayed. Use this monitor to help check the area to the right of the vehicle, for example when taking off and stopping, when turning right, etc. If displayed, the course line can be used as rough guide for steering wheel operation when turning right. (→P. 294)

- ▶ Front view enlarged display mode (with outside rear view mirrors extended)
- ▶ Full view display mode (with outside rear view mirrors retracted)

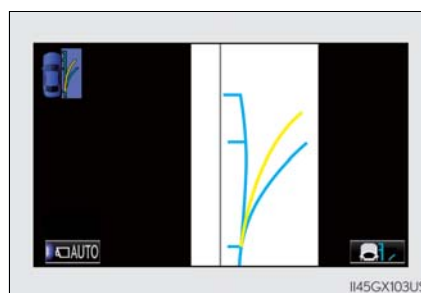
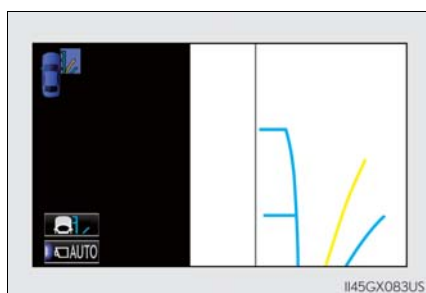

■ Changing the screen mode



This system has a 2 screen mode and a 3 screen mode.

2 screen mode:

Only the wide view front & side monitor simultaneous display can be used.

3 screen mode:

The wide view front & side monitor simultaneous display or the individual display can be used. The display can be switched between the simultaneous display and the individual display by operating the wide view front & side monitor switch.

The screen mode is changed from the wide view front & side monitor simultaneous display screen. The screen mode will change as  or  are selected.

If the screen is changed to the wide view front & side monitor simultaneous display screen while the Lexus parking assist monitor is displayed, it is not possible to switch to the 3 screen mode. (The switch is not displayed.)

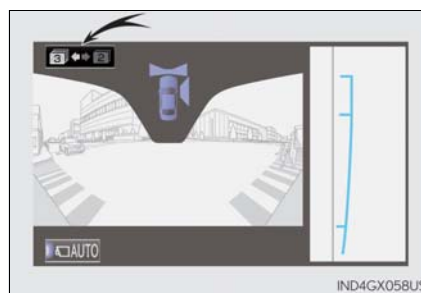

■ **Changing the display in 3 screen mode**

When in 3 screen mode, you can change the display from the simultaneous display to each individual display.

The screen changes as follows with each press of the wide view front & side monitor switch.

When the wide view front monitor was displayed the previous time:

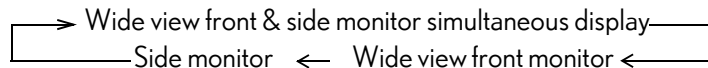

When the side monitor was displayed the previous time:

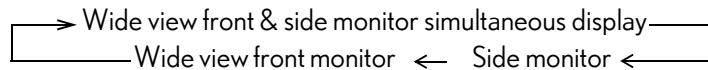

The wide view front monitor and side monitor individual displays are not accessible when the shift lever is in R.

■ **Automatic display mode**

In this mode, the screen is switched automatically in response to vehicle speed, in addition to screen switching by operating the wide view front & side monitor switch.

Select "AUTO" on the front or wide view front & side monitor screen.

- The "AUTO" indicator will come on.
- Select "AUTO" again to return to normal display mode.
- "AUTO" will not be displayed when the shift lever is in R.

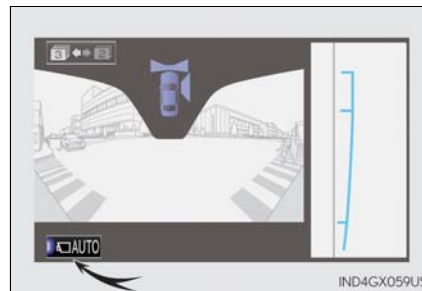

4
Driving



Using the side monitor

● Simultaneous display

- ① Front wheel contact point
Shows the position of the vehicle's front tire.
- ② Vehicle front edge line
Shows the position of the vehicle's leading edge.
- ③ Vehicle width line (blue)
Indicates the width of the vehicle including the outside rear view mirror.
- ④ Projected course line (yellow)
Displays a rough guide of the vehicle path that moves according to the steering wheel position. Displayed along with the minimum projected turning circle.
- ⑤ Minimum projected turning circle (blue)
Displays the smallest turning circle projected by the system if the steering wheel is turned to full lock. Displayed when the steering wheel is turned to the right (further than 90° from straight ahead).
- ⑥ Rear wheel contact point
Shows the position of the vehicle's rear tire.

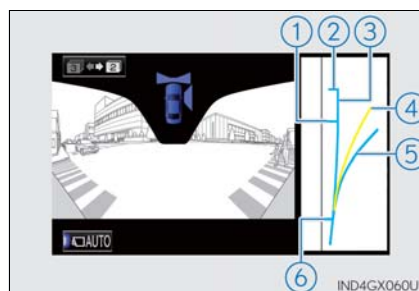

● Individual display

The side monitor screen automatically switches according to the state of the outside rear view mirrors.

- ▶ Front view enlarged display mode (with outside rear view mirrors extended)

- ▶ Full view display mode (with outside rear view mirrors retracted)

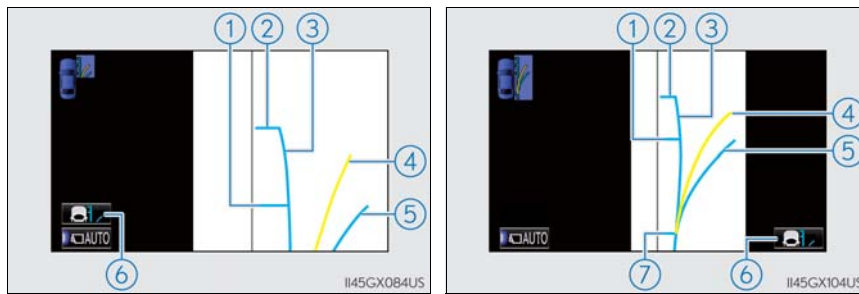

- ① Front wheel contact point
Shows the position of the vehicle's front tire.
- ② Vehicle front edge line
Shows the position of the vehicle's leading edge.
- ③ Vehicle width line (blue)
Indicates the width of the vehicle including the outside rear view mirror.
- ④ Projected course line (yellow)
Displays a rough guide of the vehicle path that moves according to the steering wheel position. Displayed along with the minimum projected turning circle.
- ⑤ Minimum projected turning circle (blue)
Displays the smallest turning circle projected by the system if the steering wheel is turned to full lock. Displayed when the steering wheel is turned to the right (further than 90° from straight ahead).
- ⑥ Projected course line switching button
The course line display mode will change as follows each time the switch is selected. When the shift lever is in R, it will not be displayed.
- ⑦ Rear wheel contact point
Shows the position of the vehicle's rear tire.



■ Changing the course line display mode

- No course lines mode

Vehicle width line is displayed.

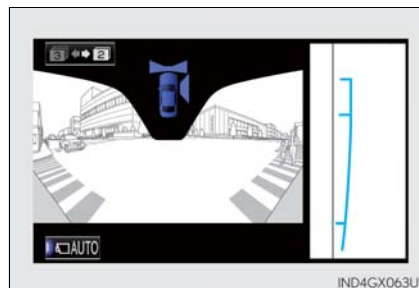

- Turning course line display mode

The projected course line is added to the minimum projected turning circle mode.

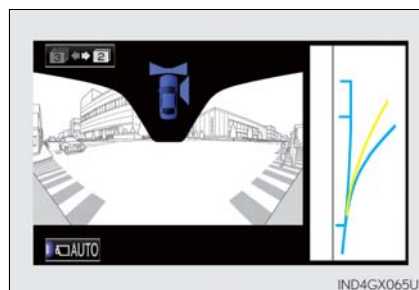

- Minimum projected turning circle display mode

The minimum projected turning circle line is added to the no course lines mode.

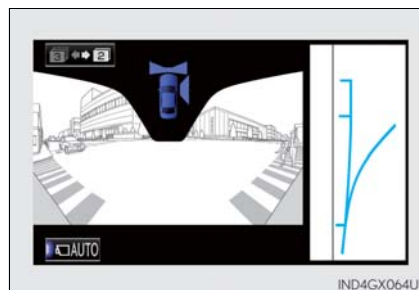

- 1 Change to the side monitor individual display.
- 2 Select .

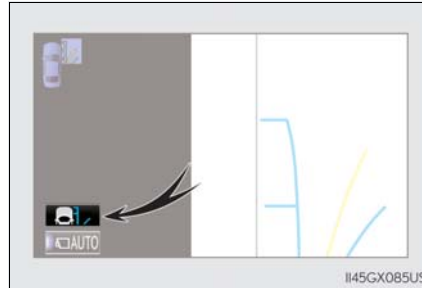

The course line display mode will change as follows each time the switch is selected.

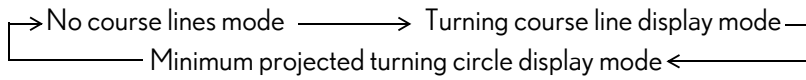

The selected mode will also be displayed on the wide view front & side monitor simultaneous display screen.

■ Using the vehicle width line & course line

● Vehicle width line

Use the vehicle width line to check the vehicle's distance from objects such as curbstones etc. As shown in the illustration, be sure that the vehicle width line does not overlap the object. If you also move the vehicle so that the vehicle width line and the object are parallel, you can park parallel to the object

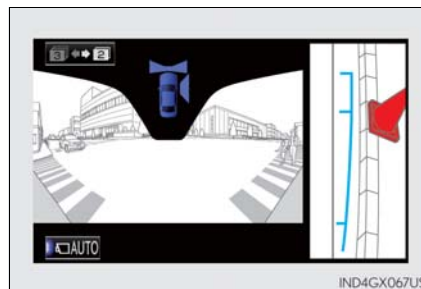

- Minimum projected turning circle & projected course line

Use the minimum projected turning circle & projected course line (when displayed) to check the vehicle's path with relation to obstacles. If the minimum projected turning circle line (blue) is over the obstacle as shown in the illustration, or the obstacle falls within the minimum projected turning circle, if you turn with the minimum possible turning circle, the vehicle may collide with the object. When the projected course line (yellow) is displayed, be sure to operate the steering wheel so that the obstacle stays outside the projected course line until the vehicle has passed the object.

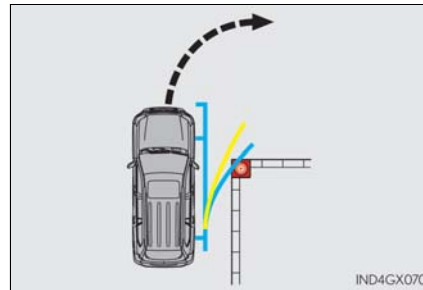
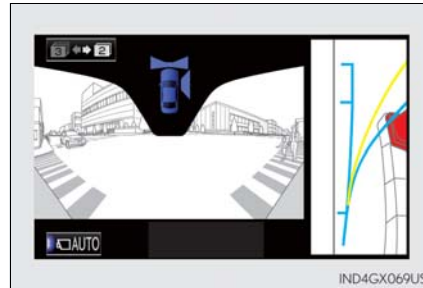

■ **The wide view front & side monitor can be operated when**

- ▶ Normal display mode
 - The engine switch is in IGNITION ON mode.
 - The vehicle speed is less than approximately 7 mph (12 km/h).
- ▶ Automatic display mode
 - The engine switch is in IGNITION ON mode.
 - When automatic display mode is selected
 - When the shift lever is shifted to D, S or N
 - When the shift lever is in D, S or N and the vehicle speed is below approximately 6 mph (10 km/h)

■ **Automatic system cancelation**

In the following situations, the image is canceled automatically.

- When the vehicle speed exceeds approximately 7 mph (12 km/h).

Automatic display mode: If the vehicle speed returns to below 6 mph (10 km/h), the image will be displayed.

- When the shift lever is in P or R.
- When another switch outside the screen has been pressed

■ **When the outside rear view mirrors have been folded**

The side monitor screen can be displayed even if the outside rear view mirrors have been folded. In this case, there will be a slight difference between the image displayed when the outside rear view mirrors are extended and when the outside rear view mirrors have been folded.

■ **When switched to from the Lexus parking assist monitor**

If the wide view front & side monitor is switched to from the Lexus parking assist monitor, the icon display area will flash to inform the driver that the currently displayed area is the front or side. The icon display area will continue to flash until the screen is turned off.

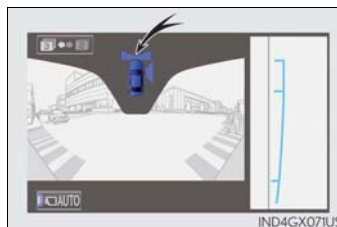

■ Displayed area

The area covered by the camera is limited. Objects which are close to either corner of the bumper or under the bumper cannot be seen on the screen.

The area displayed on the screen may vary depending on vehicle orientation or road conditions.

The camera uses a special lens. The distances in the image displayed on the screen will differ from the actual distances.

● Front camera

① Masking

This section is masked to prevent the driver from moving the vehicle while watching only the wide view front monitor screen. The driver must visually confirm this area directly.

② Camera's field of view

③ Objects visible to the camera

④ Objects not visible to the camera

⑤ Parts of the vehicle (bumper, grille, etc.)

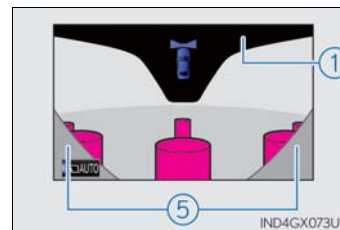
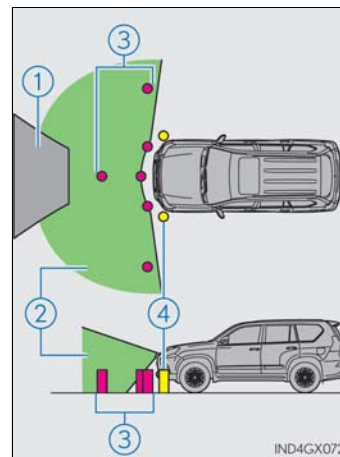

4

Driving

302 4-5. Using the driving support systems

● Side camera

- ① Camera's field of view
- ② Objects visible to the camera
- ③ Right side of vehicle

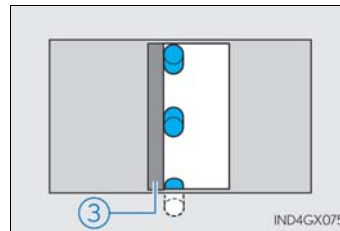
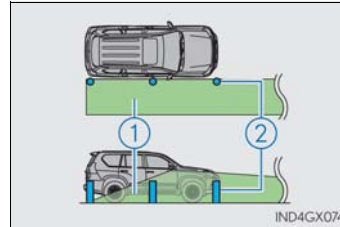

■ Wide view front & side monitor cameras

- ① Side camera
- ② Front camera

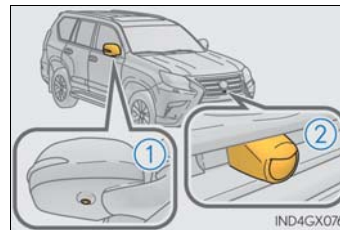

Things you should know

■ If you notice any symptoms

If you notice any of the following symptoms, refer to the likely cause and the solution, and re-check.

If the symptom is not resolved by the solution, have the vehicle inspected by your Lexus dealer.

Likely cause	Solution
□ The image is difficult to see	
<ul style="list-style-type: none"> • The vehicle is in a dark area • The temperature around the lens is either high or low • The outside temperature is low • There are water droplets on the camera • It is raining or humid • Foreign matter (mud etc.) is adhering to the camera • There are scratches on the camera • Sunlight or headlights are shining directly into the camera • The vehicle is under fluorescent lights, sodium lights, mercury lights etc. 	<p>If this happens due to these causes, it does not indicate a malfunction. Drive carefully while visually checking the vehicle's surroundings. (Use the monitor again once conditions have been improved.)</p> <p>The image on the wide view front & side monitor screen can be adjusted, refer to the "MULTIMEDIA OWNER'S MANUAL" or "NAVIGATION SYSTEM OWNER'S MANUAL".</p>
□ The image is blurry	
Dirt or foreign matter (such as water droplets, snow, mud etc.) is adhering to the camera.	If dirt or foreign matter (such as water droplets, snow, mud etc.) is adhering to the camera, it cannot transmit a clear image. In this case, flush it with a large quantity of water and wipe the camera lens clean with a soft and wet cloth.
□ The image is out of alignment	
The camera or surrounding area has received a strong impact.	Have the vehicle inspected by your Lexus dealer.
□ Motion blur occurs on the screen and the display is darker than usual	
The display is cold.	Do not rely solely upon the wide view front & side monitor. Drive carefully while directly confirming your surroundings.

Likely cause	Solution
❑ Switch sound effects do not work	
The multimedia or navigation system volume setting is low or muted.	Increase the volume in the multimedia or navigation system volume settings.
❑ The fixed guide lines are very far out of alignment	
The camera position is out of alignment.	Have the vehicle inspected by your Lexus dealer.
<ul style="list-style-type: none"> • The vehicle is tilted (there is a heavy load on the vehicle, tire pressure is low due to a tire puncture, etc.) • The vehicle is used on an incline. 	If this happens due to these causes, it does not indicate a malfunction. Drive carefully while visually checking the vehicle's surroundings.
❑ "System is initializing." is displayed	
<ul style="list-style-type: none"> • The battery has been reinstalled. • The steering wheel has been moved while the battery was being reinstalled. • Battery power is low. • The steering sensor has been reinstalled. • There is a malfunction in the signals being output by the steering sensor. 	Stop the vehicle, and turn the steering wheel as far as it will go to the left and right. (Selecting "?" on the screen displays the operating procedure above.) If this does not resolve the symptom, have the vehicle inspected by your Lexus dealer.
❑ The color of buttons on the screen are toned down	
The vehicle is driven at 7 mph (12 km/h) or more while the side monitor is displayed.	The color of buttons displayed on the side monitor that are toned down return to normal when the vehicle speed slows to approximately 6 mph (10 km/h).



 CAUTION

■ When using the wide view front & side monitor system

Observe the following precautions to avoid an accident that could result in death or serious injuries.

- When attempting to use the side camera while the door mirror is folded in, the base of the door mirror is displayed on the screen and the area in front of the vehicle cannot be observed. The image displayed on the screen differs depending on the position of the door mirror.
- The field of view of the camera is limited. Do not rely solely upon the wide view front & side monitor.
As with unequipped vehicles, drive carefully while directly confirming the safety of your surroundings.
- Always check visually to confirm your intended path is clear.
- The camera uses a special lens. The distances between objects and pedestrians that appear in the image displayed on the screen will differ from the actual distances.
- When the monitor is in front view enlarged display mode, even if obstacles in the image from the side monitor have disappeared, do not turn the steering wheel any further until the vehicle has passed the obstacle. By turning the steering wheel further, the vehicle may make a tight turn, causing the vehicle to make contact with the obstacle.
- Do not drive the vehicle while only looking at the monitor screen under any circumstances.
Driving while only viewing the monitor screen may cause a collision or lead to an accident, as the image displayed on the monitor screen may differ from actual conditions. Make sure to visually check the surrounding areas with and without the mirror while driving.
- Do not use the wide view front & side monitor in the following cases:
 - On icy or slick road surfaces, or in snow.
 - When the front passenger's door is not closed completely
 - When using tire chains
 - On roads that is not flat, such as slopes
- In low temperatures, the screen may darken or the image may become faint. The image could distort when the vehicle is moving, or you may become unable to see the image on the screen. Be sure to check direct visually all around the vehicle before proceeding.
- If the tires are changed, the position of the guide lines displayed on the screen may be incorrect. When changing the tires, consult your Lexus dealer.
- Depending on the circumstances of the vehicle (number of passengers, amount of luggage, etc.), the position of the guide lines displayed on the screen may change. Be sure to check visually behind and all around the vehicle before proceeding.
- When washing the vehicle, do not apply intensive bursts of water to the camera or camera area. Doing so may result in the camera malfunctioning.

 NOTICE

■ When a solid object is close by

The screen's guide lines are designed for level surfaces (road surface etc.) or flat walls etc. When driving near the obstacle, the obstacle may be displayed as outside the projected course line, and it may seem that there is no danger of a collision, however any sections protruding from the wall may project over the course line and the vehicle may actually collide with the obstacle.

In cases such as this were the projected course line passes close to obstacles, always visually check the surroundings for safety.

- ① Protruding section of wall
- ② Wall displayed on screen

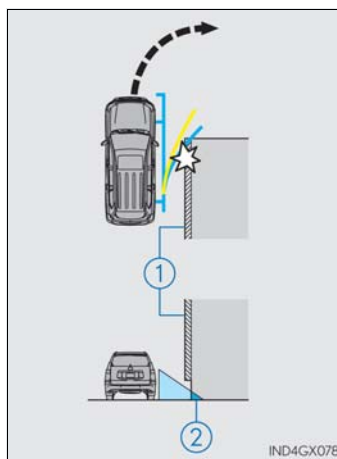
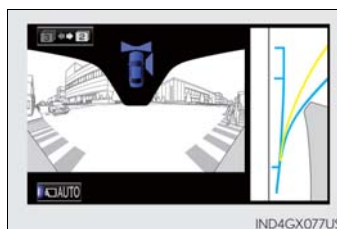

■ When using the wide view front & side monitor

Even if an obstacle is no longer visible on the side monitor, do not turn the steering wheel further in the direction the vehicle is turning until the vehicle has moved completely past the obstacle. If the steering wheel is turned to full lock, the vehicle will turn in the smallest possible turning circle, and may collide with the obstacle.

 NOTICE

■ How to use the camera

- The wide view front & side monitor may not operate properly in the following cases.
 - If the front of the vehicle or the passenger side outside rear view mirror is hit, the camera's position and mounting angle may change. Contact your Lexus dealer.
 - As the camera has a water proof construction, do not detach, disassemble or modify it. This may cause incorrect operation.
 - When cleaning the camera lens, flush the camera with a large quantity of water and wipe it with a soft and wet cloth. Strongly rubbing the camera lens may cause the camera lens to be scratched and unable to transmit a clear image.
 - Do not allow organic solvent, car wax, window cleaner or glass coat to adhere to the camera. If this happens, wipe it off as soon as possible.
 - If the temperature changes rapidly, such as when hot water is poured on the vehicle in cold weather, the system may not operate normally.
 - When washing the vehicle, do not apply intensive bursts of water to the camera or camera area. Doing so may result in the camera malfunctioning.
 - When the camera is used under fluorescent lights, sodium light or mercury light etc., the lights and the illuminated areas may appear to flicker.
 - The camera can be damaged by flying rocks and other debris.
- Do not expose the camera to strong impact as this could cause a malfunction. If this happens, have the vehicle inspected by your Lexus dealer as soon as possible.

Multi-terrain Select*

Multi-terrain Select is a system that helps drivability in off-road situations.

Select a mode that most closely matches the type of terrain on which you are driving from among 4 modes.

Engine control and brake control can be optimized in accordance with the selected mode.

- ① Menu switch
- ② "ENTER" switch
- ③ Multi-information display
- ④ Multi-terrain Select indicator

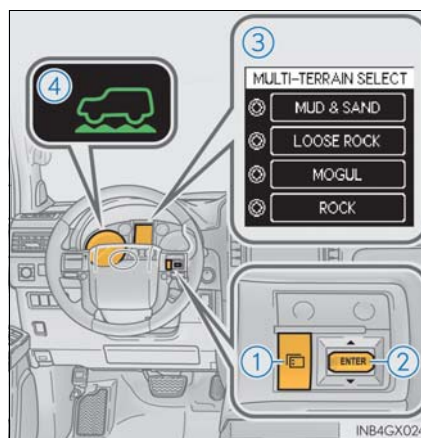

■ Selectable modes

A mode which matches the road conditions can be selected from among the following 4 modes.

Mode	Road Conditions
MUD & SAND	Suitable for muddy roads, sandy roads, snow-covered roads, dirt trails and other slippery or dirty conditions
LOOSE ROCK	Suitable for slippery conditions consisting of mixtures of earth and loose rock
MOGUL	Suitable for a wide range of off-road conditions, particularly very bumpy conditions
ROCK	Suitable for rocky terrain

*: If equipped



■ Switching modes

- 1 Push the menu switch.
The multi-information display will change to electronic features control mode.

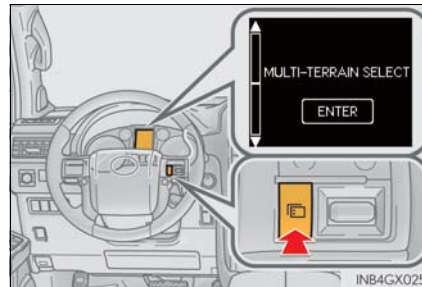

- 2 Press the "ENTER" switch upwards or downwards until "MULTI-TERRAIN SELECT" appears and then press the "ENTER" switch.
The mode selection screen is displayed.

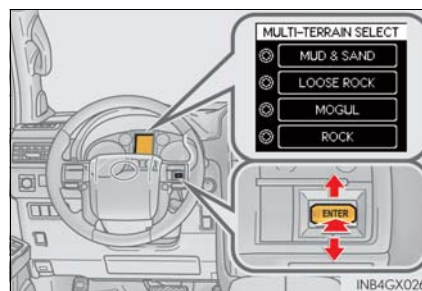

- 3 Press the "ENTER" switch upwards or downwards to select a desired mode and then press the "ENTER" switch.
The system switches to the selected mode, and the multi-terrain select indicator will turn on.

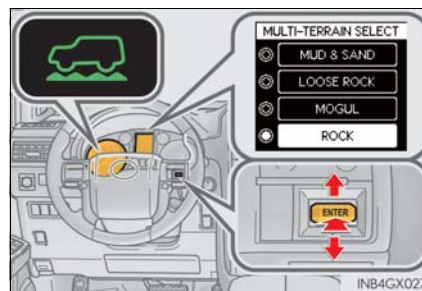

- 4 Once the mode has been set, the mode name will be displayed and operation will commence.

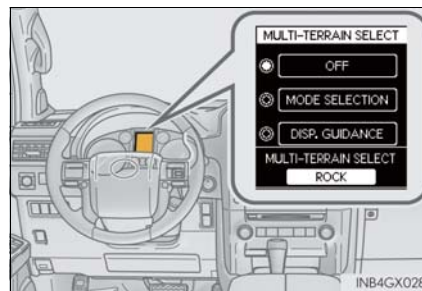

Statement on the multi-information display

■ **After mode selection**

- ① OFF
Turn the system off
- ② MODE SELECTION
Change the mode (→P. 309)
- ③ DISP. GUIDANCE
Explain other necessary operations when selecting a mode
- ④ Status
Display the status of the system

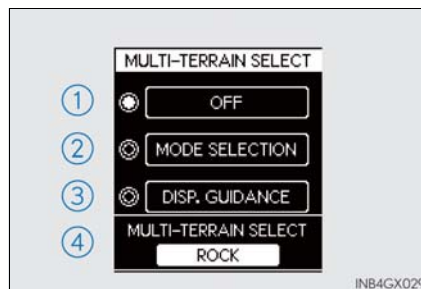

The displayed content may differ in accordance with the system status.

■ **Operation guidance**

Operation guidance is shown on the multi-information display when you cannot set a mode.

When the operation guidance is shown on the multi-information display, follow the instructions in the table.



Guidance Display	Vehicle Status	Procedure
SHIFT TO L4	LOOSE ROCK, MOGUL or ROCK mode is selected when the four-wheel drive control switch is in H4	Set the four-wheel drive control switch to L4
STOP THE VEHICLE AND SHIFT THE AUTOMATIC TRANSMISSION TO N	The four-wheel drive control switch has been shifted to H4 or L4 and LOOSE ROCK, MOGUL or ROCK mode is selected, but the automatic transmission is not in N position or the vehicle is not stopped	Stop the vehicle completely and shift the shift lever into N
ACCELERATE OR DECELERATE	The center differential lock/unlock switch is pressed when Multi-terrain Select is operating, but the center differential cannot be switched between lock and unlock	Drive straight ahead while accelerating or decelerating, or drive in reverse
RETURN THE FOUR-WHEEL DRIVE CONTROL SWITCH	The four-wheel drive control switch is shifted when Multi-terrain Select is operating, but the transfer cannot be shifted to H4 or L4 position	Return the four-wheel drive control switch to L4 or H4
MULTI-TERRAIN SELECT NOT AVAILABLE	The VSC, EFI, 4WD and/or Multi-terrain Select system may be malfunctioning	Contact your Lexus dealer

■ **The Multi-terrain Select can be operated when**

The Crawl Control is off.

■ **When using Multi-terrain Select**

The following functions cannot be switched on or off.

- VSC
- Active TRAC
- Second start mode

A message will be shown on the multi-information display stating that these functions cannot be switched using the VSC OFF switch or the menu and "ENTER" switches.

■ **When selecting a terrain mode**

If you are unsure which mode is appropriate, select MOGUL when the four-wheel drive control switch is in L4 or select MUD & SAND when it is in H4.



■ **When it is difficult to generate traction**

MUD & SAND mode provides the largest amount of tire slippage, followed by LOOSE ROCK, MOGUL and ROCK mode.

Drivability can be improved by selecting a mode which provides a smaller amount of tire slippage than the current mode when the amount of tire slippage is large, or conversely selecting a mode which provides a larger amount of tire slippage than the current mode when the amount of tire slippage is small.

■ **When the vehicle is stuck**

Switching the transfer and differential

For the operation of the following functions, refer to the following pages.

- Four-wheel drive system (→P. 342)
- Center differential lock (→P. 343)

■ **When the TRAC or Active TRAC operates continuously**

→P. 354

■ **When the four-wheel drive control switch is in L4 position**

If the Multi-terrain Select system is not operating and the four-wheel drive control switch is in L4, "TRAC OFF" will be shown on the multi-information display.

■ **When there is a malfunction in the system**

The slip indicator light will come on. Have the vehicle inspected by your Lexus dealer immediately.

 **CAUTION**

■ **When using the Multi-terrain Select**

Observe the following precautions to avoid an accident that could result in death or serious injuries:

- There is a chance that the selected mode may not be the most appropriate in terms of road conditions such as pitch, slipperiness, undulation, etc. (→P. 308)
- Multi-terrain Select is not intended to expand the limits of the vehicle. Check the road conditions thoroughly beforehand, and drive safely and carefully.

 **NOTICE**

■ **Precaution for use**

The Multi-terrain Select is intended for use during off-road driving. Do not use the system at any other time.



Multi-terrain Monitor*

The Multi-terrain Monitor displays the vehicle surroundings when driving at low speeds, thus assisting off-road driving and helping the driver to check the vehicle surroundings.

Display of the Multi-terrain Monitor

- By pressing the Multi-terrain Monitor switch, the display can be shown, or the display image can be changed between the front screen, wide view front & side monitor screen, side-front simultaneous display monitor screen, side-rear simultaneous display monitor screen or rear screen. (The screens that can be selected differ depending on the shift position and the transfer mode.)
 - By referring to the guidelines shown on the front monitor screen, you can decide a driving line while assessing the distance to obstacles ahead of the vehicle and confirm the projected path, and by using the wide view front & side monitors, the side-front simultaneous display monitor and the side-rear simultaneous display monitor to identify objects in the vicinity or course of the tires, you can drive while preventing the vehicle from becoming stuck unexpectedly.
- ① Multi-terrain Monitor switch
 - ② Multimedia screen (if equipped) or navigation system screen (if equipped)

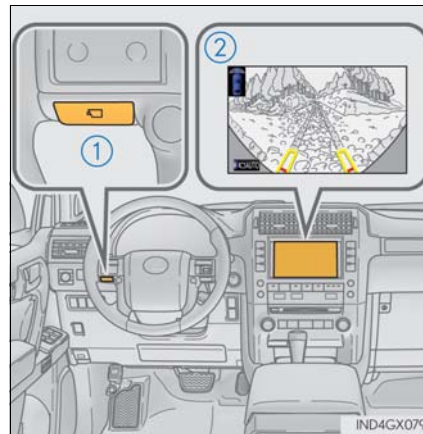

4

Driving

*: If equipped



Using the Multi-terrain Monitor

■ Switching the image

- When the shift lever is in D, S or N

Normal display mode: Press the Multi-terrain Monitor switch to display the screen.
 Automatic display mode: The screen is displayed automatically.
 The screen will switch each time the Multi-terrain Monitor switch is pressed. (The switching screen differs in accordance with the transfer range.)

Four-wheel drive control switch position	Display
H4	Wide view front & side monitor display ← ↓ Side-front simultaneous display monitor ↓ Side-rear simultaneous display monitor —
L4	Front monitor ← ↓ Side-front simultaneous display monitor ↓ Side-rear simultaneous display monitor —

- When the shift lever is in R

If the shift lever is shifted to R, the rear monitor (Lexus parking assist monitor) will be displayed, and the screen will switch every time the Multi-terrain Monitor switch is pressed.

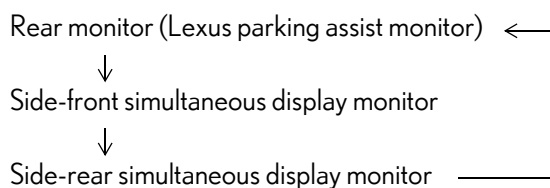

■ Automatic display mode

In this mode, the screen is switched automatically in response to vehicle speed and shift lever operation, in addition to screen switching by operating the Multi-terrain Monitor switch.

Select "AUTO" on the front or wide view front & side monitor screen.

The "AUTO" indicator will come on.
Select "AUTO" again to return to normal display mode.

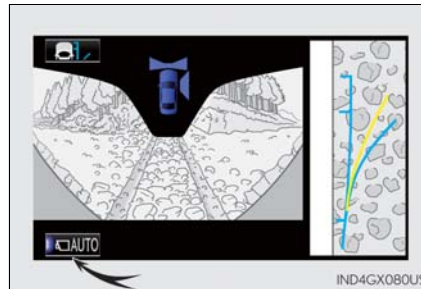

Range covered by each camera

- ① Front monitor*
- ② Side-front simultaneous display monitor*
- ③ Side-rear simultaneous display monitor*
- ④ Rear monitor

*: Range of wide view front & side monitor display (The monitor for side displays passenger's side only.)

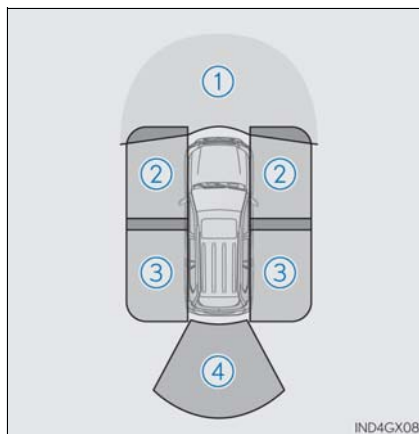

The illustration shown here is an example. As such, the actual visible area may be different. See P. 326 for information about the visual range of each camera.

Display

■ Front monitor

The image from the front camera is displayed. Use this monitor to help check the area in front of the vehicle for safety. Guidelines are shown to help determine the course.

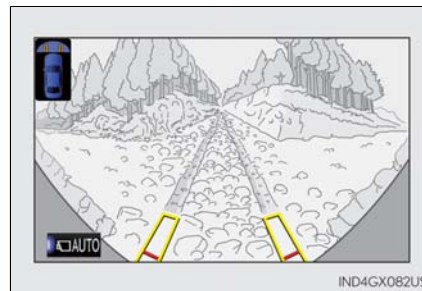

■ Wide view front & side monitor display

Images from the front and the sides of the vehicle are displayed.

This display is used to verify the situation at crossings with poor visibility, and to assist with safety confirmation when turning right.

Guidelines can also be displayed as a steering guide when turning right.

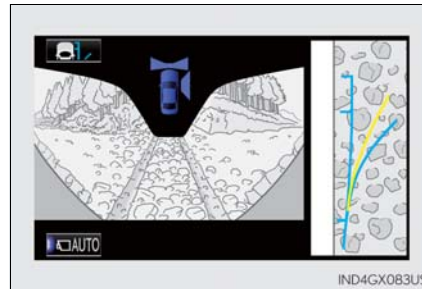

4

Driving

■ Side-front simultaneous display monitor

The image from both side cameras is displayed. Use this monitor to help check the area on both sides of the vehicle at the same time, and to check for objects near the tires or the sides of the vehicle. Guidelines showing an image of the vehicle width and the position of the front tires are displayed.

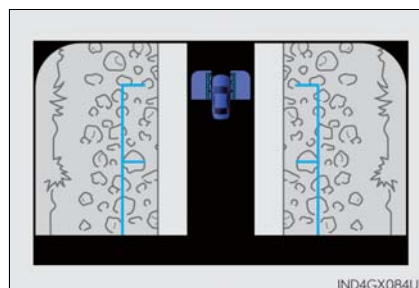

■ Side-rear simultaneous display monitor

The image from both side cameras is displayed. Use this monitor to help check the area on both sides of the vehicle at the same time, and to check for objects near the tires or the sides of the vehicle. Guidelines showing an image of the vehicle width and the position of the rear tires are displayed.

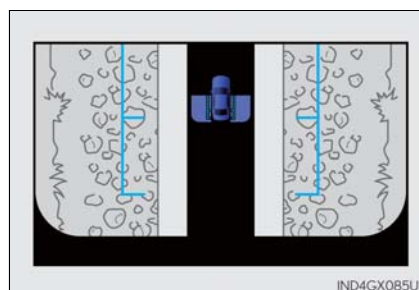

■ Rear monitor (Lexus parking assist monitor)

The image from the rear camera is displayed. (→P. 264)

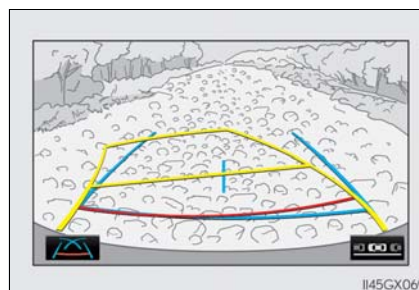

Using the monitor

■ Front monitor

- ① Vehicle icon
Displays the image being shown by the front monitor.
 - ② Trajectory line* (outside)
Indicates the outer path of the tire.
 - ③ Trajectory line* (inside)
Indicates the inner path of the tire.
 - ④ Distance guideline (yellow)
Shows the position about 3.3 ft. (1 m) away from the front edge of the vehicle.
 - ⑤ Distance guideline (red)
Shows the position about 1.6 ft. (0.5 m) away from the front edge of the vehicle.
 - ⑥ Automatic display mode
Switches the projected course mode
- *: The trajectory lines move according to the steering wheel position.

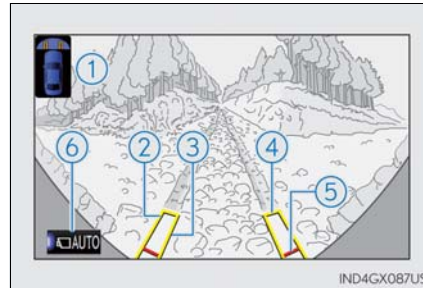

■ Wide view front & side monitor display

- ① Projected course line switching button*

The course line display mode will change as follows each time the switch is selected.

- ② Vehicle icon

Displays the image being shown by the front monitor.

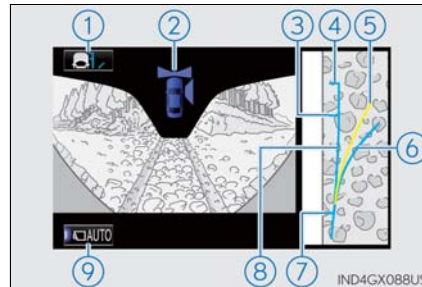

- ③ Front wheel contact point

Shows the position of the vehicle's front tire.

- ④ Vehicle front edge line

Shows the position of the vehicle's leading edge.

- ⑤ Projected course line* (yellow)

Displays a rough guide of the vehicle path that moves according to the steering wheel position. Displayed along with the minimum projected turning circle.

- ⑥ Minimum projected turning circle* (blue)

Displays the smallest turning circle projected by the system if the steering wheel is turned to full lock. Displayed when the steering wheel is turned to the right (further than 90° from straight ahead).

- ⑦ Rear wheel contact point

Shows the position of the vehicle's rear tire.

- ⑧ Vehicle width line (blue)

Indicates the width of the vehicle including the outside rear view mirror.

- ⑨ Automatic display mode*

Switches the projected course mode

*: When the shift lever is in R, it will not be displayed.

■ Side-front simultaneous display monitor

- ① Vehicle icon
Displays the image being shown by the side-front simultaneous display monitor.
- ② Vehicle front edge line
Shows the position of the vehicle's front edge.
- ③ Vehicle width line
Indicates the width of the vehicle including the outside rear view mirror.
- ④ Front wheel contact point
Shows the position of the vehicle's front tire.

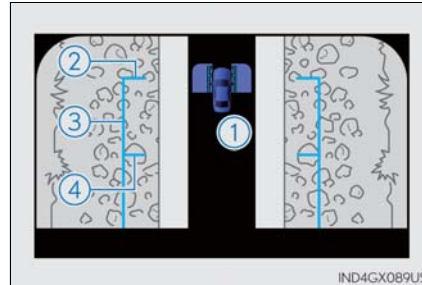

■ Side-rear simultaneous display monitor

- ① Vehicle icon
Displays the image being shown by the side-rear simultaneous display monitor.
- ② Rear wheel contact point
Shows the position of the vehicle's rear tire.
- ③ Vehicle width line
Indicates the width of the vehicle including the outside rear view mirror.
- ④ Vehicle rear edge line
Shows the position of the vehicle's rear edge.

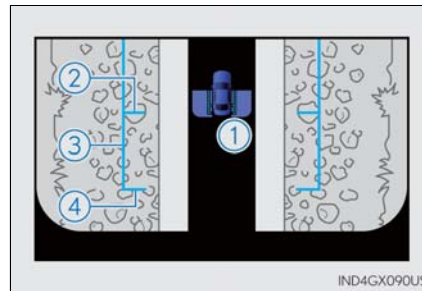

4

Driving

■ Rear monitor (Lexus parking assist monitor)

→P. 264

Projected course line display mode (Wide view front & side monitor display)

- Turning course line display mode

The projected course line is added to the minimum projected turning circle mode.

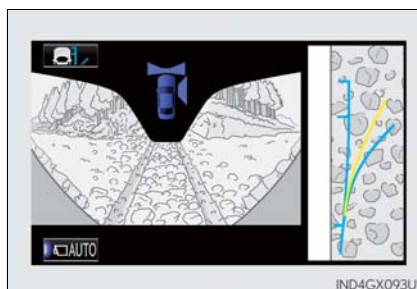

- Minimum projected turning circle display mode

The minimum projected turning circle line is added to the no course lines mode.

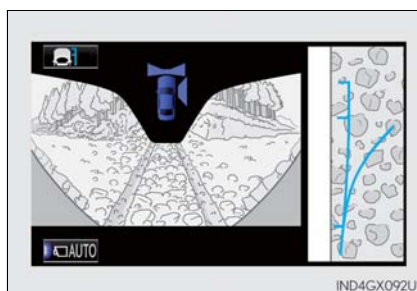

- No course lines mode

Vehicle width line displayed.

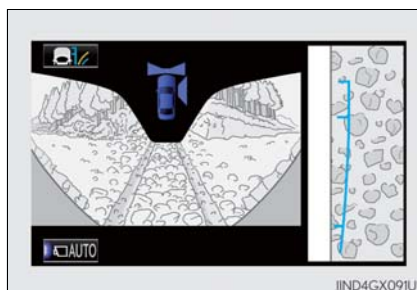

■ **Switching projected course line display mode**

Select .

The display mode switches in the following order:

Turning course line display mode ←



Minimum projected turning circle display mode



No course lines mode

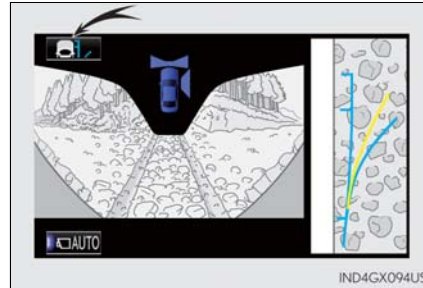

■ **Using the vehicle width line & course line**

● **Vehicle width line**

Use the vehicle width line to check the vehicle's distance from objects such as curbstones etc.

As shown in the illustration, be sure that the vehicle width line does not overlap the object. If you also move the vehicle so that the vehicle width line and the object are parallel, you can park parallel to the object.

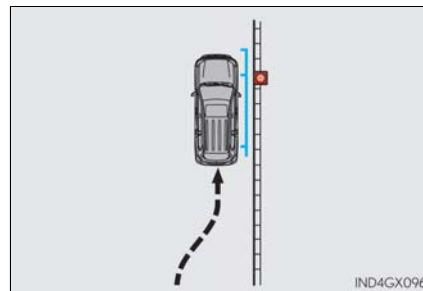
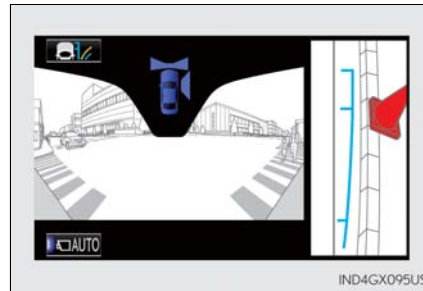

4

Driving

● Minimum projected turning circle & projected course line

Use the minimum projected turning circle & projected course line (when displayed) to check the vehicle's path with relation to obstacles.

If the minimum projected turning circle line (blue) is over the obstacle as shown in the illustration, or the obstacle falls within the minimum projected turning circle, if you turn with the minimum possible turning circle, the vehicle may collide with the object.

When the projected course line (yellow) is displayed, be sure to operate the steering wheel so that the obstacle stays outside the projected course line until the vehicle has passed the object.

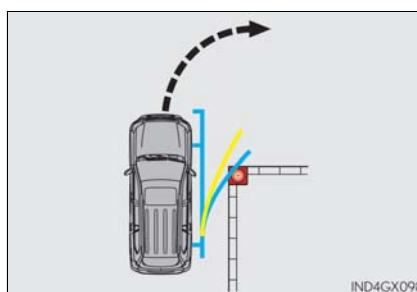
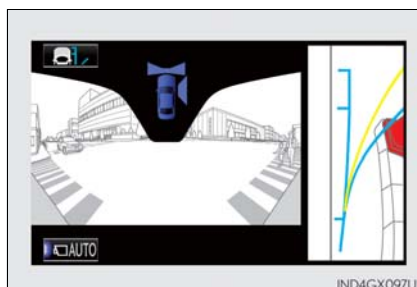

■ The Multi-terrain Monitor can be operated when

- ▶ Normal display mode
 - The engine switch is in IGNITION ON mode.
 - The vehicle speed is less than approximately 7 mph (12 km/h).
- ▶ Automatic display mode
 - When automatic display mode is selected
 - When the shift lever is shifted to D, S or N
 - When the shift lever is in D, S or N and the vehicle speed is below approximately 6 mph (10 km/h)

■ Automatic system cancellation

In the following situations, the image is canceled automatically.

- When the vehicle speed exceeds approximately 7 mph (12 km/h).
After the vehicle speed exceeds approximately 7 mph (12 km/h), the image will continue to be displayed for a short time.
If the vehicle speed returns to below 7 mph (12 km/h) before the image extinguishes, the image will continue to be displayed.
- When "SETUP" or another switch outside the screen has been pressed
- When the shift lever is in P or R.

■ Insert display

An insert display is displayed when an obstacle is within the detection range of the intuitive parking assist. (→P. 245)

■ When folding or extending the door mirrors

The screen will be turned off temporarily while the door mirrors are folding or extending, and the screen will return to normal after the door mirror operation has been completed.

■ Displayed area

The area displayed on the screen may vary depending on vehicle orientation or road conditions.

The camera uses a special lens. The distances in the image displayed on the screen will differ from the actual distances.

● Front camera

- ① Camera's field of view
- ② Objects visible to the camera
- ③ Objects not visible to the camera
- ④ Parts of the vehicle (bumper, grille, etc.)

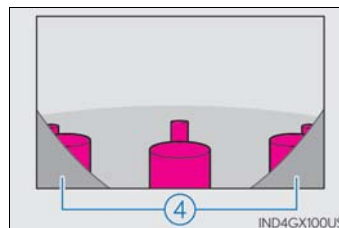
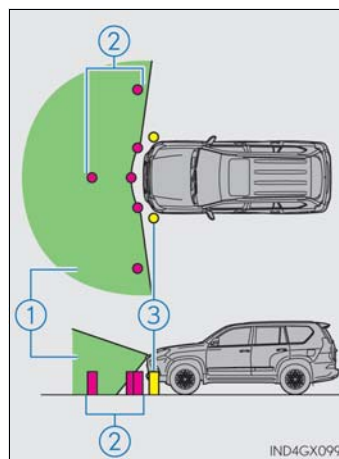

● Side camera (Wide view front & side monitor display)

- ① Camera's field of view
- ② Objects visible to the camera
- ③ Right side of vehicle

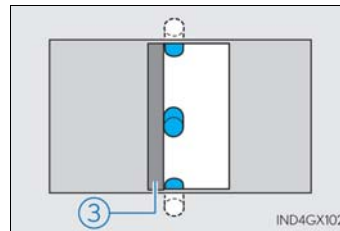
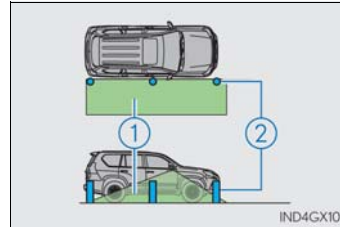

328 4-5. Using the driving support systems

● Side camera (side-front simultaneous display monitor)

- ① Camera's field of view
- ② Objects visible to the camera
- ③ Right side of vehicle
- ④ Left side of vehicle

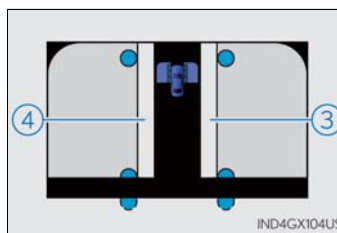
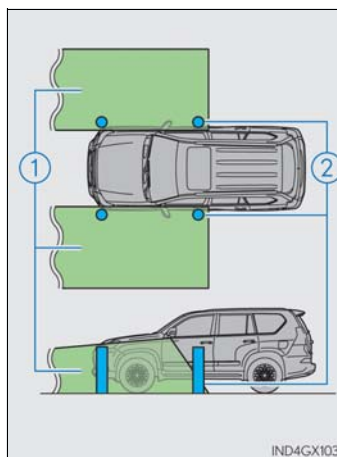

● Side camera (side-rear simultaneous display monitor)

- ① Camera's field of view
- ② Objects visible to the camera
- ③ Right side of vehicle
- ④ Left side of vehicle

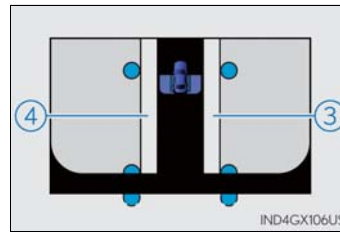
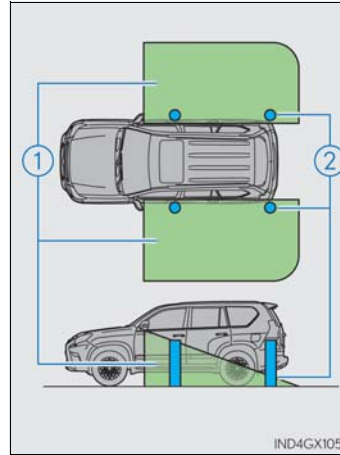

● Rear camera
→P. 264

■ Multi-terrain Monitor cameras

- ① Side cameras
- ② Front camera
- ③ Rear camera

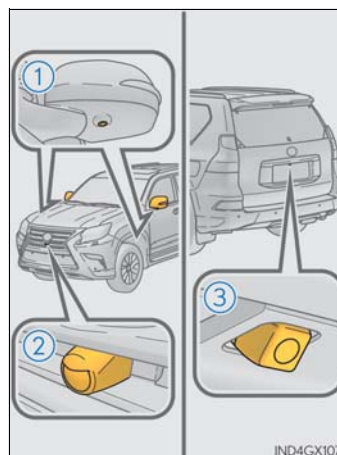

If dirt or foreign matter (such as water droplets, snow, mud etc.) is adhering to the camera, it cannot transmit a clear image. In this case, flush it with a large quantity of water and wipe the camera lens clean with a soft and wet cloth.

■ Display settings

→Refer to the "MULTIMEDIA OWNER'S MANUAL" or "NAVIGATION SYSTEM OWNER'S MANUAL".

Things you should know

■ If you notice any symptoms

If you notice any of the following symptoms, refer to the likely cause and the solution, and re-check.

If the symptom is not resolved by the solution, have the vehicle inspected by your Lexus dealer.

Likely cause	Solution
□ The image is difficult to see	
<ul style="list-style-type: none"> • The vehicle is in a dark area • The temperature around the lens is either high or low • The outside temperature is low • There are water droplets on the camera • It is raining or humid • Foreign matter (mud etc.) is adhering to the camera • There are scratches on the camera • Sunlight or headlights are shining directly into the camera • The vehicle is under fluorescent lights, sodium lights, mercury lights etc. 	<p>If this happens due to these causes, it does not indicate a malfunction. Drive carefully while visually checking the vehicle's surroundings. (Use the monitor again once conditions have been improved.)</p> <p>The image on the Multi-terrain Monitor screen can be adjusted, refer to the "MULTIMEDIA OWNER'S MANUAL" or "NAVIGATION SYSTEM OWNER'S MANUAL".</p>
□ The image is blurry	
Dirt or foreign matter (such as water droplets, snow, mud etc.) is adhering to the camera.	If dirt or foreign matter (such as water droplets, snow, mud etc.) is adhering to the camera, it cannot transmit a clear image. In this case, flush it with a large quantity of water and wipe the camera lens clean with a soft and wet cloth.
□ The image is out of alignment	
The camera or surrounding area has received a strong impact.	Have the vehicle inspected by your Lexus dealer.
□ Motion blur occurs on the screen and the display is darker than usual	
The display is cold.	Do not rely solely upon the Multi-terrain Monitor. Drive carefully while directly confirming your surroundings.
□ Switch sound effects do not work	
The multimedia or navigation system volume setting is low or muted.	Increase the volume in the multimedia or navigation system volume settings.

Likely cause	Solution
❑ The fixed guide lines are very far out of alignment	
The camera position is out of alignment.	Have the vehicle inspected by your Lexus dealer.
<ul style="list-style-type: none"> • The vehicle is tilted (there is a heavy load on the vehicle, tire pressure is low due to a tire puncture, etc.) • The vehicle is used on an incline. 	If this happens due to these causes, it does not indicate a malfunction. Drive carefully while visually checking the vehicle's surroundings.
❑ Cannot return to the rear view monitor screen	
Cannot return to the rear view monitor screen using the camera switch after the screen switches to the multimedia or navigation screen due to a multimedia or navigation operation while the vehicle is in reverse.	Shift into a gear other than R and then shift back into R. If this does not resolve the symptom, have the vehicle inspected by your Lexus dealer.
❑ "System is initializing." is displayed	
<ul style="list-style-type: none"> • The battery has been reinstalled. • The steering wheel has been moved while the battery was being reinstalled. • Battery power is low. • The steering sensor has been reinstalled. • There is a malfunction in the signals being output by the steering sensor. 	Stop the vehicle, and turn the steering wheel as far as it will go to the left and right. (Selecting "?" on the screen displays the operating procedure above.) If this does not resolve the symptom, have the vehicle inspected by your Lexus dealer.
❑ The color of buttons on the screen are toned down	
The vehicle is driven at 7 mph (12 km/h) or more while the side monitor is displayed.	The color of buttons displayed on the side monitor that are toned down return to normal when the vehicle speed slows to approximately 6 mph (10 km/h).



 CAUTION**■ When using the Multi-terrain Monitor system**

Observe the following precautions to avoid an accident that could result in death or serious injuries:

- When attempting to use the side cameras while the door mirror is folded in, the base of the door mirror is displayed on the screen and the area in front of the vehicle cannot be observed. The image displayed on the screen differs depending on the position of the door mirror.
- The field of view of the camera is limited. Do not rely solely upon the Multi-terrain Monitor.
As with unequipped vehicles, drive carefully while directly confirming the safety of your surroundings.
Take particular care to avoid parked cars and other obstacles.
- Do not drive the vehicle while only looking at the monitor screen under any circumstances.
Driving while only viewing the monitor screen may cause a collision or lead to an accident, as the image displayed on the monitor screen may differ from actual conditions. Make sure to visually check the surrounding areas with and without the mirror while driving.
- Always check visually and with the mirrors to confirm your intended path is clear.
- The camera uses a special lens. The distances between objects and pedestrians that appear in the image displayed on the screen will differ from the actual distances.
- These are just some of the functions of the Multi-terrain Monitor. The steering wheel timing and amount the steering wheel should be turned differs depending on the road condition and road surface. Use the Multi-terrain Monitor with full understanding of the above conditions.
Always confirm that there is appropriate space before attempting to park the vehicle.
- Do not use the Multi-terrain Monitor in the following cases:
 - On icy or slick road surfaces, or in snow
 - When using tire chains
 - When the back door is not closed completely
 - On roads that are not flat or straight, such as curves or slopes.
- In low temperatures, the screen may darken or the image may become faint. The image could distort when the vehicle is moving, or you may become unable to see the image on the screen. Be sure to check direct visually all around the vehicle before proceeding.

 CAUTION

■ **Conditions which may affect the Multi-terrain Monitor system**

- If the tires are changed, the position of the guide lines displayed on the screen may be incorrect. When changing the tires, consult your Lexus dealer.
- Depending on the circumstances of the vehicle (number of passengers, amount of luggage, etc.), the position of the guide lines displayed on the screen may change. Be sure to check visually behind and all around the vehicle before proceeding.
- Depending on the overall length of the vehicle (if a frontal protection system is installed or the bumper has been replaced, etc.), the position of the distance guide-lines displayed on the front monitor may change. Be sure to check visually behind and all around the vehicle before proceeding.
- When washing the vehicle, do not apply intensive bursts of water to the camera or camera area. Doing so may result in the camera malfunctioning.

 NOTICE

■ **When using the Multi-terrain Monitor**

- Even if an obstacle is no longer visible on the side monitor, do not turn the steering wheel further in the direction the vehicle is turning until the vehicle has moved completely past the obstacle. If the steering wheel is turned to full lock, the vehicle will turn in the smallest possible turning circle, and may collide with the obstacle.
- It may be difficult to judge distance with the image from the front camera due to the characteristics of the lens. Drive carefully while checking the actual distance to the obstacles displayed on the screen. Also, give your full attention to sudden bumps in the road.



 NOTICE

■ When a solid object is close by

The screen's guide lines are designed for level surfaces (road surface etc.) or flat walls etc. When driving near the obstacle, the obstacle may be displayed as outside the projected course line, and it may seem that there is no danger of a collision, however any sections protruding from the wall may project over the course line and the vehicle may actually collide with the obstacle.

In cases such as this where the projected course line passes close to obstacles, always visually check the surroundings for safety.

- ① Protruding section of wall
- ② Wall displayed on screen

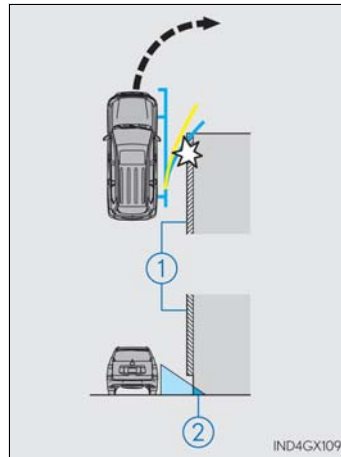
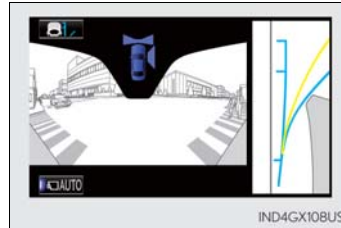

 NOTICE■ **How to use the camera**

- The Multi-terrain Monitor system may not operate properly in the following cases.
 - If the front or the rear of the vehicle or the outside rear view mirror has been hit, the camera's position and mounting angle may have changed.
 - As the camera has a water proof construction, do not detach, disassemble or modify it. This may cause incorrect operation.
 - When cleaning the camera lens, flush the camera with a large quantity of water and wipe it with a soft and wet cloth. Strongly rubbing the camera lens may cause the camera lens to be scratched and unable to transmit a clear image.
 - Do not allow organic solvent, car wax, window cleaner or glass coat to adhere to the camera. If this happens, wipe it off as soon as possible.
 - If the temperature changes rapidly, such as when hot water is poured on the vehicle in cold weather, the system may not operate normally.
 - When washing the vehicle, do not apply intensive bursts of water to the camera or camera area. Doing so may result in the camera malfunctioning.
 - When the camera is used under fluorescent lights, sodium light or mercury light etc., the lights and the illuminated areas may appear to flicker.
 - The camera can be damaged by flying rocks and other debris.
- Do not expose the camera to strong impact as this could cause a malfunction. If this happens, have the vehicle inspected by your Lexus dealer as soon as possible.

Rear height control air suspension *

The rear height control air suspension allows the driver to control vehicle rear height in order to adjust driving conditions. Select the desired height with the height control switch.

- ① Height control OFF button
- ② Height control switch

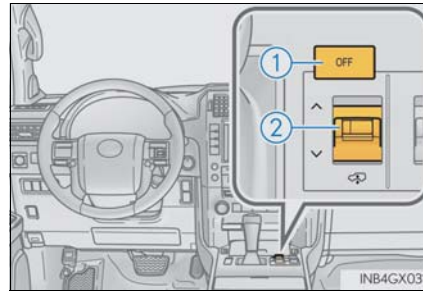

Selecting vehicle height

Operating the switch changes vehicle rear height as follows:

- ① Higher
- ② Lower

Vehicle height can be adjusted only when the engine is running.

The selected height mode will be shown on the rear height control air suspension display.

The selected mode will flash while the height mode is being changed.

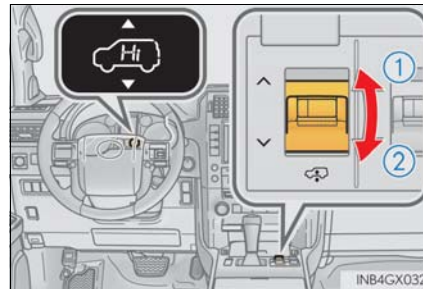

4

Driving

*: If equipped

■ Height modes

- N mode (normal mode): For ordinary driving
Normal height
- HI mode (high mode): For driving on bumpy roads
1.6 in. (40 mm) higher than the normal rear height
HI mode cannot be selected when vehicle speed exceeds 18 mph (30 km/h).
- LO mode (low mode): For the ease of egress/ingress and loading luggage
0.8 in. (20 mm) lower than the normal rear height
LO mode cannot be selected when vehicle speed exceeds 7 mph (12 km/h).

Disabling the height control

When the height control OFF button is pressed with the vehicle stopped, the vehicle height is fixed at the current height.

This status is memorized in the system even after the engine is stopped.

The height can be adjusted by pressing the height control OFF button again.

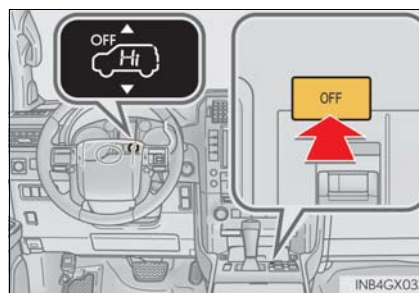

When vehicle speed exceeds 18 mph (30 km/h), the rear height control air suspension turns on automatically.

■ When HI mode is selected

The vehicle height will change to N mode when driving at the speeds of 18 mph (30 km/h). Even if vehicle speed is then reduced to under 18 mph (30 km/h), height will not return to HI mode.

■ When LO mode is selected

The vehicle height will change to N mode when vehicle speed exceeds 7 mph (12 km/h). Even if vehicle speed is then reduced to under 7 mph (12 km/h), height will not return to LO mode.

■ Automatic leveling function

Regardless of the number of occupants and the luggage load, vehicle height in any mode is always adjusted to a fixed height by the automatic leveling function.

■ The rear height control air suspension will not operate in the following cases:

- The underbody of the vehicle is touching the surface of the road.
- The area around the suspension is covered with ice.

■ Even if you hear an operating noise

This does not indicate a problem in the rear height control air suspension.

■ Parking and stopping tips

- If you immediately stop the engine after off-road driving, or park the vehicle for a long time, the vehicle height may gradually lower. When parking, make sure there is nothing under the vehicle that may come in contact with the underbody. The vehicle will return to the set height when the engine is started.
- The vehicle height may change as the temperature changes when the engine is stopped. The vehicle will return to the set height when the engine is started.

■ When lowering the vehicle

In order to prevent the vehicle height from rising as occupants leave the vehicle, lowering control will occur for a short while after the engine has been stopped.

■ The rear height control air suspension failure warning

- If a malfunction occurs in the rear height control air suspension, N mode is automatically selected. However, the system may not switch to N mode depending on the location of the malfunction.
- The warning message is displayed on the multi-information display, and the rear height control air suspension cannot be activated until the malfunction is corrected. Stop the engine and start it again. If the warning message turns off, the system is operating correctly. If the warning message continues to be displayed, have your vehicle inspected by your Lexus dealer as soon as possible.



 **CAUTION**

■ **The rear height control air suspension must be turned off**
 Be sure to observe the following precautions. Otherwise, the automatic leveling function may cause vehicle height to change, and you may catch part of your body in the vehicle, resulting in an accident:

- When jacking up the vehicle, installing tire chains or tying the vehicle with chains/wires for transportation via flatbed truck, turn off the rear height control air suspension and stop the engine.
- When the vehicle must be towed or disconnecting a trailer, put the vehicle height in N mode and turn off the rear height control air suspension.
- When the vehicle is stuck, turn off the rear height control air suspension.

■ **Selecting the correct height mode**

- HI mode should only be used when driving on rough roads, for example when driving off-road.
 Because the vehicle's center of gravity will become higher when in the mode, the vehicle may become unstable when turning abruptly, resulting in an accident.
- Do not select HI mode when loading cargo on the roof luggage carrier.
 Because the vehicle's center of gravity will become higher when in the mode, the vehicle may become unstable when turning abruptly, resulting in an accident.
- Before lowering vehicle height, check that there is no one under the vehicle.

 **NOTICE**

■ **Be careful in any place where overhead space is limited**
 The vehicle height will rise when a higher mode is selected or cargo is unloaded. This may cause damage to the vehicle.

■ **Do not select LO mode when driving on bumpy roads**
 If the underbody of the vehicle touches a rugged road surface, the vehicle may be damaged.

■ **Changing vehicle height**
 Do not change vehicle height frequently.
 The compressor may overheat and stop operation.

■ **When on the extremely uneven roads with rocks**
 Sometimes the vehicle height is not adjusted because it is judged as uneven road driving.



AVS (Adaptive Variable Suspension System)*

The driving modes can be selected to suit driving condition.

- ① Sport mode
For winding mountain road driving or high speed driving
- ② Normal mode
For normal driving
- ③ Comfort mode
When compared to normal mode, ride comfort is improved.

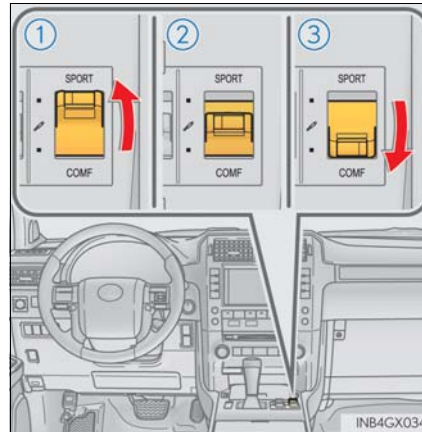

■ Driving mode

- Mode ① is suitable for heavy load or driving on a unpaved road.
- With the four-wheel drive control switch at L4, the damping effect suitable for off-road driving will be provided, regardless of the position of the AVS switch.

4

Driving

*: If equipped



Four-wheel drive system

Use the four-wheel drive control switch and center differential lock/unlock switch to select the following transfer and center differential modes.

Four-wheel drive control switch

- ① H4 (high speed position)
Normal driving on all types of roads.
- ② L4 (low speed position)
Driving requiring maximum power and traction such as climbing or descending steep hills, off-road driving, and hard pulling in sand or mud, etc.
The low speed four-wheel drive indicator will come on.

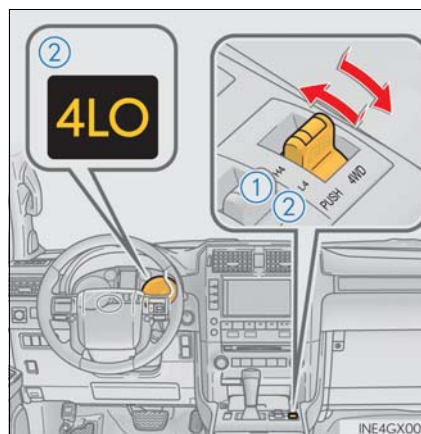

Center differential lock/unlock switch

Lock the center differential when your vehicle's wheels get stuck in a ditch or when driving on a slippery or bumpy surface.

The center differential lock indicator will come on.

Unlock the center differential after the wheels have been freed, or after moving to a flat, non-slippery surface.

To unlock the center differential, push the switch again.

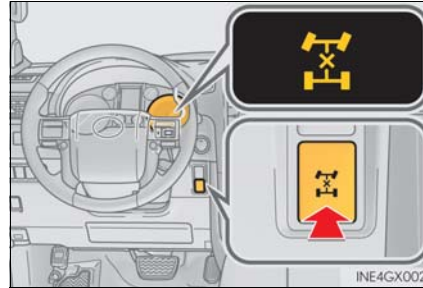

Shifting between H4 and L4

■ Shifting from H4 to L4

- 1 Stop the vehicle completely with brake pedal held down.
- 2 Shift the shift lever to N.
- 3 Push and shift the four-wheel drive control switch to L4.

Maintain this condition until the low speed four-wheel drive indicator turns on.

■ Shifting from L4 to H4

- 1 Stop the vehicle completely with brake pedal held down.
- 2 Shift the shift lever to N.
- 3 Push and shift the four-wheel drive control switch to H4.

Maintain this condition until the low speed four-wheel drive indicator turns off.

■ **When the four-wheel drive control switch can be operated**

- The engine switch is in IGNITION ON mode.
- The shift lever is in the N position.
- The vehicle is stopped completely.

■ **The low speed four-wheel drive indicator**

- The indicator blinks while switching between H4 and L4.
- If the low speed four-wheel drive indicator continues to blink when you operate the four-wheel drive control switch to the H4 or L4 position, stop the vehicle completely, shift the shift lever securely into N and then operate the switch again.
- If the shift lever is moved before the low speed four-wheel drive indicator turns on/off, the transfer mode may not be shifted completely. The transfer mode disengages both the front and rear drive shafts from the powertrain and allows the vehicle to move regardless of the shift position. (At this time, the indicator blinks and the buzzer sounds.) Therefore, the vehicle is free to roll even if the shift lever is in P. You or someone else could be seriously injured. You must complete the shifting of the transfer mode and confirm that the indicator has turned off (H4) or turned on (L4).
- If the engine coolant temperature is too low, the four-wheel drive control system may not be able to shift. When the engine is warmer operate the switch again.

If the indicator continue to blink even if doing so, have the vehicle inspected by your Lexus dealer as soon as possible. There may be a trouble in the four-wheel drive system.

■ **When the transfer mode is switched to L4**

Vehicles without Multi-terrain Select:
VSC is automatically turned off. (The VSC OFF indicator will come on.)

Vehicles with Multi-terrain Select:
VSC and TRAC/Active TRAC are automatically turned off. (The VSC OFF indicator will come on and the "TRAC OFF" will be shown on the multi-information display.)

■ **When the center differential lock/unlock switch can be operated**

The engine switch is in IGNITION ON mode.

■ **The center differential lock indicator**

- The indicator blinks while locking/unlocking the center differential.
- If the center differential lock indicator blinks and the buzzer sounds when the center differential is locked, stop the slipping or spinning and push the switch again.

If the indicator continue to blink even if doing so, have the vehicle inspected by your Lexus dealer as soon as possible. There may be a trouble in the four-wheel drive system.



■ Locking/unlocking the center differential

- If the operation is not completed, the center differential lock indicator blinks. If the indicator does not turn off when unlocking the center differential, drive straight ahead while accelerating or decelerating, or drive in reverse.
- Avoid turning suddenly while the center differential is locked. If you do turn suddenly, the difference in turning speeds between the front and rear wheels may have a similar effect to braking, thus making driving difficult.

⚠ CAUTION**■ While driving**

Observe the following precautions. Failure to do so may cause an accident resulting in death or serious injury.

- Never move the four-wheel drive control switch if the wheels have lost traction.
- Do not operate the center differential lock/unlock when the vehicle is turning or when its wheels are spinning freely off the ground.

⚠ NOTICE**■ To prevent damage to the center differential**

- For normal driving on dry and hard surface roads, unlock the center differential.
- Unlock the center differential after the wheels are out of the ditch or off the slippery or bumpy surface.

Crawl Control*

Allows travel on extremely rough off-road surfaces at a fixed low speed without pressing the accelerator or brake pedal. Minimizes loss of traction or vehicle slip when driving on slippery road surfaces, helping for stable driving.

Crawl Control switch

- ① ON/OFF switch
- ② Speed selection switch

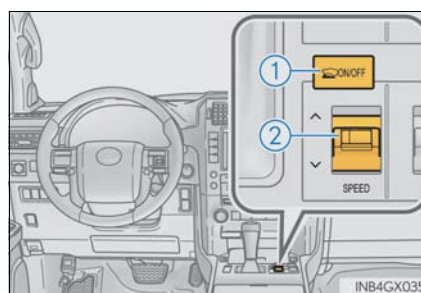

System operation

- ① On/off

The Crawl Control indicator is lit and the slip indicator flashes when operating.

Also, the operating status and speed select status of the Crawl Control are shown on the multi-information display.
- ② Higher
- ③ Lower

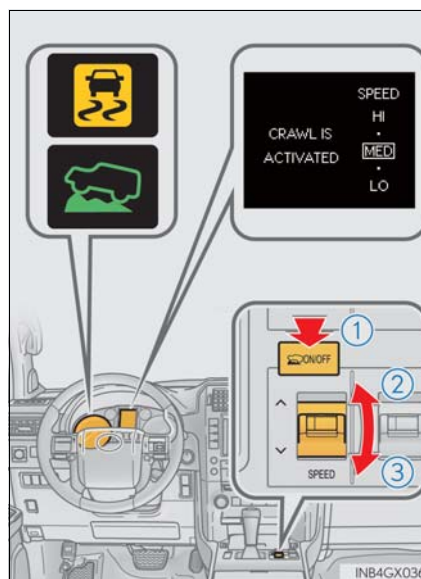

*: If equipped

Speed modes

- LO (low mode)
Effective when traveling on rocks, or descending a slope of mogul and rubble.*
- MED (medium mode)
Effective when ascending a slope of mogul.*
- HI (high mode)
Effective when ascending a slope of mogul and rubble, or traveling on snow, dirt, mud, sand, gravel, grass etc.*

The position between low and medium modes and the position between medium and high modes can also be selected.

*: Depending on the road surface, may not be the most effective.

■ The Crawl Control can be operated when

- The shift lever is in any gear other than P or N.
- The four-wheel drive control switch is in L4.
- The driver's door is closed.

■ Automatic system cancelation

In the following situations, the system is canceled automatically:

At that time, the buzzer will sound, the slip indicator turns off, and the Crawl Control indicator flashes.

A notification will be displayed on the multi-information display for several seconds. (→P. 528)

- When the shift lever is moved to P or N.
- When the four-wheel drive control switch is in H4.
- When the driver's door is opened.

When turning off Crawl Control while traveling, stop the vehicle before the Crawl Control indicator turns off, or drive extremely carefully.

■ Function limit

- In the following situations, you will be able to use brake control to drive downhill at a fixed low speed, but you will be unable to use engine control to drive uphill at a fixed low speed.
 - When the driving mode is set to second start mode.
 - When the vehicle speed is higher than 6 mph (10 km/h).
- When the vehicle speed is higher than 15 mph (25 km/h), engine control and brake control will stop temporarily. At that time, the Crawl Control indicator flashes.



■ **When the Crawl Control system is operated continuously**

This may cause the brake actuator to overheat. In this case, the Crawl Control system will stop operating, a buzzer will sound, the Crawl Control indicator will turn off after flashing and the "TRAC OFF" will be shown on the multi-information display. In this case, quickly stop the vehicle in a safe place and give the actuator adequate time to cool off. Refrain from using the system until the message goes off. (The vehicle can be driven normally during this time.)

■ **If the automatic transmission system overheats**

The system will cease operation, a buzzer will sound and a warning message will be displayed to alert the driver. Stop the vehicle in a safe place until the warning message turns off. (→P. 533)

■ **Sounds and vibrations caused by the Crawl Control system**

- A sound may be heard from the engine compartment when the engine is started or just after the vehicle begins to move. This sound does not indicate that a malfunction has occurred in Crawl Control system.
- Either of the following conditions may occur when the Crawl Control system is operating. None of these are indicators that a malfunction has occurred.
 - Vibrations may be felt through the vehicle body and steering.
 - A motor sound may be heard after the vehicle comes to a stop.

■ **If the slip indicator comes on...**

It may indicate a malfunction in the system. Consult your Lexus dealer.

 **CAUTION**

■ **When using Crawl Control**
Do not rely solely on the Crawl Control. This function does not extend the vehicle's performance limitations. Always thoroughly check the road conditions, and drive safely.

■ **These conditions may cause the system not to operate properly**
When driving on the following surfaces, the system may not be able to maintain a fixed low speed, which may result in an accident:

- Extremely steep inclines.
- Extremely uneven surfaces.
- Snow-covered roads, or other slippery surfaces.



Downhill assist control system*

The downhill assist control system helps to prevent excessive speed on steep downhill slopes.

The system will operate when the vehicle is traveling under 15 mph (25 km/h) and the four-wheel drive drive control switch is in the L4 position.

System operation

Shift the “DAC” switch to ON. The downhill assist control system indicator light comes on and the system will operate.

When the system is in operation, the slip indicator light will flash, and the stop lights/high mounted stop lights will be lit.

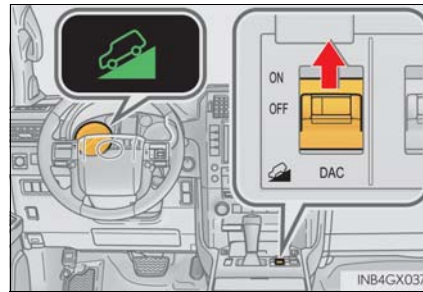

Turning off the system

Shift the “DAC” switch to OFF while the system is in operation. The downhill assist control system indicator will flash as the system gradually ceases operation, and will turn off when the system is fully off.

Shift the “DAC” switch to ON while the downhill assist control system indicator is flashing to start the system again.

4

Driving

*: If equipped



■ **Operating tips**

The system will operate when the shift lever is in a position other than P, however to make effective use of the system it is recommended that the shift lever be shifted to 2 or 1 range of S mode.

■ **If the four-wheel drive control switch is in H4**

The system does not operate.

■ **When the downhill assist control system is operated continuously**

This may cause the brake actuator to overheat. In this case, the downhill assist control system will stop operating, a buzzer will sound and the downhill assist control system indicator will start flashing, and the "TRAC OFF" will be shown on the multi-information display. Refrain from using the system until the downhill assist control system indicator stays on and the message goes off. (The vehicle can be driven normally during this time.)

■ **Sounds and vibrations caused by the downhill assist control system**

- A sound may be heard from the engine compartment when the engine is started or just after the vehicle begins to move. This sound does not indicate that a malfunction has occurred in downhill assist control system.
- Either of the following conditions may occur when the downhill assist control system is operating. None of these are indicators that a malfunction has occurred.
 - Vibrations may be felt through the vehicle body and steering.
 - A motor sound may be heard after the vehicle comes to a stop.

■ **System malfunction**

- The downhill assist control system indicator does not come on when the engine switch is turned to IGNITION ON mode.
- The downhill assist control system indicator does not come on when the "DAC" switch is pressed.
- The slip indicator comes on.

In the above cases, have your vehicle checked by your Lexus dealer.

 **CAUTION**

■ **When using downhill assist control system**
Do not rely overmuch on the downhill assist control system. This function does not extend the vehicle's performance limitations. Always thoroughly check the road conditions, and drive safely.

■ **The system may not operate on the following surfaces, which may lead to an accident causing death or serious injury**

- Slippery surfaces such as wet or muddy roads
- Icy surface
- Unpaved roads



Driving assist systems

To help enhance driving safety and performance, the following systems operate automatically in response to various driving situations. Be aware, however, that these systems are supplementary and should not be relied upon too heavily when operating the vehicle.

◆ ABS (Anti-lock Brake System)

Helps to prevent wheel lock when the brakes are applied suddenly, or if the brakes are applied while driving on a slippery road surface

◆ Multi Terrain ABS (Anti-lock Brake System) (vehicles with a Multi-terrain Select system)

Helps to prevent wheel lock when the brakes are applied suddenly, or if the brakes are applied while driving on a slippery road surface, or in off-road conditions (such as rough roads, sand and mud)

The Multi Terrain ABS operates in synchronization with the Multi-terrain Select

◆ Brake assist

Generates an increased level of braking force after the brake pedal is depressed when the system detects a panic stop situation

◆ VSC (Vehicle Stability Control)

Helps the driver to control skidding when swerving suddenly or turning on slippery road surfaces

◆ TRAC (Traction Control) for H4 position

Helps to maintain drive power and prevent the drive wheels from spinning when starting the vehicle or accelerating on slippery roads

◆ **Active TRAC (Traction Control) for L4 position ***

Helps to maintain drive power and prevent the 4 wheels from spinning when starting the vehicle or accelerating on slippery roads, or in off-road conditions

◆ **Hill-start assist control (if equipped)**

Helps to prevent the vehicle from rolling backward when starting on an incline or slippery slope

◆ **KDSS (Kinetic Dynamic Suspension System)**

KDSS helps to enhance ride comfort and handling response by using a hydraulic control system to control the suspension stabilizer bars in response to road surface and driving conditions during cornering or off-road driving

◆ **PCS (Pre-Collision system) (if equipped)**

→P. 368

◆ **Trailer Sway Control**

Helps the driver to control trailer sway by selectively applying brake pressure for individual wheels and reducing engine torque when trailer sway is detected.

Trailer Sway Control is part of the VSC system and will not operate if VSC turned off or experiences a malfunction.

*: The function only works in vehicles with Multi-terrain Select when Multi-terrain Select is switched on

When the TRAC or Active TRAC/VSC/Trailer Sway Control/hill-start assist control systems are operating

If the vehicle is in danger of slipping or rolling backward when starting on an incline, or if any of the drive wheels spins, the slip indicator light flashes to indicate that the TRAC or Active TRAC/VSC/Trailer Sway Control/hill-start assist control systems are operating.

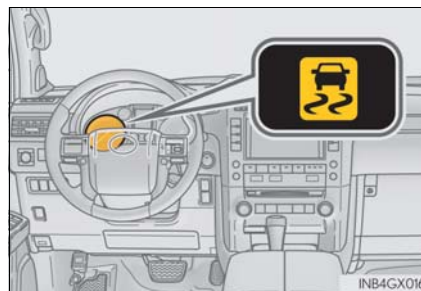

The stop lights and high mounted stoplight turn on when the hill-start assist control system is operating.

Disabling the TRAC or Active TRAC/VSC/Trailer Sway Control systems

If the vehicle gets stuck in fresh snow or mud, the TRAC or Active TRAC/VSC/Trailer Sway Control systems may reduce power from the engine to the wheels. You may need to turn the system off to enable you to rock the vehicle in order to free it.

■ Turning off TRAC or Active TRAC system only

To turn the TRAC or Active TRAC system off, quickly press and release the switch.

The "TRAC OFF" will be shown on the multi-information display.

Press the switch again to turn the system back on.

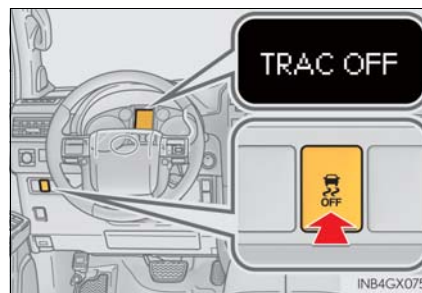

■ Turning off both TRAC or Active TRAC and VSC/Trailer Sway Control systems

To turn the TRAC or Active TRAC and VSC/Trailer Sway Control systems off, press and hold the switch for 3 seconds and more while the vehicle is stopped.

The VSC OFF indicator light will come on and the "TRAC OFF" will be shown on the multi-information display.

Press the switch again to turn the system back on.

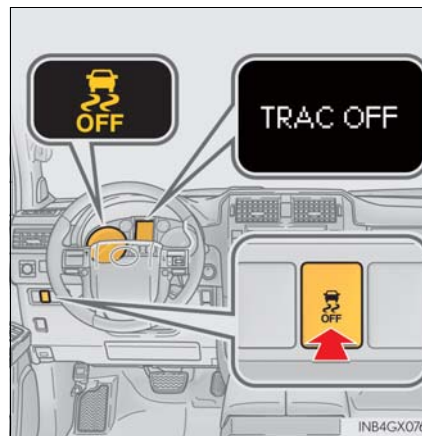

■ When the "TRAC OFF" is displayed on the multi-information display even if the VSC OFF switch has not been pressed

TRAC/Active TRAC, hill-start assist control, downhill assist control and Crawl Control cannot be operated. Contact your Lexus dealer.

■ Hill-start assist control operation conditions

- The shift lever is in D or S.
- The brake pedal is not depressed.

■ **Sounds and vibrations caused by the ABS/Multi Terrain ABS, brake assist, TRAC/Active TRAC, VSC/Trailer Sway Control and hill-start assist control systems**

- A sound may be heard from the engine compartment when the engine is started or just after the vehicle begins to move. This sound does not indicate that a malfunction has occurred in any of these systems.
- Any of the following conditions may occur when the above systems are operating. None of these indicates that a malfunction has occurred.
 - Vibrations may be felt through the vehicle body and steering.
 - A motor sound may be heard after the vehicle comes to a stop.
 - The brake pedal may pulsate slightly after the ABS/Multi Terrain ABS is activated.
 - The brake pedal may move down slightly after the ABS/Multi Terrain ABS is activated.

■ **Reactivation of the TRAC or Active TRAC/VSC/Trailer Sway Control systems after turning off the engine**

Turning off the engine after turning off the TRAC or Active TRAC/VSC/Trailer Sway Control systems will automatically re-enabled them.

■ **Reactivation of the TRAC or Active TRAC system linked to vehicle speed**

When only the TRAC or Active TRAC system is turned off, the TRAC or Active TRAC system will turn on when vehicle speed increases. However, when both TRAC or Active TRAC and VSC/Trailer Sway Control systems are turned off, the systems will not turn on even when vehicle speed increases.

■ **When the brake system operates continuously**

The brake actuator may overheat. In this case, the TRAC or Active TRAC and hill-start assist control systems will stop operating, a buzzer will sound and the "TRAC OFF" will be shown on the multi-information display. Refrain from using the system until the message goes off. (There is no problem with continuing normal driving.)

■ **If the slip indicator comes on...**

It may indicate a malfunction in the TRAC/Active TRAC, VSC/Trailer Sway Control or hill-start assist control system. Consult your Lexus dealer.

■ **KDSS**

Some difference of vehicle height between left and right side can appear. This does not indicate a malfunction in the KDSS system. For more information, contact your Lexus dealer.



 CAUTION

■ **The ABS/Multi Terrain ABS does not operate effectively when**

- The limits of tire gripping performance have been exceeded (such as excessively worn tires on a snow covered road).
- The vehicle hydroplanes while driving at high speed on the wet or slick road.

■ **Stopping distance when the ABS/Multi Terrain ABS is operating may exceed that of normal conditions**

The ABS/Multi Terrain ABS is not designed to shorten the vehicle's stopping distance. Always maintain a safe distance from the vehicle in front of you, especially in the following situations:

- When driving on dirt, gravel or snow-covered roads
- When driving with tire chains
- When driving over bumps in the road
- When driving over roads with potholes or uneven surfaces

■ **TRAC/Active TRAC may not operate effectively when**

Directional control and power may not be achievable while driving on slippery road surfaces, even if the TRAC/Active TRAC system is operating. Do not drive the vehicle in conditions where stability and power may be lost.

■ **Hill-start assist control does not operate effectively when**

Do not overly rely on the hill-start assist control. The hill-start assist control may not operate effectively on steep inclines and roads covered with ice.

■ **When the VSC/Trailer Sway Control is activated**

The slip indicator light flashes. Always drive carefully. Reckless driving may cause an accident. Exercise particular care when the indicator light flashes.

■ **When the TRAC or Active TRAC/VSC/Trailer Sway Control systems are turned off**

Be especially careful and drive at a speed appropriate to the road conditions. As these are the systems to help ensure vehicle stability and driving force, do not turn the TRAC or Active TRAC/VSC/Trailer Sway Control systems off unless necessary.

 CAUTION

■ **Replacing tires**

Make sure that all tires are of the same size, brand, tread pattern and total load capacity. In addition, make sure that the tires are inflated to the recommended tire inflation pressure level.

The ABS/Multi Terrain ABS, TRAC/Active TRAC and VSC/Trailer Sway Control will not function correctly if different tires are installed on the vehicle.

Contact your Lexus dealer for further information when replacing tires or wheels.

■ **Handling of tires and the suspension**

Using tires with any kind of problem or modifying the suspension will affect the driving assist systems, and may cause the system to malfunction.

■ **Trailer Sway Control precaution**

The Trailer Sway Control system is not able to reduce trailer sway in all situations. Depending on many factors such as the conditions of the vehicle, trailer, road surface, and driving environment, the Trailer Sway Control system may not be effective. Refer to your trailer owner's manual for information on how to tow your trailer properly.

■ **If trailer sway occurs**

Observe the following precautions.

Failing to do so may cause death or serious injury.

- Firmly grip the steering wheel. Steer straight ahead.

Do not try to control trailer swaying by turning the steering wheel.

- Begin releasing the accelerator pedal immediately but very gradually to reduce speed.

Do not increase speed. Do not apply vehicle brakes.

If you make no extreme correction with the steering or brakes, your vehicle and trailer should stabilize. (→P. 184)



BSM (Blind Spot Monitor)*

Summary of the Blind Spot Monitor

The Blind Spot Monitor is a system that has 2 functions;

- The Blind Spot Monitor function
Assists the driver in making the decision when changing lanes
- The Rear Cross Traffic Alert function
Assists the driver when backing up

These functions use same sensors.

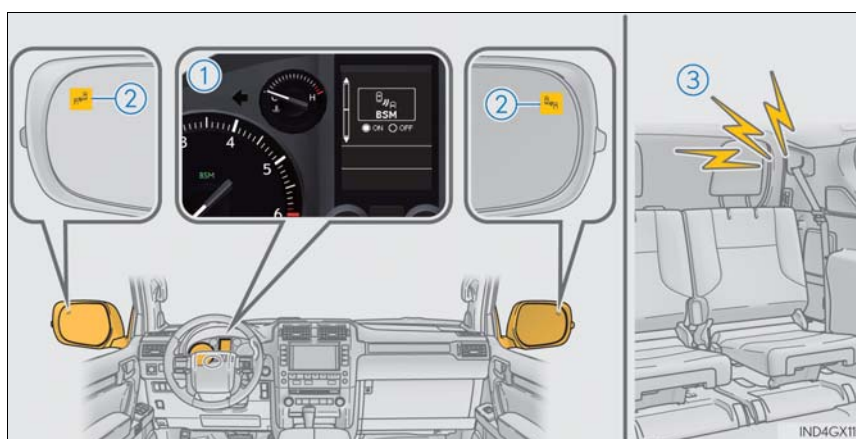

4

Driving

*: If equipped



① The Blind Spot Monitor on/off screen and indicator

The Blind Spot Monitor system can be turned on/off on the multi-information display. When the system is set to on, the indicator illuminates in the meter. The Blind Spot Monitor function and the Rear Cross Traffic Alert function are turned on/off simultaneously.

② Outside rear view mirror indicator

The Blind Spot Monitor function:

When a vehicle is detected in the blind spot, the outside rear view mirror indicator comes on while the turn signal lever is not operated. If the turn signal lever is operated toward the detected side, the outside rear view mirror indicator flashes.

The Rear Cross Traffic Alert function:

When a vehicle approaching from the right or left rear of the vehicle is detected, the outside rear view mirror indicators flash.

③ The Rear Cross Traffic Alert buzzer (The Rear Cross Traffic Alert function only)

When a vehicle approaching from the right or left rear of the vehicle is detected, a buzzer sounds from behind the rear seat.



Turning the Blind Spot Monitor system on

- 1 Display the Blind Spot Monitor on/off screen.

- ① Press the menu switch.
The multi-information display will change modes to electronic features control mode.
- ② Press the "ENTER" switch upwards or downwards until "BSM" appears in the multi-information display.

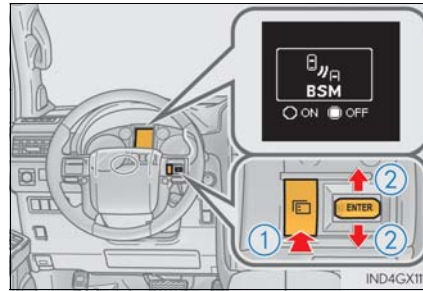

- 2 Press the "ENTER" switch to change to "ON".
"BSM" indicator will be displayed.

Each pressing of the switch turns the Blind Spot Monitor on and off.

When on, the buzzer sounds to inform the driver that the system is operational. Press the menu switch to change to the normal display.

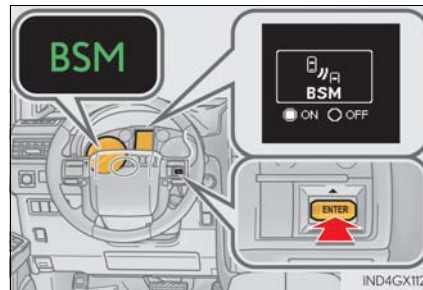

4

Driving

■ **The outside rear view mirror indicators visibility**

When under strong sunlight, the outside rear view mirror indicator may be difficult to see.

■ **The Rear Cross Traffic Alert buzzer hearing**

The Rear Cross Traffic Alert buzzer may be difficult to hear over loud noises such as high audio volume.

■ **When there is a malfunction in the Blind Spot Monitor**

If a system malfunction is detected due to any of the following reasons, warning messages will be displayed: (→P. 531, 532)

- There is a malfunction with the sensors
- The sensors have become dirty
- The outside temperature is extremely high or low
- The sensor voltage has become abnormal

■ **Certification for the Blind Spot Monitor**

- ▶ For vehicles sold in the U.S.A., Hawaii, Guam, Puerto Rico and Saipan

FCC ID : OAYSRR2A

This device complies with part 15 of the FCC Rules. Operation is subject to the following two conditions:
(1) This device may not cause harmful interference, and
(2) this device must accept any interference received, including interference that may cause undesired operation.

FCC Warning

Changes or modifications not expressly approved by the party responsible for compliance could void the user's authority to operate the equipment.

- ▶ For vehicles sold in Canada

Applicable law : Canada 310

This device complies with Industry Canada licence-exempt RSS standard(s). Operation is subject to the following two conditions: (1) this device may not cause interference, and (2) this device must accept any interference, including interference that may cause undesired operation of the device.

Frequency bands : 24.05 - 24.25GHz

Output power : less than 20 milliwatts



CAUTION**■ Handling the radar sensor**

One Blind Spot Monitor sensor is installed inside the left and right side of the vehicle rear bumper respectively. Observe the following to ensure the Blind Spot Monitor can function correctly.

- Keep the sensor and its surrounding area on the bumper clean at all times.

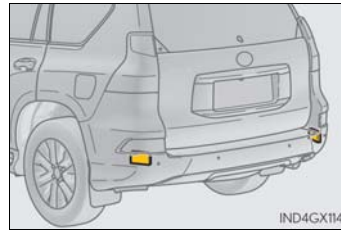

- Do not subject the sensor or surrounding area on the bumper to a strong impact. If the sensor moves even slightly off position, the system may malfunction and vehicles that enter the detection area may not be detected. If the sensor or surrounding area is subject to a strong impact, always have the area inspected by your Lexus dealer.
- Do not disassemble the sensor.
- Do not attach accessories or stickers to the sensor or surrounding area on the bumper.
- Do not modify the sensor or surrounding area on the bumper.
- Do not paint the rear bumper any color other than an official Lexus color.
- If the sensor needs to be replaced, contact your Lexus dealer.

The Blind Spot Monitor function

The Blind Spot Monitor function uses radar sensors to detect vehicles that are traveling in an adjacent lane in the area that is not reflected in the outside rear view mirror (the blind spot), and advises the driver of the vehicles existence via the outside rear view mirror indicator.

The Blind Spot Monitor function detection areas

The areas that vehicles can be detected in are outlined below.

The range of the detection area extends to:

- ① Approximately 11.5 ft. (3.5 m) from the side of the vehicle
The first 1.6 ft. (0.5 m) from the side of the vehicle is not in the detection area
- ② Approximately 9.8 ft. (3 m) from the rear bumper
- ③ Approximately 3.3 ft. (1 m) forward of the rear bumper

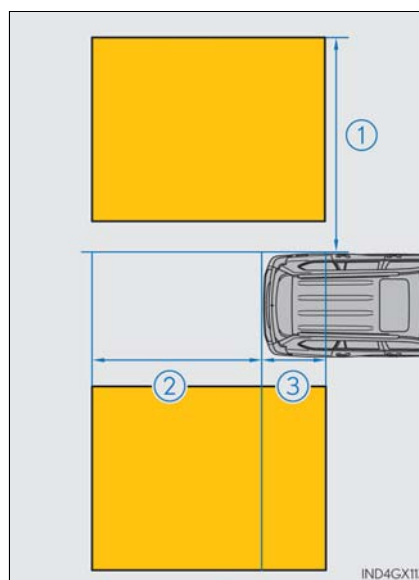

CAUTION

■ Cautions regarding the use of the system

The driver is solely responsible for safe driving. Always drive safely, taking care to observe your surroundings.

The Blind Spot Monitor function is a supplementary function which alerts the driver that a vehicle is present in the blind spot. Do not overly rely on the Blind Spot Monitor function. The function cannot judge if it is safe to change lanes, therefore over reliance could cause an accident resulting in death or serious injury.

According to conditions, the system may not function correctly. Therefore the driver's own visual confirmation of safety is necessary.

■ The Blind Spot Monitor function is operational when

- The Blind Spot Monitor system turned on.
- Vehicle speed is greater than approximately 10 mph (16 km/h).

■ The Blind Spot Monitor function will detect a vehicle when

- A vehicle in an adjacent lane overtakes your vehicle.
- Another vehicle enters the detection area when it changes lanes.

■ Conditions under which the Blind Spot Monitor function will not detect a vehicle

The Blind Spot Monitor function is not designed to detect the following types of vehicles and/or objects:

- Small motorcycles, bicycles, pedestrians etc.*
- Vehicles traveling in the opposite direction
- Guardrails, walls, signs, parked vehicles and similar stationary objects*
- Following vehicles that are in the same lane*
- Vehicles driving 2 lanes across from your vehicle*

*: Depending on conditions, detection of a vehicle and/or object may occur.

■ Conditions under which the Blind Spot Monitor function may not function correctly

- The Blind Spot Monitor function may not detect vehicles correctly in the following conditions:
 - During bad weather such as heavy rain, fog, snow etc.
 - When ice or mud etc. is attached to the rear bumper
 - When driving on a road surface that is wet due to rain, standing water etc.
 - When there is a significant difference in speed between your vehicle and the vehicle that enters the detection area
 - When a vehicle is in the detection area from a stop and remains in the detection area as your vehicle accelerates
 - When driving up or down consecutive steep inclines, such as hills, a dip in the road etc.
 - When multiple vehicles approach with only a small gap between each vehicle
 - When vehicle lanes are wide, and the vehicle in the next lane is too far away from your vehicle
 - When the vehicle that enters the detection area is traveling at about the same speed as your vehicle
 - When there is a significant difference in height between your vehicle and the vehicle that enters the detection area
 - Directly after the Blind Spot Monitor system turned on
 - When your vehicle is towing a trailer
 - When items such as a bicycle carrier are installed on the rear of the vehicle
- Instances of the Blind Spot Monitor function unnecessarily detecting a vehicle and/or object may increase under the following conditions:
 - When there is only a short distance between your vehicle and a guardrail, wall etc.
 - When there is only a short distance between your vehicle and a following vehicle
 - When vehicle lanes are narrow and a vehicle driving 2 lanes across from your vehicle enters the detection area
 - When items such as a bicycle carrier are installed on the rear of the vehicle



The Rear Cross Traffic Alert function

The Rear Cross Traffic Alert functions when your vehicle is in reverse. It can detect other vehicles approaching from the right or left rear of the vehicle. It uses radar sensors to alert the driver of the other vehicle's existence through flashing the outside rear view mirror indicators and sounding a buzzer.

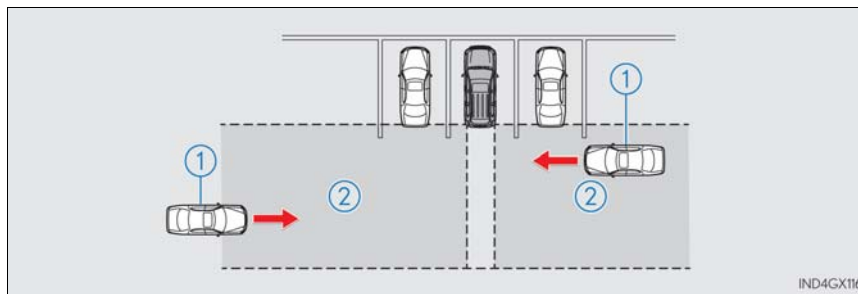

① Approaching vehicles

② Detection areas

⚠ CAUTION

■ Cautions regarding the use of the system

The driver is solely responsible for safe driving. Always drive safely, taking care to observe your surroundings.

The Rear Cross Traffic Alert function is only an assist and is not a replacement for careful driving. Driver must be careful when backing up, even when using the Rear Cross Traffic Alert function. The driver's own visual confirmation of behind you and your vehicle is necessary and be sure there are no pedestrians, other vehicles etc. before backing up. Failure to do so could cause death or serious injury.

According to conditions, the system may not function correctly. Therefore the driver's own visual confirmation of safety is necessary.

4

Driving

The Rear Cross Traffic Alert function detection areas

The areas that vehicles can be detected in are outlined below.

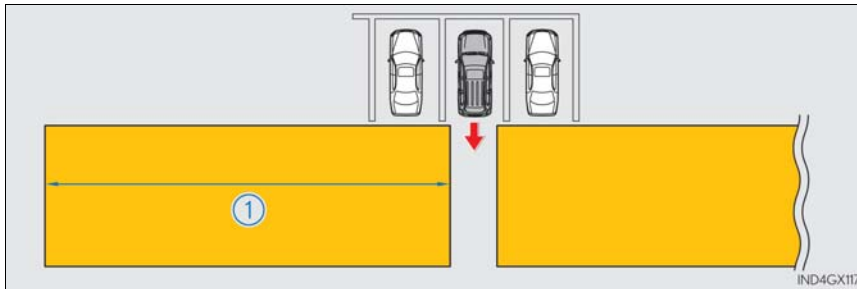

To give the driver a more consistent time to react, the buzzer can alert for faster vehicles from farther away.

Example:

Approaching vehicle	Speed	① Approximate alert distance
Fast	18 mph (28 km/h)	65 ft. (20 m)
Slow	5 mph (8 km/h)	18 ft. (5.5 m)

■ **The Rear Cross Traffic Alert function is operational when**

- The Blind Spot Monitor system turned on.
- The shift lever is in R.
- Vehicle speed is less than approximately 5 mph (8 km/h).
- Approaching vehicle speed is between approximately 5 mph (8 km/h) and 18 mph (28 km/h).



■ Conditions under which the Rear Cross Traffic Alert function will not detect a vehicle

The Rear Cross Traffic Alert function is not designed to detect the following types of vehicles and/or objects.

- Small motorcycles, bicycles, pedestrians etc.*
- Vehicles approaching from directly behind
- Guardrails, walls, signs, parked vehicles and similar stationary objects*
- Vehicles moving away from your vehicle
- Vehicles approaching from the parking spaces next to your vehicle*
- Vehicles backing up in the parking space next to your vehicle*

*: Depending on conditions, detection of a vehicle and/or object may occur.

■ Conditions under which the Rear Cross Traffic Alert function may not function correctly

The Rear Cross Traffic Alert function may not detect vehicles correctly in the following conditions:

- During bad weather such as heavy rain, fog, snow etc.
- When ice or mud etc. is attached to the rear bumper
- When multiple vehicles approach continuously
- Shallow angle parking
- When a vehicle is approaching at high speed
- When parking on a steep incline, such as hills, a dip in the road etc.
- Directly after the Blind Spot Monitor system turned on
- When your vehicle is towing a trailer
- When items such as a bicycle carrier are installed on the rear of the vehicle
- Directly after the engine is started with the BSM main switch on
- When the sensors cannot detect vehicles because of obstacles

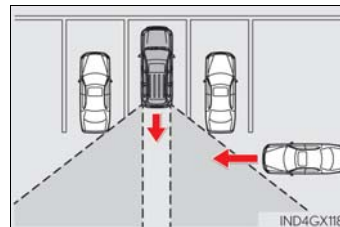

PCS (Pre-Collision system)*

When the radar sensor detects possibility of a frontal collision, the pre-collision system such as the brakes and seat belts are automatically engaged to lessen impact as well as vehicle damage.

◆ Pre-collision seat belts (front seat belts only)

If the system detects that a collision is unavoidable, the system will retract the seat belt before the collision occurs.

The same will happen if the driver makes an emergency braking or loses control of the vehicle. (→P. 31)

However, when the VSC system is disabled, the system will not operate in the event of skidding.

◆ Pre-collision brake assist

When there is a high possibility of a frontal collision, the system applies greater braking force in relation to how strongly the brake pedal is depressed.

◆ Pre-collision braking

When there is a high possibility of a frontal collision, the system warns the driver using a warning light, warning display and buzzer. If the system determines that a collision is unavoidable, the brakes are automatically applied to reduce the collision speed. Pre-collision braking can be disabled using the pre-collision braking off switch.

◆ AVS (Adaptive Variable Suspension System) control (if equipped)

When the system determines that there is a high possibility of a frontal collision, the AVS optimizes the damping effect (→P. 341)

*: If equipped



◆ Driver monitor system (if equipped)

When the system determines that there is a possibility of a collision with the vehicle in front, and the driver is not facing forward, PCS warnings are given in advance to warn the driver. If the driver continues to not be facing forward, and a high possibility of a collision with the vehicle in front is detected, PCS informs the driver of high possibility of a collision with the vehicle in front by performing slight braking to provide a physical warning (pre-collision alert braking).

Disabling pre-collision braking

- ① Pre-collision braking disabled
- ② Pre-collision braking enabled

The "PCS" warning light turns on when pre-collision braking is disabled.



4

Driving

Radar sensor

The radar sensor detects vehicles or other obstacles on or near the road ahead and determines whether a collision is imminent based on the position, speed, and heading of the obstacles.

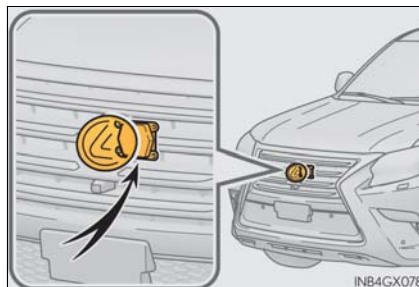

Driver monitor sensor (if equipped)

The driver monitor sensor detects the direction the driver is facing. The system determines whether the driver is facing forward.

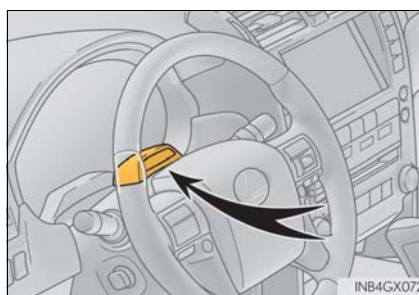

■ The pre-collision system is operational when

- Pre-collision seat belts (situation 1):
 - Vehicle speed is greater than about 4 mph (5 km/h).
 - The speed at which your vehicle is approaching the obstacle or the vehicle running ahead of you is greater than about 19 mph (30 km/h).
 - The front occupants are wearing a seat belt.
- Pre-collision seat belts (situation 2):
 - Vehicle speed is greater than about 19 mph (30 km/h).
 - The system detects sudden braking or skidding.
 - The front occupants are wearing a seat belt.
- Pre-collision brake assist:
 - Vehicle speed is greater than about 19 mph (30 km/h).
 - The speed at which your vehicle is approaching the obstacle or the vehicle running ahead of you is greater than about 19 mph (30 km/h).
 - The brake pedal is depressed.
- Pre-collision braking:
 - The pre-collision braking off switch is not pressed.
 - Vehicle speed is greater than about 10 mph (15 km/h).
 - The speed at which your vehicle is approaching the obstacle or the vehicle running ahead of you is greater than about 10 mph (15 km/h).
- AVS (Adaptive Variable Suspension System) control (if equipped):
 - Vehicle speed is greater than about 4 mph (5 km/h).
 - The speed at which your vehicle is approaching the obstacle or the vehicle running ahead of you is greater than about 19 mph (30 km/h).
- Pre-collision alert braking (vehicles with driver monitor system):
 - The system determines that the driver is not facing forward.
 - The speed at which your vehicle is approaching the vehicle running ahead of you is greater than about 25 mph (40 km/h).
 - Vehicle speed is greater than about 25 mph (40 km/h).
 - The pre-collision braking off switch is not pressed.
 - The steering is not being turned.

■ Situations in which the pre-collision system does not function properly

The system may not function effectively in situations such as the following:

- On roads with sharp bends or uneven surfaces
- If a vehicle suddenly moves in front of your vehicle, such as at an intersection
- If a vehicle suddenly cuts in front of your vehicle, such as when overtaking
- In inclement weather such as heavy rain, fog, snow or sand storms
- When your vehicle is skidding with the VSC system off
- When an extreme change in vehicle height occurs
- When the axis of the radar is out of adjustment



■ Automatic cancelation of pre-collision system

When a malfunction occurs due to sensor contaminations, etc. that results in the sensors being unable to detect obstacles, the pre-collision system will be automatically disabled. In this case, the system will not activate even if there is a collision possibility.

■ Obstacles not detected

The system cannot detect plastic obstacles such as pylons. There may also be occasions when the system cannot detect pedestrians, animals, bicycles, motorcycles, trees, or snowdrifts.

■ Conditions that may trigger the system even if there is no possibility of a collision

In any of the following situations where the frontal area of the radar sensor is interrupted, the radar sensor may detect possibility of a frontal collision and the system may be activated.

- When passing by an oncoming vehicle in a curve or a turn to the right or the left
- When rapidly approaching an obstacle ahead (e.g. preceding vehicle, toll gate barrier, etc.)
- When there is a structural object (billboard, low ceiling, fluorescent light, etc.) above the uphill road ahead
- When driving on a narrow road or through under a low overhead structure (bridge, tunnel, fly-under, etc.)
- When driving on an uneven road surface
- When there is a metal object, bump, or protrusion on the road surface
- When vehicle's front part is raised or lowered depending on loading conditions
- When the direction of radar sensor is misaligned by strong impact applied on an area around the radar sensor, etc.
- When there is an obstacle (guard rail, etc.) by the roadside at the entrance to a curve
- When the front of your vehicle is pointing upwards (caused by towing a trailer, during emergency towing or putting a heavy load in the luggage compartment etc.)

When the system is activated in the situations described above, there is also a possibility that the seat belts will retract quickly and the brakes may be applied with a force greater than normal. When the seat belt is locked in the restricted position, stop the vehicle in a safe place, release the seat belt and refasten it.

■ When there is a malfunction in the system, or if the system is temporarily unusable

Warning lights will turn on or flash, and warning messages will be displayed.
(→P. 521, 532)



■ Certification

- ▶ For vehicles sold in the U.S.A., Hawaii, Guam, Saipan and Puerto Rico

FCC ID : HYQDNMWR004

This device complies with part 15 of the FCC Rules. Operation is subject to the following two conditions :
(1) This device may not cause harmful interference, and (2) this device must accept any interference received, including interference that may cause undesired operation.

FCC WARNING

Changes or modifications not expressly approved by the party responsible for compliance could void the user's authority to operate the equipment.

Radiofrequency radiation exposure Information:

This equipment complies with FCC radiation exposure limits set forth for an uncontrolled environment. This equipment should be installed and operated with minimum distance of 20 cm between the radiator (antenna) and your body. This transmitter must not be co-located or operating in conjunction with any other antenna or transmitter.

- ▶ For vehicles sold in Canada

This device complies with Industry Canada licence-exempt RSS standard(s).

Operation is subject to the following two conditions:

- (1) this device may not cause interference, and
- (2) this device must accept any interference, including interference that may cause undesired operation of the device.



 CAUTION**■ Limitations of the pre-collision system**

The driver is solely responsible for safe driving. Always drive safely, taking care to observe your surroundings.

Do not use the pre-collision system instead of normal braking operations under any circumstances. This system will not prevent collisions or lessen damage or injuries in all cases. Do not overly rely on this system. Failure to do so may cause an accident, resulting in death or serious injury.

This system has been designed to help avoid and reduce the impact of collisions. However, the system operates differently depending on the situation (→P. 371, 372). As a result, the same level of performance may not be expected in all cases. Also, the pre-collision brakes may not operate if the driver is depressing the brake pedal or turning the steering wheel, as the system will determine such conditions as collision avoidance operations.

■ Cautions regarding the assist contents of the system

By means of alarms and brake control, the pre-collision system is intended to assist the driver in avoiding collisions through the process of LOOK-JUDGE-ACT. There are limits to the degree of assistance the system can provide, so please keep in mind the following important points.

● Assisting the driver in watching the road

The pre-collision system is only able to detect obstacles directly in front of the vehicle, and only within a limited range. It is not a mechanism that allows careless or inattentive driving, and it is not a system that can assist the driver in low-visibility conditions. It is still necessary for the driver to pay close attention to the vehicle's surroundings.

● Assisting the driver in making correct judgment

When attempting to estimate the possibility of a collision, the only data available to the pre-collision system is that from obstacles it has detected directly in front of the vehicle. Therefore, it is absolutely necessary for the driver to remain vigilant and to determine whether or not there is a possibility of collision in any given situation.

● Assisting the driver in taking action

The pre-collision system's braking assist feature is designed to help reduce the severity of a collision, and so only acts when the system has judged that a collision is unavoidable. This system is not capable of automatically avoiding a collision or bringing the vehicle to a stop safely without appropriate operations performed by the driver. For this reason, when encountering a dangerous situation the driver must take direct and immediate action in order to ensure the safety of all involved.

 CAUTION**■ When the sensor may not be correctly detecting the vehicle ahead**

Apply the brakes as necessary in any of the following situations.

- When water or snow thrown up by the surrounding vehicles hinders the functioning of the sensor
- When your vehicle is pointing upwards (caused by a heavy load in the luggage compartment etc.)
- Vehicles that cut in suddenly
- Vehicles with small rear ends (trailers with no load on board etc.)
- Motorcycles traveling in the same lane

■ Handling the radar sensor

Observe the following to ensure the pre-collision system can function effectively:

- Keep the sensor and front grille cover clean at all times.
Clean the sensor and front grille cover with a soft cloth so you do not mark or damage them.
- Do not subject the sensor or surrounding area to a strong impact.
If the sensor moves even slightly off position, the system may become inaccurate or malfunction. If the sensor or surrounding area is subject to a strong impact, always have the area inspected and adjusted by your Lexus dealer.
- Do not disassemble the sensor.
- Do not attach accessories or stickers to the sensor, grille cover or surrounding area.
- Do not modify or paint the sensor and grille cover.
- If the sensor needs to be replaced, contact your Lexus dealer.

 CAUTION**■ Handling the driver monitor sensor (vehicles with driver monitor sensor)**

Observe the following to ensure the driver monitor sensor can function effectively. Failure to do so may result in a malfunction or may prevent the system from correctly determining the direction the driver is facing, resulting in an unexpected accident.

- Do not disassemble, damage, lift or pull on the sensor.
- Do not touch the sensor while driving.
- Do not wet or spill water on the sensor.
- Do not drop anything on or allow anything to hit against the sensor. Do not subject the sensor to an impact.
- Make sure that there are no scratches, dirt or stickers on the side of the sensor that faces the driver.
- Do not place any objects in front of the side of the sensor that faces the driver or cover the sensor.

■ Determining the direction the driver is facing (vehicles with driver monitor sensor)

The direction the driver is facing may not be determined correctly if the following conditions exist:

- There is an object between the driver monitor sensor and the driver's face, such as when the sensor is blocked.
- A part of the driver's face is covered.
- The sensor or the driver's face is exposed to intense light such as sunlight.
- The driving posture is improper.

 NOTICE**■ Precautions for cleaning the driver monitor sensor (vehicles with driver monitor sensor)**

- Gently wipe the sensor with a soft cloth to prevent damage.
- Wipe any excess dirt with a cloth dampened with neutral detergent, all liquids having been wrung out of the cloth. After that, wipe again with a dry cloth.
- Do not use benzene, thinner, glass cleaners, wax, etc.

Winter driving tips

Carry out the necessary preparations and inspections before driving the vehicle in winter. Always drive the vehicle in a manner appropriate to the prevailing weather conditions.

Pre-winter preparations

- Use fluids that are appropriate to the prevailing outside temperatures.
 - Engine oil
 - Engine coolant
 - Washer fluid
- Have a service technician inspect the condition of the battery.
- Have the vehicle fitted with four snow tires or purchase a set of tire chains for the rear tires.

Ensure that all tires are the same size and brand, and that chains match the size of the tires.

Before driving the vehicle

Perform the following according to the driving conditions:

- Do not try to forcibly open a window or move a wiper that is frozen. Pour warm water over the frozen area to melt the ice. Wipe away the water immediately to prevent it from freezing.
- To ensure proper operation of the climate control system fan, remove any snow that has accumulated on the air inlet vents in front of the windshield.
- Check for and remove any excess ice or snow that may have accumulated on the exterior lights, vehicle's roof, chassis, around the tires or on the brakes.
- Remove any snow or mud from the bottom of your shoes before getting in the vehicle.

When driving the vehicle

Accelerate the vehicle slowly, keep a safe distance between you and the vehicle ahead, and drive at a reduced speed suitable to road conditions.

When parking the vehicle

- Park the vehicle and move the shift lever to P without setting the parking brake. The parking brake may freeze up, preventing it from being released. If the vehicle is parked without setting the parking brake, make sure to block the wheels.

Failure to do so may be dangerous because it may cause the vehicle to move unexpectedly, possibly leading to an accident.

- If the vehicle is parked without setting the parking brake, confirm that the shift lever cannot be moved out of P*.

*: The shift lever will be locked if it is attempted to be shifted from P to any other position without depressing the brake pedal. If the shift lever can be shifted from P, there may be a problem with the shift lock system. Have the vehicle inspected by your Lexus dealer immediately.

Selecting tire chains

Use the correct tire chain size when mounting the snow chains.

Chain size is regulated for each tire size.

- ① Side chain
(0.20 in. [5 mm] in diameter)
- ② Cross chain
(0.25 in. [6.3 mm] in diameter)

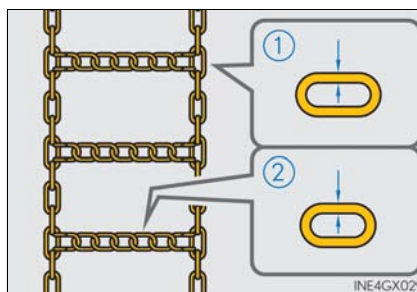

Regulations on the use of tire chains

Regulations regarding the use of tire chains vary depending on location and type of road. Always check local regulations before installing chains.

■ Tire chain installation

Observe the following precautions when installing and removing chains:

- Install and remove tire chains in a safe location.
- Install tire chains on the rear tires. Do not install tire chains on the front tires.
- Install tire chains on rear tires as tightly as possible. Retighten chains after driving 1/4 - 1/2 mile (0.5 - 1.0 km).
- Install tire chains following the instructions provided with the tire chains.

⚠ CAUTION**■ Driving with snow tires**

Observe the following precautions to reduce the risk of accidents.

Failure to do so may result in a loss of vehicle control and cause death or serious injury.

- Use tires of the specified size.
- Maintain the recommended level of air pressure.
- Do not drive in excess of 75 mph (120 km/h), regardless of the type of snow tires being used.
- Use snow tires on all, not just some wheels.
- Do not use LDA (Lane Departure Alert) system. (if equipped)

■ Driving with tire chains

Observe the following precautions to reduce the risk of accidents.

Failing to do so may result in the vehicle being unable to be driven safely, and may cause death or serious injury.

- Do not drive in excess of the speed limit specified for the tire chains being used, or 30 mph (50 km/h), whichever is lower.
- Avoid driving on bumpy road surfaces or over potholes.
- Avoid sudden acceleration, abrupt steering, sudden braking and shifting operations that cause sudden engine braking.
- Slow down sufficiently before entering a curve to ensure that vehicle control is maintained.
- Do not use LDA (Lane Departure Alert) system. (if equipped)

⚠ NOTICE**■ Repairing or replacing snow tires**

Request repairs or replacement of snow tires from Lexus dealers or legitimate tire retailers.

This is because the removal and attachment of snow tires affects the operation of the tire pressure warning valves and transmitters.

■ Fitting tire chains

The tire pressure warning valves and transmitters may not function correctly when tire chains are fitted.

Off-road precautions

This vehicle belongs to the utility vehicle class, which has higher ground clearance and narrower tread in relation to the height of its center of gravity to make it capable of performing in a wide variety of off-road applications.

Off-road vehicle features

- Specific design characteristics give it a higher center of gravity than ordinary passenger cars. This vehicle design feature causes this type of vehicle to be more likely to rollover. And, utility vehicles have a significantly higher rollover rate than other types of vehicles.
- An advantage of the higher ground clearance is a better view of the road allowing you to anticipate problems.
- It is not designed for cornering at the same speeds as ordinary passenger cars any more than low-slung sports cars are designed to perform satisfactorily under off-road conditions. Therefore, sharp turns at excessive speeds may cause the vehicle to rollover.



 CAUTION**■ Off-road vehicle precautions**

Always observe the following precautions to minimize the risk of death, serious injury or damage to your vehicle:

- In a rollover crash, an unbelted person is significantly more likely to die than a person wearing a seat belt. Therefore, the driver and all passengers should always fasten their seat belts.
- Avoid sharp turns or abrupt maneuvers, if at all possible.
Failure to operate this vehicle correctly may result in loss of control or vehicle rollover causing death or serious injury.
- Loading cargo on the roof luggage carrier will make the center of the vehicle gravity higher. Avoid high speeds, sudden starts, sharp turns, sudden braking or abrupt maneuvers, otherwise it may result in loss of control or vehicle rollover due to failure to operate this vehicle correctly.
- Always slow down in gusty crosswinds. Because of its profile and higher center of gravity, your vehicle is more sensitive to side winds than an ordinary passenger car. Slowing down will allow you to have better control.
- Do not drive horizontally across steep slopes. Driving straight up or straight down is preferred. Your vehicle (or any similar off-road vehicle) can tip over sideways much more easily than forward or backward.

Off-road driving

When driving your vehicle off-road, please observe the following precautions to ensure your driving enjoyment and to help prevent the closure of areas to off-road vehicles:

- Drive your vehicle only in areas where off-road vehicles are permitted to travel.
- Respect private property. Get owner's permission before entering private property.
- Do not enter areas that are closed. Honor gates, barriers and signs that restrict travel.
- Stay on established roads. When conditions are wet, driving techniques should be changed or travel delayed to prevent damage to roads.

■ Additional information for off-road driving

► For owners in U.S. mainland, Hawaii and Puerto Rico:

To obtain additional information pertaining to driving your vehicle off-road, consult the following organizations:

- State and Local Parks and Recreation Departments
- State Motor Vehicle Bureau
- Recreational Vehicle Clubs
- U.S. Forest Service and Bureau of Land Management



 **CAUTION****■ Off-road driving precautions**

Always observe the following precautions to minimize the risk of death, serious injury or damage to your vehicle:

- Drive carefully when off the road. Do not take unnecessary risks by driving in dangerous places.
- Do not grip the steering wheel spokes when driving off-road. A bad bump could jerk the wheel and injure your hands. Keep both hands and especially your thumbs on the outside of the rim.
- Always check your brakes for effectiveness immediately after driving in sand, mud, water or snow.
- After driving through tall grass, mud, rock, sand, rivers, etc., check that there is no grass, bush, paper, rags, stone, sand, etc. adhering or trapped on the underbody. Clear off any such matter from the underbody. If the vehicle is used with these materials trapped or adhering to the underbody, a breakdown or fire could occur.
- When driving off-road or in rugged terrain, do not drive at excessive speeds, jump, make sharp turns, strike objects, etc. This may cause loss of control or vehicle rollover causing death or serious injury. You are also risking expensive damage to your vehicle's suspension and chassis.

 NOTICE**■ To prevent the water damage**

Take all necessary safety measures to ensure that water damage to the engine or other components does not occur.

- Water entering the engine air intake will cause severe engine damage.
- Water entering the automatic transmission will cause deterioration in shift quality, locking up of your transmission accompanied by vibration, and ultimately damage.
- Water can wash the grease from wheel bearings, causing rusting and premature failure, and may also enter the differentials, transmission and transfer case, reducing the gear oil's lubricating qualities.

■ When you drive through water

If driving through water, such as when crossing shallow streams, first check the depth of the water and the bottom of the riverbed for firmness. Drive slowly and avoid deep water.

■ Inspection after off-road driving

- Sand and mud that has accumulated in brake drums and around brake discs may affect braking efficiency and may damage brake system components.
- Always perform a maintenance inspection after each day of off-road driving that has taken you through rough terrain, sand, mud, or water. For scheduled maintenance information, refer to the "Warranty and Services Guide", "Owner's Manual Supplement" or "Scheduled Maintenance".

Interior features

5

5-1. Using the air conditioning system and defogger	
Front automatic air conditioning system	386
Rear air conditioning system	396
Heated steering wheel/seat heaters/seat ventilators.....	399
5-2. Using the interior lights	
Interior lights list.....	402
• Personal/interior lights main switch	403
• Personal/interior lights.....	404
5-3. Using the storage features	
List of storage features	405
• Glove box	406
• Console box.....	406
• Coin holder	408
• Cup holders/bottle holders/door pockets.....	408
• Auxiliary boxes	410
Luggage compartment features	412
5-4. Using the other interior features	
Other interior features	419
• Cool box.....	419
• Sun visors	421
• Vanity mirror.....	421
• Conversation mirror	422
• Clock	422
• Power outlets.....	423
• Armrest.....	427
• Coat hooks.....	428
• Assist grips.....	428
• Compass	429
Garage door opener	433
LEXUS Enform Safety Connect.....	439



Front automatic air conditioning system

Air outlets and fan speed are automatically adjusted according to the temperature setting.

Press the "CLIMATE" button to display the air conditioning control screen.

◆ Control panel



◆ Control screen



▶ Without a navigation system





▶ With a navigation system



■ Adjusting the temperature setting

Press  to increase the temperature and  to decrease the temperature.

■ Adjusting the fan speed setting

Press  to increase the fan speed and  to decrease the fan speed.

Press the "OFF" button to turn the fan off.

■ Changing the air flow mode

Select an air outlet switch.

■ Option control screen

Touch  on the climate screen to display the option control screen. The functions can be switched on and off.

- ① Select to set cooling and dehumidification function on/off
- ② Adjust the temperature for driver and passenger seats separately ("DUAL" mode)/driver, passenger and rear seats separately ("3-ZONE" mode) (→P. 388)
- ③ Prevent ice from building up on the windshield and wiper blades (if equipped) (→P. 391)
- ④ Remove pollen from the air (→P. 391)



Using the speech command system

Press  to operate the speech command system. (Refer to the "NAVIGATION SYSTEM OWNER'S MANUAL".)

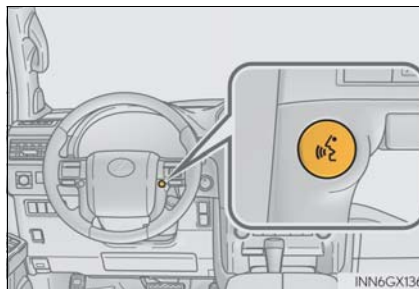

Air conditioning controls

■ Using the automatic mode

- 1 Press the "AUTO" button.
- 2 Press  to switch to automatic air intake mode. (if equipped)

The air conditioning system automatically switches between outside air and recirculated air modes.

- 3 Adjust the temperature setting.
- 4 To stop the operation, press the "OFF" button.

■ Automatic mode indicator

If the fan speed setting or air flow modes are operated, the automatic mode indicator goes off. However, automatic mode for functions other than that operated is maintained.

■ Adjusting the temperature for driver and passenger seats separately ("DUAL" mode)/driver, passenger and rear seats separately ("3-ZONE" mode)

To turn on the "DUAL"/"3-ZONE" mode, perform any of the following procedures:

- Press the "DUAL"/"3-ZONE" button.
- Select "DUAL"/"3-ZONE" on the option control screen.
- Adjust the passenger's side temperature setting.

The indicator comes on when the "DUAL"/"3-ZONE" mode is on.

While in "DUAL" mode, the temperature of the rear air outlets is set at the passenger's side temperature setting.

Changing the rear seat settings (vehicles with rear air conditioning system)

Touch  to display the rear air conditioning control screen.

■ Control screen

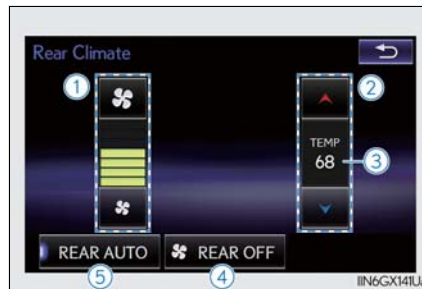

▶ Without a navigation system

▶ With a navigation system



- ① Adjust the fan speed setting
- ② Adjust the rear seats temperature setting
- ③ Display the rear seats temperature setting
- ④ Turn the fan off
- ⑤ Select to set automatic mode

■ Using the automatic mode

- 1 Touch "REAR AUTO".
- 2 Touch  to increase the temperature and  to decrease the temperature.
- 3 To stop the operation, touch "REAR OFF".

■ If the system is operated manually in automatic mode



If the fan speed setting is operated, the automatic mode indicator goes off. However, automatic mode for functions other than that operated are maintained.

Other functions

■ Switching between outside air and recirculated air modes



- ▶ Vehicles without rear air conditioning system

Press  .

The mode switches between  (recirculated air mode) and  (outside air mode) modes each time the button is pressed.

- ▶ Vehicles with rear air conditioning system

Press  .

The mode switches among  (recirculated air mode), automatic and  (outside air mode) modes each time the button is pressed.

When the system is switched to automatic mode, the air conditioning system operates automatically.

■ Defogging the windshield

Defoggers are used to defog the windshield and front side windows.

Press  .

Set the outside/recirculated air mode button to outside air mode if the recirculated air mode is used. (It may switch automatically.)

To defog the windshield and the side windows early, turn the air flow and temperature up.

To return to the previous mode,  press again when the windshield is defogged.

■ Defogging the rear window and outside rear view mirrors

Defoggers are used to defog the rear window, and to remove raindrops, dew and frost from the outside rear view mirrors.

Press  .

The defoggers will automatically turn off after a period of time.

■ Micro dust and pollen filter mode

Pollen is removed from the air and the air flows to the upper part of the body.

Touch  on the option control screen.

When the micro dust and pollen filter mode is on,  is displayed on the air conditioning control screen.

In order to prevent the windshield from fogging up when the outside air is cold, the dehumidification function may operate.

The pollens are filtered out even if the micro dust and pollen filter mode is turned off.

■ Windshield wiper de-icer (if equipped)

This feature is used to prevent ice from building up on the windshield and wiper blades.

Touch  on the option control screen.

When the windshield wiper de-icer is on,  is displayed on the air conditioning control screen.

The windshield wiper de-icer will automatically turn off after a period of time.

Air outlets

■ Location of air outlets

The air outlets and air volume changes according to the selected air flow mode.

← : Some models

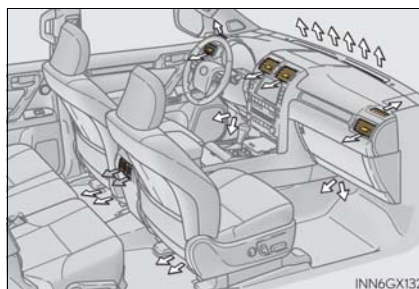

■ Adjusting the air flow direction and opening/closing the air outlets

▶ Front outlets

▶ Rear outlets (vehicles without rear air conditioning system)

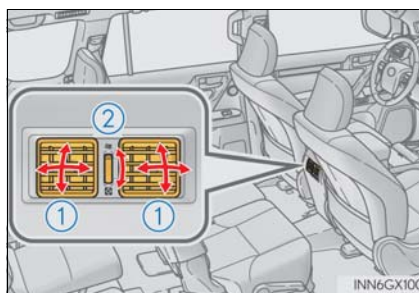
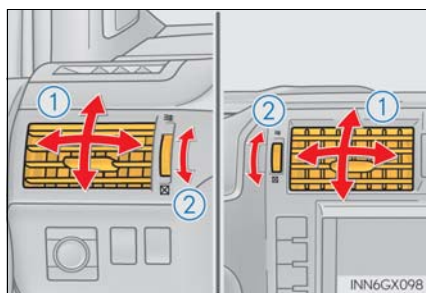

- ① Direct air flow to the left or right, up or down.
- ② Turn the knob to open or close the vent.

■ Registering air conditioning settings to electronic keys

- Unlocking the vehicle using an electronic key and turning the engine switch to IGNITION ON mode will recall that key's registered air conditioning settings.
- When the engine switch is turned off, the current air conditioning settings will automatically be registered to the electronic key that was used to unlock the vehicle.

The system may not operate correctly if more than one electronic key is in the vicinity or if the smart access system with push-button start is used to unlock a passenger door.

Settings for the electronic key and the corresponding door can be changed.
Contact your Lexus dealer.

■ Using automatic mode

Fan speed is adjusted automatically according to the temperature setting and the ambient conditions.

Therefore, the fan may stop for a while until warm or cool air is ready to flow immediately after the "AUTO" button is pressed.

■ When the outside temperature exceeds 75°F (24°C) and the air conditioning system is on

- In order to reduce the air conditioning power consumption, the air conditioning system may switch to recirculated air mode automatically.
This may also reduce fuel consumption.
- Recirculated air mode is selected as a default mode when the engine switch is turned to IGNITION ON mode.
- It is possible to switch to outside air mode at any time by pressing  or



■ Fogging up of the windows

- The windows will easily fog up when the humidity in the vehicle is high. Touching "A/C" on will dehumidify the air from the outlets and defog the windshield effectively.
- If you turn "A/C" off, the windows may fog up more easily.
- The windows may fog up if the recirculated air mode is used.

■ Outside/recirculated air mode

- When driving on dusty roads such as tunnels or in heavy traffic, set the outside/recirculated air mode button to the recirculated air mode. This is effective in preventing outside air from entering the vehicle interior. During cooling operation, setting the recirculated air mode will also cool the vehicle interior effectively.
- Outside/recirculated air mode may automatically switch depending on the temperature setting or the inside temperature.

■ **Automatic mode for air intake control (vehicles with rear air conditioning system)**

In automatic mode, the system detects exhaust gas and other pollutants and automatically switches between outside air and recirculated air modes.

When the dehumidification function is off, and the fan is operating, turning automatic mode on will activate the dehumidification function.

■ **When the outside temperature is low**

The dehumidification function may not operate even when "A/C" is touched.

■ **Ventilation and air conditioning odors**

- To let fresh air in, set the air conditioning system to the outside air mode.
- During use, various odors from inside and outside the vehicle may enter into and accumulate in the air conditioning system. This may then cause odor to be emitted from the vents.
- To reduce potential odors from occurring:
 - It is recommended that the air conditioning system be set to outside air mode prior to turning the vehicle off.
 - The start timing of the blower may be delayed for a short period of time immediately after the air conditioning system is started in automatic mode.

■ **Air conditioning filter**

→P. 489

■ **Customization**

Settings (e.g. A/C automatic mode switch operation) can be changed.
(Customizable features: →P. 594)



CAUTION**■ To prevent the windshield from fogging up**

- Do not use  during cool air operation in extremely humid weather. The difference between the temperature of the outside air and that of the windshield can cause the outer surface of the windshield to fog up, blocking your vision.
- Do not place anything on the instrument panel which may cover the air outlets. Otherwise, air flow may be obstructed, preventing the windshield defoggers from defogging.

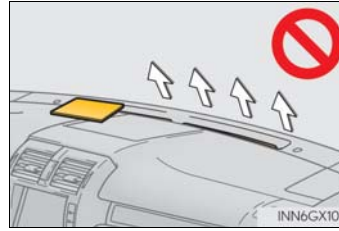
**■ To prevent burns**

- Do not touch the rear view mirror surfaces when the outside rear view mirror defoggers are on.
- Do not touch the glass at lower part of the windshield or to the side of the front pillars when the windshield wiper de-icer is on. (vehicles with windshield wiper de-icer)

NOTICE**■ To prevent battery discharge**

Do not leave the air conditioning system on longer than necessary when the engine is off.

Rear air conditioning system*

Air outlets and fan speed are automatically adjusted according to the temperature setting.



■ Adjusting the temperature setting

Press “^” on the “TEMP” button to increase the temperature and “v” to decrease the temperature.

■ Adjusting the fan speed setting

Press “^” on  to increase the fan speed and “v” to decrease the fan speed.

Press the “OFF” button to turn the fan off.

■ Changing the air flow mode

Press .

The air flow mode switch each time the button is pressed.

*: If equipped

Air conditioning controls

■ Using the automatic mode

- 1 Press the "AUTO" button.
- 2 Adjust the temperature setting.
- 3 To stop the operation, press the "OFF" button.

■ If the system is operated manually in automatic mode

If the fan speed setting or air flow modes are operated, the automatic mode indicator goes off. However, automatic mode for functions other than that operated are maintained.

Air outlets

■ Location of air outlets

The air outlets and air volume changes according to the selected air flow mode.

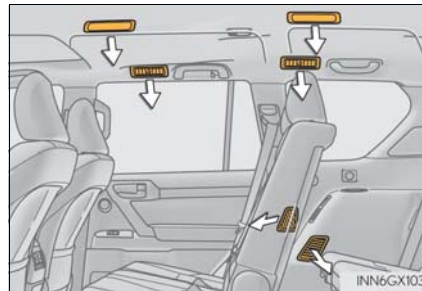

■ Adjusting the air flow direction and opening/closing the air outlets

- 1 Direct air flow to the left or right, up or down.
- 2 Turn the knob fully to the back of the vehicle to close the vent.

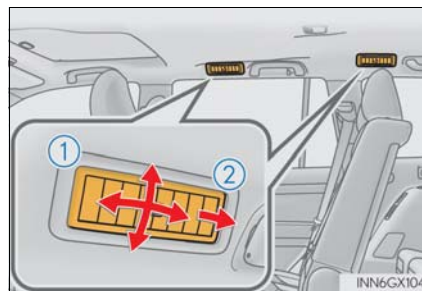

■ Registering air conditioning settings to electronic keys

- Unlocking the vehicle using an electronic key and turning the engine switch to IGNITION ON mode will recall that key's registered air conditioning settings.
- When the engine switch is turned off, the current air conditioning settings will automatically be registered to the electronic key that was used to unlock the vehicle.

The system may not operate correctly if more than one electronic key is in the vicinity or if the smart access system with push-button start is used to unlock a passenger door.

Settings for the electronic key and the corresponding door can be changed.
Contact your Lexus dealer.

**NOTICE****■ To prevent battery discharge**

Do not leave the air conditioning system on longer than necessary when the engine is off.

Heated steering wheel*/seat heaters*/seat ventilators*

Heated steering wheel and seat heaters heat the side grips of the steering wheel and seats. Seat ventilators maintain good airflow by blowing air from the seats.

⚠ CAUTION

- Care should be taken to prevent injury if anyone in the following categories comes in contact with the steering wheel and seats when the heater is on:
 - Babies, small children, the elderly, the sick and the physically challenged
 - Persons with sensitive skin
 - Persons who are fatigued
 - Persons who have taken alcohol or drugs that induce sleep (sleeping drugs, cold remedies, etc.)
- Observe the following precautions to prevent the minor burns or overheating:
 - Do not cover the seat with a blanket or cushion when using the seat heater.
 - Do not use seat heater more than necessary.

⚠ NOTICE

- Do not put heavy objects that have an uneven surface on the seat and do not stick sharp objects (needles, nails, etc.) into the seat.
- To prevent battery discharge, do not use the functions when the engine is off.

Heated steering wheel (if equipped)

Turns the heated steering wheel on/off

The indicator light comes on when the heated steering wheel is operating.

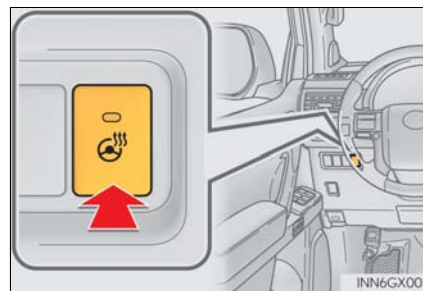

*: If equipped

- The heated steering wheel can be used when the engine switch is in IGNITION ON mode.
- The heated steering wheel will automatically turn off after about 30 minutes.
- If the indicator light flashes, press the switch to turn the heated steering wheel off and then press the switch again. If the indicator light still flashes, a malfunction may be occurring. Turn the heated steering wheel off and have the vehicle inspected by your Lexus dealer.

Seat heaters (if equipped)

■ Front seat

Turns the seat heater on

The indicator light comes on.
The higher the number of dots, the warmer the seat becomes.

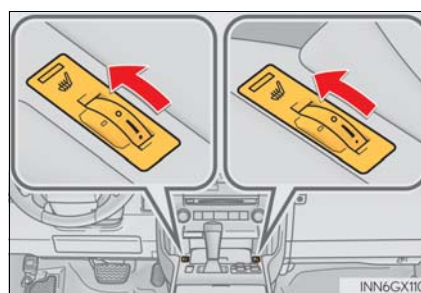

■ Rear seat

- ① For left second seat
- ② For right second seat
- ③ High heating temperature
- ④ Low heating temperature

To turn on the seat heater, press "HI" or "LO".
The indicator light on "HI" or "LO" switch indicates that the seat heater is on.

- ⑤ Off
To turn off, press "OFF".

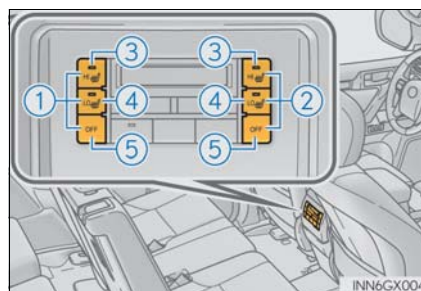

The seat heaters can be used when the engine switch is in IGNITION ON mode.

Seat heaters and ventilators (if equipped)

① Heats the seat

The indicator light comes on.
The higher the number of dots, the warmer the airflow becomes.

② Blows air from the seat

The indicator light comes on.
The higher the number of dots, the stronger the airflow becomes.

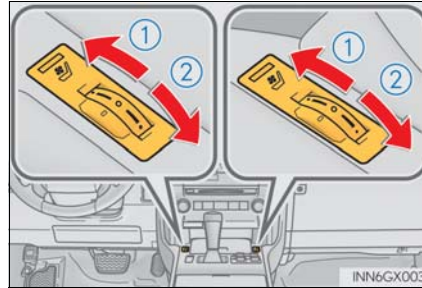

The seat heaters and ventilators can be used when the engine switch is in IGNITION ON mode.

Interior lights list

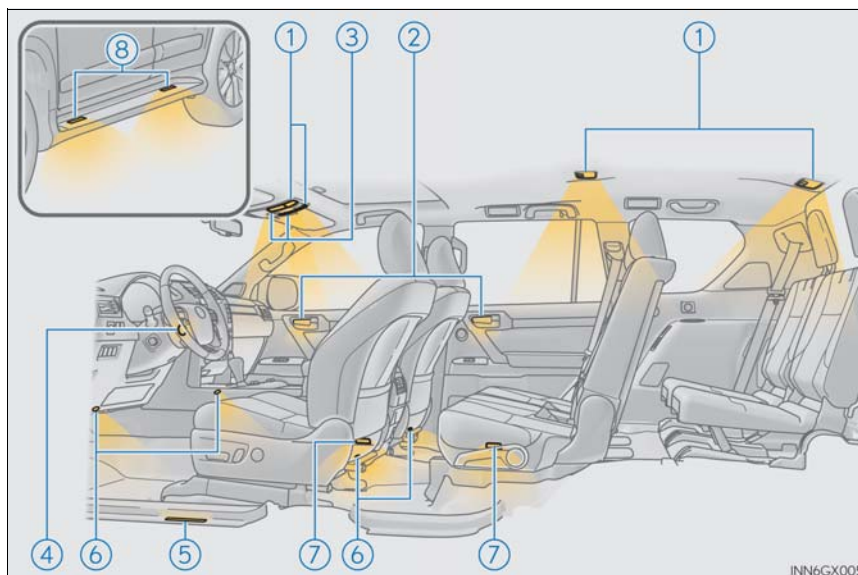

- | | |
|--------------------------------------|------------------------|
| ① Personal/interior lights (→P. 404) | ⑤ Scuff lights |
| ② Inside door handle lights | ⑥ Footwell lights |
| ③ Shift lever light | ⑦ Door courtesy lights |
| ④ Engine switch light | ⑧ Running board lights |

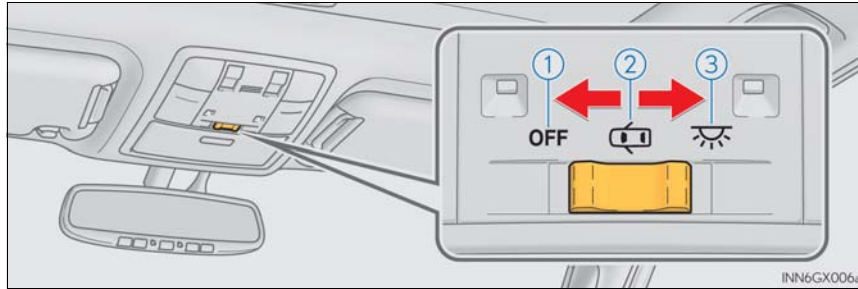
Personal/interior lights main switch

- ① Off
The personal/Interior lights and interior light can be individually turned on or off.
- ② Door position
The personal/interior lights come on when a door is opened. They turn off when the doors are closed.
- ③ On
The personal/interior lights cannot be individually turned off.

Personal/interior lights

► Front

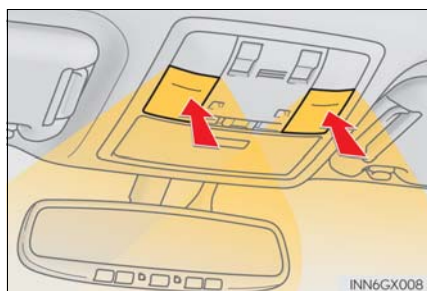

Turns the lights on/off

► Rear

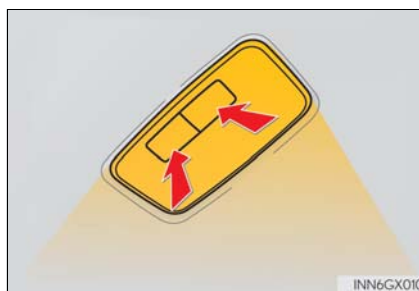

Turns the lights on/off

■ Illuminated entry system

The lights automatically turn on/off according to engine switch mode, the presence of the electronic key, whether the doors are locked/unlocked, and whether the doors are open/closed.

■ To prevent battery discharge

If the following lights remain on when the engine switch is turned off the lights will go off automatically after 20 minutes:

- Personal/interior light
- Inside door handle lights
- Footwell lights
- Running board lights

■ Customization

Settings (e.g. adjust the time elapsed before the interior lights automatically turn off) can be changed. (Customizable features: →P. 594)



NOTICE

To prevent battery discharge, do not leave the lights on longer than necessary when the engine is not running.

List of storage features

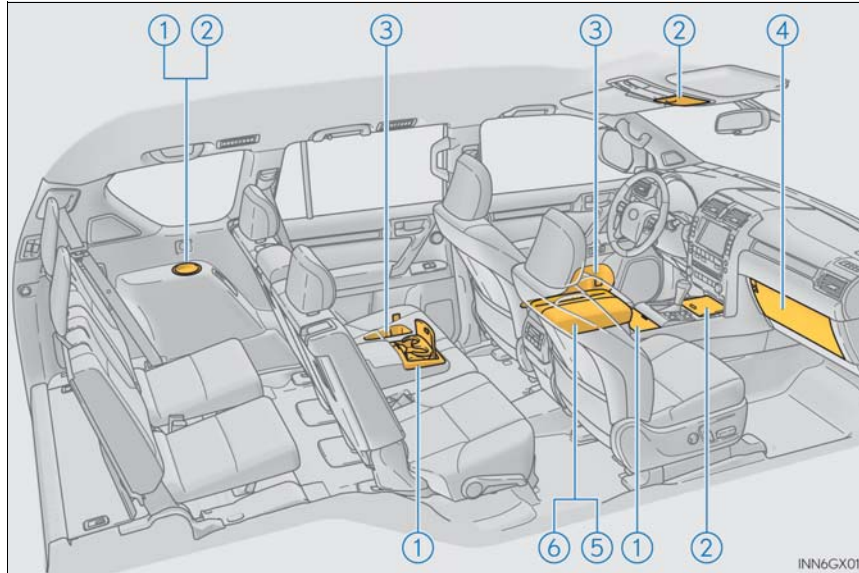

- | | | | |
|-------------------------------|-----------|-----------------------------|-----------|
| ① Cup holders | (→P. 408) | ⑤ Console box (if equipped) | (→P. 406) |
| ② Auxiliary boxes | (→P. 410) | Cool box (if equipped) | (→P. 419) |
| ③ Bottle holders/door pockets | (→P. 409) | ⑥ Coin holder (if equipped) | (→P. 408) |
| ④ Glove box | (→P. 406) | | |

⚠ CAUTION

- Do not leave glasses, lighters or spray cans in the storage spaces, as this may cause the following when cabin temperature becomes high:
 - Glasses may be deformed by heat or cracked if they come into contact with other stored items.
 - Lighters or spray cans may explode. If they come into contact with other stored items, the lighter may catch fire or the spray can may release gas, causing a fire hazard.
- When driving or when the storage compartments are not in use, keep the lids closed. In the event of sudden braking or sudden swerving, an accident may occur due to an occupant being struck by an open lid or the items stored inside.

Glove box

- ① Unlock with the mechanical key
- ② Lock with the mechanical key
- ③ Open (push the button)

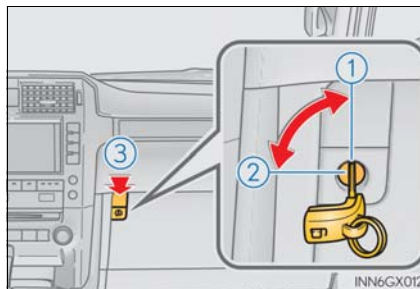

The glove box light turns on when the tail lights are on.

Console box (if equipped)

Your vehicle is equipped with either a console box or cool box.

For vehicles with the cool box, refer to P. 419.

Lift the lid while pulling up the lower lever to release the lock.

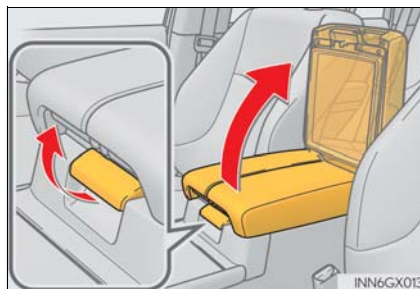

- The console box light turns on when the tail lights are on.
- When using the console box lid as an armrest, slide the console box lid forward or backward as needed. Slide the lid while pulling up the upper lever to release the lock.

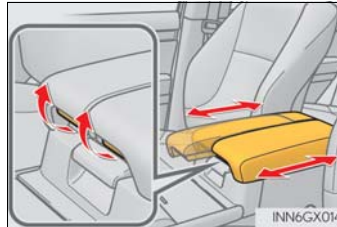

- The tray in the console box slides forward/backward.

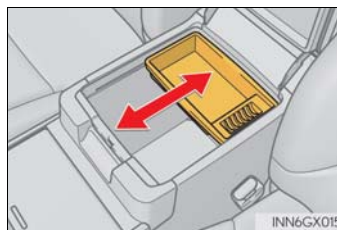

- To remove the tray, lift up.

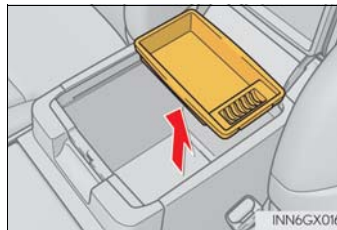

 NOTICE

Do not insert items exceeding the height of the tray. Doing so may prevent opening and closing of the lid.

Coin holder (if equipped)

The coin holder is located in the console box.

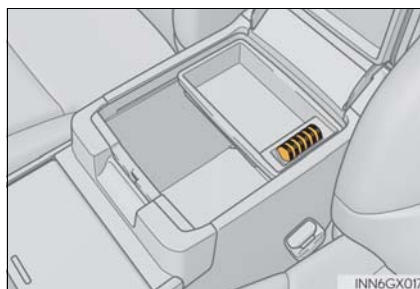

Cup holders/bottle holders/door pockets

■ Cup holders

▶ Front seats

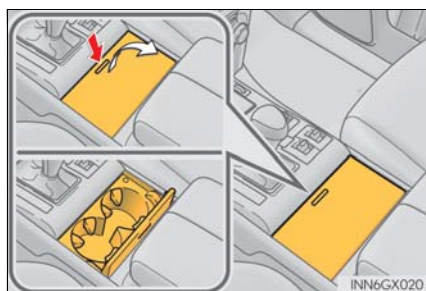

Press down and release the cup holder lid.

▶ Second seats (6-passenger models)

▶ Second seats (7-passenger models)

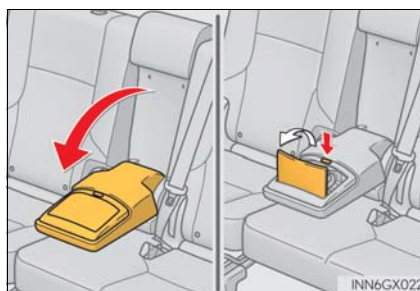

Pull the armrest down, and then press in and release the button.

▶ Third seats (if equipped)

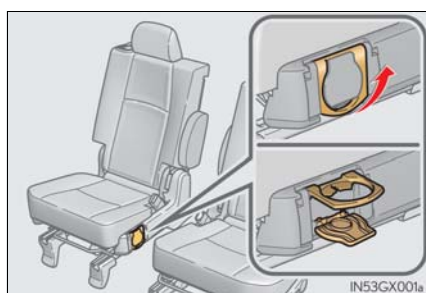

Pull the cup holder up.

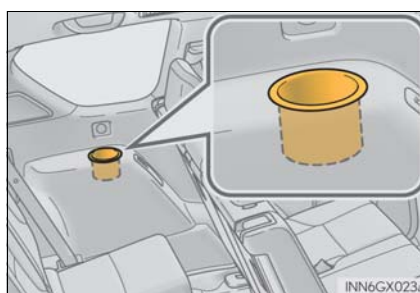

■ **Bottle holders/door pockets**

▶ Front



▶ Rear



■ **Cup holder lights (front seats)**

- The cup holder lights turn on when the tail lights are on.
- The brightness of the cup holder lights change in conjunction with the instrument cluster light. (→P. 84)

■ **When using the holder as a bottle holder**

- Close the cap.
- The bottle may not be stored depending on its size or shape.

■ **Removing the cup holders (second seats for 6-passenger models)**

The cup holders can be removed.



5

Interior features

⚠ CAUTION

■ **Items unsuitable for the cup holders/bottle holders**

- Do not place anything other than cups or beverage cans in the cup holders. Even when the lid is closed, items must not be stored in the cup holders. Other items may be thrown out of the holders in the event of sudden braking, sudden swerving or an accident, cause injury. If possible, cover hot drinks to prevent burns.
- Do not place anything other than bottles in the bottle holders. In the event of an accident or sudden braking, other items may be thrown out of the holders and cause injury.

■ **When not in use**

Keep the cup holders closed.
Injuries may result in the event of sudden braking, sudden swerving or an accident.



 NOTICE

- To prevent damage, stow the rear cup holders before stowing the armrest. (second seats for 7-passenger models)
- To prevent damage, do not fold down the second seatbacks when using a cup holder on the second seats. (6-passenger models)
- To prevent damage, do not rest your hands on the cup holders or kick them.
- Do not place open bottles or glass and paper cups containing liquid in the bottle holders. The contents may spill and glasses may break.

Auxiliary boxes

► Type A

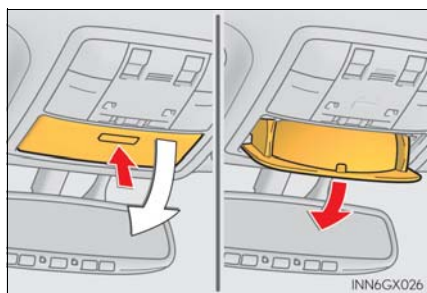

Press in the button and then pull down the lid.

The overhead console is useful for temporarily storing sunglasses and similar small items.

► Type B



Push the lid.

► Type C (if equipped)

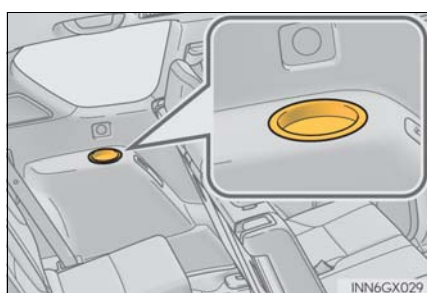

■ Auxiliary box light (type B)

- The auxiliary box light turns on when the tail lights are on.
- The brightness of the auxiliary box light changes in conjunction with the instrument cluster light. (→P. 84)

■ Closing the auxiliary box lid

Slide the auxiliary box lid forward.

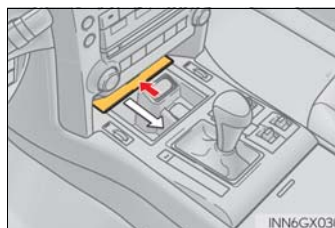
**⚠ CAUTION****■ Caution while driving**

Do not place cups, beverage cans or bottles in the box. They may be thrown out of the box in the event of sudden braking, sudden swerving or an accident, resulting in injury. (type B and C)

■ Items unsuitable for storing (type A)

- Do not store items heavier than 0.4 lb. (0.2 kg).
Doing so may cause the auxiliary box to open and the items inside may fall out, resulting in an accident.
- Do not put large items in the overhead console.
The overhead console may not be able to be shut from the conversation mirror state.

Luggage compartment features

Cargo hooks

Raise the hook to use.

The cargo hooks are provided for securing loose items.

When using the deck hooks, the third seat must be fold down. (→P. 130)

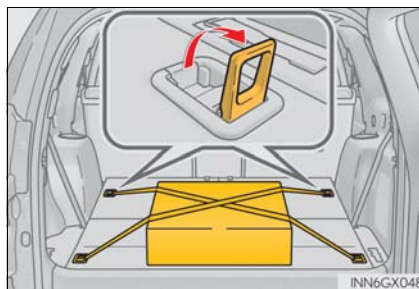

Warning reflector holder

1 Open the cover.

- ① Turn the knob clockwise.
- ② Open the cover.

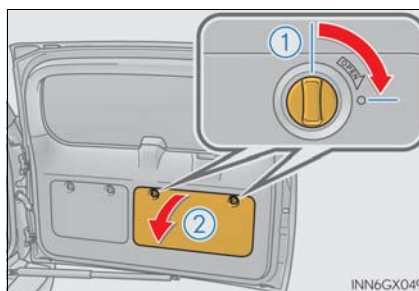

2 Secure the warning reflector.

The warning reflector itself is not included as an original equipment.

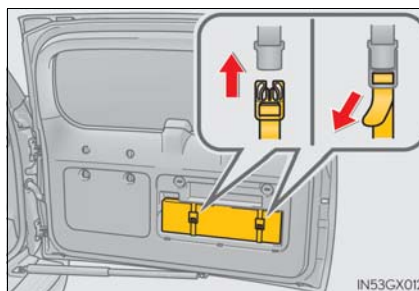

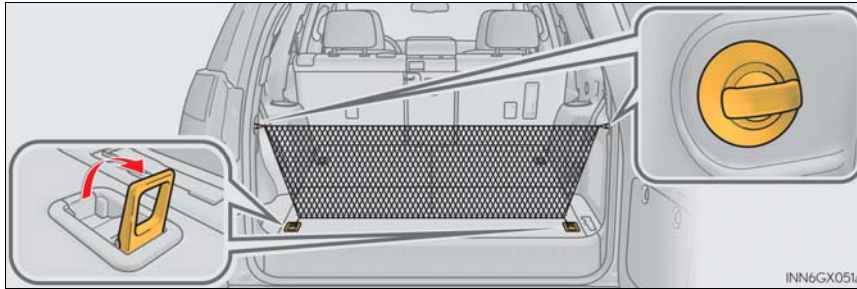
Cargo net hooks

To hang the cargo net, use the cargo net hooks.

The cargo net itself is not included as an original equipment.

Auxiliary box (if equipped)

Remove the cover.

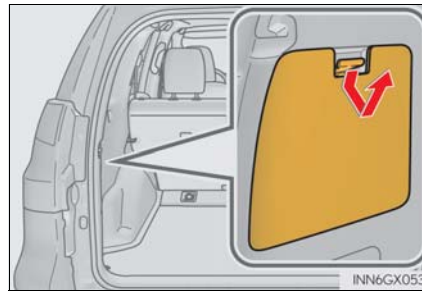

5

Interior features

Luggage cover (if equipped)

■ Installing the luggage cover

- 1 Attach the hooks to the head restraints.

When using the luggage cover, the third seats must be folded down. (→P. 130)

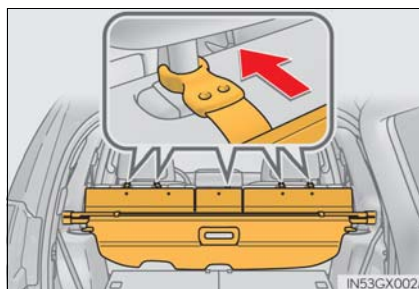

6-passenger models only: Secure the middle part of the luggage cover as shown.

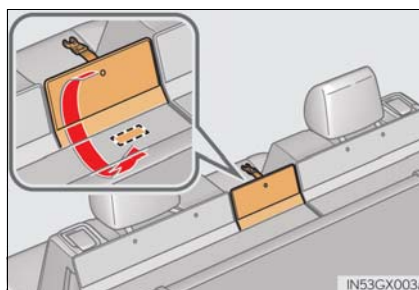

- 2 Pull out the luggage cover and hook it on the anchors.

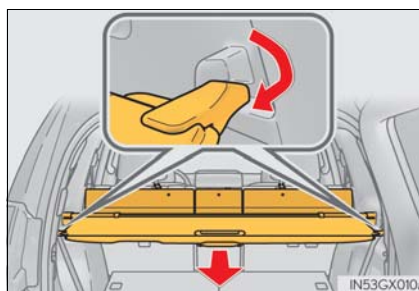

■ Removing the luggage cover

Retract the cover and release both ends, then lift it out.

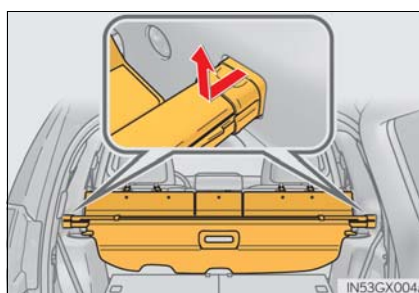

■ Stowing the luggage cover

- 1** Push the case while pressing the lock release button.

Vehicles without a rear automatic air conditioning system: Shorten one side only.

Vehicles with a rear automatic air conditioning system: Shorten both sides.

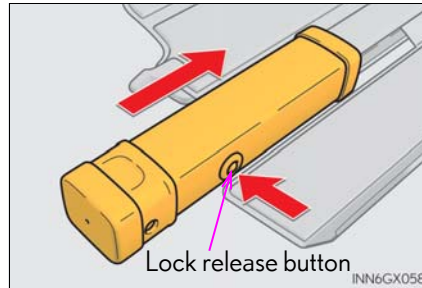

- 2** Push the case until it locks.

Check that the lock release button can be seen.

Vehicles without a rear automatic air conditioning system: Shorten one side only.

Vehicles with a rear automatic air conditioning system: Shorten both sides.

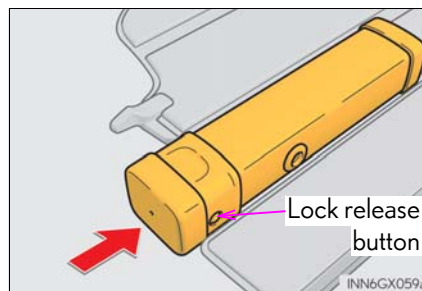

- 3** Secure the luggage cover with luggage cover restraining bands.

Check that luggage cover and luggage cover restraining bands are secured.

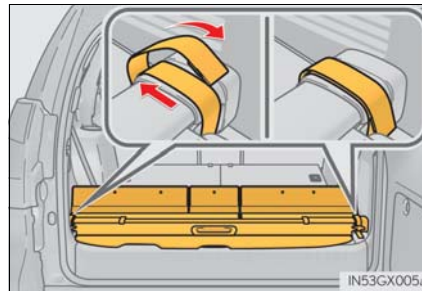

- 4** Fold over the cover and the sub cover.

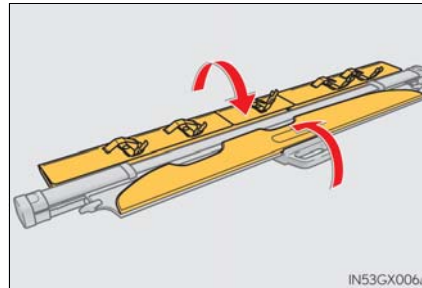

5

Interior features

- 5 Stow the hooks.

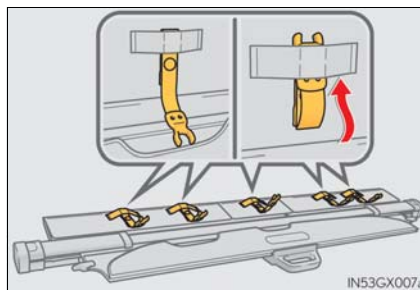

- 6 Fold over the sub cover.

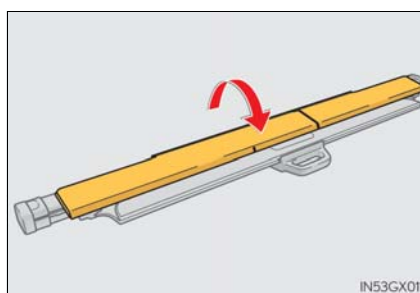

■ **Extending the case**

- 1 Push the lock release button.

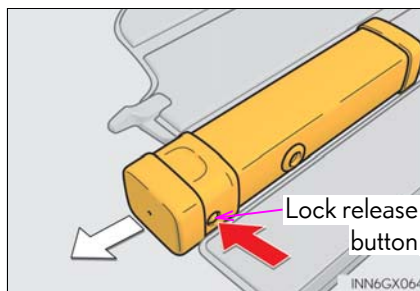

- 2 Pull the case until it locks.
Check that the lock release button can be seen.

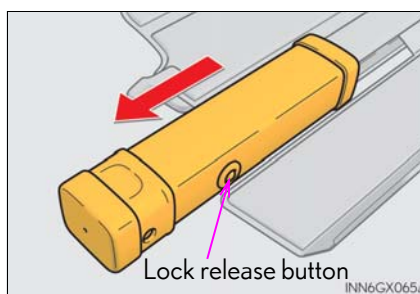

■ Adjusting the sub cover

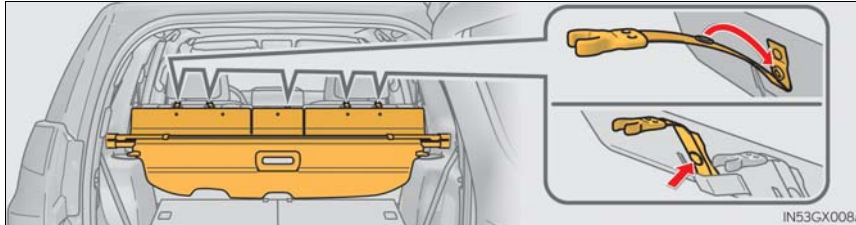

Fasten the button when the second seats are in the rear-most position.
Unfasten the buttons before sliding the second seats forward.

⚠ CAUTION

- To avoid injury, always return the cargo hooks to their stowed positions when not in use.
- Keep the auxiliary box closed. In the event of sudden braking or sudden swerving, an accident may occur due to an occupant being struck by an open auxiliary box or the items stored inside.
- Keep the both sides of the luggage cover case locked. Otherwise, the luggage cover may fly out in case of the sudden braking, sudden swerving or an accident, resulting in death or serious injury.
- When stowing the luggage cover in the luggage compartment, use the luggage cover restraining bands to secure the left and right sides of the luggage cover. Otherwise, the luggage cover may fly out in case of the sudden braking, sudden swerving or an accident, resulting in death or serious injury.
- Do not allow children to climb on the luggage cover. Climbing on the luggage cover could result in damage to the luggage cover, possibly causing death or serious injury to the child.

 NOTICE

■ **To prevent damage to the luggage cover**

When stowing the luggage cover, do not put luggage on the luggage cover.

- Do not insert coins etc. into the area shown in the illustration.



- Do not use the luggage cover restraining bands for anything other than securing the luggage cover.

Other interior features

Cool box (if equipped)

- 1 Lift the lid while pulling up the lower lever to release the lock.

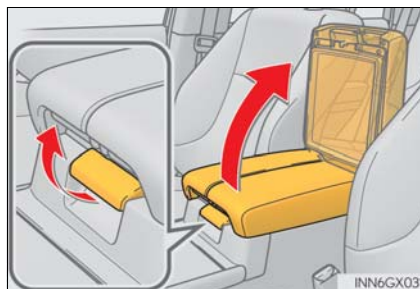

- 2 Turns the cool box on/off
When on, the indicator light comes on.

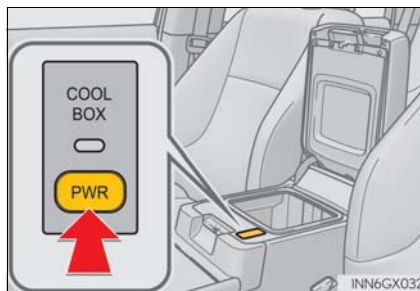

- **The cool box can be operated when**
The engine switch is in IGNITION ON mode.
- **If the front air conditioning system is not in use when the cool box is turned on**
The front air conditioning system is automatically turned on.

■ **While the cool box is on**

The front air conditioning system cannot be turned off.

■ **Items unsuitable for the cool box**

- Drinks in unsealed containers
- Fragile items, perishables or anything with strong odor
- Owner's manual, electronic devices, CDs, etc.

■ **When the indicator light flashes**

The cool box is not operated when any of the following conditions occurs.

- When the air conditioning system is off
Turn the air conditioning system on also turns on the cool box.
- When outside air temperature is about 32°F (0°C) or below.

If the indicator light continues to flash, there may be a malfunction in the system. Turn the air conditioning system off and have it inspected by your Lexus dealer.

■ **When using the cool box lid as an armrest**

Slide the cool box lid forward or backward as needed. Slide the lid while pulling up the upper lever to release the lock.

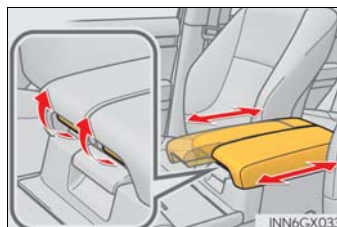

⚠ CAUTION

Keep the cool box closed. In the event of sudden braking or sudden swerving, an accident may occur due to an occupant being struck by the open cool box or the items stored inside.

⚠ NOTICE

To prevent battery discharge, do not leave the cool box on longer than necessary when the engine is not running.



Sun visors

- ① To set the visor in the forward position, flip it down.
- ② To set the visor in the side position, flip down, unhook, and swing it to the side.
- ③ To use the side extender, place the visor in the side position, then slide it backward.

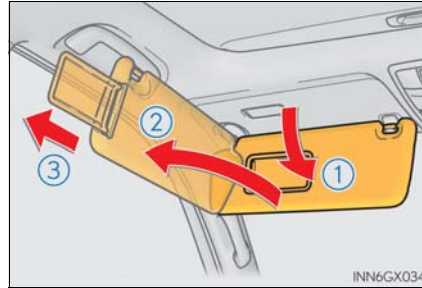

Vanity mirror

Slide the cover to open.

The light turns on when the cover is opened.

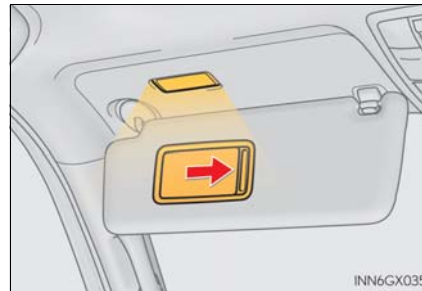

If the vanity lights remain on when the engine switch is turned off, the lights will go off automatically after 20 minutes.

NOTICE

To prevent battery discharge, do not leave the vanity lights on for extended periods when the engine is not running.

Conversation mirror

The conversation mirror can provide the driver and the front passenger with a view of the rear seat area without the need to turn around.

Press in the button.

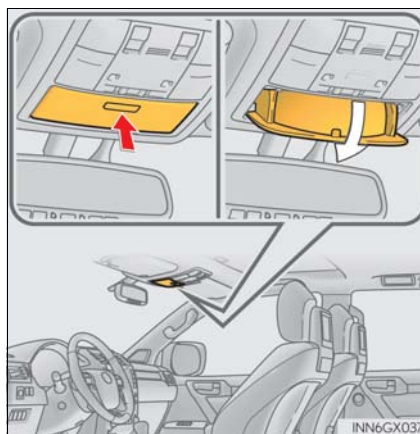

To use the overhead console when the conversation mirror is open, further extend the lid.
(→P. 410)

Clock

- ▶ Vehicles with a navigation system
Refer to the “NAVIGATION SYSTEM OWNER'S MANUAL”.
- ▶ Vehicles without a navigation system

- ① Adjusts the hours
- ② Adjusts the minutes



- **The clock is displayed when**
The engine switch is in IGNITION ON mode.
- **When disconnecting and reconnecting battery terminals**
The clock data will be reset.

Power outlets**■ Center of console (12 V DC)**

The power outlet can be used for 12 V accessories that run on less than 10 A.

► Front

Slide the auxiliary box lid.

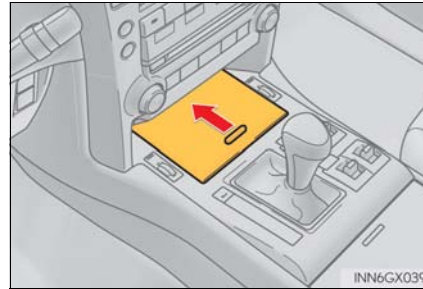
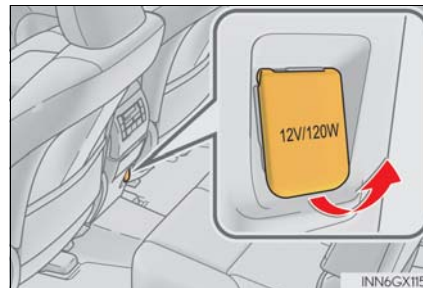
**► Rear (if equipped)**

■ **Luggage compartment (120 V AC)**

The power outlet can be used for 120 V AC accessories that run on less than 100 W.

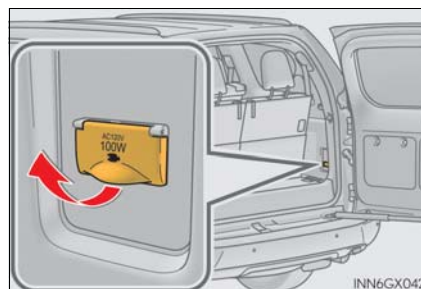

■ **The power outlet can be used when**

12 V DC: The engine switch is in ACCESSORY or IGNITION ON mode.

120 V AC: The engine switch is in IGNITION ON mode.

■ **The protection circuit may be activated to cut the power supply if any of the following conditions apply (120 V AC):**

- Use of electrical appliances exceeding 100 W is attempted.
A sound may be heard when the protection circuit is activated. This is normal and does not indicate a malfunction.
- The total power usage by all electrical features (headlights, air conditioning, etc.) has exceeded the total vehicle maximum for an extended period of time.

■ **If the protection circuit is activated and the power supply is cut, conduct the following procedure (120 V AC):**

- 1 Park the vehicle in a safe place, and then securely apply the parking brake.
- 2 Make sure that the power consumption of the electric appliance is within the maximum capacity of the power outlet and the appliance is not broken.
- 3 Turn the engine switch to IGNITION ON mode again.

When the cabin temperature is high, open the windows to cool the temperature down. Once it reaches the normal temperature, turn the engine switch to IGNITION ON mode again.

If the power supply does not resume even after the above procedure has been performed, have the vehicle inspected by your Lexus dealer.



⚠ CAUTION**■ Using a power outlet (120 V AC)**

Observe the following precautions to reduce the risk of injury.

- Use of the power outlet when it is wet with water or snow may result in electrical shocks and is extremely dangerous. The power outlet must be thoroughly dried before use.
- Do not allow children to use or play with the power outlet.
- Be careful not to get any part of your body caught in the power outlet lid.
- When using electrical appliances, strictly follow any cautions and notices written on their labels and in the manufacturers' instruction manuals.
- Do not modify, disassemble or repair the power outlet or its inverter in any way. Doing so may result in unexpected malfunctions or accidents, which could cause serious damage or injuries. Contact your Lexus dealer for any necessary repairs.

■ To prevent injuries and accidents, secure all electric appliances before use and do not use any appliances that may do any of the following (120 V AC):

- Distract the driver while driving, or hamper safe driving.
- Result in a fire or burn injuries due to the appliance rolling, falling or overheating while driving.
- Emit steam while the windows of the cabin are closed.

■ To prevent unexpected accidents, such as electric shocks, do not perform any of the following actions (120 V AC):

- Using the power outlet for electric heaters while sleeping.
- Contaminating the power outlet with liquid substances or mud.
- Handling electrical appliance plugs at the power outlet with wet hands or feet.
- Inserting foreign objects into the power outlet.
- Using malfunctioning electric appliances.
- Inserting inappropriate or badly fitting plugs into the power outlet.

⚠ NOTICE**■ To avoid damaging the power outlet and the plug (120 V AC)**

- Close the power outlet lid when not in use.
- Do not allow foreign objects or liquids to enter the power outlet, as this may cause a short circuit.
- Do not use plug adaptors to connect too many plugs to the power outlet. (120 V AC)
- After removing a plug, gently close the power outlet lid. (120 V AC)

 NOTICE**■ To prevent the fuse from being blown**

12 V DC: Do not use an accessory that uses more than 12 V 10 A.

120 V AC: Do not use a 120 V AC appliance that requires more than 100 W.

If a 120 V AC appliance that consumes more than 100 W is used, the protection circuit will cut the power supply.

■ Appliances that may not operate properly (120 V AC)

The following 120 V AC appliances may not operate even if their power consumption is under 100 W.

- Appliances with high initial peak wattage
- Measuring devices that process precise data.
- Other appliances that require an extremely stable power supply

■ To prevent battery discharge

12 V DC: Do not use the power outlet longer than necessary when the engine is not running.

120 V AC: Turn off all the vehicle's electronic equipment and accessories, such as the headlights and air conditioning, when electrical appliances that consume in excess of 100 W are used continuously for long periods of time.

■ To prevent any damage caused by heat (120 V AC)

- Do not use any electrical appliances that give off intense heat, such as toasters, in any locations including the internal or external trim, seats and deck.
- Do not use any electrical appliances that are easily affected by vibration or heat inside the vehicle. Vibration while driving, or the heat of the sun while parking, may result in damage to those electrical appliances.

■ If any electrical appliances are to be used while driving (120 V AC)

Securely fasten both the appliances and their cables to prevent them from falling or getting caught in any of the power train components.

■ If the power outlet is loose when an electrical appliance plug is connected (120 V AC)

Replace the outlet. Contact your Lexus dealer for any necessary replacements.

■ If the power outlet gets dirty (120 V AC)

Turn the main switch off and use a soft, clean cloth to wipe it gently. Do not use any cleansing materials, such as organic solvents, wax, or compound cleaners, as these may damage the power outlet or cause it to malfunction.



Armrest

▶ 7-passenger models

Fold down the armrest for use.

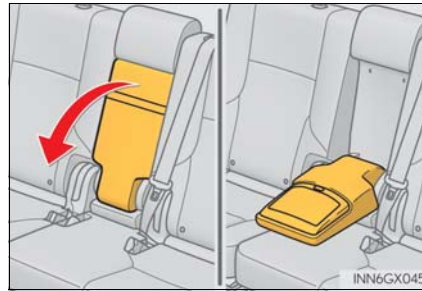

▶ 6-passenger models

To adjust the armrest angle, raise the armrest to the highest position and then lower the armrest to the lowest position. Raise the armrest again to the desired position and the armrest will be locked at that position.

When the armrest is locked, the armrest cannot be lowered.

To lower the armrest, raise the armrest to the highest position again.

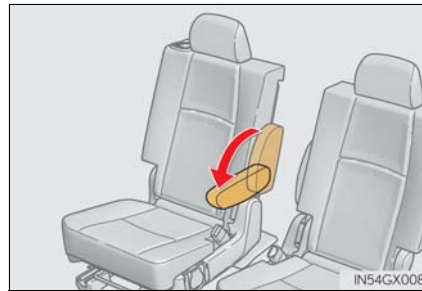

⚠ NOTICE

To prevent damage, do not apply too heavy a load on the armrest.

Coat hooks

The coat hooks are provided with the second rear assist grips.

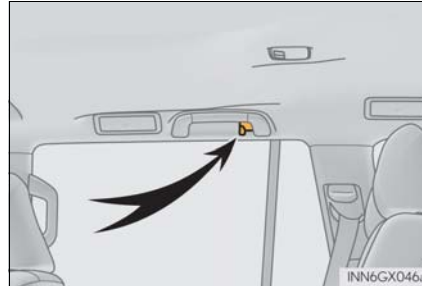

⚠ CAUTION

Do not hang coat hangers or other hard or sharp objects on the hook. If the SRS curtain shield airbags deploy, these items may become projectiles, causing death or serious injury.

Assist grips

An assist grip (type A) can be used to support your body while sitting on the seat. An assist grip (type B) can be used when getting in or out of the vehicle and others.

- ① Assist grip (type A)
- ② Assist grip (type B)

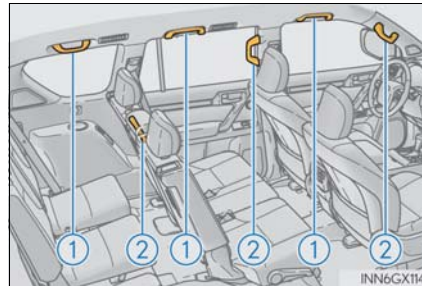

⚠ CAUTION

Do not use the assist grip (type A) when getting in or out of the vehicle or rising from your seat.

⚠ NOTICE

To prevent damage, do not hang heavy objects or put a heavy load on the assist grip.



Compass (if equipped)

The compass on the inside rear view mirror indicates the direction in which the vehicle is heading.

■ Operation

To turn the compass on or off, push the switch.

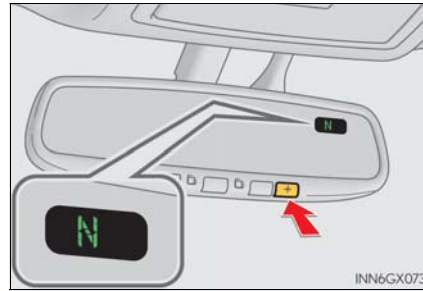

■ Displays and directions

Display	Direction
"N"	North
"NE"	Northeast
"E"	East
"SE"	Southeast
"S"	South
"SW"	Southwest
"W"	West
"NW"	Northwest

■ Calibrating the compass

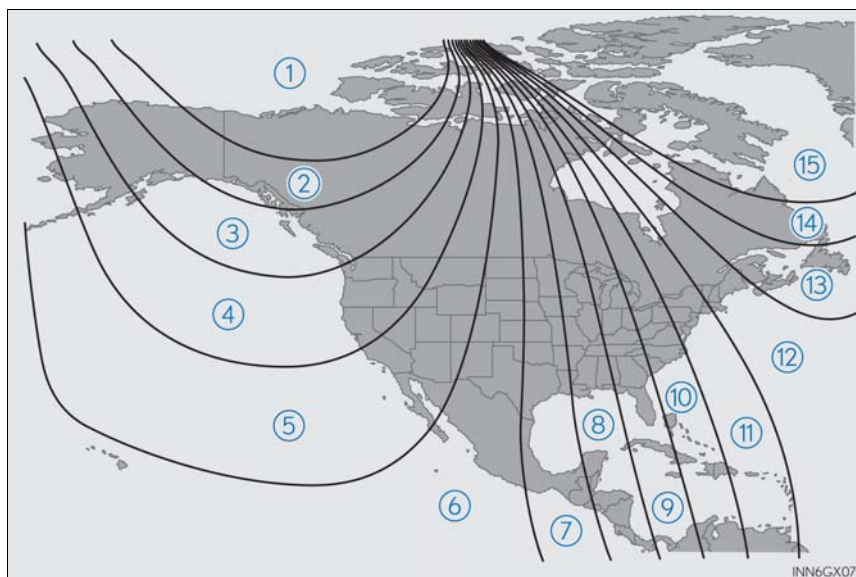

The direction display deviates from the true direction determined by the earth's magnetic field. The amount of deviation varies according to the geographic position of the vehicle.

If you cross over one of the map boundaries shown in illustration, the compass will deviate.

To obtain higher precision or perfect calibration, refer to "Deviation calibration".



◆ Deviation calibration

- 1 Stop the vehicle in a place where it is safe to drive in a circle.
- 2 Press the switch until a number (1 to 15) appears on the compass display.

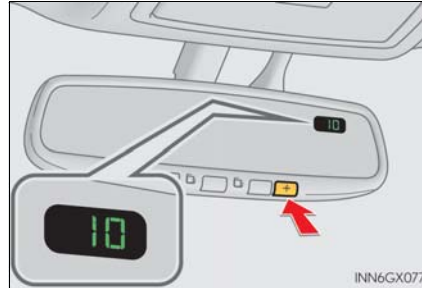

- 3 Press the switch and referring to the map above, select the number of the zone where you are.
If the direction is displayed several seconds after adjustment, the calibration is complete.

◆ Circling calibration

When "C" appears on the display, drive the vehicle at 5 mph (8 km/h) or less in a circle until a direction is displayed.

If there is not enough space to drive in a circle, drive around the block until the direction is displayed.

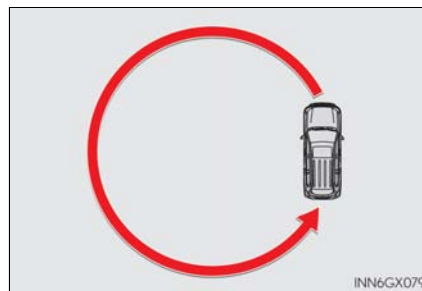

5

Interior features

■ **Conditions unfavorable to correct operation**

The compass may not show the correct direction in the following conditions:

- The vehicle is stopped immediately after turning.
- The vehicle is on an inclined surface.
- The vehicle is in a place where the earth's magnetic field is subject to interference by artificial magnetic fields (underground car park/parking lot, under a steel tower, between buildings, roof car park/parking lot, near an intersection, near a large vehicle, etc.).
- The vehicle has become magnetized.
(There is a magnet or metal object near the inside rear view mirror.)
- The battery has been disconnected.
- A door is open.

 **CAUTION**

- **While driving the vehicle**
Do not adjust the display. Adjust the display only when the vehicle is stopped.
- **When doing the circling calibration**
Secure a wide space, and watch out for people and vehicles in the vicinity. Do not violate any local traffic rules while performing circling calibration.

 **NOTICE**

- **To avoid the compass malfunctions**
Do not place magnets or any metal objects near the inside rear view mirror. Doing this may cause the compass sensor to malfunction.
- **To ensure normal operation of the compass**
 - Do not perform a circling calibration of the compass in a place where the earth's magnetic field is subject to interference by artificial magnetic fields.
 - During calibration, do not operate electric systems (moon roof, power windows, etc.) as they may interfere with the calibration.



Garage door opener

The garage door opener can be programmed to operate garage doors, gates, entry doors, door locks, home lighting systems, security systems, and other devices.

The garage door opener (HomeLink[®] Universal Transceiver) is manufactured under license from HomeLink[®].

Programming the HomeLink[®]

The HomeLink[®] compatible transceiver in your vehicle has 3 buttons which can be programmed to operate 3 different devices. Refer to the programming method below appropriate for the device.

- ① Indicator light
- ② Buttons

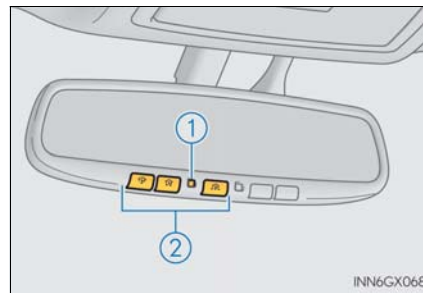

■ Before programming HomeLink[®]

- During programming, it is possible that garage doors, gates, or other devices may operate. For this reason, make sure that people and objects are clear of the garage door or other devices to prevent injury or other potential harm.
- It is recommended that a new battery be placed in the remote control transmitter for more accurate programming.
- Garage door openers manufactured after 1995 may be equipped with **rolling code protection**. If this is the case, you will need a stepladder or other sturdy, safe device to reach the “Learn” or “Smart” button on the garage door opener motor.

■ Programming HomeLink®

- 1 Point the remote control transmitter for the device 1 to 3 in. (25 to 75 mm) from the HomeLink® buttons.

Keep the HomeLink® indicator light in view while programming.

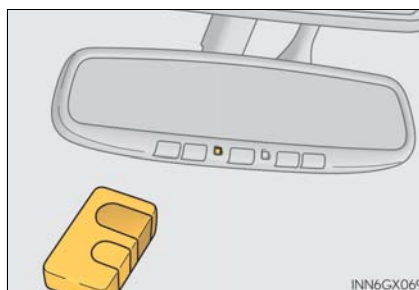

► For U.S.A. owner's

- 2 Press and hold the HomeLink® button you want to program and the remote control transmitter button simultaneously. When the HomeLink® indicator light changes from a slow to a rapid flash, you can release both buttons.

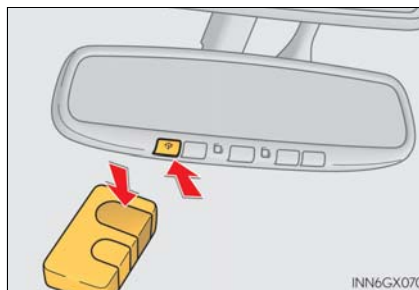

Programming has completed when the indicator light changes to a rapid flash.

► Programming an entry gate (for U.S.A. owners)/Programming a device in the Canadian market

- 2 With one hand, press and hold the HomeLink® button you want to program. With your other hand, press and release the remote control transmitter every 2 seconds and repeat this cycle until the HomeLink® indicator light starts to flash rapidly. Then, release the buttons.

- 3** Test the HomeLink[®] operation by pressing the newly programmed button and observing the indicator light:

- If the indicator light is solid/continuous, programming has been completed and your device should activate when the HomeLink[®] button is pressed and released.
- If the indicator light blinks rapidly for 2 seconds and then turns into a solid/continuous light, proceed with the following instructions **4** for programming a rolling code system.

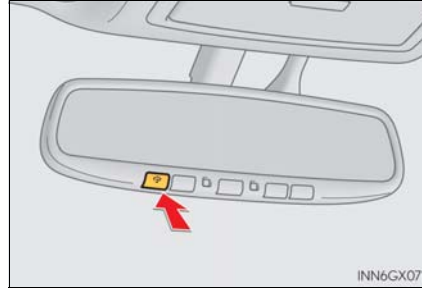

► Programming a rolling code system

- 4** Locate the “Learn” or “Smart” button on the garage door opener motor in the garage.

This button can usually be found where the hanging antenna wire is attached to the unit. The name and color of the button may vary by manufacturer. Please refer to the operator’s manual supplied with the garage door opener motor for details.

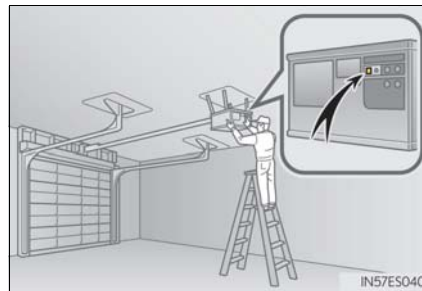

- 5** Press and release the “Learn” or “Smart” button.

Perform **6** within 30 seconds after performing **5**.

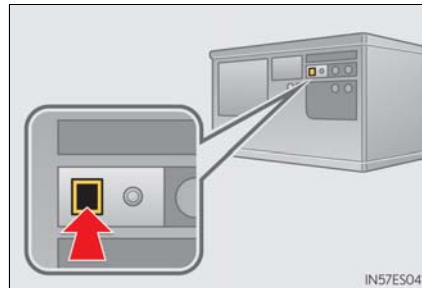

- 6 Press and hold the programmed HomeLink[®] button (located inside the vehicle) for 2 seconds and release it. Repeat this sequence (press/hold/release) up to 3 times to complete programming.

If the garage door opener motor activates when the HomeLink[®] button is pressed, the garage door opener motor recognizes the HomeLink[®] signal.

- 7 Repeat the steps above to program another device for any of the remaining HomeLink[®] buttons.

■ **Reprogramming a single HomeLink[®] button**

When the following procedure is performed, buttons which already have devices registered to them can be overwritten:

- 1 With one hand, press and hold the desired HomeLink[®] button.
- 2 When the HomeLink[®] indicator starts flashing, continue to hold the HomeLink[®] button and perform "Programming HomeLink[®]" from 1 (it takes 20 seconds for the HomeLink[®] indicator to start flashing).

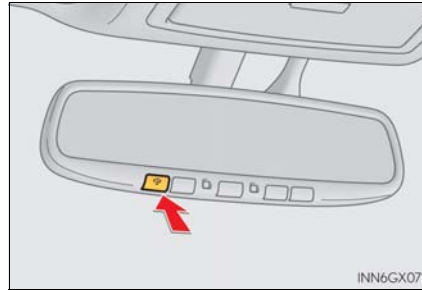

Erasing the entire HomeLink[®] memory (all three programs)

Press and hold the 2 outside buttons for 10 seconds until the indicator light flashes.

If you sell your vehicle, be sure to erase the programs stored in the HomeLink[®] memory.

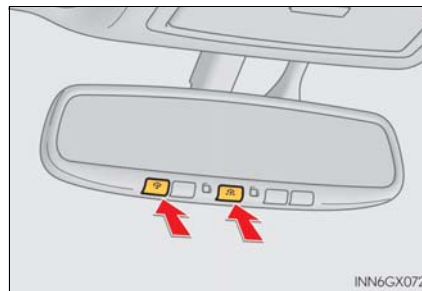

■ **Programs stored in the HomeLink® memory**

- The registered codes are not erased even if the battery cable is disconnected.
- If learning failed when registering a different code to a HomeLink® button that already has a code registered to it, the already registered code is not erased.

■ **Certification for the garage door opener**

- ▶ For vehicles sold in the U.S.A., Hawaii, NATO Germany, Guam, Saipan and Puerto Rico

This device complies with part 15 of the FCC Rules. Operation is subject to the following two conditions: (1) This device may not cause harmful interference, and (2) this device must accept any interference received, including interference that may cause undesired operation.

changes or modifications not expressly approved by the party responsible for compliance could void the user's authority to operate the equipment.

- ▶ For vehicles sold in Canada

This device complies with Industry Canada's licence-exempt RSSs. Operation is subject to the following two conditions:

- (1) This device may not cause interference; and*
- (2) This device must accept any interference, including interference that may cause undesired operation of the device.*

Le présent appareil est conforme aux CNR d'Industrie Canada applicables aux appareils radio exempts de licence. L'exploitation est autorisée aux deux conditions suivantes :

- (1) l'appareil ne doit pas produire de brouillage;*
- (2) l'utilisateur de l'appareil doit accepter tout brouillage radioélectrique subi, même si le brouillage est susceptible d'en compromettre le fonctionnement.*

■ **When support is necessary**

Visit on the web at www.homelink.com or call 1-800-355-3515.



⚠ CAUTION**■ When programming a garage door or other remote control device**

The garage door or other device may operate, so ensure people and objects are out of danger to prevent potential harm.

■ Conforming to federal safety standards

Do not use the HomeLink[®] compatible transceiver with any garage door opener or device that lacks safety stop and reverse features as required by federal safety standards.

This includes any garage door that cannot detect an interfering object. A door or device without these features increases the risk of death or serious injury.

■ When operating or programming HomeLink[®]

Never allow a child to operate or play with the HomeLink[®] buttons.



LEXUS Enform Safety Connect*

Safety Connect is a subscription-based telematics service that uses Global Positioning System (GPS) data and embedded cellular technology to provide safety and security features to subscribers. Safety Connect is supported by Lexus' designated response center, which operates 24 hours per day, 7 days per week.

Safety Connect service is available by subscription on select, telematics hardware-equipped vehicles.

By using the Safety Connect service, you are agreeing to be bound by the Telematics Subscription Service Agreement and its Terms and Conditions, as in effect and amended from time to time, a current copy of which is available at Lexus.com. All use of the Safety Connect service is subject to such then-applicable Terms and Conditions.

System components

- ① Microphone
- ② LED light indicators
- ③ "SOS" button

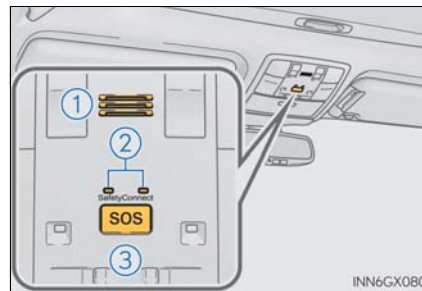

5

Interior features

*: If equipped



Services

Subscribers have the following Safety Connect services available:

- Automatic Collision Notification*
Helps drivers receive necessary response from emergency service providers.
(→P. 441)
*: U.S. Patent No. 7,508,298 B2
- Stolen Vehicle Location
Helps drivers in the event of vehicle theft. (→P. 442)
- Emergency Assistance Button (“SOS”)
Connects drivers to response-center support. (→P. 442)
- Enhanced Roadside Assistance
Provides drivers various on-road assistance. (→P. 442)

Subscription

After you have signed the Telematics Subscription Service Agreement and are enrolled, you can begin receiving services.

A variety of subscription terms is available for purchase. Contact your Lexus dealer, call 1-800-25-LEXUS (1-800-255-3987) or push the “SOS” button in your vehicle for further subscription details.

■ Safety Connect Services Information

- Phone calls using the vehicles Bluetooth® technology will not be possible during Safety Connect.
- Safety Connect is available beginning Fall 2009 on select Lexus models. Contact with the Safety Connect response center is dependent upon the telematics device being in operative condition, cellular connection availability, and GPS satellite signal reception, which can limit the ability to reach the response center or receive emergency service support. Enrollment and Telematics Subscription Service Agreement required. A variety of subscription terms is available; charges vary by subscription term selected.
- Automatic Collision Notification, Emergency Assistance and Stolen Vehicle Location will function in the United States, including Hawaii and Alaska, and in Canada, and Enhanced Roadside Assistance will function in the United States (except Hawaii) and in Canada. No Safety Connect services will function outside of the United States in countries other than Canada.
- Safety Connect services are not subject to section 255 of the Telecommunications Act and the device is not TTY compatible.



■ Languages

The Safety Connect response center will offer support in multiple languages. The Safety Connect system will offer voice prompts in English and Spanish. Please indicate your language of choice when enrolling.

■ When contacting the response center

You may be unable to contact the response center if the network is busy.

Safety Connect LED light Indicators

When the engine switch is turned to IGNITION ON mode, the red indicator light comes on for 2 seconds then turns off. Afterward, the green indicator light comes on, indicating that the service is active.

The following indicator light patterns indicate specific system usage conditions:

- Green indicator light on = Active service
- Green indicator light flashing = Safety Connect call in process
- Red indicator light (except at vehicle start-up) = System malfunction (contact your Lexus dealer)
- No indicator light (off) = Safety Connect service not active

Safety Connect services**■ Automatic Collision Notification**

In case of either airbag deployment or severe rear-end collision, the system is designed to automatically call the response center. The responding agent receives the vehicle's location and attempts to speak with the vehicle occupants to assess the level of emergency. If the occupants are unable to communicate, the agent automatically treats the call as an emergency, contacts the nearest emergency services provider to describe the situation, and requests that assistance be sent to the location.



■ **Stolen Vehicle Location**

If your vehicle is stolen, Safety Connect can work with local authorities to assist them in locating and recovering the vehicle. After filing a police report, call the Safety Connect response center at 1-800-25-LEXUS (1-800-255-3987) and follow the prompts for Safety Connect to initiate this service.

In addition to assisting law enforcement with recovery of a stolen vehicle, Safety-Connect-equipped vehicle location data may, under certain circumstances, be shared with third parties to locate your vehicle. Further information is available at Lexus.com.

■ **Emergency Assistance Button (“SOS”)**

In the event of an emergency on the road, push the “SOS” button to reach the Safety Connect response center. The answering agent will determine your vehicle’s location, assess the emergency, and dispatch the necessary assistance required.

If you accidentally press the “SOS” button, tell the response-center agent that you are not experiencing an emergency.

■ **Enhanced Roadside Assistance**

Enhanced Roadside Assistance adds GPS data to the already included warranty-based Lexus roadside service.

Subscribers can press the “SOS” button to reach a Safety Connect response-center agent, who can help with a wide range of needs, such as: towing, flat tire, fuel delivery, etc. For a description of the Roadside Assistance services and their limitations, please see the Safety Connect Terms and Conditions, which are available at Lexus.com.



Safety information for Safety Connect

Important! Read this information before using Safety Connect.

■ Exposure to radio frequency signals

The Safety Connect system installed in your vehicle is a low-power radio transmitter and receiver. It receives and also sends out radio frequency (RF) signals.

In August 1996, the Federal Communications Commission (FCC) adopted RF exposure guidelines with safety levels for mobile wireless phones. Those guidelines are consistent with the safety standards previously set by the following U.S. and international standards bodies.

- ANSI (American National Standards Institute) C95.1 [1992]
- NCRP (National Council on Radiation Protection and Measurement) Report 86 [1986]
- ICNIRP (International Commission on Non-Ionizing Radiation Protection) [1996]

Those standards were based on comprehensive and periodic evaluations of the relevant scientific literature. Over 120 scientists, engineers, and physicians from universities, and government health agencies and industries reviewed the available body of research to develop the ANSI Standard (C95.1).

The design of Safety Connect complies with the FCC guidelines in addition to those standards.

■ Certification for Lexus Enform Safety Connect

FCC ID: N7NGTM2

FCC WARNING:

This equipment complies with FCC radiation exposure limits set forth for an uncontrolled environment and meets the FCC radio frequency (RF) Exposure Guidelines in Supplement C to OET65. This equipment should be installed and operated keeping the radiator at least 20cm or more away from person's body (excluding extremities: hands, wrists, feet and ankles).





6-1. Maintenance and care

- Cleaning and protecting
the vehicle exterior 446
- Cleaning and protecting
the vehicle interior 449

6-2. Maintenance

- Maintenance
requirements 452
- General maintenance 455
- Emission inspection and
maintenance (I/M)
programs 458

6-3. Do-it-yourself maintenance

- Do-it-yourself service
precautions 459
- Hood 462
- Engine compartment 463
- Tires 476
- Tire inflation pressure 483
- Wheels 487
- Air conditioning filter 489
- Electronic key battery 491
- Checking and replacing
fuses 493
- Headlight aim 496
- Light bulbs 498

Cleaning and protecting the vehicle exterior

Perform the following to protect the vehicle and maintain it in prime condition:

- Working from top to bottom, liberally apply water to the vehicle body, wheel wells and underside of the vehicle to remove any dirt and dust.
- Wash the vehicle body using a sponge or soft cloth, such as a chamois.
- For hard-to-remove marks, use car wash soap and rinse thoroughly with water.
- Wipe away any water.
- Wax the vehicle when the waterproof coating deteriorates.
If water does not bead on a clean surface, apply wax when the vehicle body is cool.

■ Automatic car washes

- Fold the mirrors back before washing the vehicle. Start washing from the front of the vehicle. Make sure to extend the mirrors before driving.
- Brushes used in automatic car washes may scratch the vehicle surface and harm your vehicle's paint.

■ High pressure car washes

- Do not allow the nozzles of the car wash to come within close proximity of the windows and the air suspension unit.
- Before using the car wash, check that the fuel filler door on your vehicle is closed properly.

■ Aluminum wheels

- Remove any dirt immediately by using a neutral detergent.
- Wash detergent off with water immediately after use.
- To protect the paint from damage, make sure to observe the following precautions.
 - Do not use acidic, alkaline or abrasive detergent
 - Do not use hard brushes
 - Do not use detergent on the wheels when they are hot, such as after driving or parking in hot weather

■ Bumpers and side moldings

Do not scrub with abrasive cleaners.



CAUTION

■ **When washing the vehicle**

Do not apply water to the inside of the engine compartment. Doing so may cause the electrical components etc. to catch fire.

■ **When cleaning the windshield (vehicles with rain-sensing windshield wiper)**

Set the wiper switch to off.
If the wiper switch is in "AUTO", the wipers may operate unexpectedly in the following situations, and may result in hands being caught or other serious injuries and cause damage to the wiper blades.

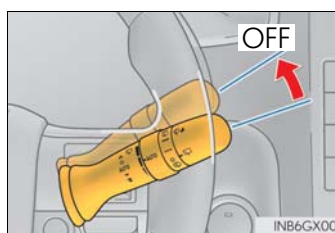

- When the upper part of the windshield where the raindrop sensor is located is touched by hand
- When a wet rag or similar is held close to the raindrop sensor
- If something bumps against the windshield
- If you directly touch the raindrop sensor body or if something bumps into the raindrop sensor

■ **Precautions regarding the exhaust pipe**

Exhaust gasses cause the exhaust pipe to become quite hot.

When washing the vehicle, be careful not to touch the pipe until it has cooled sufficiently, as touching a hot exhaust pipe can cause burns.

■ **Precautions regarding the Blind Spot Monitor (if equipped)**

If the paint of the rear bumper is chipped or scratched, the system may malfunction. If this occurs, consult your Lexus dealer.

 NOTICE

■ **To prevent paint deterioration and corrosion on the body and components (aluminum wheels etc.)**

- Wash the vehicle immediately in the following cases:
 - After driving near the sea coast
 - After driving on salted roads
 - If coal tar or tree sap is present on the paint surface
 - If you see dead insects, insect droppings or bird droppings on the paint
 - After driving in an area contaminated with soot, oily smoke, mine dust, iron powder or chemical substances
 - If the vehicle becomes heavily soiled in dust or mud
 - If liquids such as benzene and gasoline are spilled on the paint surface
- If the paint is chipped or scratched, have it repaired immediately.
- To prevent the wheels from corroding, remove any dirt and store in a place with low humidity when storing wheels.

■ **Cleaning the exterior lights**

- Wash carefully. Do not use organic substances or scrub with a hard brush. This may damage the surfaces of the lights.
- Do not apply wax on the surfaces of the lights. Wax may cause damage to the lenses.

■ **To prevent damage to the windshield wiper arms**

When lifting the wiper arms away from the windshield, pull the driver side wiper arm upward first, and repeat for the passenger side. When returning the wipers to their original position, do so from the passenger side first.

■ **When using an automatic car wash (vehicles with rain-sensing windshield wiper)**

Set the wiper switch to the off position.

If the wiper switch is in "AUTO", the wipers may operate and the wiper blades may be damaged.

■ **When using a high pressure car wash**

Do not bring the nozzle tip close to boots (rubber or resin manufactured cover), connectors or the following parts. The parts may be damaged if they come into contact with high-pressure water.

- Traction related parts
- Steering parts
- Suspension parts
- Brake parts



Cleaning and protecting the vehicle interior

The following procedures will help protect your vehicle's interior and keep it in top condition:

Protecting the vehicle interior

- Remove dirt and dust using a vacuum cleaner. Wipe dirty surfaces with a cloth dampened with lukewarm water.
- If dirt cannot be removed, wipe it off with a soft cloth dampened with neutral detergent diluted to approximately 1%.
- Wring out any excess water from the cloth and thoroughly wipe off remaining traces of detergent and water.

Cleaning the leather areas

- Remove dirt and dust using a vacuum cleaner.
- Wipe any excess dirt and dust with a soft cloth dampened with diluted detergent.
Use a diluted water solution of approximately 5% neutral wool detergent.
- Wring out any excess water from the cloth and thoroughly wipe off all remaining traces of detergent.
- Wipe the surface with a dry, soft cloth to remove any remaining moisture. Allow the leather to dry in a shaded ventilated area.

Cleaning the synthetic leather areas

- Remove dirt and dust using a vacuum cleaner.
- Wipe it off with a soft cloth dampened with neutral detergent diluted to approximately 1%.
- Wring out any excess water from the cloth and thoroughly wipe off remaining traces of detergent and water.

■ **Caring for leather areas**

Lexus recommends cleaning the interior of the vehicle at least twice a year to maintain the quality of the vehicle's interior.

■ **Shampooing the carpets**

There are several commercial foaming-type cleaners available. Use a sponge or brush to apply the foam. Rub in overlapping circles. Do not use water. The excellent results are obtained when keeping the carpet as dry as possible.

■ **Seat belts**

Clean with mild soap and lukewarm water using a cloth or sponge. Also check the belts periodically for excessive wear, fraying or cuts.

<p> CAUTION</p>
<p>■ Water in the vehicle</p> <ul style="list-style-type: none"> ● Do not splash or spill liquid in the vehicle. Doing so may cause electrical components etc. to malfunction or catch fire. ● Do not get any of the SRS components or wiring in the vehicle interior wet. (→P. 38) An electrical malfunction may cause the airbags to deploy or not function properly, resulting in death or serious injury. <p>■ Cleaning the interior (especially instrument panel)</p> <p>Do not use polish wax or polish cleaner. The instrument panel may reflect off the windshield, obstructing the driver's view and leading to an accident, resulting in death or serious injury.</p>

<p> NOTICE</p>
<p>■ Cleaning detergents</p> <ul style="list-style-type: none"> ● Do not use the following types of detergent, as they may discolor the vehicle interior or cause streaks or damage to painted surfaces: <ul style="list-style-type: none"> • Non-seat portions: Organic substances such as benzene or gasoline, alkaline or acidic solutions, dye, and bleach • Seats: Alkaline or acidic solutions, such as thinner, benzene, and alcohol ● Do not use polish wax or polish cleaner. The instrument panel's or other interior part's painted surface may be damaged.



 NOTICE**■ Preventing damage to leather surfaces**

Observe the following precautions to avoid damage to and deterioration of leather surfaces:

- Remove any dust or dirt from leather surfaces immediately.
- Do not expose the vehicle to direct sunlight for extended periods of time. Park the vehicle in the shade, especially during summer.
- Do not place items made of vinyl, plastic, or containing wax on the upholstery, as they may stick to the leather surface if the vehicle interior heats up significantly.

■ When cleaning the inside of the windshield (vehicles with LDA [Lane Departure Alert])

Be careful not to touch the camera sensor (→P. 239).

If the camera is accidentally scratched or hit, LDA may not operate properly or may cause a malfunction.

■ Water on the floor

Do not wash the vehicle floor with water.

Vehicle systems such as the audio system may be damaged if water comes into contact with electrical components such as the audio system above or under the floor of the vehicle. Water may also cause the body to rust.

■ Cleaning the inside of the rear window

- Do not use glass cleaner to clean the rear window, as this may cause damage to the rear window defogger heater wires or antenna. Use a cloth dampened with lukewarm water to gently wipe the window clean. Wipe the window in strokes running parallel to the heater wires or antenna.
- Be careful not to scratch or damage the heater wires or antenna.

Maintenance requirements

To ensure safe and economical driving, day-to-day care and regular maintenance are essential. It is the owner's responsibility to perform regular checks. Lexus recommends the following maintenance:

General maintenance

General maintenance should be performed on a daily basis. This can be done by yourself or by a Lexus dealer.

Scheduled maintenance

Scheduled maintenance should be performed at specified intervals according to the maintenance schedule.

For details about maintenance items and schedules, refer to the "Warranty and Service Guide", "Owner's Manual Supplement" or "Scheduled Maintenance".

Do-it-yourself maintenance

You can perform some maintenance procedures by yourself.

Please be aware that do-it-yourself maintenance may affect warranty coverage.

The use of Lexus repair manuals is recommended.

For details about warranty coverage, refer to the separate "Owner's Guide", "Warranty and Service Guide", "Owner's Manual Supplement" or "Warranty Booklet".



■ Repair and replacement

It is recommended that genuine Lexus parts be used for repairs to ensure performance of each system. If non-Lexus parts are used in replacement or if a repair shop other than a Lexus dealer performs repairs, confirm the warranty coverage.

■ Resetting the message indicating maintenance is required (U.S.A. only)

After the required maintenance is performed according to the maintenance schedule, please reset the message.

To reset the message, follow the procedures described below:

- 1 Press the Menu switch (→P. 87) to change the multi-information display to blank.
- 2 Turn the engine switch off.
- 3 While pressing the ODO/TRIP button (→P. 84), turn the engine switch to IGNITION ON mode.
- 4 Continue to press and hold the button for more than 7 seconds after the engine switch is turned to IGNITION ON mode.

The message shown in the illustration will appear on the display. After 5 seconds, the system reset will be completed.

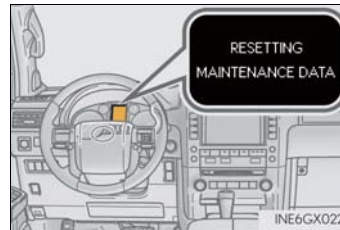

■ Allow inspection and repairs to be performed by a Lexus dealer

- Lexus technicians are well-trained specialists and are kept up to date with the latest service information. They are well informed about the operation of all systems on your vehicle.
- Keep a copy of the repair order. It proves that the maintenance that has been performed is under warranty coverage. If any problem should arise while your vehicle is under warranty, your Lexus dealer will promptly take care of it.

 CAUTION

■ **If your vehicle is not properly maintained**

Improper maintenance could result in serious damage to the vehicle and possible serious injury or death.

■ **Handling of the battery**

- Engine exhaust, some of its constituents, and a wide variety of automobile components contain or emit chemicals known to the State of California to cause cancer and birth defects and other reproductive harm. Work in a well ventilated area.
- Oils, fuels and fluids contained in vehicles as well as waste produced by component wear contain or emit chemicals known to the State of California to cause cancer and birth defects or other reproductive harm. Avoid exposure and wash any affected area immediately.
- Battery posts, terminals and related accessories contain lead and lead compounds which are known to cause brain damage. Wash your hands after handling. (→P. 472)

General maintenance

Listed below are the general maintenance items that should be performed at the intervals specified in the “Warranty and Service Guide” or “Owner’s Manual Supplement”. It is recommended that any problem you notice should be brought to the attention of your Lexus dealer or qualified service shop for advice.

Engine compartment

Items	Check points
Battery	Check the connections. (→P. 472)
Brake fluid	Is the brake fluid at the correct level? (→P. 469)
Engine coolant	Is the engine coolant at the correct level? (→P. 467)
Engine oil	Is the engine oil at the correct level? (→P. 465)
Exhaust system	There should not be any fumes or strange sounds.
Power steering fluid	Is the power steering fluid at the correct level? (→P. 471)
Radiator/condenser	The radiator and condenser should be free from foreign objects. (→P. 469)
Washer fluid	Is there sufficient washer fluid? (→P. 475)

Vehicle interior

Items	Check points
Accelerator pedal	<ul style="list-style-type: none"> The accelerator pedal should move smoothly (without uneven pedal effort or catching).
Automatic transmission "Park" mechanism	<ul style="list-style-type: none"> When parked on a slope and the shift lever is in P, is the vehicle securely stopped?
Brake pedal	<ul style="list-style-type: none"> Does the brake pedal move smoothly? Does the brake pedal have appropriate clearance from the floor? (→P. 577) Does the brake pedal have the correct amount of free play? (→P. 577)
Brakes	<ul style="list-style-type: none"> The vehicle should not pull to one side when the brakes are applied. The brakes should work effectively. The brake pedal should not feel spongy. The brake pedal should not get too close to the floor when the brakes are applied.
Head restraints	<ul style="list-style-type: none"> Do the head restraints move smoothly and lock securely?
Indicators/buzzers	<ul style="list-style-type: none"> Do the indicators and buzzers function properly?
Lights	<ul style="list-style-type: none"> Do all the lights come on? Are the headlights aimed correctly? (→P. 496)
Parking brake	<ul style="list-style-type: none"> Does the parking brake pedal move smoothly? When parked on a slope and the parking brake is on, is the vehicle securely stopped?
Seat belts	<ul style="list-style-type: none"> Do the seat belts operate smoothly? The seat belts should not be damaged.
Seats	<ul style="list-style-type: none"> Do the seat controls operate properly?
Steering wheel	<ul style="list-style-type: none"> Does the steering wheel rotate smoothly? Does the steering wheel have the correct amount of free play? There should not be any strange sounds coming from the steering wheel.



Vehicle exterior

Items	Check points
Doors	<ul style="list-style-type: none"> Do the doors operate smoothly?
Engine hood	<ul style="list-style-type: none"> Does the engine hood lock system work properly?
Fluid leaks	<ul style="list-style-type: none"> There should not be any signs of fluid leakage after the vehicle has been parked.
Tires	<ul style="list-style-type: none"> Is the tire inflation pressure correct? The tires should not be damaged or excessively worn. Have the tires been rotated according to the maintenance schedule? The wheel nuts should not be loose.
Windshield wipers/rear window wiper	<ul style="list-style-type: none"> The wiper blades should not show any signs of cracking, splitting, wear, contamination or deformation. The wiper blades should clear the windshield/rear window without streaking or skipping.

CAUTION

■ If the engine is running

Turn off the engine and ensure that there is adequate ventilation before performing maintenance checks.



Emission inspection and maintenance (I/M) programs

Some states have vehicle emission inspection programs which include OBD (On Board Diagnostics) checks. The OBD system monitors the operation of the emission control system.

If the malfunction indicator lamp comes on

The OBD system determines that a problem exists somewhere in the emission control system. Your vehicle may not pass the I/M test and may need to be repaired. Contact your Lexus dealer to service the vehicle.

Your vehicle may not pass the I/M test in the following situations:

- When the battery is disconnected or discharged
Readiness codes that are set during ordinary driving are erased. Also, depending on your driving habits, the readiness codes may not be completely set.
- When the fuel tank cap is loose
The malfunction indicator lamp comes on indicating a temporary malfunction and your vehicle may not pass the I/M test.

When the malfunction indicator lamp still remains on after several driving trips

The error code in the OBD system will not be cleared unless the vehicle is driven 40 or more times.

If your vehicle does not pass the I/M test

Contact your Lexus dealer to prepare the vehicle for re-testing.



Do-it-yourself service precautions

If you perform maintenance yourself, be sure to follow the correct procedures as given in these sections.

Items	Parts and tools
Battery condition (→P. 472)	<ul style="list-style-type: none"> • Warm water • Baking soda • Grease • Conventional wrench (for terminal clamp bolts)
Brake fluid level (→P. 469)	<ul style="list-style-type: none"> • FMVSS No.116 DOT 3 or SAE J1703 brake fluid • Rag or paper towel • Funnel (used only for adding brake fluid)
Engine coolant level (→P. 467)	<ul style="list-style-type: none"> • "Toyota Super Long Life Coolant" or similar high quality ethylene glycol based non-silicate, non-amine, non-nitrite and non-borate coolant with long-life hybrid organic acid technology. For the U.S.A.: "Toyota Super Long Life Coolant" is pre-mixed with 50 % coolant and 50 % deionized water. For Canada: "Toyota Super Long Life Coolant" is pre-mixed with 55 % coolant and 45 % deionized water. • Funnel (used only for adding coolant)
Engine oil level (→P. 465)	<ul style="list-style-type: none"> • "Toyota Genuine Motor Oil" or equivalent • Rag or paper towel • Funnel (used only for adding engine oil)
Fuses (→P. 493)	<ul style="list-style-type: none"> • Fuse with same amperage rating as original

Items	Parts and tools
Headlight aim (→P. 496)	<ul style="list-style-type: none"> • Phillips-head screwdriver
Light bulbs (→P. 498)	<ul style="list-style-type: none"> • Bulb with same number and wattage rating as original • Phillips-head screwdriver • Flathead screwdriver • Wrench
Power steering fluid level (→P. 471)	<ul style="list-style-type: none"> • Automatic transmission fluid DEXRON® II or III • Rag or paper towel • Clean funnel
Radiator and condenser (→P. 469)	—
Tire inflation pressure (→P. 483)	<ul style="list-style-type: none"> • Tire pressure gauge • Compressed air source
Washer fluid (→P. 475)	<ul style="list-style-type: none"> • Water or washer fluid containing antifreeze (for winter use) • Funnel (used only for adding water or washer fluid)



 CAUTION

The engine compartment contains many mechanisms and fluids that may move suddenly, become hot, or become electrically energized. To avoid death or serious injury, observe the following precautions:

■ When working on the engine compartment

- Keep hands, clothing and tools away from the moving fan and engine drive belt.
- Be careful not to touch the engine, radiator, exhaust manifold, etc. right after driving as they may be hot. Oil and other fluids may also be hot.
- Do not leave anything that may burn easily, such as paper or rags, in the engine compartment.
- Do not smoke, cause sparks or expose an open flame to fuel or the battery. Fuel and battery fumes are flammable.
- Be extremely cautious when working on the battery. It contains poisonous and corrosive sulfuric acid.

■ When working near the electric cooling fans or radiator grille

Be sure the engine switch is off. With the engine switch in IGNITION ON mode, the electric cooling fans may automatically start to run if the air conditioning is on and/or the coolant temperature is high. (→P. 469)

■ When working on or under the vehicle

Do not get under the vehicle with just the jack supporting it.
Always use automotive jack stands or other solid supports.

■ Safety glasses

Wear safety glasses to prevent flying or falling material, fluid spray, etc. from getting in your eyes.

 NOTICE**■ If you remove the air cleaner filter**

Driving with the air cleaner filter removed may cause excessive engine wear due to dirt in the air.

Hood

Release the lock from the inside of the vehicle to open the hood.

- 1 Pull the hood lock release lever.
The hood will pop up slightly.



- 2 Move the auxiliary catch lever to side direction and lift the hood.

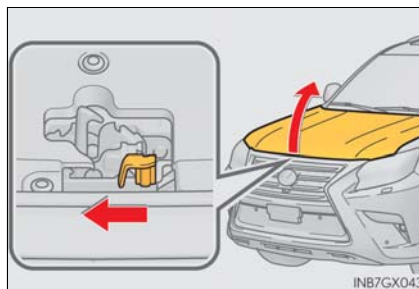

⚠ CAUTION

■ Pre-driving check

Check that the hood is fully closed and locked.
If the hood is not locked properly, it may open while the vehicle is in motion and cause an accident, which may result in death or serious injury.

Engine compartment

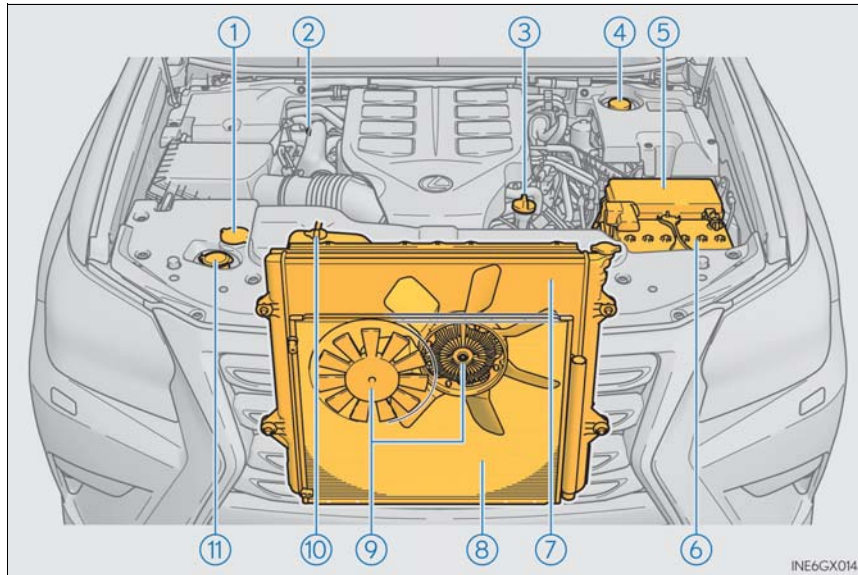

- | | |
|---|---|
| ① Power steering fluid reservoir
(→P. 471) | ⑥ Battery
(→P. 472) |
| ② Engine oil level dipstick
(→P. 465) | ⑦ Radiator
(→P. 469) |
| ③ Engine oil filler cap
(→P. 466) | ⑧ Condenser
(→P. 469) |
| ④ Brake fluid reservoir
(→P. 469) | ⑨ Cooling fans |
| ⑤ Fuse box
(→P. 493) | ⑩ Engine coolant reservoir
(→P. 467) |
| | ⑪ Washer fluid tank
(→P. 475) |

6

Maintenance and care

Engine compartment cover

■ Removing the engine compartment cover

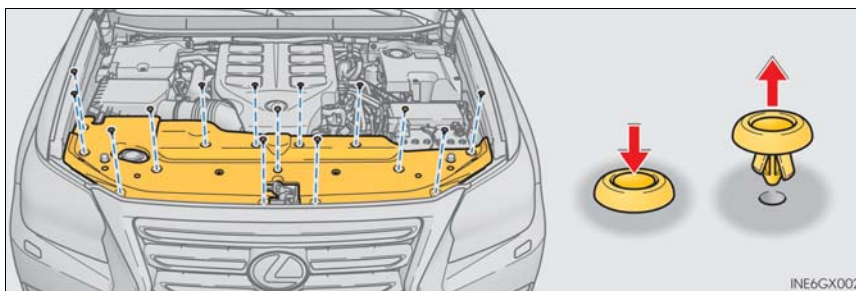

■ Installing the clips

- ① Push up center portion
- ② Insert
- ③ Press

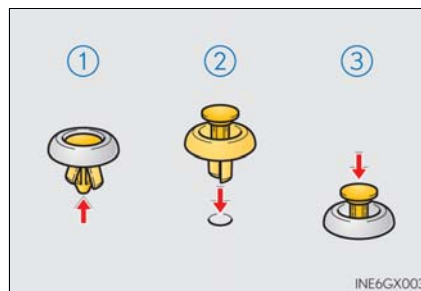

⚠ NOTICE

- **After installing an engine compartment cover**
Make sure the cover is securely installed in its original position.

Engine oil

With the engine at operating temperature and turned off, check the oil level on the dipstick.

■ Checking the engine oil

- 1 Park the vehicle on level ground. After warming up the engine and turning it off, wait more than 5 minutes for the oil to drain back into the bottom of the engine.
- 2 Holding a rag under the end, pull the dipstick out.

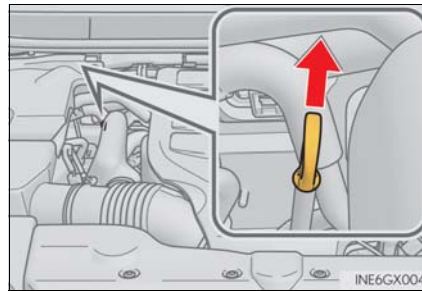

- 3 Wipe the dipstick clean.
- 4 Reinsert the dipstick fully.
- 5 Holding a rag under the end, pull the dipstick out and check the oil level.

- ① Low
- ② Normal
- ③ Excessive

The shape of the dipstick may differ depending on the type of vehicle or engine.

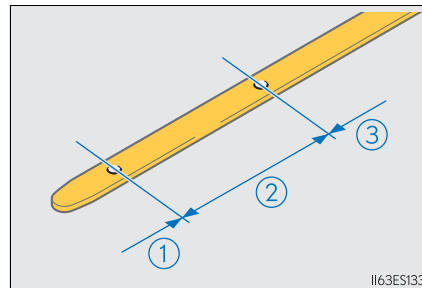

- 6 Wipe the dipstick and reinsert it fully.

6

Maintenance and care

■ Adding engine oil

If the oil level is below or near the low level mark, add engine oil of the same type as already in the engine.

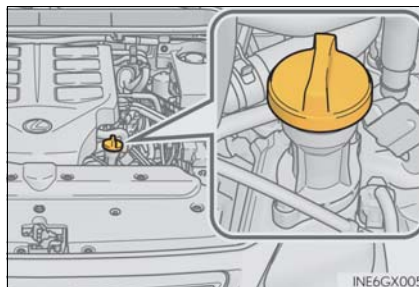

Make sure to check the oil type and prepare the items needed before adding oil.

Engine oil selection	→P. 572
Oil quantity (Low → Full)	1.6 qt. (1.5 L, 1.3 Imp.qt.)
Items	Clean funnel

- 1 Remove the oil filler cap by turning it counterclockwise.
- 2 Add engine oil slowly, checking the dipstick.
- 3 Install the oil filler cap by turning it clockwise.

■ Engine oil consumption

A certain amount of engine oil will be consumed while driving. In the following situations, oil consumption may increase, and engine oil may need to be refilled in between oil maintenance intervals.

- When the engine is new, for example directly after purchasing the vehicle or after replacing the engine
- If low quality oil or oil of an inappropriate viscosity is used
- When driving at high engine speeds or with a heavy load, when towing, or when driving while accelerating or decelerating frequently
- When leaving the engine idling for a long time, or when driving frequently through heavy traffic



⚠ CAUTION**■ Used engine oil**

- Used engine oil contains potentially harmful contaminants which may cause skin disorders such as inflammation or skin cancer, so care should be taken to avoid prolonged and repeated contact. To remove used engine oil from your skin, wash thoroughly with soap and water.
- Dispose of used oil and filters only in a safe and acceptable manner. Do not dispose of used oil and filters in household trash, in sewers or onto the ground. Call your Lexus dealer, service station or auto parts store for information concerning recycling or disposal.
- Do not leave used engine oil within the reach of children.

⚠ NOTICE**■ To prevent serious engine damage**

Check the oil level on regular basis.

■ When replacing the engine oil

- Be careful not to spill engine oil on the vehicle components.
- Avoid overfilling, or the engine could be damaged.
- Check the oil level on the dipstick every time you refill the vehicle.
- Be sure the engine oil filler cap is properly tightened.

Engine coolant

The coolant level is satisfactory if it is between the “F” and “L” lines on the reservoir when the engine is cold.

- ① Reservoir cap
- ② “F”
- ③ “L”

If the level is on or below the “L” line, add coolant up to the “F” line.

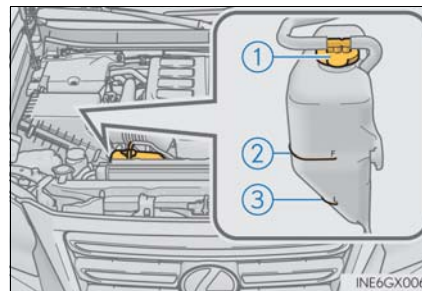

■ **Coolant selection**

Only use "Toyota Super Long Life Coolant" or a similar high quality ethylene glycol based non-silicate, non-amine, non-nitrite, and non-borate coolant with long-life hybrid organic acid technology.

U.S.A.: "Toyota Super Long Life Coolant" is a mixture of 50 % coolant and 50 % deionized water. (Minimum temperature: -31°F [-35°C])

Canada: "Toyota Super Long Life Coolant" is a mixture of 55 % coolant and 45% deionized water. (Minimum temperature: -44°F [-42°C])

For more details about engine coolant, contact your Lexus dealer.

■ **If the coolant level drops within a short time of replenishing**

Visually check the radiator, hoses, engine coolant reservoir cap, radiator cap, drain cock and water pump. If you cannot find a leak, have your Lexus dealer test the cap and check for leaks in the cooling system.

 CAUTION
<p>■ When the engine is hot</p> <p>Do not remove the radiator cap. The cooling system may be under pressure and may spray hot coolant if the cap is removed, causing serious injuries, such as burns.</p>

 NOTICE
<p>■ When adding coolant</p> <p>Coolant is neither plain water nor straight antifreeze. The correct mixture of water and antifreeze must be used to provide proper lubrication, corrosion protection and cooling. Be sure to read the antifreeze or coolant label.</p> <p>■ If you spill coolant</p> <p>Be sure to wash it off with water to prevent it from damage to parts or paint.</p>



Radiator and condenser

Check the radiator and condenser and clear any foreign objects.
If either of the above parts is extremely dirty or you are not sure of their condition, have your vehicle checked by your Lexus dealer.

⚠ CAUTION

■ When the engine is hot

Do not touch the radiator or condenser as they may be hot and cause serious injuries, such as burns.

Brake fluid

■ Checking fluid level

The brake fluid level should be between the "MAX" and "MIN" lines on the tank.

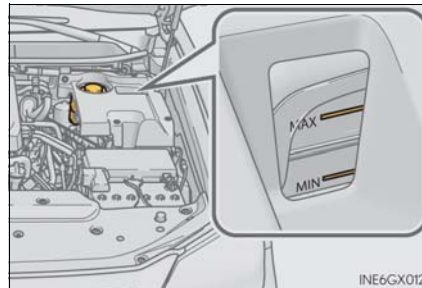

■ Adding fluid

Make sure to check the fluid type and prepare the necessary item.

Fluid type	FMVSS No.116 DOT 3 or SAE J1703 brake fluid
Items	Clean funnel

■ **Brake fluid can absorb moisture from the air**

Excess moisture in the fluid can cause a dangerous loss of braking efficiency. Use only newly opened brake fluid.

 **CAUTION**

■ **When filling the reservoir**

Take care because brake fluid can harm your hands or eyes and damage painted surfaces. If fluid gets on your eyes, flush the affected area with clean water immediately. If you still experience discomfort, see a doctor.

 **NOTICE**

■ **If the fluid level is low or high**

It is normal for the brake fluid level to go down slightly as the brake pads wear or when the fluid level in the accumulator is high. If the reservoir needs frequent refilling, it may indicate a serious problem.

Power steering fluid

■ Fluid level

The fluid level should be within the appropriate range.

- ① Full (when cold)
- ② Add fluid (when cold)
- ③ Full (when hot)
- ④ Add fluid (when hot)

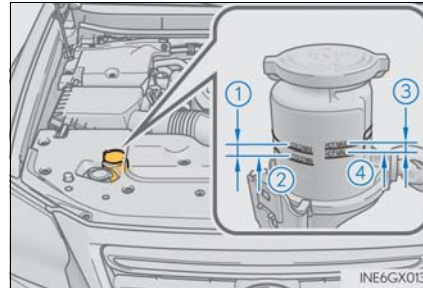

Hot: The vehicle has been driven around 50 mph (80 km/h) for 20 minutes, or slightly longer in frigid temperatures.

(Fluid temperature, 140°F - 175°F [60°C - 80°C]).

Cold: The engine has not been run for about 5 hours.

(Room temperature, 50°F - 85°F [10°C - 30°C]).

■ Checking the fluid level

Make sure to check the fluid type and prepare the necessary items.

Fluid type	Automatic transmission fluid DEXRON® II or III
Items	Rag or paper, clean funnel (only for adding fluid)

- ① Clean all dirt off the reservoir.
- ② Remove the cap by turning it counterclockwise.
- ③ Wipe the dipstick clean.
- ④ Reinstall the cap and remove it again.
- ⑤ Check the fluid level.

CAUTION

- **When checking the reservoir**
Take care as the reservoir may be hot.

NOTICE

- **When adding fluid**
Avoid overfilling, or the power steering may be damaged.
- **After replacing the reservoir cap**
Check the steering box case, vane pump and hose connections for leaks or damage.

Battery

Check the battery as follows.

■ **Battery exterior**

Make sure that the battery terminals are not corroded and that there are no loose connections, cracks, or loose clamps.

- ① Terminals
- ② Hold-down clamp



■ Before recharging

When recharging, the battery produces hydrogen gas which is flammable and explosive. Therefore, observe the following before recharging:

- If recharging with the battery installed on the vehicle, be sure to disconnect the ground cable.
- Make sure the power switch on the charger is off when connecting and disconnecting the charger cables to the battery.

■ After recharging/reconnecting the battery

The engine may not start. Follow the procedure below to initialize the system.

- 1** Shift the shift lever to P
- 2** Open and close any of the doors.
- 3** Restart the engine.
 - Unlocking the doors using the smart access system with push-button start may not be possible immediately after reconnecting the battery. If this happens, use the wireless remote control or the mechanical key to lock/unlock the doors.
 - Start the engine with the engine switch in ACCESSORY mode. The engine may not start with the engine switch turned off. However, the engine will operate normally from the second attempt.
 - The engine switch mode is recorded by the vehicle. If the battery is reconnected, the vehicle will return the engine switch mode to the status it was in before the battery was disconnected. Make sure to turn off the engine before disconnect the battery. Take extra care when connecting the battery if the engine switch mode prior to discharge is unknown.

If the system will not start even after multiple attempts, contact your Lexus dealer.

⚠ CAUTION**■ Chemicals in the battery**

Batteries contain poisonous and corrosive sulfuric acid and may produce hydrogen gas which is flammable and explosive. To reduce the risk of death or serious injury, take the following precautions while working on or near battery:

- Do not cause sparks by touching the battery terminals with tools.
- Do not smoke or light a match near the battery.
- Avoid contact with eyes, skin and clothes.
- Never inhale or swallow electrolyte.
- Wear protective safety glasses when working near the battery.
- Keep children away from the battery.

■ Where to safely charge the battery

Always charge the battery in an open area. Do not charge the battery in a garage or closed room where there is not sufficient ventilation.

 CAUTION

■ **How to recharge the battery**

Only perform a slow charge (5A or less). The battery may explode if charged at a quicker rate.

■ **Emergency measures regarding electrolyte**

● **If electrolyte gets in your eyes**

Flush your eyes with clean water for at least 15 minutes and get immediate medical attention. If possible, continue to apply water with a sponge or cloth while traveling to the nearest medical facility.

● **If electrolyte gets on your skin**

Wash the affected area thoroughly. If you feel pain or burning, get medical attention immediately.

● **If electrolyte gets on your clothes**

It can soak through clothing on to your skin. Immediately take off the clothing and follow the procedure above if necessary.

● **If you accidentally swallow electrolyte**

Drink a large quantity of water or milk. Get emergency medical attention immediately.

 NOTICE

■ **When recharging the battery**

Never recharge the battery while the engine is running. Also, be sure all accessories are turned off.



Washer fluid

If any washer does not work or the warning message appears on the multi-information display, the washer tank may be empty. Add washer fluid.

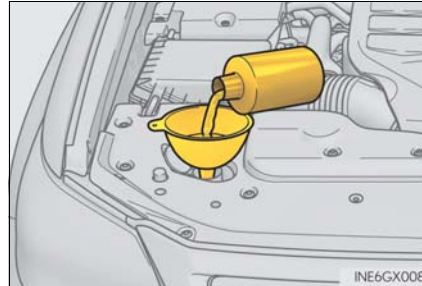

CAUTION

■ When adding washer fluid

Do not add washer fluid when the engine is hot or running as washer fluid contains alcohol and may catch fire if spilled on the engine etc.

NOTICE

■ Do not use any fluid other than washer fluid

Do not use soapy water or engine antifreeze instead of washer fluid. Doing so may cause streaking on the vehicle's painted surfaces, as well as damaging the pump leading to problems of the washer fluid not spraying.

■ Diluting washer fluid

Dilute washer fluid with water as necessary. Refer to the freezing temperatures listed on the label of the washer fluid bottle.

Tires

Replace or rotate tires in accordance with maintenance schedules and treadwear.

Checking tires

Check if the treadwear indicators are showing on the tires. Also check the tires for uneven wear, such as excessive wear on one side of the tread.

Check the spare tire condition and pressure if not rotated.

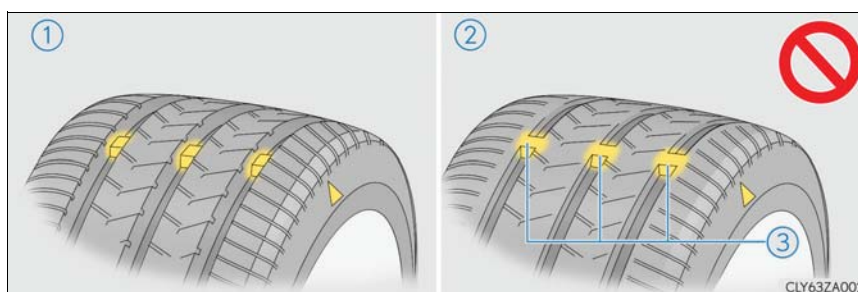

- ① New tread
- ② Worn tread
- ③ Treadwear indicator

The location of treadwear indicators is shown by the "TWI" or "Δ" mark, etc., molded into the sidewall of each tire.

Replace the tires if the treadwear indicators are showing on a tire.

Tire rotation

Rotate the tires in the order shown.

To equalize tire wear and extend tire life, Lexus recommends that tire rotation is carried out at the same interval as tire inspection.

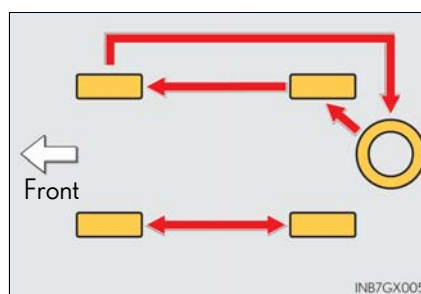

Tire pressure warning system

Your Lexus is equipped with a tire pressure warning system that uses tire pressure warning valves and transmitters to detect low tire inflation pressure before serious problems arise.

If the tire pressure drops below a predetermined level, the driver is warned by a warning light. (→P. 522)

◆ Installing tire pressure warning valves and transmitters

When replacing tires or wheels, tire pressure warning valves and transmitters must also be installed.

When new tire pressure warning valves and transmitters are installed, new ID codes must be registered in the tire pressure warning computer and the tire pressure warning system must be initialized. Have tire pressure warning valve and transmitter ID codes registered by your Lexus dealer.

◆ Registering ID codes

The tire pressure warning valve and transmitter is equipped with a unique ID code. When replacing a tire pressure warning valve and transmitter, it is necessary to register the ID code. Have the ID code registered by your Lexus dealer.

■ **When to replace your vehicle's tires**

Tires should be replaced if:

- The treadwear indicators are showing on a tire.
- You have tire damage such as cuts, splits, cracks deep enough to expose the fabric, and bulges indicating internal damage
- A tire goes flat repeatedly or cannot be properly repaired due to the size or location of a cut or other damage

If you are not sure, consult with your Lexus dealer.

■ **Replacing tires and wheels**

If the ID code of the tire pressure warning valve and transmitter is not registered, the tire pressure warning system will not work properly. After driving for about 20 minutes, the tire pressure warning light blinks for 1 minute and stays on to indicate a system malfunction.

■ **Tire life**

Any tire over 6 years old must be checked by a qualified technician even if it has seldom or never been used or damage is not obvious.

■ **Routine tire inflation pressure checks**

The tire pressure warning system does not replace routine tire inflation pressure checks. Make sure to check tire inflation pressure as part of your routine of daily vehicle checks.

■ **Maximum load of tire**

Check that the number given by dividing the maximum load by 1.10 of the replacement tire is greater than 1/2 of the Gross Axle Weight Ratings (GAWR) of either the front axle or the rear axle, whichever is greater.

For the GAWR, see the Certification Label. For the maximum load of the tire, see the load limit at maximum cold tire inflation pressure mentioned on the sidewall of the tire. (→P. 583)

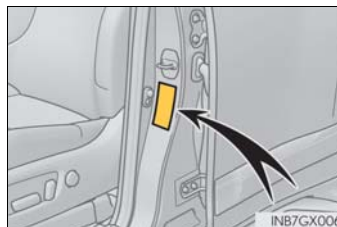

■ Tire types**● Summer tires**

Summer tires are high-speed performance tires best suited to highway driving under dry conditions. Since summer tires do not have the same traction performance as snow tires, summer tires are inadequate for driving on snow-covered or icy roads. For driving on snow-covered roads or icy roads, the use of snow tires is recommended. When installing snow tires, be sure to replace all four tires.

● All season tires

All season tires are designed to provide better traction in snow and to be adequate for driving in most winter conditions as well as for use year-round. All season tires, however, do not have adequate traction performance compared with snow tires in heavy or loose snow. Also, all season tires fall short in acceleration and handling performance compared with summer tires in highway driving.

● Snow tires

For driving on snow-covered roads or icy roads, we recommend using snow tires. If you need snow tires, select tires of the same size, construction and load capacity as the originally installed tires. Since your vehicle has radial tires as original equipment, make sure your snow tires also have radial construction. Do not install studded tires without first checking local regulations for possible restrictions. Snow tires should be installed on all wheels. (→P. 377)

■ **If the tread on snow tires wears down below 0.16 in. (4 mm)**

The effectiveness of the tires as snow tires is lost.

■ **Situations in which the tire pressure warning system may not operate properly**

- In the following cases, the tire pressure warning system may not operate properly.
 - If non-genuine Lexus wheels are used.
 - A tire has been replaced with a tire that is not an OE (Original Equipment) tire.
 - A tire has been replaced with a tire that is not of the specified size.
 - Tire chains etc. are equipped.
 - An auxiliary-supported run-flat tire is equipped.
 - If a window tint that affects the radio wave signals is installed.
 - If there is a lot of snow or ice on the vehicle, particularly around the wheels or wheel housings.
 - If the tire inflation pressure is extremely higher than the specified level.
 - If the spare tire is in a location subject to poor radio wave signal reception.
 - If a large metallic object which can interfere with signal reception is put near the spare tire.
 - If tires not equipped with the tire pressure warning valves and transmitters are used.
 - If the ID code on the tire pressure warning valves and transmitters is not registered in the tire pressure warning computer.
- Performance may be affected in the following situations.
 - Near a TV tower, electric power plant, gas station, radio station, large display, airport or other facility that generates strong radio waves or electrical noise
 - When carrying a portable radio, cellular phone, cordless phone or other wireless communication device
- When the vehicle is parked, the time taken for the warning to start or go off could be extended.
- When tire inflation pressure declines rapidly for example when a tire has burst, the warning may not function.



■ Certification for tire pressure warning system

- ▶ For vehicles sold in the U.S.A., Hawaii, NATO Germany, Guam, Saipan and Puerto Rico

FCC ID: PAXPMVC010

NOTE

This device complies with part 15 of the FCC Rules. Operation is subject to the following two conditions: (1) This device may not cause harmful interference, and (2) this device must accept any interference received, including interference that may cause undesired operation.

FCC WARNING

Changes or modifications not expressly approved by the party responsible for compliance could void the user's authority to operate the equipment.

FCC ID: HYQ13BDY

NOTE:

This device complies with part 15 of the FCC Rules. Operation is subject to the following two conditions: (1) This device may not cause harmful interference, and (2) this device must accept any interference received, including interference that may cause undesired operation.

FCC WARNING:

Changes or modifications not expressly approved by the party responsible for compliance could void the user's authority to operate the equipment.

- ▶ For vehicles sold in Canada

NOTE

Operation is subject to the following two conditions: (1) this device may not cause interference, and (2) this device must accept any interference, including interference that may cause undesired operation of the device.

CAUTION

■ Tire pressure warning system operation

The tire pressure warning system may not provide warning immediately if a tire bursts or if sudden air leakage occurs.

■ When inspecting or replacing tires

Observe the following precautions to prevent accidents. Failure to do so may cause damage to parts of the drive train as well as dangerous handling characteristics, which may lead to an accident resulting in death or serious injury.

- Do not mix tires of different makes, models or tread patterns.
Also, do not mix tires of remarkably different treadwear.
- Do not use tire sizes other than those recommended by Lexus.
- Do not mix differently constructed tires (radial, bias-belted or bias-ply tires).
- Do not mix summer, all season and snow tires.
- Do not use tires that have been used on another vehicle.
Do not use tires if you do not know how they were used previously.



 NOTICE

■ **Repairing or replacing tires, wheels, tire pressure warning valves, transmitters and tire valve caps**

- When removing or fitting the wheels, tires or the tire pressure warning valves and transmitters, contact your Lexus dealer as the tire pressure warning valves and transmitters may be damaged if not handled correctly.
- Make sure to install the tire valve caps. If the tire valve caps are not installed, water could enter the tire pressure warning valves and the tire pressure warning valves could be bound.
- When replacing tire valve caps, do not use tire valve caps other than those specified. The cap may become stuck.

■ **To avoid damage to the tire pressure warning valves and transmitters**

When a tire is repaired with liquid sealants, the tire pressure warning valve and transmitter may not operate properly. If a liquid sealant is used, contact your Lexus dealer or other qualified service shop as soon as possible. Make sure to replace the tire pressure warning valve and transmitter when replacing the tire. (→P. 477)

■ **Driving on rough roads**

Take particular care when driving on roads with loose surfaces or potholes. These conditions may cause losses in tire inflation pressure, reducing the cushioning ability of the tires. In addition, driving on rough roads may cause damage to the tires themselves, as well as the vehicle's wheels and body.

■ **If tire inflation pressure of each tire becomes low while driving**

Do not continue driving, or your tires and/or wheels may be ruined.



Tire inflation pressure

Tire inflation pressure

The recommended cold tire inflation pressure and tire size are displayed on the tire and loading information label. (→P. 578)

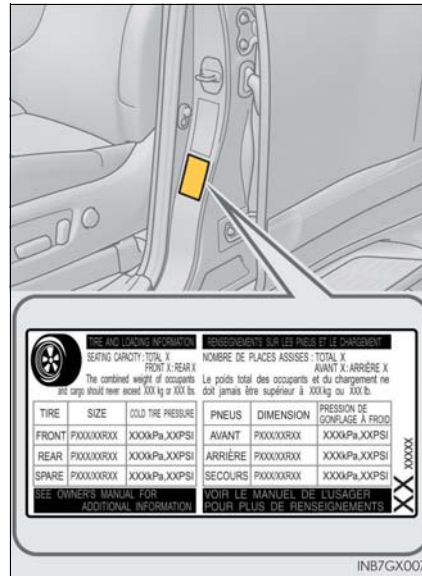

6

Maintenance and care

Inspection and adjustment procedure

- ① Tire valve
- ② Tire pressure gauge

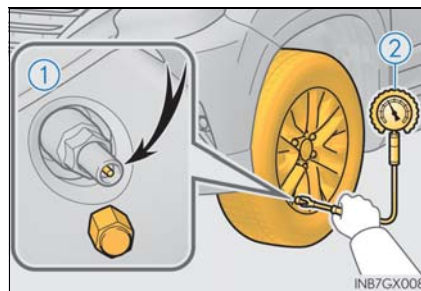

- 1 Remove the tire valve cap.
- 2 Press the tip of the tire pressure gauge onto the tire valve.
- 3 Read the pressure using the gauge gradations.
- 4 If the tire inflation pressure is not at the recommended level, adjust the pressure.
If you add too much air, press the center of the valve to deflate.
- 5 After completing the tire inflation pressure measurement and adjustment, apply soapy water to the valve and check for leakage.
- 6 Put the tire valve cap back on.

■ Tire inflation pressure check interval

You should check tire inflation pressure every two weeks, or at least once a month. Do not forget to check the spare.

■ Effects of incorrect tire inflation pressure

Driving with incorrect tire inflation pressure may result in the following:

- Reduced fuel economy
- Reduced driving comfort and poor handling
- Reduced tire life due to wear
- Reduced safety
- Damage to the drive train

If a tire needs frequent inflating, have it checked by your Lexus dealer.

■ Instructions for checking tire inflation pressure

When checking tire inflation pressure, observe the following:

- Check only when the tires are cold.
If your vehicle has been parked for at least 3 hours and has not been driven for more than 1 mile or 1.5 km, you will get an accurate cold tire inflation pressure reading.
- Always use a tire pressure gauge.
It is difficult to judge if a tire is properly inflated based only on its appearance.
- It is normal for the tire inflation pressure to be higher after driving as heat is generated in the tire. Do not reduce tire inflation pressure after driving.
- Never exceed the vehicle capacity weight.
Passengers and luggage weight should be placed so that the vehicle is balanced.



 CAUTION**■ Proper inflation is critical to save tire performance**

Keep your tires properly inflated.

If the tires are not properly inflated, the following conditions may occur which could lead to an accident resulting in death or serious injury:

- Excessive wear
- Uneven wear
- Poor handling
- Possibility of blowouts resulting from overheated tires
- Air leaking from between tire and wheel
- Wheel deformation and/or tire damage
- Greater possibility of tire damage while driving (due to road hazards, expansion joints, sharp edges in the road, etc.)

 NOTICE**■ When inspecting and adjusting tire inflation pressure**

Be sure to put the tire valve caps back on.

If a valve cap is not installed, dirt or moisture may get into the valve and cause an air leak, resulting in decreased tire inflation pressure.

Wheels

If a wheel is bent, cracked or heavily corroded, it should be replaced. Otherwise, the tire may separate from the wheel or cause loss of handling control.

Wheel selection

When replacing wheels, care should be taken to ensure that they are equivalent to those removed in load capacity, diameter, rim width, and inset*.

Replacement wheels are available at your Lexus dealer.

*: Conventionally referred to as "offset".

Lexus does not recommend using the following:

- Wheels of different sizes or types
- Used wheels
- Bent wheels that have been straightened

Aluminum wheel precautions

- Use only Lexus wheel nuts and wrenches designed for use with your aluminum wheels.
- When rotating, repairing or changing your tires, check that the wheel nuts are still tight after driving 1000 miles (1600 km).
- Be careful not to damage the aluminum wheels when using tire chains.
- Use only Lexus genuine balance weights or equivalent and a plastic or rubber hammer when balancing your wheels.

■ When replacing wheels

The wheels of your vehicle are equipped with tire pressure warning valves and transmitters that allow the tire pressure warning system to provide advance warning in the event of a loss in tire inflation pressure. Whenever wheels are replaced, tire pressure warning valves and transmitters must be installed. (→P. 477)

 CAUTION■ **When replacing wheels**

- Do not use wheels that are a different size from those recommended in the Owner's Manual, as this may result in a loss of handling control.
- Never use an inner tube in a leaking wheel which is designed for a tubeless tire. Doing so may result in an accident, causing death or serious injury.

■ **Use of defective wheels prohibited**

Do not use cracked or deformed wheels.
Doing so could cause the tire to leak air during driving, possibly causing an accident.

 NOTICE■ **Replacing tire pressure warning valves and transmitters**

- Because tire repair or replacement may affect the tire pressure warning valves and transmitters, make sure to have tires serviced by your Lexus dealer or other qualified service shop. In addition, make sure to purchase your tire pressure warning valves and transmitters at your Lexus dealer.
- Ensure that only genuine Lexus wheels are used on your vehicle.
Tire pressure warning valves and transmitters may not work properly with non-genuine wheels.

Air conditioning filter

The air conditioning filter must be changed regularly to maintain air conditioning efficiency.

Removal method

- 1 Turn the engine switch off.
- 2 Open the glove box and remove the glove box cover.

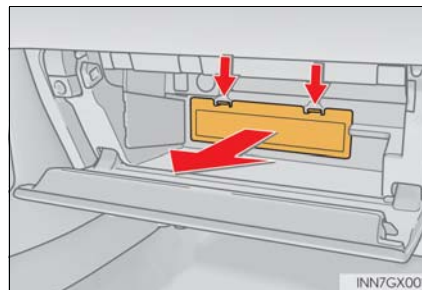

- 3 Remove the filter cover.

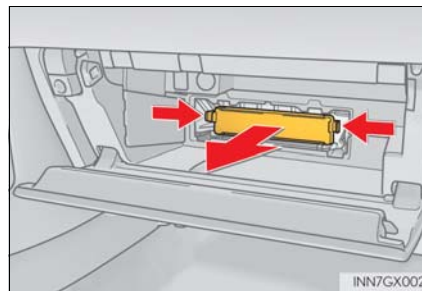

- 4 Slide and pull out the filter. Replace the filter with a new one.

The "↑UP" marks shown on the filter should be pointing up.

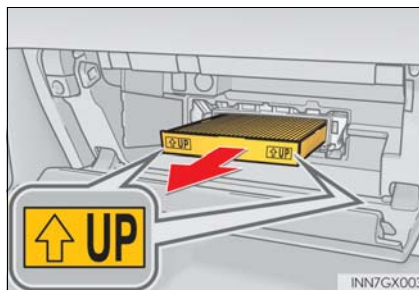

■ Changing interval

Inspect and replace the air conditioning filter according to the maintenance schedule. In dusty areas or areas with heavy traffic flow, early replacement may be required. (For scheduled maintenance information, please refer to the "Owner's Manual Supplement" or "Scheduled Maintenance".)

■ If air flow from the vents decreases dramatically

The filter may be clogged. Check the filter and replace if necessary.

⚠ NOTICE

■ When using the air conditioning system

Make sure that a filter is always installed.

Using the air conditioning system without a filter may cause damage to the system.

Electronic key battery

Replace the battery with a new one if it is depleted.

You will need the following items:

- Flathead screwdriver
- Small Phillips-head screwdriver
- Lithium battery (CR1632)

Replacing the battery

- 1 Take out the mechanical key.

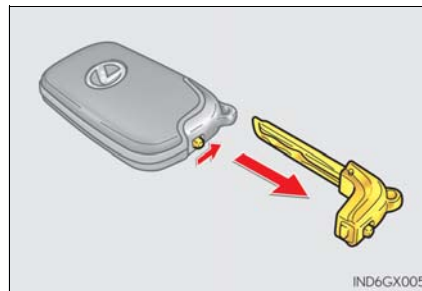

- 2 Remove the cover.
To prevent damage to the key, cover the tip of the screwdriver with a rag.

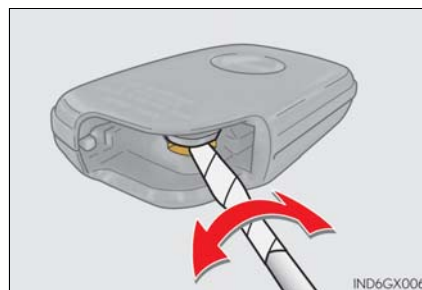

- 3 Remove the depleted battery.
Insert a new battery with the "+" terminal facing up.

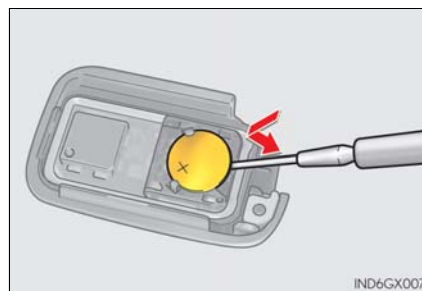

6

Maintenance and care

■ **Use a CR1632 lithium battery**

- Batteries can be purchased at your Lexus dealer, local electrical appliance shops or camera stores.
- Replace only with the same or equivalent type recommended by the manufacturer.
- Dispose of used batteries according to the local laws.

■ **If the electronic key battery is depleted**

The following symptoms may occur:

- The smart access system with push-button start and wireless remote control will not function properly.
- The operational range will be reduced.

 **CAUTION**

■ **Removed battery and other parts**

These parts are small and if swallowed by a child, they can cause choking. Keep away from children. Failure to do so could result in death or serious injury.

 **NOTICE**

■ **For normal operation after replacing the battery**

Observe the following precautions to prevent accidents:

- Always work with dry hands.
Moisture may cause the battery to rust.
- Do not touch or move any other component inside the remote control.
- Do not bend either of the battery terminals.



Checking and replacing fuses

If any of the electrical components do not operate, a fuse may have blown. If this happens, check and replace the fuses as necessary.

- 1 Turn the engine switch off.
- 2 Open the fuse box cover.

► Engine compartment

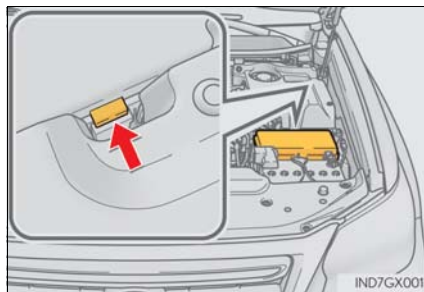

Push the tab in and lift the lid off.

► Driver's side instrument panel

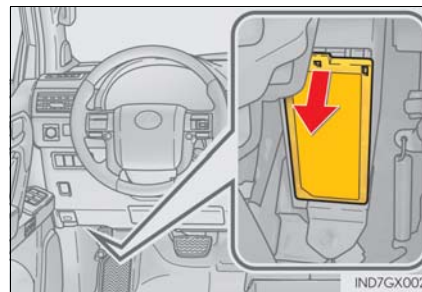

Remove the lid.

- 3 Remove the fuse with the pull-out tool.
Only type A fuse can be removed using the pull-out tool.

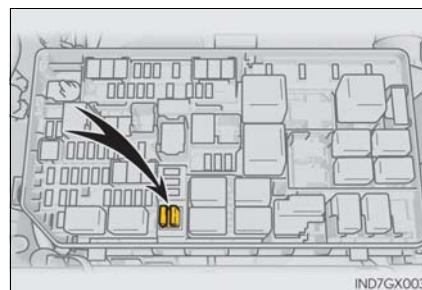

6

Maintenance and care

4 Check if the fuse is blown.

- ① Normal fuse
- ② Blown fuse

Type A:

Replace the blown fuse with a new fuse of an appropriate amperage rating. The amperage rating can be found on the fuse box lid.

Type B, C and D:

Contact your Lexus dealer.

▶ Type A

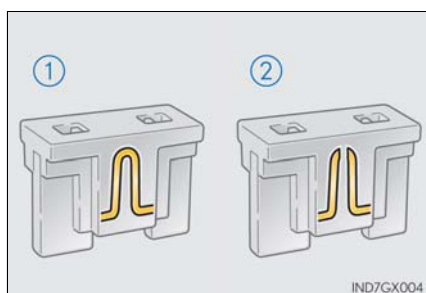

▶ Type B

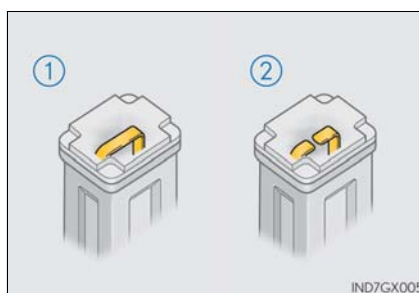

▶ Type C

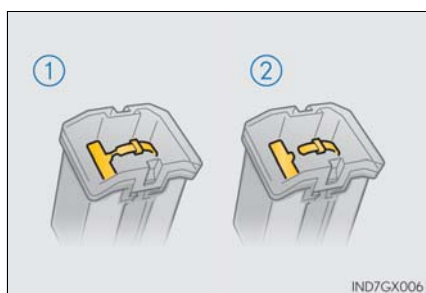

▶ Type D

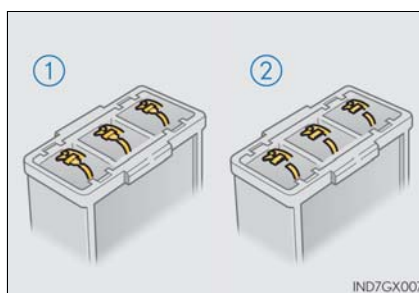

■ After a fuse is replaced

- If the lights do not turn on even after the fuse has been replaced, a bulb may need replacement. (→P. 498)
- If the replaced fuse blows again, have the vehicle inspected by your Lexus dealer.

■ If there is an overload in a circuit

The fuses are designed to blow, protecting the wiring harness from damage.

⚠ CAUTION**■ To prevent system breakdowns and vehicle fire**

Observe the following precautions.

Failure to do so may cause damage to the vehicle, and possibly a fire or injury.

- Never use a fuse of a higher amperage rating than indicated, or use any other object in place of a fuse.
- Always use a genuine Lexus fuse or equivalent.
Never replace a fuse with a wire, even as a temporary fix.
- Do not modify the fuses or the fuse boxes.

⚠ NOTICE**■ Before replacing fuses**

Have the cause of electrical overload determined and repaired by your Lexus dealer, as soon as possible.

Headlight aim

Vertical movement adjusting bolts

- ① Adjustment bolt A
- ② Adjustment bolt B

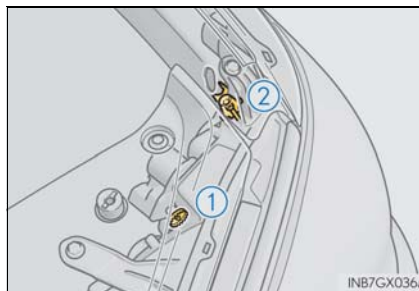

Before checking the headlight aim

- 1 Make sure the vehicle has a full tank of gasoline and the area around the headlight is not deformed.
- 2 Park the vehicle on level ground.
- 3 Sit in the driver's seat.
- 4 Bounce the vehicle several times.

Adjusting the headlight aim

- 1 Using a Phillips-head screwdriver, turn bolt A in either direction.
Remember the turning direction and the number of turns.

▶ Left-hand side

▶ Right-hand side

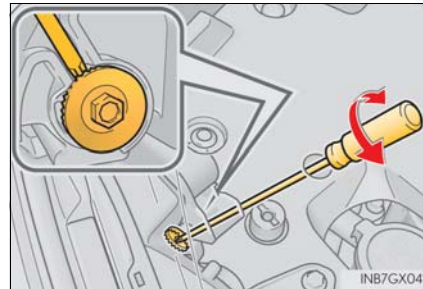
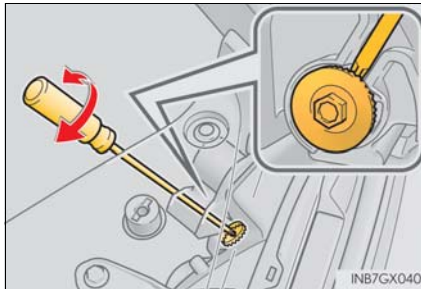

- 2 Turn bolt B the same number of turns and in the same direction as step 1.
If the headlight cannot be adjusted using this procedure, take the vehicle to your Lexus dealer to adjust the headlight aim.

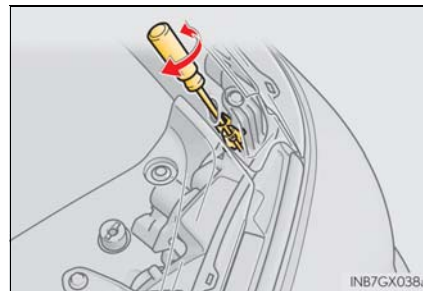

6

Maintenance and care

Light bulbs

You may replace the following bulbs yourself. The difficulty level of replacement varies depending on the bulb. If necessary bulb replacement seems difficult to perform, contact your Lexus dealer.

For more information about replacing other light bulbs, contact your Lexus dealer.

Preparing for light bulb replacement

Check the wattage and color of the light bulb being replaced. (→P. 579)

Removing the engine compartment covers

→P. 464

Bulb locations

■ Front

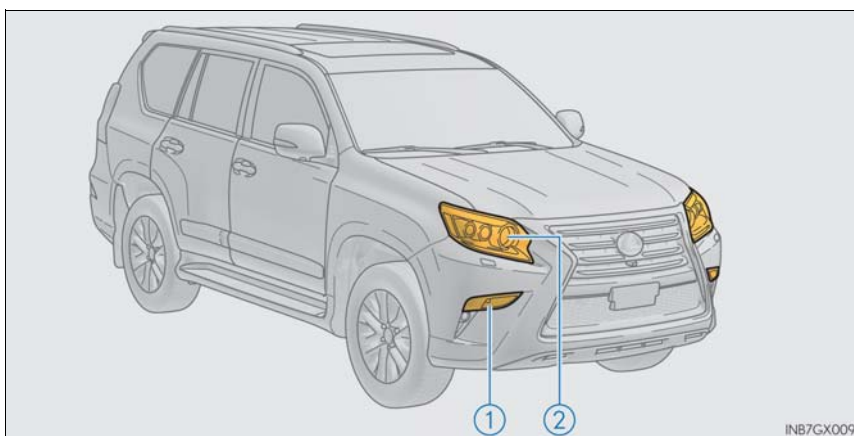

- ① Front turn signal light
- ② Headlight high beam

■ Rear

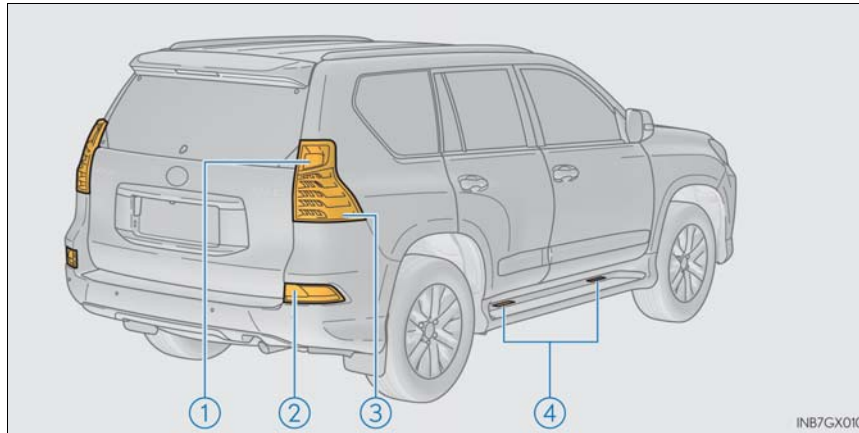

- ① Rear turn signal light
- ② Back-up light

- ③ Rear side marker light
- ④ Running board lights



Replacing light bulbs

■ Headlight high beams

- 1 Turn the cover counterclockwise.

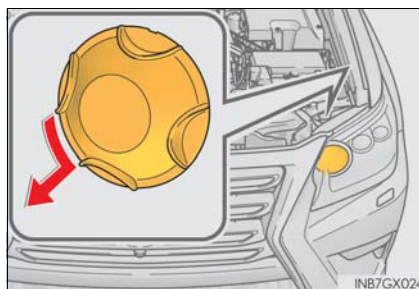

- 2 Turn the bulb base counterclockwise.

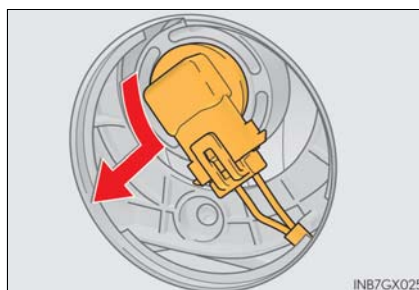

- 3 Unplug the connector while pulling the lock release.

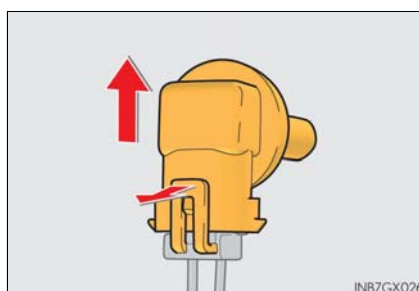

- 4** Replace the light bulb, and install the bulb base.

Align the 3 tabs on the light bulb with the mounting, and insert.

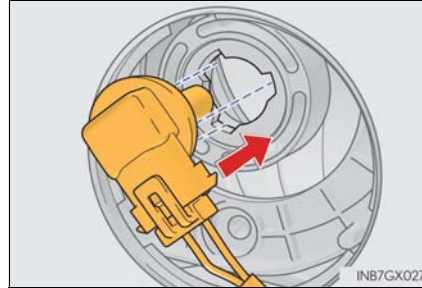

- 5** Turn and secure the bulb base.

Shake the bulb base gently to check that it is not loose, turn the headlights on once and visually confirm that no light is leaking through the mounting.

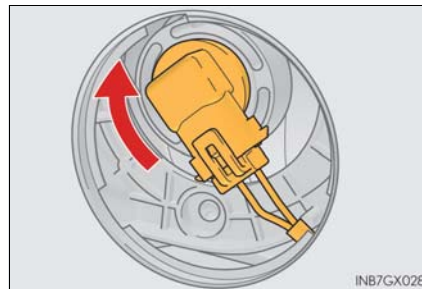

- 6** When installing the cover, conduct **1** in reverse.

■ **Front turn signal lights**

- 1** Turn the bulb base counterclockwise.

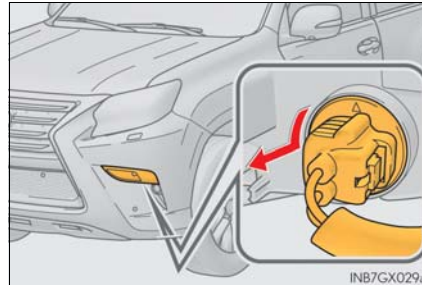

- 2** Remove the light bulb.

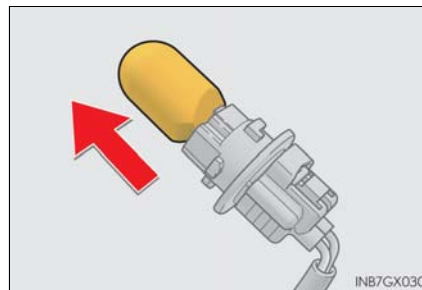

- 3** When installing, reverse the steps listed.

■ Rear turn signal lights and rear side marker lights

1 Open the back door.

▶ Left-hand side

Remove the bolts and lamp assembly.

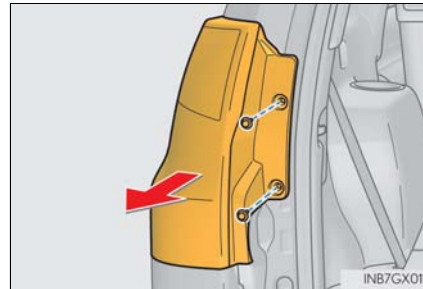

▶ Right-hand side

1 Remove the bolts.

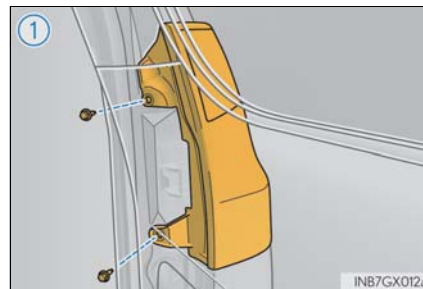

2 Close the back door half way and remove the lamp assembly.

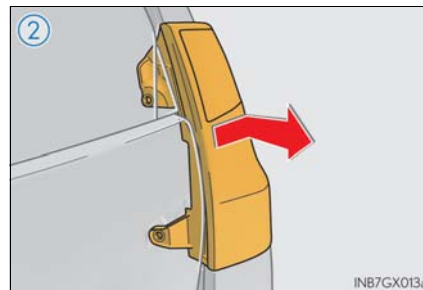

6

Maintenance and care

504 6-3. Do-it-yourself maintenance

- 2** Unplug the connector while pushing the lock release.

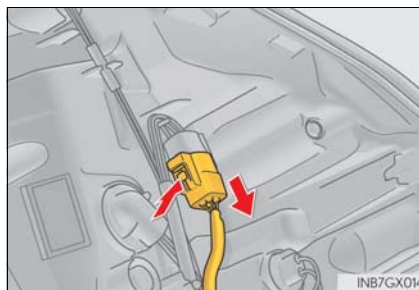

- 3** Turn the bulb bases counter-clockwise.

- ① Rear turn signal light
- ② Rear side marker light

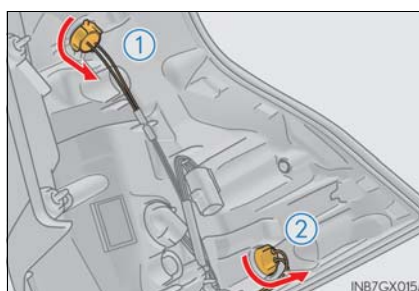

- 4** Remove the light bulb.

- ① Rear turn signal light
- ② Rear side marker light

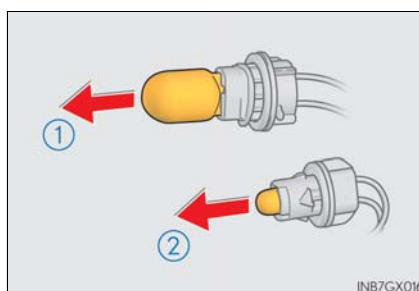

- 5** When installing, reverse the steps listed.



■ Back-up lights

- 1 Remove the bolts and pull down the under cover.

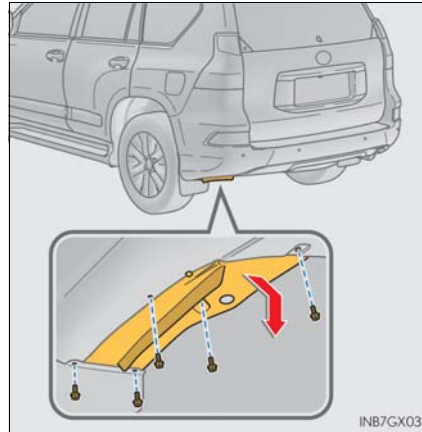

- 2 Turn the bulb base counterclockwise.

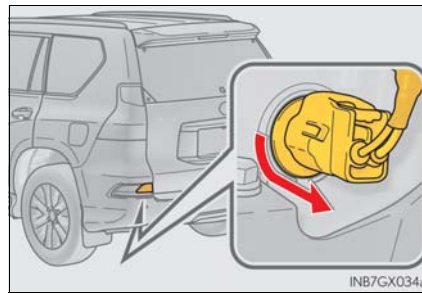

- 3 Remove the light bulb.

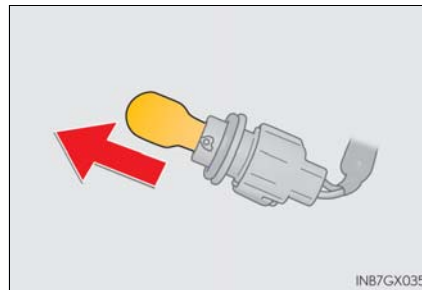

- 4 When installing, reverse the steps listed.

■ Running board lights

- 1 Turn the bulb bases counter-clockwise.

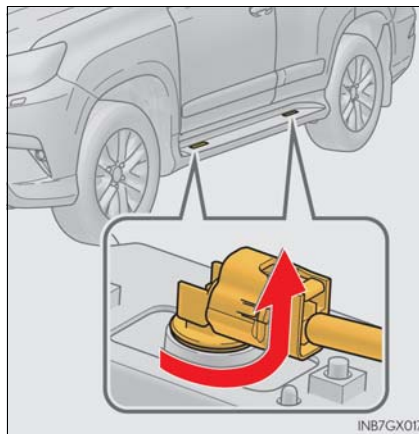

- 2 Remove the light bulb.

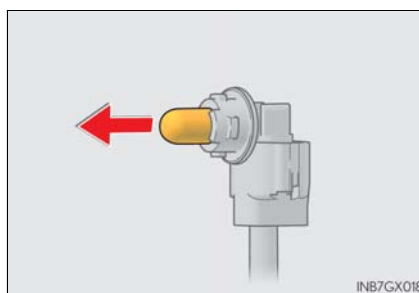

- 3 When installing, reverse the steps listed.

■ Replacing the following bulbs

If any of the lights listed below has burnt out, have it replaced by your Lexus dealer.

- Headlight low beams
- Parking lights/daytime running lights
- Front side marker lights
- Fog lights (if equipped)
- Side turn signal lights
- High mounted stoplight
- Stop/tail lights
- License plate lights



■ LED lights

The headlight low beams, parking lights/daytime running lights, front side marker lights, fog lights, side turn signal lights, high mounted stoplight, stop/tail lights and license plate lights consist of a number of LEDs. If any of the LEDs burn out, take your vehicle to your Lexus dealer to have the light replaced.

■ Condensation build-up on the inside of the lens

Temporary condensation build-up on the inside of the headlight lens does not indicate a malfunction. Contact your Lexus dealer for more information in the following situations:

- Large drops of water are built up on the inside of the lens.
- Water has built up inside the headlight.

⚠ CAUTION**■ Replacing light bulbs**

- Turn off the headlights. Do not attempt to replace the bulb immediately after turning off the headlights.

The bulbs become very hot and may cause burns.

- Do not touch the glass portion of the light bulb with bare hands. When it is unavoidable to hold the glass portion, use and hold with a clean dry cloth to avoid getting moisture and oils on the bulb.

Also, if the bulb is scratched or dropped, it may blow out or crack.

- Fully install light bulbs and any parts used to secure them. Failure to do so may result in heat damage, fire, or water entering the headlight unit. This may damage the headlights or cause condensation to build up on the lens.

- Do not attempt to repair or disassemble light bulbs, connectors, electric circuits or component parts.

Doing so may result in death or serious injury due to electric shock.

■ To prevent damage or fire

- Make sure bulbs are fully seated and locked.
- Check the wattage of the bulb before installing to prevent heat damage.



7-1. Essential information

Emergency flashers 510

If your vehicle has
to be stopped in
an emergency 511**7-2. Steps to take in an emergency**If your vehicle needs
to be towed..... 512If you think something is
wrong..... 518

Fuel pump shut off system..... 519

If a warning light turns
on or a warning buzzer
sounds..... 520If a warning message is
displayed..... 528

If you have a flat tire 542

If the engine will not start 556

If the electronic key does
not operate properly 558If the vehicle battery is
discharged 561

If your vehicle overheats..... 564

If the vehicle becomes
stuck 567

Emergency flashers

The emergency flashers are used to warn other drivers when the vehicle has to be stopped in the road due to a breakdown, etc.

Press the switch.

All the turn signals will flash.
To turn them off, press the switch once again.

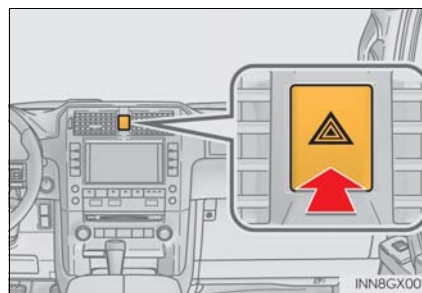

■ Emergency flashers

If the emergency flashers are used for a long time while the engine is not operating, the battery may discharge.

If your vehicle has to be stopped in an emergency

Only in an emergency, such as if it becomes impossible to stop the vehicle in the normal way, stop the vehicle using the following procedure:

- 1 Steadily step on the brake pedal with both feet and firmly depress it.
Do not pump the brake pedal repeatedly as this will increase the effort required to slow the vehicle.
- 2 Shift the shift lever to N.
 - ▶ If the shift lever is shifted to N
- 3 After slowing down, stop the vehicle in a safe place by the road.
- 4 Stop the engine.
 - ▶ If the shift lever cannot be shifted to N
- 3 Keep depressing the brake pedal with both feet to reduce vehicle speed as much as possible.
- 4 To stop the engine, press and hold the engine switch for 2 consecutive seconds or more, or press it briefly 3 times or more in succession.

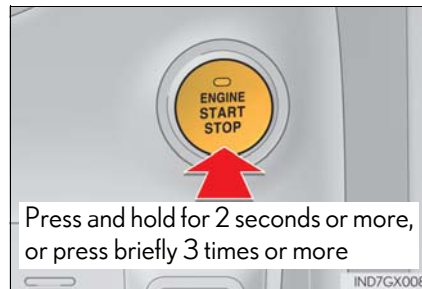

- 5 Stop the vehicle in a safe place by the road.

CAUTION

- **If the engine has to be turned off while driving**
Power assist for the brakes and steering wheel will be lost, making the brake pedal harder to depress and the steering wheel heavier to turn. Decelerate as much as possible before turning off the engine.

If your vehicle needs to be towed

If towing is necessary, we recommend having your vehicle towed by your Lexus dealer or commercial towing service, using a wheel-lift type truck or flatbed truck.

Use a safety chain system for all towing, and abide by all state/provincial and local laws.

Situations when it is necessary to contact dealers before towing

The following may indicate a problem with your transmission. Contact your Lexus dealer or commercial towing service before towing.

- The engine is running but the vehicle does not move.
- The vehicle makes an abnormal sound.



Towing with a sling-type truck

Do not tow with a sling-type truck to prevent body damage.

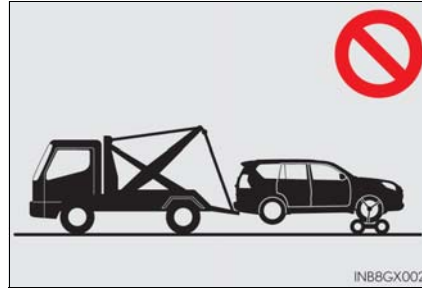
**Towing with a wheel-lift type truck**

▶ From the front

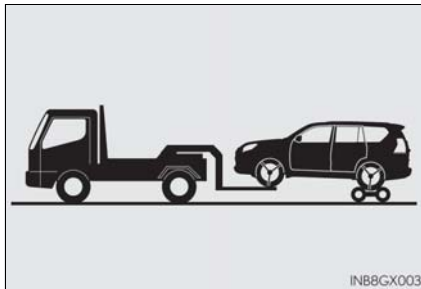

Use a towing dolly under the rear wheels.

▶ From the rear

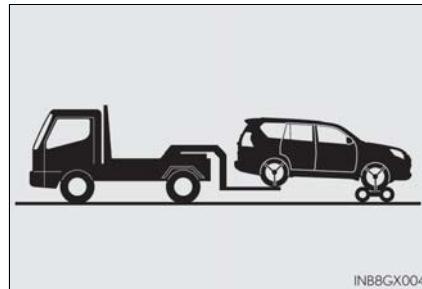

Use a towing dolly under the front wheels.

Using a flatbed truck

If your vehicle is transported by a flatbed truck, it should be tied down at the locations shown in the illustration.

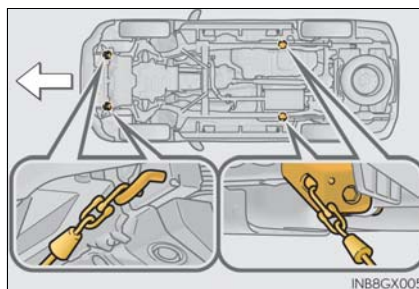

If you use cables or chains to tie down your vehicle, the angles shaded in black must be 45°.

Do not overly tighten the tie downs or the vehicle may be damaged.

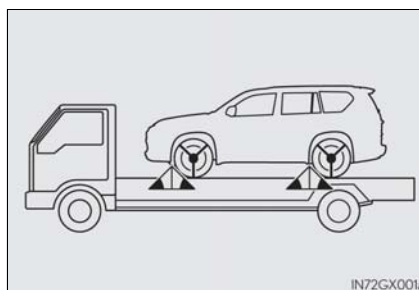

Emergency towing

If a tow truck is not available in an emergency, your vehicle may be temporarily towed using an elastic towing rope secured to the emergency towing hooks. This should only be attempted on hard surfaced roads for at most 50 miles (80 km) at under 18 mph (30 km/h).

A driver must be in the vehicle to steer and operate the brakes. The vehicle's wheels, drive train, axles, steering and brakes must be in good condition.

Emergency towing procedure

- 1 Securely attach an elastic towing rope to the towing hooks.
Take care not to damage the vehicle body.

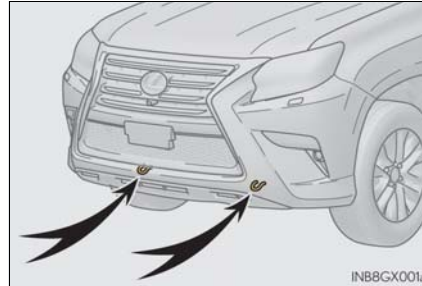

- 2 Enter the vehicle being towed and start the engine.
If the engine does not start, turn the engine switch to IGNITION ON mode.
- 3 Set the four-wheel drive control switch in H4 and push the center differential lock/unlock switch to unlock the center differential. (→P. 342)
- 4 For models with the rear height control air suspension: Change the vehicle height to N (normal) mode and end the vehicle height control operation. (→P. 337)
- 5 Shift the shift lever to N and release the parking brake.
When the shift lever cannot be shifted: →P. 198

■ While towing

If the engine is not running, the power assist for the brakes and steering will not function, making steering and braking more difficult.

CAUTION

Observe the following precautions.
Failure to do so may result in death or serious injury.

■ **When towing the vehicle**

Be sure to transport the vehicle with all four wheels raised off the ground. If the vehicle is towed with the tires contacting the ground, the drivetrain or related parts may be damaged, the vehicle may fly off the truck.

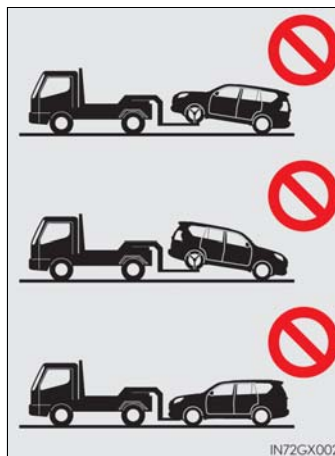

■ **While towing**

- When towing using an elastic towing rope, avoid sudden starts, etc. which place excessive stress on the towing hooks, the elastic towing rope. The towing hooks, the elastic towing rope may become damaged, broken debris may hit people and cause serious damage.
- Do not turn the engine switch off.
There is a possibility that the steering wheel is locked and cannot be operated.

 NOTICE**■ To avoid serious damage to your vehicle**

Do not use the rear emergency towing hook.

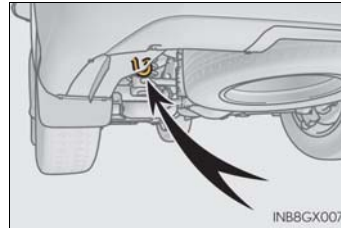
**■ To prevent damage to the vehicle when towing using a wheel-lift type truck**

- Do not tow the vehicle from the rear when the engine switch is off. The steering lock mechanism is not strong enough to hold the front wheels straight.
- When raising the vehicle, ensure adequate ground clearance for towing at the opposite end of the raised vehicle. Without adequate clearance, the vehicle could be damaged while being towed.

■ To prevent damage to the vehicle when towing with a sling-type truck

Do not tow with a sling-type truck, either from the front or rear.

■ To prevent damage to the vehicle during emergency towing

- Do not use cables or chains.
- Do not secure the elastic towing rope to the suspension components.

If you think something is wrong

If you notice any of the following symptoms, your vehicle probably needs adjustment or repair. Contact your Lexus dealer as soon as possible.

Visible symptoms

- Fluid leaks under the vehicle
(Water dripping from the air conditioning after use is normal.)
- Flat-looking tires or uneven tire wear
- Engine coolant temperature gauge needle continually points higher than normal

Audible symptoms

- Changes in exhaust sound
- Excessive tire squeal when cornering
- Strange noises related to the suspension system
- Pinging or other noises related to the engine

Operational symptoms

- Engine missing, stumbling or running roughly
- Appreciable loss of power
- Vehicle pulls heavily to one side when braking
- Vehicle pulls heavily to one side when driving on a level road
- Loss of brake effectiveness, spongy feeling, pedal almost touches the floor



Fuel pump shut off system

To minimize the risk of fuel leakage when the engine stalls or when an airbag inflates upon collision, the fuel pump shut off system stops the supply of fuel to the engine.

Follow the procedure below to restart the engine after the system is activated.

- 1 Turn the engine switch to ACCESSORY mode or turn it off.
- 2 Restart the engine.

NOTICE

■ Before starting the engine









Inspect the ground under the vehicle.





If you find that fuel has leaked onto the ground, the fuel system has been damaged and is in need of repair. Do not restart the engine.







If a warning light turns on or a warning buzzer sounds

Calmly perform the following actions if any of the warning lights comes on or flashes. If a light comes on or flashes, but then goes off, this does not necessarily indicate a malfunction in the system. However, if this continues to occur, have the vehicle inspected by your Lexus dealer.

Warning light and warning buzzer list

Warning light	Warning light/Details/Actions
 (U.S.A.)  (Canada)	Brake system warning light (warning buzzer) Indicates that: <ul style="list-style-type: none"> • The brake fluid level is low; or • The brake system is malfunctioning. → Immediately stop the vehicle in a safe place and contact your Lexus dealer. Continuing to drive the vehicle may be dangerous.
	Charging system warning light Indicates a malfunction in the vehicle's charging system → Immediately stop the vehicle in a safe place and contact your Lexus dealer.
 (U.S.A.)  (Canada)	Malfunction indicator lamp Indicates a malfunction in: <ul style="list-style-type: none"> • The electronic engine control system; • The electronic throttle control system; or • The electronic automatic transmission control system → Have the vehicle inspected by your Lexus dealer immediately.
	SRS warning light Indicates a malfunction in: <ul style="list-style-type: none"> • The SRS airbag system; or • The seat belt pretensioner system → Have the vehicle inspected by your Lexus dealer immediately.
 (U.S.A.)  (Canada)	ABS warning light Indicates a malfunction in: <ul style="list-style-type: none"> • The ABS; or • The brake assist system → Have the vehicle inspected by your Lexus dealer immediately.

Warning light	Warning light/Details/Actions
 <p>PCS (Flashes) (If equipped)</p>	<p>“PCS” warning light Indicates a malfunction in the pre-collision system The warning light will operate as follows, even when the system is not malfunctioning:</p> <ul style="list-style-type: none"> • The light will flash quickly when the system is operating. (→P. 368) • The light will turn on when the pre-collision braking is disabled. (→P. 369) • The light will turn on when the system cannot temporarily be used. (→P. 534) <p>→ Have the vehicle inspected by your Lexus dealer immediately.</p>
	<p>Slip indicator Indicates a malfunction in:</p> <ul style="list-style-type: none"> • The Multi-terrain Select (if equipped); • The Crawl Control (if equipped); • The downhill assist control system (if equipped); • The VSC (Vehicle Stability Control) system; • The TRAC (Traction Control) system; • Active TRAC (Traction Control) system; • Trailer Sway Control; or • The hill-start assist control system (if equipped) <p>The light will flash when any of the above systems other than the Multi-terrain Select are operating. → Have the vehicle inspected by your Lexus dealer immediately.</p>
	<p>LED headlight warning light Indicates a malfunction in the LED headlights The LED headlights will not normally illuminate when there is a malfunction, however it may be able to illuminate depending on the nature of the problem. → Have the vehicle inspected by your Lexus dealer immediately.</p>
 <p>(Flashes)</p>	<p>Automatic headlight leveling system warning light Indicates a malfunction in the automatic headlight leveling system → Have the vehicle inspected by your Lexus dealer immediately.</p>
	<p>Kinetic dynamic suspension system warning light Indicates a malfunction in the kinetic dynamic suspension system. → Have the vehicle inspected by your Lexus dealer immediately.</p>

Warning light	Warning light/Details/Actions
 (Flashes)	Low speed four-wheel drive indicator light Indicates a malfunction in the four-wheel drive system if the light continues flashing. (→P. 342) → Have the vehicle inspected by your Lexus dealer immediately.
 (Flashes)	Center differential lock indicator light Indicates a malfunction in the four-wheel drive system if the light continues flashing. (→P. 342) → Have the vehicle inspected by your Lexus dealer immediately.
	Open door warning light (warning buzzer)*1 Indicates that a door or the glass hatch is not fully closed → Check that all the doors and the glass hatch are closed.
	Low fuel level warning light Indicates that remaining fuel is approximately 3.5 gal. (13.1 L, 2.9 Imp. gal.) or less → Refuel the vehicle.
	Driver's and front passenger's seat belt reminder light (warning buzzer)*2 Warns the driver and/or front passenger to fasten their seat belts → Fasten the seat belt. If the front passenger's seat is occupied, the front passenger's seat belt also needs to be fastened to make the warning light (warning buzzer) turn off.
	Master warning light A buzzer sounds and the warning light comes on and flashes to indicate that the master warning system has detected a malfunction. → P. 528
	Tire pressure warning light When the light comes on: Low tire inflation pressure such as <ul style="list-style-type: none"> • Natural causes (→P. 524) • Flat tire (→P. 542) → Adjust the tire inflation pressure to the specified level. The light will turn off after a few minutes. In case the light does not turn off even if the tire inflation pressure is adjusted, have the system checked by your Lexus dealer. When the light comes on after blinking for 1 minute: Malfunction in the tire pressure warning system → Have the system checked by your Lexus dealer.

*1: Open door warning buzzer:
→P. 530

*2: Seat belt reminders:

The driver's seat belt buzzer sounds to alert the driver that his or her seat belt is not fastened. Once the engine switch is turned to IGNITION ON mode, the buzzer sounds for 6 seconds. If the vehicle reaches a speed of 12 mph (20 km/h), the buzzer sounds once. If the seat belt is still unfastened after 30 seconds, the buzzer will sound intermittently for 10 seconds. Then, if the seat belt is still unfastened, the buzzer will sound in a different tone for 20 more seconds.

The front passenger's seat belt buzzer sounds to alert the front passenger that his or her seat belt is not fastened. The buzzer sounds once if the vehicle reaches a speed of 12 mph (20 km/h). If the seat belt is still unfastened after 30 seconds, the buzzer will sound intermittently for 10 seconds. Then, if the seat belt is still unfastened, the buzzer will sound in a different tone for 20 more seconds.

■ SRS warning light

This warning light system monitors the airbag sensor assembly, front airbag sensors, side and curtain shield airbag sensors, rear side and curtain shield airbag sensors, floor sensor, driver's seat belt buckle switch, front passenger occupant classification system (ECU and sensors), "AIR BAG ON" indicator light, "AIR BAG OFF" indicator light, front passenger's seat belt buckle switch, seat belt pretensioner assemblies, airbags, interconnecting wiring and power sources. (→P. 36)

■ Front passenger detection sensor, seat belt reminder and warning buzzer

- If luggage is placed on the front passenger seat, the front passenger detection sensor may cause the warning light to flash and the warning buzzer to sound even if a passenger is not sitting in the seat.
- If a cushion is placed on the seat, the sensor may not detect a passenger, and the warning light may not operate properly.

■ If the malfunction indicator lamp comes on while driving

First check the following:

- Is the fuel tank empty?
If it is, fill the fuel tank immediately.
- Is the fuel tank cap loose?
If it is, tighten it securely.

The light will go off after several driving trips.

If the light does not go off even after several trips, contact your Lexus dealer as soon as possible.

- **If the low speed four-wheel drive indicator light or the center differential lock indicator light blinks**
Take the specified steps. (→P. 344)
- **When the tire pressure warning light comes on**
Check the tire inflation pressure and adjust to the appropriate level.
- **The tire pressure warning light may turn on due to natural causes**
The tire pressure warning light may turn on due to natural causes such as natural air leaks or tire inflation pressure changes caused by temperature. In this case, adjusting the tire inflation pressure will turn off the warning light (after a few minutes).
- **When a tire is replaced with a spare tire**
The tire pressure warning light will turn on if the tire inflation pressure of the spare tire is low. If a tire goes flat, the tire pressure warning light will not turn off even though the flat tire has been replaced with the spare tire.
- **Conditions that the tire pressure warning system may not function properly**
→P. 480
- **If the tire pressure warning light frequently comes on after blinking for 1 minute**
If the tire pressure warning light frequently comes on after blinking for 1 minute when the engine switch is turned to IGNITION ON mode, have it checked by your Lexus dealer.
- **Warning buzzer**
In some cases, the buzzer may not be heard due to being in a noisy location or audio sound.
- **Customization**
The vehicle speed linked seat belt reminder buzzer can be disabled.
(Customizable features: →P. 594)

 CAUTION**■ If both the ABS and the brake system warning lights remain on**

Stop your vehicle in a safe place immediately and contact your Lexus dealer. The vehicle will become extremely unstable during braking, and the ABS system may fail, which could cause an accident resulting in death or serious injury.

■ If the tire pressure warning light comes on

Be sure to observe the following precautions. Failure to do so could cause loss of vehicle control and result in death or serious injury.

- Stop your vehicle in a safe place as soon as possible. Adjust the tire inflation pressure immediately.
- If the tire pressure warning light comes on even after tire inflation pressure adjustment, it is probable that you have a flat tire. Check the tires. If the tire is flat, change to the spare tire and have the flat tire repaired by the nearest Lexus dealer.
- Avoid abrupt maneuvering and braking. If the vehicle tires deteriorate, you could lose control of the steering wheel or the brakes.

■ If a blowout or sudden air leakage should occur

The tire pressure warning system may not activate immediately.

 CAUTION**■ Maintenance of the tires**

Each tire, including the spare (if provided), should be checked monthly when cold and inflated to the inflation pressure recommended by the vehicle manufacturer on the vehicle placard or tire inflation pressure label (tire and load information label). (If your vehicle has tires of a different size than the size indicated on the vehicle placard or tire inflation pressure label [tire and load information label], you should determine the proper tire inflation pressure for those tires.)

As an added safety feature, your vehicle has been equipped with a tire pressure monitoring system (TPMS-tire pressure warning system) that illuminates a low tire pressure telltale (tire pressure warning light) when one or more of your tires is significantly under-inflated. Accordingly, when the low tire pressure telltale (tire pressure warning light) illuminates, you should stop and check your tires as soon as possible, and inflate them to the proper pressure. Driving on a significantly under-inflated tire causes the tire to overheat and can lead to tire failure. Under-inflation also reduces fuel efficiency and tire tread life, and may affect the vehicle's handling and stopping ability.

Please note that the TPMS (tire pressure warning system) is not a substitute for proper tire maintenance, and it is the driver's responsibility to maintain correct tire pressure, even if under-inflation has not reached the level to trigger illumination of the TPMS low tire pressure telltale (tire pressure warning light).

Your vehicle has also been equipped with a TPMS (tire pressure warning system) malfunction indicator to indicate when the system is not operating properly. The TPMS (tire pressure warning system) malfunction indicator is combined with the low tire pressure telltale (tire pressure warning light). When the system detects a malfunction, the telltale will flash for approximately one minute and then remain continuously illuminated. This sequence will continue upon subsequent vehicle start-ups as long as the malfunction exists. When the malfunction indicator is illuminated, the system may not be able to detect or signal low tire pressure as intended.

TPMS (tire pressure warning system) malfunctions may occur for a variety of reasons, including the installation of replacement or alternate tires or wheels on the vehicle that prevent the TPMS (tire pressure warning system) from functioning properly. Always check the TPMS (tire pressure warning system) malfunction telltale after replacing one or more tires or wheels on your vehicle to ensure that the replacement or alternate tires and wheels allow the TPMS (tire pressure warning system) to continue to function properly.



 NOTICE

■ **To ensure the tire pressure warning system operates properly**

Do not install tires with different specifications or makers, as the tire pressure warning system may not operate properly.



If a warning message is displayed



If a warning is shown on the instrument cluster, stay calm and perform the following actions:

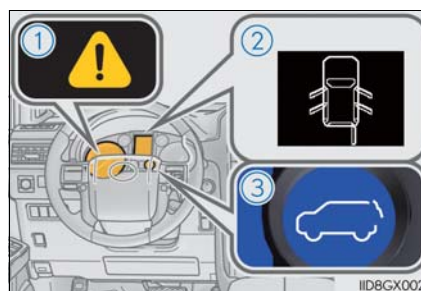





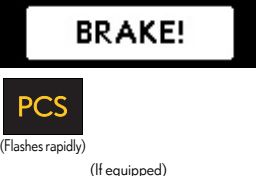

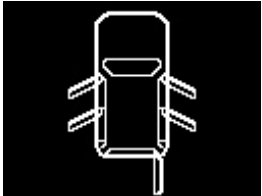

- ① Master warning light
The master warning light also comes on or flashes in order to indicate that a message is currently being displayed on the instrument cluster.
- ② Multi-information display
- ③ Rear height control air suspension display







If any of the warning lights comes on again after the following actions have been performed, contact your Lexus dealer.









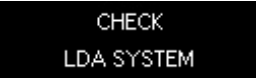

Warning message and warning buzzer list



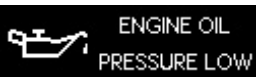

Warning message	Details/Actions
 <p>BRAKE! PCS (Flashes rapidly) (If equipped)</p>	<p>Indicates that:</p> <ul style="list-style-type: none"> • There is a high possibility of a frontal collision; or • The pre-collision braking function is operating <p>A buzzer also sounds. → Slow the vehicle by applying the brakes.</p>
 <p>(If equipped)</p>	<p>Indicates that your vehicle is nearing the vehicle ahead (in vehicle-to-vehicle distance mode)</p> <p>A buzzer also sounds. → Slow the vehicle by applying the brakes.</p>
 <p>(If equipped)</p>	<p>Alerts the driver that the vehicle is about to or actually deviates from the lane (while the LDA [Lane Departure Alert] system is operating)</p> <p>The lane line flashes. The warning buzzer sounds continuously. → Check around the vehicle and back to inside of the lane lines.</p>

Warning message	Details/Actions
 	<p>Indicates that one or more of the doors is not fully closed. The system also indicates which doors are not fully closed.</p> <p>If the vehicle reaches a speed of 3 mph (5 km/h),  flashes and a buzzer sounds to indicate that the door(s) are not yet fully closed.</p> <p>→ Make sure that all the doors are closed.</p>
 	<p>Indicates that the glass hatch is not fully closed.</p> <p>If the vehicle reaches a speed of 3 mph (5 km/h),  flashes and a buzzer sounds to indicate that the glass hatch is not yet fully closed.</p> <p>→ Close the glass hatch.</p>
<p>CHECK SONAR SYSTEM</p>  <p>(If equipped)</p>	<p>Indicates a malfunction in the Intuitive parking assist. All assist-sensors flash. A buzzer also sounds.</p> <p>→ Have the vehicle inspected by your Lexus dealer.</p>
<p>CLEAN SONAR</p>  <p>(If equipped)</p>	<p>Indicates that a intuitive parking assist is dirty or covered with ice. A buzzer also sounds.</p> <p>→ Clean the sensor.</p>
<p>RELEASE PARKING BRAKE</p>    <p>(U.S.A.) (Canada) (Flashes)</p>	<p>Indicates that the vehicle is being driven at 3 mph (5 km/h) or more with the parking brake still engaged. A buzzer also sounds.</p> <p>→ Release the parking brake.</p>



Warning message	Details/Actions
<p>CLEAN RADAR SENSOR</p>  <p>(If equipped)</p>	<p>Indicates that the radar sensor is dirty or covered with ice A buzzer also sounds. → Clean the sensor.</p>
<p>CRUISE CONTROL NOT AVAILABLE</p>  <p>(If equipped)</p>	<p>Indicates that the radar cruise control system is unable to judge vehicle-to-vehicle distance A buzzer also sounds. → Turn off snow mode. If the windshield wipers are on, turn them off or set them to a mode other than AUTO or high speed wiper operation.</p>
<p>LDA NOT AVAILABLE</p> <p>(If equipped)</p>	<p>Indicates that the LDA (Lane Departure Alert) system is suspended The camera sensor temperature is higher than the operation temperature range. A buzzer also sounds. → Restart the LDA after driving for a while.</p>
<p>BSM NOT AVAILABLE</p>  <p>(If equipped)</p>	<p>Indicates that the Blind Spot Monitor sensor or the surrounding area on the bumper is dirty or covered with ice A buzzer also sounds. → Clean the sensor and its surrounding area on the bumper.</p>
<p>CHECK CRUISE CONTROL SYSTEM</p> 	<p>Indicates a malfunction in:</p> <ul style="list-style-type: none"> • The cruise control system (if equipped); or • The dynamic radar cruise control system (if equipped) <p>Press the "ON-OFF" button once to deactivate the system, and then press the button again to reactivate the system. A buzzer also sounds. → Have the vehicle inspected by your Lexus dealer.</p>

Warning message	Details/Actions
  (If equipped)	Indicates a malfunction in the LDA (Lane Departure Alert) system A buzzer also sounds. → Have the vehicle inspected by your Lexus dealer.
 	Indicates a malfunction in the steering lock system A buzzer also sounds. → Have the vehicle inspected by your Lexus dealer.
   (Flashes) (If equipped)	Indicates a malfunction in the pre-collision system A buzzer also sounds. → Have the vehicle inspected by your Lexus dealer.
  (If equipped)	Indicates a malfunction in the BSM (Blind Spot Monitor) system A buzzer also sounds. → Have the vehicle inspected by your Lexus dealer.
 	Indicates abnormal engine oil pressure The warning light may come on if the engine oil pressure is too low. A buzzer also sounds. → Immediately stop the vehicle in a safe place and contact your Lexus dealer.

Warning message	Details/Actions
<p>HIGH TRANSMISSION FLUID TEMPERATURE</p> 	<p>Indicates that the automatic transmission fluid temperature is too high A buzzer also sounds. → Immediately stop the vehicle in a safe place, shift the shift lever to P and wait until the warning message and light go off. If the warning message and light go off, you may start the vehicle again. If the warning message and light do not go off, contact your Lexus dealer.</p>
<p>CHECK TRANSMISSION SYSTEM</p> 	<p>Indicates a malfunction in the automatic transmission system A buzzer also sounds. → Have the vehicle inspected by your Lexus dealer.</p>
<p>MOONROOF OPEN</p>  <p>(Flashes)</p>	<p>Indicates that the moon roof is not fully closed (with the engine switch off, and the driver's door open) A buzzer also sounds. → Close the moon roof.</p>
<p>ENGINE OIL LOW</p> 	<p>Indicates that engine oil level is low A buzzer also sounds. → Check the level of engine oil, and add if necessary.</p>
<p>CHECK HEADLIGHT SYSTEM</p> 	<p>Indicates a malfunction in:</p> <ul style="list-style-type: none"> • The LED headlight system; • The automatic headlight leveling system; or • The Automatic High Beam system (if equipped) <p>A buzzer also sounds. → Have the vehicle inspected by your Lexus dealer.</p>
<p>LOW WASHER FLUID</p>	<p>Indicates that the washer fluid level is low → Add washer fluid.</p>

Warning message	Details/Actions
<p data-bbox="395 477 651 555">PCS TEMPORARILY NOT AVAILABLE</p> <p data-bbox="395 566 475 622">PCS</p> <p data-bbox="483 633 563 656">(If equipped)</p>	<p data-bbox="675 499 1233 611">Indicates that the pre-collision system is not currently functional because the grille cover or the sensor is dirty → Check the grille cover and the sensor and clean them if they are dirty.</p>
<p data-bbox="395 678 651 779">CHECK AIR SUSPENSION SYSTEM</p> <p data-bbox="483 790 563 813">(If equipped)</p>	<p data-bbox="675 667 1233 801">Indicates a malfunction in the rear height control air suspension A buzzer also sounds. → Immediately stop the vehicle in a safe place and contact your Lexus dealer.</p>
<p data-bbox="395 857 651 936">OIL MAINTENANCE REQUIRED SOON</p> <p data-bbox="483 947 563 969">(U.S.A. only)</p>	<p data-bbox="675 824 1233 992">Indicates that all maintenance according to the driven distance on the maintenance schedule* should be performed soon. Comes on approximately 4500 miles (7200 km) after the message has been reset. → If necessary, perform maintenance.</p>
<p data-bbox="395 1059 651 1137">OIL MAINTENANCE REQUIRED</p> <p data-bbox="483 1149 563 1171">(U.S.A. only)</p>	<p data-bbox="675 1003 1233 1223">Indicates that all maintenance is required to correspond to the driven distance on the maintenance schedule*. Comes on approximately 5000 miles (8000 km) after the message has been reset. (The indicator will not work properly unless the message has been reset.) → Perform the necessary maintenance. Please reset the message after the maintenance is performed (→P. 453)</p>

*: Refer to the separate "Scheduled Maintenance" or "Owner's Manual Supplement" for the maintenance interval applicable to your vehicle.



Warning message	Details/Actions
<p>CRAWL HAS BEEN DEACTIVATED (If equipped)</p> 	<p>Indicates that the Crawl Control is canceled while in use A buzzer also sounds. → Use the Crawl Control under the proper operating conditions. (→P. 347)</p>
<p>CRAWL NOT AVAILABLE SELECT L4 AND SHIFT TO D OR R POSITION (If equipped)</p>	<p>Indicates that the Crawl Control is not available → Select the four-wheel driving position switch in L4 and shift the shift lever to D or R.</p>
<p>CRAWL NOT AVAILABLE CHECK SYSTEM OPERATION CONDITIONS (If equipped)</p>	<p>Indicates that the Crawl Control is not available → Confirm the operating conditions of the Crawl Control.</p>
<p>OPERATION NOT POSSIBLE WHEN MULTI-TERRAIN SELECT ACTIVATED (If equipped)</p>	<p>Indicates that the VSC OFF switch is pressed or second start mode is selected while the Multi-terrain Select system is in use → While the Multi-terrain Select system is in use, vehicle stability control cannot be turned off and second start mode cannot be activated.</p>
<p>MULTI-TERRAIN SELECT HAS BEEN CANCELED (If equipped)</p>	<p>Indicates that the Multi-terrain Select system is canceled while in use A buzzer also sounds. → Use the Multi-terrain Select system under the proper operating conditions. (→P. 325)</p>

■ **Warning message in radar cruise mode (if equipped)**

In the following situations, the warning message may not be displayed even if vehicle-to-vehicle distance decreases:

- When your vehicle and the vehicle ahead are traveling at the same speed or the vehicle ahead is traveling more quickly than your vehicle
- When the vehicle ahead is traveling at a very low speed
- Immediately after cruise control speed is set
- At the instant the accelerator pedal is depressed

■ **The LDA (Lane Departure Alert) lane departure warning function (if equipped)**

In the following situations, the warning message will not be displayed even if a lane line is crossed.



- When the vehicle speed deviates from the operating range of the LDA system functions
- When the lane lines cannot be recognized



■ **Conditions that the tire pressure warning system may not function properly**

→P. 480



■ **Warning buzzer**

In some cases, the buzzer may not be heard due to being in a noisy location or audio sound.





Interior buzzer	Exterior buzzer	Warning message	Details/Actions
Once	3 times	<p>KEY NOT DETECTED</p>  <p>(Flashes)</p>	<p>The electronic key was carried outside the vehicle and a door other than the driver's door was opened and closed while the engine switch was in a mode other than off. → Bring the electronic key back into the vehicle.</p> <p>The driver's door was opened and closed while the electronic key was not in the vehicle, the shift lever was in P and the engine switch was not turned off. → Turn the engine switch off. Bring the electronic key back into the vehicle.</p>
Once	Continuous	<p>KEY NOT DETECTED</p> <p>TURN POWER OFF (Displayed alternately)</p>  <p>(Flashes)</p>	<p>An attempt was made to exit the vehicle with the electronic key and lock the doors without first turning the engine switch off. → Turn the engine switch off and lock the doors again.</p>
Once	—	<p>KEY NOT DETECTED</p>  <p>(Flashes)</p>	<ul style="list-style-type: none"> An attempt was made to start the engine without the electronic key being present, or the electronic key was not functioning normally. An attempt was made to drive when the regular key was not inside the vehicle. <p>→ Confirm that the electronic key is inside the vehicle.</p>

Interior buzzer	Exterior buzzer	Warning message	Details/Actions
Continuous	—	<p>SHIFT TO P POSITION</p>  <p>(Flashes)</p>	<p>The driver's door was opened when the shift lever was not in P and the engine switch was not turned off.</p> <p>→ Shift the shift lever to P.</p>
Continuous	Continuous	<p>SHIFT TO P POSITION</p> <p>KEY NOT DETECTED</p> <p>(Displayed alternately)</p>  <p>(Flashes)</p>	<p>The driver's door was opened and closed while the electronic key was not in the vehicle, the shift lever was not in P and the engine switch was not turned off.</p> <p>→ Shift the shift lever to P.</p> <p>→ Bring the electronic key back into the vehicle.</p>
Once	Continuous	<p>KEY DETECTED IN VEHICLE</p>  <p>(Flashes)</p>	<ul style="list-style-type: none"> • An attempt was made to lock either front door by opening a door and putting the inside lock button into the lock position, then closing the door with the electronic key still inside the vehicle. • An attempt was made to lock the doors using the smart access system with push-button start while the electronic key was still inside the vehicle. <p>→ Retrieve the electronic key from the vehicle and lock the doors again.</p>

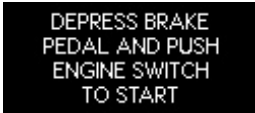

Interior buzzer	Exterior buzzer	Warning message	Details/Actions
Once	—	<p>DEPRESS BRAKE PEDAL, TOUCH ENGINE SWITCH WITH KEY</p>  <p>(Flashes)</p>	<ul style="list-style-type: none"> When the doors were unlocked with the mechanical key and then the engine switch was pressed, the electronic key could not be detected in the vehicle. The electronic key could not be detected in the vehicle even after the engine switch was pressed two consecutive times. <p>→ Touch the electronic key to the engine switch while depressing the brake pedal.</p>
—	—	<p>AUTO POWER OFF TO CONSERVE BATTERY</p>	<p>Power was turned off due to the automatic power off function.</p> <p>→ Next time when starting the engine, increase the engine speed slightly and maintain that level for approximately 5 minutes to recharge the battery.</p>
Once	—	<p>KEY BATTERY LOW</p> 	<p>The electronic key has a low battery.</p> <p>→ Replace the electronic key battery. (→P. 491)</p>

540 7-2. Steps to take in an emergency

Interior buzzer	Exterior buzzer	Warning message	Details/Actions
Once	—	  (Flashes)	<p>The driver's door was opened and closed with the engine switch turned off and then the engine switch was put in ACCESSORY mode twice without the engine being started. → Press the engine switch while depressing the brake pedal.</p> <p>During an engine starting procedure in the event that the electronic key was not functioning properly (→P. 558), the engine switch was touched with the electronic key. → Press the engine switch within 10 seconds of the buzzer sounding.</p>
Once	—	  (Flashes)	<p>The steering lock could not be released within 3 seconds of the engine switch being pressed. → Press the engine switch while depressing the brake pedal and moving the steering wheel left and right.</p>

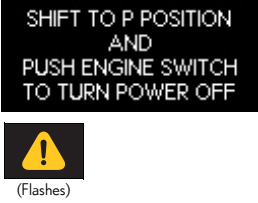
Interior buzzer	Exterior buzzer	Warning message	Details/Actions
Once	—	 <p>(Flashes)</p>	<p>An attempt was made to start the engine with the shift lever in an incorrect position. → Shift the shift lever to P and start the engine.</p>
Once	—	 <p>(Flashes)</p>	<p>An attempt was made to turn the engine switch off when the shift lever was not in P. → To turn off the engine, first shift the shift lever to P and then turn the engine switch off.</p>

■ Warning buzzer

In some cases, the buzzer may not be heard due to being in a noisy location or audio sound.

If you have a flat tire

Your vehicle is equipped with a spare tire. The flat tire can be replaced with the spare tire.

For details about tires: →P. 476

CAUTION

■ If you have a flat tire

Do not continue driving with a flat tire.

Driving even a short distance with a flat tire can damage the tire and the wheel beyond repair, which could result in an accident.

Before jacking up the vehicle

- Stop the vehicle in a safe place on a hard, flat surface.
- Set the parking brake.
- Shift the shift lever to P.
- Turn off the rear height control air suspension (if equipped). (→P. 337)
- Stop the engine.
- Turn on the emergency flashers. (→P. 510)

Location of the spare tire, jack and tools

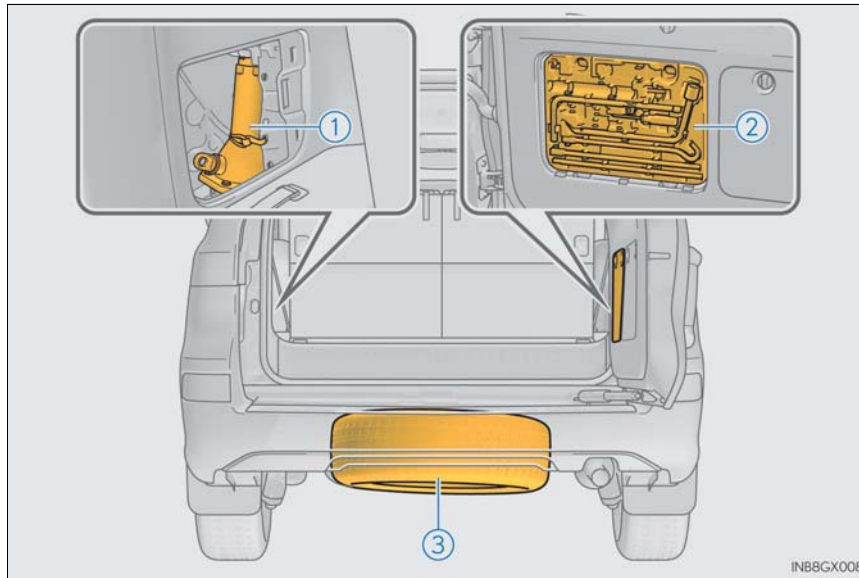

- ① Jack
- ② Tool box
- ③ Spare tire

 CAUTION**■ Using the tire jack**

Improper use of the tire jack may cause the vehicle to suddenly fall off the jack, leading to death or serious injury.

- Do not use the tire jack for any purpose other than replacing tires or installing and removing tire chains.
- Only use the tire jack that comes with this vehicle for replacing a flat tire. Do not use it on other vehicles, and do not use other tire jacks for replacing tires on this vehicle.
- Always check that the tire jack is securely set to the jack point.
- Do not put any part of your body under the vehicle while it is supported by the jack.
- Do not start or run the engine while your vehicle is supported by the jack.
- Do not raise the vehicle while someone is inside.
- When raising the vehicle, do not put an object on or under the jack.
- Do not raise the vehicle to a height greater than that required to replace the tire.
- Use a jack stand if it is necessary to get under the vehicle.
- Be sure to turn off the height control and stop the engine.

Take particular care when lowering the vehicle to ensure that no one working on or near the vehicle will be injured.

■ Using the jack handle

Tighten all the jack handle bolts securely using a Phillips-head screwdriver, to prevent the extension parts from coming apart unexpectedly.

Taking out the jack

- 1 Remove the cover.



- 2 Unhook the rubber band and take out the jack.

- 1 For loosening
- 2 For tightening

**Taking out the tool box**

- 1 Remove the cover.

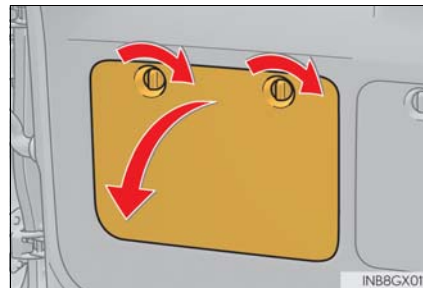

- 2 Take out the tool box.

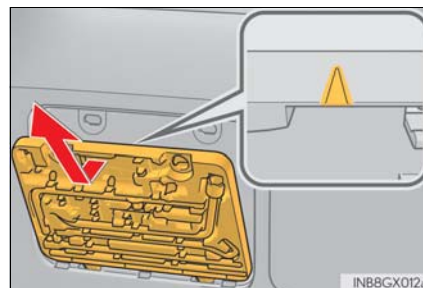

Taking out the spare tire

1 Assembling the jack handle.

Remove the jack handle and the jack handle extension bar from the tool box and assemble by following these steps.

- ① Loosen the bolt and the screw using either the jack handle end or a screwdriver.

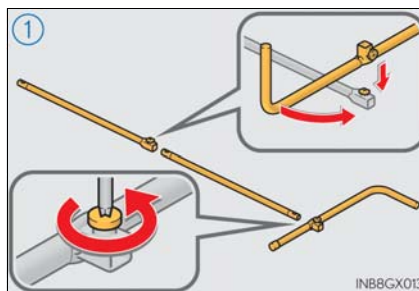

- ② Assemble the jack handle extension bar and the jack handle and tighten the bolt and the screw.

Check that the bolt and screw are firmly tightened.

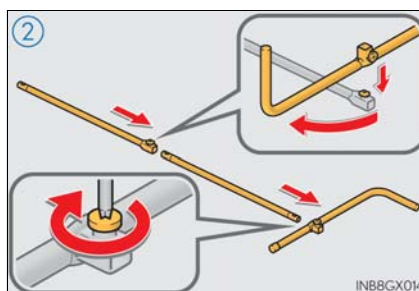

2 Remove the cover.

To protect the bodywork, place a rag between the screwdriver and the vehicle body.

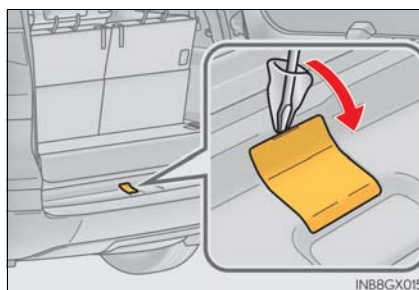

- 3** Insert the jack handle extension into the lowering socket.

- ① Lower
② Raise

Place a rag under the jack handle extension to protect the rear bumper.

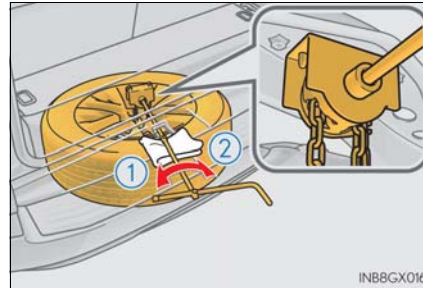

- 4** Lower the spare tire completely to the ground.

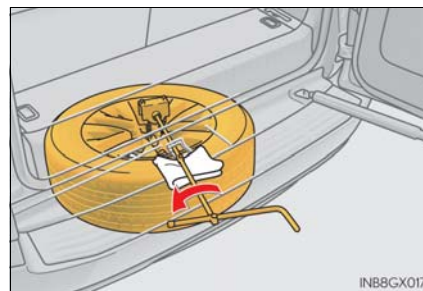

If the spare tire becomes caught on the suspension components, raise the tire, pull it towards the rear of the vehicle, and begin lowering it again.

- 5** Pull out the spare tire and remove the holding bracket.

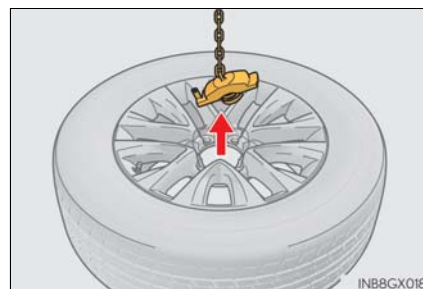

Replacing a flat tire

- 1 Check the tires.

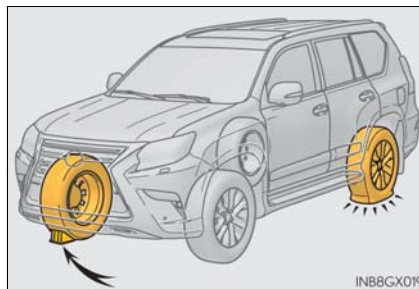

Flat tire		Wheel chock position
Front	Left-hand side	Behind the rear right-hand side tire
	Right-hand side	Behind the rear left-hand side tire
Rear	Left-hand side	In front of the front right-hand side tire
	Right-hand side	In front of the front left-hand side tire

- 2 Pry off the wheel ornament, using the beveled end of the wheel nut wrench as shown.

To protect the wheel ornament, place a rag between the wheel nut wrench and the wheel ornament.

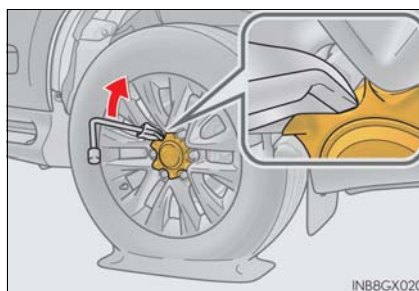

- 3 Slightly loosen the wheel nuts (one turn).

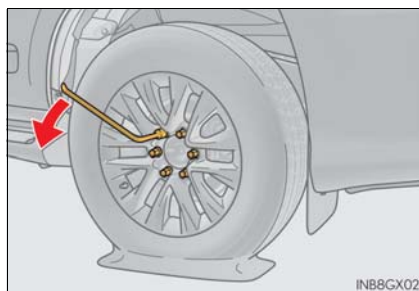

4 Assembling the jack handle.

Remove the jack handle, jack handle extension bar and jack handle bar from the tool box and assemble by following these steps.

- ① Loosen the bolt and the screw using either the jack handle end or a screwdriver.

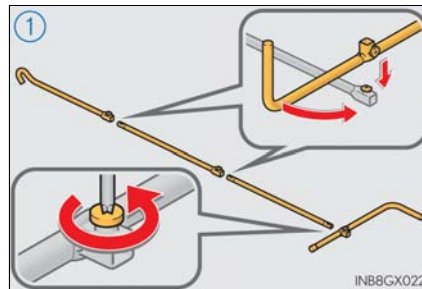

- ② Assemble the jack handle extension bar and the jack handle bar and tighten the bolts.

Check that the bolts are firmly tightened.

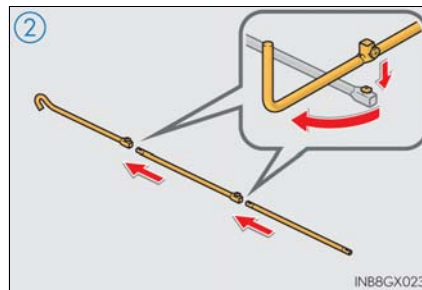

- ③ Assemble the jack handle extension bar and the jack handle and tighten the screw.

Check that the screw is firmly tightened.

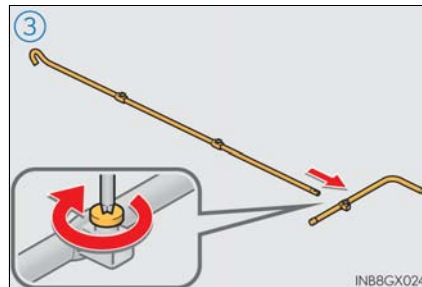

550 7-2. Steps to take in an emergency

5 Position the jack at the jack points as shown.

- ① Front
Under the chassis frame side rail
- ② Rear
Under the rear axle housing

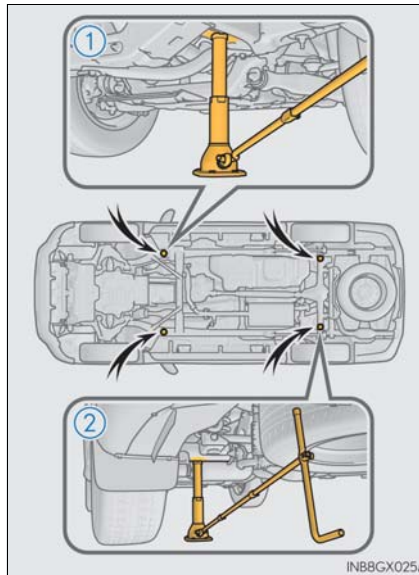

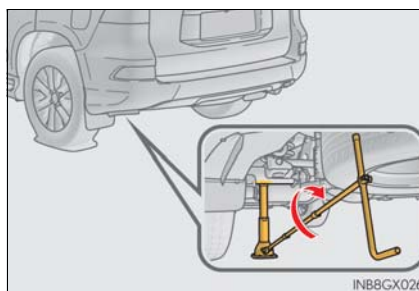

6 Raise the vehicle until the tire is slightly raised off the ground.

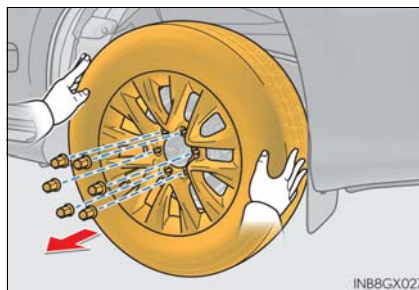

7 Remove all the wheel nuts and the tire.

When resting the tire on the ground, place the tire so that the wheel design faces up to avoid scratching the wheel surface.



 CAUTION

■ Replacing a flat tire

- Observe the following precautions.
Failure to do so may result in serious injury:
 - Lower the spare tire completely to the ground before removing it from under the vehicle.
 - Do not try to remove the wheel ornament by hand. Take due care in handling the ornament to avoid unexpected personal injury.
 - Do not touch the disc wheels or the area around the brakes immediately after the vehicle has been driven.
After the vehicle has been driven the disc wheels and the area around the brakes will be extremely hot. Touching these areas with hands, feet or other body parts while changing a tire, etc. may result in burns.
- Failure to follow these precautions could cause the nuts to loosen and the wheel may fall off, which could lead to an accident causing death or serious injury.
 - Never use oil or grease on the wheel bolts or wheel nuts.
Oil and grease may cause the wheel nuts to be excessively tightened, leading to bolt or disc wheel damage. In addition, the oil or grease can cause the wheel nuts to loosen and the wheel may fall off, causing a serious accident. Remove any oil or grease from the wheel bolts or wheel nuts.
 - Have the wheel nuts tightened with a torque wrench to 76 ft•lbf (103 N•m, 10.5 kgf•m) as soon as possible after changing wheels.
 - Do not attach a heavily damaged wheel ornament, as it may fly off the wheel while the vehicle is moving.
 - When installing a tire, only use wheel nuts that have been specifically designed for that wheel.
 - If there are any cracks or deformations in the bolt screws, nut threads or bolt holes of the wheel, have the vehicle inspected by your Lexus dealer.

Installing the spare tire

- 1 Remove any dirt or foreign matter from the wheel contact surface.

If foreign matter is on the wheel contact surface, the wheel nuts may loosen while the vehicle is in motion, and the tire may come off the vehicle.

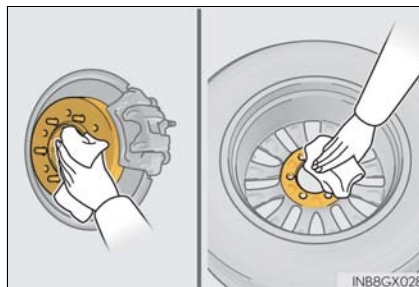

- 2 Install the spare tire and loosely tighten each nut by hand to approximately the same amount.

Turn the lug nuts until the washers come into contact with the disc wheel.

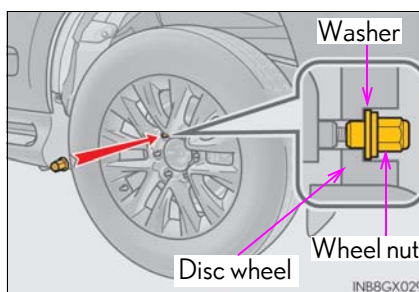

- 3 Lower the vehicle.

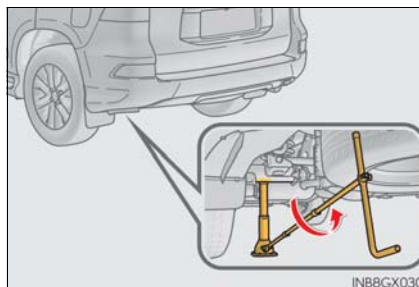

- 4 Firmly tighten each nut two or three times in the order shown in the illustration.

Tightening torque:
76 ft•lbf (103 N•m, 10.5 kgf•m)

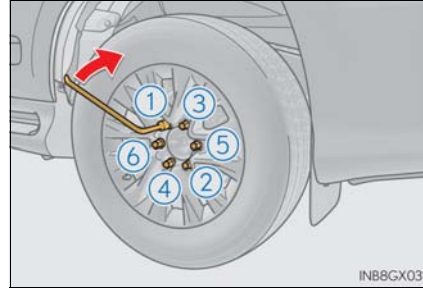

- 5 Reinstall the wheel ornament.

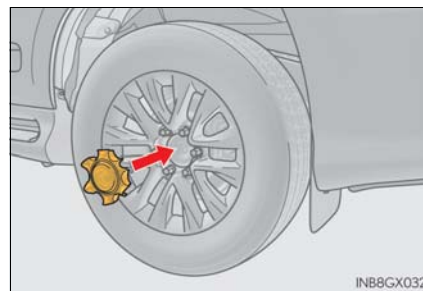

CAUTION

■ **Stowing the flat tire**

Failure to follow steps listed under stowing the tire may result in damage to the spare tire carrier and loss of the tire, which could result in death or serious injury.

Stowing the flat tire, jack and all tools

- 1 Lay down the tire with the valve stem facing up and install the holding bracket, inserting the claw into the wheel lug nut hole. Turn the jack handle extension clockwise to take up slack in the chain.

Then, check to ensure the claw is in the wheel lug nut hole and the holding bracket is centered in the wheel hub.

- 1 Claw
- 2 Holding bracket

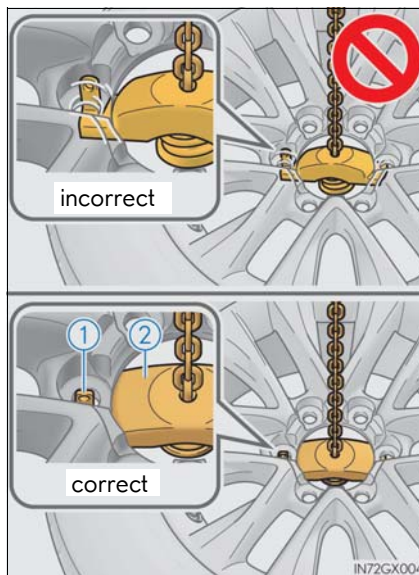

- 2 Raise the tire.

While raising, pull the tire towards the rear of the vehicle, taking care that the tire goes up without catching on any surrounding part, to prevent it from flying forward during a collision or sudden braking.

After the tire goes half way up, check that the suspended chain is able to enter the tire hole, for proper storage.

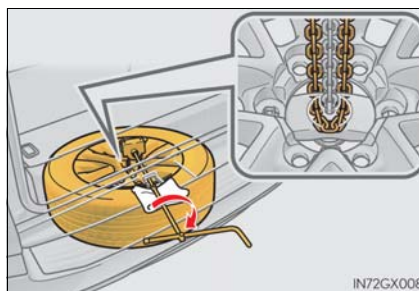

Tightening torque:

34.4 ft•lbf (46.6 N•m, 4.8 kgf•m)

- 3 Confirm that the tire is not loose after tightening:

- 1 Push and pull the tire
- 2 Try rotating

Visually check to ensure the tire is not hung on surrounding parts.

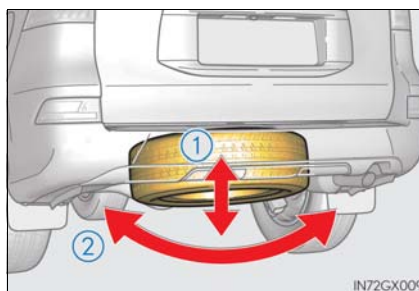

If looseness or misassembly exists, repeat step 2 and step 3.

- 4 Repeat step 3, any time the tire is lowered or disturbed.
- 5 Stow the tools and jack securely.



 CAUTION**■ After using the tools and jack**

Before driving, make sure all the tools and jack are securely in place in their storage location to reduce the possibility of personal injury during a collision or sudden braking.

 NOTICE**■ When stowing the flat tire**

Ensure that there is no object caught between the tire and the vehicle underbody.

If the engine will not start

If the engine will not start even though correct starting procedures are being followed (→P. 189), consider each of the following points:

The engine will not start even when the starter motor operates normally.

One of the following may be the cause of the problem:

- There may not be sufficient fuel in the vehicle's tank.
Refuel the vehicle.
- The engine may be flooded.
Try to restart the engine again following correct starting procedures.
(→P. 189)
- There may be a malfunction in the engine immobilizer system. (→P. 72)

The starter motor turns over slowly, the interior lights and headlights are dim, or the horn does not sound or sounds at a low volume.

One of the following may be the cause of the problem:

- The battery may be discharged. (→P. 561)
- The battery terminal connections may be loose or corroded.

The starter motor does not turn over.

The engine starting system may be malfunctioning due to an electrical problem such as an open circuit or a blown fuse. However, an interim measure is available to start the engine. (→P. 557)

The starter motor does not turn over, the interior lights and headlights do not turn on, or the horn does not sound.

One of the following may be the cause of the problem:

- One or both of the battery terminals may be disconnected.
- The battery may be discharged. (→P. 561)
- There may be a malfunction in the steering lock system.

Contact your Lexus dealer if the problem cannot be repaired, or if repair procedures are unknown.

Emergency start function

When the engine does not start, the following steps can be used as an interim measure to start the engine if the engine switch is functioning normally.

- 1 Set the parking brake.
- 2 Put the shift lever in P.
- 3 Set the engine switch to the ACCESSORY mode.
- 4 Push and hold the engine switch for about 15 seconds while depressing the brake pedal firmly.

Even if the engine can be started using the above steps, the system may be malfunctioning. Have the vehicle inspected by your Lexus dealer.

If the electronic key does not operate properly

If communication between the electronic key and vehicle is interrupted (→P. 117) or the electronic key cannot be used because the battery is depleted, the smart access system with push-button start and wireless remote control cannot be used. In such cases, the doors can be opened and the engine can be started by following the procedure below.

Locking and unlocking the doors and key linked functions

Use the mechanical key (→P. 95) in order to perform the following operations (driver's door only):

- ① Locks all the doors
- ② Closes the windows and moon roof* (turn and hold)
- ③ Unlocks the doors
Turning the key rearward unlocks the driver's door. Turning the key once again unlocks the other doors.
- ④ Opens the windows and moon roof* (turn and hold)

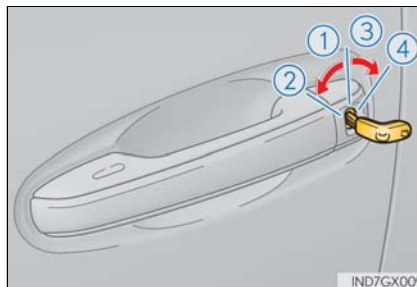

*: These settings must be customized at your Lexus dealer.

Starting the engine

- 1 Ensure that the shift lever is in P and depress the brake pedal.
- 2 Touch the Lexus emblem side of the electronic key to the engine switch.

If any of the doors is opened or closed while the key is being touched to the switch, an alarm will sound to indicate that the start function cannot detect the electronic key.



- 3 Press the engine switch within 10 seconds of the buzzer sounding, keeping the brake pedal depressed.

In the event that the engine switch still cannot be operated, contact your Lexus dealer.

■ Stopping the engine

Shift the shift lever to P and press the engine switch as you normally do when stopping the engine.

■ Replacing the key battery

As the above procedure is a temporary measure, it is recommended that the electronic key battery be replaced immediately when the battery is depleted. (→P. 491)

■ Changing engine switch modes

Within 10 seconds of the buzzer sounding, release the brake pedal and press the engine switch.

The engine does not start and modes will be changed each time the switch is pressed. (→P. 190)

■ When the electronic key does not work properly

Make sure that the smart access system with push-button start has not been deactivated in the customization setting. If it is off, turn the function on.

(Customizable features: →P. 594)

 CAUTION**■ When using the mechanical key and operating the power windows or moon roof**

Operate the power window or moon roof after checking to make sure that there is no possibility of any passenger having any of their body parts caught in the window or moon roof.

Also, do not allow children to operate the mechanical key. It is possible for children and other passengers to get caught in the power window or moon roof.

If the vehicle battery is discharged

The following procedures may be used to start the engine if the vehicle's battery is discharged.

You can call your Lexus dealer, or qualified repair shop.

If you have a set of jumper (or booster) cables and a second vehicle with a 12 volt battery, you can jump start your Lexus by following the steps below.

- 1 Confirm that the electronic key is being carried.

When connecting the jumper (or booster) cables, depending on the situation, the alarm may activate and the doors locked. (→P. 75)

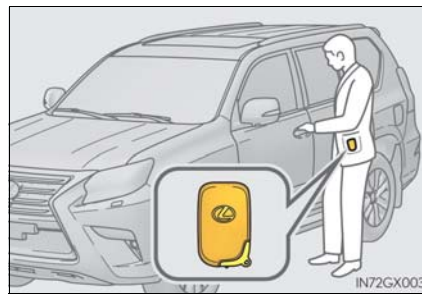

- 2 Open the hood. (→P. 462)
- 3 Connecting the jumper cables according to the following procedure:

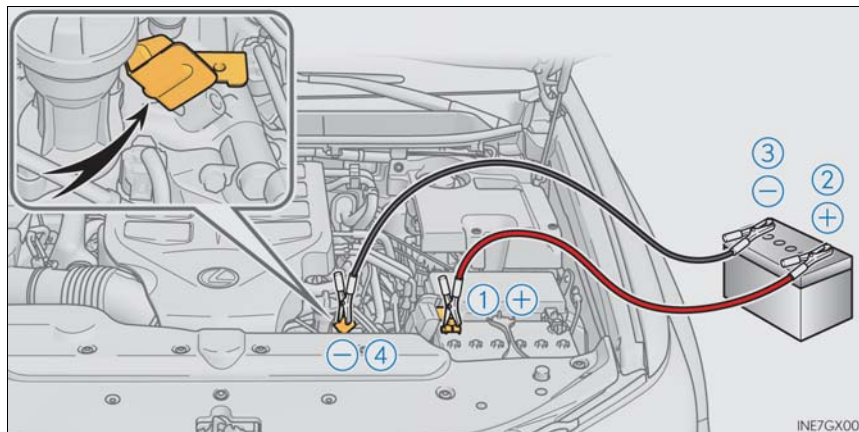

- ① Positive (+) battery terminal on your vehicle.
- ② Positive (+) battery terminal on the second vehicle.
- ③ Negative (-) battery terminal on the second vehicle.
- ④ Connect the jumper cable to ground on your vehicle as shown in the illustration.

- 4 Start the engine of the second vehicle. Increase the engine speed slightly and maintain at that level for approximately 5 minutes to recharge the battery of your vehicle.
- 5 Open and close any of the doors of your vehicle with the engine switch off.
- 6 Maintain the engine speed of the second vehicle and start the engine of your vehicle by turning the engine switch to IGNITION ON mode.
- 7 Once your vehicle's engine has started, remove the jumper cables in the exact reverse order in which they were connected.

Once the engine starts, have the vehicle checked at your Lexus dealer as soon as possible.

■ **Starting the engine when the battery is discharged**

The engine cannot be started by push-starting.

■ **To prevent battery discharge**

- Turn off the headlights and the audio system while the engine is off.
- Turn off any unnecessary electrical components when the vehicle is running at a low speed for an extended period, such as in heavy traffic.

■ **Charging the battery**

The electricity stored in the battery will discharge gradually even when the vehicle is not in use, due to natural discharge and the draining effects of certain electrical appliances. If the vehicle is left for a long time, the battery may discharge, and the engine may be unable to start. (The battery recharges automatically during driving.)

■ **When recharging or replacing the battery**

- In some cases, it may not be possible to unlock the doors using the smart access system with push-button start when the battery is discharged. Use the wireless remote control or the mechanical key to lock or unlock the doors.
- The engine may not start on the first attempt after the battery has recharged but will start normally after the second attempt. This is not a malfunction.
- The engine switch mode is memorized by the vehicle. When the battery is reconnected, the system will return to the mode it was in before the battery was discharged. Before disconnecting the battery, turn the engine switch off. If you are unsure what mode the engine switch was in before the battery discharged, be especially careful when reconnecting the battery.



 CAUTION**■ Avoiding battery fires or explosions**

Observe the following precautions to prevent accidentally igniting the flammable gas that may be emitted from the battery:

- Make sure the jumper cable is connected to the correct terminal and that it is not unintentionally in contact with any other than the intended terminal.
- Do not allow the + and - clamps of the jumper cables to come into contact with each other.
- Do not smoke, use matches, cigarette lighters or allow open flame near the battery.

■ Battery precautions

The battery contains poisonous and corrosive acidic electrolyte, while related parts contain lead and lead compounds. Observe the following precautions when handling the battery:

- When working with the battery, always wear safety glasses and take care not to allow any battery fluids (acid) to come into contact with skin, clothing or the vehicle body.
- Do not lean over the battery.
- In the event that battery fluid comes into contact with the skin or eyes, immediately wash the affected area with water and seek medical attention.
Place a wet sponge or cloth over the affected area until medical attention can be received.
- Always wash your hands after handling the battery support, terminals, and other battery-related parts.
- Do not allow children near the battery.

 NOTICE**■ When handling jumper cables**

When connecting the jumper cables, ensure that they do not become entangled in the cooling fans or belt.

If your vehicle overheats

The following may indicate that your vehicle is overheating.

- The needle of the engine coolant temperature gauge (→P. 83) enters the red zone or a loss of engine power is experienced. (For example, the vehicle speed does not increase.)
- Steam is coming from under the hood.

Correction procedures

- 1 Stop the vehicle in a safe place and turn off the air conditioning system, and then stop the engine.
- 2 If you see steam:
Carefully lift the hood after the steam subsides.
If you do not see steam:
Carefully lift the hood.
- 3 After the engine has cooled down sufficiently, inspect the hoses and radiator core (radiator) for any leaks.
 - 1 Radiator
 - 2 Cooling fansIf a large amount of coolant leaks, immediately contact your Lexus dealer.

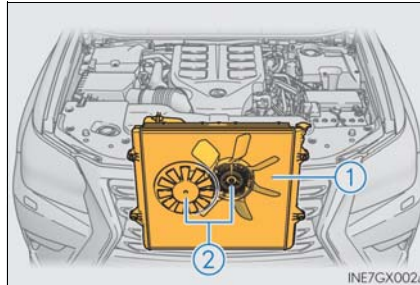

- 4** The coolant level is satisfactory if it is between the “F” and “L” lines on the reservoir.

- ① Reservoir
- ② “F”
- ③ “L”
- ④ Radiator cap

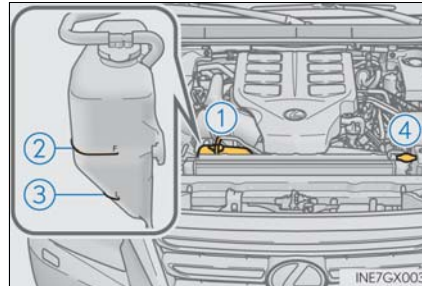

- 5** Add coolant if necessary.

Water can be used in an emergency if coolant is unavailable.

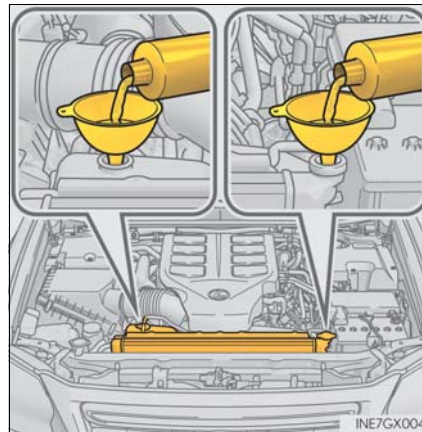

- 6** Start the engine and turn the air conditioning system on to check that the radiator cooling fans operate and to check for coolant leaks from the radiator or hoses.

The fans operate when the air conditioning system is turned on immediately after a cold start. Confirm that the fans are operating by checking the fan sound and air flow. If it is difficult to check these, turn the air conditioning system on and off repeatedly. (The fans may not operate in freezing temperatures.)

- 7** If the fans are not operating:
Stop the engine immediately and contact your Lexus dealer.
- If the fans are operating:
Have the vehicle inspected at the nearest Lexus dealer.

 CAUTION**■ When inspecting under the hood of your vehicle**

Observe the following precautions.

Failure to do so may result in serious injury such as burns.

- If steam is seen coming from under the hood, do not open the hood until the steam has subsided. The engine compartment may be very hot.
- Keep hands and clothing (especially a tie, a scarf or a muffler) away from the fans and belts. Failure to do so may cause the hands or clothing to be caught, resulting in serious injury.
- Do not loosen the radiator cap or the coolant reservoir cap while the engine and radiator are hot. High temperature steam or coolant could spray out.

 NOTICE**■ When adding engine coolant**

Add coolant slowly after the engine has cooled down sufficiently. Adding cool coolant to a hot engine too quickly can cause damage to the engine.

■ To prevent damage to the cooling system

Observe the following precautions:

- Avoid contaminating the coolant with foreign matter (such as sand or dust etc.).
- Do not use any coolant additive.

If the vehicle becomes stuck

Carry out the following procedures if the tires spin or the vehicle becomes stuck in mud, dirt, or snow:

- 1 Stop the engine. Set the parking brake and shift the shift lever to P.
- 2 Remove the mud, snow or sand from around the stuck tire.
- 3 Place wood, stones or some other material under the tires to help provide traction.
- 4 Restart the engine.
- 5 Lock the center differential. (→P. 343)
- 6 Shift the shift lever to the D or R position and release the parking brake. Then, while exercising caution, depress the accelerator pedal.

■ When it is difficult to free the vehicle

Turn off TRAC or Active TRAC/VSC/Trailer Sway Control if these functions are hampering your attempts to free the vehicle. (→P. 353)

Press to turn off TRAC or Active TRAC/VSC/Trailer Sway Control.

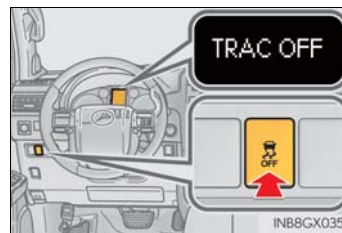

 CAUTION

■ **When attempting to free a stuck vehicle**

If you choose to push the vehicle back and forth to free it, make sure the surrounding area is clear, to avoid striking other vehicles, objects or people. The vehicle may also lunge forward or lunge back suddenly as it becomes free. Use extreme caution.

■ **When shifting the shift lever**

Be careful not to shift the shift lever with the accelerator pedal depressed. This may lead to unexpected rapid acceleration of the vehicle that may cause an accident and result in death or serious injury.

 NOTICE

■ **To avoid damaging the transmission and other components**

- Avoid spinning the wheels and depressing the accelerator pedal more than necessary.
- If the vehicle remains stuck even after these procedures are performed, the vehicle may require towing to be freed.
- When a warning message for the automatic transmission fluid temperature is displayed while attempting to free a stuck vehicle, immediately remove your foot from the accelerator pedal and wait until the warning message disappears. Otherwise, the transmission may become damaged. (→P. 533)

Vehicle specifications

8

569

8-1. Specifications

Maintenance data (fuel, oil level, etc.)	570
Fuel information.....	580
Tire information	583

8-2. Customization

Customizable features	594
Items to initialize.....	605



Maintenance data (fuel, oil level, etc.)

Dimensions and weights

Overall length	189.2 in. (4880 mm)	
Overall width	74.2 in. (1885 mm)	
Overall height*1	71.7 in. (1820 mm)*2,6 72.0 in. (1830 mm)*2,5 72.2 in. (1835 mm)*3,6 72.6 in. (1845 mm)*3,5 73.8 in. (1875 mm)*4,6 74.2 in. (1885 mm)*4,5	
Wheelbase	109.8 in. (2790 mm)	
Front and rear tread	62.4 in. (1585 mm)	
Vehicle capacity weight (Occupants + luggage)	1280 lb. (580 kg)*6 1315 lb. (595 kg)*5	
TWR (trailer weight + cargo weight) (With towing hitch)	With brake	6500 lb. (2950 kg)
	Without brake	1000 lb. (453 kg)

- *1: Unladen vehicles
- *2: Vehicles without roof rails and shark fin antenna
- *3: Vehicles with roof rails and without shark fin antenna
- *4: Vehicles with shark fin antenna
- *5: Vehicles without rear height control air suspension
- *6: Vehicles with rear height control air suspension



Vehicle identification

■ Vehicle identification number

The vehicle identification number (VIN) is the legal identifier for your vehicle. This is the primary identification number for your Lexus. It is used in registering the ownership of your vehicle.

This number is stamped on the front right frame.

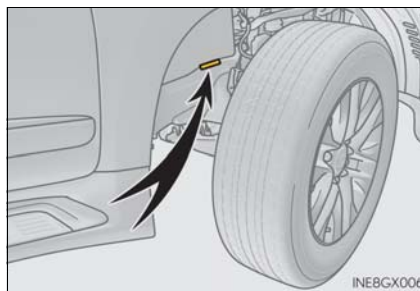

This number is also stamped on the top left of the instrument panel.



This number is also on the Certification label on the left-hand side center pillar.

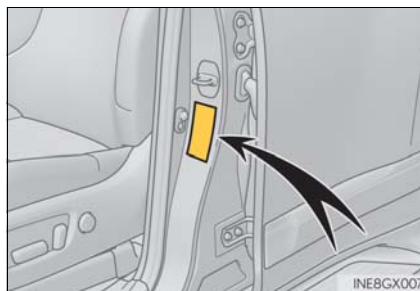

■ Engine number

The engine number is stamped on the engine block as shown.

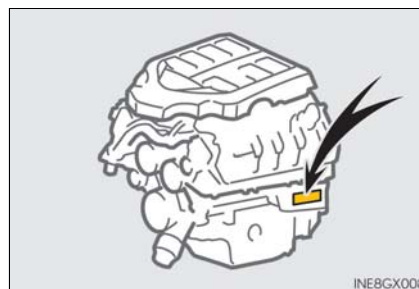

Engine

Model	4.6 L 8-cylinder (1UR-FE)
Type	8-cylinder V type, 4-cycle, gasoline
Bore and stroke	3.70 × 3.27 in. (94.0 × 83.0 mm)
Displacement	281.2 cu.in. (4608 cm ³)
Valve clearance	Automatic adjustment
Drive belt tension	Automatic adjustment

Fuel

Fuel type	Unleaded gasoline only
Octane rating	91 (Research Octane Number 96) or higher
Fuel tank capacity (Reference)	23.0 gal. (87 L, 19.1 Imp.gal.)

Lubrication system

Oil capacity (Drain and refill – reference *)	
With filter	8.2 qt. (7.8 L, 6.9 Imp.qt.)
Without filter	7.8 qt. (7.4 L, 6.5 Imp.qt.)

*: The engine oil capacity is a reference quantity to be used when changing the engine oil. Warm up and turn off the engine, wait more than 5 minutes, and check the oil level on the dipstick.



■ Engine oil selection

“Toyota Genuine Motor Oil” is used in your Lexus vehicle. Use Lexus approved “Toyota Genuine Motor Oil” or equivalent to satisfy the following grade and viscosity.

Oil grade: ILSAC GF-5 multigrade engine oil

Recommended viscosity: SAE 0W-20

SAE 0W-20 is the best choice for good fuel economy and good starting in cold weather.

If SAE 0W-20 is not available, SAE 5W-20 oil may be used. However, it must be replaced with SAE 0W-20 at the next oil change.

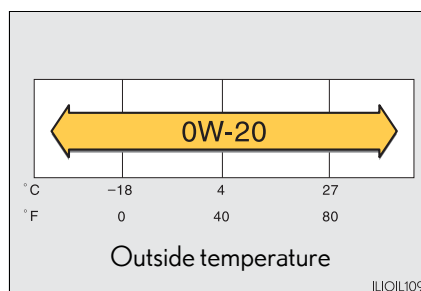

Oil viscosity (0W-20 is explained here as an example):

- The 0W in 0W-20 indicates the characteristic of the oil which allows cold startability. Oils with a lower value before the W allow for easier starting of the engine in cold weather.
- The 20 in 0W-20 indicates the viscosity characteristic of the oil when the oil is at high temperature. An oil with a higher viscosity (one with a higher value) may be better suited if the vehicle is operated at high speeds, or under extreme load conditions.

How to read oil container label:

The International Lubricant Specification Advisory Committee (ILSAC) Certification Mark is added to some oil containers to help you select the oil you should use.



Cooling system

Capacity (reference)	With rear heater	16.3 qt. (15.4 L, 13.6 Imp.qt.)
	Without rear heater	14.5 qt. (13.7 L, 12.1 Imp.qt.)
Coolant type		Use either of the following: <ul style="list-style-type: none"> • "Toyota Super Long Life Coolant" • A similar high-quality ethylene glycol-based non-silicate, non-amine, non-nitrite, and non-borate coolant with long-life hybrid organic acid technology Do not use plain water alone.

Ignition system (spark plug)

Make	DENSO SK20HR11
Gap	0.043 in. (1.1 mm)

 NOTICE

■ Iridium-tipped spark plugs

Use only iridium-tipped spark plugs. Do not adjust the spark plug gap.



Electrical system (battery)

Specific gravity reading at 68°F (20°C):	12.6 — 12.8 V Fully charged 12.2 — 12.4 V Half charged 11.8 — 12.0 V Discharged Voltage is checked 20 minutes after the engine and all the lights are turned off.
Charging rates	5 A max.

Front differential

Oil capacity	1.48 qt. (1.40 L, 1.23 Imp.qt.)
Oil type and viscosity *	Toyota Genuine Differential Gear Oil LT 75W-85 GL-5 or equivalent

*: Your Lexus vehicle is filled with "Toyota Genuine Differential Gear Oil" at the factory. Use Lexus approved "Toyota Genuine Differential Gear Oil" or an equivalent of matching quality to satisfy the above specification. Please contact your Lexus dealer for further details.

Rear differential

Oil capacity	2.85 qt. (2.70 L, 2.38 Imp.qt.)
Oil type and viscosity *	Toyota Genuine Differential Gear Oil LT 75W-85 GL-5 or equivalent

*: Your Lexus vehicle is filled with "Toyota Genuine Differential Gear Oil" at the factory. Use Lexus approved "Toyota Genuine Differential Gear Oil" or an equivalent of matching quality to satisfy the above specification. Please contact your Lexus dealer for further details.

Automatic transmission

Fluid capacity*	With air-cooled type ATF cooler	11.8 qt. (11.2 L, 9.9 Imp.qt.)
	Without air-cooled type ATF cooler	11.6qt. (11.0 L, 9.7 Imp.qt.)
Fluid type		Toyota Genuine ATF WS

*: The fluid capacity is a reference quantity. If replacement is necessary, contact your Lexus dealer.

 NOTICE

■ **Transmission fluid type**

Using transmission fluid other than “Toyota Genuine ATF WS” may cause deterioration in shift quality, locking up of the transmission accompanied by vibration and, ultimately, damage to the vehicle’s transmission.

Transfer

Oil capacity	1.5 qt. (1.4 L, 1.2 Imp.qt.)
Oil type*	Toyota Genuine Transfer Gear oil LF or equivalent
Recommended oil viscosity	SAE 75W

*: Your Lexus vehicle is filled with “Toyota Genuine Transfer Gear oil LF” at the factory. Use Lexus approved “Toyota Genuine Transfer Gear oil LF” or an equivalent of matching quality to satisfy the above specification. Please contact your Lexus dealer for further details.



Brakes

Pedal clearance* ¹	3.4 in. (86 mm) Min.
Pedal free play	0.04—0.24 in. (1—6 mm)
Brake pad wear limit	0.04 in. (1.0 mm)
Parking brake lining wear limit	0.04 in. (1.0 mm)
Parking brake pedal travel* ²	5—7 clicks
Fluid type	SAE J1703 or FMVSS No. 116 DOT 3

*¹: Minimum pedal clearance when depressed with a force of 110 lbf (490 N, 50 kgf) while the engine is running

*²: Parking brake pedal travel when pulled up with a force of 44.1 lbf (196 N, 20.0 kgf)

Chassis lubrication (Propeller shafts)

Spider	Lithium base chassis grease, NLGI No.2
Slide yoke	Molybdenum-disulfide lithium base chassis grease, NLGI No.2 or lithium base chassis grease, NLGI No.2

Steering

Free play	Less than 1.18 in. (30 mm)
Power steering fluid type	Automatic transmission fluid DEXRON® II or III

Tires and wheels

Tire size	P265/60R18 109H
Tire inflation pressure (Recommended cold tire inflation pressure)	Front tire 32 psi (220 kPa, 2.2 kgf/cm ² or bar) Rear tire 32 psi (220 kPa, 2.2 kgf/cm ² or bar) Spare tire 32 psi (220 kPa, 2.2 kgf/cm ² or bar)
Wheel size	18 × 7 1/2J
Wheel nut torque	76 ft•lbf (103 N•m, 10.5 kgf•m)



Light bulbs

	Light bulbs	Bulb No.	W	Type	
Exterior	Headlights (High beam)	9703	65	A	
	Front turn signal lights	—	21	B	
	Rear turn signal lights	—	21	B	
	Back-up lights	921	16	C	
	Rear side marker lights	—	5	C	
	Running board lights	—	5	C	
Interior	Personal/ Interior lights	Front	—	5	C
		Rear	—	5	C
	Vanity lights	—	8	C	
	Door courtesy lights	—	5	C	

A: H9 halogen bulbs

B: Wedge base bulb (amber)

C: Wedge base bulb (clear)



Fuel information

You must only use unleaded gasoline.

Select premium unleaded gasoline with an octane rating of 91 (Research Octane Number 96) or higher required for optimum engine performance and fuel economy. If the octane rating is less than 91, damage to the engine may occur and may void the vehicle warranty.

At minimum, the gasoline you use should meet the specifications of ASTM D4814 in the U.S.A..

■ Gasoline quality

In very few cases, driveability problems may be caused by the brand of gasoline you are using. If driveability problems persist, try changing the brand of gasoline. If this does not correct the problem, consult your Lexus dealer.

■ Gasoline quality standards

- Automotive manufacturers in the U.S.A., Europe and Japan have developed a specification for fuel quality called the World-Wide Fuel Charter (WWFC), which is expected to be applied worldwide.
- The WWFC consists of four categories that are based on required emission levels. In the U.S., category 4 has been adopted.
- The WWFC improves air quality by lowering emissions in vehicle fleets, and improves customer satisfaction through better performance.



■ Recommendation of the use of gasoline containing detergent additives

- Lexus recommends the use of gasoline that contains detergent additives to avoid the build-up of engine deposits.
- All gasoline sold in the U.S.A. contains minimum detergent additives to clean and/or keep clean intake systems, per EPA's lowest additives concentration program.
- Lexus strongly recommends the use of Top Tier Detergent Gasoline. For more information on Top Tier Detergent Gasoline and a list of marketers, please go to the official website www.toptiergas.com.

■ Recommendation of the use of low emissions gasoline

Gasolines containing oxygenates such as ethers and ethanol, as well as reformulated gasolines, are available in some cities. These fuels are typically acceptable for use, providing they meet other fuel requirements.

Lexus recommends these fuels, since the formulations allow for reduced vehicle emissions.

■ Non-recommendation of the use of blended gasoline

- Use only gasoline containing up to 15% ethanol.
DO NOT use any flex-fuel or gasoline that could contain more than 15% ethanol, including from any pump labeled E30, E50, E85 (which are only some examples of fuel containing more than 15% ethanol).

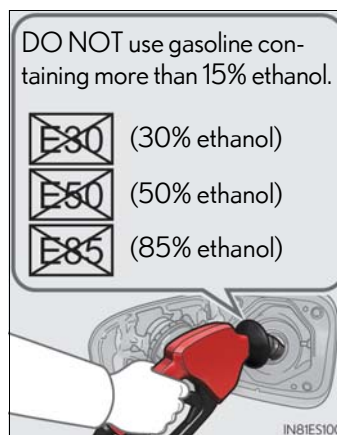

- If you use gasohol in your Lexus, be sure that it has an octane rating no lower than 91.
- Lexus does not recommend the use of gasoline containing methanol.

■ Non-recommendation of the use of gasoline containing MMT

Some gasoline contains an octane enhancing additive called MMT (Methylcyclopentadienyl Manganese Tricarbonyl).

Lexus does not recommend the use of gasoline that contains MMT. If fuel containing MMT is used, your emission control system may be adversely affected.

The malfunction indicator lamp on the instrument cluster may come on. If this happens, contact your Lexus dealer for service.

■ **If your engine knocks**

- Consult your Lexus dealer.
- You may occasionally notice light knocking for a short time while accelerating or driving uphill. This is normal and there is no need for concern.

 **NOTICE**

■ **Notice on fuel quality**

- Do not use improper fuels. If improper fuels are used, the engine will be damaged.
- Do not use leaded gasoline.
Leaded gasoline can cause damage to your vehicle's three-way catalytic converters causing the emission control system to malfunction.
- Do not use gasohol other than the type previously stated.
Other gasohol may cause fuel system damage or vehicle performance problems.
- Using unleaded gasoline with an octane number or rating lower than the level previously stated may cause persistent heavy knocking.
At worst, this may lead to engine damage and will void the vehicle warranty.

■ **Fuel-related poor driveability**

If poor driveability (poor hot starting, vaporization, engine knocking, etc.) is encountered after using a different type of fuel, discontinue the use of that type of fuel.

■ **When refueling with gasohol**

Take care not to spill gasohol. It can damage your vehicle's paint.



Tire information

Typical tire symbols

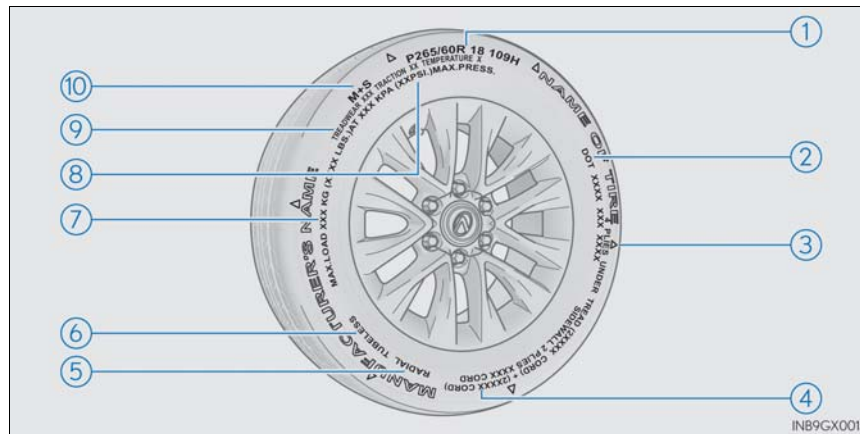

- ① Tire size (→P. 585)
- ② DOT and Tire Identification Number (TIN) (→P. 584)
- ③ Location of treadwear indicators (→P. 476)
- ④ Tire ply composition and materials
Plies are layers of rubber-coated parallel cords. Cords are the strands which form the plies in a tire.
- ⑤ Radial tires or bias-ply tires
A radial tire has "RADIAL" on the sidewall. A tire not marked "RADIAL" is a bias-ply tire.
- ⑥ TUBELESS or TUBE TYPE
A tubeless tire does not have a tube and air is directly put into the tire. A tube type tire has a tube inside the tire and the tube maintains the air pressure.
- ⑦ Load limit at maximum cold tire inflation pressure (→P. 589)
- ⑧ Maximum cold tire inflation pressure (→P. 589)
This means the pressure to which a tire may be inflated.
- ⑨ Uniform tire quality grading
For details, see "Uniform Tire Quality Grading" that follows.
- ⑩ Summer tires or all season tires (→P. 479)
An all season tire has "M+S" on the sidewall. A tire not marked "M+S" is a summer tire.

Typical DOT and Tire Identification Number (TIN)

▶ Type A

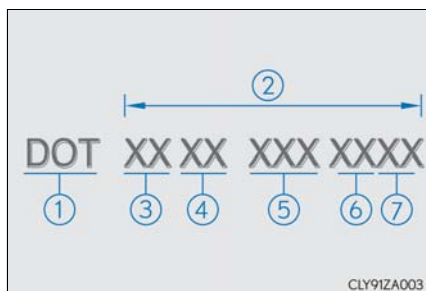

▶ Type B

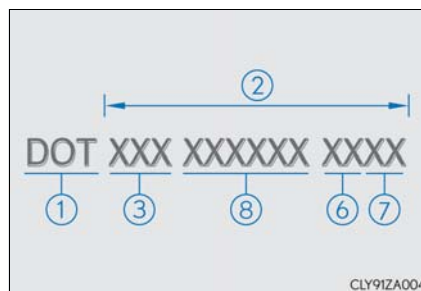

- ① DOT symbol*
- ② Tire Identification Number (TIN)
- ③ Tire manufacturer's identification mark
- ④ Tire size code
- ⑤ Manufacturer's optional tire type code (3 or 4 letters)
- ⑥ Manufacturing week
- ⑦ Manufacturing year
- ⑧ Manufacturer's code

*: The DOT symbol certifies that the tire conforms to applicable Federal Motor Vehicle Safety Standards.



Tire size

■ Typical tire size information

The illustration indicates typical tire size.

- ① Tire use (P = Passenger car, T = Temporary use)
- ② Section width (millimeters)
- ③ Aspect ratio (tire height to section width)
- ④ Tire construction code (R = Radial, D = Diagonal)
- ⑤ Wheel diameter (inches)
- ⑥ Load index (2 digits or 3 digits)
- ⑦ Speed symbol (alphabet with one letter)



■ Tire dimensions

- ① Section width
- ② Tire height
- ③ Wheel diameter

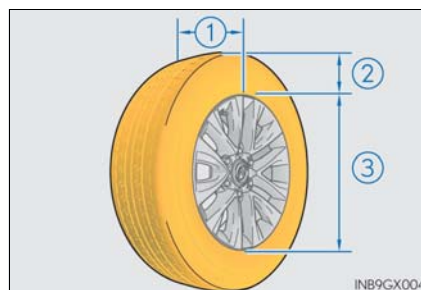

Tire section names

- ① Bead
- ② Sidewall
- ③ Shoulder
- ④ Tread
- ⑤ Belt
- ⑥ Inner liner
- ⑦ Reinforcing rubber
- ⑧ Carcass
- ⑨ Rim lines
- ⑩ Bead wires
- ⑪ Chafer

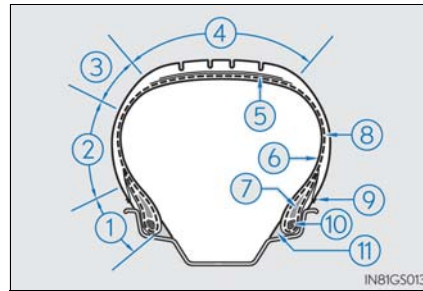

Uniform Tire Quality Grading

This information has been prepared in accordance with regulations issued by the National Highway Traffic Safety Administration of the U.S. Department of Transportation.

It provides the purchasers and/or prospective purchasers of Lexus vehicles with information on uniform tire quality grading.

Your Lexus dealer will help answer any questions you may have as you read this information.

■ DOT quality grades

All passenger vehicle tires must conform to Federal Safety Requirements in addition to these grades. Quality grades can be found where applicable on the tire sidewall between tread shoulder and maximum section width.

For example: Treadwear 200 Traction AA Temperature A

■ Treadwear

The treadwear grade is a comparative rating based on the wear rate of the tire when tested under controlled conditions on a specified government test course.

For example, a tire graded 150 would wear one and a half (1 - 1/2) times as well on the government course as a tire graded 100.

The relative performance of tires depends upon the actual conditions of their use. Performance may differ significantly from the norm due to variations in driving habits, service practices and differences in road characteristics and climate.

■ Traction AA, A, B, C

The traction grades, from highest to lowest, are AA, A, B and C, and they represent the tire's ability to stop on wet pavement as measured under controlled conditions on specified government test surfaces of asphalt and concrete.

A tire marked C may have poor traction performance.

Warning: The traction grade assigned to this tire is based on braking (straight ahead) traction tests and does not include cornering (turning) traction.



■ **Temperature A, B, C**

The temperature grades are A (the highest), B, and C, representing the tire's resistance to the generation of heat and its ability to dissipate heat when tested under controlled conditions on a specified indoor laboratory test wheel.

Sustained high temperature can cause the material of the tire to degenerate and reduce tire life, and excessive temperature can lead to sudden tire failure.

Grade C corresponds to a level of performance which all passenger car tires must meet under the Federal Motor Vehicle Safety Standard No. 109.

Grades B and A represent higher levels of performance on the laboratory test wheel than the minimum required by law.

Warning: The temperature grades of a tire assume that it is properly inflated and not overloaded.

Excessive speed, underinflation, or excessive loading, either separately or in combination, can cause heat buildup and possible tire failure.



Glossary of tire terminology

Tire related term	Meaning
Cold tire inflation pressure	Tire pressure when the vehicle has been parked for three hours or more, or has not been driven more than 1 mile or 1.5 km under that condition
Maximum inflation pressure	The maximum cold inflated pressure to which a tire may be inflated, shown on the sidewall of the tire
Recommended inflation pressure	Cold tire inflation pressure recommended by a manufacturer
Accessory weight	The combined weight (in excess of those standard items which may be replaced) of automatic transmission, power steering, power brakes, power windows, power seats, radio and heater, to the extent that these items are available as factory-installed equipment (whether installed or not)
Curb weight	The weight of a motor vehicle with standard equipment, including the maximum capacity of fuel, oil and coolant, and if so equipped, air conditioning and additional weight optional engine
Maximum loaded vehicle weight	The sum of: (a) Curb weight (b) Accessory weight (c) Vehicle capacity weight (d) Production options weight
Normal occupant weight	150 lb. (68 kg) times the number of occupants specified in the second column of Table 1* that follows
Occupant distribution	Distribution of occupants in a vehicle as specified in the third column of Table 1* below
Production options weight	The combined weight of installed regular production options weighing over 5 lb. (2.3 kg) in excess of the standard items which they replace, not previously considered in curb weight or accessory weight, including heavy duty brakes, ride levelers, roof rack, heavy duty battery, and special trim
Rim	A metal support for a tire or a tire and tube assembly upon which the tire beads are seated



Tire related term	Meaning
Rim diameter (Wheel diameter)	Nominal diameter of the bead seat
Rim size designation	Rim diameter and width
Rim type designation	The industry manufacturer's designation for a rim by style or code
Rim width	Nominal distance between rim flanges
Vehicle capacity weight (Total load capacity)	The rated cargo and luggage load plus 150 lb. (68 kg) times the vehicle's designated seating capacity
Vehicle maximum load on the tire	The load on an individual tire that is determined by distributing to each axle its share of the maximum loaded vehicle weight, and dividing by two
Vehicle normal load on the tire	The load on an individual tire that is determined by distributing to each axle its share of curb weight, accessory weight, and normal occupant weight (distributed in accordance with Table 1* below), and dividing by two
Weather side	The surface area of the rim not covered by the inflated tire
Bead	The part of the tire that is made of steel wires, wrapped or reinforced by ply cords and that is shaped to fit the rim
Bead separation	A breakdown of the bond between components in the bead
Bias ply tire	A pneumatic tire in which the ply cords that extend to the beads are laid at alternate angles substantially less than 90 degrees to the centerline of the tread
Carcass	The tire structure, except tread and sidewall rubber which, when inflated, bears the load
Chunking	The breaking away of pieces of the tread or sidewall
Cord	The strands forming the plies in the tire
Cord separation	The parting of cords from adjacent rubber compounds
Cracking	Any parting within the tread, sidewall, or innerliner of the tire extending to cord material



Tire related term	Meaning
CT	A pneumatic tire with an inverted flange tire and rim system in which the rim is designed with rim flanges pointed radially inward and the tire is designed to fit on the underside of the rim in a manner that encloses the rim flanges inside the air cavity of the tire
Extra load tire	A tire designed to operate at higher loads and at higher inflation pressures than the corresponding standard tire
Groove	The space between two adjacent tread ribs
Innerliner	The layer(s) forming the inside surface of a tubeless tire that contains the inflating medium within the tire
Innerliner separation	The parting of the innerliner from cord material in the carcass
Intended outboard sidewall	(a) The sidewall that contains a whitewall, bears white lettering, or bears manufacturer, brand, and/or model name molding that is higher or deeper than the same molding on the other sidewall of the tire, or (b) The outward facing sidewall of an asymmetrical tire that has a particular side that must always face outward when mounted on a vehicle
Light truck (LT) tire	A tire designated by its manufacturer as primarily intended for use on lightweight trucks or multipurpose passenger vehicles
Load rating	The maximum load that a tire is rated to carry for a given inflation pressure
Maximum load rating	The load rating for a tire at the maximum permissible inflation pressure for that tire
Maximum permissible inflation pressure	The maximum cold inflation pressure to which a tire may be inflated
Measuring rim	The rim on which a tire is fitted for physical dimension requirements
Open splice	Any parting at any junction of tread, sidewall, or innerliner that extends to cord material
Outer diameter	The overall diameter of an inflated new tire



Tire related term	Meaning
Overall width	The linear distance between the exteriors of the sidewalls of an inflated tire, including elevations due to labeling, decorations, or protective bands or ribs
Passenger car tire	A tire intended for use on passenger cars, multipurpose passenger vehicles, and trucks, that have a gross vehicle weight rating (GVWR) of 10,000 lb. or less.
Ply	A layer of rubber-coated parallel cords
Ply separation	A parting of rubber compound between adjacent plies
Pneumatic tire	A mechanical device made of rubber, chemicals, fabric and steel or other materials, that, when mounted on an automotive wheel, provides the traction and contains the gas or fluid that sustains the load
Radial ply tire	A pneumatic tire in which the ply cords that extend to the beads are laid at substantially 90 degrees to the centerline of the tread
Reinforced tire	A tire designed to operate at higher loads and at higher inflation pressures than the corresponding standard tire
Section width	The linear distance between the exteriors of the sidewalls of an inflated tire, excluding elevations due to labeling, decoration, or protective bands
Sidewall	That portion of a tire between the tread and bead
Sidewall separation	The parting of the rubber compound from the cord material in the sidewall
Snow tire	A tire that attains a traction index equal to or greater than 110, compared to the ASTM E-1136 Standard Reference Test Tire, when using the snow traction test as described in ASTM F-1805-00, Standard Test Method for Single Wheel Driving Traction in a Straight Line on Snow-and Ice-Covered Surfaces, and which is marked with an Alpine Symbol () on at least one sidewall



Tire related term	Meaning
Test rim	The rim on which a tire is fitted for testing, and may be any rim listed as appropriate for use with that tire
Tread	That portion of a tire that comes into contact with the road
Tread rib	A tread section running circumferentially around a tire
Tread separation	Pulling away of the tread from the tire carcass
Treadwear indicators (TWI)	The projections within the principal grooves designed to give a visual indication of the degrees of wear of the tread
Wheel-holding fixture	The fixture used to hold the wheel and tire assembly securely during testing

*: Table 1— Occupant loading and distribution for vehicle normal load for various designated seating capacities

Designated seating capacity, Number of occupants	Vehicle normal load, Number of occupants	Occupant distribution in a normally loaded vehicle
2 through 4	2	2 in front
5 through 10	3	2 in front, 1 in second seat
11 through 15	5	2 in front, 1 in second seat, 1 in third seat, 1 in fourth seat
16 through 20	7	2 in front, 2 in second seat, 2 in third seat, 1 in fourth seat



Customizable features

Your vehicle includes a variety of electronic features that can be personalized to suit your preferences. The settings of these features can be changed by using the steering wheel switches, the multimedia system or navigation system or at your Lexus dealer.

It is also possible to customize certain vehicle features yourself using the menu switch and the “ENTER” switch.

Customizing vehicle features

■ Changing by using the menu switch and the “ENTER” switch

When customizing vehicle features, ensure that the vehicle is parked in a safe place with the shift lever in P and the parking brake set.

- 1 Press and hold the menu switch to display customization mode. (→P. 87)
- 2 Press the “ENTER” switch upwards or downwards to select the item to be customized.
Press the “ENTER” switch to confirm.
- 3 Press the “ENTER” switch upwards or downwards to select the desired setting for the item being customized.
Press the “ENTER” switch to confirm.

When customization is completed, press the menu switch to clear the customization screen.

■ Changing by using the multimedia system or navigation system

- 1 Press the “SETUP” button on the multimedia system or navigation system.
- 2 Select “Vehicle” on the “Setup” screen and select “Vehicle Customization”.
Various setting can be changed. Refer to the list of settings that can be changed for details.



Customizable features

Some function settings are changed simultaneously with other functions being customized. Contact your Lexus dealer for further details.

- ① Settings that can be changed using the menu switch and the “ENTER” switch
- ② Settings that can be changed using the multimedia system or navigation system
- ③ Settings that can be changed by your Lexus dealer

Definition of symbols: ○ = Available, - =Not available

■ **Multi-information display (→P. 86)**

Function	Default setting	Customized setting	①	②	③
Language*	English	French	○	○	○
		Spanish	○	○	○
Units*	miles (MPG US)	km (km/L)	○	-	○
		km (L/100km)	○	-	○
Eco Driving Indicator Light	On	Off	○	-	○

*: The default setting varies according to countries.



■ Door lock (→P. 98, 105, 558)

Function	Default setting	Customized setting	①	②	③
Unlocking using a mechanical key	Driver's door unlocked in one step, all doors unlocked in two steps	All doors unlocked in one step	-	-	○
Speed linked door locking function	Off	On	-	○	○
Shift position linked door locking function	On	Off	-	○	○
Shift position linked door unlocking function	On	Off	-	○	○
Driver's door linked door unlocking function	Off	On	-	○	○



■ Smart access system with push-button start and wireless remote control
(→P. 98, 105)

Function	Default setting	Customized setting	①	②	③
Operation buzzer volume	Level 7	Off	-	○	○
		Level 1 to 6			
Operation signal (buzzer)	On	Off	-	-	○
Operation signal (emergency flashers)	On	Off	-	○	○
Time elapsed before the automatic door lock function is activated if a door is not opened after being unlocked	60 seconds	Off	-	○	○
		30 seconds			
		120 seconds			
Open door warning buzzer (when locking the vehicle)	On	Off	-	-	○

■ Smart access system with push-button start (→P. 98, 105, 115)

Function	Default setting	Customized setting	①	②	③
Smart door unlocking	Driver's door	All the doors	-	○	○
Smart access system with push-button start	On	Off	-	○	○
Number of consecutive door lock operations	2 times	As many as desired	-	-	○

■ Wireless remote control (→P. 94, 98)

Function	Default setting	Customized setting	①	②	③
Wireless remote control	On	Off	-	-	○
Unlocking operation	Driver's door unlocked in one step, all doors unlocked in two steps	All doors unlocked in one step	-	○	○
Panic function	On	Off	-	-	○
Glass hatch opening operation	Push and hold (Short)	Push twice	-	-	○
		One short push			
		Push and hold (Long)			
		Off			



■ Automatic light control system (→P. 202)

Function	Default setting	Customized setting	①	②	③
Time elapsed before the headlights turn off	30 seconds	Off			
		60 seconds	-	○	○
		90 seconds			
Light sensor sensitivity	Standard	-2 to 2	-	○	○
Daytime running light system (except for Canada)	On	Off	-	○	○
Automatic High Beam*	On	Off	-	-	○
Welcome lighting illumination control	On	Off	-	-	○

*: If equipped

■ Interior lights (→P. 402)

Function	Default setting	Customized setting	①	②	③
Time elapsed before the interior lights turn off	15 seconds	Off			
		7.5 seconds	-	○	○
		30 seconds			
Operation after the engine switch is turned to OFF	On	Off	-	-	○
Operation when the doors are unlocked with the smart access system with push-button start or wireless remote control	On	Off	-	-	○
Operation when you approach the vehicle with the electronic key on your person	On	Off	-	-	○
Shift lever light	On	Off	-	-	○
Footwell lighting	On	Off	-	-	○
Lounge illumination control	On	Off	-	-	○



■ Exterior lights (→P. 402)

Function	Default setting	Customized setting	①	②	③
Time elapsed before the exterior lights turn off	15 seconds	Off			
		7.5 seconds	-	○	○
		30 seconds			
Operation when the doors are unlocked with the smart access system with push-button start or wireless remote control	On	Off	-	-	○
Operation when you approach the vehicle with the electronic key on your person	On	Off	-	-	○
Running board lights	On	Off	-	-	○
Operation when the door is opened	On	Off	-	-	○

■ Meters (→P. 83)

Function	Default setting	Customized setting	①	②	③
Sensitivity of the ambient light sensor used for dimming the meter lights etc.	Standard	-2 to 2	-	-	○
Sensitivity of the ambient light sensor used for brightening the meter lights etc.	Standard	-2 to 2	-	-	○

■ Front automatic air conditioning system (→P. 386)

Function	Default setting	Customized setting	①	②	③
Switching between outside air and recirculated air mode linked to automatic mode switch operation*	Auto	Manual	-	○	○
A/C automatic mode switch operation	Auto	Manual	-	○	○
Exhaust gas sensor sensitivity	Standard	-3 to 3	-	○	○

*: If equipped

■ Driving position memory (→P. 135)

Function	Default setting	Customized setting	①	②	③
Driver's seat movement when exiting the vehicle	Full	Off	-	○	○
		Partial			
Selecting the door linking driving position memory with door unlock operation	Driver's door	All doors	-	-	○



■ Seat belt reminder buzzer (→P. 520)

Function	Default setting	Customized setting	①	②	③
Speed-linked seat belt reminder function	On	Off	-	-	○

■ Power windows (→P. 150) and moon roof (→P. 153)

Function	Default setting	Customized setting	①	②	③
Mechanical key linked operation (close)	Off	On	-	-	○
Mechanical key linked operation (open)	Off	On	-	-	○
Wireless remote control linked operation (open)	Off	On	-	-	○
Wireless remote control linked operation signal (buzzer)	On	Off	-	-	○

■ Intuitive parking assist* (→P. 245)

Function	Default setting	Customized setting	①	②	③
Buzzer volume	Level 5	Level 1 to 5	–	○	○
Display setting	All sensors displayed	Display off	–	○	○
Detection distance of the front center sensor	Far	Near	–	○	○
Detection distance of the rear center sensor	Far	Near	–	○	○

*: If equipped

■ In the following situations, customize mode will automatically be turned off.

- A warning message appears after the customize mode screen is displayed.
- The engine switch is turned to OFF.
- The vehicle begins to move while the customize mode screen is displayed.

⚠ CAUTION

■ **During customization**
 As the engine needs to be running during customization, ensure that the vehicle is parked in a place with adequate ventilation. In a closed area such as a garage, exhaust gases including harmful carbon monoxide (CO) may collect and enter the vehicle. This may lead to death or a serious health hazard.

⚠ NOTICE

■ **During customization**
 To prevent battery discharge, ensure that the engine is running while customizing features.



Items to initialize

The following item must be initialized for normal system operation after such cases as the battery being reconnected, or maintenance being performed on the vehicle:

Item	When to initialize	Reference
Message indicating maintenance is required (U.S.A. only)	After the maintenance is performed	P.453



For owners

9

607

Reporting safety defects for U.S. owners.....	608
Seat belt instructions for Canadian owners (in French).....	609
SRS airbag instructions for Canadian owners (in French).....	611
Headlight aim instructions for Canadian owners (in French).....	619



Reporting safety defects for U.S. owners

If you believe that your vehicle has a defect which could cause a crash or could cause injury or death, you should immediately inform the National Highway Traffic Safety Administration (NHTSA) in addition to notifying the Lexus Division of Toyota Motor Sales, U.S.A., Inc. (Toll-free: 1-800-25-LEXUS).

If NHTSA receives similar complaints, it may open an investigation, and if it finds that a safety defect exists in a group of vehicles, it may order a recall and remedy campaign. However, NHTSA cannot become involved in individual problems between you, your dealer, or Lexus Division of Toyota Motor Sales, U.S.A., Inc.

To contact NHTSA, you may call the Vehicle Safety Hotline toll-free at 1-888-327-4236 (TTY: 1-800-424-9153); go to <http://www.safercar.gov>; or write to: Administrator, NHTSA, 1200 New Jersey Ave, S.E., Washington, DC 20590. You can also obtain other information about motor vehicle safety from <http://www.safercar.gov>.



Seat belt instructions for Canadian owners (in French)

The following is a French explanation of seat belt instructions extracted from the seat belt section in this manual.

See the seat belt section for more detailed seat belt instructions in English.

Utilisation adéquate des ceintures de sécurité

- Tirez sur la ceinture épaulière jusqu'à ce qu'elle recouvre entièrement l'épaule; elle ne doit cependant pas toucher le cou ni glisser de l'épaule.
- Placez la ceinture abdominale le plus bas possible sur les hanches.
- Réglez la position du dossier. Tenez-vous assis bien au fond du siège, le dos droit.
- Ne vrillez pas la ceinture de sécurité.

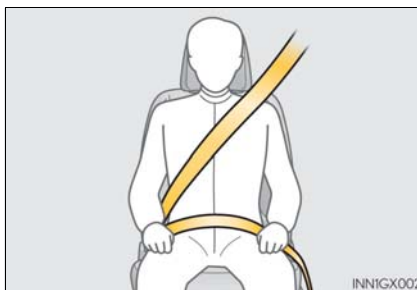

Entretien et soin

■ Ceintures de sécurité

Avec un chiffon ou une éponge, nettoyez à l'aide d'un savon doux et de l'eau tiède. Vérifiez aussi les ceintures régulièrement pour vous assurer qu'elles ne présentent pas d'usure excessive, d'effilochage ou de coupures.

ATTENTION

■ Dommages et usure de la ceinture de sécurité

Vérifiez périodiquement le système de ceintures de sécurité. Vérifiez qu'il n'y a pas de coupures, d'effilochures ni de pièces desserrées. N'utilisez pas une ceinture de sécurité endommagée avant qu'elle ne soit remplacée. Une ceinture de sécurité endommagée ne peut pas protéger les occupants contre des blessures graves, voire mortelles.

SRS airbag instructions for Canadian owners (in French)

The following is a French explanation of SRS airbag instructions extracted from the SRS airbag section in this manual.

See the SRS airbag section for more detailed SRS airbag instructions in English.

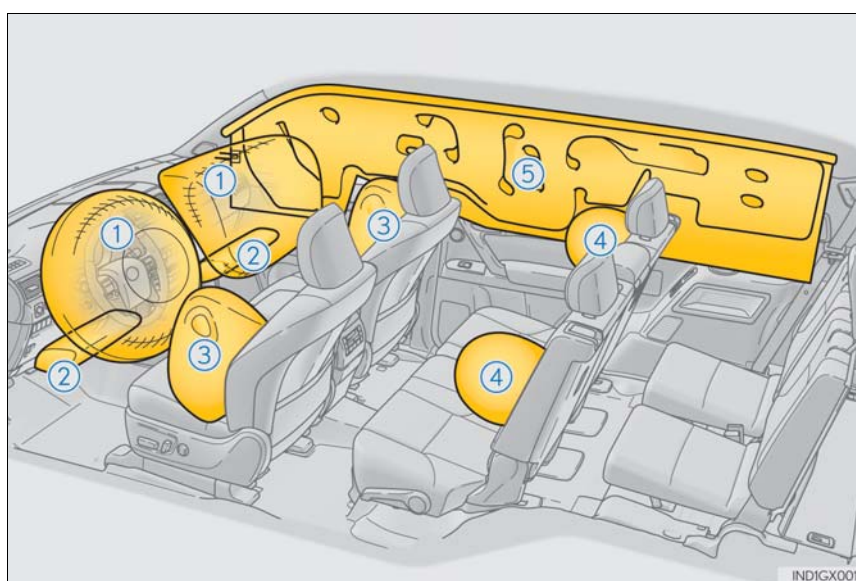

◆ Coussins gonflables SRS avant

- ① Coussin gonflable SRS du conducteur/coussin gonflable SRS du passager avant
Peuvent aider à protéger la tête et la poitrine du conducteur et du passager avant contre les impacts avec des composants intérieurs
- ② Coussins gonflables SRS de protection des genoux
Peuvent aider à protéger le conducteur et le passager avant

◆ Coussins gonflables SRS latéraux et en rideau

- ③ Coussins gonflables SRS latéraux avant
Peuvent aider à protéger le torse des occupants des sièges avant
- ④ Coussins gonflables SRS latéraux arrière
Peuvent aider à protéger le torse des occupants des sièges latéraux de la deuxième rangée de sièges (modèles à 7 passagers) ou des sièges de la deuxième rangée (modèles à 6 passagers)
- ⑤ Coussins gonflables SRS en rideau
 - Peuvent aider à protéger principalement la tête des occupants des sièges latéraux
 - Peuvent empêcher les occupants d'être éjectés du véhicule en cas de tonneaux

Composants du système de coussins gonflables

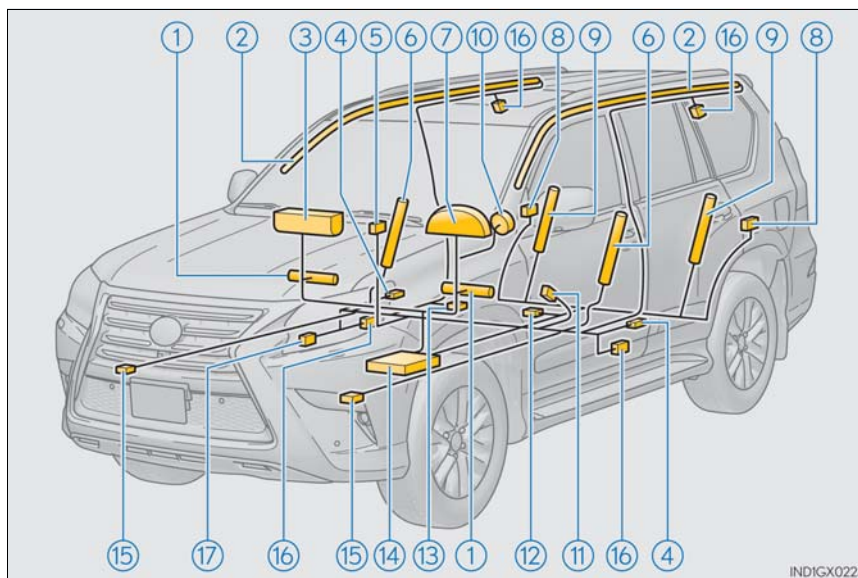

- | | |
|--|--|
| ① Coussins gonflables de protection des genoux | ⑩ Coussin gonflable du conducteur |
| ② Coussins gonflables en rideau | ⑪ Contacteur de boucle de ceinture de sécurité du conducteur |
| ③ Coussin gonflable du passager avant | ⑫ Capteur de sûreté (arrière) |
| ④ Capteurs d'impact latéral (portière avant) | ⑬ Contacteur de boucle de ceinture de sécurité du passager avant |
| ⑤ Voyants "AIR BAG ON" et "AIR BAG OFF" | ⑭ Module de capteur de coussin gonflable |
| ⑥ Coussins gonflables latéraux avant | ⑮ Capteurs d'impact avant |
| ⑦ Lampe témoin SRS | ⑯ Limiteurs de force et dispositifs de tension des ceintures de sécurité |
| ⑧ Capteurs d'impact latéral (arrière) | ⑰ Système de classification de l'occupant du siège du passager avant (ECU et capteurs) |
| ⑨ Coussins gonflables latéraux arrière (sièges latéraux de la deuxième rangée de sièges [modèles à 7 passagers] ou sièges de la deuxième rangée [modèles à 6 passagers]) | |

- ◆ Votre véhicule est doté de **COUSSINS GONFLABLES ÉVOLUÉS** dont la conception s'appuie sur les normes de sécurité des véhicules à moteur américains (FMVSS208). Le module de capteur de coussin gonflable (ECU) contrôle le déploiement des coussins gonflables en fonction des informations obtenues des capteurs et d'autres éléments affichés dans le diagramme des composants du système ci-dessus. Ces informations comprennent des données relatives à la gravité de l'accident et aux occupants. Au moment du déploiement des coussins gonflables, une réaction chimique se produit dans les gonfleurs de coussin gonflable et les coussins gonflables se remplissent rapidement d'un gaz non toxique pour aider à limiter le mouvement des occupants.

ATTENTION

■ Précautions relatives aux coussins gonflables SRS

Observez les précautions suivantes en ce qui concerne les coussins gonflables SRS. Les négliger pourrait occasionner des blessures graves, voire mortelles.

- Le conducteur et tous les passagers du véhicule doivent porter leur ceinture de sécurité de la manière appropriée. Les coussins gonflables SRS sont des dispositifs supplémentaires qui doivent être utilisés avec les ceintures de sécurité.

- Le coussin gonflable SRS du conducteur se déploie avec une force considérable et peut occasionner des blessures graves, voire mortelles, notamment lorsque le conducteur se trouve très près du coussin gonflable. La National Highway Traffic Safety Administration (NHTSA), aux États-Unis, fait les recommandations suivantes :

La zone à risque du coussin gonflable du conducteur couvre 2 à 3 in. (50 à 75 mm) de la zone de déploiement du coussin gonflable. Pour assurer une marge de sécurité suffisante, restez à 10 in. (250 mm) du coussin gonflable. Cette distance est mesurée depuis le centre du volant jusqu'à votre sternum. Si maintenant vous vous tenez assis à moins de 10 in. (250 mm), vous pouvez changer votre position de conduite de plusieurs manières :

- Reculez votre siège à la position maximale vous permettant d'atteindre encore aisément les pédales.
- Inclinez légèrement le dossier du siège. Même si les véhicules sont conçus différemment, la plupart des conducteurs peuvent maintenir une distance de 10 in. (250 mm), même si leur siège se trouve complètement vers l'avant, simplement en inclinant un peu le dossier du siège vers l'arrière. Si la visibilité avant est moindre après avoir incliné le dossier de votre siège, utilisez un coussin ferme et non glissant pour être assis plus haut ou relevez le siège si cette option est disponible sur votre véhicule.
- Si votre volant est réglable en hauteur, inclinez-le vers le bas. Cela vous permet d'orienter le coussin gonflable vers votre buste plutôt que vers votre tête et vers votre cou.

Le siège doit être réglé de la manière recommandée ci-dessus par la NHTSA, tout en gardant le contrôle des pédales et du volant, ainsi que la vue sur les commandes du tableau de bord.

ATTENTION

■ **Précautions relatives aux coussins gonflables SRS**

- Si la rallonge de ceinture de sécurité a été reliée à la boucle des ceintures de sécurité des sièges avant sans avoir aussi été attachée à la plaque de blocage des ceintures de sécurité, les coussins gonflables SRS avant considéreront que le conducteur et le passager avant portent tout de même leur ceinture de sécurité même si les ceintures de sécurité ne sont pas attachées. Les coussins gonflables SRS avant peuvent alors ne pas s'activer correctement lors d'une collision, ce qui pourrait occasionner des blessures graves, voire mortelles, en cas de collision. Assurez-vous de toujours porter la ceinture de sécurité avec la rallonge de ceinture de sécurité.



- Le coussin gonflable SRS du passager avant se déploie également avec une force considérable et peut occasionner des blessures graves, voire mortelles, notamment lorsque le passager avant se trouve très près du coussin gonflable. Le siège du passager avant doit se trouver le plus loin possible du coussin gonflable et le dossier doit être réglé de manière à ce que le passager avant soit assis bien droit.
- Le déploiement d'un coussin gonflable risque d'infliger des blessures graves, voire mortelles, aux bébés et aux enfants mal assis et/ou mal attachés. Un bébé ou un enfant trop petit pour utiliser une ceinture de sécurité doit être correctement retenu à l'aide d'un dispositif de retenue pour enfants. Lexus recommande vivement de placer et d'attacher correctement tous les bébés et tous les enfants sur les sièges arrière du véhicule à l'aide de dispositifs de retenue adaptés. Les sièges arrière sont plus sécuritaires pour les bébés et les enfants que le siège du passager avant.
- N'installez jamais un dispositif de retenue pour enfants de type dos à la route sur le siège du passager avant, même si le voyant "AIR BAG OFF" est allumé. En cas d'accident, la force et la vitesse de déploiement du coussin gonflable du passager avant pourraient infliger à l'enfant des blessures graves, voire mortelles, si le dispositif de retenue pour enfants de type dos à la route était installé sur le siège du passager avant.

ATTENTION

■ **Précautions relatives aux coussins gonflables SRS**

- Ne vous asseyez pas sur le bord du siège et ne vous appuyez pas sur la planche de bord.



- Ne laissez pas un enfant se tenir face au coussin gonflable SRS du passager avant ni s'asseoir sur les genoux d'un passager avant.

- Ne laissez pas les occupants des sièges avant tenir des objets sur leurs genoux.



- Ne vous appuyez pas sur la portière ou sur le brancard de pavillon, ni sur les montants avant, latéraux ou arrière.



- Ne laissez personne s'agenouiller face à la portière sur les sièges des passagers ni sortir la tête ou les mains à l'extérieur du véhicule.



- Ne fixez et n'appuyez rien sur des zones telles que la planche de bord, le tampon de volant ou encore la partie inférieure du tableau de bord. Ces objets peuvent se transformer en projectiles lorsque les coussins gonflables SRS du conducteur, du passager avant ou de protection des genoux se déploient.

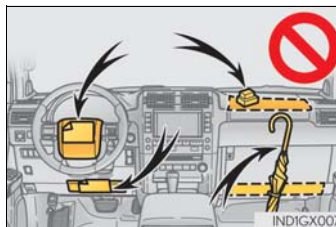

⚠ ATTENTION

■ Précautions relatives aux coussins gonflables SRS

- Ne fixez rien sur des zones telles que les portières, le pare-brise, les glaces de portières, les montants avant, latéraux ou arrière, le brancard de pavillon et la poignée de maintien.



- N'accrochez pas de cintres ni d'autres objets rigides sur les crochets porte-vêtements. Tous ces objets pourraient se transformer en projectiles et vous occasionner des blessures graves, voire mortelles, en cas de déploiement des coussins gonflables SRS en rideau.
- Si le recouvrement de vinyle est placé sur la zone de déploiement du coussin gonflable SRS de protection des genoux, veillez à le retirer.
- N'utilisez pas d'accessoires recouvrant les parties du siège où les coussins gonflables SRS latéraux se déploient, car ces accessoires pourraient entraver le déploiement des coussins gonflables. De tels accessoires peuvent empêcher les coussins gonflables latéraux de se déployer correctement, rendre le système inopérant ou provoquer accidentellement le déploiement des coussins gonflables latéraux, occasionnant des blessures graves, voire mortelles.
- Ne frappez pas et n'appliquez pas une pression importante à l'emplacement des composants des coussins gonflables SRS. Cela peut provoquer un mauvais fonctionnement des coussins gonflables SRS.
- Ne touchez à aucun composant des coussins gonflables SRS immédiatement après leur déploiement (gonflage), car ils pourraient être chauds.
- Si vous avez de la difficulté à respirer après le déploiement des coussins gonflables SRS, ouvrez une portière ou une glace pour laisser entrer l'air, ou quittez le véhicule si vous pouvez le faire en toute sécurité. Dès que possible, nettoyez tous les résidus afin d'éviter les irritations cutanées.
- Si les emplacements de stockage des coussins gonflables SRS, tels que le tampon de volant et les garnitures des montants avant, latéraux et arrière, sont endommagés ou fissurés, faites-les remplacer par votre concessionnaire Lexus.
- Ne placez aucun objet, par exemple un coussin, sur le siège du passager avant. Cela disperserait le poids du passager, ce qui empêcherait le capteur de le détecter correctement. Cela pourrait empêcher le déploiement des coussins gonflables SRS du passager avant en cas de collision.

 **ATTENTION****■ Modification et mise au rebut des composants du système de coussins gonflables SRS**

Ne mettez pas votre véhicule au rebut et n'effectuez aucune des modifications suivantes sans d'abord consulter votre concessionnaire Lexus. Les coussins gonflables SRS pourraient fonctionner de manière incorrecte ou se déployer (gonfler) accidentellement, ce qui serait susceptible d'occasionner des blessures graves, voire mortelles.

- Installation, retrait, démontage et réparation des coussins gonflables SRS
- Réparations, modifications, retrait ou remplacement du volant, du tableau de bord, de la planche de bord, des sièges, du capitonnage des sièges, des montants avant, latéraux et arrière ou des brancards de pavillon
- Réparations ou modifications de l'aile avant, du pare-chocs avant ou du côté de l'habitacle
- Installation d'une protection de calandre (barre safari, barre kangourou, etc.), de lames de déneigement, de treuils ou d'un porte-bagages de toit
- Modifications du système de suspension du véhicule
- Installation d'appareils électroniques tels qu'un émetteur-récepteur radio ou un lecteur de CD
- Modifications à votre véhicule pour une personne aux capacités physiques réduites

Headlight aim instructions for Canadian owners (in French)

The following is a French explanation of headlight aim instructions from the headlight aim section in this manual.

Boulons de réglage vertical

- ① Boulon de réglage A
- ② Boulon de réglage B

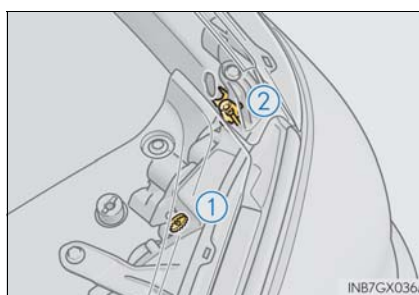

Avant de vérifier la portée des phares

- ① Assurez-vous que le réservoir de carburant du véhicule est plein et que la partie de carrosserie située autour des phares n'est pas déformée.
- ② Garez le véhicule sur un sol parfaitement horizontal.
- ③ Asseyez-vous sur le siège du conducteur.
- ④ Faites rebondir le véhicule à plusieurs reprises.

Réglage de la portée des phares

- 1** Tournez le boulon A vers la droite ou vers la gauche à l'aide d'un tournevis cruciforme.

Retenez le sens de rotation et le nombre de tours.

► Côté gauche

► Côté droit

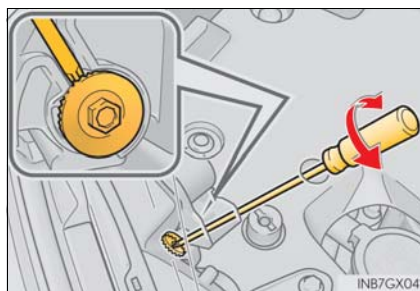
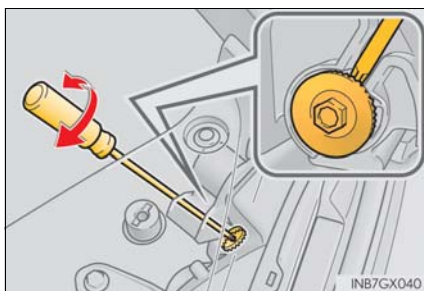

- 2** Tournez le boulon B du même nombre de tours et dans le même sens qu'à l'étape **1**.

Si vous n'arrivez pas à régler vos phares en suivant cette procédure, apportez le véhicule chez votre concessionnaire Lexus afin qu'il règle la portée des phares.

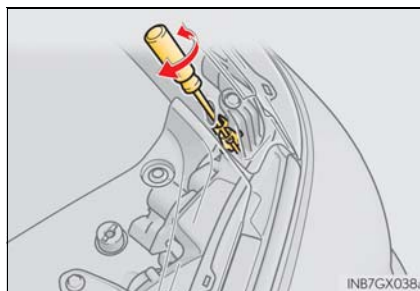

Index

What to do if... (Troubleshooting).....	622
Alphabetical index.....	626

For vehicles with a navigation system or a multimedia system, refer to the “NAVIGATION SYSTEM OWNER’S MANUAL” or “MULTIMEDIA OWNER’S MANUAL” for information regarding the equipment listed below.

- Navigation system
- Audio/video system
- Rear seat entertainment system
- Hands-free system (for cellular phone)
- Lexus Enform



What to do if... (Troubleshooting)

If you have a problem, check the following before contacting your Lexus dealer.

The doors cannot be locked, unlocked, opened or closed



You lose your keys

- If you lose your mechanical keys, new genuine mechanical keys can be made by your Lexus dealer. (→P. 95)
- If you lose your electronic keys, the risk of vehicle theft increases significantly. Contact your Lexus dealer immediately. (→P. 97)



The doors cannot be locked or unlocked

- Is the electronic key battery weak or depleted? (→P. 491)
- Is the engine switch in IGNITION ON mode?
When locking the doors, turn the engine switch off. (→P. 190)
- Is the electronic key left inside the vehicle?
When locking the doors, make sure that you have the electronic key on your person.
- The function may not operate properly due to the condition of the radio wave. (→P. 117)



The rear door cannot be opened

- Is the child-protector lock set?
The rear door cannot be opened from inside the vehicle when the lock is set. Open the rear door from outside and then unlock the child-protector lock. (→P. 101)

If you think something is wrong**The engine does not start**

- Did you press the engine switch while firmly depressing the brake pedal? (→P. 189)
- Is the shift lever in P? (→P. 189)
- Is the electronic key anywhere detectable inside the vehicle? (→P. 116)
- Is the steering wheel unlocked? (→P. 192)
- Is the electronic key battery weak or depleted?
In this case, the engine can be started in a temporary way. (→P. 559)
- Is the battery discharged? (→P. 561)

**The shift lever cannot be shifted from P even if you depress the brake pedal**

- Is the engine switch in IGNITION ON mode?
If you cannot release the shift lever by depressing the brake pedal with the engine switch in IGNITION ON mode (→P. 198)



The steering wheel cannot be turned after the engine is stopped

- It is locked automatically to prevent theft of the vehicle. (→P. 191)



The windows do not open or close by operating the power window switches

- Is the window lock switch pressed?
The power window except for the one at the driver's seat cannot be operated if the window lock switch is pressed. (→P. 150)



The engine switch is turned off automatically

- The auto power off function will be operated if the vehicle is left in ACCESSORY or IGNITION ON mode (the engine is not running) for a period of time. (→P. 191)



A warning buzzer sounds during driving

- The seat belt reminder light is flashing
Are the driver and the front passenger wearing the seat belts?
(→P. 522)
 - The parking brake indicator is on
Is the parking brake released? (→P. 201)
- Depending on the situation, other types of warning buzzer may also sound.
(→P. 520, 528)



An alarm is activated and the horn sounds

- Did anyone inside the vehicle open a door during setting the alarm?
The sensor detects it and the alarm sounds. (→P. 74)
- To stop the alarm, turn the engine switch to IGNITION ON mode or start the engine.

**A warning buzzer sounds when leaving the vehicle**

- Is the electronic key left inside the vehicle or the moon roof opened?
Check the message on the multi-information display. (→P. 528)

**A warning light turns on or a warning message is displayed**

- When a warning light turns on or a warning message is displayed, refer to P. 520, 528.

When a problem has occurred**If you have a flat tire**

- Stop the vehicle in a safe place and replace the flat tire with the spare tire.
(→P. 542)

**The vehicle becomes stuck**

- Try the procedure for when the vehicle becomes stuck in mud, dirt, or snow.
(→P. 567)

Alphabetical index

A

A/C.....	386, 396
Air conditioning filter.....	489
ABS (Anti-lock Brake System).....	351
Function.....	351
Warning light.....	520
Active Traction Control.....	352
Air conditioning filter.....	489
Air conditioning system.....	386, 396
Air conditioning filter.....	489
Micro dust and pollen filter.....	391
Airbags.....	36
Airbag operating conditions.....	44
Airbag precautions	
for your child.....	39
Airbag warning light.....	520
Correct driving posture.....	28
Curtain shield airbag	
operating conditions.....	44
Curtain shield airbag	
precautions.....	39
General airbag precautions.....	39
Locations of airbags.....	36
Modification and	
disposal of airbags.....	43
Side airbag operating	
conditions.....	44
Side airbag precautions.....	39
Side and curtain shield airbags	
operating conditions.....	44
Side and curtain shield airbags	
precautions.....	39
SRS airbags.....	36
SRS warning light.....	520
Alarm	
Alarm.....	74
Warning buzzer.....	520

Anchor brackets.....	59
Antennas (smart access system	
with push-button start).....	115
Anti-lock brake system	
(ABS).....	351
Function.....	351
Warning light.....	520
Armrest.....	427
Assist grip.....	428
Audio input*	
Audio system*	
Automatic headlight	
leveling system.....	205
Automatic High Beam.....	206
Automatic light control system.....	202
Automatic transmission.....	194
If the shift lever cannot be	
shifted from P.....	198
S mode.....	196
AUX port*	
Auxiliary boxes.....	410
AVS.....	341

B

Back door.....	105
Back-up lights	
Replacing light bulbs.....	505
Wattage.....	579
Battery.....	472
Battery checking.....	472
If the vehicle battery is	
discharged.....	561
Preparing and checking	
before winter.....	377
Warning light.....	520
Bluetooth®*	



Bottle holders.....409

Brake

 Fluid.....577

 Parking brake.....201

 Warning light520

Brake assist351

Break-in tips.....159

Brightness control

 Instrument panel light
 control.....84

BSM (Blind Spot Monitor).....357

 The Blind Spot Monitor
 function.....362

 The Rear Cross Traffic Alert
 function.....365

C

Care.....446, 449

 Aluminum wheels446

 Exterior.....446

 Interior449

 Seat belts.....450

Cargo hooks412

Center differential.....342

CD player *

Chains377

Child restraint system.....55

 Booster seats, definition56

 Booster seats, installation.....66

 Convertible seats, definition.....56

 Convertible seats,
 installation.....63

 Installing child restraint system
 with LATCH system.....61

 Installing child restraint system
 with seat belts.....63

 Installing child restraint system
 with top tether strap.....67

 Infant seats, definition.....56

 Infant seats, installation.....63

Child safety.....54

 Airbag precautions.....39

 Back door precautions.....107

 Battery precautions473, 563

 Child restraint system.....55

 Glass hatch precaution.....112

 How your child should wear
 the seat belt.....32

 Installing child restraints59

 Moon roof precautions156

 Power window lock switch.....150

 Power window precautions.....152

 Rear door child-protectors.....101

 Removed key battery
 precautions492

 Seat belt precautions.....33

 Seat heater precautions399

Child-protectors101

Cleaning

 Aluminum wheels.....446

 Exterior446

 Interior449

 Seat belts.....450

Coat hooks428

Compass429

*: For vehicles with a navigation system or a multimedia system, refer to the "NAVIGATION SYSTEM OWNER'S MANUAL" or "MULTIMEDIA OWNER'S MANUAL".



Condenser 469
 Console box 406
 Cool box 419
 Cooling system 467
 Engine overheating..... 564
 Conversation mirror 422
 Crawl Control 346
 Cruise control
 Cruise control..... 225
 Dynamic radar cruise control..... 228
 Cup holders 408
 Curtain shield airbags 36
 Current fuel consumption 87
 Customizable features..... 594

D

DAC (Downhill Assist Control system)..... 349
 Daytime running light system 204
 Defogger
 Front windshield 390
 Outside rear view mirrors..... 391
 Rear window 391
 Differential..... 575
 Dimension 570
 Display
 Multi-information display 86
 Trip information 87
 Warning message..... 528
 Do-it-yourself maintenance..... 459
 Doors..... 98
 Back door 105
 Door glasses 150
 Door lock..... 98
 Open door warning light..... 522
 Outside rear view mirrors..... 147
 Rear door child-protector..... 101

Driver's seat position memory..... 135
 Driving 158
 AVS switch 341
 Break-in tips 159
 Correct posture 28
 Procedures 158
 Winter drive tips 377
 Dynamic radar cruise control..... 228

E

Eco Driving Indicator 90
 EDR (Event data recorder)..... 10
 Electronic key..... 94
 Battery-saving function 117
 If the electronic key does not
 operate properly 558
 Replacing the battery 491
 Emergency, in case of
 If the electronic key does not
 operate properly 558
 If the engine will not start 556
 If the vehicle has
 discharged battery 561
 If the warning buzzer
 sounds 520
 If the warning light turns on 520
 If you have a flat tire..... 542
 If you lose your keys..... 622
 If you think something is
 wrong..... 518
 If your vehicle becomes
 stuck..... 567
 If your vehicle needs to be
 towed 512
 If your vehicle overheats..... 564



Emergency flashers.....	510
Engine	
Accessory mode.....	190
Compartment.....	463
Hood.....	462
How to start the engine.....	189
Identification number.....	572
If the engine will not start.....	556
Ignition switch (engine switch).....	189
Overheating.....	564
Engine compartment cover.....	464
Engine coolant.....	467
Capacity.....	574
Checking.....	467
Preparing and checking	
before winter.....	377
Engine immobilizer system.....	72
Engine oil.....	465
Capacity.....	572
Checking.....	465
Preparing and checking	
before winter.....	377
Engine switch.....	189
Engine switch light.....	402
Event data recorder (EDR).....	10

F

Flat tire.....	542
Floor mats.....	26
Fluid	
Automatic transmission.....	576
Brake.....	577
Steering.....	578
Washer.....	475
Fog lights.....	211
Switch.....	211
Four-wheel drive system.....	342
Front passenger occupant	
classification system.....	48
Front passenger's seat belt	
reminder light.....	522
Front seats.....	122
Adjustment.....	122
Cleaning.....	449
Correct driving posture.....	28
Driving position memory.....	135
Head restraints.....	140
Seat heaters.....	400
Seat position memory.....	135
Front turn signal lights.....	200
Replacing light bulbs.....	502
Turn signal lever.....	200
Wattage.....	579

Fuel.....	572
Capacity	572
Fuel gauge.....	83
Fuel pump shut off system.....	519
Information.....	580
Refueling.....	221
Type	221, 572
Warning light	522
Fuel consumption information	92
Fuel filler door.....	221
Refueling.....	221
Fuel gauge.....	83
Fuel pump shut off system.....	519
Fuses.....	493

G

Garage door opener.....	433
Gauges.....	83
Glass hatch	110
Glove box.....	406

H

Hands-free system (for cellular phone)*	
Head restraints.....	140
Headlights	202
Light switch.....	202
Replacing light bulbs.....	500
Wattage.....	579
Headlights cleaner.....	220
Heaters	
Automatic air conditioning system	386, 396
Seat heaters	400
Outside rear view mirrors.....	391

Height control	337
Hill-start assist control	352
Hood	462
Hooks	
Cargo hooks	412, 413
Coat hooks.....	428
Retaining hooks (floor mat).....	26
Horn.....	143

I

I/M test	458
Identification	
Engine	572
Vehicle.....	571
Ignition switch (engine switch)	189
Ignition switch light.....	402
Illuminated entry system	404
Immobilizer system	72
Indicators.....	78
Initialization	
Moon roof.....	154
Power windows.....	151
Inside rear view mirror.....	145
Instrument panel light control.....	84
Interior lights	402
Switch	403
Wattage	579

J

Jack	
Vehicle-equipped jack	543
Jack handle	546
Jam protection function	
Moon roof.....	154
Power windows.....	151



K

Keyless entry
 Smart access system with
 push-button start 98, 105
 Wireless remote control 98
Keys 94
 Battery-saving function 117
 Electronic key 94
 If the electronic key does not
 operate properly 558
 If you lose your keys 622
 Key number plate 94
 Keyless entry 98, 105
 Mechanical key 95
 Replacing the battery 491
 Wireless remote control 94
KDSS 352
 Warning light 521

L

Lane Departure Alert (LDA) 239
Lever
 Auxiliary catch lever 462
 Hood lock release lever 462
 Shift lever 194
 Turn signal lever 200
 Wiper lever 213
Lexus Enform Safety Connect 439
License plate lights 202
 Light switch 202

Light

 Engine switch light 402
 Fog light switch 211
 Headlight switch 202
 Illuminated entry system 404
 Interior light 403
 Interior light list 402
 Personal light 403
 Replacing light bulbs 498
 Turn signal lever 200
 Vanity lights 421
 Wattage 579
 Welcome lighting 205
Light bulbs
 Replacing 498
 Wattage 579
Lock steering column 191
Luggage cover 414

M

Maintenance
 Do-it-yourself maintenance 459
 Maintenance data 570
 Maintenance requirements 452
 Resetting the message
 indicating maintenance is
 required 453
Malfunction indicator lamp 520
Master warning light 528

*: For vehicles with a navigation system or a multimedia system, refer to the
 “NAVIGATION SYSTEM OWNER’S MANUAL” or
 “MULTIMEDIA OWNER’S MANUAL”.



Meter.....83
 Indicators.....78
 Instrument panel light control.....84
 Meters.....83
 Multi-information display86
 Warning lights78
Micro dust and pollen filter391
Mirrors
 Inside rear view mirror 145
 Outside rear view mirror
 defoggers..... 391
 Outside rear view mirrors.....147
 Vanity mirrors.....421
Moon roof..... 153
 Jam protection function..... 154
 Operation..... 153
MP3 disc *
Multi-information display 86
 Switching the display.....87
 Trip information87
Multi-terrain Monitor313
Multi-terrain Select.....308

N

Navigation system*

O

Odometer..... 83
Off-road precautions380
Oil
 Engine oil.....572
 Front differential oil.....575
 Rear differential oil575
 Transfer.....576
Opener
 Back door.....106
 Fuel filler door.....223
 Hood.....462
Outside rear view mirrors..... 147
 Adjusting and folding147
 Blind Spot Monitor357
 Outside rear view mirror
 defoggers.....391
Outside temperature display 90
Overheating, Engine 564

P

Parking assist sensors
 (intuitive parking assist).....245
 Parking assist monitor264
 Parking brake201
 Operation.....201
 Parking brake engaged
 warning buzzer530
Personal lights 402
 Switch403
 Wattage579



Power outlet 423
 Power windows 150
 Jam protection function 151
 Operation 150
 Window lock switch 150
 Pre-Collision System (PCS) 368
 Function 368
 PCS OFF switch 369
 Warning light 521

R

Radiator 469
 Radio*
 Rear seat 124
 Adjustment 124
 Rear turn signal lights 200
 Replacing light bulbs 503
 Turn signal lever 200
 Wattage 579
 Rear view mirror
 Inside rear view mirror 145
 Outside rear view mirrors 147
 Rear view monitor system 254
 Rear window defogger 391
 Rear window wiper 218
 Refueling 221
 Capacity 572
 Fuel types 221, 572
 Opening the fuel tank cap 223

Replacing
 Electronic key battery 491
 Fuses 493
 Light bulbs 498
 Tires 542
 Wireless remote control
 battery 491
 Reporting safety defects
 for U.S. owners 608
 Reset the maintenance data 453

S

Safety connect 439
 Seat belts 30
 Adjusting the seat belt 31
 Automatic Locking Retractor 32
 Child restraint system
 installation 59
 Cleaning and maintaining
 the seat belt 450
 Emergency Locking
 Retractor 32
 How to wear your seat belt 30
 How your child should wear
 the seat belt 32
 Pregnant women,
 proper seat belt use 33
 Reminder light and buzzer 522
 Seat belt pretensioners 31
 Seat belt extender 32
 SRS warning light 520

*: For vehicles with a navigation system or a multimedia system, refer to the “NAVIGATION SYSTEM OWNER’S MANUAL” or “MULTIMEDIA OWNER’S MANUAL”.



Seat heaters.....	400	Smart access system with	
Seat ventilators.....	401	push-button start.....	115
Seat position memory.....	135	Antenna location.....	115
Seats.....	122, 124	Starting the engine.....	189
Adjustment.....	122, 124	Snow tires.....	379
Adjustment precautions.....	123, 134	Spare tire.....	542
Child seats/child restraint		Inflation pressure.....	578
system installation.....	59	Storage location.....	543
Cleaning.....	449	Spark plug.....	574
Driving position memory.....	135	Specifications.....	570
Head restraint.....	140	Speedometer.....	83
Properly sitting in the seat.....	28	Steering lock	
Seat position memory.....	135	Column lock release.....	192
Ventilators.....	401	Steering wheel.....	143
Sensor		Adjustment.....	143
Automatic headlight system.....	204	Audio switches*	
Inside rear view mirror.....	146	Heated steering wheel.....	399
Intuitive parking		Steering wheel position	
assist-sensor.....	245	memory.....	135
Rain-sensing windshield		Stop/tail lights	
wipers.....	216	Replacing light bulbs.....	506
Service reminder indicators.....	78	Storage feature.....	405
Shift lever		Stuck	
Automatic transmission.....	194	If the vehicle becomes stuck.....	567
If the shift lever cannot be		Sun shade	
shifted from P.....	198	Roof.....	154
Shift lock system.....	197	Sun visors.....	421
Shopping bag hooks.....	413	Switch	
Side airbags.....	36	"2nd START" button.....	195
Side mirrors.....	147	AVS switch.....	341
Adjusting and folding.....	147	BSM (Blind Spot Monitor)	
Blind Spot Monitor.....	357	switch.....	357
Side turn signal lights.....	200	Center differential lock/	
Replacing light bulbs.....	506	unlock switch.....	343
Turn signal lever.....	200	Crawl Control switch.....	346



Cruise control switch.....225, 228
 "DAC" switch.....349
 Door lock switches105
 Driving position memory
 switches.....135
 Emergency flashers switch510
 Engine switch.....189
 Fog light switch211
 Four-wheel drive control
 switch.....342
 Headlight cleaner switch220
 Height control button337
 LDA switch239
 Light switches202
 Moon roof switches.....153
 Multi-terrain Monitor switch313
 Multi-terrain Select switch.....308
 "ODO TRIP" button.....84
 Outside rear view mirror
 switches.....147
 Parking assist.....245
 PCS off switch.....369
 Power door lock switch105
 Power window switch150
 Rear window wiper and
 washer switch.....218
 Rear window and outside
 rear view mirror
 defoggers switch.....391
 Seat heater switches.....400
 Talk switch*
 Tilt and telescopic steering
 control switch.....143

Vehicle-to-vehicle distance
 button.....230
 VSC OFF switch.....353
 Window lock switch150
 Windshield wipers and
 washer switch213

T

Tachometer83
 Tail lights202
 Light switch.....202
 Talk switch*
 Telephone switch*
 Theft deterrent system
 Alarm74
 Engine immobilizer system72
 Tire inflation pressure.....483
 Maintenance data.....578
 Tires476
 Chains377
 Checking.....476
 If you have a flat tire.....542
 Inflation pressure.....483
 Information.....583
 Replacing.....542
 Rotating tires.....476
 Size578
 Snow tires.....379
 Spare tire.....542
 Tire pressure warning
 system.....477

*: For vehicles with a navigation system or a multimedia system, refer to the "NAVIGATION SYSTEM OWNER'S MANUAL" or "MULTIMEDIA OWNER'S MANUAL".



Tools.....543

Towing

- Dinghy towing.....188
- Emergency towing..... 514
- Towing hooks.....515
- Trailer Sway Control.....352
- Trailer towing.....170

Trailer Sway Control.....352

TRAC (Traction Control)..... 351

Transmission

- Automatic transmission.....194
- AVS switch..... 341
- If the shift lever cannot be shifted from P.....198

Trip information..... 87

Trip meters..... 83

Turn signal lights.....200

- Replacing light bulbs.....502, 503
- Turn signal lever.....200
- Wattage.....579

U

USB port*

V

Vanity lights

- Vanity lights.....421
- Wattage.....579

Vanity mirrors.....421

Vehicle identification number.....571

VSC (Vehicle Stability Control)..... 351

W

Warning buzzers..... 520

- Brake system.....520
- Downshifting..... 198
- Open back door.....530
- Open door.....530
- Seat belt remainder.....523

Warning lights..... 520

- ABS.....520
- Automatic headlight leveling system.....521
- Brake system.....520
- Charging system.....520
- KDSS.....521
- LED headlight.....521
- Low fuel level.....522
- Malfunction indicator lamp.....520
- Master warning light.....522
- Open door.....522
- Parking brake indicator.....520
- PCS.....521
- Seat belt reminder light.....522
- Slip indicator.....521
- SRS.....520
- Tire pressure warning light.....522

Warning message.....528

Warning reflector holder.....412

Washer.....213

- Checking.....475
- Preparing and checking before winter.....377
- Switch.....213

Washing and waxing.....446

Wide view front & side monitor.....290



Weight	
Cargo capacity	169
Load limits.....	169
Weight.....	570
Wheels.....	487
Replacing wheels.....	487
Size.....	578
Window glasses	150
Window lock switch	150
Windows.....	150
Power windows	150
Rear window defogger.....	391
Windshield wipers.....	213
Intermittent windshield wipers with interval adjuster	213
Rain-sensing windshield wipers.....	214
Windshield wiper de-icer	391
Winter driving tips.....	377
Wireless remote control	94
Locking/Unlocking.....	98
Replacing the battery	491
WMA disc*	

X

XM® Satellite Radio*	
----------------------	--

*: For vehicles with a navigation system or a multimedia system, refer to the "NAVIGATION SYSTEM OWNER'S MANUAL" or "MULTIMEDIA OWNER'S MANUAL".





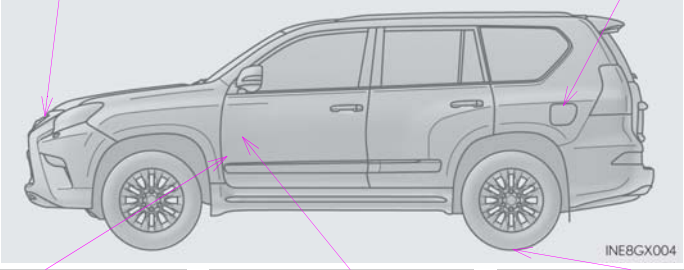

GAS STATION INFORMATION		
Auxiliary catch lever P. 462	Fuel filler door P. 223	
 <p style="text-align: right; font-size: small;">INEBGX004</p>		
Hood lock release lever P. 462	Fuel filler door opener P. 223	Tire inflation pressure P. 578
Fuel tank capacity (Reference)	23.0 gal. (87 L, 19.1 Imp.gal.)	
Fuel type	Unleaded gasoline with a Octane Rating of 91 or higher (Research Octane Number 96) P. 572, 580	
Cold tire inflation pressure	P. 578	
Engine oil capacity (Drain and refill – reference)	With filter 8.2 qt.(7.8 L, 6.9 Imp.qt.) Without filter 7.8 qt.(7.4 L, 6.5 Imp.qt.)	
Engine oil type	"Toyota Genuine Motor Oil" or equivalent P. 572	

