

|    |                                    |   |  |
|----|------------------------------------|---|--|
|    | <b>Pictorial index</b>             | Search by illustration  |  |
| 1  | <b>For safety and security</b>     | Make sure to read through them  |  |
| 2  | <b>Instrument cluster</b>          | How to read the gauges and meters, the variety of warning lights and indicators, etc.                   |  |
| 3  | <b>Operation of each component</b> | Opening and closing the doors and windows, adjustment before driving, etc.                              |  |
| 4  | <b>Driving</b>                     | Operations and advice which are necessary for driving   |  |
| 5  | <b>Lexus Display Audio system</b>  | Operating the Lexus Display Audio system  |  |
| 6  | <b>Interior features</b>           | Usage of the interior features, etc.  |  |
| 7  | <b>Maintenance and care</b>        | Caring for your vehicle and maintenance procedures  |  |
| 8  | <b>When trouble arises</b>         | What to do in case of malfunction or emergency  |  |
| 9  | <b>Vehicle specifications</b>      | Vehicle specifications, customizable features, etc.   |  |
| 10 | <b>For owners</b>                  | Reporting safety defects for U.S. owners, and seat belt and SRS airbag instructions for Canadian owners |  |
|    | <b>Index</b>                       | Search by symptom   |  |
|    |                                    | Search alphabetically   |  |

## 2 TABLE OF CONTENTS

---

|                           |    |
|---------------------------|----|
| For your information..... | 8  |
| Reading this manual.....  | 12 |
| How to search.....        | 13 |
| Pictorial index.....      | 14 |

### 1 For safety and security

|  |    |
|--|----|
| <b>1-1. For safe use</b>                               |    |
| Before driving.....                                    | 30 |
| For safety drive.....                                  | 32 |
| Seat belts.....  | 34 |
| SRS airbags.....                                       | 40 |
| Front passenger occupant<br>classification system..... | 50 |
| Safety information for<br>children.....                | 56 |
| Child restraint systems.....                           | 57 |
| Exhaust gas precautions.....                           | 75 |
| <b>1-2. Theft deterrent system</b>                     |    |
| Engine immobilizer system.....                         | 76 |
| Alarm.....   | 79 |
| Theft prevention labels.....                           | 81 |

### 2 Instrument cluster

|  |     |
|--|-----|
| <b>2. Instrument cluster</b>                               |     |
| Warning lights and<br>indicators.....                      | 84  |
| Gauges and meters<br>(RC350/RC300/<br>RC200t).....         | 92  |
| Gauges and meters<br>(RC F).....                           | 98  |
| Multi-information display<br>(RC350/RC300/<br>RC200t)..... | 105 |
| Multi-information display<br>(RC F).....                   | 113 |
| Fuel consumption<br>information.....                       | 126 |

### 3 Operation of each component

- 3-1. **Key information**
  - Keys .....132
- 3-2. **Opening, closing and locking the doors and trunk**
  - Doors ..... 137
  - Trunk.....143
  - Smart access system with push-button start..... 148
- 3-3. **Adjusting the seats**
  - Front seats.....155
  - Rear seats..... 158
  - Driving position memory..... 160
  - Head restraints .....164
- 3-4. **Adjusting the steering wheel and mirrors**
  - Steering wheel ..... 167
  - Inside rear view mirror.....169
  - Outside rear view mirrors..... 171
- 3-5. **Opening, closing the windows and moon roof**
  - Power windows.....174
  - Moon roof.....178

### 4 Driving

- 4-1. **Before driving**
  - Driving the vehicle ..... 184
  - Cargo and luggage .....193
  - Vehicle load limits .....196
  - Trailer towing .....197
  - Dinghy towing ..... 198
- 4-2. **Driving procedures**
  - Engine (ignition) switch.....199
  - Automatic transmission .....205
  - Turn signal lever ..... 210
  - Parking brake ..... 211
  - ASC (Active Sound Control) (RC350/RC300/RC200t).....212
  - ASC (Active Sound Control) (RC F) .....213
- 4-3. **Operating the lights and wipers**
  - Headlight switch .....214
  - Automatic High Beam.....217
  - Fog light switch ..... 222
  - Windshield wipers and washer ..... 223
- 4-4. **Refueling**
  - Opening the fuel tank cap .....231

**4-5. Using the driving support systems**  
 Cruise control ..... 235  
 Dynamic radar cruise control ..... 239  
 LDA (Lane Departure Alert)..... 253  
 Intuitive parking assist ..... 259  
 Lexus parking assist monitor ..... 268  
 Driving mode select switch ..... 283  
 Driving assist systems ..... 287  
 PCS (Pre-Collision System) ..... 295  
 BSM (Blind Spot Monitor) ..... 302  
 • BSM function ..... 306  
 • RCTA function ..... 310  
 Active rear wing ..... 315  
 TVD (Torque Vectoring Differential) ..... 318  
**4-6. Driving tips**  
 Winter driving tips ..... 320

**5 Lexus Display Audio system**

**5-1. Basic Operations**  
 Lexus Display Audio System ..... 326  
 Steering wheel audio switches ..... 331  
 Mobile Assistant ..... 332  
 USB/AUX ports ..... 334  
**5-2. Setup**  
 Setup menu ..... 336  
 General settings ..... 337  
 Voice settings ..... 340  
 Display settings ..... 341  
**5-3. Using the audio system**  
 Selecting the audio source ..... 343  
 Optimal use of the audio system ..... 344  
 Audio settings ..... 345  
 Audio menu screen operation ..... 348  
**5-4. Using the radio**  
 Radio operation ..... 351  
**5-5. Playing an audio CD and MP3/WMA/AAC discs**  
 CD player operation ..... 357  
**5-6. Using an external device**  
 Listening to an iPod ..... 364  
 Listening USB memory device ..... 368  
 Using the AUX port ..... 372



|   |     |
|---|-----|
| <b>5-7. Connecting Bluetooth®</b>                           |     |
| Steps for using Bluetooth® devices .....                    | 373 |
| Registering a Bluetooth® device .....                       | 375 |
| Selecting a Bluetooth® device .....                         | 376 |
| Connecting a Bluetooth® audio player .....                  | 377 |
| Connecting a Bluetooth® phone .....                         | 378 |
| Displaying a Bluetooth® device details .....                | 379 |
| Detailed Bluetooth® settings .....                          | 380 |
| <b>5-8. Bluetooth® Audio</b>                                |     |
| Listening to Bluetooth® Audio .....                         | 381 |
| <b>5-9. Bluetooth® Phone</b>                                |     |
| Using a Bluetooth® Phone .....                              | 383 |
| Making a call .....   | 385 |
| Receiving a call .....                                      | 388 |
| Speaking on the phone .....                                 | 389 |
| Using a Bluetooth® phone message .....                      | 391 |
| Using the steering wheel switches .....                     | 393 |
| Bluetooth® phone settings .....                             | 394 |
| <b>5-10. Phonebook</b>                                      |     |
| Contact settings .....                                      | 396 |
| Messaging setting .....                                     | 399 |
| <b>5-11. Bluetooth®</b>                                     |     |
| What to do if... (Troubleshooting) .....                    | 400 |
| Bluetooth® .....  | 404 |
| <b>5-12. Other function</b>                                 |     |
| “Information” screen .....                                  | 409 |
| USB photo .....   | 411 |
| Weather information .....                                   | 413 |
| Voice command system .....                                  | 414 |
| <b>6 Interior features</b>                                  |     |
| <b>6-1. Using the air conditioning system</b>               |     |
| Automatic air conditioning system .....                     | 420 |
| Heated steering wheel/ seat heaters/ seat ventilators ..... | 429 |
| <b>6-2. Using the interior lights</b>                       |     |
| Interior lights list .....                                  | 432 |
| • Interior lights .....                                     | 433 |
| • Personal lights .....                                     | 434 |
| <b>6-3. Using the storage features</b>                      |     |
| List of storage features .....                              | 435 |
| • Glove box .....   | 436 |
| • Console box .....   | 436 |
| • Cup holders .....   | 437 |
| Trunk features .....  | 438 |

**6-4. Using the other interior features**

- Other interior features ..... 439
  - Sun visors ..... 439
  - Vanity mirrors ..... 439
  - Clock ..... 440
  - Power outlet ..... 440
  - Armrest ..... 441
  - Trunk storage extension ..... 442
  - Assist grips ..... 443
  - Coat hooks ..... 443
- Garage door opener ..... 444
- Compass ..... 451
- LEXUS Enform Safety Connect ..... 455
- LEXUS Enform Remote ..... 460
- LEXUS Enform Service Connect ..... 461

**7 Maintenance and care**

**7-1. Maintenance and care**

- Cleaning and protecting the vehicle exterior ..... 464
- Cleaning and protecting the vehicle interior ..... 469

**7-2. Maintenance**

- Maintenance requirements ..... 472
- General maintenance ..... 475
- Emission inspection and maintenance (I/M) programs ..... 478

**7-3. Do-it-yourself maintenance**

- Do-it-yourself service precautions ..... 479
- Hood ..... 481
- Positioning a floor jack ..... 482
- Engine compartment ..... 485
- Tires ..... 501
- Tire inflation pressure ..... 510
- Wheels ..... 513
- Air conditioning filter ..... 515
- Electronic key battery ..... 517
- Checking and replacing fuses ..... 519
- Light bulbs ..... 522

**8 When trouble arises**

**8-1. Essential information**

- Emergency flashers ..... 532
- If your vehicle has to be stopped in an emergency ..... 533

## 8-2. Steps to take in an emergency

|  |     |
|--|-----|
| If your vehicle needs to be towed .....  | 534 |
| If you think something is wrong.....   | 541 |
| Fuel pump shut off system.....   | 542 |
| If a warning light turns on or a warning buzzer sounds .....                       | 543 |
| If a warning message is displayed .....  | 549 |
| If you have a flat tire (vehicles with a spare tire).....                          | 570 |
| If you have a flat tire (vehicles with an emergency tire puncture repair kit)..... | 584 |
| If the engine will not start .....   | 597 |
| If the shift lever cannot be shifted from P .....                                  | 599 |
| If the electronic key does not operate properly .....                              | 600 |
| If the vehicle battery is discharged.....  | 604 |
| If your vehicle overheats.....   | 608 |
| If the vehicle becomes stuck.....  | 614 |

## 9 Vehicle specifications

### 9-1. Specifications

|  |     |
|--|-----|
| Maintenance data (fuel, oil level, etc.) ..... | 618 |
| Fuel information .....                         | 636 |
| Tire information.....                          | 639 |

### 9-2. Customization

|                             |     |
|-----------------------------|-----|
| Customizable features ..... | 651 |
|-----------------------------|-----|

### 9-3. Items to initialize

|                          |     |
|--------------------------|-----|
| Items to initialize..... | 662 |
|--------------------------|-----|

## 10 For owners

|  |     |
|--|-----|
| Reporting safety defects for U.S. owners .....               | 664 |
| Seat belt instructions for Canadian owners (in French).....  | 665 |
| SRS airbag instructions for Canadian owners (in French)..... | 667 |

## Index

|  |     |
|--|-----|
| What to do if... (Troubleshooting) ..... | 676 |
| Alphabetical index .....                 | 680 |

For vehicles with a navigation system, refer to the "NAVIGATION SYSTEM OWNER'S MANUAL" for information regarding the equipment listed below.

- Navigation system
- Audio/video system
- Intuitive parking assist
- Lexus parking assist monitor
- Lexus Enform

## For your information

### Main Owner's Manual

Please note that this manual applies to all models and explains all equipment, including options. Therefore, you may find some explanations for equipment not installed on your vehicle.

All specifications provided in this manual are current at the time of printing. However, because of the Lexus policy of continual product improvement, we reserve the right to make changes at any time without notice.

Depending on specifications, the vehicle shown in the illustrations may differ from your vehicle in terms of color and equipment.

### Noise from under vehicle after turning off the engine

Approximately five hours after the engine is turned off, you may hear sound coming from under the vehicle for several minutes. This is the sound of a fuel evaporation leakage check and, it does not indicate a malfunction.

### Accessories, spare parts and modification of your Lexus

A wide variety of non-genuine spare parts and accessories for Lexus vehicles are currently available in the market. You should know that Toyota does not warrant these products and is not responsible for their performance, repair, or replacement, or for any damage they may cause to, or adverse effect they may have on, your Lexus vehicle.

This vehicle should not be modified with non-genuine Lexus products. Modification with non-genuine Lexus products could affect its performance, safety or durability, and may even violate governmental regulations. In addition, damage or performance problems resulting from the modification may not be covered under warranty.

### Installation of a mobile two-way radio system

The installation of a mobile two-way radio system in your vehicle could affect electronic systems such as:

- Multiport fuel injection system/sequential multiport fuel injection system
- Dynamic radar cruise control system
- Cruise control system
- Anti-lock brake system
- Vehicle dynamics integrated management
- SRS airbag system
- Seat belt pretensioner system

Be sure to check with your Lexus dealer for precautionary measures or special instructions regarding installation of a mobile two-way radio system.

## Vehicle data recording

Your Lexus is equipped with several sophisticated computers that will record certain data, such as:

- Engine speed
- Accelerator status
- Brake status
- Vehicle speed
- Shift position

The recorded data varies according to the vehicle grade level and options with which it is equipped. Furthermore, these computers do not record conversations, sounds or pictures.

### ● Data usage

Lexus may use the data recorded in these computers to diagnose malfunctions, conduct research and development, and improve quality.

Lexus will not disclose the recorded data to a third party except:

- With the consent of the vehicle owner or with the consent of the lessee if the vehicle is leased
  - In response to an official request by the police, a court of law or a government agency
  - For use by Lexus in a law suit.
  - For research purposes where the data is not tied to a specific vehicle or vehicle owner
- ### ● Usage of data collected through Safety Connect / Lexus Enform (U.S. mainland only)
- If your Lexus has Safety Connect or Lexus Enform and if you have subscribed to those services, please refer to the Safety Connect / Lexus Enform Telematics Subscription Service Agreement for information on data collected and its usage.

## Event data recorder

This vehicle is equipped with an event data recorder (EDR). The main purpose of an EDR is to record, in certain crash or near crash-like situations, such as an air bag deployment or hitting a road obstacle, data that will assist in understanding how a vehicle's systems performed. The EDR is designed to record data related to vehicle dynamics and safety systems for a short period of time, typically 30 seconds or less.

The EDR in this vehicle is designed to record such data as:

- How various systems in your vehicle were operating;
- Whether or not the driver and passenger safety belts were buckled/fastened;
- How far (if at all) the driver was depressing the accelerator and/or brake pedal; and,
- How fast the vehicle was traveling.

These data can help provide a better understanding of the circumstances in which crashes and injuries occur.

NOTE: EDR data are recorded by your vehicle only if a non-trivial crash situation occurs; no data are recorded by the EDR under normal driving conditions and no personal data (e.g., name, gender, age, and crash location) are recorded. However, other parties, such as law enforcement, could combine the EDR data with the type of personally identifying data routinely acquired during a crash investigation.

To read data recorded by an EDR, special equipment is required, and access to the vehicle or the EDR is needed. In addition to the vehicle manufacturer, other parties, such as law enforcement, that have the special equipment, can read the information if they have access to the vehicle or the EDR.

### ● Disclosure of the EDR data

Lexus will not disclose the data recorded in an EDR to a third party except when:

- An agreement from the vehicle's owner (or the lessee for a leased vehicle) is obtained
- In response to an official request by the police, a court of law or a government agency
- For use by Lexus in a law suit

However, if necessary, Lexus may:

- Use the data for research on vehicle safety performance
- Disclose the data to a third party for research purposes without disclosing information about the specific vehicle or vehicle owner

## Scrapping of your Lexus

The SRS airbag and seat belt pretensioner devices in your Lexus contain explosive chemicals. If the vehicle is scrapped with the airbags and seat belt pretensioners left as they are, this may cause an accident such as fire. Be sure to have the systems of the SRS airbag and seat belt pretensioner removed and disposed of by a qualified service shop or by your Lexus dealer before you scrap your vehicle.

## Perchlorate Material

Special handling may apply, See [www.dtsc.ca.gov/hazardouswaste/perchlorate](http://www.dtsc.ca.gov/hazardouswaste/perchlorate).

Your vehicle has components that may contain perchlorate. These components may include airbag, seat belt pretensioners, and wireless remote control batteries.

### WARNING

#### ■ General precautions while driving

**Driving under the influence:** Never drive your vehicle when under the influence of alcohol or drugs that have impaired your ability to operate your vehicle. Alcohol and certain drugs delay reaction time, impair judgment and reduce coordination, which could lead to an accident that could result in death or serious injury.

**Defensive driving:** Always drive defensively. Anticipate mistakes that other drivers or pedestrians might make and be ready to avoid accidents.

**Driver distraction:** Always give your full attention to driving. Anything that distracts the driver, such as adjusting controls, talking on a cellular phone or reading can result in a collision with resulting death or serious injury to you, your occupants or others.

#### ■ General precaution regarding children's safety

Never leave children unattended in the vehicle, and never allow children to have or use the key.

Children may be able to start the vehicle or shift the vehicle into neutral. There is also a danger that children may injure themselves by playing with the windows, the moon roof, or other features of the vehicle. In addition, heat build-up or extremely cold temperatures inside the vehicle can be fatal to children.

## Reading this manual

 **WARNING:**  
Explains something that, if not obeyed, could cause death or serious injury to people.

 **NOTICE:**  
Explains something that, if not obeyed, could cause damage to or a malfunction in the vehicle or its equipment.

**1 2 3**... Indicates operating or working procedures. Follow the steps in numerical order.

 Indicates the action (pushing, turning, etc.) used to operate switches and other devices.

 Indicates the outcome of an operation (e.g. a lid opens).



 Indicates the component or position being explained.

 Means "Do not", "Do not do this", or "Do not let this happen".

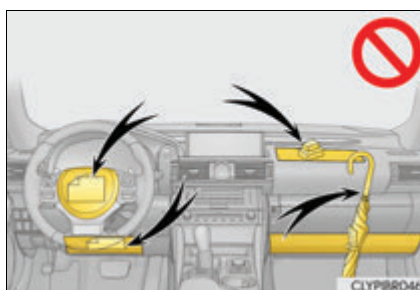



## How to search

### ■ Searching by name

- Alphabetical index.....P. 680

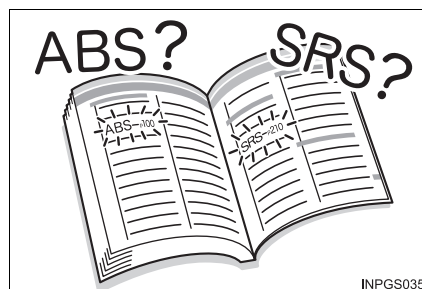

### ■ Searching by installation position

- Pictorial index .....P. 14

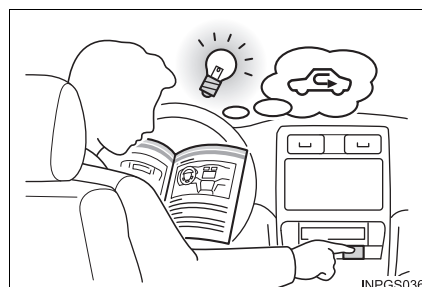

### ■ Searching by symptom or sound

- What to do if...  
(Troubleshooting)..... P. 676



### ■ Searching by title

- Table of contents..... P. 2

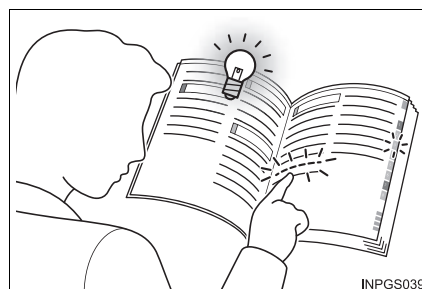

## Pictorial index

### ■ Exterior (front)

#### ▶ RC350/RC300/RC200t

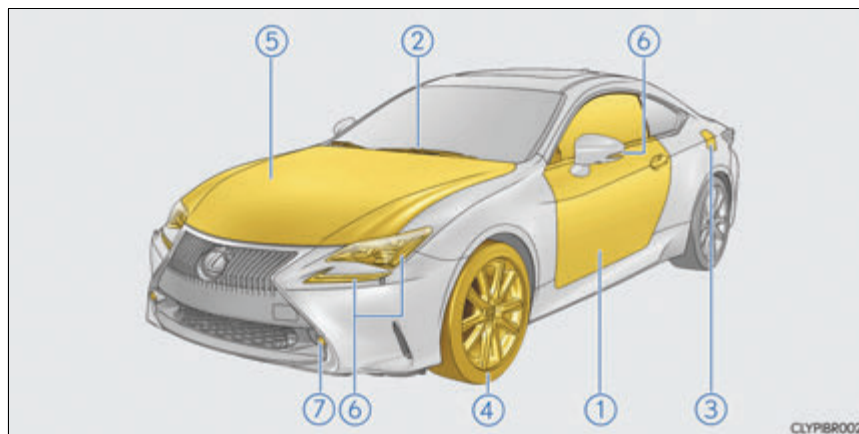

The shape of the headlights may differ depending on the grade, etc.

#### ▶ RC F

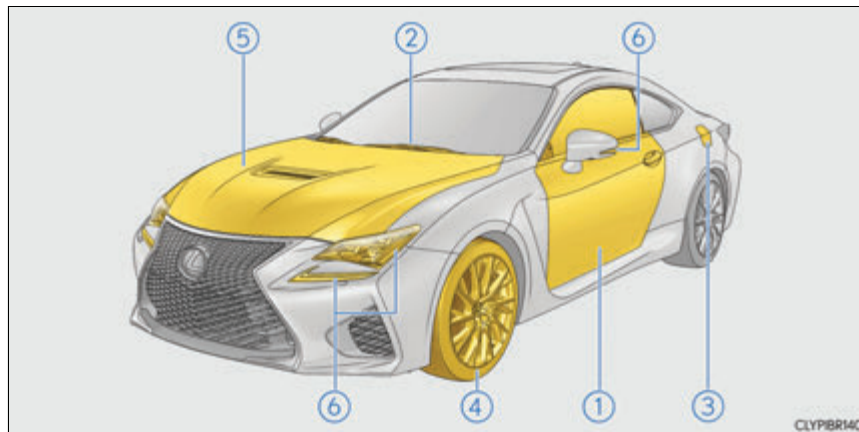

The shape of the headlights may differ depending on the grade, etc.

- ① **Doors** ..... P. 137
    - Locking/unlocking ..... P. 137
    - Opening/closing the side window ..... P. 174
    - Locking/unlocking by using the mechanical key ..... P. 600
    - Warning lights/warning messages ..... P. 544, 551
  - ② **Windshield wipers** ..... P. 223
    - Precautions against winter season ..... P. 320
    - To prevent freezing (windshield wiper de-icer)\* ..... P. 425
    - Precautions against car wash ..... P. 466
  - ③ **Fuel filler door** ..... P. 231
    - Refueling method ..... P. 231
    - Fuel type/fuel tank capacity ..... P. 622
  - ④ **Tires** ..... P. 501
    - Tire size/inflation pressure ..... P. 630
    - Winter tires/tire chain ..... P. 320
    - Checking/rotation/tire pressure warning system ..... P. 501
    - Coping with flat tires ..... P. 570, 584
  - ⑤ **Hood** ..... P. 481
    - Opening ..... P. 481
    - Engine oil ..... P. 622
    - Coping with overheating ..... P. 608
    - Warning messages ..... P. 551
- Light bulbs of the exterior lights for driving**  
(Replacing method: P. 522, Watts: P. 635)
- ⑥ **Headlights/parking lights/daytime running lights/  
turn signal lights /side marker lights** ..... P. 210, 214
  - ⑦ **Front fog lights\*** ..... P. 222

\*: If equipped

**■ Exterior (rear)**

## ▶ RC350/RC300/RC200t

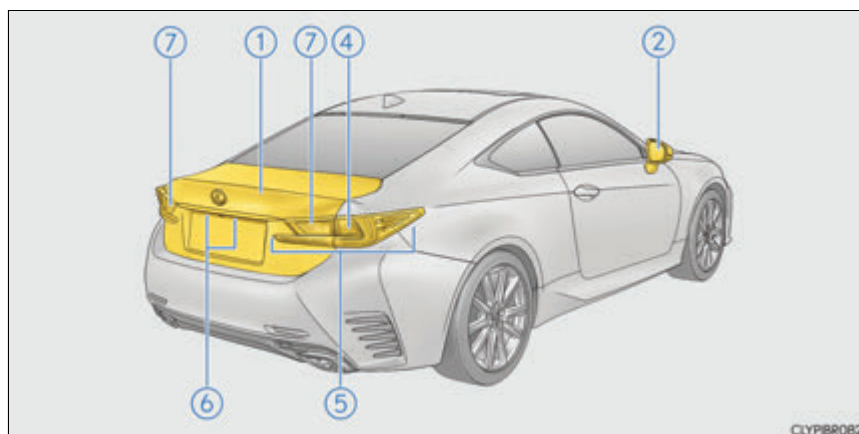

## ▶ RC F

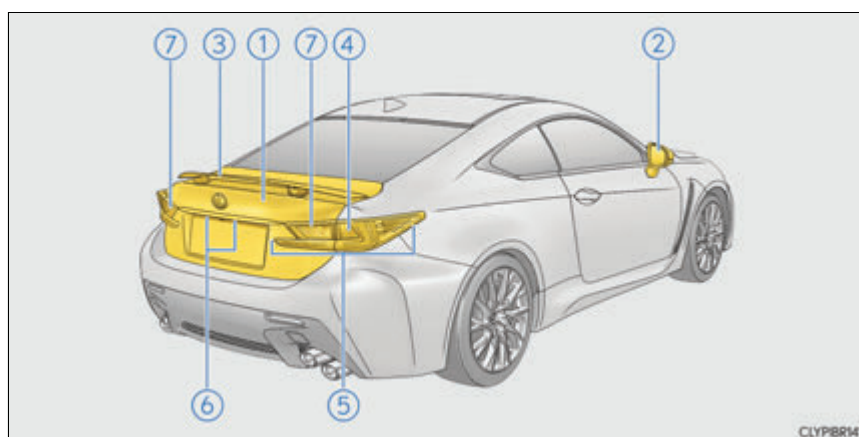

RC350\_RC300\_RC200t\_RC F\_U (OM24671U)

|   |   |               |
|---|---|---------------|
| ① | <b>Trunk</b> .....                        | <b>P. 143</b> |
|   | Opening from inside the cabin .....       | P. 143        |
|   | Opening from outside .....                | P. 143        |
|   | Opening by using the mechanical key ..... | P. 601        |
|   | Warning lights/warning messages .....     | P. 544, 551   |
| ② | <b>Outside rear view mirrors</b> .....    | <b>P. 171</b> |
|   | Adjusting the mirror angle .....          | P. 171        |
|   | Folding the mirrors .....                 | P. 171        |
|   | Driving position memory * .....           | P. 160        |
|   | Defogging the mirrors .....               | P. 424        |
| ③ | <b>Active rear wing</b> .....             | <b>P. 315</b> |

**Light bulbs of the exterior lights for driving**  
(Replacing method: P. 522, Watts: P. 635)

|   |                                     |               |
|---|-------------------------------------|---------------|
| ④ | <b>Turn signal lights</b> .....     | <b>P. 210</b> |
| ⑤ | <b>Tail lights</b> .....            | <b>P. 214</b> |
|   | <b>Stop lights</b> .....            | <b>P. 184</b> |
|   | <b>Side marker lights</b> .....     | <b>P. 214</b> |
| ⑥ | <b>License plate lights</b> .....   | <b>P. 214</b> |
| ⑦ | <b>Back up lights</b>               |               |
|   | Shifting the shift lever to R ..... | P. 205        |

\*: If equipped

■ Instrument panel

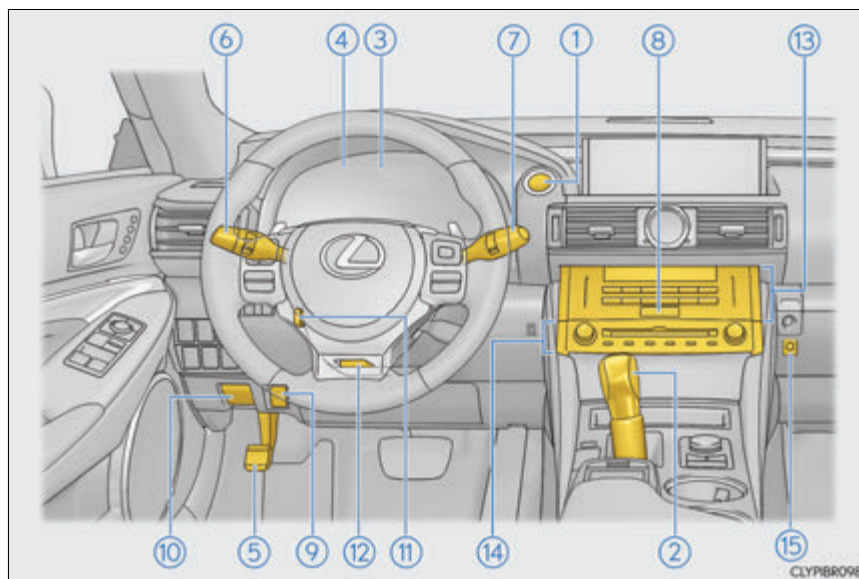

|   |  |                  |
|---|--|------------------|
| ① | <b>Engine switch</b> .....                                     | <b>P. 199</b>    |
|   | Starting the engine/changing the mode .....                    | P. 199           |
|   | Emergency stop of the engine .....                             | P. 533           |
|   | When the engine will not start .....                           | P. 597           |
|   | Warning messages .....   | P. 566           |
| ② | <b>Shift lever</b> .....                                       | <b>P. 205</b>    |
|   | Changing the shift position .....                              | P. 205           |
|   | Precautions against towing .....                               | P. 534           |
|   | When the shift lever does not move .....                       | P. 599           |
| ③ | <b>Meters</b> .....  | <b>P. 92, 98</b> |
|   | Reading the meters/adjusting the instrument panel lights ..... | P. 92, 98        |
|   | Warning lights/indicator lights .....                          | P. 84            |
|   | When the warning lights come on .....                          | P. 543           |

|   |  |                    |
|---|--|--------------------|
| ④ | <b>Multi-information display</b> .....                                     | <b>P. 105, 113</b> |
|   | Display .....  | P. 105, 113        |
|   | When the warning messages are displayed .....                              | P. 549             |
| ⑤ | <b>Parking brake</b> .....   | <b>P. 211</b>      |
|   | Applying/releasing .....   | P. 211             |
|   | Precautions against winter season .....                                    | P. 321             |
|   | Warning buzzer/message .....   | P. 549             |
| ⑥ | <b>Turn signal lever</b> .....   | <b>P. 210</b>      |
|   | <b>Headlight switch</b> .....  | <b>P. 214</b>      |
|   | Headlights/parking lights/tail lights/daytime running lights .....         | P. 214             |
|   | Front fog lights <sup>*1</sup> .....                                       | P. 222             |
| ⑦ | <b>Windshield wiper and washer switch</b> .....                            | <b>P. 223</b>      |
|   | Usage .....  | P. 223             |
|   | Adding washer fluid .....  | P. 500             |
|   | Warning messages <sup>*1</sup> .....                                       | P. 562             |
|   | Headlight cleaners <sup>*1</sup> .....                                     | P. 223             |
| ⑧ | <b>Emergency flasher switch</b> .....                                      | <b>P. 532</b>      |
| ⑨ | <b>Trunk opener</b> .....  | <b>P. 143</b>      |
| ⑩ | <b>Hood lock release lever</b> .....                                       | <b>P. 481</b>      |
| ⑪ | <b>Tilt and telescopic steering control switch</b> <sup>*1</sup> .....     | <b>P. 167</b>      |
|   | Adjustment .....   | P. 167             |
|   | Driving position memory <sup>*1</sup> .....                                | P. 160             |
| ⑫ | <b>Tilt and telescopic steering lock release lever</b> <sup>*1</sup> ..... | <b>P. 167</b>      |
|   | Adjustment .....   | P. 167             |
| ⑬ | <b>Air conditioning system</b> .....                                       | <b>P. 420</b>      |
|   | Usage .....  | P. 420             |
|   | Rear window defogger .....   | P. 424             |
| ⑭ | <b>Audio system</b> <sup>*2</sup> .....                                    | <b>P. 326</b>      |
|   | Audio system .....   | P. 326             |
|   | Hands-free system .....  | P. 383             |
| ⑮ | <b>Trunk opener main switch</b> .....                                      | <b>P. 144</b>      |

<sup>\*1</sup>: If equipped

<sup>\*2</sup>: For vehicles with a navigation system, refer to "NAVIGATION SYSTEM OWNER'S MANUAL".

■ Switches

▶ RC350/RC300/RC200t

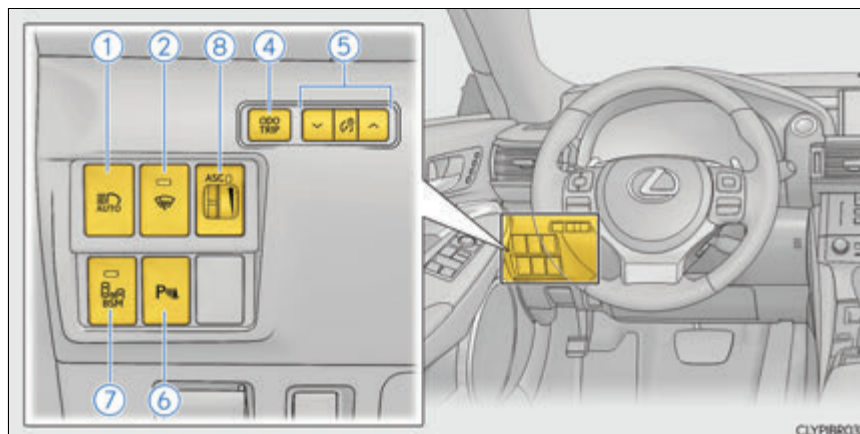

▶ RC F

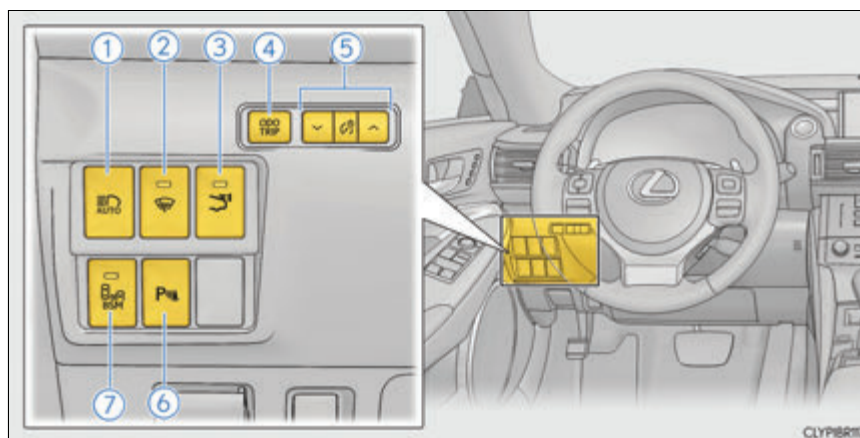

RC350\_RC300\_RC200t\_RC F\_U (OM24671U)



|   |  |            |
|---|--|------------|
| ① | Automatic high beam switch <sup>*1</sup> .....           | P. 217     |
| ② | Windshield wiper de-icer switch <sup>*1</sup> .....      | P. 425     |
| ③ | Active rear wing switch .....                            | P. 315     |
| ④ | Odometer/trip meter/trip meter reset button .....        | P. 95, 102 |
| ⑤ | Instrument panel light control switches .....            | P. 96, 103 |
| ⑥ | Intuitive parking assist switch <sup>*1, 2</sup> .....   | P. 259     |
| ⑦ | BSM (Blind Spot Monitor) main switch <sup>*1</sup> ..... | P. 302     |
| ⑧ | ASC switch <sup>*1</sup> .....                           | P. 212     |

<sup>\*1</sup>: If equipped

<sup>\*2</sup>: For vehicles with a navigation system, refer to "NAVIGATION SYSTEM OWNER'S MANUAL".

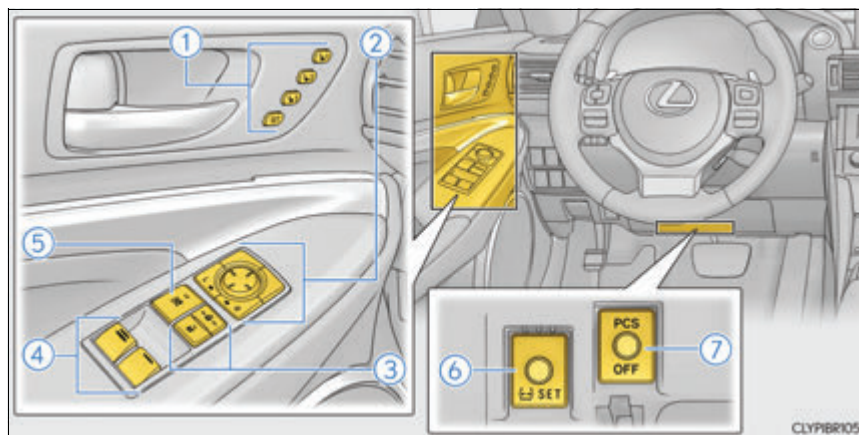

- ① Driving position memory switches \*1 ..... P.160
- ② Outside rear view mirror switches ..... P.171
- ③ Door lock switches ..... P.139
- ④ Power window switches ..... P.174
- ⑤ Window lock switch ..... P.174
- ⑥ Tire pressure warning reset switch..... P.503
- ⑦ PCS OFF switch \*1 ..... P.296

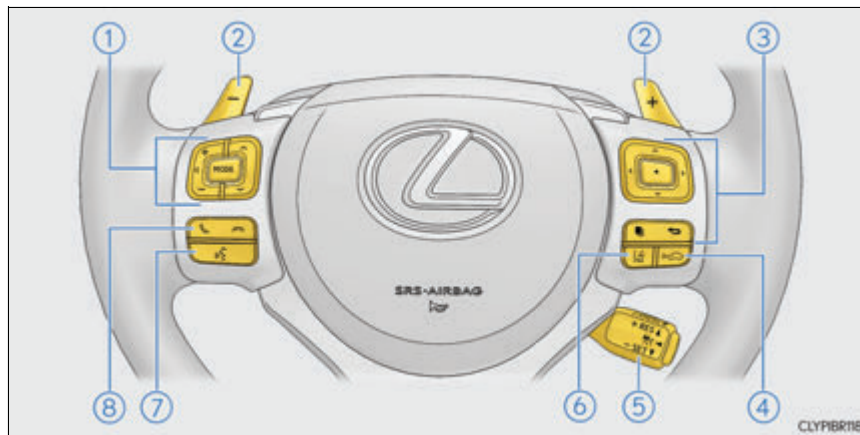

- ① Audio remote control switches<sup>\*2</sup> ..... P. 331
- ② Paddle shift switches ..... P. 207, 208
- ③ Meter control switches ..... P. 107, 114
- ④ Vehicle-to-vehicle distance button<sup>\*1</sup> ..... P. 243
- ⑤ Cruise control switch  
   Cruise control<sup>\*1</sup> ..... P. 235  
   Dynamic radar cruise control<sup>\*1</sup> ..... P. 239
- ⑥ LDA (Lane Departure Alert) switch<sup>\*1</sup> ..... P. 253
- ⑦ Talk switch<sup>\*2</sup> ..... P. 393
- ⑧ Telephone switches<sup>\*2</sup> ..... P. 393

<sup>\*1</sup>: If equipped

<sup>\*2</sup>: For vehicles with a navigation system, refer to "NAVIGATION SYSTEM OWNER'S MANUAL".

► RC350/RC300/RC200t

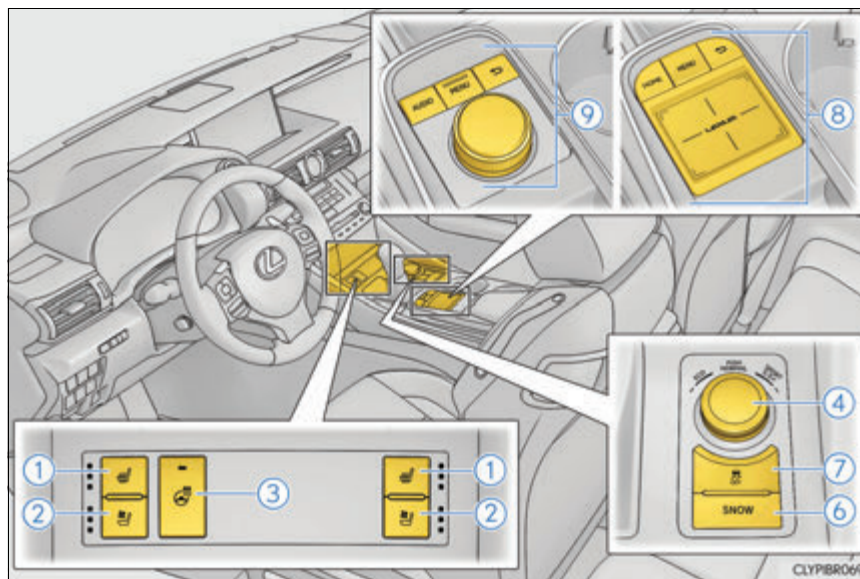

► RC F

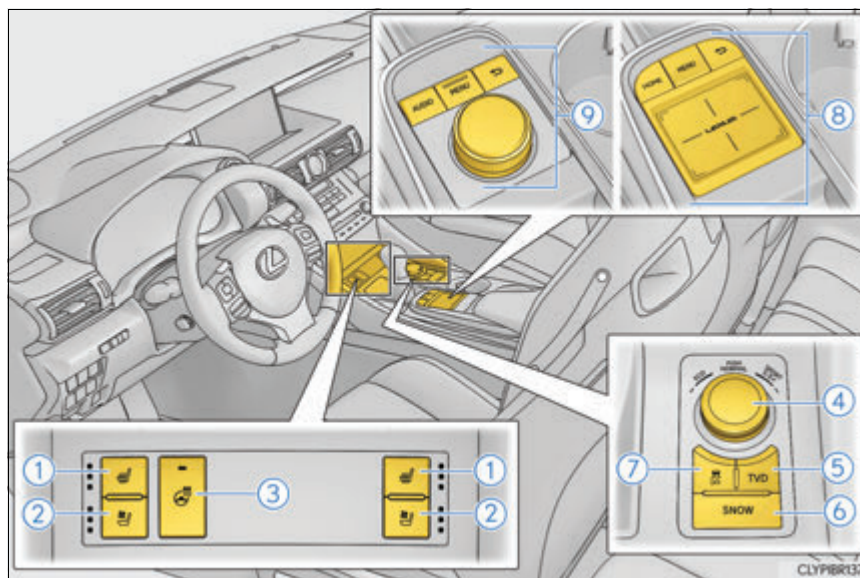

RC350\_RC300\_RC200t\_RC F\_U (OM24671U)

|   |  |        |
|---|--|--------|
| ① | Seat heater switches <sup>*1</sup> .....           | P. 430 |
| ② | Seat ventilator switches <sup>*1</sup> .....       | P. 431 |
| ③ | Heated steering wheel switch <sup>*1</sup> .....   | P. 429 |
| ④ | Driving mode select switch .....                   | P. 283 |
| ⑤ | TVD switch <sup>*1</sup> .....                     | P. 318 |
| ⑥ | Snow mode switch .....                             | P. 206 |
| ⑦ | VSC OFF switch .....                               | P. 289 |
| ⑧ | Remote Touch <sup>*1,2</sup>                       |        |
| ⑨ | Lexus Display Audio controller <sup>*1</sup> ..... | P. 328 |

<sup>\*1</sup>: If equipped

<sup>\*2</sup>: Refer to "NAVIGATION SYSTEM OWNER'S MANUAL".

■ Interior

► RC350/RC300/RC200t

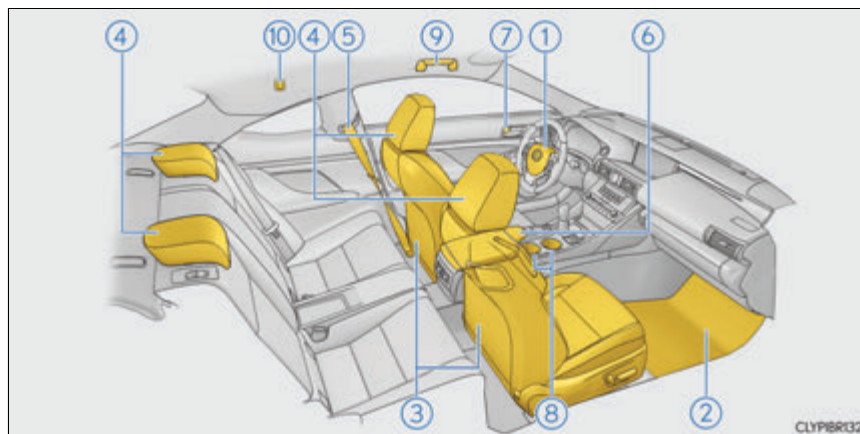

► RC F

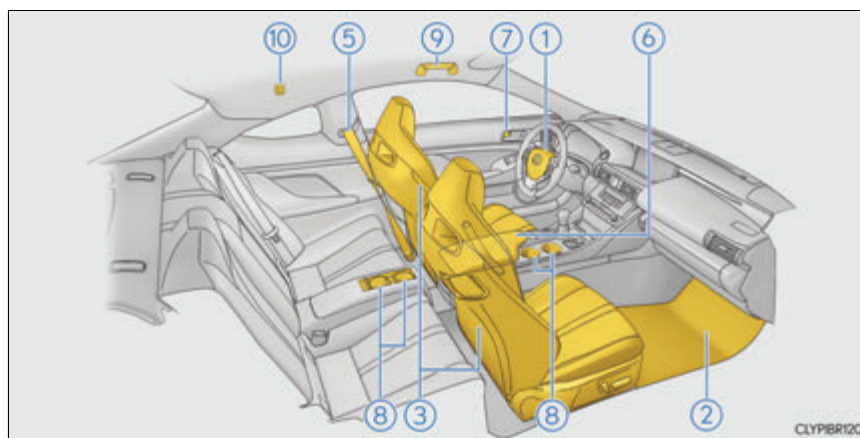

RC350\_RC300\_RC200t\_RC F\_U (OM24671U)

|                            |        |
|----------------------------|--------|
| ① SRS airbags.....         | P. 40  |
| ② Floor mats.....          | P. 30  |
| ③ Front seats.....         | P. 155 |
| ④ Head restraints.....     | P. 164 |
| ⑤ Seat belts.....          | P. 34  |
| ⑥ Console box.....         | P. 436 |
| ⑦ Inside lock buttons..... | P. 139 |
| ⑧ Cup holders.....         | P. 437 |
| ⑨ Assist grips.....        | P. 443 |
| ⑩ Coat hooks.....          | P. 443 |

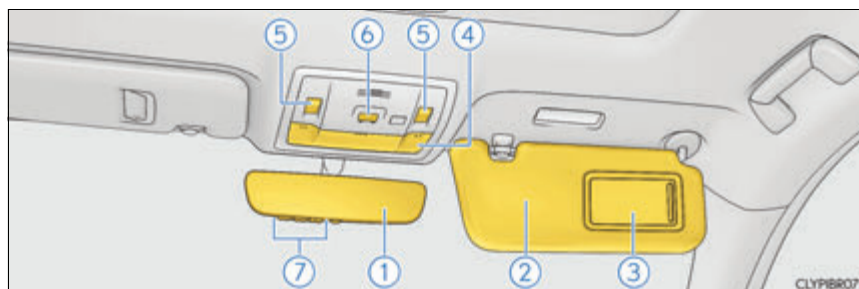

|                                    |        |
|------------------------------------|--------|
| ① Inside rear view mirror .....    | P. 169 |
| ② Sun visors .....                 | P. 439 |
| ③ Vanity mirrors.....              | P. 439 |
| ④ Interior light .....             | P. 433 |
| Personal lights .....              | P. 434 |
| ⑤ Moon roof switches * .....       | P. 178 |
| ⑥ "SOS" button * .....             | P. 455 |
| ⑦ Garage door opener buttons ..... | P. 444 |

\*: If equipped



- 1-1. For safe use**
  - Before driving.....30
  - For safety drive..... 32
  - Seat belts ..... 34
  - SRS airbags .....40
  - Front passenger occupant classification system.....50
  - Safety information for children ..... 56
  - Child restraint systems ..... 57
  - Exhaust gas precautions ..... 75
- 1-2. Theft deterrent system**
  - Engine immobilizer system .....76
  - Alarm ..... 79
  - Theft prevention labels ..... 81

## Before driving

### Floor mat

Use only floor mats designed specifically for vehicles of the same model and model year as your vehicle. Fix them securely in place onto the carpet.

- 1 Insert the retaining hooks (clips) into the floor mat eyelets.

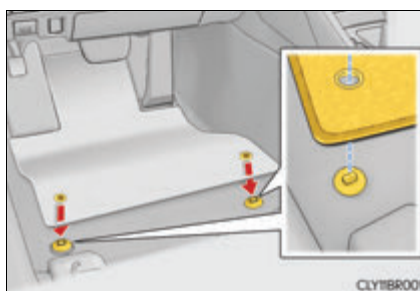

- 2 Turn the upper knob of each retaining hook (clip) to secure the floor mats in place.

\*: Always align the  $\Delta$  marks.

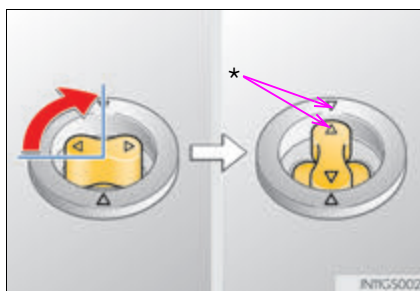

The shape of the retaining hooks (clips) may differ from that shown in the illustration.

**⚠ WARNING**

Observe the following precautions.

Failure to do so may cause the driver's floor mat to slip, possibly interfering with the pedals while driving. An unexpectedly high speed may result or it may become difficult to stop the vehicle. This could lead to an accident, resulting in death or serious injury.

**■ When installing the driver's floor mat**

- Do not use floor mats designed for other models or different model year vehicles, even if they are Lexus Genuine floor mats.
- Only use floor mats designed for the driver's seat.
- Always install the floor mat securely using the retaining hooks (clips) provided.
- Do not use two or more floor mats on top of each other.
- Do not place the floor mat bottom-side up or upside-down.

**■ Before driving**

- Check that the floor mat is securely fixed in the correct place with all the provided retaining hooks (clips). Be especially careful to perform this check after cleaning the floor.
- With the engine stopped and the shift lever in P, fully depress each pedal to the floor to make sure it does not interfere with the floor mat.



## For safety drive

For safe driving, adjust the seat and mirror to an appropriate position before driving.

### Correct driving posture

- ① Adjust the angle of the seatback so that you are sitting straight up and so that you do not have to lean forward to steer. (→P. 155)
- ② Adjust the seat so that you can depress the pedals fully and so that your arms bend slightly at the elbow when gripping the steering wheel. (→P. 155)
- ③ RC350/RC300/RC200t: Lock the head restraint in place with the center of the head restraint closest to the top of your ears. (→P. 164)
- ④ Wear the seat belt correctly. (→P. 34)

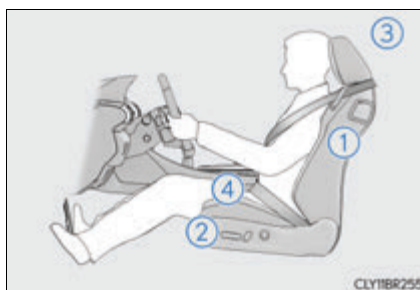

### Correct use of the seat belts

Make sure that all occupants are wearing their seat belts before driving the vehicle. (→P. 34)

Use a child restraint system appropriate for the child until the child becomes large enough to properly wear the vehicle's seat belt. (→P. 57)

### Adjusting the mirrors

Make sure that you can see backward clearly by adjusting the inside and outside rear view mirrors properly. (→P. 169, 171)

#### WARNING

Observe the following precautions.

Failure to do so may result in death or serious injury.

- Do not adjust the position of the driver's seat while driving.  
Doing so could cause the driver to lose control of the vehicle.
- Do not place a cushion between the driver or passenger and the seatback.  
A cushion may prevent correct posture from being achieved, and reduce the effectiveness of the seat belt and head restraint.
- Do not place anything under the front seats.  
Objects placed under the front seats may become jammed in the seat tracks and stop the seat from locking in place. This may lead to an accident and the adjustment mechanism may also be damaged.
- When driving over long distances, take regular breaks before you start to feel tired.  
Also, if you feel tired or sleepy while driving, do not force yourself to continue driving and take a break immediately.

1

For safety and security

## Seat belts

Make sure that all occupants are wearing their seat belts before driving the vehicle.

### Correct use of the seat belts

- Extend the shoulder belt so that it comes fully over the shoulder, but does not come into contact with the neck or slide off the shoulder.
- Position the lap belt as low as possible over the hips.
- Adjust the position of the seatback. Sit up straight and well back in the seat.
- Do not twist the seat belt.
  - ① Not twisted
  - ② Twisted

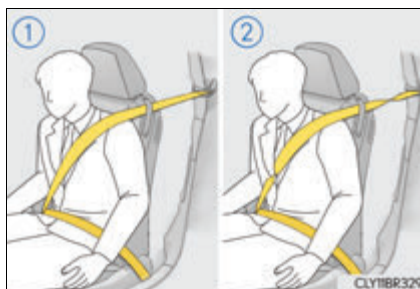

### Fastening and releasing the seat belt

- ① To fasten the seat belt, push the plate into the buckle until a click sound is heard.
- ② To release the seat belt, press the release button.

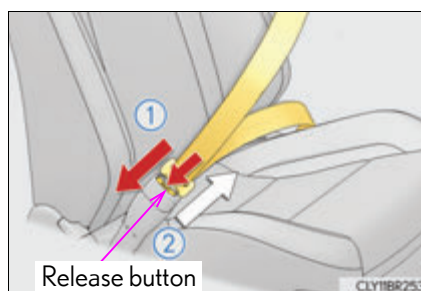

### Seat belt guide

When fastening a front seat belt, ensure that it is passed through the seat belt guide. Passing the seat belt through the guide enables the seat belt to be easily extended.

When you get into or out of the rear seats, release the seat belt from the seat belt guide.

► RC350/RC300/RC200t

► RC F

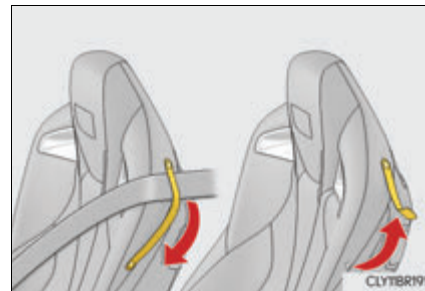
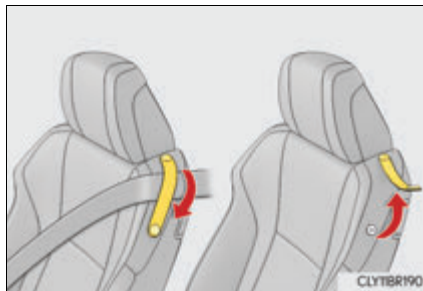

### Seat belt pretensioners

The pretensioners help the seat belts to quickly restrain the occupants by retracting the seat belts when the vehicle is subjected to certain types of severe frontal collision.

The front seat belt pretensioners also activate when the vehicle is subjected to certain types of severe side collision.

The pretensioners do not activate in the event of a minor frontal impact, a minor side impact, a rear impact or a vehicle rollover.

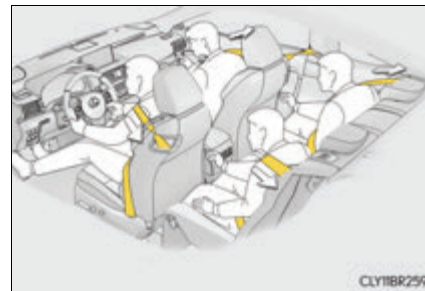

**■ Emergency locking retractor (ELR)**

The retractor will lock the belt during a sudden stop or on impact. It may also lock if you lean forward too quickly. A slow, easy motion will allow the belt to extend so that you can move around fully.

**■ Automatic locking retractor (ALR)**

When a passenger's shoulder belt is completely extended and then retracted even slightly, the belt is locked in that position and cannot be extended. This feature is used to hold a child restraint system (CRS) firmly. To free the belt again, fully retract the belt and then pull the belt out once more. (→P. 59)

**■ Child seat belt usage**

The seat belts of your vehicle were principally designed for persons of adult size.

- Use a child restraint system appropriate for the child, until the child becomes large enough to properly wear the vehicle's seat belt. (→P. 57)
- When the child becomes large enough to properly wear the vehicle's seat belt, follow the instructions regarding seat belt usage. (→P. 34)

**■ Replacing the belt after the pretensioner has been activated**

If the vehicle is involved in multiple collisions, the pretensioner will activate for the first collision, but will not activate for the second or subsequent collisions.

**■ Seat belt extender**

If your seat belts cannot be fastened securely because they are not long enough, a personalized seat belt extender is available from your Lexus dealer free of charge.

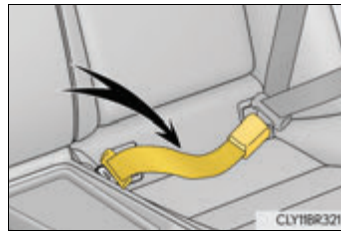



**⚠ WARNING**

Observe the following precautions to reduce the risk of injury in the event of sudden braking, sudden swerving or an accident.  
Failure to do so may cause death or serious injury.

**■ Wearing a seat belt**

- Ensure that all passengers wear a seat belt.
- Always wear a seat belt properly.
- Each seat belt should be used by one person only. Do not use a seat belt for more than one person at once, including children.
- Lexus recommends that children be seated in the rear seat and always use a seat belt and/or an appropriate child restraint system.
- To achieve a proper seating position, do not recline the seat more than necessary. The seat belt is most effective when the occupants are sitting up straight and well back in the seats.
- Do not wear the shoulder belt under your arm.
- Always wear your seat belt low and snug across your hips.

**■ Pregnant women**

Obtain medical advice and wear the seat belt in the proper way. (→P. 34)

Women who are pregnant should position the lap belt as low as possible over the hips in the same manner as other occupants, extending the shoulder belt completely over the shoulder and avoiding belt contact with the rounding of the abdominal area.

If the seat belt is not worn properly, not only the pregnant woman, but also the fetus could suffer death or serious injury as a result of sudden braking or a collision.

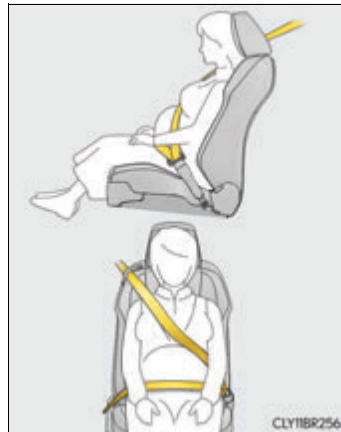

 **WARNING****■ People suffering illness**

Obtain medical advice and wear the seat belt in the proper way. (→P. 34)

**■ When children are in the vehicle**

Do not allow children to play with the seat belt. If the seat belt becomes twisted around a child's neck, it may lead to choking or other serious injuries that could result in death. If this occurs and the buckle cannot be unfastened, scissors should be used to cut the belt.

**■ Seat belt pretensioners**

- Do not place anything, such as a cushion, on the front passenger's seat. Doing so will disperse the passenger's weight, which prevents the sensor from detecting the passenger's weight properly. As a result, the seat belt pretensioner for the front passenger's seat may not activate in the event of a collision.
- If the pretensioner has activated, the SRS warning light will come on. In that case, the seat belt cannot be used again and must be replaced at your Lexus dealer.

**■ Seat belt damage and wear**

- Do not damage the seat belts by allowing the belt, plate, or buckle to be jammed in the door.
- Inspect the seat belt system periodically. Check for cuts, fraying, and loose parts. Do not use a damaged seat belt until it is replaced. Damaged seat belts cannot protect an occupant from death or serious injury.
- Ensure that the belt and plate are locked and the belt is not twisted.  
If the seat belt does not function correctly, immediately contact your Lexus dealer.
- Replace the seat assembly, including the belts, if your vehicle has been involved in a serious accident, even if there is no obvious damage.
- Do not attempt to install, remove, modify, disassemble or dispose of the seat belts. Have any necessary repairs carried out by your Lexus dealer. Inappropriate handling may lead to incorrect operation.

**■ When using the seat belt guide**

- Always make sure that the belt is not twisted, and runs freely through the guide.
- Regardless of whether the guide is used or not, always secure the seat belt guide button.
- Do not hang from or pull the guide forcefully.

 **WARNING****■ Using a seat belt extender**

- Do not wear the seat belt extender if you can fasten the seat belt without the extender.
- Do not use the seat belt extender when installing a child restraint system because the belt will not securely hold the child restraint system, increasing the risk of death or serious injury in the event of an accident.
- The personalized extender may not be safe on another vehicle, when used by another person, or at a different seating position other than the one originally intended.

 **NOTICE****■ When using a seat belt extender**

When releasing the seat belt, press on the buckle release button on the extender, not on the seat belt.  
This helps prevent damage to the vehicle interior and the extender itself.

## SRS airbags

The SRS airbags inflate when the vehicle is subjected to certain types of severe impacts that may cause significant injury to the occupants. They work together with the seat belts to help reduce the risk of death or serious injury.

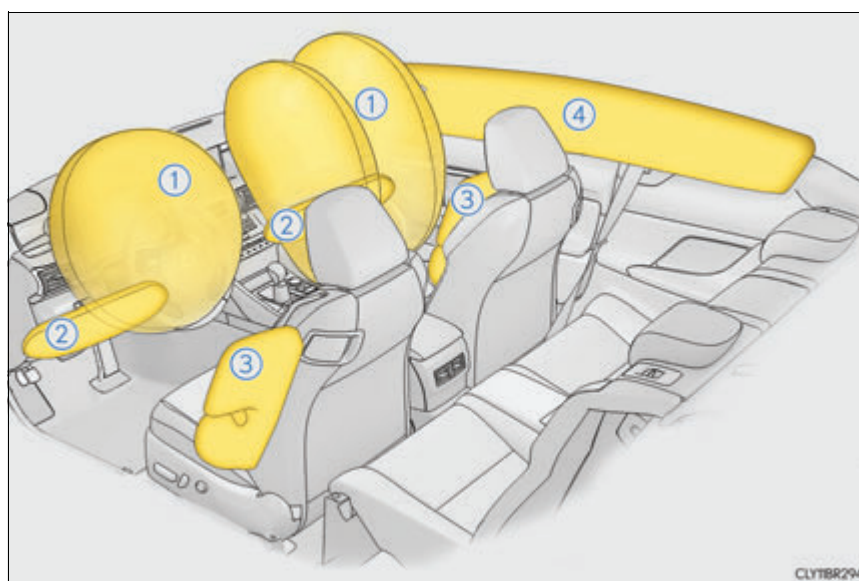

### ◆ SRS front airbags

- ① SRS driver airbag/front passenger airbag  
Can help protect the head and chest of the driver and front passenger from impact with interior components
- ② SRS knee airbags  
Can help provide driver and front passenger protection

### ◆ SRS side and curtain shield airbags

- ③ SRS side airbags  
Can help protect the torso of the front seat occupants
- ④ SRS curtain shield airbags  
Can help protect primarily the head of occupants

## SRS airbag system components

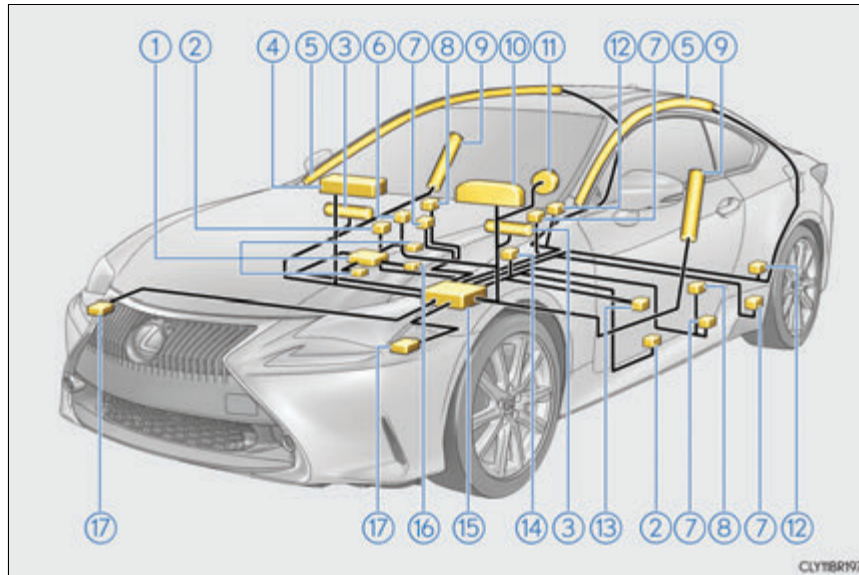

- |  |   |
|--|---|
| ① Front passenger occupant classification system (ECU and sensors) | ⑨ Front side airbags                        |
| ② Side impact sensors (door)                                       | ⑩ SRS warning light                         |
| ③ Knee airbags   | ⑪ Driver airbag                             |
| ④ Front passenger airbag   | ⑫ Side impact sensors (rear)                |
| ⑤ Curtain shield airbags   | ⑬ Driver's seat position sensor             |
| ⑥ "AIR BAG ON" and "AIR BAG OFF" indicator lights                  | ⑭ Driver's seat belt buckle switch          |
| ⑦ Seat belt pretensioners and force limiters                       | ⑮ Airbag sensor assembly                    |
| ⑧ Side impact sensors (front)                                      | ⑯ Front passenger's seat belt buckle switch |
|  | ⑰ Front impact sensors                      |

Your vehicle is equipped with ADVANCED AIRBAGS designed based on the US motor vehicle safety standards (FMVSS208). The airbag sensor assembly (ECU) controls airbag deployment based on information obtained from the sensors etc. shown in the system components diagram above. This information includes crash severity and occupant information. As the airbags deploy, a chemical reaction in the inflators quickly fills the airbags with non-toxic gas to help restrain the motion of the occupants.

 **WARNING****■ SRS airbag precautions**

Observe the following precautions regarding the SRS airbags. Failure to do so may cause death or serious injury.

- The driver and all passengers in the vehicle must wear their seat belts properly. The SRS airbags are supplemental devices to be used with the seat belts.
- The SRS driver airbag deploys with considerable force, and can cause death or serious injury especially if the driver is very close to the airbag. The National Highway Traffic Safety Administration (NHTSA) advises:

Since the risk zone for the driver's airbag is the first 2 - 3 in. (50 - 75 mm) of inflation, placing yourself 10 in. (250 mm) from your driver airbag provides you with a clear margin of safety. This distance is measured from the center of the steering wheel to your breastbone. If you sit less than 10 in. (250 mm) away now, you can change your driving position in several ways:

- Move your seat to the rear as far as you can while still reaching the pedals comfortably.
- Slightly recline the back of the seat. Although vehicle designs vary, many drivers can achieve the 10 in. (250 mm) distance, even with the driver seat all the way forward, simply by reclining the back of the seat somewhat. If reclining the back of your seat makes it hard to see the road, raise yourself by using a firm, non-slippery cushion, or raise the seat if your vehicle has that feature.
- If your steering wheel is adjustable, tilt it downward. This points the airbag toward your chest instead of your head and neck.

The seat should be adjusted as recommended by NHTSA above, while still maintaining control of the foot pedals, steering wheel, and your view of the instrument panel controls.

**⚠ WARNING****■ SRS airbag precautions**

- If the seat belt extender has been connected to the front seat belt buckles but the seat belt extender has not also been fastened to the latch plate of the seat belt, the SRS front airbags will judge that the driver and front passenger are wearing the seat belt even though the seat belt has not been connected. In this case, the SRS front airbags may not activate correctly in a collision, resulting in death or serious injury in the event of a collision. Be sure to wear the seat belt with the seat belt extender.
- The SRS front passenger airbag also deploys with considerable force, and can cause death or serious injury especially if the front passenger is very close to the airbag. The front passenger seat should be as far from the airbag as possible with the seatback adjusted, so the front passenger sits upright.
- Improperly seated and/or restrained infants and children can be killed or seriously injured by a deploying airbag. An infant or child who is too small to use a seat belt should be properly secured using a child restraint system. Lexus strongly recommends that all infants and children be placed in the rear seats of the vehicle and properly restrained. The rear seats are safer for infants and children than the front passenger seat. (→P. 57)
- Do not sit on the edge of the seat or lean against the dashboard.

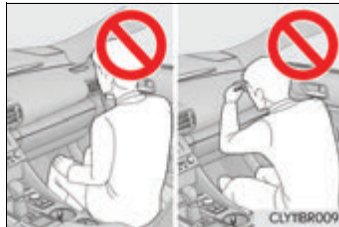
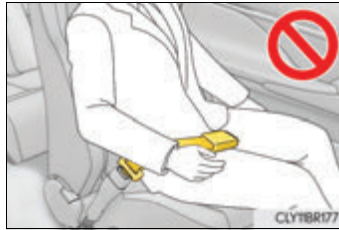

**⚠ WARNING**

■ **SRS airbag precautions**

- Do not allow a child to stand in front of the SRS front passenger airbag unit or sit on the knees of a front passenger.



- Do not allow the front seat occupants to hold items on their knees.

- Do not lean against the door, the roof side rail or the front, side and rear pillars.



- Do not allow anyone to kneel on the passenger seats toward the door or put their head or hands outside the vehicle.



- Do not attach anything to or lean anything against areas such as the dashboard, steering wheel pad and lower portion of the instrument panel. These items can become projectiles when the SRS driver, front passenger and knee airbags deploy.

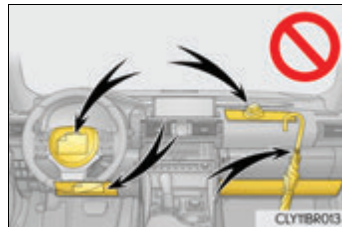

- Do not attach anything to areas such as a door, windshield, side windshield, front or rear pillar, roof side rail and assist grip. (Except for the speed limit sticker →P. 590)

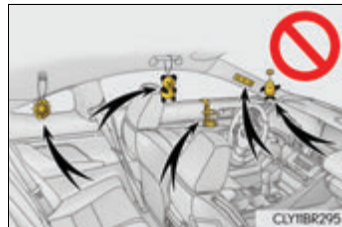



 **WARNING****■ SRS airbag precautions**

- Do not hang coat hangers or hard objects on the coat hooks. All of these items could become projectiles and may cause death or serious injury, should the SRS curtain shield airbags deploy.
- If a vinyl cover is put on the area where the SRS knee airbag will deploy, be sure to remove it.
- Do not use seat accessories which cover the parts where the SRS side airbags inflate as they may interfere with inflation of the airbags. Such accessories may prevent the side airbags from activating correctly, disable the system or cause the side airbags to inflate accidentally, resulting in death or serious injury.
- Do not strike or apply significant levels of force to the area of the SRS airbag components.  
Doing so can cause the SRS airbags to malfunction.
- Do not touch any of the component parts immediately after the SRS airbags have deployed (inflated) as they may be hot.
- If breathing becomes difficult after the SRS airbags have deployed, open a door or window to allow fresh air in, or leave the vehicle if it is safe to do so. Wash off any residue as soon as possible to prevent skin irritation.
- If the areas where the SRS airbags are stored, such as the steering wheel pad and front and rear pillar garnishes are damaged or cracked, have them replaced by your Lexus dealer.
- Do not place anything, such as a cushion, on the front passenger's seat. Doing so will disperse the passenger's weight, which prevents the sensor from detecting the passenger's weight properly. As a result, the SRS front airbags for the front passenger may not deploy in the event of a collision.

 **WARNING****■ Modification and disposal of SRS airbag system components**

Do not dispose of your vehicle or perform any of the following modifications without consulting your Lexus dealer. The SRS airbags may malfunction or deploy (inflate) accidentally, causing death or serious injury.

- Installation, removal, disassembly and repair of the SRS airbags
- Repairs, modifications, removal or replacement of the steering wheel, instrument panel, dashboard, seats or seat upholstery, front, side and rear pillars or roof side rails
- Repairs or modifications of the front fender, front bumper, or side of the occupant compartment
- Installation of a grille guard (bull bars, kangaroo bar, etc.), snow plows, winches
- Modifications to the vehicle's suspension system
- Installation of electronic devices such as mobile two-way radios and CD players
- Modifications to your vehicle for a person with a physical disability

**■ If the SRS airbags deploy (inflate)**

- Slight abrasions, burns, bruising etc., may be sustained from SRS airbags, due to the extremely high speed deployment (inflation) by hot gases.
- A loud noise and white powder will be emitted.
- Parts of the airbag module (steering wheel hub, airbag cover and inflator) as well as the front seats, parts of the front and rear pillars, and roof side rails may be hot for several minutes. The airbag itself may also be hot.
- The windshield may crack.
- For Lexus Enform Safety Connect subscribers, if the SRS airbags deploy or in the event of a severe rear-end collision, the system is designed to send an emergency call to the response center, notifying them of the vehicle's location (without needing to push the "SOS" button) and an agent will attempt to speak with the occupants to ascertain the level of emergency and assistance required. If the occupants are unable to communicate, the agent automatically treats the call as an emergency and helps to dispatch the necessary emergency services. (→P. 455)

### ■ SRS airbag deployment conditions (SRS front airbags)

- The SRS front airbags will deploy in the event of an impact that exceeds the set threshold level (the level of force corresponding to an approximately 12 - 18 mph [20 - 30 km/h] frontal collision with a fixed wall that does not move or deform).

However, this threshold velocity will be considerably higher in the following situations:

- If the vehicle strikes an object, such as a parked vehicle or sign pole, which can move or deform on impact
- If the vehicle is involved in an underride collision, such as a collision in which the front of the vehicle "underrides", or goes under, the bed of a truck
- Depending on the type of collision, it is possible that only the seat belt pretensioners will activate.
- The SRS front airbags for the front passenger will not activate if there is no passenger sitting in the front passenger seat. However, the SRS front airbags for the front passenger may deploy if luggage is put in the seat, even if the seat is unoccupied. (→P. 50)

### ■ SRS airbag deployment conditions (SRS side and curtain shield airbags)

- The SRS side and curtain shield airbags will deploy in the event of an impact that exceeds the set threshold level (the level of force corresponding to the impact force produced by an approximately 3300 lb. [1500 kg] vehicle colliding with the vehicle cabin from a direction perpendicular to the vehicle orientation at an approximate speed of 12 - 18 mph [20 - 30 km/h]).
- The SRS side and curtain shield airbags will deploy in the event of a severe frontal collision.

### ■ Conditions under which the SRS airbags may deploy (inflate), other than a collision

The SRS front airbags, SRS side and curtain shield airbags may also deploy if a serious impact occurs to the underside of your vehicle. Some examples are shown in the illustration.

- Hitting a curb, edge of pavement or hard surface
- Falling into or jumping over a deep hole
- Landing hard or falling

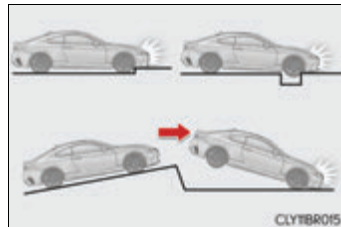

#### ■ Types of collisions that may not deploy the SRS airbags (SRS front airbags)

The SRS front airbags do not generally inflate if the vehicle is involved in a side or rear collision, if it rolls over, or if it is involved in a low-speed frontal collision. But, whenever a collision of any type causes sufficient forward deceleration of the vehicle, deployment of the SRS front airbags may occur.

- Collision from the side
- Collision from the rear
- Vehicle rollover

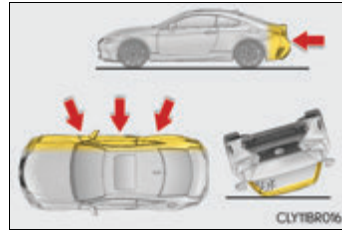

#### ■ Types of collisions that may not deploy the SRS airbags (SRS side and curtain shield airbags)

The SRS side and curtain shield airbags may not activate if the vehicle is subjected to a collision from the side at certain angles, or a collision to the side of the vehicle body other than the passenger compartment.

- Collision from the side to the vehicle body other than the passenger compartment
- Collision from the side at an angle

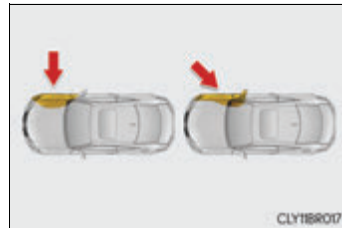

The SRS side and curtain shield airbags do not generally inflate if the vehicle is involved in a rear collision, if it rolls over, or if it is involved in a low-speed side or low-speed frontal collision.

- Collision from the rear
- Vehicle rollover

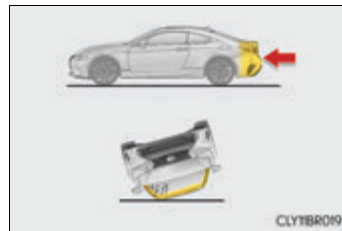

### ■ When to contact your Lexus dealer

In the following cases, the vehicle will require inspection and/or repair. Contact your Lexus dealer as soon as possible.

- Any of the SRS airbags have been inflated.
- The front of the vehicle is damaged or deformed, or was involved in an accident that was not severe enough to cause the SRS front airbags to inflate.
- A portion of a door or its surrounding area is damaged or deformed, or the vehicle was involved in an accident that was not severe enough to cause the SRS side and curtain shield airbags to inflate.
- The pad section of the steering wheel, dashboard near the front passenger airbag or lower portion of the instrument panel is scratched, cracked, or otherwise damaged.
- The surface of the seats with the side airbag is scratched, cracked, or otherwise damaged.
- The portion of the front pillars, rear pillars or roof side rail garnishes (padding) containing the curtain shield airbags inside is scratched, cracked, or otherwise damaged.

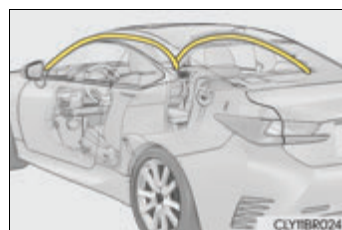
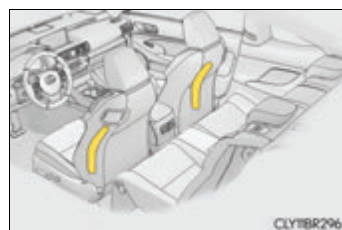
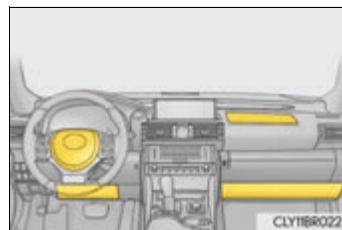
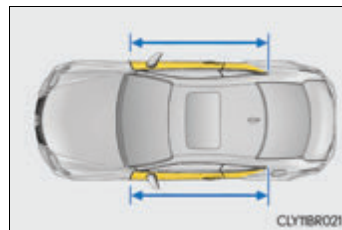
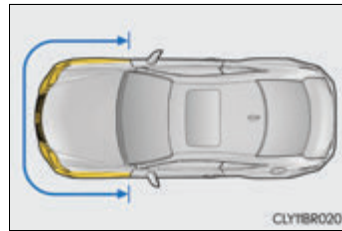

## Front passenger occupant classification system

Your vehicle is equipped with a front passenger occupant classification system. This system detects the conditions of the front passenger seat and activates or deactivates the devices for the front passenger.

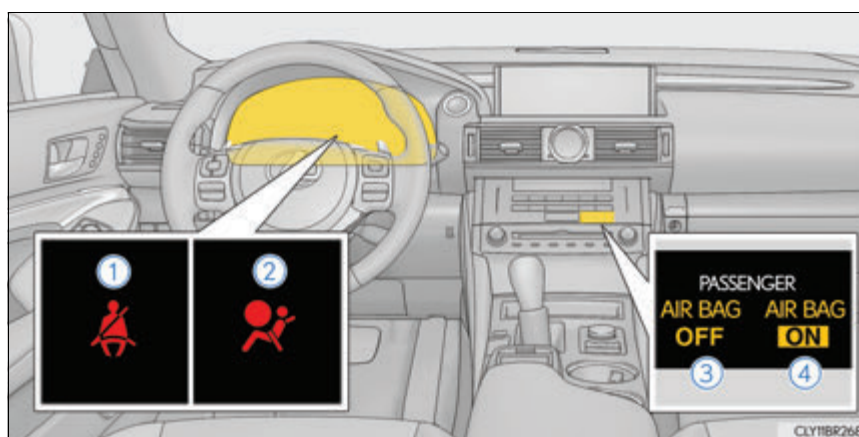

- ① Seat belt reminder light
- ② SRS warning light
- ③ "AIR BAG OFF" indicator light
- ④ "AIR BAG ON" indicator light

### Condition and operation in the front passenger occupant classification system

#### ■ Adult\*<sup>1</sup>

|                             |  |   |
|-----------------------------|--|---|
| Indicator/<br>warning light | "AIR BAG ON" and "AIR BAG OFF"<br>indicator lights   | "AIR BAG ON"                                |
|                             | SRS warning light                                    | Off   |
|                             | Seat belt reminder light                             | Off* <sup>2</sup> or flashing* <sup>3</sup> |
| Devices                     | Front passenger airbag                               | Activated                                   |
|                             | Side airbag<br>on the front passenger seat           |   |
|                             | Curtain shield airbag<br>in the front passenger side |   |
|                             | Front passenger knee airbag                          |   |
|                             | Front passenger's seat belt pretensioner             |   |

#### ■ Child\*<sup>4</sup>

|                             |  |  |
|-----------------------------|--|--|
| Indicator/<br>warning light | "AIR BAG ON" and "AIR BAG OFF"<br>indicator lights   | "AIR BAG OFF" or<br>"AIR BAG ON"* <sup>4</sup> |
|                             | SRS warning light                                    | Off  |
|                             | Seat belt reminder light                             | Off* <sup>2</sup> or<br>flashing* <sup>3</sup> |
| Devices                     | Front passenger airbag                               | Deactivated or<br>activated* <sup>4</sup>      |
|                             | Side airbag<br>on the front passenger seat           | Activated                                      |
|                             | Curtain shield airbag<br>in the front passenger side |  |
|                             | Front passenger knee airbag                          | Deactivated or<br>activated* <sup>4</sup>      |
|                             | Front passenger's seat belt pretensioner             | Activated                                      |

1

For safety and security

### ■ Child restraint system with infant\*<sup>5</sup>

|                             |  |  |
|-----------------------------|--|--|
| Indicator/<br>warning light | "AIR BAG ON" and "AIR BAG OFF"<br>indicator lights   | "AIR BAG OFF"* <sup>6</sup>                    |
|                             | SRS warning light                                    | Off  |
|                             | Seat belt reminder light                             | Off* <sup>2</sup> or<br>flashing* <sup>3</sup> |
| Devices                     | Front passenger airbag                               | Deactivated                                    |
|                             | Side airbag<br>on the front passenger seat           | Activated                                      |
|                             | Curtain shield airbag<br>in the front passenger side |  |
|                             | Front passenger knee airbag                          | Deactivated                                    |
|                             | Front passenger's seat belt pretensioner             | Activated                                      |

### ■ Unoccupied

|                             |  |               |
|-----------------------------|--|---------------|
| Indicator/<br>warning light | "AIR BAG ON" and "AIR BAG OFF"<br>indicator lights   | "AIR BAG OFF" |
|                             | SRS warning light                                    | Off           |
|                             | Seat belt reminder light                             |               |
| Devices                     | Front passenger airbag                               | Deactivated   |
|                             | Side airbag<br>on the front passenger seat           | Activated     |
|                             | Curtain shield airbag<br>in the front passenger side |               |
|                             | Front passenger knee airbag                          | Deactivated   |
|                             | Front passenger's seat belt pretensioner             | Activated     |



■ There is a malfunction in the system

|                             | "AIR BAG ON" and "AIR BAG OFF" indicator lights   | "AIR BAG OFF" |
|-----------------------------|---|---------------|
| Indicator/<br>warning light | SRS warning light                                 | On            |
|                             | Seat belt reminder light                          |               |
| Devices                     | Front passenger airbag                            | Deactivated   |
|                             | Side airbag on the front passenger seat           | Activated     |
|                             | Curtain shield airbag in the front passenger side |               |
|                             | Front passenger knee airbag                       | Deactivated   |
|                             | Front passenger's seat belt pretensioner          | Activated     |

\*1: The system judges a person of adult size as an adult. When a smaller adult sits in the front passenger seat, the system may not recognize him/her as an adult depending on his/her physique and posture.

\*2: In the event the front passenger is wearing a seat belt.

\*3: In the event the front passenger does not wear a seat belt

\*4: For some children, child in seat, child in booster seat or child in convertible seat, the system may not recognize him/her as a child. Factors which may affect this can be the physique or posture.

\*5: Never install a rear-facing child restraint system on the front passenger seat. A forward-facing child restraint system should only be installed on the front passenger seat when it is unavoidable. (→P. 57)

\*6: In case the indicator light is not illuminated, consult this manual on how to install the child restraint system properly. (→P. 59)

 **WARNING****■ Front passenger occupant classification system precautions**

Observe the following precautions regarding the front passenger occupant classification system.

Failure to do so may cause death or serious injury.

- Wear the seat belt properly.
- Make sure the front passenger's seat belt plate has not been left inserted into the buckle before someone sits in the front passenger seat.
- Make sure the "AIR BAG OFF" indicator light is not illuminated when using the seat belt extender for the front passenger seat. If the "AIR BAG OFF" indicator light is illuminated, disconnect the extender tongue from the seat belt buckle, and reconnect the seat belt. Reconnect the seat belt extender after making sure the "AIR BAG ON" indicator light is illuminated. If you use the seat belt extender while the "AIR BAG OFF" indicator light is illuminated, the SRS airbags for the front passenger may not activate, which could cause death or serious injury in the event of a collision.
- Do not apply a heavy load to the front passenger seat or equipment (e.g. seatback pocket).
- Do not put weight on the front passenger seat by putting your hands or feet on the front passenger seat seatback from the rear passenger seat.
- Do not let a rear passenger lift the front passenger seat with their feet or press on the seatback with their legs.
- Do not put objects under the front passenger seat.

 **WARNING****■ Front passenger occupant classification system precautions**

- Do not recline the front passenger seatback so far that it touches a rear seat. This may cause the "AIR BAG OFF" indicator light to be illuminated, which indicates that the SRS airbags for the front passenger will not activate in the event of a severe accident. If the seatback touches the rear seat, return the seatback to a position where it does not touch the rear seat. Keep the front passenger seatback as upright as possible when the vehicle is moving. Reclining the seatback excessively may lessen the effectiveness of the seat belt system.
- If an adult sits in the front passenger seat, the "AIR BAG ON" indicator light is illuminated. If the "AIR BAG OFF" indicator is illuminated, ask the passenger to sit up straight, well back in the seat, feet on the floor, and with the seat belt worn correctly. If the "AIR BAG OFF" indicator still remains illuminated, either ask the passenger to move to the rear seat, or if that is not possible, move the front passenger seat fully rearward.
- When it is unavoidable to install a forward-facing child restraint system on the front passenger seat, install the child restraint system on the front passenger seat in the proper order. (→P. 59)
- Do not modify or remove the front seats.
- Do not kick the front passenger seat or subject it to severe impact. Otherwise, the SRS warning light may come on to indicate a malfunction of the front passenger occupant classification system. In this case, contact your Lexus dealer immediately.
- Child restraint systems installed on the rear seat should not contact the front seatbacks.
- Do not use a seat accessory, such as a cushion and seat cover, that covers the seat cushion surface.
- Do not modify or replace the upholstery of the front seat.
- Do not place anything between the console box and front passenger seat. Otherwise, the system may not detect the front passenger properly, leading to improper operation of the airbags.
- Adjust the front passenger seat so that the head restraint does not touch the ceiling. If the head restraint is left in contact with the ceiling, the system may not detect the front passenger properly, leading to improper operation of the airbags.

## Safety information for children

Observe the following precautions when children are in the vehicle.

Use a child restraint system appropriate for the child, until the child becomes large enough to properly wear the vehicle's seat belt.

- It is recommended that children sit in the rear seats to avoid accidental contact with the shift lever, wiper switch, etc.
- Use the window lock switch to avoid children operating the power window accidentally.
- Do not let small children operate equipment which may catch or pinch body parts, such as the power window, hood, trunk, seats etc.

### WARNING

Never leave children unattended in the vehicle, and never allow children to have or use the key.

Children may be able to start the vehicle or shift the vehicle into neutral. There is also a danger that children may injure themselves by playing with the windows, the moon roof or other features of the vehicle. In addition, heat build-up or extremely cold temperatures inside the vehicle can be fatal to children.

## Child restraint systems

Before installing a child restraint system in the vehicle, there are precautions that need to be observed, different types of child restraint systems, as well as installation methods, etc., written in this manual.

Use a child restraint system when riding with a small child that cannot properly use a seat belt. For the child's safety, install the child restraint system to a rear seat. Be sure to follow the installation method that is in the operation manual enclosed with the restraint system.

### Table of contents

|   |       |
|---|-------|
| Points to remember .....  | P. 57 |
| Child restraint system .....  | P. 59 |
| When using a child restraint system on the front passenger seat ..... | P. 61 |
| When using a child restraint system on a rear seat .....              | P. 63 |
| Child restraint system installation method                            |       |
| • Fixed with a seat belt.....   | P. 64 |
| • Fixed with child restraint LATCH anchors .....                      | P. 70 |
| • Using an anchor bracket (for top tether strap) .....                | P. 73 |

### Points to remember

The laws of all 50 states of the U.S.A. as well as Canada now require the use of child restraint systems.

- Prioritize and observe the warnings, as well as the laws and regulations for child restraint systems.
- Choose a child restraint system that suits your vehicle and is appropriate to the age and size of the child.
- Use a child restraint system appropriate for the child until the child becomes large enough to properly wear the vehicle's seat belt.

 **WARNING****■ When a child is riding**

Observe the following precautions.

Failure to do so may result in death or serious injury.

- For effective protection in automobile accidents and sudden stops, a child must be properly restrained, using a seat belt or child restraint system depending on the age and size of the child.
- Lexus strongly urges the use of a proper child restraint system that conforms to the size of the child, installed on the rear seat. According to accident statistics, the child is safer when properly restrained in the rear seat than in the front seat.
- Holding a child in your or someone else's arms is not a substitute for a child restraint system. In an accident, the child can be crushed against the windshield or between the holder and the interior of the vehicle.
- Place one child to a child restraint system and then secure the child with the harness of the child restraint system.

**■ Handling the child restraint system**



If the child restraint system is not properly fixed in place, the child or other passengers may be seriously injured or even killed in the event of sudden braking, sudden swerving, or an accident.

- If the vehicle were to receive a strong impact from an accident, etc., it is possible that the child restraint system has damage that is not readily visible. In such cases, do not reuse the restraint system.
- Make sure you have complied with all installation instructions provided with the child restraint system manufacturer and that the system is properly secured.
- Keep the child restraint system properly secured on the seat even if it is not in use. Do not store the child restraint system unsecured in the passenger compartment.
- If it is necessary to detach the child restraint system, remove it from the vehicle or store it securely in the trunk.

## Child restraint system

### ■ Types of child restraint system installation methods

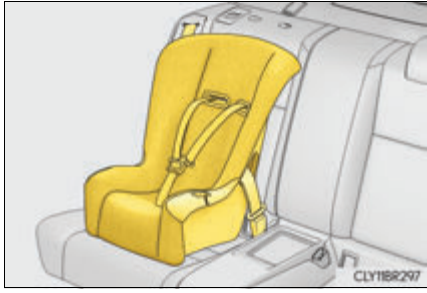
Confirm with the operation manual enclosed with the child restraint system about the installation of the child restraint system.

| Installation method                      |   | Page  |
|--|---|-------|
| Seat belt attachment                     |   | P. 64 |
| Child restraint LATCH anchors attachment |  | P. 70 |

1

For safety and security

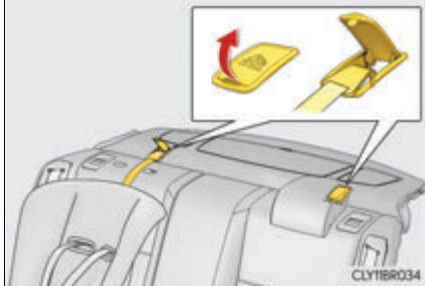
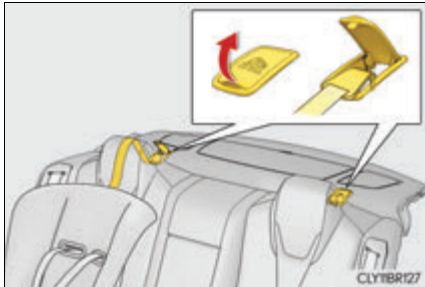
|   | Installation method   | Page |
|---|---|------|
| Anchor brackets<br>(for top tether strap)<br>attachment | ▶ RC350/RC300/RC200t<br><br>CLY1BR034 | P.73 |
|   | ▶ RC F<br><br>CLY1BR127              |      |



**When using a child restraint system on the front passenger seat****■ When installing a child restraint system to a passenger seat**

For the safety of a child, install child restraint systems to a rear seat. When installing child restraint system to a front passenger seat is unavoidable, adjust the passenger seat as follows and install the child restraint system.

- The seatback to the most upright position
- Move the seat to the rearmost position
- Raise the seat to the highest position
- If the head restraint interferes with the installation of the child restraint system, and the head restraint can be removed, remove the head restraint



1

For safety and security

**⚠ WARNING****■ When installing a child restraint system**

Observe the following when installing child restraint system to the front passenger seat if it is unavoidable. The front passenger SRS airbag inflates with considerable speed and force that if not observed may lead to death or serious injury to the child.

- Never install a rear-facing child restraint system on the front passenger seat even if the "AIR BAG OFF" indicator light is illuminated. In the event of an accident, the force of the rapid inflation of the front passenger airbag can cause death or serious injury to the child if the rear-facing child restraint system is installed on the front passenger seat.
- A forward-facing child restraint system may be installed on the front passenger seat only when it is unavoidable. A child restraint system that requires a top tether strap should not be used in the front passenger seat since there is no top tether strap anchor for the front passenger seat.
- A forward-facing child restraint system may be installed on the front passenger seat only when it is unavoidable. When installing a forward-facing child restraint system on the front passenger seat, adjust the seatback to the most upright position, move the seat to the rearmost position, and raise the seat to the highest position, even if the "AIR BAG OFF" indicator light is illuminated.



If the head restraint interferes with the installation of the child restraint system, and the head restraint can be removed, remove the head restraint.

- Do not allow the child to lean his/her head or any part of his/her body against the door or the area of the seat, front pillars or roof side rails from which the SRS side airbags or SRS curtain shield airbags deploy even if the child is seated in the child restraint system. It is dangerous if the SRS side and curtain shield airbags inflate, and the impact could cause death or serious injury to the child.
- When a booster seat is installed, always ensure that the shoulder belt is positioned across the center of the child's shoulder. The belt should be kept away from the child's neck, but not so that it could fall off the child's shoulder.

**When using a child restraint system on a rear seat****⚠ WARNING****■ When installing a child restraint system**

Observe the following precautions.

Failure to do so may result in death or serious injury.

- Use child restraint system suitable to the age and size of the child and install it to the rear seat.
- If the driver's seat interferes with the child restraint system and prevents it from being attached correctly, attach the child restraint system to the right-hand rear seat.
- Adjust the front passenger seat so that it does not interfere with the child restraint system.

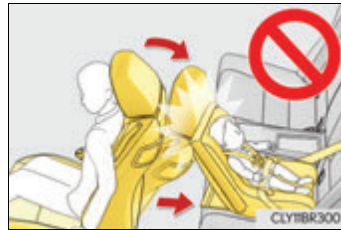

- Do not allow the child to lean his/her head or any part of his/her body against the door or the area of the seat, rear pillars or roof side rails from which the SRS curtain shield airbag deploys even if the child is seated in the child restraint system. It is dangerous if the SRS curtain shield airbag inflates, and the impact could cause death or serious injury to the child.

### Child restraint system fixed with a seat belt

A child restraint system for a small child or baby must itself be properly restrained on the seat with the lap portion of the lap/shoulder belt.

#### ◆ Installing child restraint system using a seat belt (child restraint lock function belt)

Install the child restraint system in accordance to the operation manual enclosed with the child restraint system.

#### ■ Rear-facing — Infant seat/convertible seat

##### 1 When using the front seat: Adjust the seatback

If there is gap between the child seat and the seatback, adjust the seatback until good contact is achieved.

##### 2 Place the child restraint system on the rear seat facing the rear of the vehicle.



##### 3 Run the seat belt through the child restraint system and insert the plate into the buckle. Make sure that the belt is not twisted.

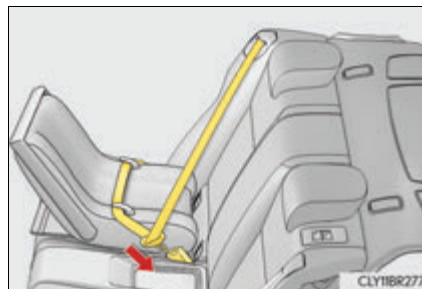

- 4 Fully extend the shoulder belt and allow it to retract to put it in lock mode. In lock mode, the belt cannot be extended.



- 5 While pushing the child restraint system down into the rear seat, allow the shoulder belt to retract until the child restraint system is securely in place.

After the shoulder belt has retracted to a point where there is no slack in the belt, pull the belt to check that it cannot be extended.

- 6 After installing the child restraint system, rock it back and forth to ensure that it is installed securely.

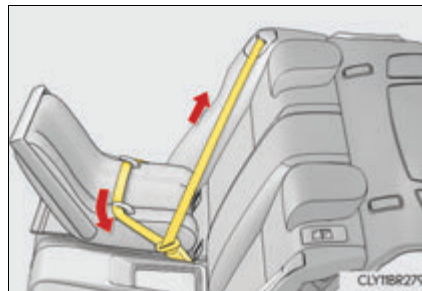

### ■ Forward-facing— Convertible seat

- 1 When using the front seat: Adjust the seatback

If there is gap between the child seat and the seatback, adjust the seatback until good contact is achieved.

- 2 RC350/RC300/RC200t:  
Remove the head restraint if it interferes with your child restraint system. (→P.164)

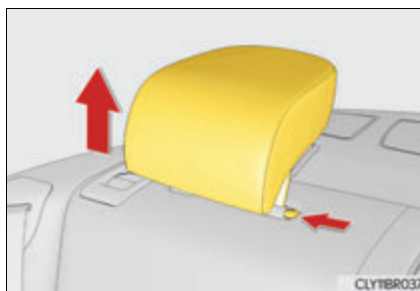

- 3 Place the child restraint system on the seat facing the front of the vehicle.



- 4 Run the seat belt through the child restraint system and insert the plate into the buckle. Make sure that the belt is not twisted.



- 5 Fully extend the shoulder belt and allow it to retract to put it in lock mode. In lock mode, the belt cannot be extended.



- 6 While pushing the child restraint system into the rear seat, allow the shoulder belt to retract until the child restraint system is securely in place.

After the shoulder belt has retracted to a point where there is no slack in the belt, pull the belt to check that it cannot be extended.



- 7 If the child restraint has a top tether strap, follow the child restraint manufacturer's operation manual regarding the installation, using the top tether strap to latch onto the top tether strap anchor. (→P. 73)
- 8 After installing the child restraint system, rock it back and forth to ensure that it is installed securely.

#### ■ Booster seat

- 1 High back type on RC350/RC300/RC200t: Remove the head restraint if it interferes with your child restraint system. (→P. 164)

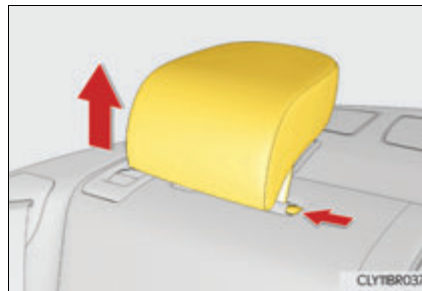

- 2 Place the child restraint system on the seat facing the front of the vehicle.

▶ Booster type



▶ High back type

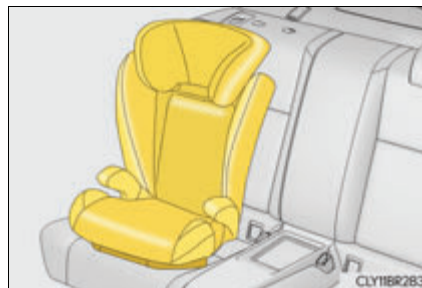

- 3 Sit the child in the child restraint system. Fit the seat belt to the child restraint system according to the manufacturer's instructions and insert the plate into the buckle. Make sure that the belt is not twisted.

Check that the shoulder belt is correctly positioned over the child's shoulder and that the lap belt is as low as possible. (→P. 34)



#### ◆ Removing a child restraint system installed with a seat belt

Press the buckle release button and fully retract the seat belt.

When releasing the buckle, the child restraint system may spring up due to the rebound of the seat cushion. Release the buckle while holding down the child restraint system.

Since the seat belt automatically reels itself, slowly return it to the stowing position.

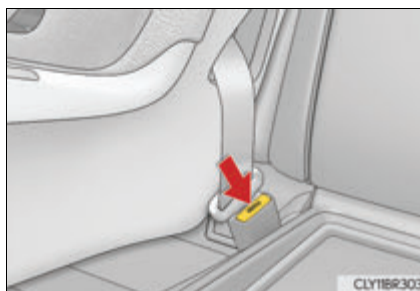



 **WARNING****■ When installing a child restraint system**

Observe the following precautions.

Failure to do so may result in death or serious injury.

- Do not allow children to play with the seat belt. If the seat belt becomes twisted around a child's neck, it may lead to choking or other serious injuries that could result in death. If this occurs and the buckle cannot be unfastened, scissors should be used to cut the belt.
- Ensure that the belt and plate are securely locked and the seat belt is not twisted.
- Shake the child restraint system left and right, and forward and backward to ensure that it has been securely installed.
- After securing a child restraint system, never adjust the seat.
- When a booster seat is installed, always ensure that the shoulder belt is positioned across the center of the child's shoulder. The belt should be kept away from the child's neck, but not so that it could fall off the child's shoulder.
- Follow all installation instructions provided by the child restraint system manufacturer.

**■ When installing a booster seat**

To prevent the belt from going into ALR lock mode, do not fully extend the shoulder belt. ALR mode causes the belt to tighten only. This could cause injury or discomfort to the child. (→P. 36)

**■ Do not use a seat belt extender**

If a seat belt extender is used when installing a child restraint system, the seat belt will not securely hold the child restraint system, which could cause death or serious injury to the child or other passengers in the event of sudden braking, sudden swerving or an accident.

**Child restraint system fixed with child restraint LATCH anchors****■ Child restraint LATCH anchors**

LATCH anchors are provided for the each rear seats. (Mark displaying the location of the anchors are attached to the seats.)

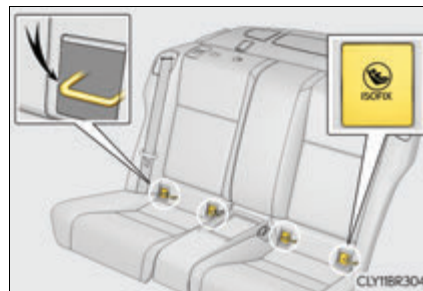

### ■ Installation with LATCH system

Install the child restraint system in accordance to the operation manual enclosed with the child restraint system.

- 1 RC350/RC300/RC200t:  
Remove the head restraint if it interferes with your child restraint system. (→P.164)

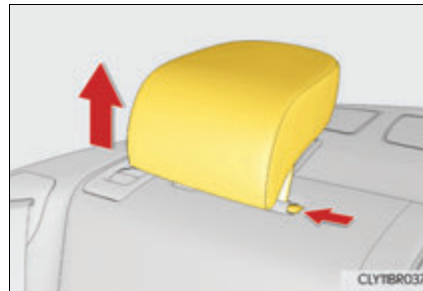

#### ▶ Type A

- 2 Latch the hooks of the lower straps onto the LATCH anchors.  
For owners in Canada:  
The symbol on a child restraint system indicates the presence of a lower connector system.

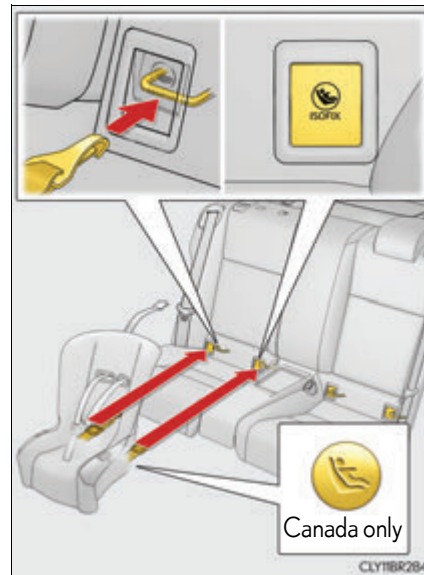

## ▶ Type B

- 2 Latch the buckles onto the LATCH anchors.

For owners in Canada:

The symbol on a child restraint system indicates the presence of a lower connector system.

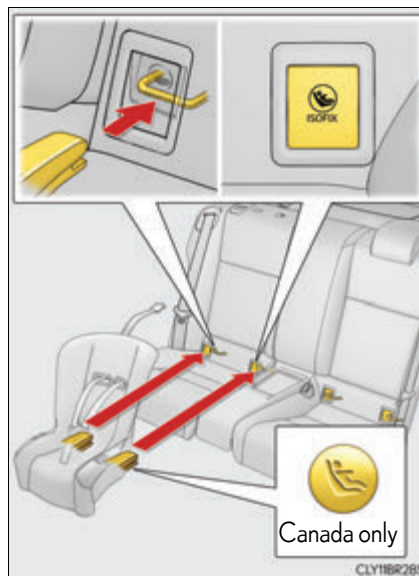

- 3 If the child restraint has a top tether strap, follow the child restraint manufacturer's operation manual regarding the installation, using the top tether strap to latch onto the top tether strap anchor. (→P. 73)
- 4 After installing the child restraint system, rock it back and forth to ensure that it is installed securely.

#### ■ Laws and regulations pertaining to anchorages

The LATCH system conforms to FMVSS225 or CMVSS210.2.

Child restraint systems conforming to FMVSS213 or CMVSS213 specifications can be used.

This vehicle is designed to conform to the SAE J1819.

#### ⚠ WARNING

##### ■ When installing a child restraint system

Observe the following precautions.

Failure to do so may result in death or serious injury.

- Shake the child restraint system left and right, and forward and backward to ensure that it has been securely installed.
- After securing a child restraint system, never adjust the seat.
- When using the LATCH anchors, be sure that there are no foreign objects around the anchors and that the seat belt is not caught behind the child restraint system.
- Follow all installation instructions provided by the child restraint system manufacturer.

## Using an anchor bracket (for top tether strap)

### ■ Anchor brackets (for top tether strap)

Anchor brackets are provided for the each rear seat.  
Use anchor brackets when fixing the top tether strap.

- ▶ RC350/RC300/RC200t
- ▶ RC F

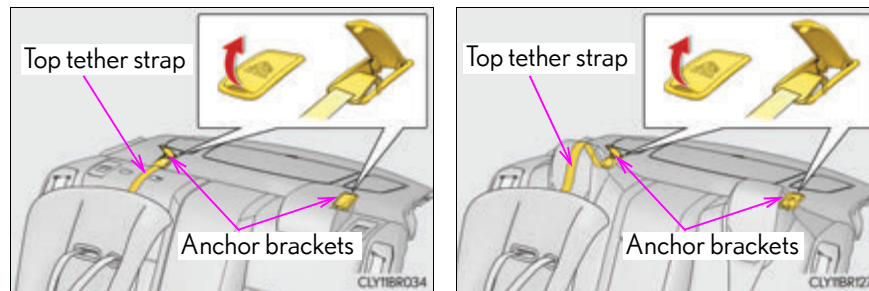

### ■ Fixing the top tether strap to the anchor bracket

Install the child restraint system in accordance to the operation manual enclosed with the child restraint system.

- 1 RC350/RC300/RC200t:  
Remove the head restraint if it interferes with your child restraint system. (→P.164)

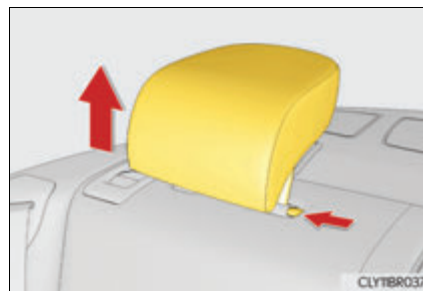

- 2 Open the anchor bracket cover, latch the hook onto the anchor bracket and tighten the top tether strap.

Make sure the top tether strap is securely latched.

- ▶ RC350/RC300/RC200t
- ▶ RC F

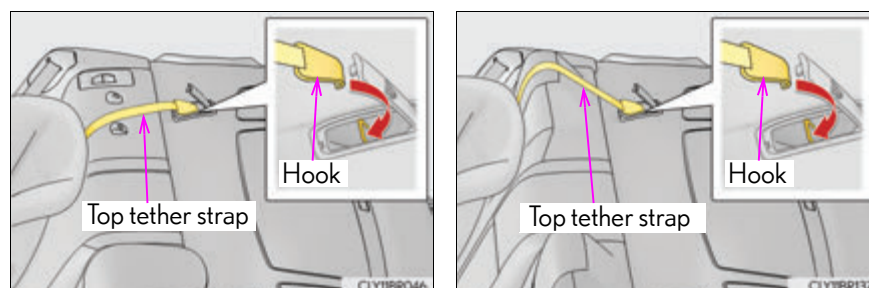

**■ Laws and regulations pertaining to anchorages**

The LATCH system conforms to FMVSS225 or CMVSS210.2.

Child restraint systems conforming to FMVSS213 or CMVSS213 specifications can be used.

This vehicle is designed to conform to the SAE J1819.

**⚠ WARNING****■ When installing a child restraint system**

Observe the following precautions.

Failure to do so may result in death or serious injury.

- Firmly attach the top tether strap and make sure that the belt is not twisted.
- Do not attach the top tether strap to anything other than the anchor bracket.
- Shake the child restraint system left and right, and forward and backward to ensure that it has been securely installed.
- After securing a child restraint system, never adjust the seat.
- Follow all installation instructions provided by the child restraint system manufacturer.

**⚠ NOTICE****■ Anchor brackets (for top tether strap)**

When not in use, make certain to close the lid. If it remains open, the lid may be damaged.

## Exhaust gas precautions

Harmful substance to the human body is included in exhaust gases if inhaled.

### WARNING

Exhaust gases include harmful carbon monoxide (CO), which is colorless and odorless. Observe the following precautions. Failure to do so may cause exhaust gases enter the vehicle and may lead to an accident caused by light-headedness, or may lead to death or a serious health hazard.

#### ■ Important points while driving

- Keep the trunk lid closed.
- If you smell exhaust gases in the vehicle even when the trunk lid is closed, open the windows and have the vehicle inspected at your Lexus dealer as soon as possible.

#### ■ When parking

- If the vehicle is in a poorly ventilated area or a closed area, such as a garage, stop the engine.
- Do not leave the vehicle with the engine on for a long time.  
If such a situation cannot be avoided, park the vehicle in an open space and ensure that exhaust fumes do not enter the vehicle interior.
- Do not leave the engine running in an area with snow build-up, or where it is snowing.  
If snowbanks build up around the vehicle while the engine is running, exhaust gases may collect and enter the vehicle.

#### ■ Exhaust pipe

The exhaust system needs to be checked periodically. If there is a hole or crack caused by corrosion, damage to a joint or abnormal exhaust noise, be sure to have the vehicle inspected and repaired by your Lexus dealer.

## Engine immobilizer system

The vehicle's keys have built-in transponder chips that prevent the engine from starting if a key has not been previously registered in the vehicle's on-board computer.

Never leave the keys inside the vehicle when you leave the vehicle.

This system is designed to help prevent vehicle theft but does not guarantee absolute security against all vehicle thefts.

The indicator light flashes after the engine switch has been turned off to indicate that the system is operating.

The indicator light stops flashing after the engine switch has been turned to ACCESSORY or IGNITION ON mode to indicate that the system has been canceled.

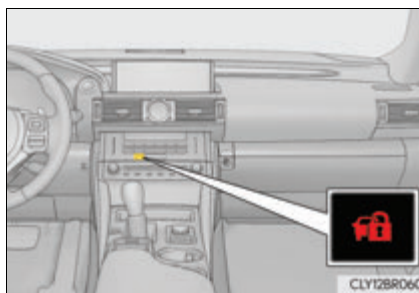

### ■ System maintenance

The vehicle has a maintenance-free type engine immobilizer system.

### ■ Conditions that may cause the system to malfunction

- If the grip portion of the key is in contact with a metallic object
- If the key is in close proximity to or touching a key registered to the security system (key with a built-in transponder chip) of another vehicle



**■ Certifications for the engine immobilizer system**

- ▶ For vehicles sold in the U.S.A.

FCC ID: NI4TMIMB-3

**NOTE:**

This device complies with part 15 of the FCC Rules. Operation is subject to the following two conditions: (1) This device may not cause harmful interference; and (2) This device must accept any interference received, including interference that may cause undesired operation.

This device complies with part 15 of the FCC Rules. Operation is subject to the following two conditions: (1) This device may not cause harmful interference, and (2) this device must accept any interference received, including interference that may cause undesired operation.

**FCC WARNING:**

Changes or modifications not expressly approved by the party responsible for compliance could void the user's authority to operate the equipment.

- ▶ For vehicles sold in Canada

This device complies with Industry Canada licence-exempt RSSs.

Operation is subject to the following two conditions:

- (1) This device may not cause interference; and
- (2) This device must accept any interference, including interference that may cause undesired operation of the device.

This device complies with Industry Canada licence-exempt RSS standard(s). Operation is subject to the following two conditions: (1) this device may not cause interference, and (2) this device must accept any interference, including interference that may cause undesired operation of the device.

**NOTE:**

**Le présent appareil est conforme aux CNR d'Industrie Canada applicables aux appareils radio exempts de licence. L'exploitation est autorisée aux deux conditions suivantes:**

- (1) l'appareil ne doit pas produire de brouillage;
- (2) l'utilisateur de l'appareil doit accepter tout brouillage radioélectrique subi, même si le brouillage est susceptible d'en compromettre le fonctionnement.

Le présent appareil est conforme aux CNR d'Industrie Canada applicables aux appareils radio exempts de licence. L'exploitation est autorisée aux deux conditions suivantes : (1) l'appareil ne doit pas produire de brouillage, et (2) l'appareil doit accepter tout brouillage radioélectrique subi, même si le brouillage est susceptible d'en compromettre le fonctionnement.

 NOTICE**■ To ensure the system operates correctly**

Do not modify or remove the system. If modified or removed, the proper operation of the system cannot be guaranteed.

## Alarm

### The alarm

The alarm uses light and sound to give an alert when an intrusion is detected. The alarm is triggered in the following situations when the alarm is set:

- A locked door or trunk is unlocked or opened in any way other than using the entry function, wireless remote control or mechanical key. (The doors will lock again automatically.)
- The hood is opened.

### Setting the alarm system

Close the doors, trunk and hood, and lock both side doors. The system will be set automatically after 30 seconds.

The indicator light changes from being on to flashing when the system is set.

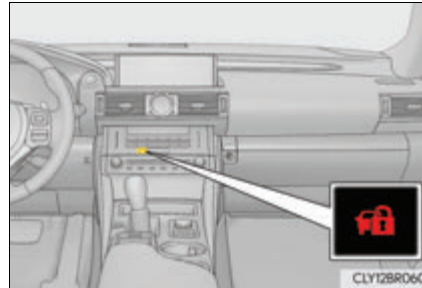

### Deactivating or stopping the alarm

Do one of the following to deactivate or stop the alarms:

- Unlock the doors or open the trunk.
- Turn the engine switch to ACCESSORY or IGNITION ON mode, or start the engine. (The alarm will be deactivated or stopped after a few seconds.)

■ **System maintenance**

The vehicle has a maintenance-free type alarm system.

■ **Items to check before locking the vehicle**

To prevent unexpected triggering of the alarm and vehicle theft, make sure of the following:

- Nobody is in the vehicle.
- The windows and moon roof (if equipped) are closed before the alarm is set.
- No valuables or other personal items are left in the vehicle.

■ **Triggering of the alarm**

The alarm may be triggered in the following situations:  
(Stopping the alarm deactivates the alarm system.)

- A person inside the vehicle opens a door, the trunk or hood, or unlocks the vehicle using an inside lock button.
- The battery is recharged or replaced when the vehicle is locked. (→P. 606)



■ **Alarm-operated door lock**

In the following cases, depending on the situation, the door may automatically lock to prevent improper entry into the vehicle:

- When a person remaining in the vehicle unlocks the door and the alarm is activated.
- While the alarm is activated, a person remaining in the vehicle unlocks the door.
- When recharging or replacing the battery

 **NOTICE**

■ **To ensure the system operates correctly**

Do not modify or remove the system. If modified or removed, the proper operation of the system cannot be guaranteed.

### Theft prevention labels (U.S.A.)

These labels are attached to the vehicle to reduce vehicle theft by facilitating the tracing and recovery of parts from stolen vehicles. Do not remove under penalty of law.



1

For safety and security



|   |     |
|---|-----|
| <b>2. Instrument cluster</b>                        |     |
| Warning lights and indicators.....                  | 84  |
| Gauges and meters (RC350/RC300/RC200t).....         | 92  |
| Gauges and meters (RC F).....                       | 98  |
| Multi-information display (RC350/RC300/RC200t)..... | 105 |
| Multi-information display (RC F).....               | 113 |
| Fuel consumption information.....                   | 126 |

## Warning lights and indicators

The warning lights and indicators on the instrument cluster, center panel and outside rear view mirrors inform the driver of the status of the vehicle's various systems.

For the purpose of explanation, the following illustrations display all warning lights and indicators illuminated.

- ▶ RC350/RC300/RC200t (except F SPORT models)



- ▶ RC350/RC300/RC200t (F SPORT models)





## ▶ RC F



The units used on the meters and some indicators may differ depending on the target region.

















2

Instrument cluster

RC350\_RC300\_RC200t\_RC F\_U (OM24671U)

### Warning lights

Warning lights inform the driver of malfunctions in the indicated vehicle systems.



















|   |  |  |   |
|---|--|--|---|
| <p><sup>*1</sup><br/> <br/>           (U.S.A.)</p>   | <p><sup>*1</sup> Brake system warning light<br/>           (→P. 543)</p>                   | <p><sup>*1,2</sup><br/> <br/>           (if equipped)</p> | <p>Pre-collision system warning light<br/>           (→P. 544)</p>                |
| <p><sup>*1</sup><br/> <br/>           (Canada)</p>   | <p><sup>*1</sup> Brake system warning light<br/>           (→P. 543)</p>                   | <p><sup>*1</sup><br/> </p>                                | <p>Slip indicator (→P. 544)</p>   |
| <p><sup>*1</sup><br/> </p>                           | <p><sup>*1</sup> Charging system warning light<br/>           (→P. 543)</p>                | <p><sup>*1</sup><br/> </p>                                | <p>Automatic headlight leveling system warning light<br/>           (→P. 544)</p> |
| <p><sup>*1</sup><br/> <br/>           (U.S.A.)</p>  | <p><sup>*1</sup> Malfunction indicator lamp<br/>           (→P. 543)</p>                   | <p></p>  | <p>Open door warning light<br/>           (→P. 544)</p>                           |
| <p><sup>*1</sup><br/> <br/>           (Canada)</p> | <p><sup>*1</sup> Malfunction indicator lamp<br/>           (→P. 543)</p>                   | <p></p>   | <p>Low fuel level warning light<br/>           (→P. 544)</p>                      |
| <p><sup>*1</sup><br/> </p>                         | <p><sup>*1</sup> SRS warning light<br/>           (→P. 543)</p>                            | <p></p>   | <p>Seat belt reminder light<br/>           (→P. 544)</p>                          |
| <p><sup>*1</sup><br/> <br/>           (U.S.A.)</p> | <p><sup>*1</sup> ABS warning light<br/>           (→P. 543)</p>                            | <p><sup>*1</sup><br/> </p>                              | <p>Master warning light<br/>           (→P. 544)</p>                              |
| <p><sup>*1</sup><br/> <br/>           (Canada)</p> | <p><sup>*1</sup> ABS warning light<br/>           (→P. 543)</p>                            | <p><sup>*1</sup><br/> </p>                              | <p>Tire pressure warning light<br/>           (→P. 545)</p>                       |
| <p><sup>*1</sup><br/> </p>                         | <p><sup>*1</sup> Electric power steering system warning light<br/>           (→P. 544)</p> |  |   |



\*1: These lights turn on when the engine switch is turned to IGNITION ON mode to indicate that a system check is being performed. They will turn off after the engine is started, or after a few seconds. There may be a malfunction in a system if a light does not come on, or turn off. Have the vehicle inspected by your Lexus dealer.



\*2: The light flashes to indicate a malfunction.

## Indicators

The indicators inform the driver of the operating state of the vehicle's various systems.

|   |   |   |  |
|---|---|---|--|
|    | Turn signal indicator<br>(→P. 210)                                |    | LDA (Lane Departure Alert) indicator (→P. 253)<br>(if equipped)                                  |
|    | Headlight indicator<br>(→P. 214)<br>(U.S.A.)                      |    | Intuitive parking assist indicator (→P. 260)<br>(if equipped)                                    |
|   | Tail light indicator<br>(→P. 214)<br>(Canada)                     |   | *1, 2<br>Slip indicator (→P. 289)  |
|  | Headlight high beam indicator (→P. 215)                           |  | *1<br>VSC OFF indicator (→P. 290)  |
|  | Automatic High Beam indicator (→P. 217)<br>(if equipped)          |  | *1, 8<br>TRAC OFF indicator (→P. 289)  |
|  | Front fog light indicator (→P. 222)<br>(if equipped)              |  | *1, 3<br>PCS<br>Pre-collision system warning light (→P. 296)<br>(if equipped)                    |
|  | Cruise control indicator (→P. 235, 239)                           |  | *4, 6<br>BSM (Blind Spot Monitor) outside rear view mirror indicators (→P. 302)<br>(if equipped) |
|  | Dynamic radar cruise control indicator (→P. 239)<br>(if equipped) |  | *7<br>Security indicator (→P. 76, 79)  |
|  | Cruise control "SET" indicator (→P. 235, 239)                     |  | *5<br>Low outside temperature indicator (→P. 92, 98)   |



|   |  |
|---|--|
| <p><sup>*1</sup><br/>  Eco Driving Indicator Light<br/>         (→P. 90)</p> | <p><sup>*1,7</sup><br/>  "AIR BAG ON/OFF"<br/>         indicator (→P. 50)</p> |
|---|--|

|  |   |
|--|---|
| <p><sup>*8</sup><br/>  Parking brake indicator<br/>         (→P. 211)<br/>         (U.S.A.)</p> | <p><sup>*8</sup><br/>  "EXPERT" indicator<br/>         (→P. 291)</p> |
|--|---|

<sup>\*8</sup>  
 Parking brake indicator  
 (→P. 211)  
 (Canada)



● Drive mode indicators

▶ RC350/RC300/RC200t (except F SPORT models)

|   |  |
|---|--|
| <p> Eco drive mode indicator<br/>         (→P. 283)</p> | <p> "SPORT" indicator<br/>         (→P. 283)</p> |
|---|--|

 Snow mode indicator  
 (→P. 206)

▶ RC350/RC300/RC200t (F SPORT models)

|  |   |
|--|---|
| <p> Eco drive mode indicator<br/>         (→P. 283)</p> | <p> "SPORT S" indicator<br/>         (→P. 283)</p> |
|--|---|

|  |   |
|--|---|
| <p> "SPORT S+" indicator<br/>         (→P. 283)</p> | <p> Snow mode indicator<br/>         (→P. 206)</p> |
|--|---|

## ▶ RC F



"NORMAL" indicator  
(→P. 283)



Eco drive mode indicator  
(→P. 283)



"SPORT S" indicator  
(→P. 283)



"SPORT S+" indicator  
(→P. 283)



Snow mode indicator  
(→P. 206)

## ● TVD (Torque Vectoring Differential) control mode indicators (RC F)



(if equipped)

"STANDARD" indicator  
(→P. 318)



(if equipped)

"SLALOM" indicator  
(→P. 318)



(if equipped)

"TRACK" indicator  
(→P. 318)

- \*1: These lights turn on when the engine switch is turned to IGNITION ON mode to indicate that a system check is being performed. They will turn off after the engine is started, or after a few seconds. There may be a malfunction in a system if a light does not come on, or turn off. Have the vehicle inspected by your Lexus dealer.
- \*2: The light flashes to indicate that the system is operating.
- \*3: The light comes on when the system is turned off. The light will flash quickly when the system is operating.
- \*4: In order to confirm operation, the BSM outside rear view mirror indicators illuminate in the following situations:
- When the engine switch is turned to IGNITION ON mode while the BSM main switch is turned on.
  - When the BSM main switch is turned on while the engine switch is in IGNITION ON mode.
- If the system is functioning correctly, the BSM outside rear view mirror indicators will turn off after a few seconds.  
If the BSM outside rear view mirror indicators do not illuminate or do not turn off, there may be a malfunction in the system.  
If this occurs, have the vehicle inspected by your Lexus dealer.
- \*5: When the outside temperature is approximately 37°F (3°C) or lower, the indicator will flash for approximately 10 seconds, then stay on.
- \*6: This light illuminates on the outside rear view mirrors.
- \*7: This light illuminates on the center panel.
- \*8: RC F

### ■ Eco Driving Indicator

#### ▶ RC350/RC300/RC200t

- ① Eco Driving Indicator Light  
During Eco-friendly acceleration (Eco driving), the Eco Driving Indicator Light will turn on. When the acceleration exceeds the Zone of Eco driving, or when the vehicle is stopped, the light turns off.
- ② Eco Driving Indicator Zone Display  
Suggests the Zone of Eco driving with current Eco driving ratio based on acceleration.
- ③ Eco driving ratio based on acceleration  
If the acceleration exceeds the Zone of Eco driving, the right side of the Eco Driving Indicator Zone Display will illuminate.
- ④ Zone of Eco driving

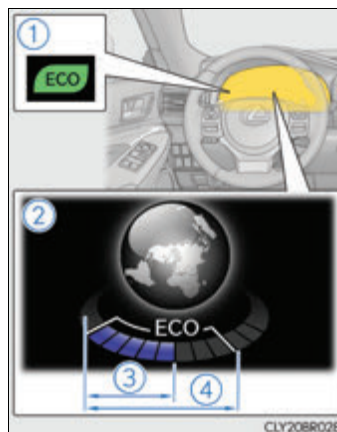

Eco Driving Indicator will not operate under the following conditions:

- The shift lever is in any position other than D.
  - A paddle shift switch is operated.
  - Neither normal mode nor Eco drive mode is selected. (→P. 283)
  - The vehicle speed is approximately 80 mph (130 km/h) or higher.
- ▶ RC F

During Eco-friendly acceleration (Eco driving), the Eco Driving Indicator Light will turn on. When the acceleration exceeds the Zone of Eco driving, or when the vehicle is stopped, the light turns off.

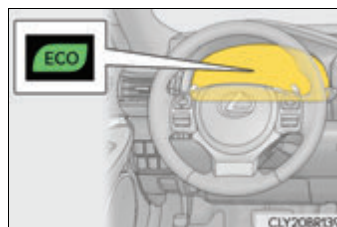

Eco Driving Indicator will not operate under the following conditions:

- The shift lever is in any position other than D.
- A paddle shift switch is operated.
- Neither normal mode nor Eco drive mode is selected. (→P. 283)
- The vehicle speed is approximately 80 mph (130 km/h) or higher.

 **WARNING****■ If a safety system warning light does not come on**

Should a safety system light such as the ABS and SRS warning light not come on when you start the engine, this could mean that these systems are not available to help protect you in an accident, which could result in death or serious injury. Have the vehicle inspected by your Lexus dealer immediately if this occurs.

## Gauges and meters (RC350/RC300/RC200t)

### ◆ Except F SPORT models

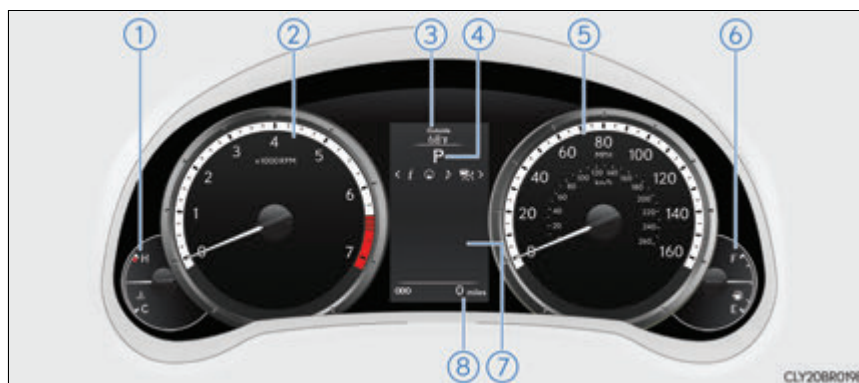

### ◆ F SPORT models

When the main meter is moved to the right, some of the meter displays and the gauge layout will change.

- ▶ Main meter in center position

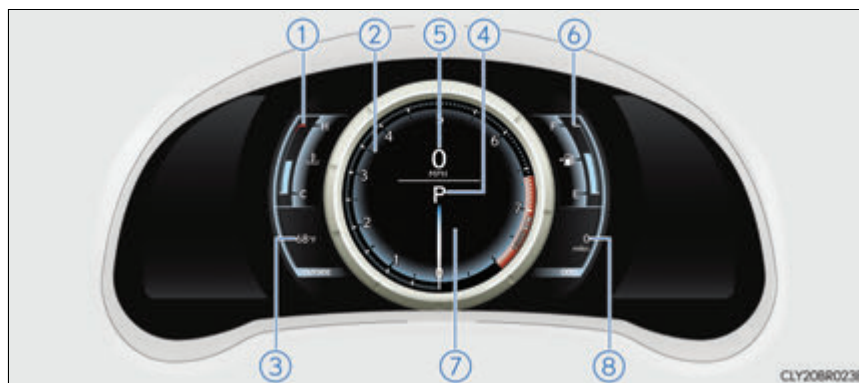



- Main meter moved to the right

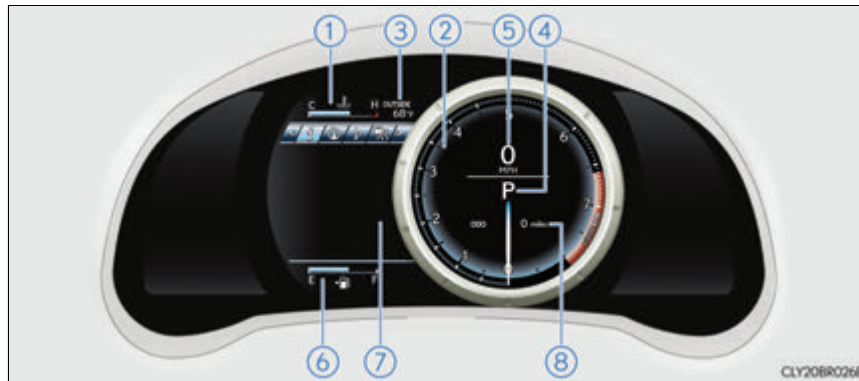

The units used on the meters may differ depending on the target region.

- ① Engine coolant temperature gauge  
Displays the engine coolant temperature
- ② Tachometer  
Displays the engine speed in revolutions per minute
- ③ Outside temperature  
Displays the outside temperature within the range of -40°F (-40°C) to 122°F (50°C). Low outside temperature indicator comes on when the ambient temperature is 37°F (3°C) or lower.
- ④ Shift position and gear position (→P. 205)
- ⑤ Speedometer
- ⑥ Fuel gauge
- ⑦ Multi-information display  
Presents the driver with a variety of vehicle data (→P. 105)  
Displays warning messages in case of a malfunction (→P. 549)
- ⑧ Odometer and trip meter display  
Odometer:  
Displays the total distance the vehicle has been driven  
Trip meter:  
Displays the distance the vehicle has been driven since the meter was last reset.  
Trip meters "A" and "B" can be used to record and display different distances independently.

### ■ Speed indicator (F SPORT models)

When the vehicle reaches a set speed, indicators will be displayed on both sides of the displayed speed unit.

The indicators will be displayed in yellow (corresponding to a speed set by a user) or red (fixed at 100 mph [160 km/h])<sup>\*</sup>.

This setting can be enabled on the multi-information display.

<sup>\*</sup>: Always observe the legal speed limit when driving on public roads.



### ■ Rev indicator (F SPORT models)

When the engine reaches a set speed, a ring-shaped indicator will be displayed on the tachometer.



### ■ Rev peak (F SPORT models)

The engine speed reaches or exceeds 5000 rpm, an afterimage of the tachometer will be displayed at the highest engine speed for approximately 0.5 seconds.



## Changing the display

### ■ Odometer/Trip meter

Switches between odometer and trip meter displays. When the trip meter is displayed, pressing and holding the button will reset the trip meter.

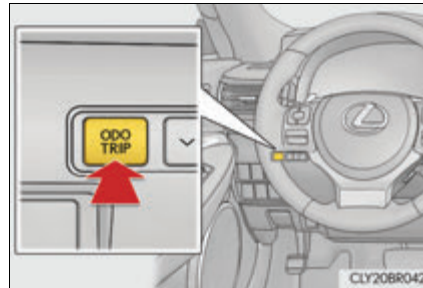

### ■ Main meter (F SPORT models)

Moves between center and right-side positions.

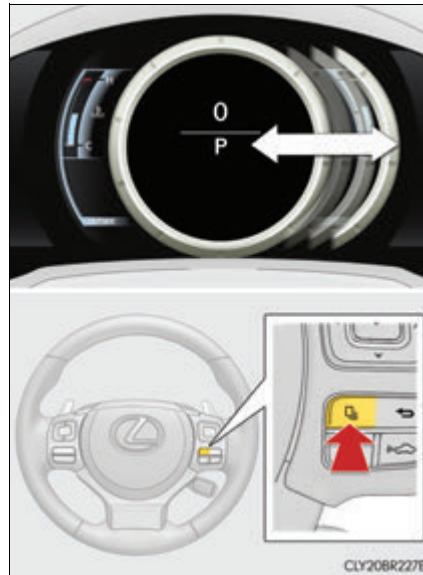

2

Instrument cluster

### Instrument panel light control

The brightness of the instrument panel lights can be adjusted.

- ① Darker
- ② Brighter

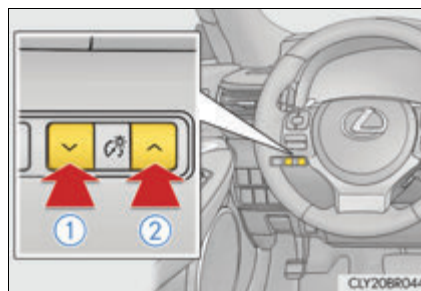

#### ■ The meters and display illuminate when

The engine switch is in IGNITION ON mode.

#### ■ Instrument panel brightness adjustment

The instrument panel brightness levels when the tail lights are on and off can be adjusted individually. However, when the surroundings are bright (daytime, etc.), turning on the tail lights will not change the instrument panel brightness. At this time, any adjustments made to the instrument panel brightness levels will be applied to both settings at once.

#### ■ Outside temperature display

- In the following situations, the correct outside temperature may not be displayed, or the display may take longer than normal to change.
  - When stopped, or driving at low speeds (less than 12 mph [20 km/h])
  - When the outside temperature has changed suddenly (at the entrance/exit of a garage, tunnel, etc.)
- When “- -” or “E” is displayed, the system may be malfunctioning. Take your vehicle to your Lexus dealer.

#### ■ Pop-up display

- In some situations, a pop-up display will be temporarily displayed on the multi-information display or the odometer/trip meter screen (F SPORT models only).
- Some pop-up displays can be set on/off. (→P. 110)

#### ■ Liquid crystal display

Small spots or light spots may appear on the display. This phenomenon is characteristic of liquid crystal displays, and there is no problem continuing to use the display.

#### ■ Customization

The meter display can be customized on the multi-information display. (→P. 105)

 NOTICE**■ To prevent damage to the engine and its components**

- Do not let the indicator of the tachometer enter the red zone, as it represents the engine speed range which exceeds the maximum safe engine speed.
- If the engine coolant temperature gauge is in the red zone (H), the engine may be overheating. In this case, immediately stop the vehicle in a safe place, and check the engine after it has cooled completely. (→P. 608)

## Gauges and meters (RC F)

If the drive mode is changed, some of the meter displays and the gauge layout will be changed.

- Normal mode



- Eco drive mode

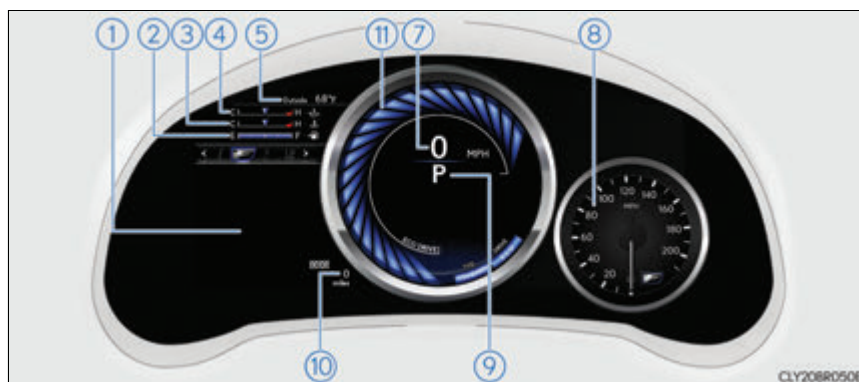

## ▶ SPORT S mode\*



## ▶ SPORT S+ mode\*



The units used on the meters may differ depending on the target region.

\*: These illustrations show the default meter display for SPORT S mode and SPORT S+ mode. The meter displays for SPORT S mode and SPORT S+ mode can be changed on the settings display of the multi-information display.

- ① Multi-information display  
Presents the driver with a variety of vehicle data (→P. 113)  
Displays warning messages in case of a malfunction (→P. 549)
- ② Fuel gauge
- ③ Engine coolant temperature gauge  
Displays the engine coolant temperature. If the engine coolant temperature gauge indicator (▼) enters the red zone, a buzzer will sound and the indicator will turn red and start flashing. Also, a warning message will be displayed.
- ④ Engine oil temperature gauge  
Displays the engine oil temperature. If the engine oil temperature gauge indicator (▼) enters the red zone, the indicator will turn red and start flashing.
- ⑤ Outside temperature  
Displays the outside temperature within the range of -40°F (-40°C) to 122°F (50°C). Low outside temperature indicator comes on when the ambient temperature is 37°F (3°C) or lower.
- ⑥ Tachometer  
Displays the engine speed in revolutions per minute
- ⑦ Digital speedometer
- ⑧ Analog speedometer
- ⑨ Shift position and gear position (→P. 205)
- ⑩ Odometer and trip meter display  
Odometer:  
Displays the total distance the vehicle has been driven  
Trip meter:  
Displays the distance the vehicle has been driven since the meter was last reset. Trip meters "A" and "B" can be used to record and display different distances independently.
- ⑪ Eco driving meter  
Displays the vehicle acceleration. The more rapidly the vehicle is accelerated, the lower the number of blue segments displayed, indicating that your driving is less eco-friendly. This meter is designed as a guideline to show the eco-friendliness of your driving.



### ■ Speed indicator

When the vehicle reaches the set speed, the speed unit display will turn yellow.

The indicators will be displayed in yellow (corresponding to a speed set by a user) or red (fixed at 100 mph [160 km/h])<sup>\*</sup>.

This setting can be enabled on the multi-information display.

<sup>\*</sup>: Always observe the legal speed limit when driving on public roads.

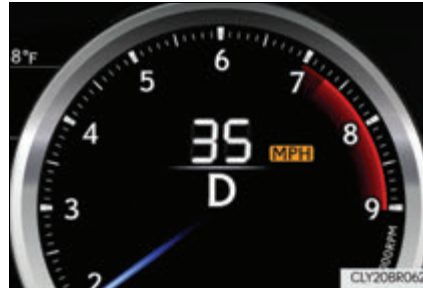

### ■ Rev indicator (SPORT S mode/SPORT S+ mode)

When the shift lever is in M, an indicator on the tachometer will be displayed in 3 steps. When the 3rd level indicator is displayed, the indicator will flash and a buzzer will sound to notify you of shift-up timing.

The indicator may be displayed when downshifting, depending on the engine speed.

<sup>\*</sup>: These illustrations show the default meter display for SPORT S mode and SPORT S+ mode. The meter displays for SPORT S mode and SPORT S+ mode can be changed on the settings display of the multi-information display.



■ Rev peak (Normal mode/SPORT S mode)

The engine speed reaches or exceeds 3600 rpm, an afterimage of the tachometer will be displayed at the highest engine speed for approximately 1 second.

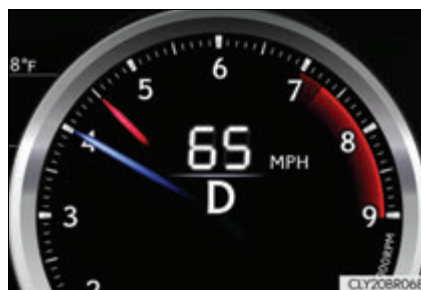

Changing the display

■ Odometer/Trip meter

Switches between odometer and trip meter displays. When the trip meter is displayed, pressing and holding the button will reset the trip meter.

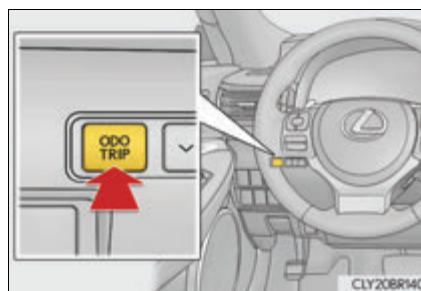

■ Meter display and layout

If the drive mode is changed, some of the meter displays and the gauge layout will be changed.

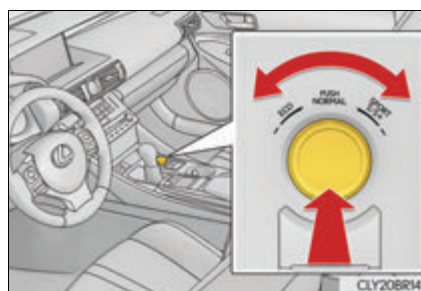

### Instrument panel light control

The brightness of the instrument panel lights can be adjusted.

- ① Darker
- ② Brighter

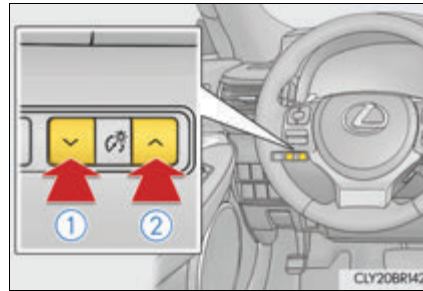

2

Instrument cluster

#### ■ The meters and display illuminate when

The engine switch is in IGNITION ON mode.

#### ■ Welcome illumination of the analog speedometer

- When the driver's door is opened, the analog speedometer will illuminate. Then, when the driver's door is closed, the analog speedometer will illuminate and go off (pulsate) 3 times.
- In the following situations, the analog speedometer will not pulsate even though the driver's door is opened and closed:
  - Within 60 seconds after the analog meter pulsation completes
  - Within 60 seconds of turning the engine switch off

#### ■ Variable red zone

To help protect the engine, the engine speed is controlled by starting the red zone of the tachometer at different engine speeds ranging from 3700 rpm to 7300 rpm depending on the engine coolant temperature. Before driving under extremely high load conditions, make sure to sufficiently warm up the engine.

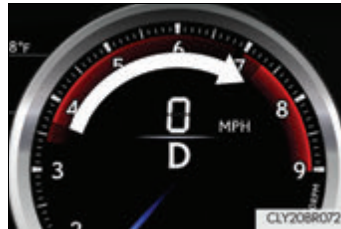

#### ■ Eco driving meter

- The number of blue segments displayed on the eco driving meter decreases/increases depending on the vehicle acceleration. Use this meter as a guideline when you wish to drive in an eco-friendly manner that reduces fuel consumption. However, on a downward grade where the vehicle can accelerate without the accelerator pedal being depressed, the eco driving meter may not display the eco-driving state correctly.
- When the shift lever is moved to P, N or R, the segments will turn gray and the eco driving meter will not operate.

■ **Instrument panel brightness adjustment**

The instrument panel brightness levels when the tail lights are on and off can be adjusted individually. However, when the surroundings are bright (daytime, etc.), turning on the tail lights will not change the instrument panel brightness. At this time, any adjustments made to the instrument panel brightness levels will be applied to both settings at once.

■ **Dimming the analog speedometer lighting**

The analog speedometer lighting will be dimmed when the ambient light is bright, such as during the daytime, and SPORT S or SPORT S+ mode is selected.

■ **Outside temperature display**

- In the following situations, the correct outside temperature may not be displayed, or the display may take longer than normal to change.
  - When stopped, or driving at low speeds (less than 12 mph [20 km/h])
  - When the outside temperature has changed suddenly (at the entrance/exit of a garage, tunnel, etc.)
- When “-” or “E” is displayed, the system may be malfunctioning. Take your vehicle to your Lexus dealer.

■ **Pop-up display**

- In some situations, such as when a switch operation is performed, a pop-up display will be temporarily displayed on the multi-information display.
- Some pop-up displays can be set on/off. (→P. 122)

■ **Liquid crystal display**



Small spots or light spots may appear on the display. This phenomenon is characteristic of liquid crystal displays, and there is no problem continuing to use the display.

■ **Customization**

The meter display can be customized on the multi-information display. (→P. 113)

 NOTICE

■ **To prevent damage to the engine and its components**

- Do not let the indicator of the tachometer enter the red zone, as it represents the engine speed range which exceeds the maximum safe engine speed.
- In the following situations, the engine may be overheating. In this case, immediately stop the vehicle in a safe place, and check the engine after it has cooled completely. (→P. 608)
  - The engine coolant temperature gauge indicator () is in the red zone and flashing.
  - The engine oil temperature gauge indicator () is in the red zone and flashing.

## Multi-information display (RC350/RC300/RC200t)

### ◆ Display content

- ▶ Except F SPORT models

Selecting a menu icon displays a variety of vehicle data or allows vehicle settings to be customized.



- ▶ F SPORT models

- Main meter in center position:

Displays various drive information on the main meter.

Content displayed is the same as those which are displayed when the main meter is moved to the right. (→P.108)

- Main meter moved to the right: Selecting a menu icon displays a variety of vehicle data or allows vehicle settings to be customized.



2

Instrument cluster

■ **Menu icons**

Displays the following information when an icon is selected.



Drive information (→P. 108)

Select to display various drive data.



Navigation system-linked display (if equipped)

Select to display the following navigation system-linked information.

- Route guidance
- Compass display (north-up display/heading-up display)



Audio system-linked display

Select to enable selection of an audio source or track on the meter using the meter control switches.



Dynamic radar cruise control operation guide

(vehicles with dynamic radar cruise control)

- Select to display operation procedures of the dynamic radar cruise control. (→P. 239)
- When the vehicle is in constant speed control mode (→P. 245), the menu icon will change to .
- Vehicles with LDA (Lane Departure Alert): If the LDA system (→P. 255) is activated, its operational status will also be displayed.



LDA (Lane Departure Alert) operational status

(vehicles with LDA but without a dynamic radar cruise control)

Select to display the operational status of the LDA system. (→P. 255)



Warning message display (→P. 549)

Select to display warning messages and measures to be taken if a malfunction is detected.







Settings display (→P. 110)

Select to change the meter display settings.

### ◆ Operating the meter control switches

The multi-information display is operated using the meter control switches.

①   : Switch menu

  : Change displayed content, scroll up/down the screen and move the cursor up/down

② Press: Enter/Set

Press and hold: Reset

③ Return to the previous screen

▶ Except F SPORT models

④ Press: Displays the screen registered to 

When no screen has been registered, the drive information screen will be displayed.

Press and hold: Registers the currently displayed screen to 

When the confirmation screen is displayed, select yes to register the screen. If the selected screen cannot be registered, a registration failure message will be shown.

▶ F SPORT models

④ Move the main meter

When the main meter moves to the right, the menu icons will be displayed on the left side.

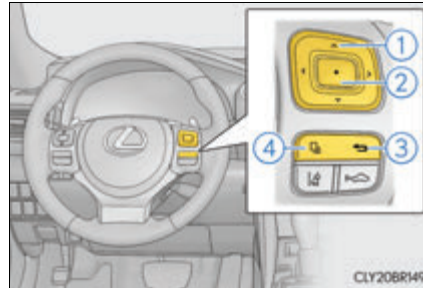

2

Instrument cluster

**Drive information**

■ **Drive information 1/Drive information 2**

Select to select up to 2 of the following items to display on each screen respectively.

F SPORT models (main meter in center position): Each item is displayed separately.

| Item                                | Content   |
|-------------------------------------|---|
| Current fuel consumption            | Displays instantaneous current fuel consumption         |
| Average fuel economy (after reset)  | Displays average fuel consumption since display reset*1 |
| Average fuel economy (after start)  | Displays average fuel consumption since engine start*1  |
| Average fuel economy (after refuel) | Displays average fuel consumption since refuel*1        |
| Average vehicle speed (after reset) | Displays average vehicle speed since display reset*1    |
| Average vehicle speed (after start) | Displays average vehicle speed since engine start*1     |
| Elapsed time (after reset)          | Displays elapsed time since display reset*1             |
| Elapsed time (after start)          | Displays elapsed time since engine start*1              |
| Distance (driving range)            | Displays driving range with remaining fuel*2, 3         |
| Distance (after start)              | Displays drive distance since vehicle start             |

\*1: Use the displayed figure (average fuel consumption, average vehicle speed, elapsed time) for reference only.

\*2: This distance is computed based on your average fuel consumption. As a result, the actual distance that can be driven may differ from that displayed.

\*3: When only a small amount of fuel is added to the tank, the display may not be updated.

When refueling, turn the engine switch off. If the vehicle is refueled without turning the engine switch off, the display may not be updated.



- **Resetting**

The following displays can be reset: average fuel consumption after reset, average vehicle speed after reset, and elapsed time after reset.

- To reset, display the desired item and press and hold .
- If both displayed items are resettable, a reset selection screen will appear.

- **Eco Driving Indicator**

→P. 90

- **Boost Meter/Oil Temperature Gauge/Oil Pressure Gauge (F SPORT models for RC200t)**

Boost Meter:

Displays the boost pressure. The display changes colors when the set pressure is exceeded.

Oil Temperature Gauge:

Displays the temperature of the engine oil. The display flashes when the engine oil exceeds 284°F (140°C).

Oil Pressure Gauge:

Displays the oil pressure for the engine interior. A buzzer sounds and warning message is displayed when the oil pressure gets low. (→P. 556)

Depending on the road conditions, temperature, vehicle speed, etc., the actual vehicle condition on the display screen may differ.  
Use the display screen as a reference.

- **Tire pressure**

→P. 502

- **Gear positions**



Displays the current gear position when the shift lever is in D or M.

- **Speed unit (F SPORT models with main meter in center position)**

The units of measure used can be changed while driving.

Unlike the units setting performed on the settings display, the units setting performed on the drive information menu can be changed while driving.

## Settings display

- **Language**  
Select to change the language on the display.
- **Units**  
Select to change the unit of measure for fuel consumption.
- **Maintenance system (if equipped)**  
Select to reset the maintenance data after the required maintenance is performed. (→P. 473)
- **Eco Driving Indicator Light**  
Select to activate/deactivate the Eco Driving Indicator Light.
- ** switch settings (except F SPORT models)**  
Displays a procedure to register a desired screen to .  
You can register 1 screen as a shortcut, which can be displayed by pressing . (→P. 107)
- **Drive information 1/Drive information 2**  
Select to select up to 2 items that will be displayed on the “Drive Info 1” screen and “Drive Info 2” screen respectively. (→P. 108)
- **Pop-up display**  
Select to set the following pop-up displays, which may appear in some situations, on/off.
  - Route guidance display of the navigation system-linked system (if equipped)
  - Incoming call display of the hands-free phone system
  - Windshield wiper switch operation display (if equipped)
  - Headlight switch operation display (if equipped)
  - Dynamic radar cruise control operation display (if equipped)
  - Instrument panel brightness adjustment display
  - Main meter switch operation display (F SPORT models)
- **Accent color (except F SPORT models)**  
Select to change the accent colors on the screen, such as the cursor color.
- **Needle (F SPORT models)**  
Select to change the needle color for the tachometer.

### ■ Rev indicator (F SPORT models)

Select to set the rev indicator on/off.

When set to on, proceed to set the engine speed at which the rev indicator will be displayed.

Selectable engine speed range:  
RC350/RC300: 2000 rpm to 6600 rpm  
RC200t: 2000 rpm to 6100 rpm

### ■ Rev peak (F SPORT models)

Select to set the rev peak on/off.

### ■ Speed indicator (F SPORT models)

Select to set the speed indicator on/off.

When set to on, proceed to set the vehicle speed at which the speed indicator will be displayed.

Selectable speed range:  
30 mph to 100 mph (50 km/h to 160 km/h)\*

\*: Always observe the legal speed limit when driving on public roads.

### ■ Initialization

Select to reset the meter display settings. (→P. 652)

### ■ Suspension of the settings display

In the following situations, operation of the settings display will be temporarily suspended.

- When a warning message appears on the multi-information display
- When the vehicle begins to move

### ■ Tire pressure

- It may take a few minutes to display the tire inflation pressure after the engine switch is turned to IGNITION ON mode. It may also take a few minutes to display the tire inflation pressure after inflation pressure has been adjusted.
- “---” may be displayed if the tire information cannot be determined due to unfavorable radio wave conditions.
- Tire inflation pressure changes with temperature. The displayed values may also be different from the values measured using a tire pressure gauge.

### ■ When disconnecting and reconnecting battery terminals

The drive information data will be reset.

### ■ Liquid crystal display

→P. 96

 **WARNING****■ Caution for use while driving**

- When operating the multi-information display while driving, pay extra attention to the safety of the area around the vehicle.
- Do not look continuously at the multi-information display while driving as you may fail to see pedestrians, objects on the road, etc. ahead of the vehicle.

**■ The information display at low temperatures**

Allow the interior of the vehicle to warm up before using the liquid crystal information display. At extremely low temperatures, the information display monitor may respond slowly, and display changes may be delayed.

For example, there is a lag between the driver's shifting and the new gear number appearing on the display. This lag could cause the driver to downshift again, causing rapid and excessive engine braking and possibly an accident resulting in death or injury.

**■ Cautions during setting up the display**

As the engine needs to be running during setting up the display, ensure that the vehicle is parked in a place with adequate ventilation. In a closed area such as a garage, exhaust gases including harmful carbon monoxide (CO) may collect and enter the vehicle. This may lead to death or a serious health hazard.

 **NOTICE****■ While setting up the display**

To prevent battery discharge, ensure that the engine is running while setting up the display features.

## Multi-information display (RC F)

### ◆ Display content

Selecting a menu icon displays a variety of vehicle data or allows vehicle settings to be customized.



### ■ Menu icons

Displays the following information when an icon is selected.



Drive information (→P. 115)

Select to display various drive data.



"F" content (→P. 117)

Select to display the lap timer, G-force, torque distribution (vehicles with TVD [Torque Vectoring Differential]) and other useful functions for sporty driving.



Navigation system-linked display (if equipped)

Select to display the following navigation system-linked information.

- Route guidance
- Compass display (north-up display/heading-up display)



Audio system-linked display

Select to enable selection of an audio source or track on the meter using the meter control switches.



Dynamic radar cruise control operation guide

(vehicles with dynamic radar cruise control)

- Select to display operation procedures of the dynamic radar cruise control. (→P. 239)
- When the vehicle is in constant speed control mode (→P. 245), the menu icon will change to .
- Vehicles with LDA (Lane Departure Alert): If the LDA system (→P. 255) is activated, its operational status will also be displayed.



LDA (Lane Departure Alert) operational status

(vehicles with LDA but without a dynamic radar cruise control)

Select to display the operational status of the LDA system. (→P. 255)



Warning message display (→P. 549)

Select to display warning messages and measures to be taken if a malfunction is detected.







Settings display (→P. 122)

Select to change the meter display settings.

◆ Operating the meter control switches

The multi-information display is operated using the meter control switches.

- ①   : Switch menu
-   : Change displayed content, scroll up/down the screen and move the cursor up/down

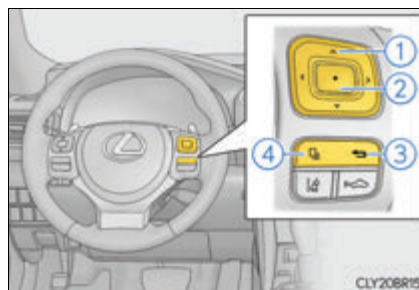

- ② Press: Enter/Set  
Press and hold: Reset
- ③ Return to the previous screen
- ④ Press: Displays the screen registered to 

When no screen has been registered, the drive information screen will be displayed.

Press and hold: Registers the currently displayed screen to 

When the confirmation screen is displayed, select yes to register the screen. If the selected screen cannot be registered, a registration failure message will be shown.

## Drive information

### ■ Drive information 1/Drive information 2

Select to select up to 2 of the following items to display on each screen respectively.

| Item                                | Content   |
|-------------------------------------|---|
| Current fuel consumption            | Displays instantaneous current fuel consumption                     |
| Average fuel economy (after reset)  | Displays average fuel consumption since display reset <sup>*1</sup> |
| Average fuel economy (after start)  | Displays average fuel consumption since engine start <sup>*1</sup>  |
| Average fuel economy (after refuel) | Displays average fuel consumption since refuel <sup>*1</sup>        |
| Average vehicle speed (after reset) | Displays average vehicle speed since display reset <sup>*1</sup>    |
| Average vehicle speed (after start) | Displays average vehicle speed since engine start <sup>*1</sup>     |
| Elapsed time (after reset)          | Displays elapsed time since display reset <sup>*1</sup>             |
| Elapsed time (after start)          | Displays elapsed time since engine start <sup>*1</sup>              |
| Distance (driving range)            | Displays driving range with remaining fuel <sup>*2, 3</sup>         |
| Distance (after start)              | Displays drive distance since vehicle start                         |

<sup>\*1</sup>: Use the displayed figure (average fuel consumption, average vehicle speed, elapsed time) for reference only.

<sup>\*2</sup>: This distance is computed based on your average fuel consumption. As a result, the actual distance that can be driven may differ from that displayed.

<sup>\*3</sup>: When only a small amount of fuel is added to the tank, the display may not be updated.

When refueling, turn the engine switch off. If the vehicle is refueled without turning the engine switch off, the display may not be updated.

● **Resetting**

The following displays can be reset: average fuel consumption after reset, average vehicle speed after reset, and elapsed time after reset.

- To reset, display the desired item and press and hold .
- If both displayed items are resettable, a reset selection screen will appear.

■ **Tire pressure**

→P.502

■ **Gear positions**

Displays the current gear position when the shift lever is in D or M.

■ **Units**

The units of measure used can be changed while driving.

Unlike the units setting performed on the settings display, the units setting performed on the drive information menu can be changed while driving.



## "F" content

### ■ Lap timer

Measures and displays current lap time and previous lap times

#### ● Reading the display

Measured lap times since the timer was last reset are displayed as follows:

- Multi-information display

- ① Total lap time
- ② Past lap times
- ③ Fastest lap (marked with a star)
- Main meter
  - ④ Current lap time
  - ⑤ Most recent lap time

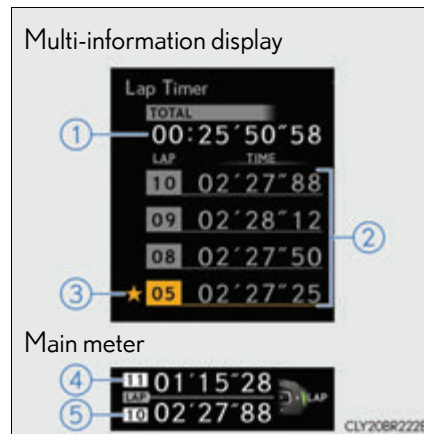

#### ● Operating the meter control switches

- ① Press: Start/stop lap timer  
Press and hold: Reset
- ② : Mark off one lap  
 : Change displayed content

While a lap time is being measured, the display can be changed to show the following content:

- Torque distribution (if equipped)
- G-force
- Tire pressure
- Rear wing position

#### ● Resetting/saving measured lap times

After stopping the lap timer, press and hold .

When a confirmation screen is displayed, select to reset/save the measured lap times.

When saved, the lap time data will be displayed on the history screen. (→P. 118)

■ History (Lap timer)

Displays the saved lap times

- Reading the display

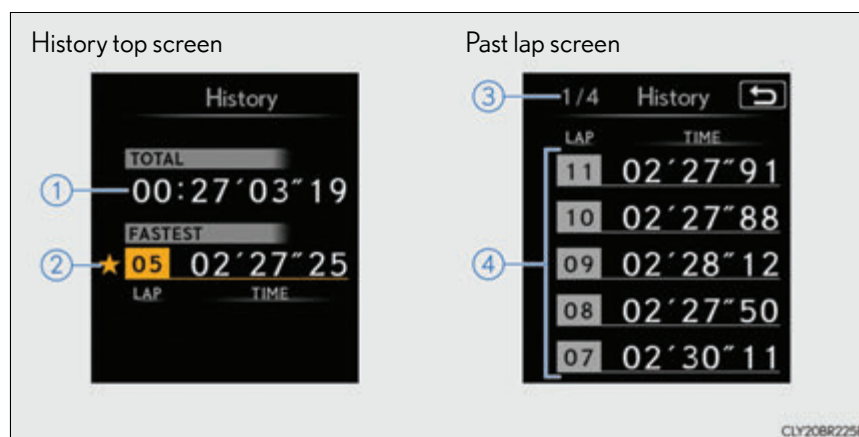

- History top screen

① Total lap time

② Fastest lap time

- Past lap screen

③ Page

④ Past lap times (20 most recent lap times)

Press / to scroll up and down the screen.

- Switching the display

To display the past lap screen, press .

To return to the history top screen, press .

- Deleting history

When the history top screen is displayed, press and hold to display a confirmation screen. To delete the history, follow the instructions displayed on the screen.

### ■ Torque distribution (if equipped)

Displays the distribution of driving torque between the left and right rear wheels

#### ● Reading the display

##### • Normal display

Displays the amount of drive torque applied to the left and right rear wheels through bars that fluctuate in length on the multi-information display

##### • Advanced display

Displays the difference in torque applied to the left and right rear wheels through displayed segments on the main meter in addition to the bar display.

The greater the number of segments displayed, the greater the difference in torque is.

#### ● Switching the display

To switch to advanced display, press .

To return to normal display, press .

#### ● Peak hold function (advanced display only)

If the difference in torque of 4 segments or more is applied to the left or right rear wheel, a yellow outline will be displayed for the highest segment that was reached, for a certain amount of time.

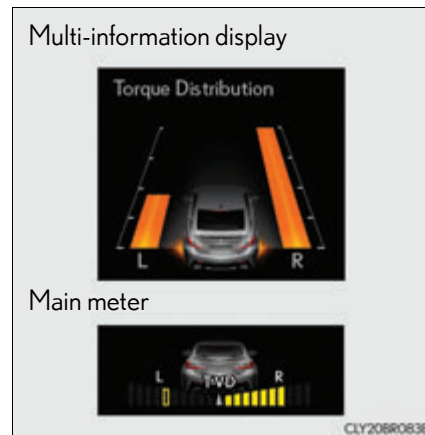

2

Instrument cluster

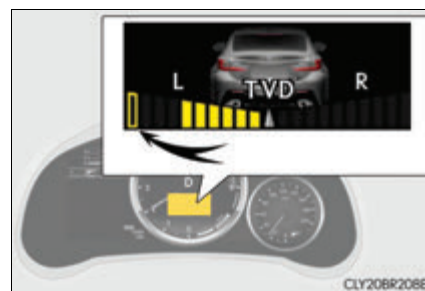

■ G-force

Displays lateral G-forces on the vehicle

Also displays, around the periphery of the G-force display, the left and right steering amount, accelerator pedal input, and brake fluid pressure

● Reading the display

- Normal display

Displays the following on the multi-information display

- ① Acceleration G-force on the vehicle
- ② Current G-force value (analyzed value of front/rear and left/right G-forces)
- ③ Accelerator pedal input
- ④ Brake fluid pressure
- ⑤ Steering amount

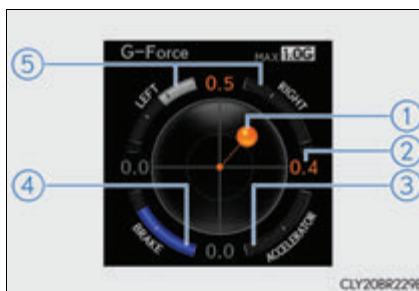

- Advanced display

Displays the following on the main meter and multi-information display

- ① Acceleration G-force on the vehicle
- ② Record of the maximum G-forces
- ③ Value of the maximum G-force since display reset (analyzed value of front/rear and left/right G-forces)
- ④ Accelerator pedal input
- ⑤ Brake fluid pressure
- ⑥ Steering amount
- ⑦ G-force direction

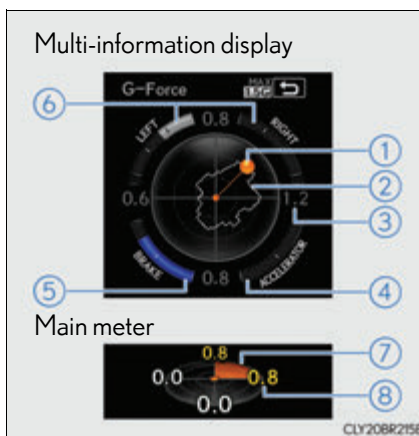

- ⑧ Current G-force value (analyzed value of front/rear and left/right G-forces)

This display is intended for use as a guideline. Depending on factors such as the road surface condition, temperature and vehicle speed, the display may not show the actual condition of the vehicle.

- Switching the display

To switch to advanced display, press .

To return to normal display, press .

- Resetting the record of maximum G-forces

With the record of maximum G-forces displayed, press and hold  to reset the display.

- Peak hold function (advanced display only)

If lateral G-forces of 0.5 G or greater are generated, the G-force value displayed on the main meter will turn yellow and be held for 3 seconds.

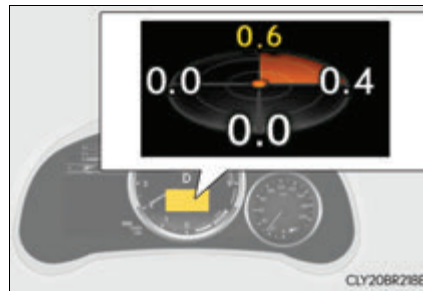

2

Instrument cluster

- Tire pressure



Displays the tire inflation pressure (→P. 502)

Unlike the tire pressure display on the drive information menu, the tire inflation pressure display of the "F" content menu can be displayed while lap time is being measured.

- Rear wing position

Displays the raised/retracted state of the active rear wing

## Settings display

- **Language**  
Select to change the language on the display.
- **Units**  
Select to change the unit of measure for fuel consumption.
- **Maintenance system (U.S.A. only)**  
Select to reset the maintenance data after the required maintenance is performed. (→P. 473)
- **Eco Driving Indicator Light**  
Select to activate/deactivate the Eco Driving Indicator Light.
-  **switch settings**  
Displays a procedure to register a desired screen to .  
You can register 1 screen as a shortcut, which can be displayed by pressing . (→P. 114)
- **Drive information 1/Drive information 2**  
Select to select up to 2 items that will be displayed on the “Drive Info 1” screen and “Drive Info 2” screen respectively. (→P. 115)
- **Pop-up display**  
Select to set the following pop-up displays, which may appear in some situations, on/off.
  - Route guidance display of the navigation system-linked system (if equipped)
  - Incoming call display of the hands-free phone system
  - Windshield wiper switch operation display (if equipped)
  - Headlight switch operation display (if equipped)
  - Dynamic radar cruise control operation display (if equipped)
  - Instrument panel brightness adjustment display
  - TVD control mode change display (if equipped)
  - Drive mode change display
- **Rev indicator**  
Select to set the rev indicator on/off.  
When set to on, proceed to select the engine speed at which the rev indicator will be displayed.
- **Rev peak**  
Select to set the rev peak on/off.

**■ Speed indicator**

Select to set the speed indicator on/off.

When set to on, proceed to set the vehicle speed at which the speed indicator will be displayed.

Selectable speed range:  
30 mph to 100 mph (50 km/h to 160 km/h)\*

\*: Always observe the legal speed limit when driving on public roads.

**■ Rear wing**

Select to enable/disable the active rear wing.

**■ SPORT gauges**

The SPORT S or SPORT S+ mode meter display can be selected and set as the customized display for either SPORT S or SPORT S+ mode.

**■ Initialization**

Select to reset the meter display settings. (→P. 652)

**■ Start-up display**

When the engine is started, the name of the vehicle is displayed on the multi-information display.

While the start-up display is being displayed, the meter display cannot be changed even if the drive mode is changed. When the start-up display is finished, the meter display for the currently selected mode will be displayed.

**■ Torque distribution display (if equipped)**

Torque distribution may not be displayed correctly in some cases, such as when the vehicle passes over road expansion joints.

**■ G-force display**

- The G-force values may not be zero even when the vehicle is parked, such as when it is parked on an incline.
- The steering amount, accelerator pedal input, and brake fluid pressure displays are disabled until the engine has warmed up (the variable red zone of the tachometer has retracted to 7300 rpm).  
After the engine has warmed up, these displays will be enabled.
- Depending on the vehicle usage conditions, the brake fluid pressure display may not reach its maximum reading even though the brake pedal is fully depressed.
- If a battery terminal is disconnected and reconnected, the steering amount display may be disabled temporarily. After driving the vehicle for a while, the display will be enabled.

■ **Suspension of the settings display**

In the following situations, operation of the settings display will be temporarily suspended.

- When a warning message appears on the multi-information display
- When the vehicle begins to move

■ **Tire pressure**

- It may take a few minutes to display the tire inflation pressure after the engine switch is turned to IGNITION ON mode. It may also take a few minutes to display the tire inflation pressure after inflation pressure has been adjusted.
- “---” may be displayed if the tire position information cannot be determined due to unfavorable radio wave conditions.
- Tire inflation pressure changes with temperature. The displayed values may also be different from the values measured using a tire pressure gauge.

■ **When disconnecting and reconnecting battery terminals**

The following information data will be reset:

- Drive information
- Lap timer: Measured lap times, history
- G-force: Record of the maximum G-forces

■ **Using the lap timer**

If the engine is stopped while a lap is being timed, the lap timer will stop and the lap time up to that point will be recorded.

■ **Liquid crystal display**

→P.104

|  |
|--|
|  <b>WARNING</b>   |
| <p>■ <b>Caution for use while driving</b></p> <ul style="list-style-type: none"> <li>● When operating the multi-information display while driving, pay extra attention to the safety of the area around the vehicle.</li> <li>● Do not look continuously at the multi-information display while driving as you may fail to see pedestrians, objects on the road, etc. ahead of the vehicle.</li> </ul> <p>■ <b>The information display at low temperatures</b></p> <p>Allow the interior of the vehicle to warm up before using the liquid crystal information display. At extremely low temperatures, the information display monitor may respond slowly, and display changes may be delayed.</p> <p>For example, there is a lag between the driver's shifting and the new gear number appearing on the display. This lag could cause the driver to downshift again, causing rapid and excessive engine braking and possibly an accident resulting in death or injury.</p> <p>■ <b>Cautions during setting up the display</b></p> <p>As the engine needs to be running during setting up the display, ensure that the vehicle is parked in a place with adequate ventilation. In a closed area such as a garage, exhaust gases including harmful carbon monoxide (CO) may collect and enter the vehicle. This may lead to death or a serious health hazard.</p> |



 NOTICE■ **While setting up the display**

To prevent battery discharge, ensure that the engine is running while setting up the display features.

## Fuel consumption information

Fuel consumption information can be displayed on the navigation system screen or the Lexus Display Audio screen.

▶ Vehicles with a navigation system

▶ Vehicles with a Lexus Display Audio system

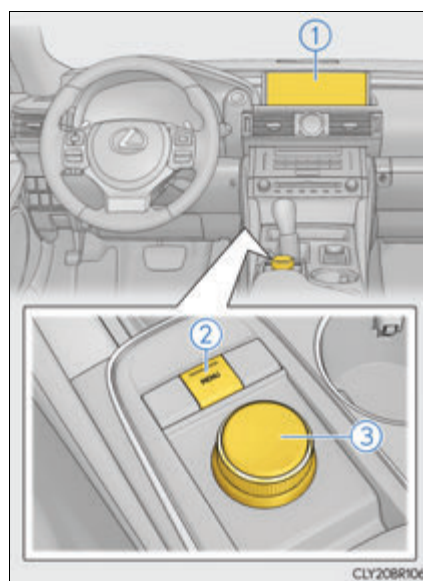
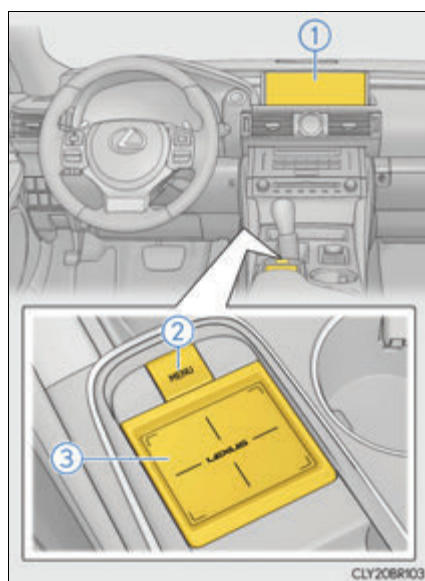

① Navigation system screen

② "MENU" button

③ Touchpad\*

\*: For use of the Remote Touch, refer to "NAVIGATION SYSTEM OWNER'S MANUAL".

① Lexus Display Audio screen

② "MENU" button

③ Lexus Display Audio controller (→P. 328)

## Trip information

### ▶ Navigation system screen

Press the "MENU" button on the Remote Touch, then select "Info" on the "Menu" screen, and then select "Fuel Consumption".

If the "Past Record" screen is displayed, select "Trip Information".



### ■ Trip information screen

- ① Resetting the consumption data
- ② Fuel consumption in the past 15 minutes
- ③ Displays the average vehicle speed since the engine was started.
- ④ Displays the elapsed time since the engine was started.
- ⑤ Cruising range (→P. 130)



2

Instrument cluster

▶ Lexus Display Audio screen

Press the “MENU” button on the Lexus Display Audio controller, then select “Info” on the “Menu” screen, and then select “Fuel Consumption”.

If the “Trip Information” screen does not appear, move the controller to the right and select “Trip Information”.



■ Trip information screen

- ① Fuel consumption in the past 15 minutes
- ② Displays the average vehicle speed since the engine was started.
- ③ Displays the elapsed time since the engine was started.
- ④ Cruising range (→P. 130)

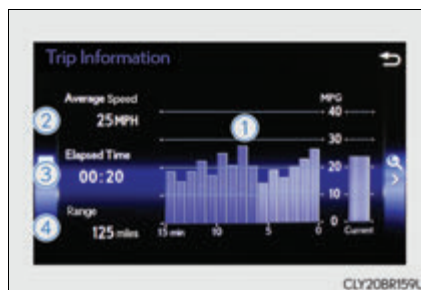

Average fuel consumption for the past 15 minutes is divided by color into past averages and averages attained since the engine switch was last turned to IGNITION ON mode. Use the displayed average fuel consumption as a reference.

The image is an example only.

## Past record

### ▶ Navigation system screen

Press the "MENU" button on the Remote Touch, then select "Info" on the "Menu" screen, and then select "Fuel Consumption".

If the "Trip Information" screen is displayed, select "Past Record".

### ■ Past record screen

- ① Resetting the past record data
- ② Best recorded fuel consumption
- ③ Average fuel consumption
- ④ Previous fuel consumption record
- ⑤ Updating the average fuel consumption data



### ▶ Lexus Display Audio screen

Press the "MENU" button on the Lexus Display Audio controller, then select "Info" on the "Menu" screen, and then select "Fuel Consumption".

If the "Past Record" screen does not appear, move the controller to the right and select "Past Record".

### ■ Past record screen

- ① Previous fuel consumption record
- ② Average fuel consumption
- ③ Best recorded fuel consumption



The average fuel consumption history is divided by color into past averages and the average fuel consumption since the last updated. Use the displayed average fuel consumption as a reference.

The image is an example only.

■ **Updating the past record data**

- ▶ Navigation system

Update the average fuel consumption by selecting "Update" to measure the current fuel consumption again.

- ▶ Lexus Display Audio system

Update the average fuel consumption by moving the controller to the left and select "Update" to measure the current fuel consumption again.

■ **Resetting the data**

- ▶ Navigation system

The fuel consumption data can be deleted by selecting "Clear".

- ▶ Lexus Display Audio system

The fuel consumption data can be deleted by moving the controller to the left and select "Clear".

■ **Cruising range**

Displays the estimated maximum distance that can be driven with the quantity of fuel remaining.

This distance is computed based on your average fuel consumption.

As a result, the actual distance that can be driven may differ from that displayed.

|  |     |
|--|-----|
| <b>3-1. Key information</b>                                  |     |
| Keys .....   | 132 |
| <b>3-2. Opening, closing and locking the doors and trunk</b> |     |
| Doors .....  | 137 |
| Trunk.....   | 143 |
| Smart access system with push-button start.....              | 148 |
| <b>3-3. Adjusting the seats</b>                              |     |
| Front seats.....   | 155 |
| Rear seats.....  | 158 |
| Driving position memory.....                                 | 160 |
| Head restraints .....  | 164 |
| <b>3-4. Adjusting the steering wheel and mirrors</b>         |     |
| Steering wheel .....   | 167 |
| Inside rear view mirror.....                                 | 169 |
| Outside rear view mirrors .....                              | 171 |
| <b>3-5. Opening, closing the windows and moon roof</b>       |     |
| Power windows .....  | 174 |
| Moon roof.....   | 178 |

## Keys

### The keys

The following keys are provided with the vehicle.

- ① Electronic keys
  - Operating the smart access system with push-button start (→P. 148)
  - Operating the wireless remote control function
- ② Mechanical keys
- ③ Key number plate
- ④ Card key (electronic key) (if equipped)
  - Operating the smart access system with push-button start (→P. 148)

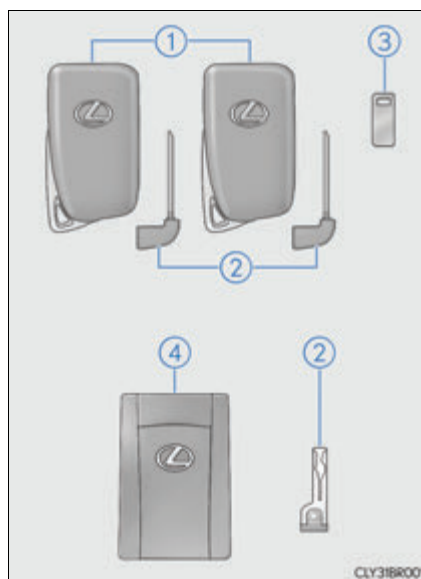

### Wireless remote control

- ① Locks the doors (→P. 137)
- ② Unlocks the doors (→P. 137)
- ③ Opens the windows and moon roof\* (→P. 137)
- ④ Opens the trunk (→P. 143)
- ⑤ Sounds the alarm (→P. 133)

\*: This setting must be customized at your Lexus dealer.

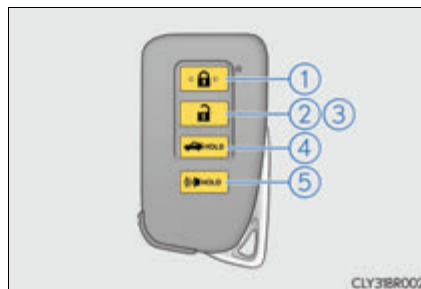



### Using the mechanical key

To take out the mechanical key, push the release button and take the key out.

The mechanical key can only be inserted in one direction, as the key only has grooves on one side. If the key cannot be inserted in a lock cylinder, turn it over and re-attempt to insert it.

After using the mechanical key, store it in the electronic key. Carry the mechanical key together with the electronic key. If the electronic key battery is depleted or the entry function does not operate properly, you will need the mechanical key. (→P. 600)

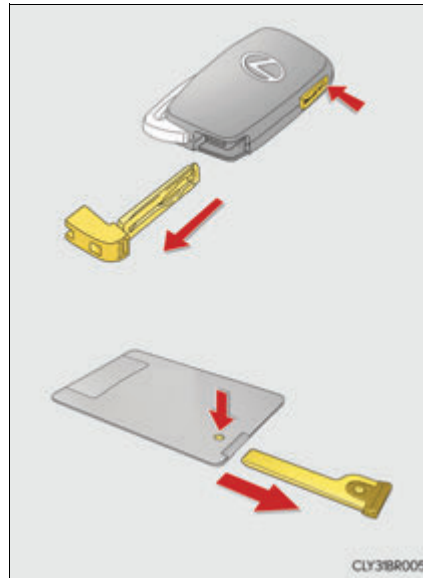

3

Operation of each component

### ■ Panic mode

When  is pressed for longer than about one second, an alarm will sound intermittently and the vehicle lights will flash to deter any person from trying to break into or damage your vehicle.

To stop the alarm, press any button on the electronic key.



■ **Card key (if equipped)**

- The card key is not waterproof.
- The mechanical key that is stored inside the card key should be used only if a problem arises, such as when the card key does not operate properly.
- If it is difficult to take out the mechanical key, push down the lock release button using a pen tip etc. If it is still difficult to pull it out, use a coin etc.
- To store the mechanical key in the card key, insert it while pressing the lock release button.



- If the battery cover is not installed and the battery falls out or if the battery was removed because the key got wet, reinstall the battery with the positive terminal facing the Lexus emblem.

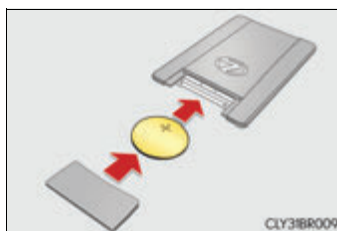

■ **When required to leave the vehicle's key with a parking attendant**

Set the luggage security system (→P. 144) on and lock the glove box (→P. 436) as circumstances demand.  
Remove the mechanical key for your own use and provide the attendant with the electronic key only.

■ **If you lose your mechanical keys**

New genuine mechanical keys can be made by your Lexus dealer using another mechanical key and the key number stamped on your key number plate. Keep the plate in a safe place such as your wallet, not in the vehicle.

■ **When riding in an aircraft**

When bringing an electronic key onto an aircraft, make sure you do not press any buttons on the electronic key while inside the aircraft cabin. If you are carrying an electronic key in your bag etc., ensure that the buttons are not likely to be pressed accidentally. Pressing a button may cause the electronic key to emit radio waves that could interfere with the operation of the aircraft.

**■ Electronic key battery depletion**

- The standard battery life is 1 to 2 years. (The card key battery life is about a year and a half.)
- If the battery becomes low, an alarm will sound in the cabin when the engine is stopped. (→P. 567)
- As the electronic key always receives radio waves, the battery will become depleted even if the electronic key is not used. The following symptoms indicate that the electronic key battery may be depleted. Replace the battery when necessary. (→P. 517)
  - The smart access system with push-button start or the wireless remote control does not operate.
  - The detection area becomes smaller.
  - The LED indicator on the key surface does not turn on.
- To avoid serious deterioration, do not leave the electronic key within 3 ft. (1 m) of the following electrical appliances that produce a magnetic field:
  - TVs
  - Personal computers
  - Cellular phones, cordless phones and battery chargers
  - Recharging cellular phones or cordless phones
  - Table lamps
  - Induction cookers

**■ Replacing the battery**

→P. 517

**■ Confirmation of the registered key number**

The number of keys already registered to the vehicle can be confirmed. Ask your Lexus dealer for details.

**■ If a wrong key is used**

The key cylinder rotates freely, isolated from the internal mechanism.

 NOTICE

■ **To prevent key damage**

- Do not drop the keys, subject them to strong shocks or bend them.
- Do not expose the keys to high temperatures for long periods of time.
- Do not get the keys wet or wash them in an ultrasonic washer etc.
- Do not attach metallic or magnetic materials to the keys or place the keys close to such materials.
- Do not disassemble the keys.
- Do not attach a sticker or anything else to the surface of the electronic key.
- Do not place the keys near objects that produce magnetic fields, such as TVs, audio systems and induction cookers.

■ **Carrying the electronic key on your person**

Carry the electronic key 3.9 in. (10 cm) or more away from electric appliances that are turned on. Radio waves emitted from electric appliances within 3.9 in. (10 cm) of the electronic key may interfere with the key, causing the key to not function properly.

■ **In case of a smart access system with push-button start malfunction or other key-related problems**

Take your vehicle with all the electronic keys provided with your vehicle, including the card key, to your Lexus dealer.

■ **When an electronic key is lost**

If the electronic key remains lost, the risk of vehicle theft increases significantly. Visit your Lexus dealer immediately with all remaining electronic keys and the card key that were provided with your vehicle.

■ **Handling the card key (if equipped)**

- Do not apply excess force when inserting the mechanical key into the card key. Doing so may damage the card key.
- If the battery or card key terminals get wet, the battery may corrode.  
If the key is dropped into water, or if drinking water etc. is spilled on the key, immediately remove the battery cover and wipe the battery and terminals. (To remove the battery cover, lightly grasp and pull it.) If the battery is corroded, have your Lexus dealer replace the battery.
- Do not crush the battery cover or use a screwdriver to remove the battery cover. Forcibly removing the battery cover may bend or damage the key.
- If the battery cover is frequently removed, the battery cover may become loose.
- When installing the battery, make sure to check the direction of the battery.  
Installing the battery in the wrong direction may cause the battery to deplete rapidly.
- The surface of the card key may be damaged, or its coating may peel off in the following situations:
  - The card key is carried together with hard objects, such as coins and keys.
  - The card key is scraped with a sharp object, such as the tip of a mechanical pencil.
  - The surface of the card key is wiped with thinner or benzene.

## Doors

### Unlocking and locking the doors from the outside

#### ◆ Smart access system with push-button start

Carry the electronic key to enable this function.

- ① Grip the driver's door handle to unlock the door. Grip the passenger's door handle to unlock both side doors.\*

Make sure to touch the sensor on the back of the handle.

The doors cannot be unlocked for 3 seconds after the doors are locked.

\*: The door unlock settings can be changed. (→P. 141, 651)

- ② Touch the lock sensor (indentation on the side of the door handle) to lock both side doors.

Check that the door is securely locked.

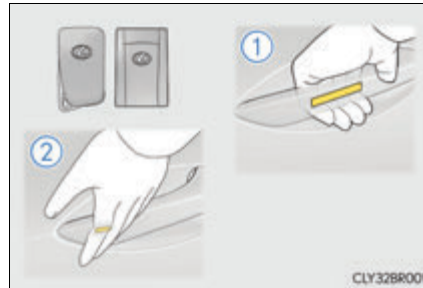

#### ◆ Wireless remote control

- ① Locks both side doors

Check that the door is securely locked.

- ② Unlocks both side doors

Pressing the button unlocks the driver's door. Pressing the button again within 5 seconds unlocks the other door.

Press and hold to open the windows and moon roof.\*

\*: This setting must be customized at your Lexus dealer.

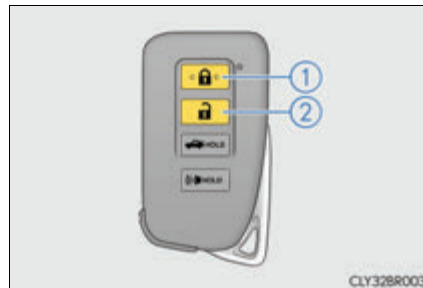

3

Operation of each component

■ **Operation signals**

A buzzer sounds and the emergency flashers flash to indicate that the doors have been locked/unlocked. (Locked: once; Unlocked: twice)

A buzzer sounds to indicate that the windows and moon roof are operating.

■ **Security feature**

If a door is not opened within approximately 60 seconds after the vehicle is unlocked, the security feature automatically locks the vehicle again.

■ **Welcome light illumination control**

The side marker, parking, tail and license plate lights automatically turn on at night when the doors are unlocked using the entry function or wireless remote control if the light switch is in the "AUTO" position.

■ **When the door cannot be locked by the lock sensor on the surface of the door handle**

Use your palm to touch the lock sensor.



■ **Door lock buzzer**

If an attempt to lock the doors is made when a door is not fully closed, a buzzer sounds continuously for 5 seconds. Fully close the door to stop the buzzer, and lock the vehicle once more.

■ **Setting the alarm**

Locking the doors will set the alarm system. (→P. 79)

■ **If the smart access system with push-button start or the wireless remote control does not operate properly**

Use the mechanical key and/or inside lock buttons to lock and unlock the doors. (→P. 600)

Replace the key battery with a new one if it is depleted. (→P. 517)

### Unlocking and locking the doors from the inside

#### ◆ Door lock switches

- ① Locks both side doors
- ② Unlocks both side doors

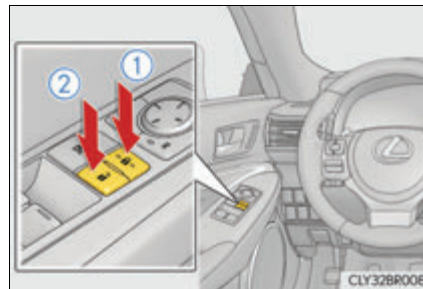

#### ◆ Inside lock buttons

- ① Locks the door
- ② Unlocks the door

Both side doors can be opened by pulling the inside handle even if the lock buttons are in the lock position.

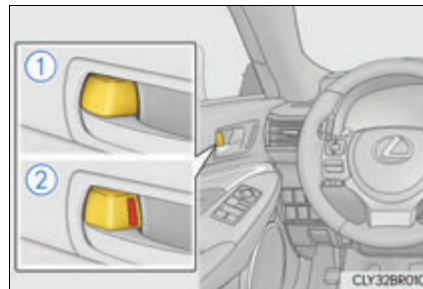

### Locking the doors from the outside without a key

- 1 Move the inside lock button to the lock position.
- 2 Close the door.

The door cannot be locked if the engine switch is in ACCESSORY or IGNITION ON mode, or the electronic key is left inside the vehicle. However, the key may not be detected correctly and the door may be locked.

3

Operation of each component

**Automatic door locking and unlocking systems**

The following functions can be set or canceled:

For instructions on customizing, refer to P. 651.

| Function                                      | Operation  |
|---|--|
| Speed linked door locking function            | Both side doors are automatically locked when vehicle speed is approximately 12 mph (20 km/h) or higher. |
| Shift position linked door locking function   | Both side doors are automatically locked when the shift lever is shifted to a position other than P.     |
| Shift position linked door unlocking function | Both side doors are automatically unlocked when the shift lever is shifted to P.                         |
| Driver's door linked door unlocking function  | Both side doors are automatically unlocked when driver's door is opened.                                 |







### ■ Side window open/close function linked to door operation



When a door is opened, its window opens slightly. When a door is closed, its window closes completely.

### ■ Switching the door unlock function

It is possible to set which doors the entry function unlocks using the wireless remote control.

- 1 Turn the engine switch off.
- 2 When the indicator light on the key surface is not on, press and hold  ,  or  for approximately 5 seconds while pressing and holding  .

The setting changes each time an operation is performed, as shown below. (When changing the setting continuously, release the buttons, wait for at least 5 seconds, and repeat step 2.)

| Multi-information display   | Unlocking function   | Beep  |
|---|--|---|
|   | Holding the driver's door handle unlocks only the driver's door. | Exterior: Beeps 3 times<br>Interior: Pings once |
|   | Holding the passenger's door handle unlocks both side doors.     |   |
|  | Holding either door handle unlocks both side doors.              | Exterior: Beeps twice<br>Interior: Pings once   |

To prevent unintended triggering of the alarm, unlock the doors using the wireless remote control and open and close a door once after the settings have been changed. (If a door is not opened within 60 seconds after  is pressed, the doors will be locked again and the alarm will automatically be set.)

In a case that the alarm is triggered, immediately stop the alarm. (→P. 79)

### ■ Impact detection door lock release system

In the event that the vehicle is subject to a strong impact, both side doors are unlocked. Depending on the force of the impact or the type of accident, however, the system may not operate.

### ■ Using the mechanical key

The doors can also be unlocked with the mechanical key. (→P. 600)

### ■ Conditions affecting the operation of the smart access system with push-button start or wireless remote control

→P. 150

### ■ Customization

Settings (e.g. unlocking function using a key) can be changed. (Customizable features: →P. 651)

3

Operation of each component

**WARNING****■ To prevent an accident**

Observe the following precautions while driving the vehicle.

Failure to do so may result in a door opening and an occupant being thrown out of the vehicle, resulting in death or serious injury.

- Ensure that both side doors are properly closed and locked.

- Do not pull the inside handle of the doors while driving.

The doors may be opened even if the inside lock buttons are in locked position.

**■ Side window open/close function linked to door operation**

Do not hold the upper edge of the side window when you close the door. Otherwise, your fingers or hand may be caught in the window.

## Trunk

The trunk can be opened using the trunk opener, entry function or wireless remote control.

### Opening the trunk from inside the vehicle

Press the opener switch.

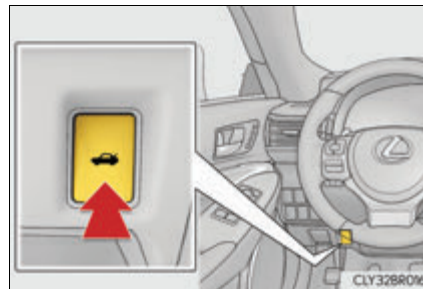

### Opening the trunk from outside the vehicle

#### ◆ Smart access system with push-button start

While carrying the electronic key, press the button on the trunk lid.

When both side doors are unlocked using one of the following methods, the trunk can be opened without the electronic key:

- Entry function
- Wireless remote control
- Door lock switches
- Automatic door unlocking system
- Mechanical key

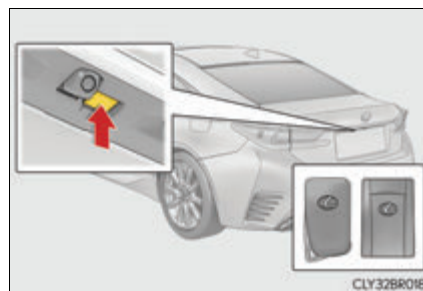

#### ◆ Wireless remote control

Press and hold the switch.

A buzzer sounds.



### When closing the trunk

Using the trunk grip, lower the trunk without applying force to the side and push the trunk down from the outside to close it.



### Luggage security system

To protect luggage stored in the trunk against theft, the luggage security system can be set to on.

- 1 RC350/RC300/RC200t: Move the luggage security system levers to the lock position.

To lock a luggage security system lever from inside the cabin, fold the rear seat-back forward, move the lever to the lock position, and return the seatback to its original position.

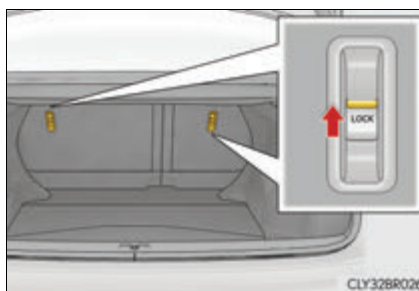

- 1 RC F: Close the inside trunk door. (→P. 442)

- 2 To disable the trunk opener, turn the main switch in the glove box off.

- ① On
- ② Off

When the main switch is off, the trunk lid cannot be opened even with the wireless remote control or entry function.

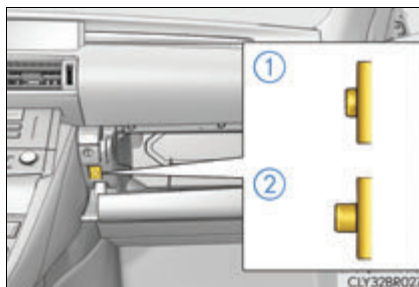

### ■ Trunk light

- The trunk light turns on when the trunk is opened.
- If the trunk light is left on when the engine switch is turned off, the light will go off automatically after 20 minutes.

### ■ Function to prevent the trunk being locked with the electronic key inside

- When both side doors are locked, closing the trunk lid with the electronic key left inside the trunk will sound an alarm.  
In this case, the trunk lid can be opened by pressing the trunk release button on the trunk lid.
- If the spare electronic key is put in the trunk with both side doors locked, the key confinement prevention function is activated so the trunk can be opened. In order to prevent theft, take all electronic keys with you when leaving the vehicle.
- If the electronic key is put in the trunk with both side doors locked, the key may not be detected depending on the location of the key and the surrounding radio wave conditions. In this case, the key confinement prevention function cannot be activated, causing the doors to lock when the trunk is closed. Make sure to check where the key is before closing the trunk.
- The key confinement prevention function cannot be activated if either door is unlocked. In this case, open the trunk using the trunk opener.

### ■ Internal trunk release lever

The trunk lid can be opened by pulling the glow-in-the-dark lever located on the inside of the trunk lid upward.

The lever will continue to glow for some time after the trunk lid is closed.

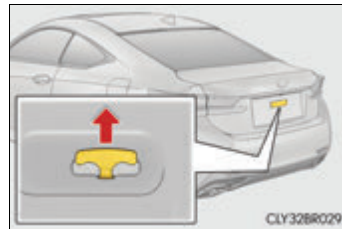

### ■ Using the mechanical key

The trunk can be also opened using the mechanical key. (→P. 601)

### ■ If the smart access system with push-button start or the wireless remote control does not operate properly

Use the mechanical key to unlock the trunk. (→P. 601)

Replace the key battery with a new one if it is depleted. (→P. 517)

### ■ When leaving a key to the vehicle with a parking attendant

→P. 134

### ■ Customization

The trunk unlocking operation can be changed. (Customizable features: →P. 651)

 **WARNING**

Observe the following precautions.  
Failure to do so may result in death or serious injury.

**■ Before driving**

- Make sure that the trunk lid is fully closed. If the trunk lid is not fully closed, it may open unexpectedly while driving and hit near-by objects or luggage in the trunk may be thrown out, causing an accident.
- Do not allow children to play in the trunk.  
If a child is accidentally locked in the trunk, they could suffer from heat exhaustion, suffocation or other injuries.
- Do not allow a child to open or close the trunk lid.  
Doing so may cause the trunk lid to open unexpectedly, or cause the child's hands, head, or neck to be caught by the closing trunk lid.

**■ Important points while driving**

Never let anyone sit in the trunk. In the event of sudden braking or a collision, they are susceptible to death or serious injury.

**⚠ WARNING****■ Using the trunk**

Observe the following precautions.

Failure to do so may cause parts of the body to be caught, resulting in serious injury.

- Remove any heavy loads, such as snow and ice, from the trunk lid before opening it. Failure to do so may cause the trunk lid to suddenly shut again after it is opened.
- When opening or closing the trunk lid, thoroughly check to make sure the surrounding area is safe.
- If anyone is in the vicinity, make sure they are safe and let them know that the trunk is about to open or close.
- Use caution when opening or closing the trunk lid in windy weather as it may move abruptly in strong wind.
- On an incline it is more difficult to open or close the trunk lid than on a level surface, so beware of the trunk lid unexpectedly opening or closing by itself. Make sure that the trunk lid is fully open and secure before using the trunk.
- When opening the trunk lid, take care so that it does not hit anyone in the face or any other part of the body.



- When closing the trunk lid, take extra care to prevent your fingers etc. from being caught.
- When closing the trunk lid, make sure to press it lightly on its outer surface. If the trunk handle is used to fully close the trunk lid, it may result in hands or arms being caught.



- Do not attach any accessories other than genuine Lexus parts to the trunk lid. Such additional weight on the trunk lid may cause the lid to suddenly shut again after it is opened.

## Smart access system with push-button start

The following operations can be performed simply by carrying the electronic key (including the card key) on your person, for example in your pocket. The driver should always carry the electronic key.

- Locks and unlocks the doors (→P. 137)
- Opens the trunk (→P. 143)
- Starts the engine (→P. 199)

### ■ Antenna location

- ① Antennas outside the cabin
- ② Antennas inside the cabin
- ③ Antenna inside the trunk
- ④ Antenna outside the trunk

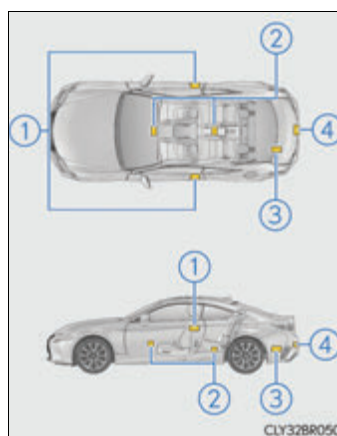

### ■ Effective range (areas within which the electronic key is detected)

- When locking or unlocking the doors  
The system can be operated when the electronic key is within about 2.3 ft. (0.7 m) of an outside door handle. (Only the doors detecting the key can be operated.)
- When opening the trunk  
The system can be operated when the electronic key is within about 2.3 ft. (0.7 m) of the trunk release button.

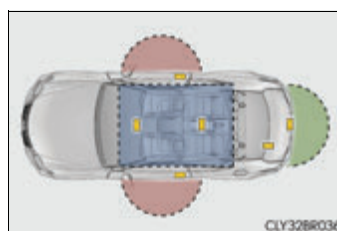

- When starting the engine or changing engine switch modes  
The system can be operated when the electronic key is inside the vehicle.



### ■ Alarms and warning indicators

An alarm sounds and warning messages are displayed on the multi-information display to protect against unexpected accidents or theft of the vehicle resulting from erroneous operation. When a warning message is displayed, take appropriate measures based on the displayed message. (→P. 549)

When only an alarm sounds, circumstances and correction procedures are as follows.

| Alarm                                    | Situation  | Correction procedure  |
|--|--|---|
| Exterior alarm sounds once for 5 seconds | The trunk was closed while the electronic key was still inside the trunk and both side doors were locked.  | Retrieve the electronic key from the trunk and close the trunk lid. |
|  | An attempt was made to lock the vehicle while a door was open.   | Close both side doors and lock the doors again.                     |
| Interior alarm sounds continuously       | The engine switch was turned to ACCESSORY mode while the driver's door was open (or the driver's door was opened while the engine switch was in ACCESSORY mode). | Turn the engine switch off and close the driver's door.             |
|  | The engine switch was turned off while the driver's door was open.   | Close the driver's door.  |



### ■ Battery-saving function

The battery-saving function will be activated in order to prevent the electronic key battery and the vehicle battery from being discharged while the vehicle is not in operation for a long time.

- In the following situations, the smart access system with push-button start may take some time to unlock the doors.
  - The electronic key has been left within approximately 6 ft. (2 m) of the outside of the vehicle for 10 minutes or longer.
  - The smart access system with push-button start has not been used for 5 days or longer.
- If the smart access system with push-button start has not been used for 14 days or longer, the doors cannot be unlocked at the passenger door. In this case, hold the driver's door handle, or use the wireless remote control or mechanical key, to unlock the doors.

■ **Electronic Key Battery-Saving Function**

When battery-saving mode is set, battery depletion is minimized by stopping the electronic key from receiving radio waves.

Press  twice while pressing and holding . Confirm that the electronic key indicator flashes 4 times.

While the battery-saving mode is set, the smart access system with push-button start cannot be used. To cancel the function, press any of the electronic key buttons.



■ **Conditions affecting operation**

The smart access system with push-button start uses weak radio waves. In the following situations, the communication between the electronic key and the vehicle may be affected, preventing the smart access system with push-button start, wireless remote control and engine immobilizer system from operating properly.  
(Ways of coping: →P. 600)

- When the electronic key battery is depleted
- Near a TV tower, electric power plant, gas station, radio station, large display, airport or other facility that generates strong radio waves or electrical noise
- When carrying a portable radio, cellular phone, cordless phone or other wireless communication device
- When the electronic key is in contact with, or is covered by the following metallic objects
  - Cards to which aluminum foil is attached
  - Cigarette boxes that have aluminum foil inside
  - Metallic wallets or bags
  - Coins
  - Hand warmers made of metal
  - Media such as CDs and DVDs
- When other wireless keys (that emit radio waves) are being used nearby
- When carrying the electronic key together with the following devices that emit radio waves
  - Another vehicle's electronic key or a wireless key that emits radio waves
  - Personal computers or personal digital assistants (PDAs)
  - Digital audio players
  - Portable game systems
- If window tint with a metallic content or metallic objects are attached to the rear window
- When the electronic key is placed near a battery charger or electronic devices

### ■ Note for the entry function

- Even when the electronic key is within the effective range (detection areas), the system may not operate properly in the following cases:
  - The electronic key is too close to the window or outside door handle, near the ground, or in a high place when the doors are locked or unlocked.
  - The electronic key is near the ground or in a high place, or too close to the rear bumper center when the trunk is opened.
  - The electronic key is on the instrument panel, rear package tray or floor, or in the door pockets or glove box when the engine is started or engine switch modes are changed.
- Do not leave the electronic key on top of the instrument panel or near the door pockets when exiting the vehicle. Depending on the radio wave reception conditions, it may be detected by the antenna outside the cabin and the doors will become lockable from the outside, possibly trapping the electronic key inside the vehicle.
- As long as the electronic key is within the effective range, the doors may be locked or unlocked by anyone. However, only the doors detecting the electronic key can be used to unlock the vehicle.
- Even if the electronic key is not inside the vehicle, it may be possible to start the engine if the electronic key is near the window.
- The doors may unlock or lock if a large amount of water splashes on the door handle, such as in the rain or in a car wash, when the electronic key is within the effective range. (The doors will automatically be locked after approximately 60 seconds if the doors are not opened and closed.)
- If the wireless remote control is used to lock the doors when the electronic key is near the vehicle, there is a possibility that the door may not be unlocked by the entry function. (Use the wireless remote control to unlock the doors.)
- Touching the door lock or unlock sensor while wearing gloves may prevent lock or unlock operation.
- When the lock operation is performed using the lock sensor, recognition signals will be shown up to two consecutive times. After this, no recognition signals will be given.
- If the door handle becomes wet while the electronic key is within the effective range, the door may lock and unlock repeatedly. In this case, follow the following correction procedures to wash the vehicle:
  - Place the electronic key in a location 6 ft. (2 m) or more away from the vehicle. (Take care to ensure that the key is not stolen.)
  - Set the electronic key to battery-saving mode to disable the smart access system with push-button start. (→P. 150)
- If the electronic key is inside the vehicle and a door handle becomes wet during a car wash, a message may be shown on the multi-information display and a buzzer will sound outside the vehicle. To turn off the alarm, lock both side doors.
- The lock sensor may not work properly if it comes into contact with ice, snow, mud, etc. Clean the lock sensor and attempt to operate it again.
- A sudden handle operation or a handle operation immediately after entering the effective range may prevent the doors from being unlocked. Touch the door unlock sensor and check that the doors are unlocked before pulling the door handle again.
- Unlocking the vehicle may take more time if another electronic key is within the effective range.

■ **When the vehicle is not driven for extended periods**

- To prevent theft of the vehicle, do not leave the electronic key within 6 ft. (2 m) of the vehicle.
- The smart access system with push-button start can be deactivated in advance. (→P. 651)

■ **To operate the system properly**

- Make sure to carry the electronic key when operating the system. Do not get the electronic key too close to the vehicle when operating the system from the outside of the vehicle.

Depending on the position and holding condition of the electronic key, the key may not be detected correctly and the system may not operate properly. (The alarm may go off accidentally, or the door lock prevention function may not operate.)

- Do not leave the electronic key inside the trunk.  
The key confinement prevention function may not operate, depending on the location of the key (close to a spare tire [if equipped], the inside edge of the trunk), conditions (inside a metal bag, close to metallic objects) and the radio waves in the surrounding area. (→P. 145)

■ **If the smart access system with push-button start does not operate properly**

- Locking and unlocking the doors and opening the trunk: →P. 600
- Starting the engine: →P. 602

■ **Customization**

Settings (e. g. smart access system with push-button start) can be changed. (Customizable features: →P. 651)

■ **If the smart access system with push-button start has been deactivated in a customized setting**

- Locking and unlocking the doors and opening the trunk:  
Use the wireless remote control or mechanical key. (→P. 137, 143, 600)
- Starting the engine and changing engine switch modes: →P. 602
- Stopping the engine: →P. 199

**■ Certification for the smart access system with push-button start**

- ▶ For vehicles sold in the U.S.A.

FCC ID: HYQ23AAB      FCC ID: HYQ14FBA

FCC ID: HYQ14CBB

FCC ID: NI4TMLF12-4

**NOTE:**

This device complies with part 15 of the FCC Rules. Operation is subject to the following two conditions: (1) This device may not cause harmful interference, and (2) this device must accept any interference received, including interference that may cause undesired operation.

This device complies with part 15 of the FCC Rules. Operation is subject to the following two conditions: (1) This device may not cause harmful interference; and (2) This device must accept any interference received, including interference that may cause undesired operation.

**FCC WARNING:**

Changes or modifications not expressly approved by the party responsible for compliance could void the user's authority to operate the equipment.

- ▶ For vehicles sold in Canada

**NOTE:**

This device complies with Industry Canada's licence-exempt RSSs.

Operation is subject to the following two conditions:

- (1) This device may not cause interference; and
- (2) This device must accept any interference, including interference that may cause undesired operation of the device.

This device complies with Industry Canada licence-exempt RSSs.

Operation is subject to the following two conditions:

- (1) This device may not cause interference; and
- (2) This device must accept any interference, including interference that may cause undesired operation of the device.

**NOTE:**

**Le présent appareil est conforme aux CNR d'Industrie Canada applicables aux appareils radio exempts de licence. L'exploitation est autorisée aux deux conditions suivantes:**

- (1) l'appareil ne doit pas produire de brouillage;
- (2) l'utilisateur de l'appareil doit accepter tout brouillage radioélectrique subi, même si le brouillage est susceptible d'en compromettre le fonctionnement.

 **WARNING****■ Caution regarding interference with electronic devices**

- People with implantable cardiac pacemakers, cardiac resynchronization therapy-pacemakers or implantable cardioverter defibrillators should keep away from the smart access system with push-button start antennas. (→P.148)  
The radio waves may affect the operation of such devices. If necessary, the entry function can be disabled. Ask your Lexus dealer for details, such as the frequency of radio waves and timing of the emitted radio waves. Then, consult your doctor to see if you should disable the entry function.
- Users of any electrical medical device other than implantable cardiac pacemakers, cardiac resynchronization therapy-pacemakers or implantable cardioverter defibrillators should consult the manufacturer of the device for information about its operation under the influence of radio waves.  
Radio waves could have unexpected effects on the operation of such medical devices.

Ask your Lexus dealer for details on disabling the entry function.

## Front seats

### Adjustment procedure

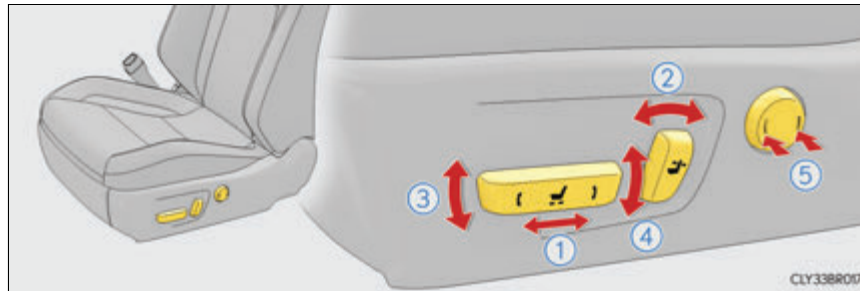

- |   |   |
|---|---|
| ① Seat position adjustment              | ④ Vertical height adjustment              |
| ② Seatback angle adjustment             | ⑤ Lumbar support adjustment (if equipped) |
| ③ Seat cushion (front) angle adjustment |   |

### Entering/exiting the rear seats (lever-operated “Front, Fold & Return” seat)

#### ■ Before entering/exiting the rear seats

Remove the seat belt from the seat belt guide. (→P. 35)

#### ■ Entering/exiting the rear seat

- 1 Pull the lever.  
The front seat will lower automatically.



3

Operation of each component

- 2 Fold the seatback completely forward.

The front seat will move forward automatically.

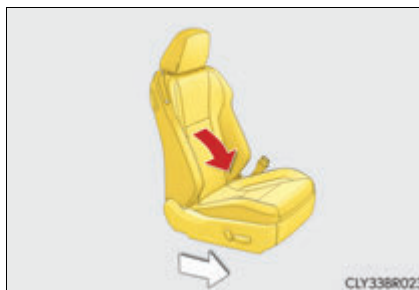

■ Returning the front seat to its original position

Move the seatback backward until it locks. The front seat will return to its original position automatically.

■ When adjusting the seat

- Take care when adjusting the seat so that the head restraint does not touch the ceiling.
- RC350/RC300/RC200t: When folding down a rear seatback, if it interferes with a front seatback, adjust the front seat position so that the seats no longer interfere with each other. However, if adjusting the front seat position causes the correct driving posture to not be maintained, return the rear seatback to its original position. (→P. 158)

■ Lever-operated “Front, Fold & Return” seat

- After the front seat is moved forward by operating the “Front, Fold & Return” seat lever, if a power seat adjusting switch or a driving position memory switch is pressed, the front seat will not return to its original position even if the front seatback is moved backward until it locks.
- The lever-operated “Front, Fold & Return” seat will not operate in the following situations:
  - The front seat belt of the seat to be operated is fastened.
  - The engine switch is in IGNITION ON mode and the shift lever is in a position other than P (driver's seat only).
- Operation of the lever-operated “Front, Fold & Return” seat will stop in the following situations:
  - A power seat adjusting switch or a driving position memory switch is pressed.
  - The front seat belt of the seat which is operating is fastened.
  - The engine switch is in IGNITION ON mode and the shift lever is moved to a position other than P (driver's seat only).

■ Jam protection function

While the lever-operated “Front, Fold & Return” seat is operating, if an object is stuck either in front of or behind the front seat, the front seat will stop and then move in the opposite direction slightly.



 **WARNING****■ When adjusting the seat position**

- Take care when adjusting the seat position to ensure that other passengers are not injured by the moving seat.
- Do not put your hands under the seat or near the moving parts to avoid injury. Fingers or hands may become jammed in the seat mechanism.
- Make sure to leave enough space around the feet so they do not get stuck.

**■ Seat adjustment**

To reduce the risk of sliding under the lap belt during a collision, do not recline the seat more than necessary.

If the seat is too reclined, the lap belt may slide past the hips and apply restraint forces directly to the abdomen, or your neck may contact the shoulder belt, increasing the risk of death or serious injury in the event of an accident.

Adjustments should not be made while driving as the seat may unexpectedly move and cause the driver to lose control of the vehicle.

**■ Lever-operated "Front, Fold & Return" seat**

- Before operating the lever-operated "Front, Fold & Return" seat, ensure that any surrounding passengers or objects will not contact the seat.
- Make sure the seatback is locked securely before driving.
- Never operate the lever-operated "Front, Fold & Return" seat while the vehicle is moving.

**■ Jam protection function**

Do not use a hand, foot, or any other part of your body to intentionally activate the jam protection function.

## Rear seats (folding type)\*

The rear seatbacks can be folded down.

### Folding down the rear seatbacks

- 1 Move the luggage security system lever to the unlock position.

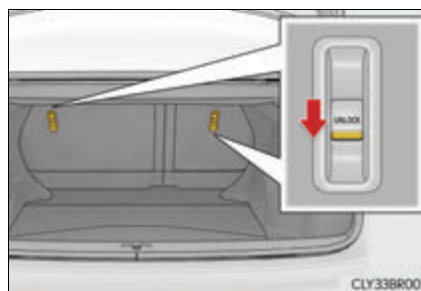

- 2 Pull the seatback lock release lever and fold the seatback down.

To return a rear seatback to its original position, lift it until it locks. If a rear head restraint contacts the ceiling and the seatback cannot be returned smoothly, lower the head restraint to the lowest position.

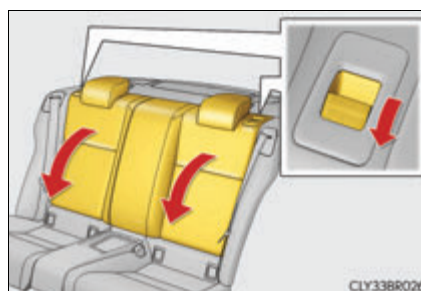

### Luggage security system

→P. 144

\*: If equipped

**⚠ WARNING**

Observe the following precautions. Failure to do so may result in death or serious injury.

**■ When folding the rear seatbacks down**

- Do not fold the seatbacks down while driving.
- Stop the vehicle on level ground, set the parking brake and shift the shift lever to P.
- Do not allow anyone to sit on a folded seatback or in the trunk while driving.
- Do not allow children to enter the trunk.

**■ After returning the rear seatback to the upright position**

- Make sure that the seatback is securely locked in position by lightly pushing it back and forth.  
If the seatback is not securely locked, the red marking will be visible on the seatback lock release knob. Make sure that the red marking is not visible.

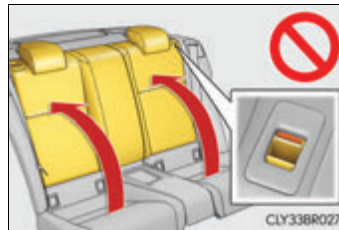

- Check that the seat belts are not twisted or caught in the seatback.

## Driving position memory\*

This feature automatically adjusts the driver's seat, steering wheel and outside rear view mirrors to suit your preferences.

### Driving position memory

Your preferred driving position (the position of the driver's seat, steering wheel and outside rear view mirrors) can be recorded and recalled by pressing a button.

Three different driving positions can be recorded into memory.

#### ■ Recording procedure

- 1 Check that the shift lever is in P.
- 2 Turn the engine switch to IGNITION ON mode.
- 3 Adjust the driver's seat, steering wheel, and outside rear view mirrors to the desired positions.
- 4 While pressing the "SET" button, or within 3 seconds after the "SET" button is pressed, press button "1", "2" or "3" until the buzzer sounds.

If the selected button has already been preset, the previously recorded position will be overwritten.

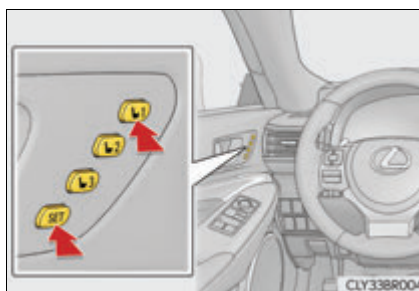

#### ■ Recall procedure

- 1 Check that the shift lever is in P.
- 2 Turn the engine switch to IGNITION ON mode.
- 3 Press one of the buttons for the driving position you want to recall until the buzzer sounds.

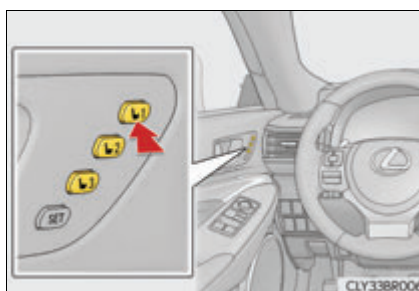

\*: If equipped

**■ To stop the position recall operation part-way through**

Perform any of the following:

- Press the "SET" button.
- Press button "1", "2" or "3".
- Operate any of the seat adjustment switches (only cancels seat position recall).
- Operate the tilt and telescopic steering control switch (only cancels steering wheel position recall).

**■ Seat positions that can be memorized (→P. 155)**

The adjusted positions other than the position adjusted by lumbar support switch can be recorded.

**■ Operating the driving position memory after turning the engine switch off**

Recorded seat positions can be activated up to 180 seconds after the driver's door is opened and another 60 seconds after it is closed again.

**■ In order to correctly use the driving position memory function**

If a seat position is already in the furthest possible position and the seat is operated in the same direction, the recorded position may be slightly different when it is recalled.

3

Operation of each component

### Memory recall function

Each electronic key (including a card key) can be registered to recall your preferred driving position.

#### ■ Registering procedure

Record your driving position to button “1”, “2” or “3” before performing the following:

Carry only the key you want to register, and then close the driver’s door.

If 2 or more keys are in the vehicle, the driving position cannot be recorded properly.

- 1 Check that the shift lever is in P.
- 2 Turn the engine switch to IGNITION ON mode.
- 3 Recall the driving position that you want to record.
- 4 While pressing the recalled button, press and hold the door lock switch (either lock or unlock) until the buzzer sounds.

If the button could not be registered, the buzzer sounds continuously for approximately 3 seconds.

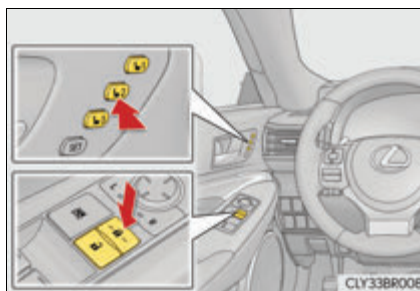

#### ■ Recall procedure

- 1 Carry the electronic key that has been registered to the driving position, and then unlock and open the driver’s door using the smart access system with push-button start or wireless remote control.

The driving position will move to the recorded position (not including the steering wheel).

If the driving position is in a position that has already been recorded, the seat and outside rear view mirrors will not move.

- 2 Turn the engine switch to ACCESSORY mode or IGNITION ON mode.

The steering wheel will move to the recorded position.

**■ Cancellation procedure**

Carry only the key you want to cancel and then close the driver's door.

If 2 or more keys are in the vehicle, the driving position cannot be canceled properly.

- 1 Turn the engine switch to IGNITION ON mode.
- 2 While pressing the "SET" button, press and hold the door lock switch (either lock or unlock) until the buzzer sounds twice.

If the button could not be canceled, the buzzer sounds continuously for approximately 3 seconds.

**■ Recalling the driving position using the memory recall function**

- Different driving positions can be registered for each electronic key. Therefore, the driving position that is recalled may be different depending on the key being carried.
- If a door other than the driver's door is unlocked with the smart access system with push-button start, the driving position cannot be recalled. In this case, press the driving position button which has been set.

**■ Customization**

The unlock door settings of the memory recall function can be changed.  
(Customizable features: →P. 651)

**⚠ WARNING****■ Seat adjustment caution**

Take care during seat adjustment so that the seat does not strike the rear passenger or squeeze your body against the steering wheel.

## Head restraints

Head restraints are provided for all seats.

RC F: The head restraints are integrated into the seatback and cannot be adjusted.

### Front seats

#### ◆ Vertical adjustment

- ① Up  
Pull the head restraints up.
- ② Down  
Push the head restraint down while pressing the lock release button.

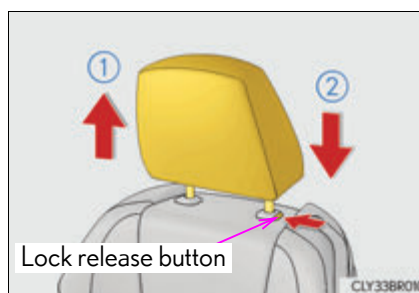

#### ◆ Horizontal adjustment

The position of the head restraint can be adjusted forward in 4 stages.

If the head restraint is pulled forward from the foremost position, it will return to the rearmost position.





### Rear seats

- ① Up  
Pull the head restraints up.
- ② Down  
Push the head restraint down while pressing the lock release button.

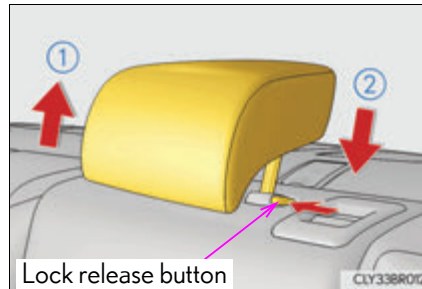

#### ■ Removing the head restraints

Pull the head restraint up while pressing the lock release button.

If the head restraint touches the ceiling, making the removal difficult, change the seat height or angle. (→P. 155, 158)



#### ■ Installing the head restraints

##### ► Front seats

Align the head restraint with the installation holes and push it down to the lock position. Press and hold the lock release button when lowering the head restraint.



##### ► Rear seats

Align the head restraint with the installation holes and push it down to the lowest lock position while pressing the lock release button.



3

Operation of each component

■ **Adjusting the height of the head restraints**

Make sure that the head restraints are adjusted so that the center of the head restraint is closest to the top of your ears.



■ **Adjusting the rear seat head restraint**

Always raise the head restraint one level from the stowed position when using.

**⚠ WARNING**

■ **Head restraint precautions**

Observe the following precautions regarding the head restraints. Failure to do so may result in death or serious injury.

- Use the head restraints designed for each respective seat.
- Adjust the head restraints to the correct position at all times.
- After adjusting the head restraints, push down on them and make sure they are locked in position.
- Do not drive with the head restraints removed.

## Steering wheel

### Adjustment procedure

- ▶ Manual type

- 1 Hold the steering wheel and push the lever down.

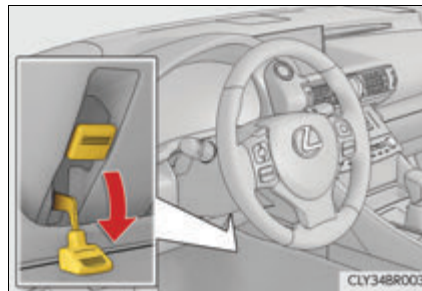

- 2 Adjust to the ideal position by moving the steering wheel horizontally and vertically.

After adjustment, pull the lever up to secure the steering wheel.

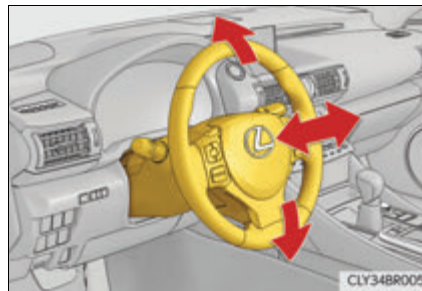

- ▶ Power type

Operating the switch moves the steering wheel in the following directions:

- 1 Up
- 2 Down
- 3 Toward the driver
- 4 Away from the driver

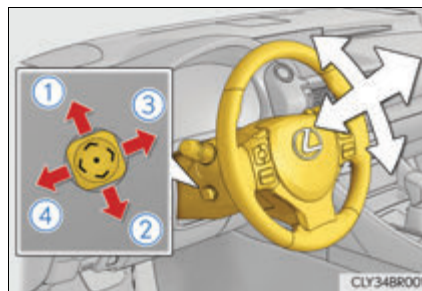

3

Operation of each component

### Auto tilt away (power type)

When the engine switch is turned off, the steering wheel returns to its stowed position by moving up and away to enable easier driver entry and exit.

Turning the engine switch to ACCESSORY or IGNITION ON mode will return the steering wheel to the original position.

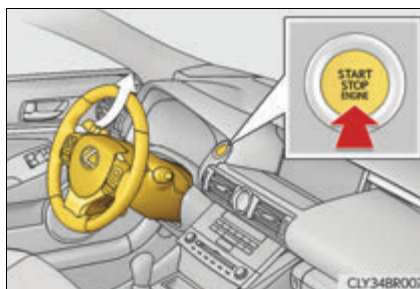

### Horn

To sound the horn, press on or close to the  mark.

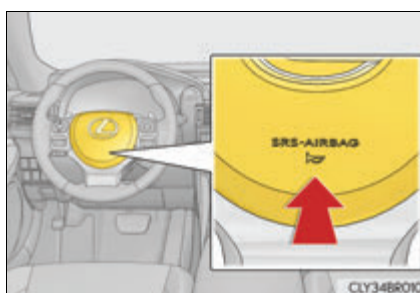

- **The steering wheel can be adjusted when (power type)**

The engine switch is in ACCESSORY or IGNITION ON mode.

- **Automatic adjustment of the steering position (if equipped)**

A desired steering position can be entered to memory and recalled automatically by the driving position memory system. (→P. 160)

- **Customization**

The auto tilt away function can be changed. (Customizable features: →P. 651)

### WARNING

- **Caution while driving**

Do not adjust the steering wheel while driving. Doing so may cause the driver to mishandle the vehicle and cause an accident, resulting in death or serious injury.

- **After adjusting the steering wheel (manual type)**

Make sure that the steering wheel is securely locked. Otherwise, the steering wheel may move suddenly, possibly causing an accident, and resulting in death or serious injury. Also, the horn may not sound if the steering wheel is not securely locked.

## Inside rear view mirror

The rear view mirror's position can be adjusted to enable sufficient confirmation of the rear view.

### Adjusting the height of rear view mirror

The height of the rear view mirror can be adjusted to suit your driving posture.

Adjust the height of the rear view mirror by moving it up and down.

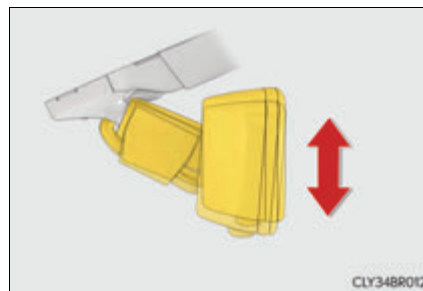

### Anti-glare function

Responding to the level of brightness of the headlights of vehicles behind, the reflected light is automatically reduced.

Changing automatic anti-glare function mode

ON/OFF

When the automatic anti-glare function is in ON mode, the indicator illuminates. The function will set to ON mode each time the engine switch is turned to IGNITION ON mode.

Pressing the button turns the function to OFF mode. (The indicator also turns off.)

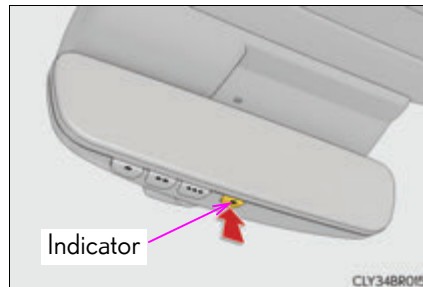

3

Operation of each component

■ **To prevent sensor error**

To ensure that the sensors operate properly, do not touch or cover them.



**⚠ WARNING**

Do not adjust the position of the mirror while driving. Doing so may lead to mishandling of the vehicle and cause an accident, resulting in death or serious injury.

## Outside rear view mirrors

### Adjustment procedure

- 1** To select a mirror to adjust, press the switch.

- ① Left
- ② Right

Pressing the same switch again will put the switch in neutral.

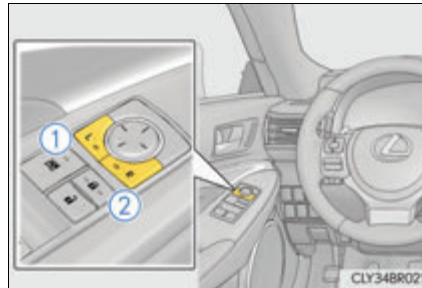

- 2** To adjust the mirror, press the switch.

- ① Up
- ② Right
- ③ Down
- ④ Left

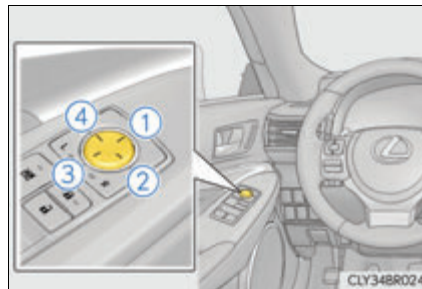

### Folding the mirrors

Push the mirror back in the direction of the vehicle's rear.



3

Operation of each component

### Linked mirror function when reversing (if equipped)

When either “L” or “R” of the mirror select switch is selected, the outside rear view mirrors will automatically angle downwards when the vehicle is reversing in order to give a better view of the ground.

To disable this function, select neither “L” nor “R”.

#### ■ Adjusting the mirror angle when the vehicle is reversing

With the shift lever in R, adjust the mirror angle at a desired position.

The adjusted angle will be memorized and the mirror will automatically tilt to the memorized angle whenever the shift lever is shifted to R from next time.

The memorized downward tilt position of the mirror is linked to the normal position (angle adjusted with the shift lever in other than R). Therefore, if the normal position is changed after adjustment, the tilt position will also change.

When the normal position is changed, readjust the angle in reversing.

---

#### ■ Mirror angle can be adjusted when

The engine switch is in ACCESSORY or IGNITION ON mode.

#### ■ When the mirrors are fogged up

The outside rear view mirrors can be cleared using the mirror defoggers. Turn on the rear window defogger to turn on the outside rear view mirror defoggers. (→P. 424)

#### ■ Automatic adjustment of the mirror angle (if equipped)

A desired mirror face angle can be entered to memory and recalled automatically by the driving position memory. (→P. 160)

#### ■ Auto anti-glare function (if equipped)

When the anti-glare inside rear view mirror is set to automatic mode, the outside rear view mirrors will activate in conjunction with the anti-glare inside rear view mirror to reduce reflected light. (→P. 169)



 **WARNING****■ Important points while driving**

Observe the following precautions while driving.  
Failure to do so may result in loss of control of the vehicle and cause an accident, resulting in death or serious injury.

- Do not adjust the mirrors while driving.
- Do not drive with the mirrors folded.
- Both the driver and passenger side mirrors must be extended and properly adjusted before driving.

**■ When the mirror defoggers are operating**

Do not touch the rear view mirror surfaces, as they can become very hot and burn you.

3

Operation of each component

## Power windows

### Opening and closing procedures

The power windows can be opened and closed using the switches.

Operating the switch moves the windows as follows:

- ① Closing
- ② One-touch closing\*
- ③ Opening
- ④ One-touch opening\*

\*: To stop the window partway, operate the switch in the opposite direction.

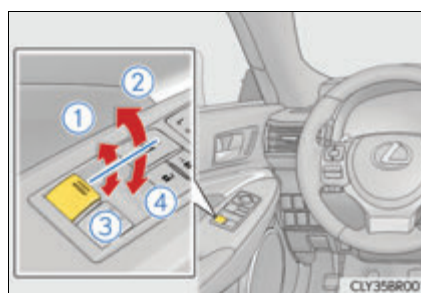

### Window lock switch

Press the switch to lock the passenger window.

The indicator will come on.

Use this switch to prevent children from accidentally opening or closing a passenger window.

The passenger window can still be opened and closed using the driver's switch even if the lock switch is on.

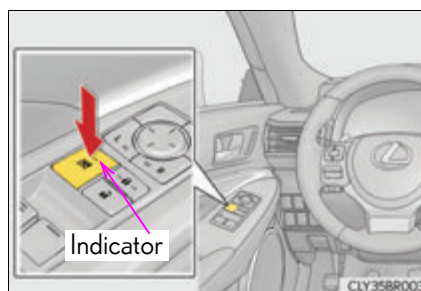

■ **The power windows can be operated when**

The engine switch is in IGNITION ON mode.

■ **Operating the power windows after turning the engine off**

The power windows can be operated for approximately 45 seconds after the engine switch is turned to ACCESSORY mode or turned off. They cannot, however, be operated once either door is opened.

■ **Jam protection function**

If an object becomes caught between the window and the window frame, window travel is stopped and the window is opened slightly.

■ **Pinch protection function**

While the window is opening, if an object is caught between the door and window, window travel is stopped.

■ **If the power window does not close or open normally**

If the jam protection function or pinch protection function is malfunctioning and a window cannot be closed or opened completely, perform the following operations using the power window switch of the relevant door:

● **When not closing normally**

With the vehicle stopped and the engine switch in IGNITION ON mode, within 4 seconds of the jam protection function operating, pull and hold the power window switch in the one-touch closing position. When the window is closed completely, release the switch.

● **When not opening normally**

With the vehicle stopped and the engine switch in IGNITION ON mode, within 4 seconds of the pinch protection function operating, press and hold the power window switch in the one-touch opening position. When the window is opened completely, release the switch.

If the window still cannot be closed or opened completely even though the above operations have been carried out, perform the following initialization procedure.

- 1 Turn the engine switch to IGNITION ON mode.
- 2 Pull and hold the power window switch in the one-touch closing position.
- 3 When the window is closed completely, release the power window switch. Pull and hold the switch in the one-touch closing position again for approximately 4 seconds.
- 4 Press and hold the power window switch in the one-touch opening position. Continue pressing the switch for 1 second after the window has opened completely.
- 5 Pull and hold the power window switch in the one-touch closing position. Continue pulling the switch for 1 second after the window has closed.

If you release the switch while the window is moving, perform the procedure again from the beginning.

If, after performing the above procedure correctly, the window continues to close but then re-open slightly or open but then close again slightly, have the vehicle inspected by your Lexus dealer.

■ **Door lock linked window operation**

- The power windows can be opened and closed using the mechanical key.\* (→P. 601)
- The power windows can be opened using the wireless remote control.\* (→P. 137)

\*: These settings must be customized at your Lexus dealer.

■ **When the battery is disconnected**

The window lock switch is disabled. If necessary, press the window lock switch after reconnecting the battery.

■ **Power windows open warning buzzer**

The buzzer sounds and a message is shown on the multi-information display in the instrument cluster when the engine switch is turned off and the driver's door is opened with the power windows open.

■ **Customization**

Settings (e.g. linked door lock operation) can be changed.  
(Customizable features: →P. 651)

**⚠ WARNING**

Observe the following precautions.  
Failure to do so may result in death or serious injury.

**■ Closing the windows**

- The driver is responsible for all the power window operations, including the operation for the passengers. In order to prevent accidental operation, especially by a child, do not let a child operate the power windows. It is possible for children and other passengers to have body parts caught in the power window. Also, when riding with a child, it is recommended to use the window lock switch. (→P. 174)
- Check to make sure that all passengers do not have any part of their body in a position where it could be caught when a window is being operated.
- When using the wireless remote control or mechanical key and operating the power windows, operate the power window after checking to make sure that there is no possibility of any passenger having any of their body parts caught in the window. Also do not let a child operate window by the wireless remote control or mechanical key. It is possible for children and other passengers to get caught in the power window.
- When exiting the vehicle, turn the engine switch off, carry the key and exit the vehicle along with the child. There may be accidental operation, due to mischief, etc., that may possibly lead to an accident.

**■ Jam protection function**

- Never use any part of your body to intentionally activate the jam protection function.
- The jam protection function may not work if something gets caught just before the window fully closes.

**■ Pinch protection function**

- Do not use a hand, arm, or clothing to intentionally activate the pinch protection function.
- The pinch protection function may not operate if something gets caught just before the window is fully opened. Take care so that your hands, arms, or clothing do not get caught.

## Moon roof\*

Use the overhead switches to open and close the moon roof and tilt it up and down.

### Opening and closing

- ① Opens the moon roof\*  
The moon roof tilts up and then fully opens.

- ② Closes the moon roof\*

\*: Lightly press either way of the moon roof switch to stop the moon roof part-way.

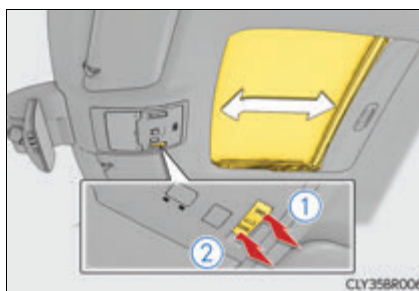

### Tilting up and down

- ① Tilts the moon roof up\*

- ② Tilts the moon roof down\*

\*: Lightly press either way of the moon roof switch to stop the moon roof part-way.



\*: If equipped

**■ The moon roof can be operated when**

The engine switch is in IGNITION ON mode.

**■ Operating the moon roof after turning the engine off**

The moon roof can be operated for approximately 45 seconds after the engine switch is turned to ACCESSORY mode or turned off. It cannot, however, be operated once either door is opened.

**■ Jam protection function**

If an object is detected between the moon roof and the frame while the moon roof is closing or tilting down, travel is stopped and the moon roof opens slightly.

**■ Sunshade**

The sunshade can be opened and closed manually. However, the sunshade will open automatically when the moon roof is opened.

**■ Door lock linked moon roof operation**

● The moon roof can be opened and closed using the mechanical key.\* (→P. 601)

● The moon roof can be opened using the wireless remote control.\* (→P. 137)

\*: These settings must be customized at your Lexus dealer.

**■ If the moon roof does not close normally**

Perform the following procedure:

- 1 Stop the vehicle.
- 2 Press and hold the "CLOSE" switch.\*  
The moon roof will close, reopen and pause for approximately 10 seconds. Then it will close again and stop at the completely closed position.
- 3 Check to make sure that the moon roof is completely closed and then release the switch.

\*: If the switch is released at the incorrect time, the procedure will have to be performed again from the beginning.

If the moon roof does not fully close even after performing the above procedure correctly, have the vehicle inspected by your Lexus dealer.

**■ If the moon roof does not move normally**

If the moon roof does not open or close normally or the automatic opening function does not operate, perform the following initialization procedure.

- 1 Turn the engine switch to IGNITION ON mode.
- 2 Operate the moon roof.  
Depending on the kind of malfunction perform either of the following:
  - ▶ If the moon roof does not open when the "OPEN" switch is pressed
- 3 Press and hold the "DOWN" switch or "CLOSE" switch until the moon roof is completely closed.  
The moon roof will open and close a few times before it closes completely.
- 4 Confirm that the moon roof has completely stopped and release the switch.
  - ▶ If the moon roof does not open completely automatically even though it tilts up and opens while the "OPEN" switch is being pressed and held
- 3 Press and hold the "OPEN" switch until the moon roof opens completely.
- 4 Press and hold the "CLOSE" switch until the moon roof closes completely.
- 5 Press and hold the "UP" switch until the moon roof tilts up and stops.
- 6 Press and hold the "DOWN" switch until the moon roof tilts down and stops at the completely closed position.

If you release the switch while the moon roof is moving, perform the procedure again from the beginning.

If, after performing the above procedures correctly, the moon roof still does not open or close normally or the automatic opening function does not operate, have the vehicle inspected by your Lexus dealer.

**■ Moon roof open warning buzzer**

The buzzer sounds and a message is shown on the multi-information display in the instrument cluster when the engine switch is turned off and the driver's door is opened with the moon roof open.

**■ Customization**

Settings (e.g. linked door lock operation) can be changed.  
(Customizable features: →P. 651)



**⚠ WARNING**

Observe the following precautions.  
Failure to do so may cause death or serious injury.

**■ Opening the moon roof**

- Do not allow any passengers to put their hands or heads outside the vehicle while it is moving.
- Do not sit on top of the moon roof.

**■ Closing the moon roof**

- The driver is responsible for moon roof opening and closing operations.  
In order to prevent accidental operation, especially by a child, do not let a child operate the moon roof. It is possible for children and other passengers to have body parts caught in the moon roof.
- Check to make sure that all passengers do not have any part of their body in a position where it could be caught when the moon roof is being operated.
- When using the wireless remote control or mechanical key and operating the moon roof, operate the moon roof after checking to make sure that there is no possibility of any passenger having any of their body parts caught in the moon roof. Also, do not let a child operate moon roof by the wireless remote control or mechanical key. It is possible for children and other passengers to get caught in the moon roof.
- When exiting the vehicle, turn the engine switch off, carry the key and exit the vehicle along with the child. There may be accidental operation, due to mischief, etc., that may possibly lead to an accident.

**■ Jam protection function**

- Never use any part of your body to intentionally activate the jam protection function.
- The jam protection function may not work if something gets caught just before the moon roof is fully closed. Also, the jam protection function is not designed to operate while the moon roof switch is being pressed. Take care so that your fingers, etc. do not get caught.

**⚠ NOTICE****■ To prevent damage to the moon roof**

- Before opening, make sure that there are no foreign objects such as stones or ice around the opening.
- Do not hit the face or edge of the moon roof with hard objects.

**■ Operating the moon roof**

There is the possibility that water or rain will get into the vehicle if you operate the moon roof after a rainfall, snowfall or car wash. Wipe the moon roof dry with a cloth before operating it.



- |   |  |
|---|--|
| <p><b>4-1. Before driving</b></p> <ul style="list-style-type: none"> <li>Driving the vehicle..... 184</li> <li>Cargo and luggage..... 193</li> <li>Vehicle load limits ..... 196</li> <li>Trailer towing.....197</li> <li>Dinghy towing.....198</li> </ul> <p><b>4-2. Driving procedures</b></p> <ul style="list-style-type: none"> <li>Engine (ignition) switch ..... 199</li> <li>Automatic transmission..... 205</li> <li>Turn signal lever ..... 210</li> <li>Parking brake.....211</li> <li>ASC<br/>(Active Sound Control)<br/>(RC350/RC300/<br/>RC200t)..... 212</li> <li>ASC (Active Sound Control)<br/>(RC F)..... 213</li> </ul> <p><b>4-3. Operating the lights and wipers</b></p> <ul style="list-style-type: none"> <li>Headlight switch..... 214</li> <li>Automatic High Beam ..... 217</li> <li>Fog light switch.....222</li> <li>Windshield wipers and washer.....223</li> </ul> <p><b>4-4. Refueling</b></p> <ul style="list-style-type: none"> <li>Opening the fuel tank cap..... 231</li> </ul> | <p><b>4-5. Using the driving support systems</b></p> <ul style="list-style-type: none"> <li>Cruise control ..... 235</li> <li>Dynamic radar cruise control ..... 239</li> <li>LDA<br/>(Lane Departure Alert)..... 253</li> <li>Intuitive parking assist ..... 259</li> <li>Lexus parking assist monitor ..... 268</li> <li>Driving mode select switch ..... 283</li> <li>Driving assist systems..... 287</li> <li>PCS<br/>(Pre-Collision System)..... 295</li> <li>BSM<br/>(Blind Spot Monitor)..... 302 <ul style="list-style-type: none"> <li>• BSM function.....306</li> <li>• RCTA function ..... 310</li> </ul> </li> <li>Active rear wing ..... 315</li> <li>TVD (Torque Vectoring Differential)..... 318</li> </ul> <p><b>4-6. Driving tips</b></p> <ul style="list-style-type: none"> <li>Winter driving tips ..... 320</li> </ul> |
|---|--|

## Driving the vehicle

The following procedures should be observed to ensure safe driving:

### Starting the engine

→P. 199

### Driving

- 1 With the brake pedal depressed, shift the shift lever to D. (→P. 205)
- 2 Release the parking brake. (→P. 211)
- 3 Gradually release the brake pedal and gently depress the accelerator pedal to accelerate the vehicle.

### Stopping

- 1 With the shift lever in D, depress the brake pedal.
- 2 If necessary, set the parking brake.  
If the vehicle is to be stopped for an extended period of time, shift the shift lever to P or N. (→P. 205)

### Parking the vehicle

- 1 With the shift lever in D, depress the brake pedal.
- 2 Set the parking brake. (→P. 211)
- 3 Shift the shift lever to P. (→P. 205)  
If parking on a hill, block the wheels as needed.
- 4 Press the engine switch to stop the engine.
- 5 Lock the door, making sure that you have the electronic key on your person.

### Starting off on a steep uphill

- 1 Make sure that the parking brake is set and shift the shift lever to D.
- 2 Gently depress the accelerator pedal.
- 3 Release the parking brake.

#### ■ When starting off on an uphill

The hill-start assist control will activate. (→P. 287)

#### ■ Driving in the rain

- Drive carefully when it is raining, because visibility will be reduced, the windows may become fogged-up, and the road will be slippery.
- Drive carefully when it starts to rain, because the road surface will be especially slippery.
- Refrain from high speeds when driving on an expressway in the rain, because there may be a layer of water between the tires and the road surface, preventing the steering and brakes from operating properly.

#### ■ Engine speed while driving

In the following conditions, the engine speed may become high while driving. This is due to automatic up-shifting control or down-shifting implementation to meet driving conditions. It does not indicate sudden acceleration.

- The vehicle is judged to be driving uphill or downhill
- When the accelerator pedal is released
- When the brake pedal is depressed while sport mode is selected

#### ■ Restraining the engine output (brake override system)

- When the accelerator and brake pedals are depressed at the same time, the engine output may be restrained.
- A warning message is displayed on the multi-information display while the system is operating. (→P. 560)

#### ■ Breaking in your new Lexus

To extend the life of the vehicle, observing the following precautions is recommended:

- For the first 186 miles (300 km):  
Avoid sudden stops.
- For the first 621 miles (1000 km):
  - Do not drive at extremely high speeds.
  - Avoid sudden acceleration.
  - Do not drive continuously in low gears.
  - Do not drive at a constant speed for extended periods.

#### ■ Drum-in-disc type parking brake system

Your vehicle has a drum-in-disc type parking brake system. This type of brake system needs bedding-down of the brake shoes periodically or whenever the parking brake shoes and/or drum are replaced. Have your Lexus dealer perform the bedding down operation.

#### ■ Operating your vehicle in a foreign country

Comply with the relevant vehicle registration laws and confirm the availability of the correct fuel. (→P. 636)

#### ■ Brake pads and discs (RC F)

The brake pads and discs are designed for use under high load conditions. Therefore, brake noise may be generated depending on the vehicle speed, braking force and vehicle environment (temperature, humidity, etc.).

**■ Idling time before engine stop (RC200t)**

To prevent damage to the turbocharger, allow the engine to idle immediately after high-speed driving or hill climbing.

| Driving condition  | Idling time             |
|--|-------------------------|
| Normal city driving  | Not necessary           |
| High-speed driving (Constant speed of approx. 62 mph [100 km/h])                                 | Approximately 1 minute  |
| Steep hill driving or continuous driving at 62 mph (100 km/h) or more (race track driving, etc.) | Approximately 2 minutes |

**⚠ WARNING**

Observe the following precautions.  
Failure to do so may result in death or serious injury.

■ **When starting the vehicle**

Always keep your foot on the brake pedal while stopped with the engine running. This prevents the vehicle from creeping.

■ **When driving the vehicle**

- Do not drive if you are unfamiliar with the location of the brake and accelerator pedals to avoid depressing the wrong pedal.
  - Accidentally depressing the accelerator pedal instead of the brake pedal will result in sudden acceleration that may lead to an accident.
  - When backing up, you may twist your body around, leading to a difficulty in operating the pedals. Make sure to operate the pedals properly.
  - Make sure to keep a correct driving posture even when moving the vehicle only slightly. This allows you to depress the brake and accelerator pedals properly.
  - Depress the brake pedal using your right foot. Depressing the brake pedal using your left foot may delay response in an emergency, resulting in an accident.
- Do not drive the vehicle over or stop the vehicle near flammable materials. The exhaust system and exhaust gases can be extremely hot. These hot parts may cause a fire if there is any flammable material nearby.
- During normal driving, do not turn off the engine. Turning the engine off while driving will not cause loss of steering or braking control, but the power assist to these systems will be lost. This will make it more difficult to steer and brake, so you should pull over and stop the vehicle as soon as it is safe to do so. However, in the event of an emergency, such as if it becomes impossible to stop the vehicle in the normal way: →P. 533
- Use engine braking (downshift) to maintain a safe speed when driving down a steep hill. Using the brakes continuously may cause the brakes to overheat and lose effectiveness. (→P. 205)
- Do not adjust the positions of the steering wheel, the seat, or the inside or outside rear view mirrors while driving. Doing so may result in a loss of vehicle control.
- Always check that all passengers' arms, heads or other parts of their body are not outside the vehicle.
- Do not drive in excess of the speed limit. Even if the legal speed limit permits it, do not drive over 85 mph (140 km/h) unless your vehicle has high-speed capability tires. Driving over 85 mph (140 km/h) may result in tire failure, loss of control and possible injury. Be sure to consult a tire dealer to determine whether the tires on your vehicle are high-speed capability tires or not before driving at such speeds.

 **WARNING**

Observe the following precautions.  
Failure to do so may result in death or serious injury.

**■ When driving on slippery road surfaces**

- Sudden braking, acceleration and steering may cause tire slippage and reduce your ability to control the vehicle.
- Sudden acceleration, engine braking due to shifting, or changes in engine speed could cause the vehicle to skid.
- After driving through a puddle, lightly depress the brake pedal to make sure that the brakes are functioning properly. Wet brake pads may prevent the brakes from functioning properly. If the brakes on only one side are wet and not functioning properly, steering control may be affected.

**■ When shifting the shift lever**

- Do not let the vehicle roll backward while the shift lever is in a driving position, or roll forward while the shift lever is in R.  
Doing so may cause the engine to stall or lead to poor brake and steering performance, resulting in an accident or damage to the vehicle.
- Do not shift the shift lever to P while the vehicle is moving.  
Doing so can damage the transmission and may result in a loss of vehicle control.
- Do not shift the shift lever to R while the vehicle is moving forward.  
Doing so can damage the transmission and may result in a loss of vehicle control.
- Do not shift the shift lever to a driving position while the vehicle is moving backward.  
Doing so can damage the transmission and may result in a loss of vehicle control.
- Moving the shift lever to N while the vehicle is moving will disengage the engine from the transmission. Engine braking is not available when N is selected.
- Be careful not to shift the shift lever with the accelerator pedal depressed. Shifting the shift lever to a gear other than P or N may lead to unexpected rapid acceleration of the vehicle that may cause an accident and result in death or serious injury.

**■ If you hear a squealing or scraping noise (brake pad wear limit indicators) (RC350/RC300/RC200t)**

Have the brake pads checked and replaced by your Lexus dealer as soon as possible.  
Rotor damage may result if the pads are not replaced when needed.

Front brakes on F SPORT models (RC350/RC200t only): Moderate levels of brake pad and disc wear allow enhanced front braking power. As a result, the discs may wear more quickly than conventional brake discs. Therefore, when replacing the brake pads, Lexus recommends that you also have the thickness of the discs measured.

It is dangerous to drive the vehicle when the wear limits of the brake pads and/or those of the brake discs are exceeded.



**⚠ WARNING**

Observe the following precautions.  
Failure to do so may result in death or serious injury.

**■ If a brake pad wear warning message is displayed (RC F)**

Have the brake pads checked and replaced by your Lexus dealer as soon as possible.  
Rotor damage may result if the pads are not replaced when needed.

Moderate levels of the brake pad and disc wear allow enhanced braking power. As a result, the discs may wear more quickly than conventional brake discs. Therefore, when replacing the brake pads, Lexus recommends that you also have the thickness of the discs measured.

It is dangerous to drive the vehicle when the wear limits of the brake pads and/or those of the brake discs are exceeded.

**■ When the vehicle is stopped**

- Do not race the engine.  
If the vehicle is in any gear other than P or N, the vehicle may accelerate suddenly and unexpectedly, causing an accident.
- In order to prevent accidents due to the vehicle rolling away, always keep depressing the brake pedal while the engine is running, and apply the parking brake as necessary.
- If the vehicle is stopped on an incline, in order to prevent accidents caused by the vehicle rolling forward or backward, always depress the brake pedal and securely apply the parking brake as needed.
- Avoid revving or racing the engine.  
Running the engine at high speed while the vehicle is stopped may cause the exhaust system to overheat, which could result in a fire if combustible material is nearby.

 **WARNING**

Observe the following precautions.  
Failure to do so may result in death or serious injury.

**■ When the vehicle is parked**

- Do not leave glasses, cigarette lighters, spray cans, or soft drink cans in the vehicle when it is in the sun.  
Doing so may result in the following:
  - Gas may leak from a cigarette lighter or spray can, and may lead to a fire.
  - The temperature inside the vehicle may cause the plastic lenses and plastic material of glasses to deform or crack.
  - Soft drink cans may fracture, causing the contents to spray over the interior of the vehicle, and may also cause a short circuit in the vehicle's electrical components.
- Do not leave cigarette lighters in the vehicle. If a cigarette lighter is in a place such as the glove box or on the floor, it may be lit accidentally when luggage is loaded or the seat is adjusted, causing a fire.
- Do not attach adhesive discs to the windshield or windows. Do not place containers such as air fresheners on the instrument panel or dashboard. Adhesive discs or containers may act as lenses, causing a fire in the vehicle.
- Do not leave a door or window open if the curved glass is coated with a metallized film such as a silver-colored one. Reflected sunlight may cause the glass to act as a lens, causing a fire.
- Always apply the parking brake, shift the shift lever to P, stop the engine and lock the vehicle.  
Do not leave the vehicle unattended while the engine is running.
- Do not touch the exhaust pipes while the engine is running or immediately after turning the engine off.  
Doing so may cause burns.

**■ When taking a nap in the vehicle**

Always turn the engine off. Otherwise, if you accidentally move the shift lever or depress the accelerator pedal, this could cause an accident or fire due to engine overheating. Additionally, if the vehicle is parked in a poorly ventilated area, exhaust gases may collect and enter the vehicle, leading to death or a serious health hazard.

**⚠ WARNING**

Observe the following precautions.  
Failure to do so may result in death or serious injury.

**■ When braking**

- When the brakes are wet, drive more cautiously.  
Braking distance increases when the brakes are wet, and this may cause one side of the vehicle to brake differently than the other side. Also, the parking brake may not securely hold the vehicle.
- If the power brake assist function does not operate, do not follow other vehicles closely and avoid hills or sharp turns that require braking.  
In this case, braking is still possible, but the brake pedal should be depressed more firmly than usual. Also, the braking distance will increase. Have your brakes fixed immediately.
- Do not pump the brake pedal if the engine stalls.  
Each push on the brake pedal uses up the reserve for the power-assisted brakes.
- The brake system consists of 2 individual hydraulic systems; if one of the systems fails, the other will still operate. In this case, the brake pedal should be depressed more firmly than usual and the braking distance will increase. Have your brakes fixed immediately.

**■ If the vehicle becomes stuck**

Do not spin the wheels excessively when any of the tires is up in the air, or the vehicle is stuck in sand, mud, etc. This may damage the driveline components or propel the vehicle forward or backward, causing an accident.

 NOTICE

■ **When driving the vehicle**

- Do not depress the accelerator and brake pedals at the same time while driving, as this may restrain the engine output.
- Do not use the accelerator pedal or depress the accelerator and brake pedals at the same time to hold the vehicle on a hill.

■ **When parking the vehicle**

Always shift the shift lever to P. Failure to do so may cause the vehicle to move or the vehicle may accelerate suddenly if the accelerator pedal is accidentally depressed.

■ **Avoiding damage to vehicle parts**

- Do not turn the steering wheel fully in either direction and hold it there for an extended period of time.  
Doing so may damage the power steering motor.
- When driving over bumps in the road, drive as slowly as possible to avoid damaging the wheels, underside of the vehicle, etc.
- RC200t: Make sure to idle the engine immediately after high speed driving or hill climbing. Stop the engine only after the turbocharger has cooled down.  
Failure to do so may cause damage to the turbocharger.

■ **If you get a flat tire while driving**

A flat or damaged tire may cause the following situations. Hold the steering wheel firmly and gradually depress the brake pedal to slow down the vehicle.

- It may be difficult to control your vehicle.
- The vehicle will make abnormal sounds or vibrations.
- The vehicle will lean abnormally.

Information on what to do in case of a flat tire (→P. 570, 584)

■ **When encountering flooded roads**

Do not drive on a road that has flooded after heavy rain etc. Doing so may cause the following serious damage to the vehicle:

- Engine stalling
- Short in electrical components
- Engine damage caused by water immersion

In the event that you drive on a flooded road and the vehicle is flooded, be sure to have your Lexus dealer check the following:

- Brake function
- Changes in quantity and quality of oil and fluid used for the engine, transmission, transfer (AWD models), differential, etc.
- Lubricant condition for the propeller shaft, bearings and suspension joints (where possible), and the function of all joints, bearings, etc.

## Cargo and luggage

Take notice of the following information about storage precautions, cargo capacity and load:

### Capacity and distribution

Cargo capacity depends on the total weight of the occupants.

(Cargo capacity) = (Total load capacity) – (Total weight of occupants)

#### Steps for Determining Correct Load Limit –

- (1) Locate the statement “The combined weight of occupants and cargo should never exceed XXX kg or XXX lbs.” on your vehicle’s placard.
- (2) Determine the combined weight of the driver and passengers that will be riding in your vehicle.
- (3) Subtract the combined weight of the driver and passengers from XXX kg or XXX lbs.
- (4) The resulting figure equals the available amount of cargo and luggage load capacity.  
For example, if the “XXX” amount equals 1400 lbs. and there will be five 150 lb passengers in your vehicle, the amount of available cargo and luggage load capacity is 650 lbs.  $(1400 - 750 (5 \times 150) = 650 \text{ lbs.})$
- (5) Determine the combined weight of luggage and cargo being loaded on the vehicle. That weight may not safely exceed the available cargo and luggage load capacity calculated in Step 4.
- (6) If your vehicle will be towing a trailer, load from your trailer will be transferred to your vehicle. Consult this manual to determine how this reduces the available cargo and luggage load capacity of your vehicle.

(→P.196)

Lexus does not recommend towing a trailer with your vehicle. Your vehicle is not designed for trailer towing.

**Calculation formula for your vehicle**

- ① Cargo capacity
- ② Total load capacity (vehicle capacity weight) (→P. 618)

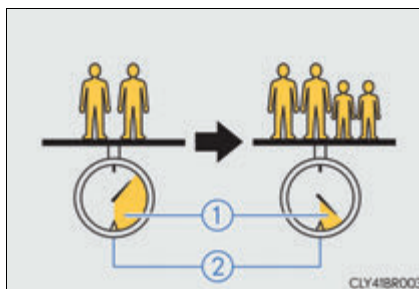

When 2 people with the combined weight of A lb. (kg) are riding in your vehicle, which has a total load capacity (vehicle capacity weight) of B lb. (kg), the available amount of cargo and luggage load capacity will be C lb. (kg) as follows:

$$B^{*2} \text{ lb. (kg)} - A^{*1} \text{ lb. (kg)} = C^{*3} \text{ lb. (kg)}$$

- \*1: A = Weight of people
- \*2: B = Total load capacity
- \*3: C = Available cargo and luggage load

In this condition, if 2 more passengers with the combined weight of D lb. (kg) get on, the available cargo and luggage load will be reduced E lb. (kg) as follows:

$$C \text{ lb. (kg)} - D^{*4} \text{ lb. (kg)} = E^{*5} \text{ lb. (kg)}$$

- \*4: D = Additional weight of people
- \*5: E = Available cargo and luggage load

As shown in the example above, if the number of occupants increases, the cargo and luggage load will be reduced by an amount that equals the increased weight due to the additional occupants. In other words, if an increase in the number of occupants causes an excess of the total load capacity (combined weight of occupants plus cargo and luggage load), you must reduce the cargo and luggage on your vehicle.

**⚠ WARNING****■ Things that must not be carried in the trunk**

The following things may cause a fire if loaded in the trunk:

- Receptacles containing gasoline
- Aerosol cans

**■ Storage precautions**

Observe the following precautions.

Failure to do so may prevent the pedals from being depressed properly, may block the driver's vision, or may result in items hitting the driver or passengers, possibly causing an accident.

- Stow cargo and luggage in the trunk whenever possible.
- RC350/RC300/RC200t: To prevent cargo and luggage from sliding forward during braking, do not stack anything in the enlarged trunk. Keep cargo and luggage low, as close to the floor as possible.
- RC350/RC300/RC200t: When you fold down the rear seats, long items should not be placed directly behind the front seats.
- RC350/RC300/RC200t: Never allow anyone to ride in the enlarged trunk. It is not designed for passengers. They should ride in their seats with their seat belts properly fastened.
- Do not place cargo or luggage in or on the following locations.
  - At the feet of the driver
  - On the front passenger or rear seats (when stacking items)
  - On the package tray
  - On the instrument panel
  - On the dashboard
  - In front of the navigation system screen (if equipped) or Lexus Display Audio screen (if equipped)
- Secure all items in the occupant compartment.

**■ Capacity and distribution**

- Do not exceed the maximum axle weight rating or the total vehicle weight rating.
- Even if the total load of occupant's weight and the cargo load is less than the total load capacity, do not apply the load unevenly. Improper loading may cause deterioration of steering or braking control which may cause death or serious injury.

## Vehicle load limits

Vehicle load limits include total load capacity, seating capacity, towing capacity and cargo capacity.

◆ **Total load capacity (vehicle capacity weight): (→P. 618)**

Total load capacity means the combined weight of occupants, cargo and luggage.

◆ **Seating capacity: 4 occupants (Front 2, Rear 2)**

Seating capacity means the maximum number of occupants whose estimated average weight is 150 lb. (68 kg) per person.

◆ **Towing capacity**

Lexus does not recommend towing a trailer with your vehicle.

◆ **Cargo capacity**

Cargo capacity may increase or decrease depending on the weight and the number of occupants.

■ **Total load capacity and seating capacity**

These details are also described on the tire and loading information label. (→P. 510)

 **WARNING**

■ **Overloading the vehicle**

Do not overload the vehicle.  
It may not only cause damage to the tires, but also degrade steering and braking ability, resulting in an accident.



## Trailer towing

Lexus does not recommend towing a trailer with your vehicle. Lexus also does not recommend the installation of a tow hitch or the use of a tow hitch carrier for a wheelchair, scooter, bicycle, etc. Your vehicle is not designed for trailer towing or for the use of tow hitch mounted carriers.



4

Driving

## Dinghy towing

Your vehicle is not designed to be dinghy towed (with 4 wheels on the ground) behind a motor home.

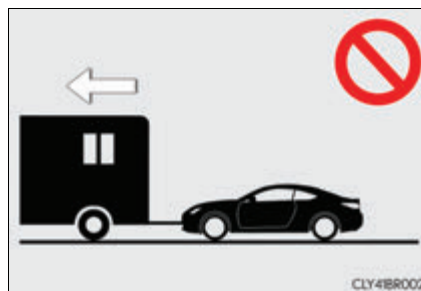

 NOTICE

- **To avoid serious damage to your vehicle**  
Do not tow your vehicle with the four wheels on the ground.

## Engine (ignition) switch

Performing the following operations when carrying the electronic key on your person starts the engine or changes engine switch modes.

### Starting the engine

- 1 Check that the parking brake is set.
- 2 Check that the shift lever is in P.
- 3 Firmly depress the brake pedal.



and a message will be displayed on the multi-information display.

If it is not displayed, the engine cannot be started.

- 4 Press the engine switch.

The engine will crank until it starts or for up to 30 seconds, whichever is less.

Continue depressing the brake pedal until the engine is completely started.

The engine can be started from any engine switch mode.

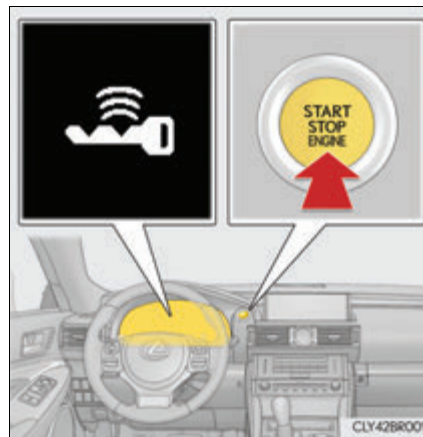

4

Driving

### Stopping the engine

- 1 Stop the vehicle.
- 2 Shift the shift lever to P.
- 3 Set the parking brake. (→P. 211)
- 4 Press the engine switch.
- 5 Release the brake pedal and check that the display on the meters is off.

### Changing engine switch modes

Modes can be changed by pressing the engine switch with brake pedal released. (The mode changes each time the switch is pressed.)

▶ RC350/RC300/RC200t

① Off\*

The emergency flashers can be used.

② ACCESSORY mode

Some electrical components such as the audio system can be used.

"ACCESSORY" will be displayed on the meters.

③ IGNITION ON mode

All electrical components can be used.

"IGNITION ON" will be displayed on the meters.

\*: If the shift lever is in a position other than P when turning off the engine, the engine switch will be turned to ACCESSORY mode, not to off.

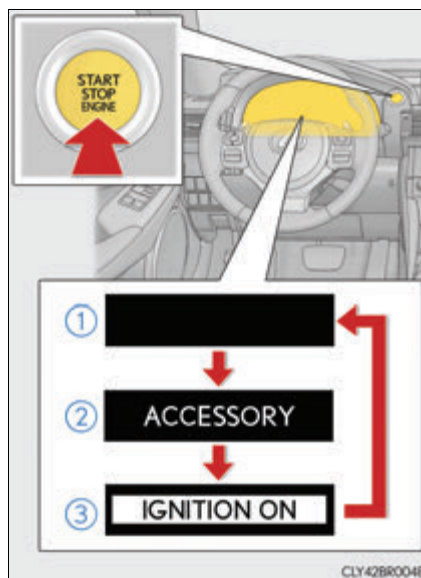

## ▶ RC F

## ① Off\*

The emergency flashers can be used.  
The analog speedometer and the tachometer will not be illuminated. However, if the welcome illumination is operating, the analog speedometer will illuminate.  
(Welcome illumination: →P. 103)

## ② ACCESSORY mode

Some electrical components such as the audio system can be used.

The analog speedometer is illuminated.

## ③ IGNITION ON mode

All electrical components can be used.

The analog speedometer and the tachometer will be illuminated.

\*: If the shift lever is in a position other than P when turning off the engine, the engine switch will be turned to ACCESSORY mode, not to off.

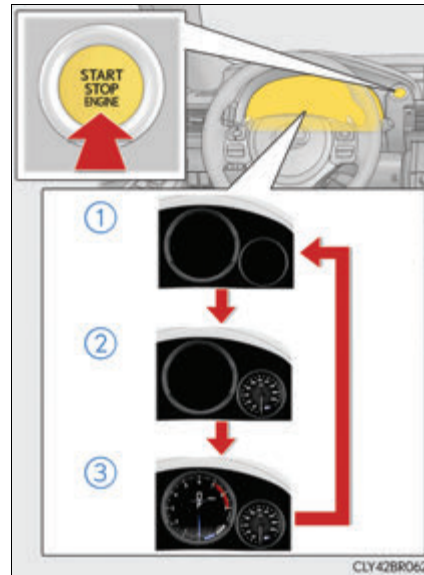

4

Driving

### When stopping the engine with the shift lever in a position other than P

If the engine is stopped with the shift lever in a position other than P, the engine switch will not be turned off but instead be turned to ACCESSORY mode. Perform the following procedure to turn the switch off:

- 1 Check that the parking brake is set.
- 2 Shift the shift lever to P.
- 3 Check that "Turn Power OFF" is displayed on the multi-information display and then press the engine switch once.
- 4 Check that "Turn Power OFF" on the multi-information display is off.

■ **Auto power off function**

If the vehicle is left in ACCESSORY mode for more than 20 minutes or IGNITION ON mode (the engine is not running) for more than an hour with the shift lever in P, the engine switch will automatically turn off. However, this function cannot entirely prevent battery discharge. Do not leave the vehicle with the engine switch in ACCESSORY or IGNITION ON mode for long periods of time when the engine is not running.

■ **Electronic key battery depletion**

→P. 135

■ **Conditions affecting operation**

→P. 150

■ **Notes for the entry function**

→P. 151

■ **If the engine does not start**

- Check that the shift lever is securely set in P. The engine may not start if the shift lever is displaced out of P.
- The engine immobilizer system may not have been deactivated. (→P. 76)  
Contact your Lexus dealer.

■ **Steering lock**

After turning the engine switch off and opening and closing the doors, the steering wheel will be locked due to the steering lock function. Operating the engine switch again automatically cancels the steering lock.

■ **When the steering lock cannot be released**

“Steering Lock active” will be displayed on the multi-information display.

Check that the shift lever is in P. Press the engine switch while turning the steering wheel left and right.

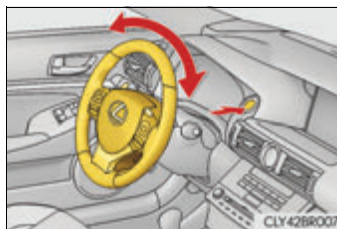

■ **Steering lock motor overheating prevention**

To prevent the steering lock motor from overheating, operation of the motor may be suspended if the engine is turned on and off repeatedly in a short period of time. In this case, refrain from operating the engine switch. After about 10 seconds, the steering lock motor will resume functioning.

■ **When “Check Access System with Elec. Key” is displayed on the multi-information display**

The system may be malfunctioning. Have the vehicle inspected by your Lexus dealer immediately.

■ **If the electronic key battery is depleted**

→P. 517

**■ Operation of the engine switch**

- When operating the engine switch, one short, firm press is enough. If the switch is pressed improperly, the engine may not start or the engine switch mode may not change. It is not necessary to press and hold the switch.
- If attempting to restart the engine immediately after turning the engine switch off, the engine may not start in some cases. After turning the engine switch off, please wait a few seconds before restarting the engine.

**■ If the smart access system with push-button start has been deactivated by a customized setting**

→P. 600

**WARNING****■ When starting the engine**

Always start the engine while sitting in the driver's seat. Do not depress the accelerator pedal while starting the engine under any circumstances. Doing so may cause an accident resulting in death or serious injury.

**■ Caution while driving**

If engine failure occurs while the vehicle is moving, do not lock or open the doors until the vehicle reaches a safe and complete stop. Activation of the steering lock in this circumstance may lead to an accident, resulting in death or serious injury.

**■ Stopping the engine in an emergency**

If you want to stop the engine in an emergency while driving the vehicle, press and hold the engine switch for more than 2 seconds, or press it briefly 3 times or more in succession. (→P. 533)

However, do not touch the engine switch while driving except in an emergency. Turning the engine off while driving will not cause loss of steering or braking control, but the power assist to these systems will be lost. This will make it more difficult to steer and brake, so you should pull over and stop the vehicle as soon as it is safe to do so.

 NOTICE

■ **To prevent battery discharge**

- Do not leave the engine switch in ACCESSORY or IGNITION ON mode for long periods of time without the engine running.
- RC350/RC300/RC200t: If "ACCESSORY" or "IGNITION ON" is displayed on the meters while the engine is not running, the engine switch is not off. Exit the vehicle after turning the engine switch off.
- RC F: If the analog speedometer is illuminated and the engine is not running, the engine switch is not off. Exit the vehicle after turning the engine switch off. However, if the welcome illumination is operating, the analog speedometer will be illuminated even though the engine switch is off. (Welcome illumination: →P.103)
- Do not stop the engine when the shift lever is in a position other than P. If the engine is stopped in another shift lever position, the engine switch will not be turned off but instead be turned to ACCESSORY mode. If the vehicle is left in ACCESSORY mode, battery discharge may occur.

■ **When starting the engine**

- Do not race a cold engine.
- If the engine becomes difficult to start or stalls frequently, have your vehicle checked by your Lexus dealer immediately.

■ **Symptoms indicating a malfunction with the engine switch**

If the engine switch seems to be operating somewhat differently than usual, such as the switch sticking slightly, there may be a malfunction. Contact your Lexus dealer immediately.



## Automatic transmission

### Shifting the shift lever

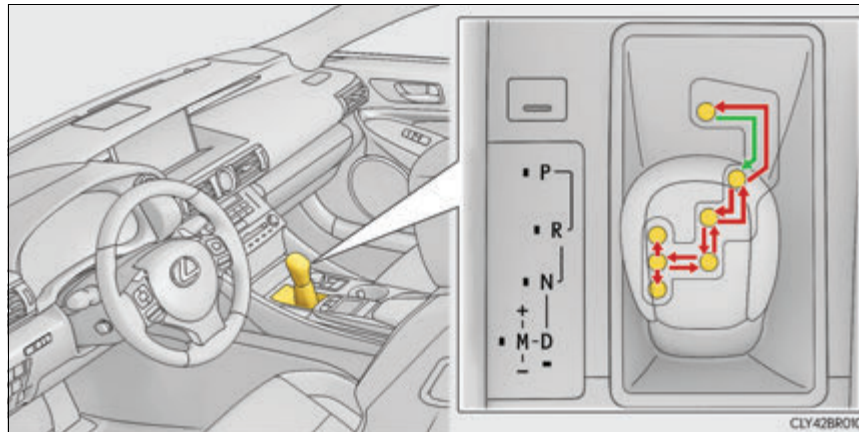

- ← While the engine switch is in IGNITION ON mode, move the shift lever with the brake pedal depressed.

When shifting the shift lever between P and D, make sure that the vehicle is completely stopped.

4

Driving

### Shift position purpose

| Shift position | Objective or function  |
|----------------|--|
| P              | Parking the vehicle/starting the engine                      |
| R              | Reversing  |
| N              | Neutral<br>(Condition in which the power is not transmitted) |
| D              | Normal driving <sup>*1</sup>                                 |
| M              | M mode driving <sup>*2</sup> (→P. 208)                       |

<sup>\*1</sup>: To improve fuel efficiency and reduce noise, shift the shift lever to D for normal driving.

<sup>\*2</sup>: Any gear range can be fixed when driving in M mode.

### Selecting the driving mode

■ **Sport mode/Eco drive mode**

→P. 283

■ **Snow mode**

Snow mode can be selected to suit the conditions when driving on slippery road surfaces, such as snow.

Press the switch.

Press the switch again to return to normal mode.



### Selecting shift ranges in the D position

To drive using temporary shift range selection, operate the “-” or “+” paddle shift switch.

When the “-” paddle shift switch is operated, the shift range will be downshifted to a range that enables engine braking force that is suitable to driving conditions.

When the “+” paddle shift switch is operated, the shift range will be one gear higher than the gear in use during normal D position driving.

Changing the shift range allows restriction of the highest gear, preventing unnecessary upshifting and enabling the level of engine braking force to be selected.

① Upshifting

② Downshifting

8-speed models: The selected shift range, from D1 to D8, will be displayed in the meter.

6-speed models: The selected shift range, from D1 to D6, will be displayed in the meter.

To return to normal D position driving, the “+” paddle shift switch must be held down for a period of time.



4

Driving

#### ■ Shift ranges and their functions

| Meter display               | Function  |
|-----------------------------|---|
| D2 - D8<br>(8-speed models) | A gear in the range between 1 and the selected gear is automatically chosen depending on vehicle speed and driving conditions |
| D2 - D6<br>(6-speed models) |   |
| D1                          | Setting the gear at 1   |

A lower shift range will provide greater engine braking forces than a higher shift range.

### Selecting gears in the M position

To enter M mode, shift the shift lever to M. Gears can then be selected by operating the shift lever or paddle shift switches, allowing you to drive in the gear of your choosing.

- ① Upshifting
- ② Downshifting

The gear changes once every time the shift lever or paddle shift switch is operated.

8-speed models: The selected gear, from M1 to M8, will be fixed and displayed in the meter.

6-speed models: The selected gear, from M1 to M6, will be fixed and displayed in the meter.

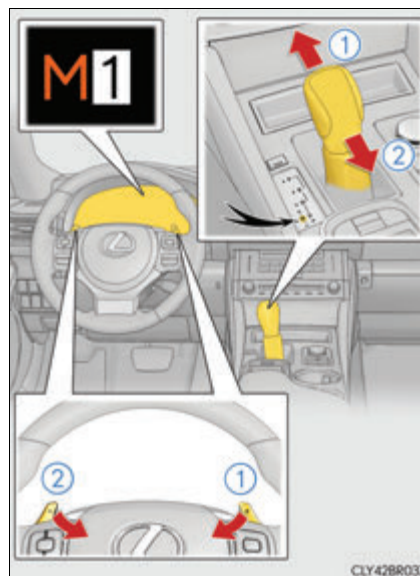

When in the M position, the gear will not change unless the shift lever or paddle shift switches are operated.

However, even when in the M position, the gears will be automatically changed in the following situation:

- When vehicle speed drops (downshift only).
- When a gear change is necessary to protect the engine or automatic transmission when the engine coolant temperature or automatic transmission fluid temperature is low, or other reasons.

In the following situations, the gear will not shift even if the shift lever or paddle shift switches are operated.

- “1st Gear not available due to slippery road surface” is displayed on the multi-information display.
- The vehicle speed is low (upshift only).

#### ■ Automatic deactivation of shift range selection in the D position

Shift range selection in the D position will be deactivated in the following situations:

- When the vehicle comes to a stop
- If the accelerator pedal is depressed for more than a certain period of time
- When the shift lever is shifted to a position other than D

#### ■ To protect the automatic transmission

If the automatic transmission fluid temperature is high, "Transmission Fluid High Temperature" will be displayed on the multi-information display and the vehicle will go into transmission protection mode automatically. Have the vehicle inspected by your Lexus dealer.

#### ■ Downshifting restriction warning buzzer

To help ensure safety and driving performance, downshifting operation may sometimes be restricted. In some circumstances, downshifting may not be possible even when the shift lever or paddle shift switch is operated. (A buzzer will sound twice.)

#### ■ Snow mode automatic deactivation

Snow mode is automatically deactivated if the engine switch is turned off after driving in snow mode.

#### ■ When driving with cruise control or dynamic radar cruise control activated

Even when performing the following actions with the intent of enabling engine braking, engine braking will not activate because cruise control or dynamic radar cruise control will not be canceled.

- 8-speed models: While driving in the D position, downshifting to 7, 6, 5 or 4. (→P. 235, 239)
- 6-speed models: While driving in the D position, downshifting to 5 or 4. (→P. 235, 239)
- When switching the driving mode to sport mode while driving in D position. (→P. 283)

#### ■ If the shift lever cannot be shifted from P

→P. 599

#### ■ AI-SHIFT

- The AI-SHIFT automatically selects the suitable gear according to driver performance and driving conditions.  
The AI-SHIFT automatically operates when the shift lever is in D. (Shifting the shift lever to the M position cancels the function.)
- 8-speed models: G AI-SHIFT automatically selects a suitable gear for sporty driving according to driver's input and driving conditions. G AI-SHIFT operates automatically when the shift lever is in D and sport mode is selected for the driving mode. (Selecting normal mode with the driving mode select switch or shifting the shift lever to the M position cancels this function.)

#### WARNING

##### ■ When driving on slippery road surfaces

Be careful of downshifting and sudden acceleration, as this could result in the vehicle skidding to the side or spinning.

## Turn signal lever

### Operating instructions

The lever will return to its original position immediately after operation.

- ① Right turn
- ② Lane change to the right (move the lever partway and release it)  
The right hand signals will flash 3 times.
- ③ Lane change to the left (move the lever partway and release it)  
The left hand signals will flash 3 times.
- ④ Left turn

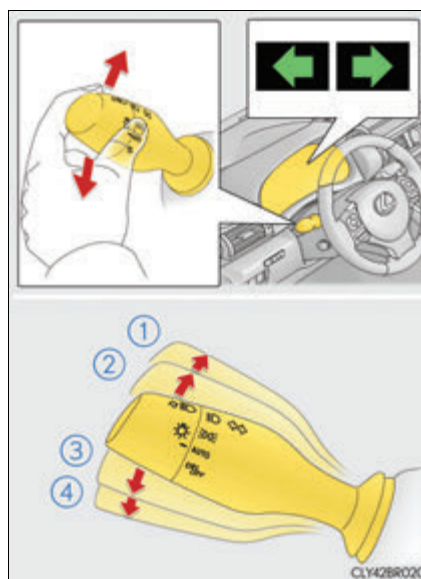

■ **If the turn signals do not stop flashing after turning left or right, or if you want to stop them flashing**

Operate the lever in the opposite direction to either position ② or ③. If you move the lever to either position ① or ④, the selected turn signals will flash.

■ **Turn signals can be operated when**

The engine switch is in IGNITION ON mode.

■ **If the indicator flashes faster than usual**

Check that a light bulb in the front or rear turn signal lights has not burned out.

■ **If the turn signals stop flashing before a lane change has been performed**

Operate the lever again.

■ **Customization**

The number of times the turn signals flash during a lane change can be changed. (Customizable feature →P. 651)

## Parking brake

### Operating instructions

To set the parking brake, fully depress the parking brake pedal with your left foot while depressing the brake pedal with your right foot.  
(Depressing the pedal again releases the parking brake.)

▶ RC350/RC300/RC200t

▶ RC F

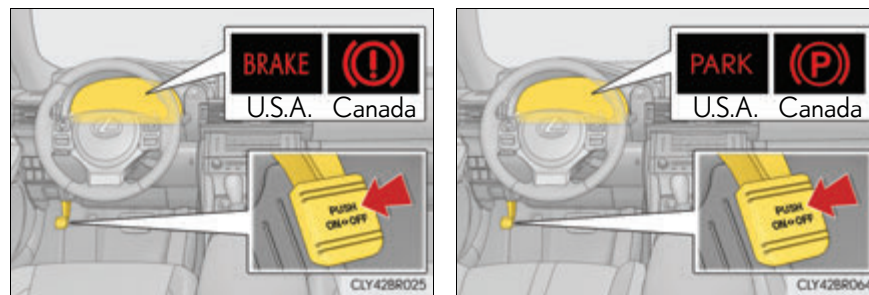

#### ■ Parking brake engaged warning buzzer

→P. 553

#### ■ Usage in winter time

→P. 321

#### ⚠ NOTICE

##### ■ Before driving

Fully release the parking brake.

Driving the vehicle with the parking brake set will lead to brake components overheating, which may affect braking performance and increase brake wear.

## ASC (Active Sound Control)\* (RC350/RC300/RC200t)

The ASC system is an electronic sound system that generates engine sound, conveying the kinetic situations of the vehicle's acceleration and deceleration to the driver through the speakers inside the instrument panel.

The vehicle's response to the driver's acceleration behavior and shift operations are also conveyed in sound.

When sport mode is selected, the sound conveyed to the driver will be louder.

### Controlling volume

- ① Louder
- ② Lower

The indicator comes on when the ASC system is on.

When the dial is turned to the lowest volume, the ASC system will be turned off and the indicator will go off.



#### ■ The ASC system can be operated when

The driving mode select switch is in normal mode or sport mode. (→P. 283)

#### ■ Temporary cancelation of the ASC system functions

The ASC system may be temporarily canceled depending on the driving conditions, such as when the tires slip due to sudden acceleration.

\*: If equipped



## ASC (Active Sound Control)\* (RC F)

The ASC system sonically emphasizes the vehicle's response to the driver's operation of the accelerator pedal and shift lever or paddle shift switches. The dynamic engine sound enabled by this system helps the driver further enjoy the feeling of unity with the vehicle, particularly when driving in M mode. (→P. 208)

- The ASC system can be operated when  
The driving mode select switch is in SPORT S+ mode. (→P. 283)



\*: If equipped

## Headlight switch

The headlights can be operated manually or automatically.

### Operating instructions

Turning the end of the lever turns on the lights as follows:

- ①  The side marker, tail, license plate and instrument panel lights turn on.
- ②  The headlights and all lights listed above turn on.
- ③ **AUTO** The headlights, daytime running lights (→P. 215) and all the lights listed above turn on and off automatically. (When the engine switch is in IGNITION ON mode.)
- ④ **DRL OFF** Off  
(U.S.A.)
  - The daytime running lights (Canada) turn on. (→P. 215)

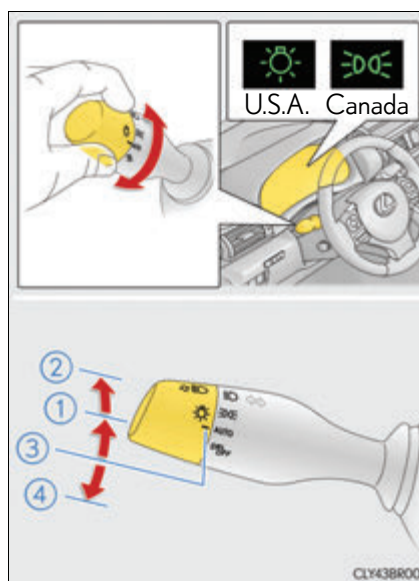

### Turning on the high beam headlights

- ① With the headlights on, push the lever away from you to turn on the high beams.

Pull the lever toward you to the center position to turn the high beams off.

- ② Pull the lever toward you and release it to flash the high beams once.

You can flash the high beams with the headlights on or off.

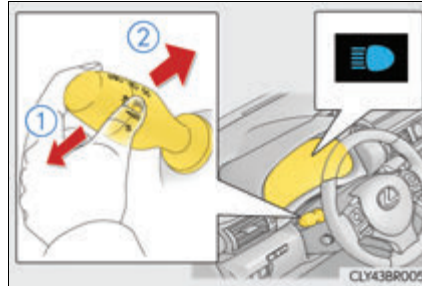

#### ■ Daytime running light system

- To make your vehicle more visible to other drivers during daytime driving, the daytime running lights turn on automatically whenever the engine is started and the parking brake is released with the headlight switch off (for Canada) or in the "AUTO" position. (Illuminate brighter than the parking lights.) Daytime running lights are not designed for use at night.
- Compared to turning on the headlights, the daytime running light system offers greater durability and consumes less electricity, so it can help improve fuel economy.
- Vehicles with LED front turn signal lights: If a turn signal light is in use, the daytime running light, on the same side, is turned off. For emergency flashers, both are turned off.

#### ■ Headlight control sensor

The sensor may not function properly if an object is placed on the sensor, or anything that blocks the sensor is affixed to the windshield. Doing so interferes with the sensor detecting the level of ambient light and may cause the automatic headlight system to malfunction.

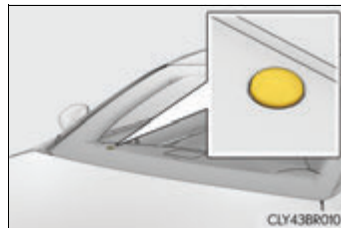

#### ■ Automatic light off system

When the light switch is in **AUTO**, **☞** or **☞**: The headlights and tail lights turn off 30 seconds after the engine switch is turned to **ACCESSORY** mode or turned off and a door is opened and all of the doors and trunk are closed. (The lights turn off immediately if **🔑** on the key is pressed twice after both side doors are closed.)

To turn the lights on again, turn the engine switch to **IGNITION ON** mode, or turn the light switch off once and then back to **☞** or **☞**.

If any of the doors or trunk lid is left open, the lights automatically turn off after 20 minutes.

■ **Automatic headlight leveling system**

The level of the headlights is automatically adjusted according to the number of passengers and the loading condition of the vehicle to ensure that the headlights do not interfere with other road users.

■ **Light reminder buzzer**

A buzzer sounds when the engine switch is turned off or turned to ACCESSORY mode and the driver's door is opened while the lights are turned on.

■ **Operation guide display (vehicles with rain-sensing windshield wipers only)**

When the headlight switch is operated to and from the "AUTO" position, the current status is displayed on the meters for a few seconds to show that AUTO mode is activated/deactivated. (→P. 110, 122)

■ **Customization**

Settings (e.g. light sensor sensitivity) can be changed.  
(Customizable features: →P. 651)

 **NOTICE**

■ **To prevent battery discharge**

Do not leave the lights on longer than necessary when the engine is not running.

## Automatic High Beam \*

The Automatic High Beam uses an in-vehicle camera sensor to assess the brightness of streetlights, the lights of oncoming and preceding vehicles, etc., and automatically turns the high beam on or off as necessary.

### Activating the Automatic High Beam system

- 1 Push the lever away from you with the headlight switch in the **AUTO** or  position.

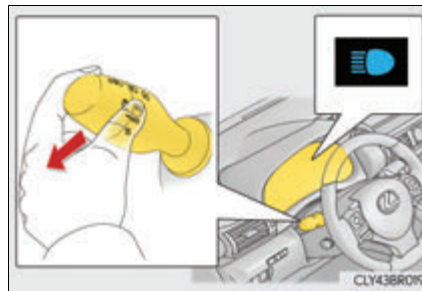

- 2 Press the Automatic High Beam switch.

The Automatic High Beam indicator will come on when the headlights are turned on automatically to indicate that the system is active.

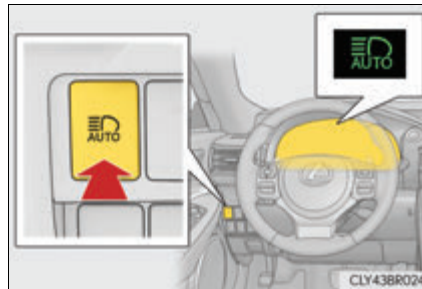

4

Driving

\*: If equipped

### High beam automatic turning on or off conditions

When all of the following conditions are met, the high beam will be automatically turned on (after approximately 1 second):

- Vehicle speed is above approximately 21 mph (34 km/h).
- The area ahead of the vehicle is dark.
- There are no oncoming or preceding vehicles with headlights or tail lights turned on.
- There are few streetlights on the road ahead.

If any of the following conditions are met, the high beam will be automatically turned off:

- Vehicle speed drops below approximately 17 mph (27 km/h).
- The area ahead of the vehicle is not dark.
- Oncoming or preceding vehicles have headlights or tail lights turned on.
- There are many streetlights on the road ahead.

### Turning the high beam on/off manually

#### ■ Switching to low beam

Pull the lever to the original position.

The Automatic High Beam indicator will turn off.

Push the lever away from you to activate the Automatic High Beam system again.

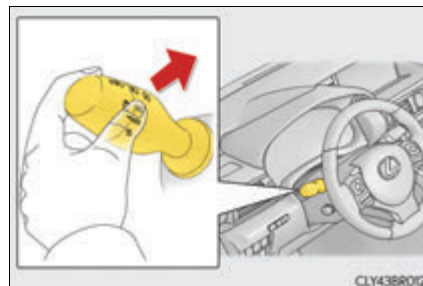

#### ■ Switching to high beam

Press the Automatic High Beam switch.

The Automatic High Beam indicator will turn off and the high beam indicator will turn on.

Press the switch to activate the Automatic High Beam system again.

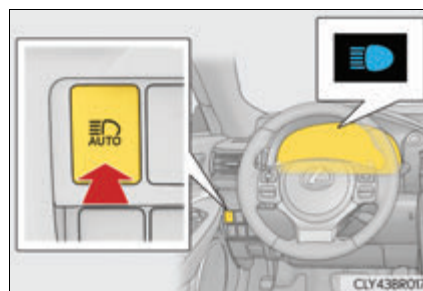

### ■ The Automatic High Beam can be operated when

The engine switch is in IGNITION ON mode.

### ■ Camera sensor detection information

- High beam may not be automatically turned off in the following situations:
  - When oncoming vehicles suddenly appear from a curve
  - When the vehicle is cut in front of by another vehicle
  - When oncoming or preceding vehicles are hidden from sight due to repeated curves, road dividers or roadside trees
- High beam may be turned off if an oncoming vehicle that is using fog lights without using the headlights is detected.
- House lights, street lights, red traffic signals, and illuminated billboards or signs may cause the high beam to turn off.
- The following factors may affect the amount of time taken to turn high beam on or off:
  - The brightness of headlights, fog lights, and tail lights of oncoming and preceding vehicles
  - The movement and direction of oncoming and preceding vehicles
  - When an oncoming or preceding vehicle only has operational lights on one side
  - When an oncoming or preceding vehicle is a two-wheeled vehicle
  - The condition of the road (gradient, curve, condition of the road surface etc.)
  - The number of passengers and amount of luggage
- High beam may be turned on or off when unexpected by the driver.
- Small vehicles, such as bicycles, may not be detected.
- In the situations below, the system may not be able to correctly detect the surrounding brightness levels, and may flash or expose nearby pedestrians to the high beam. Therefore, you should consider turning the high beams on or off manually rather than relying on the Automatic High Beam system.
  - In bad weather (rain, snow, fog, sandstorms etc.)
  - The windshield is obscured by fog, mist, ice, dirt etc.
  - The windshield is cracked or damaged.
  - The camera sensor is deformed or dirty.
  - Surrounding brightness levels are equal to those of headlights, tail lights or fog lights.
  - Vehicles ahead have headlights or tail lights that are either switched off, dirty, changing color, or have improperly adjusted aim.
  - When driving through an area of intermittently changing brightness and darkness.
  - When frequently and repeatedly driving ascending/descending roads, or roads with rough, bumpy or uneven surfaces (such as stone-paved roads, gravel tracks etc.).
  - When frequently and repeatedly taking curves or driving on a winding road.
  - There is a highly reflective object ahead of the vehicle, such as a sign or a mirror.
  - The vehicle's headlights are damaged or dirty.
  - The vehicle is listing or titling, due to a flat tire, a trailer being towed etc.
  - The driver believes that the high beam may be causing problems or distress to other drivers or pedestrians nearby.

■ **Temporarily lowering sensor sensitivity**

The sensitivity of the sensor can be temporarily lowered.

- 1 Turn the engine switch off while the following conditions are met.
  - The headlight switch is in AUTO or .
  - The headlight switch lever is in high beam position.
  - Automatic High Beam switch is on.
- 2 Turn the engine switch to IGNITION ON mode.
- 3 Within 5 seconds after 2, repeat pulling the headlight switch lever to the original position then pushing it to the high beam position quickly 9 times, then leave the lever in high beam position.

Automatic High Beam (headlights) may turn on even the vehicle is stopped.

 **WARNING**

■ **Limitations of the Automatic High Beam**

Do not rely on the Automatic High Beam. Always drive safely, taking care to observe your surroundings and turning high beam on or off manually if necessary.



 NOTICE**■ Notes when using the Automatic High Beam system**

Observe the following to ensure that the Automatic High Beam functions correctly.

- Do not touch the camera sensor.
- Do not subject the camera sensor to a strong impact.
- Do not disassemble the camera sensor.
- Do not spill liquid onto the camera sensor.
- Do not apply window tinting or stickers to the camera sensor or the area of windshield near the camera sensor.
- Do not place items on the dashboard. There is a possibility that the camera sensor will mistake items reflected in the windshield for streetlights, the headlights of other vehicles, etc.
- Do not install a parking tag or any other accessories near or around the camera sensor.
- Do not overload the vehicle.
- Do not modify the vehicle.
- If the windshield needs to be replaced, contact your Lexus dealer.

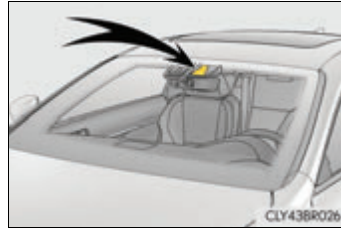

## Fog light switch \*

The fog lights secure excellent visibility in difficult driving conditions, such as in rain and fog.

- ① OFF (U.S.A.) or ○ (Canada)  
Turns the front fog lights off
- ②  Turns the front fog lights on

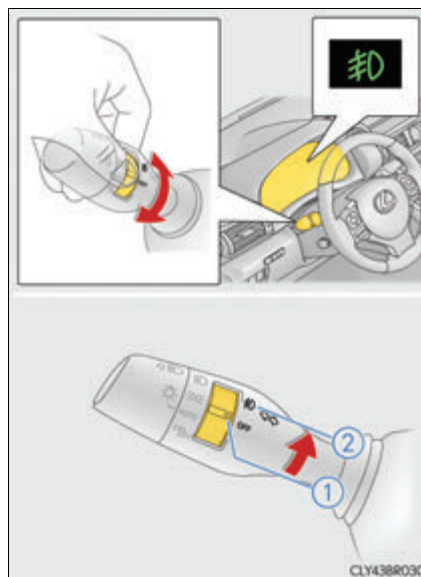

### ■ Fog lights can be used when

The headlights are on in low beam.

### ■ Operation guide display (vehicles with rain-sensing windshield wipers only)

When the fog light switch is operated, the current status is displayed on the meters for a few seconds. (→P. 110, 122)







\*: If equipped

## Windshield wipers and washer

### Operating the wiper lever





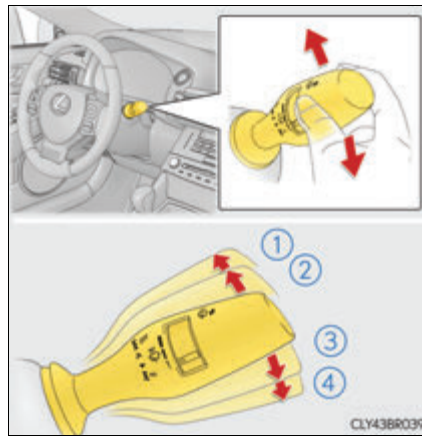

Operate the lever as follows to operate the wipers. The lever will return to its original position after operation.

► Intermittent windshield wipers with interval adjuster

- ①  OFF (U.S.A.) or  (Canada)  
Move the lever up by 2 levels
- ②  Move the lever up by 1 level
- ③  (U.S.A.) or  (Canada)  
Move the lever down by 1 level
- ④  HI (U.S.A.) or  (Canada)  
Move the lever down by 2 levels



4  
Driving

| Operation<br>Status before operation |  OFF or  |  |  or  |  HI or  |
|--------------------------------------|--|---|--|---|
| Off                                  | Temporary operation  | Temporary operation   | Intermittent operation   | High speed operation  |
| Intermittent operation               | Off  | Off   | Low speed operation  | High speed operation  |
| Low speed operation                  | Off  | Intermittent operation  | High speed operation   | High speed operation  |
| High speed operation                 | Off  | Low speed operation   | No change  | No change   |

Wiper intervals can be adjusted when intermittent operation is selected.

- ⑤ Increases the intermittent windshield wiper frequency
- ⑥ Decreases the intermittent windshield wiper frequency

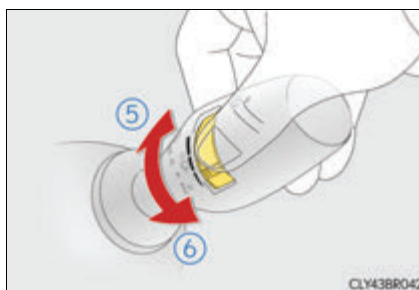

- ⑦ Washer/wiper dual operation

The wipers will automatically operate a couple of times after the washer squirts.

Vehicles with headlight cleaners: When the engine switch is in IGNITION ON mode and the headlights are on, if the lever is pulled, the headlight cleaners will operate once. After this, the headlight cleaners will operate every 5th time the lever is pulled.

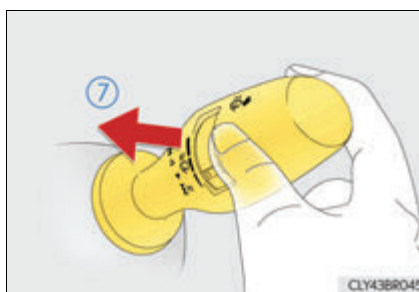

► Rain-sensing windshield wipers

- ① OFF (U.S.A.) or (Canada)  
Move the lever up by 2 levels
- ② Move the lever up by 1 level
- ③ (U.S.A.) or (Canada)  
Move the lever down by 1 level
- ④ HI (U.S.A.) or (Canada)  
Move the lever down by 2 levels

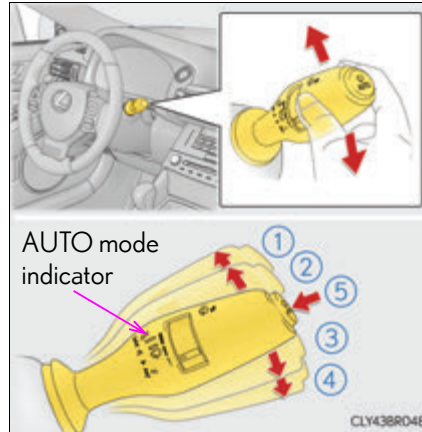

- ⑤ AUTO AUTO mode on/off switch

With AUTO mode selected, the wipers will operate automatically when the sensor detects falling rain. The system automatically adjusts wiper timing in accordance with rain volume and vehicle speed.

The AUTO mode indicator will turn on when AUTO mode is selected.

| Status before operation \ Operation |                        | OFF or              |                        | or                     | HI or                   |
|-------------------------------------|------------------------|---------------------|------------------------|------------------------|-------------------------|
|                                     |                        | Off                 | Temporary operation    | Temporary operation    | Low speed operation     |
| Low speed operation                 | Off                    | Off                 | High speed operation   | High speed operation   |                         |
| High speed operation                | Off                    | Low speed operation | No change              | No change              |                         |
| AUTO mode                           | Intermittent operation | Off                 | Temporary operation *1 | Low speed operation *2 | High speed operation *2 |
|                                     | Continuously           |                     | No change              |                        |                         |

\*1: After temporary operation, the mode will return to AUTO mode.

\*2: AUTO mode will be canceled.

When AUTO mode is selected, the sensor sensitivity can be adjusted by turning the switch ring.

- ⑥ Increases the sensitivity
- ⑦ Decreases the sensitivity

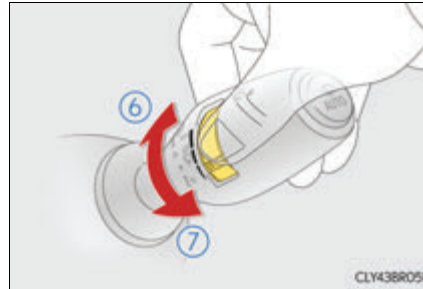

- ⑧ Washer/wiper dual operation

The wipers will automatically operate a couple of times after the washer squirts.

Vehicles with headlight cleaners: When the engine switch is in IGNITION ON mode and the headlights are on, if the lever is pulled, the headlight cleaners will operate once. After this, the headlight cleaners will operate every 5th time the lever is pulled.

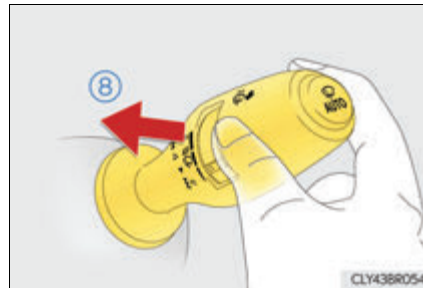

### Switching between the intermittent windshield wipers and rain-sensing windshield wipers (vehicles with rain-sensing windshield wipers)





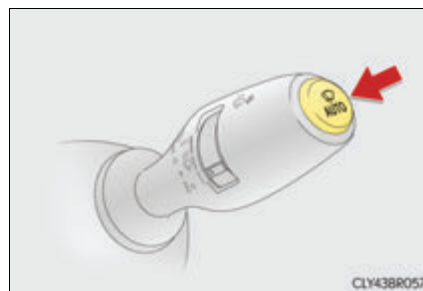

The wipers can be used as intermittent windshield wipers, which operate regardless of vehicle speed or amount of raindrops. The intermittent windshield wiper operation can be switched when the vehicle is stopped and the wiper is off. The wiper operation cannot be switched during AUTO mode or while the intermittent windshield wipers are operating.

Press and hold  until the AUTO mode indicator stops flashing.







If  is pressed and held until the AUTO mode indicator stops flashing again, it will return to its previous state. The wiper can be switched when the vehicle is stopped and the wipers are off.

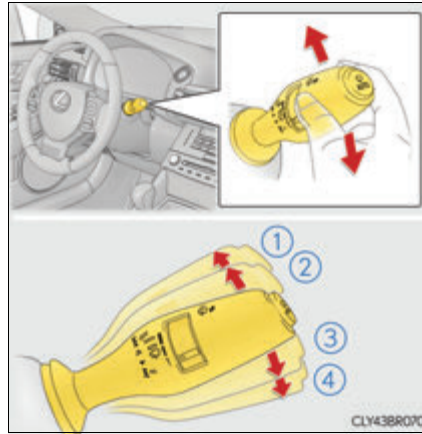

■ Operation of the intermittent windshield wipers with interval adjuster

- ①  OFF (U.S.A.) or  (Canada)  
Move the lever up by 2 levels
- ②  Move the lever up by 1 level
- ③  (U.S.A.) or  (Canada)  
Move the lever down by 1 level
- ④  HI (U.S.A.) or  (Canada)  
Move the lever down by 2 levels



| Operation<br>Status before operation |  OFF or  |  |  or  |  HI or  |
|--------------------------------------|--|--|--|---|
| Off                                  | Temporary operation  | Temporary operation  | Intermittent operation   | High speed operation  |
| Intermittent operation               | Off  | Off  | Low speed operation  | High speed operation  |
| Low speed operation                  | Off  | Intermittent operation   | High speed operation   | High speed operation  |
| High speed operation                 | Off  | Low speed operation  | No change  | No change   |

4  
Driving

Wiper intervals can be adjusted when intermittent operation is selected.

- ⑤ Increases the intermittent windshield wiper frequency
- ⑥ Decreases the intermittent windshield wiper frequency

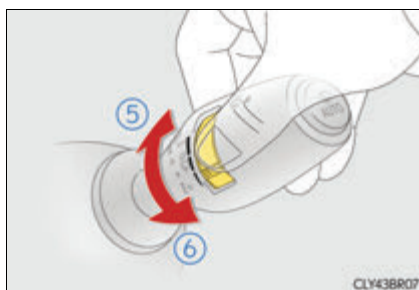

- ⑦ Washer/wiper dual operation

The wipers will automatically operate a couple of times after the washer squirts.

Vehicles with headlight cleaners: When the engine switch is in IGNITION ON mode and the headlights are on, if the lever is pulled, the headlight cleaners will operate once. After this, the headlight cleaners will operate every 5th time the lever is pulled.

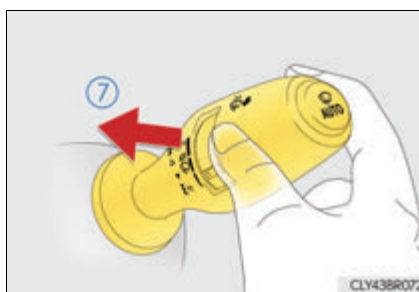



■ **The windshield wiper and washer can be operated when**

The engine switch is in IGNITION ON mode.

■ **Dripping prevention wiper sweep**

After performing a washing and wiping operation several times, the wipers operate one more time after a short delay to prevent dripping.

However, this final wiper operation will not be performed while driving.

■ **Effects of vehicle speed on wiper operation (vehicles with rain-sensing windshield wipers)**

Vehicle speed affects the following even when the wipers are not in AUTO mode.

- Intermittent wiper interval
- Wiper operation when the washer is being used (delay until drip prevention wiper sweep occurs)

With low speed windshield wiper operation selected, wiper operation will be switched from low speed to intermittent wiper operation only when the vehicle is stationary.

■ **Raindrop sensor (vehicles with rain-sensing windshield wipers)**

- The raindrop sensor judges the amount of raindrops.

An optical sensor is adopted. It may not operate properly when sunlight from the rising or setting of the sun intermittently strikes the windshield, or if bugs etc. are present on the windshield.

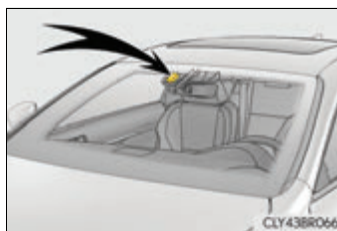

- If the wiper is turned to AUTO mode while the engine switch is in IGNITION ON mode, the wipers will operate once to show that AUTO mode is activated.
- If the temperature of the raindrop sensor is 185°F (85°C) or higher, or -22°F (-30°C) or lower, automatic operation may not occur. In this case, operate the wipers in any mode other than AUTO mode.

■ **When the windshield wipers are in temporary operation (vehicles with rain-sensing windshield wipers)**

AUTO mode cannot be activated even if  is pressed.

■ **If no windshield washer fluid sprays**

Check that the washer nozzles are not blocked if there is washer fluid in the windshield washer fluid reservoir.

■ **Operation guide display (vehicles with rain-sensing windshield wipers only)**

When the windshield wiper switch is operated to activate AUTO mode or when the rain-sensing level is adjusted, the current status is displayed on the meters for a few seconds. (→P. 110, 122)

 **WARNING**

■ **Caution regarding the use of windshield wipers in AUTO mode**

The windshield wipers may operate unexpectedly if the sensor is touched or the windshield is subject to vibration in AUTO mode. Take care that your fingers or anything else do not become caught in the windshield wipers.

■ **Caution regarding the use of washer fluid**

When it is cold, do not use the washer fluid until the windshield becomes warm. The fluid may freeze on the windshield and cause low visibility. This may lead to an accident, resulting in death or serious injury.

 **NOTICE**

■ **When the windshield is dry**

Do not use the wipers, as they may damage the windshield.

■ **When there is no washer fluid spray from the nozzle**

Damage to the washer fluid pump may be caused if the lever is pulled toward you and held continually.

■ **When a nozzle becomes blocked**

In this case, contact your Lexus dealer.

Do not try to clear it with a pin or other object. The nozzle will be damaged.

## Opening the fuel tank cap

Perform the following steps to open the fuel tank cap:

### Before refueling the vehicle

- Close both side doors and windows, and turn the engine switch off.
- Confirm the type of fuel.

#### ■ Fuel types

→P. 636

#### ■ Fuel tank opening for unleaded gasoline

To help prevent incorrect fueling, your vehicle has a fuel tank opening that only accommodates the special nozzle on unleaded fuel pumps.

### WARNING

#### ■ When refueling the vehicle

Observe the following precautions while refueling the vehicle. Failure to do so may result in death or serious injury.

- After exiting the vehicle and before opening the fuel door, touch an unpainted metal surface to discharge any static electricity. It is important to discharge static electricity before refueling because sparks resulting from static electricity can cause fuel vapors to ignite while refueling.
- Always hold the grips on the fuel tank cap and turn it slowly to remove it. A whooshing sound may be heard when the fuel tank cap is loosened. Wait until the sound cannot be heard before fully removing the cap. In hot weather, pressurized fuel may spray out the filler neck and cause injury.
- Do not allow anyone that has not discharged static electricity from their body to come close to an open fuel tank.
- Do not inhale vaporized fuel. Fuel contains substances that are harmful if inhaled.
- Do not smoke while refueling the vehicle. Doing so may cause the fuel to ignite and cause a fire.
- Do not return to the vehicle or touch any person or object that is statically charged. This may cause static electricity to build up, resulting in a possible ignition hazard.

#### ■ When refueling

Observe the following precautions to prevent fuel overflowing from the fuel tank:

- Securely insert the fuel nozzle into the fuel filler neck.
- Stop filling the tank after the fuel nozzle automatically clicks off.
- Do not top off the fuel tank.

 NOTICE

■ **Refueling**

Do not spill fuel during refueling.  
Doing so may damage the vehicle, such as causing the emission control system to operate abnormally or damaging fuel system components or the vehicle's painted surface.

### Opening the fuel tank cap

- 1 With the doors unlocked, press the center of the rear edge of the fuel filler door.

Push until you hear a click and take your hand away to slightly open the fuel filler door. Then open the door fully by hand.



- 2 Turn the fuel tank cap slowly and remove it, then put it into the holder on the fuel filler door.

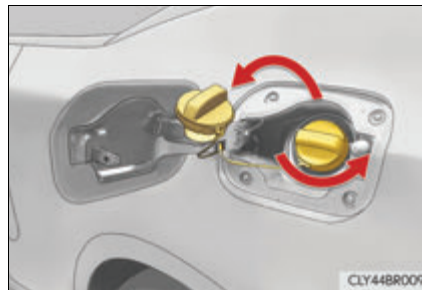

#### ■ If the fuel filler door cannot be opened

Remove the cover inside the trunk and pull the lever to open the fuel filler door if it cannot be opened by pressing the rear edge of the fuel filler door with the doors unlocked.

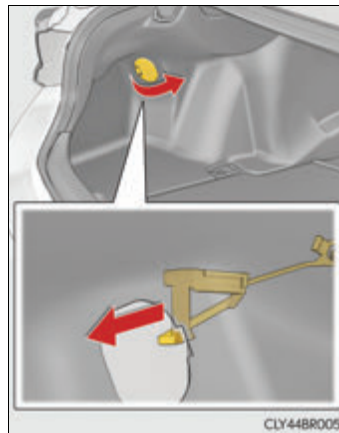

### Closing the fuel tank cap

- 1 After refueling, turn the fuel tank cap until you hear a click. Once the cap is released, it will turn slightly in the opposite direction.

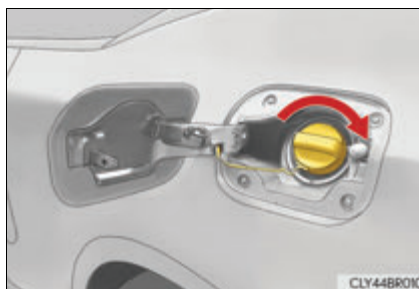

- 2 Close the fuel filler door, and press the center of the rear edge of the fuel filler door until you hear a click. When you lock the doors, the fuel filler door will also lock.



#### ■ When closing the fuel filler door

Do not lock the doors before closing the fuel filler door, as the fuel filler door cannot be closed if the doors are locked. If the doors are locked and the fuel filler door cannot be closed, unlock the doors and then close the fuel filler door.

#### ■ Fuel filler door lock condition

The fuel filler door may not be locked even when the vehicle's doors are locked in the following situations:

- When operating the door lock button inside the vehicle
- When the automatic door locking system is operated (→P. 655)

#### ⚠ WARNING

#### ■ When replacing the fuel tank cap

Do not use anything but a genuine Lexus fuel tank cap designed for your vehicle. Doing so may cause a fire or other incident which may result in death or serious injury.

## Cruise control\*

### Summary of functions

Use the cruise control to maintain a set speed without depressing the accelerator pedal.

- ① Indicators
- ② Cruise control switch

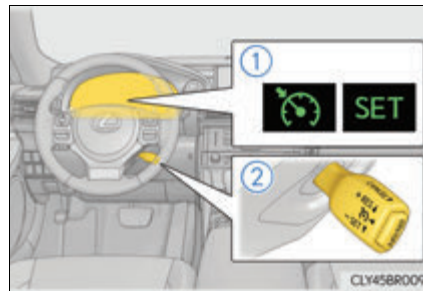

### Setting the vehicle speed

- 1 Press the "ON/OFF" button to activate the cruise control.

Cruise control indicator will come on.  
Press the button again to deactivate the cruise control.

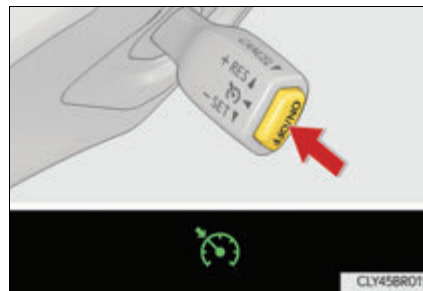

- 2 Accelerate or decelerate, with accelerator pedal operation, to the desired vehicle speed (above approximately 25 mph [40 km/h]) and push the lever down to set the speed.

Cruise control "SET" indicator will come on.  
The vehicle speed at the moment the lever is released becomes the set speed.

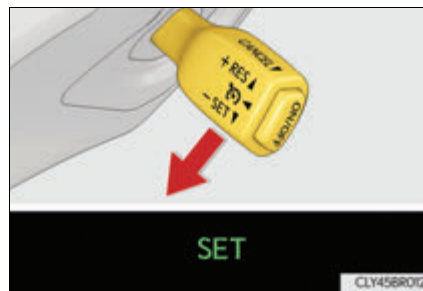

4

Driving

\*: If equipped

### Adjusting the set speed

To change the set speed, operate the lever until the desired set speed is obtained.

- ① Increases the speed
- ② Decreases the speed

Fine adjustment: Momentarily move the lever in the desired direction.

Large adjustment: Hold the lever in the desired direction.

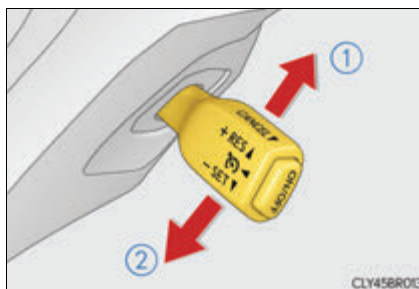

The set speed will be increased or decreased as follows:

Fine adjustment: By approximately 1 mph (1.6 km/h) each time the lever is operated.

Large adjustment: The set speed can be increased or decreased continually until the lever is released.

### Canceling and resuming the constant speed control

- ① Pulling the lever toward you cancels the constant speed control.

The speed setting is also canceled when the brake pedal is depressed.

- ② Pushing the lever up resumes the constant speed control.

However, resuming is available when the vehicle speed is more than approximately 25 mph (40 km/h).

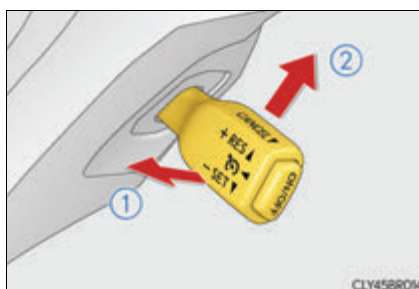



**■ Cruise control can be set when**

- The shift lever is in D.
- Range 4 or higher of D has been selected by using the paddle shift.
- Vehicle speed is above approximately 25 mph (40 km/h).

**■ Accelerating after setting the vehicle speed**

- The vehicle can be accelerated by operating accelerator pedal. After accelerating, the set speed resumes.
- Even without canceling the cruise control, the set speed can be increased by first accelerating the vehicle to the desired speed and then pushing the lever down to set the new speed.

**■ Automatic cruise control cancelation**

Cruise control is automatically canceled in any of the following situations.

- Actual vehicle speed falls more than approximately 10 mph (16 km/h) below the set speed.
- Actual vehicle speed is below approximately 25 mph (40 km/h).
- VSC is activated.
- TRAC is activated for a period of time.
- When the VSC or TRAC system is turned off by pressing the VSC OFF switch.

**■ If the warning message for the cruise control is shown on the multi-information display**

Press the "ON/OFF" button once to deactivate the system, and then press the button again to reactivate the system.

If the cruise control speed cannot be set or if the cruise control cancels immediately after being activated, there may be a malfunction in the cruise control system. Have the vehicle inspected by your Lexus dealer.

 **WARNING****■ To avoid operating the cruise control by mistake**

Switch the cruise control off using the "ON/OFF" button when not in use.

**■ Situations unsuitable for cruise control**

Do not use cruise control in any of the following situations.

Doing so may result in loss of control and could cause an accident resulting in death or serious injury.

- In heavy traffic
- On roads with sharp bends
- On winding roads
- On slippery roads, such as those covered with rain, ice or snow
- On steep hills  
Vehicle speed may exceed the set speed when driving down a steep hill.
- During emergency towing

## Dynamic radar cruise control\*

### Summary of functions

Without accelerator pedal operation by the driver, in vehicle-to-vehicle distance control mode, the vehicle automatically accelerates and decelerates in accordance to the changes in speed of the preceding vehicle. In constant speed control mode, the vehicle runs at a fixed speed.

Use the dynamic radar cruise control on freeways and highways.

- Vehicle-to-vehicle distance control mode (→P. 240)
- Constant speed control mode (→P. 245)

- ① Vehicle-to-vehicle distance button
- ② Display
- ③ Set speed
- ④ Indicators
- ⑤ Cruise control switch

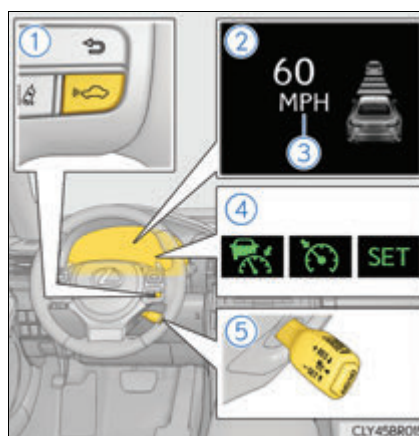

4

Driving

\*: If equipped

### Driving in vehicle-to-vehicle distance control mode

This mode employs a radar sensor to detect the presence of vehicles up to approximately 400 ft. (120 m) ahead, determines the current vehicle-to-vehicle following distance, and operates to maintain a suitable following distance from the vehicle ahead.

Note that vehicle-to-vehicle distance will close in when traveling on long downhill slopes.

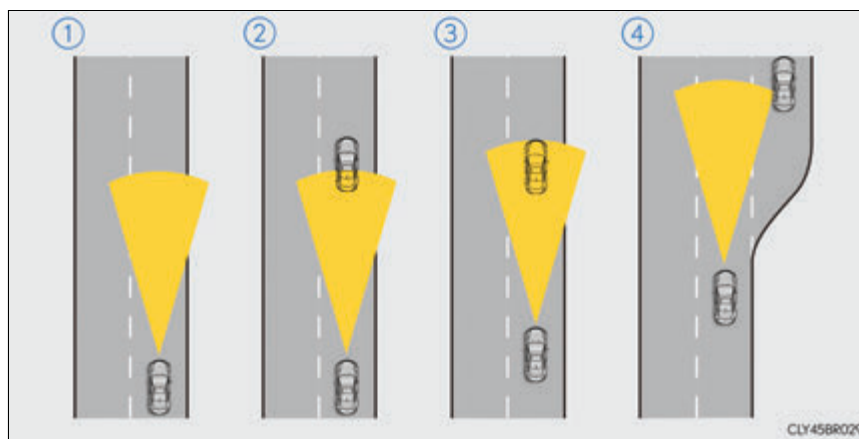

① Example of constant speed cruising

When there are no vehicles ahead

The vehicle travels at the speed set by the driver. The desired vehicle-to-vehicle distance can also be set by operating the vehicle-to-vehicle distance control.

② Example of deceleration cruising

When a preceding vehicle driving slower than the set speed appears

When a vehicle is detected running ahead of you, the system automatically decelerates your vehicle. When a greater reduction in vehicle speed is necessary, the system applies the brakes (the stop lights will come on at this time). A warning tone warns you when the system cannot decelerate sufficiently to prevent your vehicle from closing in on the vehicle ahead.

③ Example of follow-up cruising

When following a preceding vehicle driving slower than the set speed

The system continues follow-up cruising while adjusting for changes in the speed of the vehicle ahead in order to maintain the vehicle-to-vehicle distance set by the driver.

④ Example of acceleration

When there are no longer any preceding vehicles driving slower than the set speed

The system accelerates until the set speed is reached. The system then returns to constant speed cruising.

### Setting the vehicle speed (vehicle-to-vehicle distance control mode)

- 1 Press the "ON/OFF" button to activate the cruise control.

Radar cruise control indicator will come on and a message will be displayed on the multi-information display.

Press the button again to deactivate the cruise control.

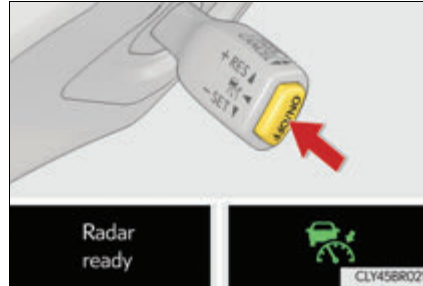

- 2 Accelerate or decelerate, with accelerator pedal operation, to the desired vehicle speed (above approximately 30 mph [50 km/h]) and push the lever down to set the speed.

Cruise control "SET" indicator and set speed will be displayed.

The vehicle speed at the moment the lever is released becomes the set speed.

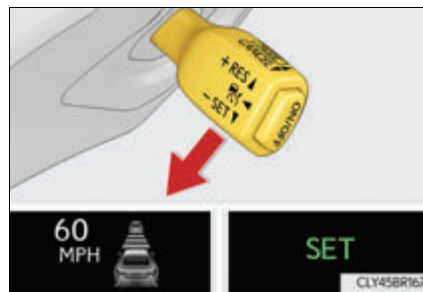

### Adjusting the set speed

To change the set speed, operate the lever until the desired set speed is displayed.

- ① Increases the speed
- ② Decreases the speed

Fine adjustment: Momentarily move the lever in the desired direction.

Large adjustment: Hold the lever in the desired direction.

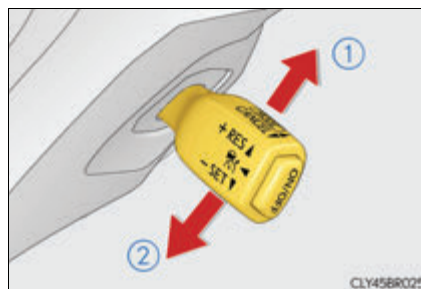

In the vehicle-to-vehicle distance control mode, the set speed will be increased or decreased as follows:

- When the set speed is shown in "MPH"
  - Fine adjustment: By approximately 1 mph (1.6 km/h) each time the lever is operated
  - Large adjustment: By approximately 5 mph (8 km/h) for each 0.75 seconds the lever is held
- When the set speed is shown in "km/h"
  - Fine adjustment: By approximately 0.6 mph (1 km/h) each time the lever is operated
  - Large adjustment: By approximately 3.1 mph (5 km/h) for each 0.75 seconds the lever is held

In the constant speed control mode (→P. 245), the set speed will be increased or decreased as follows:

- Fine adjustment: By approximately 1 mph (1.6 km/h) each time the lever is operated
- Large adjustment: The set speed can be increased or decreased continually until the lever is released.

### Changing the vehicle-to-vehicle distance (vehicle-to-vehicle distance control mode)

Pressing the button changes the vehicle-to-vehicle distance as follows:

- ① Long
- ② Medium
- ③ Short

The vehicle-to-vehicle distance is set automatically to long mode when the engine switch is turned to IGNITION ON mode.

If a vehicle is running ahead of you, the preceding vehicle mark will also be displayed.

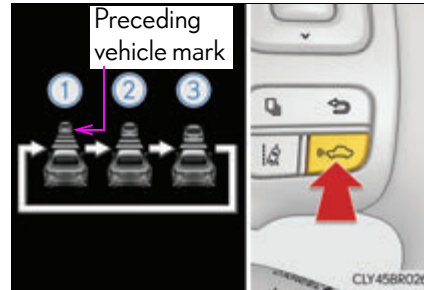

### Vehicle-to-vehicle distance settings (vehicle-to-vehicle distance control mode)

Select a distance from the table below. Note that the distances shown correspond to a vehicle speed of 50 mph (80 km/h). Vehicle-to-vehicle distance increases/decreases in accordance with vehicle speed.

| Distance options | Vehicle-to-vehicle distance  |
|------------------|------------------------------|
| Long             | Approximately 160 ft. (50 m) |
| Medium           | Approximately 130 ft. (40 m) |
| Short            | Approximately 100 ft. (30 m) |

### Canceling and resuming the speed control

- ① Pulling the lever toward you cancels the speed control.

The speed setting is also canceled when the brake pedal is depressed.

- ② Pushing the lever up resumes the speed control and returns vehicle speed to the set speed.

Resuming is available when the vehicle speed is more than approximately 25 mph (40 km/h).

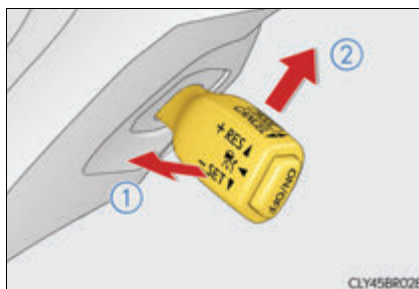

### Approach warning (vehicle-to-vehicle distance control mode)

When your vehicle is too close to a vehicle ahead, and sufficient automatic deceleration via the cruise control is not possible, the display will flash and the buzzer will sound to alert the driver. An example of this would be if another driver cuts in front of you while you are following a vehicle. Depress the brake pedal to ensure an appropriate vehicle-to-vehicle distance.

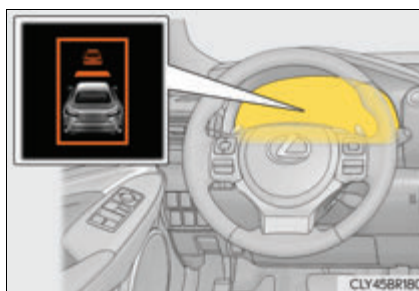

#### ■ Warnings may not occur when

In the following instances, there is a possibility that the warnings will not occur:

- When the speed of the preceding vehicle matches or exceeds your vehicle speed
- When the preceding vehicle is traveling at an extremely slow speed
- Immediately after the cruise control speed was set
- When depressing the accelerator pedal



### Selecting constant speed control mode

When constant speed control mode is selected, your vehicle will maintain a set speed without controlling the vehicle-to-vehicle distance. Select this mode only when vehicle-to-vehicle distance control mode does not function correctly due to dirt, etc.

- ① Press the "ON/OFF" button to activate the cruise control.

Press the button again to deactivate the cruise control.

- ② Switch to constant speed control mode.

(Push the lever forward and hold for approximately 1 second.)

Cruise control indicator will come on.

When in constant speed control mode, to return to vehicle-to-vehicle distance control mode, push the lever forward again and hold for approximately 1 second.

After the desired speed has been set, it is not possible to return to vehicle-to-vehicle distance control mode.

If the engine switch is turned off and then turned to IGNITION ON mode again, the vehicle will automatically return to vehicle-to-vehicle distance control mode.

Adjusting the speed setting: →P. 242

Canceling and resuming the speed setting: →P. 244

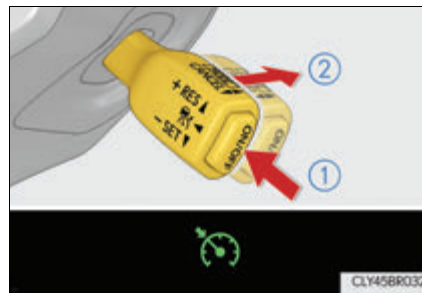

4

Driving

#### ■ Dynamic radar cruise control can be set when

- The shift lever is in D.
- Range 4 or higher of D has been selected by using the paddle shift.
- Vehicle speed is above approximately 30 mph (50 km/h).

#### ■ Accelerating after setting the vehicle speed

The vehicle can accelerate by operating the accelerator pedal. After accelerating, the set speed resumes. However, during vehicle-to-vehicle distance control mode, the vehicle speed may decrease below the set speed in order to maintain the distance to the preceding vehicle.

■ **Automatic cancelation of vehicle-to-vehicle distance control mode**

Vehicle-to-vehicle distance control driving is automatically canceled in the following situations:

- Actual vehicle speed falls below approximately 25 mph (40 km/h).
- VSC is activated.
- TRAC is activated for a period of time.
- When the VSC or TRAC system is turned off by pressing the VSC OFF switch.
- The sensor cannot detect correctly because it is covered in some way.
- The windshield wipers are operating at high speed (when the wipers are in AUTO mode or the high speed wiper operation).
- When snow mode is set.
- Pre-collision braking is activated.

If vehicle-to-vehicle distance control mode is automatically canceled for any other reason, there may be a malfunction in the system. Contact your Lexus dealer.

■ **Automatic cancelation of constant speed control mode**

Constant speed control mode is automatically canceled in the following situations:

- Actual vehicle speed is more than approximately 10 mph (16 km/h) below the set vehicle speed.
- Actual vehicle speed falls below approximately 25 mph (40 km/h).
- VSC is activated.
- TRAC is activated for a period of time.
- When the VSC or TRAC system is turned off by pressing the VSC OFF switch.
- Pre-collision braking is activated.

■ **Radar sensor and grille cover**

Always keep the sensor and grille cover clean to ensure that the vehicle-to-vehicle distance control mode operates properly. (Some obstructions, such as snow, ice and plastic objects, cannot be detected by the obstruction sensor.)

Dynamic radar cruise control is canceled if an obstruction is detected.

- ① Grille cover
- ② Radar sensor

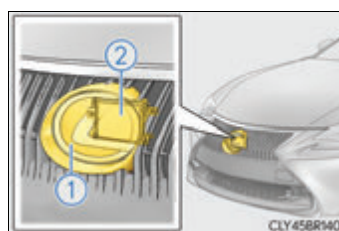

■ **Operation guide display**

When the dynamic radar cruise control switch is operated, a guidance display is shown on the meters for a few seconds as to how to operate the dynamic radar cruise control switch or distance switch. (→P. 110, 122)

■ **Warning messages and buzzers for dynamic radar cruise control**

Warning messages and buzzers are used to indicate a system malfunction or to inform the driver of the need for caution while driving. (→P. 555)

**■ Certification**

- ▶ For vehicles sold in the U.S.A.

FCC ID: BABFT0041A

CAUTION: Radio Frequency Radiation Exposure

This equipment complies with FCC radiation exposure limits set forth for an uncontrolled environment.

This equipment should be installed and operated keeping the radiator at least 20cm or more away from person's body (excluding extremities: hands, wrists, feet and ankles).

Co-location: This transmitter must not be co-located or operated in conjunction with any other antenna or transmitter.

This device complies with part 15 of the FCC Rules. Operation is subject to the following two conditions: (1) This device may not cause harmful interference, and (2) this device must accept any interference received, including interference that may cause undesired operation.

FCC WARNING

Changes or modifications not expressly approved by the party responsible for compliance could void the user's authority to operate the equipment.

- ▶ For vehicles sold in Canada

IC: 2024B-FT0041A

This device complies with Industry Canada licence-exempt RSS standard(s). Operation is subject to the following two conditions: (1) this device may not cause interference, and (2) this device must accept any interference, including interference that may cause undesired operation of the device.

4

Driving

 **WARNING****■ Before using dynamic radar cruise control**

Do not overly rely on vehicle-to-vehicle distance control mode.

Be aware of the set speed. If automatic deceleration/acceleration is not appropriate, adjust the vehicle speed, as well as the distance between your vehicle and vehicles ahead by applying the brakes, etc.

**■ Cautions regarding the driving assist systems**

Observe the following precautions.

Failure to do so may cause an accident resulting in death or serious injury.

**● Assisting the driver to measure following distance**

The dynamic radar cruise control is only intended to help the driver in determining the following distance between the driver's own vehicle and a designated vehicle traveling ahead. It is not a mechanism that allows careless or inattentive driving, and it is not a system that can assist the driver in low-visibility conditions. It is still necessary for driver to pay close attention to the vehicle's surroundings.

**● Assisting the driver to judge proper following distance**

The dynamic radar cruise control determines whether the following distance between the driver's own vehicle and a designated vehicle traveling ahead is appropriate or not. It is not capable of making any other type of judgement. Therefore, it is absolutely necessary for the driver to remain vigilant and to determine whether or not there is a possibility of danger in any given situation.

**● Assisting the driver to operate the vehicle**

The dynamic radar cruise control has no capability to prevent or avoid a collision with a vehicle traveling ahead. Therefore, if there is ever any danger, the driver must take immediate and direct control of the vehicle and act appropriately in order to ensure the safety of all involved.

**■ To avoid inadvertent dynamic radar cruise control activation**

Switch the dynamic radar cruise control off using the "ON/OFF" button when not in use.

 **WARNING****■ Situations unsuitable for dynamic radar cruise control**

Do not use dynamic radar cruise control in any of the following situations. Doing so may result in inappropriate speed control and could cause an accident resulting in death or serious injury.

- Roads where there are pedestrians, cyclers, etc.
- In heavy traffic
- On roads with sharp bends
- On winding roads
- On slippery roads, such as those covered with rain, ice or snow
- On steep downhill, or where there are sudden changes between sharp up and down gradients  
Vehicle speed may exceed the set speed when driving down a steep hill.
- At entrances to freeways and highways
- When weather conditions are bad enough that they may prevent the sensors from detecting correctly (fog, snow, sandstorm, heavy rain, etc.)
- When an approach warning buzzer is heard often
- During emergency towing

**⚠ WARNING**

■ **When the sensor may not be correctly detecting the vehicle ahead**

In the case of the following and depending on the conditions, operate the brake pedal when deceleration of the system is insufficient or operate the accelerator pedal when acceleration is required.

As the sensor may not be able to correctly detect these types of vehicles, the approach warning (→P. 244) will not be activated, which may lead to an accident resulting in death or serious injury.

- Vehicles that cut in suddenly



- Vehicles traveling at low speeds
- Vehicles that are not moving in the same lane



- Vehicles with small rear ends (trailers with no load on board, etc.)

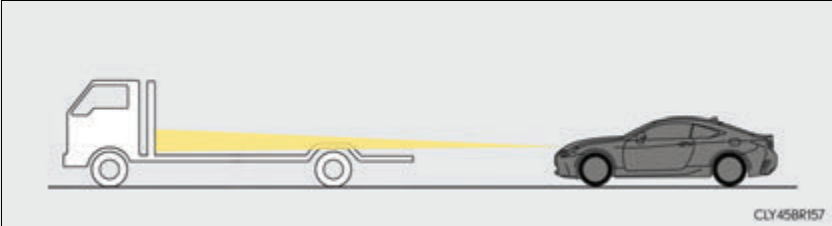

- Motorcycles traveling in the same lane



**⚠ WARNING**

■ **Conditions under which the vehicle-to-vehicle distance control mode may not function correctly**

Operate the brake pedal (or accelerator pedal operation depending on the situation) as necessary in the following conditions as the radar sensor may not be able to correctly detect vehicles ahead, which may lead to an accident resulting in death or serious injury.

- When water or snow thrown up by the surrounding vehicles hinders the detecting of the sensor

- When your vehicle is pointing upwards (caused by a heavy load in the trunk, etc.)

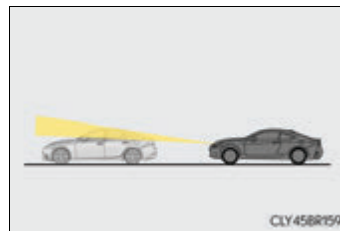

- When the road curves or when the lanes are narrow

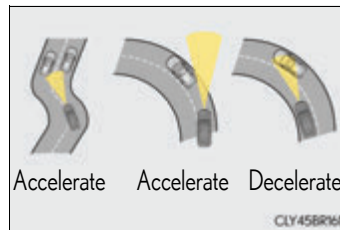

- When steering wheel operation or your position in the lane is unstable

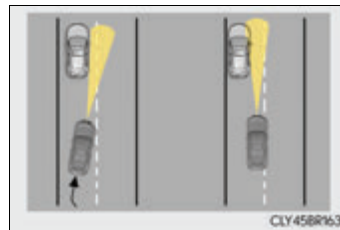

- When the vehicle ahead of you decelerates suddenly



 **WARNING****■ Handling the radar sensor**

Observe the following to ensure the dynamic radar cruise control can function effectively.

Otherwise, the radar sensor may not detect correctly and could result in an accident.

- Keep the sensor and grille cover clean at all times.  
Clean the sensor and grille cover with a soft cloth so you do not mark or damage them.
- Do not subject the sensor or surrounding area to a strong impact.  
If the sensor moves even slightly off position, the system may become inaccurate or malfunction. If the sensor or surrounding area is subject to a strong impact, always have the area inspected and adjusted by your Lexus dealer.
- Do not disassemble the sensor.
- Do not attach accessories or stickers to the sensor, grille cover or surrounding area.
- Do not modify or paint the sensor and grille cover.
- If the radar sensor needs to be replaced, contact your Lexus dealer.



## LDA (Lane Departure Alert)\*

### Summary of function

While driving on a road that has lane markers, this system recognizes the lane markers using a camera as a sensor to alert the driver when the vehicle deviates from its lane.

If the system judges that the vehicle has deviated from its lane, it alerts the driver using a buzzer and indications on the multi-information display.

Camera sensor

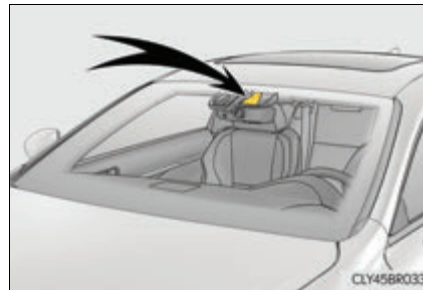

4

Driving

\*: If equipped

### Turning the LDA system on

Press the LDA switch to activate the system.

The LDA indicator and lane lines will come on.

Press the switch again to turn the LDA system off.

The LDA system will remain on or off even if the engine switch is turned to IGNITION ON mode.

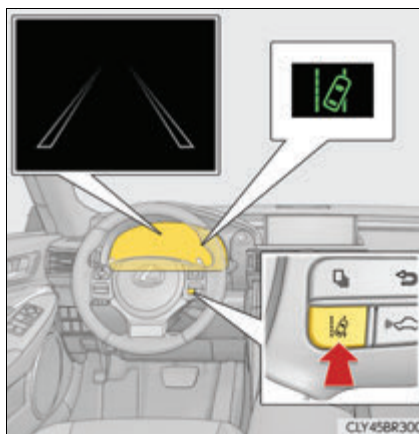

### Operating conditions

- When the vehicle speed is approximately 32 mph (50 km/h) or more
- When the lane width is more than approximately 8.2 ft. (2.5 m)
- When driving on a straight road or through a curve with a radius of more than approximately 328 ft. (100 m)

### Indication on the multi-information display

When the inside of both lane lines turn white:

Indicates that both right and left lane markers are recognized.

If the vehicle deviates from the lane, the lane line on the side the vehicle has deviated from will flash in yellow. (→P. 551)



When the inside of either lane line turns white:

Indicates that the lane marker on the white-marked side is recognized.

If the vehicle deviates from the side of a lane with recognized lane markers, the lane line will flash in yellow. (→P. 551)



When the inside of both lane lines are black:

Indicates that no lane markers are recognized or the LDA system is temporarily canceled.



4

Driving

**■ Temporary cancelation of the LDA system functions**

If any of the following occurs, the LDA system functions will be temporarily canceled. The functions will resume after the necessary operating conditions have returned.

- The turn signal lever is operated.
- The vehicle speed deviates from the operating range of the LDA system functions.
- When the lane lines cannot be recognized while driving.
- When the lane departure warning sounds.  
The lane departure warning function will not operate again for a several seconds after it has been activated, even if the vehicle leaves the lane again.

**■ The lane departure warning**

Depending on the audio system sound level or air conditioning fan noise while the audio system or air conditioning system is in use, it may be difficult to hear the warning sound.

**■ After the vehicle has been parked in the sun**

The LDA system may not be available and a warning message (→P. 554) will be displayed for a while after driving has started. When the temperature in the cabin decreases and the temperature around the camera sensor (→P. 239) becomes suitable for its operation, the functions will begin to operate.

**■ If there are lane markers on only one side of the vehicle**

The lane departure warning will not operate for the side on which lane markers could not be recognized.

**■ Conditions in which the function may not operate correctly**

In the following situations, the camera sensor may be unable to recognize lane markers causing the lane departure warning function to operate incorrectly. However, this does not indicate a malfunction.

- When driving through an area with no lane markers, such as a tollbooth, a crossing or before a ticket checkpoint
- When driving on a sharp curve
- When lane markers are extremely narrow or extremely wide
- When the vehicle leans to one side an unusual amount due to a heavy load or improper tire inflation pressure
- When the following distance between your vehicle and the vehicle ahead is extremely short
- When the lane markers are yellow (These may be more difficult for the system to recognize compared to white markers.)
- When the lane markers are broken, Botts' dots (raised pavement markers) or stones
- When the lane markers are on a curb etc.
- When lane markers are obscured or partially obscured by sand, dirt, etc.
- When there are shadows on the road running parallel with lane markers, or if a shadow covers the lane markers
- When driving on a particularly bright road surface, such as concrete
- When driving on a road surface that is bright due to reflected light
- When driving in a location where the light level changes rapidly, such as the entrance to or exit from a tunnel

- When sunlight or the headlights of oncoming vehicles are shining directly into the camera lens
  - When driving on roads that are branching or merging
  - When driving on a road surface that is wet due to rain, previous rainfall, standing water, etc.
  - When the vehicle experiences strong up-and-down motion such as when driving on an extremely rough road or on a seam in the pavement
  - When headlight brightness at nighttime is reduced due to dirt on the lenses, or when the headlights are misaligned
  - When driving on winding roads or roads that are uneven
  - When driving on rough or unpaved roads
- **When changing the tires**  
Depending on the tires used, sufficient performance may not be maintainable.
- **Warning messages for the LDA system**  
Warning messages are used to indicate a system malfunction or to inform the driver of the need for caution while driving. (→P. 555)

|  <b>WARNING</b> |  |
|--|--|
| <b>■ Before using the LDA system</b>   | Do not rely solely on the LDA system. The LDA system does not drive the vehicle automatically, nor does it reduce the amount of care you need to take. As such, the driver must always assume full responsibility for understanding his/her surroundings, for operating the steering wheel to correct the driving line, and for driving safely.<br>Inappropriate or negligent driving could lead to an accident.   |
| <b>■ To avoid operating the LDA by mistake</b>   | Switch the LDA system off using the LDA switch when not in use.  |
| <b>■ Situations unsuitable for LDA system</b>  | Do not use the LDA system in any of the following situations. Otherwise, the system may not function correctly and could result in an accident. <ul style="list-style-type: none"> <li>● When driving with tire chains, a spare tire, or similar equipment</li> <li>● When there are objects or structures along the roadside that might be misinterpreted as lane markers (such as guardrails, a curb, reflector posts, etc.)</li> <li>● When driving on snowy roads</li> <li>● When pavement lane markers are difficult to see due to rain, snow, fog, sand, dirt, etc.</li> <li>● When there are visible lines on the pavement from road repairs, or if the remains of old lane markers are still visible on the road</li> <li>● When driving on a road with lane closures due to maintenance, or when driving in a temporary lane</li> </ul> |

 NOTICE

■ **To prevent damage to or incorrect operation of the LDA system**

- Do not modify the headlights or attach stickers to the surface of the lights.
- Do not modify the suspension.  
If any suspension parts need to be replaced, contact your Lexus dealer.
- Do not install or place anything on the hood or the grille. Also, do not install a grille guard (bull bars, kangaroo bar etc.).
- If your windshield needs repairs, contact your Lexus dealer.

■ **Camera sensor**

Observe the following to ensure that the LDA system functions correctly.

- Keep the windshield clean at all times.  
Performance could be affected if the windshield is dirty, or if raindrops, condensation or ice are adhering to the windshield.
- Do not attach a sticker or other items to the windshield near the camera sensor.



- Do not spill liquid onto the camera sensor.
- Do not attach window tinting to the windshield.
- Do not install an antenna in front of the camera lens.
- If the area of the windshield in front of the camera sensor is fogged up, use the windshield defogger to remove the fog.  
When it is cold, setting the heater to blow air to the feet only may cause the area of the windshield in front of the camera sensor to fog up. This will have a negative effect on the images.
- Do not scratch the camera lens, or let it get dirty.  
When cleaning the inside of the windshield, be careful not to get any glass cleaner etc. on the lens. Also, do not touch the lens.  
For lens repair, contact your Lexus dealer.
- Do not change the installation position or direction of the camera sensor or remove it.  
The direction of the camera sensor is precisely adjusted.
- Do not subject the camera sensor to strong impact or force, and do not disassemble the camera sensor.
- If the windshield needs to be replaced, contact your Lexus dealer.

## Intuitive parking assist\*

### Vehicles with a Lexus Display Audio system:

The distance from your vehicle to nearby obstacles when parallel parking or maneuvering into a garage is measured by the sensors and communicated via the multi-information display, Lexus Display Audio screen and a buzzer. Always check the surrounding area when using this system.

### Vehicles with a navigation system:

Refer to the "NAVIGATION SYSTEM OWNER'S MANUAL".

#### ■ Types of sensors

- ▶ RC350/RC300/RC200t



- ▶ RC F

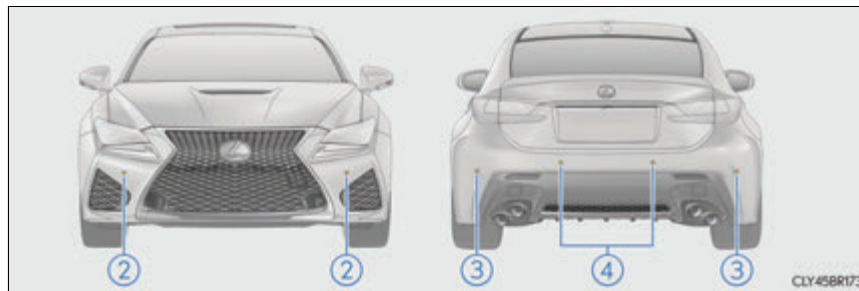

- ① Front center sensors
- ② Front corner sensors
- ③ Rear corner sensors
- ④ Rear center sensors

4  
Driving

\*: If equipped

■ Intuitive parking assist switch

Turns the intuitive parking assist on/off

When on, the indicator light comes on to inform the driver that the system is operational.

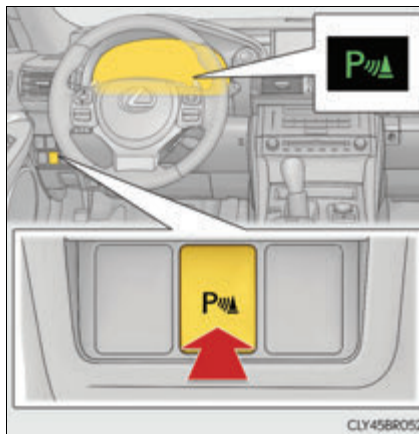



**Display**

When the sensors detect an obstacle, a graphic is shown on the multi-information display and Lexus Display Audio screen depending on the position and distance to the obstacle.

■ **Multi-information display**

▶ RC350/RC300/RC200t

▶ RC F



- ① Front corner sensor detection
- ② Front center sensor detection
- ③ Rear corner sensor detection
- ④ Rear center sensor detection

■ **Lexus Display Audio screen**

- ① When the Lexus parking assist monitor system is not displayed

A graphic is automatically displayed when an obstacle is detected. The screen can be set so that the graphic is not displayed. (→P. 265)

: Select to mute the buzzer sounds.

- ② When the Lexus parking assist monitor system is displayed (insert display)

A simplified image is displayed on the upper right corner of the Lexus Display Audio screen when an obstacle is detected.

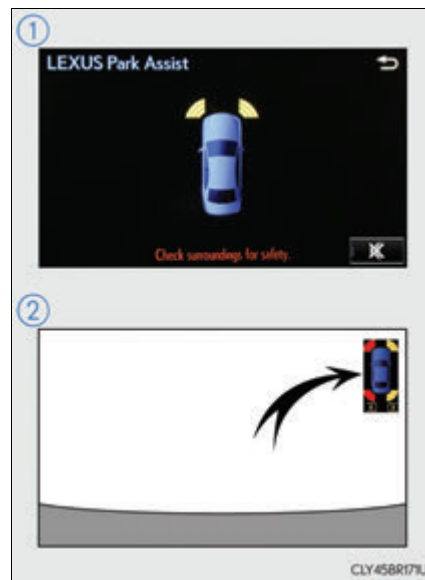









**Sensor detection display, obstacle distance**

■ Multi-information display and Lexus Display Audio screen

Sensors that detect an obstacle will illuminate continuously or blink.









▶ RC350/RC300/RC200t

| Display  | Insert display<br>(Lexus Display<br>Audio screen<br>only)   | Approximate distance to obstacle                                       |  |
|--|---|--|--|
|  |   | Corner sensor/<br>front center sensor                                  | Rear center sensor                     |
| <br>(continuous)                        | <br>(blinking slowly)    | Front center sensor<br>only:<br>3.3 ft. (100 cm) to 1.6 ft.<br>(50 cm) | 4.9 ft. (150 cm) to 2.0<br>ft. (60 cm) |
| <br>(continuous)                       | <br>(blinking)          | 1.6 ft. (50 cm) to 1.3 ft.<br>(40 cm)                                  | 2.0 ft. (60 cm) to 1.5 ft.<br>(45 cm)  |
| <br>(continuous)                      | <br>(blinking rapidly) | 1.3 ft. (40 cm) to 1.0 ft.<br>(30 cm)                                  | 1.5 ft. (45 cm) to 1.1 ft.<br>(35 cm)  |
| <br>(blinking *1 or<br>continuous *2) | <br>(continuous)       | Less than 1.0 ft. (30 cm)  | Less than 1.1 ft. (35 cm)              |

\*1: Multi-information display

\*2: Lexus Display Audio screen

► RC F

| Display   | Insert display<br>(Lexus Display<br>Audio screen<br>only)   | Approximate distance to obstacle  |                                     |
|---|---|---|-------------------------------------|
|   |   | Corner sensor   | Rear center sensor                  |
| <br>(continuous)   | <br>(blinking slowly)    | —   | 4.9 ft. (150 cm) to 2.0 ft. (60 cm) |
| <br>(continuous)   | <br>(blinking)           | Front corner sensor:<br>1.6 ft. (50 cm) to 1.3 ft. (40 cm)<br><br>Rear corner sensor:<br>2.0 ft. (60 cm) to 1.5 ft. (45 cm) | 2.0 ft. (60 cm) to 1.5 ft. (45 cm)  |
| <br>(continuous)   | <br>(blinking rapidly) | Front corner sensor:<br>1.3 ft. (40 cm) to 1.0 ft. (30 cm)<br><br>Rear corner sensor:<br>1.5 ft. (45 cm) to 1.0 ft. (30 cm) | 1.5 ft. (45 cm) to 1.1 ft. (35 cm)  |
| <br>(blinking <sup>*1</sup> or<br>continuous <sup>*2</sup> ) | <br>(continuous)       | Less than 1.0 ft. (30 cm)   | Less than 11 ft. (35 cm)            |

\*1: Multi-information display

\*2: Lexus Display Audio screen

■ **Buzzer operation and distance to an obstacle**

A buzzer sounds when the sensors are operating.

- The buzzer beeps faster as the vehicle approaches an obstacle. When the vehicle comes within the following distance of the obstacle, the buzzer sounds continuously:
  - Front center sensors (RC350/RC300/RC200t): Approximately 1.0 ft. (30 cm)
  - Corner sensors: Approximately 1.0 ft. (30 cm)
  - Rear center sensors: Approximately 1.1 ft. (35 cm)
- When 2 or more obstacles are detected simultaneously, the buzzer system responds to the nearest obstacle. If one or both come within the above distances, the beep will repeat a long tone, followed by fast beeps.

**Detection range of the sensors**

▶ RC350/RC300/RC200t

▶ RC F

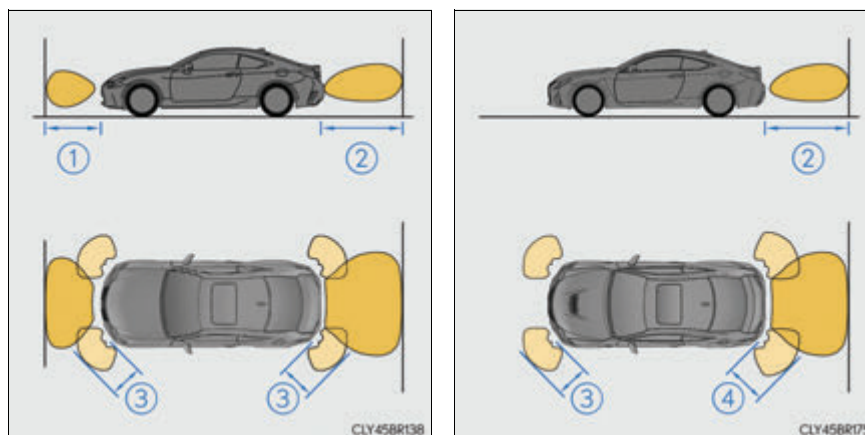

① Approximately 3.3 ft. (100 cm)

② Approximately 4.9 ft. (150 cm)

③ Approximately 1.6 ft. (50 cm)

④ Approximately 2.0 ft. (60 cm)

The diagram shows the detection range of the sensors. Note that the sensors cannot detect obstacles that are extremely close to the vehicle.

The range of the sensors may change depending on the shape of the object etc.

### Setting up intuitive parking assist

You can change the warning beep volume and Lexus Display Audio screen operating conditions.

- 1 Press the "MENU" button on the Lexus Display Audio controller. (→P. 328)
- 2 Select "Setup" on the "Menu" screen.
- 3 Select "Vehicle" on the "Setup" screen.
- 4 Select "LEXUS Park Assist" on the "Vehicle Settings" screen.
- 5 Select the desired button.

▶ RC350/RC300/RC200t

▶ RC F



- 1 The alert volume can be adjusted.
- 2 On or off can be selected for intuitive parking assist display.
- 3 Front center sensor display and tone indication can be set.
- 4 Rear center sensor display and tone indication can be set.

#### ■ The intuitive parking assist can be operated when

- Front center sensors (RC350/RC300/RC200t):
  - The engine switch is in IGNITION ON mode.
  - The shift lever is in a position other than P or R.
  - The vehicle speed is less than about 6 mph (10 km/h).
- Front corner sensors:
  - The engine switch is in IGNITION ON mode.
  - The shift lever is in a position other than P.
  - The vehicle speed is less than about 6 mph (10 km/h).  
(At any speed when the shift lever is in R)
- Rear corner and rear center sensors:
  - The engine switch is in IGNITION ON mode.
  - The shift lever is in R.

#### ■ Intuitive parking assist display

When an obstacle is detected while the Lexus parking assist monitor system is in use, the warning indicator will appear in the top right of the screen even if the display setting has been set to off.

RC350\_RC300\_RC200t\_RC F\_U (OM24671U)

#### ■ Sensor detection information

- RC350/RC300/RC200t: The sensor's detection areas are limited to the areas around the vehicle's front and rear bumpers.
- RC F: The sensor's detection areas are limited to the areas around the vehicle's front corner and rear bumpers.
- Certain vehicle conditions and the surrounding environment may affect the ability of the sensor to correctly detect obstacles. Particular instances where this may occur are listed below.
  - There is dirt, snow or ice on the sensor. (Wiping the sensors will resolve this problem.)
  - The sensor is frozen. (Thawing the area will resolve this problem.)  
In especially cold weather, if a sensor is frozen the screen may show an abnormal display, or obstacles may not be detected.
  - The sensor is covered in any way.
  - The vehicle is leaning considerably to one side.
  - On an extremely bumpy road, on an incline, on gravel, or on grass.
  - The vicinity of the vehicle is noisy due to vehicle horns, motorcycle engines, air brakes of large vehicles, or other loud noises producing ultrasonic waves.
  - There is another vehicle equipped with parking assist sensor in the vicinity.
  - The sensor is coated with a sheet of spray or heavy rain.
  - The vehicle is equipped with a fender pole or wireless antenna.
  - Towing eyelets are installed.
  - The bumper or sensor receives a strong impact.
  - The vehicle is approaching a tall or curved curb.
  - In harsh sunlight or intense cold weather.
  - The area directly under the bumpers is not detected.
  - If obstacles draw too close to the sensor.
  - A non-genuine Lexus suspension (lowered suspension etc.) is installed.
  - People may not be detected if they are wearing certain types of clothing.

In addition to the examples above, there are instances in which, because of their shape, signs and other objects may be judged by the sensor to be closer than they are.
- The shape of the obstacle may prevent the sensor from detecting it. Pay particular attention to the following obstacles:
  - Wires, fences, ropes, etc.
  - Cotton, snow and other materials that absorb sound waves
  - Sharply-angled objects
  - Low obstacles
  - Tall obstacles with upper sections projecting outwards in the direction of your vehicle
- The following situations may occur during use.
  - Depending on the shape of the obstacle and other factors, the detection distance may shorten, or detection may be impossible.
  - Obstacles may not be detected if they are too close to the sensor.
  - There will be a short delay between obstacle detection and display. Even at slow speeds, there is a possibility that the obstacle will come within the sensor's detection areas before the display is shown and the warning beep sounds.
  - Thin posts or objects lower than the sensor may not be detected when approached, even if they have been detected once.
  - It might be difficult to hear beeps due to the volume of the audio system or air flow noise of the air conditioning system.

■ **If a message is displayed on the multi-information display**

→P. 552

■ **Certification**

- ▶ For vehicles sold in the U.S.A.

This device complies with Part 15 of the FCC Rules. Operation is subject to the following two conditions; (1) This device may not cause harmful interference, and (2) this device must accept any interference received, including interference that may cause undesired operation.

- ▶ For vehicles sold in Canada

This ISM device complies with Canadian ICES-001.

Cet appareil ISM est conforme a la norme NMB-001 du Canada.

 **WARNING**

■ **When using the intuitive parking assist**

Observe the following precautions.

Failing to do so may result in the vehicle being unable to be driven safely and possibly cause an accident.

- Do not use the sensor at speeds in excess of 6 mph (10 km/h).
- The sensors' detection areas and reaction times are limited. When moving forward or reversing, check the areas surrounding the vehicle (especially the sides of the vehicle) for safety, and drive slowly, using the brake to control the vehicle's speed.
- Do not install accessories within the sensors' detection areas.

 **NOTICE**

■ **When using intuitive parking assist**

In the following situations, the system may not function correctly due to a sensor malfunction etc. Have the vehicle checked by your Lexus dealer.

- The intuitive parking assist operation display flashes, and a beep sounds when no obstacles are detected.
- If the area around a sensor collides with something, or is subjected to strong impact.
- If the bumper or grille collides with something.
- If the display shows continuously without beeping, except when the  switch has been turned on.
- If a display error occurs, first check the sensor.  
If the error occurs even when there is no ice, snow or mud on the sensor, it is likely that the sensor is malfunctioning.

■ **Notes when washing the vehicle**

Do not apply intensive bursts of water or steam to the sensor area.

Doing so may result in the sensor malfunctioning.

## Lexus parking assist monitor\*

The parking assist monitor assists the driver by displaying an image of the view behind the vehicle while backing up, for example while parking.

Owners of models equipped with a navigation system should refer to the "NAVIGATION SYSTEM OWNER'S MANUAL".

The screen illustrations used in this text are intended as examples, and may differ from the image that is actually displayed on the screen.

The rear view image is displayed when the shift lever is in R and the engine switch is in IGNITION ON mode.

The parking assist monitor system will be deactivated when the shift lever is shifted to any position other than R.

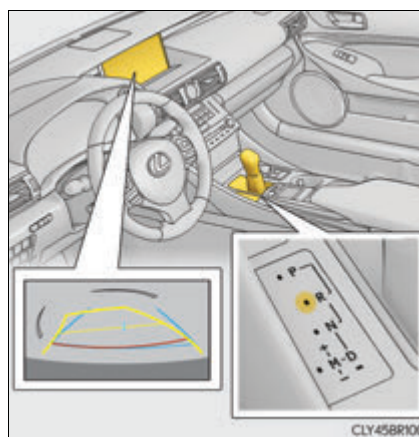

## Using the Lexus parking assist monitor

### ■ Screen display

The parking assist monitor screen will be displayed if the shift lever is shifted to R while the engine switch is in IGNITION ON mode.

#### Ⓐ Insert display (if equipped)

- Intuitive parking assist display: →P. 259
- RCTA icon display: →P. 302

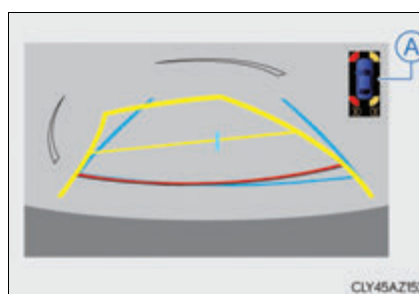

\*: If equipped



### ■ Using the system

Use any of the following modes.

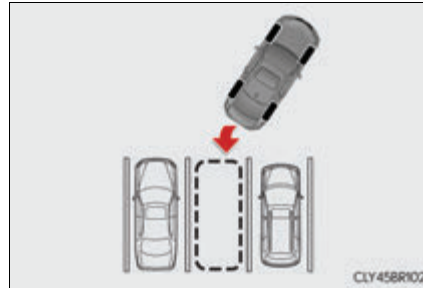

#### ● Estimated course line display mode (→P. 271)

Estimated course lines are displayed which move in accordance with the operation of the steering wheel.

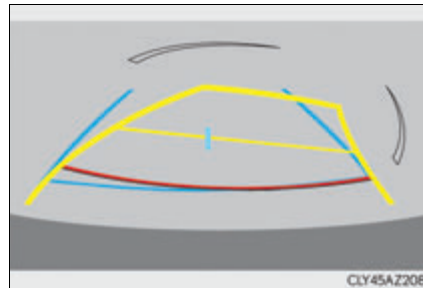

#### ● Parking assist guide line display mode (→P. 273)

The steering wheel return points (parking assist guide lines) are displayed.

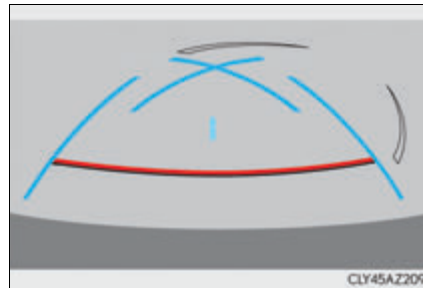

#### ● Distance guide line display mode

Distance guide lines only are displayed.

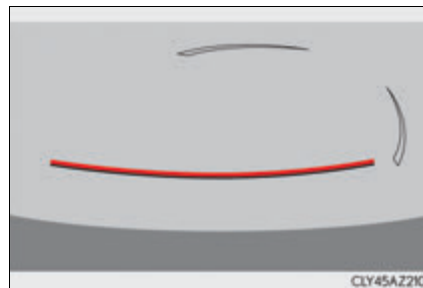

### Switching the display mode

When the shift lever is in any position other than R, the display mode can be changed in the following procedure.

- 1 Press the "MENU" button on the Lexus Display Audio controller, and then select "Setup" on the screen.
- 2 Select "Vehicle", and then select "Back Camera Guide Line Setting" on the screen.
- 3 Select the desired display mode.
  - 1 Estimated course line display mode (→P. 271)
  - 2 Parking assist guide line display mode (→P. 273)
  - 3 Distance guide line display mode  
Distance guide lines only are displayed.



## Estimated course line display mode

### ■ Screen description

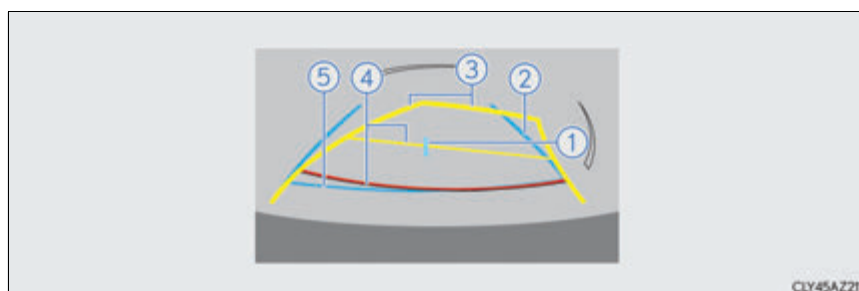

- ① Vehicle center guide line  
This line indicates the estimated vehicle center on the ground.
- ② Vehicle width guide line  
These lines indicate a guide path when the vehicle is being backed straight up. The displayed width is wider than the actual vehicle width. These lines align with the estimated course lines when the steering wheel is straight.
- ③ Estimated course lines  
These lines show an estimated course when the steering wheel is turned.
- ④ Distance guide line  
These lines move, together with the estimated course lines, in sync with the steering wheel and show points approximately 1.5 ft. (0.5 m) (red) and 3 ft. (1 m) (yellow) from the center of the edge of the bumper.
- ⑤ Distance guide line  
This line indicates a point approximately 1.5 ft. (0.5 m) (blue) from the edge of the bumper.

■ Parking operation

When parking in a space which is in the reverse direction to the space described in the procedure below, the steering directions will be reversed.

- 1 Shift the shift lever to R.
- 2 Turn the steering wheel so that the estimated course lines are within the parking space, and back up slowly.

- ① Parking space
- ② Estimated course lines

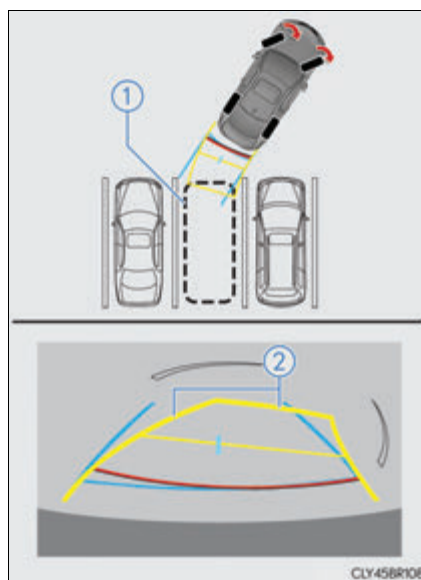

- 3 When the rear position of the vehicle has entered the parking space, turn the steering wheel so that the vehicle width guide lines are within the left and right dividing lines of the parking space.

- ③ Vehicle width guide line

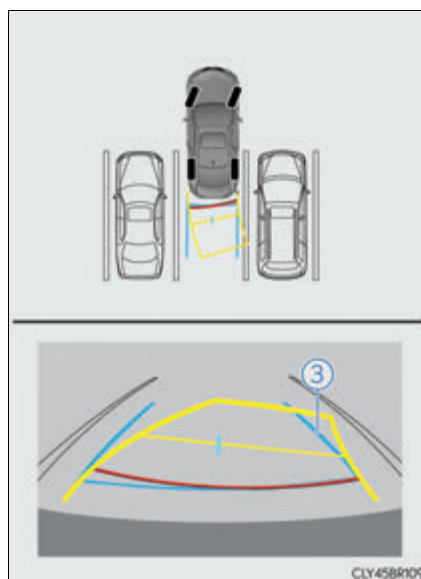

- 4 Once the vehicle width guide lines and the parking space lines are parallel, straighten the steering wheel and back up slowly until the vehicle has completely entered the parking space.
- 5 Stop the vehicle in an appropriate place, and finish parking.

### Parking assist guide line display mode

#### ■ Screen description

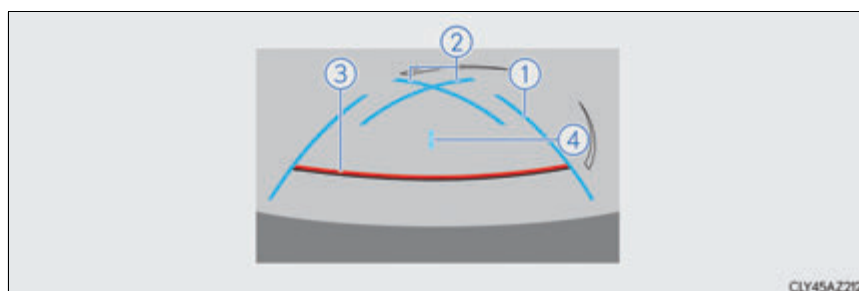

- ① Vehicle width guide lines  
These lines indicate a guide path when the vehicle is being backed straight up. The displayed width is wider than the actual vehicle width.
- ② Parking assist guide lines  
These lines indicate the path of the smallest turn possible behind the vehicle.  
These lines also indicate the approximate position of the steering wheel when parking.
- ③ Distance guide line  
This line (red) indicates a point approximately 1.5 ft. (0.5 m) behind the rear bumper of your vehicle.
- ④ Vehicle center guide line  
This line indicates the estimated vehicle center on the ground.

■ **Parking operation**

When parking in a space which is in the reverse direction to the space described in the procedure below, the steering directions will be reversed.

- 1 Shift the shift lever to R.
- 2 Back up until the parking assist guide line meets the edge of the left-hand dividing line of the parking space.
  - ① Parking assist guide line
  - ② Parking space dividing line

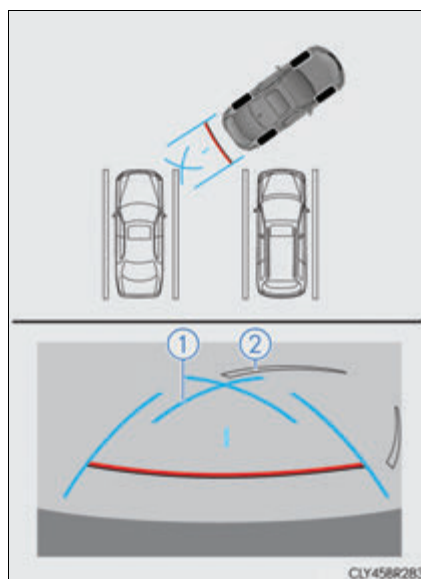

- 3 Turn the steering wheel all the way to the right, and back up slowly.
- 4 Once the vehicle is parallel with the parking space, straighten the steering wheel and back up slowly until the vehicle has completely entered the parking space.
- 5 Stop the vehicle in an appropriate place, and finish parking.

### Lexus parking assist monitor precautions

#### ■ Area displayed on screen

The parking assist monitor displays an image of the view from the bumper of the rear area of the vehicle.

The image on the Lexus parking assist monitor system screen can be adjusted. (→P. 342)

- The area displayed on the screen may vary according to vehicle orientation conditions.
- Objects which are close to either corner of the bumper or under the bumper cannot be seen on the screen.
- The camera uses a special lens. The distance of the image that appears on the screen differs from the actual distance.
- Items which are located higher than the camera may not be displayed on the monitor.
- If your vehicle is equipped with a backlit license plate, it may interfere with the display.

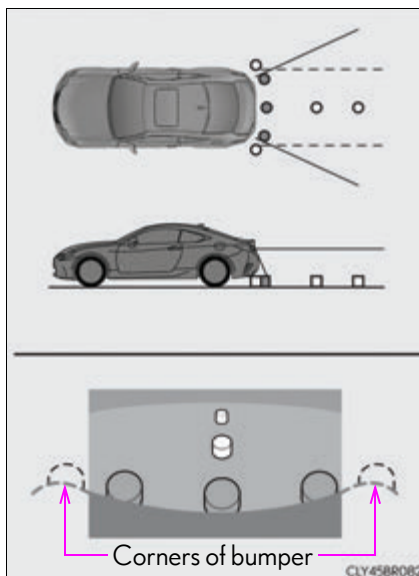

4

Driving

■ **Lexus parking assist monitor camera**

The camera for the parking assist monitor is located above the license plate.

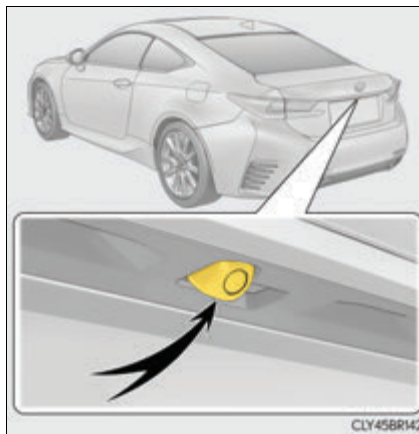

● **Using the camera**

If dirt or foreign matter (such as water droplets, snow, mud etc.) is adhering to the camera, it cannot transmit a clear image. In this case, flush it with a large quantity of water and wipe the camera lens clean with a soft and wet cloth.

■ **Differences between the screen and the actual road**

The distance guide lines and the vehicle width guide lines may not actually be parallel with the dividing lines of the parking space, even when they appear to be so. Be sure to check visually.

The distances between the vehicle width guide lines and the left and right dividing lines of the parking space may not be equal, even when they appear to be so. Be sure to check visually.

The distance guide lines give a distance guide for flat road surfaces. In any of the following situations, there is a margin of error between the guide lines on the screen and the actual distance/course on the road.



- When the ground behind the vehicle slopes up sharply

The distance guide lines will appear to be closer to the vehicle than the actual distance. Because of this, objects will appear to be farther away than they actually are. In the same way, there will be a margin of error between the guide lines and the actual distance/course on the road.

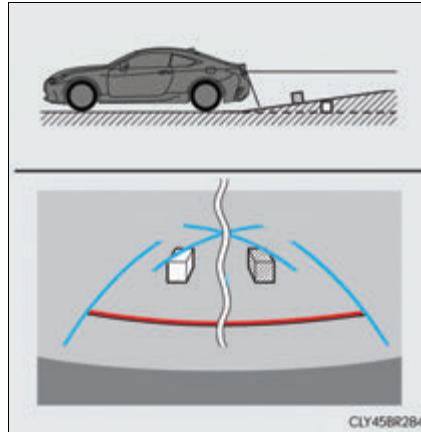

- When the ground behind the vehicle slopes down sharply

The distance guide lines will appear to be further from the vehicle than the actual distance. Because of this, objects will appear to be closer than they actually are. In the same way, there will be a margin of error between the guide lines and the actual distance/course on the road.

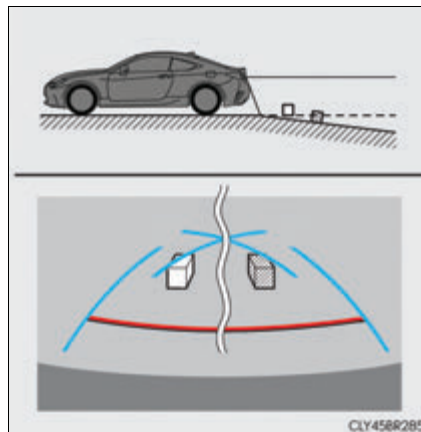

- When any part of the vehicle sags

When any part of the vehicle sags due to the number of passengers or the distribution of the load, there is a margin of error between the guide lines on the screen and the actual distance/course on the road.

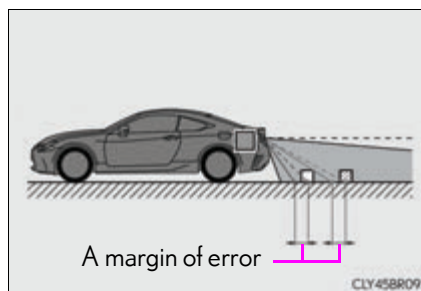

■ When approaching three-dimensional objects

The estimated course lines target a flat surfaced objects (such as the road). It is not possible to determine the position of three-dimensional objects (such as vehicles) using the estimated course lines and distance guide lines. When approaching a three-dimensional object that extends outward (such as the flatbed of a truck), be careful of the following.

● Estimated course lines

Visually check the surroundings and the area behind the vehicle. In the case shown in the illustration, the truck appears to be outside of the estimated course lines and the vehicle does not look as if it will hit the truck. However, the rear body of the truck may actually cross over the estimated course lines. In reality if you back up as guided by the estimated course lines, the vehicle may hit the truck.

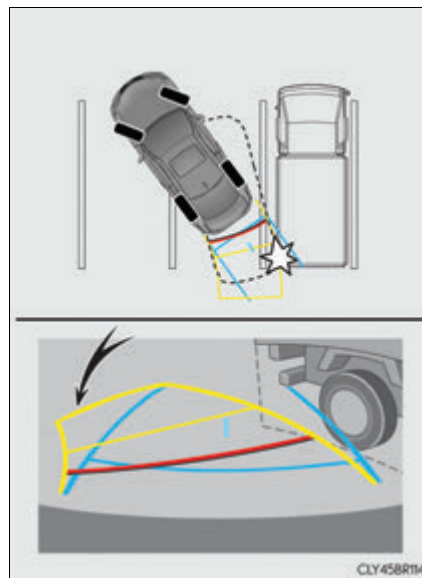

● Distance guide lines

Visually check the surroundings and the area behind the vehicle. On the screen, it appears that a truck is parked at point ②. However, in reality if you back up to point ①, you will hit the truck. On the screen, it appears that ① is closest and ③ is farthest away. However, in reality, the distance to ① and ③ is the same and ② is farther than ① and ③.

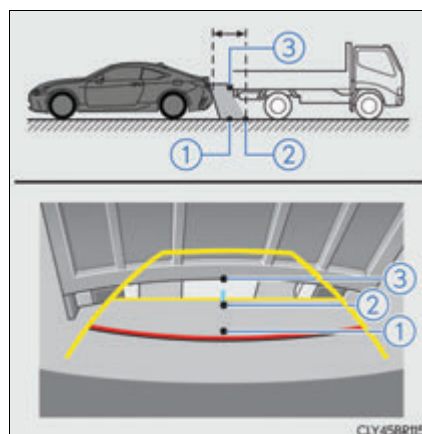

### Things you should know

#### ■ If you notice any symptoms

If you notice any of the following symptoms, refer to the likely cause and the solution, and re-check.

If the symptom is not resolved by the solution, have the vehicle inspected by your Lexus dealer.

| Likely cause  | Solution  |
|---|---|
| <b>□ The image is difficult to see</b>  |   |
| <ul style="list-style-type: none"> <li>• The vehicle is in a dark area</li> <li>• The temperature around the lens is either high or low</li> <li>• The outside temperature is low</li> <li>• There are water droplets on the camera</li> <li>• It is raining or humid</li> <li>• Foreign matter (mud etc.) is adhering to the camera</li> <li>• Sunlight or headlights are shining directly into the camera</li> <li>• The vehicle is under fluorescent lights, sodium lights, mercury lights etc.</li> </ul> | <p>If this happens due to these causes, it does not indicate a malfunction. Back up while visually checking the vehicle's surroundings. (Use the monitor again once conditions have been improved.)</p> <p>The image on the Lexus parking assist monitor system screen can be adjusted. (→P. 342)</p> |
| <b>□ The image is blurry</b>  |   |
| Dirt or foreign matter (such as water droplets, snow, mud etc.) is adhering to the camera.  | Flush the camera with a large quantity of water and wipe the camera lens clean with a soft and wet cloth.   |
| <b>□ The image is out of alignment</b>  |   |
| The camera or surrounding area has received a strong impact.  | Have the vehicle inspected by your Lexus dealer.  |
| <b>□ The guide lines are very far out of alignment</b>  |   |
| The camera position is out of alignment.  | Have the vehicle inspected by your Lexus dealer.  |
| <ul style="list-style-type: none"> <li>• The vehicle is tilted (there is a heavy load on the vehicle, tire pressure is low due to a tire puncture, etc.)</li> <li>• The vehicle is used on an incline.</li> </ul>   | <p>If this happens due to these causes, it does not indicate a malfunction. Back up while visually checking the vehicle's surroundings.</p>   |

| Likely cause   | Solution  |
|--|---|
| <b>❑ The estimated course lines move even though the steering wheel is straight</b>  |   |
| There is a malfunction in the signals being output by the steering sensor.   | Have the vehicle inspected by your Lexus dealer.  |
| <b>❑ Guide lines are not displayed</b>   |   |
| The trunk is open.   | Close the trunk.<br>If this does not resolve the symptom, have the vehicle inspected by your Lexus dealer.  |
| <b>❑ The estimated course lines are not displayed</b>  |   |
| <ul style="list-style-type: none"> <li>• The steering wheel has been moved while the battery was being reinstalled.</li> <li>• Battery power is low.</li> <li>• The steering sensor has been reinstalled.</li> <li>• There is a malfunction in the signals being output by the steering sensor.</li> </ul> | Stop the vehicle, and turn the steering wheel as far as it will go to the left and right.<br>If this does not resolve the symptom, have the vehicle inspected by your Lexus dealer. |

**⚠ WARNING****■ When using the Lexus parking assist monitor system**

The parking assist monitor is a supplemental device intended to assist the driver when backing up. When backing up, be sure to check visually behind and all around the vehicle before proceeding.

Observe the following precautions to avoid an accident that could result in death or serious injuries.

- Never depend on the parking assist monitor entirely when backing up. The image and the position of the guide lines displayed on the screen may differ from the actual state.

Use caution, just as you would when backing up any vehicle.

- Be sure to back up slowly, depressing the brake pedal to control vehicle speed.
- If you seem likely to hit nearby vehicles, obstacles, people or mount the shoulder, depress the brake pedal to stop the vehicle.
- The instructions given are only guidelines.

When and how much to turn the steering wheel will vary according to traffic conditions, road surface conditions, vehicle condition, etc. when parking. It is necessary to be fully aware of this before using the parking assist system.

- When parking, be sure to check that the parking space will accommodate your vehicle before maneuvering into it.
- Do not use the parking assist monitor in the following cases:
  - On icy or slick road surfaces, or in snow
  - When using tire chains or emergency tires
  - When the trunk is not closed completely
  - On roads that are not flat or straight, such as curves or slopes.
- In low temperatures, the screen may darken or the image may become faint. The image could distort when the vehicle is moving, or you may become unable to see the image on the screen. Be sure to check direct visually and with the mirrors all around the vehicle before proceeding.
- If the tire sizes are changed, the position of the guide lines displayed on the screen may change.
- The camera uses a special lens. The distances between objects and pedestrians that appear in the image displayed on the screen will differ from the actual distances. (→P. 276)
- Estimated course line display mode: If the steering wheel is straight and the vehicle width guide lines and the estimated course lines are not in alignment, have the vehicle inspected by your Lexus dealer.

 NOTICE

■ **How to use the camera**

- The parking assist monitor may not operate properly in the following cases.
  - If the back of the vehicle is hit, the position and mounting angle of the camera may change.
  - As the camera has a water proof construction, do not detach, disassemble or modify it. This may cause incorrect operation.
  - When cleaning the camera lens, flush the camera with a large quantity of water and wipe it with a soft and wet cloth. Strongly rubbing the camera lens may cause the camera lens to be scratched and unable to transmit a clear image.
  - Do not allow organic solvent, car wax, window cleaner or glass coat to adhere to the camera. If this happens, wipe it off as soon as possible.
  - If the temperature changes rapidly, such as when hot water is poured on the vehicle in cold weather, the system may not operate normally.
  - When washing the vehicle, do not apply intensive bursts of water to the camera or camera area. Doing so may result in the camera malfunctioning.
- Do not expose the camera to strong impact as this could cause a malfunction. If this happens, have the vehicle inspected by your Lexus dealer as soon as possible.

## Driving mode select switch

The driving modes can be selected to suit driving condition.

- ▶ RC350/RC300/RC200t (vehicles without Adaptive Variable Suspension System)

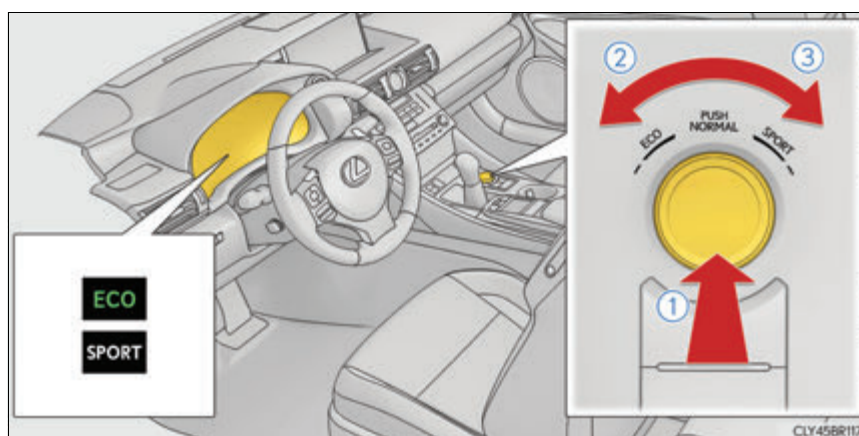

### ① Normal mode

Provides an optimal balance of fuel economy, quietness, and dynamic performance. Suitable for city driving.

Press the switch to change the driving mode to normal mode when Eco drive mode or sport mode is selected.

### ② Eco drive mode

Helps the driver accelerate in an eco-friendly manner and improve fuel economy through moderate throttle characteristics and by controlling the operation of the air conditioning system (heating/cooling).

When not in Eco drive mode, if the driving mode select switch is turned to the left, the Eco drive mode indicator will come on.

### ③ Sport mode

Controls the transmission and engine to provide quick, powerful acceleration. This mode also changes the steering feel, making it suitable for when agile driving response is desired, such as when driving on roads with many curves.

When not in sport mode, if the driving mode select switch is turned to the right, the "SPORT" indicator will come on.

- ▶ RC350/RC300/RC200t (vehicles with Adaptive Variable Suspension System)

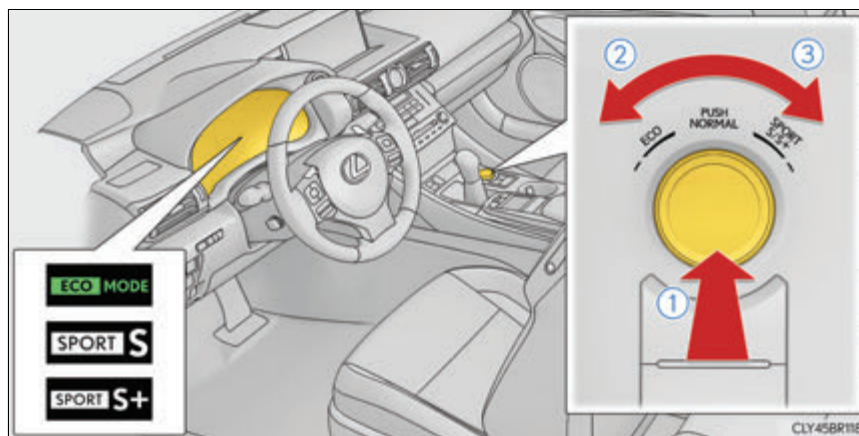

① Normal mode

Provides an optimal balance of fuel economy, quietness, and dynamic performance. Suitable for city driving.

Press the switch to change the driving mode to normal mode when Eco drive mode or sport mode is selected.

② Eco drive mode

Helps the driver accelerate in an eco-friendly manner and improve fuel economy through moderate throttle characteristics and by controlling the operation of the air conditioning system (heating/cooling).

When not in Eco drive mode, if the driving mode select switch is turned to the left, the Eco drive mode indicator will come on.

③ Sport mode

- SPORT S mode

Controls the transmission and engine to provide quick, powerful acceleration. This mode is suitable for when agile driving response is desired, such as when driving on roads with many curves.

When not in SPORT S mode, if the driving mode select switch is turned to the right, the "SPORT S" indicator will come on.

- SPORT S+ mode

Helps to ensure steering performance and driving stability by simultaneously controlling the steering and suspension in addition to the transmission and engine. Suitable for sportier driving.

When in SPORT S mode, if the driving mode select switch is turned to the right, the "SPORT S+" indicator will come on.



## ▶ RC F

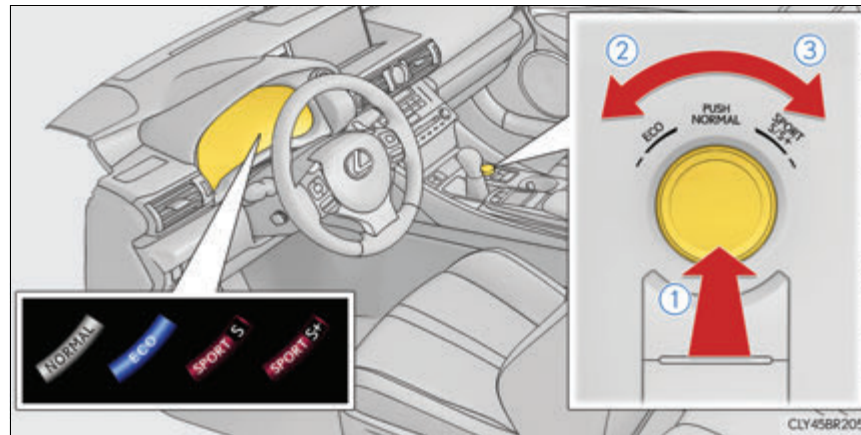

## ① Normal mode

Provides an optimal balance of fuel economy, quietness, and dynamic performance. Suitable for city driving.

Press the switch to change the driving mode to normal mode when Eco drive mode or sport mode is selected. The normal mode indicator will come on.

## ② Eco drive mode

Helps the driver accelerate in an eco-friendly manner and improve fuel economy through moderate throttle characteristics and by controlling the operation of the air conditioning system (heating/cooling).

When not in Eco drive mode, if the driving mode select switch is turned to the left, the Eco drive mode indicator will come on.

## ③ Sport mode

## • SPORT S mode

Controls the transmission and engine to provide quick, powerful acceleration. Also, gear shift timing is controlled to suit sporty driving, making this mode suitable for when agile driving response is desired, such as when driving on roads with many curves.

When not in SPORT S mode, if the driving mode select switch is turned to the right, the "SPORT S" indicator will come on.

## • SPORT S+ mode

Provides earlier downshift timing than SPORT S mode in order to maintain a high engine speed and provides faster gear changes. This mode also changes the steering feel and VDIM control, making it suitable for powerful sporty driving.

When in SPORT S mode, if the driving mode select switch is turned to the right, the "SPORT S+" indicator will come on.

■ **Operation of the air conditioning system in Eco drive mode**

Eco drive mode controls the heating/cooling operations and fan speed of the air conditioning system to enhance fuel efficiency (→P. 420). To improve air conditioning performance, adjust the fan speed or turn off Eco drive mode.

■ **Sport mode automatic deactivation**

Sport mode is automatically deactivated if the engine switch is turned off after driving in sport mode.

## Driving assist systems

To help enhance driving safety and performance, the following systems operate automatically in response to various driving situations. Be aware, however, that these systems are supplementary and should not be relied upon too heavily when operating the vehicle.

### ◆ ABS (Anti-lock Brake System)

Helps to prevent wheel lock when the brakes are applied suddenly, or if the brakes are applied while driving on a slippery road surface

### ◆ Brake assist

Generates an increased level of braking force after the brake pedal is depressed when the system detects a panic stop situation

### ◆ VSC (Vehicle Stability Control)

Helps the driver to control skidding when swerving suddenly or turning on slippery road surfaces

### ◆ Enhanced VSC (Enhanced Vehicle Stability Control)

Provides cooperative control of the ABS, TRAC, VSC and EPS. Helps to maintain directional stability when swerving on slippery road surfaces by controlling steering performance.

### ◆ TRAC (Traction Control)

Helps to maintain drive power and prevent the drive wheels from spinning when starting the vehicle or accelerating on slippery roads

### ◆ Hill-start assist control

Helps to prevent the vehicle from rolling backward when starting on an incline or slippery slope

### ◆ VGRS (Variable Gear Ratio Steering) (if equipped)

Adjusts the front wheel turning angle in accordance with the vehicle speed and steering wheel movement

### ◆ DRS (Dynamic Rear Steering) (if equipped)

Contributes to the turning characteristics and responsiveness of the vehicle by slightly adjusting the rear wheel angle of the vehicle in accordance with steering wheel movement.

◆ **EPS (Electric Power Steering)**

Employs an electric motor to reduce the amount of effort needed to turn the steering wheel

◆ **Adaptive Variable Suspension System (if equipped)**

By independently controlling the damping force of the shock absorbers for each of the 4 wheels according to the road and driving conditions, this system combines riding comfort with superior steering stability, and helps good vehicle posture. (→P. 284)

◆ **LDH (Lexus Dynamic Handling system) (if equipped)**

Provides integrated control of the VGRS, DRS and EPS. Contributes to turning characteristics at low speeds, responsiveness at medium speeds and safety at high speeds by controlling the steering angle of the front and rear wheels in accordance with the steering wheel operation and vehicle speed.

◆ **VDIM (Vehicle Dynamics Integrated Management)**

Provides integrated control of the ABS, brake assist, TRAC, VSC, hill-start assist control, EPS, VGRS (if equipped) and DRS (if equipped) systems

Helps to maintain vehicle stability when swerving on slippery road surfaces by controlling the brakes, engine output, steering assist, and if equipped with VGRS, steering ratio

◆ **PCS (Pre-Collision System) (if equipped)**

→P. 295

◆ **BSM (Blind Spot Monitor) (if equipped)**

→P. 302

◆ **TVD (Torque Vectoring Differential) (if equipped)**



→P. 318

### When the TRAC/VSC systems are operating

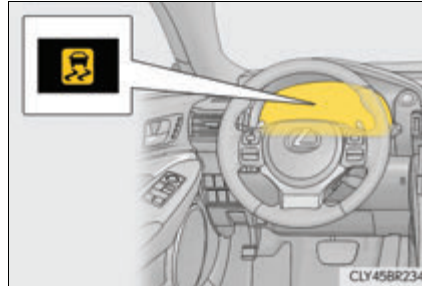
The slip indicator light will flash while the TRAC/VSC systems are operating.



### Disabling the TRAC system

If the vehicle gets stuck in mud, dirt or snow, the TRAC system may reduce power from the engine to the wheels. Pressing  () to turn the system off may make it easier for you to rock the vehicle in order to free it.

#### ► RC350/RC300/RC200t

To turn the TRAC system off, quickly press and release .

The "TRAC OFF" will be shown on the multi-information display.

Press  again to turn the system back on.

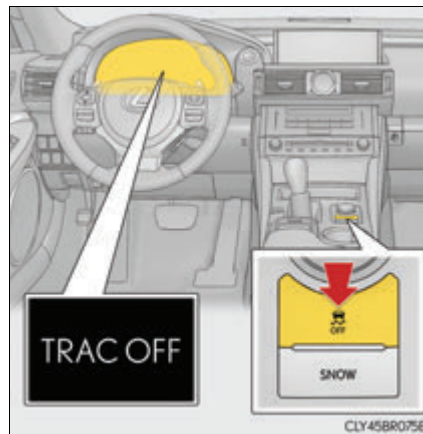



► RC F

To turn the TRAC system off, quickly

press and release  ().

The “TRAC OFF” indicator light will come on.

Press  () again to turn the system back on.

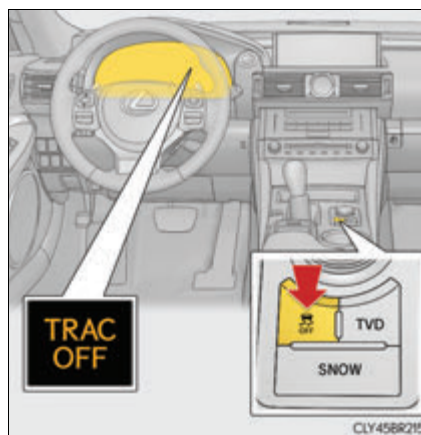

■ Turning off both TRAC and VSC systems



► RC350/RC300/RC200t

To turn the TRAC and VSC systems off, press and hold  for more than 3 seconds while the vehicle is stopped.



The VSC OFF indicator light will come on and the “TRAC OFF” will be shown on the multi-information display.\*1

Press  again to turn the systems back on.

► RC F

To turn the TRAC and VSC systems off, press and hold  () for more than 3 seconds.

The “TRAC OFF” indicator light and the VSC OFF indicator light will come on.\*2



Press  () again to turn the systems back on.

\*1: On vehicles with PCS (Pre-Collision System), pre-collision brake assist, pre-collision braking, and steering control (performed through cooperative control of PCS and LDH) (if equipped) will also be disabled. The pre-collision system warning light will come on and a message will be displayed on the multi-information display. (→P. 563)



\*2: On vehicles with PCS (Pre-Collision System), pre-collision brake assist and pre-collision braking will also be disabled. The pre-collision system warning light will come on and a message will be displayed on the multi-information display. (→P. 563)

### ■ Expert mode (RC F)

When expert mode is selected, it is possible to drive in a more sporty manner than other drive modes. Expert mode disables the TRAC and VSC systems but the engine and brakes may be controlled depending on the vehicle behavior.

To select expert mode, press  () when in SPORT S+ mode.



The "EXPERT" indicator will come on together with the TRAC OFF and VSC OFF indicators.

To cancel expert mode, press  () or use the driving mode select switch to select a driving mode other than SPORT S+ mode.



- When the message is displayed on the multi-information display showing that TRAC has been disabled even if  has not been pressed (RC350/RC300/RC200t)

TRAC and hill-start assist control cannot be operated. Contact your Lexus dealer.

- When the "TRAC OFF" indicator light comes on even if  () has not been pressed (RC F)

TRAC and hill-start assist control cannot be operated. Contact your Lexus dealer.

- VGRS is disabled when

VGRS may stop operating in the following situations.

In this event, the steering wheel may move from its straight forward position, but it will return when the system restarts.

- When the steering wheel is operated for an extended period of time while the vehicle is stopped or is moving very slowly (on vehicles with LDH, DRS is disabled together with VGRS)
- When the steering wheel has been held fully to the left or right

The center position of the steering wheel may change when VGRS is disabled. However, the position will return to normal after VGRS is reactivated.

- When the battery is disconnected (vehicles with VGRS)

The steering wheel may move from its straight forward position, but this will be corrected automatically when driving.

■ **Sounds and vibrations caused by the ABS, brake assist, VSC, TRAC, hill-start assist control and VGRS systems**

- A sound may be heard from the engine compartment when the brake pedal is depressed repeatedly, when the engine is started or just after the vehicle begins to move. This sound does not indicate that a malfunction has occurred in any of these systems.
- Any of the following conditions may occur when the above systems are operating. None of these indicates that a malfunction has occurred.
  - Vibrations may be felt through the vehicle body and steering.
  - A motor sound may be heard after the vehicle comes to a stop.
  - The brake pedal may pulsate slightly after the ABS is activated.
  - The brake pedal may move down slightly after the ABS is activated.

■ **EPS, VGRS and DRS operation sound**

When the steering wheel is operated, a motor sound may be heard. This does not indicate a malfunction.

■ **Reactivation of the TRAC/VSC systems**

Even after the TRAC/VSC systems have been turned off, turning the engine off and then on again will automatically reactivate the TRAC/VSC systems.

■ **Reactivation of the TRAC system linked to vehicle speed**

When only the TRAC system is turned off, the TRAC system will turn on when vehicle speed increases. However, when both TRAC/VSC systems are turned off, the systems will not turn on even when vehicle speed increases.

■ **Reduced effectiveness of the EPS system**

The effectiveness of the EPS system is reduced to prevent the system from overheating when there is frequent steering input over an extended period of time. The steering wheel may feel heavy as a result. Should this occur, refrain from excessive steering input or stop the vehicle and turn the engine off. The EPS system should return to normal within 10 minutes.

■ **Operating conditions of hill-start assist control**

When the following four conditions are met, the hill-start assist control will operate:

- The shift lever is in a position other than P or N (when starting off forward/backward on an upward incline).
- The vehicle is stopped.
- The accelerator pedal is not depressed.
- The parking brake is not engaged.

■ **Automatic system cancelation of hill-start assist control**

The hill-start assist control will turn off in any of the following situations:

- The shift lever is moved to P or N.
- The accelerator pedal is depressed.
- The parking brake is engaged.
- Approximately 2 seconds elapse after the brake pedal is released.



 **WARNING****■ The ABS does not operate effectively when**

- The limits of tire gripping performance have been exceeded (such as excessively worn tires on a snow covered road).
- The vehicle hydroplanes while driving at high speed on wet or slick roads.

**■ Stopping distance when the ABS is operating may exceed that of normal conditions**

The ABS is not designed to shorten the vehicle's stopping distance. Always maintain a safe distance from the vehicle in front of you, especially in the following situations:

- When driving on dirt, gravel or snow-covered roads
- When driving with tire chains
- When driving over bumps in the road
- When driving over roads with potholes or uneven surfaces

**■ TRAC may not operate effectively when**

Directional control and power may not be achievable while driving on slippery road surfaces, even if the TRAC system is operating.

Drive the vehicle carefully in conditions where stability and power may be lost.

**■ Hill- start assist control does not operate effectively when**

- Do not overly rely on hill-start assist control. Hill-start assist control may not operate effectively on steep inclines and roads covered with ice.
- Unlike the parking brake, hill-start assist control is not intended to hold the vehicle stationary for an extended period of time. Do not attempt to use hill-start assist control to hold the vehicle on an incline, as doing so may lead to an accident.

**■ When the VSC is activated**

The slip indicator light flashes. Always drive carefully. Reckless driving may cause an accident. Exercise particular care when the indicator light flashes.

 **WARNING****■ When the TRAC/VSC systems are turned off**

Be especially careful and drive at a speed appropriate to the road conditions. As these are the systems to help ensure vehicle stability and driving force, do not turn the TRAC/VSC systems off unless necessary.

**■ Expert mode precautions**

- Do not use on public roads.
- Use only when the road conditions and safety of the surrounding area can be ensured.
- Proper use of expert mode requires a professional level of driving skill. When using expert mode, always check the road conditions and surrounding area and drive more carefully than usual.

**■ Replacing tires**

Make sure that all tires are of the specified size, brand, tread pattern and total load capacity. In addition, make sure that the tires are inflated to the recommended tire inflation pressure level.

The ABS, TRAC and VSC systems will not function correctly if different tires are installed on the vehicle.

Contact your Lexus dealer for further information when replacing tires or wheels.

**■ Handling of tires and the suspension**

Using tires with any kind of problem or modifying the suspension will affect the driving assist systems, and may cause a system to malfunction.

## PCS (Pre-Collision System)\*

When the radar sensor detects the possibility of a frontal collision, brakes are automatically engaged to lessen impact as well as vehicle damage.

The pre-collision system can be turned on and off as necessary by operating the switch. (→P. 296)

### ◆ Pre-collision warning

When a high possibility of a frontal collision is detected, the pre-collision system warning light flashes, a buzzer sounds and a message is shown on the multi-information display to urge the driver to take evasive action.

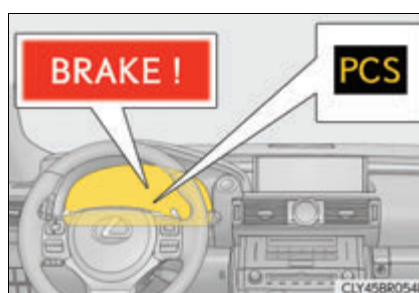

### ◆ Pre-collision brake assist

When there is a high possibility of a frontal collision, the system applies greater braking force in relation to how strongly the brake pedal is depressed. The system may not warn the driver using a warning light, warning display and buzzer when the system detects and judges braking operations.

### ◆ Pre-collision braking

When there is a high possibility of a frontal collision, the system warns the driver using a warning light, warning display and buzzer. If the system determines that a collision is unavoidable, the brakes are automatically applied to reduce the collision speed.

### ◆ Suspension control (if equipped)

When the system determines that there is a high possibility of a frontal collision, the operation of Adaptive Variable Suspension System (→P. 288) optimally controls the damping force of the shock absorber.

\*: If equipped

◆ **Steering control (if equipped)**

When the system determines that there is a high possibility of a frontal collision while the steering wheel is being operated, the LDH (Lexus Dynamic Handling) system controls the steering angle of the front and rear wheels and torque applied to the steering wheel to enhance the steering wheel operation response.

**Disabling pre-collision system**

- ① Enabled
- ② Disabled

The pre-collision system warning light comes on when pre-collision system is disabled.

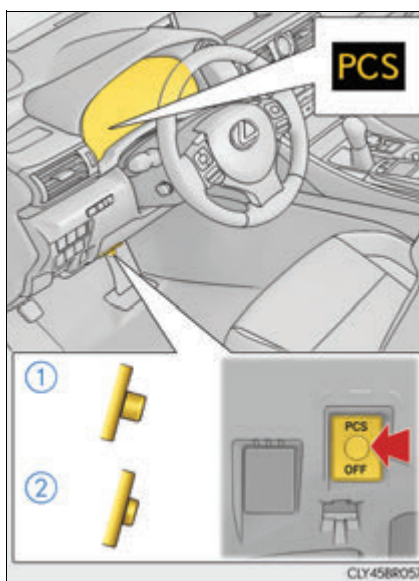

**Radar sensor**

The radar sensor detects vehicles or other obstacles on or near the road ahead and determines whether a collision is imminent based on the position, speed, and heading of the obstacles.

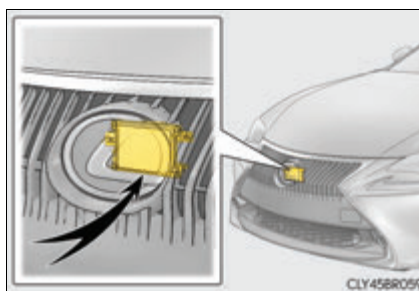

**■ The pre-collision system is operational when**

The pre-collision system is enabled and the following conditions are met:

- Pre-collision warning:
  - Vehicle speed is greater than about 10 mph (15 km/h).
  - The speed at which your vehicle is approaching the obstacle or the vehicle running ahead of you is greater than about 10 mph (15 km/h).
- Pre-collision brake assist:
  - The VSC system is not disabled.
  - Vehicle speed is greater than about 19 mph (30 km/h).
  - The speed at which your vehicle is approaching the obstacle or the vehicle running ahead of you is greater than about 19 mph (30 km/h).
  - The brake pedal is depressed.
- Pre-collision braking:
  - The VSC system is not disabled.
  - Vehicle speed is greater than about 10 mph (15 km/h).
  - The speed at which your vehicle is approaching the obstacle or the vehicle running ahead of you is greater than about 10 mph (15 km/h).
- Suspension control:
  - Vehicle speed is greater than about 4 mph (5 km/h).
  - The speed at which your vehicle is approaching the obstacle or the vehicle running ahead of you is greater than about 19 mph (30 km/h).
- Steering control:
  - The VSC system is not disabled.
  - Vehicle speed is greater than about 19 mph (30 km/h).
  - The speed at which your vehicle is approaching the obstacle or the vehicle running ahead of you is greater than about 19 mph (30 km/h).

#### ■ Conditions that may trigger the system even if there is no danger of a collision

In any of the following situations where the frontal area of the radar sensor is interrupted, the radar sensor may detect possibility of a frontal collision and the system may be activated.

- When passing by an oncoming vehicle in a curve or a turn to the right or the left
- When rapidly approaching an obstacle ahead (e.g. preceding vehicle, toll gate barrier, etc.)
- When there is a structural object (billboard, low ceiling, fluorescent light, etc.) above the uphill road ahead
- When driving on a narrow road or through under a low overhead structure (bridge, tunnel, fly-under, etc.)
- When driving on an uneven road surface
- When there is a metal object, bump, or protrusion on the road surface
- When vehicle's front part is raised or lowered depending on loading conditions
- When the direction of radar sensor is misaligned by strong impact applied on an area around the radar sensor, etc.
- When there is an obstacle (guard rail, etc.) by the roadside at the entrance to a curve
- When the front of your vehicle is pointing upwards (caused by putting a heavy load in the trunk etc.)

When the system is activated in the situations described above, there is also a possibility that the brakes may be applied with a force greater than normal.

#### ■ Obstacles not detected

The sensor cannot detect plastic obstacles such as traffic cones. There may also be occasions when the sensor cannot detect pedestrians, animals, bicycles, motorcycles, trees, or snowdrifts.

#### ■ Situations in which the pre-collision system does not function properly

The system may not function effectively in situations such as the following:

- On roads with sharp bends or uneven surfaces
- If a vehicle suddenly moves in front of your vehicle, such as at an intersection
- If a vehicle suddenly cuts in front of your vehicle, such as when overtaking
- In inclement weather such as heavy rain, fog, snow or sand storms
- If the vehicle is skidding when VSC is not operating
- When your vehicle is steeply inclined
- When only part of your vehicle's front end collides with, or contacts, a vehicle or object in a frontal collision
- When the radar sensor moves off position due to its surrounding area being subjected to a strong impact
- When an obstacle suddenly appears in front of the vehicle due to the steering wheel being turned sharply or another cause

#### ■ Automatic cancelation of the pre-collision system

When a malfunction occurs due to sensor contamination, etc. that results in the sensors being unable to detect obstacles, the pre-collision system will be automatically disabled. In this case, the system will not activate even if there is a collision possibility.

**■ When there is a malfunction in the system or if the system is temporarily unusable**

The pre-collision system warning light will flash and warning messages will be displayed. (→P. 544, 555)

**■ Certification**

► For vehicles sold in the U.S.A.

FCC ID: BABFT0041A

CAUTION: Radio Frequency Radiation Exposure

This equipment complies with FCC radiation exposure limits set forth for an uncontrolled environment.

This equipment should be installed and operated keeping the radiator at least 20cm or more away from person's body (excluding extremities: hands, wrists, feet and ankles).

Co-location: This transmitter must not be co-located or operated in conjunction with any other antenna or transmitter.

This device complies with part 15 of the FCC Rules. Operation is subject to the following two conditions: (1) This device may not cause harmful interference, and (2) this device must accept any interference received, including interference that may cause undesired operation.

**FCC WARNING**

Changes or modifications not expressly approved by the party responsible for compliance could void the user's authority to operate the equipment.

► For vehicles sold in Canada

IC: 2024B-FT0041A

This device complies with Industry Canada licence-exempt RSS standard(s). Operation is subject to the following two conditions: (1) this device may not cause interference, and (2) this device must accept any interference, including interference that may cause undesired operation of the device.

**⚠ WARNING****■ Limitations of the pre-collision system**

- The driver is solely responsible for safe driving. Always drive safely, taking care to observe your surroundings.

Do not use the pre-collision system instead of normal braking operations under any circumstances. This system will not prevent collisions or lessen damage or injuries in all cases. Do not overly rely on this system. Failure to do so may cause an accident, resulting in death or serious injury.

This system has been designed to help avoid and reduce the impact of collisions.

However, the system operates differently depending on the situation (→P. 297, 298). As a result, the same level of performance may not be expected in all cases.

Also, the pre-collision brakes may not operate if the driver is depressing the brake pedal or turning the steering wheel, as the system will determine such conditions as collision avoidance operations.

- As the pre-collision system is designed to assist the driver in safe driving, it may operate under sporty driving conditions, which may cause an accident. For this reason under sporty driving conditions, it is recommended that this system be disabled by using the PCS OFF switch.

**■ Handling the radar sensor**

Observe the following to ensure the pre-collision system can function effectively. Otherwise, the system may not function correctly and could result in an accident.

- Keep the sensor and grille cover clean at all times.  
Clean the sensor and grille cover with a soft cloth so you do not mark or damage them.
- Do not subject the sensor or surrounding area to a strong impact.  
If the sensor moves even slightly off position, the system may become inaccurate or malfunction. If the sensor or surrounding area is subject to a strong impact, always have the area inspected and adjusted by your Lexus dealer.
- Do not disassemble the sensor.
- Do not attach accessories or stickers to the sensor, grille cover or surrounding area.
- Do not modify or paint the sensor and grille cover.
- If the radar sensor needs to be replaced, contact your Lexus dealer.



 **WARNING****■ Cautions regarding the assist contents of the system**

By means of alarms and brake control, the pre-collision system is intended to assist the driver in avoiding collisions through the process of LOOK-JUDGE-ACT. There are limits to the degree of assistance the system can provide, so please keep in mind the following important points.

- **Assisting the driver in watching the road**  
The pre-collision system is only able to detect obstacles directly in front of the vehicle, and only within a limited range. It is not a mechanism that allows careless or inattentive driving, and it is not a system that can assist the driver in low-visibility conditions. It is still necessary for the driver to pay close attention to the vehicle's surroundings.
- **Assisting the driver in making correct judgment**  
When attempting to estimate the possibility of a collision, the only data available to the pre-collision system is that from obstacles it has detected directly in front of the vehicle. Therefore, it is absolutely necessary for the driver to remain vigilant and to determine whether or not there is a possibility of collision in any given situation.
- **Assisting the driver in taking action**  
The pre-collision brake assist function of the pre-collision system is designed to help reduce the severity of a collision, and will only operate when the system determines that a collision is unavoidable. This system is not capable of automatically avoiding a collision or bringing the vehicle to a stop safely without appropriate operations performed by the driver. For this reason, when encountering a dangerous situation the driver must take direct and immediate action in order to ensure the safety of all involved.

## **BSM (Blind Spot Monitor)\***

### **Summary of the Blind Spot Monitor**

The Blind Spot Monitor is a system that has 2 functions:

- The BSM (Blind Spot Monitor) function
  - Assists the driver in making a decision when changing lanes
- The RCTA (Rear Cross Traffic Alert) function
  - Assists the driver when backing up

These functions use same sensors.

\*: If equipped

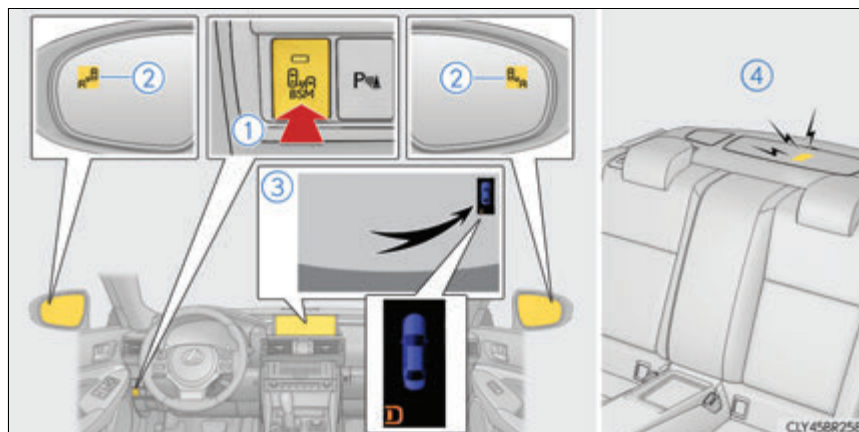

① BSM main switch

This switch is for both the BSM function and RCTA function. Pressing the switch turns the system on or off. When the switch is turned on, the indicator on the switch illuminates.

② Outside rear view mirror indicators

BSM function:

When a vehicle is detected in a blind spot of the outside rear view mirrors or approaching rapidly from behind into a blind spot, the outside rear view mirror indicator on the detected side will illuminate. If the turn signal lever is operated toward the detected side, the outside rear view mirror indicator will flash.

RCTA function:

When a vehicle approaching from the right or left at the rear of the vehicle is detected, both outside rear view mirror indicators will flash.

③ Monitor screen display (RCTA function only) (if equipped)

If a vehicle approaching from the right or left at the rear of the vehicle is detected, the RCTA icon (→P. 311) for the detected side will be displayed on the monitor screen. This illustration shows an example of a vehicle approaching from the left at the rear of the vehicle.

④ RCTA buzzer (RCTA function only)

If a vehicle approaching from the right or left at the rear of the vehicle is detected, a buzzer will sound. The buzzer also sounds for approximately 1 second immediately after the BSM main switch is operated to turn the system on.

■ **Outside rear view mirror indicator visibility**

In strong sunlight, the outside rear view mirror indicator may be difficult to see.

■ **Hearing the RCTA buzzer**

The RCTA buzzer may be difficult to hear over loud noises, such as if the audio system volume is high.

■ **When there is a malfunction in the Blind Spot Monitor**

If a system malfunction is detected due to any of the following, a warning message will be displayed: (→P. 555, 556)

- A sensor is malfunctioning
- A sensor is dirty or covered with snow or a sticker
- The outside temperature is extremely high or low
- Sensor voltage is abnormal
- A sensor is misaligned

■ **Certification for the Blind Spot Monitor**

- ▶ For vehicles sold in the U.S.A.

FCC ID : OAYSRR2A

This device complies with part 15 of the FCC Rules. Operation is subject to the following two conditions:

- (1) This device may not cause harmful interference, and
- (2) this device must accept any interference received, including interference that may cause undesired operation.

FCC Warning

Changes or modifications not expressly approved by the party responsible for compliance could void the user's authority to operate the equipment.

- ▶ For vehicles sold in Canada

Applicable law : Canada 310

This device complies with Industry Canada licence-exempt RSS standard(s). Operation is subject to the following two conditions: (1) this device may not cause interference, and (2) this device must accept any interference, including interference that may cause undesired operation of the device.

Frequency bands : 24.05 - 24.25GHz

Output power : less than 20 milliwatts

**⚠ WARNING****■ Handling the radar sensor**

Blind Spot Monitor sensors are installed behind the left and right sides of the rear bumper respectively. Observe the following to ensure the Blind Spot Monitor can function correctly.

- Keep the sensors and the surrounding areas on the rear bumper clean at all times.  
If a sensor or its surrounding area on the rear bumper is dirty or covered with snow, the Blind Spot Monitor may not operate and a warning message (→P. 555, 556) will be displayed. In this situation, clear off the dirt or snow and drive the vehicle with the operation conditions of the BSM function (→P. 308) satisfied for approximately 10 minutes. If the warning message does not disappear, have the vehicle inspected by your Lexus dealer.
- Do not subject a sensor or its surrounding area on the rear bumper to a strong impact.  
If a sensor is moved even slightly off position, the system may malfunction and vehicles may not be detected correctly.  
In the following situations, have your vehicle inspected by your Lexus dealer.
  - A sensor or its surrounding area is subject to a strong impact.
  - If the surrounding area of a sensor is scratched or dented, or part of them has become disconnected.
- Do not disassemble the sensor.
- Do not attach stickers to the sensor or surrounding area on the rear bumper.
- Do not modify the sensor or surrounding area on the rear bumper.
- Do not paint the rear bumper any color other than an official Lexus color.

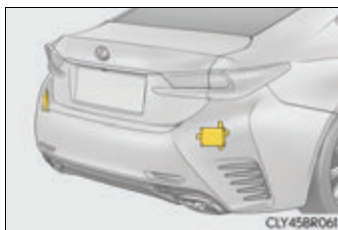

### BSM function

The BSM function uses radar sensors to detect the following vehicles traveling in adjacent lanes and advises the driver of the presence of such vehicles via the indicators on the outside rear view mirrors.

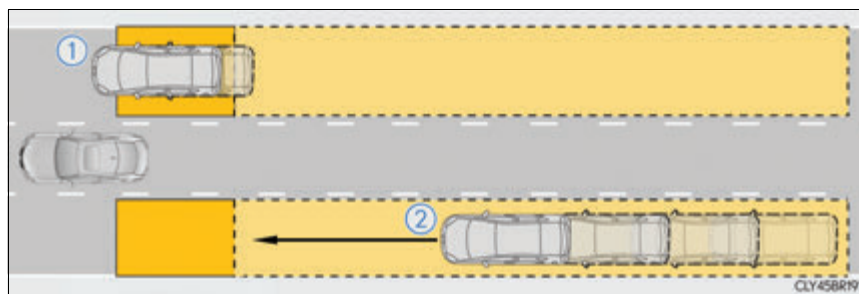

- ① Vehicles that are traveling in areas that are not visible using the outside rear view mirrors (the blind spots)
- ② Vehicles that are approaching rapidly from behind in areas that are not visible using the outside rear view mirrors (the blind spots)

### BSM function detection areas

The areas that vehicles can be detected in are outlined below.



The range of each detection area is:

- ① Approximately 1.6 ft. (0.5 m) to 11.5 ft. (3.5 m) from either side of the vehicle\*

\*: The area between the side of the vehicle and 1.6 ft. (0.5 m) from the side of the vehicle cannot be detected.

- ② Approximately 3.3 ft. (1 m) forward of the rear bumper

- ③ Approximately 9.8 ft. (3 m) from the rear bumper

- ④ Approximately 9.8 ft. (3 m) to 197 ft. (60 m) from the rear bumper\*

\*: The greater the difference in speed between your vehicle and the detected vehicle is, the farther away the vehicle will be detected, causing the outside rear view mirror indicator to illuminate or flash.

4

Driving

#### **⚠ WARNING**

##### **■ Cautions regarding the use of the function**

The driver is solely responsible for safe driving. Always drive safely, taking care to observe your surroundings.

The BSM function is a supplementary function which alerts the driver that a vehicle is in a blind spot of the outside rear view mirrors or is approaching rapidly from behind into a blind spot. Do not overly rely on the BSM function. As the function cannot judge if it is safe to change lanes, over reliance could lead to an accident resulting in death or serious injury.

As the system may not function correctly under certain conditions, the driver's own visual confirmation of safety is necessary.

■ **The BSM function is operational when**

The BSM function is operational when all of the following conditions are met:

- The BSM main switch is on.
- The shift lever is in a position other than R.
- The vehicle speed is greater than approximately 10 mph (16 km/h).

■ **The BSM function will detect a vehicle when**

The BSM function will detect a vehicle present in the detection area in the following situations:

- A vehicle in an adjacent lane overtakes your vehicle.
- Another vehicle enters the detection area when it changes lanes.

■ **Conditions under which the BSM function will not detect a vehicle**

The BSM function is not designed to detect the following types of vehicles and/or objects:

- Small motorcycles, bicycles, pedestrians, etc.\*
- Vehicles traveling in the opposite direction
- Guardrails, walls, signs, parked vehicles and similar stationary objects\*
- Following vehicles that are in the same lane\*
- Vehicles traveling 2 lanes away from your vehicle\*

\*: Depending on the conditions, detection of a vehicle and/or object may occur.



**■ Conditions under which the BSM function may not function correctly**

- The BSM function may not detect vehicles correctly in the following situations:
  - When the sensor is misaligned due to a strong impact to the sensor or its surrounding area
  - When mud, snow, ice, a sticker, etc. is covering the sensor or surrounding area on the rear bumper
  - When driving on a road surface that is wet with standing water during bad weather, such as heavy rain, snow, or fog
  - When multiple vehicles are approaching with only a small gap between each vehicle
  - When the distance between your vehicle and a following vehicle is short
  - When there is a significant difference in speed between your vehicle and the vehicle that enters the detection area
  - When the difference in speed between your vehicle and another vehicle is changing
  - When a vehicle enters a detection area traveling at about the same speed as your vehicle
  - As your vehicle starts from a stop, a vehicle remains in the detection area
  - When driving up and down consecutive steep inclines, such as hills, dips in the road, etc.
  - When driving on roads with sharp bends, consecutive curves, or uneven surfaces
  - When vehicle lanes are wide, or when driving on the edge of a lane, and the vehicle in an adjacent lane is far away from your vehicle
  - When a bicycle carrier or other accessory is installed to the rear of the vehicle
  - When there is a significant difference in height between your vehicle and the vehicle that enters the detection area
  - Immediately after the BSM main switch is turned on
- Instances of the BSM function unnecessarily detecting a vehicle and/or object may increase in the following situations:
  - When the sensor is misaligned due to a strong impact to the sensor or its surrounding area
  - When the distance between your vehicle and a guardrail, wall, etc. that enters the detection area is short
  - When driving up and down consecutive steep inclines, such as hills, dips in the road, etc.
  - When vehicle lanes are narrow, or when driving on the edge of a lane, and a vehicle traveling in a lane other than the adjacent lanes enters the detection area
  - When driving on roads with sharp bends, consecutive curves, or uneven surfaces
  - When the tires are slipping or spinning
  - When the distance between your vehicle and a following vehicle is short
  - When a bicycle carrier or other accessory is installed to the rear of the vehicle

### RCTA function



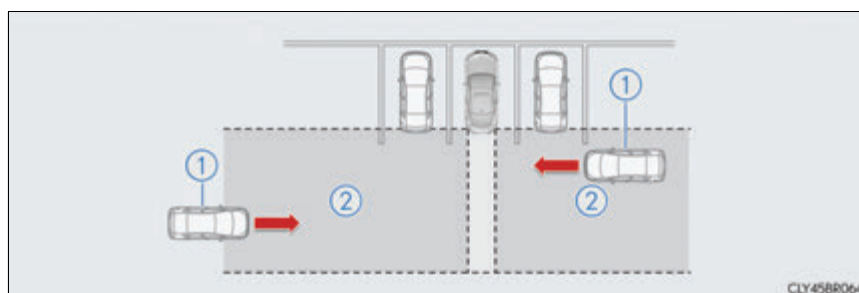

The RCTA function uses radar sensors to detect vehicles approaching from the right or left at the rear of the vehicle and alerts the driver of the presence of such vehicles by flashing the outside rear view mirror indicators and sounding a buzzer.



- ① Approaching vehicles
- ② Detection areas of approaching vehicles

### ■ RCTA icon display (if equipped)

When a vehicle approaching from the right or left at the rear of the vehicle is detected, the following will be displayed on the monitor screen.

| Display   | Content  |
|---|--|
|    | A vehicle is approaching from the left at the rear of the vehicle  |
|    | A vehicle is approaching from the right at the rear of the vehicle |
|   | Vehicles are approaching from both sides of the vehicle            |
|  | The RCTA function is malfunctioning<br>(→P. 304)                   |

4

Driving

### ⚠ WARNING

#### ■ Cautions regarding the use of the function

The driver is solely responsible for safe driving. Always drive safely, taking care to observe your surroundings.

The RCTA function is only a supplementary function which alerts the driver that a vehicle is approaching from the right or left at the rear of the vehicle. As the RCTA function may not function correctly under certain conditions, the driver's own visual confirmation of safety is necessary. Over reliance on this function may lead to an accident resulting death or serious injury.

### RCTA function detection areas

The areas that vehicles can be detected in are outlined below.

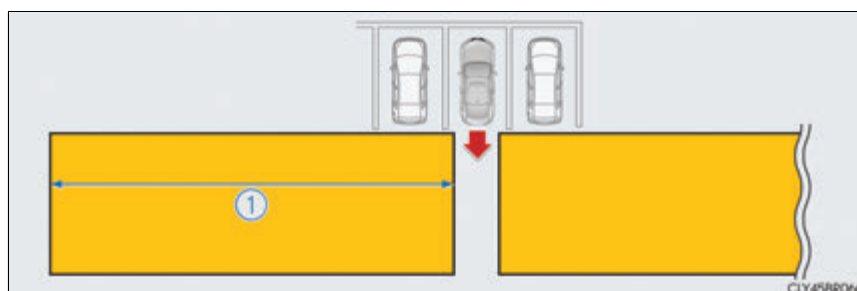

The buzzer can alert the driver of faster vehicles approaching from farther away.

Example:

| Approaching vehicle | Speed            | ① Approximate alert distance |
|---------------------|------------------|------------------------------|
| Fast                | 18 mph (28 km/h) | 65 ft. (20 m)                |
| Slow                | 5 mph (8 km/h)   | 18 ft. (5.5 m)               |

■ **The RCTA function is operational when**

The RCTA function operates when all of the following conditions are met:

- The BSM main switch is on.
- The shift lever is in R.
- The vehicle speed is less than approximately 5 mph (8 km/h).
- The approaching vehicle speed is between approximately 5 mph (8 km/h) and 18 mph (28 km/h).

#### ■ Conditions under which the RCTA function will not detect a vehicle

The RCTA function is not designed to detect the following types of vehicles and/or objects:

- Vehicles approaching from directly behind
- Vehicles backing up in a parking space next to your vehicle
- Vehicles that the sensors cannot detect due to obstructions

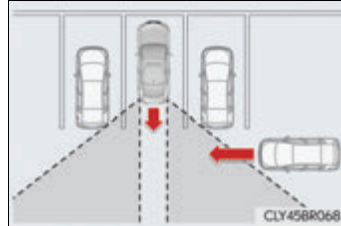

- Guardrails, walls, signs, parked vehicles and similar stationary objects \*
- Small motorcycles, bicycles, pedestrians, etc. \*
- Vehicles moving away from your vehicle
- Vehicles approaching from the parking spaces next to your vehicle \*

\*: Depending on the conditions, detection of a vehicle and/or object may occur.

#### ■ Conditions under which the RCTA function may not function correctly

- The RCTA function may not detect vehicles correctly in the following situations:
  - When the sensor is misaligned due to a strong impact to the sensor or its surrounding area
  - When mud, snow, ice, a sticker, etc. is covering the sensor or surrounding area on the rear bumper
  - When driving on a road surface that is wet with standing water during bad weather, such as heavy rain, snow, or fog
  - When multiple vehicles are approaching with only a small gap between each vehicle
  - When a vehicle is approaching at high speed
  - When backing up on a slope with a sharp change in grade

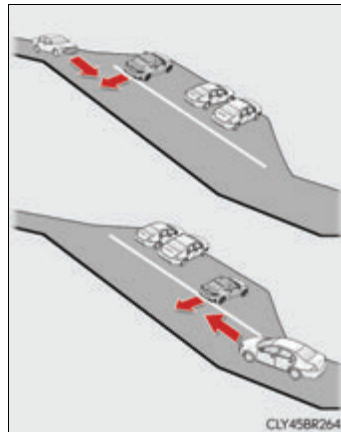

## 314 4-5. Using the driving support systems

- When backing out of a shallow angle parking spot

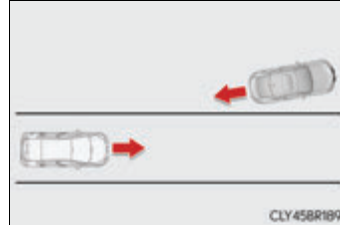

- Immediately after the BSM main switch is turned on
- Immediately after the engine is started with the BSM main switch on
- When the sensors cannot detect a vehicle due to obstructions

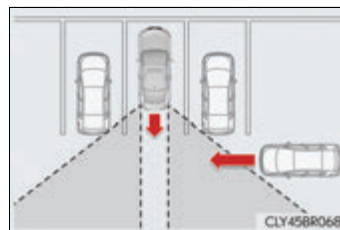

- Instances of the RCTA function unnecessarily detecting a vehicle and/or object may increase in the following situations:

- When a vehicle passes by the side of your vehicle
- When the parking space faces a street and vehicles are being driven on the street

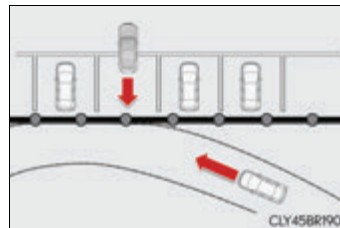

- When the distance between your vehicle and metal objects, such as a guardrail, wall, sign, or parked vehicle, which may reflect electrical waves toward the rear of the vehicle, is short

## Active rear wing (RC F)

### Features

The RC F is equipped with an active rear wing that operates automatically while the vehicle is being driven. This active rear wing enhances aerodynamic performance, especially at high speeds, contributing to a more stable ride.

The active rear wing can be controlled using a switch.

- ① Multi-information display (→P. 113)  
Displays the status of the active rear wing
- ② Active rear wing switch  
Operates the active rear wing manually
- ③ Indicator  
Illuminates when the active rear wing is raised and turns off when it is retracted

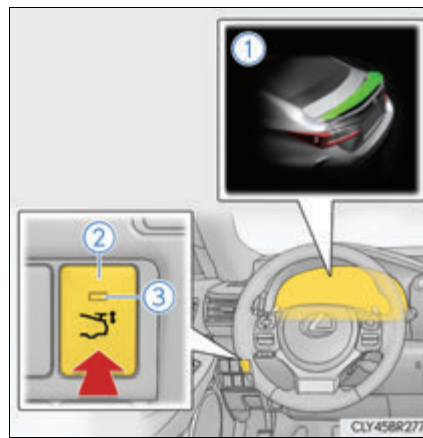

4

Driving

### Automatic operation

The active rear wing will operate automatically at the following speeds according to the selected driving mode (→P. 283).

(Always observe the legal speed limit when driving on public roads.)

| Driving mode | Up                                 | Down                              |
|--------------|------------------------------------|-----------------------------------|
| Normal Sport | Approximately 50 mph<br>(80 km/h)  | Approximately 25 mph<br>(40 km/h) |
| Eco drive    | Approximately 80 mph<br>(130 km/h) | Approximately 25 mph<br>(40 km/h) |

### Manual operation

Operate the active rear wing switch to raise/retract the active rear wing manually. (The active rear wing retracts when it is raised and raises when retracted.)

#### ■ Operation by switch

| Vehicle speed                                | Up                     | Down                   |
|--|------------------------|------------------------|
| 0 mph (0 km/h)<br>(vehicle stopped)          | Press                  | Press and hold*        |
| Approximately 0 - 12 mph<br>(0 - 20 km/h)    | Operation not possible | Operation not possible |
| Approximately 12 - 80<br>mph (20 - 130 km/h) | Press                  | Press                  |
| Approximately 80 mph<br>(130 km/h) or more   | Operation not possible | Operation not possible |

\*: Press and hold the switch until the indicator turns off. If the switch is released while the active rear wing is moving, it will return to the raised position automatically.

#### ■ The active rear wing can be operated when

- The engine switch is in IGNITION ON mode.
- The trunk is closed.

#### ■ Conditions which stop the operation of the active rear wing

In the following situations operation of the active rear wing will stop:

- The engine switch is turned off while the active rear wing is operating.
- The trunk is opened while the active rear wing is operating.
- The raising operation of the active rear wing is interrupted by an object, etc.
- The active rear wing is operated in an unusual manner causing it to stop at an irregular position.

In such cases, pressing the active rear wing switch will fully raise the active rear wing. Or, begin driving the vehicle and the active rear wing will raise automatically when the vehicle speed reaches 16 mph (25 km/h).

#### ■ Restoring automatic operation after the active rear wing is operated manually

If the active rear wing is operated manually, automatic operation will resume according to the vehicle speed.

#### ■ When there is a malfunction in the system

A warning message will be displayed on the multi-information display. (→P. 561)

#### ■ Customization

The active rear wing can be held at the raised position or retracted position. (Customizable features: →P. 651)



**⚠ WARNING**

■ **When manually operating the active rear wing**

Observe the following precautions before operating the active rear wing. Failure to do so may result in death or serious injury.

- Ensure that the surrounding area is free of any objects that may come into contact with or get caught on the active rear wing.
- If there are people near the active rear wing, make sure that there is no possibility of their clothing, personal belongings or body parts getting caught. Children especially should be warned not to touch the active rear wing while it is being operated.
- If there is a risk that an object may become caught on the active rear wing during operation, stop operation immediately.

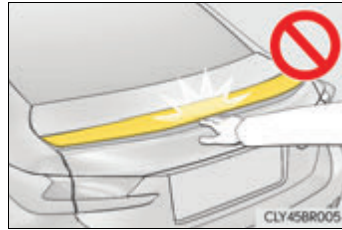

**⚠ NOTICE**

■ **To prevent system damage**

- Do not apply pressure to the active rear wing when pushing or pulling the vehicle.
- Do not lean on the active rear wing.
- Do not attach any accessories or other objects to the active rear wing.
- Do not modify or disassemble the active rear wing.
- Do not subject the active rear wing to severe impact.

■ **To prevent battery discharge**

Do not operate the active rear wing repeatedly while the engine is turned off.

## TVD (Torque Vectoring Differential)\*

The TVD system distributes driving force (torque) between the right and left rear wheels automatically. This system contributes to enhanced steering response while cornering and increased traction when exiting a corner, providing an agile driving experience.

### Changing TVD control modes

With the engine switch in IGNITION ON mode, pressing the TVD switch changes the TVD control mode.

The current TVD control mode will be displayed on the meters.

- ① STANDARD mode  
This is the default mode and provides an optimum balance of driving agility and stability.
- ② SLALOM mode  
This mode emphasizes enhanced steering response.
- ③ TRACK mode  
This mode emphasizes stability for high speed sporty driving.

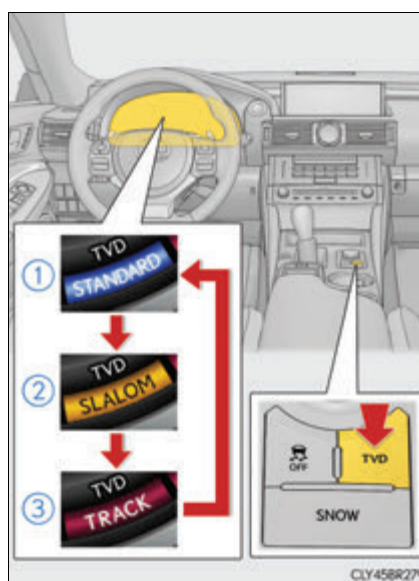

### TVD control status on the multi-information display

The multi-information display shows the distribution of driving force between the right and left rear wheels. (→P. 113)

\*: If equipped

**■ Automatic cancelation of the selected TVD control mode**

SLALOM and TRACK mode are canceled when the engine switch is turned off. When the engine switch is turned to IGNITION ON mode, the TVD system will be in STANDARD mode.

**■ Automatic disabling of the TVD system**

If a malfunction is detected in the TVD system, a warning message will be displayed on the multi-information display (→P. 558) and the TVD system will be disabled automatically. If the system is disabled, driving force will not be distributed by the TVD but through normal differential operation.

**■ To protect the system**

The TVD fluid temperature may become excessively high when driving for a long time under extremely high load conditions. In this case, a warning message will be displayed on the multi-information display. (→P. 558)

**⚠ WARNING****■ Cautions regarding the use of the system**

The driver is solely responsible for safe driving. Do not overly rely on the TVD system. Always drive safely, taking care to observe your surroundings.

4

Driving

## Winter driving tips

Carry out the necessary preparations and inspections before driving the vehicle in winter. Always drive the vehicle in a manner appropriate to the prevailing weather conditions.

### Preparation for winter (RC350/RC300/RC200t)

- Use fluids that are appropriate to the prevailing outside temperatures.
  - Engine oil
  - Engine coolant
  - Washer fluid
- Have a service technician inspect the condition of the battery.
- Have the vehicle fitted with four snow tires or purchase a set of tire chains for the rear tires.\*

Ensure that all tires are the specified size and brand, and that chains match the size of the tires.

\*: Tire chains cannot be mounted on vehicles with front and rear tires of differing sizes and vehicles with LDH and 19-inch tires.

### Preparation for winter (RC F)

- Use fluids that are appropriate to the prevailing outside temperatures.
  - Engine oil
  - Engine coolant
  - Washer fluid
- Have a service technician inspect the condition of the battery.
- Have the vehicle fitted with four snow tires.

Ensure that all tires are the specified size and brand.

### Before driving the vehicle

Perform the following according to the driving conditions:

- Do not try to forcibly open a window or move a wiper that is frozen. Pour warm water over the frozen area to melt the ice. Wipe away the water immediately to prevent it from freezing.
- To ensure proper operation of the climate control system fan, remove any snow that has accumulated on the air inlet vents in front of the windshield.
- Check for and remove any excess ice or snow that may have accumulated on the exterior lights, vehicle's roof, chassis, around the tires or on the brakes.
- Remove any snow or mud from the bottom of your shoes before getting in the vehicle.

### When driving the vehicle

Accelerate the vehicle slowly, keep a safe distance between you and the vehicle ahead, and drive at a reduced speed suitable to road conditions.

### When parking the vehicle

Park the vehicle and move the shift lever to P without setting the parking brake. The parking brake may freeze up, preventing it from being released. If necessary, block the wheels to prevent inadvertent sliding or creeping.

### Selecting tire chains (RC350/RC300/RC200t)

- ▶ Vehicles with front and rear tires of the same size except for vehicles with LDH and 19-inch tires

Use the correct tire chain size when mounting the tire chains.

Chain size is regulated for each tire size.

- ① Side chain  
(0.12 in. [3 mm] in diameter)
- ② Cross chain  
(0.16 in. [4 mm] in diameter)

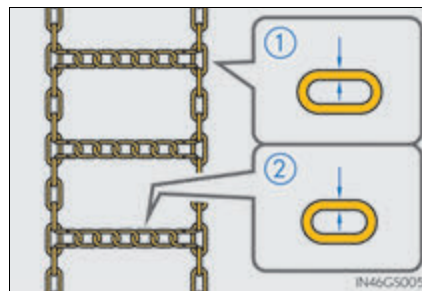

- ▶ Vehicles with front and rear tires of differing sizes and vehicles with LDH and 19-inch tires

Tire chains cannot be mounted.

Snow tires should be used instead.

### Selecting tire chains (RC F)

Tire chains cannot be mounted.

Snow tires should be used instead.

### Regulations on the use of tire chains

Regulations regarding the use of tire chains vary depending on location and type of road. Always check local regulations before installing chains.

---

#### ■ Tire chain installation

Observe the following precautions when installing and removing chains:

- Install and remove tire chains in a safe location.
- Install tire chains on the rear tires. Do not install tire chains on the front tires.
- Install tire chains on rear tires as tightly as possible. Retighten chains after driving 1/4 — 1/2 mile (0.5 — 1.0 km).
- Install tire chains following the instructions provided with the tire chains.

 **WARNING****■ Driving with snow tires**

Observe the following precautions to reduce the risk of accidents. Failure to do so may result in a loss of vehicle control and cause death or serious injury.

- Use tires of the specified size.
- Maintain the recommended level of air pressure.
- Do not drive in excess of 75 mph (120 km/h), regardless of the type of snow tires being used.
- Use snow tires on all, not just some wheels.

**■ Driving with tire chains**

Observe the following precautions to reduce the risk of accidents. Failure to do so may result in the vehicle being unable to be driven safely, and may cause death or serious injury.

- Do not drive in excess of the speed limit specified for the tire chains being used, or 30 mph (50 km/h), whichever is lower.
- Avoid driving on bumpy road surfaces or over potholes.
- Avoid sudden acceleration, abrupt steering, sudden braking and shifting operations that cause sudden engine braking.
- Slow down sufficiently before entering a curve to ensure that vehicle control is maintained.
- Vehicles with LDA (Lane Departure Alert): Do not use the LDA system.

 **NOTICE****■ Repairing or replacing snow tires**

Request repairs or replacement of snow tires from Lexus dealers or legitimate tire retailers.

This is because the removal and attachment of snow tires affects the operation of the tire pressure warning valves and transmitters.

**■ Fitting tire chains**

The tire pressure warning valves and transmitters may not function correctly when tire chains are fitted.

|   |     |
|---|-----|
| <b>5-1. Basic Operations</b>                          |     |
| Lexus Display Audio System .....                      | 326 |
| Steering wheel audio switches.....                    | 331 |
| Mobile Assistant.....                                 | 332 |
| USB/AUX ports .....                                   | 334 |
| <b>5-2. Setup</b>                                     |     |
| Setup menu .....                                      | 336 |
| General settings.....                                 | 337 |
| Voice settings .....                                  | 340 |
| Display settings.....                                 | 341 |
| <b>5-3. Using the audio system</b>                    |     |
| Selecting the audio source .....                      | 343 |
| Optimal use of the audio system .....                 | 344 |
| Audio settings.....                                   | 345 |
| Audio menu screen operation .....                     | 348 |
| <b>5-4. Using the radio</b>                           |     |
| Radio operation .....                                 | 351 |
| <b>5-5. Playing an audio CD and MP3/WMA/AAC discs</b> |     |
| CD player operation .....                             | 357 |



|   |     |
|---|-----|
| <b>5-6. Using an external device</b>            |     |
| Listening to an iPod .....                      | 364 |
| Listening USB memory<br>device .....            | 368 |
| Using the AUX port .....                        | 372 |
| <b>5-7. Connecting Bluetooth®</b>               |     |
| Steps for using Bluetooth®<br>devices .....     | 373 |
| Registering a Bluetooth®<br>device .....        | 375 |
| Selecting a Bluetooth®<br>device .....          | 376 |
| Connecting a Bluetooth®<br>audio player .....   | 377 |
| Connecting a Bluetooth®<br>phone .....          | 378 |
| Displaying a Bluetooth®<br>device details ..... | 379 |
| Detailed Bluetooth®<br>settings .....           | 380 |
| <b>5-8. Bluetooth® Audio</b>                    |     |
| Listening to Bluetooth®<br>Audio .....          | 381 |
| <b>5-9. Bluetooth® Phone</b>                    |     |
| Using a Bluetooth®<br>Phone .....               | 383 |
| Making a call .....                             | 385 |
| Receiving a call .....                          | 388 |
| Speaking on the phone .....                     | 389 |
| Using a Bluetooth® phone<br>message .....       | 391 |
| Using the steering wheel<br>switches .....      | 393 |
| Bluetooth® phone<br>settings .....              | 394 |
| <b>5-10. Phonebook</b>                          |     |
| Contact settings .....                          | 396 |
| Messaging setting .....                         | 399 |
| <b>5-11. Bluetooth®</b>                         |     |
| What to do if...<br>(Troubleshooting) .....     | 400 |
| Bluetooth® .....                                | 404 |
| <b>5-12. Other function</b>                     |     |
| "Information" screen .....                      | 409 |
| USB photo .....                                 | 411 |
| Weather information .....                       | 413 |
| Voice command system .....                      | 414 |

## Lexus Display Audio System\*

Use the following buttons to start listening to the audio system.

### Lexus Display Audio operation buttons

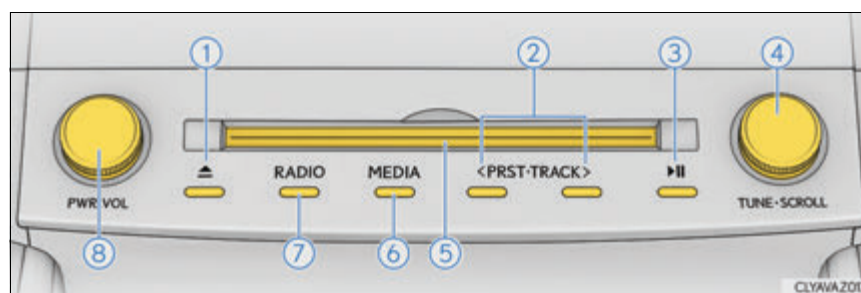

- ① Eject a disc.
- ② Seek up or down for a radio station, or to access a desired track or file.
- ③ Except radio and A/V mode: Pause or resume playing a track.  
Radio and A/V mode: Turn mute on/off.
- ④ Select a radio station band, track or file.
- ⑤ Disc slot
- ⑥ Display the media top screen.
- ⑦ Display the radio top screen.
- ⑧ Press to turn the audio system on/off, and turn to adjust the volume.

\*: If equipped

### ■ “Menu” screen

To display the “Menu” screen, press the  button on the controller unit.

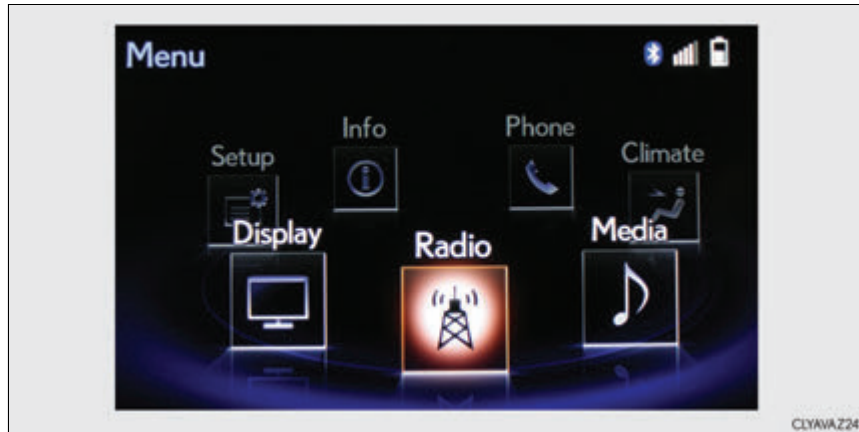

| Button    | Function   |
|-----------|--|
| “Radio”   | Display the radio top screen (→P. 351)                     |
| “Media”   | Display the media top screen (→P. 357, 364, 368, 372, 381) |
| “Climate” | Automatic air conditioning system (→P. 420)                |
| “Phone”   | Display the phone top screen (→P. 383)                     |
| “Info”    | Display the “Information” screen (→P. 409)                 |
| “Setup”   | Setup menu (→P. 336)                                       |
| “Display” | Display settings (→P. 341)                                 |

### Lexus Display Audio controller

By using the Lexus Display Audio controller, you can control the audio system, hands-free system, etc.

- ① Display the "Source" screen or audio top screen (→P. 343)
- ② Display the "Menu" screen (→P. 327)
- ③ Display the previous screen
- ④ Turn or move the controller to select a function and number.

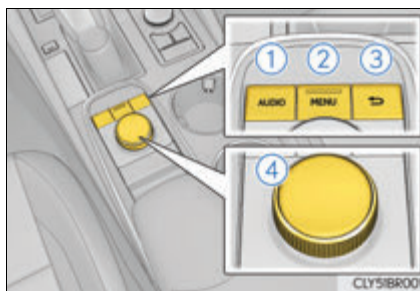

Move the controller to display the left or right side of screen.

Push the controller to enter the selected function and number.

#### ■ Using the Lexus Display Audio controller

- ① Select: Turn or move the controller.
- ② Enter: Push the controller.

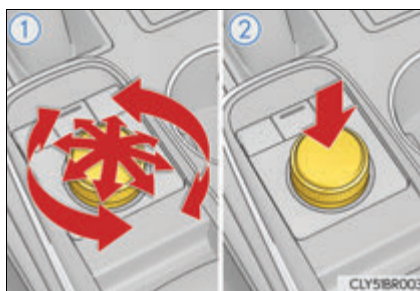

#### ■ Basic screen operation

When a list is displayed, use the appropriate button to scroll through the list.

- ① Indicator turns on when you can select the list by turning the controller.
- ② Indicator turns on when you can return to the previous screen by pressing the back button.
- ③ Indicator turns on when you can move the controller left to view additional screen text.
- ④ Indicator turns on when you can move the controller right to view additional screen text.

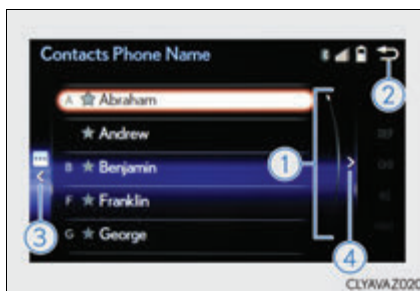

## Inputting letters and numbers

### ■ Input mode

Letters and numbers are inputted via the screen.

- ① Turn the controller to select the desired character and press the controller to input the character.
- ② When this indicator is shown, you can change input fields by moving the controller forward.
- ③ When this indicator is shown, you can change character types by moving the controller to the right and then selecting the desired character type.
- ④ Select to erase characters one by one. Select and hold to erase all characters.
- ⑤ Select to complete data input.



### ■ Input field mode

When in the input field you can move the cursor to the desired position.

- ① Turn the controller to move the cursor left or right.
- ② When this indicator is shown, you can move the cursor to the right input field by moving the controller to the right.
- ③ When this indicator is shown, you can move the cursor to the left input field by moving the controller to the left.
- ④ When this indicator is shown, you can change to input mode by moving the controller backward.

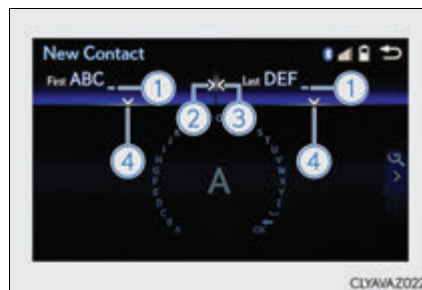



■ **When using the screen**

- Under extremely cold conditions, the Lexus Display Audio controller may react slowly.
- If the screen is cold, the display may be dark, or the system may seem to be operating slightly slower than normal.
- The screen may seem dark and hard to see when viewed through sunglasses. Change your angle of viewing, adjust the display on the "Display" screen (→P. 341) or remove your sunglasses.

■ **Using cellular phones**

Interference may be heard through the audio system's speakers if a cellular phone is being used inside or close to the vehicle while the audio system is operating.

|   |
|---|
|  <b>WARNING</b>  |
| <p>■ <b>Using the Lexus Display Audio controller</b><br/>Be careful when touching the Lexus Display Audio controller in extreme temperatures as it may become very hot or cold due to the temperature inside the vehicle.</p> <p>■ <b>Laser product</b></p> <ul style="list-style-type: none"> <li>● CAUTION<br/>USE OF CONTROL OR ADJUSTMENT OR PERFORMANCE OF PROCEDURES OTHER THAN THOSE SPECIFIED HEREIN MAY RESULT IN HAZARDOUS RADIATION EXPOSURE.</li> <li>● CAUTION<br/>THE USE OF OPTICAL INSTRUMENTS WITH THIS PRODUCT WILL INCREASE EYE HAZARD.</li> </ul> |

|  |
|--|
|  <b>NOTICE</b>  |
| <p>■ <b>To prevent Lexus Display Audio controller malfunction</b></p> <ul style="list-style-type: none"> <li>● Do not allow the Lexus Display Audio controller to come into contact with food, liquid, stickers or lit cigarettes as doing so may cause it to change color, emit a strange odor or stop functioning.</li> <li>● Do not subject the Lexus Display Audio controller to excessive pressure or strong impact as the controller may bend or break off.</li> </ul> <p>■ <b>To prevent battery discharge</b><br/>Do not leave the audio system on longer than necessary when the engine is off.</p> <p>■ <b>To avoid damaging the audio system</b><br/>Take care not to spill drinks or other fluids on the audio system.</p> |

## Steering wheel audio switches

Some audio features can be controlled using the switches on the steering wheel.

Operation may differ depending on the type of audio system or navigation system. For details, refer to the manual provided with the audio system or navigation system.

### Operating the audio system using the steering wheel switches

- ① Volume switch
  - Increases/decreases volume
  - Press and hold: Continuously increases/decreases volume
- ② Radio mode:
  - Press: Select a radio station
  - Press and hold: Seek up/down
 CD, MP3/WMA/AAC disc, Bluetooth<sup>®</sup>, iPod or USB mode:
  - Press: Select a track/file/video
  - Press and hold: Continuously tracks/files/videos up/down. (MP3/WMA/AAC disc, iPod or USB)
- ③ "MODE" switch
  - Turns the power on, selects audio source
  - Press and hold this switch to mute or pause the current operation. To cancel the mute or pause, press and hold.

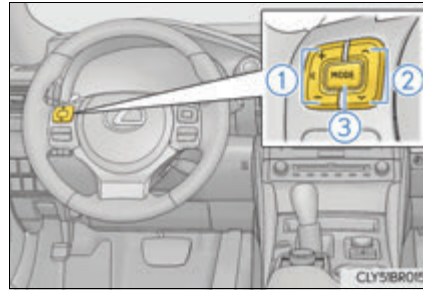

5

Lexus Display Audio system

#### WARNING

##### To reduce the risk of an accident

Exercise care when operating the audio switches on the steering wheel.

## Mobile Assistant

The Mobile Assistant feature will activate Apple's Siri® Eyes Free mode via the steering wheel switches. To operate the Mobile Assistant, a compatible cellular phone must be registered and connected to this system via Bluetooth®. (→P.383)

- 1 Press and hold the  switch until you hear beeps indicating that the system is listening.

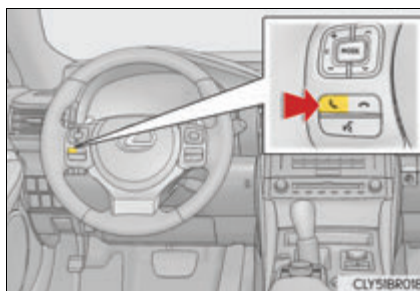

- 2 The Mobile Assistant can be used only when the following screen is displayed.

To cancel the Mobile Assistant, select "Cancel", or press and hold the off hook switch.

To restart the Mobile Assistant for additional commands, press the off hook switch. Mobile Assistant can only be restarted after the system responds to a voice command. After some phone and music commands, the Mobile Assistant feature will automatically end to complete the requested action.

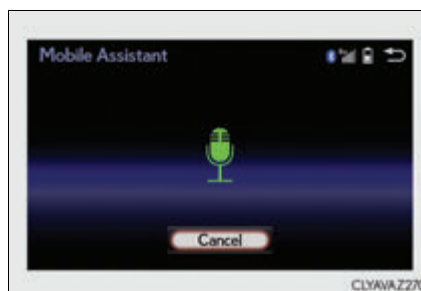



**■ Adjusting the volume**

The volume of the Mobile Assistant can be adjusted using the “PWR·VOL” knob or steering wheel volume switches. The Mobile Assistant and phone call volumes are synchronized.

**■ Microphone**

It is not necessary to speak directly into the microphone when using the Mobile Assistant.

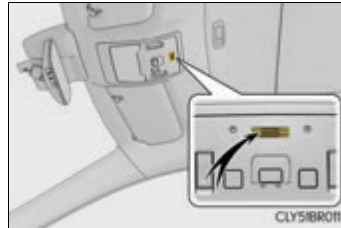

- Wait for the listening beeps before using the Mobile Assistant.
- The Mobile Assistant may not recognize commands in the following situations:
  - When spoken too quickly.
  - When spoken at a low or high volume.
  - When the roof or windows are open.
  - When passengers are talking while the Mobile Assistant is being used.
  - When the air conditioning system's fan speed is set high.
  - When the air conditioning vents are turned toward the microphone.

**■ Mobile Assistant precautions**

- The available features and functions may vary based on the iOS version installed on the connected device.
- Some Siri features are limited in Eyes Free mode. If you attempt to use an unavailable function, Siri will inform you that the function is not available.
- If Siri is not enabled on the cellular phone connected via Bluetooth<sup>®</sup>, an error message will be displayed on the screen.
- While a phone call is active, the Mobile Assistant cannot be used.
- If using the navigation feature of the cellular phone, ensure the active audio source is Bluetooth<sup>®</sup> audio or iPod in order to hear turn by turn direction prompts.

## USB/AUX ports

Connect an iPod, USB memory device or portable audio player to the USB/AUX port as indicated below. Select "iPod", "USB", "AUX" or "A/V" on the audio source selection screen and the device can be operated via the Lexus Display Audio system.

### Connecting using the USB/AUX port

#### ■ iPod

Open the cover and connect an iPod using an iPod cable.

Turn on the power of the iPod if it is not turned on.



#### ■ USB memory

Open the cover and connect the USB memory device.

Turn on the power of the USB memory device if it is not turned on.

#### ■ Portable audio player

Open the cover and connect the portable audio player.

Turn on the power of the portable audio player if it is not turned on.

### Using a 4-pole AUX cable

To view a video on an iPod video or VTR, it is necessary to use a 4-pole AUX cable to connect the portable audio device.

When connecting a portable audio device to the AUX port, use a 4-pole AUX cable with a plug that matches the exact layout shown in the illustration.

- ① Connected device (portable audio device, etc.)
- ② Left audio
- ③ Right audio
- ④ Ground
- ⑤ Video

When using an iPod video, a cable that has a 4-pole AUX plug and a USB connector is necessary. Connect the plug and connector to the AUX and USB ports.

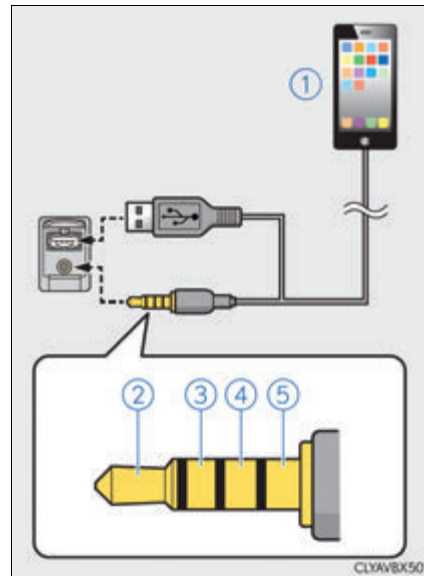

#### ■ When using a 4-pole AUX cable

If a 4-pole AUX cable with a different layout is used, audio and/or video may not be output properly.

#### ⚠ WARNING

##### ■ While driving

Do not connect a device or operate the device controls.

## Setup menu

The Lexus Display Audio system can be adjusted to the desired settings.

### Display "Setup" screen

"Setup" screen:  → "Setup"

- ① Change the settings for operation sounds, screen animation, etc. (→P. 337)
- ② Adjust the settings for voice guidance volume and voice recognition prompts. (→P. 340)
- ③ Change the settings for registering, removing, connecting and disconnecting Bluetooth<sup>®</sup> devices. (→P. 374)
- ④ Change the settings for FM radio, iPod, etc. (→P. 345)
- ⑤ Change the settings for vehicle customization. (→P. 651)
- ⑥ Change the settings for phone sound, phonebook, etc. (→P. 394)

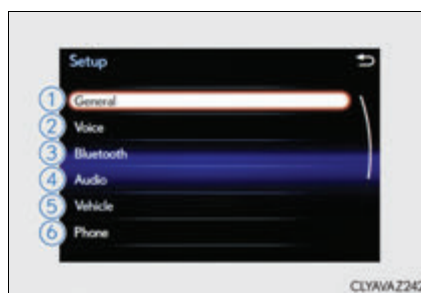

## General settings

Settings are available for adjusting the operation sounds, screen animation, etc.

### Screen for general settings

“General Settings” screen:  → “Setup” → “General”

- ① Change language.  
The selectable languages may differ depending on the model or region.
- ② Change the distance unit.
- ③ Set the beep sound on/off.
- ④ Change the button color.
- ⑤ Change the startup image and screen off image. (→P. 338)
- ⑥ Set the animation effect on/off.
- ⑦ Delete personal data (→P. 339)
- ⑧ Update program versions.  
For details, contact your Lexus dealer.
- ⑨ Update gracenote database versions.  
For details, contact your Lexus dealer.
- ⑩ Display the open source license.



5

Lexus Display Audio system

### Customizing images

- 1 Go to “Customize Images”:  → “Setup” → “General” → “Customize Images”
- 2 Select “Set Images” and then select the desired image.
  - 1 Set as startup image.
  - 2 Set as screen off image.
  - 3 Set as startup image and screen off image.

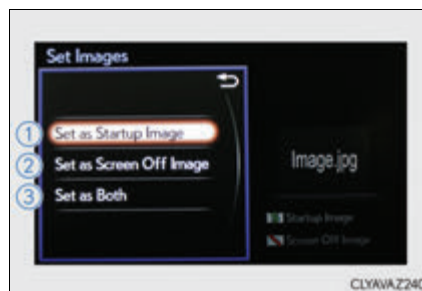

#### ■ Adding an image

- 1 Connect a USB memory device. (→P. 334)
- 2 Select “Copy from USB” on the “Customize Images” screen and then select the desired image.
- 3 Move the controller to the left and then select “Copy”.  
Up to 10 images can be downloaded.

#### ■ Deleting images

Select “Delete Images” on the “Customize Images” screen and then select the desired images.

#### ■ USB memory

When saving the images to a USB memory device, name the folder that the images are saved to “Image”.

##### ● Compatible device formats

The following device format can be used:

- USB communication format: USB2.0 HS (480 Mbps) and FS (12 Mbps)
- File system format: FAT16/32 (Windows)
- Correspondence class: Mass storage class

The following types of files can be used:

- The image’s file format must be JPEG.
- The file name may only contain ASCII characters.

##### ● JPEG file compatibility

Compatible image size: Maximum 5 MB

 NOTICE

■ To prevent damage to the USB memory device or its terminals  
→P. 371

**Deleting personal data**

- 1  → “Setup” → “General” → “Delete Personal Data”
- 2 Select “Delete”.

Check carefully beforehand, as data cannot be retrieved once deleted.

The following personal data will be deleted or changed to its default settings.

- Phonebook data
- Call history data
- Favorite data
- Bluetooth® devices data
- Phone sound settings
- Detailed Bluetooth® settings
- Audio/video setting
- Preset switch data
- Last used radio station
- Customized image data
- FM info setting
- iPod tagging information
- Software update history
- Software update detail information
- Phone display setting
- Contact/call history setting
- Messaging setting
- Traffic information map
- Weather information
- Phonebook data for voice recognition
- Music data for voice recognition

## Voice settings

This screen is used for guidance for voice command systems setting.

Go to "Voice Settings":  → "Setup" → "Voice"

- ① Adjust the voice guidance volume setting.
- ② Set the voice recognition prompts on/off.

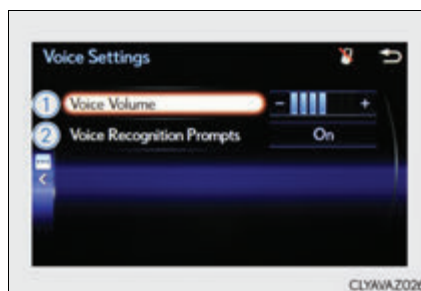

### ■ Return to the default settings

Move the controller to the left and select "Default".



## Display settings

Settings are available for adjusting the contrast and brightness of the screen. The display can also be turned off.



### Screen for display settings

Go to "Display":  → "Display"

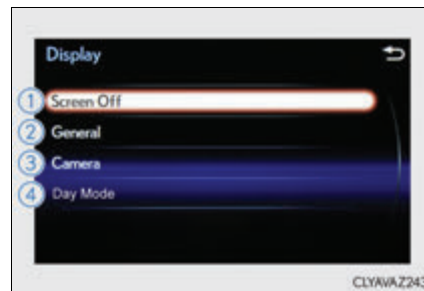
- ① Turn off screen.
- ② Adjust screen quality.
- ③ Adjust screen quality of the Lexus parking assist monitor camera.
- ④ Change to day mode.



### Screen off

This setting turns the screen off. To turn it on, press any button such as  or .

If a screen off image has been set, the set image will be displayed.

### Day mode

When the headlights are turned on, the screen dims.

However, the screen can be switched to day mode by selecting "Day Mode".

The screen will stay in day mode when the headlights are turned on until "Day Mode" is selected again.

### Adjusting the screen quality

- 1 Select "General" or "Camera" on the "Display" screen or select "Display" on each audio menu screen. (→P. 348)
- 2 Adjust the display as desired by turning the controller clockwise (+) or counterclockwise (-).  
To select "Contrast", "Brightness", "Color" or "Tone", move the controller to the left. ("Color" and "Tone" are available when "Display" on each audio menu screen or the audio settings screen for each audio source is selected.)

---



### ■ Changing the sample image (when "General" is selected)

Move the controller to the right and select the desired sample image.

## Selecting the audio source

Switching between audio sources such as radio and CD are explained in this section.

### Changing audio source

- 1 Press the  button to display the "Source" screen.  
If the "Source" screen is not displayed, press the  button again.
- 2 Select the desired audio source.  
The audio source can be selected by pressing the "RADIO" or "MEDIA" button.

### Using the steering wheel switches to change audio sources

Press the "MODE" switch when the audio system is turned on. The audio source changes each time the "MODE" switch is pressed.

#### ■ Rearranging the list

The listing order of the source list can be rearranged.

- 1 Move the controller to the left while on the "Source" screen.
- 2 Select "Audio Source Select".
- 3 Select an item you wish to move and then select where to move the item to.

## Optimal use of the audio system

On the “Sound Settings” screen, sound quality (Treble/Mid/Bass), volume balance and DSP settings can be adjusted.

### How to adjust the sound settings and sound quality

1 Display the audio menu screen. (→P. 348)

2 Select “Sound Settings”.

To change between the sound setting screen and DSP setting screen, move the controller to the right then select the desired screen.

▶ “Sound”

1 2 3 Adjust the treble, mid or bass.

4 Adjust the front/rear audio balance.

5 Adjust the left/right audio balance.



▶ “DSP”

1 Set the automatic sound levelizer (ASL) on/off

2 Set the surround function on/off

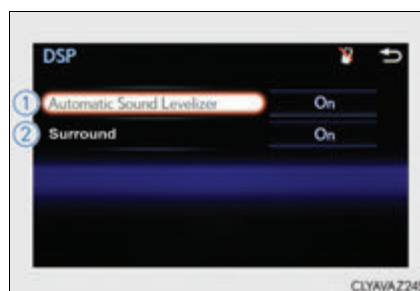

#### ■ The sound quality level is adjusted individually

The treble, mid and bass levels can be adjusted for each audio mode separately.

#### ■ About Automatic Sound Levelizer (ASL)

ASL automatically adjusts the volume and tone quality according to the vehicle speed.

## Audio settings

### Screen for audio settings

Go to "Audio Settings":  → "Setup" → "Audio"

- ① Change radio settings (→P. 345)
- ② Change iPod settings (→P. 346)
- ③ Change A/V settings (→P. 346)
- ④ Change the cover art settings (→P. 347)
- ⑤ Change USB settings (→P. 347)

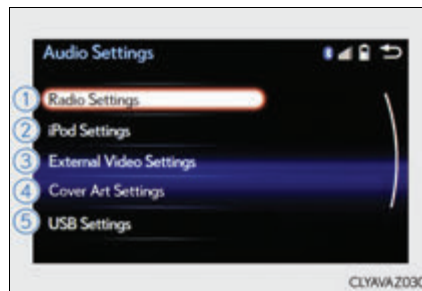

### Changing radio settings

To change radio settings, select "Radio Settings" on the "Audio Settings" screen or radio menu screen. (→P. 348)

- ① Set the displaying RBDS text message on/off
- ② Change the number of radio presets



5

Lexus Display Audio system

### Changing iPod settings

To change iPod settings, select “iPod Settings” on the “Audio Settings” screen or iPod menu screen. (→P. 348)

- ① Change the screen size (video mode)
- ② Change the cover art settings (→P. 347)
- ③ Adjust the screen quality (video mode) (→P. 341)
- ④ Change video sound input port

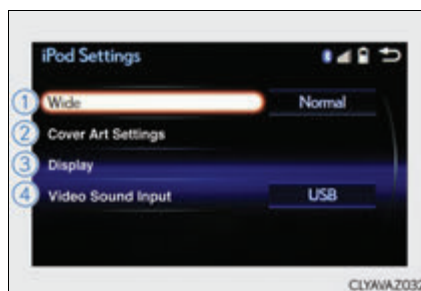

### Changing A/V settings

To change A/V settings, select “External Video Settings” on the “Audio Settings” screen or A/V menu screen. (→P. 348)

- ① Change the screen size
- ② Change the video signal
- ③ Adjust the screen quality (video mode) (→P. 341)

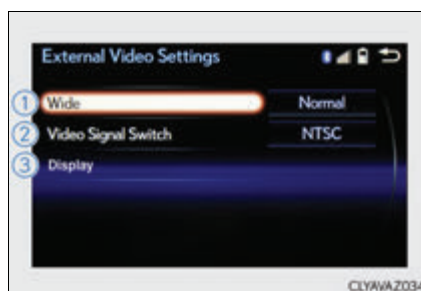

### Changing the cover art settings

To change the cover art settings, select “Cover Art Settings” on the “Audio Settings” screen, CD or MP3/WMA/AAC disc menu screen. (→P. 348)

- ① Select to set the cover art display of the DISC mode on/off.
- ② Select to set the cover art display of the USB mode on/off.
- ③ Change the priority of the Gracenote database of the USB mode.
- ④ Select to set the cover art display of the iPod mode on/off.
- ⑤ Change the priority of the Gracenote database of the iPod mode.

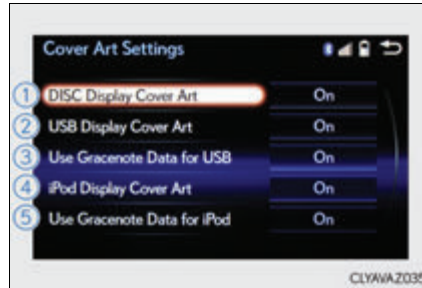

### Changing USB settings

To change USB settings, select “USB Settings” on the “Audio Settings” screen or USB menu screen. (→P. 348)

- ① Change the cover art settings (→P. 347)

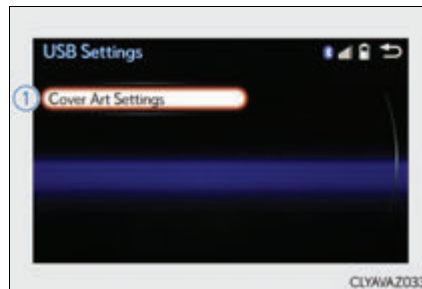

## Audio menu screen operation

You can change the settings and control functions for each audio source.

### Audio menu screen

To display the audio menu screen, move the controller to the left while on an audio top screen.

▶ AM, FM radio or XM Satellite Radio

- ① Scan for receivable stations (AM, FM radio)
- ② Seek a station of the nearest frequency (stops when a station is found) (AM, FM radio)
- ③ Captures the song title and artist name information for potential purchase (when the "HD" indicator on the selected station is appears) (FM radio)
- ④ Changes the channel of HD Radio (HD2, HD3, HD4 where applicable) (FM radio)
- ⑤ Seek a station of the traffic announcement (FM radio)
- ⑥ Turn HD Radio on/off (AM, FM radio)
- ⑦ Change radio settings (→P. 345)
- ⑧ Change sound settings (→P. 344)







▶ CD, MP3/WMA/AAC disc, iPod, USB or Bluetooth®

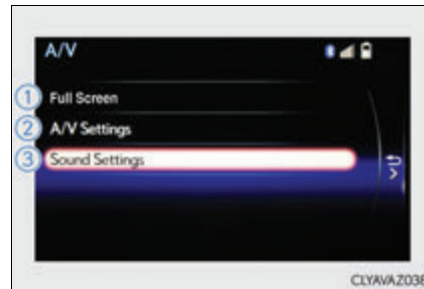

- ① Play or pause a track/file
  - ② Select a track/file
  - ③ Select a folder/album (MP3/WMA/AAC disc or USB)
  - ④ Select and hold: Fast-forward or reverse a track/file
  - ⑤ Select a repeat mode. (→P. 350)
  - ⑥ Select a random/shuffle play mode. (→P. 350)
  - ⑦ Select a full screen mode (iPod video mode)
  - ⑧ Change iPod settings (iPod) (→P. 346)
  - ⑨ Change USB settings (USB) (→P. 347)
  - ⑩ Connect a Bluetooth device (Bluetooth®) (→P. 376)
  - ⑪ Change the cover art settings (CD or MP3/WMA/AAC disc) (→P. 347)
  - ⑫ Change sound settings (→P. 344)
- ▶ A/V
- ① Select full screen mode
  - ② Change A/V settings (→P. 346)
  - ③ Change sound settings (→P. 344)



### Repeat play

| Mode  | Action            | Target audio source   |
|---|-------------------|-----------------------|
|  | File/track repeat | All media             |
|  | Folder repeat     | MP3/WMA/AAC disc, USB |
|  | Album repeat      | USB, Bluetooth®       |

### Random/shuffle playback

| Mode   | Action   | Target audio source   |
|--|--|-----------------------|
|   | Random/shuffle play of the disc/<br>folder/album | All media             |
|   | Random play of all folders                       | MP3/WMA/AAC disc, USB |
|  | Random/shuffle play of all albums                | iPod, USB, Bluetooth® |

## Radio operation

Select “AM”, “FM” or “SAT” on the audio source selection screen to begin listening to the radio.

### Radio top screen

Pressing the “RADIO” button displays the radio top screen from any screen of the selected source.

- **Menu screen**

→P. 348

### Selecting a station (AM or FM radio)

Tune in to the desired station using one of the following methods.

- **Seek tuning**

Press and hold then release “<” or “>” button.

The radio will begin seeking up or down for a station of the nearest frequency and will stop when a station is found.

- **Manual tuning**

Turn the “TUNE/SCROLL” knob.

- **Preset stations**

Select the desired preset station by pressing “<” or “>” button or controller.

- **Station list**

- 1 Move the controller to the right and selecting “Station List”.

- 2 AM radio: Selecting a desired station.

FM radio: Selecting a desired type of station and selecting a desired station.

To refreshing the station list, select “Refresh”. Select “Source” on the refresh screen, can be change to the other audio source while refreshing.

### Selecting an HD Radio channel

When "HD Radio" is set to "On", available stations with HD Radio channels are marked with "HD".

- 1 In AM or FM mode, select a station marked with "HD".
- 2 Turn the "TUNE/SCROLL" knob to select an HD Radio channel.  
HD Radio channels can also be selected by selecting "Multicast" on the menu screen. (→P. 348)

### Selecting a channel (XM Satellite Radio)

Select in to the desired channel using one of the following methods.

#### ■ Turning up/down the channel

Press and hold "<" or ">" button or turn the "TUNE/SCROLL" knob.

#### ■ Preset channels

Select the desired preset channel by pressing "<" or ">" button or controller.

#### ■ Channel list

- 1 Move the controller to the right and selecting "Select a SAT Category".
- 2 Selecting a desired category of channel and selecting a desired channel.

### Setting presets

- 1 Search for desired stations or channel.
- 2 Select and hold one of the preset until you hear a beep.

### Display the text message

#### ■ Display the song information

Move the controller to the right and selecting "Text".

#### ■ Display the Additional information (AM, FM radio)

Move the controller to the right and selecting "Additional Information".

## HD Radio™ Technology

HD Radio™ Technology is the digital evolution of analog AM/FM radio. Your radio product has a special receiver which allows it to receive digital broadcasts (where available) in addition to the analog broadcasts it already receives.

Digital broadcasts have better sound quality than analog broadcasts as digital broadcasts provide free, crystal clear audio with no static or distortion. For more information, and a guide to available radio stations and programming, refer to [www.hdradio.com](http://www.hdradio.com).

“HD Radio features included in Lexus radios:

Digital Sound - HD Radio broadcasts deliver crystal-clear, digital audio quality to listeners.

HD2/HD3 Channels - FM stations can provide additional digital only audio programming with expanded content and format choices on HD2/HD3 channels.

PSD - Program Service Data (PSD) gives you on-screen information such as artist name and song title.

iTunes® Tagging - Listeners can tag (store) songs they like for later review and purchase through iTunes.

Artist Experience® - Images related to the broadcast are displayed on the radio screen, such as album cover art and station logos.”



HD Radio Technology manufactured under license from iBiquity Digital Corporation. U.S. and Foreign Patents. HD Radio™ and the HD, HD Radio, and “Arc” logos are proprietary trademarks of iBiquity Digital Corp.

### ■ HD Radio™ Technology troubleshooting guide

| Experience  | Cause   | Action  |
|---|---|---|
| Mismatch of time alignment- a user may hear a short period of programming replayed or an echo, stutter or skip. | The radio stations analog and digital volume are not properly aligned or the station is in ballgame mode. | None, radio broadcast issue. A user can contact the radio station.  |
| Sound fades, blending in and out.   | Radio is shifting between analog and digital audio.   | Reception issue, may clear-up as the vehicle continues to be driven. Set “HD Radio” to off, can force radio in an analog audio. |

| Experience  | Cause   | Action  |
|---|---|---|
| Audio mute condition when an HD2/HD3 multi-cast channel had been playing. | The radio does not have access to digital signals at the moment.  | This is normal behavior, wait until the digital signal returns. If out of the coverage area, seek a new station.  |
| Audio mute delay when selecting an HD2/HD3 multicast channel preset.      | The digital multicast content is not available until HD Radio™ broadcast can be decoded and make the audio available. This takes up to 7 seconds. | This is normal behavior, wait for the audio to become available.  |
| Text information does not match the present song audio.                   | Data service issue at the radio broadcaster.  | Broadcaster should be notified. Complete the form: <a href="http://www.ibequity.com/automotive/report_radio_station_experiences">www.ibequity.com/automotive/report_radio_station_experiences</a> . |
| No text information shown for the present selected frequency.             | Data service issue by the radio broadcaster.  | Broadcaster should be notified. Complete the form: <a href="http://www.ibequity.com/automotive/report_radio_station_experiences">www.ibequity.com/automotive/report_radio_station_experiences</a> . |

■ **Reception sensitivity**

- Maintaining perfect radio reception at all times is difficult due to the continually changing position of the antenna, differences in signal strength and surrounding objects, such as trains, transmitters, etc.
- The radio antenna is mounted inside the rear window. To maintain clear radio reception, do not attach metallic window tinting or other metallic objects to the antenna wire mounted inside the rear window.

■ **XM Radio Services – Descriptions**

- **Radio and Entertainment**  
 XM offers more than 170 satellite radio channels of commercial-free music and premier sports, news, talk, and entertainment. XM is broadcast via satellites to millions of listeners across the continental United States. XM subscribers listen to XM on satellite radio receivers for the car, home, and portable use. More information about XM is available online at [www.siriusxm.com](http://www.siriusxm.com) (U.S.A.) or [www.xmradio.ca](http://www.xmradio.ca) (Canada).
- **Satellite tuner**  
 The tuner supports only Audio Services (Music and Talk) and the accompanying Text Information of XM Satellite Radio.

### ■ XM Radio Services – Subscription Instructions

- For XM Services requiring a subscription (such as XM Radio), the following paragraph shall be included.

Required XM Radio monthly subscriptions sold separately after trial period. Subscription fee is consumer only. All fees and programming subject to change. Subscriptions are subject to the Customer Agreement available at [www.siriusxm.com](http://www.siriusxm.com) (U.S.A.) or [www.xmradio.ca](http://www.xmradio.ca) (Canada) XM service only available in the 48 contiguous United States and 10 Canadian provinces. © 2011 Sirius XM Radio Inc. Sirius, XM and all related marks and logos are trademarks of Sirius XM Radio Inc. All other marks, channel names and logos are the property of their respective owners.

For more information, program schedules, and to subscribe or extend subscription after complimentary trial period; more information is available at:

- ▶ U.S.A. Customers:  
Visit [www.siriusxm.com](http://www.siriusxm.com) or call 1-877-515-3987
- ▶ Canadian Customers:  
Visit [www.xmradio.ca](http://www.xmradio.ca) or call 1-877-438-9677

- Radio ID

You will need the radio ID when activating XM service or reporting a problem. If "Ch000" is selected using the "TUNE•SCROLL" knob, the ID code, which is 8 alphanumeric characters, will be displayed. If another channel is selected, the ID code will no longer be displayed. The channel (000) alternates between displaying the radio ID and the specific radio code.

### ■ XM Radio Services – Legal Disclaimers and Warnings

- Fees and Taxes – Subscription fee, taxes, one time activation fee, and other fees may apply. Subscription fee is consumer only. All fees and programming subject to change. Subscriptions subject to Customer Agreement available at [www.siriusxm.com](http://www.siriusxm.com) (U.S.A.) or [www.xmradio.ca](http://www.xmradio.ca) (Canada) XM service only available in the 48 contiguous United States and Canada\*.

\*: Canada - some deterioration of service may occur in extreme northern latitudes. This is beyond the control of XM Satellite Radio.

- Explicit Language Notice – Channels with frequent explicit language are indicated with an "XL" preceding the channel name. Channel blocking is available for XM Satellite Radio receivers by notifying XM at;

- ▶ U.S.A. Customers:  
Visit [www.siriusxm.com](http://www.siriusxm.com) or calling 1-877-515-3987
- ▶ Canadian Customers:  
Visit [www.xmradio.ca](http://www.xmradio.ca) or calling 1-877-438-9677

It is prohibited to copy, decompile, disassemble, reverse engineer, hack, manipulate, or otherwise make available any technology or software incorporated in receivers compatible with the XM Satellite Radio System or that support the XM website, the Online Service or any of its content. Furthermore, the AMBE® voice compression software included in this product is protected by intellectual property rights including patent rights, copyrights, and trade secrets of Digital Voice Systems, Inc.

Note: this applies to XM receivers only and not XM Ready devices.

■ If the satellite radio does not operate normally

If a problem occurs with the XM tuner, a message will appear on the screen. Refer to the table below to identify the problem, and take the suggested corrective action.

|                      |   |
|----------------------|---|
| SAT Check Antenna    | The XM antenna is not connected. Check whether the XM antenna cable is attached securely.   |
|                      | There is a short-circuit in the antenna or the surrounding antenna cable. See a Lexus certified dealer.   |
| SAT Ch Unauthorized  | You have not subscribed to XM Satellite Radio. The radio is being updated with the latest encryption code. Contact XM Satellite Radio for subscription information. When a contract is canceled, you can choose "Ch000" and all free-to-air channels.               |
|                      | The premium channel you selected is not authorized. Wait for about 2 seconds until the radio returns to the previous channel or "Ch001". If it does not change automatically, select another channel. To listen to the premium channel, contact XM Satellite Radio. |
| SAT No Signal        | The XM signal is too weak at the current location. Wait until your vehicle reaches a location with a stronger signal.   |
| SAT Loading          | The unit is acquiring audio or program information. Wait until the unit has received the information.   |
| SAT Channel Off Air  | The channel you selected is not broadcasting any programming. Select another channel.   |
| -----                | There is no song/program title or artist name/feature associated with the channel at that time. No action is required.  |
| SAT Chan Unavailable | The channel you selected is no longer available. Wait for about 2 seconds until the radio returns to the previous channel or "Ch001". If it does not change automatically, select another channel.  |

Contact the XM Listener Care Center at 1-877-515-3987 (U.S.A.) or 1-877-438-9677 (Canada).



## CD player operation

Insert a disc, press the "MEDIA" button or select "DISC" on the "Source" screen with a disc inserted to begin listening to a CD.

### CD top screen

Pressing the "MEDIA" button displays the CD top screen from any screen of the selected source.

#### ■ Menu screen

→P. 348

#### ■ Selecting a track/file

Press the "<" or ">" button or turn the "TUNE/SCROLL" knob to select the desired track/file number.

To fast-forward or rewind, press and hold the "<" or ">" button.

#### ■ Selecting the track by the list (CD)

Move the controller to the right and then select the desired track.

#### ■ Selecting a folder (MP3/WMA/AAC disc)

1 Move the controller to the right and then select "Folders".

2 Select the desired folder. Then select a file to begin using the selected folder.

#### ■ Selecting a file by the selected folder (MP3/WMA/AAC disc)

1 Move the controller to the right and then select "Files".

2 Select the desired file.

### ■ Error messages

If the following error messages appear on the screen, refer to the table and take the appropriate measures. If the problem is not rectified, take the vehicle to your Lexus dealer.

| Message                 | Cause   | Correction procedures  |
|-------------------------|---|--|
| "Check disc"            | <ul style="list-style-type: none"> <li>• The disc is dirty or damaged.</li> <li>• The disc is inserted upside down.</li> <li>• The disc is not playable with the player.</li> </ul> | <ul style="list-style-type: none"> <li>• Clean the disc.</li> <li>• Insert the disc correctly.</li> <li>• Confirm the disc is playable with the player.</li> </ul> |
| "DISC Error"            | There is a malfunction within the system.   | Eject the disc.  |
| "No music files found." | No playable data is included on the disc.   | Eject the disc.  |

### ■ Discs that can be used

Discs with the marks shown below can be used.

Playback may not be possible depending on recording format or disc features, or due to scratches, dirt or deterioration.



CDs with copy-protection features may not play correctly.

### ■ CD player protection feature

To protect the internal components, playback is automatically stopped when a problem is detected.

### ■ If a disc is left inside the CD player or in the ejected position for extended periods

Disc may be damaged and may not play properly.

### ■ Lens cleaners

Do not use lens cleaners. Doing so may damage the CD player.

### ■ MP3, WMA and AAC files

MP3 (MPEG Audio LAYER3) is a standard audio compression format.

Files can be compressed to approximately 1/10 of their original size by using MP3 compression.

WMA (Windows Media Audio) is a Microsoft audio compression format.

This format compresses audio data to a size smaller than that of the MP3 format.

AAC is short for Advanced Audio Coding and refers to an audio compression technology standard used with MPEG2 and MPEG4.

MP3, WMA and AAC file and media/formats compatibility are limited.

- MP3 file compatibility
  - Compatible standards  
MP3 (MPEG1 LAYER3, MPEG2 LSF LAYER3)
  - Compatible sampling frequencies  
MPEG1 LAYER3: 32, 44.1, 48 (kHz)  
MPEG2 LSF LAYER3: 16, 22.05, 24 (kHz)
  - Compatible bit rates (compatible with VBR)  
MPEG1 LAYER3: 32-320 (kbps)  
MPEG2 LSF LAYER3: 8-160 (kbps)
  - Compatible channel modes: stereo, joint stereo, dual channel and monaural
- WMA file compatibility
  - Compatible standards  
WMA Ver. 7, 8, 9 (only compatible with Window Media Audio Standard)
  - Compatible sampling frequencies  
32, 44.1, 48 (kHz)
  - Compatible bit rates (only compatible with 2-channel playback)  
Ver. 7, 8: CBR 48-192 (kbps)  
Ver. 9: CBR 48-320 (kbps)
- AAC file compatibility
  - Compatible standards  
MPEG4/AAC-LC
  - Compatible sampling frequencies  
11.025/12/16/22.05/24/32/44.1/48 (kHz)
  - Compatible bit rates  
16-320 (kbps)
  - Compatible channel modes: 1 ch and 2 ch
- Compatible media  
Media that can be used for MP3, WMA and AAC playback are CD-Rs and CD-RWs. Playback in some instances may not be possible if the CD-R or CD-RW is not finalized. Playback may not be possible or the audio may jump if the disc is scratched or marked with fingerprints.
- Compatible disc formats  
The following disc formats can be used.
  - Disc formats: CD-ROM Mode 1 and Mode 2  
CD-ROM XA Mode 2, Form 1 and Form 2
  - File formats: ISO9660 Level 1, Level 2, (Romeo, Joliet)  
UDF (2.01 or lower)

MP3, WMA and AAC files written in any format other than those listed above may not play correctly, and their file names and folder names may not be displayed correctly.

Items related to standards and limitations are as follows.

  - Maximum directory hierarchy: 8 levels (including the root)
  - Maximum length of folder names/file names: 32 characters
  - Maximum number of folders: 192 (including the root)
  - Maximum number of files per disc: 255

- File names  
The only files that can be recognized as MP3/WMA/AAC and played are those with the extension .mp3, .wma or .m4a.
- Discs containing multi-session recordings  
As the audio system is compatible with multi-session discs, it is possible to play discs that contain MP3, WMA and AAC files. However, only the first session can be played.
- ID3, WMA and AAC tags  
ID3 tags can be added to MP3 files, making it possible to record the track title, artist name, etc.  
The system is compatible with ID3 Ver. 1.0, 1.1, and Ver. 2.2, 2.3 ID3 tags. (The number of characters is based on ID3 Ver. 1.0 and 1.1.)  
WMA tags can be added to WMA files, making it possible to record the track title and artist name in the same way as with ID3 tags.  
AAC tags can be added to AAC files, making it possible to record the track title and artist name in the same way as with ID3 tags.
- MP3, WMA and AAC playback  
When a disc containing MP3, WMA or AAC files is inserted, all files on the disc are first checked. Once the file check is finished, the first MP3, WMA or AAC file is played. To make the file check finish more quickly, we recommend you do not write any files to the disc other than MP3, WMA or AAC files or create any unnecessary folders.  
Discs that contain a mixture of music data and MP3, WMA or AAC format data cannot be played.
- Extensions  
If the file extensions .mp3, .wma and .m4a are used for files other than MP3, WMA and AAC files, they may be mistakenly recognized and played as MP3, WMA and AAC files. This may result in large amounts of interference and damage to the speakers.
- Playback
  - To play MP3 files with steady sound quality, we recommend a fixed bit rate of at least 128 kbps and a sampling frequency of 44.1 kHz.
  - CD-R or CD-RW playback may not be possible in some instances, depending on the characteristics of the disc.
  - There is a wide variety of freeware and other encoding software for MP3, WMA and AAC files on the market, and depending on the status of the encoding and the file format, poor sound quality or noise at the start of playback may result. In some cases, playback may not be possible at all.
  - When files other than MP3, WMA or AAC files are recorded on a disc, it may take more time to recognize the disc and in some cases, playback may not be possible at all.
  - Microsoft, Windows, and Windows Media are the registered trademarks of Microsoft Corporation in the U.S.A. and other countries.

**■ The Gracenote® media database**

- Music recognition technology and related data are provided by Gracenote®. Gracenote is the industry standard in music recognition technology and related content delivery. For more information visit [www.gracenote.com](http://www.gracenote.com).
- CD and music-related data from Gracenote, Inc., copyright © 2000 to present Gracenote. Gracenote Software, copyright © 2000 to present Gracenote. One or more patents owned by Gracenote apply to this product and service. See the Gracenote website for a non-exhaustive list of applicable Gracenote patents. Gracenote, CDDDB, MusicID, MediaVOCS, the Gracenote logo and logotype, and the "Powered by Gracenote" logo are either registered trademarks or trademarks of Gracenote in the United States and/or other countries.



**Gracenote® End User License Agreement - Music**

This application or device contains software from Gracenote, Inc. of Emeryville, California ("Gracenote"). The software from Gracenote (the "Gracenote Software") enables this application to perform disc and/or file identification and obtain music-related information, including name, artist, track, and title information ("Gracenote Data") from online servers or embedded databases (collectively, "Gracenote Servers") and to perform other functions. You may use Gracenote Data only by means of the intended End-User functions of this application or device.

This application or device may contain content belonging to Gracenote's providers. If so, all of the restrictions set forth herein with respect to Gracenote Data shall also apply to such content and such content providers shall be entitled to all of the benefits and protections set forth herein that are available to Gracenote.

You agree that you will use Gracenote Data, the Gracenote Software, and Gracenote Servers for your own personal non-commercial use only. You agree not to assign, copy, transfer or transmit the Gracenote Software or any Gracenote Data to any third party. YOU AGREE NOT TO USE OR EXPLOIT GRACENOTE DATA, THE GRACENOTE SOFTWARE, OR GRACENOTE SERVERS, EXCEPT AS EXPRESSLY PERMITTED HEREIN.

You agree that your non-exclusive license to use the Gracenote Data, the Gracenote Software, and Gracenote Servers will terminate if you violate these restrictions. If your license terminates, you agree to cease any and all use of the Gracenote Data, the Gracenote Software, and Gracenote Servers. Gracenote reserves all rights in Gracenote Data, the Gracenote Software, and the Gracenote Servers, including all ownership rights. Under no circumstances will Gracenote become liable for any payment to you for any information that you provide. You agree that Gracenote, Inc. may enforce its rights under this Agreement against you directly in its own name.

The Gracenote service uses a unique identifier to track queries for statistical purposes. The purpose of a randomly assigned numeric identifier is to allow the Gracenote service to count queries without knowing anything about who you are. For more information, see the web page for the Gracenote Privacy Policy for the Gracenote service.

The Gracenote Software and each item of Gracenote Data are licensed to you "AS IS." Gracenote makes no representations or warranties, express or implied, regarding the accuracy of any Gracenote Data from the Gracenote Servers. Gracenote reserves the right to delete data from the Gracenote Servers or to change data categories for any cause that Gracenote deems sufficient. No warranty is made that the Gracenote Software or Gracenote Servers are error-free or that functioning of Gracenote Software or Gracenote Servers will be uninterrupted. Gracenote is not obligated to provide you with new enhanced or additional data types or categories that Gracenote may provide in the future and is free to discontinue its services at any time.

GRACENOTE DISCLAIMS ALL WARRANTIES EXPRESS OR IMPLIED, INCLUDING, BUT NOT LIMITED TO, IMPLIED WARRANTIES OF MERCHANTABILITY, FITNESS FOR A PARTICULAR PURPOSE, TITLE, AND NON-INFRINGEMENT. GRACENOTE DOES NOT WARRANT THE RESULTS THAT WILL BE OBTAINED BY YOUR USE OF THE GRACENOTE SOFTWARE OR ANY GRACENOTE SERVER. IN NO CASE WILL GRACENOTE BE LIABLE FOR ANY CONSEQUENTIAL OR INCIDENTAL DAMAGES OR FOR ANY LOST PROFITS OR LOST REVENUES.

© 2012 Gracenote, Inc. All rights reserved.

 NOTICE**■ Discs and adapters that cannot be used**

Do not use the following types of discs.

Also, do not use 3 in. (8 cm) disc adapters, DualDiscs or printable discs.

Doing so may damage the player and/or disc insert/eject function.

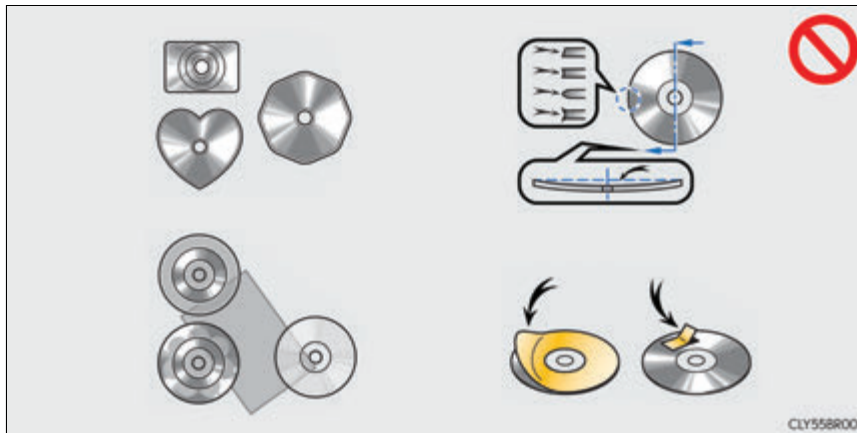

- Discs that have a diameter that is not 4.7 in. (12 cm).
- Low-quality or deformed discs.
- Discs with a transparent or translucent recording area.
- Discs that have tape, stickers or CD-R labels attached to them, or that have had the label peeled off.

**■ Player precautions**

Failure to follow the precautions below may result in damage to the discs or the player itself.

- Do not insert anything other than discs into the disc slot.
- Do not apply oil to the player.
- Store discs away from direct sunlight.
- Never try to disassemble any part of the player.

## Listening to an iPod

Connecting an iPod enables you to enjoy music from the vehicle speakers. Press the "MEDIA" button or select "iPod" on the audio source selection screen.

### Connecting an iPod

→P. 334

### iPod top screen

Pressing the "MEDIA" button displays the iPod top screen from any screen of the selected source.

- **Menu screen**

→P. 348

- **Selecting a song**

Press the "<" or ">" button or turn the "TUNE/SCROLL" knob to select the desired song number.

To fast-forward or rewind, press and hold the "<" or ">" button.

- **Selecting a play mode**

- 1 Move the controller to the right and then select "Browse".
- 2 Select the desired play mode, and then select a song to begin using the selected play mode.

- **Displaying the now playing list**

Move the controller to the right and then select "Now Playing List".



### ■ About iPod



- "Made for iPod" and "Made for iPhone" mean that an electronic accessory has been designed to connect specifically to an iPod, or iPhone, respectively, and has been certified by the developer to meet Apple performance standards.
- Apple is not responsible for the operation of this device or its compliance with safety and regulatory standards. Please note that the use of this accessory with iPod or iPhone may affect wireless performance.
- iPhone, iPod, iPod classic, iPod nano and iPod touch are trademarks of Apple Inc., registered in the U.S. and other countries.

### ■ iPod cover art

- Depending on the iPod and songs in the iPod, iPod cover art may be displayed.
- This function can be changed to on/off. (→P. 347)
- It may take time to display iPod cover art, and the iPod may not be operated while the cover art display is in process.

### ■ iPod functions

- When an iPod is connected and the audio source is changed to iPod mode, the iPod will resume play from the same point in which it was last used.
- Depending on the iPod that is connected to the system, certain functions may not be available. If a function is unavailable due to a malfunction (as opposed to a system specification), disconnecting the device and reconnecting it may resolve the problem.
- Depending on the iPod, while connected to the system, the iPod cannot be operated with its own controls. It is necessary to use the controls of the vehicle's audio system instead.
- When the battery level of an iPod is very low, the iPod may not operate. If so, charge the iPod before use.
- Compatible models (→P. 366)

### ■ iPod problems

To resolve most problems encountered when using your iPod, disconnect your iPod from the vehicle iPod connection and reset it. For instructions on how to reset your iPod, refer to your iPod Owner's Manual.

■ Error messages

If the following error messages appear on the screen, refer to the table and take the appropriate measures. If the problem is not rectified, take the vehicle to your Lexus dealer.

| Message                                      | Cause/Correction procedures  |
|--|--|
| "Connection error."                          | This indicates a problem in the iPod or its connection.  |
| "There are no songs available for playback." | This indicates that there is no music data in the iPod.  |
| "No items available."                        | This indicates that songs are not found in a selected playlist.  |
| "Please check the iPod firm-ware version."   | This indicates that the software version is not compatible.<br>Please check the compatible models. (→P. 366) |
| "iPod authorization failed."                 | This indicates that the Lexus Display Audio system failed to authorize the iPod.<br>Please check your iPod.  |

■ Compatible models

The following iPod®, iPod nano®, iPod classic®, iPod touch® and iPhone® devices can be used with this system.

- Made for
  - iPod touch (5th generation)
  - iPod touch (4th generation)
  - iPod touch (3rd generation)
  - iPod touch (2nd generation)
  - iPod touch (1st generation)
  - iPod classic
  - iPod with video
  - iPod nano (7th generation)
  - iPod nano (6th generation)
  - iPod nano (5th generation)
  - iPod nano (4th generation)
  - iPod nano (3rd generation)
  - iPod nano (2nd generation)
  - iPod nano (1st generation)
  - iPhone 5
  - iPhone 4S
  - iPhone 4
  - iPhone 3GS
  - iPhone 3G
  - iPhone

Depending on differences between models or software versions etc., some models might be incompatible with this system.

 NOTICE**■ To prevent damage to the iPod or its terminals**

- Do not leave the iPod in the vehicle. The temperature inside the vehicle may become high, resulting in damage to the iPod.
- Do not push down on or apply unnecessary pressure to the iPod while it is connected.
- Do not insert foreign objects into the port.

## Listening USB memory device

Connecting a USB memory device enables you to enjoy music from the vehicle speakers.

Select "USB1" or "USB2" on the audio source selection screen.

## Connecting a USB memory device

→P. 334

## USB top screen

Pressing the "MEDIA" button displays the USB top screen from any screen of the selected source.

### ■ Menu screen

→P. 348

### ■ Selecting a file

Press the "<" or ">" button or turn the "TUNE/SCROLL" knob to select the desired file number.

To fast-forward or rewind, press and hold the "<" or ">" button.

### ■ Selecting a play mode

- 1 Move the controller to the right and select "Browse".
- 2 Select the desired play mode, then select a file to begin the selected play mode.

### ■ Displaying the now playing list

Move the controller to the right and select "Now Playing List".

### ■ USB memory functions

- Depending on the USB memory device that is connected to the system, the device itself may not be operable and certain functions may not be available. If the device is inoperable or a function is unavailable due to a malfunction (as opposed to a system specification), disconnecting the device and reconnecting it may resolve the problem.
- If the USB memory device still does not begin operation after being disconnected and reconnected, format the device.

### ■ Error messages for USB memory

If the following error messages appear on the screen, refer to the table and take the appropriate measures. If the problem is not rectified, take the vehicle to your Lexus dealer.

| Message                                      | Cause/Correction procedures   |
|--|---|
| "Connection error."                          | This indicates a problem with the USB memory device or its connection.          |
| "There are no files available for playback." | This indicates that no MP3/WMA/AAC files are included on the USB memory device. |

### ■ USB memory

- Compatible devices  
USB memory devices that can be used for MP3, WMA and AAC playback.

- Compatible device formats

The following device format can be used:

- USB communication format: USB2.0 HS (480 Mbps) and FS (12 Mbps)
  - File system format: FAT16/32 (Windows)
  - Correspondence class: Mass storage class
- MP3, WMA and AAC files written to a device with any format other than those listed above may not play correctly, and their file names and folder names may not be displayed correctly.

Items related to standards and limitations are as follows:

- Maximum directory hierarchy: 8 levels
- Maximum number of folders in a device: 3000 (including the root)
- Maximum number of files in a device: 9999
- Maximum number of files per folder: 255

### ■ MP3, WMA and AAC files

MP3 (MPEG Audio LAYER 3) is a standard audio compression format. Files can be compressed to approximately 1/10 of their original size using MP3 compression.

WMA (Windows Media Audio) is a Microsoft audio compression format. This format compresses audio data to a size smaller than that of the MP3 format.

AAC is short for Advanced Audio Coding and refers to an audio compression technology standard used with MPEG2 and MPEG4.

MP3, WMA and AAC file and media/formats compatibility are limited.

#### ● MP3 file compatibility

- Compatible standards  
MP3 (MPEG1 AUDIO LAYERIII, MPEG2 AUDIO LAYERIII)
- Compatible sampling frequencies  
MPEG1 AUDIO LAYERIII: 32, 44.1, 48 (kHz)  
MPEG2 AUDIO LAYERIII: 16, 22.05, 24 (kHz)
- Compatible bit rates (compatible with VBR)  
MPEG1 AUDIO LAYERIII: 32-320 (kbps)  
MPEG2 AUDIO LAYERIII: 8-160 (kbps)
- Compatible channel modes: stereo, joint stereo, dual channel and monaural

#### ● WMA file compatibility

- Compatible standards  
WMA Ver. 7, 8, 9 (only compatible with Window Media Audio Standard)
- Compatible sampling frequencies  
32, 44.1, 48 (kHz)
- Compatible bit rates (only compatible with 2-channel playback)  
Ver. 7, 8: CBR 48-192 (kbps)  
Ver. 9: CBR 48-320 (kbps)

#### ● AAC file compatibility

- Compatible standards  
MPEG4/AAC-LC
- Compatible sampling frequencies  
11.025/12/16/22.05/24/32/44.1/48 (kHz)
- Compatible bit rates  
16-320 (kbps)
- Compatible channel modes: 1 ch and 2 ch

#### ● File names

The only files that can be recognized as MP3/WMA/AAC and played are those with the extension .mp3, .wma or .m4a.

#### ● ID3, WMA and AAC tags

ID3 tags can be added to MP3 files, making it possible to record the track title, artist name, etc.

The system is compatible with ID3 Ver. 1.0, 1.1, and Ver. 2.2, 2.3 ID3 tags. (The number of characters is based on ID3 Ver. 1.0 and 1.1.)

WMA tags can be added to WMA files, making it possible to record the track title and artist name in the same way as with ID3 tags.

AAC tags can be added to AAC files, making it possible to record the track title and artist name in the same way as with ID3 tags.

- MP3, WMA and AAC playback
  - When a device containing MP3, WMA or AAC files is connected, all files in the USB memory device are checked. Once the file check is finished, the first MP3, WMA or AAC file is played. To make the file check finish more quickly, we recommend that you do not include any files other than MP3, WMA or AAC files or create any unnecessary folders.
  - When a USB memory device is connected and the audio source is changed to USB memory mode, the USB memory device will start playing the first file in the first folder. If the same device is removed and reconnected (and the contents have not been changed), the USB memory device will resume play from the same point in which it was last used.
- Extensions
 

If the file extensions .mp3, .wma and .m4a are used for files other than MP3, WMA and AAC files, they will be skipped (not played).
- Playback
  - To play MP3 files with steady sound quality, we recommend a fixed bit rate of at least 128 kbps and a sampling frequency of 44.1 kHz.
  - There is a wide variety of freeware and other encoding software for MP3, WMA and AAC files on the market, and depending on the status of the encoding and the file format, poor sound quality or noise at the start of playback may result. In some cases, playback may not be possible at all.
  - Microsoft, Windows, and Windows Media are the registered trademarks of Microsoft Corporation in the U.S.A. and other countries.

 NOTICE

■ **To prevent damage to the USB memory device or its terminals**

- Do not leave the USB memory device in the vehicle. The temperature inside the vehicle may become high, resulting in damage to the USB memory device.
- Do not push down on or apply unnecessary pressure to the USB memory device while it is connected.
- Do not insert foreign objects into the port.

## Using the AUX port

To use the AUX port, connect a portable player, press the “MEDIA” button or select “AUX” or “A/V” on the “Source” screen.

### Connecting a portable player

→P. 334

### Top screen

Pressing the “MEDIA” button displays the top screen from any screen of the selected source.

#### ■ Menu screen

→P. 348

#### ■ Operating portable players connected to the audio system

Volume can be adjusted using the vehicle’s audio controls. All other adjustments must be made on the portable player itself.

#### ■ When using a portable player connected to the power outlet

Noise may occur during playback. Use the power source of the portable player.



#### NOTICE

#### ■ To prevent damage to the portable player or its terminal

- Do not leave portable player in the vehicle. The temperature inside the vehicle may become high.
- Do not push down on or apply unnecessary pressure to the portable player while it is connected.
- Do not insert foreign objects into the port.



## Steps for using Bluetooth® devices

The following can be performed using Bluetooth® wireless communication:

- A portable audio player can be operated and listened to via the Lexus Display Audio system
- Hands-free phone calls can be made via a cellular phone

In order to use wireless communication, register and connect a Bluetooth® device by performing the following procedures.

### Device registration/connection flow

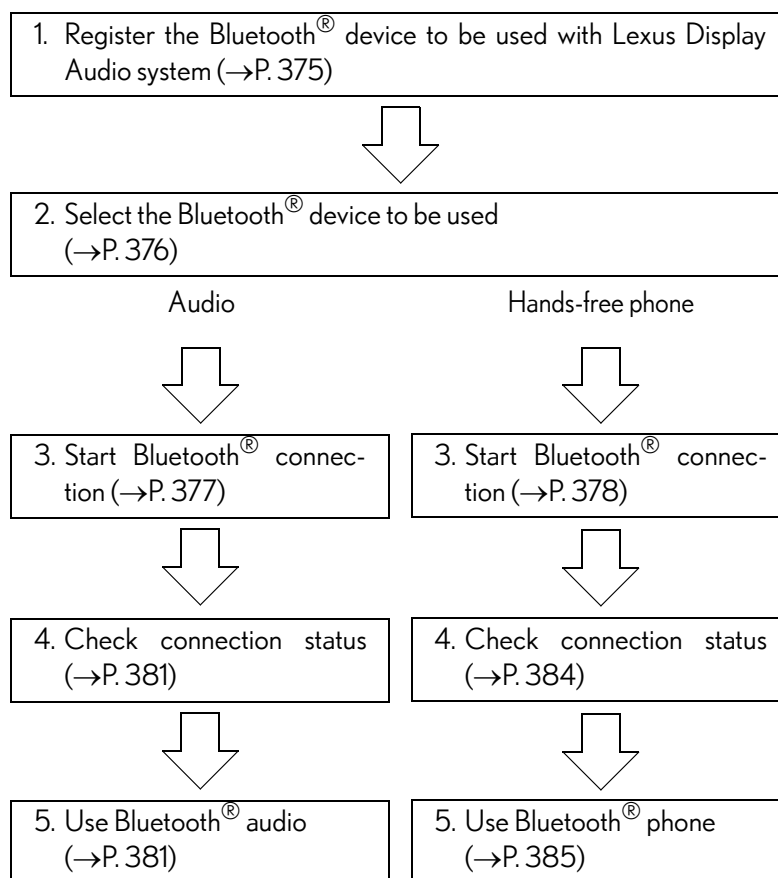

### “Bluetooth\* Setup” screen

Go to “Bluetooth\* Setup”:  → “Setup” → “Bluetooth\*”

\*: Bluetooth is a registered trademark of Bluetooth SIG, Inc.

---

■ **When displaying “Bluetooth\* Setup” screen from the “Bluetooth\* Audio” screen**

- 1 Display the “Bluetooth\* Audio” screen. (→P. 343)
- 2 Move the controller to the left and select “Connect”.

■ **When displaying “Bluetooth\* Setup” screen from the phone top screen**

- 1 Display the phone top screen. (→P. 383)
- 2 Move the controller to the left and select “Connect Phone”.

\*: Bluetooth is a registered trademark of Bluetooth SIG, Inc.

## Registering a Bluetooth® device

Bluetooth® compatible phones (HFP) and portable audio players (AVP) can be registered simultaneously. You can register up to 5 Bluetooth® devices.

### How to register a Bluetooth® device

- 1 Turn the Bluetooth® connection setting of your device set to on.
- 2 Go to "Bluetooth\* Setup":  → "Setup" → "Bluetooth\*"
- 3 Move the controller to the left and then select "Add Device"

- 4 When this screen is displayed, input the passcode displayed on the screen into your Bluetooth® device.

For operation of the Bluetooth® device, see the manual that comes with your Bluetooth® device.

- 5 Register the Bluetooth® device using your Bluetooth® device.

A PIN code are not required for SSP (Secure Simple Pairing) compatible Bluetooth® devices. Depending on the device, you may need to select Yes to register, or No to cancel on the device.

If an error message is displayed, follow the guidance on the screen to try again.

\*: Bluetooth is a registered trademark of Bluetooth SIG, Inc.

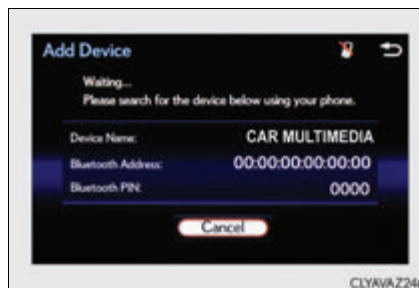

5

Lexus Display Audio system

### Removing a Bluetooth® device

- 1 Go to "Bluetooth\* Setup":  → "Setup" → "Bluetooth\*"
- 2 Move the controller to the left and then select "Remove Device".
- 3 Select the device to remove.

\*: Bluetooth is a registered trademark of Bluetooth SIG, Inc.

## Selecting a Bluetooth® device

If multiple Bluetooth® devices are registered, follow the procedure below to select the Bluetooth® device to be used. You may only use one device at a time.

### How to select a Bluetooth® device

- 1 Go to "Bluetooth\* Setup":  → "Setup" → "Bluetooth\*"
- 2 Select the device to connect.
- 3 Select "Connect All", "Connect as a Phone" or "Connect as an Audio Player".

If the desired Bluetooth® device is not displayed, register the device.

(→P. 375)

\*: Bluetooth is a registered trademark of Bluetooth SIG, Inc.

## Connecting a Bluetooth® audio player

There are 2 portable audio player connection settings available: connecting from the vehicle and connecting from the portable player.

### Connecting method is set to “Vehicle”

When the portable audio player is in standby for a connection, it will be automatically connected whenever the engine switch is in either ACCESSORY or IGNITION ON mode.

### Connecting method is set to “Device”

Operate the portable player and connect it to the Bluetooth® audio system.

- 1 Go to “Bluetooth\* Setup”:  → “Setup” → “Bluetooth\*”
- 2 Select the device to connect.
- 3 Select “Connect All” or “Connect as an Audio player”.

If the desired Bluetooth® device is not displayed, register the device.  
(→P. 375)

\*: Bluetooth is a registered trademark of Bluetooth SIG, Inc.

## Connecting a Bluetooth® phone

There are two connecting methods available: automatic and manual.

### Auto connection

When you register a phone, auto connection will be activated. Always set it to this mode and leave the Bluetooth® phone in a place where a connection can be established.

When the engine switch is turned to ACCESSORY or IGNITION ON mode, the system will search for a nearby cellular phone you have registered.

Next, the system automatically connects with the most recent phone that was connected. The connected result is displayed.

### Manual connection

When auto connection has failed or “Bluetooth\* Power” is turned off, you must connect the Bluetooth® device manually.

- 1 Go to “Bluetooth\* Setup”:  → “Setup” → “Bluetooth\*”
- 2 Select the device to connect.
- 3 Select “Connect All”, “Connect as a Phone” or “Connect as an Audio player”.

If the desired Bluetooth® device is not displayed, register the device.  
(→P. 375)

\*: Bluetooth is a registered trademark of Bluetooth SIG, Inc.

### ■ Reconnecting a Bluetooth® phone

If the system cannot connect due to poor signal strength with the engine switch in ACCESSORY or IGNITION ON mode, the system will automatically attempt to reconnect.

If the phone is turned off, the system will not attempt to reconnect. In this case, the connection must be made manually, or the phone must be reselected.

### ■ Connecting a phone while Bluetooth® audio is playing

- Bluetooth® audio will stop temporarily.
- It may take time to connect.

## Displaying a Bluetooth® device details

You can confirm and change the registered device details.

### Bluetooth® device registration status

- 1 Go to "Bluetooth\* Setup":  → "Setup" → "Bluetooth\*"
- 2 Select the desired device and then select "Device Info".

- 1 Change the name of the device
- 2 Change the connection method  
 "Vehicle": Connect the audio system to the portable audio player.  
 "Device": Connect the portable audio player to the audio system
- 3 Device address
- 4 Device telephone number



- 5 Depending on the model of phone, the number may not be displayed.
- 5 Compatibility profile of the device

\*: Bluetooth is a registered trademark of Bluetooth SIG, Inc.

#### Restoring the default settings

Move the controller to the left and select "Default" on the "Device Information" screen.

## Detailed Bluetooth® settings

You can confirm and change the detailed Bluetooth® settings.

### How to check and change detailed Bluetooth® settings

- 1 Go to "Bluetooth\* Setup":  → "Setup" → "Bluetooth\*"
- 2 Move the controller to the left and then select "System Settings".

① Select to set the Bluetooth® function on/off

② Change the name of the device

③ Change the PIN-code

You can change the PIN-code that is used to register your Bluetooth® devices in the system.

④ Device address

⑤ Select to set the display of the telephone status on/off

You can set the system to show the status confirmation display when connecting a telephone.

⑥ Select to set the display of the audio player status on/off

You can set the system to show the status confirmation display when connecting an audio player.

⑦ Compatibility profile of the system

\*: Bluetooth is a registered trademark of Bluetooth SIG, Inc.



#### Restoring the default settings

Move the controller to the left and select "Default" on the "System Settings" screen.



## Listening to Bluetooth® Audio

The Bluetooth® audio system enables the user to enjoy music played on a portable player from the vehicle speakers via wireless communication.

When a Bluetooth® device cannot be connected, check the connection status on the “Bluetooth\* Audio” screen. If the device is not connected, either register or reconnect the device. (→P. 376, 377)

\*: Bluetooth is a registered trademark of Bluetooth SIG, Inc.





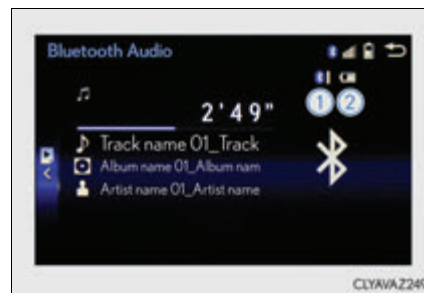

### Status display

You can check indicators, such as signal strength and battery charge, on the screen.

- ① Connection status
- ② Battery charge

Depending on the type of portable audio player used, some titles may not be displayed.



| Indicators        | Conditions   |
|-------------------|--|
| Connection status | Good ←————→ Not connected<br>   |
| Battery charge    | Full ←————→ Empty<br>           |

### Bluetooth® audio top screen

Pressing the “MEDIA” button displays the Bluetooth® audio top screen from any screen of the selected source.

■ **Menu screen**

→P. 348

■ **Selecting a song**

Press the “<” or “>” button or turn the “TUNE/SCROLL” knob to select the desired song number.

To fast-forward or reverse, press and hold the “<” or “>” button.

■ **Selecting a play mode**

- 1 Move the controller to the right and then select “Browse”.
- 2 Select the desired play mode, and then select a song to begin using the selected play mode.

■ **Displaying the now playing list**

Move the controller to the right and then select “Now Playing List”.

## Using a Bluetooth® Phone

The hands-free system is a function that allows you to use your cellular phone without touching it.

This system supports Bluetooth®. Bluetooth® is a wireless data system that allows the cellular phone to wirelessly connect to the hands-free system and make/receive calls.

Before making a phone call, check the connection status, battery charge, call area and signal strength. (→P. 384)

If a Bluetooth® device cannot be connected, check the connection status. If the device is not connected, either register or reconnect it. (→P. 376, 378)

### Phone top screen

To display the screen shown below, press the  switch on the steering wheel or select "Phone" on the "Menu" screen.

- ① Phone name
- ② Bluetooth® connection status (→P. 384)
- ③ Display the call history screen (→P. 387)
- ④ Display the favorites screen (→P. 387)
- ⑤ Display the contacts screen (→P. 385)
- ⑥ Display the dial pad screen (→P. 385)
- ⑦ Display the message inbox screen (→P. 391)

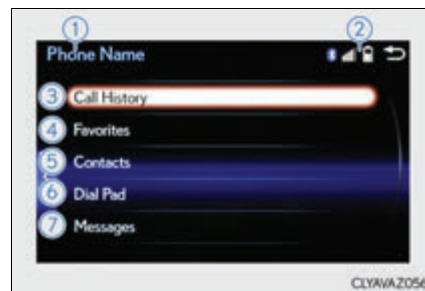

5

Lexus Display Audio system

◆ Telephone switch (→P. 393)

◆ Microphone

The vehicle's built-in microphone is used when talking on the phone.

The person you are speaking to can be heard from the front speakers.

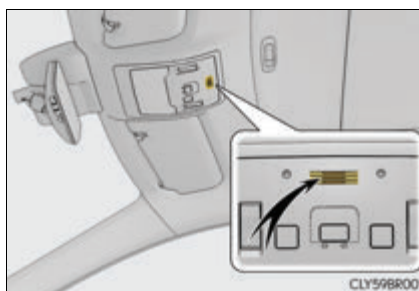

To use the hands-free system, you must register your Bluetooth® phone in the system. (→P. 375)

**Status display**

You can check indicators such as signal strength and battery charge on any screen.

- ① Connection status
- ② Signal strength
- ③ Battery charge

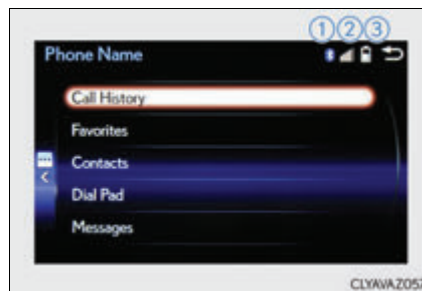



| Indicators        | Conditions    |           |                   |
|-------------------|---------------|-----------|-------------------|
| Connection status | Good<br>      | Poor<br>  | Not connected<br> |
| Battery charge    | Full<br>      | Empty<br> |                   |
| Signal strength   | Excellent<br> | Poor<br>  |                   |

## Making a call



Once a Bluetooth® phone is registered, you can make a call using the following procedure:

### Dialing

- 1 Go to "Dial Pad":  → "Phone" → "Dial Pad"
- 2 Input a phone number. (→P. 329)
- 3 Press the  switch on the steering wheel or select .

### Dialing from the phonebook

You can dial a number from the phonebook data imported from your cellular phone. The system has one phonebook for each registered telephone. Up to 2500 contacts may be stored in each phonebook. (→P. 386)

- 1 Go to "Contacts":  → "Phone" → "Contacts"
- 2 Choose the desired contact to call from the list.
- 3 Choose the number and then press the  switch on the steering wheel or press the controller.

### When the phonebook is empty

You can transfer the phone numbers in a Bluetooth® phone to the system. Operation methods differ between PBAP (Phone Book Access Profile) compatible and PBAP incompatible Bluetooth® phones. If the cellular phone does not support either PBAP or OPP (Object Push Profile) service, you cannot transfer contacts.

- 1 Press the  switch on the steering wheel.

If the phonebook is empty, a message will be displayed.

- ▶ For a PBAP compatible Bluetooth® phone and “Automatic Transfer” is off

- 2 To transfer new contacts from a cellular phone, select “Always” and then enable “Automatic Transfer”. (→P. 396)  
Select “Once” if you want to transfer new contacts from a cellular phone.

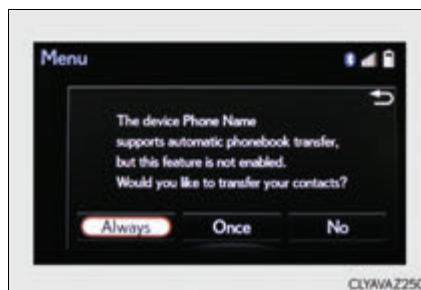

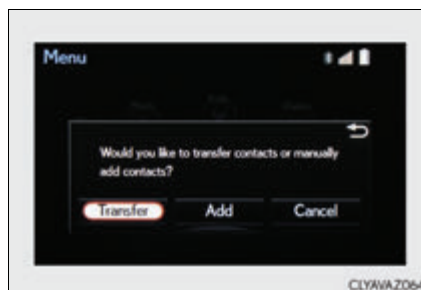

- ▶ For a PBAP incompatible and OPP compatible Bluetooth® phone

- 2 Select “Transfer” and operate your cellular phone to transfer new contacts from a cellular phone.  
Select “Add” if you want to add a new contact manually.





### Dialing from favorites

You can make a call using numbers registered in the favorites.

- 1 Go to "Favorites":  → "Phone" → "Favorites"
- 2 Choose the desired contact to call from the list.
- 3 Choose the number and then press the  switch on the steering wheel or press the controller.

### Dialing from history

You can make a call using the call history.

- 1 Go to "Call History":  → "Phone" → "Call History"
- 2 Select the desired entry from the list.
- 3 Press the  switch on the steering wheel or select .



#### ■ Call history list

- If you make a call to or receive a call from a number registered in the phonebook, the name is displayed in the call history.
- If you make multiple calls to the same number, only the last call made is displayed in the call history.

#### ■ International calls

Depending on the mobile phone in use, you may not be able to make international calls.

#### ■ Calling by using the latest call history entry

- 1 Press the  switch on the steering wheel to display the phone top screen.
- 2 Press the  switch on the steering wheel to display the "Call History" screen.
- 3 Press the  switch on the steering wheel to select the latest call history entry.

## Receiving a call



When a call is received, the following screen is displayed together with a sound.

### To answer the phone

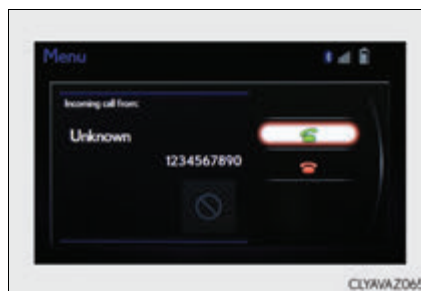
Press the  switch on the steering wheel or select .



### To refuse a call

Press the  switch on the steering wheel or select .

#### ■ International calls

Depending on the cellular phone in use, received international calls may not be displayed correctly.



## Speaking on the phone

The following screen is displayed when speaking on the phone.

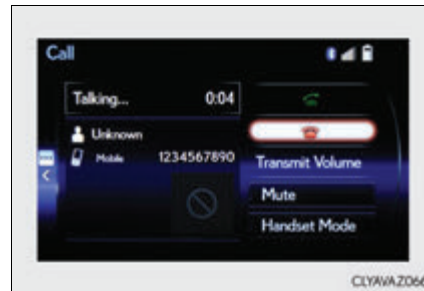

### To adjust the call volume

Select "Transmit Volume". To restore default volume, move the controller to the left on the "Transmit Volume" screen and then select "Default".

### To adjust in call volume

Move the controller to the left and then select "In-call Volume". You can also adjust the volume using the steering switches or volume knob.

### To prevent the other party from hearing your voice

Select "Mute".

### Inputting tones

When using phone services such as an answering service or a bank, you can store phone numbers and code numbers in the contacts using "p" or "w" symbols (eg. 056133 w 0123p#1).

- ▶ Contact including a phone number only
- 1** Move the controller to the left and then select "0-9".
- 2** Input the number.
  - ▶ Phone number containing a "p" symbol

When the "p" symbol is dialed in an outgoing call, there will be a pause for 2 seconds before the following digits are dialed automatically.



- ▶ Phone number containing a “w” symbol

When the “w” symbol is dialed in an outgoing call, you need to go to the “Release Tones” screen to dial the following digits. Move the controller to the left and then select “Release Tones”.

### To transfer a call

Select “Handset Mode” to change from a hands-free call to a cellular phone call or vice versa.

### To hang up

Press the  switch on the steering wheel or select .

### Call waiting

When a call is interrupted by a third party while talking, an incoming call message will be displayed.



To talk with the other party:

Press the  switch on the steering wheel or select .

To refuse the call:

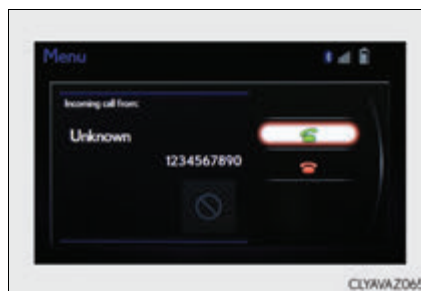
Press the  switch on the steering wheel or select .



Every time you press the  switch on the steering wheel or select  during call waiting, you will be switched to the other party.

### ■ Transferring calls

- It is not possible to transfer from hands-free to the cellular phone while driving.
- If you transfer from the cellular phone to hands-free, the hands-free screen will be displayed, and you can operate the system using the screen.
- Transfer method and operation may vary according to the cellular phone used.
- For operation of the cellular phone in use, see the phone's manual.

### ■ Call waiting operation

Call waiting operation may differ depending on your phone company and cellular phone.

## Using a Bluetooth® phone message

Once a MAP-profile compatible Bluetooth phone is registered, you can check the E-mail/SMS/MMS and reply to a message using the following procedures:

### Checking messages

- 1 Go to message screen:  → "Phone" → "Messages"
- 2 Select a message.

Moving the controller to the left while on the message screen displays the setting screen. (→P.399)

Move the controller to the right while on the message screen and then select an account to display a message list for the selected account.

### Message screen

Selecting "Next" or "Previous" displays the next or previous message.  
If a message is too long, select "Read More" to display the full text.

#### ■ Option menu

Move the controller to the left while on the message screen.

- 1 Select a prepared message and send a return message.
- 2 Call a sender.  
If more than one phone number is registered for a sender, a phone number selection screen will be displayed.

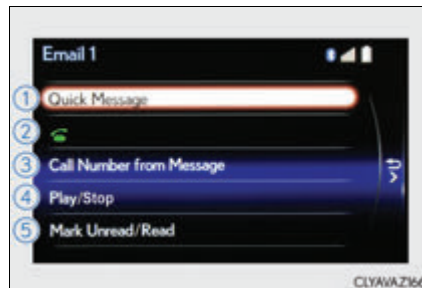

- 3 Call a phone number written in a message.
- 4 Select "Play" to have a message read out loud.  
Select "Stop" to stop this function.
- 5 Select "Mark Unread" to mark mail that has been read as unread. Select "Mark Read" to mark mail that has not been read as read.

### Replying to a message

- 1 Move the controller to the left while on the message screen.
- 2 Select "Quick Message" to display the "Quick Message" screen.
- 3 Select the desired message and then select "Send".

#### ■ Editing a quick message

- 1 Move the controller to the left while on the message screen.
- 2 Select "Quick Message" and move the cursor to the desired message.
- 3 Move the controller to the left and select "Edit".

To return to the default message after editing, select "Default".

### Receiving a message popup function

This function is available when the "E-mail Notification Popup" or "SMS/MMS Notification Popup" are set to on. (→P. 399)

- ▶ "Incoming E-mail Display" or "Incoming SMS/MMS Display" are set to "Drop-Down"

When E-mail/ SMS/MMS are received, the incoming message is displayed on the upper side of the screen with a sound.

- ▶ "Incoming E-mail Display" or "Incoming SMS/MMS Display" are set to "Full Screen"

When E-mail/ SMS/MMS are received, the incoming message screen is displayed with a sound and it can be operated on the screen.

- 1 Check the message.
- 2 Refuse to check the message.
- 3 Call to receive the message sender's phone number.

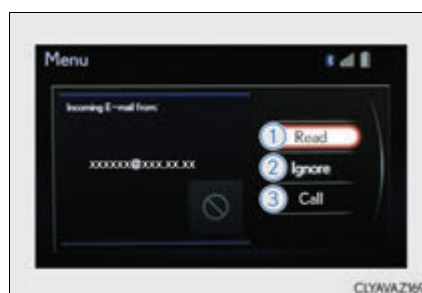

## Using the steering wheel switches

The steering wheel switches can be used to operate a connected cellular phone.

### Operating a telephone using the steering wheel switches

① Volume switch

During an incoming call: Adjusts the ring tone volume

During speaking on the phone: Adjusts in call volume

The voice guidance volume cannot be adjusted using this button.

② Off hook switch

- Start call
- Receiving
- Phone top screen display

③ On hook switch

- End call
- Refuse call

④ Talk switch

Press: Turns the voice command system on

Press and hold: Turns the voice command system off

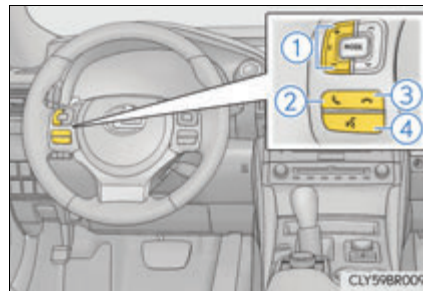

## Bluetooth® phone settings

You can adjust the hands-free system to your desired settings.

### “Phone/Message Settings” screen

Go to “Phone/Message Settings”:  → “Setup” → “Phone”

- ① Register and connect a Bluetooth® device. (→P. 374)
- ② Adjust the call volume and message readout volume. (→P. 394)
- ③ Change the contact/call history settings. (→P. 396)
- ④ Change messaging settings. (→P. 399)
- ⑤ Change phone display settings. (→P. 395)

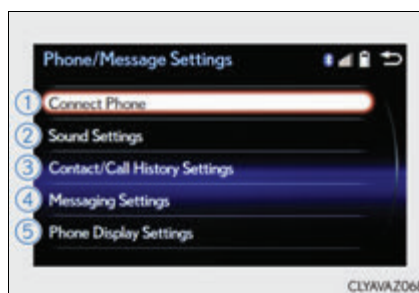

### Sound settings

Go to “Sound Settings”:  → “Setup” → “Phone” → “Sound Settings”

- ① Change the ring tone type
- ② Adjust the ring tone volume
- ③ Adjust the message readout volume
- ④ Change the incoming SMS/MMS tone type
- ⑤ Adjust the incoming SMS/MMS tone volume
- ⑥ Change the incoming email tone type
- ⑦ Adjust the incoming email tone volume
- ⑧ Adjust in call tone volume

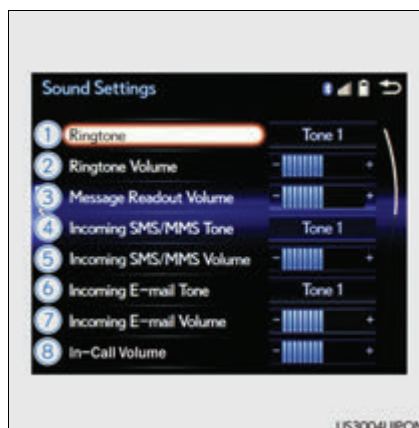

### Phone display settings

Go to "Phone Display Settings":  → "Setup" → "Phone" → "Phone Display Settings"

- ① Change the incoming call display
- ② Set the phonebook/history transfer status notification display on/off

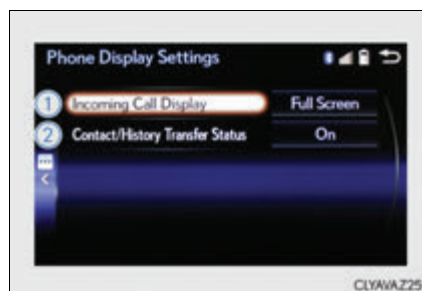

#### ■ To return to the default volume settings

Move the controller to the left and then select "Default".

## Contact settings

Individual phonebooks can be registered for a maximum of 5 phones in total. The data for 2500 contacts (up to 4 numbers per contact) can be registered in each phonebook.

### “Contact/Call History Settings” screen

Go to “Contact/Call History Settings”:  → “Setup” → “Phone” → “Contact/Call History Settings”

- ① Select to set the automatic phonebook download on/off  
With this setting on, phonebook data will be automatically transferred.  
Depending on the cellular phone, call history will be also transferred.
- ② Update contacts
- ③ Change the sort contacts mode
- ④ Add a favorite (→P. 397)
- ⑤ Delete a favorite (→P. 398)
- ⑥ Select to set the display of contact images on/off
- ⑦ Delete call history (PBAP incompatible Bluetooth<sup>®</sup> phones, or compatible phones with “Automatic Transfer” off)
- ⑧ Add a new contact (PBAP incompatible Bluetooth<sup>®</sup> phones, or compatible phones with “Automatic Transfer” off)  
Input the name, phone number and phone number type to add a new contact.
- ⑨ Edit a contact (PBAP incompatible Bluetooth<sup>®</sup> phones, or compatible phones with “Automatic Transfer” off)  
Select the desired contact to edit.
- ⑩ Delete contacts (→P. 398) (PBAP incompatible Bluetooth<sup>®</sup> phones, or compatible phones with “Automatic Transfer” off)

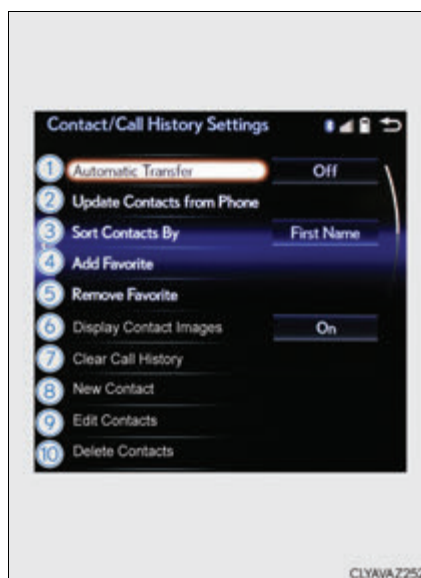

#### ■ Return to the default settings

Move the controller to the left and select “Default”.



### Transferring a phone number

You can transfer the phone numbers in your Bluetooth<sup>®</sup> phone to the system. Operation methods differ between PBAP compatible and PBAP incompatible Bluetooth<sup>®</sup> phones. If your cellular phone does not support either PBAP or OPP services, you cannot transfer contacts.

Go to "Transfer Contacts":  → "Setup" → "Phone" → "Contact/Call History Settings" → "Update Contacts from Phone"

- ▶ For PBAP compatible Bluetooth<sup>®</sup> phones when "Automatic Transfer" is set to on

Start the update automatically.

- ▶ For PBAP compatible Bluetooth<sup>®</sup> phones when "Automatic Transfer" is set to off and PBAP incompatible Bluetooth<sup>®</sup> phones

- ① Select to transfer the contact from the connected cellular phone and replace the current one.
- ② Select to transfer the desired contact data from the connected cellular phone to add to the current one.

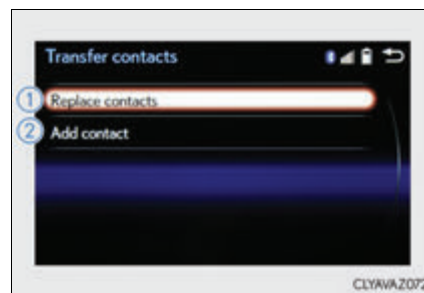

### Registering favorites

You can register the desired contact from the phonebook. Up to 15 contacts per phone can be registered.

- ① Go to "Add Favorite":  → "Setup" → "Phone" → "Contact/Call History Settings" → "Add Favorite"
- ② Choose the contact to register.

### Removing favorites

- 1 Go to "Remove Favorite":  → "Setup" → "Phone" → "Contact/Call History Settings" → "Remove Favorite"
- 2 Select the desired contacts.  
You can select all contacts by selecting "Select All"
- 3 Move the controller to the left and select "Remove".

### Deleting the contacts data

- 1 Go to "Delete Contact":  → "Setup" → "Phone" → "Contact/Call History Settings" → "Delete Contacts"
- 2 Select the desired contacts.  
You can select all contacts by selecting "Select All".
- 3 Move the controller to the left and select "Delete".

#### ■ Phonebook data

Phonebook data is managed separately for every registered phone. When another phone is connected, you cannot read the registered data.

#### ■ When transferring contacts

Transfer contacts while the engine is running.

If the cellular phone is OPP or PBAP compatible, you may need to input "1234" on the cellular phone for OBEX certification.

#### ■ When you have selected "Replace contacts" or "Add contact" to transfer contacts

If the cellular phone does not support OPP service, you cannot use these functions. You can transfer the phonebook data only by operating your phone.

#### ■ Transferring contacts while Bluetooth® audio is playing

Bluetooth® audio will disconnect. It will reconnect automatically when data transfer finishes. It may not reconnect depending on the phone which is connected.

## Messaging setting

Go to “Messaging Settings”:  → “Setup” → “Phone” → “Messaging Settings”

- ① Set the message forwarding from cellular phones on/off
- ② Set the automatic message read out function on/off
- ③ Set the new SMS/MMS notification display on/off
- ④ Set the new email notification display on/off
- ⑤ Set the add vehicle signature function on/off
- ⑥ Set the cellular phone’s message read and unread status update function on/off
- ⑦ Change the incoming SMS/MMS display
- ⑧ Change the incoming email display
- ⑨ Change the account name to “Service name” (names from the connected device) or “Fixed name” (pre-defined names)



5

Lexus Display Audio system

### ■ Restoring the default settings

Move the controller to the left then select “Default” on the “Messaging Settings” screen.

## What to do if... (Troubleshooting)

If there is a problem with the hands-free system or a Bluetooth® device, first check the table below.

- ▶ When using the hands-free system with a Bluetooth® device

|   |
|---|
| The hands-free system or Bluetooth® device does not work.   |
| The connected device may not be a compatible Bluetooth® cellular phone.<br>→ <b>For a list of specific devices which operation has been confirmed on this system, check with your Lexus dealer or the following website:</b><br><a href="http://www.lexus.com/MobileLink">http://www.lexus.com/MobileLink</a> |
| The Bluetooth® version of the connected cellular phone may be older than the specified version.<br>→ <b>Use a cellular phone with Bluetooth® version 2.0 or higher (recommended: Ver. 3.0 with EDR or higher). (→P. 406)</b>  |

## ▶ When registering/connecting a cellular phone

|   |
|---|
| A cellular phone cannot be registered.  |
| An incorrect passcode was entered on the cellular phone.<br>→ <b>Enter the correct passcode on the cellular phone.</b>  |
| The registration operation has not been completed on the cellular phone side.<br>→ <b>Complete the registration operation on the cellular phone (approve registration on the phone).</b>  |
| Old registration information remains on either this system or the cellular phone.<br>→ <b>Delete the existing registration information from both this system and the cellular phone, then register the cellular phone you wish to connect to this system. (→P. 375)</b> |
| A Bluetooth® connection cannot be made.   |
| Another Bluetooth® device is already connected.<br>→ <b>Manually connect the cellular phone you wish to use to this system. (→P. 378)</b>   |
| Bluetooth® function is not enabled on the cellular phone.<br>→ <b>Enable the Bluetooth® function on the cellular phone.</b>   |

## ▶ When making/receiving a call

|  |
|--|
| A call cannot be made/received.  |
| Your vehicle is in a "No Service" area.<br>→ <b>Move to where "No Service" no longer appears on the display.</b> |

▶ When using the phonebook

|  |
|--|
| Phonebook data cannot be transferred manually/automatically.   |
| The profile version of the connected cellular phone may not be compatible with transferring phonebook data.<br>→ <b>For a list of specific devices which operation has been confirmed on this system, check with your Lexus dealer or the following website:<br/><a href="http://www.lexus.com/MobileLink">http://www.lexus.com/MobileLink</a></b> |
| Automatic phonebook transfer function on this system is set to off.<br>→ <b>Set automatic phonebook transfer function on this system to on. (→P. 396)</b>  |
| Passcode has not been entered on the cellular phone.<br>→ <b>Enter the passcode on the cellular phone if requested (default passcode: 1234).</b>   |
| Transfer operation on the cellular phone has not completed.<br>→ <b>Complete transfer operation on the cellular phone (approve transfer operation on the phone).</b>   |
| Phonebook data cannot be edited.   |
| Automatic phonebook transfer function on this system is set to on.<br>→ <b>Set automatic phonebook transfer function on this system to off. (→P. 396)</b>  |

▶ When using the Bluetooth® message function

|   |
|---|
| Messages cannot be viewed.  |
| Message transfer is not enabled on the cellular phone.<br>→ <b>Enable message transfer on the cellular phone (approve message transfer on the phone).</b>       |
| Automatic transfer function on this system is set to off.<br>→ <b>Set automatic transfer function on this system to on. (→P. 399)</b>                           |
| New message notifications are not displayed.  |
| Notification of SMS/MMS/E-mail reception on this system is set to off.<br>→ <b>Set notification of SMS/MMS/E-mail reception on this system to on. (→P. 399)</b> |
| Automatic message transfer function is not enabled on the cellular phone.<br>→ <b>Enable automatic transfer function on the cellular phone.</b>                 |

## ▶ In other situations

Even though all conceivable measures have been taken, the symptom status does not change.

The cellular phone is not close enough to this system.  
→ **Bring the cellular phone closer to this system.**

The cellular phone is the most likely cause of the symptom.  
→ **Turn the cellular phone off, remove and reinstall the battery pack, and then restart the cellular phone.**  
→ **Enable the cellular phone's Bluetooth® connection.**  
→ **Stop the cellular phone's security software and close all applications.**  
→ **Before using an application installed on the cellular phone, carefully check its source and how its operation might affect this system.**

## Bluetooth®

### ■ When using the Bluetooth® audio system

- In the following situations, the system may not function.
  - If the portable audio player is turned off
  - If the portable audio player is not connected
  - If the portable audio player's battery is low
- There may be a delay if a cellular phone connection is made during Bluetooth® audio play.
- Depending on the type of portable audio player that is connected to the system, operation may differ slightly and certain functions may not be available.

### ■ When using the hands-free system

- The audio system is muted when making a call.
- If both parties speak at the same time, it may be difficult to hear.
- If the received call volume is overly loud, an echo may be heard.  
If the Bluetooth® phone is too close to the system, quality of the sound may deteriorate and connection status may deteriorate.
- In the following situations, it may be difficult to hear the other party:
  - When driving on unpaved roads
  - When driving at high speeds
  - If a window is open
  - If the air conditioning is blowing directly on the microphone
  - If there is interference from the network of the cellular phone
- Depending on the type of phone, certain functions may not be available.

### ■ Conditions under which the system will not operate

- If using a cellular phone that does not support Bluetooth®
- If the cellular phone is turned off
- If you are outside of cellular phone service coverage
- If the cellular phone is not connected
- If the cellular phone's battery is low
- When outgoing calls are controlled, due to heavy traffic on telephone lines, etc.
- When the cellular phone itself cannot be used
- When transferring phonebook data from the cellular phone



### ■ Bluetooth® antenna

The antenna is built into the instrument panel.

If the portable audio player is behind the seat or in the glove box or console box, or is touching or covered by metal objects, the connection status may deteriorate.

If the cellular phone is behind the seat or in the console box, or touching or covered by metal objects, the connection status may deteriorate.

### ■ Battery charge/signal status

- This display may not correspond exactly with the portable audio player or cellular phone itself.
- This system does not have a charging function.
- The portable audio player or cellular phone battery will be depleted quickly when the device is connected to Bluetooth®.

### ■ When using the Bluetooth® audio and hands-free system at the same time

The following problems may occur.

- The Bluetooth® audio connection may be interrupted.
- Noise may be heard during Bluetooth® audio playback.

### ■ About the contact in this system

The following data is stored for every registered cellular phone. When another phone is connecting, you cannot read the registered data.

- Contact data
- Call history
- Favorite
- Message

When removing a Bluetooth® phone from the system, the above-mentioned data is also deleted.

### ■ About Bluetooth®

The Bluetooth® word mark and logos are registered trademarks owned by the Bluetooth SIG, Inc. and any use of such marks by PIONEER Corporation is under license. Other trademarks and trade names are those of their respective owners.



### ■ Compatible models

The Bluetooth® audio system supports portable audio players with the following specifications

- Bluetooth® specifications:  
Ver. 2.0 or higher (Recommended: Ver. 3.0 +EDR or higher)
- Profiles:
  - A2DP (Advanced Audio Distribution Profile) Ver. 1.0, or higher  
(Recommended: Ver. 1.2 or higher)  
This is a profile to transmit stereo audio or high quality sound to the audio system.
  - AVRCP (Audio/Video Remote Control Profile) Ver. 1.0 or higher  
(Recommended: Ver. 1.4 or higher)  
This is a profile to allow remote control of the A/V equipment.

However, please note that some functions may be limited depending on the type of portable audio player connected.

The hands-free system supports cellular phones with the following specifications.

- Bluetooth® specification:  
Ver. 2.0 or higher (Recommended: Ver. 3.0 +EDR or higher)
- Profiles:
  - HFP (Hands Free Profile) Ver. 1.0 or higher (Recommended: Ver. 1.6 or higher)  
This is a profile to allow hands-free phone calls using a cellular phone or head set. It has outgoing and incoming call functions.
  - OPP (Object Push Profile) Ver. 1.1 or higher (Recommended: Ver. 1.1)  
This is a profile to transfer phonebook data. When a Bluetooth® compatible cellular phone has both PBAP and OPP, OPP cannot be used.
  - PBAP (Phone Book Access Profile) Ver. 1.0 or higher (Recommended: Ver. 1.1)  
This is a profile to transfer phonebook data.
  - MAP (Message Access Profile) Ver.1.0 or higher  
This is a profile to using phone message.

If the cellular phone does not support HFP, you cannot register it with the hands-free system. OPP, PBAP or MAP services must be selected individually.

### ■ Reconnecting the portable audio player

If the portable audio player is disconnected due to poor reception when the engine switch is in ACCESSORY or IGNITION ON mode, the system automatically reconnects the portable audio player.

If you have switched off the portable audio player yourself, follow the instructions below to reconnect:

- Select the portable audio player again
- Enter the portable audio player

### ■ When you sell your car

Be sure to delete your personal data. (→P. 339)

**■ Certification**

- ▶ For vehicles sold in the U.S.A.

FCC ID: AJDK061

NOTE:

This device complies with part 15 of the FCC Rules. Operation is subject to the following two conditions: (1) This device may not cause harmful interference, and (2) this device must accept any interference received, including interference that may cause undesired operation.

FCC WARNING:

Changes or modifications not expressly approved by the party responsible for compliance could void the user's authority to operate the equipment.

CAUTION:

This equipment complies with FCC radiation exposure limits set forth for an uncontrolled environment and meets the FCC radio frequency (RF) Exposure Guidelines. This equipment should be installed and operated keeping the radiator at least 20cm or more away from person's body.

Co-location:

This transmitter must not be co-located or operated in conjunction with any other antenna or transmitter.

- ▶ For vehicles sold in Canada

IC: 775E-K061

NOTE:

This device complies with Industry Canada licence-exempt RSS standard(s). Operation is subject to the following two conditions: (1) this device may not cause interference, and (2) this device must accept any interference, including interference that may cause undesired operation of the device.

Le présent appareil est conforme aux CNR d'Industrie Canada applicables aux appareils radio exempts de licence. L'exploitation est autorisée aux deux conditions suivantes : (1) l'appareil ne doit pas produire de brouillage, et (2) l'utilisateur de l'appareil doit accepter tout brouillage radioélectrique subi, même si le brouillage est susceptible d'en compromettre le fonctionnement.

CAUTION:

This equipment complies with IC radiation exposure limits set forth for an uncontrolled environment and meets RSS-102 of the IC radio frequency (RF) Exposure rules. This equipment should be installed and operated keeping the radiator at least 20cm or more away from person's body.

Cet équipement est conforme aux limites d'exposition aux rayonnements énoncées pour un environnement non contrôlé et respecte les règles d'exposition aux fréquences radioélectriques (RF) CNR-102 de l'IC. Cet équipement doit être installé et utilisé en gardant une distance de 20 cm ou plus entre le dispositif rayonnant et le corps.

Under Industry Canada regulations, this radio transmitter may only operate using an antenna of a type and maximum (or lesser) gain approved for the transmitter by Industry Canada. To reduce potential radio interference to other users, the antenna type and its gain should be so chosen that the equivalent isotropically radiated power (e.i.r.p.) is not more than that necessary for successful communication.

Conformément à la réglementation d'Industrie Canada, le présent émetteur radio peut fonctionner avec une antenne d'un type et d'un gain maximal (ou inférieur) approuvé pour l'émetteur par Industrie Canada. Dans le but de réduire les risques de brouillage radioélectrique à l'intention des autres utilisateurs, il faut choisir le type d'antenne et son gain de sorte que la puissance isotrope rayonnée équivalente (p.i.r.e.) ne dépasse pas l'intensité nécessaire à l'établissement d'une communication satisfaisante.

**⚠ WARNING****■ While driving**

Do not operate the portable audio player, cellular phone or connect a device to the Bluetooth® system.

**■ Caution regarding interference with electronic devices**

- Your audio unit is fitted with Bluetooth® antennas. People with implantable cardiac pacemakers, cardiac resynchronization therapy-pacemakers or implantable cardioverter defibrillators should maintain a reasonable distance between themselves and the Bluetooth® antennas. The radio waves may affect the operation of such devices.
- Before using Bluetooth® devices, users of any electrical medical device other than implantable cardiac pacemakers, cardiac resynchronization therapy-pacemakers or implantable cardioverter defibrillators should consult the manufacturer of the device for information about its operation under the influence of radio waves. Radio waves could have unexpected effects on the operation of such medical devices.

**⚠ NOTICE****■ When leaving the vehicle**

Do not leave your portable audio player or cellular phone in the vehicle. The inside of the vehicle may become hot, causing damage to the portable audio player or cellular phone.

## “Information” screen

### Display “Information” screen

Go to “Information”:  → “Info”

- ① Display the fuel consumption.  
(→P.126)
- ② Display the “USB Photo” screen.  
(→P.411)
- ③ Display the weather information.  
(→P.413)
- ④ Display the Traffic Map picture.

Available when in a traffic supported  
HD Radio coverage area



### Traffic information map

Go to “Traffic Map”:  → “Info” → “Traffic Incidents”

- ① Current position of your car
- ② Traffic information line

The line color means the following:

Red: Heavy congestion

Yellow: Moderate traffic

Green: Free flowing traffic



■ Certification for U.S. owners

**I. Clear Channel Disclaimers**

"Total Traffic Network, a division of Clear Channel Broadcasting, Inc., owns or holds the rights to the traffic, news, sports, weather, stocks and other data (the "TOTAL TRAFFIC-HD+ Data") and TOTAL TRAFFIC-HD+ network through which it is delivered, together the "TTN Service". Use of the TTN Service is subject to the terms of these Device End User Terms.

"The TTN Service is informational only. User assumes all risk of use. Total Traffic Network and its suppliers and licensors make no representations about the accuracy or timeliness of any of the TOTAL TRAFFIC-HD+ Data, including traffic and road conditions, route usability, or speed."

"TOTAL TRAFFIC-HD+ NETWORK DATA IS PROVIDED "AS IS," AND "WHERE IS". TOTAL TRAFFIC NETWORK AND ITS SUPPLIERS AND LICENSORS EXPRESSLY DISCLAIM ALL WARRANTIES WITH RESPECT TO THE DATA (INCLUDING, WITHOUT LIMITATION, THAT THE DATA WILL BE ERROR-FREE, WILL OPERATE WITHOUT INTERRUPTION OR THAT THE DATA WILL BE ACCURATE), EXPRESS, IMPLIED OR STATUTORY, INCLUDING, WITHOUT LIMITATION, THE IMPLIED WARRANTIES OF MERCHANTABILITY, NON-INFRINGEMENT, FITNESS FOR A PARTICULAR PURPOSE, OR THOSE ARISING FROM A COURSE OF DEALING OR USAGE OF TRADE."

"TOTAL TRAFFIC NETWORK AND ITS SUPPLIERS AND LICENSORS WILL NOT BE LIABLE TO YOU FOR ANY INDIRECT, SPECIAL, CONSEQUENTIAL, EXEMPLARY, OR INCIDENTAL DAMAGES (INCLUDING, WITHOUT LIMITATION, LOST REVENUES, ANTICIPATED REVENUES, OR PROFITS RELATING TO THE SAME) ARISING FROM ANY CLAIM RELATING DIRECTLY OR INDIRECTLY TO USE OF THE DATA, WHETHER A CLAIM FOR SUCH DAMAGES IS BASED ON WARRANTY, CONTRACT, TORT (INCLUDING, WITHOUT LIMITATION, NEGLIGENCE OR STRICT LIABILITY) OR ANY OTHER LEGAL THEORY."

**II. The Weather Channel's (TWC's) Disclaimers**

THE FOLLOWING TERMS APPLY TO THE USE OF ANY MATERIAL, DATA OR INFORMATION PROVIDED BY THE WEATHER CHANNEL, LLC ("THE WEATHER CHANNEL"), INCLUDING WEATHER-RELATED INFORMATION AND REPORTS, OBTAINED BY YOU OR OTHERS THROUGH THE TTN SERVICE ("THE WC DATA").

**DISCLAIMER OF WARRANTIES.**

YOUR USE OF THE WC DATA IS AT YOUR SOLE RISK. THE WC DATA IS PROVIDED ON AN "AS IS" AND "AS AVAILABLE" BASIS. THE WEATHER CHANNEL EXPRESSLY DISCLAIMS ALL WARRANTIES OF ANY KIND, WHETHER EXPRESS OR IMPLIED, INCLUDING, BUT NOT LIMITED TO THE IMPLIED WARRANTIES OF MERCHANTABILITY, FITNESS FOR A PARTICULAR PURPOSE AND NON-INFRINGEMENT. THE WEATHER CHANNEL MAKES NO REPRESENTATION OR WARRANTY THAT (i) THE WC DATA WILL MEET YOUR REQUIREMENTS, (ii) THE WC DATA WILL BE UNINTERRUPTED, TIMELY, SECURE, OR ERROR-FREE, (iii) THE RESULTS THAT MAY BE OBTAINED FROM THE USE OF THE WC DATA WILL BE ACCURATE OR RELIABLE, OR (iv) ANY ERRORS OR BUGS IN THE WC DATA WILL BE CORRECTED. ACCORDINGLY, THE WEATHER CHANNEL SHALL NOT BE RESPONSIBLE OR LIABLE FOR THE ACCURACY, USEFULNESS OR AVAILABILITY OF THE WC DATA.

**LIMITATION OF LIABILITY.**

YOU EXPRESSLY UNDERSTAND AND AGREE THAT THE WEATHER CHANNEL, ITS SUPPLIERS, ITS LICENSORS AND ITS AFFILIATE COMPANIES SHALL NOT BE LIABLE, UNDER ANY LEGAL THEORY, INCLUDING CONTRACT, TORT, NEGLIGENCE OR STRICT LIABILITY, FOR ANY DIRECT, INDIRECT, INCIDENTAL, SPECIAL, PUNITIVE, CONSEQUENTIAL OR EXEMPLARY DAMAGES, INCLUDING BUT NOT LIMITED TO, DAMAGES FOR LOSS OF PROFITS, GOODWILL, USE, DATA OR OTHER INTANGIBLE LOSSES (EVEN IF THE WEATHER CHANNEL HAS BEEN ADVISED OF THE POSSIBILITY OF SUCH DAMAGES), RESULTING FROM OR ARISING OUT OF YOUR USE OF, OR YOUR INABILITY TO USE, THE WC DATA, THIS AGREEMENT, OR ANY OTHER MATTER RELATING TO THE WC DATA. YOUR SOLE AND EXCLUSIVE REMEDY FOR ANY DISPUTE WITH THE WEATHER CHANNEL RELATED TO THE WC DATA OR CONTENT SHALL BE CANCELLATION OF RECEIPT OF THE WC DATA. SOME JURISDICTIONS DO NOT ALLOW THE EXCLUSION OF CERTAIN WARRANTIES OR THE LIMITATION OR EXCLUSION OF LIABILITY FOR INCIDENTAL OR CONSEQUENTIAL DAMAGES. ACCORDINGLY, SOME OF THE ABOVE LIMITATIONS MAY NOT APPLY TO YOU.

## USB photo

Connecting a USB memory device enables you to enjoy photo on the Lexus Display Audio display.

### USB photo screen

Go to "USB Photo":  → "Info" → "USB1 Photo" or "USB2 Photo"

### Connecting a USB memory device

→P. 334

### Menu screen

Move the controller to the left to display the menu screen.

- ① Change the full screen mode.
- ② Select to set the slide show display on/off.  
Start the slide show at a selected folder.
- ③ Change the play speed.
- ④ Change the play mode.



### Selecting a folder and a file

- 1 Move the controller to the right and select "Browse".
- 2 Select the desired folder, and then select a desired file to begin using the selected folder.

■ **USB memory functions**

→P. 369

■ **USB memory**

● **Compatible devices**

USB memory device that can be used for JPEG display.

● **Compatible device formats**

The following device format can be used:

- USB communication format: USB2.0 HS (480 Mbps) and FS (12 Mbps)
- File system format: FAT16/32 (Windows)
- Correspondence class: Mass storage class

● **JPEG file compatibility**

- Compatible image size: Maximum 10MB
- Compatible pixel size: Maximum 10,000,000 pixels



**NOTICE**

■ **To prevent damage to the USB memory device or its terminals**

→P. 371



## Weather information

Weather information for the selected city is displayed.

Available when in weather supported HD Radio coverage area

### How to check the weather information

1 Go to "Weather":  → "Info" → "Weather"

2 Select the desired city/location.

- ① Current location of your car
- ② Select of the recently checked location list

Select the desired location on the recently checked location list.

③ Select of the National City list.

Select the region on the region list and then select the city on the National City list.

④ Select of the local location list

Select the location on the local location list.

3 Select the time

- ① Display the current weather information.
  - ② Display the 3 days weather information.
- You can display detail of a week, move the controller right and then select the desired week.
- ③ Display the 6/12 hour weather information.

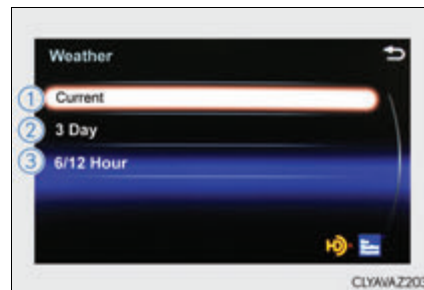
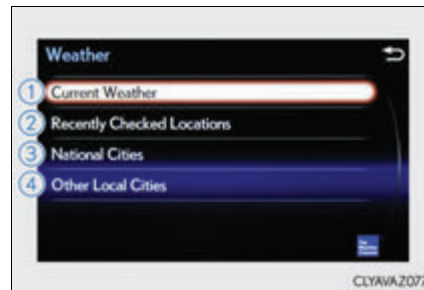

5

Lexus Display Audio system

## Voice command system

The voice command system enables the audio and hands-free systems to be operated using voice commands.

Operations of the voice command system can be performed by selecting the menu corresponding to each function on the right part of the screen. Even if any menu is selected, commands displayed on all menus can be operated.

### Using the voice command system

- 1 Press the talk switch.  
To cancel the voice command system, press and hold the talk switch.
- 2 After a beep sounds, say the desired command.  
On the list screen, you can select the desired command.

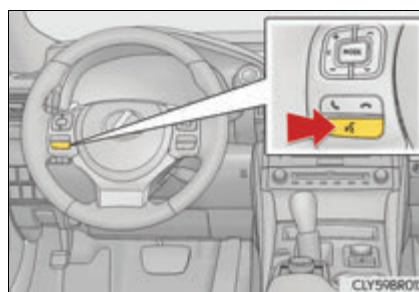

#### ■ Menu screen

To display the menu screen, move the controller to the left.

- ① Offer examples of commands and operation methods
- ② Adjust the settings for voice guidance volume and voice recognition prompts. ("Hints" screen) (→P. 340)
- ③ Start over voice recognition (except "Hints" screen)
- ④ Cancel voice recognition

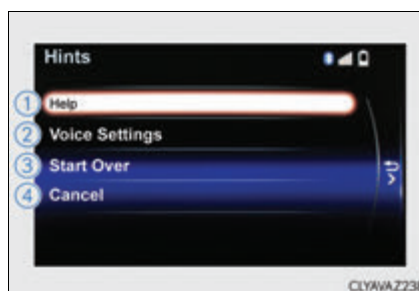

#### ■ Microphone

→P. 384

#### ■ When using the microphone

- It is unnecessary to speak directly into the microphone when giving a command.
- Wait for the confirmation beep before speaking a command.

- Voice commands may not be recognized if:
  - Spoken too quickly.
  - Spoken at a low or high volume.
  - The roof or windows are open.
  - Passengers are talking while voice commands are spoken.
  - The air conditioning speed is set high.
  - The air conditioning vents are turned towards the microphone.
- In the following conditions, the system may not recognize the command properly and using voice commands may not be possible:
  - The command is incorrect or unclear. Note that certain words, accents or speech patterns may be difficult for the system to recognize.
  - There is excessive background noise, such as wind noise.
- **When searching for a track**
  - A USB memory or iPod must be connected to enable track searching and playback. (→P. 334)
  - When a USB memory or iPod is connected, recognition data is created so tracks can be searched using voice commands.
  - Recognition data is updated under the following conditions:
    - When the USB memory or iPod data has changed.
    - When the voice recognition language is changed. (→P. 337)
  - While the recognition data is being created or being updated, a track search cannot be performed using a voice command.
- **The Gracenote® media database**  
→P. 361

### Casual speech recognition

Due to natural language speech recognition technology, this system enables recognition of a command when spoken naturally. However, the system cannot recognize every variation of each command.

In some situations, it is possible to omit the command for the procedure and directly state the desired operation.

This function is available in English, Spanish and French.

■ Expression examples for each function

| Command              | Expression examples   |
|----------------------|---|
| "Call <name> <type>" | Get me <Robert Brown>.<br>I need to call <Robert Brown> at <Work> right away. |
| "Dial <number>"      | Please dial the number <3334445555>.<br>Ring <3334445555>.                    |
| "Play Artist <name>" | Play the artist <XXXXX>.<br>I'd like to hear the band <XXXXX>.*               |
| "Play Album <name>"  | Play album <XXXXX>.<br>Music from album <XXXXX>.*                             |

\*: Say the desired artist name or album name in the place of the "<>".

**Command list**

Some recognizable voice commands and their actions are shown below as examples.

► Basic

| Command       | Action  |
|---------------|---|
| "Help"        | Prompts voice guidance to offer examples of commands or operation methods |
| "Go Back"     | Returns to the previous screen  |
| "Go to <tab>" | Displays the command list of the selected tab                             |

## ▶ Phone

| Command                         | Action   |
|---------------------------------|--|
| "Redial"                        | Places a call to the phone number of the latest outgoing call          |
| "Call Back"                     | Places a call to the phone number of latest incoming call              |
| "Show Recent Calls"             | Displays the call history screen                                       |
| "Dial <phone number>"           | Places a call to the said phone number                                 |
| "Call <contacts> <phone-types>" | Place a call to the said phone type of the contact from the phone book |

## ▶ Audio

| Command                     | Action                                  |
|-----------------------------|---|
| "Play Playlist <playlists>" | Plays tracks from the selected playlist |
| "Play Artist <artist>"      | Plays tracks from the selected artist   |
| "Play Song <songs>"         | Plays the selected track                |
| "Play Album <albums>"       | Plays tracks from the selected album    |
| "Turn Music On/Off"         | Turns the audio system on/off           |
| Audio source name           | Selects audio source                    |

## ▶ Info

| Command         | Action                       |
|-----------------|------------------------------|
| "Show Forecast" | Displays weather information |
| "Show Traffic"  | Displays traffic information |



## Interior features

## 6

- |   |   |
|---|---|
| <p><b>6-1. Using the air conditioning system</b></p> <p>Automatic air conditioning system .....420</p> <p>Heated steering wheel/ seat heaters/ seat ventilators..... 429</p> <p><b>6-2. Using the interior lights</b></p> <p>Interior lights list.....432</p> <ul style="list-style-type: none"> <li>• Interior lights .....433</li> <li>• Personal lights.....434</li> </ul> <p><b>6-3. Using the storage features</b></p> <p>List of storage features.....435</p> <ul style="list-style-type: none"> <li>• Glove box.....436</li> <li>• Console box.....436</li> <li>• Cup holders.....437</li> </ul> <p>Trunk features ..... 438</p> | <p><b>6-4. Using the other interior features</b></p> <p>Other interior features .....439</p> <ul style="list-style-type: none"> <li>• Sun visors .....439</li> <li>• Vanity mirrors .....439</li> <li>• Clock .....440</li> <li>• Power outlet .....440</li> <li>• Armrest.....441</li> <li>• Trunk storage extension ..... 442</li> <li>• Assist grips.....443</li> <li>• Coat hooks.....443</li> </ul> <p>Garage door opener.....444</p> <p>Compass .....451</p> <p>LEXUS Enform Safety Connect.....455</p> <p>LEXUS Enform Remote .....460</p> <p>LEXUS Enform Service Connect.....461</p> |
|---|---|

## Automatic air conditioning system

Air outlets and fan speed are automatically adjusted according to the temperature setting.

Vehicles with a Lexus Display Audio system: Press the "MENU" button on the Lexus Display Audio controller, then select "Climate" to display the air conditioning operation screen.

For details on the Lexus Display Audio controller, refer to "Lexus Display Audio controller" on P.328.

Vehicles with a navigation system: Press the "MENU" button on the Remote Touch, then select "Climate" to display the air conditioning control screen.

For details on the Remote Touch, refer to the "NAVIGATION SYSTEM OWNER'S MANUAL".

## Air conditioning controls

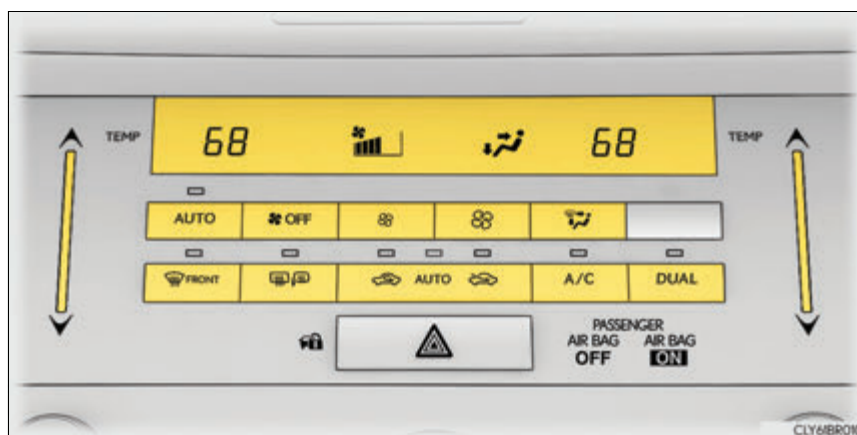



### ■ Adjusting the temperature setting

To adjust the temperature setting, touch and slide your finger up or down on the sensor.

The temperature setting can also be adjusted by touching on the sensor.

When the temperature setting is changed, a buzzer sounds.

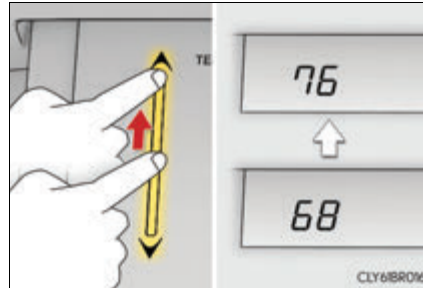

### ■ Fan speed setting

Press  to increase the fan speed.

Press  to decrease the fan speed.

### ■ Change the airflow mode

To change the airflow, press .

The air outlets used are switched each time the button is pressed.

- ① Air flows to the upper body.
- ② Air flows to the upper body and feet.
- ③ Air flows to the feet.
- ④ Air flows to the feet and the windshield defogger operates.

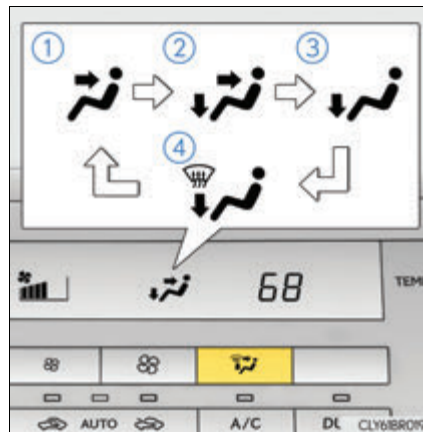

### ■ Other functions

- Switching between outside air and recirculated air modes (→P. 424)
- Defogging the windshield (→P. 424)
- Defogging the rear window and outside rear view mirrors (→P. 424)

### Air conditioning control screen

▶ With a Lexus Display Audio

- ① Adjust the left-hand side temperature setting.
- ② Adjust the fan speed setting
- ③ Select to set automatic mode on/off, fan off and displaying the option control screen (→P. 423)
- ④ Select the air flow mode



- ⑤ Adjust the right-hand side temperature setting
- 1 Move the Lexus Display Audio controller left/right to select the desired item (① to ⑤).
- 2 When ①, ② or ⑤ is selected:  
Move the controller forward/backward or turn it left/right for adjusting.
- When ③ or ④ is selected:  
Move the controller forward/backward or turn it left/right to select a screen button, then press the controller.

▶ With a navigation system

- ① Adjust the left-hand side temperature setting
- ② Adjust the fan speed setting
- ③ Select the air flow mode
- ④ Adjust the right-hand side temperature setting
- ⑤ Display the option control screen (→P. 423)
- ⑥ Turn the fan off
- ⑦ Select to set automatic mode on/off



Using the Remote Touch, select the button on the screen and activate it by pressing on or double tapping the Remote Touch Pad.



### ■ Option control screen

The functions can be switched on and off.

- ① Cooling and dehumidification function
- ② Adjusting the temperature for driver and passenger seats separately ("DUAL" mode) (→P. 423)
- ③ Removing pollen from the air (Micro dust and pollen filter) (→P. 424)



### Using automatic mode

- 1 Press , or select "AUTO" on the air conditioning control screen.
- 2 Press  to switch to automatic air intake mode.  
The air conditioning system automatically switches between outside air and recirculated air modes.
- 3 Adjust the temperature setting.
- 4 To stop the operation, press  or select "OFF" on the air conditioning control screen.

### ■ Automatic mode indicator

If the fan speed setting or air flow modes are operated, the automatic mode indicator goes off. However, automatic mode for functions other than that operated is maintained.

### ■ Adjusting the temperature for driver and passenger seats separately ("DUAL" mode)

To turn on the "DUAL" mode, perform any of the following procedures:

- Press .
- Select "DUAL" on the option control screen.
- Adjust the passenger's side temperature setting.



The indicator comes on when the "DUAL" mode is on.

While in "DUAL" mode, the temperature of the rear air outlets is set at the right-hand side temperature setting.

### Other functions

#### ■ Switching between outside air and recirculated air modes

Press .

The mode switches among  (recirculated air mode), automatic and  (outside air mode) modes each time the button is pressed.

When the system is switched to automatic mode, the air conditioning system operates automatically.

The indicator above the selected button comes on.

#### ■ Micro dust and pollen filter

Pollen is removed from the air and the air flows to the upper part of the body.

Select  on the option control screen.

When the micro dust and pollen filter is on,  is displayed on the air conditioning control screen.

In order to prevent the windshield from fogging up when the outside air is cold, the dehumidification function may operate.

Pollen is filtered even if the micro dust and pollen filter is turned off.

#### ■ Defogging the windshield

Defoggers are used to defog the windshield and side windows.

Press .

Set the outside/recirculated air mode button to outside air mode if the recirculated air mode is used. (It may switch automatically.)

To defog the windshield and the side windows early, turn the air flow and temperature up.

To return to the previous mode, press  again when the windshield is defogged.

#### ■ Defogging the rear window and outside rear view mirrors

Defoggers are used to defog the rear window, and to remove raindrops, dew and frost from the outside rear view mirrors.

Press .

The defoggers will automatically turn off after a period of time.

### ■ Windshield wiper de-icer (if equipped)

This feature is used to prevent ice from building up on the windshield and wiper blades.

Turns on/off.

The indicator comes on when the windshield wiper de-icer is on.

The windshield de-icer will automatically turn off after a period of time.

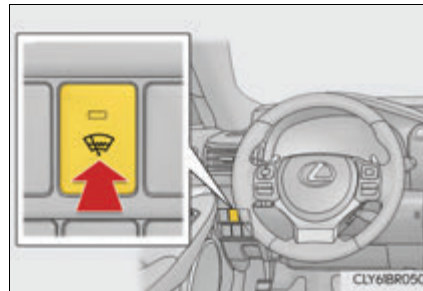

## Air outlets

### ■ Location of air outlets

The air outlets and air volume changes according to the selected airflow mode.

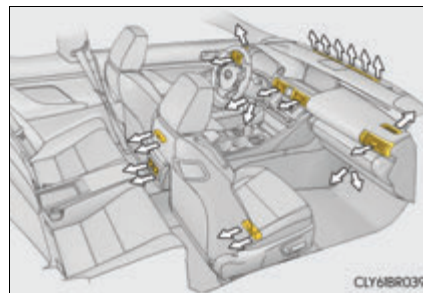

### ■ Adjusting the position of and opening and closing the air outlets

▶ Front

▶ Rear

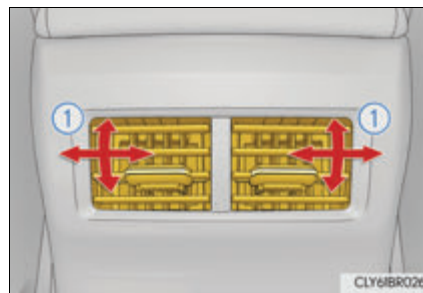
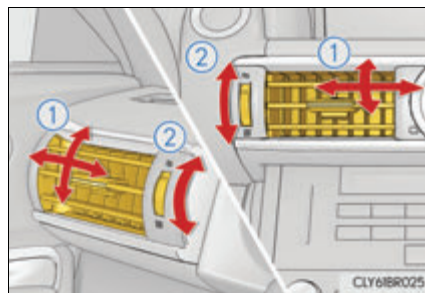

- ① Direct air flow to the left or right, up or down  
To close the vent, move the knob to the most outside position. (rear outlets only)
- ② Turn the knob to open or close the vent

■ **Registering air conditioning settings to electronic keys (vehicles with driving position memory)**

- Unlocking the vehicle using an electronic key and turning the engine switch to IGNITION ON mode will recall that key's registered air conditioning settings.
- When the engine switch is turned off, the current air conditioning settings will automatically be registered to the electronic key that was used to unlock the vehicle.
- The system may not operate correctly if more than one electronic key is in the vicinity or if the smart access system with push-button start is used to unlock a passenger door.
- The doors that can recall the air conditioning setting\* when unlocked using the smart access system with push-button start can be changed. For details, contact your Lexus dealer.

\*: The doors that can recall the driving position memory are changed at the same time.

■ **Using automatic mode**

Fan speed is adjusted automatically according to the temperature setting and the ambient conditions.

Therefore, the fan may stop for a while until warm or cool air is ready to flow immediately after  is pressed or "AUTO" is selected.

■ **Using the voice command system (vehicles with a navigation system)**

Air conditioning system can be operated using voice commands. For details, refer to the "NAVIGATION SYSTEM OWNER'S MANUAL".

■ **Fogging up of the windows**

The windows will easily fog up when the humidity in the vehicle is high. Turning  ("A/C") on will dehumidify the air from the outlets and defog the windshield effectively.

- If you turn  ("A/C") off, the windows may fog up more easily.
- The windows may fog up if the recirculated air mode is used.

■ **Outside/recirculated air mode**

- When driving on dusty roads such as tunnels or in heavy traffic, set the outside/recirculated air mode button to the recirculated air mode. This is effective in preventing outside air from entering the vehicle interior. During cooling operation, setting the recirculated air mode will also cool the vehicle interior effectively.
- Outside/recirculated air mode may automatically switch depending on the temperature setting or the inside temperature.

■ **When the outside temperature exceeds 75°F (24°C) and the air conditioning system is on**

- In order to reduce the air conditioning power consumption, the air conditioning system may switch to recirculated air mode automatically. This may also reduce fuel consumption.
- Recirculated air mode is selected as a default mode when the engine switch is turned to IGNITION ON mode.
- It is possible to switch to outside air mode at any time by pressing .

**■ Automatic mode for air intake control**

In automatic mode, the system detects exhaust gas and other pollutants and automatically switches between outside air and recirculated air modes.

When the dehumidification function is off, and the fan is operating, turning automatic mode on will activate the dehumidification function.

**■ Operation of the air conditioning system in Eco drive mode**

In Eco drive mode, the air conditioning system is controlled as follows to prioritize fuel efficiency:

- Engine speed and compressor operation controlled to restrict heating/cooling capacity
- Fan speed restricted when automatic mode is selected

To improve air conditioning performance, perform the following operations:

- Adjust the fan speed
- Turn off Eco drive mode

**■ When the outside temperature falls to nearly 32°F (0°C)**

The dehumidification function may not operate even when  is pressed or "A/C" is selected.

**■ Ventilation and air conditioning odors**

- To let fresh air in, set the air conditioning system to the outside air mode.
- During use, various odors from inside and outside the vehicle may enter into and accumulate in the air conditioning system. This may then cause odor to be emitted from the vents.
- To reduce potential odors from occurring:
  - It is recommended that the air conditioning system be set to outside air mode prior to turning the vehicle off.
  - The start timing of the blower may be delayed for a short period of time immediately after the air conditioning system is started in automatic mode.

**■ Air conditioning filter**

→P. 515

**■ Customization**

Settings (e.g. A/C Auto switch operation) can be changed.  
(Customizable features →P. 659)

**⚠ WARNING****■ To prevent the windshield from fogging up**

- Do not use  during cool air operation in extremely humid weather. The difference between the temperature of the outside air and that of the windshield can cause the outer surface of the windshield to fog up, blocking your vision.
- Do not place anything on the instrument panel which may cover the air outlets. Otherwise, air flow may be obstructed, preventing the windshield defoggers from defogging.

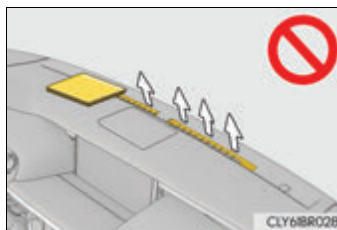
**■ To prevent burns**

- Do not touch the rear view mirror surfaces when the outside rear view mirror defoggers are on.
- Do not touch the glass at lower part of the windshield or to the side of the front pillars when the windshield wiper de-icer is on.

**⚠ NOTICE****■ To prevent battery discharge**

Do not leave the air conditioning system on longer than necessary when the engine is stopped.



## Heated steering wheel\*/seat heaters\*/seat ventilators\*

Heated steering wheel and seat heaters heat the side grips of the steering wheel and seats, respectively. Seat ventilators maintain good airflow by blowing air from the seats.

### WARNING

- Care should be taken to prevent injury if anyone in the following categories comes in contact with the steering wheel or seats when the heater is on:
  - Babies, small children, the elderly, the sick and the physically challenged
  - Persons with sensitive skin
  - Persons who are fatigued
  - Persons who have taken alcohol or drugs that induce sleep (sleeping drugs, cold remedies, etc.)
- Observe the following precautions to prevent the minor burns or overheating
  - Do not cover the seat with a blanket or cushion when using the seat heater.
  - Do not use seat heater more than necessary.

### NOTICE

- Do not put heavy objects that have an uneven surface on the seat and do not stick sharp objects (needles, nails, etc.) into the seat.
- To prevent battery discharge, do not use the functions when the engine is off.

### Heated steering wheel

Turn the heated steering wheel on/off

The indicator light comes on when the heated steering wheel is operating.



6

Interior features

\*: If equipped

- The heated steering wheel can be used when the engine switch is in IGNITION ON mode.
- The heated steering wheel will automatically turn off after about 30 minutes.

### Seat heaters

Each time the switch is pressed, the intensity of the seat heater changes and the level indicator lights (amber) light as follows:

Hi (3 segments lit) → Mid (2 segments lit) → Lo (1 segment lit) → Off

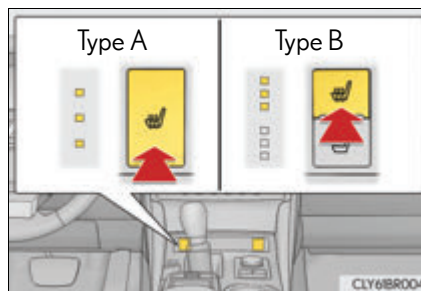

- **The seat heaters can be used when**  
The engine switch is in IGNITION ON mode.

- **Seat heater timer control**

To enable seat heater timer control, press and hold the driver and front passenger seat heater switches at the same time when the vehicle is stopped until a buzzer sounds once. If a seat heater is turned on while seat heater timer control is enabled, the intensity of the seat heater will automatically change from Hi→Mid→Lo.

The timing of the change in seat heater intensity differs depending on the temperature inside the cabin, etc. when the seat heater is operating.

To disable seat heater timer control, press and hold the driver and front passenger seat heater switches at the same time until a buzzer sounds twice.

### Seat ventilators

Each time the switch is pressed, the intensity of the seat ventilator changes and the level indicator lights (green) light as follows:

Hi (3 segments lit) → Mid (2 segments lit) → Lo (1 segment lit) → Off

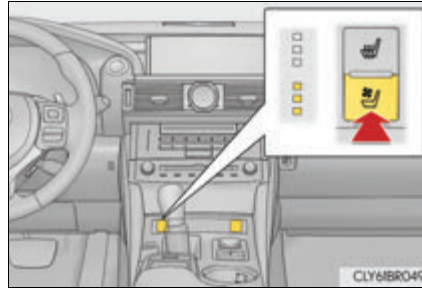

- **The seat ventilators can be used when**  
The engine switch is in IGNITION ON mode.

## Interior lights list

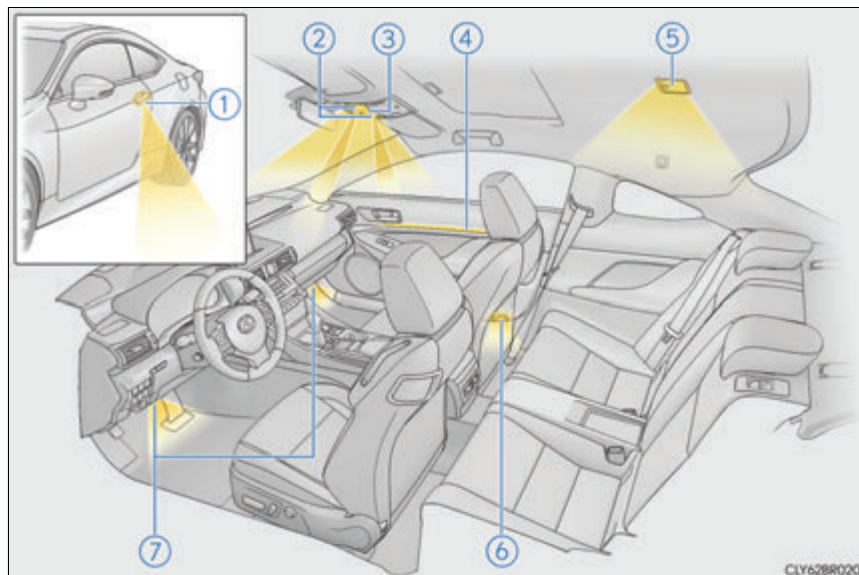

- ① Outer foot lights
- ② Personal lights (→P. 434)
- ③ Front interior light (→P. 433)
- ④ Ambient lights
- ⑤ Rear interior light (→P. 433)
- ⑥ Door courtesy lights
- ⑦ Footwell lights

### Interior lights

The rear interior light turns on/off together with the front interior light.

► Front

Turns the light on/off (touch the light)

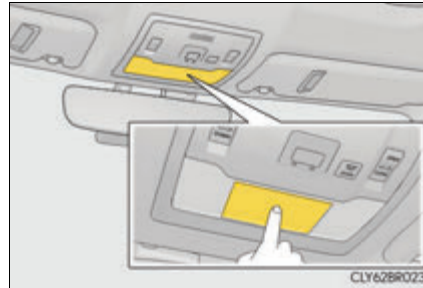

Turns the door position on/off

- ① On
- ② Off

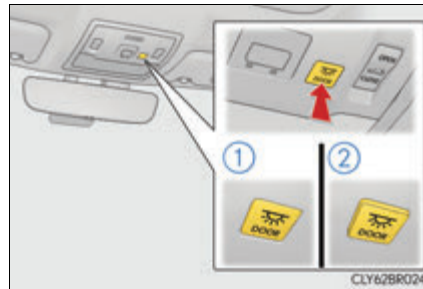

► Rear

Turns the light on/off

If the front interior light is off, the rear light can be turned on/off separately.

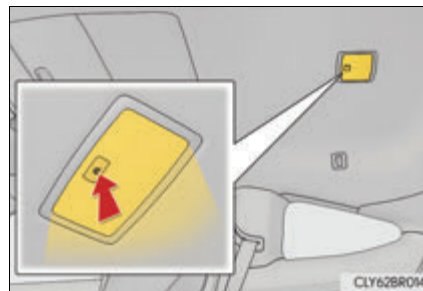

### Personal lights

Turns the lights on/off (touch the lights)

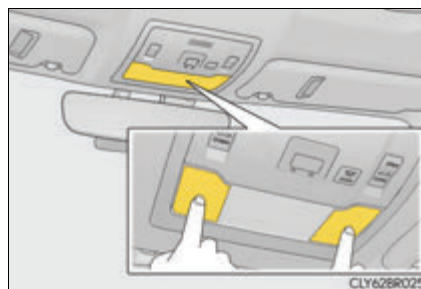

- Illuminated entry system: The lights automatically turn on/off according to engine switch mode, the presence of the electronic key, whether the doors are locked/unlocked, and whether the doors are opened/closed.
- If the interior lights remain on when the engine switch is turned off, the lights will go off automatically after 20 minutes.
- In the following cases, the front interior lights and personal lights may not respond as normal.
  - When water, dirt, etc., have adhered to the lens surface
  - When operated with a wet hand
  - When wearing gloves, etc.
- Setting (e.g. the time elapsed before lights turn off) can be changed. (Customizable features: →P. 660)

#### NOTICE

- Never remove the lens for the front interior light and personal lights. Otherwise, the lights will be damaged.
- To prevent battery discharge, do not leave the lights on longer than necessary when the engine is off.

## List of storage features

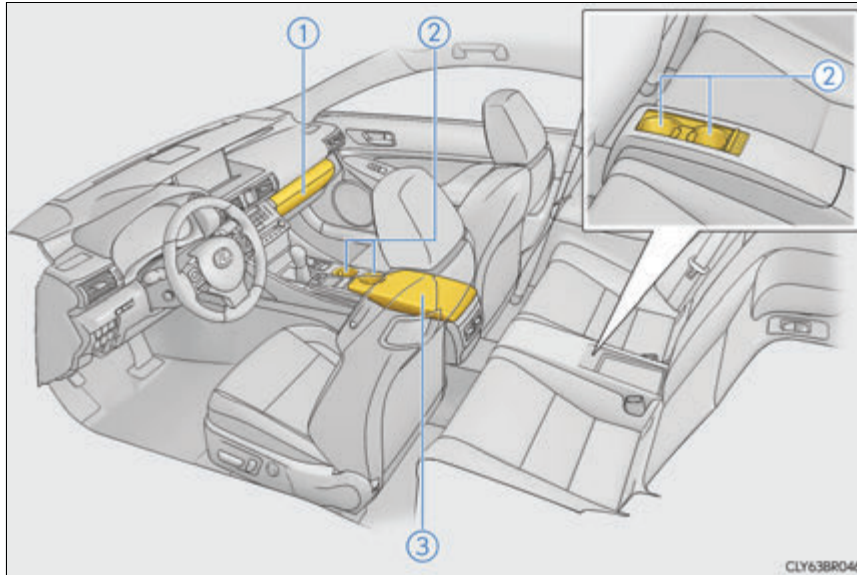

- ① Glove box (→P. 436)      ③ Console box (→P. 436)  
 ② Cup holders (if equipped)  
 (→P. 437)

### ⚠ WARNING

- Do not leave glasses, lighters or spray cans in the storage spaces, as this may cause the following when cabin temperature becomes high:
  - Glasses may be deformed by heat or cracked if they come into contact with other stored items.
  - Lighters or spray cans may explode. If they come into contact with other stored items, the lighter may catch fire or the spray can may release gas, causing a fire hazard.
- When driving or when the storage compartments are not in use, keep the lids closed. In the event of sudden braking or sudden swerving, an accident may occur due to an occupant being struck by an open lid or the items stored inside.

### Glove box

- ① Open (press the button)
- ② Unlock with the mechanical key
- ③ Lock with the mechanical key

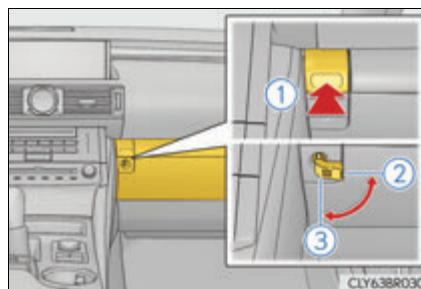

- The glove box light turns on when the engine switch is in ACCESSORY or IGNITION ON mode.
- The trunk opener main switch is located in the glove box. (→P.144)
- The insert inside the glove box can be removed.

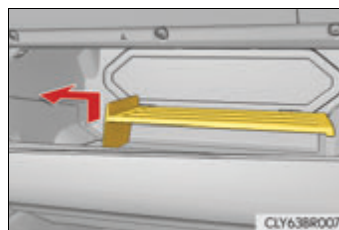

### Console box

Push the knob.

Lift by hand to fully open the console box.

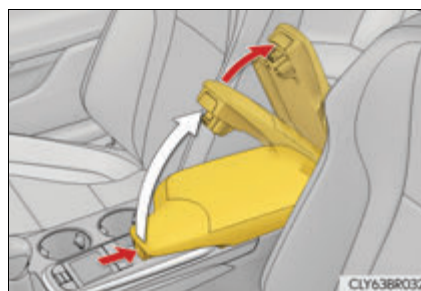



## Cup holders

### ▶ Front

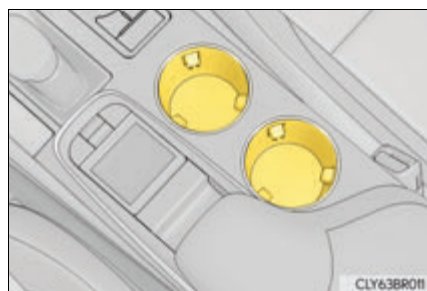

### ▶ Rear (RC F)

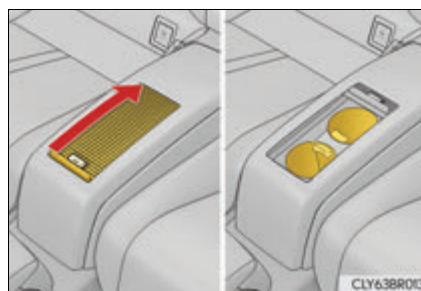

- Rear cup holder insert can be removed.



- The rubber mats at the bottom of the front cup holders can be removed.

### ⚠ WARNING

#### ■ Items unsuitable for the cup holder

Do not place anything other than cups or aluminum cans in the cup holders. Other items may be thrown out of the holders in the event of an accident or sudden braking, causing injury. If possible, cover hot drinks to prevent burns.

#### ■ When not in use (rear)

Keep the cup holders closed. In the event of sudden braking, an accident may occur due to an occupant being struck by the items stored inside.

## Trunk features

### Cargo hooks

Raise the hooks when needed.

The cargo hooks are provided for securing loose items.

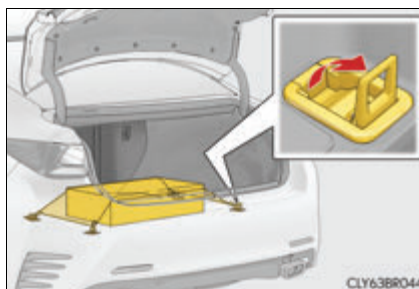

### ⚠ WARNING

To avoid injury, always return the cargo hooks to their stowed positions when not in use.

### First-aid kit storage belt

- ① Loosen the belt
- ② Tighten the belt

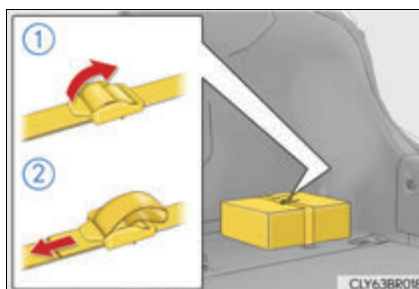

## Other interior features

### Sun visors

- ① To set the visor in the forward position, flip it down.
- ② To set the visor in the side position, flip down, unhook, and swing it to the side.
- ③ To use the side extender, place the visor in the side position, then slide it backward.

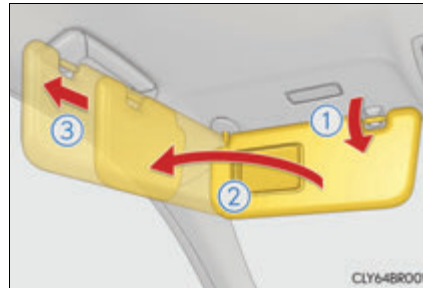

### Vanity mirrors

Slide the cover to open.

The light turns on when the cover is opened.

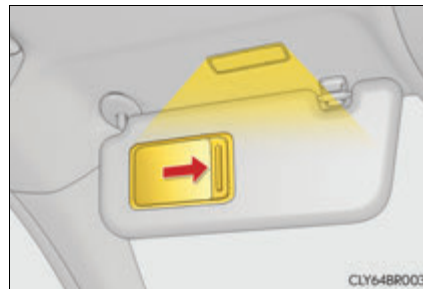

If the vanity lights remain on when the engine switch is turned off, the lights will go off automatically after 20 minutes.

#### NOTICE

To prevent battery discharge, do not leave the lights on longer than necessary when the engine is off.

### Clock

The clock can be adjusted.

- ① Pressing and holding will move the clock hands backward.
- ② Pressing and holding will move the clock hands forward.

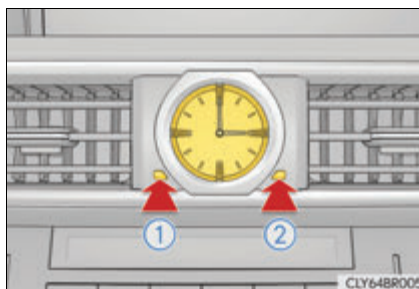

### Power outlet

Please use as a power supply for electronic goods that use less than 12 VDC/10 A (power consumption of 120 W).

Open the lid.



- The power outlet can be used when the engine switch is in ACCESSORY or IGNITION ON mode.
- The shape of the console box rim allows power cables to be passed through when the console box lid is closed.

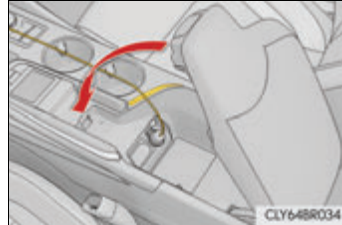

 NOTICE

- To avoid damaging the power outlet, close the power outlet lid when the power outlet is not in use. Foreign objects or liquids that enter the power outlet may cause a short circuit.
- To prevent battery discharge, do not use the power outlet longer than necessary when the engine is off.

### Armrest (RC F)

Fold down the armrest for use.

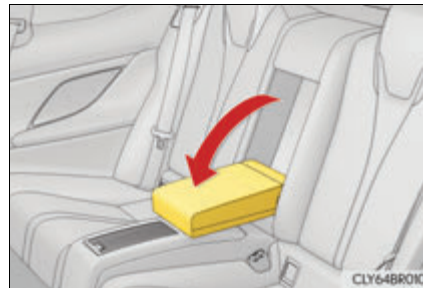

 NOTICE

To prevent damage to the armrest, do not apply too much load on the armrest.

### Trunk storage extension (RC F)

Long objects can be loaded in the vehicle by utilizing the trunk space and rear seat area.

- 1 Pull down the armrest.

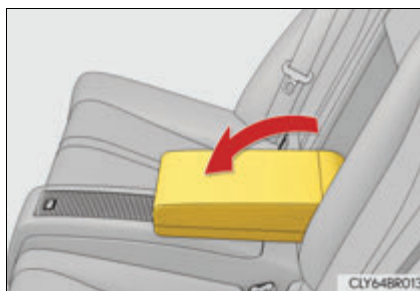

- 2 Separate the fastener and turn back the trunk door cover.

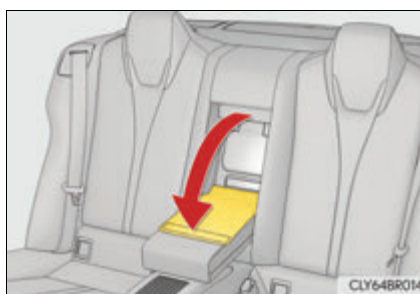

- 3 Open the inside trunk door from the trunk and load baggage or other items.

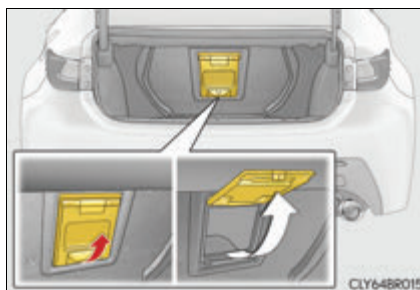

#### WARNING

##### ■ When not in use

Ensure that the inside trunk door is closed.  
In the event of sudden braking, items stored in the trunk may be thrown forward into the cabin, resulting in injury.

### Assist grips

An assist grip installed on the ceiling can be used to support your body while sitting on the seat.



#### WARNING

Do not use the assist grip when getting in or out of the vehicle or rising from your seat.

#### NOTICE

To prevent damage to the assist grip, do not put a heavy load on the assist grip.

### Coat hooks

To use the coat hook, push it in.

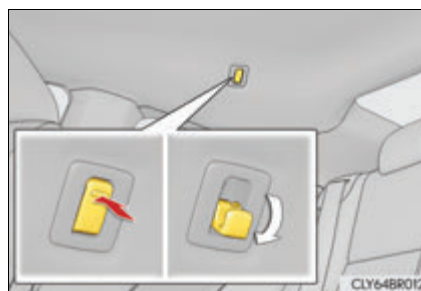

#### WARNING

Do not hang coat hangers or other hard or sharp objects on the hook. If the SRS curtain shield airbags deploy, these items may become projectiles, causing death or serious injury.

## Garage door opener

The garage door opener can be programmed to operate garage doors, gates, entry doors, door locks, home lighting systems, security systems, and other devices.

### Programming the HomeLink®

The HomeLink® wireless control system in your vehicle has 3 buttons which can be programmed to operate 3 different devices. Refer to the programming methods on the following pages to determine the method which is appropriate for the device.

- ① HomeLink® indicator light
- ② Garage door operation indicators
- ③ HomeLink® icon  
Illuminates while HomeLink® is operating.
- ④ Buttons

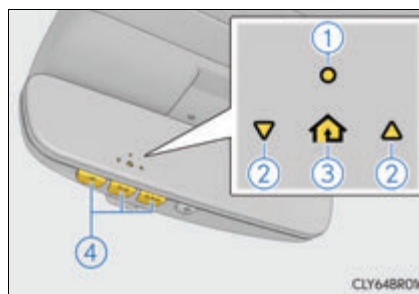

#### ■ Before programming HomeLink®

- During programming, it is possible that garage doors, gates, or other devices may operate. For this reason, make sure that people and objects are clear of the garage door or other devices to prevent injury or other potential harm.
- It is recommended that a new battery be placed in the remote control transmitter for more accurate programming.
- Garage door opener motors manufactured after 1995 may be equipped with rolling code protection. If this is the case, you may need a stepladder or other sturdy, safe device to reach the “Learn” or “Smart” button on the garage door opener motor.



### ■ Programming HomeLink®

- 1 Press and release the HomeLink® button you want to program and check that the HomeLink® indicator light flashes (orange).

Perform 3 within 60 seconds of 1, or the indicator light will stop flashing and programming will not be able to be completed.

- 2 Point the remote control transmitter for the device at the rear view mirror, 1 to 3 in. (25 to 75 mm) from the HomeLink® buttons.

Keep the HomeLink® indicator light in view while programming.

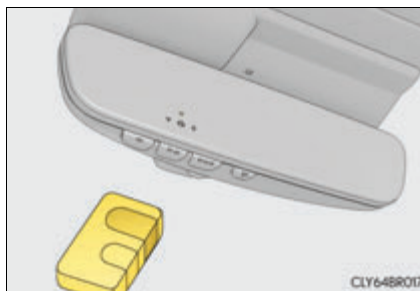

► For U.S.A. owners

- 3 Press and hold the handheld transmitter button until the HomeLink® indicator light changes from slowly flashing orange to rapidly flashing green (rolling code) or continuously lit green (fixed code), then release the button.

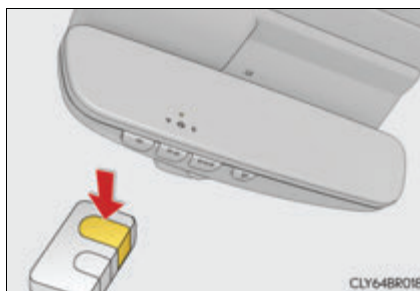

► Programming an entry gate (for U.S.A. owners)/Programming a device in the Canadian market

- 3 Press and release the remote control transmitter button at 2 second intervals, repeatedly, until the HomeLink® indicator light changes from slowly flashing (orange) to rapidly flashing (green) (rolling code) or continuously lit (green) (fixed code).

- 4 Test the HomeLink® operation by pressing the newly programmed button and observing the indicator light:

- Device with fixed code: If the indicator light is solid/continuous, programming has been completed and your garage door or other device should operate when the HomeLink® button is pressed and released.
- Device with rolling code: If the indicator light flashes rapidly, your garage door opener motor (or other device) is equipped with a rolling code. Complete the programming process by firmly pressing and holding the programmed HomeLink® button for 2 seconds and then release the button.

- If the garage door or other device does not operate, proceed to “Programming a rolling code system”.

- 5 Repeat the steps above to program another device for any of the remaining HomeLink® buttons.

#### ■ Programming a rolling code system

- 1 Locate the “Learn” or “Smart” button on the garage door opener motor in the garage.

This button can usually be found where the hanging antenna wire is attached to the unit. The name and color of the button may vary by manufacturer. Refer to the owner’s manual supplied with the garage door opener motor for details.

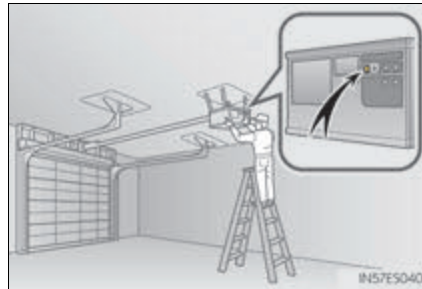

- 2 Press and release the “Learn” or “Smart” button. Perform 3 within 30 seconds after performing 2.

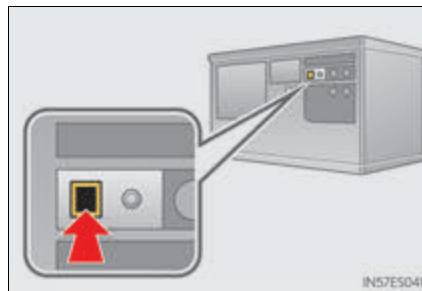

- 3 Press and hold the desired HomeLink® button (inside the vehicle) for 2 seconds and release it. Repeat this sequence (press/hold/release) up to 3 times to complete programming.

If the garage door opener motor operates when the HomeLink® button is pressed, the garage door opener motor recognizes the HomeLink® signal.

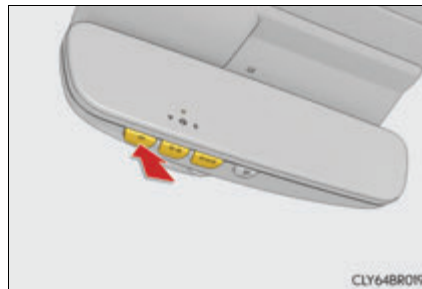

### ■ Enabling 2-way communication with a garage door (only available for compatible devices)

When enabled, 2-way communication allows you to check the status of the opening and closing of a garage door through indicators in your vehicle.

2-way communication is only available if the garage door opener motor used is a compatible device. (To check device compatibility, refer to [www.HomeLink.com](http://www.HomeLink.com).)

- 1 Within 5 seconds after programming the garage door opener has been completed, if the garage door opener motor is trained to HomeLink<sup>®</sup>, both garage door operation indicators will flash rapidly (green) and the light on the garage door opener motor will blink twice, indicating that 2-way communication is enabled.

If the indicators do not flash, perform **2** and **3** within the first 10 presses of the HomeLink<sup>®</sup> button after programming has been completed.

- 2 Press a programmed HomeLink<sup>®</sup> button to operate a garage door.
- 3 Within 1 minute of pressing the HomeLink<sup>®</sup> button, after the garage door operation has stopped, press the "Learn" or "Smart" button on the garage door opener motor. Within 5 seconds of the establishment of 2-way communication with the garage door opener, both garage door operation indicators in the vehicle will flash rapidly (green) and the light on the garage door opener motor will blink twice, indicating that 2-way communication is enabled.

### ■ Reprogramming a single HomeLink<sup>®</sup> button

When the following procedure is performed, buttons which already have devices registered to them can be overwritten:

- 1 With one hand, press and hold the desired HomeLink<sup>®</sup> button.
- 2 When the HomeLink<sup>®</sup> indicator starts flashing (orange), continue to hold the HomeLink<sup>®</sup> button and perform "Programming HomeLink<sup>®</sup>" **1** (it takes 20 seconds for the HomeLink<sup>®</sup> indicator to start flashing).

### Operating HomeLink®

Press the appropriate HomeLink® button. The HomeLink® indicator light should turn on.

### Garage door operation indicators

The status of the opening and closing of a garage door is shown by the indicators.

- ① Opening
- ② Closing

This function is only available if the garage door opener motor used is a compatible device. (To check device compatibility, refer to [www.HomeLink.com](http://www.HomeLink.com).)



| Color             | Status                              |
|-------------------|-------------------------------------|
| Orange (flashing) | Currently opening/closing           |
| Green             | Opening/closing has completed       |
| Red (flashing)    | Feedback signals cannot be received |

The indicators can operate within approximately 820 ft. (250 m) of the garage door. However, if there are obstructions between the garage door and the vehicle, such as houses and trees, feedback signals from the garage door may not be received.

To recall the previous door operation status, press and release either

HomeLink® buttons  and  or  and  simultaneously.

The last recorded status will be displayed for 3 seconds.

### Erasing the entire HomeLink® memory (all three codes)

Press and hold the 2 outside buttons for 10 seconds until the HomeLink® indicator light changes from continuously lit (orange) to rapidly flashing (green).

If you sell your vehicle, be sure to erase the programs stored in the HomeLink® memory.



#### Codes stored in the HomeLink® memory

- The registered codes are not erased even if the battery cable is disconnected.
- If learning failed when registering a different code to a HomeLink® button that already has a code registered to it, the already registered code will not be erased.

#### Before programming

- Install a new battery in the transmitter.
- The battery side of the transmitter must be pointed away from the HomeLink®.

#### Certification for the garage door opener

- ▶ For vehicles sold in the U.S.A.

##### NOTE:

This device complies with part 15 of the FCC Rules. Operation is subject to the following two conditions: (1) This device may not cause harmful interference, and (2) this device must accept any interference received, including interference that may cause undesired operation.

##### FCC WARNING:

changes or modifications not expressly approved by the party responsible for compliance could void the user's authority to operate the equipment.

- ▶ For vehicles sold in Canada

##### NOTE:

This device complies with Industry Canada licence-exempt RSS standard(s). Operation is subject to the following two conditions: (1) this device may not cause interference, and (2) this device must accept any interference, including interference that may cause undesired operation of the device.

##### NOTE:

Le présent appareil est conforme aux CNR d'Industrie Canada applicables aux appareils radio exempts de licence. L'exploitation est autorisée aux deux conditions suivantes : (1) l'appareil ne doit pas produire de brouillage, et (2) l'utilisateur de l'appareil doit accepter tout brouillage radioélectrique subi, même si le brouillage est susceptible d'en compromettre le fonctionnement.

#### When support is necessary

Visit on the web at [www.homelink.com](http://www.homelink.com) or call 1-800-355-3515.

**⚠ WARNING****■ When programming a garage door or other remote control device**

The garage door or other device may operate, so ensure people and objects are out of danger to prevent potential harm.

**■ Conforming to federal safety standards**

Do not use the HomeLink<sup>®</sup> compatible transceiver with any garage door opener or device that lacks safety stop and reverse features as required by federal safety standards.

This includes any garage door that cannot detect an interfering object. A door or device without these features increases the risk of death or serious injury.

**■ When operating or programming HomeLink<sup>®</sup>**

Never allow a child to operate or play with the HomeLink<sup>®</sup> buttons.

## Compass\*

The compass on the inside rear view mirror indicates the direction in which the vehicle is heading.

### Operation

To turn the compass on or off, press and hold the switch for 3 seconds.

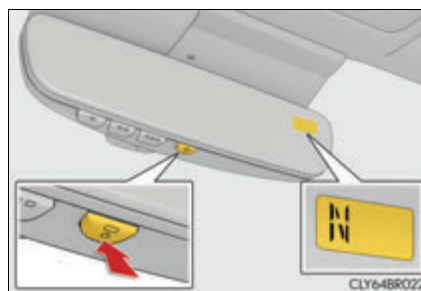

### Displays and directions

| Display | Direction |
|---------|-----------|
| N       | North     |
| NE      | Northeast |
| E       | East      |
| SE      | Southeast |
| S       | South     |
| SW      | Southwest |
| W       | West      |
| NW      | Northwest |

\*: If equipped

### Calibrating the compass

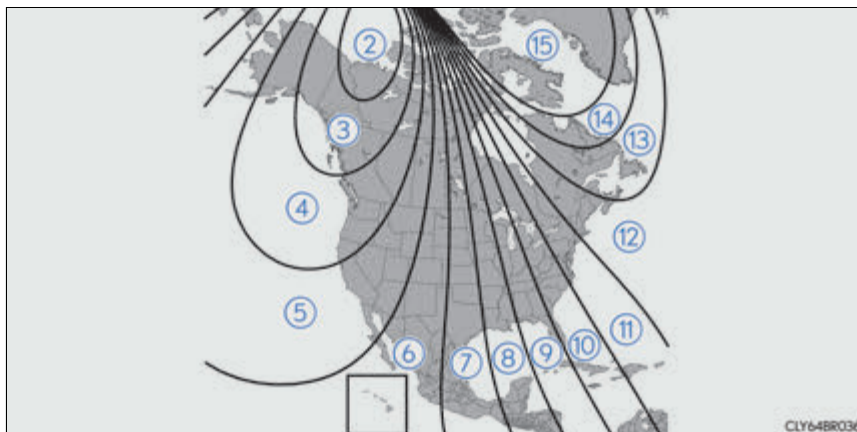

The direction display deviates from the true direction determined by the earth's magnetic field. The amount of deviation varies according to the geographic position of the vehicle.

If you cross over a map boundary shown in illustration, the compass will deviate.  
To obtain higher precision or perfect calibration, refer to the following.

#### ■ Deviation calibration

- 1 Stop the vehicle.
- 2 Press and hold the switch for 6 seconds.  
A number (1 to 15) appears on the compass display.

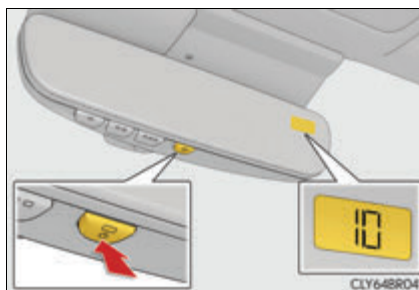

- 3 Press the switch and, referring to the map above, select the number of the zone where you are.  
If the direction is displayed several seconds after adjustment, the calibration is complete.



### ■ Circling calibration

- 1 Stop the vehicle in a place where it is safe to drive in a circle.
- 2 Press and hold the switch for 9 seconds.  
"C" appears on the compass display.

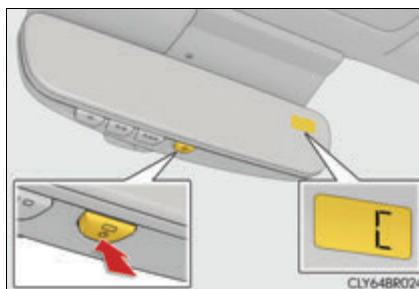

- 3 Drive the vehicle at 5 mph (8 km/h) or less in a circle until a direction is displayed.

If there is not enough space to drive in a circle, drive around the block until the direction is displayed.



### ■ Conditions unfavorable to correct operation

The compass may not show the correct direction in the following conditions:

- The vehicle is stopped immediately after turning.
- The vehicle is on an inclined surface.
- The vehicle is in a place where the earth's magnetic field is subject to interference by artificial magnetic fields (underground car park/parking lot, under a steel tower, between buildings, roof car park/parking lot, near an intersection, near a large vehicle, etc.).
- The vehicle has become magnetized.  
(There is a magnet or metal object near the inside rear view mirror.)
- The battery has been disconnected.
- A door is open.

### ⚠ WARNING

#### ■ While driving the vehicle

Do not adjust the display. Adjust the display only when the vehicle is stopped.

#### ■ When doing the circling calibration

Secure a wide space, and watch out for people and vehicles in the neighborhood. Do not violate any local traffic rules while performing circling calibration.

 NOTICE

■ **To avoid compass malfunctions**

Do not place magnets or any metal objects near the inside rear view mirror. Doing this may cause the compass sensor to malfunction.

■ **To ensure normal operation of the compass**

- Do not perform circling calibration of the compass in a place where the earth's magnetic field is subject to interference by artificial magnetic fields.
- During calibration, do not operate electric systems (moon roof, power windows, etc.) as they may interfere with the calibration.

## LEXUS Enform Safety Connect\*

Safety Connect is a subscription-based telematics service that uses Global Positioning System (GPS) data and embedded cellular technology to provide safety and security features to subscribers. Safety Connect is supported by Lexus' designated response center, which operates 24 hours per day, 7 days per week.

Safety Connect service is available by subscription on select, telematics hardware-equipped vehicles.

By using the Safety Connect service, you are agreeing to be bound by the Telematics Subscription Service Agreement and its Terms and Conditions, as in effect and amended from time to time, a current copy of which is available at Lexus.com. All use of the Safety Connect service is subject to such then-applicable Terms and Conditions.

### System components

- ① "SOS" button
- ② LED light indicators
- ③ Microphone

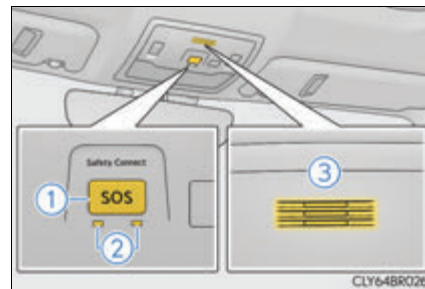

6

Interior features

\*: If equipped

### Services

Subscribers have the following Safety Connect services available:

- Automatic Collision Notification\*  
Helps drivers receive necessary response from emergency service providers.  
(→P. 457)  
\*: U.S. Patent No. 7,508,298 B2
- Stolen Vehicle Location  
Helps drivers in the event of vehicle theft. (→P. 458)
- Emergency Assistance Button (“SOS”)  
Connects drivers to response-center support. (→P. 458)
- Enhanced Roadside Assistance  
Provides drivers various on-road assistance. (→P. 458)

### Subscription

After you have signed the Telematics Subscription Service Agreement and are enrolled, you can begin receiving services.

A variety of subscription terms is available for purchase. Contact your Lexus dealer, call 1-800-25-LEXUS (1-800-255-3987) or push the “SOS” button in your vehicle for further subscription details.

#### ■ Safety Connect Services Information

- Phone calls using the vehicles Bluetooth® technology will not be possible during Safety Connect.
- Safety Connect is available beginning Fall 2009 on select Lexus models. Contact with the Safety Connect response center is dependent upon the telematics device being in operative condition, cellular connection availability, and GPS satellite signal reception, which can limit the ability to reach the response center or receive emergency service support. Enrollment and Telematics Subscription Service Agreement required. A variety of subscription terms is available; charges vary by subscription term selected.
- Automatic Collision Notification, Emergency Assistance and Stolen Vehicle Location will function in the United States, including Hawaii and Alaska, and in Canada, and Enhanced Roadside Assistance will function in the United States (except Hawaii) and in Canada. No Safety Connect services will function outside of the United States in countries other than Canada.
- Safety Connect services are not subject to section 255 of the Telecommunications Act and the device is not TTY compatible.

#### ■ Languages

The Safety Connect response center will offer support in multiple languages. The Safety Connect system will offer voice prompts in English and Spanish. Please indicate your language of choice when enrolling.

#### ■ When contacting the response center

You may be unable to contact the response center if the network is busy.

### Safety Connect LED light Indicators

When the engine switch is turned to IGNITION ON mode, the red indicator light comes on for 2 seconds then turns off. Afterward, the green indicator light comes on, indicating that the service is active.

The following indicator light patterns indicate specific system usage conditions:

- Green indicator light on = Active service
- Green indicator light flashing = Safety Connect call in process
- Red indicator light (except at vehicle start-up) = System malfunction (contact your Lexus dealer)
- No indicator light (off) = Safety Connect service not active

### Safety Connect services

#### ■ Automatic Collision Notification

In case of either airbag deployment or severe rear-end collision, the system is designed to automatically call the response center. The responding agent receives the vehicle's location and attempts to speak with the vehicle occupants to assess the level of emergency. If the occupants are unable to communicate, the agent automatically treats the call as an emergency, contacts the nearest emergency services provider to describe the situation, and requests that assistance be sent to the location.

■ **Stolen Vehicle Location**

If your vehicle is stolen, Safety Connect can work with local authorities to assist them in locating and recovering the vehicle. After filing a police report, call the Safety Connect response center at 1-800-25-LEXUS (1-800-255-3987) and follow the prompts for Safety Connect to initiate this service.

In addition to assisting law enforcement with recovery of a stolen vehicle, Safety-Connect-equipped vehicle location data may, under certain circumstances, be shared with third parties to locate your vehicle. Further information is available at [Lexus.com](http://Lexus.com).

■ **Emergency Assistance Button (“SOS”)**

In the event of an emergency on the road, push the “SOS” button to reach the Safety Connect response center. The answering agent will determine your vehicle’s location, assess the emergency, and dispatch the necessary assistance required.

If you accidentally press the “SOS” button, tell the response-center agent that you are not experiencing an emergency.

■ **Enhanced Roadside Assistance**

Enhanced Roadside Assistance adds GPS data to the already included warranty-based Lexus roadside service.

Subscribers can press the “SOS” button to reach a Safety Connect response-center agent, who can help with a wide range of needs, such as: towing, flat tire, fuel delivery, etc. For a description of the Roadside Assistance services and their limitations, please see the Safety Connect Terms and Conditions, which are available at [Lexus.com](http://Lexus.com).

## Safety information for Safety Connect

Important! Read this information before using Safety Connect.

### ■ Exposure to radio frequency signals

The Safety Connect system installed in your vehicle is a low-power radio transmitter and receiver. It receives and also sends out radio frequency (RF) signals.

In August 1996, the Federal Communications Commission (FCC) adopted RF exposure guidelines with safety levels for mobile wireless phones. Those guidelines are consistent with the safety standards previously set by the following U.S. and international standards bodies.

- ANSI (American National Standards Institute) C95.1 [1992]
- NCRP (National Council on Radiation Protection and Measurement) Report 86 [1986]
- ICNIRP (International Commission on Non-Ionizing Radiation Protection) [1996]

Those standards were based on comprehensive and periodic evaluations of the relevant scientific literature. Over 120 scientists, engineers, and physicians from universities, and government health agencies and industries reviewed the available body of research to develop the ANSI Standard (C95.1).

The design of Safety Connect complies with the FCC guidelines in addition to those standards.

### ■ Certification for Lexus Enform

FCC ID: O6Y-CDMRF101

FCC ID: XOECDMRF101B

FCC ID: N7NGTM2

FCC WARNING:

This equipment complies with FCC radiation exposure limits set forth for an uncontrolled environment and meets the FCC radio frequency (RF) Exposure Guidelines in Supplement C to OET65. This equipment should be installed and operated keeping the radiator at least 20cm or more away from person's body (excluding extremities: hands, wrists, feet and ankles).

## LEXUS Enform Remote\*

Lexus Enform Remote is a cellular phone application that lets you view and remotely control certain aspects of your vehicle.

For details about the functions and services of this application, refer to <http://www.lexus.com/enform/>.

Function of the Lexus Enform Remote is achieved by using an embedded cellular device in the vehicle (DCM: Data Communication Module).

### Subscription

After you sign the Telematics Subscription Service Agreement, download the Lexus Enform Remote app from your cellular phone's app store, and register within the app (or enroll and complete registration at the dealer), you can begin using these services. (→P. 455)

A variety of subscription terms are available. Contact your Lexus dealer, or call 1-800-25-LEXUS (1-800-255-3987) for further subscription details.

#### ■ Availability of service

Lexus Enform Remote is available in the contiguous United States, Washington D.C. and Alaska.

#### ■ Lexus Enform Remote Information

- Lexus Enform Remote should only be used by authorized users.
- Laws in some communities may require that the vehicle be within view of the user when operating Lexus Enform Remote.  
In some states, use of Lexus Enform Remote may violate state or local laws. Before using Lexus Enform Remote, check your state and local laws.
- Any malfunction of the Lexus should be repaired by your Lexus dealer.
- Lexus Enform Remote is designed to work at temperatures above -22°F (-30°C). This specification is related to the Lexus Enform Remote operation, but is dependent on the vehicle's operating temperature range which may be different.
- Content is subject to change without notice.
- Some features of the Lexus Enform Remote may not be available on some models.
- Additional information can be found at [www.lexus.com/enform/](http://www.lexus.com/enform/).
- Availability of functions of the Lexus Enform service is dependent on network reception level.

#### ■ Safety information for Lexus Enform Remote

Refer to the safety information for Safety Connect: →P. 459

\*: If equipped



## LEXUS Enform Service Connect\*

Lexus Enform Service Connect uses embedded telematics hardware to collect and transmit vehicle data that allows Lexus to provide:

- Vehicle Health Report (VHR)  
(Safety Recalls, Service Campaigns, Current Vehicle Alerts, Required Maintenance, and Vehicle Condition Status)
- Maintenance Notifications
- Vehicle Alert Notifications

For details about this service and how to register, refer to <http://www.lexus.com/enform/>.

The Lexus Enform Service Connect is achieved by using a Data Communication Module (DCM) built in the vehicle.

### ■ Availability of service

Lexus Enform Service Connect is available in the contiguous United States, Washington D.C., Hawaii, Alaska, and Canada.

### ■ Lexus Enform Service Connect Information

Availability of functions of the Lexus Enform Service Connect is dependent on network reception level.

### ■ Safety information for Lexus Enform Service Connect

Refer to the safety information for Safety Connect: →P. 459

\*: If equipped



**7-1. Maintenance and care**

Cleaning and protecting  
the vehicle exterior..... 464

Cleaning and protecting  
the vehicle interior..... 469

**7-2. Maintenance**

Maintenance  
requirements.....472

General maintenance..... 475

Emission inspection and  
maintenance (I/M)  
programs ..... 478

**7-3. Do-it-yourself maintenance**

Do-it-yourself service  
precautions..... 479

Hood ..... 481

Positioning a floor jack..... 482

Engine compartment ..... 485

Tires..... 501

Tire inflation pressure ..... 510

Wheels ..... 513

Air conditioning filter ..... 515

Electronic key battery .....517

Checking and replacing  
fuses..... 519

Light bulbs..... 522

## Cleaning and protecting the vehicle exterior

Perform the following to protect the vehicle and maintain it in prime condition:

- Working from top to bottom, liberally apply water to the vehicle body, wheel wells and underside of the vehicle to remove any dirt and dust.
- Wash the vehicle body using a sponge or soft cloth, such as a chamois.
- For hard-to-remove marks, use car wash soap and rinse thoroughly with water.
- Wipe away any water.
- Wax the vehicle when the waterproof coating deteriorates.  
If water does not bead on a clean surface, apply wax when the vehicle body is cool.

### ■ CFRP (Carbon Fiber Reinforced Plastic) part (if equipped)

- As the CFRP parts may change color if they are exposed to ultraviolet rays for extended periods of time, Lexus recommends that your vehicle be stored in a place where it will not be exposed to direct sunlight.
- Do not use wax that contains abrasives.

### ■ Self-restoring coat\*

The vehicle body has a self-restoring coating that is resistant to small surface scratches caused in a car wash etc.

- The coating lasts for 5 to 8 years from when the vehicle is delivered from the plant.
- The restoration time differs depending on the depth of the scratch and outside temperature.  
The restoration time may become shorter when the coating is warmed by applying warm water.
- Deep scratches caused by keys, coins, etc. cannot be restored.
- Do not use wax that contains abrasives.

\*: CFRP parts (if equipped) do not have a self-restoring coat.

### ■ Automatic car washes (vehicles without CFRP parts)

- Fold the mirrors before washing the vehicle. Start washing from the front of the vehicle. Make sure to extend the mirrors before driving.
- RC F: Wash the vehicle with the active rear wing retracted. If the vehicle is washed with the active rear wing raised, depending on the type of automatic car wash, the brushes of the automatic car wash may become stuck on the active rear wing. In this case, the active rear wing may not be washed very well or may even be scratched or damaged.
- Brushes used in automatic car washes may scratch the vehicle body and damage the paint.

#### ■ Automatic car washes (vehicles with CFRP parts)

Do not use automatic car washes as they may scratch the CFRP parts and damage the paint.

#### ■ High pressure car washes

- Do not allow the nozzles of the car wash to come within close proximity of the windows.
- Before using the car wash, check that the fuel filler door on your vehicle is closed properly.

#### ■ When using a car wash

If the door handle becomes wet while the electronic key is within the effective range, the door may lock and unlock repeatedly. In that case, follow the following correction procedures to wash the vehicle:

- Place the key in a position 6 ft. (2 m) or more separate from the vehicle while the vehicle is being washed. (Take care to ensure that the key is not stolen.)
- Set the electronic key to battery-saving mode to disable the smart access system with push-button start. (→P. 150)

#### ■ Aluminum wheels

- Remove any dirt immediately by using a neutral detergent. Do not use hard brushes or abrasive cleaners. Do not use strong or harsh chemical cleaners. Use the same mild detergent and wax as used on the paint.
- Do not use detergent on the wheels when they are hot, for example after driving a long distance in hot weather.
- Wash detergent from the wheels immediately after use.

#### ■ When cleaning the painted brake calipers (if equipped)

- If a detergent is to be used to clean the painted brake calipers, use a neutral detergent. Do not use hard brushes or abrasive cleaners as they may damage the paint.
- Do not use detergent on the brake calipers when they are hot.
- Wash detergent from the brake calipers immediately after use.

#### ■ Bumpers

Do not scrub with abrasive cleaners.

#### ■ Side windows water-repellent coating (if equipped)

- The following precautions can extend the effectiveness of the water-repellent coating.
  - Remove any dirt, etc. from the side windows regularly.
  - Do not allow dirt and dust to accumulate on the windows for a long period. Clean the windows with a soft, damp cloth as soon as possible.
  - Do not use wax or glass cleaners that contain abrasives when cleaning the windows.
  - Do not use any metallic objects to remove condensation build up.
- When the water-repellent performance has become insufficient, the coating can be repaired. Contact your Lexus dealer.

**⚠ WARNING**

■ **When washing the vehicle**

Do not apply water to the inside of the engine compartment. Doing so may cause the electrical components etc. to catch fire.

■ **When cleaning the windshield (vehicles with rain-sensing windshield wipers)**

Set the wipers to the intermittent windshield wipers. (→P. 226)

If AUTO mode is selected, the wipers may operate unexpectedly in the following situations, and may result in hands being caught or other serious injuries and cause damage to the wiper blades.

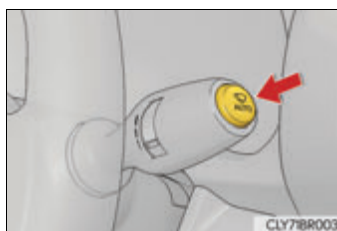

● When the upper part of the windshield where the raindrop sensor is located is touched by hand

● When a wet rag or similar is held close to the raindrop sensor

● If something bumps against the windshield

● If you directly touch the raindrop sensor body or if something bumps into the raindrop sensor

■ **Precautions regarding the exhaust pipes**

As exhaust gases cause the exhaust pipes to become quite hot, do not touch the exhaust pipes while the engine is running or immediately after the engine is turned off.

When washing the vehicle, be careful not to touch the exhaust pipes until they have cooled sufficiently, as touching hot exhaust pipes can cause burns.

■ **Precaution regarding the rear bumper with Blind Spot Monitor (if equipped)**

If the paint of the rear bumper is chipped or scratched, the system may malfunction. If this occurs, consult your Lexus dealer.

 NOTICE**■ Application of coatings to the vehicle body (vehicles with CFRP parts)**

Do not apply any kind of coating to the vehicle body as doing so may damage the paint or reduce its durability.

**■ To prevent paint deterioration and corrosion on the body and components (aluminum wheels etc.)**

● Wash the vehicle immediately in the following cases:

- After driving near the sea coast
- After driving on salted roads
- If coal tar or tree sap is present on the paint surface
- If dead insects, insect droppings or bird droppings are present on the paint surface
- After driving in an area contaminated with soot, oily smoke, mine dust, iron powder or chemical substances
- If the vehicle becomes heavily soiled with dust or mud
- If liquids such as benzene and gasoline are spilled on the paint surface

● If the paint is chipped or scratched, have it repaired immediately.

● To prevent the wheels from corroding, remove any dirt and store in a place with low humidity when storing the wheels.

**■ Cleaning the exterior lights**

● Wash carefully. Do not use organic substances or scrub with a hard brush. This may damage the surfaces of the lights.

● Do not apply wax to the surfaces of the lights. Wax may cause damage to the lenses.

**■ To prevent damage to the windshield wiper arms**

When lifting the wiper arms away from the windshield, pull the driver side wiper arm upward first, and repeat for the passenger side. When returning the wipers to their original position, do so from the passenger side first.

**■ When using an automatic car wash (vehicles with rain-sensing windshield wipers)**

Set the wipers to the intermittent windshield wipers. (→P. 226)

If AUTO mode is selected, the wipers may operate and the wiper blades may be damaged.

 NOTICE

■ When using a high pressure car wash

- When washing the vehicle, do not spray the camera or its surrounding area directly with a high pressure washer. Shock applied from high pressure water may cause the device to not operate normally.
- Do not bring the nozzle tip close to boots (rubber or resin manufactured cover), connectors or the following parts. The parts may be damaged if they come into contact with high-pressure water.
  - Traction related parts
  - Steering parts
  - Suspension parts
  - Brake parts
- RC F: Do not point the nozzle of a high pressure washer at the areas shown in the illustration, as high pressure water may damage the oil coolers.

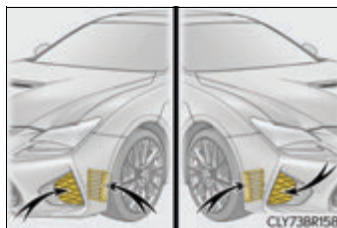

■ Hood vent (RC F)

When washing the vehicle, do not allow a large amount of water to enter the hood vent at once, such as when using a bucket, etc. or point the nozzle of a high pressure washer at the hood vent.

Water may get inside the engine compartment and affect the engine and other components.





## Cleaning and protecting the vehicle interior

The following procedures will help protect your vehicle's interior and keep it in top condition:

### Protecting the vehicle interior

Remove dirt and dust using a vacuum cleaner. Wipe dirty surfaces with a cloth dampened with lukewarm water.

### Cleaning the leather areas

- Remove dirt and dust using a vacuum cleaner.
- Wipe off any excess dirt and dust with a soft cloth dampened with diluted detergent.  
Use a diluted water solution of approximately 5% neutral wool detergent.
- Wring out any excess water from the cloth and thoroughly wipe off all remaining traces of detergent.
- Wipe the surface with a dry, soft cloth to remove any remaining moisture. Allow the leather to dry in a shaded and ventilated area.

### Cleaning the synthetic leather areas

- Remove loose dirt using a vacuum cleaner.
- Apply a mild soap solution to the synthetic leather using a sponge or soft cloth.
- Allow the solution to soak in for a few minutes. Remove the dirt and wipe off the solution with a clean, damp cloth.

### Cleaning the artificial leather (Alcantara®\*) areas

- Brush the surfaces using a soft brush.  
Do not brush hard as doing so may cause damage.
- Wipe the surfaces clean with a soft cloth that has been dampened in cold or lukewarm water and squeezed out.
- Allow the artificial leather (Alcantara®\*) to dry in a shaded and ventilated area.

\*: "Alcantara®" is a registered trademark of Alcantara S.p.A.

■ **Caring for leather areas**

Lexus recommends cleaning the interior of the vehicle at least twice a year to maintain the quality of the vehicle's interior.

■ **Shampooing the carpets**

There are several commercial foaming-type cleaners available. Use a sponge or brush to apply the foam. Rub in overlapping circles. Do not use water. Wipe dirty surfaces and let them dry. Excellent results are obtained by keeping the carpet as dry as possible.

■ **Seat belts**

Clean with mild soap and lukewarm water using a cloth or sponge. Also check the belts periodically for excessive wear, fraying or cuts.

■ **When cleaning the carpeted portions of the glove box, console box, etc.**

If a strong adhesive tape is used, there is a possibility that the surface of the carpet could be damaged.

 **WARNING**

■ **Water in the vehicle**

- Do not splash or spill liquid in the vehicle.  
Doing so may cause electrical components etc. to malfunction or catch fire.
- Do not get any of the SRS components or wiring in the vehicle interior wet.  
(→P. 41)  
An electrical malfunction may cause the airbags to deploy or not function properly, resulting in death or serious injury.

■ **Cleaning the interior (especially instrument panel)**

Do not use polish wax or polish cleaner. The instrument panel may reflect off the windshield, obstructing the driver's view and leading to an accident, resulting in death or serious injury.

 NOTICE

**■ Cleaning detergents**

- Do not use the following types of detergent, as they may discolor the vehicle interior or cause streaks or damage to painted surfaces:
  - Non-seat portions: Organic substances such as benzene or gasoline, alkaline or acidic solutions, dye, and bleach
  - Seats: Alkaline or acidic solutions, such as thinner, benzene, and alcohol
- Do not use polish wax or polish cleaner. The instrument panel's or other interior part's painted surface may be damaged.

**■ Preventing damage to leather surfaces**

Observe the following precautions to avoid damage to and deterioration of leather surfaces:

- Remove any dust or dirt from leather surfaces immediately.
- Do not expose the vehicle to direct sunlight for extended periods of time. Park the vehicle in the shade, especially during summer.
- Do not place items made of vinyl, plastic, or containing wax on the upholstery, as they may stick to the leather surface if the vehicle interior heats up significantly.

**■ Water on the floor**

Do not wash the vehicle floor with water.

Vehicle systems such as the audio system may be damaged if water comes into contact with electrical components such as the audio system above or under the floor of the vehicle. Water may also cause the body to rust.

**■ When cleaning the inside of the windshield (vehicles with LDA [Lane Departure Alert])**

Be careful not to touch the camera sensor (→P. 253).

If the camera is accidentally scratched or hit, LDA may not operate properly or may cause a malfunction.

**■ Cleaning the inside of the rear window**

- Do not use glass cleaner to clean the rear window, as this may cause damage to the rear window defogger heater wires or antenna. Use a cloth dampened with lukewarm water to gently wipe the window clean. Wipe the window in strokes running parallel to the heater wires or antenna.
- Be careful not to scratch or damage the heater wires or antenna.

## Maintenance requirements

To ensure safe and economical driving, day-to-day care and regular maintenance are essential. It is the owner's responsibility to perform regular checks. Lexus recommends the following maintenance:

### General maintenance

General maintenance should be performed on a daily basis. This can be done by yourself or by a Lexus dealer.

### Scheduled maintenance

Scheduled maintenance should be performed at specified intervals according to the maintenance schedule.

For details about maintenance items and schedules, refer to the "Warranty and Service Guide", "Owner's Manual Supplement" or "Scheduled Maintenance".

### Do-it-yourself maintenance

You can perform some maintenance procedures by yourself.

Please be aware that do-it-yourself maintenance may affect warranty coverage.

The use of Lexus repair manuals is recommended.

For details about warranty coverage, refer to the separate "Owner's Guide", "Warranty and Service Guide", "Owner's Manual Supplement" or "Warranty Booklet".

**■ Repair and replacement**

It is recommended that genuine Lexus parts be used for repairs to ensure performance of each system. If non-Lexus parts are used in replacement or if a repair shop other than a Lexus dealer performs repairs, confirm the warranty coverage.

**■ Resetting the message indicating maintenance is required (U.S.A. only)**

After the required maintenance is performed according to the maintenance schedule, please reset the message.

To reset the message, follow the procedure described below:

- 1 While the engine is running, switch the multi-information display to the "Settings" screen. (→P. 92, 98)
- 2 Select "Scheduled Maintenance" (or "Maintenance System") on the "Settings" screen.
- 3 Select "Yes" on the "Scheduled Maintenance" (or "Maintenance System") screen.

A message will be displayed when the reset procedure has been completed.

**■ Allow inspection and repairs to be performed by a Lexus dealer**

- Lexus technicians are well-trained specialists and are kept up to date with the latest service information. They are well informed about the operations of all systems on your vehicle.
- Keep a copy of the repair order. It proves that the maintenance that has been performed is under warranty coverage. If any problem should arise while your vehicle is under warranty, your Lexus dealer will promptly take care of it.

 **WARNING**

■ **If your vehicle is not properly maintained**

Improper maintenance could result in serious damage to the vehicle and possible death or serious injury.

■ **Handling of the battery**

- Engine exhaust, some of its constituents, and a wide variety of automobile components contain or emit chemicals known to the State of California to cause cancer and birth defects and other reproductive harm. Work in a well ventilated area.
- Oils, fuels and fluids contained in vehicles as well as waste produced by component wear contain or emit chemicals known to the State of California to cause cancer and birth defects or other reproductive harm. Avoid exposure and wash any affected area immediately.
- Battery posts, terminals and related accessories contain lead and lead compounds which are known to cause brain damage. Wash your hands after handling. (→P. 497)

## General maintenance

Listed below are the general maintenance items that should be performed at the intervals specified in the “Warranty and Service Guide” or “Owner’s Manual Supplement”. It is recommended that any problem you notice should be brought to the attention of your Lexus dealer or qualified service shop for advice.

### Engine compartment

| Items  | Check points  |
|--|---|
| Battery                                      | Check the indicator (if equipped) and connections. (→P. 497)                                    |
| Brake fluid                                  | Is the brake fluid at the correct level? (→P. 496)  |
| Engine/intercooler coolant                   | Is the engine/intercooler coolant at the correct level? (→P. 493)                               |
| Engine oil                                   | Is the engine oil at the correct level? (→P. 488)   |
| Exhaust system                               | There should not be any fumes or strange sounds.  |
| Radiator, condenser and intercooler radiator | The radiator, condenser and intercooler radiator should be free from foreign objects. (→P. 495) |
| Washer fluid                                 | Is there sufficient washer fluid? (→P. 500)   |

**Vehicle interior**

| Items                                   | Check points   |
|---|--|
| Accelerator pedal                       | <ul style="list-style-type: none"> <li>The accelerator pedal should move smoothly (without uneven pedal effort or catching).</li> </ul>  |
| Automatic transmission "Park" mechanism | <ul style="list-style-type: none"> <li>When parked on a slope and the shift lever is in P, is the vehicle securely stopped?</li> </ul>   |
| Brake pedal                             | <ul style="list-style-type: none"> <li>Does the brake pedal move smoothly?</li> <li>Does the brake pedal have appropriate clearance from the floor? (→P. 629)</li> <li>Does the brake pedal have the correct amount of free play? (→P. 629)</li> </ul>   |
| Brakes                                  | <ul style="list-style-type: none"> <li>The vehicle should not pull to one side when the brakes are applied.</li> <li>The brakes should work effectively.</li> <li>The brake pedal should not feel spongy.</li> <li>The brake pedal should not get too close to the floor when the brakes are applied.</li> </ul> |
| Head restraints (RC350/RC300/RC200t)    | <ul style="list-style-type: none"> <li>Do the head restraints move smoothly and lock securely?</li> </ul>  |
| Indicators/buzzers                      | <ul style="list-style-type: none"> <li>Do the indicators and buzzers function properly?</li> </ul>   |
| Lights                                  | <ul style="list-style-type: none"> <li>Do all the lights come on?</li> </ul>   |
| Parking brake                           | <ul style="list-style-type: none"> <li>Does the parking brake pedal move smoothly?</li> <li>When parked on a slope and the parking brake is on, is the vehicle securely stopped?</li> </ul>  |
| Seat belts                              | <ul style="list-style-type: none"> <li>Do the seat belts operate smoothly?</li> <li>The seat belts should not be damaged.</li> </ul>   |
| Seats                                   | <ul style="list-style-type: none"> <li>Do the seat controls operate properly?</li> </ul>   |
| Steering wheel                          | <ul style="list-style-type: none"> <li>Does the steering wheel rotate smoothly?</li> <li>Does the steering wheel have the correct amount of free play?</li> <li>There should not be any strange sounds coming from the steering wheel.</li> </ul>  |



### Vehicle exterior

| Items             | Check points   |
|-------------------|--|
| Doors/trunk       | <ul style="list-style-type: none"> <li>Do the doors/trunk operate smoothly?</li> </ul>   |
| Engine hood       | <ul style="list-style-type: none"> <li>Does the engine hood lock system work properly?</li> </ul>  |
| Fluid leaks       | <ul style="list-style-type: none"> <li>There should not be any signs of fluid leakage after the vehicle has been parked.</li> </ul>  |
| Tires             | <ul style="list-style-type: none"> <li>Is the tire inflation pressure correct?</li> <li>The tires should not be damaged or excessively worn.</li> <li>Have the tires been rotated according to the maintenance schedule?</li> <li>The wheel nuts should not be loose.</li> </ul> |
| Windshield wipers | <ul style="list-style-type: none"> <li>The wiper blades should not show any signs of cracking, splitting, wear, contamination or deformation.</li> <li>The wiper blades should clear the windshield without streaking or skipping.</li> </ul>                                    |

#### WARNING

##### If the engine is running

Turn the engine off and ensure that there is adequate ventilation before performing maintenance checks.

## Emission inspection and maintenance (I/M) programs

Some states have vehicle emission inspection programs which include OBD (On Board Diagnostics) checks. The OBD system monitors the operation of the emission control system.

### If the malfunction indicator lamp comes on

The OBD system determines that a problem exists somewhere in the emission control system. Your vehicle may not pass the I/M test and may need to be repaired. Contact your Lexus dealer to service the vehicle.

### Your vehicle may not pass the I/M test in the following situations:

- When the battery is disconnected or discharged  
Readiness codes that are set during ordinary driving are erased.  
Also, depending on your driving habits, the readiness codes may not be completely set.
- When the fuel tank cap is loose  
The malfunction indicator lamp comes on indicating a temporary malfunction and your vehicle may not pass the I/M test.

### When the malfunction indicator lamp still remains on after several driving trips

The error code in the OBD system will not be cleared unless the vehicle is driven 40 or more times.

### If your vehicle does not pass the I/M test

Contact your Lexus dealer to prepare the vehicle for re-testing.

## Do-it-yourself service precautions

If you perform maintenance by yourself, be sure to follow the correct procedure as given in these sections.

| Items   | Parts and tools   |
|---|---|
| Battery condition<br>(→P. 497)                            | <ul style="list-style-type: none"> <li>• Warm water</li> <li>• Baking soda</li> <li>• Grease</li> <li>• Conventional wrench (for terminal clamp bolts)</li> </ul>   |
| Brake fluid level<br>(→P. 496)                            | <ul style="list-style-type: none"> <li>• SAE J1703 or FMVSS No.116 DOT 3 brake fluid</li> <li>• Rag or paper towel</li> <li>• Funnel (used only for adding brake fluid)</li> </ul>  |
| Engine/intercooler coolant level<br>(→P. 493)             | <ul style="list-style-type: none"> <li>• "Toyota Super Long Life Coolant" or a similar high quality ethylene glycol-based non-silicate, non-amine, non-nitrite and non-borate coolant with long-life hybrid organic acid technology</li> <li>For the U.S.A.:<br/>"Toyota Super Long Life Coolant" is pre-mixed with 50% coolant and 50% deionized water.</li> <li>For Canada:<br/>"Toyota Super Long Life Coolant" is pre-mixed with 55% coolant and 45% deionized water.</li> <li>• Funnel (used only for adding coolant)</li> </ul> |
| Engine oil level<br>(→P. 488)                             | <ul style="list-style-type: none"> <li>• "Toyota Genuine Motor Oil" or equivalent</li> <li>• Rag or paper towel</li> <li>• Funnel (used only for adding engine oil)</li> </ul>  |
| Fuses<br>(→P. 519)  | <ul style="list-style-type: none"> <li>• Fuse with same amperage rating as original</li> </ul>  |
| Light bulbs<br>(→P. 522)                                  | <ul style="list-style-type: none"> <li>• Bulb with same number and wattage rating as original</li> <li>• Phillips-head screwdriver</li> <li>• Flathead screwdriver</li> <li>• Wrench</li> </ul>   |
| Radiator, condenser and intercooler radiator<br>(→P. 495) | —   |
| Tire inflation pressure<br>(→P. 510)                      | <ul style="list-style-type: none"> <li>• Tire pressure gauge</li> <li>• Compressed air source</li> </ul>  |
| Washer fluid<br>(→P. 500)                                 | <ul style="list-style-type: none"> <li>• Water or washer fluid containing antifreeze (for winter use)</li> <li>• Funnel (used only for adding water or washer fluid)</li> </ul>   |

 **WARNING**

The engine compartment contains many mechanisms and fluids that may move suddenly, become hot, or become electrically energized. To avoid death or serious injury, observe the following precautions.

**■ When working on the engine compartment**

- Keep hands, clothing and tools away from the moving fan and engine drive belt.
- Be careful not to touch the engine, radiator, exhaust manifold, etc. right after driving as they may be hot. Oil and other fluids may also be hot.
- Do not leave anything that may burn easily, such as paper and rags, in the engine compartment.
- Do not smoke, cause sparks or expose an open flame to fuel or the battery. Fuel and battery fumes are flammable.
- Be extremely cautious when working on the battery. It contains poisonous and corrosive sulfuric acid.

**■ When working near the electric cooling fans or radiator grille**

Be sure the engine switch is off.

With the engine switch in IGNITION ON mode, the electric cooling fans may automatically start to run if the air conditioning is on and/or the coolant temperature is high. (→P. 495)

**■ Safety glasses**

Wear safety glasses to prevent flying or falling material, fluid spray, etc. from getting in your eyes.

 **NOTICE****■ If you remove the air cleaner filter**

Driving with the air cleaner filter removed may cause excessive engine wear due to dirt in the air.

## Hood

Release the lock from the inside of the vehicle to open the hood.

- 1 Pull the hood lock release lever.  
The hood will pop up slightly.

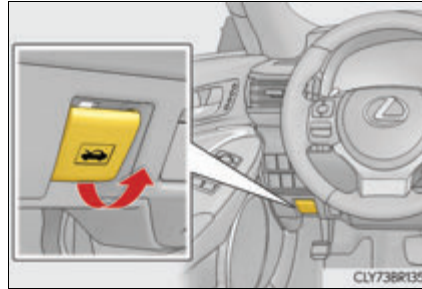

- 2 Pull up the auxiliary catch lever and lift the hood.

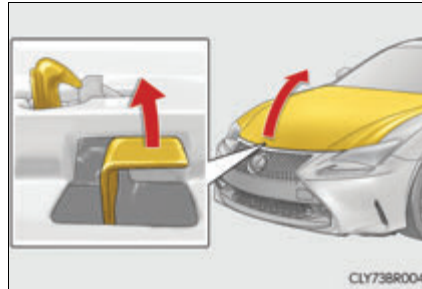

### WARNING

#### ■ Pre-driving check

Check that the hood is fully closed and locked.  
If the hood is not locked properly, it may open while the vehicle is in motion and cause an accident, which may result in death or serious injury.

## Positioning a floor jack

When using a floor jack, follow the instructions in the manual provided with the jack and perform the operation safely.

When raising your vehicle with a floor jack, position the jack correctly. Improper placement may damage your vehicle or cause injury.

### ◆ Front

#### ▶ 2WD models

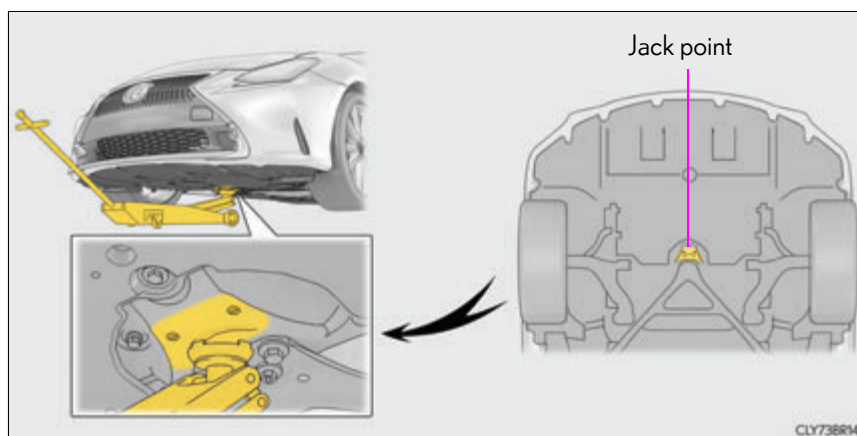

#### ▶ AWD models

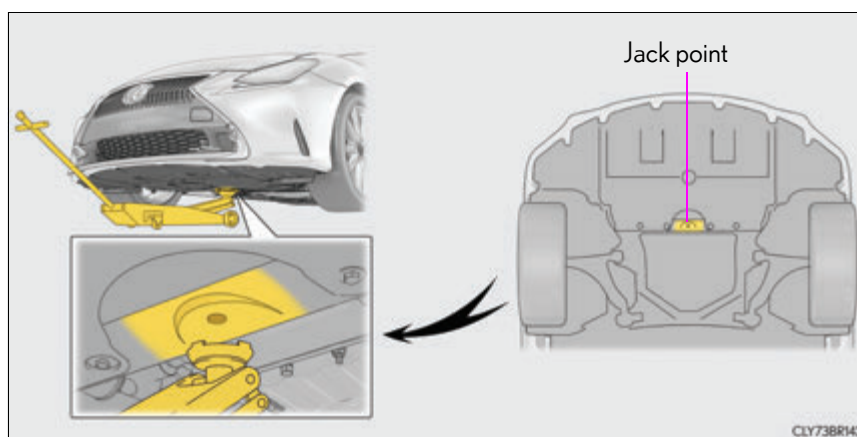

◆ Rear

▶ RC350/RC300/RC200t

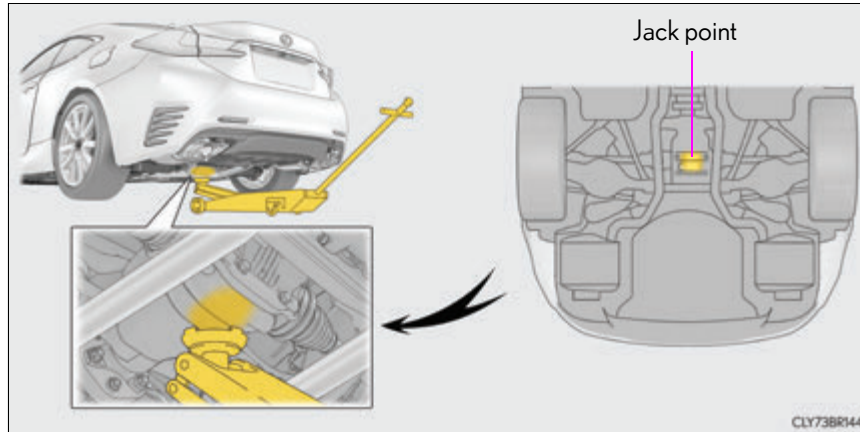

▶ RC F (vehicles with LSD [Limited Slip Differential])

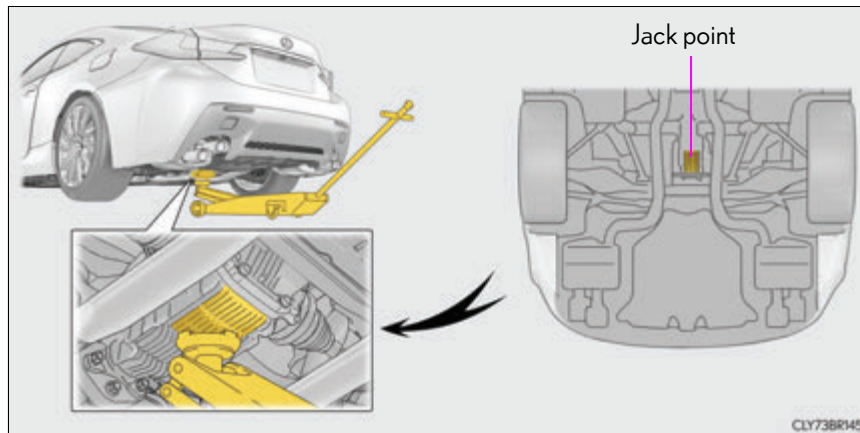

**484** 7-3. Do-it-yourself maintenance

- ▶ RC F (vehicles with TVD [Torque Vectoring Differential])

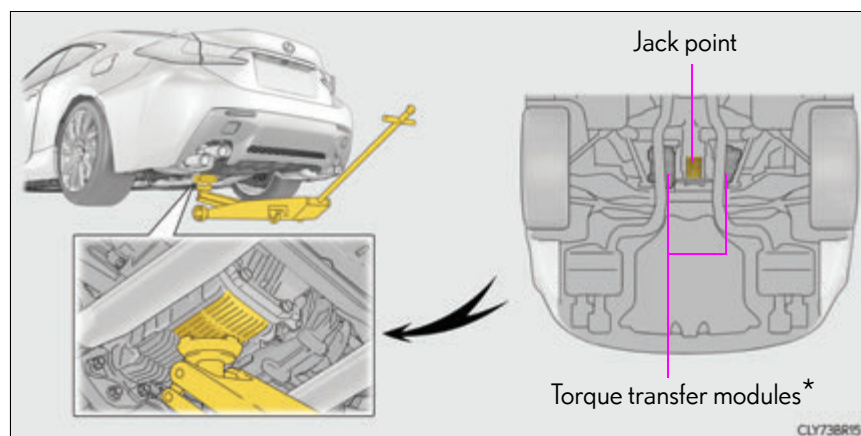

\*: Do not place the floor jack under either torque transfer module.



## Engine compartment

### ► RC350/RC300

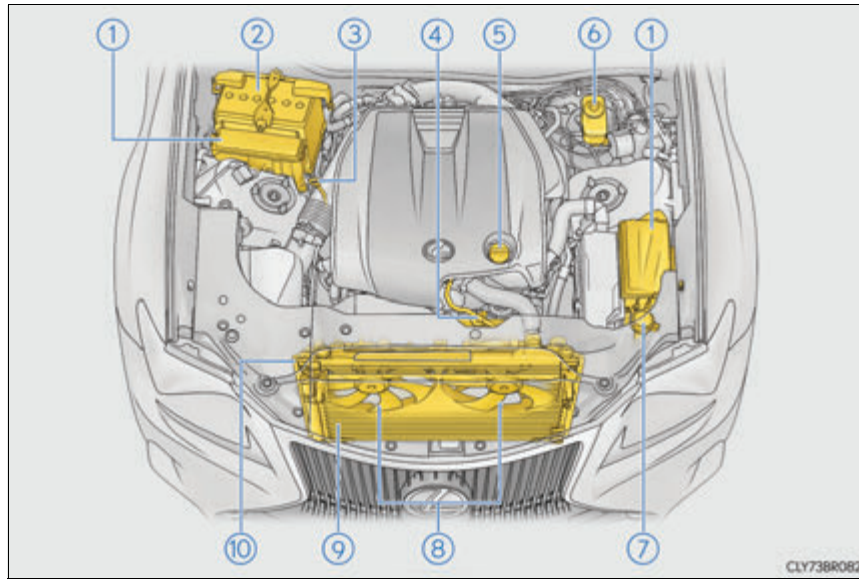

- |                             |           |                         |           |
|-----------------------------|-----------|-------------------------|-----------|
| ① Fuse boxes                | (→P. 519) | ⑥ Brake fluid reservoir | (→P. 496) |
| ② Battery                   | (→P. 497) | ⑦ Washer fluid tank     | (→P. 500) |
| ③ Engine oil level dipstick | (→P. 488) | ⑧ Electric cooling fans |           |
| ④ Engine coolant reservoir  | (→P. 493) | ⑨ Condenser             | (→P. 495) |
| ⑤ Engine oil filler cap     | (→P. 490) | ⑩ Radiator              | (→P. 495) |

7

Maintenance and care

► RC200t

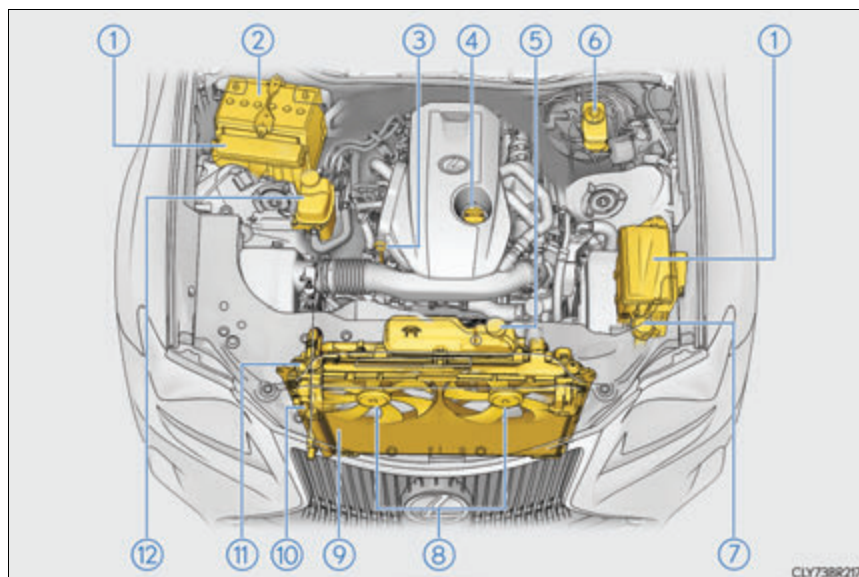

- |                             |           |                                 |           |
|-----------------------------|-----------|---------------------------------|-----------|
| ① Fuse boxes                | (→P. 519) | ⑦ Washer fluid tank             | (→P. 500) |
| ② Battery                   | (→P. 497) | ⑧ Electric cooling fans         |           |
| ③ Engine oil level dipstick | (→P. 488) | ⑨ Condenser                     | (→P. 495) |
| ④ Engine oil filler cap     | (→P. 490) | ⑩ Intercooler radiator          | (→P. 493) |
| ⑤ Engine coolant reservoir  | (→P. 493) | ⑪ Radiator                      | (→P. 495) |
| ⑥ Brake fluid reservoir     | (→P. 496) | ⑫ Intercooler coolant reservoir | (→P. 495) |

## ▶ RC F

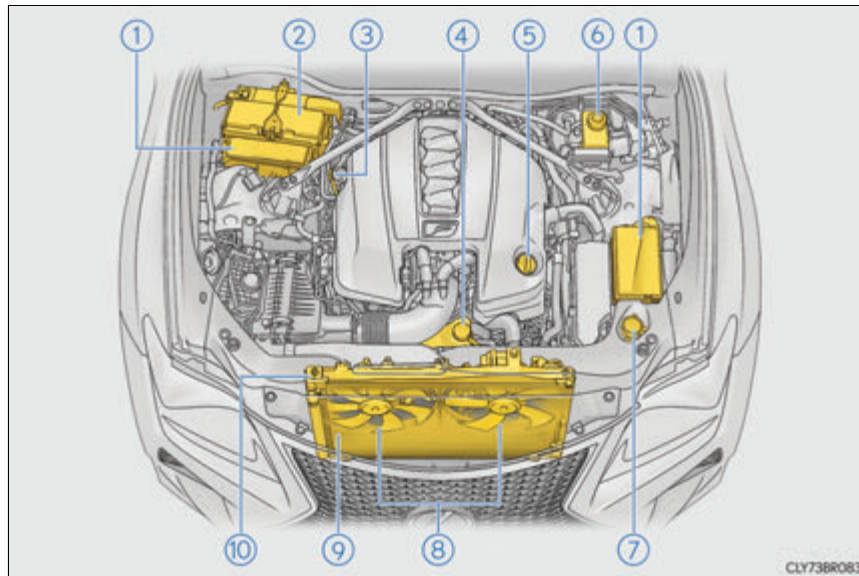

- |                             |           |                         |           |
|-----------------------------|-----------|-------------------------|-----------|
| ① Fuse boxes                | (→P. 519) | ⑥ Brake fluid reservoir | (→P. 496) |
| ② Battery                   | (→P. 497) | ⑦ Washer fluid tank     | (→P. 500) |
| ③ Engine oil level dipstick | (→P. 488) | ⑧ Electric cooling fans |           |
| ④ Engine coolant reservoir  | (→P. 493) | ⑨ Condenser             | (→P. 495) |
| ⑤ Engine oil filler cap     | (→P. 490) | ⑩ Radiator              | (→P. 495) |

### Engine oil

With the engine at operating temperature and turned off, check the oil level on the dipstick.

#### ■ Checking the engine oil

**1** Park the vehicle on level ground. After warming up the engine and turning it off, wait more than 5 minutes for the oil to drain back into the bottom of the engine.

**2** Holding a rag under the end, pull the dipstick out.

▶ RC350/RC300

▶ RC200t

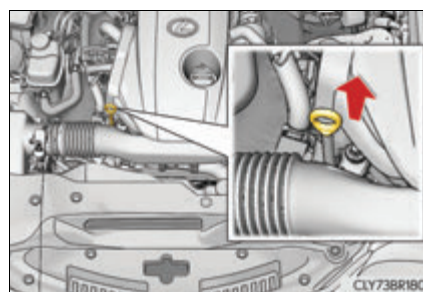
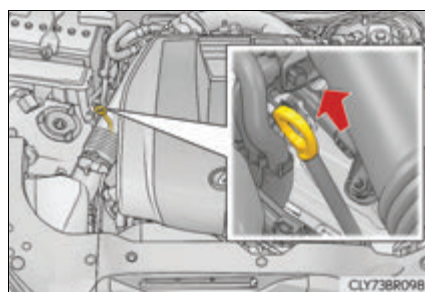

▶ RC F

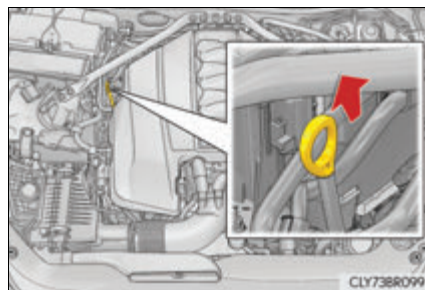

**3** Wipe the dipstick clean.

**4** Reinsert the dipstick fully.

5 Holding a rag under the end, pull the dipstick out and check the oil level.

- ① Low
- ② Normal
- ③ Excessive

The shape of the dipstick may differ depending on the type of vehicle or engine.

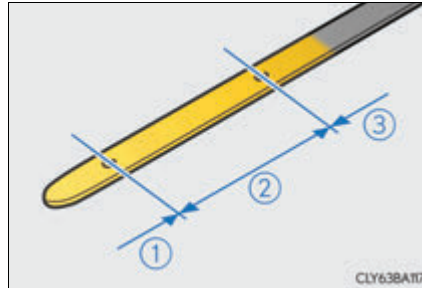

6 Wipe the dipstick and reinsert it fully.

■ Adding engine oil

If the oil level is below or near the low level mark, add engine oil of the same type as that already in the engine.

▶ RC350/RC300

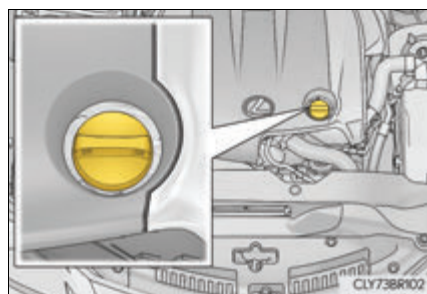

▶ RC200t

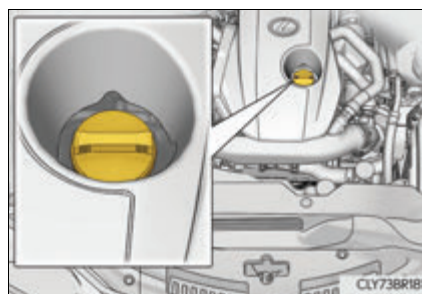

▶ RC F

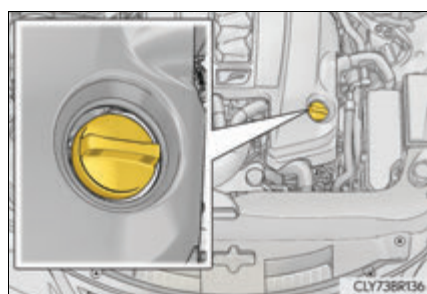

Make sure to check the oil type and prepare the items needed before adding oil.

|                           |                               |
|---------------------------|-------------------------------|
| Engine oil selection      | →P. 623, 625                  |
| Oil quantity (Low → Full) | 1.6 qt. (1.5 L, 1.3 Imp. qt.) |
| Items                     | Clean funnel                  |

- 1 Remove the oil filler cap by turning it counterclockwise.
- 2 Add engine oil slowly, checking the dipstick.
- 3 Install the oil filler cap by turning it clockwise.





### ■ Engine oil consumption

A certain amount of engine oil will be consumed while driving. In the following situations, oil consumption may increase, and engine oil may need to be refilled in between oil maintenance intervals.

- When the engine is new, for example directly after purchasing the vehicle or after replacing the engine
- If low quality oil or oil of an inappropriate viscosity is used
- When driving at high engine speeds or with a heavy load, or when driving while accelerating or decelerating frequently
- When leaving the engine idling for a long time, or when driving frequently through heavy traffic

### ■ After changing the engine oil (RC200t only)

The engine oil maintenance data should be reset. Perform the following procedures:

- 1 While the vehicle is stopped, press the  meter control switch on the steering wheel.
- 2 Press the < or > meter control switch on the steering wheel, select,  and then press the  meter control switch.
- 3 Press ^ or v meter control switch on the steering wheel to select "Oil Maintenance" and then press .
- 4 Select "Yes" and then press .

A message will be displayed on the multi-information display.

### WARNING

#### ■ Used engine oil

- Used engine oil contains potentially harmful contaminants which may cause skin disorders such as inflammation and skin cancer, so care should be taken to avoid prolonged and repeated contact. To remove used engine oil from your skin, wash thoroughly with soap and water.
- Dispose of used oil and filters only in a safe and acceptable manner. Do not dispose of used oil and filters in household trash, in sewers or onto the ground.  
Call your Lexus dealer, service station or auto parts store for information concerning recycling or disposal.
- Do not leave used engine oil within the reach of children.

 NOTICE

■ **To prevent serious engine damage**

Check the oil level on a regular basis.

■ **When replacing the engine oil**

- Be careful not to spill engine oil on the vehicle components.
- Avoid overfilling, or the engine could be damaged.
- Check the oil level on the dipstick every time you refill the vehicle.
- Be sure the engine oil filler cap is properly tightened.



## Coolant

### ■ Engine coolant reservoir

The coolant level is satisfactory if it is between the "FULL" and "LOW" lines on the reservoir when the engine is cold.

▶ RC350/RC300

▶ RC200t

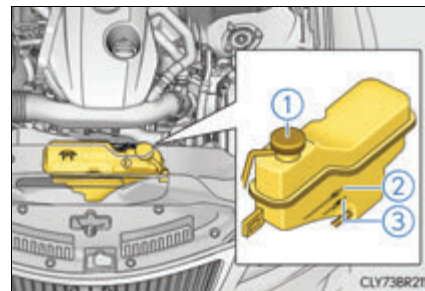
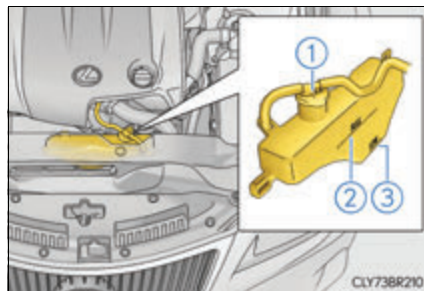

▶ RC F

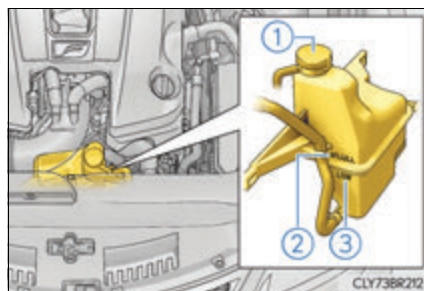

- ① Reservoir cap
- ② "FULL" line
- ③ "LOW" line

If the level is on or below the "LOW" line, add coolant up to the "FULL" line.  
(→P. 608)

■ **Intercooler coolant reservoir (RC200t only)**

The coolant level is satisfactory if it is between the “F” and “L” lines on the reservoir when the engine is cold.

- ① Reservoir cap
- ② “F” line
- ③ “L” line

If the level is on or below the “L” line, add coolant up to the “F” line.  
(→P. 608)

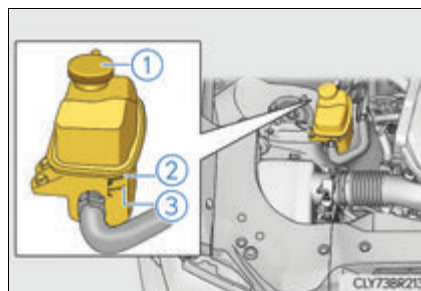

■ **Coolant selection**

Only use “Toyota Super Long Life Coolant” or a similar high quality ethylene glycol based non-silicate, non-amine, non-nitrite, and non-borate coolant with long-life hybrid organic acid technology.

U.S.A.:

“Toyota Super Long Life Coolant” is a mixture of 50% coolant and 50% deionized water.  
(Minimum temperature: -31°F [-35°C])

Canada:

“Toyota Super Long Life Coolant” is a mixture of 55% coolant and 45% deionized water.  
(Minimum temperature: -44°F [-42°C])

For more details about engine coolant, contact your Lexus dealer.

■ **If the coolant level drops within a short time of replenishing**

Visually check the radiator, hoses, engine and intercooler coolant reservoir caps, drain cock and water pump.

If you cannot find a leak, have your Lexus dealer test the cap and check for leaks in the cooling system.

**⚠ WARNING****■ When the engine is hot (RC350/RC300/RC200t)**

Do not remove the engine coolant reservoir cap, intercooler coolant reservoir cap and radiator cap. (→P. 612)

The cooling system may be under pressure and may spray hot coolant if the cap is removed, causing serious injuries, such as burns.

**■ When the engine is hot (RC F)**

Do not remove the engine coolant reservoir cap. (→P. 612)

The cooling system may be under pressure and may spray hot coolant if the cap is removed, causing serious injuries, such as burns.

**⚠ NOTICE****■ When adding coolant**

Coolant is neither plain water nor straight antifreeze. The correct mixture of water and antifreeze must be used to provide proper lubrication, corrosion protection and cooling. Be sure to read the antifreeze or coolant label.

**■ If you spill coolant**

Be sure to wash it off with water to prevent it from damaging parts or paint.

**Radiator, condenser and intercooler radiator (if equipped)**

Check the radiator, condenser and intercooler radiator and clear away any foreign objects.

If any of the above parts are extremely dirty or you are not sure of their condition, have your vehicle inspected by your Lexus dealer.

**⚠ WARNING****■ When the engine is hot**

Do not touch the radiator, condenser or intercooler as they may be hot and cause serious injuries, such as burns.

### Brake fluid

#### ■ Checking fluid level

The brake fluid level should be between the “MAX” and “MIN” lines on the tank.

▶ RC350/RC300/RC200t

▶ RC F

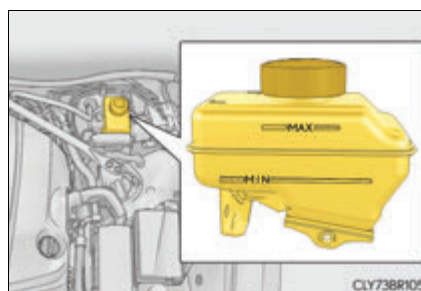
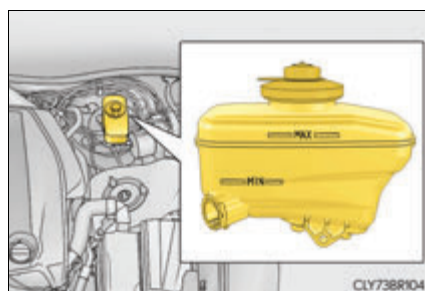

#### ■ Adding fluid

Make sure to check the fluid type and prepare the necessary items.

|            |   |
|------------|---|
| Fluid type | SAE J1703 or FMVSS No.116 DOT 3 brake fluid |
| Items      | Clean funnel                                |

#### ■ Brake fluid can absorb moisture from the air

Excess moisture in the brake fluid can cause a dangerous loss of braking efficiency. Use only newly opened brake fluid.

**⚠ WARNING**

■ **When filling the reservoir**  
 Take care as brake fluid can harm your hands and eyes and damage painted surfaces. If fluid gets on your hands or in your eyes, flush the affected area with clean water immediately.  
 If you still experience discomfort, see a doctor.

**⚠ NOTICE**

■ **If the fluid level is low or high**  
 It is normal for the brake fluid level to go down slightly as the brake pads wear out or when the fluid level in the accumulator is high.  
 If the reservoir needs frequent refilling, there may be a serious problem.

## Battery

Check the battery as follows.

### ■ Battery exterior

Make sure that the battery terminals are not corroded and that there are no loose connections, cracks, or loose clamps.

- ① Terminals
- ② Hold-down clamp

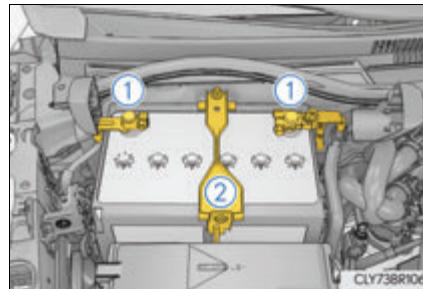

### ■ Checking battery condition (vehicles with the battery indicator)

Check the battery condition by indicator color.

- ① Blue: Good condition
- ② Red: Not working properly.  
Have the battery checked by your Lexus dealer.
- ③ White: Charging is necessary.  
Have the vehicle inspected by your Lexus dealer.

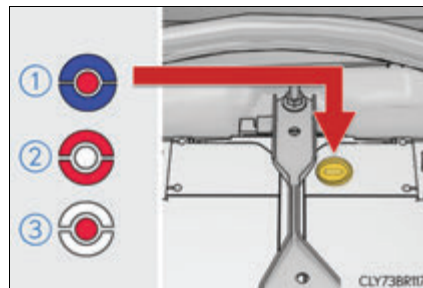

■ **Before recharging**

When recharging, the battery produces hydrogen gas which is flammable and explosive. Therefore, observe the following before recharging:

- If recharging with the battery installed on the vehicle, be sure to disconnect the ground cable.
- Make sure the power switch on the charger is off when connecting and disconnecting the charger cables to the battery.

■ **After recharging/reconnecting the battery**

The engine may not start. Follow the procedure below to initialize the system.

- 1 Shift the shift lever to P.
  - 2 Open and close either door.
  - 3 Restart the engine.
- Unlocking the doors using the smart access system with push-button start may not be possible immediately after reconnecting the battery. If this happens, use the wireless remote control or the mechanical key to lock/unlock the doors.
  - Start the engine with the engine switch in ACCESSORY mode. The engine may not start with the engine switch turned off. However, the engine will operate normally from the second attempt.
  - The engine switch mode is recorded by the vehicle. If the battery is disconnected and reconnected, the vehicle will return the engine switch mode to the status it was in before the battery was disconnected. Make sure to turn off the engine before disconnecting the battery. Take extra care when connecting the battery if the engine switch mode prior to the battery being disconnected is unknown.

If the system will not start even after multiple attempts, contact your Lexus dealer.

 **WARNING****■ Chemicals in the battery**

Batteries contain poisonous and corrosive sulfuric acid and may produce hydrogen gas which is flammable and explosive. To reduce the risk of death or serious injury, take the following precautions while working on or near the battery:

- Do not cause sparks by touching the battery terminals with tools.
- Do not smoke or light a match near the battery.
- Avoid contact with eyes, skin and clothes.
- Never inhale or swallow electrolyte.
- Wear protective safety glasses when working near the battery.
- Keep children away from the battery.

**■ Where to safely charge the battery**

Always charge the battery in an open area. Do not charge the battery in a garage or closed room where there is insufficient ventilation.

**■ How to recharge the battery**

Only perform a slow charge (5 A or less). The battery may explode if charged at a quicker rate.

**■ Emergency measures regarding electrolyte**

- If electrolyte gets in your eyes  
Flush your eyes with clean water for at least 15 minutes and get immediate medical attention. If possible, continue to apply water with a sponge or cloth while traveling to the nearest medical facility.
- If electrolyte gets on your skin  
Wash the affected area thoroughly. If you feel pain or burning, get medical attention immediately.
- If electrolyte gets on your clothes  
It can soak through clothing on to your skin. Immediately take off the clothing and follow the procedure above if necessary.
- If you accidentally swallow electrolyte  
Drink a large quantity of water or milk. Get emergency medical attention immediately.

 **NOTICE****■ When recharging the battery**

Never recharge the battery while the engine is running. Also, be sure all accessories are turned off.

### Washer fluid

If any washer does not work or the warning message appears on the multi-information display, the washer tank may be empty. Add washer fluid.

▶ RC350/RC300

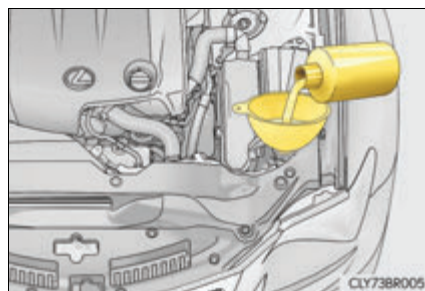

▶ RC200t

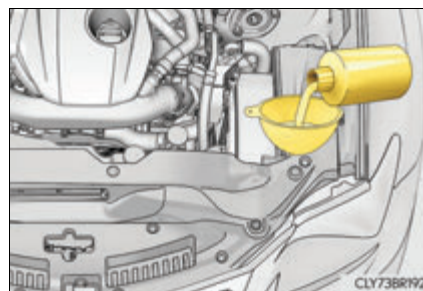

▶ RC F

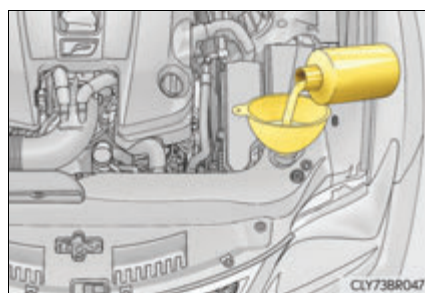

#### WARNING

■ **When adding washer fluid**

Do not add washer fluid when the engine is hot or running as washer fluid contains alcohol and may catch fire if spilled on the engine etc.

#### NOTICE

■ **Do not use any fluid other than washer fluid**

Do not use soapy water or engine antifreeze instead of washer fluid. Doing so may cause streaking on the vehicle's painted surfaces.

■ **Diluting washer fluid**

Dilute washer fluid with water as necessary. Refer to the freezing temperatures listed on the label of the washer fluid bottle.



## Tires

Replace or rotate tires in accordance with maintenance schedules and treadwear.

### Checking tires

Check if the treadwear indicators are showing on the tires. Also check the tires for uneven wear, such as excessive wear on one side of the tread.

Check the spare tire condition and pressure if not rotated.

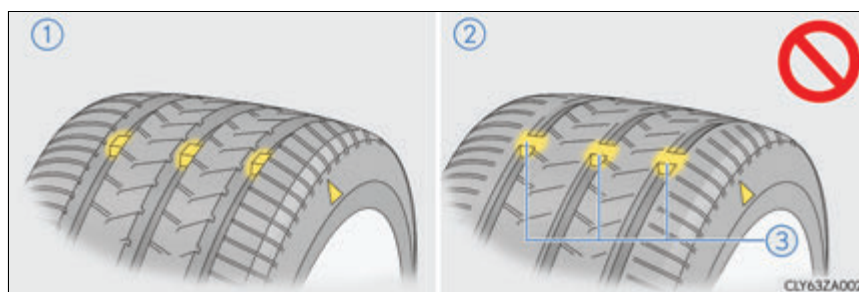

- ① New tread
- ② Worn tread
- ③ Treadwear indicator

The location of treadwear indicators is shown by a "TWI" or "Δ" mark, etc., molded into the sidewall of each tire.

Replace the tires if the treadwear indicators are showing on a tire.

### Tire rotation

- ▶ Vehicles with front and rear tires of the same size

Rotate the tires in the order shown.

To equalize tire wear and extend tire life, Lexus recommends that tire rotation is carried out at the same interval as tire inspection.

Do not fail to initialize the tire pressure warning system after tire rotation.

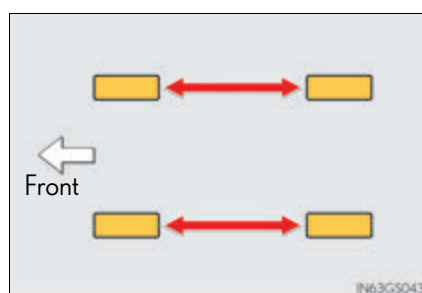

- ▶ Vehicles with front and rear tires of differing sizes

Tires cannot be rotated.

### Tire pressure warning system

Your vehicle is equipped with a tire pressure warning system that uses tire pressure warning valves and transmitters to detect low tire inflation pressure before serious problems arise.

- If the tire pressure drops below a predetermined level, the driver is warned by a screen display and a warning light. (→P. 545, 561)
- The tire pressure detected by the tire pressure warning system can be displayed on the multi-information display. (→P. 105, 113)

The illustration used is intended as an example, and may differ from the image that is actually displayed on the multi-information display.



#### ◆ Installing tire pressure warning valves and transmitters

When replacing tires or wheels, tire pressure warning valves and transmitters must also be installed.

When new tire pressure warning valves and transmitters are installed, new ID codes must be registered in the tire pressure warning computer and the tire pressure warning system must be initialized. Have tire pressure warning valve and transmitter ID codes registered by your Lexus dealer. (→P. 503)

#### ◆ Initializing the tire pressure warning system

##### ■ The tire pressure warning system must be initialized in the following circumstances:

- When rotating the tires.
- When the tire inflation pressure is changed such as when changing traveling speed.
- When changing the tire size.

When the tire pressure warning system is initialized, the current tire inflation pressure is set as the benchmark pressure.

**■ How to initialize the tire pressure warning system**

- 1** Park the vehicle in a safe place and turn the engine switch off.

Initialization cannot be performed while the vehicle is moving.

- 2** Adjust the tire inflation pressure to the specified cold tire inflation pressure level. (→P. 630)

Make sure to adjust the tire pressure to the specified cold tire inflation pressure level. The tire pressure warning system will operate based on this pressure level.

- 3** Turn the engine switch to IGNITION ON mode.

- 4** Press and hold the tire pressure warning reset switch until the tire pressure warning light blinks slowly 3 times.

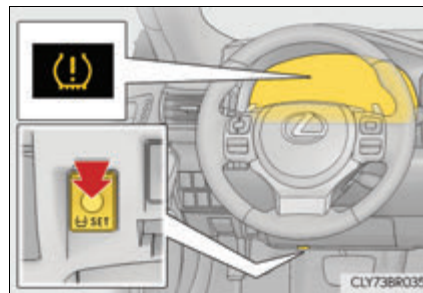

- 5** Wait for a few minutes with the engine switch in IGNITION ON mode and then turn the engine switch off.

**◆ Registering ID codes**

The tire pressure warning valve and transmitter is equipped with a unique ID code. When replacing a tire pressure warning valve and transmitter, it is necessary to register the ID code. Have the ID code registered by your Lexus dealer.

■ **When to replace your vehicle's tires**

Tires should be replaced if:

- The treadwear indicators are showing on a tire.
- You have tire damage such as cuts, splits, cracks deep enough to expose the fabric, and bulges indicating internal damage
- A tire goes flat repeatedly or cannot be properly repaired due to the size or location of a cut or other damage

If you are not sure, consult your Lexus dealer.

■ **Replacing tires and wheels**

If the ID code of the tire pressure warning valve and transmitter is not registered, the tire pressure warning system will not work properly. After driving for about 20 minutes, the tire pressure warning light blinks for 1 minute and stays on to indicate a system malfunction.

■ **Tire life**

Any tire over 6 years old must be checked by a qualified technician even if it has seldom or never been used or damage is not obvious.

■ **Routine tire inflation pressure checks**

The tire pressure warning system does not replace routine tire inflation pressure checks. Make sure to check tire inflation pressure as part of your routine of daily vehicle checks.

■ **When rotating the tires**

Make sure that the engine switch is off. If the tires are rotated while the engine switch is in IGNITION ON mode, the tire position information will not be updated.

If this accidentally occurs, either turn the engine switch to off and then to IGNITION ON mode, or initialize the system after checking that the tire pressure is properly adjusted.

■ **Low profile tires**

Generally, low profile tires will wear more rapidly and tire grip performance will be reduced on snowy and/or icy roads when compared to standard tires. Be sure to use snow tires or tire chains on snowy and/or icy roads and drive carefully at a speed appropriate for road and weather conditions.

**■ Maximum load of tire**

Check that the maximum load of the replacement tire is greater than 1/2 of the Gross Axle Weight Ratings (GAWR) of either the front axle or the rear axle, whichever is greater.

For the GAWR, see the Certification Label. For the maximum load of the tire, see the load limit at maximum cold tire inflation pressure mentioned on the sidewall of the tire. (→P. 639)

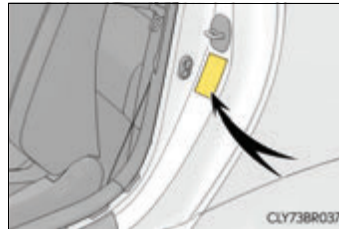
**■ Tire types****● Summer tires**

Summer tires are high-speed performance tires best suited to highway driving under dry conditions. Since summer tires do not have the same traction performance as snow tires, summer tires are inadequate for driving on snow-covered or icy roads. For driving on snow-covered roads or icy roads, the use of snow tires is recommended. When installing snow tires, be sure to replace all four tires.

**● All season tires**

All season tires are designed to provide better traction in snow and to be adequate for driving in most winter conditions as well as for use year-round. All season tires, however, do not have adequate traction performance compared with snow tires in heavy or loose snow. Also, all season tires fall short in acceleration and handling performance compared with summer tires in highway driving.

**● Snow tires**

For driving on snow-covered roads or icy roads, we recommend using snow tires. If you need snow tires, select tires of the same size, construction and load capacity as the originally installed tires. Since your vehicle has radial tires as original equipment, make sure your snow tires also have radial construction. Do not install studded tires without first checking local regulations for possible restrictions. Snow tires should be installed on all wheels. (→P. 320)

**■ If the tread on snow tires wears down below 0.16 in. (4 mm)**

The effectiveness of the tires as snow tires is lost.

**■ Situations in which the tire pressure warning system may not operate properly**

- In the following cases, the tire pressure warning system may not operate properly.
  - If non-genuine Lexus wheels are used.
  - A tire has been replaced with a tire that is not an OE (Original Equipment) tire.
  - A tire has been replaced with a tire that is not of the specified size.
  - Tire chains etc. are equipped.
  - An auxiliary-supported run-flat tire is equipped.
  - If a window tint that affects the radio wave signals is installed.
  - If there is a lot of snow or ice on the vehicle, particularly around the wheels or wheel housings.
  - If the tire inflation pressure is extremely higher than the specified level.
  - If tires not equipped with tire pressure warning valves and transmitters are used.
  - If the ID code on the tire pressure warning valves and transmitters is not registered in the tire pressure warning computer.
- Performance may be affected in the following situations.
  - Near a TV tower, electric power plant, gas station, radio station, large display, airport or other facility that generates strong radio waves or electrical noise
  - When carrying a portable radio, cellular phone, cordless phone or other wireless communication device

If tire position information is not correctly displayed due to the radio wave conditions, the display may be corrected by driving and changing the radio wave conditions.
- When the vehicle is parked, the time taken for the warning to start or go off could be extended.
- When tire inflation pressure declines rapidly for example when a tire has burst, the warning may not function.

**■ The initialization operation**

- Make sure to carry out initialization after adjusting the tire inflation pressure. Also, make sure the tires are cold before carrying out initialization or tire inflation pressure adjustment.
- If you have accidentally turned the engine switch off during initialization, it is not necessary to press the reset switch again as initialization will restart automatically when the engine switch has been turned to IGNITION ON mode for the next time.
- If you accidentally press the reset switch when initialization is not necessary, adjust the tire inflation pressure to the specified level when the tires are cold, and conduct initialization again.

**■ When initialization of the tire pressure warning system has failed**

Initialization can be completed in a few minutes. However, in the following cases, the settings have not been recorded and the system will not operate properly. If repeated attempts to record tire inflation pressure settings are unsuccessful, have the vehicle inspected by your Lexus dealer.

- When operating the tire pressure warning reset switch, the tire pressure warning light does not blink 3 times.
- After carrying out the initialization procedure, the tire pressure warning light blinks for 1 minute then stays on after driving for 20 minutes.

**■ Tire pressure warning system certification****● Initiateur**

- ▶ For vehicles sold in the U.S.A.

FCC ID: HYQ22AAA

**NOTE:**

This device complies with part 15 of the FCC Rules. Operation is subject to the following two conditions: (1) This device may not cause harmful interference, and (2) this device must accept any interference received, including interference that may cause undesired operation.

**FCC WARNING:**

Changes or modifications not expressly approved by the party responsible for compliance could void the user's authority to operate the equipment.

- ▶ For vehicles sold in Canada

**NOTE:**

This device complies with Industry Canada's licence-exempt RSSs.

Operation is subject to the following two conditions:

- (1) This device may not cause interference; and
- (2) This device must accept any interference, including interference that may cause undesired operation of the device.

**● Transmitter**

- ▶ For vehicles sold in the U.S.A.

FCC ID: PAXPMVC010

**NOTE:**

This device complies with part 15 of the FCC Rules. Operation is subject to the following two conditions: (1) This device may not cause harmful interference, and (2) this device must accept any interference received, including interference that may cause undesired operation.

**FCC WARNING:**

Changes or modifications not expressly approved by the party responsible for compliance could void the user's authority to operate the equipment.

- ▶ For vehicles sold in Canada

**NOTE:**

Operation is subject to the following two conditions: (1) this device may not cause interference, and (2) this device must accept any interference, including interference that may cause undesired operation of the device.

**⚠ WARNING****■ When inspecting or replacing tires**

Observe the following precautions to prevent accidents.

Failure to do so may cause damage to parts of the drivetrain as well as dangerous handling characteristics, which may lead to an accident resulting in death or serious injury.

- Do not mix tires of different makes, models or tread patterns.  
Also, do not mix tires of remarkably different treadwear.
- Do not use tire sizes other than those recommended by Lexus.
- Do not mix differently constructed tires (radial, bias-belted or bias-ply tires).
- Do not mix summer, all season and snow tires.
- Do not use tires that have been used on another vehicle.  
Do not use tires if you do not know how they were used previously.
- Vehicles with a compact spare tire: Do not tow if your vehicle has a compact spare tire installed.
- Vehicles with an emergency tire puncture repair kit: Do not tow anything if a tire that has been repaired using the emergency tire puncture repair kit is installed. The load on the tire may cause unexpected damage to the tire.

**■ When initializing the tire pressure warning system**

Do not operate the tire pressure warning reset switch without first adjusting the tire inflation pressure to the specified level. Otherwise, the tire pressure warning light may not come on even if the tire inflation pressure is low, or it may come on when the tire inflation pressure is actually normal.

**■ Caution regarding interference with electronic devices**

- People with implantable cardiac pacemakers, cardiac resynchronization therapy-pacemakers or implantable cardioverter defibrillators should not come within 17.7 in. (450 mm) of the tire pressure warning system initiators. The radio waves may affect the operation of such devices.

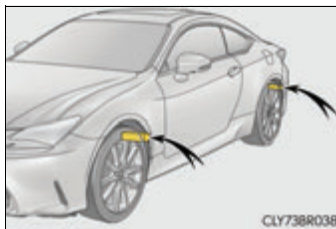

- Users of any electrical medical device other than implantable cardiac pacemakers, cardiac resynchronization therapy-pacemakers or implantable cardioverter defibrillators should consult the manufacturer of the device for information about its operation under the influence of radio waves. Radio waves could have unexpected effects on the operation of such medical devices.



 NOTICE**■ Repairing or replacing tires, wheels, tire pressure warning valves, transmitters and tire valve caps**

- When removing or fitting the wheels, tires or the tire pressure warning valves and transmitters, contact your Lexus dealer as the tire pressure warning valves and transmitters may be damaged if not handled correctly.
- Make sure to install the tire valve caps. If the tire valve caps are not installed, water could enter the tire pressure warning valves and the tire pressure warning valves could be bound.
- When replacing tire valve caps, do not use tire valve caps other than those specified. The cap may become stuck.

**■ To avoid damage to the tire pressure warning valves and transmitters**

When a tire is repaired with liquid sealants, the tire pressure warning valve and transmitter may not operate properly. If a liquid sealant is used, contact your Lexus dealer or other qualified service shop as soon as possible. After use of liquid sealant, make sure to replace the tire pressure warning valve and transmitter when repairing or replacing the tire. (→P. 502)

**■ Driving on rough roads**

Take particular care when driving on roads with loose surfaces or potholes. These conditions may cause losses in tire inflation pressure, reducing the cushioning ability of the tires. In addition, driving on rough roads may cause damage to the tires themselves, as well as the vehicle's wheels and body.

**■ Low profile tires**

Low profile tires may cause greater damage than usual to the tire wheel when sustaining impact from the road surface. Therefore, pay attention to the following:

- Be sure to use proper tire inflation pressure. If tires are under-inflated, they may be damaged more severely.
- Avoid potholes, uneven pavement, curbs and other road hazards. Failure to do so may lead to severe tire and wheel damage.

**■ If tire inflation pressure of each tire becomes low while driving**

Do not continue driving, or your tires and/or wheels may be ruined.

## Tire inflation pressure

### Tire inflation pressure

The recommended cold tire inflation pressure and tire size are displayed on the tire and loading information label. (→P.630)

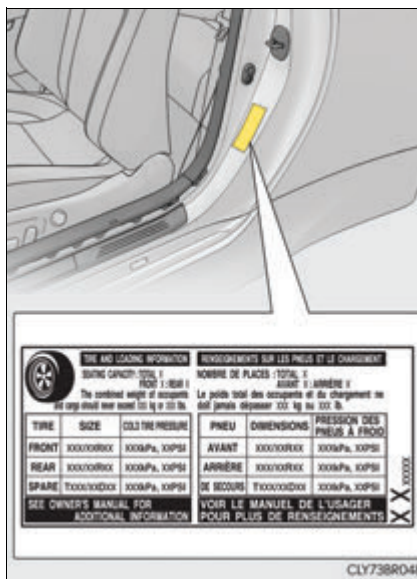

### Inspection and adjustment procedure

- ① Tire valve
- ② Tire pressure gauge

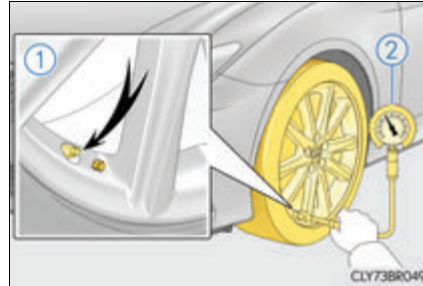

- 1 Remove the tire valve cap.
- 2 Press the tip of the tire pressure gauge onto the tire valve.
- 3 Read the pressure using the gauge gradations.
- 4 If the tire inflation pressure is not at the recommended level, adjust the pressure.  
If you add too much air, press the center of the valve to deflate.
- 5 After completing the tire inflation pressure measurement and adjustment, apply soapy water to the valve and check for leakage.
- 6 Put the tire valve cap back on.

#### ■ Tire inflation pressure check interval

You should check tire inflation pressure every two weeks, or at least once a month. Do not forget to check the spare.

#### ■ Effects of incorrect tire inflation pressure

Driving with incorrect tire inflation pressure may result in the following:

- Reduced fuel economy
- Reduced driving comfort and poor handling
- Reduced tire life due to wear
- Reduced safety
- Damage to the drivetrain

If a tire needs frequent inflating, have it checked by your Lexus dealer.

■ **Instructions for checking tire inflation pressure**

When checking tire inflation pressure, observe the following:

- Check only when the tires are cold.  
If your vehicle has been parked for at least 3 hours or has not been driven for more than 1 mile or 1.5 km, you will get an accurate cold tire inflation pressure reading.
- Always use a tire pressure gauge.  
It is difficult to judge if a tire is properly inflated based only on its appearance.
- It is normal for the tire inflation pressure to be higher after driving as heat is generated in the tire. Do not reduce tire inflation pressure after driving.
- Never exceed the vehicle capacity weight.  
Passengers and luggage weight should be placed so that the vehicle is balanced.

 **WARNING**

■ **Proper inflation is critical to save tire performance**

Keep your tires properly inflated.

If the tires are not properly inflated, the following conditions may occur which could lead to an accident resulting in death or serious injury:

- Excessive wear
- Uneven wear
- Poor handling
- Possibility of blowouts resulting from overheated tires
- Air leaking from between tire and wheel
- Wheel deformation and/or tire damage
- Greater possibility of tire damage while driving (due to road hazards, expansion joints, sharp edges in the road, etc.)

 **NOTICE**

■ **When inspecting and adjusting tire inflation pressure**

Be sure to put the tire valve caps back on.

If a valve cap is not installed, dirt or moisture may get into the valve and cause an air leak, resulting in decreased tire inflation pressure.

## Wheels

If a wheel is bent, cracked or heavily corroded, it should be replaced. Otherwise, the tire may separate from the wheel or cause a loss of handling control.

### Wheel selection

When replacing wheels, care should be taken to ensure that they are equivalent to those removed in load capacity, diameter, rim width and inset\*.

Replacement wheels are available at your Lexus dealer.

\*: Conventionally referred to as "offset".

Lexus does not recommend using the following:

- Wheels of different sizes or types
- Used wheels
- Bent wheels that have been straightened

### Aluminum wheel precautions

- Use only Lexus wheel nuts and wrenches designed for use with your aluminum wheels.
- When rotating, repairing or changing your tires, check that the wheel nuts are still tight after driving 1000 miles (1600 km).
- Be careful not to damage the aluminum wheels when using tire chains.
- Use only Lexus genuine balance weights or equivalent and a plastic or rubber hammer when balancing your wheels.

#### ■ When replacing wheels

The wheels of your vehicle are equipped with tire pressure warning valves and transmitters that allow the tire pressure warning system to provide advance warning in the event of a loss in tire inflation pressure. Whenever wheels are replaced, tire pressure warning valves and transmitters must be installed. (→P. 502)

 **WARNING**

■ **When replacing wheels**

- Do not use wheels that are a different size from those recommended in the Owner's Manual, as this may result in a loss of handling control.
- Never use an inner tube in a leaking wheel which is designed for a tubeless tire. Doing so may result in an accident, causing death or serious injury.

 **NOTICE**

■ **Replacing tire pressure warning valves and transmitters**

- Because tire repair or replacement may affect the tire pressure warning valves and transmitters, make sure to have tires serviced by your Lexus dealer or other qualified service shop. In addition, make sure to purchase your tire pressure warning valves and transmitters at your Lexus dealer.
- Ensure that only genuine Lexus wheels are used on your vehicle. Tire pressure warning valves and transmitters may not work properly with non-genuine wheels.

## Air conditioning filter

The air conditioning filter must be changed regularly to maintain air conditioning efficiency.

### Removal method

- 1 Turn the engine switch off.
- 2 Open the glove box. Lift up the side with the stay, disconnect the stay tabs and remove the partition by pulling horizontally.
- 3 Press the tabs and remove the filter cover.
- 4 Press the tabs and remove the filter case.

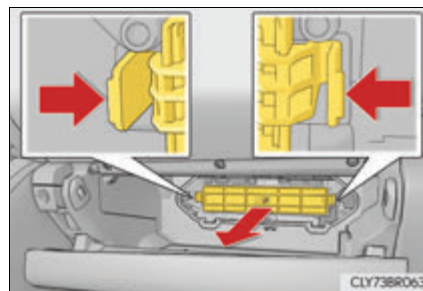
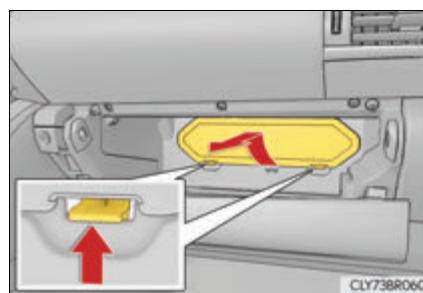
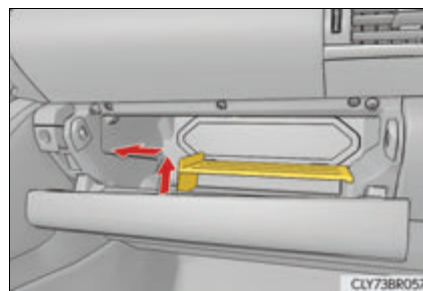

## 516 7-3. Do-it-yourself maintenance

- 5 Remove the air conditioning filter from the filter case and replace it with a new one.

The “↑UP” marks shown on the filter and the filter case should be pointing up.

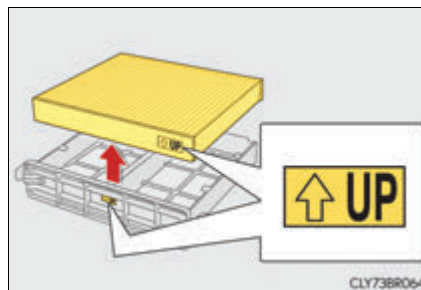

### ■ Checking interval

Inspect and replace the air conditioning filter according to the maintenance schedule. In dusty areas or areas with heavy traffic flow, early replacement may be required. (For scheduled maintenance information, please refer to the “Owner’s Manual Supplement” or “Scheduled Maintenance”.)

### ■ If air flow from the vents decreases dramatically

The filter may be clogged. Check the filter and replace if necessary.

### ⚠ NOTICE

#### ■ When using the air conditioning system

Make sure that a filter is always installed.

Using the air conditioning system without a filter may cause damage to the system.



## Electronic key battery

Replace the battery with a new one if it is depleted.

### You will need the following items:

- Flathead screwdriver
- Small flathead screwdriver
- Lithium battery CR2032

### Replacing the battery

- 1 Take out the mechanical key.

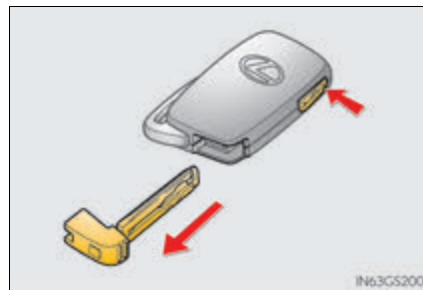

- 2 Remove the cover.  
To prevent damage to the key, wrap the tip of the screwdriver with tape.

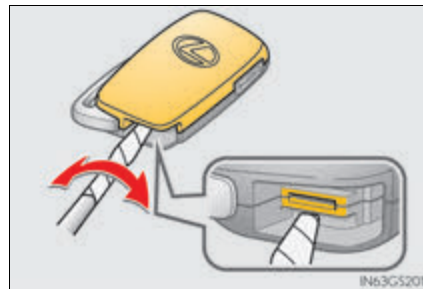

- 3 Remove the depleted battery.  
Insert a new battery with the "+" terminal facing up.

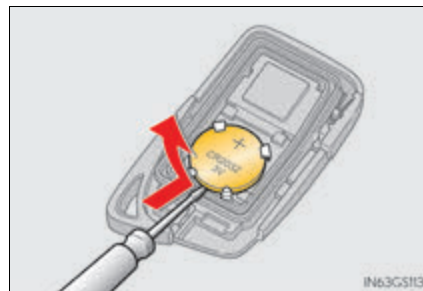

■ **Use a CR2032 lithium battery**

- Batteries can be purchased at your Lexus dealer, local electrical appliance shops or camera stores.
- Replace only with the same or equivalent type recommended by the manufacturer.
- Dispose of used batteries according to local laws.

■ **When the card key battery needs to be replaced (if equipped)**

The battery for the card key is available only at Lexus dealers. Your Lexus dealer can replace the battery for you.

■ **If the electronic key battery is depleted**

The following symptoms may occur:

- The smart access system with push-button start and wireless remote control will not function properly.
- The operational range will be reduced.

|   |
|---|
|  <b>WARNING</b>  |
| ■ <b>Removed battery and other parts</b><br>These parts are small and if swallowed by a child, they can cause choking. Keep away from children. Failure to do so could result in death or serious injury. |

|   |
|---|
|  <b>NOTICE</b>   |
| ■ <b>For normal operation after replacing the battery</b><br>Observe the following precautions to prevent accidents: <ul style="list-style-type: none"><li>● Always work with dry hands.<br/>Moisture may cause the battery to rust.</li><li>● Do not touch or move any other component inside the remote control.</li><li>● Do not bend either of the battery terminals.</li></ul> |

## Checking and replacing fuses

If any of the electrical components do not operate, a fuse may have blown. If this happens, check and replace the fuses as necessary.

- 1 Turn the engine switch off.
  - 2 Open the Fuse box cover.
    - ▶ Engine compartment: type A fuse box
- Push the tab in and lift the lid off.

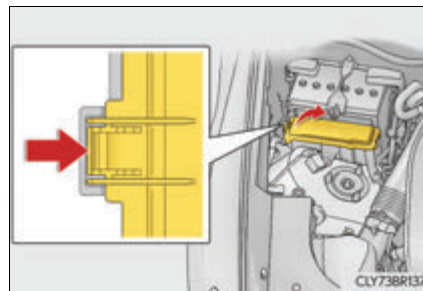

- ▶ Engine compartment: type B fuse box
- Push the tab in and lift the lid off.

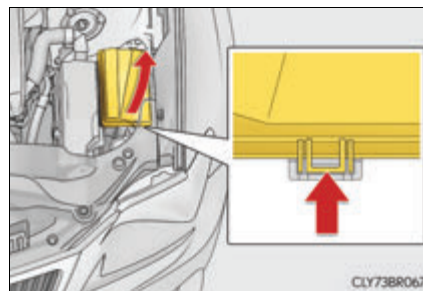

- ▶ Driver's side instrument panel
- Remove the lid.

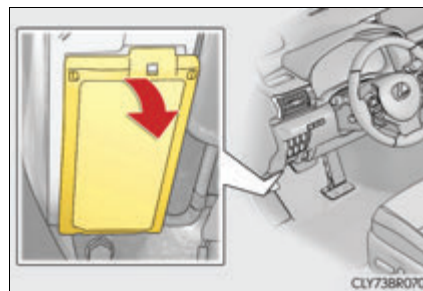

- 3 Remove the fuse with the pullout tool.

Only type A fuses can be removed using the pullout tool.

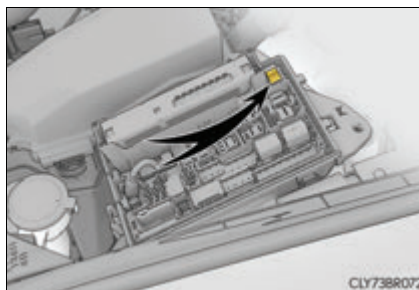

- 4 Check if the fuse is blown.

- ① Normal fuse
- ② Blown fuse

Type A and B:  
Replace the blown fuse with a new fuse of an appropriate amperage rating. The amperage rating can be found on the fuse box lid.

Type C and D:  
Contact your Lexus dealer.

► Type A

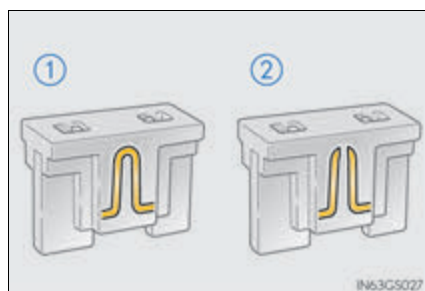

► Type B

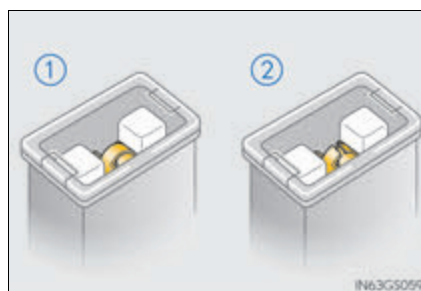

► Type C

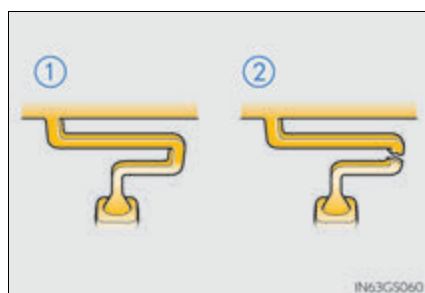

► Type D

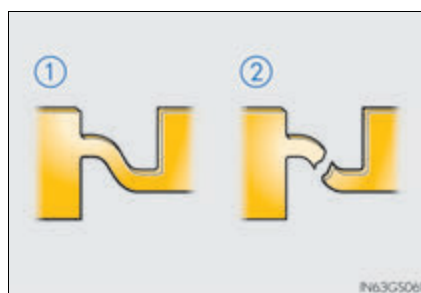

■ **After a fuse is replaced**

- If the lights do not turn on even after the fuse has been replaced, a bulb may need replacement. (→P. 522)
- If the replaced fuse blows again, have the vehicle inspected by your Lexus dealer.

■ **If there is an overload in a circuit**

The fuses are designed to blow, protecting the wiring harness from damage.

■ **When replacing light bulbs**

Lexus recommends that you use genuine Lexus products designed for this vehicle. Because certain bulbs are connected to circuits designed to prevent overload, non-genuine parts or parts not designed for this vehicle may be unusable.

 **WARNING**

■ **To prevent system breakdowns and vehicle fire**

Observe the following precautions.

Failure to do so may cause damage to the vehicle, and possibly a fire or injury.

- Never use a fuse of a higher amperage rating than that indicated, or use any other object in place of a fuse.
- Always use a genuine Lexus fuse or equivalent.  
Never replace a fuse with a wire, even as a temporary fix.
- Do not modify the fuses or fuse boxes.

 **NOTICE**

■ **Before replacing fuses**

Have the cause of electrical overload determined and repaired by your Lexus dealer as soon as possible.

## Light bulbs

You may replace the following bulbs by yourself. The difficulty level of replacement varies depending on the bulb. If necessary bulb replacement seems difficult to perform, contact your Lexus dealer.

For more information about replacing other light bulbs, contact your Lexus dealer.

### Preparing for light bulb replacement

Check the wattage of the light bulb to be replaced. (→P. 635)

**Bulb locations**

■ Front

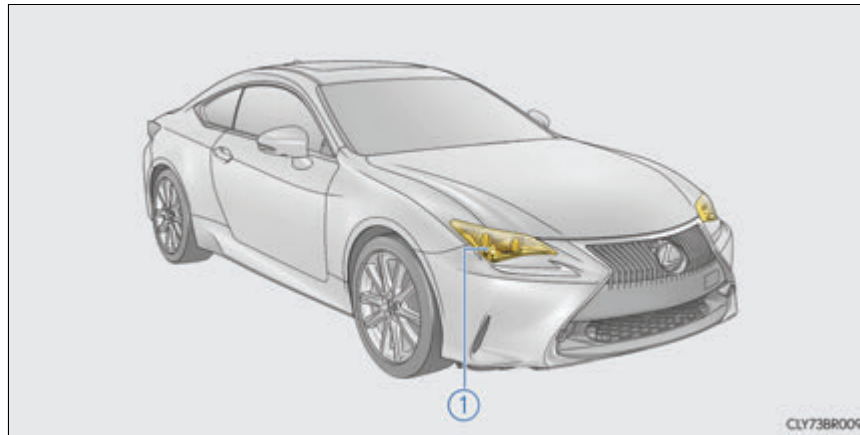

① Front turn signal light (bulb type)

■ Rear

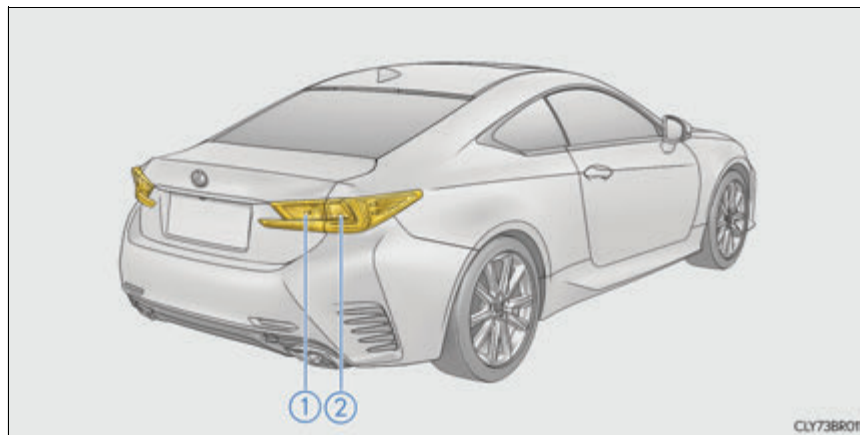

① Back-up light  
② Rear turn signal light

## Replacing light bulbs

### ■ Front turn signal lights (bulb type)

- 1** To ensure enough space to perform work, turn the steering wheel to move the front wheel toward the bulb to be replaced. Remove the fender liner clip.

To remove the clip, turn the head of the clip to unlock it, then pull it out.

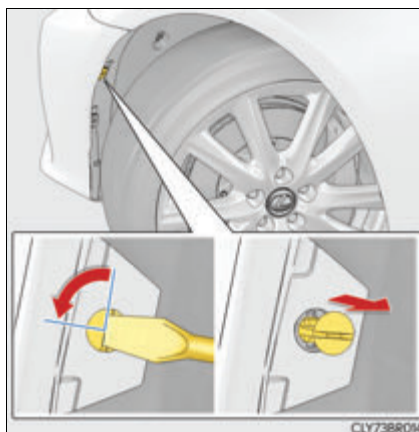

- 2** Disengage the fender liner from the clamp then pull it back.

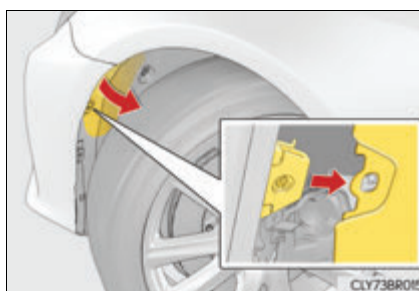

- 3** Turn the bulb base counterclockwise.

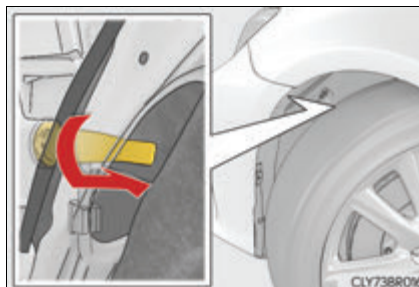



- 4 Remove the light bulb.

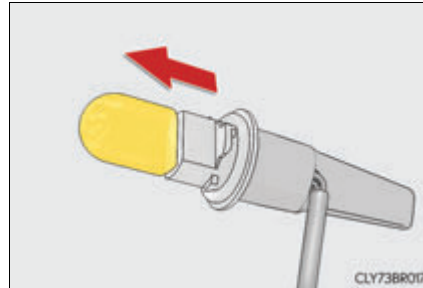

- 5 Install a new light bulb then install the bulb base to the light unit by inserting it and turning the bulb base clockwise.

After installing the light bulb, turn on the front turn signal light to visually check that there is no light leaking from the bulb base.

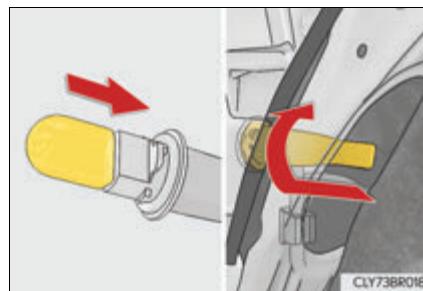

- 6 Engage the clamp to reinstall the fender liner and install the clip.

Insert the clip with its groove aligned vertically to install it.

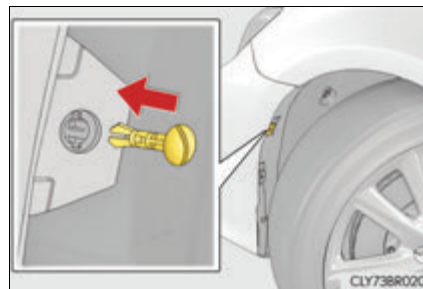

■ Rear turn signal lights

- 1 Open the trunk, remove the 2 covers and 2 screws and pull the light unit toward the rear of the vehicle to remove it.

When removing the cover, wrap the tip of the screwdriver with tape to protect the vehicle from damage.

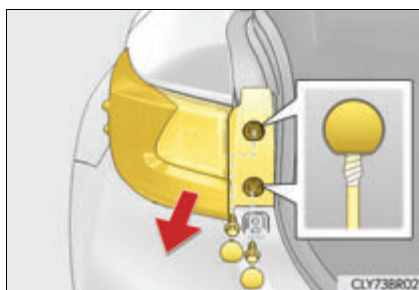

- 2 Turn the bulb base counterclockwise.

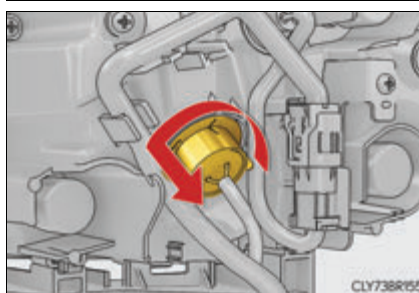

- 3 Remove the light bulb.

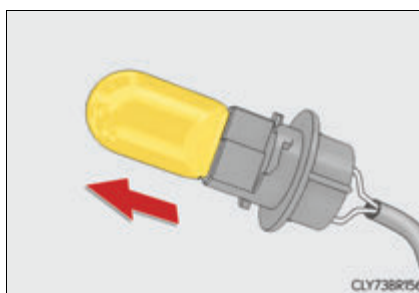

- 4 Install a new light bulb then install the bulb base to the light unit by inserting it and turning the bulb base clockwise.

After installing the light bulb, turn on the rear turn signal light to visually check that there is no light leaking from the bulb base.

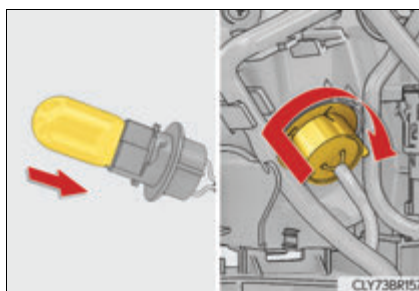

- 5 Align the tabs and push the light unit toward the front of the vehicle to install it.

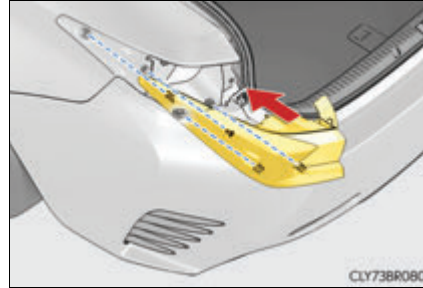

- 6 Install the 2 screws and 2 covers.

■ Back-up lights

- 1 Open the trunk, remove the 2 clips on the side which the bulb is to be replaced and pull back the trunk lid cover.

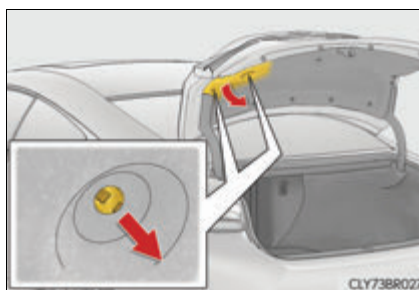

- 2 Turn the bulb base counterclockwise.

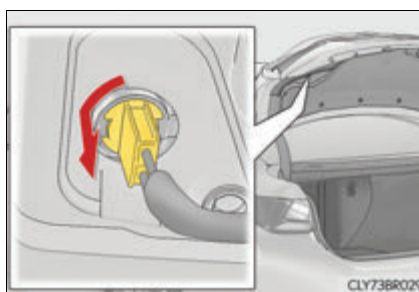

- 3 Remove the light bulb.

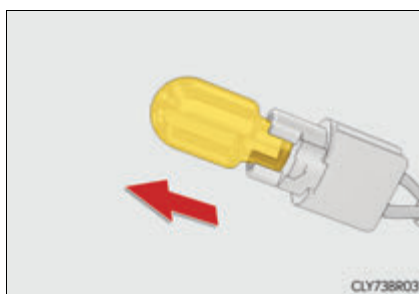

- 4 Install a new light bulb then install the bulb base to the light unit by inserting it and turning the bulb base clockwise.

After installing the light bulb, turn on the back-up light to visually check that there is no light leaking from the bulb base.

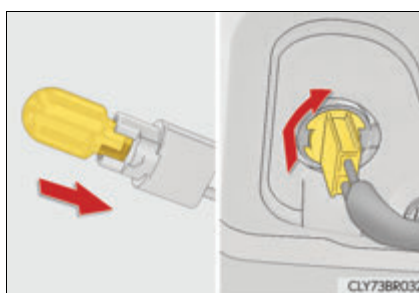

- 5 Reinstall the trunk lid cover with the 2 clips.  
To install the clips, simply push them in.

---

**■ Replacing the following bulbs**

If any of the lights listed below has burnt out, have it replaced by your Lexus dealer.

- Headlights
- Parking lights and daytime running lights
- Front turn signal lights (LED type)
- Front fog lights (if equipped)
- Side marker lights
- Side turn signal lights
- Stop/tail lights
- Stop lights
- High mounted stoplight
- License plate lights

---

**■ LED lights**

The lights other than the front turn signal lights (bulb type), rear turn signal lights and back-up lights each consist of a number of LEDs. If any of the LEDs burn out, take your vehicle to your Lexus dealer to have the light replaced.

**■ Condensation build-up on the inside of the lens**

Temporary condensation build-up on the inside of the headlight lens does not indicate a malfunction. Contact your Lexus dealer for more information in the following situations:

- Large drops of water have built up on the inside of the lens.
- Water has built up inside the headlight.

**■ When replacing light bulbs**

→P. 521

 **WARNING**

■ **Replacing light bulbs**

- Turn off the lights. Do not attempt to replace the bulb immediately after turning off the lights.  
The bulbs become very hot and may cause burns.
- Do not touch the glass portion of the light bulb with bare hands. When it is unavoidable to hold the glass portion, use and hold with a clean dry cloth to avoid getting moisture and oils on the bulb.  
Also, if the bulb is scratched or dropped, it may blow out or crack.
- Fully install light bulbs and any parts used to secure them. Failure to do so may result in heat damage, fire, or water entering the headlight unit. This may damage the headlights or cause condensation to build up on the lens.

■ **To prevent damage or fire**

- Make sure bulbs are fully seated and locked.
- Check the wattage of the bulb before installing to prevent heat damage.

## When trouble arises

## 8

**8-1. Essential information**

|   |     |
|---|-----|
| Emergency flashers.....                                       | 532 |
| If your vehicle has to be<br>stopped in an<br>emergency ..... | 533 |

**8-2. Steps to take in an emergency**

|  |     |
|--|-----|
| If your vehicle needs to be<br>towed .....   | 534 |
| If you think something is<br>wrong .....   | 541 |
| Fuel pump shut off system .....  | 542 |
| If a warning light turns on or<br>a warning buzzer<br>sounds.....                            | 543 |
| If a warning message is<br>displayed.....  | 549 |
| If you have a flat tire<br>(vehicles with a spare<br>tire).....                              | 570 |
| If you have a flat tire<br>(vehicles with an<br>emergency tire puncture<br>repair kit) ..... | 584 |
| If the engine will not start .....   | 597 |
| If the shift lever cannot be<br>shifted from P.....  | 599 |
| If the electronic key does<br>not operate properly .....                                     | 600 |
| If the vehicle battery is<br>discharged .....  | 604 |
| If your vehicle overheats .....  | 608 |
| If the vehicle becomes<br>stuck .....  | 614 |

## Emergency flashers

The emergency flashers are used to warn other drivers when the vehicle has to be stopped in the road due to a breakdown, etc.

Press the switch.

All the turn signals will flash.  
To turn them off, press the switch once again.

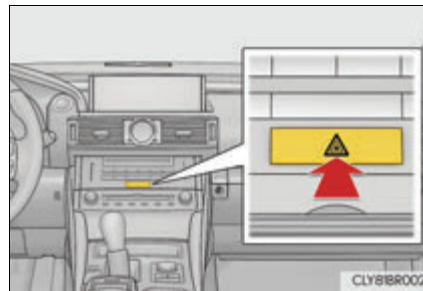

### ■ Emergency flashers

If the emergency flashers are used for a long time while the engine is not operating, the battery may discharge.



## If your vehicle has to be stopped in an emergency

Only in an emergency, such as if it becomes impossible to stop the vehicle in the normal way, stop the vehicle using the following procedure:

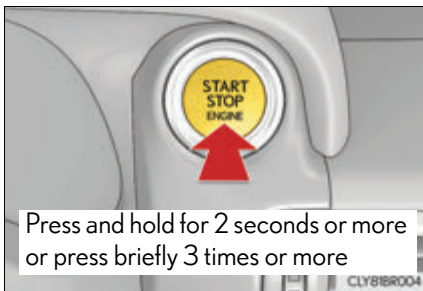
- 1 Steadily step on the brake pedal with both feet and firmly depress it.  
Do not pump the brake pedal repeatedly as this will increase the effort required to slow the vehicle.
  - 2 Shift the shift lever to N.
    - ▶ If the shift lever is shifted to N
  - 3 After slowing down, stop the vehicle in a safe place by the road.
  - 4 Stop the engine.
    - ▶ If the shift lever cannot be shifted to N
  - 3 Keep depressing the brake pedal with both feet to reduce vehicle speed as much as possible.
  - 4 To stop the engine, press and hold the engine switch for 2 consecutive seconds or more, or press it briefly 3 times or more in succession.
- 
- Press and hold for 2 seconds or more or press briefly 3 times or more
- 5 Stop the vehicle in a safe place by the road.

### WARNING

#### ■ If the engine has to be turned off while driving

Power assist for the brakes and steering wheel will be lost, making the brake pedal harder to depress and the steering wheel heavier to turn. Decelerate as much as possible before turning off the engine.

### If your vehicle needs to be towed

If towing is necessary, we recommend having your vehicle towed by your Lexus dealer or commercial towing service, using a wheel-lift type truck or flatbed truck.

Use a safety chain system for all towing, and abide by all state/provincial and local laws.

### Situations when it is necessary to contact dealers before towing

The following may indicate a problem with your transmission. Contact your Lexus dealer or commercial towing service before towing.

- The engine is running but the vehicle does not move.
- The vehicle makes an abnormal sound.

**Towing with a sling-type truck**

Do not tow with a sling-type truck to prevent body damage.

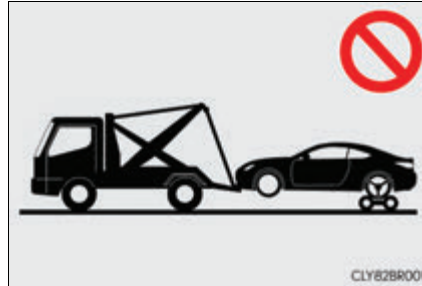
**Towing with a wheel-lift type truck**

▶ From the front

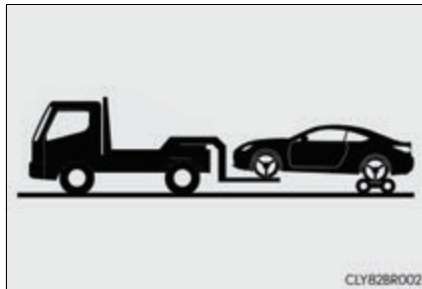

Use a towing dolly under the rear wheels.

▶ From the rear

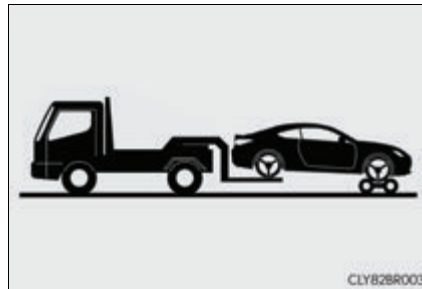

Use a towing dolly under the front wheels.

### Using a flatbed truck

If your vehicle is transported by a flatbed truck, it should be tied down at the locations shown in the illustration.

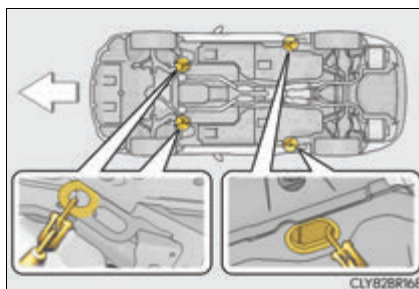

If you use chains or cables to tie down your vehicle, the angles shaded in black must be 45°.

Do not overly tighten the tie downs or the vehicle may be damaged.

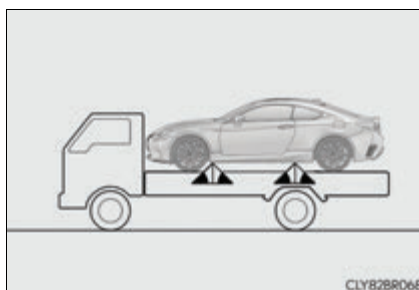

### Emergency towing

If a tow truck is not available in an emergency, your vehicle may be temporarily towed using cables or chains secured to the emergency towing eyelets. This should only be attempted on hard surfaced roads for at most 50 miles (80 km) at under 18 mph (30 km/h).

A driver must be in the vehicle to steer and operate the brakes. The vehicle's wheels, drive train, axles, steering and brakes must be in good condition.

### Emergency towing procedure

- 1 Take out the towing eyelet. (→P. 571, 585)
- 2 Remove the eyelet cover using a flathead screwdriver.

To protect the bodywork, place a rag between the screwdriver and the vehicle body as shown in the illustration.

- ▶ RC350/RC300/RC200t  
(except F SPORT models)

- ▶ RC350/RC300/RC200t  
(F SPORT models)

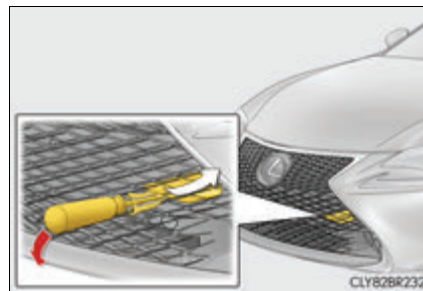
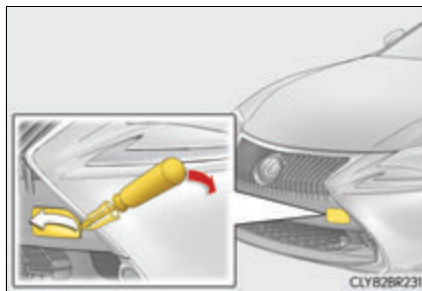

- ▶ RC F

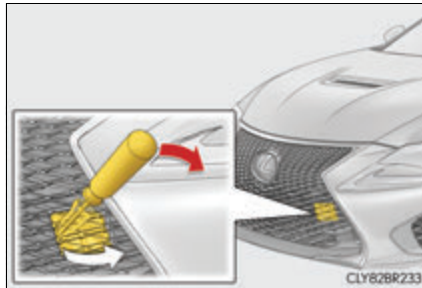

**538** 8-2. Steps to take in an emergency

- 3 Insert the towing eyelet into the hole and tighten partially by hand.

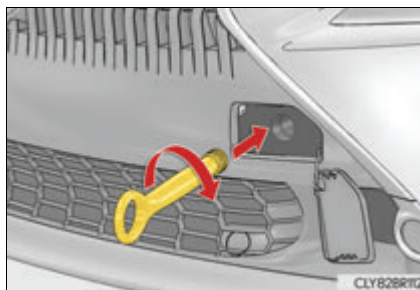

- 4 Tighten down the towing eyelet securely using a wheel nut wrench or hard metal bar.

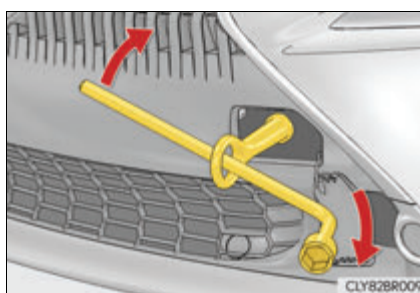

- 5 Securely attach cables or chains to the towing eyelet.  
Take care not to damage the vehicle body.
- 6 Enter the vehicle being towed and start the engine.  
If the engine does not start, turn the engine switch to IGNITION ON mode.
- 7 Shift the shift lever to N and release the parking brake.  
When the shift lever cannot be shifted: →P. 599

■ **While towing**

If the engine is not running, the power assist for the brakes and steering will not function, making steering and braking more difficult.

■ **Wheel nut wrench**

Wheel nut wrench is installed in trunk. (→P. 571, 585)

**⚠ WARNING**

Observe the following precautions.  
Failure to do so may result in death or serious injury.

**■ When towing the vehicle**

## ▶ 2WD models

Be sure to transport the vehicle with all four wheels raised off the ground. If the vehicle is towed with the tires contacting the ground, the drivetrain and related parts may be damaged or an accident may occur due to a change in direction of the vehicle.

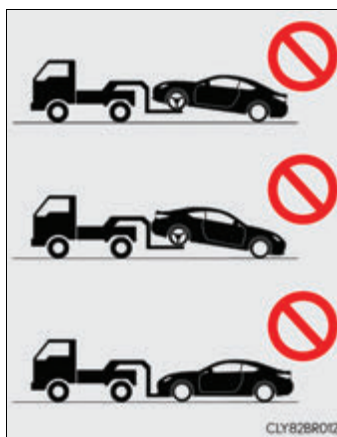

## ▶ AWD models

Be sure to transport the vehicle with all four wheels raised off the ground. If the vehicle is towed with the tires contacting the ground, the drivetrain or related parts may be damaged, the vehicle may fly off the truck.

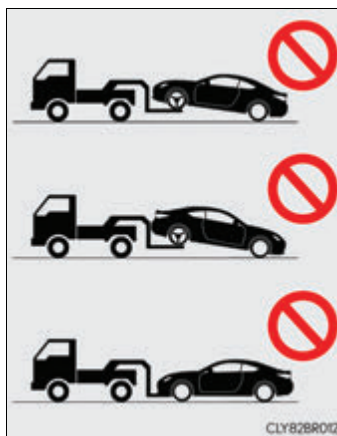

 **WARNING****■ While towing**

- When towing using cables or chains, avoid sudden starts, etc. which place excessive stress on the towing eyelets, cables or chains. The towing eyelets, cables or chains may become damaged, broken debris may hit people, and cause serious damage.
- Do not turn the engine switch off.  
There is a possibility that the steering wheel is locked and cannot be operated.

**■ Installing towing eyelets to the vehicle**

Make sure that towing eyelets are installed securely.  
If not securely installed, towing eyelets may come loose during towing.

 **NOTICE****■ To prevent damage to the vehicle when towing using a wheel-lift type truck**

- Do not tow the vehicle from the rear when the engine switch is off. The steering lock mechanism is not strong enough to hold the front wheels straight.
- When raising the vehicle, ensure adequate ground clearance for towing at the opposite end of the raised vehicle. Without adequate clearance, the vehicle could be damaged while being towed.

**■ To prevent damage to the vehicle when towing with a sling-type truck**

Do not tow with a sling-type truck, either from the front or rear.

**■ To prevent damage to the vehicle during emergency towing**

Do not secure cables or chains to the suspension components.



## If you think something is wrong

If you notice any of the following symptoms, your vehicle probably needs adjustment or repair. Contact your Lexus dealer as soon as possible.

### Visible symptoms

- Fluid leaks under the vehicle.  
(Water dripping from the air conditioning after use is normal.)
- Flat-looking tires or uneven tire wear
- Engine coolant temperature gauge continually points higher than normal.

### Audible symptoms

- Changes in exhaust sound
- Excessive tire squeal when cornering
- Strange noises related to the suspension system
- Pinging or other noises related to the engine

### Operational symptoms

- Engine missing, stumbling or running roughly
- Appreciable loss of power
- Vehicle pulls heavily to one side when braking
- Vehicle pulls heavily to one side when driving on a level road
- Loss of brake effectiveness, spongy feeling, pedal almost touches the floor

## Fuel pump shut off system

To minimize the risk of fuel leakage when the engine stalls or when an airbag inflates upon collision, the fuel pump shut off system stops the supply of fuel to the engine.

Follow the procedure below to restart the engine after the system is activated.

- 1 Turn the engine switch to ACCESSORY mode or turn it off.
- 2 Restart the engine.

 NOTICE

■ **Before starting the engine**









Inspect the ground under the vehicle.









If you find that fuel has leaked onto the ground, the fuel system has been damaged and is in need of repair. Do not restart the engine.

## If a warning light turns on or a warning buzzer sounds

Calmly perform the following actions if any of the warning lights comes on or flashes. If a light comes on or flashes, but then goes off, this does not necessarily indicate a malfunction in the system. However, if this continues to occur, have the vehicle inspected by your Lexus dealer.

### Warning light and warning buzzer list

| Warning light  | Warning light/Details/Actions   |
|--|---|
| <br>(U.S.A.)<br><br>(Canada)    | <b>Brake system warning light (warning buzzer)*<sup>1</sup></b><br>Indicates that: <ul style="list-style-type: none"> <li>• The brake fluid level is low; or</li> <li>• The brake system is malfunctioning</li> </ul> RC350/RC300/RC200t: This light also comes on when the parking brake is not released. If the light turns off after the parking brake is fully released the system is operating normally.<br>→ <b>Immediately stop the vehicle in a safe place and contact your Lexus dealer. Continuing to drive the vehicle may be dangerous.</b> |
|   | <b>Charging system warning light</b><br>Indicates a malfunction in the vehicle's charging system<br>→ <b>Immediately stop the vehicle in a safe place and contact your Lexus dealer.</b>  |
| <br>(U.S.A.)<br><br>(Canada) | <b>Malfunction indicator lamp</b><br>Indicates a malfunction in: <ul style="list-style-type: none"> <li>• The electronic engine control system;</li> <li>• The electronic throttle control system; or</li> <li>• The electronic automatic transmission control system</li> </ul> → <b>Have the vehicle inspected by your Lexus dealer immediately.</b>  |
|   | <b>SRS warning light</b><br>Indicates a malfunction in: <ul style="list-style-type: none"> <li>• The SRS airbag system;</li> <li>• The front passenger occupant classification system; or</li> <li>• The seat belt pretensioner system</li> </ul> → <b>Have the vehicle inspected by your Lexus dealer immediately.</b>   |
| <br>(U.S.A.)<br><br>(Canada) | <b>ABS warning light</b><br>Indicates a malfunction in: <ul style="list-style-type: none"> <li>• The ABS; or</li> <li>• The brake assist system</li> </ul> → <b>Have the vehicle inspected by your Lexus dealer immediately.</b>  |

| Warning light   | Warning light/Details/Actions   |
|---|---|
|    | <p><b>Electric power steering system warning light (warning buzzer)</b><br/>                     Indicates a malfunction in the EPS (Electric Power Steering) system<br/>                     → <b>Have the vehicle inspected by your Lexus dealer immediately.</b></p>   |
|    | <p><b>Pre-collision system warning light</b><br/>                     Indicates a malfunction in the PCS (Pre-Collision System)<br/>                     The warning light will operate as follows, even when the system is not malfunctioning:</p> <ul style="list-style-type: none"> <li>• The light will flash quickly when the system is operating. (→P. 295)</li> <li>• The light will turn on when the pre-collision system is disabled. (→P. 296)</li> <li>• The light will turn on when the VSC (Vehicle Stability Control) system is disabled. (→P. 290)</li> <li>• The light will flash when the system cannot temporarily be used. (→P. 563)</li> </ul> <p>→ <b>Have the vehicle inspected by your Lexus dealer immediately.</b></p> |
|  | <p><b>Slip indicator</b><br/>                     Indicates a malfunction in:</p> <ul style="list-style-type: none"> <li>• The VSC (Vehicle Stability Control) system;</li> <li>• The TRAC (Traction Control) system; or</li> <li>• The hill-start assist control system</li> </ul> <p>The light will flash when the VSC or the TRAC system is operating.<br/>                     → <b>Have the vehicle inspected by your Lexus dealer immediately.</b></p>  |
|  | <p><b>Automatic headlight leveling system warning light</b><br/>                     Indicates a malfunction in the automatic headlight leveling system<br/>                     → <b>Have the vehicle inspected by your Lexus dealer immediately.</b></p>  |
|  | <p><b>Open door warning light (warning buzzer)*2</b><br/>                     Indicates that a door or the trunk is not fully closed<br/>                     → <b>Check that both side doors and the trunk are closed.</b></p>   |
|  | <p><b>Low fuel level warning light</b><br/>                     Indicates that remaining fuel is approximately 2.6 gal. (10 L, 2.2 Imp. gal.) or less<br/>                     → <b>Refuel the vehicle.</b></p>   |
|  | <p><b>Seat belt reminder light (warning buzzer)*3</b><br/>                     Warns the driver and/or front passenger to fasten their seat belts<br/>                     → <b>Fasten the seat belt.</b><br/>                     If the front passenger's seat is occupied, the front passenger's seat belt also needs to be fastened to make the warning light (warning buzzer) turn off.</p>  |
|  | <p><b>Master warning light</b><br/>                     A buzzer sounds and the warning light comes on and flashes to indicate that the master warning system has detected a malfunction.<br/>                     → <b>P. 549</b></p>  |

| Warning light   | Warning light/Details/Actions   |
|---|---|
|  | <p><b>Tire pressure warning light</b><br/>           When the light comes on:<br/>           Low tire inflation pressure such as</p> <ul style="list-style-type: none"> <li>• Natural causes (→P. 546)</li> <li>• Flat tire (→P. 570, 584)</li> </ul> <p>→ <b>Adjust the tire inflation pressure to the specified level.</b><br/> <b>The light will turn off after a few minutes. In case the light does not turn off even if the tire inflation pressure is adjusted, have the system checked by your Lexus dealer.</b></p> <p>When the light comes on after blinking for 1 minute:<br/>           Malfunction in the tire pressure warning system<br/>           → <b>Have the system checked by your Lexus dealer.</b></p> |

\*1: Parking brake engaged warning buzzer (RC350/RC300/RC200t):

→P. 553

\*2: Open door warning buzzer:

→P. 551

\*3: Driver's seat belt buzzer:

The driver's seat belt buzzer sounds to alert the driver that his or her seat belt is not fastened. Once the engine switch is turned to IGNITION ON mode, the buzzer sounds for 6 seconds. If the vehicle reaches a speed of 12 mph (20 km/h), the buzzer sounds once. If the seat belt is still unfastened after 24 seconds, the buzzer will sound intermittently for 10 seconds. Then, if the seat belt is still unfastened, the buzzer will sound in a different tone for 20 more seconds.

Front passenger's seat belt buzzer:

The front passenger's seat belt buzzer sounds to alert the front passenger that his or her seat belt is not fastened. The buzzer sounds once if the vehicle reaches a speed of 12 mph (20 km/h). If the seat belt is still unfastened after 24 seconds, the buzzer will sound intermittently for 10 seconds. Then, if the seat belt is still unfastened, the buzzer will sound in a different tone for 20 more seconds.

**■ SRS warning light**

This warning light system monitors the airbag sensor assembly, front impact sensors, side impact sensors (door), side impact sensors (front), side impact sensors (rear), driver's seat position sensor, driver's seat belt buckle switch, front passenger occupant classification system, "AIR BAG ON" indicator light, "AIR BAG OFF" indicator light, front passenger's seat belt buckle switch, seat belt pretensioners, airbags, interconnecting wiring and power sources. (→P. 41)

**■ Front passenger detection sensor, seat belt reminder and warning buzzer**

If luggage is placed on the front passenger seat, the front passenger detection sensor may cause the warning light to flash and the warning buzzer to sound even if a passenger is not sitting in the seat.

**■ If the malfunction indicator lamp comes on while driving**

First check the following:

- Is the fuel tank empty?  
If it is, fill the fuel tank immediately.
- Is the fuel tank cap loose?  
If it is, tighten it securely.

The light will go off after several driving trips.

If the light does not go off even after several trips, contact your Lexus dealer as soon as possible.

**■ Electric power steering system warning light (warning buzzer)**

When the battery charge becomes insufficient or the voltage temporarily drops, the electric power steering system warning light may come on and the warning buzzer may sound.

**■ When the tire pressure warning light comes on**

Check the tire inflation pressure and adjust to the appropriate level. Pushing the tire pressure warning reset switch will not turn off the tire pressure warning light.

**■ The tire pressure warning light may come on due to natural causes**

The tire pressure warning light may come on due to natural causes such as natural air leaks and tire inflation pressure changes caused by temperature. In this case, adjusting the tire inflation pressure will turn off the warning light (after a few minutes).

**■ When a tire is replaced with the spare tire (if equipped)**

The spare tire is not equipped with a tire pressure warning valve and transmitter. If a tire goes flat, the tire pressure warning light will not turn off even though the flat tire has been replaced with the spare tire.

**■ Conditions that the tire pressure warning system may not function properly**

→P. 506

**■ If the tire pressure warning light frequently comes on after blinking for 1 minute**

If the tire pressure warning light frequently comes on after blinking for 1 minute when the engine switch is turned to IGNITION ON mode, have it checked by your Lexus dealer.

**■ Warning buzzer**

In some cases, the buzzer may not be heard due to being in a noisy location or audio sound.

**⚠ WARNING****■ If both the ABS and the brake system warning lights remain on**

Stop your vehicle in a safe place immediately and contact your Lexus dealer. The vehicle will become extremely unstable during braking, and the ABS system may fail, which could cause an accident resulting in death or serious injury.

**■ When the electric power steering system warning light comes on**

The steering wheel may become extremely heavy.  
If the steering wheel becomes heavier than usual when operating, hold firmly and operate using more force than usual.

**■ If the tire pressure warning light comes on**

Be sure to observe the following precautions. Failure to do so could cause a loss of vehicle control and result in death or serious injury.

**▶ Vehicles with a spare tire**

● Stop your vehicle in a safe place as soon as possible. Adjust the tire inflation pressure immediately.

● If the tire pressure warning light comes on even after tire inflation pressure adjustment, it is probable that you have a flat tire. Check the tires. If a tire is flat, change it with the spare tire and have the flat tire repaired by the nearest Lexus dealer.

● Avoid abrupt maneuvering and braking. If the vehicle tires deteriorate, you could lose control of the steering wheel or the brakes.

**▶ Vehicles with an emergency tire puncture repair kit**

● Stop your vehicle in a safe place as soon as possible. Adjust the tire inflation pressure immediately.

● If the tire pressure warning light comes on even after tire inflation pressure adjustment, it is probable that you have a flat tire. Check the tires. If a tire is flat, repair the flat tire by using emergency tire puncture repair kit.

● Avoid abrupt maneuvering and braking. If the vehicle tires deteriorate, you could lose control of the steering wheel or the brakes.

**■ If a blowout or sudden air leakage should occur**

The tire pressure warning system may not activate immediately.

 **WARNING****■ Maintenance of the tires**

Each tire, including the spare (if provided), should be checked monthly when cold and inflated to the inflation pressure recommended by the vehicle manufacturer on the vehicle placard or tire inflation pressure label (tire and load information label). (If your vehicle has tires of a different size than the size indicated on the vehicle placard or tire inflation pressure label [tire and load information label], you should determine the proper tire inflation pressure for those tires.)

As an added safety feature, your vehicle has been equipped with a tire pressure monitoring system (TPMS-tire pressure warning system) that illuminates a low tire pressure telltale (tire pressure warning light) when one or more of your tires is significantly under-inflated. Accordingly, when the low tire pressure telltale (tire pressure warning light) illuminates, you should stop and check your tires as soon as possible, and inflate them to the proper pressure. Driving on a significantly under-inflated tire causes the tire to overheat and can lead to tire failure. Under-inflation also reduces fuel efficiency and tire tread life, and may affect the vehicle's handling and stopping ability.

Please note that the TPMS (tire pressure warning system) is not a substitute for proper tire maintenance, and it is the driver's responsibility to maintain correct tire pressure, even if under-inflation has not reached the level to trigger illumination of the TPMS low tire pressure telltale (tire pressure warning light).

Your vehicle has also been equipped with a TPMS (tire pressure warning system) malfunction indicator to indicate when the system is not operating properly. The TPMS (tire pressure warning system) malfunction indicator is combined with the low tire pressure telltale (tire pressure warning light). When the system detects a malfunction, the telltale will flash for approximately one minute and then remain continuously illuminated. This sequence will continue upon subsequent vehicle start-ups as long as the malfunction exists. When the malfunction indicator is illuminated, the system may not be able to detect or signal low tire pressure as intended.

TPMS (tire pressure warning system) malfunctions may occur for a variety of reasons, including the installation of replacement or alternate tires or wheels on the vehicle that prevent the TPMS (tire pressure warning system) from functioning properly. Always check the TPMS (tire pressure warning system) malfunction telltale after replacing one or more tires or wheels on your vehicle to ensure that the replacement or alternate tires and wheels allow the TPMS (tire pressure warning system) to continue to function properly.

 **NOTICE****■ To ensure the tire pressure warning system operates properly**

Do not install tires with different specifications or makers, as the tire pressure warning system may not operate properly.



## If a warning message is displayed

If a warning is shown on the multi-information display, stay calm and perform the following actions:

- ▶ RC350/RC300/RC200t (except F SPORT models)
- ▶ RC350/RC300/RC200t (F SPORT models: main meter in center position)













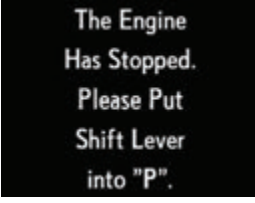





- ▶ RC350/RC300/RC200t (F SPORT models: main meter moved to the right)
- ▶ RC F

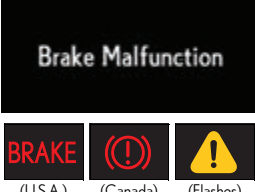









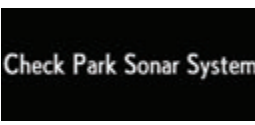

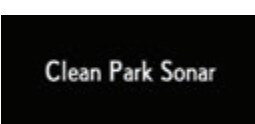

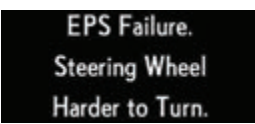

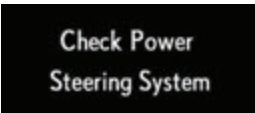





- ① Master warning light  
The master warning light also comes on or flashes in order to indicate that a message is currently being displayed on the multi-information display.
- ② Multi-information display  
If any of the warning messages is shown again after the following actions have been performed, contact your Lexus dealer.









## Warning message and warning buzzer list



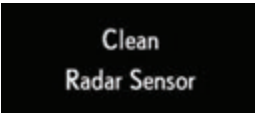



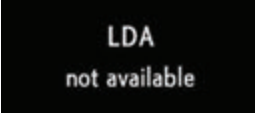

| Warning message  | Details/Actions  |
|--|--|
| <br><br>(Flashes)<br>(If equipped) | Indicates that: <ul style="list-style-type: none"> <li>• There is a high possibility of a frontal collision; or</li> <li>• The pre-collision braking function is operating</li> </ul> A buzzer also sounds.<br>→ <b>Slow the vehicle by applying the brakes.</b> |
| <br><br>(Flashes)               | Indicates that the engine was stopped with the shift lever not in P<br>A buzzer also sounds.<br>→ <b>Shift the shift lever to P.</b>   |
| <br><br>(Flashes)              | Indicates that the engine was stopped while driving<br>A buzzer also sounds.<br>→ <b>Stop the vehicle in a safe place such as the shoulder of a road.</b>  |
| <br>(If equipped)   | Indicates that your vehicle is nearing the vehicle ahead (in vehicle-to-vehicle distance mode)<br>A buzzer also sounds.<br>→ <b>Slow the vehicle by applying the brakes.</b>   |

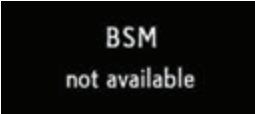







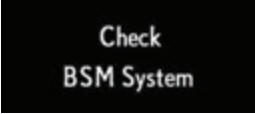

| Warning message   | Details/Actions  |
|---|--|
|  <p>(If equipped)</p>  | <p>Alerts the driver that the vehicle has deviated from the lane (while the LDA [Lane Departure Alert] system is operating)</p> <p>The lane line on the side the vehicle has deviated from flashes in yellow.</p> <p>The warning buzzer sounds continuously.</p> <p>→ <b>Check around the vehicle and back to inside of the lane lines.</b></p>  |
| <p><b>Brake Malfunction</b></p>  <p>(U.S.A.) (Canada) (Flashes)</p>                    | <p>Indicates that:</p> <ul style="list-style-type: none"> <li>• The brake fluid level is low; or</li> <li>• The brake system is malfunctioning</li> </ul> <p>A buzzer also sounds.</p> <p>→ <b>Immediately stop the vehicle in a safe place and contact your Lexus dealer. Continuing to drive the vehicle may be dangerous.</b></p>   |
|    | <p>Indicates that one or more of the doors is not fully closed</p> <p>The system also indicates which doors are not fully closed.</p> <p>If the vehicle reaches a speed of 3 mph (5 km/h),  flashes and a buzzer sounds to indicate that the door(s) are not yet fully closed.</p> <p>→ <b>Make sure that both side doors are closed.</b></p> |
|    | <p>Indicates that the hood is not fully closed</p> <p>If the vehicle reaches a speed of 3 mph (5 km/h),  flashes and a buzzer sounds to indicate that the hood is not yet fully closed.</p> <p>→ <b>Close the hood.</b></p>   |
|   | <p>Indicates that the trunk is not fully closed</p> <p>If the vehicle reaches a speed of 3 mph (5 km/h),  flashes and a buzzer sounds to indicate that the trunk is not yet fully closed.</p> <p>→ <b>Close the trunk.</b></p>  |

| Warning message   | Details/Actions  |
|---|--|
| <br><br><br>(If equipped)  | <p>Indicates a malfunction in the intuitive parking assist-sensor<br/>           A buzzer also sounds.<br/>           → <b>Have the vehicle inspected by your Lexus dealer.</b></p>      |
| <br><br><br>(If equipped)   | <p>Indicates that an intuitive parking assist-sensor is dirty or covered with ice<br/>           A buzzer also sounds.<br/>           → <b>Clean the sensor.</b></p>                     |
| <br><br><br><br> | <p>Indicates a malfunction in the EPS (Electric Power Steering) system<br/>           A buzzer also sounds.<br/>           → <b>Have the vehicle inspected by your Lexus dealer.</b></p> |

| Warning message   | Details/Actions  |
|---|--|
| <p data-bbox="395 472 651 584"><b>Release Parking Brake</b></p> <p data-bbox="384 589 592 645">▶ RC350/RC300/RC200t</p> <div data-bbox="395 667 651 745">    </div> <p data-bbox="384 750 464 779">▶ RC F</p> <div data-bbox="395 801 651 880">    </div> | <p data-bbox="675 618 1233 674">Indicates that the vehicle is being driven at 3 mph (5 km/h) or more with the parking brake still engaged.</p> <p data-bbox="675 678 978 723">A buzzer also sounds.</p> <p data-bbox="675 696 978 723">→ <b>Release the parking brake.</b></p>   |
| <p data-bbox="395 913 651 1070"><b>1st Gear not available due to slippery road surface</b></p> <div data-bbox="395 1081 475 1137">  </div>   | <p data-bbox="675 925 1233 1003">Indicates that the shift lever was used to attempt to shift to the first gear position in M mode on a slippery road surface</p> <p data-bbox="675 1008 1233 1064">The gear position will not shift from the second gear.</p> <p data-bbox="675 1068 1233 1113">A buzzer also sounds.</p> <p data-bbox="675 1086 1233 1113">→ <b>Drive the vehicle in the second or a higher gear position.</b></p>                  |
| <p data-bbox="395 1171 651 1283"><b>Check SRS Airbag System</b></p> <div data-bbox="395 1294 563 1350">   </div>  | <p data-bbox="675 1171 930 1198">Indicates a malfunction in:</p> <ul data-bbox="675 1202 1233 1283" style="list-style-type: none"> <li>• The SRS airbag system;</li> <li>• The front passenger occupant classification system; or</li> <li>• The seat belt pretensioner system</li> </ul> <p data-bbox="675 1288 914 1314">A buzzer also sounds.</p> <p data-bbox="675 1319 1201 1346">→ <b>Have the vehicle inspected by your Lexus dealer.</b></p> |
| <p data-bbox="395 1384 651 1496"><b>Check ABS</b></p> <div data-bbox="395 1507 563 1585">   </div>  | <p data-bbox="675 1417 930 1444">Indicates a malfunction in:</p> <ul data-bbox="675 1449 930 1507" style="list-style-type: none"> <li>• The ABS; or</li> <li>• The brake assist system</li> </ul> <p data-bbox="675 1512 914 1538">A buzzer also sounds.</p> <p data-bbox="675 1543 1201 1570">→ <b>Have the vehicle inspected by your Lexus dealer.</b></p>   |







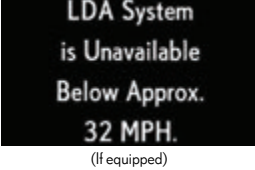
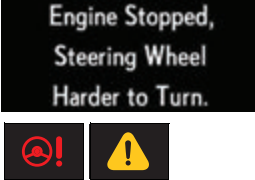
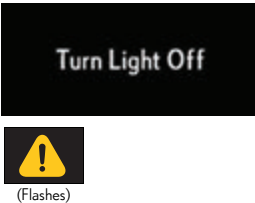
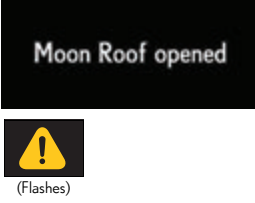

| Warning message  | Details/Actions  |
|--|--|
|  <p>Engine Coolant<br/>High Temperature</p>                        | <p>Indicates that the engine coolant temperature is too high<br/>A buzzer also sounds.<br/>→ <b>P. 608</b></p>   |
|  <p>Clean<br/>Radar Sensor</p>  <p>(If equipped)</p>              | <p>Indicates that the radar sensor is dirty or covered with ice<br/>A buzzer also sounds.<br/>→ <b>Clean the sensor.</b></p>   |
|  <p>Cruise Control<br/>not available</p>  <p>(If equipped)</p> | <p>Indicates that the dynamic radar cruise control system is unable to judge vehicle-to-vehicle distance<br/>A buzzer also sounds.<br/>→ <b>Turn off snow mode.</b><br/><b>If the windshield wipers are on, turn them off or set them to a mode other than AUTO or high speed wiper operation.</b></p> |
|  <p>LDA<br/>not available</p>  <p>(If equipped)</p>            | <p>Indicates that the LDA (Lane Departure Alert) system is suspended (The camera sensor temperature is higher than the operation temperature range)<br/>A buzzer also sounds.<br/>→ <b>Restart the LDA after driving for a while.</b></p>  |

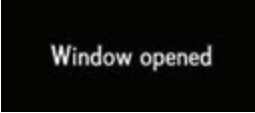

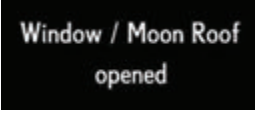





| Warning message  | Details/Actions  |
|--|--|
| <br><br>(If equipped)  | Indicates that a Blind Spot Monitor sensor or the surrounding area on the rear bumper is dirty or covered with snow, ice, etc. or that a sensor is misaligned<br>A buzzer also sounds.<br>→ <b>Clean off the dirt, snow, ice, etc. and drive the vehicle with the operation conditions of the BSM function (→P. 308) satisfied for approximately 10 minutes. If the warning message does not disappear, the sensor may be misaligned. Have the vehicle inspected by your Lexus dealer.</b> |
| <br>   | Indicates a malfunction in: <ul style="list-style-type: none"> <li>• The cruise control system; or</li> <li>• The dynamic radar cruise control system (if equipped)</li> </ul> Press the "ON/OFF" button once to deactivate the system, and then press the button again to reactivate the system.<br>A buzzer also sounds.<br>→ <b>Have the vehicle inspected by your Lexus dealer.</b>  |
| <br><br>(If equipped)   | Indicates a malfunction in the LDA (Lane Departure Alert) system<br>A buzzer also sounds.<br>→ <b>Have the vehicle inspected by your Lexus dealer.</b>   |
| <br> <br>(Flashes)<br>(If equipped) | Indicates a malfunction in the PCS (Pre-Collision System)<br>A buzzer also sounds.<br>→ <b>Have the vehicle inspected by your Lexus dealer immediately.</b>  |

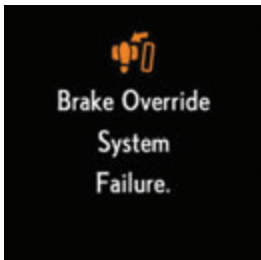

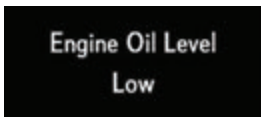

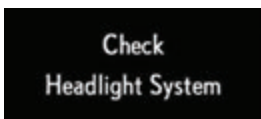

| Warning message   | Details/Actions  |
|---|--|
|  <p>Check<br/>BSM System</p>  <p>(If equipped)</p>                                      | <p>Indicates a malfunction in the BSM (Blind Spot Monitor) system<br/>A buzzer also sounds.<br/>→ <b>Have the vehicle inspected by your Lexus dealer.</b></p>            |
|  <p>Engine Oil<br/>Pressure Low</p>    | <p>Indicates abnormal engine oil pressure<br/>A buzzer also sounds.<br/>→ <b>Immediately stop the vehicle in a safe place and contact your Lexus dealer.</b></p>         |
|  <p>Transmission Fluid<br/>High Temperature</p>                                     | <p>Indicates that the automatic transmission fluid temperature is too high<br/>A buzzer also sounds.<br/>→ <b>Have the vehicle inspected by your Lexus dealer.</b></p>   |
| <p>▶ RC350/RC300/<br/>RC200t only</p>  <p>Check AWD System</p>  <p>(AWD models)</p> | <p>Indicates a malfunction in the AWD system<br/>A buzzer also sounds.<br/>→ <b>Have the vehicle inspected by your Lexus dealer.</b></p>                                 |
| <p>▶ RC350 only</p>  <p>Check<br/>VGRS System</p>  <p>(If equipped)</p>             | <p>Indicates a malfunction in the VGRS (Variable Gear Ratio Steering) system<br/>A buzzer also sounds.<br/>→ <b>Have the vehicle inspected by your Lexus dealer.</b></p> |





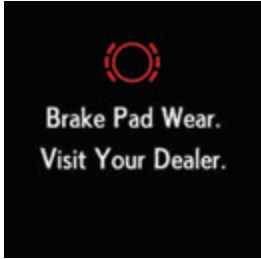

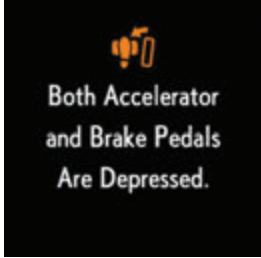



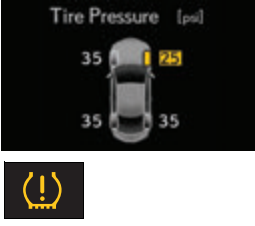
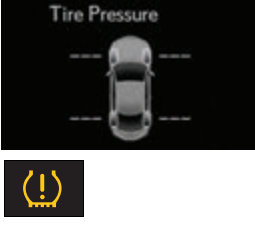

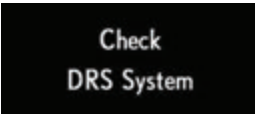

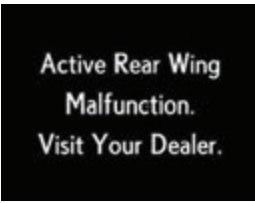
| Warning message  | Details/Actions  |
|--|--|
| <p>► RC F only</p>  | <p>Indicates that the active rear wing switch was pressed when the active rear wing was disabled<br/> → <b>Enable the active rear wing (→P. 123) then press the active rear wing switch.</b></p>                 |
|                     | <p>Indicates that the LDA (Lane Departure Alert) system cannot be used because the vehicle speed is lower than approximately 32 mph (50 km/h)<br/> → <b>Drive the vehicle at 32 mph (50 km/h) or higher.</b></p> |
|                    | <p>Indicates that the engine was stopped while driving<br/> A buzzer also sounds.<br/> → <b>Operate the steering wheel with more force than usual.</b></p>   |
|                   | <p>Indicates that the engine switch is turned off or turned to ACCESSORY mode and the driver's door is opened while the lights are turned on<br/> A buzzer also sounds.<br/> → <b>Turn the lights off.</b></p>   |
|                   | <p>Indicates that the moon roof is not fully closed (with the engine switch off, and the driver's door open)<br/> A buzzer also sounds.<br/> → <b>Close the moon roof.</b></p>                                   |



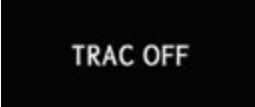

| Warning message   | Details/Actions  |
|---|--|
|  <p>Window opened</p>  <p>(Flashes)</p>   | <p>Indicates that the windows are not fully closed (with the engine switch off, and the driver's door open)<br/>A buzzer also sounds.<br/>→ <b>Close all the windows.</b></p>  |
|  <p>Window / Moon Roof<br/>opened</p>  <p>(Flashes)<br/>(If equipped)</p>   | <p>Indicates that the windows and the moon roof are not fully closed (with the engine switch off, and the driver's door open)<br/>A buzzer also sounds.<br/>→ <b>Close all the windows and the moon roof.</b></p>  |
| <p>► RC F only</p>  <p>TVD System<br/>Malfunction.<br/>Visit Your Dealer.</p>  <p>(If equipped)</p>               | <p>Indicates a malfunction in the TVD (Torque Vectoring Differential) system<br/>A buzzer also sounds.<br/>→ <b>Have the vehicle inspected by your Lexus dealer.</b></p>   |
| <p>► RC F only</p>  <p>TVD System<br/>Overheated.<br/>Reduce Engine<br/>Speed and Load.</p>  <p>(If equipped)</p> | <p>Indicates that the TVD (Torque Vectoring Differential) system has overheated<br/>This message may be displayed when driving under extremely high load conditions such as the following:</p> <ul style="list-style-type: none"> <li>• Continuously driving at high speeds or through sharp turns</li> <li>• If either right or left rear tire loses traction and spins continuously</li> </ul> <p>A buzzer also sounds.<br/>→ <b>Drive the vehicle for a while, while avoiding extremely high load conditions.</b></p> |

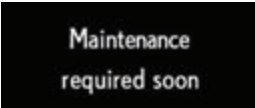
| Warning message   | Details/Actions   |
|---|---|
|  <p>Brake Override System Failure.</p>    | <p>Indicates a malfunction in the brake override system<br/>A buzzer also sounds.<br/>→ <b>Have the vehicle inspected by your Lexus dealer.</b></p>   |
|  <p>Engine Oil Level Low</p>   | <p>Indicates that engine oil level is low<br/>This message may appear if the vehicle is stopped on a slope. Move the vehicle to a level surface and check to see if the message disappears.<br/>A buzzer also sounds.<br/>→ <b>Check the level of engine oil, and add if necessary.</b></p> |
|  <p>Check Headlight System</p>   | <p>Indicates a malfunction in the automatic headlight leveling system<br/>A buzzer also sounds.<br/>→ <b>Have the vehicle inspected by your Lexus dealer.</b></p>   |
|  <p>Check Headlight System</p>    | <p>Indicates a malfunction in:<br/> <ul style="list-style-type: none"> <li>• The Automatic High Beam system (if equipped); or</li> <li>• The LED headlight system</li> </ul> A buzzer also sounds.<br/> → <b>Have the vehicle inspected by your Lexus dealer.</b></p>                       |

| Warning message   | Details/Actions   |
|---|---|
| <p>▶ RC F only</p>   <p>(USA.)</p>      | <p>Indicates that the brake pads are worn out<br/>A buzzer also sounds.<br/>→ <b>Have the vehicle inspected by your Lexus dealer.</b></p>   |
| <p>▶ RC F only</p>   <p>(Canada)</p> |   |
|   <p>(Flashes)</p>                  | <p>Indicates that the accelerator and brake pedals are being depressed simultaneously, and the brake override system is operating. (→P. 185)<br/>→ <b>Release the accelerator or brake pedal.</b></p> |

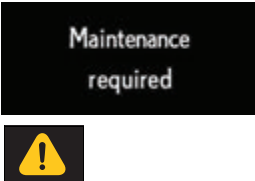
| Warning message  | Details/Actions   |
|--|---|
|   | <p>Indicates that the tire inflation pressure is low<br/> → Check the tire inflation pressure, and adjust to the appropriate level.</p>   |
|   | <p>Indicates a malfunction in the tire pressure warning system<br/> → Stop the vehicle in a safe place and turn the engine switch off then on again.<br/> If the tire pressure warning indicator flashes for 1 minute then illuminates, there is a malfunction in the system. Have the vehicle inspected at your Lexus dealer.</p>  |
|   | <p>Indicates that the tire position information cannot be recognized<br/> → Drive for a short while and check if the display updates.<br/> If the radio wave conditions improve, the display may return to normal. If the tire pressure is still not displayed after driving for several minutes, stop the vehicle in a safe place, turn the engine switch off then on again, and start driving.<br/> If the tire pressure is still not displayed even after repeating this process several times, have the vehicle inspected at your Lexus dealer.</p> |
| <p>▶ RC350 only</p>   <p>(If equipped)</p> | <p>Indicates a malfunction in the DRS (Dynamic Rear Steering) system<br/> A buzzer also sounds.<br/> → Have the vehicle inspected by your Lexus dealer.</p>   |
| <p>▶ RC F only</p>    | <p>Indicates a malfunction in the active rear wing<br/> → Have the vehicle inspected by your Lexus dealer.</p>  |

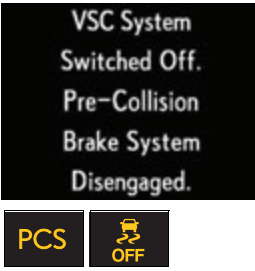
| Warning message  | Details/Actions  |
|--|--|
|   | Indicates that the washer fluid level is low<br>→ <b>Add washer fluid.</b>   |
| <br>   | Indicates that remaining fuel is approximately 2.6 gal. (10 L, 2.2 Imp. gal.) or less<br>→ <b>Refuel the vehicle.</b>  |
| ▶ RC350/RC300/<br>RC200t only<br>   | Indicates that the TRAC (Traction Control) system has been deactivated<br>→ <b>Turn the TRAC on. (→P. 289)</b>   |
| ▶ RC200t only<br>   | Indicates that the engine oil is scheduled to be changed. (The indicator will not work properly unless the message has been reset.)<br>→ <b>Check the engine oil, and change if necessary. After changing the engine oil, the message should be reset.</b> |
| ▶ RC350/RC300/<br>RC200t<br><br><br><small>(U.S.A. only)</small> | Indicates that all maintenance according to the driven distance on the maintenance schedule* should be performed soon.<br>Comes on approximately 4500 miles (7200 km) after the message has been reset.  |
| ▶ RC F<br><br><small>(U.S.A. only)</small>  | → <b>If necessary, perform maintenance.</b>  |

| Warning message  | Details/Actions   |
|--|---|
| <p>▶ RC200t only</p>                  | <p>Indicates that the engine oil should be changed. (After the engine oil is changed and the message has been reset.)<br/> → <b>Check and change the engine oil, and oil filter by your Lexus dealer. After changing the engine oil, the message should be reset.</b></p>   |
|  <p>(U.S.A. only)</p>                 | <p>Indicates that all maintenance is required to correspond to the driven distance on the maintenance schedule*. Comes on approximately 5000 miles (8000 km) after the message has been reset. (The indicator will not work properly unless the message has been reset.)<br/> → <b>Perform the necessary maintenance. Please reset the message after the maintenance is performed (→P. 473)</b></p> |
|  <p>(If equipped)</p>                | <p>Indicates that the Automatic High Beam switch is pressed while the headlights are in low beam.<br/> → <b>Turn the high beam on and press the Automatic High Beam switch again.</b></p>   |
|  <p>(If equipped)</p>               | <p>Indicates that, since the VSC (Vehicle Stability Control) system was turned off, the pre-collision brake system operation is stopped<br/> Operation of the pre-collision brake assist and the steering control (if equipped) of the PCS (Pre-Collision system) are also stopped.<br/> → <b>Turn the VSC on. (→P. 290)</b></p>  |
|  <p>(Flashes)<br/>(If equipped)</p> | <p>Indicates that the PCS (Pre-Collision System) is not currently functional because the grille cover or the sensor is dirty<br/> → <b>Check the grille cover and the sensor and clean them if they are dirty.</b></p>  |

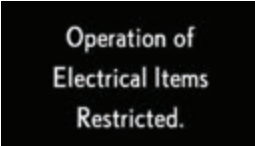
| Warning message   | Details/Actions   |
|---|---|
|  | Indicates that operation of large electricity consuming systems such as the air conditioning system are suspended<br>→ <b>Stop using unnecessary electric components to reduce electricity consumption. Wait a while until the electric power supply is restored.</b> |

\*: Refer to the separate “Scheduled Maintenance” or “Owner’s Manual Supplement” for the maintenance interval applicable to your vehicle.

■ **Warning messages**

The warning message illustrations used are intended as examples, and may differ from the image that is actually displayed on the multi-information display.

■ **Warning message in radar cruise mode (if equipped)**

In the following situations, the warning message may not be displayed even if vehicle-to-vehicle distance decreases:

- When your vehicle and the vehicle ahead are traveling at the same speed or the vehicle ahead is traveling more quickly than your vehicle
- When the vehicle ahead is traveling at a very low speed
- Immediately after cruise control speed is set
- At the instant the accelerator pedal is depressed

■ **The LDA (Lane Departure Alert) lane departure warning function**

In the following situations, the warning message will not be displayed even if a lane line is crossed.

- When the vehicle speed deviates from the operating range of the LDA system functions
- When the lane lines cannot be recognized

■ **Resetting the message indicating maintenance is required**

Make sure to reset the oil change system. (→P. 473)







■ **Conditions that the tire pressure warning system may not function properly**



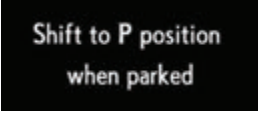

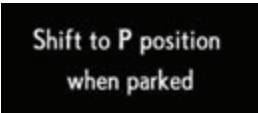
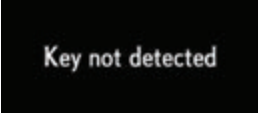

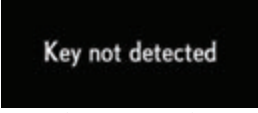
→P. 506



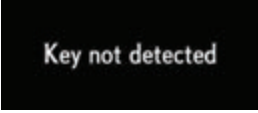

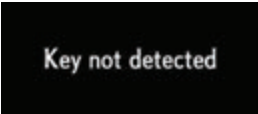

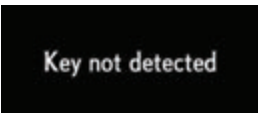

■ **Warning buzzer**



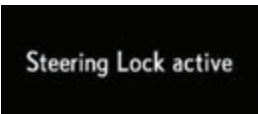

→P. 546

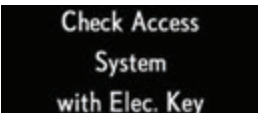



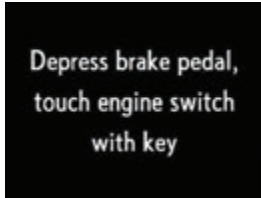

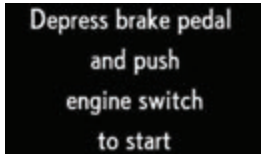
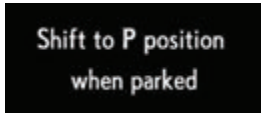

| Interior buzzer | Exterior buzzer | Warning message   | Details/Actions  |
|-----------------|-----------------|---|--|
| Continuous      | —               | <br><br>(Flashes)   | <p>The driver's door was opened when the shift lever was not in P and the engine switch was not turned off.</p> <p>→ <b>Shift the shift lever to P.</b></p>  |
| Continuous      | Continuous      | <br><br>(Displayed alternately)<br><br>(Flashes)     | <p>The driver's door was opened and closed while the electronic key was not in the vehicle, the shift lever was not in P and the engine switch was not turned off.</p> <p>→ <b>Shift the shift lever to P.</b></p> <p>→ <b>Bring the electronic key back into the vehicle.</b></p> |
| Once            | Continuous      | <br><br>(Displayed alternately)<br><br>(Flashes) | <p>An attempt was made to exit the vehicle with the electronic key and lock the doors without first turning the engine switch off when the shift lever was in P.</p> <p>→ <b>Turn the engine switch off and lock the doors again.</b></p>  |

| Interior buzzer | Exterior buzzer | Warning message   | Details/Actions  |
|-----------------|-----------------|---|--|
| Once            | 3 times         | <br><br>(Flashes)     | <p>The electronic key was carried outside the vehicle and a door other than the driver's door was opened and closed while the engine switch was in a mode other than off.<br/>           → <b>Bring the electronic key back into the vehicle.</b></p> <p>The driver's door was opened and closed while the electronic key was not in the vehicle, the shift lever was in P and the engine switch was not turned off.<br/>           → <b>Turn the engine switch off.</b><br/>           → <b>Bring the electronic key back into the vehicle.</b></p> |
| Once            | —               | <br><br>(Flashes)  | <p>The electronic key is not detected when an attempt is made to start the engine.<br/>           → <b>Start the engine with the electronic key present.</b></p>   |
| 9 times         | —               | <br><br>(Flashes) | <p>An attempt was made to drive when the electronic key was not inside the vehicle.<br/>           → <b>Confirm that the electronic key is inside the vehicle.</b></p>   |

| Interior buzzer | Exterior buzzer | Warning message   | Details/Actions  |
|-----------------|-----------------|---|--|
| Once            | Continuous      | <br><br>(Flashes)     | <p>An attempt was made to lock the doors using the smart access system with push-button start while the electronic key was still inside the vehicle.<br/>           → <b>Retrieve the electronic key from the vehicle and lock the doors again.</b></p> <p>An attempt was made to lock either door by opening a door and putting the inside lock button into the lock position, then closing the door with the electronic key still inside the vehicle.<br/>           → <b>Retrieve the electronic key from the vehicle and lock the doors again.</b></p> |
| Once            | —               | <br>               | <p>The electronic key has a low battery.<br/>           → <b>Replace the electronic key battery. (→P. 517)</b></p>   |
| Once            | —               | <br><br>(Flashes) | <p>The steering lock could not be released within 3 seconds of the engine switch being pressed.<br/>           → <b>Press the engine switch while depressing the brake pedal and moving the steering wheel left and right.</b></p>   |
| Once            | —               | <br><br>(Flashes) | <p>Indicates a malfunction in the smart access system with push-button start<br/>           → <b>Have the vehicle inspected by your Lexus dealer.</b></p>  |

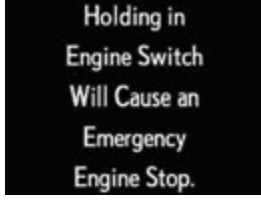
| Interior buzzer | Exterior buzzer | Warning message   | Details/Actions  |
|-----------------|-----------------|---|--|
| Once            | —               | <br><br>(Flashes)     | <ul style="list-style-type: none"> <li>When the doors were unlocked with the mechanical key and then the engine switch was pressed, the electronic key could not be detected in the vehicle.</li> <li>The electronic key could not be detected in the vehicle even after the engine switch was pressed two consecutive times.</li> </ul> → <b>Touch the electronic key to the engine switch while depressing the brake pedal.</b>                    |
| Once            | —               |   | During an engine starting procedure in the event that the electronic key was not functioning properly (→P. 602), the engine switch was touched with the electronic key.<br>→ <b>Press the engine switch within 10 seconds of the buzzer sounding.</b>  |
| —               | —               |    | Indicates that: <ul style="list-style-type: none"> <li>With the engine switch off, the doors were unlocked and then the driver's door was opened and closed</li> <li>The engine switch was turned to ACCESSORY mode without starting the engine</li> <li>The shift lever was shifted to P or N from another shift position with the engine switch in IGNITION ON mode.</li> </ul> → <b>Press the engine switch while depressing the brake pedal.</b> |
| —               | —               | <br><br>(Flashes) | The engine switch has been turned off with the shift lever in a position other than P or N.<br>→ <b>Shift the shift lever to P.</b>  |

| Interior buzzer    | Exterior buzzer | Warning message   | Details/Actions  |
|--------------------|-----------------|---|--|
| Once <sup>*1</sup> | —               |    | After the engine switch has been turned off with the shift lever in a position other than P, the shift lever has been shifted to P.<br>→ Turn the engine switch off.   |
| — <sup>*2</sup>    | —               | <br>(Flashes)  |  |
| —                  | —               |    | Power was turned off due to the automatic power off function.<br>→ Next time when starting the engine, increase the engine speed slightly and maintain that level for approximately 5 minutes to recharge the battery. |
| Continuous         | —               | <br><br>(Flashes)  | Indicates that the engine was stopped in an emergency while driving<br>→ To restart the engine, shift the shift lever to N and turn the engine switch to IGNITION ON mode. <sup>*3</sup>                               |
| Once               | —               | <br><br>(Flashes) | Indicates that the engine switch has been pressed while driving<br>→ Except when emergency stopping of the vehicle is needed, immediately release the engine switch.   |

\*1: RC350/RC300/RC200t (F SPORT models) and RC F

\*2: RC350/RC300/RC200t (except F SPORT models)

\*3: The engine may not be restarted depending on the vehicle condition.

■ **Warning messages**

→P. 564

■ **Warning buzzer**

→P. 546

### If you have a flat tire (vehicles with a spare tire)

Your vehicle is equipped with a spare tire. The flat tire can be replaced with the spare tire.

For details about tires: →P. 501

#### WARNING

##### ■ If you have a flat tire

Do not continue driving with a flat tire.

Driving even a short distance with a flat tire can damage the tire and the wheel beyond repair, which could result in an accident.

### Before jacking up the vehicle

- Stop the vehicle on a hard, flat surface.
- Set the parking brake.
- Shift the shift lever to P.
- Stop the engine.
- Turn on the emergency flashers. (→P. 532)

**Location of the spare tire, jack and tools**

## ▶ RC350/RC300/RC200t (type A)

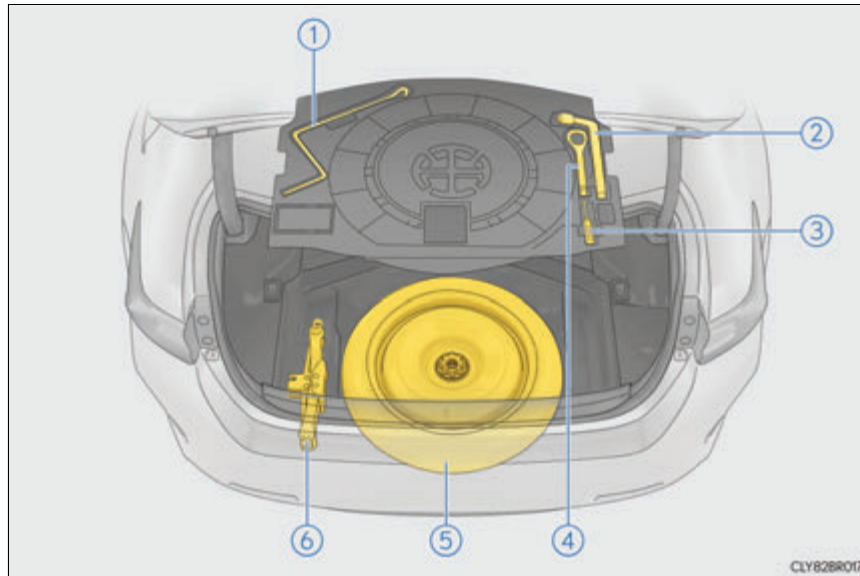

- |                    |                 |
|--------------------|-----------------|
| ① Jack handle      | ④ Towing eyelet |
| ② Wheel nut wrench | ⑤ Spare tire    |
| ③ Screwdriver      | ⑥ Jack          |

**572** 8-2. Steps to take in an emergency

▶ RC350/RC300/RC200t (type B)

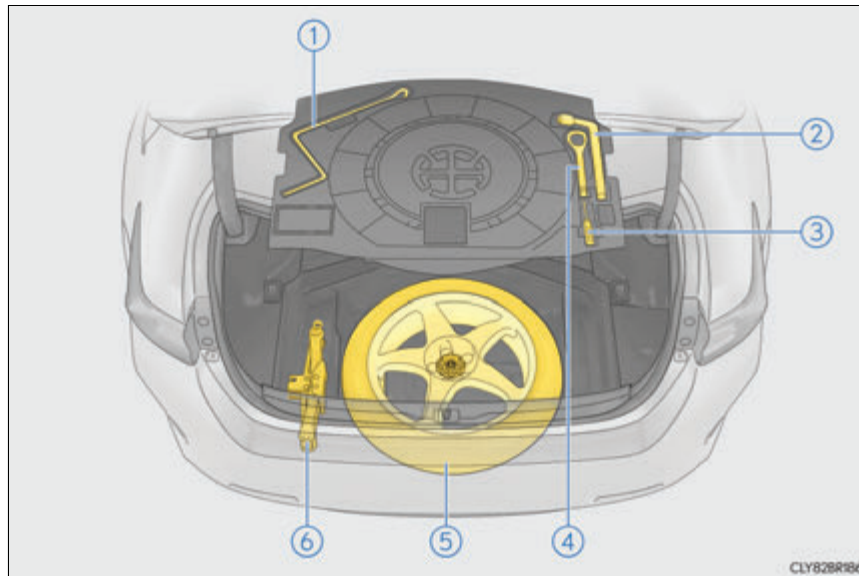

- |                    |                 |
|--------------------|-----------------|
| ① Jack handle      | ④ Towing eyelet |
| ② Wheel nut wrench | ⑤ Spare tire    |
| ③ Screwdriver      | ⑥ Jack          |



## ► RC F

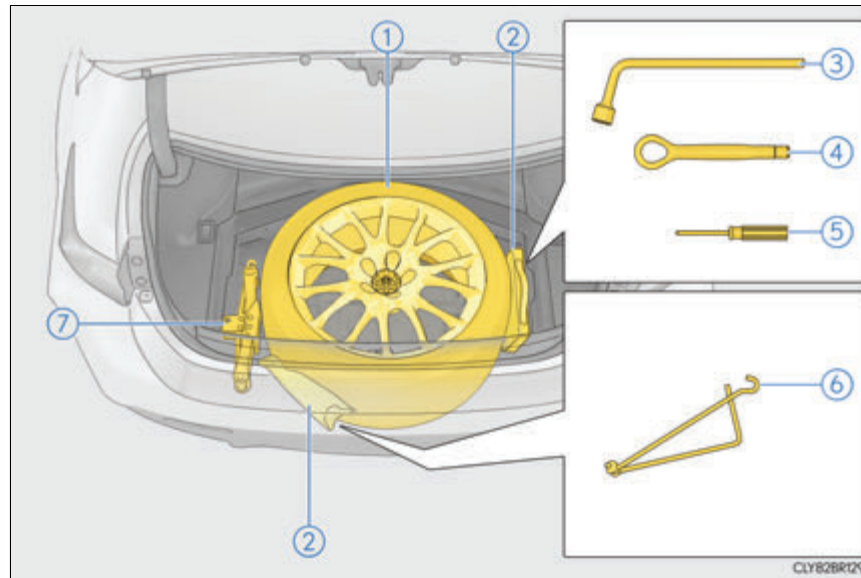

- |                    |               |
|--------------------|---------------|
| ① Spare tire       | ⑤ Screwdriver |
| ② Tool bags        | ⑥ Jack handle |
| ③ Wheel nut wrench | ⑦ Jack        |
| ④ Towing eyelet    |               |

 **WARNING****■ Using the tire jack**

Observe the following precautions.

Improper use of the tire jack may cause the vehicle to suddenly fall off the jack, leading to death or serious injury.

- Do not use the tire jack for any purpose other than replacing tires or installing and removing tire chains.
- Only use the tire jack that comes with this vehicle for replacing a flat tire.  
Do not use it on other vehicles, and do not use other tire jacks for replacing tires on this vehicle.
- Put the jack properly in its jack point.
- Do not put any part of your body under the vehicle while it is supported by the jack.
- Do not start the engine or drive the vehicle while the vehicle is supported by the jack.
- Do not raise the vehicle while someone is inside.
- When raising the vehicle, do not put an object on or under the jack.
- Do not raise the vehicle to a height greater than that required to replace the tire.
- Use a jack stand if it is necessary to get under the vehicle.
- When lowering the vehicle, make sure that there is no-one near the vehicle. If there are people nearby, warn them vocally before lowering.

### Taking out the jack

- ▶ RC350/RC300/RC200t

- 1 Hold the hook and lift up the luggage mat.



- 2 Secure the luggage mat using the hook.

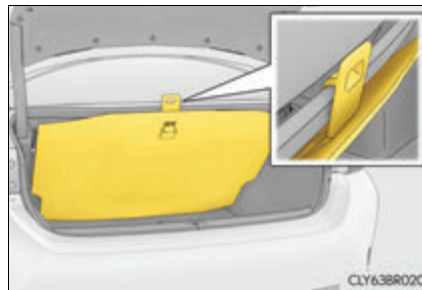

- 3 Remove the tool tray.



- 4 Take out the jack.

- 1 For tightening
- 2 For loosening

If the jack is too tightly installed to be removed by hand, insert a tool, such as the screwdriver included with the vehicle, into the hole of the jack (portion "A") and loosen the jack.

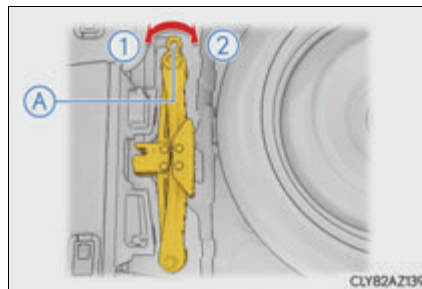

 NOTICE

When closing the trunk door, do not leave the luggage mat lever hooked on the edge of the trunk. The luggage mat may get damaged.

► RC F

- 1 Remove the luggage mat.

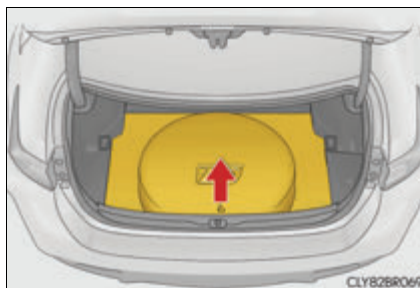

- 2 Take out the jack.

- 1 For tightening
- 2 For loosening

If the jack is too tightly installed to be removed by hand, insert a tool, such as the screwdriver included with the vehicle, into the hole of the jack (portion "A") and loosen the jack.

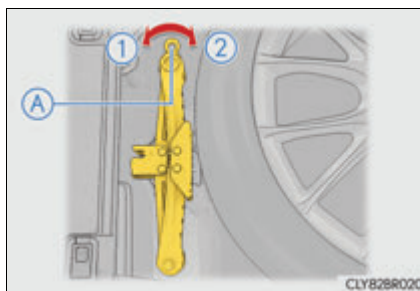

### Taking out the spare tire

▶ RC350/RC300/RC200t

- 1 Secure the luggage mat using the hook. (→P. 575)
- 2 Remove the tool tray.



- 3 Loosen the center fastener that secures the spare tire.

If the center fastener cannot be turned by hand, use the wheel nut wrench that is stored in the trunk. (To secure the tire, tighten the center fastener by hand. Do not use the wrench or other tools.)

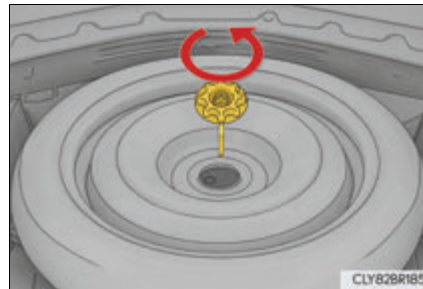

▶ RC F

- 1 Remove the luggage mat.

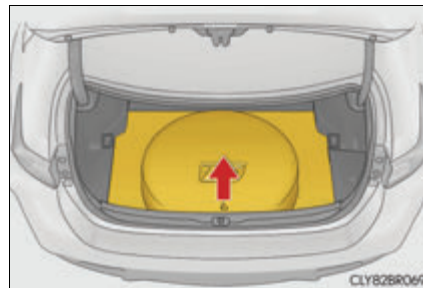

- 2 Loosen the center fastener that secures the spare tire.

If the center fastener cannot be turned by hand, use the wheel nut wrench that is stored in the trunk. (To secure the tire, tighten the center fastener by hand. Do not use the wrench or other tools.)

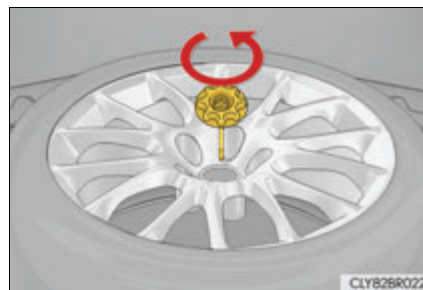

**⚠ WARNING**

**■ When storing the spare tire**

Be careful not to catch fingers or other body parts between the spare tire and the body of the vehicle.

**Replacing a flat tire**

- 1** Chock the tires.

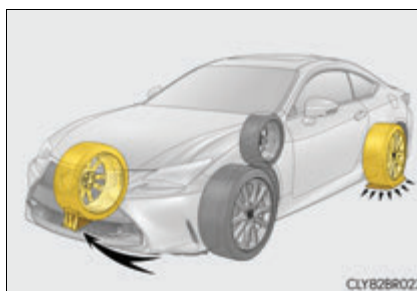

| Flat tire |                 | Wheel chock positions                      |
|-----------|-----------------|--|
| Front     | Left-hand side  | Behind the rear right-hand side tire       |
|           | Right-hand side | Behind the rear left-hand side tire        |
| Rear      | Left-hand side  | In front of the front right-hand side tire |
|           | Right-hand side | In front of the front left-hand side tire  |

- 2** Slightly loosen the wheel nuts (one turn).

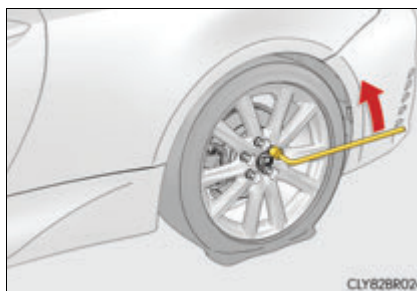

- 3** Turn the tire jack portion "A" by hand until the notch of the jack is in contact with the jack point.

The jack point guides are located under the rocker panel. They indicate the jack point positions.

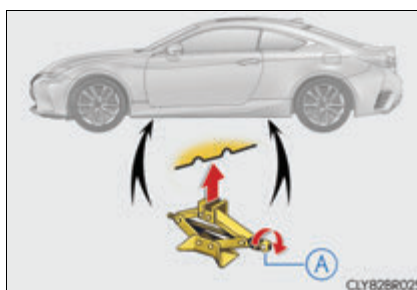

- 4 Raise the vehicle until the tire is slightly raised off the ground.

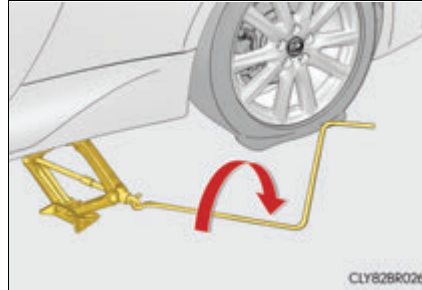

- 5 Remove all the wheel nuts and the tire.

When resting the tire on the ground, place the tire so that the wheel design faces up to avoid scratching the wheel surface.

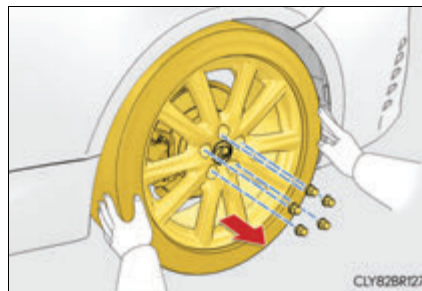

**⚠ WARNING**

■ **Replacing a flat tire**

- Do not touch the disc wheels or the area around the brakes immediately after the vehicle has been driven. After the vehicle has been driven the disc wheels and the area around the brakes will be extremely hot. Touching these areas with hands, feet or other body parts while changing a tire, etc. may result in burns.
- Failure to follow these precautions could cause the wheel nuts to loosen and the tire to fall off, resulting in death or serious injury.
  - Never use oil or grease on the wheel bolts or wheel nuts. Oil and grease may cause the wheel nuts to be excessively tightened, leading to bolt or disc wheel damage. In addition, the oil or grease can cause the wheel nuts to loosen and the wheel may fall off, causing a serious accident. Remove any oil or grease from the wheel bolts or wheel nuts.
  - Have the wheel nuts tightened with a torque wrench to 76 ft•lbf (103 N•m, 10.5 kgf•m) as soon as possible after changing wheels.
  - Do not attach a heavily damaged wheel ornament, as it may fly off the wheel while the vehicle is moving.
  - When installing a tire, only use wheel nuts that have been specifically designed for that wheel.
  - If there are any cracks or deformations in the bolt screws, nut threads or bolt holes of the wheel, have the vehicle inspected by your Lexus dealer.

### Installing the spare tire

- 1 Remove any dirt or foreign matter from the wheel contact surface.

If foreign matter is on the wheel contact surface, the wheel nuts may loosen while the vehicle is in motion, causing the tire to come off.

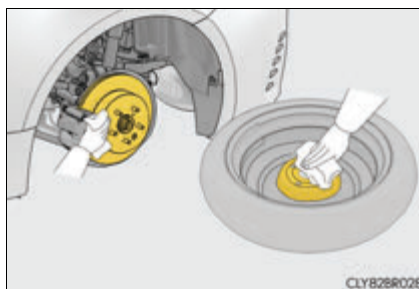

- 2 Install the spare tire and loosely tighten each wheel nut by hand by approximately the same amount.

When replacing an aluminum wheel with a steel wheel, tighten the wheel nuts until the tapered portion comes into loose contact with the disc wheel seat.

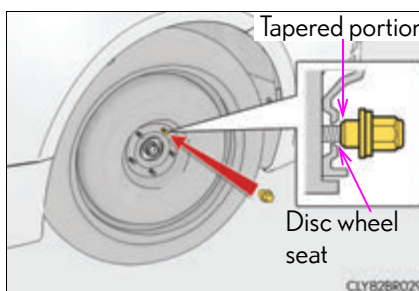

When replacing an aluminum wheel with an aluminum wheel, turn the wheel nuts until the washers come into contact with the disc wheel.

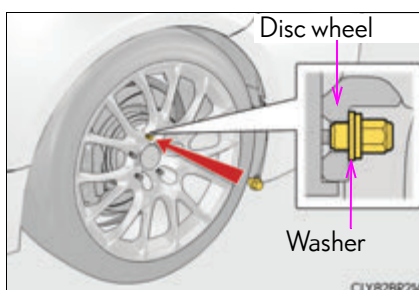

- 3 Lower the vehicle.

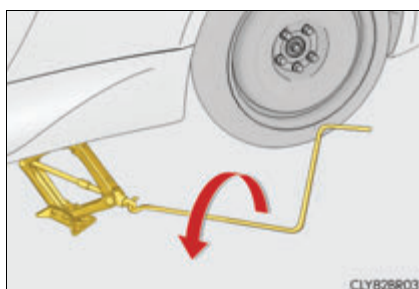



- 4 Firmly tighten each wheel nut two or three times in the order shown in the illustration.

**Tightening torque:**  
76 ft•lbf (103 N•m, 10.5 kgf•m)

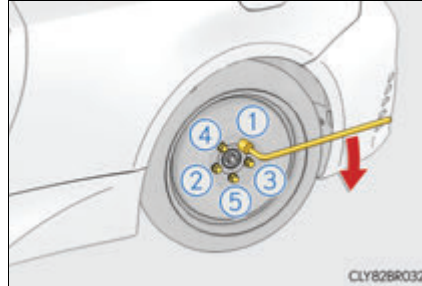

- 5 Stow the flat tire, tire jack and all tools.

#### ■ The spare tire

- RC350/RC300/RC200t:  
The spare tire is identified by the label "TEMPORARY USE ONLY" on the tire sidewall.
- Use the spare tire temporarily, and only in an emergency.
- Make sure to check the tire inflation pressure of the spare tire.  
(→P. 630)

#### ■ When using the spare tire

As the spare tire is not equipped with a tire pressure warning valve and transmitter, low inflation pressure of the spare tire will not be indicated by the tire pressure warning system. Also, if you replace the spare tire after the tire pressure warning light comes on, the light remains on.

#### ■ When the spare tire is equipped

The vehicle becomes lower when driving with the spare tire compared to when driving with standard tires.

#### ■ If you have a flat rear tire on a road covered with snow or ice (vehicles with front and rear tires of the same size except for vehicles with LDH and 19-inch tires)

Install the spare tire on one of the front wheels of the vehicle. Perform the following steps and fit tire chains to the rear tires:

- 1 Replace a front tire with the spare tire.
- 2 Replace the flat rear tire with the tire removed from the front of the vehicle.
- 3 Fit tire chains to the rear tires.

**⚠ WARNING**

■ **When using the spare tire**

- Remember that the spare tire provided is specifically designed for use with your vehicle. Do not use your spare tire on another vehicle.
- Do not use more than one spare tires simultaneously.
- Replace the spare tire with a standard tire as soon as possible.
- Avoid sudden acceleration, abrupt steering, sudden braking and shifting operations that cause sudden engine braking.

■ **When the spare tire is attached**

The vehicle speed may not be correctly detected, and the following systems may not operate correctly:

- |   |   |
|---|---|
| • ABS & Brake assist                                | • VGRS (if equipped)                                |
| • VSC   | • LDH (Lexus Dynamic Handling system) (if equipped) |
| • TRAC  | • DRS (Dynamic Rear Steering) (if equipped)         |
| • Cruise control (if equipped)                      | • VDIM (Vehicle Dynamics Integrated Management)     |
| • Dynamic radar cruise control (if equipped)        | • Tire pressure warning system                      |
| • PCS (if equipped)                                 | • Lexus parking assist monitor                      |
| • EPS   | • Intuitive parking assist (if equipped)            |
| • Adaptive Variable Suspension System (if equipped) | • Navigation system (if equipped)                   |
| • LDA (Lane Departure Alert) (if equipped)          |   |

Also, not only can the following system not be utilized fully, but it may even negatively affect the drive-train components:

- AWD system (if equipped)

■ **Speed limit when using the spare tire**

Do not drive at speeds in excess of 50 mph (80 km/h) when a spare tire is installed on the vehicle.

The spare tire is not designed for driving at high speeds. Failure to observe this precaution may lead to an accident causing death or serious injury.

■ **After using the tools and jack**

Before driving, make sure all the tools and jack are securely in place in their storage location to reduce the possibility of personal injury during a collision or sudden braking.

 NOTICE**■ Driving with tire chains and the spare tire**

Do not fit tire chains to the spare tire.

Tire chains may damage the vehicle body and adversely affect driving performance.

**■ When replacing the tires**

When removing or fitting the wheels, tires or the tire pressure warning valve and transmitter, contact your Lexus dealer as the tire pressure warning valve and transmitter may be damaged if not handled correctly.

### If you have a flat tire (vehicles with an emergency tire puncture repair kit)

Your vehicle is not equipped with a spare tire, but instead is equipped with an emergency tire puncture repair kit.

A puncture caused by a nail or screw passing through the tire tread can be repaired temporarily with the emergency tire puncture repair kit.

#### WARNING

##### ■ If you have a flat tire

Do not continue driving with a flat tire.

Driving even a short distance with a flat tire can damage the tire and the wheel beyond repair. Driving with a flat tire may cause a circumferential groove on the side wall. In such a case, the tire may explode when using the emergency tire puncture repair kit, resulting in death or serious injury.

#### Before repairing the vehicle

- Stop the vehicle in a safe place on a hard, flat surface.
- Set the parking brake.
- Shift the shift lever to P.
- Stop the engine.
- Turn on the emergency flashers. (→P. 532)

## Location of the emergency tire puncture repair kit, jack and tools

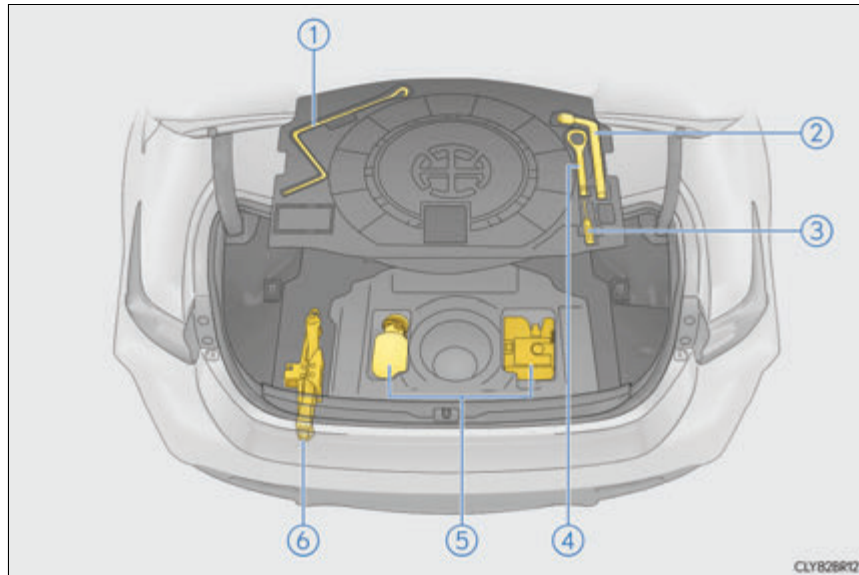

- ① Jack handle
- ② Wheel nut wrench
- ③ Screwdriver
- ④ Towing eyelet
- ⑤ Emergency tire puncture repair kits
- ⑥ Jack\*

\*: Use of the jack (→P. 578)

### Emergency tire puncture repair kit components

#### ■ Bottle

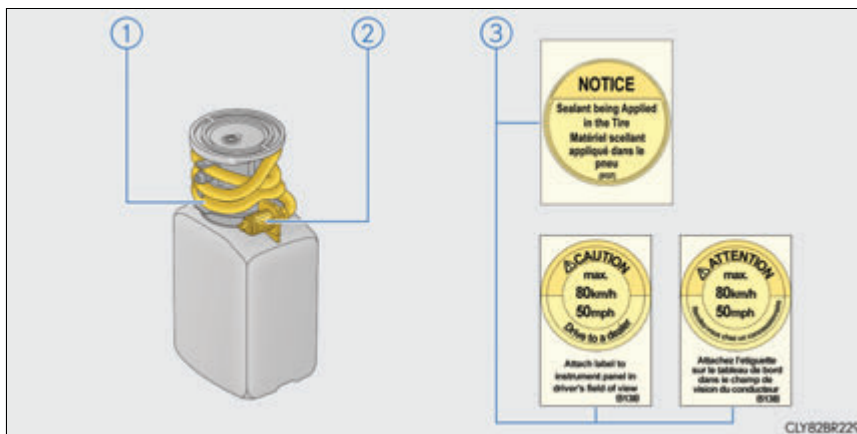

- ① Hose
- ② Air release cap
- ③ Stickers

#### ■ Compressor

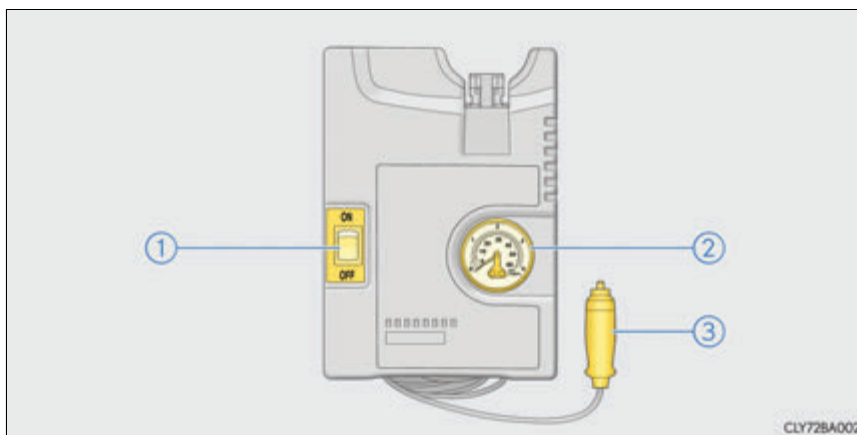

- ① Compressor switch
- ② Air pressure gauge
- ③ Power plug

**Taking out the emergency tire puncture repair kits**

- 1 Secure the luggage mat using the hook. (→P. 575)
- 2 Remove the tool tray.

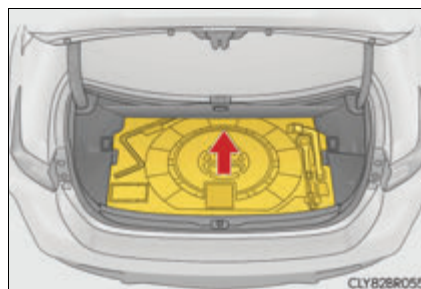

- 3 Take out the emergency tire puncture repair kits.

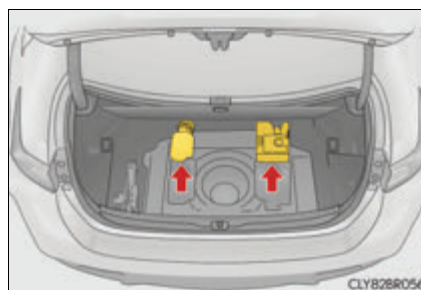
**Before performing emergency repair**

Check the degree of the tire damage.

A tire should only be repaired with the emergency tire puncture repair kit if the damage is caused by a nail or screw passing through the tire tread.

- Do not remove the nail or screw from the tire. Removing the object may widen the opening and disable emergency repair with the kit.
- To avoid sealant leakage, move the vehicle until the area of the puncture, if known, is positioned at the top of the tire.

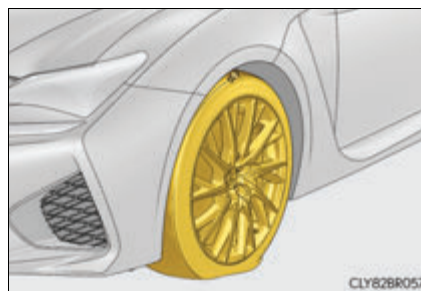

### Emergency repair method

- 1 Remove the valve cap from the valve of the punctured tire.

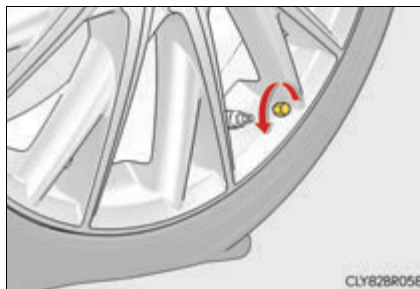

- 2 Extend the hose. Remove the air release cap from the hose. You will use the air release cap again. Therefore keep it in a safe place.

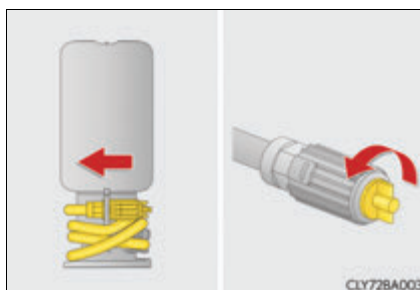

- 3 Connect the hose to the valve. Screw the end of the hose clockwise as far as possible.

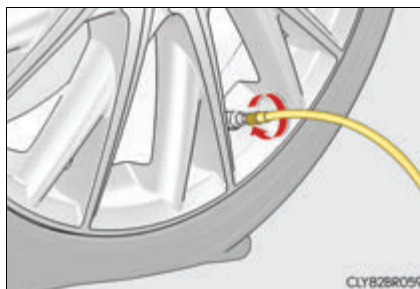

- 4 Make sure that the compressor switch is off.

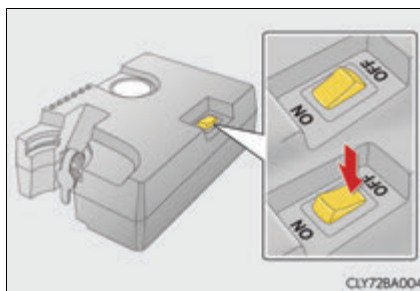



- 5 Lift the rubber stopper on the compressor.

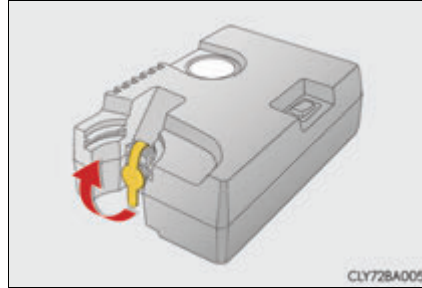

- 6 Remove the power plug from the compressor.

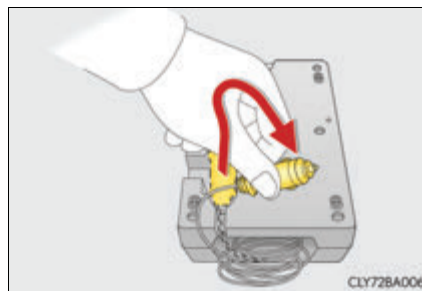

- 7 Connect the power plug to the power outlet socket. (→P. 440)

- 8 Connect the bottle to the compressor.  
Make sure that the bottle is securely connected.

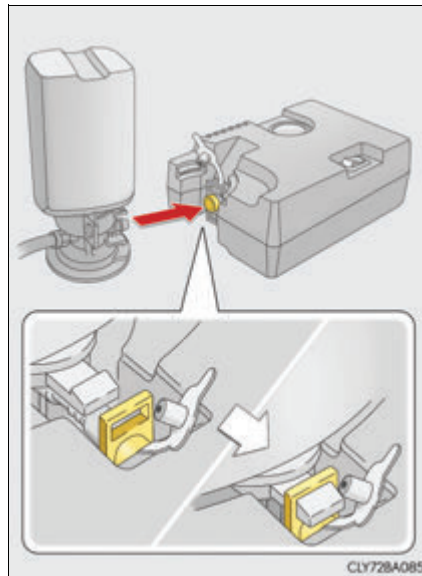

- 9 Attach the 2 stickers as shown.

Remove any dirt and moisture from the wheel before attaching the label. If it is impossible to attach the label, make sure to tell your Lexus dealer when you have them repair and replace the tire that sealant is injected.

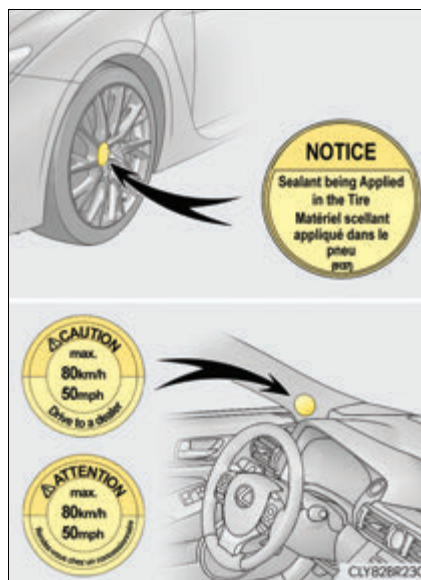

- 10 Check the specified tire inflation pressure.

Tire inflation pressure is specified on the label as shown. (→P. 630)

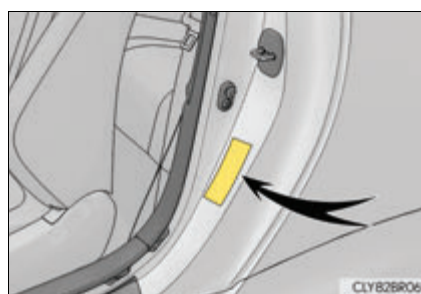

- 11 Start the engine. (→P. 199)

- 12 To inject the sealant and inflate the tire, turn the compressor switch on.

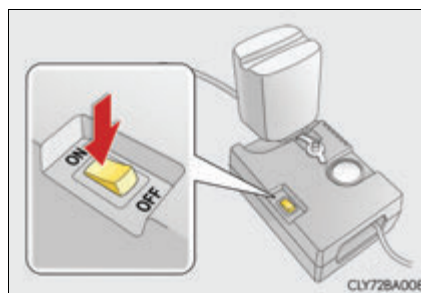

**13** Inflate the tire until the recommended pressure is reached.

① The sealant will be injected and the pressure will spike to 44 psi (300 kPa, 3.0 kgf/cm<sup>2</sup> or bar) or 58 psi (400 kPa, 4.0 kgf/cm<sup>2</sup> or bar), then gradually decrease.

② The air pressure gauge will display the actual tire inflation pressure about 1 minute (15 minutes at low temperature) after the switch is turned on.

- Turn the compressor switch off and then check the tire inflation pressure. Being careful not to over inflate, check and repeat the inflation procedure until the recommended tire inflation pressure is reached.
- If the tire inflation pressure is still lower than the recommended level after inflation for 10 minutes (35 minutes at low temperature) with the switch on, the tire is too damaged to be repaired. Turn the compressor switch off and contact your Lexus dealer.
- If the tire inflation pressure exceeds the recommended level, let out some air to adjust the tire inflation pressure. (→P. 594, 630)

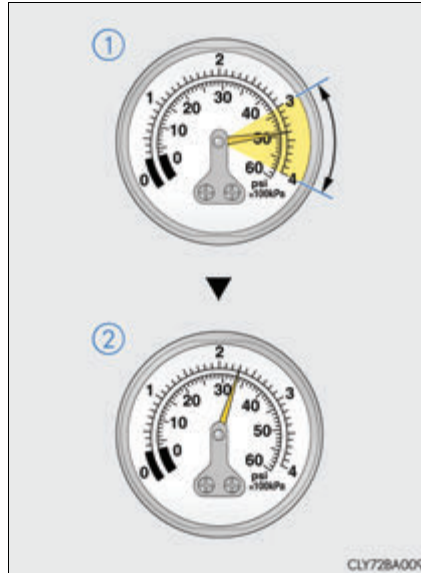

**14** With the compressor switch off, disconnect the hose from the valve on the tire and then pull out the power plug from the power outlet socket.

Some sealant may leak when the hose is removed.

**15** Install the valve cap onto the valve of the emergency repaired tire.

**16** Attach the air release cap to the end of the hose.

If the air release cap is not attached, the sealant may leak and the vehicle may get dirty.

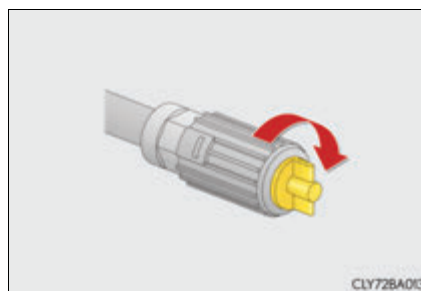

**17** Temporarily store the bottle in the trunk while it is connected to the compressor.

**18** To spread the liquid sealant evenly within the tire, immediately drive safely for about 3 miles (5 km) below 50 mph (80 km/h).

**592** 8-2. Steps to take in an emergency

- 19** After driving, stop your vehicle in a safe place on a hard, flat surface and reconnect the compressor.

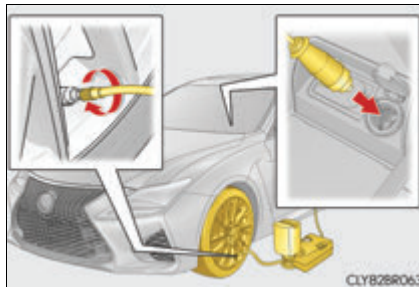

- 20** Turn the compressor switch on and wait for several seconds, then turn it off. Check the tire inflation pressure.

- ① If the tire inflation pressure is below 19 psi (130 kPa, 1.3 kgf/cm<sup>2</sup> or bar): The puncture cannot be repaired. Contact your Lexus dealer.



- ② If the tire inflation pressure is between 19 psi (130 kPa, 1.3 kgf/cm<sup>2</sup> or bar) and a point below the recommended level: The tire can be repaired. Proceed to step **21**.
- ③ If the tire inflation pressure is at the recommended level: Proceed to step **22**.

- 21** Turn the compressor switch on to inflate the tire until the recommended tire inflation pressure is reached. Drive for about 3 miles (5 km) and then perform step **19**.

- 22** Attach the air release cap to the end of the hose.

If the air release cap is not attached, the sealant may leak and the vehicle may get dirty.

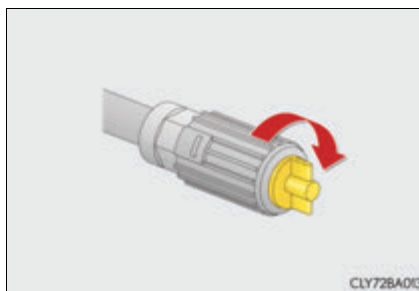

- 23** Store the bottle in the trunk while it is connected to the compressor.

- 24** Taking precautions to avoid sudden braking, sudden acceleration and sharp turns, drive carefully at under 50 mph (80 km/h) to your Lexus dealer that is less than 62 miles (100 km) away for tire repair or replacement.

■ **In the following cases, the tire cannot be repaired with the emergency tire puncture repair kit. Contact your Lexus dealer.**

- When the tire is damaged due to driving without sufficient air pressure
- When the tire lost air pressure due to a crack or damage in the tire sidewall
- When the tire is visibly separated from the wheel
- When the cut or damage to the tread is 0.16 in. (4 mm) long or more
- When the wheel is damaged
- When 2 or more sharp objects, such as nails or screws, have passed through the tread on a single tire
- When there is more than one hole or cut in the damaged tire
- When the sealant has expired

■ **Emergency tire puncture repair kit**

- The sealant has a limited lifespan. The expiry date is marked on the bottle. The sealant should be replaced before the expiry date. Contact your Lexus dealer for replacement.
- The sealant stored in the emergency tire puncture repair kit can be used only once to temporarily repair a single tire. If the sealant has been used and needs to be purchased, contact your Lexus dealer. The compressor is reusable.
- The sealant can be used when the outside temperature is from -40°F (-40°C) to 140°F (60°C).
- The kit is exclusively designed for size and type of tires originally installed on your vehicle. Do not use it for tires that a different size than the original ones, or for any other purposes.
- If the sealant gets on your clothes, it may stain.
- If the sealant adheres to a wheel or the surface of the vehicle body, the stain may not be removable if it is not cleaned at once. Immediately wipe away the sealant with a wet cloth.
- During operation of the kit, a loud operation noise is produced. This does not indicate a malfunction.
- Do not use the emergency tire puncture repair kit to check or to adjust the tire pressure.

## 594 8-2. Steps to take in an emergency

### ■ If the tire is inflated to more than the recommended level

- 1 Disconnect the hose from the valve.
- 2 Install the air release cap to the end of the hose and push the protrusion on the air release cap into the valve to let some air out.

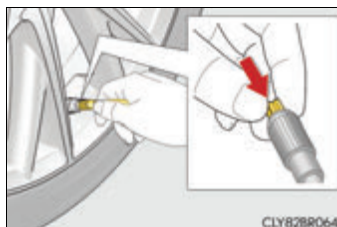

- 3 Disconnect the hose from the valve, remove the air release cap from the hose and then reconnect the hose.
- 4 Turn the compressor switch on and wait for several seconds, then turn it off. Check that the air pressure indicator shows the recommended level. (→P. 630)  
If the air pressure is lower than the recommended level, turn the compressor switch on again and repeat the inflation procedure until the recommended pressure is reached.

### ■ After a tire is repaired with the emergency tire puncture repair kit

- The tire pressure warning valve and transmitter should be replaced.
- Even if the tire inflation pressure is at the recommended level, the tire pressure warning light may come on/flash.

### ■ Note for checking the emergency tire puncture repair kit

Check the sealant expiry date occasionally.

The expiry date is shown on the bottle. Do not use sealant whose expiry date has already passed. Otherwise, repairs conducted using the emergency tire puncture repair kit may not be performed properly.

### ⚠ WARNING

#### ■ Caution while driving

Observe the following precautions.  
Failure to do so may cause an accident.

- The emergency tire puncture repair kit is made exclusively for your vehicle. Do not use it on other vehicles.
- Do not use the emergency tire puncture repair kit for tires that are a different size than the specified ones or for any other purpose. Doing so may cause the tires to not be repaired properly.

#### ■ Precautions for use of the sealant

- Ingesting the sealant is hazardous to your health. If you ingest sealant, consume as much water as possible, then immediately consult a doctor.
- If sealant gets in eyes or adheres to skin, immediately wash it off with water. If discomfort persists, consult a doctor.

 **WARNING****■ When fixing the flat tire**

- Stop your vehicle in a safe and flat area.
- Do not touch the wheels or the area around the brakes immediately after the vehicle has been driven.  
After the vehicle has been driven, the wheels and the area around the brakes may be extremely hot. Touching these areas with hands, feet or other body parts may result in burns.
- Connect the valve and hose securely with the tire installed on the vehicle.
- If the hose is not properly connected to the valve, air leakage may occur or sealant may be sprayed out.
- If the hose comes off the valve while inflating the tire, there is a risk that the hose will move abruptly due to air pressure.
- After inflation of the tire has completed, the sealant may splatter when the hose is disconnected or some air is let out of the tire.
- Follow the operation procedure to repair the tire. If the procedure is not followed, the sealant may spray out.
- Keep back from the tire while it is being repaired, as there is a chance of it bursting while the repair operation is being performed. If you notice any cracks or deformation of the tire, turn off the compressor switch and stop the repair operation immediately.
- The kit may overheat if operated for a long period of time. Do not operate the compressor continuously for more than 35 minutes.
- Parts of the kit become hot during operation. Be careful handling the kit during and after operation. Do not touch the metal part around the connecting area between the bottle and compressor. It will be extremely hot.
- Do not attach the vehicle speed warning sticker to an area other than the one indicated. If the sticker is attached to an area where an SRS airbag is located, such as the pad of the steering wheel, it may prevent the SRS airbag from operating properly.

**■ Driving to spread the liquid sealant evenly**

- Drive the vehicle carefully at a low speed. Be especially careful when turning and cornering.
- If the vehicle does not drive straight or you feel a pull through the steering wheel, stop the vehicle and check the following:
  - Tire condition. The tire may have separated from the wheel.
  - Tire inflation pressure. If tire inflation pressure is 19 psi (130 kPa, 1.3 kgf/cm<sup>2</sup> or bar) or below, this may indicate severe tire damage.

 NOTICE**■ When performing an emergency repair**

- Perform the emergency repair without removing the nail or screw that has punctured the tread of the tire. If the object that has punctured the tire is removed, repair by the emergency tire puncture repair kit may not be possible.
- The kit is not waterproof. Make sure that the kit is not exposed to water, such as when it is being used in the rain.
- Do not put the kit directly onto dusty ground such as sand at the side of the road. If the kit vacuums up dust etc., a malfunction may occur.
- Make sure to stand the kit with the bottle vertical. The kit cannot work properly if it is laid on its side.

**■ Handling the emergency tire puncture repair kit**

- The compressor power source should be 12 V DC suitable for vehicle use. Do not connect the compressor to any other source.
- If gasoline splatters on the kit, the kit may deteriorate. Take care not to allow gasoline to contact it.
- Store the emergency tire puncture repair kit in the trunk.  
The kit may be thrown around during sudden braking and so forth, damaging the kit.
- Store the kit in its assigned place out of reach of children.
- Do not disassemble or modify the kit. Do not subject parts such as the air pressure indicator to impacts. This may cause a malfunction.

**■ To avoid damage to the tire pressure warning valves and transmitters**

When a tire is repaired with liquid sealants, the tire pressure warning valve and transmitter may not operate properly. If a liquid sealant is used, contact your Lexus dealer as soon as possible. After use of liquid sealant, make sure to replace the tire pressure warning valve and transmitter when repairing or replacing the tire. (→P. 502)



## If the engine will not start

If the engine will not start even though correct starting procedures are being followed (→P. 199), consider each of the following points:

### The engine will not start even though the starter motor operates normally.

One of the following may be the cause of the problem:

- There may not be sufficient fuel in the vehicle's tank.  
Refuel the vehicle.
- The engine may be flooded.  
Try to restart the engine again following correct starting procedures.  
(→P. 199)
- There may be a malfunction in the engine immobilizer system. (→P. 76)

### The starter motor turns over slowly, the interior lights and headlights are dim, or the horn does not sound or sounds at a low volume.

One of the following may be the cause of the problem:

- The battery may be discharged. (→P. 604)
- The battery terminal connections may be loose or corroded.

### The starter motor does not turn over

The engine starting system may be malfunctioning due to an electrical problem such as electronic key battery depletion or a blown fuse. However, an interim measure is available to start the engine. (→P. 598)

**The starter motor does not turn over, the interior lights and headlights do not turn on, or the horn does not sound.**

One of the following may be the cause of the problem:

- One or both of the battery terminals may be disconnected.
- The battery may be discharged. (→P. 604)
- There may be a malfunction in the steering lock system.

Contact your Lexus dealer if the problem cannot be repaired, or if repair procedures are unknown.

**Emergency start function**

When the engine does not start, the following steps can be used as an interim measure to start the engine if the engine switch is functioning normally:

- 1 Set the parking brake.
- 2 Shift the shift lever to P.
- 3 Turn the engine switch to ACCESSORY mode.
- 4 Press and hold the engine switch for about 15 seconds while depressing the brake pedal firmly.

Even if the engine can be started using the above steps, the system may be malfunctioning. Have the vehicle inspected by your Lexus dealer.

## If the shift lever cannot be shifted from P

If the shift lever cannot be shifted with your foot on the brake pedal, there may be a problem with the shift lock system (a system to prevent accidental operation of the shift lever). Have the vehicle inspected by your Lexus dealer immediately.

The following steps may be used as an emergency measure to ensure that the shift lever can be shifted:

- 1 Set the parking brake.
- 2 Turn the engine switch to ACCESSORY mode.
- 3 Depress the brake pedal.

- 4 Pry the cover up with a flathead screwdriver or equivalent tool.

To prevent damage to the cover, cover the tip of the screwdriver with a rag.

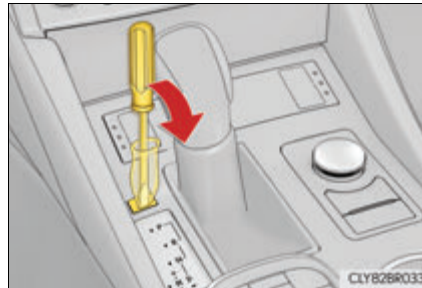

- 5 Press the shift lock override button.  
The shift lever can be shifted while the button is pressed.



### If the electronic key does not operate properly

If communication between the electronic key and vehicle is interrupted (→P. 150) or the electronic key cannot be used because the battery is depleted, the smart access system with push-button start and wireless remote control cannot be used. In such cases, the doors and trunk can be opened and the engine can be started by following the procedure below.

#### Locking and unlocking the doors and opening the trunk

Use the mechanical key (→P. 133) in order to perform the following operations:

##### ■ Unlocking the door

- 1 Insert the mechanical key while pulling on the driver's door handle.



- 2 Unlocking the door.

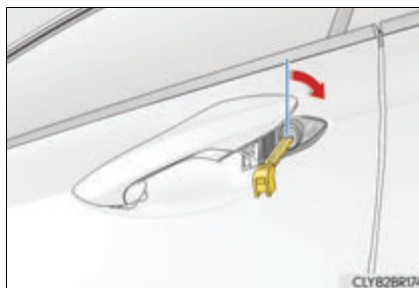

- 3 Remove the key, return the handle, and then pull the handle again.

### ■ Locking the door

- 1 Move the inside lock button to the lock position.

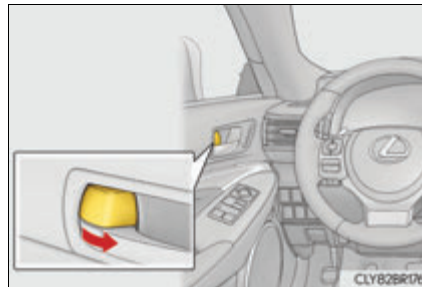

- 2 Close the door.

### ■ Opening the trunk

Turn the mechanical key clockwise to open.

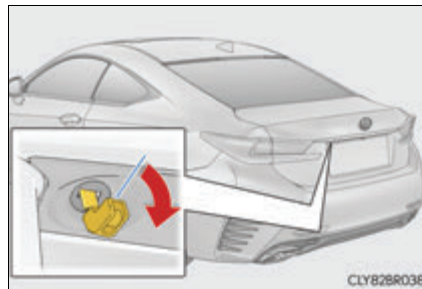

### ■ Key linked functions

- 1 Locks both side door
- 2 Closes the windows and moon roof (if equipped) (turn and hold)\*
- 3 Unlocks the door  
Turning the key rearward unlocks the driver's door. Turning the key again unlocks the other door.
- 4 Opens the windows and moon roof (if equipped) (turn and hold)\*

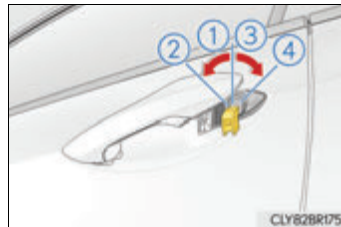

\*: These settings must be customized at your Lexus dealer.

### Starting the engine

1 Ensure that the shift lever is in P and depress the brake pedal.

2 Touch the Lexus emblem side of the electronic key to the engine switch.

When the electronic key is detected, a buzzer sounds and the engine switch will turn to IGNITION ON mode.

When the smart access system with push-button start is deactivated in customization setting, the engine switch will turn to ACCESSORY mode.

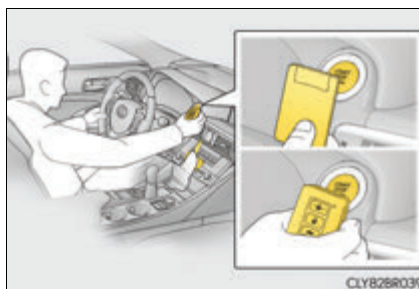

3 Firmly depress the brake pedal and check that  is shown on the multi-information display.

4 Press the engine switch.

In the event that the engine still cannot be started, contact your Lexus dealer.

#### ■ Stopping the engine

Shift the shift lever to P and press the engine switch as you normally do when stopping the engine.

#### ■ Replacing the key battery

As the above procedure is a temporary measure, it is recommended that the electronic key battery be replaced immediately when the battery is depleted. (→P. 517)

#### ■ Changing engine switch modes

Release the brake pedal and press the engine switch in step 3 above.

The engine does not start and modes will be changed each time the switch is pressed. (→P. 200)

#### ■ When the electronic key does not work properly

- Make sure that the smart access system with push-button start has not been deactivated in the customization setting. If it is off, turn the function on. (Customizable features →P. 651)
- Check if battery-saving mode is set. If it is set, cancel the function. (→P. 150)

 **WARNING****■ When using the mechanical key and operating the power windows or moon roof**

Operate the power window or moon roof after checking to make sure that there is no possibility of any passenger having any of their body parts caught in the window or moon roof.

Also, do not allow children to operate the mechanical key. It is possible for children and other passengers to get caught in the power window or moon roof.

## If the vehicle battery is discharged

The following procedures may be used to start the engine if the vehicle's battery is discharged.

You can also call your Lexus dealer or a qualified repair shop.

If you have a set of jumper (or booster) cables and a second vehicle with a 12-volt battery, you can jump start your vehicle by following the steps below.

- 1 Confirm that the electronic key is being carried.

When connecting the jumper (or booster) cables, depending on the situation, the alarm may activate and doors locked. (→P. 80)

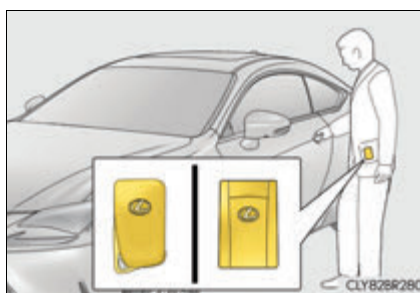

- 2 Open the hood. (→P. 481)

- 3 Remove the engine cover.

▶ RC350/RC300

Raise the rear of the engine cover to remove the rear clip, and then raise the front of the engine cover to remove the front clips.

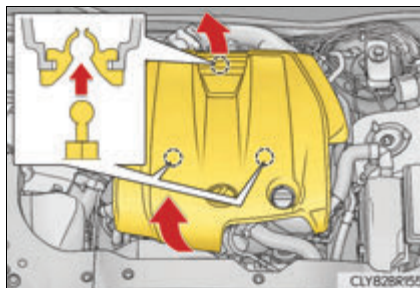

▶ RC F

Raise the front of the engine cover to remove the front clips, and then raise the rear of the engine cover to remove the rear clips.

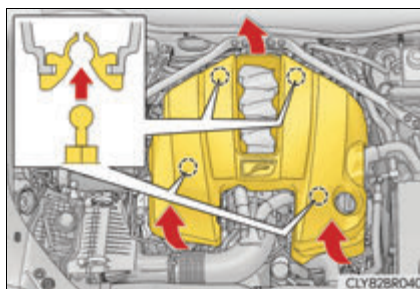



- 4 Connect the jumper cables according to the following procedure:

▶ RC350/RC300

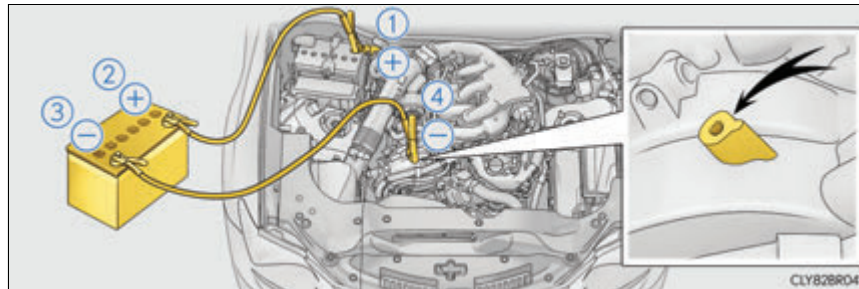

▶ RC200t

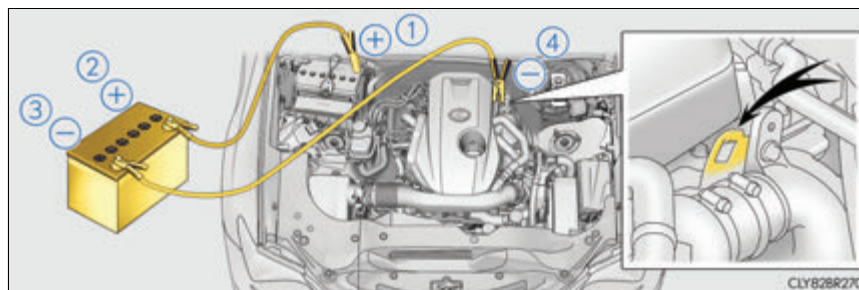

▶ RC F

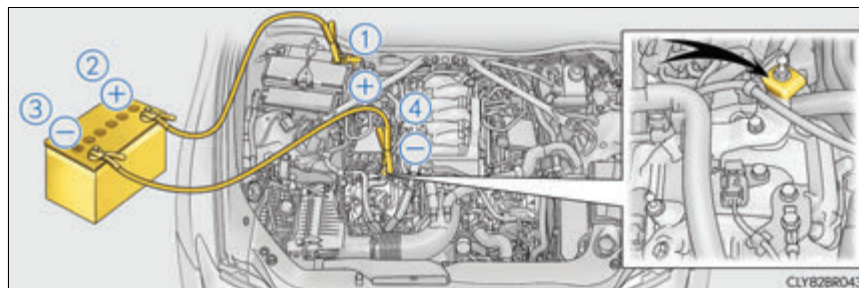

- ① Connect a positive jumper cable clamp to the positive (+) battery terminal on your vehicle.
- ② Connect the clamp on the other end of the positive cable to the positive (+) battery terminal on the second vehicle.
- ③ Connect a negative cable clamp to the negative (-) battery terminal on the second vehicle.
- ④ Connect the clamp at the other end of the negative cable to a solid, stationary, unpainted metallic point away from the battery and any moving parts, as shown in the illustration.

- 5 Start the engine of the second vehicle. Increase the engine speed slightly and maintain at that level for approximately 5 minutes to recharge the battery of your vehicle.
- 6 Open and close any of the door of your vehicle with the engine switch off.
- 7 Maintain the engine speed of the second vehicle and start the engine of your vehicle by turning the engine switch to IGNITION ON mode.
- 8 Once the vehicle's engine has started, remove the jumper cables in the exact reverse order from which they were connected.

Once the engine starts, have the vehicle inspected at your Lexus dealer as soon as possible.

---

■ **Starting the engine when the battery is discharged**

The engine cannot be started by push-starting.

■ **To prevent battery discharge**

- Turn off the headlights and the audio system while the engine is off.
- Turn off any unnecessary electrical components when the vehicle is running at a low speed for an extended period, such as in heavy traffic.

■ **Charging the battery**

The electricity stored in the battery will discharge gradually even when the vehicle is not in use, due to natural discharge and the draining effects of certain electrical appliances. If the vehicle is left for a long time, the battery may discharge, and the engine may be unable to start. (The battery recharges automatically during driving.)

■ **When recharging or replacing the battery**

- In some cases, it may not be possible to unlock the doors using the smart access system with push-button start when the battery is discharged. Use the wireless remote control or the mechanical key to lock or unlock the doors.
- The engine may not start on the first attempt after the battery has recharged but will start normally after the second attempt. This is not a malfunction.
- The engine switch mode is memorized by the vehicle. When the battery is reconnected, the system will return to the mode it was in before the battery was discharged. Before disconnecting the battery, turn the engine switch off. If you are unsure what mode the engine switch was in before the battery discharged, be especially careful when reconnecting the battery.

 **WARNING****■ Avoiding battery fires or explosions**

Observe the following precautions to prevent accidentally igniting the flammable gas that may be emitted from the battery:

- Make sure each jumper cable is connected to the correct terminal and that it is not unintentionally in contact with any other than the intended terminal.
- Do not allow the other end of the jumper cable connected to the “+” terminal to come into contact with any other parts or metal surfaces in the area, such as brackets or unpainted metal.
- Do not allow the + and - clamps of the jumper cables to come into contact with each other.
- Do not smoke, use matches, cigarette lighters or allow open flame near the battery.

**■ Battery precautions**

The battery contains poisonous and corrosive acidic electrolyte, while related parts contain lead and lead compounds. Observe the following precautions when handling the battery:

- When working with the battery, always wear safety glasses and take care not to allow any battery fluids (acid) to come into contact with skin, clothing or the vehicle body.
- Do not lean over the battery.
- In the event that battery fluid comes into contact with the skin or eyes, immediately wash the affected area with water and seek medical attention.  
Place a wet sponge or cloth over the affected area until medical attention can be received.
- Always wash your hands after handling the battery support, terminals, and other battery-related parts.
- Do not allow children near the battery.

 **NOTICE****■ When handling jumper cables**

When connecting the jumper cables, ensure that they do not become entangled in the cooling fans or engine drive belt.

## If your vehicle overheats

The following may indicate that your vehicle is overheating.

- The engine coolant temperature gauge (→P. 92, 98) is in the red zone or a loss of engine power is experienced. (For example, the vehicle speed does not increase.)
- “Engine Coolant High Temperature” is shown on the multi-information display.
- Steam comes out from under the hood.

### Correction procedures

- 1** Stop the vehicle in a safe place and turn off the air conditioning system, and then stop the engine.
- 2** If you see steam:  
Carefully lift the hood after the steam subsides.  
If you do not see steam:  
Carefully lift the hood.

- 3 After the engine has cooled down sufficiently, inspect the hoses and radiator core (radiator) for any leaks.

- ① Radiator
- ② Cooling fans

If a large amount of coolant leaks, immediately contact your Lexus dealer.

▶ RC350/RC300

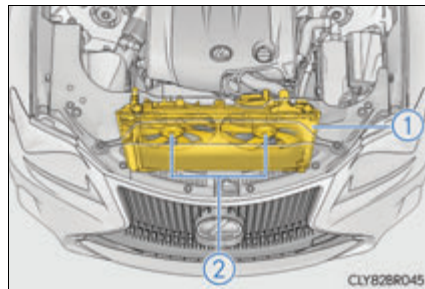

▶ RC200t

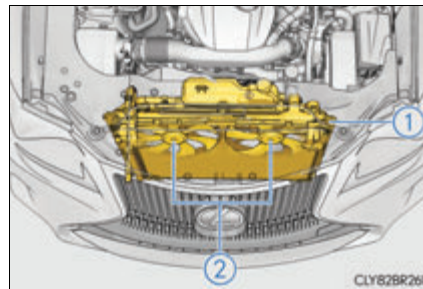

▶ RC F

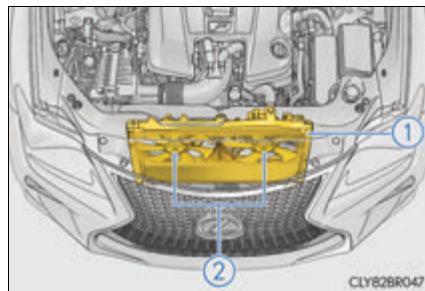

**610** 8-2. Steps to take in an emergency

4 The coolant level is satisfactory if it is between the full ("FULL" or "F") and low ("LOW" or "L") lines on the reservoir.

- ① Reservoir
- ② "FULL" or "F"
- ③ "LOW" or "L"

► Engine (RC350/RC300)

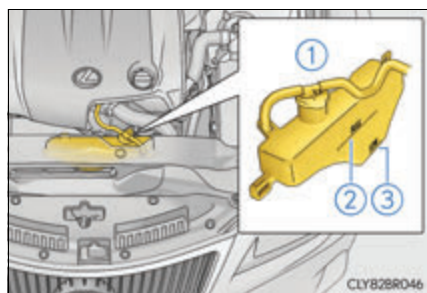

► Engine (RC200t)

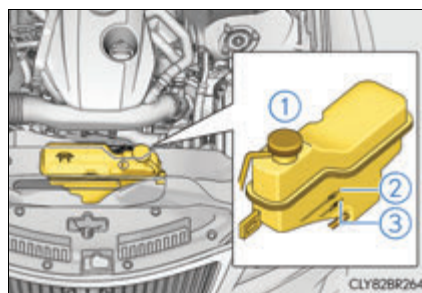

► Engine (RC F)

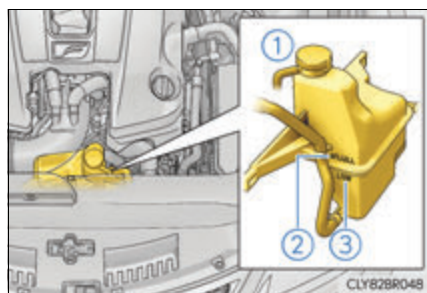

► Intercooler (RC200t)

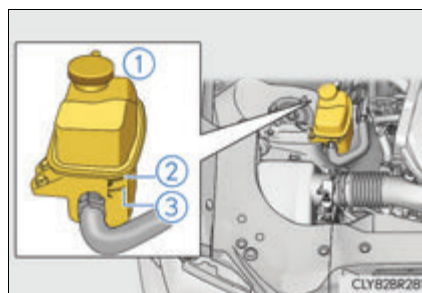

**5** Add coolant if necessary.

Water can be used in an emergency if coolant is unavailable.

## ▶ Engine (RC350/RC300)

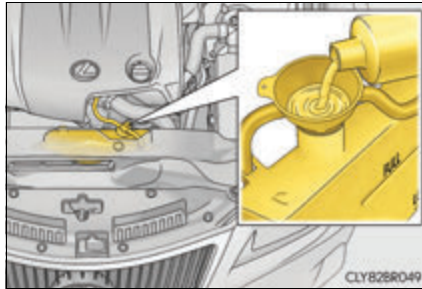

## ▶ Engine (RC200t)

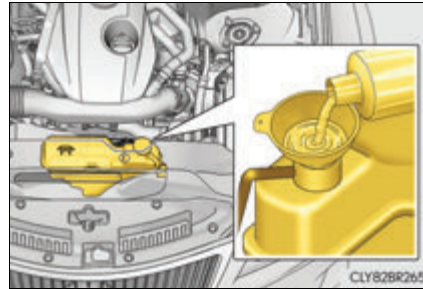

## ▶ Engine (RC F)

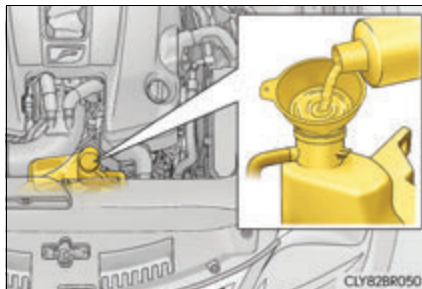

## ▶ Intercooler (RC200t)

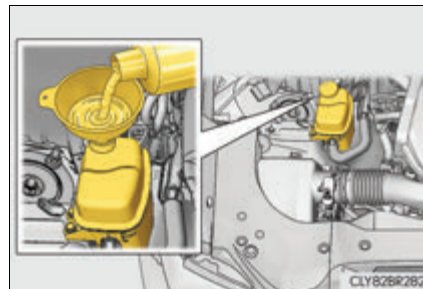
**6** Start the engine and turn the air conditioning system on to check that the radiator cooling fans operate and to check for coolant leaks from the radiator or hoses.

The fans operate when the air conditioning system is turned on immediately after a cold start. Confirm that the fans are operating by checking the fan sound and air flow. If it is difficult to check these, turn the air conditioning system on and off repeatedly. (The fan may not operate in freezing temperatures.)

**7** If the fans are not operating:

Stop the engine immediately and contact your Lexus dealer.

If the fans are operating:

Have the vehicle inspected at the nearest Lexus dealer.



**⚠ WARNING**

■ **When inspecting under the hood of your vehicle**

Observe the following precautions.

Failure to do so may result in serious injury such as burns.

- If steam is seen coming from under the hood, do not open the hood until the steam has subsided. The engine compartment may be very hot.
- Keep hands and clothing (especially a tie, a scarf or a muffler) away from the fans and belts. Failure to do so may cause the hands or clothing to be caught, resulting in serious injury.

- **RC350/RC300:** While the engine and radiator are hot, do not loosen or remove the coolant reservoir cap or radiator cap. (The radiator cap is located under the engine cover.)

High temperature steam or coolant could spray out.

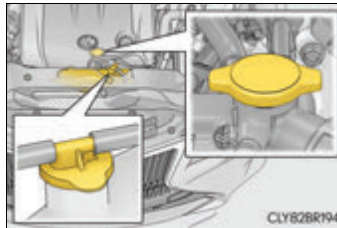

- **RC200t:** While the engine and radiators are hot, do not loosen or remove the coolant reservoir cap, radiator cap, or intercooler coolant reservoir cap.

High temperature steam or coolant could spray out.

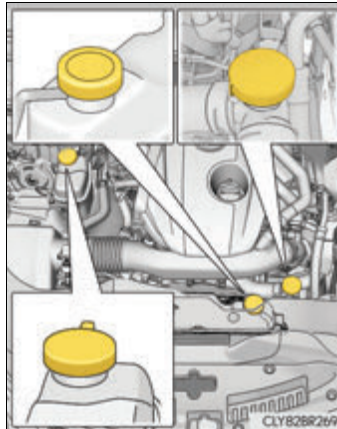

- **RC F:** While the engine and radiator are hot, do not loosen or remove the coolant reservoir cap.

High temperature steam or coolant could spray out.

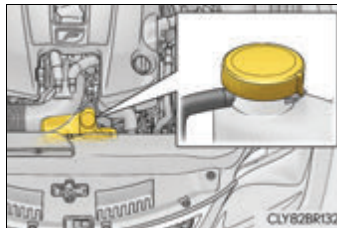



 NOTICE**■ When adding engine coolant**

Add coolant slowly after the engine has cooled down sufficiently. Adding cool coolant to a hot engine too quickly can cause damage to the engine.

**■ To prevent damage to the cooling system**

Observe the following precautions:

- Avoid contaminating the coolant with foreign matter (such as sand or dust etc.).
- Do not use any coolant additive.

## If the vehicle becomes stuck

Carry out the following procedures if the tires spin or the vehicle becomes stuck in mud, dirt or snow:

- 1 Stop the engine. Set the parking brake and shift the shift lever to P.
- 2 Remove the mud, snow or sand from around the rear wheels.
- 3 Place wood, stones or some other material under the rear wheels to help provide traction.
- 4 Restart the engine.
- 5 Shift the shift lever to D or R and release the parking brake. Then, while exercising caution, depress the accelerator pedal.



### ■ When it is difficult to free the vehicle

▶ RC350/RC300/RC200t

Press  (  ) to turn off TRAC.



## ► RC F

Press  (  ) to turn off TRAC.



 **WARNING**

■ **When attempting to free a stuck vehicle**

If you choose to push the vehicle back and forth to free it, make sure the surrounding area is clear to avoid striking other vehicles, objects or people. The vehicle may also lunge forward or lunge back suddenly as it becomes free. Use extreme caution.

■ **When shifting the shift lever**

Be careful not to shift the shift lever with the accelerator pedal depressed. This may lead to unexpected rapid acceleration of the vehicle that may cause an accident resulting in death or serious injury.

 **NOTICE**

■ **To avoid damaging the transmission and other components**

- Avoid spinning the rear wheels and depressing the accelerator pedal more than necessary.
- If the vehicle remains stuck even after these procedures are performed, the vehicle may require towing to be freed.



## Vehicle specifications

9

617

### 9-1. Specifications

|  |     |
|--|-----|
| Maintenance data<br>(fuel, oil level, etc.)..... | 618 |
| Fuel information.....                            | 636 |
| Tire information.....                            | 639 |

### 9-2. Customization

|                             |     |
|-----------------------------|-----|
| Customizable features ..... | 651 |
|-----------------------------|-----|

### 9-3. Items to initialize

|                           |     |
|---------------------------|-----|
| Items to initialize ..... | 662 |
|---------------------------|-----|

## Maintenance data (fuel, oil level, etc.)

### Dimensions and weight

► RC350/RC300/RC200t

|  |       |  |
|--|-------|--|
| Overall length                                   |       | 184.8 in. (4695 mm)                                    |
| Overall width                                    |       | 72.4 in. (1840 mm)                                     |
| Overall height <sup>*1</sup>                     |       | 54.9 in. (1395 mm)                                     |
| Wheelbase  |       | 107.5 in. (2730 mm)                                    |
| Tread <sup>*1</sup>                              | Front | 62.2 in. (1580 mm)                                     |
|  | Rear  | 63.0 in. (1600 mm)<br>61.8 in. (1570 mm) <sup>*2</sup> |
| Vehicle capacity weight<br>(Occupants + luggage) |       | 700 lb. (320 kg)                                       |

<sup>\*1</sup>: Unladen vehicle

<sup>\*2</sup>: Vehicles with 265/35R19 tires

► RC F

|  |       |                     |
|--|-------|---------------------|
| Overall length                                   |       | 185.2 in. (4705 mm) |
| Overall width                                    |       | 72.6 in. (1845 mm)  |
| Overall height <sup>*</sup>                      |       | 54.7 in. (1390 mm)  |
| Wheelbase  |       | 107.5 in. (2730 mm) |
| Tread <sup>*</sup>                               | Front | 61.2 in. (1555 mm)  |
|  | Rear  | 61.4 in. (1560 mm)  |
| Vehicle capacity weight<br>(Occupants + luggage) |       | 700 lb. (320 kg)    |

<sup>\*</sup>: Unladen vehicle

## Vehicle identification

### ■ Vehicle identification number

The vehicle identification number (VIN) is the legal identifier for your vehicle. This is the primary identification number for your Lexus. It is used in registering the ownership of your vehicle.

This number is stamped on the top left of the instrument panel and in the engine compartment.



▶ RC350/RC300

▶ RC200t

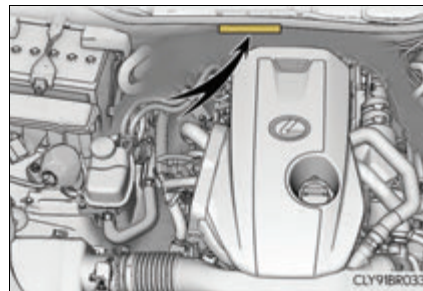
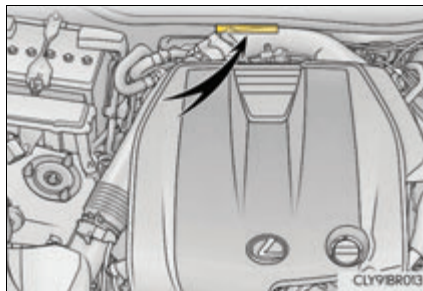

▶ RC F

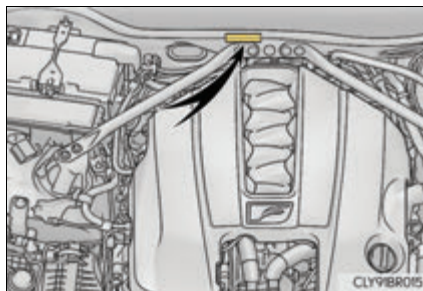

This number is also on the Certification Label.



■ **Engine number**

The engine number is located as shown.

▶ RC350/RC300

▶ RC200t

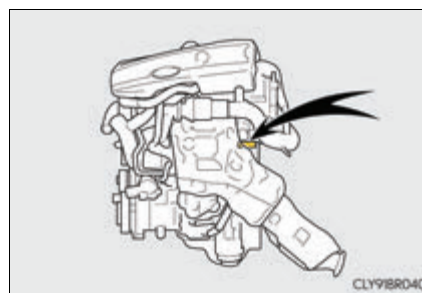
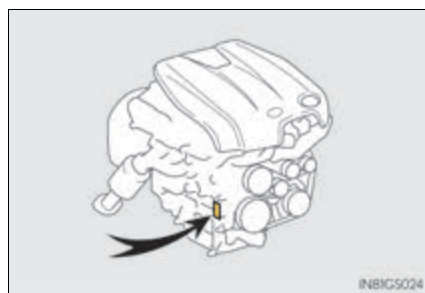

▶ RC F

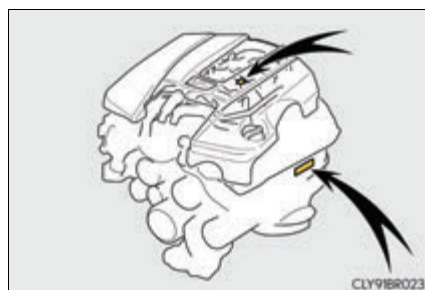



## Engine

### ▶ RC350/RC300

|                    |                                       |
|--------------------|---------------------------------------|
| Model              | 3.5 L 6-cylinder (2GR-FSE) engine     |
| Type               | 6-cylinder V type, 4-cycle, gasoline  |
| Bore and stroke    | 3.70 × 3.27 in. (94.0 × 83.0 mm)      |
| Displacement       | 210.9 cu. in. (3456 cm <sup>3</sup> ) |
| Drive belt tension | Automatic adjustment                  |

### ▶ RC200t

|                    |   |
|--------------------|---|
| Model              | 2.0 L 4-cylinder (8AR-FTS) engine                         |
| Type               | 4-cylinder in line, 4-cycle, gasoline (with turbocharger) |
| Bore and stroke    | 3.39 × 3.39 in. (86.0 × 86.0 mm)                          |
| Displacement       | 121.9 cu. in. (1998 cm <sup>3</sup> )                     |
| Drive belt tension | Automatic adjustment                                      |

### ▶ RC F

|                    |                                       |
|--------------------|---------------------------------------|
| Model              | 5.0 L 8-cylinder (2UR-GSE) engine     |
| Type               | 8-cylinder V type, 4-cycle, gasoline  |
| Bore and stroke    | 3.70 × 3.52 in. (94.0 × 89.5 mm)      |
| Displacement       | 303.2 cu. in. (4969 cm <sup>3</sup> ) |
| Drive belt tension | Automatic adjustment                  |

**Fuel**

|                                |  |
|--------------------------------|--|
| Fuel type                      | Unleaded gasoline only                   |
| Octane Rating                  | 91 (Research Octane Number 96) or higher |
| Fuel tank capacity (Reference) | 17.5 gal. (66.3 L, 14.6 Imp. gal.)       |

**Lubrication system**

■ Oil capacity (Drain and refill [Reference\*])

|                       | With filter                   | Without filter                |
|-----------------------|-------------------------------|-------------------------------|
| RC350 (2WD)           | 6.6 qt. (6.2 L, 5.5 Imp. qt.) | 6.2 qt. (5.9 L, 5.2 Imp. qt.) |
| RC350 (AWD)/<br>RC300 | 6.8 qt. (6.4 L, 5.6 Imp. qt.) | 6.3 qt. (6.0 L, 5.3 Imp. qt.) |
| RC200t                | 4.9 qt. (4.6 L, 4.0 Imp. qt.) | 4.5 qt. (4.3 L, 3.8 Imp. qt.) |
| RC F                  | 9.3 qt. (8.8 L, 7.7 Imp. qt.) | 8.3 qt. (7.9 L, 7.0 Imp. qt.) |

\*: The engine oil capacity is a reference quantity to be used when changing the engine oil. Warm up and turn off the engine, wait more than 5 minutes, and check the oil level on the dipstick.

### ■ Engine oil selection (RC350/RC300)

“Toyota Genuine Motor Oil” is used in your Lexus vehicle. Use Lexus approved “Toyota Genuine Motor Oil” or equivalent to satisfy the following grade and viscosity.

Oil grade: ILSAC GF-5 multigrade engine oil

Recommended viscosity: SAE 0W-20

SAE 0W-20 is the best choice for good fuel economy and good starting in cold weather.

If SAE 0W-20 is not available, SAE 5W-20 oil may be used. However, it must be replaced with SAE 0W-20 at the next oil change.

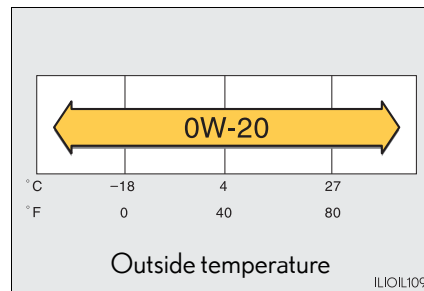

Oil viscosity (0W-20 is explained here as an example):

- The 0W in 0W-20 indicates the characteristic of the oil which allows cold startability. Oils with a lower value before the W allow for easier starting of the engine in cold weather.
- The 20 in 0W-20 indicates the viscosity characteristic of the oil when the oil is at high temperature. An oil with a higher viscosity (one with a higher value) may be better suited if the vehicle is operated at high speeds, or under extreme load conditions.

How to read oil container label:

The International Lubricant Specification Advisory Committee (ILSAC) Certification Mark is added to some oil containers to help you select the oil you should use.

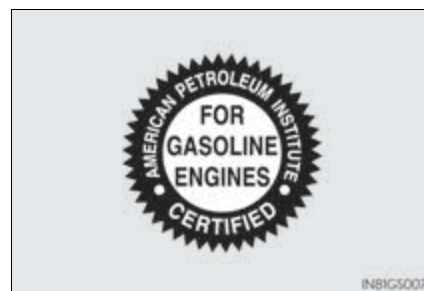

■ Engine oil selection (RC200t)

“Toyota Genuine Motor Oil SAE 0W-20 for Direct Injection Turbo Gasoline Engines” is used in your Lexus vehicle. Use Lexus approved “Toyota Genuine Motor Oil SAE 0W-20 for Direct Injection Turbo Gasoline Engines” or equivalent to satisfy the following grade and viscosity.

Oil grade: “Toyota Genuine Motor Oil SAE 0W-20 for Direct Injection Turbo Gasoline Engines” or ILSAC GF-5 multigrade engine oil

Recommended viscosity: SAE 0W-20

SAE 0W-20 is the best choice for good fuel economy and good starting in cold weather.

If SAE 0W-20 is not available, SAE 5W-20 oil may be used. However, it must be replaced with SAE 0W-20 at the next oil change.

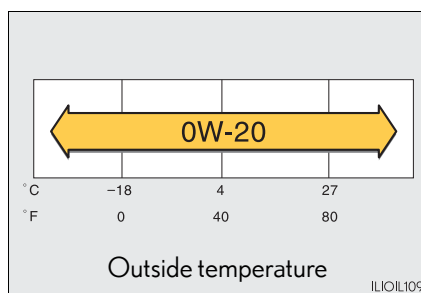

Oil viscosity (0W-20 is explained here as an example):

- The 0W in 0W-20 indicates the characteristic of the oil which allows cold startability. Oils with a lower value before the W allow for easier starting of the engine in cold weather.
- The 20 in 0W-20 indicates the viscosity characteristic of the oil when the oil is at high temperature. An oil with a higher viscosity (one with a higher value) may be better suited if the vehicle is operated at high speeds, or under extreme load conditions.

How to read oil container label:

The International Lubricant Specification Advisory Committee (ILSAC) Certification Mark is added to some oil containers to help you select the oil you should use.

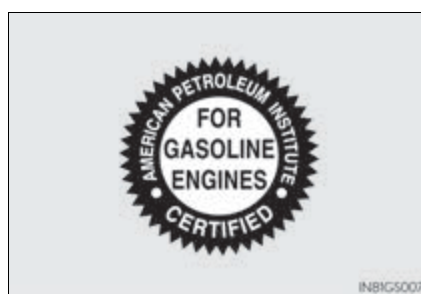

### ■ Engine oil selection (RC F)

“Toyota Genuine Motor Oil” is used in your Lexus vehicle. Use Lexus approved “Toyota Genuine Motor Oil” or equivalent to satisfy the following grade and viscosity.

Oil grade: ILSAC GF-5 multigrade engine oil

Recommended viscosity: SAE 5W-30

SAE 5W-30 is the best choice for good fuel economy and good starting in cold weather.

If SAE 5W-30 is not available, SAE 10W-30 oil may be used. However, it should be replaced with SAE 5W-30 at the next oil change.

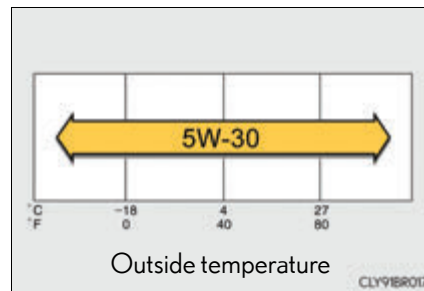

Oil viscosity (5W-30 is explained here as an example):

- The 5W in 5W-30 indicates the characteristic of the oil which allows cold startability. Oils with a lower value before the W allow for easier starting of the engine in cold weather.
- The 30 in 5W-30 indicates the viscosity characteristic of the oil when the oil is at high temperature. An oil with a higher viscosity (one with a higher value) may be better suited if the vehicle is operated at high speeds, or under extreme load conditions.

How to read oil container label:

The International Lubricant Specification Advisory Committee (ILSAC) Certification Mark is added to some oil containers to help you select the oil you should use.

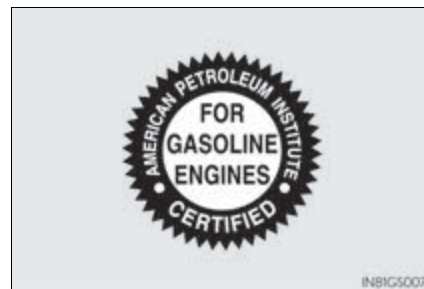

### Cooling system

|              |  |  |
|--------------|--|--|
| Capacity     | RC350/<br>RC300  | 10.1 qt. (9.6 L, 8.4 Imp. qt.)   |
|              | RC200t   | <ul style="list-style-type: none"> <li>▶ Gasoline engine<br/>8.5 qt. (8.0 L, 7.0 Imp. qt.)</li> <li>▶ Intercooler<br/>3.3 qt. (3.1 L, 2.7 Imp. qt.)</li> </ul> |
|              | RC F   | 12.3 qt. (11.6 L, 10.2 Imp. qt.)   |
| Coolant type | Use either of the following: <ul style="list-style-type: none"> <li>• “Toyota Super Long Life Coolant”</li> <li>• Similar high-quality ethylene glycol-based non-silicate, non-amine, non-nitrite, and non-borate coolant with long-life hybrid organic acid technology</li> </ul> Do not use plain water alone. |  |

### Ignition system

#### ■ Spark plug

|      | RC350/RC300        | RC200t             | RC F                |
|------|--------------------|--------------------|---------------------|
| Make | DENSO<br>FK20HBR11 | NGK DILFR7K9G      | DENSO<br>FK20HBR-J8 |
| Gap  | 0.043 in. (1.1 mm) | 0.035 in. (0.9 mm) | 0.031 in. (0.8 mm)  |

#### NOTICE

#### ■ Iridium-tipped spark plugs

Use only iridium-tipped spark plugs. Do not adjust the spark plug gap.

### Electrical system

|                              |   |
|------------------------------|---|
| Battery                      |   |
| Open voltage at 68°F (20°C): | 12.6 — 12.8 V Fully charged<br>12.2 — 12.4 V Half charged<br>11.8 — 12.0 V Discharged<br>(Check the voltage 20 minutes after the engine and all lights are turned off.) |
| Charging rates               | 5 A max.  |

### Automatic transmission

|                 |                       |                                 |
|-----------------|-----------------------|---------------------------------|
| Fluid capacity* | RC350 (2WD)           | 10.0 qt. (9.5 L, 8.4 Imp. qt.)  |
|                 | RC350/RC300 (AWD)     | 10.6 qt. (10.0 L, 8.8 Imp. qt.) |
|                 | RC200t                | 9.2 qt. (8.7 L, 7.7 Imp. qt.)   |
|                 | RC F                  | 11.8 qt. (11.2 L, 9.9 Imp. qt.) |
| Fluid type      | Toyota Genuine ATF WS |                                 |

\*: The fluid capacity is a reference quantity.  
If replacement is necessary, contact your Lexus dealer.

#### NOTICE

##### ■ Automatic transmission fluid type

Using transmission fluid other than "Toyota Genuine ATF WS" may cause deterioration in shift quality, locking up of your transmission accompanied by vibration, and ultimately damage the transmission of your vehicle.

### Front differential (AWD models)

|                        |  |
|------------------------|--|
| Oil capacity           | 0.74 qt. (0.70 L, 0.61 Imp. qt.)   |
| Oil type and viscosity | Hypoid gear oil API GL-5<br>Above 0°F (-18°C): SAE90<br>Below 0°F (-18°C): SAE80W or SAE80W-90 |

**Rear differential**

- ▶ RC350/RC300/RC200t (vehicles without LSD [Limited Slip Differential])

|                        |   |
|------------------------|---|
| Oil capacity           | 1.42 qt. (1.35 L, 1.19 Imp. qt.)                                    |
| Oil type and viscosity | Toyota Genuine Differential gear oil LT 75W-85 GL-5 or equivalent*1 |

- ▶ RC350/RC200t/RC F (vehicles with LSD [Limited Slip Differential])

|                        |   |
|------------------------|---|
| Oil capacity           | 1.42 qt. (1.35 L, 1.19 Imp. qt.)                                    |
| Oil type and viscosity | Toyota Genuine Differential gear oil LX 75W-85 GL-5 or equivalent*1 |

- ▶ RC F (vehicles with TVD [Torque Vectoring Differential])

|                        | Differential  | Torque transfer module*2  |
|------------------------|---|---|
| Oil capacity           | 1.42 qt. (1.35 L, 1.19 Imp. qt.)                                    | Left-hand side:<br>0.74 qt. (0.70 L, 0.62 Imp. qt.)<br>Right-hand side:<br>0.74 qt. (0.70 L, 0.62 Imp. qt.) |
| Oil type and viscosity | Toyota Genuine Differential gear oil LT 75W-85 GL-5 or equivalent*1 | Toyota Genuine ATF WS*3   |

\*1: Your Lexus vehicle is filled with “Toyota Genuine Differential Gear Oil” at the factory. Use Lexus approved “Toyota Genuine Differential Gear Oil” or an equivalent of matching quality to satisfy the above specification. Please contact your Lexus dealer for further details.

\*2: Torque transfer modules are located on the right and left sides of the rear differential unit.

\*3: Using torque transfer module fluid other than “Toyota Genuine ATF WS” may cause deterioration of performance, vibration, or ultimately damage the TVD system of your vehicle.



## Brakes

|  |                   |                                 |
|--|-------------------|---------------------------------|
| Pedal clearance <sup>*1</sup>            | RC350 (2WD)       | 4.3 in. (108 mm) Min.           |
|  | RC350/RC300 (AWD) | 4.5 in. (115 mm) Min.           |
|  | RC200t            | 4.1 in. (104 mm) Min.           |
|  | RC F              | 4.4 in. (112 mm) Min.           |
| Pedal free play                          |                   | 0.04 – 0.24 in. (1.0 – 6.0 mm)  |
| Brake pad wear limit                     |                   | 0.04 in. (1.0 mm)               |
| Parking brake lining wear limit          |                   | 0.04 in. (1.0 mm)               |
| Parking brake pedal travel <sup>*2</sup> |                   | 7—10 clicks                     |
| Fluid type                               |                   | SAE J1703 or FMVSS No.116 DOT 3 |

\*1: Minimum pedal clearance when depressed with a force of 112.4 lbf (500 N, 51.0 kgf) while the engine is running.

\*2: Parking brake pedal travel when depressed with a force of 67.4 lbf (300 N, 30.6 kgf)

## Steering

|           |                           |
|-----------|---------------------------|
| Free play | Less than 1.2 in. (30 mm) |
|-----------|---------------------------|

**Tires and wheels**

► RC350/RC300/RC200t (type A)

|   |  |
|---|--|
| Tire size   | 235/45R18 94Y, T155/70D17 110M (spare)   |
| Tire inflation pressure<br>(Recommended cold tire inflation pressure) | <p>Driving under normal conditions</p> <p>Front: 35 psi (240 kPa, 2.4 kgf/cm<sup>2</sup> or bar)</p> <p>Rear: 35 psi (240 kPa, 2.4 kgf/cm<sup>2</sup> or bar)</p> <p>Spare: 60 psi (420 kPa, 4.2 kgf/cm<sup>2</sup> or bar)</p> <p>Driving at high speeds (above 100 mph [160 km/h]) (in countries where such speeds are permitted by law)</p> <p>Add 3 psi (20 kPa, 0.2 kgf/cm<sup>2</sup> or bar) to the front tires, 6 psi (40 kPa, 0.4 kgf/cm<sup>2</sup> or bar) to the rear tires. Never exceed the maximum cold tire inflation pressure indicated on the tire sidewall.</p> |
| Wheel size  | 18 × 8J, 17 × 4T (spare)   |
| Wheel nut torque  | 76 ft•lbf (103 N•m, 10.5 kgf•m)  |

► RC350/RC300/RC200t (type B)

|   |  |
|---|--|
| Tire size   | 235/45R18 94Y, T145/70D18 107M (spare)   |
| Tire inflation pressure<br>(Recommended cold tire inflation pressure) | <p>Driving under normal conditions</p> <p>Front: 35 psi (240 kPa, 2.4 kgf/cm<sup>2</sup> or bar)</p> <p>Rear: 35 psi (240 kPa, 2.4 kgf/cm<sup>2</sup> or bar)</p> <p>Spare: 60 psi (420 kPa, 4.2 kgf/cm<sup>2</sup> or bar)</p> <p>Driving at high speeds (above 100 mph [160 km/h]) (in countries where such speeds are permitted by law)</p> <p>Add 3 psi (20 kPa, 0.2 kgf/cm<sup>2</sup> or bar) to the front tires, 6 psi (40 kPa, 0.4 kgf/cm<sup>2</sup> or bar) to the rear tires. Never exceed the maximum cold tire inflation pressure indicated on the tire sidewall.</p> |
| Wheel size  | 18 × 8J, 18 × 4T (spare)   |
| Wheel nut torque  | 76 ft•lbf (103 N•m, 10.5 kgf•m)  |

## ► RC350/RC300/RC200t (type C)

|   |  |
|---|--|
| Tire size   | P235/45R18 94V, T155/70D17 110M (spare)  |
| Tire inflation pressure<br>(Recommended cold tire inflation pressure) | <p>Driving under normal conditions</p> <p>Front: 35 psi (240 kPa, 2.4 kgf/cm<sup>2</sup> or bar)</p> <p>Rear: 35 psi (240 kPa, 2.4 kgf/cm<sup>2</sup> or bar)</p> <p>Spare: 60 psi (420 kPa, 4.2 kgf/cm<sup>2</sup> or bar)</p> <p>Driving at high speeds (above 100 mph [160 km/h]) (in countries where such speeds are permitted by law)</p> <p>Add 3 psi (20 kPa, 0.2 kgf/cm<sup>2</sup> or bar) to the front tires, 6 psi (40 kPa, 0.4 kgf/cm<sup>2</sup> or bar) to the rear tires. Never exceed the maximum cold tire inflation pressure indicated on the tire sidewall.</p> |
| Wheel size  | 18 × 8J, 17 × 4T (spare)   |
| Wheel nut torque  | 76 ft•lbf (103 N•m, 10.5 kgf•m)  |

## ► RC350/RC300/RC200t (type D)

|   |  |
|---|--|
| Tire size   | P235/45R18 94V, T145/70D18 107M (spare)  |
| Tire inflation pressure<br>(Recommended cold tire inflation pressure) | <p>Driving under normal conditions</p> <p>Front: 35 psi (240 kPa, 2.4 kgf/cm<sup>2</sup> or bar)</p> <p>Rear: 35 psi (240 kPa, 2.4 kgf/cm<sup>2</sup> or bar)</p> <p>Spare: 60 psi (420 kPa, 4.2 kgf/cm<sup>2</sup> or bar)</p> <p>Driving at high speeds (above 100 mph [160 km/h]) (in countries where such speeds are permitted by law)</p> <p>Add 3 psi (20 kPa, 0.2 kgf/cm<sup>2</sup> or bar) to the front tires, 6 psi (40 kPa, 0.4 kgf/cm<sup>2</sup> or bar) to the rear tires. Never exceed the maximum cold tire inflation pressure indicated on the tire sidewall.</p> |
| Wheel size  | 18 × 8J, 18 × 4T (spare)   |
| Wheel nut torque  | 76 ft•lbf (103 N•m, 10.5 kgf•m)  |

► RC350/RC300/RC200t (type E)

|   |  |
|---|--|
| Tire size   | 235/40R19 96V, T155/70D17 110M (spare)   |
| Tire inflation pressure<br>(Recommended cold tire inflation pressure) | <p>Driving under normal conditions</p> <p>Front: 35 psi (240 kPa, 2.4 kgf/cm<sup>2</sup> or bar)</p> <p>Rear: 36 psi (250 kPa, 2.5 kgf/cm<sup>2</sup> or bar)</p> <p>Spare: 60 psi (420 kPa, 4.2 kgf/cm<sup>2</sup> or bar)</p> <p>Driving at high speeds (above 100 mph [160 km/h]) (in countries where such speeds are permitted by law)</p> <p>Add 6 psi (40 kPa, 0.4 kgf/cm<sup>2</sup> or bar) to the front tires, 8 psi (50 kPa, 0.5 kgf/cm<sup>2</sup> or bar) to the rear tires. Never exceed the maximum cold tire inflation pressure indicated on the tire sidewall.</p> |
| Wheel size  | 19 × 8J, 17 × 4T (spare)   |
| Wheel nut torque  | 76 ft•lbf (103 N•m, 10.5 kgf•m)  |

► RC350/RC300/RC200t (type F)

|   |  |
|---|--|
| Tire size   | 235/40R19 96V, T145/70D18 107M (spare)   |
| Tire inflation pressure<br>(Recommended cold tire inflation pressure) | <p>Driving under normal conditions</p> <p>Front: 35 psi (240 kPa, 2.4 kgf/cm<sup>2</sup> or bar)</p> <p>Rear: 36 psi (250 kPa, 2.5 kgf/cm<sup>2</sup> or bar)</p> <p>Spare: 60 psi (420 kPa, 4.2 kgf/cm<sup>2</sup> or bar)</p> <p>Driving at high speeds (above 100 mph [160 km/h]) (in countries where such speeds are permitted by law)</p> <p>Add 6 psi (40 kPa, 0.4 kgf/cm<sup>2</sup> or bar) to the front tires, 8 psi (50 kPa, 0.5 kgf/cm<sup>2</sup> or bar) to the rear tires. Never exceed the maximum cold tire inflation pressure indicated on the tire sidewall.</p> |
| Wheel size  | 19 × 8J, 18 × 4T (spare)   |
| Wheel nut torque  | 76 ft•lbf (103 N•m, 10.5 kgf•m)  |

## ► RC350/RC200t (type G)

|   |  |
|---|--|
| Tire size   | Front tires: 235/40R19 96Y XL<br>Rear tires: 265/35R19 94Y<br>Spare tire: T155/70D17 110M  |
| Tire inflation pressure<br>(Recommended cold tire inflation pressure) | Driving under normal conditions<br>Front: 35 psi (240 kPa, 2.4 kgf/cm <sup>2</sup> or bar)<br>Rear: 36 psi (250 kPa, 2.5 kgf/cm <sup>2</sup> or bar)<br>Spare: 60 psi (420 kPa, 4.2 kgf/cm <sup>2</sup> or bar)<br>Driving at high speeds (above 100 mph [160 km/h]) (in countries where such speeds are permitted by law)<br>Add 6 psi (40 kPa, 0.4 kgf/cm <sup>2</sup> or bar) to the front tires. Never exceed the maximum cold tire inflation pressure indicated on the tire sidewall. |
| Wheel size  | Front wheels: 19 × 8J<br>Rear wheels: 19 × 9J<br>Spare wheel: 17 × 4T  |
| Wheel nut torque  | 76 ft•lbf (103 N•m, 10.5 kgf•m)  |

## ► RC350/RC200t (type H)

|   |  |
|---|--|
| Tire size   | Front tires: 235/40R19 96Y XL<br>Rear tires: 265/35R19 94Y<br>Spare tire: T145/70D18 107M  |
| Tire inflation pressure<br>(Recommended cold tire inflation pressure) | Driving under normal conditions<br>Front: 35 psi (240 kPa, 2.4 kgf/cm <sup>2</sup> or bar)<br>Rear: 36 psi (250 kPa, 2.5 kgf/cm <sup>2</sup> or bar)<br>Spare: 60 psi (420 kPa, 4.2 kgf/cm <sup>2</sup> or bar)<br>Driving at high speeds (above 100 mph [160 km/h]) (in countries where such speeds are permitted by law)<br>Add 6 psi (40 kPa, 0.4 kgf/cm <sup>2</sup> or bar) to the front tires. Never exceed the maximum cold tire inflation pressure indicated on the tire sidewall. |
| Wheel size  | Front wheels: 19 × 8J<br>Rear wheels: 19 × 9J<br>Spare wheel: 18 × 4T  |
| Wheel nut torque  | 76 ft•lbf (103 N•m, 10.5 kgf•m)  |

► RC F (type A)

|   |  |
|---|--|
| Tire size   | Front tires: 255/35ZR19 (92Y)<br>Rear tires: 275/35ZR19 (96Y)  |
| Tire inflation pressure<br>(Recommended cold tire inflation pressure) | Driving under normal conditions<br>Front: 36 psi (250 kPa, 2.5 kgf/cm <sup>2</sup> or bar)<br>Rear: 36 psi (250 kPa, 2.5 kgf/cm <sup>2</sup> or bar)<br>Driving at high speeds (above 137 mph [220 km/h]) (in countries where such speeds are permitted by law)<br>Add 8 psi (50 kPa, 0.5 kgf/cm <sup>2</sup> or bar) to the front tires and rear tires. Never exceed the maximum cold tire inflation pressure indicated on the tire sidewall. |
| Wheel size  | Front wheels: 19 × 9J<br>Rear wheels: 19 × 10J   |
| Wheel nut torque  | 76 ft•lbf (103 N•m, 10.5 kgf•m)  |

► RC F (type B)

|   |   |
|---|---|
| Tire size   | Front tires: 255/35ZR19 (92Y)<br>Rear tires: 275/35ZR19 (96Y)<br>Spare tire: 225/40ZR19 (93Y)   |
| Tire inflation pressure<br>(Recommended cold tire inflation pressure) | Driving under normal conditions<br>Front: 36 psi (250 kPa, 2.5 kgf/cm <sup>2</sup> or bar)<br>Rear: 36 psi (250 kPa, 2.5 kgf/cm <sup>2</sup> or bar)<br>Spare: 42 psi (290 kPa, 2.9 kgf/cm <sup>2</sup> or bar)<br>Driving at high speeds (above 137 mph [220 km/h]) (in countries where such speeds are permitted by law)<br>Add 8 psi (50 kPa, 0.5 kgf/cm <sup>2</sup> or bar) to the front tires and rear tires. Never exceed the maximum cold tire inflation pressure indicated on the tire sidewall. |
| Wheel size  | Front wheels: 19 × 9J<br>Rear wheels: 19 × 10J<br>Spare wheel: 19 × 8 1/2J  |
| Wheel nut torque  | 76 ft•lbf (103 N•m, 10.5 kgf•m)   |

### Light bulbs

|          | Light bulbs                          | Bulb No. | W    | Type |
|----------|--------------------------------------|----------|------|------|
| Exterior | Front turn signal lights (bulb type) | 7444NA   | 28/8 | A    |
|          | Rear turn signal lights              | —        | 21   | A    |
|          | Back-up lights                       | 921      | 16   | B    |
| Interior | Vanity lights                        | —        | 8    | B    |
|          | Footwell lights                      | 194      | 3.8  | B    |
|          | Trunk light                          | —        | 5    | B    |

A: Wedge base bulbs (amber)

B: Wedge base bulbs (clear)

## Fuel information

You must only use unleaded gasoline.

RC350/RC300/RC F:

Select premium unleaded gasoline with an octane rating of 91 (Research Octane Number 96) or higher required for optimum engine performance. If 91 octane cannot be obtained, you may use unleaded gasoline with an octane rating as low as 87 (Research Octane Number 91). Use of unleaded gasoline with an octane rating lower than 91 may result in engine knocking and significantly reduced performance. Persistent knocking can lead to engine damage and should be corrected by refueling with higher octane unleaded gasoline.

RC200t:

Select premium unleaded gasoline with an octane rating of 91 (Research Octane Number 96) or higher required for optimum engine performance. If 91 octane cannot be obtained, you may use unleaded gasoline with an octane rating as low as 87 (Research Octane Number 91). Use of unleaded gasoline with an octane rating lower than 91 may result in engine knocking. Persistent knocking can lead to engine damage and should be corrected by refueling with higher octane unleaded gasoline.

At minimum, the gasoline you use should meet the specifications of ASTM D4814 in the U.S.A..

### ■ Gasoline quality

In very few cases, driveability problems may be caused by the brand of gasoline you are using. If driveability problems persist, try changing the brand of gasoline. If this does not correct the problem, consult your Lexus dealer.

### ■ Gasoline quality standards

- Automotive manufacturers in the U.S.A., Europe and Japan have developed a specification for fuel quality called the World-Wide Fuel Charter (WWFC), which is expected to be applied worldwide.
- The WWFC consists of four categories that are based on required emission levels. In the U.S., category 4 has been adopted.
- The WWFC improves air quality by lowering emissions in vehicle fleets, and improves customer satisfaction through better performance.



#### ■ Recommendation of the use of gasoline containing detergent additives

- Lexus recommends the use of gasoline that contains detergent additives to avoid the build-up of engine deposits.
- All gasoline sold in the U.S.A. contains minimum detergent additives to clean and/or keep clean intake systems, per EPA's lowest additives concentration program.
- Lexus strongly recommends the use of Top Tier Detergent Gasoline. For more information on Top Tier Detergent Gasoline and a list of marketers, please go to the official website [www.toptiergas.com](http://www.toptiergas.com).

#### ■ Recommendation of the use of low emissions gasoline

Gasolines containing oxygenates such as ethers and ethanol, as well as reformulated gasolines, are available in some cities. These fuels are typically acceptable for use, providing they meet other fuel requirements.

Lexus recommends these fuels, since the formulations allow for reduced vehicle emissions.

#### ■ Non-recommendation of the use of blended gasoline

- Use only gasoline containing up to 15% ethanol.  
DO NOT use any flex-fuel or gasoline that could contain more than 15% ethanol, including from any pump labeled E30, E50, E85 (which are only some examples of fuel containing more than 15% ethanol).

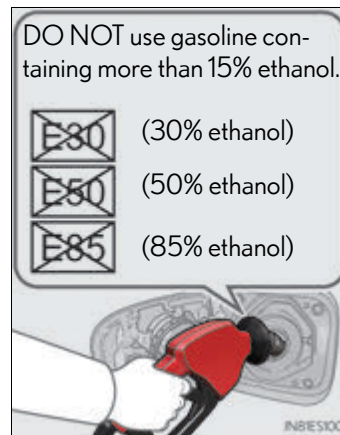

- If you use gasohol in your vehicle, be sure that it has an octane rating no lower than 87.
- Lexus does not recommend the use of gasoline containing methanol.

#### ■ Non-recommendation of the use of gasoline containing MMT

Some gasoline contains an octane enhancing additive called MMT (Methylcyclopentadienyl Manganese Tricarbonyl).

Lexus does not recommend the use of gasoline that contains MMT. If fuel containing MMT is used, your emission control system may be adversely affected.

The malfunction indicator lamp on the instrument cluster may come on. If this happens, contact your Lexus dealer for service.

#### ■ If your engine knocks

- Consult your Lexus dealer.
- You may occasionally notice light knocking for a short time while accelerating or driving uphill. This is normal and there is no need for concern.

 NOTICE

■ **Notice on fuel quality**

- Do not use improper fuels. If improper fuels are used, the engine will be damaged.
- Do not use leaded gasoline.  
Leaded gasoline can cause damage to your vehicle's three-way catalytic converters causing the emission control system to malfunction.
- Do not use gasohol other than the type previously stated.  
Other gasohol may cause fuel system damage or vehicle performance problems.
- Using unleaded gasoline with an octane number or rating lower than the level previously stated will cause persistent heavy knocking.  
At worst, this will lead to engine damage.

■ **Fuel-related poor driveability**

If poor driveability (poor hot starting, vaporization, engine knocking, etc.) is encountered after using a different type of fuel, discontinue the use of that type of fuel.

■ **When refueling with gasohol**

Take care not to spill gasohol. It can damage your vehicle's paint.

## Tire information

### Typical tire symbols

► Full-size tire

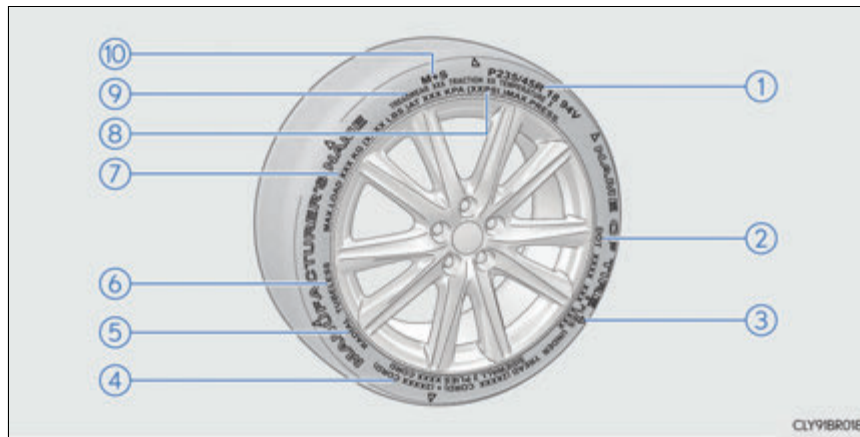

► Compact spare tire

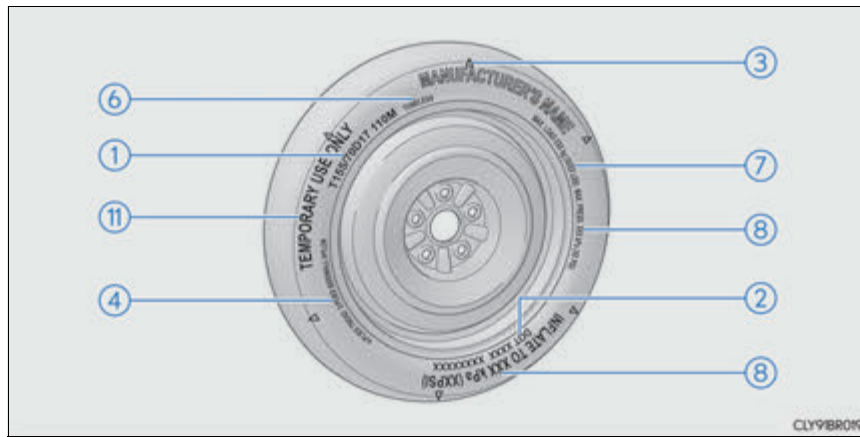

- 
- ① Tire size (→P. 642)
  - ② DOT and Tire Identification Number (TIN) (→P. 641)
  - ③ Location of treadwear indicators (→P. 501)
  - ④ Tire ply composition and materials  
Plies are layers of rubber-coated parallel cords. Cords are the strands which form the plies in a tire.
  - ⑤ Radial tires or bias-ply tires  
A radial tire has "RADIAL" on the sidewall. A tire not marked "RADIAL" is a bias-ply tire.
  - ⑥ TUBELESS or TUBE TYPE  
A tubeless tire does not have a tube and air is directly put into the tire. A tube type tire has a tube inside the tire and the tube maintains the air pressure.
  - ⑦ Load limit at maximum cold tire inflation pressure (→P. 646)
  - ⑧ Maximum cold tire inflation pressure (→P. 646)  
This means the pressure to which a tire may be inflated.
  - ⑨ Uniform tire quality grading  
For details, see "Uniform Tire Quality Grading" that follows.
  - ⑩ Summer tires or all season tires (→P. 505)  
An all season tire has "M+S" on the sidewall. A tire not marked "M+S" is a summer tire.
  - ⑪ "TEMPORARY USE ONLY"  
A compact spare tire is identified by the phrase "TEMPORARY USE ONLY" molded on its sidewall. This tire is designed for temporary emergency use only.

**Typical DOT and Tire Identification Number (TIN)**

- ① DOT symbol\*
- ② Tire Identification Number (TIN)
- ③ Tire manufacturer's identification mark
- ④ Tire size code
- ⑤ Manufacturer's optional tire type code (3 or 4 letters)
- ⑥ Manufacturing week
- ⑦ Manufacturing year

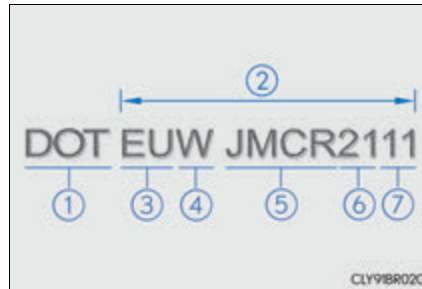

\*: The DOT symbol certifies that the tire conforms to applicable Federal Motor Vehicle Safety Standards.

### Tire size

#### ■ Typical tire size information

The illustration indicates typical tire size.

- ① Tire use (P = Passenger car, T = Temporary use)
- ② Section width (millimeters)
- ③ Aspect ratio (tire height to section width)
- ④ Tire construction code (R = Radial, D = Diagonal)
- ⑤ Wheel diameter (inches)
- ⑥ Load index (2 digits or 3 digits)
- ⑦ Speed symbol (alphabet with one letter)

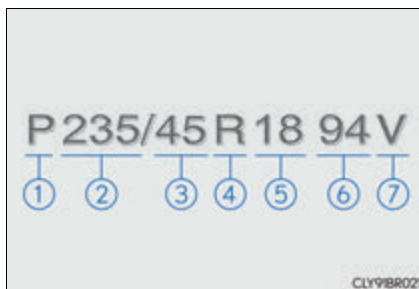

#### ■ Tire dimensions

- ① Section width
- ② Tire height
- ③ Wheel diameter

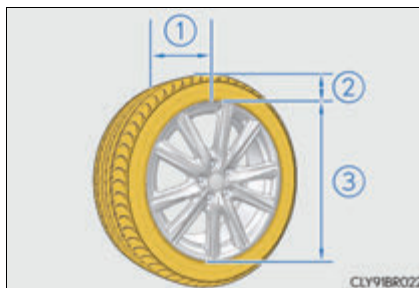

**Tire section names**

- ① Bead
- ② Sidewall
- ③ Shoulder
- ④ Tread
- ⑤ Belt
- ⑥ Inner liner
- ⑦ Reinforcing rubber
- ⑧ Carcass
- ⑨ Rim lines
- ⑩ Bead wires
- ⑪ Chafer

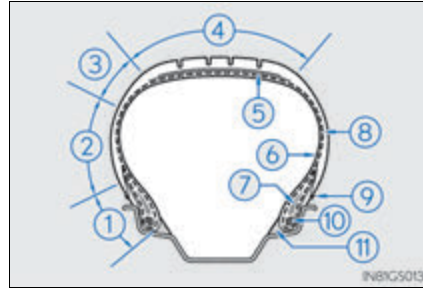

### Uniform Tire Quality Grading

This information has been prepared in accordance with regulations issued by the National Highway Traffic Safety Administration of the U.S. Department of Transportation.

It provides the purchasers and/or prospective purchasers of Lexus vehicles with information on uniform tire quality grading.

Your Lexus dealer will help answer any questions you may have as you read this information.

#### ■ DOT quality grades

All passenger vehicle tires must conform to Federal Safety Requirements in addition to these grades. Quality grades can be found where applicable on the tire sidewall between tread shoulder and maximum section width.

For example: Treadwear 200 Traction AA Temperature A

#### ■ Treadwear

The treadwear grade is a comparative rating based on the wear rate of the tire when tested under controlled conditions on a specified government test course.

For example, a tire graded 150 would wear one and a half (1 - 1/2) times as well on the government course as a tire graded 100.

The relative performance of tires depends upon the actual conditions of their use. Performance may differ significantly from the norm due to variations in driving habits, service practices and differences in road characteristics and climate.

#### ■ Traction AA, A, B, C

The traction grades, from highest to lowest, are AA, A, B and C, and they represent the tire's ability to stop on wet pavement as measured under controlled conditions on specified government test surfaces of asphalt and concrete.

A tire marked C may have poor traction performance.

Warning: The traction grade assigned to this tire is based on braking (straight ahead) traction tests and does not include cornering (turning) traction.



### ■ Temperature A, B, C

The temperature grades are A (the highest), B, and C, representing the tire's resistance to the generation of heat and its ability to dissipate heat when tested under controlled conditions on a specified indoor laboratory test wheel.

Sustained high temperature can cause the material of the tire to degenerate and reduce tire life, and excessive temperature can lead to sudden tire failure.

Grade C corresponds to a level of performance which all passenger car tires must meet under the Federal Motor Vehicle Safety Standard No. 109.

Grades B and A represent higher levels of performance on the laboratory test wheel than the minimum required by law.

Warning: The temperature grades of a tire assume that it is properly inflated and not overloaded.

Excessive speed, underinflation, or excessive loading, either separately or in combination, can cause heat buildup and possible tire failure.

### Glossary of tire terminology

| Tire related term              | Meaning  |
|--------------------------------|--|
| Cold tire inflation pressure   | Tire pressure when the vehicle has been parked for three hours or more, or has not been driven more than 1 mile or 1.5 km under that condition   |
| Maximum inflation pressure     | The maximum cold inflated pressure to which a tire may be inflated, shown on the sidewall of the tire  |
| Recommended inflation pressure | Cold tire inflation pressure recommended by a manufacturer   |
| Accessory weight               | The combined weight (in excess of those standard items which may be replaced) of automatic transmission, power steering, power brakes, power windows, power seats, radio and heater, to the extent that these items are available as factory-installed equipment (whether installed or not)            |
| Curb weight                    | The weight of a motor vehicle with standard equipment, including the maximum capacity of fuel, oil and coolant, and if so equipped, air conditioning and additional weight optional engine   |
| Maximum loaded vehicle weight  | The sum of:<br>(a) Curb weight<br>(b) Accessory weight<br>(c) Vehicle capacity weight<br>(d) Production options weight   |
| Normal occupant weight         | 150 lb. (68 kg) times the number of occupants specified in the second column of Table 1* that follows  |
| Occupant distribution          | Distribution of occupants in a vehicle as specified in the third column of Table 1* below  |
| Production options weight      | The combined weight of installed regular production options weighing over 5 lb. (2.3 kg) in excess of the standard items which they replace, not previously considered in curb weight or accessory weight, including heavy duty brakes, ride levelers, roof rack, heavy duty battery, and special trim |
| Rim                            | A metal support for a tire or a tire and tube assembly upon which the tire beads are seated  |

| Tire related term                                | Meaning  |
|--|--|
| Rim diameter<br>(Wheel diameter)                 | Nominal diameter of the bead seat  |
| Rim size designation                             | Rim diameter and width   |
| Rim type designation                             | The industry manufacturer's designation for a rim by style or code   |
| Rim width  | Nominal distance between rim flanges   |
| Vehicle capacity weight<br>(Total load capacity) | The rated cargo and luggage load plus 150 lb. (68 kg) times the vehicle's designated seating capacity  |
| Vehicle maximum load on the tire                 | The load on an individual tire that is determined by distributing to each axle its share of the maximum loaded vehicle weight, and dividing by two   |
| Vehicle normal load on the tire                  | The load on an individual tire that is determined by distributing to each axle its share of curb weight, accessory weight, and normal occupant weight (distributed in accordance with Table 1* below), and dividing by two |
| Weather side                                     | The surface area of the rim not covered by the inflated tire   |
| Bead   | The part of the tire that is made of steel wires, wrapped or reinforced by ply cords and that is shaped to fit the rim   |
| Bead separation                                  | A breakdown of the bond between components in the bead   |
| Bias ply tire                                    | A pneumatic tire in which the ply cords that extend to the beads are laid at alternate angles substantially less than 90 degrees to the centerline of the tread  |
| Carcass  | The tire structure, except tread and sidewall rubber which, when inflated, bears the load  |
| Chunking   | The breaking away of pieces of the tread or sidewall   |
| Cord   | The strands forming the plies in the tire  |
| Cord separation                                  | The parting of cords from adjacent rubber compounds  |
| Cracking   | Any parting within the tread, sidewall, or innerliner of the tire extending to cord material   |

| Tire related term                      | Meaning   |
|--|---|
| CT                                     | A pneumatic tire with an inverted flange tire and rim system in which the rim is designed with rim flanges pointed radially inward and the tire is designed to fit on the underside of the rim in a manner that encloses the rim flanges inside the air cavity of the tire  |
| Extra load tire                        | A tire designed to operate at higher loads and at higher inflation pressures than the corresponding standard tire   |
| Groove                                 | The space between two adjacent tread ribs   |
| Innerliner                             | The layer(s) forming the inside surface of a tubeless tire that contains the inflating medium within the tire   |
| Innerliner separation                  | The parting of the innerliner from cord material in the carcass   |
| Intended outboard sidewall             | (a) The sidewall that contains a whitewall, bears white lettering, or bears manufacturer, brand, and/or model name molding that is higher or deeper than the same molding on the other sidewall of the tire, or<br>(b) The outward facing sidewall of an asymmetrical tire that has a particular side that must always face outward when mounted on a vehicle |
| Light truck (LT) tire                  | A tire designated by its manufacturer as primarily intended for use on lightweight trucks or multipurpose passenger vehicles  |
| Load rating                            | The maximum load that a tire is rated to carry for a given inflation pressure   |
| Maximum load rating                    | The load rating for a tire at the maximum permissible inflation pressure for that tire  |
| Maximum permissible inflation pressure | The maximum cold inflation pressure to which a tire may be inflated   |
| Measuring rim                          | The rim on which a tire is fitted for physical dimension requirements   |
| Open splice                            | Any parting at any junction of tread, sidewall, or innerliner that extends to cord material   |
| Outer diameter                         | The overall diameter of an inflated new tire  |

| Tire related term   | Meaning   |
|---------------------|---|
| Overall width       | The linear distance between the exteriors of the sidewalls of an inflated tire, including elevations due to labeling, decorations, or protective bands or ribs  |
| Passenger car tire  | A tire intended for use on passenger cars, multipurpose passenger vehicles, and trucks, that have a gross vehicle weight rating (GVWR) of 10,000 lb. or less.   |
| Ply                 | A layer of rubber-coated parallel cords   |
| Ply separation      | A parting of rubber compound between adjacent plies   |
| Pneumatic tire      | A mechanical device made of rubber, chemicals, fabric and steel or other materials, that, when mounted on an automotive wheel, provides the traction and contains the gas or fluid that sustains the load   |
| Radial ply tire     | A pneumatic tire in which the ply cords that extend to the beads are laid at substantially 90 degrees to the centerline of the tread  |
| Reinforced tire     | A tire designed to operate at higher loads and at higher inflation pressures than the corresponding standard tire   |
| Section width       | The linear distance between the exteriors of the sidewalls of an inflated tire, excluding elevations due to labeling, decoration, or protective bands   |
| Sidewall            | That portion of a tire between the tread and bead   |
| Sidewall separation | The parting of the rubber compound from the cord material in the sidewall   |
| Snow tire           | A tire that attains a traction index equal to or greater than 110, compared to the ASTM E-1136 Standard Reference Test Tire, when using the snow traction test as described in ASTM F-1805-00, Standard Test Method for Single Wheel Driving Traction in a Straight Line on Snow-and Ice-Covered Surfaces, and which is marked with an Alpine Symbol (  ) on at least one sidewall |
| Test rim            | The rim on which a tire is fitted for testing, and may be any rim listed as appropriate for use with that tire  |

| Tire related term          | Meaning   |
|----------------------------|---|
| Tread                      | That portion of a tire that comes into contact with the road  |
| Tread rib                  | A tread section running circumferentially around a tire   |
| Tread separation           | Pulling away of the tread from the tire carcass   |
| Treadwear indicators (TWI) | The projections within the principal grooves designed to give a visual indication of the degrees of wear of the tread |
| Wheel-holding fixture      | The fixture used to hold the wheel and tire assembly securely during testing  |

\*: Table 1— Occupant loading and distribution for vehicle normal load for various designated seating capacities

| Designated seating capacity, Number of occupants | Vehicle normal load, Number of occupants | Occupant distribution in a normally loaded vehicle              |
|--|--|---|
| 2 through 4                                      | 2  | 2 in front  |
| 5 through 10                                     | 3  | 2 in front, 1 in second seat                                    |
| 11 through 15                                    | 5  | 2 in front, 1 in second seat, 1 in third seat, 1 in fourth seat |
| 16 through 20                                    | 7  | 2 in front, 2 in second seat, 2 in third seat, 1 in fourth seat |

## Customizable features

Your vehicle includes a variety of electronic features that can be personalized to your preferences. The settings of these features can be changed by using the meter control switches, the Remote Touch or Lexus Display Audio controller or at your Lexus dealer.

### Customizing vehicle features

#### ■ Changing by using the Remote Touch or Lexus Display Audio controller

- ▶ Vehicles with a Remote Touch

- 1 Press the "MENU" button on the Remote Touch.
- 2 Select "Setup" on the "Menu" screen and select "Vehicle".

Various setting can be changed. Refer to the list of settings that can be changed for details.

For details on the Remote Touch, refer to the "NAVIGATION SYSTEM OWNER'S MANUAL".

- ▶ Vehicles with a Lexus Display Audio controller

- 1 Press the "MENU" button on the Lexus Display Audio controller.  
(→P. 328)
- 2 Select "Setup" on the "Menu" screen and select "Vehicle".

Various setting can be changed. Refer to the list of settings that can be changed for details.

#### ■ Changing by using the meter control switches

→P. 107, 114

**Customizable features**



Some function settings are changed simultaneously with other functions being customized. Contact your Lexus dealer for further details.

- ① Settings that can be changed using the Remote Touch or Lexus Display Audio controller
- ② Settings that can be changed using the meter control switches
- ③ Settings that can be changed by your Lexus dealer

Definition of symbols: ○ = Available, – = Not available

■ **Gauges, meters and multi-information display** (→P. 84, 92, 98, 105, 113)

▶ RC350/RC300/RC200t

| Function *1                 | Default setting  | Customized setting  | ① | ② | ③ |
|-----------------------------|--|---|---|---|---|
| Language                    | English  | French  | ○ | ○ | – |
|                             |  | Spanish   |   |   |   |
| Units *2                    | miles (MPG US)   | km (km/L)   | ○ | ○ | – |
|                             |  | km (L/100 km)   |   |   |   |
|                             |  | miles (MPG Imperial)  |   |   |   |
| Eco Driving Indicator Light | ON (Self-lighting)   | OFF   | – | ○ | – |
| ■ switch settings *3        | Drive information 1  | Desired status screen *4  | – | ○ | – |
| Drive information 1         | Current fuel economy   | *5  | – | ○ | – |
|                             | Average fuel economy (after reset)   |   |   |   |   |
| Drive information 2         | Distance (driving range)   | *5  | – | ○ | – |
|                             | Average vehicle speed (after reset)  |   |   |   |   |
| Pop-up display              | ON   | OFF   | – | ○ | – |
| Accent color *3             | Color 1<br> | Color 2<br> | ○ | ○ | – |
| Needle *6                   | Blue   | Red   | – | ○ | – |
|                             |  | White   |   |   |   |



| Function <sup>*1</sup>        | Default setting | Customized setting             | ① | ② | ③ |
|-------------------------------|-----------------|--------------------------------|---|---|---|
| Speed indicator <sup>*6</sup> | OFF             | 30 to 100 mph (50 to 160 km/h) | – | ○ | – |
| Rev indicator <sup>*6</sup>   | 5000 rpm        | 2000 to 6600 rpm <sup>*7</sup> | – | ○ | – |
|                               |                 | 2000 to 6100 rpm <sup>*8</sup> |   |   |   |
|                               |                 | OFF                            |   |   |   |
| Rev peak <sup>*6</sup>        | ON              | OFF                            | – | ○ | – |

\*1: For details about each function: →P. 110

\*2: The default setting varies according to country.

\*3: Except F SPORT models

\*4: Some status screens cannot be registered (indicated on multi-information display).

\*5: 2 of the following items: current fuel consumption, average fuel economy (after reset), average fuel economy (after start), average fuel economy (after refuel), average vehicle speed (after reset), average vehicle speed (after start), elapsed time (after reset), elapsed time (after start), distance (driving range), distance (after start), blank.

\*6: F SPORT models

\*7: RC350/RC300

\*8: RC200t

▶ RC F

| Function <sup>*1</sup>  | Default setting     | Customized setting                  | ① | ② | ③ |
|---|---------------------|-------------------------------------|---|---|---|
| Language  | English             | French                              | ○ | ○ | – |
|   |                     | Spanish                             |   |   |   |
| Units <sup>*2</sup>   | miles (MPG US)      | km (km/L)                           | ○ | ○ | – |
|   |                     | km (L/100 km)                       |   |   |   |
|   |                     | miles (MPG Imperial)                |   |   |   |
| Eco Driving Indicator Light   | ON (Self-lighting)  | OFF                                 | – | ○ | – |
|  switch settings | Drive information 1 | Desired status screen <sup>*3</sup> | – | ○ | – |

| Function *1         | Default setting                     | Customized setting             | ① | ② | ③ |
|---------------------|-------------------------------------|--------------------------------|---|---|---|
| Drive information 1 | Current fuel economy                | *4                             | - | ○ | - |
|                     | Average fuel economy (after reset)  |                                |   |   |   |
| Drive information 2 | Distance (driving range)            | *4                             | - | ○ | - |
|                     | Average vehicle speed (after reset) |                                |   |   |   |
| Pop-up display      | ON                                  | OFF                            | - | ○ | - |
| Rev indicator       | Setting 2                           | Setting 1                      | - | ○ | - |
|                     |                                     | Setting 3                      |   |   |   |
|                     |                                     | OFF                            |   |   |   |
| Rev peak            | ON                                  | OFF                            | - | ○ | - |
| Speed indicator     | OFF                                 | 30 to 100 mph (50 to 160 km/h) | - | ○ | - |
| SPORT gauges        | SPORT S:<br>Type A                  | Type B                         | - | ○ | - |
|                     | SPORT S+:<br>Type B                 | Type A                         |   |   |   |

\*1: For details about each function: →P. 122

\*2: The default setting varies according to country.

\*3: Some status screens cannot be registered (indicated on multi-information display).

\*4: 2 of the following items: current fuel consumption, average fuel economy (after reset), average fuel economy (after start), average fuel economy (after refuel), average vehicle speed (after reset), average vehicle speed (after start), elapsed time (after reset), elapsed time (after start), distance (driving range), distance (after start), blank.

■ Door lock (→P.137, 143, 600)

| Function  | Default setting   | Customized setting  | ① | ② | ③ |
|---|---|---|---|---|---|
| Unlocking using a mechanical key  | Driver's door unlocked in one step, both side doors unlocked in two steps | Both side doors unlocked in one step                      | - | - | ○ |
| Automatic door lock   | Shifting the shift lever to position other than P                         | Off   | ○ | - | ○ |
|   |   | Vehicle speed is approximately 12 mph (20 km/h) or higher |   |   |   |
| Automatic door unlock   | Shifting the shift lever to P   | Off   | ○ | - | ○ |
|   |   | Driver's door is opened                                   |   |   |   |
| Locking/unlocking of the trunk when both side doors are locked/unlocked | On  | Off   | - | - | ○ |

■ Smart access system with push-button start and wireless remote control (→P.137, 143)

| Function   | Default setting | Customized setting | ① | ② | ③ |
|--|-----------------|--------------------|---|---|---|
| Operation buzzer volume  | 5               | Off                | ○ | - | ○ |
|  |                 | 1 to 7             |   |   |   |
| Operation signal (Emergency flashers)  | On              | Off                | ○ | - | ○ |
| Time elapsed before automatic door lock function is activated if door is not opened after being unlocked | 60 seconds      | Off                | ○ | - | ○ |
|  |                 | 30 seconds         |   |   |   |
|  |                 | 120 seconds        |   |   |   |
| Open door warning buzzer   | On              | Off                | - | - | ○ |
| Welcome light illumination control   | On              | Off                | - | - | ○ |

■ Smart access system with push-button start (→P. 137, 143, 148)

| Function                                   | Default setting | Customized setting | ① | ② | ③ |
|--|-----------------|--------------------|---|---|---|
| Smart access system with push-button start | On              | Off                | - | - | ○ |
| Smart door unlocking                       | Driver's door   | Both side doors    | ○ | - | ○ |
| Number of consecutive door lock operations | 2 times         | As many as desired | - | - | ○ |

■ Wireless remote control (→P. 132, 137, 143)

| Function                  | Default setting   | Customized setting                   | ① | ② | ③ |
|---------------------------|---|--------------------------------------|---|---|---|
| Wireless remote control   | On  | Off                                  | - | - | ○ |
| Unlocking operation       | Driver's door unlocked in one step, both side doors unlocked in two steps | Both side doors unlocked in one step | ○ | - | ○ |
| Trunk unlocking operation | Press and hold (short)  | One short press                      | - | - | ○ |
|                           |   | Push twice                           |   |   |   |
|                           |   | Press and hold (long)                |   |   |   |
|                           |   | Off                                  |   |   |   |
| Alarm (panic mode)        | On  | Off                                  | - | - | ○ |

■ Driving position memory\* (→P. 160)

| Function  | Default setting | Customized setting | ① | ② | ③ |
|---|-----------------|--------------------|---|---|---|
| Selecting the door linking driving position memory with door unlock operation | Driver's door   | Both side doors    | - | - | ○ |

\*: If equipped

### ■ Steering wheel (→P.167)

| Function                 | Default setting | Customized setting | ① | ② | ③ |
|--------------------------|-----------------|--------------------|---|---|---|
| Auto tilt away function* | On              | Off                | - | - | ○ |

\*: If equipped

### ■ Power windows (→P.174)

| Function   | Default setting | Customized setting | ① | ② | ③ |
|--|-----------------|--------------------|---|---|---|
| Mechanical key linked operation                          | Off             | On                 | - | - | ○ |
| Wireless remote control linked operation                 | Off             | On (Open only)     | - | - | ○ |
| Wireless remote control linked operation signal (buzzer) | On              | Off                | - | - | ○ |

### ■ Moon roof\* (→P.178)

| Function   | Default setting | Customized setting | ① | ② | ③ |
|--|-----------------|--------------------|---|---|---|
| Mechanical key linked operation                          | Off             | On                 | - | - | ○ |
| Wireless remote control linked operation                 | Off             | On (Open only)     | - | - | ○ |
| Wireless remote control linked operation signal (buzzer) | On              | Off                | - | - | ○ |

\*: If equipped

■ Turn signal lever (→P. 210)

| Function  | Default setting | Customized setting | ① | ② | ③ |
|---|-----------------|--------------------|---|---|---|
| The number of times the turn signal lights flash automatically when the turn signal lever is moved to the first position* <sup>1</sup> during a lane change* <sup>1</sup> | 3               | 5                  | - | - | ○ |
|   |                 | 7                  |   |   |   |
|   |                 | Off* <sup>2</sup>  |   |   |   |
|   |                 | Off* <sup>3</sup>  |   |   |   |

\*<sup>1</sup>: After flashing the turn signal lights when turning left or right while this function is off and the turn signal lever is moved to the first position in the direction of the flashing light, the turn signal lights can be selected to be flashing or off.

\*<sup>2</sup>: The turn signal lights keep flashing if the turn signal lever is moved to the first position in the direction of flashing light.

\*<sup>3</sup>: The turn signal lights will be off if the turn signal lever is moved to the first position in the direction of flashing light.

■ Automatic light control system (→P. 214)

| Function   | Default setting | Customized setting | ① | ② | ③ |
|--|-----------------|--------------------|---|---|---|
| Light sensor sensitivity   | Standard        | -2 to 2            | ○ | - | ○ |
| Time elapsed before headlights automatically turn off after doors are closed | 30 seconds      | Off                | ○ | - | ○ |
|  |                 | 60 seconds         |   |   |   |
|  |                 | 90 seconds         |   |   |   |

■ Lights (→P. 214)

| Function                                     | Default setting | Customized setting | ① | ② | ③ |
|--|-----------------|--------------------|---|---|---|
| Daytime running light system (except Canada) | On              | Off                | ○ | - | ○ |

### ■ Intuitive parking assist\*<sup>1</sup> (→P. 259)

| Function  | Default setting       | Customized setting | ①                     | ② | ③                     |
|---|-----------------------|--------------------|-----------------------|---|-----------------------|
| Detection distance of the front center sensor* <sup>1</sup> | Far                   | Near               | <input type="radio"/> | - | <input type="radio"/> |
| Detection distance of the rear center sensor                | Far                   | Near               | <input type="radio"/> | - | <input type="radio"/> |
| Buzzer volume   | 3                     | 1 to 5             | <input type="radio"/> | - | <input type="radio"/> |
| Display setting* <sup>2</sup>                               | All sensors displayed | Display off        | <input type="radio"/> | - | <input type="radio"/> |

\*<sup>1</sup>: If equipped

\*<sup>2</sup>: When intuitive parking assist is operating.

### ■ Active rear wing\* (→P. 315)

| Function                          | Default setting | Customized setting | ① | ②                     | ③                     |
|-----------------------------------|-----------------|--------------------|---|-----------------------|-----------------------|
| Operation of the active rear wing | Off             | On                 | - | <input type="radio"/> | <input type="radio"/> |

\*: RC F

### ■ Automatic air conditioning system (→P. 420)

| Function                       | Default setting | Customized setting | ①                     | ② | ③                     |
|--------------------------------|-----------------|--------------------|-----------------------|---|-----------------------|
| A/C auto switch operation      | On              | Off                | <input type="radio"/> | - | <input type="radio"/> |
| Exhaust gas sensor sensitivity | Standard        | -3 to 3            | <input type="radio"/> | - | <input type="radio"/> |

### ■ Seat heaters\* (→P. 430)

| Function                  | Default setting | Customized setting | ①                     | ② | ③                     |
|---------------------------|-----------------|--------------------|-----------------------|---|-----------------------|
| Seat heater timer control | Off             | On                 | <input type="radio"/> | - | <input type="radio"/> |

\*: If equipped

■ Illumination (→P. 432)

| Function  | Default setting | Customized setting | ① | ② | ③ |
|---|-----------------|--------------------|---|---|---|
| Time elapsed before the interior lights turn off  | 15 seconds      | Off                | ○ | - | ○ |
|   |                 | 7.5 seconds        |   |   |   |
|   |                 | 30 seconds         |   |   |   |
| Operation after the engine switch is turned off   | On              | Off                | - | - | ○ |
| Operation when the doors are unlocked   | On              | Off                | - | - | ○ |
| Operation when you approach the vehicle with the electronic key on your person                          | On              | Off                | - | - | ○ |
| Ambient lights and Remote Touch pad light*  | On              | Off                | - | - | ○ |
| Time elapsed before the outer foot lights turn off  | 15 seconds      | Off                | ○ | - | ○ |
|   |                 | 7.5 seconds        |   |   |   |
|   |                 | 30 seconds         |   |   |   |
| Operation of the outer foot lights when you approach the vehicle with the electronic key on your person | On              | Off                | - | - | ○ |
| Operation of the outer foot lights when the doors are unlocked with the power door lock switch          | On              | Off                | - | - | ○ |
| Operation of the outer foot lights when a door is opened  | On              | Off                | - | - | ○ |
| Fading out of the outer foot lights when they turn off  | Long            | Short              | - | - | ○ |

\*: If equipped

■ Seat belt reminder (→P. 544)

| Function                                       | Default setting | Customized setting | ① | ② | ③ |
|--|-----------------|--------------------|---|---|---|
| Vehicle speed linked seat belt reminder buzzer | On              | Off                | - | - | ○ |



### ■ Vehicle customization

- When the smart access system with push-button start is off, the entry unlock function cannot be customized.
- When the doors remain closed after unlocking the doors and the timer activated automatic door lock function activates, signals will be generated in accordance with the operation buzzer volume and operational signal (Emergency flashers) function settings.
- Some settings can be changed using a switch or the audio system screen. If a setting is changed using a switch, the changed setting will not be reflected on the audio system screen until the engine switch is turned off and then to IGNITION ON mode.

### ■ When customizing using the Remote Touch or Lexus Display Audio controller

Stop the vehicle in a safe place, apply the parking brake, and shift the shift lever to P. Also, to prevent battery discharge, leave the engine running while customizing the features.

#### WARNING

##### ■ During customization

As the engine needs to be running during customization, ensure that the vehicle is parked in a place with adequate ventilation. In a closed area such as a garage, exhaust gases including harmful carbon monoxide (CO) may collect and enter the vehicle. This may lead to death or a serious health hazard.

#### NOTICE

##### ■ During customization

To prevent battery discharge, ensure that the engine is running while customizing features.

## Items to initialize

The following items must be initialized for normal system operation after such cases as the battery being reconnected, or maintenance being performed on the vehicle:

| Item   | When to initialize  | Reference |
|--|---|-----------|
| Message indicating maintenance is required (U.S.A. only) | After the maintenance is performed  | P. 473    |
| Engine oil maintenance data*                             | After changing the engine oil   | P. 491    |
| Tire pressure warning system                             | <ul style="list-style-type: none"> <li>• When rotating the tires</li> <li>• When changing the tire inflation pressure by changing traveling speed or load weight, etc.</li> </ul> | P. 503    |

\*: If equipped

For owners

10

663

Reporting safety defects  
for U.S. owners..... 664

Seat belt instructions  
for Canadian owners  
(in French)..... 665

SRS airbag instructions  
for Canadian owners  
(in French)..... 667

## Reporting safety defects for U.S. owners

If you believe that your vehicle has a defect which could cause a crash or could cause injury or death, you should immediately inform the National Highway Traffic Safety Administration (NHTSA) in addition to notifying the Lexus Division of Toyota Motor Sales, U.S.A., Inc. (Toll-free: 1-800-25-LEXUS).

If NHTSA receives similar complaints, it may open an investigation, and if it finds that a safety defect exists in a group of vehicles, it may order a recall and remedy campaign. However, NHTSA cannot become involved in individual problems between you, your dealer, or Lexus Division of Toyota Motor Sales, U.S.A., Inc.

To contact NHTSA, you may call the Vehicle Safety Hotline toll-free at 1-888-327-4236 (TTY: 1-800-424-9153); go to <http://www.safercar.gov>; or write to: Administrator, NHTSA, 1200 New Jersey Ave, S.E., Washington, DC 20590. You can also obtain other information about motor vehicle safety from <http://www.safercar.gov>.

## Seat belt instructions for Canadian owners (in French)

The following is a French explanation of seat belt instructions extracted from the seat belt section in this manual.

See the seat belt section for more detailed seat belt instructions in English.

### Utilisation correcte des ceintures de sécurité

- Déroulez la sangle diagonale de telle sorte qu'elle passe bien sur l'épaule, sans pour autant être en contact avec le cou ou glisser de l'épaule.
- Placez la sangle abdominale le plus bas possible sur les hanches.
- Réglez la position du dossier de siège. Asseyez-vous le dos droit et calez-vous bien dans le siège.
- Ne vrillez pas la ceinture de sécurité.
  - ① Non vrillée
  - ② Vrillée

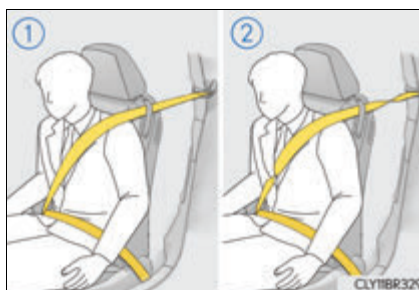

## Entretien et soin

### ■ Ceintures de sécurité

Nettoyez avec un chiffon ou une éponge humidifiés avec de l'eau savonneuse tiède. Vérifiez régulièrement que les ceintures ne sont pas usées, effilochées ou entaillées excessivement.

### AVERTISSEMENT

#### ■ Détérioration et usure des ceintures de sécurité

Inspectez le système de ceintures de sécurité régulièrement. Contrôlez l'absence de coupures, d'effilochages et de pièces desserrées. N'utilisez pas une ceinture de sécurité endommagée avant qu'elle ne soit remplacée. Une ceinture de sécurité endommagée ne permet pas de protéger un occupant de blessures graves ou mortelles.

## SRS airbag instructions for Canadian owners (in French)

The following is a French explanation of SRS airbag instructions extracted from the SRS airbag section in this manual.

See the SRS airbag section for more detailed SRS airbag instructions in English.

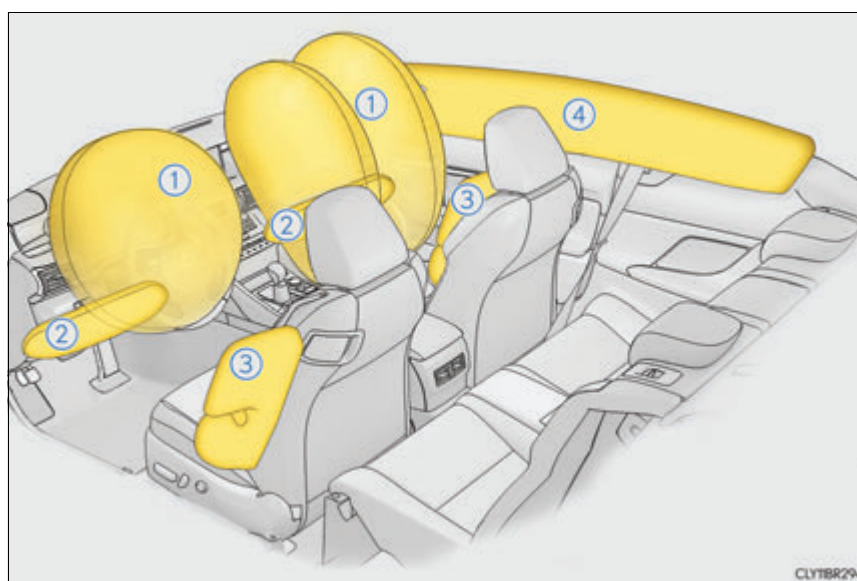

### ◆ Coussins gonflables frontaux SRS

- ① Coussin gonflable conducteur/coussin gonflable du passager avant SRS  
Participent à la protection de la tête et du thorax du conducteur et du passager avant contre les chocs contre les éléments de l'habitacle
- ② Coussins gonflables de genoux SRS  
Participent à la protection du conducteur et du passager avant

### ◆ Coussins gonflables latéraux et rideaux SRS

- ③ Coussins gonflables latéraux SRS  
Participent à la protection du torse des occupants de siège avant
- ④ Coussins gonflables rideaux SRS  
Participent principalement à la protection de la tête des occupants

For owners

### Composants du système de coussins gonflables SRS

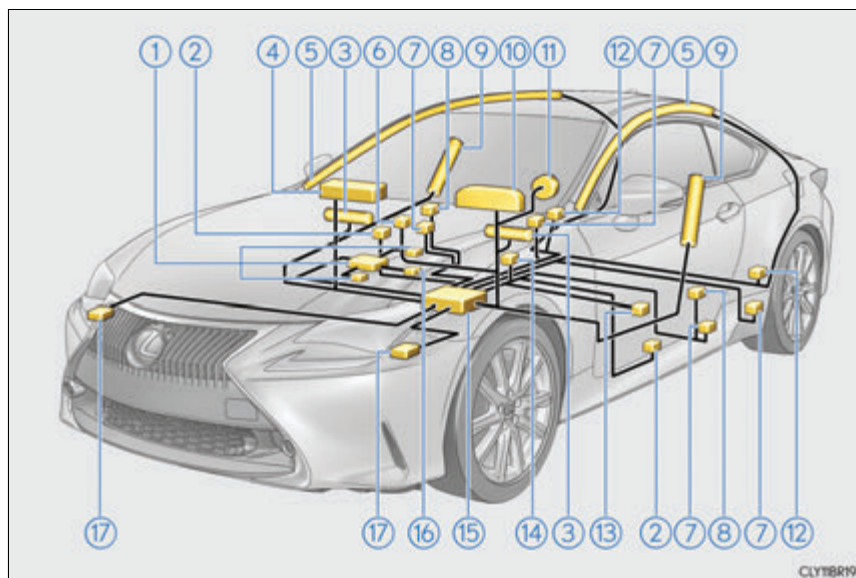

- |   |   |
|---|---|
| ① Système de classification de l'occupant du siège passager avant (ECU et capteurs) | ⑨ Coussins gonflables latéraux avant                          |
| ② Capteurs d'impact latéral (porte)   | ⑩ Témoin d'avertissement SRS                                  |
| ③ Coussins gonflables de genoux   | ⑪ Coussin gonflable conducteur                                |
| ④ Coussin gonflable passager avant  | ⑫ Capteurs d'impact latéral (arrière)                         |
| ⑤ Coussins gonflables rideaux   | ⑬ Capteur de position du siège conducteur                     |
| ⑥ Témoin indicateurs "AIR BAG ON" et "AIR BAG OFF"                                  | ⑭ Contact de boucle de ceinture de sécurité conducteur        |
| ⑦ Prétensionneurs de ceintures de sécurité et limiteurs de force                    | ⑮ Ensemble de capteurs de coussins gonflables                 |
| ⑧ Capteurs d'impact latéral (avant)   | ⑯ Contact de boucle de ceinture de sécurité du passager avant |
|   | ⑰ Capteurs d'impact avant                                     |



Votre véhicule est équipé de COUSSINS GONFLABLES INTELLIGENTS conçus selon les normes de sécurité américaines applicables aux véhicules à moteur (FMVSS208). L'ensemble de capteurs de coussins gonflables (ECU) régule le déploiement des coussins gonflables sur la base des informations qu'il reçoit des capteurs, etc., indiqués ci-dessus dans le schéma illustrant les composants du système. Parmi ces informations figurent la gravité du choc et l'occupation du véhicule par les passagers. Le déploiement rapide des coussins gonflables est obtenu au moyen d'une réaction chimique dans les dispositifs pyrotechniques, qui produit un gaz inoffensif permettant d'amortir le mouvement des occupants.

#### AVERTISSEMENT

##### ■ Précautions relatives aux coussins gonflables SRS

Respectez les précautions suivantes concernant les coussins gonflables SRS.

Le non-respect de ces précautions peut occasionner des blessures graves, voire mortelles.

- Le conducteur et tous les passagers du véhicule doivent porter correctement leur ceinture de sécurité.  
Les coussins gonflables SRS sont des dispositifs supplémentaires à utiliser avec les ceintures de sécurité.
- Le coussin gonflable conducteur SRS se déploie avec une force considérable, pouvant occasionner des blessures graves, voire mortelles, si le conducteur se trouve très près du coussin gonflable. L'autorité fédérale chargée de la sécurité routière aux États-Unis (NHTSA) conseille:

La zone à risque du coussin gonflable conducteur se situant dans les premiers 2 à 3 in. (50 à 75 mm) de déploiement, vous placer à 10 in. (250 mm) de votre coussin gonflable conducteur vous garantit une marge de sécurité suffisante. Cette distance est à mesurer entre le centre du volant et le sternum. Si vous êtes assis à moins de 10 in. (250 mm), vous pouvez changer votre position de conduite de plusieurs façons:

- Reculez votre siège le plus possible, de manière à pouvoir encore atteindre confortablement les pédales.
- Inclinez légèrement le dossier du siège.  
Bien que les véhicules aient une conception différente, un grand nombre de conducteurs peuvent s'asseoir à une distance de 10 in. (250 mm), même avec le siège conducteur complètement avancé, simplement en inclinant un peu le dossier de votre siège. Si vous avez des difficultés à voir la route après avoir incliné le dossier de votre siège, utilisez un coussin ferme et antidérapant pour vous rehausser ou remontez le siège si votre véhicule est équipé de cette fonction.
- Si votre volant est réglable, inclinez-le vers le bas. Cela a pour effet d'orienter le coussin gonflable en direction de votre poitrine plutôt que de votre tête et de votre cou.

Réglez votre siège selon les recommandations de la NHTSA ci-dessus, tout en conservant le contrôle des pédales, du volant et la vue des commandes du tableau de bord.

For owners

**⚠ AVERTISSEMENT**

■ **Précautions relatives aux coussins gonflables SRS**

- Si vous attachez une rallonge de ceinture de sécurité aux boucles de ceinture de sécurité avant, sans l'attacher au pêne de la ceinture de sécurité, les coussins gonflables frontaux SRS déterminent que le conducteur et le passager avant ont attaché leur ceinture de sécurité, bien que la ceinture de sécurité ne soit pas attachée. Dans ce cas, les coussins gonflables frontaux SRS peuvent ne pas se déployer correctement en cas de collision, pouvant occasionner des blessures graves, voire mortelles. Veillez à porter la ceinture de sécurité avec la rallonge de ceinture de sécurité.



- Le coussin gonflable passager avant SRS se déploie également avec une force considérable, pouvant occasionner des blessures graves, voire mortelles, si le passager avant se trouve très près du coussin gonflable. Le siège du passager avant doit être éloigné le plus possible du coussin gonflable en réglant le dossier de siège de façon à ce que le passager avant soit assis bien droit dans le siège.
- Les nourrissons et les enfants qui ne sont pas correctement assis et/ou attachés peuvent être grièvement blessés ou tués par le déploiement d'un coussin gonflable. Un nourrisson ou un enfant trop petit pour utiliser une ceinture de sécurité doit être correctement attaché au moyen d'un siège de sécurité enfant. Lexus recommande vivement d'installer tous les nourrissons et enfants sur les sièges arrière du véhicule et de prévoir pour eux des systèmes de retenue adaptés. Les sièges arrière sont plus sûrs pour les nourrissons et les enfants que le siège du passager avant.
- N'installez jamais un siège de sécurité enfant type dos à la route sur le siège passager avant, même si le témoin indicateur "AIR BAG OFF" est allumé. En cas d'accident, par la violence et la vitesse de son déploiement, le coussin gonflable du passager avant peut blesser grièvement, voire tuer l'enfant si le siège de sécurité enfant type dos à la route est installé sur le siège passager avant.
- Ne vous asseyez pas sur le bord du siège et ne vous appuyez pas contre la planche de bord.



**⚠ AVERTISSEMENT**

■ **Précautions relatives aux coussins gonflables SRS**

- Ne laissez pas un enfant rester debout devant le coussin gonflable passager avant SRS ou s'asseoir sur les genoux du passager avant.



- Ne laissez pas les occupants des sièges avant voyager avec un objet sur les genoux.

- Ne vous appuyez pas contre la porte, le rail latéral de toit ou les montants avant, latéraux et arrière.



- Ne laissez personne s'agenouiller sur les sièges passagers en appui contre la porte ou sortir la tête ou les mains à l'extérieur du véhicule.



- Ne fixez rien et ne posez rien sur des emplacements tels que la planche de bord, la garniture du volant et la partie inférieure du tableau de bord.

Ces éléments peuvent se transformer en projectiles lorsque les coussins gonflables conducteur, passager avant et genoux SRS se déploient.

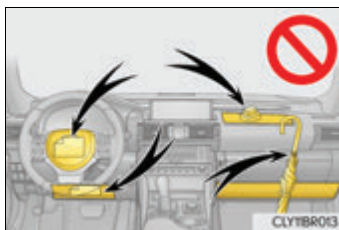

- Ne fixez rien aux portes, à la vitre du pare-brise, aux vitres latérales, aux montants avant et arrière, au rail latéral de toit et à la poignée de maintien. (Sauf pour l'autocollant de limitation de vitesse)

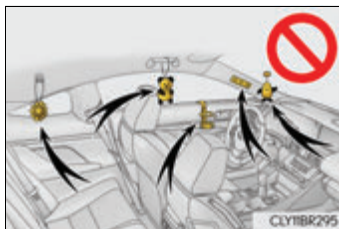

For owners

 **AVERTISSEMENT****■ Précautions relatives aux coussins gonflables SRS**

- Ne suspendez aucun cintre ou objet dur aux crochets à vêtements. Tous ces objets pourraient se transformer en projectiles et causer des blessures graves, voire mortelles en cas de déploiement des coussins gonflables rideaux SRS.
- Si un cache en vinyle est placé sur la zone où le coussin gonflable de genoux SRS se déploie, assurez-vous de le retirer.
- N'utilisez aucun accessoire de siège recouvrant les zones de déploiement des coussins gonflables latéraux SRS, car il risque de gêner le déploiement des coussins gonflables. De tels accessoires peuvent empêcher les coussins gonflables latéraux de fonctionner correctement, désactiver le système ou entraîner le déploiement accidentel des coussins gonflables latéraux, occasionnant des blessures graves, voire mortelles.
- Évitez de faire subir des chocs ou des pressions excessives aux parties renfermant les composants de coussins gonflables SRS.  
En effet, cela pourrait entraîner un dysfonctionnement des coussins gonflables SRS.
- Ne touchez aucun composant immédiatement après le déploiement (gonflage) des coussins gonflables SRS, car ils peuvent être chauds.
- Si vous avez des difficultés à respirer après le déploiement des coussins gonflables SRS, ouvrez une porte ou une vitre pour faire entrer de l'air frais, ou bien descendez du véhicule si cela ne présente pas de danger. Essayez tout résidu dès que possible afin d'éviter d'éventuelles irritations de la peau.
- Si les parties renfermant les coussins gonflables SRS, comme les garnitures du volant et des montants avant et arrière, sont endommagées ou craquelées, faites-les remplacer par votre concessionnaire Lexus.
- Ne placez rien sur le siège du passager avant, comme un coussin par exemple. Cela a pour conséquence de répartir le poids du passager sur toute la surface du siège, ce qui empêche le capteur de détecter correctement le poids du passager. En conséquence, les coussins gonflables frontaux SRS du passager avant risquent de ne pas se déployer en cas de collision.

 **AVERTISSEMENT****■ Modification et mise au rebut des composants du système de coussins gonflables SRS**

Ne mettez pas votre véhicule au rebut et ne procédez à aucune des modifications suivantes sans consulter votre concessionnaire Lexus. Les coussins gonflables SRS peuvent ne pas fonctionner correctement ou se déployer (se gonfler) accidentellement, provoquant la mort ou de graves blessures.

- Installation, dépose, démontage et réparation des coussins gonflables SRS
- Réparations, modifications, dépose ou remplacement du volant, du tableau de bord, de la planche de bord, des sièges ou de leur garnissage, des montants avant, latéraux et arrière ou des rails latéraux de toit
- Réparations ou modifications des ailes avant, du pare-chocs avant ou des flancs de l'habitacle
- Installation d'un protège-calandre (pare-buffle, pare-kangourou, etc.), de chasse-neige, de treuils
- Modifications du système de suspension du véhicule
- Installation d'appareils électroniques tels que les émetteurs/récepteurs radios mobiles et les lecteurs CD
- Modifications de votre véhicule pour une personne atteinte d'un handicap physique



## Index

675

|  |     |
|--|-----|
| What to do if...<br>(Troubleshooting)..... | 676 |
| Alphabetical index.....                    | 680 |

For vehicles with a navigation system, refer to the “NAVIGATION SYSTEM OWNER’S MANUAL” for information regarding the equipment listed below.

- Navigation system
- Audio/video system
- Intuitive parking assist
- Lexus parking assist monitor
- Lexus Enform

## What to do if... (Troubleshooting)

If you have a problem, check the following before contacting your Lexus dealer.

### The doors cannot be locked, unlocked, opened or closed



#### You lose your keys

- If you lose your mechanical keys, new genuine mechanical keys can be made by your Lexus dealer. (→P. 134)
- If you lose your electronic keys, the risk of vehicle theft increases significantly. Contact your Lexus dealer immediately. (→P. 136)



#### The doors cannot be locked or unlocked

- Is the electronic key battery weak or depleted? (→P. 517)
- Is the engine switch in IGNITION ON mode?  
When locking the doors, turn the engine switch off. (→P. 200)
- Is the electronic key left inside the vehicle?  
When locking the doors, make sure that you have the electronic key on your person.
- The function may not operate properly due to the condition of the radio wave. (→P. 150)



#### The trunk lid is closed with the electronic key left inside

- The function to prevent the electronic key from being left inside the trunk will operate and you can open the trunk as usual. Take the key out from the trunk. (→P. 145)



**If you think something is wrong****The engine does not start**

- Did you press the engine switch while firmly depressing the brake pedal? (→P. 199)
- Is the shift lever in P? (→P. 202)
- Is the electronic key anywhere detectable inside the vehicle? (→P. 148)
- Is the steering wheel unlocked? (→P. 202)
- Is the electronic key battery weak or depleted?  
In this case, the engine can be started in a temporary way. (→P. 602)
- Is the battery discharged? (→P. 604)

**The shift lever cannot be shifted from P even if you depress the brake pedal**

- Is the engine switch in IGNITION ON mode?  
If you cannot release the shift lever by depressing the brake pedal with the engine switch in IGNITION ON mode. (→P. 599)

**The steering wheel cannot be turned after the engine is stopped**

- It is locked automatically to prevent theft of the vehicle. (→P. 202)

**The windows do not open or close by operating the power window switches**

- Is the window lock switch pressed?  
The power window except for the one at the driver's seat cannot be operated if the window lock switch is pressed. (→P. 174)

**The engine switch is turned off automatically**

- The auto power off function will be operated if the vehicle is left in ACCESSORY or IGNITION ON mode (the engine is not running) for a period of time. (→P. 202)

 **A warning buzzer sounds during driving**

- The seat belt reminder light is flashing  
Are the driver and the front passenger wearing the seat belts? (→P. 544)
  - The parking brake indicator is on  
Is the parking brake released? (→P. 211)
- Depending on the situation, other types of warning buzzer may also sound.  
(→P. 543, 549)

 **An alarm is activated and the horn sounds**

- Did anyone inside the vehicle open a door during setting the alarm?  
The sensor detects it and the alarm sounds. (→P. 79)
- Do one of the following to deactivate or stop the alarms:
- Unlock the doors or open the trunk.
  - Turn the engine switch to ACCESSORY or IGNITION ON mode, or start the engine.

 **A warning buzzer sounds when leaving the vehicle**

- Is the electronic key left inside the vehicle or the moon roof opened?  
Check the message on the multi-information display. (→P. 549)

 **A warning light turns on or a warning message is displayed**

- When a warning light turns on or a warning message is displayed, refer to P. 543, 549.

**When a problem has occurred****If you have a flat tire**

- Vehicles with a spare tire  
Stop the vehicle in a safe place and replace the flat tire with the spare tire.  
(→P. 570)
- Vehicles with an emergency tire puncture repair kit  
Stop the vehicle in a safe place and repair the flat tire temporarily with the emergency tire puncture repair kit. (→P. 584)

**The vehicle becomes stuck**

- Try the procedure for when the vehicle becomes stuck in mud, dirt, or snow.  
(→P. 614)

## Alphabetical index

### A

|                                   |          |                                   |     |
|-----------------------------------|----------|-----------------------------------|-----|
| A/C.....                          | 420      | Airbags.....                      | 40  |
| Air conditioning filter.....      | 515      | Airbag operating conditions ..... | 47  |
| Automatic air conditioning        |          | Airbag precautions                |     |
| system .....                      | 420      | for your child .....              | 42  |
| AAC disc .....                    | 357      | Correct driving posture.....      | 32  |
| ABS (Anti-lock Brake System)..... | 287      | Curtain shield airbag             |     |
| Warning light .....               | 543      | operating conditions .....        | 47  |
| Active rear wing.....             | 315      | Curtain shield airbag             |     |
| Active Sound Control              |          | precautions .....                 | 44  |
| (ASC).....                        | 212, 213 | Front passenger occupant          |     |
| Adaptive Variable                 |          | classification system.....        | 50  |
| Suspension System.....            | 288      | General airbag precautions .....  | 42  |
| Air conditioning filter .....     | 515      | Locations of airbags.....         | 40  |
| Air conditioning system.....      | 420      | Modification and disposal         |     |
| Air conditioning filter .....     | 515      | of airbags.....                   | 46  |
| Automatic air conditioning        |          | Side airbag operating             |     |
| system .....                      | 420      | conditions .....                  | 47  |
|                                   |          | Side airbag precautions.....      | 42  |
|                                   |          | Side and curtain shield airbags   |     |
|                                   |          | operating conditions .....        | 47  |
|                                   |          | Side and curtain shield           |     |
|                                   |          | airbags precautions.....          | 42  |
|                                   |          | SRS airbags .....                 | 40  |
|                                   |          | SRS warning light .....           | 543 |

|                                   |          |                                     |          |
|-----------------------------------|----------|-------------------------------------|----------|
| Alarm.....                        | 79       | Automatic headlight leveling        |          |
| Anchor brackets.....              | 59       | system.....                         | 216      |
| Antennas (smart access system     |          | Warning light.....                  | 544      |
| with push-button start).....      | 148      | Automatic High Beam.....            | 217      |
| Anti-lock Brake System (ABS)..... | 287      | Automatic light control system..... | 214      |
| Warning light.....                | 543      | Automatic transmission.....         | 205      |
| Approach warning.....             | 244      | If the shift lever                  |          |
| Armrest.....                      | 441      | cannot be shifted from P.....       | 599      |
| ASC                               |          | M mode.....                         | 208      |
| (Active Sound Control).....       | 212, 213 | Paddle shift switches.....          | 207, 208 |
| Assist grip.....                  | 443      | AUX port.....                       | 334      |
| Audio input.....                  | 334      | Average fuel economy.....           | 108, 115 |
| Audio system.....                 | 326      | Average vehicle speed.....          | 108, 115 |
| Audio input.....                  | 334      |                                     |          |
| AUX port/USB port.....            | 334      |                                     |          |
| Bluetooth® audio.....             | 381      |                                     |          |
| CD player.....                    | 357      |                                     |          |
| iPod.....                         | 364      |                                     |          |
| MP3/WMA/AAC disc.....             | 357      |                                     |          |
| Optimal use.....                  | 344      |                                     |          |
| Portable music player.....        | 372      |                                     |          |
| Radio.....                        | 351      |                                     |          |
| Steering wheel audio switch.....  | 331      |                                     |          |
| USB memory.....                   | 368      |                                     |          |

**B**

|                                      |            |
|--------------------------------------|------------|
| Back-up lights                       |            |
| Replacing light bulbs.....           | 528        |
| Wattage.....                         | 635        |
| <b>Battery.....</b>                  | <b>497</b> |
| Battery checking.....                | 497        |
| If the vehicle battery               |            |
| is discharged.....                   | 604        |
| Preparing and checking before        |            |
| winter.....                          | 320        |
| Warning light.....                   | 543        |
| <b>Blind Spot Monitor (BSM).....</b> | <b>302</b> |
| <b>Bluetooth®</b>                    |            |
| Audio system.....                    | 381        |
| Hands-free system                    |            |
| (for cellular phone).....            | 383        |
| <b>Brake</b>                         |            |
| Fluid.....                           | 496        |
| Parking brake.....                   | 211        |
| Warning light.....                   | 543        |
| <b>Brake assist.....</b>             | <b>287</b> |
| <b>Break-in tips.....</b>            | <b>185</b> |
| <b>Brightness control</b>            |            |
| Instrument panel light               |            |
| control.....                         | 96, 103    |
| <b>BSM (Blind Spot Monitor).....</b> | <b>302</b> |

**C**

|                                     |                 |
|-------------------------------------|-----------------|
| Card key.....                       | 132             |
| <b>Care.....</b>                    | <b>464, 469</b> |
| Aluminum wheels.....                | 465             |
| Exterior.....                       | 464             |
| Interior.....                       | 469             |
| Seat belts.....                     | 470             |
| <b>Cargo capacity.....</b>          | <b>196</b>      |
| <b>Cargo hooks.....</b>             | <b>438</b>      |
| <b>CD player.....</b>               | <b>357</b>      |
| <b>Chains.....</b>                  | <b>321</b>      |
| <b>Child restraint system.....</b>  | <b>57</b>       |
| Child seats definition.....         | 57              |
| Child seats installation.....       | 64, 70          |
| Front passenger occupant            |                 |
| classification system.....          | 50              |
| Installing a CRS to                 |                 |
| the passenger seat.....             | 61              |
| Installing a CRS to the rear        |                 |
| seat.....                           | 63              |
| Installing CRS                      |                 |
| with LATCH anchors.....             | 71              |
| Installing CRS with seat belts..... | 64              |
| Installing CRS                      |                 |
| with top tether strap.....          | 73              |

|                                   |          |                                    |          |
|-----------------------------------|----------|------------------------------------|----------|
| Child safety .....                | 56       | Cleaning .....                     | 464, 469 |
| Airbag precautions .....          | 42       | Aluminum wheels .....              | 465      |
| Battery precautions .....         | 499, 607 | Exterior .....                     | 464      |
| Child restraint system .....      | 57       | Interior .....                     | 469      |
| How your child should wear        |          | Seat belts .....                   | 470      |
| the seat belt .....               | 36       | Clock .....                        | 440      |
| Installing child restraints ..... | 57       | Coat hooks .....                   | 443      |
| Moon roof precautions .....       | 181      | Compass .....                      | 451      |
| Power window lock switch .....    | 174      | Condenser .....                    | 495      |
| Power window precautions .....    | 177      | Console box .....                  | 436      |
| Removed electronic                |          | Cooling system .....               | 493      |
| key battery precautions .....     | 518      | Engine overheating .....           | 608      |
| Seat belt extender                |          | Cruise control                     |          |
| precautions .....                 | 39       | Cruise control .....               | 235      |
| Seat belt precautions .....       | 38       | Dynamic radar cruise control ..... | 239      |
| Seat heater precautions .....     | 429      | Cup holders .....                  | 437      |
| Trunk precautions .....           | 146      | Current fuel consumption .....     | 108, 110 |
|                                   |          | Curtain shield airbags .....       | 40       |
|                                   |          | Customizable features .....        | 651      |

**D**

Daytime running light system .....215

Defogger

- Outside rear view mirrors.....424
- Rear window .....424
- Windshield.....424

Differential

- Front differential .....627
- Rear differential ..... 628

Dimension ..... 618

Dinghy towing..... 198

Display

- Drive information .....108, 115
- Dynamic radar cruise control.....239
- LDA (Lane Departure Alert).....254
- Multi-information display ..... 105, 113
- Warning message..... 549

Distance ..... 108, 110

Do-it-yourself maintenance ..... 479

Door courtesy lights

- Location .....432

Door lock

- Doors .....137
- Smart access system with

  - push-button start ..... 148

- Wireless remote control.....132

Doors ..... 137

- Automatic door locking

  - and unlocking system .....140

- Door lock.....139
- Open door warning buzzer ..... 138
- Open door warning light ..... 544
- Outside rear view mirrors .....171
- Side windows .....174

Drive info 1/Drive info 2 ..... 110, 122

Drive information .....108, 115

- Resetting ..... 108, 115

Driver's seat position memory.....160

Driving .....184

- Break-in tips ..... 185
- Correct driving posture .....32
- Driving mode select switch .....283
- Procedures .....184
- Winter drive tips .....320

DRS (Dynamic Rear Steering) .....287

- Warning message.....549

Dynamic radar cruise control..... 239

Dynamic Rear Steering (DRS).....287

- Warning message.....549



## E

- E-mail.....391
- Eco drive mode.....283
- Eco Driving Indicator..... 90
- Eco Driving Indicator Light .....110, 122
- Eco driving meter..... 98
- EDR (Event data recorder).....10
- Elapsed time..... 108, 110
- Electric Power Steering (EPS) .....288
  - Warning light.....544
- Electronic key ..... 132
  - Battery-saving function.....150
  - If the electronic key does not operate properly.....600
  - Replacing the battery..... 517
- Emergency flashers ..... 532
- Emergency tire puncture repair kit..... 584
- Emergency, in case of
  - If a warning buzzer sounds .....543
  - If a warning light turns on .....543
  - If a warning message is displayed.....549
  - If the electronic key does not operate properly..... 600
  - If the engine will not start .....597
  - If the shift lever cannot be shifted from P .....599
  - If the vehicle battery is discharged.....604
  - If you have a flat tire..... 570, 584
  - If you think something is wrong .....541
  - If your vehicle becomes stuck.....614
  - If your vehicle has to be stopped in an emergency.....533
  - If your vehicle needs to be towed.....534
  - If your vehicle overheats..... 608

|  |            |
|--|------------|
| Engine .....                               | 621        |
| ACCESSORY mode.....                        | 200        |
| Compartment.....                           | 485        |
| Engine switch.....                         | 199        |
| Hood.....                                  | 481        |
| How to start the engine .....              | 199        |
| Identification number .....                | 620        |
| If the engine will not start.....          | 597        |
| Ignition switch (engine switch)....        | 199        |
| Overheating.....                           | 608        |
| <b>Engine coolant.....</b>                 | <b>493</b> |
| Capacity .....                             | 626        |
| Checking.....                              | 493        |
| Preparing and checking                     |            |
| before winter .....                        | 320        |
| <b>Engine coolant temperature</b>          |            |
| gauge .....                                | 92, 98     |
| <b>Engine immobilizer system .....</b>     | <b>76</b>  |
| <b>Engine oil .....</b>                    | <b>488</b> |
| Capacity .....                             | 622        |
| Checking.....                              | 488        |
| Preparing and checking                     |            |
| before winter .....                        | 320        |
| <b>Engine oil maintenance data .....</b>   | <b>491</b> |
| <b>Engine oil temperature gauge .....</b>  | <b>98</b>  |
| <b>Engine switch .....</b>                 | <b>199</b> |
| <b>Enhanced VSC .....</b>                  | <b>287</b> |
| <b>EPS (Electric Power Steering) .....</b> | <b>288</b> |
| Warning light .....                        | 544        |
| <b>Event data recorder (EDR).....</b>      | <b>10</b>  |
| <b>Expert mode.....</b>                    | <b>291</b> |

## F

|  |            |
|--|------------|
| <b>First-aid kit storage belt.....</b> | <b>438</b> |
| <b>Flat tire</b>                       |            |
| Vehicles with a spare tire .....       | 570        |
| Vehicles with emergency tire           |            |
| puncture repair kit .....              | 584        |
| <b>Floor mats.....</b>                 | <b>30</b>  |
| <b>Fluid</b>                           |            |
| Automatic transmission.....            | 627        |
| Brake.....                             | 629        |
| Washer .....                           | 500        |
| <b>Fog lights.....</b>                 | <b>222</b> |
| Replacing light bulbs .....            | 529        |
| Switch.....                            | 222        |
| <b>Footwell light.....</b>             | <b>432</b> |
| Wattage .....                          | 635        |
| <b>Front fog lights.....</b>           | <b>222</b> |
| Replacing light bulbs .....            | 529        |
| Switch.....                            | 222        |
| <b>Front passenger occupant</b>        |            |
| classification system .....            | 50         |
| <b>Front seats.....</b>                | <b>155</b> |
| Adjustment.....                        | 155        |
| Cleaning.....                          | 469        |
| Correct driving posture.....           | 32         |
| Driving position memory.....           | 160        |
| Head restraints .....                  | 164        |
| Jam protection function.....           | 156        |
| Seat heaters.....                      | 430        |
| Seat position memory.....              | 160        |
| Seat ventilators.....                  | 431        |

Front turn signal lights ..... 210  
 Replacing light bulbs..... 524, 529  
 Turn signal lever ..... 210  
 Wattage..... 635  
**Fuel**.....231  
 Capacity ..... 622  
 Fuel gauge..... 92, 98  
 Fuel pump shut off system.....542  
 Information ..... 636  
 Refueling..... 231  
 Type ..... 622, 636  
 Warning light .....544  
**Fuel consumption**  
 Average fuel economy .....108, 115  
 Current fuel consumption.....108, 115  
**Fuel filler door**.....231  
 If the fuel filler door  
 cannot be opened ..... 233  
 Refueling..... 231  
 Fuel gauge..... 92, 98  
 Fuel pump shut off system..... 542  
 Fuses..... 519

**G**

Garage door opener ..... 444  
 Gauges ..... 92, 98  
 Glove box..... 436  
 Glove box light..... 436

**H**

**Hands-free system**  
 (for cellular phone)..... 383  
**HD Radio® system**.....351  
**Head restraints**.....164  
**Headlight cleaner** .....223  
**Headlights**..... 214  
 Automatic High Beam  
 system ..... 217  
 Light switch..... 214  
 Replacing light bulbs ..... 529  
**Heaters**  
 Air conditioning system .....420  
 Heated steering wheel ..... 429  
 Outside rear view mirrors ..... 424  
 Seat heaters.....430  
**Hill-start assist control** .....287  
**Hood** .....481  
 Open ..... 481  
**Hooks**  
 Cargo hooks .....438  
 Coat hooks..... 443  
 Retaining hooks (floor mat).....30  
**Horn**.....168

## I

|  |          |
|--|----------|
| I/M test .....                                     | 478      |
| Identification                                     |          |
| Engine .....                                       | 620      |
| Vehicle .....                                      | 619      |
| Ignition switch (engine switch) .....              | 199      |
| Illuminated entry system .....                     | 434      |
| Immobilizer system .....                           | 76       |
| Indicators .....                                   | 87       |
| Initialization                                     |          |
| Maintenance .....                                  | 473, 491 |
| Meter .....  | 110, 122 |
| Moon roof .....                                    | 179      |
| Multi-information display .....                    | 110, 122 |
| Power windows .....                                | 175      |
| Tire pressure<br>warning system .....              | 502      |
| Initiators (tire pressure<br>warning system) ..... | 508      |
| Inside rear view mirror .....                      | 169      |
| Instrument panel light<br>control .....            | 96, 103  |
| Intercooler .....                                  | 495      |
| Intercooler coolant .....                          | 493      |
| Capacity .....                                     | 626      |
| Checking .....                                     | 493      |
| Preparing and checking<br>before winter .....      | 320      |
| Interior lights .....                              | 433      |
| Intuitive parking assist .....                     | 259      |

## J

|                                |          |
|--------------------------------|----------|
| Jack                           |          |
| Positioning a floor jack ..... | 482      |
| Vehicle-equipped jack .....    | 570, 584 |
| Jack handle .....              | 570, 584 |
| Jam protection function        |          |
| Front seats .....              | 156      |
| Moon roof .....                | 179      |
| Power windows .....            | 175      |

## K

|  |          |
|--|----------|
| Keyless entry  |          |
| Smart access system<br>with push-button start .....      | 137, 143 |
| Wireless remote control .....                            | 137, 143 |
| Keys .....   | 132      |
| Battery-saving function .....                            | 150      |
| Electronic key .....                                     | 132      |
| Engine switch .....                                      | 199      |
| If the electronic key<br>does not operate properly ..... | 600      |
| Key number plate .....                                   | 132      |
| Keyless entry .....                                      | 132      |
| Mechanical key .....                                     | 133      |
| Replacing the battery .....                              | 517      |
| Warning buzzer .....                                     | 138      |
| Wireless remote control .....                            | 132      |
| Knee airbags .....                                       | 40       |

## L

|  |          |
|--|----------|
| Lane Departure Alert (LDA) .....                     | 253      |
| Language (multi-information display).....            | 110, 122 |
| LATCH anchors .....                                  | 70       |
| LDA (Lane Departure Alert) .....                     | 253      |
| LDH (Lexus Dynamic Handling system).....             | 288      |
| Lever  |          |
| Auxiliary catch lever .....                          | 481      |
| Hood lock release lever .....                        | 481      |
| Internal trunk release lever.....                    | 145      |
| Shift lever.....                                     | 205      |
| Tilt and telescopic steering lock release lever..... | 167      |
| Turn signal lever .....                              | 210      |
| Wiper lever .....                                    | 223      |
| Lexus Display Audio controller.....                  | 328      |
| Lexus Display Audio system.....                      | 326      |
| Lexus Enform *                                       |          |
| Lexus Enform Remote * .....                          | 460      |
| Lexus Enform Safety Connect.....                     | 455      |
| Lexus Enform Service                                 |          |
| Connect * .....                                      | 461      |
| Lexus parking assist monitor .....                   | 268      |
| License plate lights.....                            | 214      |
| Light switch .....                                   | 214      |
| Replacing light bulbs.....                           | 529      |

|                                 |     |
|---------------------------------|-----|
| Light bulbs                     |     |
| Replacing.....                  | 524 |
| Wattage .....                   | 635 |
| Lights                          |     |
| Automatic High Beam system .... | 217 |
| Fog light switch.....           | 222 |
| Headlight switch .....          | 214 |
| Illuminated entry system.....   | 434 |
| Interior lights .....           | 433 |
| Interior lights list.....       | 432 |
| Personal lights.....            | 434 |
| Replacing light bulbs .....     | 524 |
| Trunk light.....                | 145 |
| Turn signal lever .....         | 210 |
| Vanity lights .....             | 439 |
| Wattage .....                   | 635 |
| Lock steering column.....       | 202 |
| Low profile tire .....          | 504 |
| Luggage security system .....   | 144 |

\*: For vehicles with a navigation system, refer to the "NAVIGATION SYSTEM OWNER'S MANUAL".

## M

|   |          |
|---|----------|
| <b>Maintenance</b>                        |          |
| Do-it-yourself maintenance.....           | 479      |
| General maintenance .....                 | 475      |
| Maintenance data .....                    | 618      |
| Maintenance requirements.....             | 472      |
| <b>Maintenance system</b> .....           | 110, 122 |
| <b>Malfunction indicator lamp</b> .....   | 543      |
| <b>Master warning light</b> .....         | 544      |
| <b>Meter</b>                              |          |
| Changing the display .....                | 95, 102  |
| Indicators.....                           | 87       |
| Instrument panel light                    |          |
| control.....                              | 96, 103  |
| Meters.....                               | 92, 98   |
| Multi-information display .....           | 105, 113 |
| Operating the meter control               |          |
| switches.....                             | 107, 114 |
| Settings.....                             | 110, 122 |
| Warning lights .....                      | 86       |
| Warning message.....                      | 549      |
| <b>Micro dust and pollen filter</b> ..... | 424      |
| <b>Mirrors</b>                            |          |
| Inside rear view mirror .....             | 169      |
| Outside rear view mirror                  |          |
| defoggers.....                            | 424      |
| Outside rear view mirrors.....            | 171      |
| Vanity mirrors.....                       | 439      |

|   |          |
|---|----------|
| <b>MMS (Multimedia messaging service)</b> ..... | 391      |
| <b>Mobile Assistant</b> .....                   | 332      |
| <b>Moon roof</b> .....                          | 178      |
| Door lock linked                                |          |
| moon roof operation.....                        | 179      |
| Jam protection function.....                    | 179      |
| Operation.....                                  | 178      |
| <b>MP3 disc</b> .....                           | 357      |
| <b>Multi-information display</b> .....          | 105, 113 |
| Audio system-linked.....                        | 105, 113 |
| Drive information.....                          | 108, 115 |
| Dynamic radar cruise control .....              | 239      |
| "F" content.....                                | 117      |
| G-force .....                                   | 120      |
| Lap timer.....                                  | 117      |
| LDA (Lane Departure Alert).....                 | 254      |
| Navigation system-linked .....                  | 105, 113 |
| Settings .....                                  | 110, 122 |
| switch settings.....                            | 110, 122 |
| Switching the display .....                     | 107, 114 |
| Torque distribution .....                       | 119      |
| Warning message.....                            | 549      |

## N

|                                       |   |
|---------------------------------------|---|
| <b>Navigation system</b> *            |   |
| <b>Noise from under vehicle</b> ..... | 8 |

O

Odometer ..... 92, 98

Oil

- Engine oil..... 622
- Front differential oil..... 627
- Rear differential oil..... 628

Opener

- Hood..... 481
- Trunk ..... 143

Outer foot lights..... 432

Outside rear view mirrors ..... 171

- Adjusting and folding..... 171
- Blind spot monitor..... 302
- Linked mirror function
  - when reversing..... 172
- Mirror position memory..... 160
- Outside rear view
  - mirror defoggers..... 424

Outside temperature..... 92, 98

Overheating ..... 608

P

Paddle shift switches..... 207, 208

Parking assist sensors  
(intuitive parking assist)..... 259

Parking brake..... 211

Parking lights ..... 214

- Light switch..... 214
- Replacing light bulbs ..... 529

PCS (Pre-Collision System)..... 295

- PCS OFF switch..... 296
- Warning light..... 544

Personal lights ..... 434

Pop-up display ..... 110, 122

Power outlet..... 440

Power steering (Electric power  
steering system) ..... 288

- Warning light..... 544

Power windows..... 174

- Door lock linked
  - window operation ..... 176
- Jam protection function..... 175
- Operation..... 174
- Window lock switch ..... 174

Pre-Collision System (PCS)..... 295

- PCS OFF switch..... 296
- Warning light..... 544

\*: For vehicles with a navigation system, refer to the "NAVIGATION SYSTEM OWNER'S MANUAL".

**R**

Radar cruise control (dynamic radar cruise control)..... 239

Radiator .....495

Radio..... 351

Rear seats ..... 158

    Fold down the seatback.....158

    Luggage security system ..... 144

Rear turn signal lights ..... 210

    Replacing light bulbs.....526

    Turn signal lever ..... 210

    Wattage..... 635

Rear view mirror

    Inside rear view mirror..... 169

    Outside rear view mirrors..... 171

Rear window defogger.....424

Refueling..... 231

    Capacity..... 622

    Fuel types..... 622

    If the fuel filler door cannot be opened..... 233

    Opening the fuel tank cap..... 233

Remote Touch\*

Replacing

    Electronic key battery .....517

    Fuses .....519

    Light bulbs..... 522

    Tires.....570

Reporting safety defects for U.S. owners .....664

Resetting the message indicating maintenance is required .....473

Rev indicator ..... 94, 101

Rev peak ..... 94, 102



## S

|                                  |     |   |               |
|----------------------------------|-----|---|---------------|
| Seat belt reminder light.....    | 544 | Seats, Front.....                       | 155           |
| Seat belts.....                  | 34  | Adjustment.....                         | 155           |
| Automatic Locking Retractor..... | 36  | Adjustment precautions.....             | 157           |
| Child restraint system           |     | Child seats/child restraint             |               |
| installation.....                | 57  | system installation.....                | 57            |
| Cleaning and maintaining         |     | Cleaning.....                           | 469           |
| the seat belt.....               | 470 | Driving position memory.....            | 160           |
| Emergency Locking                |     | Head restraints.....                    | 164           |
| Retractor.....                   | 36  | Jam protection function.....            | 156           |
| How to wear your seat belt.....  | 34  | Properly sitting in the seat.....       | 32            |
| How your child should wear       |     | Seat heaters.....                       | 430           |
| the seat belt.....               | 36  | Seat position memory.....               | 160           |
| Pregnant women, proper           |     | Seat ventilators.....                   | 431           |
| seat belt use.....               | 37  | <b>Seats, Rear.....</b>                 | <b>158</b>    |
| Reminder light and buzzer.....   | 544 | Fold down the seatback.....             | 158           |
| Seat belt extender.....          | 36  | Luggage security system.....            | 144           |
| Seat belt guide.....             | 35  | <b>Sensor</b>                           |               |
| Seat belt pretensioners.....     | 35  | Automatic headlight system.....         | 215           |
| SRS warning light.....           | 543 | Automatic High Beam                     |               |
| Seat heaters.....                | 430 | system.....                             | 221           |
| Seat position memory.....        | 160 | Inside rear view mirror.....            | 170           |
| Seat ventilators.....            | 431 | Intuitive parking assist.....           | 259           |
| Seating capacity.....            | 196 | LDA (Lane Departure Alert).....         | 253           |
|                                  |     | Radar sensor.....                       | 246, 296, 305 |
|                                  |     | Rain-sensing windshield                 |               |
|                                  |     | wipers.....                             | 229           |
|                                  |     | <b>Service reminder indicators.....</b> | <b>84</b>     |

\*: For vehicles with a navigation system, refer to the "NAVIGATION SYSTEM OWNER'S MANUAL".

|                                |          |                                    |         |
|--------------------------------|----------|------------------------------------|---------|
| Shift lever .....              | 205      | SMS (Short message service) .....  | 391     |
| Automatic transmission .....   | 205      | Snow mode .....                    | 206     |
| If the shift lever             |          | Snow tires .....                   | 323     |
| cannot be shifted from P ..... | 599      | Spare tire .....                   | 570     |
| Shift lock system .....        | 599      | Inflation pressure .....           | 630     |
| Shift position and gear        |          | Storage location .....             | 571     |
| position .....                 | 92, 98   | Spark plug .....                   | 626     |
| Side airbags .....             | 40       | Specifications .....               | 618     |
| Side marker lights .....       | 214      | Speed indicator .....              | 94, 101 |
| Light switch .....             | 214      | Speedometer .....                  | 92, 98  |
| Replacing light bulbs .....    | 529      | Sport mode .....                   | 283     |
| Side mirrors .....             | 171      | Steering lock .....                | 202     |
| Adjusting and folding .....    | 171      | Column lock release .....          | 202     |
| BSM (Blind spot monitor) ..... | 302      | Steering wheel .....               | 167     |
| Linked mirror function         |          | Adjustment .....                   | 167     |
| when reversing .....           | 172      | Audio switches .....               | 331     |
| Mirror position memory .....   | 160      | Auto tilt away .....               | 168     |
| Side turn signal lights .....  | 210      | Heated steering wheel .....        | 429     |
| Replacing light bulbs .....    | 529      | Steering wheel                     |         |
| Turn signal lever .....        | 210      | position memory .....              | 160     |
| Side windows .....             | 174      | Stop lights                        |         |
| Slip indicator .....           | 544      | Replacing light bulbs .....        | 529     |
| Smart access system            |          | Storage feature .....              | 435     |
| with push-button start .....   | 148      | Stuck                              |         |
| Antenna location .....         | 148      | If the vehicle becomes stuck ..... | 614     |
| Entry functions .....          | 137, 143 | Sun shade .....                    | 179     |
| Starting the engine .....      | 199      | Sun visors .....                   | 439     |

## Switches

|                                      |          |                                |          |
|--------------------------------------|----------|--------------------------------|----------|
| Active rear wing switch .....        | 315      | Moon roof switches .....       | 178      |
| ASC (Active Sound Control)           |          | Outside rear view mirror       |          |
| switch.....                          | 212      | switches .....                 | 171      |
| Audio remote control                 |          | Paddle shift switches.....     | 207, 208 |
| switches.....                        | 331      | PCS OFF switch.....            | 296      |
| Automatic High Beam system.....      | 217      | Power door lock switch.....    | 139      |
| BSM (Blind spot monitor)             |          | Power window switches.....     | 174      |
| switch.....                          | 302      | Rear window and outside        |          |
| Cruise control switch.....           | 235, 239 | rear view mirror defoggers     |          |
| Door lock switches .....             | 139      | switch .....                   | 424      |
| Driving mode select switch .....     | 283      | Seat heater switches.....      | 430      |
| Driving position memory              |          | Seat ventilator switches ..... | 431      |
| switches.....                        | 160      | Snow mode switch .....         | 206      |
| Dynamic radar cruise                 |          | "SOS" button.....              | 455      |
| control switch.....                  | 239      | Talk switch.....               | 393      |
| Emergency flashers switch .....      | 532      | Telephone switches.....        | 393      |
| Engine switch.....                   | 199      | Tilt and telescopic            |          |
| Fog light switch .....               | 222      | steering control switch.....   | 167      |
| Garage door opener                   |          | Tire pressure warning reset    |          |
| switches.....                        | 444      | switch .....                   | 503      |
| Heated steering wheel                |          | Trunk opener main switch ..... | 144      |
| switch.....                          | 429      | Trunk opener switch.....       | 143      |
| Ignition switch.....                 | 199      | TVD (Torque Vectoring          |          |
| Intuitive parking assist switch..... | 260      | Differential) switch.....      | 318      |
| LDA (Lane Departure Alert)           |          | Vehicle-to-vehicle distance    |          |
| switch.....                          | 254      | button.....                    | 243      |
| Light switches .....                 | 214      | VSC OFF switch.....            | 289      |
| Meter control switches .....         | 107, 114 | Window lock switch .....       | 174      |
|                                      |          | Windshield wiper               |          |
|                                      |          | and washer switch.....         | 223      |
|                                      |          | Windshield wiper de-icer       |          |
|                                      |          | switch .....                   | 425      |

## T

- |                                 |        |                                    |          |
|---------------------------------|--------|------------------------------------|----------|
| Tachometer .....                | 92, 98 | Tire pressure warning system ..... | 502      |
| Variable red zone.....          | 103    | Initializing .....                 | 502      |
| Tail lights.....                | 214    | Installing tire pressure warning   |          |
| Light switch .....              | 214    | valves and transmitters.....       | 502      |
| Replacing light bulbs.....      | 529    | Registering ID codes .....         | 503      |
| Talk switch * .....             | 393    | Tire pressure warning reset        |          |
| Telephone switches * .....      | 393    | switch .....                       | 503      |
| Theft deterrent system          |        | Warning light.....                 | 545      |
| Alarm.....                      | 79     | Tires .....                        | 501      |
| Engine immobilizer system.....  | 76     | Chains .....                       | 321      |
| Luggage security system .....   | 144    | Checking .....                     | 501      |
| Theft prevention labels.....    | 81     | Emergency tire puncture            |          |
| Tire inflation pressure .....   | 510    | repair kit.....                    | 584      |
| Maintenance data.....           | 630    | If you have a flat tire.....       | 570, 584 |
| Tire inflation pressure display |        | Inflation pressure.....            | 630      |
| function.....                   | 502    | Information.....                   | 639      |
| Warning light.....              | 545    | Replacing.....                     | 570      |
| Tire information.....           | 639    | Rotating tires.....                | 501      |
| Glossary .....                  | 646    | Size .....                         | 630      |
| Size.....                       | 642    | Snow tires.....                    | 323      |
| Tire identification number..... | 641    | Spare tire.....                    | 570      |
| Uniform Tire Quality            |        | Tire inflation pressure display    |          |
| Grading.....                    | 644    | function.....                      | 502      |
|                                 |        | Tire pressure warning system.....  | 502      |
|                                 |        | Warning light.....                 | 545      |

|  |          |  |               |
|--|----------|--|---------------|
| Tools.....   | 571, 585 | Trunk .....  | 143           |
| Top tether strap.....                                | 73       | Internal trunk release lever .....                 | 145           |
| Torque Vectoring Differential<br>(TVD).....          | 318      | Luggage security system.....                       | 144           |
| Total load capacity.....                             | 196      | Smart access system<br>with push-button start..... | 143           |
| Towing   |          | Trunk features.....                                | 438           |
| Dinghy towing.....                                   | 198      | Trunk grip.....                                    | 144           |
| Emergency towing.....                                | 534      | Trunk light.....                                   | 145           |
| Towing eyelet.....                                   | 537      | Trunk opener main switch .....                     | 144           |
| Trailer towing.....                                  | 197      | Trunk opener switch.....                           | 143           |
| TRAC (Traction Control).....                         | 287      | Trunk storage extension .....                      | 442           |
| Traction Control (TRAC).....                         | 287      | Wireless remote control.....                       | 143           |
| Trailer towing.....                                  | 197      | Trunk light.....                                   | 145           |
| Transmission.....                                    | 205      | Wattage .....                                      | 635           |
| Automatic transmission .....                         | 205      | Turn signal lights.....                            | 210           |
| Driving mode select switch .....                     | 283      | Replacing light<br>bulbs .....                     | 524, 526, 529 |
| If the shift lever cannot be<br>shifted from P ..... | 599      | Turn signal lever.....                             | 210           |
| M mode .....   | 208      | Wattage .....                                      | 635           |
| Paddle shift switches .....                          | 207, 208 | TVD (Torque Vectoring<br>Differential) .....       | 318           |
| Trip meters.....                                     | 92, 98   |  |               |

\*: For vehicles with a navigation system, refer to the "NAVIGATION SYSTEM OWNER'S MANUAL".

## U

|                  |          |
|------------------|----------|
| Units.....       | 110, 122 |
| USB device ..... | 368, 411 |
| Connecting.....  | 334      |
| USB audio.....   | 368      |
| USB photo.....   | 411      |
| USB port .....   | 334      |

## V

|   |     |
|---|-----|
| Vanity lights.....                                    | 439 |
| Wattage.....  | 635 |
| Vanity mirrors.....                                   | 439 |
| Variable Gear Ratio Steering<br>(VGRS).....           | 287 |
| Warning message.....                                  | 549 |
| VDIM (Vehicle Dynamics<br>Integrated Management)..... | 288 |
| Vehicle data recordings.....                          | 9   |
| Vehicle Dynamics Integrated<br>Management (VDIM)..... | 288 |
| Vehicle identification number.....                    | 619 |
| Vehicle Stability Control<br>(VSC).....               | 287 |
| Ventilators (seat ventilators).....                   | 431 |
| VGRS (Variable Gear Ratio<br>Steering).....           | 287 |
| Warning message.....                                  | 549 |
| Voice command system.....                             | 414 |
| VSC<br>(Vehicle Stability Control).....               | 287 |

## W

|   |     |
|---|-----|
| Warning buzzers                             |     |
| Approach warning .....                      | 244 |
| Brake system .....                          | 543 |
| Downshifting.....                           | 209 |
| Intuitive parking assist.....               | 259 |
| Key reminder .....                          | 567 |
| LDA (Lane Departure Alert).....             | 253 |
| Open door .....                             | 544 |
| Open hood.....                              | 551 |
| Open moon roof.....                         | 557 |
| Open trunk.....                             | 551 |
| Open window.....                            | 558 |
| Pre-collision braking.....                  | 295 |
| Seat belt reminder.....                     | 544 |
| Warning lights .....                        | 86  |
| ABS .....                                   | 543 |
| Automatic headlight leveling<br>system..... | 544 |
| Brake system .....                          | 543 |
| Charging system .....                       | 543 |
| Electric power steering .....               | 544 |
| Low fuel level.....                         | 544 |
| Malfunction indicator lamp.....             | 543 |
| Master warning light .....                  | 544 |
| Open door .....                             | 544 |
| Pre-collision system .....                  | 544 |
| Seat belt reminder light .....              | 544 |
| Slip indicator .....                        | 544 |
| SRS.....                                    | 543 |
| Tire pressure.....                          | 545 |
| Warning messages.....                       | 549 |

Washer ..... 223  
 Checking..... 500  
 Preparing and checking  
     before winter ..... 320  
 Switch..... 223  
 Washing and waxing..... 464  
**Weight**  
     Cargo capacity ..... 196  
     Load limits..... 196  
     Weight..... 618  
**Wheels..... 513**  
     Replacing wheels..... 513  
     Size..... 630  
**Window lock switch ..... 174**  
**Windows ..... 174**  
     Power windows ..... 174  
     Rear window defogger ..... 424  
**Windshield wiper de-icer ..... 425**  
**Windshield wipers ..... 223**  
     Intermittent windshield  
         wipers with interval adjuster .... 223  
     Rain-sensing windshield  
         wipers..... 225  
**Winter driving tips..... 320**  
**Wireless remote control..... 132**  
     Battery-Saving Function..... 150  
     Locking/Unlocking..... 137, 143  
     Replacing the battery..... 517  
**WMA disc..... 357**

**X**

XM® Satellite Radio..... 351

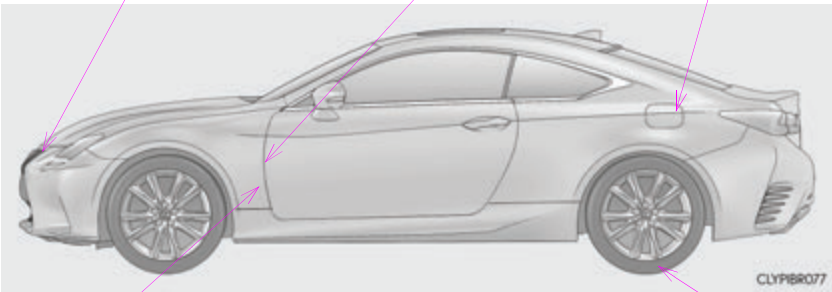
| <b>GAS STATION INFORMATION</b>   |                                    |                            |
|--|------------------------------------|----------------------------|
| Auxiliary catch lever<br>P. 481  | Trunk opener<br>P. 143             | Fuel filler door<br>P. 233 |
|  |                                    |                            |
| Hood lock release lever<br>P. 481  | Tire inflation pressure<br>P. 630  |                            |
| Fuel tank capacity<br>(Reference)  | 17.5 gal. (66.3 L, 14.6 Imp. gal.) |                            |
| Fuel type  | Unleaded gasoline only             | P. 622, 636                |
| Cold tire inflation<br>pressure  |                                    | P. 630                     |
| Engine oil capacity<br>(Drain and refill –<br>reference)                           |                                    | P. 622                     |
| Engine oil type  |                                    | P. 622                     |