

Pictorial index	Search by illustration
1 For safety and security	Make sure to read through them
2 Instrument cluster	How to read the gauges and meters, the variety of warning lights and indicators, etc.
3 Operation of each component	Opening and closing the doors and windows, adjustment before driving, etc.
4 Driving	Operations and advices which are necessary for driving
5 Lexus Display Audio system	Operating the Lexus Display Audio system
6 Interior features	Usage of the interior features, etc.
7 Maintenance and care	Caring for your vehicle and maintenance procedures
8 When trouble arises	What to do in case of malfunction or emergency
9 Vehicle specifications	Vehicle specifications, customizable features, etc.
10 For owners	Reporting safety defects for US owners, and seat belt and SRS airbag instructions for Canadian owners
Index	Search by symptom
	Search alphabetically

2 TABLE OF CONTENTS

For your information.....	8
Reading this manual.....	14
How to search.....	15
Pictorial index.....	16

1 For safety and security

1-1. For safe use	
Before driving.....	28
For safety drive.....	30
Seat belts.....	32
SRS airbags.....	40
Front passenger occupant classification system.....	53
Safety information for children.....	59
Child restraint systems.....	60
Exhaust gas precautions.....	76
1-2. Hybrid system	
Hybrid system features.....	77
Hybrid system precautions.....	81
1-3. Theft deterrent system	
Immobilizer system.....	86
Alarm.....	88
Theft prevention labels (for U.S.A.).....	90

2 Instrument cluster

2. Instrument cluster	
Warning lights and indicators.....	92
Gauges and meters.....	97
Multi-information display.....	102
Head-up display.....	106
Energy monitor/ consumption screen.....	111

3 Operation of each component

3-1. Key information	
Keys.....	118
3-2. Opening, closing and locking the doors	
Side doors.....	124
Back door.....	129
Smart access system with push-button start.....	140
3-3. Adjusting the seats	
Front seats.....	146
Rear seats.....	147
Driving position memory.....	154
Head restraints.....	158

3-4. Adjusting the steering wheel and mirrors

- Steering wheel 160
- Inside rear view mirror..... 161
- Outside rear view mirrors.....163

3-5. Opening, closing the windows and moon roof

- Power windows.....166
- Moon roof.....169

4 Driving**4-1. Before driving**

- Driving the vehicle174
- Cargo and luggage..... 182
- Vehicle load limits..... 186
- Trailer towing (vehicles with towing package) 187
- Trailer towing (vehicles without towing package) 199
- Dinghy towing200

4-2. Driving procedures

- Power (ignition) switch 201
- EV drive mode.....206
- Hybrid transmission.....208
- Turn signal lever.....212
- Parking brake213
- Brake Hold216
- ASC (Active Sound Control) 218

4-3. Operating the lights and wipers

- Headlight switch219
- Automatic High Beam..... 223
- Fog light switch227
- Windshield wipers and washer 228
- Rear window wiper and washer 234

4-4. Refueling

- Opening the fuel tank cap 236

4-5. Using the driving support systems

- Dynamic radar cruise control 240
- Dynamic radar cruise control with full-speed range..... 253
- Cruise control.....267
- LDA (Lane Departure Alert with steering control).....270
- Intuitive parking assist.....279
- Lexus parking assist monitor.....287
- Driving mode select switch..... 303
- Driving assist systems305
- PCS (Pre-Collision System) 310
- BSM (Blind Spot Monitor).....316

4-6. Driving tips

- Hybrid vehicle driving tips..... 324
- Winter driving tips 326
- Utility vehicle precautions.....330

5 Lexus Display Audio system

5-1. Basic Operations

Lexus Display Audio System 336

Steering wheel audio switches..... 342

Mobile Assistant..... 343

USB/AUX ports 345

5-2. Setup

Setup menu 347

General settings..... 348

Voice settings..... 351

Display settings..... 352

5-3. Using the audio system

Selecting the audio source 353

Optimal use of the audio system..... 354

Audio settings..... 355

Audio menu screen operation 358

5-4. Using the radio

Radio operation..... 361

5-5. Playing an audio CD and MP3/WMA/AAC discs

CD player operation 367

5-6. Using an external device

Listening to an iPod..... 374

Using USB memory device..... 377

Using the AUX port 381

5-7. Connecting Bluetooth®

Steps for using Bluetooth® devices..... 382

Registering a Bluetooth® device..... 384

Selecting a Bluetooth® device..... 385

Connecting a Bluetooth® audio player..... 386

Connecting a Bluetooth® phone 387

Displaying a Bluetooth® device details 388

Detailed Bluetooth® settings 389

5-8. Bluetooth® Audio

Listening to Bluetooth® Audio 390

5-9. Bluetooth® Phone

Using a Bluetooth® Phone.....	392
Making a call.....	394
Receiving a call.....	397
Speaking on the phone.....	398
Using a Bluetooth® phone message.....	400
Using the steering wheel switches.....	402
Bluetooth® phone settings.....	403

5-10. Phonebook

Contact settings.....	405
Messaging setting.....	408

5-11. Bluetooth®

What to do if.. (Troubleshooting).....	409
Bluetooth®.....	413

5-12. Other function

“Information” screen.....	418
USB photo.....	420
Weather information.....	422
Voice command system.....	423
LEXUS Enform Remote.....	427

6 Interior features**6-1. Using the air conditioning system and defogger**

Automatic air conditioning system.....	430
Heated steering wheel/ seat heaters/ seat ventilators.....	440

6-2. Using the interior lights

Interior lights list.....	443
• Front interior light.....	444
• Personal lights.....	444
• Rear interior light.....	445

6-3. Using the storage features

List of storage features.....	446
• Glove box.....	447
• Console box.....	447
• Cup holders/ bottle holders.....	448
• Sunglass holder.....	449
Luggage compartment features.....	450

6-4. Other interior features

- Other interior features 455
 - Sun visors 455
 - Vanity mirrors 455
 - Clock 456
 - Power outlet (12 VDC)..... 456
 - Power outlet (120 VAC).... 457
 - Wireless charger..... 458
 - Armrest..... 465
 - Assist grips 465
 - Coat hooks..... 466
- Garage door opener 467
- Compass 473
- Safety Connect..... 477

7 Maintenance and care

7-1. Maintenance and care

- Cleaning and protecting the vehicle exterior 484
- Cleaning and protecting the vehicle interior 488

7-2. Maintenance

- Maintenance requirements 491
- General maintenance..... 494
- Emission inspection and maintenance (I/M) programs..... 497

7-3. Do-it-yourself maintenance

- Do-it-yourself service precautions..... 498
- Hood 500
- Positioning a floor jack..... 501
- Engine compartment 502
- 12-volt battery 512
- Tires..... 516
- Tire inflation pressure 525
- Wheels 528
- Air conditioning filter 530
- Electronic key battery..... 532
- Checking and replacing fuses..... 534
- Light bulbs 538

8 When trouble arises

8-1. Essential information

- Emergency flashers 556
- If your vehicle has to be stopped in an emergency 557

8-2. Steps to take in an emergency

If your vehicle needs to be towed.....	558
If you think something is wrong.....	564
If a warning light turns on or a warning buzzer sounds	565
If a warning message is displayed	572
If you have a flat tire	575
If the hybrid system will not start.....	588
If the shift lever cannot be shifted from P	590
If the electronic key does not operate properly	591
If the 12-volt battery is discharged.....	594
If your vehicle overheats.....	599
If the vehicle becomes stuck	603

9 Vehicle specifications**9-1. Specifications**

Maintenance data (fuel, oil level, etc.)	606
Fuel information	616
Tire information.....	619

9-2. Customization

Customizable features.....	631
----------------------------	-----

9-3. Initialization

Items to initialize.....	641
--------------------------	-----

10 For owners

Reporting safety defects for U.S. owners.....	644
Seat belt instructions for Canadian owners (in French).....	645
SRS airbag instructions for Canadian owners (in French).....	647

Index

What to do if... (Troubleshooting)	656
Alphabetical index	660

For vehicles with a navigation system, refer to the "NAVIGATION SYSTEM OWNER'S MANUAL" for information regarding the equipment listed below.

- Navigation system
- Lexus parking assist monitor
- Audio/visual system
- Lexus Enform with Safety Connect

For your information

Main Owner's Manual

Please note that this manual applies to all models and explains all equipment, including options. Therefore, you may find some explanations for equipment not installed on your vehicle.

All specifications provided in this manual are current at the time of printing. However, because of the Lexus policy of continual product improvement, we reserve the right to make changes at any time without notice.

Depending on specifications, the vehicle shown in the illustrations may differ from your vehicle in terms of color and equipment.

Noise from under vehicle after turning off the hybrid system

Approximately five hours after the hybrid system is turned off, you may hear sound coming from under the vehicle for several minutes. This is the sound of a fuel evaporation leakage check and, it does not indicate a malfunction.

Accessories, spare parts and modification of your Lexus

A wide variety of non-genuine spare parts and accessories for Lexus vehicles are currently available in the market. You should know that Toyota does not warrant these products and is not responsible for their performance, repair, or replacement, or for any damage they may cause to, or adverse effect they may have on, your Lexus vehicle.

This vehicle should not be modified with non-genuine Lexus products. Modification with non-genuine Lexus products could affect its performance, safety or durability, and may even violate governmental regulations. In addition, damage or performance problems resulting from the modification may not be covered under warranty.

Installation of a mobile two-way radio system

The installation of a mobile two-way radio system in your vehicle could affect electronic systems such as:

- Multiport fuel injection system/sequential multiport fuel injection system
- Dynamic radar cruise control system
- Cruise control system
- Anti-lock brake system
- SRS airbag system
- Seat belt pretensioner system

Be sure to check with your Lexus dealer for precautionary measures or special instructions regarding installation of a mobile two-way radio system.

High voltage parts and cables on the hybrid vehicles emit approximately the same amount of electromagnetic waves as the conventional gasoline powered vehicles or home electronic appliances despite of their electromagnetic shielding.

Unwanted noise may occur in the reception of the mobile two-way radio.

Vehicle data recordings

Your Lexus is equipped with several sophisticated computers that will record certain data, such as:

- Engine speed
- Electric motor speed (traction motor speed)
- Accelerator status
- Brake status
- Vehicle speed
- Shift position
- Hybrid battery (traction battery) status

The recorded data varies according to the vehicle grade level and options with which it is equipped. Furthermore, these computers do not record conversations, sounds or pictures.

● Data usage

Lexus may use the data recorded in these computers to diagnose malfunctions, conduct research and development, and improve quality.

Lexus will not disclose the recorded data to a third party except:

- With the consent of the vehicle owner or with the consent of the lessee if the vehicle is leased
- In response to an official request by the police, a court of law or a government agency
- For use by Lexus in a lawsuit
- For research purposes where the data is not tied to a specific vehicle or vehicle owner

● Usage of data collected through Safety Connect / Lexus Enform (U.S. mainland only)

If your Lexus has Safety Connect or Lexus Enform and if you have subscribed to those services, please refer to the Safety Connect / Lexus Enform Telematics Subscription Service Agreement for information on data collected and its usage.

Event data recorder

This vehicle is equipped with an event data recorder (EDR). The main purpose of an EDR is to record, in certain crash or near crash-like situations, such as an air bag deployment or hitting a road obstacle, data that will assist in understanding how a vehicle's systems performed. The EDR is designed to record data related to vehicle dynamics and safety systems for a short period of time, typically 30 seconds or less.

The EDR in this vehicle is designed to record such data as:

- How various systems in your vehicle were operating;
- Whether or not the driver and passenger safety belts were buckled/fastened;
- How far (if at all) the driver was depressing the accelerator and/or brake pedal; and,
- How fast the vehicle was traveling.

These data can help provide a better understanding of the circumstances in which crashes and injuries occur.

NOTE: EDR data are recorded by your vehicle only if a non-trivial crash situation occurs; no data are recorded by the EDR under normal driving conditions and no personal data (e.g., name, gender, age, and crash location) are recorded. However, other parties, such as law enforcement, could combine the EDR data with the type of personally identifying data routinely acquired during a crash investigation.

To read data recorded by an EDR, special equipment is required, and access to the vehicle or the EDR is needed. In addition to the vehicle manufacturer, other parties, such as law enforcement, that have the special equipment, can read the information if they have access to the vehicle or the EDR.

● Disclosure of the EDR data

Lexus will not disclose the data recorded in an EDR to a third party except when:

- An agreement from the vehicle's owner (or the lessee for a leased vehicle) is obtained
- In response to an official request by the police, a court of law or a government agency
- For use by Lexus in a lawsuit

However, if necessary, Lexus may:

- Use the data for research on vehicle safety performance
- Disclose the data to a third party for research purposes without disclosing information about the specific vehicle or vehicle owner

Scrapping of your Lexus

The SRS airbag and seat belt pretensioner devices in your Lexus contain explosive chemicals. If the vehicle is scrapped with the airbags and seat belt pretensioners left as they are, this may cause an accident such as fire. Be sure to have the systems of the SRS airbag and seat belt pretensioner removed and disposed of by a qualified service shop or by your Lexus dealer before you scrap your vehicle.

Perchlorate Material

Special handling may apply, See www.dtsc.ca.gov/hazardouswaste/perchlorate. Your vehicle has components that may contain perchlorate. These components may include airbag, seat belt pretensioners, and wireless remote control batteries.

WARNING

■ General precautions while driving

Driving under the influence: Never drive your vehicle when under the influence of alcohol or drugs that have impaired your ability to operate your vehicle. Alcohol and certain drugs delay reaction time, impair judgment and reduce coordination, which could lead to an accident that could result in death or serious injury.

Defensive driving: Always drive defensively. Anticipate mistakes that other drivers or pedestrians might make and be ready to avoid accidents.

Driver distraction: Always give your full attention to driving. Anything that distracts the driver, such as adjusting controls, talking on a cellular phone or reading can result in a collision with resulting death or serious injury to you, your occupants or others.

■ General precaution regarding children's safety

Never leave children unattended in the vehicle, and never allow children to have or use the key.

Children may be able to start the vehicle or shift the vehicle into neutral. There is also a danger that children may injure themselves by playing with the windows, the moon roof, or other features of the vehicle. In addition, heat build-up or extremely cold temperatures inside the vehicle can be fatal to children.

Reading this manual

 **WARNING:**
Explains something that, if not obeyed, could cause death or serious injury to people.

 **NOTICE:**
Explains something that, if not obeyed, could cause damage to or a malfunction in the vehicle or its equipment.

1 2 3... Indicates operating or working procedures. Follow the steps in numerical order.

 Indicates the action (pushing, turning, etc.) used to operate switches and other devices.

 Indicates the outcome of an operation (e.g. a lid opens).

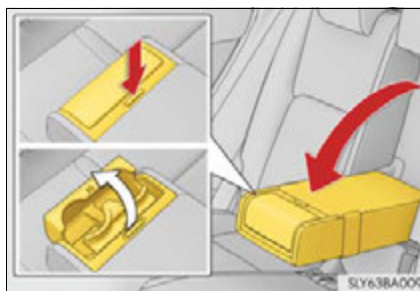

 Indicates the component or position being explained.

 Means "Do not", "Do not do this", or "Do not let this happen".

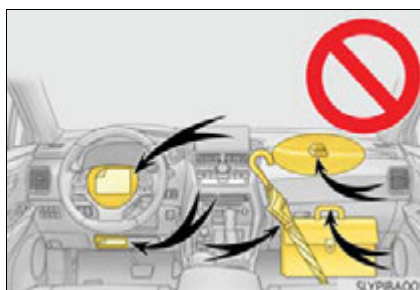

How to search

■ Searching by name

- Alphabetical index.....P. 660

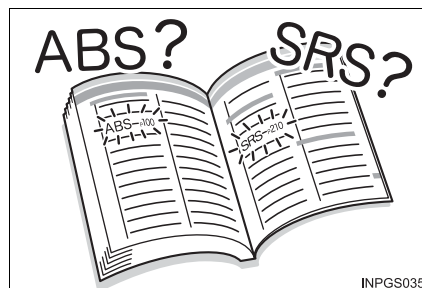

■ Searching by installation position

- Pictorial index.....P. 16

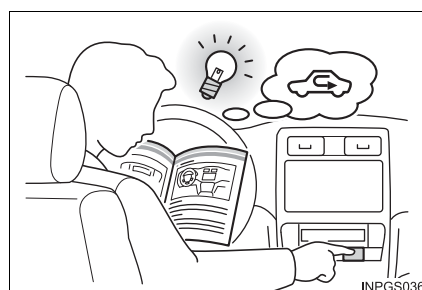

■ Searching by symptom or sound

- What to do if...
(Troubleshooting).....P. 656



■ Searching by title

- Table of contents.....P. 2

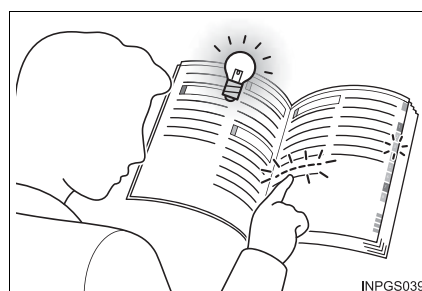

Pictorial index

■ Exterior

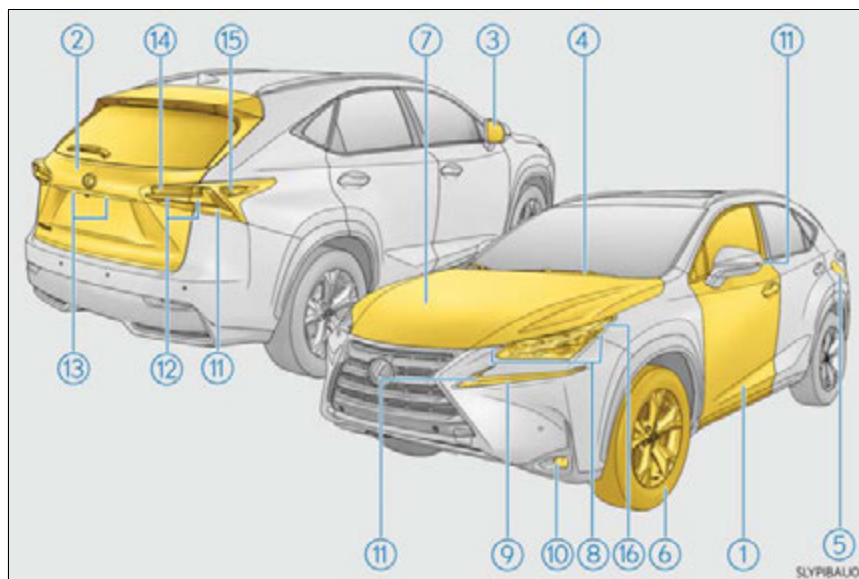

The shape of the headlights may differ depending on the grade, etc.

①	Side doors	P. 124
	Locking/unlocking.....	P. 124
	Opening/closing the door glasses.....	P. 166
	Locking/unlocking by using the mechanical key.....	P. 591
	Warning messages.....	P. 572
②	Back door	P. 129
	Opening from inside the cabin*.....	P. 130
	Opening from outside.....	P. 130
	Warning messages.....	P. 572
③	Outside rear view mirrors	P. 163
	Adjusting the mirror angle.....	P. 163
	Folding the mirrors.....	P. 163
	Driving position memory*.....	P. 154
	Defogging the mirrors.....	P. 435

④	Windshield wipers	P. 228
	Precautions against winter season	P. 326
	To prevent freezing (windshield wiper de-icer)	P. 436
	Precautions against car wash	P. 486
⑤	Fuel filler door	P. 236
	Refueling method	P. 236
	Fuel type/fuel tank capacity	P. 608
⑥	Tires	P. 516
	Tire size/inflation pressure	P. 613
	Winter tires/tire chain	P. 327
	Checking/rotation/tire pressure warning system	P. 516
	Coping with flat tires	P. 575
⑦	Hood	P. 500
	Opening	P. 500
	Engine compartment cover	P. 503
	Engine oil	P. 609
	Coping with overheat	P. 599
	Warning messages	P. 572

Light bulbs of the exterior lights for driving
(Replacing method: P. 538, Watts: P. 615)

⑧	Headlights	P. 219
⑨	Parking lights/daytime running lights	P. 219
⑩	Fog lights	P. 227
⑪	Turn signal lights	P. 212
⑫	Tail lights	P. 219
⑬	License plate lights	P. 219
⑭	Back-up light	
	Shifting the shift lever to R	P. 208
⑮	Side marker lights	P. 219

*: If equipped

■ Instrument panel

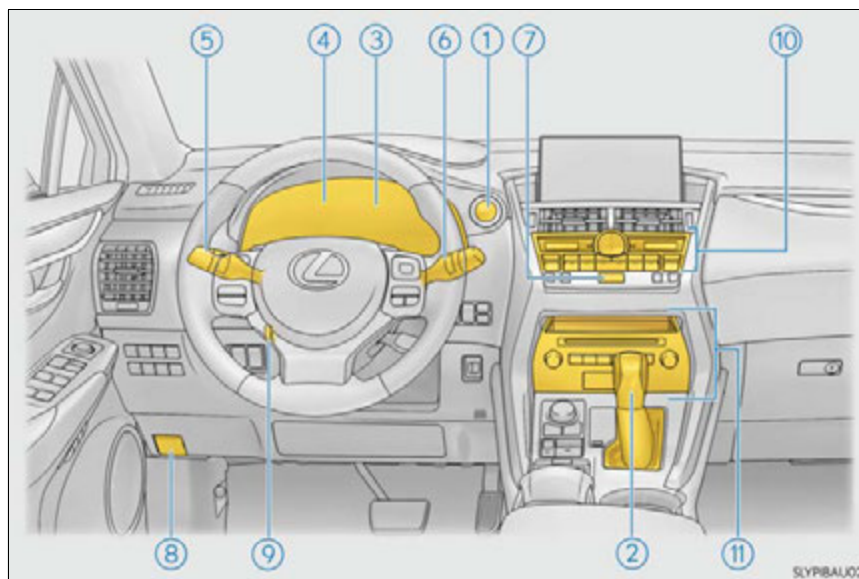

①	Power switch	P. 201
	Starting the hybrid system/changing the modes.....	P. 201
	Emergency stop of the hybrid system.....	P. 557
	When the hybrid system will not start.....	P. 588
	Warning messages.....	P. 572
②	Shift lever	P. 208
	Changing the shift position.....	P. 208
	Precautions against towing.....	P. 558
	When the shift lever does not move.....	P. 590
③	Meters	P. 97, 99
	Reading the meters/adjusting the instrument panel light.....	P. 97
	Warning lights/indicator lights.....	P. 92
	When the warning lights come on.....	P. 565

④	Multi-information display	P. 102
	Display	P. 102
	Energy monitor	P. 111
	When the warning messages are displayed	P. 572
⑤	Turn signal lever	P. 212
	Headlight switch	P. 219
	Headlights/parking lights/tail lights/license plate lights/ daytime running lights	P. 219
	Fog lights	P. 227
⑥	Windshield wiper and washer switch	P. 228, 234
	Usage	P. 228, 234
	Adding washer fluid	P. 511
	Warning messages	P. 572
⑦	Emergency flasher switch	P. 556
⑧	Hood lock release lever	P. 500
⑨	Tilt and telescopic steering control switch	P. 160
	Adjustment	P. 160
	Driving position memory ^{*1}	P. 154
⑩	Air conditioning system	P. 430
	Usage	P. 430
	Rear window defogger	P. 435
⑪	Audio system ^{*2}	
	Audio system	P. 336
	Hands-free system	P. 392

^{*1}: If equipped

^{*2}: For vehicles with a navigation system, refer to
"NAVIGATION SYSTEM OWNER'S MANUAL".

■ Switches

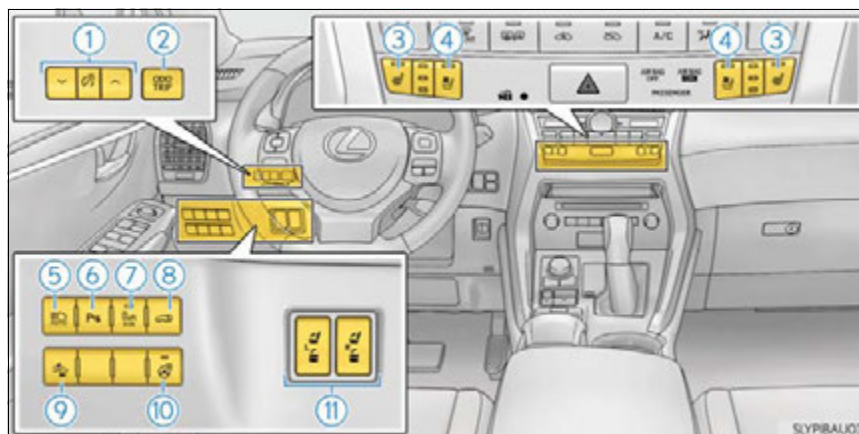

- ① Instrument panel light control switches..... P. 99
- ② Odometer/trip meter and trip meter reset button P. 99
- ③ Seat heater switches* P. 441
- ④ Seat ventilator switches* P. 442
- ⑤ Automatic High Beam switch* P. 223
- ⑥ Intuitive parking assist switch* P. 279
- ⑦ BSM (Blind Spot Monitor) main switch* P. 316
- ⑧ Power back door switch* P. 130
- ⑨ PCS (Pre-Collision System) switch* P. 311
- ⑩ Heated steering wheel switch* P. 441
- ⑪ Rear seat operations switch* P. 148

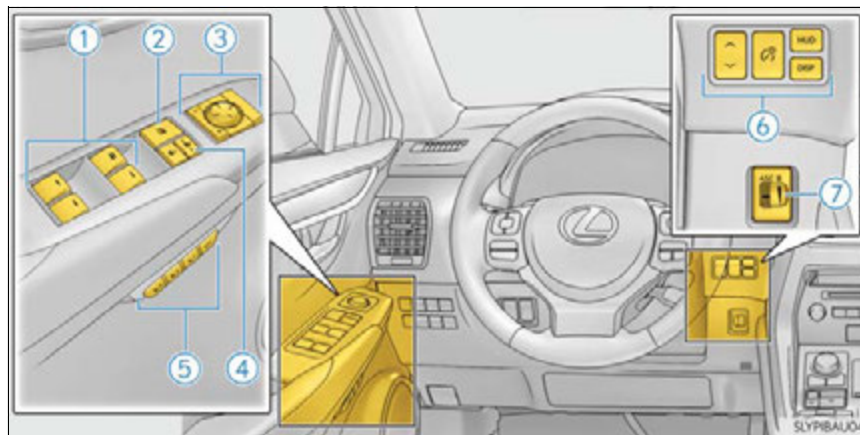

- ① Power window switches P.166
- ② Window lock switch P.166
- ③ Outside rear view mirror switches P.163
- ④ Door lock switch..... P.126
- ⑤ Driving position memory switches* P.155
- ⑥ HUD (Head-up display) switches* P.106
- ⑦ ASC (Active Sound Control) dial* P.218

*: If equipped

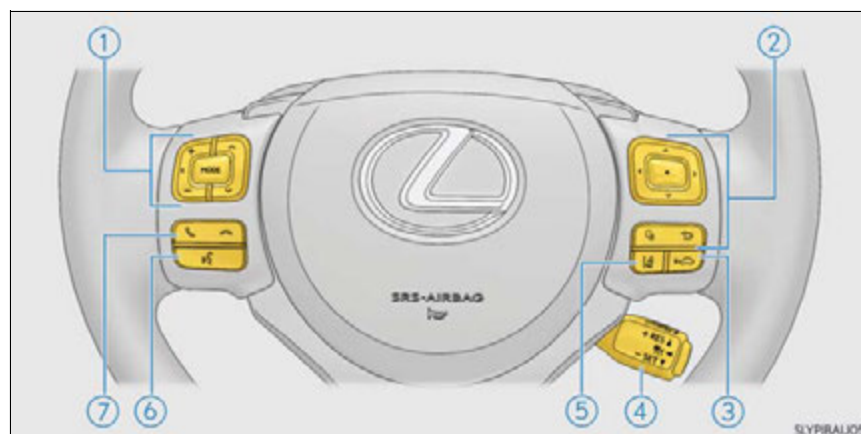

①	Audio remote control switches ^{*1}	P. 342
②	Meter control switches	P. 103
③	Vehicle-to-vehicle distance button ^{*2}	P. 244, 257
④	Cruise control switch	
	Cruise control ^{*2}	P. 267
	Dynamic radar cruise control ^{*2}	P. 240, 253
⑤	LDA switch ^{*2}	P. 270
	LDA (Lane Departure Alert with steering control) ^{*2}	P. 270
⑥	Talk switch ^{*1}	P. 402
⑦	Telephone switches ^{*1}	P. 402

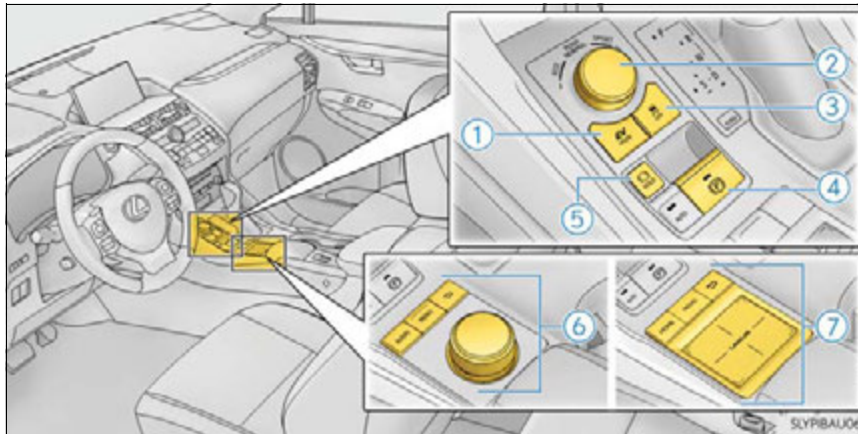

- ① EV drive mode switch P. 206
- ② Driving mode select switch P. 303
- ③ VSC OFF switch P. 307
- ④ Parking brake switches P. 213, 214
 - Applying/releasing P. 213, 214
 - Precautions against winter season P. 327
 - Warning buzzer/message P. 566, 572
- ⑤ Brake hold switch P. 216
- ⑥ Lexus Display Audio controller ^{*2} P. 338
- ⑦ Remote Touch ^{*1,2}

^{*1}: For vehicles with a navigation system, refer to "NAVIGATION SYSTEM OWNER'S MANUAL".

^{*2}: If equipped

■ Interior

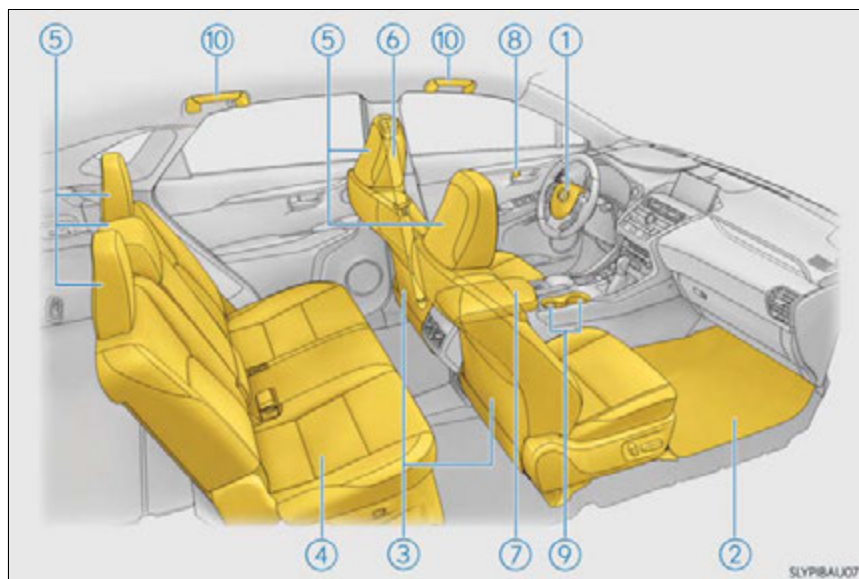

① SRS airbags.....	P. 40
② Floor mats.....	P. 28
③ Front seats.....	P. 146
④ Rear seats.....	P. 147
⑤ Head restraints.....	P. 158
⑥ Seat belts.....	P. 32
⑦ Console box.....	P. 447
⑧ Inside lock buttons.....	P. 126
⑨ Cup holders.....	P. 448
⑩ Assist grips.....	P. 465

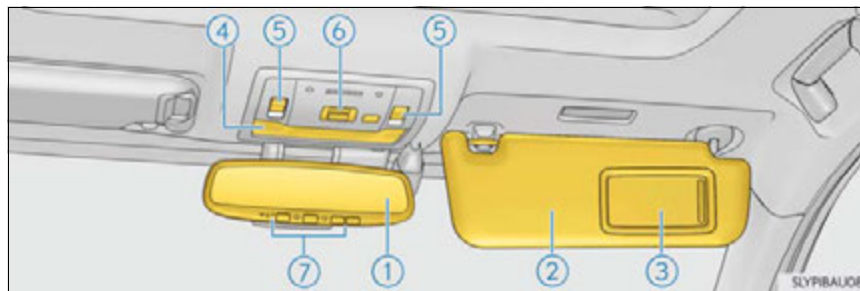

- ① Inside rear view mirror P.161
- ② Sun visors P.455
- ③ Vanity mirrors..... P.455
- ④ Interior light*² P.444, 445
- Personal lights P.444
- ⑤ Moon roof switches*¹ P.169
- ⑥ "SOS" button*¹ P.477
- ⑦ Garage door opener switches*¹ P.467

*¹: If equipped

*²: The illustration shows the front, but they are also equipped in the rear.

1-1. For safe use	
Before driving.....	28
For safety drive.....	30
Seat belts	32
SRS airbags	40
Front passenger occupant classification system.....	53
Safety information for children	59
Child restraint systems	60
Exhaust gas precautions	76
1-2. Hybrid system	
Hybrid system features.....	77
Hybrid system precautions	81
1-3. Theft deterrent system	
Immobilizer system	86
Alarm	88
Theft prevention labels (for U.S.A.).....	90

Before driving

Floor mat

Use only floor mats designed specifically for vehicles of the same model and model year as your vehicle. Fix them securely in place onto the carpet.

- 1 Insert the retaining hooks (clips) into the floor mat eyelets.

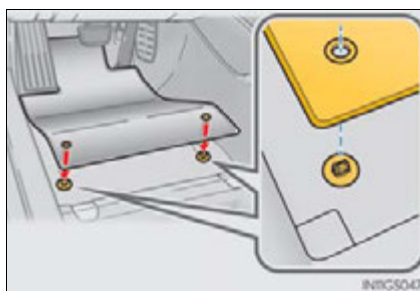

- 2 Turn the upper knob of each retaining hook (clip) to secure the floor mats in place.

*: Always align the \triangle marks.

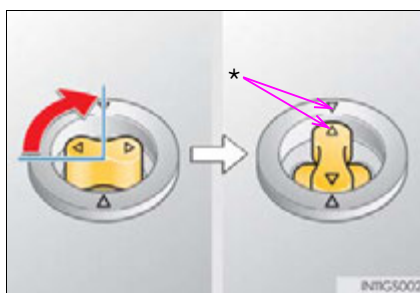

The shape of the retaining hooks (clips) may differ from that shown in the illustration.

⚠ WARNING

Observe the following precautions.

Failure to do so may cause the driver's floor mat to slip, possibly interfering with the pedals while driving. An unexpectedly high speed may result or it may become difficult to stop the vehicle. This could lead to an accident, resulting in death or serious injury.

■ When installing the driver's floor mat

- Do not use floor mats designed for other models or different model year vehicles, even if they are Lexus Genuine floor mats.
- Only use floor mats designed for the driver's seat.
- Always install the floor mat securely using the retaining hooks (clips) provided.
- Do not use two or more floor mats on top of each other.
- Do not place the floor mat bottom-side up or upside-down.

■ Before driving

- Check that the floor mat is securely fixed in the correct place with all the provided retaining hooks (clips). Be especially careful to perform this check after cleaning the floor.
- With the hybrid system stopped and the shift lever in P, fully depress each pedal to the floor to make sure it does not interfere with the floor mat.



For safety drive

For safe driving, adjust the seat and mirror to an appropriate position before driving.

Correct driving posture

- ① Adjust the angle of the seatback so that you are sitting straight up and so that you do not have to lean forward to steer. (→P. 146)
- ② Adjust the seat so that you can depress the pedals fully and so that your arms bend slightly at the elbow when gripping the steering wheel. (→P. 146, 160)
- ③ Lock the head restraint in place with the center of the head restraint closest to the top of your ears. (→P. 158)
- ④ Wear the seat belt correctly. (→P. 32)



Correct use of the seat belts

Make sure that all occupants are wearing their seat belts before driving the vehicle. (→P. 32)

Use a child restraint system appropriate for the child until the child becomes large enough to properly wear the vehicle's seat belt. (→P. 60)

Adjusting the mirrors

Make sure that you can see the rear of the vehicle clearly, by adjusting the inside and outside rear view mirrors properly. (→P. 161, 163)

 **WARNING**

Observe the following precautions.
Failure to do so may result in death or serious injury.

- Do not adjust the position of the driver's seat while driving.
Doing so could cause the driver to lose control of the vehicle.
- Do not place a cushion between the driver or passenger and the seatback.
A cushion may prevent correct posture from being achieved, and reduce the effectiveness of the seat belt and head restraint.
- Do not place anything under the front seats.
Objects placed under the front seats may become jammed in the seat tracks and stop the seat from locking in place. This may lead to an accident and the adjustment mechanism may also be damaged.
- When driving over long distances, take regular breaks before you start to feel tired.
Also, if you feel tired or sleepy while driving, do not force yourself to continue driving and take a break immediately.

Seat belts

Make sure that all occupants are wearing their seat belts before driving the vehicle.

Correct use of the seat belts

- Extend the shoulder belt so that it comes fully over the shoulder, but does not come into contact with the neck or slide off the shoulder.
- Position the lap belt as low as possible over the hips.
- Adjust the position of the seatback. Sit up straight and well back in the seat.
- Do not twist the seat belt.



Fastening and releasing the seat belt (except for the rear center seat)

- ① To fasten the seat belt, push the plate into the buckle until a click sound is heard.
- ② To release the seat belt, press the release button.

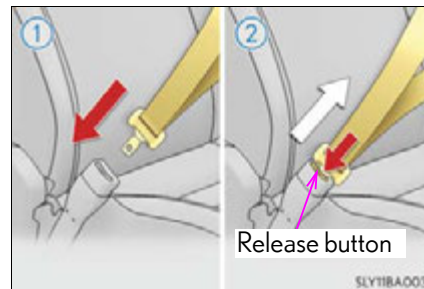

Fastening the seat belt (for the rear center seat)

- 1 Take out the plate.

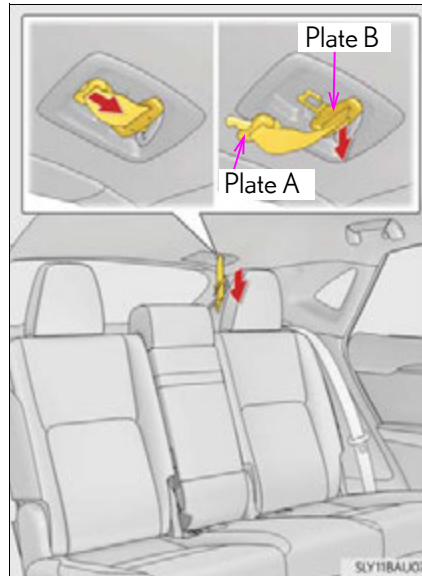

- 2 When fixing the belt, in the order of plate A and then plate B, insert the plate into the buckle until a clicking sound is heard.

- ① Plate A, buckle A
- ② Plate B, buckle B

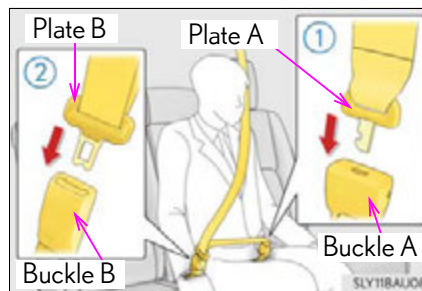

Releasing and stowing the seat belt (for the rear center seat)

- 1** To release the hooked buckle B, push the buckle release button.

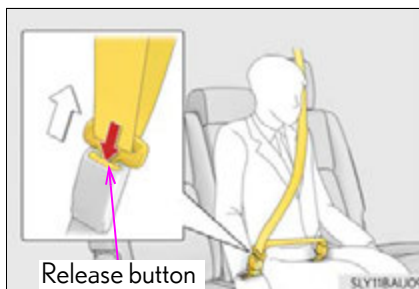

- 2** Insert the mechanical key (→P. 118) or plate B into the notch of buckle A and remove the belt.

Retract the belt slowly when releasing and stowing the seat belt.

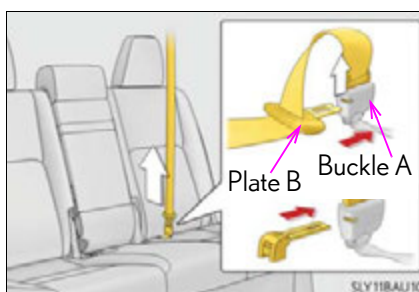

- 3** Stow in the cover in the order of plate B and then plate A.

In order to securely fix it, firmly insert it to the back.

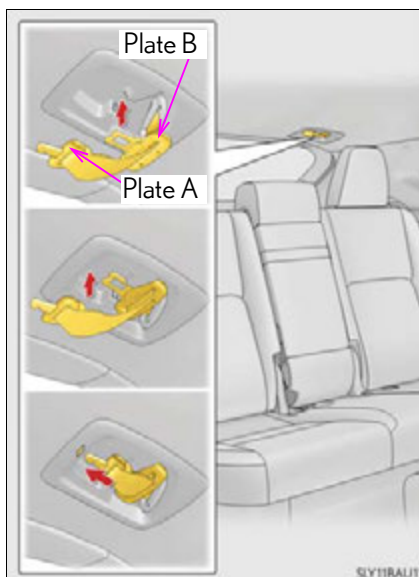

- 4 Stow seat belt buckle A and buckle B in the pockets.

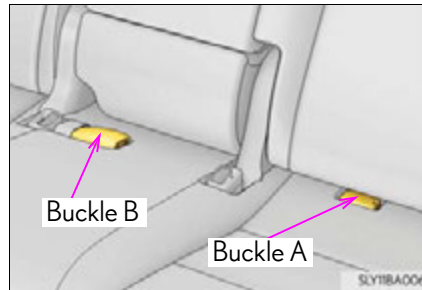

Adjusting the seat belt shoulder anchor height (front seats)

- 1 Push the seat belt shoulder anchor down while pressing the release button.
 - 2 Push the seat belt shoulder anchor up.
- Move the height adjuster up and down as needed until you hear a click.



Seat belt pretensioners (front seats)

The pretensioners help the seat belts to quickly restrain the occupants by retracting the seat belts when the vehicle is subjected to certain types of severe frontal or side collision or a vehicle rollover.

The pretensioners do not activate in the event of a minor frontal impact, a minor side impact or a rear impact.

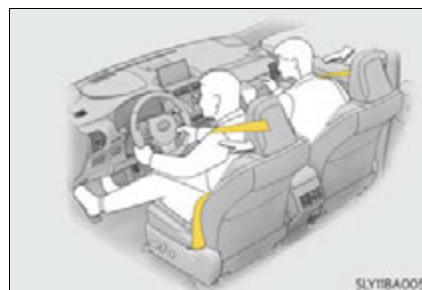

■ Emergency locking retractor (ELR)

The retractor will lock the belt during a sudden stop or on impact. It may also lock if you lean forward too quickly. A slow, easy motion will allow the belt to extend so that you can move around fully.

■ Automatic locking retractor (ALR)

When a passenger's shoulder belt is completely extended and then retracted even slightly, the belt is locked in that position and cannot be extended. This feature is used to hold the child restraint system (CRS) firmly. To free the belt again, fully retract the belt and then pull the belt out once more.

■ Child seat belt usage

The seat belts of your vehicle were principally designed for persons of adult size.

- Use a child restraint system appropriate for the child, until the child becomes large enough to properly wear the vehicle's seat belt. (→P. 60)
- When the child becomes large enough to properly wear the vehicle's seat belt, follow the instructions regarding seat belt usage. (→P. 32)

■ Replacing the belt after the pretensioner has been activated

If the vehicle is involved in multiple collisions, the pretensioner will activate for the first collision, but will not activate for the second or subsequent collisions.

■ Seat belt extender

If your seat belts cannot be fastened securely because they are not long enough, a personalized seat belt extender is available from your Lexus dealer free of charge.



⚠ WARNING

Observe the following precautions to reduce the risk of injury in the event of sudden braking, sudden swerving or an accident. Failing to do so may cause death or serious injury.

■ Wearing a seat belt

- Ensure that all passengers wear a seat belt.
- Always wear a seat belt properly.
- Each seat belt should be used by one person only. Do not use a seat belt for more than one person at once, including children.
- Lexus recommends that children be seated in the rear seat and always use a seat belt and/or an appropriate child restraint system.
- To achieve a proper seating position, do not recline the seat more than necessary. The seat belt is most effective when the occupants are sitting up straight and well back in the seats.
- Do not wear the shoulder belt under your arm.
- Always wear your seat belt low and snug across your hips.

■ Pregnant women

Obtain medical advice and wear the seat belt in the proper way. (→P. 32)

Women who are pregnant should position the lap belt as low as possible over the hips in the same manner as other occupants, extending the shoulder belt completely over the shoulder and avoiding belt contact with the rounding of the abdominal area.

If the seat belt is not worn properly, not only the pregnant woman, but also the fetus could suffer death or serious injury as a result of sudden braking or a collision.

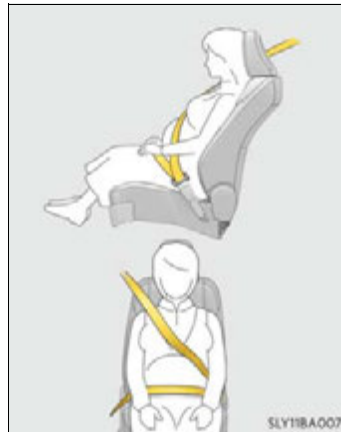

 **WARNING**

■ **People suffering illness**

Obtain medical advice and wear the seat belt in the proper way. (→P. 32)

■ **When children are in the vehicle**

Do not allow children to play with the seat belt. If the seat belt becomes twisted around a child's neck, it may lead to choking or other serious injuries that could result in death. If this occurs and the buckle cannot be unfastened, scissors should be used to cut the belt.

■ **Seat belt pretensioners**

- Do not place anything, such as a cushion, on the front passenger's seat. Doing so will disperse the passenger's weight, which prevents the sensor from detecting the passenger's weight properly. As a result, the seat belt pretensioner for the front passenger's seat may not activate in the event of a collision.
- If the pretensioner has activated, the SRS warning light will come on. In that case, the seat belt cannot be used again and must be replaced at your Lexus dealer.

■ **Adjustable shoulder anchor**

Always make sure the shoulder belt is positioned across the center of your shoulder. The belt should be kept away from your neck, but not falling off your shoulder. Failure to do so could reduce the amount of protection in an accident and cause death or serious injuries in the event of a sudden stop, sudden swerve or accident. (→P. 35)

■ **Seat belt damage and wear**

- Do not damage the seat belts by allowing the belt, plate, or buckle to be jammed in the door.
- Inspect the seat belt system periodically. Check for cuts, fraying, and loose parts. Do not use a damaged seat belt until it is replaced. Damaged seat belts cannot protect an occupant from death or serious injury.
- Ensure that the belt and plate are locked and the belt is not twisted. If the seat belt does not function correctly, immediately contact your Lexus dealer.
- Replace the seat assembly, including the belts, if your vehicle has been involved in a serious accident, even if there's no obvious damage.
- Do not attempt to install, remove, modify, disassemble or dispose of the seat belts. Have any necessary repairs carried out by your Lexus dealer. Inappropriate handling may lead to incorrect operation.

■ **When using the rear center seat belt**

Do not use the rear center seat belt with either buckle released. Fastening only one of the buckles may result in death or serious injury in case of sudden braking or a collision.



 **WARNING****■ Using a seat belt extender**

- Do not wear the seat belt extender if you can fasten the seat belt without the extender.
- Do not use the seat belt extender when installing a child restraint system because the belt will not securely hold the child restraint system, increasing the risk of death or serious injury in the event of an accident.
- The personalized extender may not be safe on another vehicle, when used by another person, or at a different seating position other than the one originally intended.

 **NOTICE****■ When releasing a seat belt extender**

Press on the buckle release button on the extender, not on the seat belt, then, release the extender from the seat belt buckle. (→P. 44)
This helps prevent damage to the vehicle interior and the extender itself.

SRS airbags

The SRS airbags inflate when the vehicle is subjected to certain types of severe impacts that may cause significant injury to the occupants. They work together with the seat belts to help reduce the risk of death or serious injury.

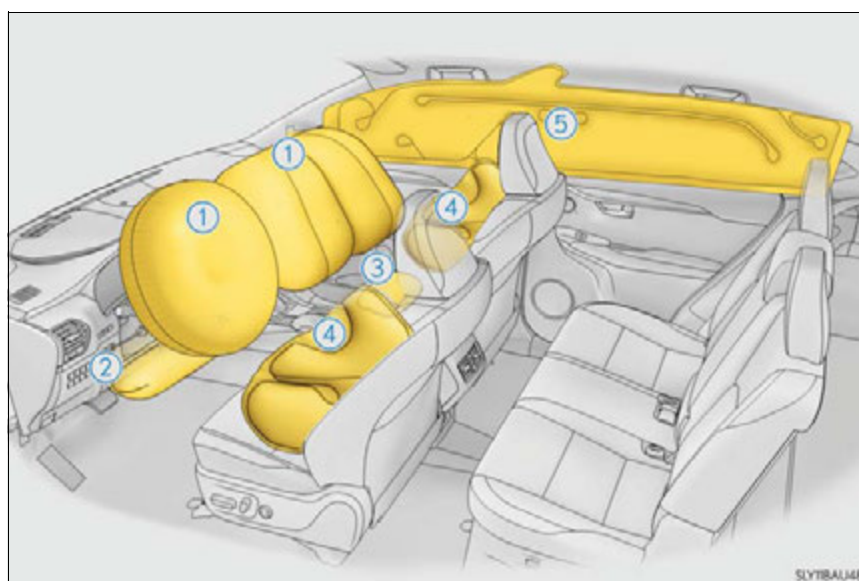

◆ SRS front airbags

- ① SRS driver airbag/front passenger airbag
Can help protect the head and chest of the driver and front passenger from impact with interior components
- ② SRS knee airbag
Can help provide driver protection
- ③ SRS seat cushion airbag
Can help restrain the front passenger.

◆ SRS side and curtain shield airbags

- ④ SRS side airbags
 - Can help protect the torso of the front seat occupants
- ⑤ SRS curtain shield airbags
 - Can help protect primarily the head of occupants in the outer seats
 - Can prevent the occupants from being thrown from the vehicle in the event of vehicle rollover

SRS airbag system components

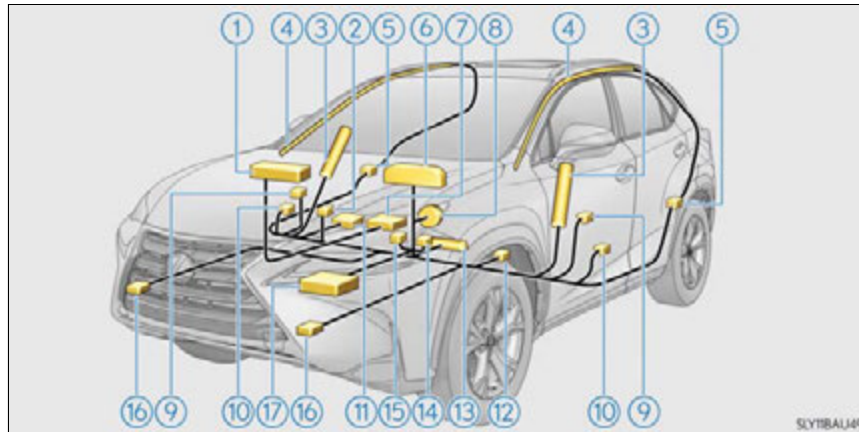

- | | |
|--|--|
| ① Front passenger airbag | ⑨ Side impact sensors (front) |
| ② "AIR BAG ON" and "AIR BAG OFF" indicator lights | ⑩ Seat belt pretensioners and force limiters |
| ③ Side airbags | ⑪ Passenger seat cushion airbag |
| ④ Curtain shield airbags | ⑫ Driver's seat position sensor |
| ⑤ Side impact sensors (rear) | ⑬ Driver knee airbag |
| ⑥ SRS warning light | ⑭ Driver's seat belt buckle switch |
| ⑦ Front passenger occupant classification system (ECU and sensors) | ⑮ Front passenger's seat belt buckle switch |
| ⑧ Driver airbag | ⑯ Front impact sensors |
| | ⑰ Airbag sensor assembly |

Your vehicle is equipped with ADVANCED AIRBAGS designed based on the US motor vehicle safety standards (FMVSS208). The airbag sensor assembly (ECU) controls airbag deployment based on information obtained from the sensors etc. shown in the system components diagram above. This information includes crash severity and occupant information. As the airbags deploy, a chemical reaction in the inflators quickly fills the airbags with non-toxic gas to help restrain the motion of the occupants.

 **WARNING****■ SRS airbag precautions**

Observe the following precautions regarding the SRS airbags. Failure to do so may cause death or serious injury.

- The driver and all passengers in the vehicle must wear their seat belts properly. The SRS airbags are supplemental devices to be used with the seat belts.
- The SRS driver airbag deploys with considerable force, and can cause death or serious injury especially if the driver is very close to the airbag. The National Highway Traffic Safety Administration (NHTSA) advises:

Since the risk zone for the driver's airbag is the first 2 - 3 in. (50 - 75 mm) of inflation, placing yourself 10 in. (250 mm) from your driver airbag provides you with a clear margin of safety. This distance is measured from the center of the steering wheel to your breastbone. If you sit less than 10 in. (250 mm) away now, you can change your driving position in several ways:

- Move your seat to the rear as far as you can while still reaching the pedals comfortably.
- Slightly recline the back of the seat. Although vehicle designs vary, many drivers can achieve the 10 in. (250 mm) distance, even with the driver seat all the way forward, simply by reclining the back of the seat somewhat. If reclining the back of your seat makes it hard to see the road, raise yourself by using a firm, non-slippery cushion, or raise the seat if your vehicle has that feature.
- If your steering wheel is adjustable, tilt it downward. This points the airbag toward your chest instead of your head and neck.

The seat should be adjusted as recommended by NHTSA above, while still maintaining control of the foot pedals, steering wheel, and your view of the instrument panel controls.

⚠ WARNING**■ SRS airbag precautions**

- If the seat belt extender has been connected to the front seat belt buckles but the seat belt extender has not also been fastened to the latch plate of the seat belt, the SRS front airbags will judge that the driver and front passenger are wearing the seat belt even though the seat belt has not been connected. In this case, the SRS front airbags may not activate correctly in a collision, resulting in death or serious injury in the event of a collision. Be sure to wear the seat belt with the seat belt extender.
- The SRS front passenger airbag also deploys with considerable force, and can cause death or serious injury especially if the front passenger is very close to the airbag. The front passenger seat should be as far from the airbag as possible with the seatback adjusted, so the front passenger sits upright.
- Improperly seated and/or restrained infants and children can be killed or seriously injured by a deploying airbag. An infant or child who is too small to use a seat belt should be properly secured using a child restraint system. Lexus strongly recommends that all infants and children be placed in the rear seats of the vehicle and properly restrained. The rear seats are safer for infants and children than the front passenger seat. (→P. 60)



⚠ WARNING

■ **SRS airbag precautions**

- Do not sit on the edge of the seat or lean against the dashboard.

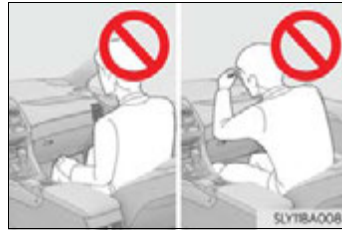

- Do not allow a child to stand in front of the SRS front passenger airbag unit or sit on the knees of a front passenger.
- Do not allow the front seat occupants to hold items on their knees.

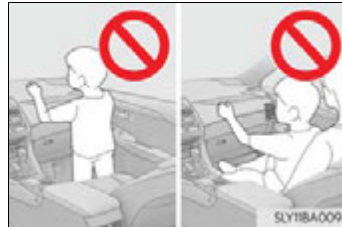

- Do not lean against the door, the roof side rail or the front, side and rear pillars.



- Do not allow anyone to kneel on the passenger seat toward the door or put their head or hands outside the vehicle.



⚠ WARNING

■ **SRS airbag precautions**

- Do not attach anything to or lean anything against areas such as the dashboard, steering wheel pad and lower portion of the instrument panel. These items can become projectiles when the SRS driver, front passenger and knee airbags deploy.

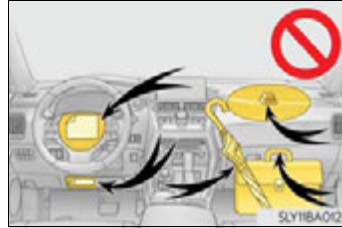

- Do not attach anything to areas such as a door, windshield glass, side door glass, front or rear pillar, roof side rail and assist grip.

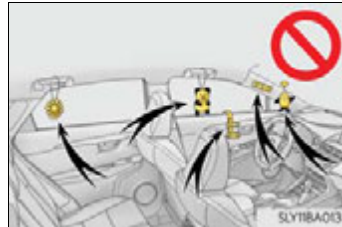

- Do not hang coat hangers or other hard objects on the coat hooks. All of these items could become projectiles and may cause death or serious injury, should the SRS curtain shield airbags deploy.
- If a vinyl cover is put on the area where the SRS knee airbag will deploy, be sure to remove it.
- Do not use seat accessories which cover the parts where the SRS side airbags and SRS seat cushion airbag inflate as they may interfere with inflation of the SRS airbags. Such accessories may prevent the side airbags and SRS seat cushion airbag from activating correctly, disable the system or cause the side airbags and SRS seat cushion airbag to inflate accidentally, resulting in death or serious injury.
- Do not strike or apply significant levels of force to the area of the SRS airbag components. Doing so can cause the SRS airbags to malfunction.
- Do not touch any of the component parts immediately after the SRS airbags have deployed (inflated) as they may be hot.

 **WARNING****■ SRS airbag precautions**

- If breathing becomes difficult after the SRS airbags have deployed, open a door or window to allow fresh air in, or leave the vehicle if it is safe to do so. Wash off any residue as soon as possible to prevent skin irritation.
- If the areas where the SRS airbags are stored, such as the steering wheel pad and front and rear pillar garnishes, are damaged or cracked, have them replaced by your Lexus dealer.
- Do not place anything, such as a cushion, on the front passenger's seat. Doing so will disperse the passenger's weight, which prevents the sensor from detecting the passenger's weight properly. As a result, the SRS front airbags for the front passenger may not deploy in the event of a collision.

■ Modification and disposal of SRS airbag system components

Do not dispose of your vehicle or perform any of the following modifications without consulting your Lexus dealer. The SRS airbags may malfunction or deploy (inflate) accidentally, causing death or serious injury.

- Installation, removal, disassembly and repair of the SRS airbags
- Repairs, modifications, removal or replacement of the steering wheel, instrument panel, dashboard, seats or seat upholstery, front, side and rear pillars or roof side rails
- Repairs or modifications of the front fender, front bumper, or side of the occupant compartment
- Installation of a grille guard (bull bars, kangaroo bar, etc.), snow plows, winches or roof luggage carrier
- Modifications to the vehicle's suspension system
- Installation of electronic devices such as mobile two-way radios and CD players
- Modifications to your vehicle for a person with a physical disability

■ If the SRS airbags deploy (inflate)

- Slight abrasions, burns, bruising, etc., may be sustained from SRS airbags, due to the extremely high speed deployment (inflation) by hot gases.
- A loud noise and white powder will be emitted.
- Parts of the airbag module (steering wheel hub, airbag cover and inflator) as well as the front seats, parts of the front and rear pillars, and roof side rails, may be hot for several minutes. The airbag itself may also be hot.
- The windshield may crack.
- For Safety Connect subscribers, if the SRS airbags deploy or in the event of a severe rear-end collision, the system is designed to send an emergency call to the response center, notifying them of the vehicle's location (without needing to push the "SOS" button) and an agent will attempt to speak with the occupants to ascertain the level of emergency and assistance required. If the occupants are unable to communicate, the agent automatically treats the call as an emergency and helps to dispatch the necessary emergency services. (→P. 477)

■ SRS airbag deployment conditions (SRS front airbags)

- The SRS front airbags will deploy in the event of an impact that exceeds the set threshold level (the level of force corresponding to an approximately 12-18 mph [20-30 km/h] frontal collision with a fixed wall that does not move or deform).

However, this threshold velocity will be considerably higher in the following situations:

- If the vehicle strikes an object, such as a parked vehicle or sign pole, which can move or deform on impact
- If the vehicle is involved in an underride collision, such as a collision in which the front of the vehicle "underrides", or goes under, the bed of a truck
- Depending on the type of collision, it is possible that only the seat belt pretensioners will activate.
- The SRS front airbags for the front passenger will not activate if there is no passenger sitting in the front passenger seat. However, the SRS front airbags for the front passenger may deploy if luggage is put in the seat, even if the seat is unoccupied. (→P. 53)
- The SRS seat cushion airbag on the front passenger seat will not operate if the occupant is not wearing a seat belt.

■ SRS airbag deployment conditions (SRS side and curtain shield airbags)

- The SRS side and curtain shield airbags will deploy in the event of an impact that exceeds the set threshold level (the level of force corresponding to the impact force produced by an approximately 3300 lb. [1500 kg] vehicle colliding with the vehicle cabin from a direction perpendicular to the vehicle orientation at an approximate speed of 12-18 mph [20-30 km/h]).
- The SRS curtain shield airbags will deploy in the event of vehicle rollover.
- The SRS side and curtain shield airbags may also deploy in the event of a severe frontal collision.

■ Conditions under which the SRS airbags may deploy (inflate), other than a collision

The SRS front airbags and SRS side and curtain shield airbags may also deploy if a serious impact occurs to the underside of your vehicle. Some examples are shown in the illustration.

- Hitting a curb, edge of pavement or hard surface
- Falling into or jumping over a deep hole
- Landing hard or falling

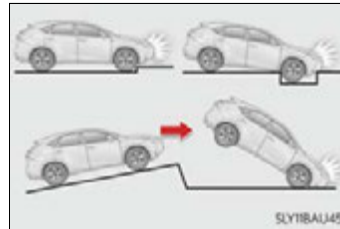

The SRS curtain shield airbags may also deploy under the situations shown in the illustration.

- The angle of vehicle tip-up is marginal.
- The vehicle skids and hits a curb stone.

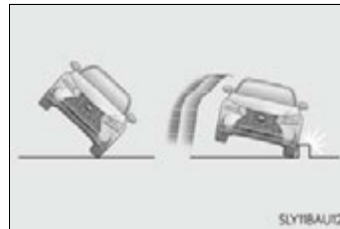

■ Types of collisions that may not deploy the SRS airbags (SRS front airbags)

The SRS front airbags do not generally inflate if the vehicle is involved in a side or rear collision, if it rolls over, or if it is involved in a low-speed frontal collision. But, whenever a collision of any type causes sufficient forward deceleration of the vehicle, deployment of the SRS front airbags may occur.

- Collision from the side
- Collision from the rear
- Vehicle rollover

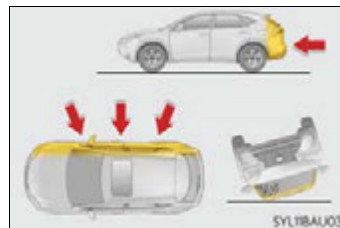

■ Types of collisions that may not deploy the SRS airbags (SRS side and curtain shield airbags)

The SRS side and curtain shield airbags may not activate if the vehicle is subjected to a collision from the side at certain angles, or a collision to the side of the vehicle body other than the passenger compartment.

- Collision from the side to the vehicle body other than the passenger compartment
- Collision from the side at an angle

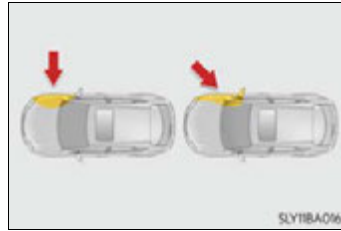

The SRS side airbags do not generally inflate if the vehicle is involved in a rear collision, if it rolls over, or if it is involved in a low-speed side or low-speed frontal collision.

- Collision from the rear
- Vehicle rollover

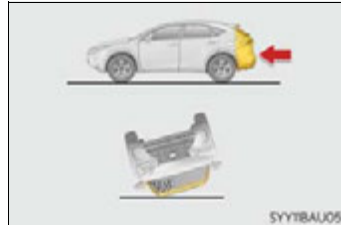

The SRS curtain shield airbags do not generally inflate if the vehicle is involved in a rear collision, if it pitches end over end, or if it is involved in a low-speed side or low-speed frontal collision.

- Collision from the rear
- Pitching end over end

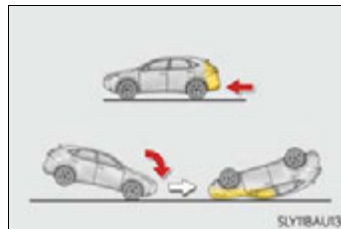

■ When to contact your Lexus dealer

In the following cases, the vehicle will require inspection and/or repair. Contact your Lexus dealer as soon as possible.

- Any of the SRS airbags have been inflated.
- The front of the vehicle is damaged or deformed, or was involved in an accident that was not severe enough to cause the SRS front airbags to inflate.
- A portion of a door or its surrounding area is damaged or deformed, or the vehicle was involved in an accident that was not severe enough to cause the SRS side and curtain shield airbags to inflate.
- The pad section of the steering wheel, dashboard near the front passenger airbag or lower portion of the instrument panel is scratched, cracked, or otherwise damaged.
- The front passenger's seat cushion surface is scratched, cracked, or otherwise damaged.
- The surface of the seats with the side airbag is scratched, cracked, or otherwise damaged.

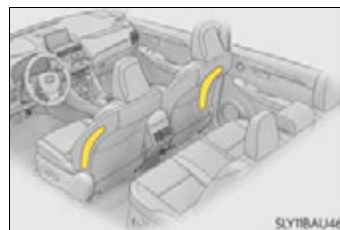
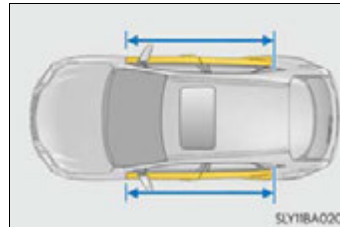
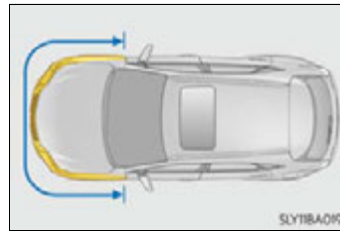

- The portion of the front pillars, rear pillars or roof side rail garnishes (padding) containing the curtain shield airbags inside is scratched, cracked, or otherwise damaged.

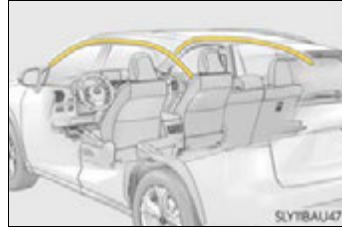

Front passenger occupant classification system

Your vehicle is equipped with a front passenger occupant classification system. This system detects the conditions of the front passenger seat and activates or deactivates the devices for the front passenger.



- ① SRS warning light
- ② Seat belt reminder light
- ③ "AIR BAG OFF" indicator light
- ④ "AIR BAG ON" indicator light

1

For safety and security

Condition and operation in the front passenger occupant classification system

■ Adult*¹

Indicator/ warning light	"AIR BAG ON" and "AIR BAG OFF" indicator lights	"AIR BAG ON"
	SRS warning light	Off
	Seat belt reminder light	Off* ² or flashing* ³
Devices	Front passenger airbag	Activated
	Side airbag on the front passenger seat	
	Curtain shield airbag in the front passenger side	
	Seat cushion airbag in the front passenger side	Activated* ² or deactivated* ³
	Front passenger's seat belt pretensioner and force limiter	Activated

■ Child*⁴

Indicator/ warning light	"AIR BAG ON" and "AIR BAG OFF" indicator lights	"AIR BAG OFF" or "AIR BAG ON"* ⁴
	SRS warning light	Off
	Seat belt reminder light	Off* ² or flashing* ³
Devices	Front passenger airbag	Deactivated or activated* ⁴
	Side airbag on the front passenger seat	Activated
	Curtain shield airbag in the front passenger side	
	Seat cushion airbag in the front passenger side	Deactivated or activated* ^{2,4}
	Front passenger's seat belt pretensioner and force limiter	Activated

■ Child restraint system with infant*⁵

Indicator/ warning light	"AIR BAG ON" and "AIR BAG OFF" indicator lights	"AIR BAG OFF"* ⁶
	SRS warning light	Off
	Seat belt reminder light	Off* ² or flashing* ³
Devices	Front passenger airbag	Deactivated
	Side airbag on the front passenger seat	Activated
	Curtain shield airbag in the front passenger side	
	Seat cushion airbag in the front passenger side	Deactivated
	Front passenger's seat belt pretensioner and force limiter	Activated

■ Unoccupied

Indicator/ warning light	"AIR BAG ON" and "AIR BAG OFF" indicator lights	"AIR BAG OFF"
	SRS warning light	Off
	Seat belt reminder light	
Devices	Front passenger airbag	Deactivated
	Side airbag on the front passenger seat	Activated
	Curtain shield airbag in the front passenger side	
	Seat cushion airbag in the front passenger side	Deactivated
	Front passenger's seat belt pretensioner and force limiter	Activated

1

For safety and security

■ There is a malfunction in the system

Indicator/ warning light	"AIR BAG ON" and "AIR BAG OFF" indicator lights	"AIR BAG OFF"
	SRS warning light	On
	Seat belt reminder light	Off
Devices	Front passenger airbag	Deactivated
	Side airbag on the front passenger seat	Activated
	Curtain shield airbag in the front passenger side	
	Seat cushion airbag in the front passenger side	Deactivated
	Front passenger's seat belt pretensioner and force limiter	Activated

*1: The system judges a person of adult size as an adult. When a smaller adult sits in the front passenger seat, the system may not recognize him/her as an adult depending on his/her physique and posture.

*2: In the event the front passenger is wearing a seat belt.

*3: In the event the front passenger does not wear a seat belt.

*4: For some children, child in seat, child in booster seat or child in convertible seat, the system may not recognize him/her as a child. Factors which may affect this can be the physique or posture.

*5: Never install a rear-facing child restraint system on the front passenger seat. A forward-facing child restraint system should only be installed on the front passenger seat when it is unavoidable. (→P. 63)

*6: In case the indicator light is not illuminated, consult this manual on how to install the child restraint system properly. (→P. 60)

 **WARNING****■ Front passenger occupant classification system precautions**

Observe the following precautions regarding the front passenger occupant classification system.

Failure to do so may cause death or serious injury.

- Wear the seat belt properly.
- Make sure the front passenger's seat belt plate has not been left inserted into the buckle before someone sits in the front passenger seat.
- Make sure the "AIR BAG OFF" indicator light is not illuminated when using the seat belt extender for the front passenger seat. If the "AIR BAG OFF" indicator light is illuminated, disconnect the extender tongue from the seat belt buckle, and reconnect the seat belt. Reconnect the seat belt extender after making sure the "AIR BAG ON" indicator light is illuminated. If you use the seat belt extender while the "AIR BAG OFF" indicator light is illuminated, the SRS airbags for the front passenger will not activate, which could cause death or serious injury in the event of a collision.
- Do not apply a heavy load to the front passenger seat or equipment (e.g. seatback pocket).
- Do not put weight on the front passenger seat by putting your hands or feet on the front passenger seat seatback from the rear passenger seat.
- Do not let a rear passenger lift the front passenger seat with their feet or press on the seatback with their legs.
- Do not put objects under the front passenger seat.

 **WARNING****■ Front passenger occupant classification system precautions**

- Do not recline the front passenger seatback so far that it touches a rear seat. This may cause the "AIR BAG OFF" indicator light to be illuminated, which indicates that the SRS airbags for the front passenger will not activate in the event of a severe accident. If the seatback touches the rear seat, return the seatback to a position where it does not touch the rear seat. Keep the front passenger seatback as upright as possible when the vehicle is moving. Reclining the seatback excessively may lessen the effectiveness of the seat belt system.
- If an adult sits in the front passenger seat, the "AIR BAG ON" indicator light is illuminated. If the "AIR BAG OFF" indicator is illuminated, ask the passenger to sit up straight, well back in the seat, feet on the floor, and with the seat belt worn correctly. If the "AIR BAG OFF" indicator still remains illuminated, either ask the passenger to move to the rear seat, or if that is not possible, move the front passenger seat fully rearward.
- When it is unavoidable to install a forward-facing child restraint system on the front passenger seat, install the child restraint system on the front passenger seat in the proper order. (→P. 63)
- Do not modify or remove the front seats.
- Do not kick the front passenger seat or subject it to severe impact. Otherwise, the SRS warning light may come on to indicate a malfunction of the front passenger occupant classification system. In this case, contact your Lexus dealer immediately.
- Child restraint systems installed on the rear seat should not contact the front seatbacks.
- Do not use a seat accessory, such as a cushion and seat cover, that covers the seat cushion surface.
- Do not modify or replace the upholstery of the front seat.

Safety information for children

Observe the following precautions when children are in the vehicle.
Use a child restraint system appropriate for the child, until the child becomes large enough to properly wear the vehicle's seat belt.

- It is recommended that children sit in the rear seats to avoid accidental contact with the shift lever, wiper switch, etc.
- Use the rear door child-protector lock or the window lock switch to avoid children opening the door while driving or operating the power window accidentally. (→P. 126, 166)
- Do not let small children operate equipment which may catch or pinch body parts, such as the power window, hood, back door, seats etc.

WARNING

Never leave children unattended in the vehicle, and never allow children to have or use the key.

Children may be able to start the vehicle or shift the vehicle into neutral. There is also a danger that children may injure themselves by playing with the windows, the moon roof (if equipped) or other features of the vehicle. In addition, heat build-up or extremely cold temperatures inside the vehicle can be fatal to children.

Child restraint systems

Before installing a child restraint system in the vehicle, there are precautions that need to be observed, different types of child restraint systems, as well as installation methods, etc., written in this manual.

- Use a child restraint system when riding with a small child that cannot properly use a seat belt. For the child's safety, install the child restraint system to a rear seat. Be sure to follow the installation method that is in the operation manual enclosed with the restraint system.

Table of contents

Points to remember	P. 60
Child restraint system	P. 62
When using a child restraint system on a passenger seat	P. 63
When using a child restraint system on a rear seat	P. 65
Child restraint system installation method	
• Fixed with a seat belt	P. 66
• Fixed with a child restraint LATCH anchor	P. 71
• Using an anchor bracket (for top tether strap)	P. 73

Points to remember

The laws of all 50 states of the U.S.A. as well as Canada now require the use of child restraint systems.

- Prioritize and observe the warnings, as well as the laws and regulations for child restraint systems.
- Choose a child restraint system that suits your vehicle and is appropriate to the age and size of the child.
- Use a child restraint system appropriate for the child until the child becomes large enough to properly wear the vehicle's seat belt.

 **WARNING****■ When a child is riding**

Observe the following precautions.

Failure to do so may result in death or serious injury.

- For effective protection in automobile accidents and sudden stops, a child must be properly restrained, using a seat belt or child restraint system depending on the age and size of the child.
- Lexus strongly urges the use of a proper child restraint system that conforms to the size of the child, installed on the rear seat. According to accident statistics, the child is safer when properly restrained in the rear seat than in the front seat.
- Holding a child in your or someone else's arms is not a substitute for a child restraint system. In an accident, the child can be crushed against the windshield or between the holder and the interior of the vehicle.
- Place one child to a child restraint system and then secure the child with the harness of the child restraint system.

■ Handling the child restraint system

If the child restraint system is not properly fixed in place, the child or other passengers may be seriously injured or even killed in the event of sudden braking, sudden swerving, or an accident.

- If the vehicle were to receive a strong impact from an accident, etc., it is possible that the child restraint system has damage that is not readily visible. In such cases, do not reuse the restraint system.
- Make sure you have complied with all installation instructions provided with the child restraint system manufacturer and that the system is properly secured.
- Keep the child restraint system properly secured on the seat even if it is not in use. Do not store the child restraint system unsecured in the passenger compartment.
- If it is necessary to detach the child restraint system, remove it from the vehicle or store it securely in the luggage compartment.

Child restraint system

■ Types of child restraint system installation methods

Confirm with the operation manual enclosed with the child restraint system about the installation of the child restraint system.

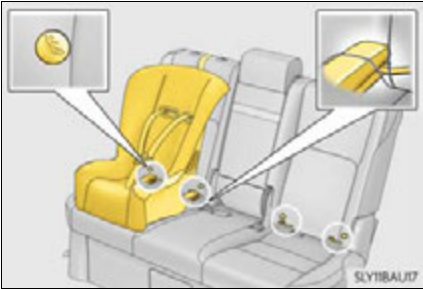
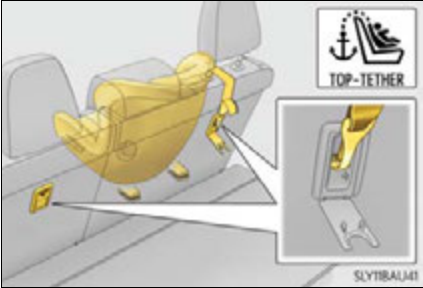
	Installation method	Page
Seat belt attachment		P. 66
Child restraint LATCH anchors attachment		P. 71
Anchor brackets (for top tether strap) attachment		P. 73

When using a child restraint system on a passenger seat**■ When installing a child restraint system to a passenger seat**

For the safety of a child, install child restraint systems to a rear seats. When installing child restraint system to a front passenger seat is unavoidable, adjust the passenger seat as follows and install the child restraint system.

- Raise the seatback as much as possible
- Move the seat to the rearmost position
- Raise the seat to the upper most position
- If the head restraint interferes with the child restraint system installation and the head restraint can be removed, remove the head restraint



1

For safety and security

⚠ WARNING**■ When installing a child restraint system**

Observe the following when installing child restraint system to the front passenger seat if it is unavoidable. The front passenger SRS air bag inflates with considerable speed and force that if not observed may lead to death or serious injury to the child.

- Never install a rear-facing child restraint system on the front passenger seat even if the "AIR BAG OFF" indicator light is illuminated. In the event of an accident, the force of the rapid inflation of the front passenger airbag can cause death or serious injury to the child if the rear-facing child restraint system is installed on the front passenger seat.

- A forward-facing child restraint system may be installed on the front passenger seat only when it is unavoidable. A child restraint system that requires a top tether strap should not be used in the front passenger seat since there is no top tether strap anchor for the front passenger seat.

- A forward-facing child restraint system may be installed on the front passenger seat only when it is unavoidable. When installing a forward-facing child restraint system on the front passenger seat, move the seat as far back as possible, and raise the seat to the upper most position, even if the "AIR BAG OFF" indicator light is illuminated.



If the head restraint interferes with the child restraint system installation and the head restraint can be removed, remove the head restraint.

- Do not allow the child to lean his/her head or any part of his/her body against the door or the area of the seat, front pillars or roof side rails from which the SRS side airbags or SRS curtain shield airbags deploy even if the child is seated in the child restraint system. It is dangerous if the SRS side and curtain shield airbags inflate, and the impact could cause death or serious injury to the child.
- When a booster seat is installed, always ensure that the shoulder belt is positioned across the center of the child's shoulder. The belt should be kept away from the child's neck, but not so that it could fall off the child's shoulder.

When using a child restraint system on a rear seat**⚠ WARNING****■ When installing a child restraint system**

Observe the following precautions.

Failure to do so may result in death or serious injury.

- Use child restraint system suitable to the age and size of the child and install it to the rear seat.
- If the driver's seat interferes with the child restraint system and prevents it from being attached correctly, attach the child restraint system to the right-hand rear seat.
- Adjust the front passenger seat so that it does not interfere with the child restraint system.



- Do not allow the child to lean his/her head or any part of his/her body against the door or the area of the seat, rear pillars or roof side rails from which the SRS curtain shield airbag deploys even if the child is seated in the child restraint system. It is dangerous if the SRS curtain shield airbag inflates, and the impact could cause death or serious injury to the child.

Child restraint system fixed with a seat belt

A child restraint system for a small child or baby must itself be properly restrained on the seat with the lap/shoulder belt.

◆ Installing child restraint system using a seat belt (child restraint lock function belt)

Install the child restraint system in accordance to the operation manual enclosed with the child restraint system.

■ Rear-facing – Infant seat/convertible seat

1 Adjust the seatback

If there is a gap between the child seat and the seatback, adjust the seatback until good contact is achieved.

2 Place the child restraint system on the rear seat facing the rear of the vehicle.



3 Run the seat belt through the child restraint system and insert the plate into the buckle. Make sure that the belt is not twisted.



4 Fully extend the shoulder belt and allow it to retract to put it in lock mode. In lock mode, the belt cannot be extended.



- 5 While pushing the child restraint system down into the rear seat, allow the shoulder belt to retract until the child restraint system is securely in place.

After the shoulder belt has retracted to a point where there is no slack in the belt, pull the belt to check that it cannot be extended.



- 6 After installing the child restraint system, rock it back and forth to ensure that it is installed securely.

■ Forward-facing – Convertible seat

- 1 Adjust the seatback

If there is gap between the child seat and the seatback, adjust the seatback until good contact is achieved.

- 2 If the head restraint interferes with the child restraint system installation and the head restraint can be removed, remove the head restraint. (→P. 158)

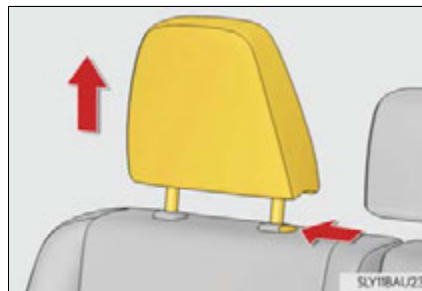

- 3 Place the child restraint system on the seat facing the front of the vehicle.



- 4 Run the seat belt through the child restraint system and insert the plate into the buckle. Make sure that the belt is not twisted.



- 5 Fully extend the shoulder belt and allow it to retract to put it in lock mode. In lock mode, the belt cannot be extended.



- 6 While pushing the child restraint system into the rear seat, allow the shoulder belt to retract until the child restraint system is securely in place.

After the shoulder belt has retracted to a point where there is no slack in the belt, pull the belt to check that it cannot be extended.

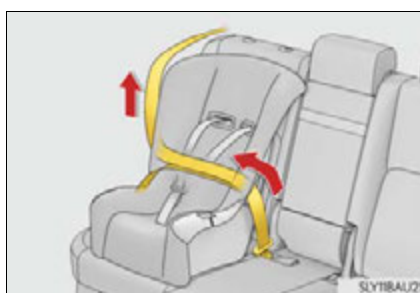

- 7 If the child restraint has a top tether strap, follow the child restraint manufacturer's operation manual regarding the installation, using the top tether strap to latch onto the top tether strap anchor. (→P. 73)
- 8 After installing the child restraint system, rock it back and forth to ensure that it is installed securely.

■ Booster seat

- 1 High back type: If the head restraint interferes with your child restraint system, and the head restraint can be removed, remove the head restraint. (→P. 158)

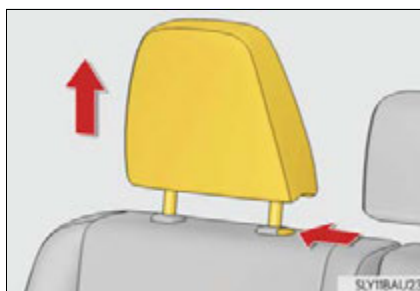

2 Place the child restraint system on the seat facing the front of the vehicle.

▶ Booster type



▶ High back type



3 Sit the child in the child restraint system. Fit the seat belt to the child restraint system according to the manufacturer's instructions and insert the plate into the buckle. Make sure that the belt is not twisted.

Check that the shoulder belt is correctly positioned over the child's shoulder and that the lap belt is as low as possible. (→P. 32)





◆ Removing a child restraint system installed with a seat belt

Press the buckle release button and fully retract the seat belt.

When releasing the buckle, the child restraint system may spring up due to the rebound of the seat cushion. Release the buckle while holding down the child restraint system.

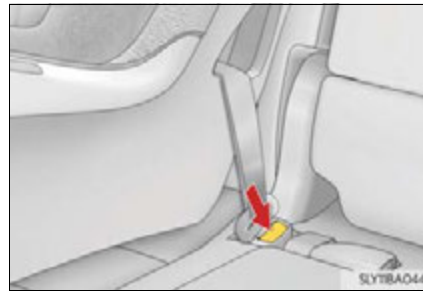
Since the seat belt automatically reels itself, slowly return it to the stowing position.



 **WARNING****■ When installing a child restraint system**

Observe the following precautions.

Failure to do so may result in death or serious injury.

- Do not allow children to play with the seat belt. If the seat belt becomes twisted around a child's neck, it may lead to choking or other serious injuries that could result in death.
If this occurs and the buckle cannot be unfastened, scissors should be used to cut the belt.
- Ensure that the belt and plate are securely locked and the seat belt is not twisted.
- Shake the child restraint system left and right, and forward and backward to ensure that it has been securely installed.
- After securing a child restraint system, never adjust the seat.
- When a booster seat is installed, always ensure that the shoulder belt is positioned across the center of the child's shoulder. The belt should be kept away from the child's neck, but not so that it could fall off the child's shoulder.
- Follow all installation instructions provided by the child restraint system manufacturer.
- When securing some types of child restraint systems in rear seats, it may not be possible to properly use the seat belts in positions next to the child restraint without interfering with it or affecting seat belt effectiveness. Be sure your seat belt fits snugly across your shoulder and low on your hips. If it does not, or if it interferes with the child restraint, move to a different position. Failure to do so may result in death or serious injury.
- When installing a child restraint system in the rear center seat, adjust both seatbacks at the same angle. Otherwise, the child restraint system cannot be securely restrained and this may cause death or serious injuries in the event of sudden braking, sudden swerving or an accident.

■ When installing a booster seat

To prevent the belt from going into ALR lock mode, do not fully extend the shoulder belt. ALR mode causes the belt to tighten only. This could cause injury or discomfort to the child. (→P. 36)

■ Do not use a seat belt extender

If a seat belt extender is used when installing a child restraint system, the seat belt will not securely hold the child restraint system, which could cause death or serious injury to the child or other passengers in the event of sudden braking, sudden swerving or an accident.

Child restraint system fixed with a child restraint LATCH anchor

■ Child restraint LATCH anchors

LATCH anchors are provided for the outboard rear seats. (Buttons displaying the location of the anchors are attached to the seats.)

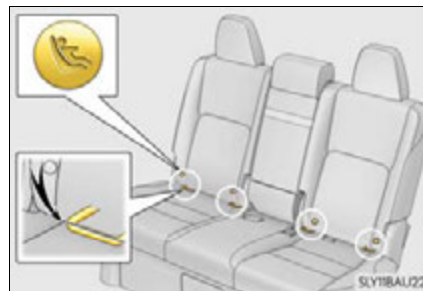

■ Installation with LATCH system

Install the child restraint system in accordance to the operation manual enclosed with the child restraint system.

1 Adjust the seatback

If there is a gap between the child seat and the seatback, adjust the seatback until good contact is achieved.

2 If the head restraint interferes with the child restraint system installation and the head restraint can be removed, remove the head restraint. (→P. 158)

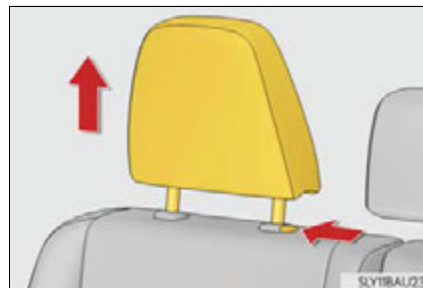

3 Widen the gap between the seat cushion and seatback slightly.

▶ Type A

- 4 Latch the hooks of the lower straps onto the LATCH anchors.

For owners in Canada:
The symbol on a child restraint system indicates the presence of a lower connector system.

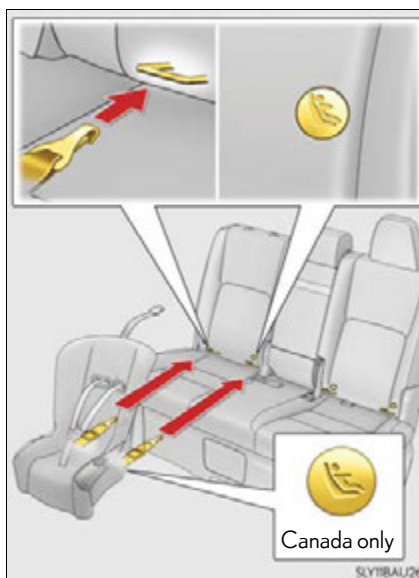

▶ Type B

- 4 Latch the buckles onto the LATCH anchors.

For owners in Canada:
The symbol on a child restraint system indicates the presence of a lower connector system.

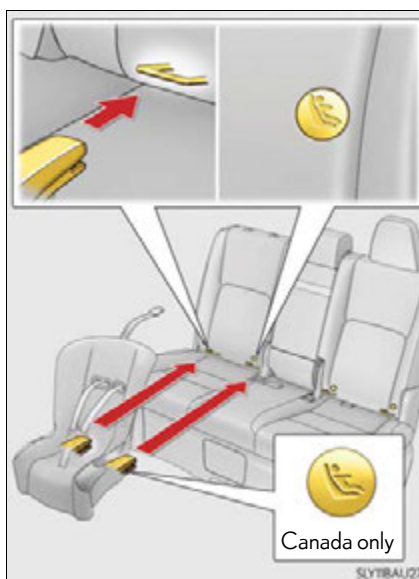

- 5 If the child restraint has a top tether strap, follow the child restraint manufacturer's operation manual regarding the installation, using the top tether strap to latch onto the top tether strap anchor. (→P. 73)

- 6 After installing the child restraint system, rock it back and forth to ensure that it is installed securely.

■ Laws and regulations pertaining to anchors

The LATCH system conforms to FMVSS225 or CMVSS210.2.

Child restraint systems conforming to FMVSS213 or CMVSS213 specifications can be used.

This vehicle is designed to conform to SAE J1819.

⚠ WARNING

■ When installing a child restraint system

Observe the following precautions.

Failure to do so may result in death or serious injury.

- Shake the child restraint system left and right, and forward and backward to ensure that it has been securely installed.
- After securing a child restraint system, never adjust the seat.
- When using the LATCH anchors, be sure that there are no foreign objects around the anchors and that the seat belt is not caught behind the child restraint system.
- Follow all installation instructions provided by the child restraint system manufacturer.
- When securing some types of child restraint systems in rear seats, it may not be possible to properly use the seat belts in positions next to the child restraint without interfering with it or affecting seat belt effectiveness. Be sure your seat belt fits snugly across your shoulder and low on your hips. If it does not, or if it interferes with the child restraint, move to a different position. Failure to do so may result in death or serious injury.

Using an anchor bracket (for top tether strap)

■ Anchor brackets (for top tether strap)

Anchor brackets are provided for each rear seat.

Use anchor brackets when fixing the top tether strap.

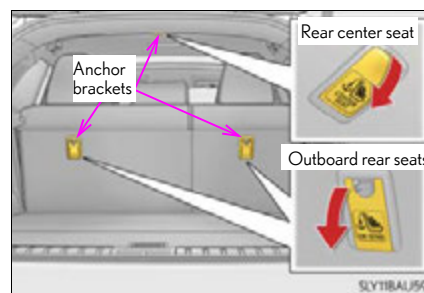

■ Fixing the top tether strap to the anchor bracket

Install the child restraint system in accordance to the operation manual enclosed with the child restraint system.

▶ Outboard rear seats

- 1 Adjust the head restraint to the upmost position.

If the head restraint interferes with the child restraint system installation and the head restraint can be removed, remove the head restraint. (→P.158)

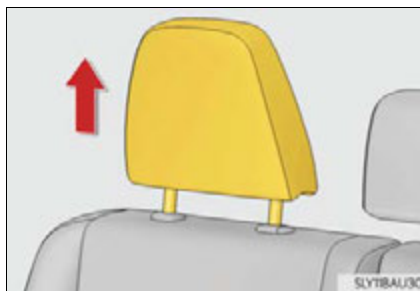

- 2 Open the anchor bracket cover, latch the hook onto the anchor bracket and tighten the top tether strap.

Make sure the top tether strap is securely latched.

When installing the child restraint system with the head restraint being raised, be sure to have the top tether strap pass underneath the head restraint.

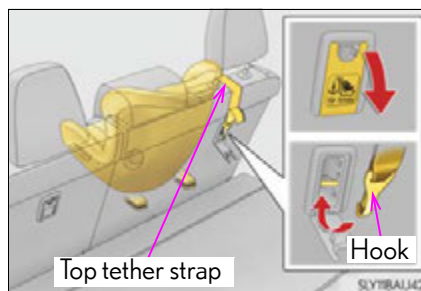

▶ Rear center seat

- 1 Adjust the head restraint to the downmost position.

If the head restraint interferes with the child restraint system installation and the head restraint can be removed, remove the head restraint. (→P.158)

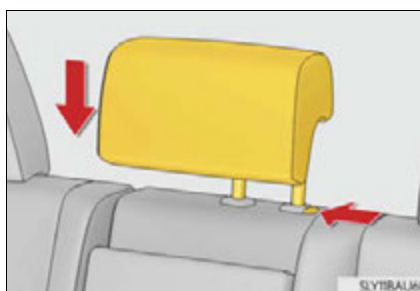

- 2** Open the anchor bracket cover, latch the hook onto the anchor bracket and tighten the top tether strap.

Make sure the top tether strap is securely latched.

When installing the child restraint system with the head restraint being lower, be sure to have the top tether strap pass over the top of the head restraint.

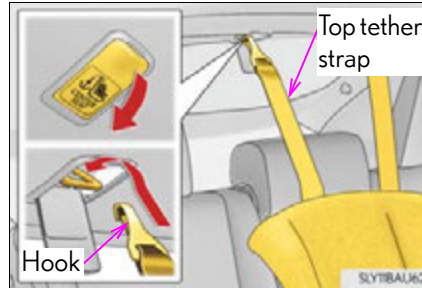

■ Laws and regulations pertaining to anchors

The LATCH system conforms to FMVSS225 or CMVSS210.2.

Child restraint systems conforming to FMVSS213 or CMVSS213 specifications can be used.

This vehicle is designed to conform to SAE J1819.

⚠ WARNING

■ When installing a child restraint system

Observe the following precautions.
Failure to do so may result in death or serious injury.

- Firmly attach the top tether strap and make sure that the belt is not twisted.
- Do not attach the top tether strap to anything other than the anchor bracket.
- Shake the child restraint system left and right, and forward and backward to ensure that it has been securely installed.
- After securing a child restraint system, never adjust the seat.
- Follow all installation instructions provided by the child restraint system manufacturer.
- Outboard rear seats: When installing the child restraint system with the head restraint being raised, after the head restraint has been raised and then the anchor bracket has been fixed, do not lower the head restraint.
- Rear center seat: When installing the child restraint system with the head restraint being lowered, be sure to have the top tether strap pass over the top of the head restraint. If the belt passes below the head restraint, it is possible that the child restraint system may not be securely fixed.

⚠ NOTICE

■ Anchor brackets (for top tether strap)

When not in use, make certain to close the lid. If it remains open, the lid may be damaged.

Exhaust gas precautions

Harmful substance to the human body are contained in exhaust gases if inhaled.

WARNING

Exhaust gases contain harmful carbon monoxide (CO), which is colorless and odorless. Observe the following precautions. Failure to do so may cause exhaust gases enter the vehicle and may lead to an accident caused by light-headedness, or may lead to death or a serious health hazard.

■ Important points while driving

- Keep the back door closed.
- If you smell exhaust gases in the vehicle even when the back door is closed, open the windows and have the vehicle inspected at your Lexus dealer as soon as possible.

■ When parking

- If the vehicle is in a poorly ventilated area or a closed area, such as a garage, stop the hybrid system.
- Do not leave the vehicle with the hybrid system on for a long time. If such a situation cannot be avoided, park the vehicle in an open space and ensure that exhaust fumes do not enter the vehicle interior.
- Do not leave the hybrid system operating in an area with snow build-up, or where it is snowing. If snowbanks build up around the vehicle while the hybrid system is operating, exhaust gases may collect and enter the vehicle.

■ Exhaust pipe

The exhaust system needs to be checked periodically. If there is a hole or crack caused by corrosion, damage to a joint or abnormal exhaust noise, be sure to have the vehicle inspected and repaired by your Lexus dealer.

Hybrid system features

Your vehicle is a hybrid vehicle. It has characteristics different from conventional vehicles. Be sure you are closely familiar with the characteristics of your vehicle, and operate it with care.

The hybrid system combines the use of a gasoline engine and an electric motor (traction motor) according to driving conditions, improving fuel efficiency and reducing exhaust emissions.

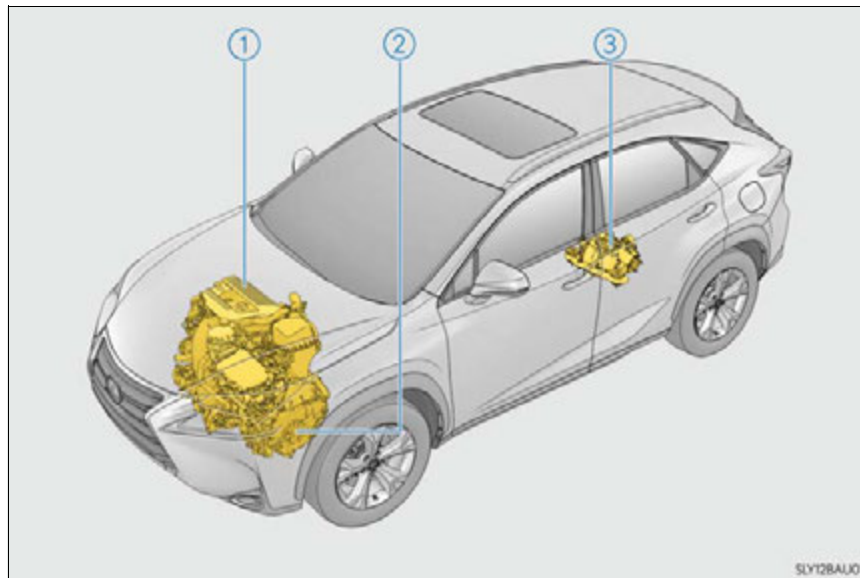

The illustration is an example for explanation and may differ from the actual item.

- ① Gasoline engine
- ② Front electric motor (traction motor)
- ③ Rear electric motor (traction motor)*

*: AWD models only

◆ When stopped/during start off

The gasoline engine stops* when the vehicle is stopped. During start off, the electric motor (traction motor) drives the vehicle. At slow speeds or when traveling down a gentle slope, the engine is stopped* and the electric motor (traction motor) is used.

When the shift lever is in N, the hybrid battery (traction battery) is not being charged. When the vehicle is stopped, always put the shift lever to P.

Also, even in heavy traffic conditions, drive the vehicle in D or S.

*: When the hybrid battery (traction battery) requires charging or the engine is warming up, etc., the gasoline engine will not automatically stop. (→P. 79)

◆ During normal driving

The gasoline engine is predominantly used. The electric motor (traction motor) charges the hybrid battery (traction battery) as necessary.

◆ When accelerating sharply

When the accelerator pedal is depressed heavily, the power of the hybrid battery (traction battery) is added to that of the gasoline engine via the electric motor (traction motor).

◆ When braking (regenerative braking)

The wheels operate the electric motor (traction motor) as a power generator, and the hybrid battery (traction battery) is charged.

Vehicle proximity notification system

When driving with the gasoline engine stopped, a sound, which changes in accordance with the driving speed, will be played in order to warn people nearby of the vehicle's approach. The sound will stop when the vehicle speed exceeds approximately 15 mph (25 km/h).

■ Regenerative braking

In the following situations, kinetic energy is converted to electric energy and deceleration force can be obtained in conjunction with the recharging of the hybrid battery (traction battery).

- The accelerator pedal is released while driving with the shift lever in D or S.
- The brake pedal is depressed while driving with the shift lever in D or S.

■ EV indicator

The EV indicator comes on when the vehicle is driven using only the electric motor (traction motor) or the gasoline engine is stopped.



■ Conditions in which the gasoline engine may not stop

The gasoline engine starts and stops automatically. However, it may not stop automatically in the following conditions:

- During gasoline engine warm-up
- During hybrid battery (traction battery) charging
- When the temperature of the hybrid battery (traction battery) is high or low
- When the heater is switched on

■ Charging the hybrid battery (traction battery)

As the gasoline engine charges the hybrid battery (traction battery), the battery does not need to be charged from an outside source. However, if the vehicle is left parked for a long time the hybrid battery (traction battery) will slowly discharge. For this reason, be sure to drive the vehicle at least once every few months for at least 30 minutes or 10 miles (16 km). If the hybrid battery (traction battery) becomes fully discharged and you are unable to start the hybrid system, contact your Lexus dealer.

■ Charging the 12-volt battery

→P. 596

■ After the 12-volt battery has discharged or when the terminal has been removed and installed during exchange, etc.

The gasoline engine may not stop even if the vehicle is being driven by the hybrid battery (traction battery). If this continues for a few days, contact your Lexus dealer.

■ Sounds and vibrations specific to a hybrid vehicle

There may be no engine sound or vibration even though the vehicle is able to move with the "READY" indicator is illuminated. For safety, make sure to shift the shift lever to P and apply the parking brake when parked.

The following sounds or vibrations may occur when the hybrid system is operating and are not a malfunction:

- Motor sounds may be heard from the engine compartment.
- Sounds may be heard from the hybrid battery (traction battery) behind the rear seats when the hybrid system starts or stops.
- Relay operating sounds such as a snap or soft clank will be emitted from the hybrid battery (traction battery), behind the rear seats, when the hybrid system is started or stopped.
- Sounds from the hybrid system may be heard when the back door is open.
- Sounds may be heard from the transmission when the gasoline engine starts or stops, when driving at low speeds, or during idling.
- Engine sounds may be heard when accelerating sharply.
- Sounds may be heard due to regenerative braking when the brake pedal is depressed or as the accelerator pedal is released.
- Vibration may be felt when the gasoline engine starts or stops.
- Cooling fan sounds may be heard from the air intake vents under the rear seats.

■ Vehicle proximity notification system

In the following cases, the vehicle proximity notification system may be difficult for surrounding people to hear.

- In very noisy areas
- In the wind or the rain

Also, as the vehicle proximity notification system is installed on the front of the vehicle, it may be more difficult to hear from the rear of the vehicle compared to the front.

■ Maintenance, repair, recycling, and disposal

Contact your Lexus dealer regarding maintenance, repair, recycling and disposal. Do not dispose of the vehicle yourself.

■ Customization

Settings (e.g. on/off operation of the EV indicator) can be changed.
(Customizable features: →P. 631)

Hybrid system precautions

Take care when handling the hybrid system, as it is a high voltage system (about 650 V at maximum) as well as contains parts that become extremely hot when the hybrid system is operating. Obey the warning labels attached to the vehicle.

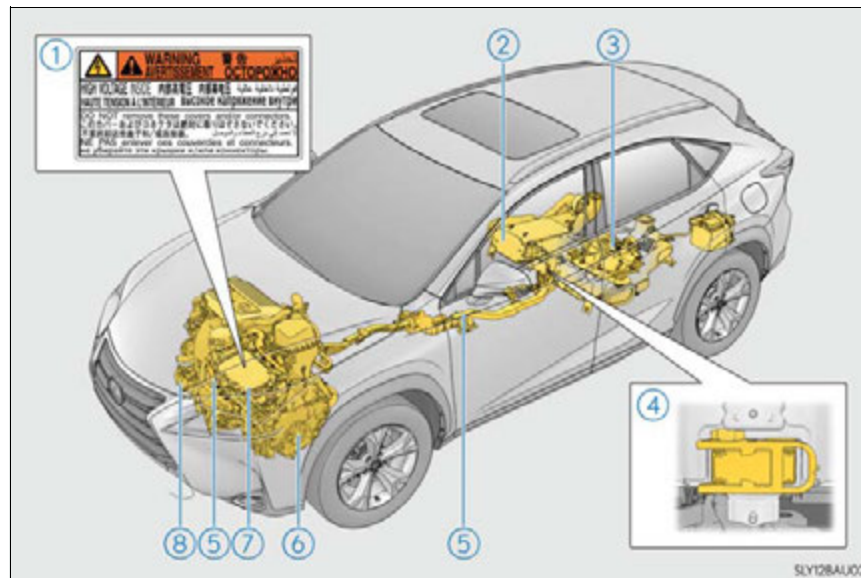

The illustration is an example for explanation and may differ from the actual item.

- | | |
|---|---|
| ① Warning label | ⑤ High voltage cables (orange) |
| ② Hybrid battery (traction battery) | ⑥ Front electric motor (traction motor) |
| ③ Rear electric motor (traction motor)* | ⑦ Power control unit |
| ④ Service plug | ⑧ Air conditioning compressor |

*: AWD models only

1

For safety and security

Hybrid battery (traction battery) air intake and discharge vents

The cooling air intake and discharge vents for the hybrid battery (traction battery) are located under the rear seats and between the rear seats and deck board, respectively. If the air intake vents are blocked, it could lead to a reduction in hybrid battery (traction battery) output.

The hybrid battery (traction battery) output will not be reduced, even if the space between the upper part of the air discharge vents on the back of the rear seat and deck board is blocked with luggage, etc.

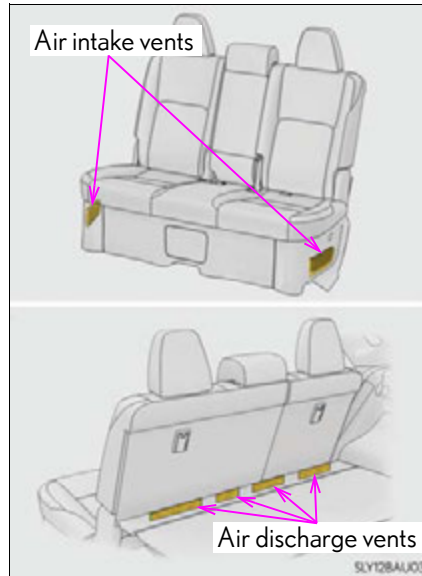

Emergency shut off system

When a certain level of impact is detected by the impact sensor, the emergency shut off system blocks the high voltage current and stops the fuel pump to minimize the risk of electrocution and fuel leakage. If the emergency shut off system activates, your vehicle will not restart. To restart the hybrid system, contact your Lexus dealer.

Hybrid warning message

A message is automatically displayed when a malfunction occurs in the hybrid system or an improper operation is attempted.

If a warning message is shown on the multi-information display, read the message and follow the instructions.

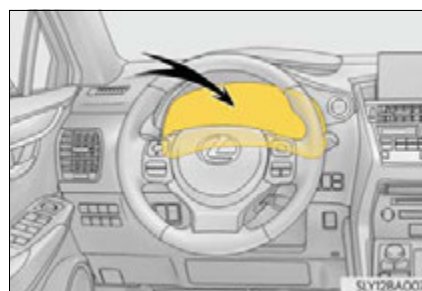

■ **If a warning light comes on, a warning message is displayed, or the 12-volt battery is disconnected**

The hybrid system may not start. In this case, try to start the system again. If the "READY" indicator does not come on, contact your Lexus dealer.

■ **Running out of fuel**

When the vehicle has run out of fuel and the hybrid system cannot be started, refuel the vehicle with at least enough gasoline to make the low fuel level warning light (→P. 567) go off. If there is only a small amount of fuel, the hybrid system may not be able to start. (The standard amount of fuel is about 2.7 gal. [10.1 L, 2.2 Imp.gal.], when the vehicle is on a level surface. This value may vary when the vehicle is on a slope. Add extra fuel when the vehicle is inclined.)

■ **Electromagnetic waves**

- High voltage parts and cables on hybrid vehicles incorporate electromagnetic shielding, and therefore emit approximately the same amount of electromagnetic waves as conventional gasoline powered vehicles or home electronic appliances.
- Your vehicle may cause sound interference in some third party-produced radio parts.

■ **Hybrid battery (traction battery)**

The hybrid battery (traction battery) has a limited service life. The lifespan of the hybrid battery (traction battery) can change in accordance with driving style and driving conditions.

⚠ WARNING

■ **High voltage precautions**

This vehicle has high voltage DC and AC systems as well as a 12-volt system. DC and AC high voltage is very dangerous and can cause severe burns and electric shock that may result in death or serious injury.

- Never touch, disassemble, remove or replace the high voltage parts, cables or their connectors.
- The hybrid system will become hot after starting as the system uses high voltage. Be careful of both the high voltage and the high temperature, and always obey the warning labels attached to the vehicle.
- Never try to open the service plug access hole located underneath the rear seats. The service plug is used only when the vehicle is serviced and is subject to high voltage.

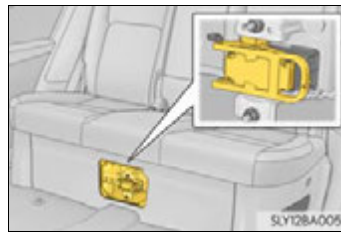

 **WARNING****■ Road accident cautions**

Observe the following precautions to reduce the risk of death or serious injury:

- Pull your vehicle off the road, shift the shift lever to P, apply the parking brake, and turn the hybrid system off.
- Do not touch the high voltage parts, cables and connectors.
- If electric wires are exposed inside or outside your vehicle, an electric shock may occur. Never touch exposed electric wires.
- If a fluid leak occurs, do not touch the fluid as it may be strong alkaline electrolyte from the hybrid battery (traction battery). If it comes into contact with your skin or eyes, wash it off immediately with a large amount of water or, if possible, boric acid solution. Seek immediate medical attention.
- If a fire occurs in the hybrid vehicle, leave the vehicle as soon as possible. Never use a fire extinguisher that is not meant for electric fires. Using even a small amount of water may be dangerous.
- If your vehicle needs to be towed, do so with front wheels (2WD models) or four wheels (AWD models) raised. If the wheels connected to the electric motor (traction motor) are on the ground when towing, the motor may continue to generate electricity. This may cause a fire. (→P. 558)
- Carefully inspect the ground under the vehicle. If you find that liquid has leaked onto the ground, the fuel system may have been damaged. Leave the vehicle as soon as possible.

 **WARNING****■ Hybrid battery (traction battery)**

- Never resell, hand over or modify the hybrid battery. To prevent accidents, hybrid batteries that have been removed from a disposed vehicle are collected through Lexus dealer. Do not dispose of the battery yourself.

Unless the battery is properly collected, the following may occur, resulting in death or serious injury:

- The hybrid battery may be illegally disposed of or dumped, and it is hazardous to the environment or someone may touch a high voltage part, resulting in an electric shock.
- The hybrid battery is intended to be used exclusively with your hybrid vehicle. If the hybrid battery is used outside of your vehicle or modified in any way, accidents such as electric shock, heat generation, smoke generation, an explosion and electrolyte leakage may occur.

When reselling or handing over your vehicle, the possibility of an accident is extremely high because the person receiving the vehicle may not be aware of these dangers.

- If your vehicle is disposed of without the hybrid battery having been removed, there is a danger of serious electric shock if high voltage parts, cables and their connectors are touched. In the event that your vehicle must be disposed of, the hybrid battery must be disposed of by your Lexus dealer or a qualified service shop. If the hybrid battery is not disposed of properly, it may cause electric shock that can result in death or serious injury.

 **NOTICE****■ Hybrid battery (traction battery) air intake and discharge vents**

- Do not place objects that will block the air intake vents. The hybrid battery (traction battery) may have a reduction in hybrid battery (traction battery) output as well as be damaged.
- Clean the air intake and discharge vents regularly to prevent the hybrid battery (traction battery) from overheating.
- Do not get water or foreign materials in either the air intake and discharge vents as this may cause a short circuit and damage the hybrid battery (traction battery).
- Do not carry large amounts of water such as water cooler bottles in the vehicle. If water spills onto the hybrid battery (traction battery), the battery may be damaged. Have the vehicle inspected by your Lexus dealer.

Immobilizer system

The vehicle's keys have built-in transponder chips that prevent the hybrid system from starting if a key has not been previously registered in the vehicle's on-board computer.

Never leave the keys inside the vehicle when you leave the vehicle.

This system is designed to help prevent vehicle theft but does not guarantee absolute security against all vehicle thefts.

The indicator light flashes after the power switch has been turned off to indicate that the system is operating.

The indicator light stops flashing after the power switch has been turned to ACCESSORY or ON mode to indicate that the system has been canceled.

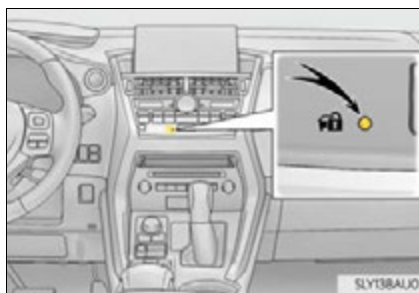

■ System maintenance

The vehicle has a maintenance-free type immobilizer system.

■ Conditions that may cause the system to malfunction

- If the grip portion of the key is in contact with a metallic object
- If the key is in close proximity to or touching a key registered to the security system (key with a built-in transponder chip) of another vehicle

■ Certification for the immobilizer system

- ▶ For vehicles sold in the U.S.A.

FCC ID: NI4TMIMB-3

This device complies with part 15 of the FCC Rules. Operation is subject to the following two conditions: (1) This device may not cause harmful interference; and (2) This device must accept any interference received, including interference that may cause undesired operation.

Changes or modifications not expressly approved by the party responsible for compliance could void the user's authority to operate the equipment.

- ▶ For vehicles sold in Canada

This device complies with Industry Canada licence-exempt RSSs. Operation is subject to the following two conditions: (1) This device may not cause interference; and (2) This device must accept any interference received, including interference that may cause undesired operation of the device.

 **WARNING****■ Certifications for the immobilizer system**

Changes or modifications not expressly approved by the party responsible for compliance could void the user's authority to operate the equipment.

 **NOTICE****■ To ensure the system operates correctly**

Do not modify or remove the system. If modified or removed, the proper operation of the system cannot be guaranteed.

1

For safety and security

Alarm

The alarm

The alarm uses light and sound to give an alert when an intrusion is detected.

The alarm is triggered in the following situations when the alarm is set:

- A locked door is unlocked or opened in any way other than using the entry function, wireless remote control or mechanical key. (The doors will lock again automatically.)
- The hood is opened.

Setting the alarm system

Close the doors and hood, and lock all the doors. The system will be set automatically after 30 seconds.

The indicator light changes from being on to flashing when the system is set.

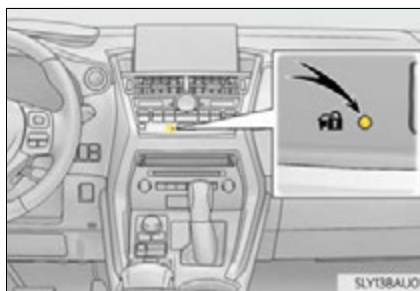

Deactivating or stopping the alarm

Do one of the following to deactivate or stop the alarms:

- Unlock the doors.
- Turn the power switch to ACCESSORY or ON mode, or start the hybrid system. (The alarm will be deactivated or stopped after a few seconds.)

■ System maintenance

The vehicle has a maintenance-free type alarm system.

■ Items to check before locking the vehicle

To prevent unexpected triggering of the alarm and vehicle theft, make sure of the following:

- Nobody is in the vehicle.
- The windows and moon roof (if equipped) are closed before the alarm is set.
- No valuables or other personal items are left in the vehicle.

■ Triggering of the alarm

The alarm may be triggered in the following situations:
(Stopping the alarm deactivates the alarm system.)

- A person inside the vehicle opens a door or hood, or unlocks the vehicle using an inside lock button.
- The 12-volt battery is recharged or replaced when the vehicle is locked. (→P. 596)



■ Alarm-operated door lock

In the following cases, depending on the situation, the door may automatically lock to prevent improper entry into the vehicle:

- When a person remaining in the vehicle unlocks the door and the alarm is activated.
- While the alarm is activated, a person remaining in the vehicle unlocks the door.
- When recharging or replacing the 12-volt battery

⚠ NOTICE

■ To ensure the system operates correctly

Do not modify or remove the system. If modified or removed, the proper operation of the system cannot be guaranteed.

Theft prevention labels (for U.S.A.)



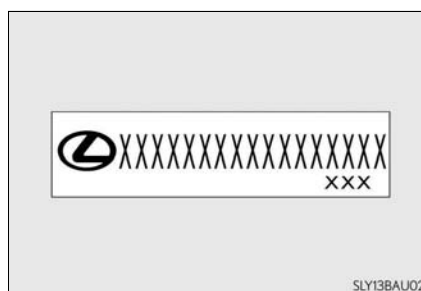













These labels are attached to the vehicle to reduce vehicle theft by facilitating the tracing and recovery of parts from stolen vehicles. Do not remove under penalty of law.





2. Instrument cluster	
Warning lights and indicators.....	92
Gauges and meters.....	97
Multi-information display	102
Head-up display	106
Energy monitor/ consumption screen	111

Warning lights

Warning lights inform the driver of malfunctions in any of the vehicle's systems.

<p>^{*1}  Brake system warning light (→P. 565) (U.S.A.)</p>	<p>^{*1}  ABS warning light (→P. 566) (Canada)</p>
<p>^{*1}  Brake system warning light (→P. 565) (Canada)</p>	<p>^{*1}  Electric power steering system warning light (→P. 566)</p>
<p>^{*2}  Charging system warning light (→P. 565)</p>	<p>^{*1}  Electric power steering system warning light (→P. 566)</p>
<p>^{*2}  Low engine oil pressure warning light (→P. 565)</p>	<p>^{*1,3}  PCS warning light (→P. 566) (if equipped)</p>
<p>^{*2}  High coolant temperature warning light (→P. 565)</p>	<p>^{*1}  Slip indicator light (→P. 566)</p>
<p>^{*1}  Brake system warning light (→P. 565)</p>	<p>^{*1,3}  Brake hold operated indicator (→P. 566)</p>
<p>^{*1}  Malfunction indicator lamp (→P. 565) (U.S.A.)</p>	<p>^{*3}  Parking brake indicator (→P. 566) (U.S.A.)</p>
<p>^{*1}  Malfunction indicator lamp (→P. 565) (Canada)</p>	<p>^{*3}  Parking brake indicator (→P. 566) (Canada)</p>
<p>^{*1}  SRS warning light (→P. 566)</p>	<p>[*]  Low fuel level warning light (→P. 567)</p>
<p>^{*1}  ABS warning light (→P. 566) (U.S.A.)</p>	<p>[*]  Driver's and front passenger's seat belt reminder light (→P. 567)</p>

<p>^{*1}</p>  <p>Master warning light (→P. 567)</p>	<p>^{*2}</p>  <p>Brake Override System/ Drive-Start Control warning light (→P. 567)</p>
<p>^{*1}</p>  <p>Tire pressure warning light (→P. 567)</p>	













^{*1}: These lights turn on when the power switch is turned to ON mode to indicate that a system check is being performed. They will turn off after the hybrid system is on, or after a few seconds. There may be a malfunction in a system if the lights do not turn on, or turn off. Have the vehicle inspected by your Lexus dealer.















^{*2}: This light illuminates on the multi-information display.

^{*3}: The light flashes to indicate a malfunction.

Indicators

The indicators inform the driver of the operating state of the vehicle's various systems.

 <p>Turn signal indicator (→P. 212)</p>	 <p>"READY" indicator (→P. 201)</p>
 <p>(U.S.A.) Headlight indicator (→P. 219)</p>	 <p>EV indicator (→P. 79)</p>
 <p>(Canada) Tail light indicator (→P. 220)</p>	<p>^{*8}</p>  <p>EV drive mode indicator (→P. 206)</p>
 <p>Headlight high beam indicator (→P. 220)</p>	<p>^{*8}</p>  <p>"ECO" indicator (→P. 303)</p>
 <p>(if equipped) Automatic High Beam indicator (→P. 223)</p>	<p>^{*8}</p>  <p>"SPORT" indicator (→P. 303)</p>
 <p>Fog light indicator (→P. 227)</p>	<p>^{*8}</p>  <p>(if equipped) Radar cruise control indicator (→P. 240, 253)</p>

^{*8} 	Cruise control "SET" indicator (→P. 240, 253, 267)		Parking brake indicator (→P. 213, 214) (U.S.A.)
^{*8} 	Cruise control indicator (→P. 240, 253, 267)		Parking brake indicator (→P. 213, 214) (Canada)
^{*8}  (if equipped)	LDA indicator (→P. 270)	^{*1} 	Brake hold standby indicator (→P. 216)
^{*8}  (if equipped)	Steering control indicator (→P. 270)	^{*1} 	Brake hold operated indicator (→P. 216)
 (if equipped)	Intuitive parking assist indicator (→P. 279)	^{*4, 8} 	Low outside temperature indicator (→P. 97)
^{*1, 2} 	Slip indicator light (→P. 306)	^{*5, 6}  (if equipped)	BSM outside rear view mirror indicators (→P. 316)
^{*1} 	VSC OFF indicator (→P. 307)	^{*7} 	Security indicator (→P. 86, 88)
^{*1, 3}  (if equipped)	PCS warning light (→P. 311)	^{*7} 	"AIR BAG ON/OFF" indicator (→P. 53)

^{*1}: These lights turn on when the power switch is turned to the ON mode to indicate that a system check is being performed. They will turn off after the hybrid system is on, or after a few seconds. There may be a malfunction in a system if the lights do not turn on, or turn off. Have the vehicle inspected by your Lexus dealer.

^{*2}: The light flashes to indicate that the system is operating.

^{*3}: The light comes on when the system is turned off.

^{*4}: When the outside temperature is approximately 37°F (3°C) or lower, the indicator will flash for approximately 10 seconds, then stay on.

*5: In order to confirm operation, the BSM outside rear view mirror indicators illuminate in the following situations:

- When the power switch is turned to ON mode while the BSM main switch is set to ON.
- When the BSM main switch is set to ON while the power switch is in ON mode.

If the system is functioning correctly, the BSM outside rear view mirror indicators will turn off after a few seconds.

If the BSM outside rear view mirror indicators do not illuminate or do not turn off, there may be a malfunction in the system.

If this occurs, have the vehicle inspected by your Lexus dealer.

*6: This light illuminates on the outside rear view mirrors.

*7: This light illuminates on the center panel.

*8: This light illuminates on the multi-information display.

 **WARNING**

■ If a safety system warning light does not come on

Should a safety system light such as the ABS and SRS airbag warning light not come on when you start the hybrid system, this could mean that these systems are not available to help protect you in an accident, which could result in death or serious injury. Have the vehicle inspected by your Lexus dealer immediately if this occurs.

Gauges and meters

- ▶ When driving mode is in other than sport mode (→P. 303)

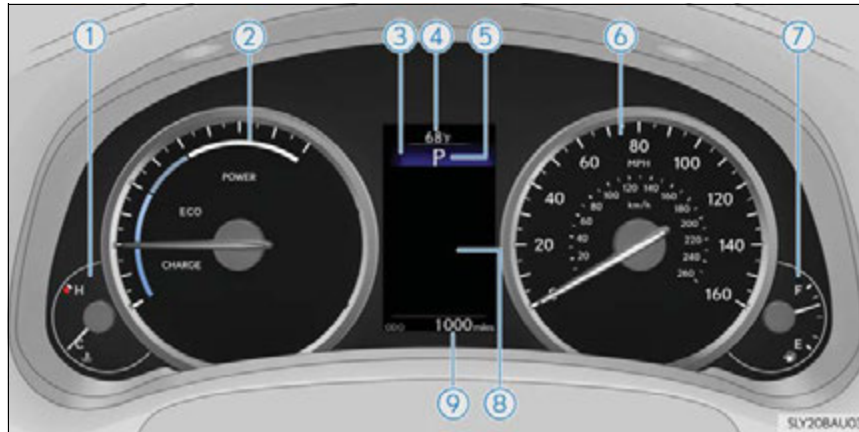

- ▶ When driving mode is in sport mode (→P. 303)



The units used on the meters may differ depending on the target region.

- ① Engine coolant temperature gauge
Displays the engine coolant temperature
- ② Hybrid System Indicator
Displays hybrid system output or regeneration level (→P. 100)

- ③ Background color of drive mode
Background color changes according to the drive mode. (→P. 303)
 - Sport mode: Red
 - Eco drive mode: BlueWhen in Normal mode, the background color is Black.
- ④ Outside temperature
Displays the outside temperature within the range of -40°F (-40°C) to 122°F (50°C). Low outside temperature indicator comes on when the ambient temperature is 37°F (3°C) or lower.
- ⑤ Shift position and shift range
Displays the selected shift position or selected shift range (→P. 208)
- ⑥ Speedometer
Displays the vehicle speed
- ⑦ Fuel gauge
Displays the quantity of fuel remaining in the tank
- ⑧ Multi-information display
Presents the driver with a variety of vehicle data (→P. 102)
Displays warning messages in case of a malfunction (→P. 572)
- ⑨ Odometer, trip meter and maintenance required information display
Odometer:
Displays the total distance the vehicle has been driven
Trip meter:
Displays the distance the vehicle has been driven since the meter was last reset.
Trip meters "A" and "B" can be used to record and display different distances independently.
Maintenance required information:
Displays the remaining distance until the engine oil should be changed.
 - Displays the maintenance required information when the power switch is ON mode.
 - It can be reset from the "settings display" of the multi-information display. (→P. 102)
- ⑩ Tachometer
Displays the engine speed in revolutions per minute

Changing the display

Switches between odometer, trip meter and maintenance required information displays. When the trip meter is displayed, pressing and holding the button will reset the trip meter.

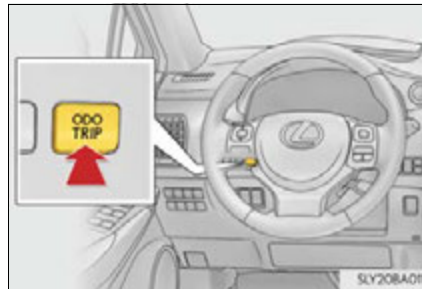

Instrument panel light control

The brightness of the instrument panel lights can be adjusted.

- ① Darker
- ② Brighter

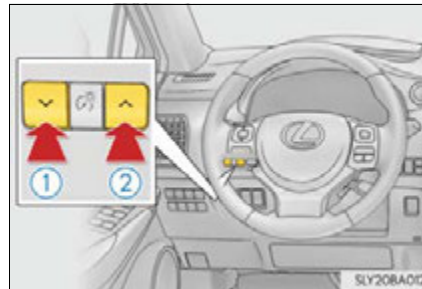

2

Instrument cluster

■ The meters and display illuminate when

The power switch is in ON mode.

■ Instrument panel brightness adjustment

The instrument panel brightness levels when the tail lights are on and off can be adjusted individually. However, when the surroundings are bright (daytime, etc.), turning on the tail lights will not change the instrument panel brightness. At this time, any adjustments made to the instrument panel brightness levels will be applied to both settings at once.

■ Hybrid System Indicator

- ① Power area
Shows that an Eco-friendly driving range is being exceeded (during full power driving etc.)
- ② Eco area
Shows that the vehicle is being driven in an Eco-friendly manner.
- ③ Hybrid Eco area
Shows that gasoline engine power is not being used very often.
The gasoline engine will automatically stop and restart under various conditions.
- ④ Charge area
Shows that energy is being recovered via the regenerative brake.

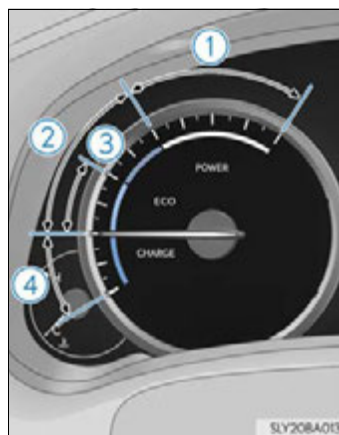

- Hybrid System Indicator is displayed when the driving mode is in other than the sport mode.
 - By keeping the indicator needle within Eco area, more Eco-friendly driving can be achieved.
 - Charge area indicates regeneration* status. Regenerated energy will be used to charge the hybrid battery (traction battery).
- *: When used in this manual, "regeneration" refers to the conversion of energy created by the movement of the vehicle into electrical energy.

■ Tachometer

Hybrid System Indicator switches to the tachometer when driving mode is in sport mode. The settings of the tachometer display can be changed on the multi-information display. (→P. 636)

■ Engine speed

On hybrid vehicles, engine speed is precisely controlled in order to help improve fuel efficiency and reduce exhaust emissions, etc. There are times when the engine speed that is displayed may differ even when vehicle operation and driving conditions are the same.

■ Outside temperature display

- In the following situations, the correct outside temperature may not be displayed, or the display may take longer than normal to change.
 - When stopped, or driving at low speeds (less than 12 mph [20 km/h])
 - When the outside temperature has changed suddenly (at the entrance/exit of a garage, tunnel, etc.)
- When "--" or "E" is displayed, the system may be malfunctioning. Take your vehicle to your Lexus dealer.

■ Pop-up display

In some situations, a pop-up display will be temporarily displayed on the multi-information display or the odometer/trip meter/maintenance required information screen. The pop-up display function can be set on/off. (→P. 636)

■ Liquid crystal display

Small spots or light spots may appear on the display. This phenomenon is characteristic of liquid crystal displays, and there is no problem continuing to use the display.

■ Customization

The meter display can be customized on the multi-information display. (Customizable features: →P. 631)



WARNING

■ The information display at low temperatures

Allow the interior of the vehicle to warm up before using the liquid crystal information display. At extremely low temperatures, the information display monitor may respond slowly, and display changes may be delayed. For example, there is a lag between the driver's shifting and the new gear number appearing on the display. This lag could cause the driver to downshift again, causing rapid and excessive engine braking and possibly an accident resulting in personal death or injury.



NOTICE

■ To prevent damage to the engine and its components

- When the tachometer is displayed, do not let the indicator needle of the tachometer enter the red zone, which indicates the maximum engine speed.
- The engine may be overheating if the engine coolant temperature gauge is in the red zone (H); or "Engine Coolant Temp High" or "Hybrid System Overheated" is shown on the multi-information display. In this case, immediately stop the vehicle in a safe place, and check the engine or hybrid system after it has cooled completely. (→P. 599)

Multi-information display

Display contents

The multi-information display presents the driver with a variety of vehicle data.

● **Menu icons**

Displays the following information when an icon is selected. (→P.103)
Some of the information may be displayed automatically depending on the situation.



Drive information

Select to display various drive data. (→P.103)



Navigation system-linked display

Select to display the following navigation system-linked information.

- Route guidance
- Compass display (north-up display/heading-up display)



Audio system-linked display (if equipped)

Select to enable selection of an audio source or track on the display using the meter control switches.



Dynamic radar cruise control (if equipped)/Dynamic radar cruise control with full-speed range (if equipped)/Cruise control (if equipped)

Select to display the dynamic radar cruise control/dynamic radar cruise control with full-speed range/cruise control information, when the system is used. (→P. 240, 253, 267)

The displayed icon changes depending on the system used.



LDA (Lane Departure Alert with steering control) [Vehicles without dynamic radar cruise control, dynamic radar cruise control with full-speed range, nor cruise control; Vehicles with LDA (Lane Departure Alert with steering control)]

If activated, the operational status of LDA (Lane Departure Alert with steering control) will also be displayed. (→P. 270)



Warning message display

Select to display warning messages and measures to be taken if a malfunction is detected. (→P. 572)



Settings display

Select to change the meter display settings. (→P. 636)

- **Energy monitor**
Displays the status of the hybrid system. (→P. 111)
- **Intuitive parking assist (if equipped)**
Automatically displayed when the system is used. (→P. 279)

Operating the meter control switches

The multi-information display is operated using the meter control switches.

- ① Select an item/change pages
- ② Enter/Set
- ③ Return to the previous screen
- ④ Press:
Displays the screen registered to



When no screen has been registered, the drive information screen will be displayed.

Press and hold:

Registers the currently displayed screen to (→P. 636)

The registration confirmation screen is displayed. If the selected screen cannot be registered, a registration failure message will be shown.

Drive information

Items displayed can be switched by pressing or of the meter control switches to select and pressing or .

- **Current fuel consumption*1**
Displays the current rate of fuel consumption
- **Average fuel consumption (after reset*2/after start/after refuel)*1**
Displays the average fuel consumption since the function was reset, the hybrid system was started, and the vehicle was refueled, respectively
Use the displayed average fuel consumption as a reference.

■ **Average vehicle speed (after reset^{*2}/after start)^{*1}**

Displays the average vehicle speed since the function was reset and the hybrid system was started, respectively

■ **Elapsed time (after reset^{*2}/after start)^{*1}**

Displays the elapsed time since the function was reset and the hybrid system was started, respectively

■ **Distance (driving range/after start)^{*1}**

Displays the estimated maximum distance that can be driven with the quantity of fuel remaining and the distance driven after the hybrid system was started respectively.

- This distance is computed based on your average fuel consumption. As a result, the actual distance that can be driven may differ from that displayed.
- When only a small amount of fuel is added to the tank, the display may not be updated.

When refueling, turn the power switch off. If the vehicle is refueled without turning the power switch off, the display may not be updated.

■ **Energy monitor**

→P. 111

■ **Tire inflation pressure**

Displays inflation pressure of each tire.

The inflation pressure of the spare tire will not be displayed.

■ **Display off**

A blank screen is displayed

^{*1}: Displayed when the item is set in "Drive Info 1" or "Drive Info 2". (→P. 636)

^{*2}: The function can be reset by pressing the  of the meter control switches for longer than 1 second when the item to reset is displayed.

If there is more than one item that can be reset, the item selection screen will appear.

■ **Suspension of the settings display**

In the following situations, the settings display using the meter control switches will be suspended.

- When a warning message appears on the multi-information display
- When the vehicle begins to move

■ **Tire inflation pressure**

- It may take a few minutes to display the tire inflation pressure after the power switch is turned to ON mode. It may also take a few minutes to display the tire inflation pressure after inflation pressure has been adjusted.
- “---” may be displayed if the tire information cannot be determined due to unfavorable radio wave conditions.
- Tire inflation pressure changes with temperature. The displayed values may also be different from the values measured using a tire pressure gauge.

■ **When disconnecting and reconnecting 12-volt battery terminals**

The drive information will be reset.

■ **Liquid crystal display**

→P.101

 **WARNING**

■ **Cautions during setting up the display**

As the hybrid system needs to be operating during setting up the display, ensure that the vehicle is parked in a place with adequate ventilation. In a closed area such as a garage, exhaust gases including harmful carbon monoxide (CO) may collect and enter the vehicle. This may lead to death or a serious health hazard.

 **NOTICE**

■ **The multi-information display at low temperatures**

Allow the interior of the vehicle to warm up before using the liquid crystal information display. At extremely low temperatures, the information display monitor may respond slowly, and display changes may be delayed.

■ **During setting up the display**

To prevent 12-volt battery discharge, ensure that the hybrid system is operating while setting up the display features.

Head-up display*

Summary of functions

The head-up display can be used to project vehicle speed and other information onto the windshield.

- ① Head-up display
Display brightness will change automatically according to the brightness of the surrounding area.
- ② Display position adjustment switch
- ③ Display brightness adjustment switch
Display brightness can be adjusted to the desired level.
- ④ "HUD" button
- ⑤ "DISP" button



Head-up display contents

- Vehicle speed
- Hybrid System Indicator (→P.108)
- Tachometer
- Shift position and shift range
Displays the selected shift position or selected shift range (→P. 208)
- Audio display
Displays audio information for approximately 3 seconds when the audio system is operated
- Route guidance display (vehicles with navigation system) (→P.109)
When approaching an intersection while the navigation system is giving route guidance, an arrow will automatically be displayed to indicate the direction of travel.
- Lane departure warning display (LDA [Lane Departure Alert with steering control]) (if equipped) (→P. 270)

*: If equipped

- Approach warning display (dynamic radar cruise control)
(if equipped) (→P. 240, 253)
- Pre-collision warning message (pre-collision system)
(if equipped) (→P. 310)
- Speed limit display (vehicles with navigation system) (→P. 109)

Switching the head-up display

■ “HUD” button

Pressing the switch turns the head-up display on/off and changes the vehicle speed display units as follows:

- ▶ U.S.A.
OFF→ON (MPH) →
ON (km/h)→OFF
- ▶ Canada
OFF→ON (km/h)→ON (MPH)→OFF

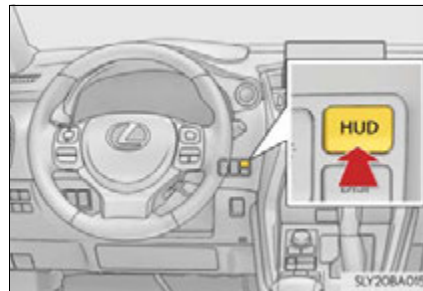

■ “DISP” button

Pressing the button changes the display items (except vehicle speed).

- ① Off
- ② Hybrid System Indicator
- ③ Tachometer

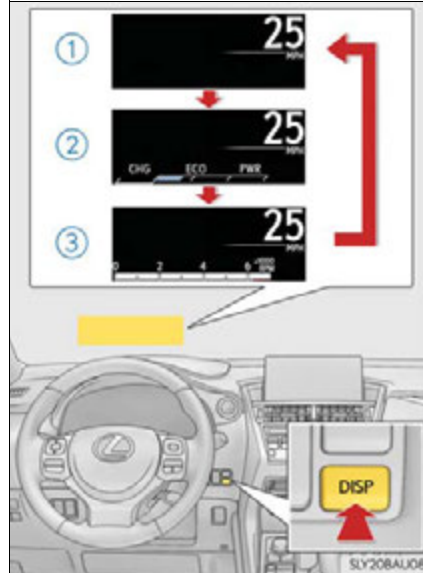

2
Instrument cluster

Making the display easier to see

■ Adjusting the display position

- ① Higher
- ② Lower

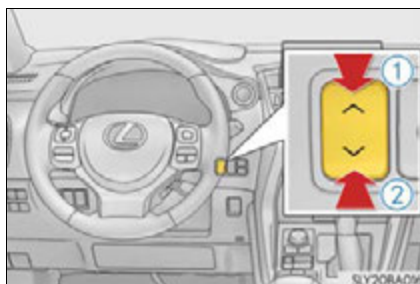

■ Setting the brightness

The brightness of the display is automatically adjusted in accordance with the brightness of the surrounding environment. However, the brightness can also be manually adjusted in 9 stages.

- ① Brighter
- ② Darker



Hybrid System Indicator

- ① Charge area
Shows regenerative charging.
- ② Hybrid Eco area
Shows that gasoline engine power is not being used very often.
The gasoline engine will automatically stop and restart under various conditions.
- ③ Eco area
Shows that the vehicle is being driven in an Eco-friendly manner.
- ④ Power area
Shows that an Eco-friendly driving range is being exceeded (during full power driving, etc.)

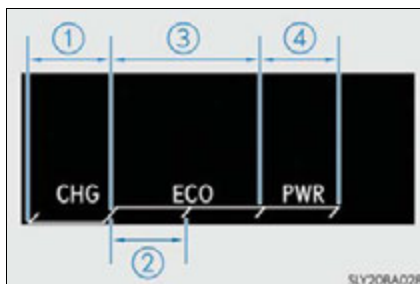

Route guidance display (vehicles with navigation system)

When the vehicle approaches an intersection, the direction the vehicle should go is guided by the arrow. When the vehicle approaches an intersection, the route guidance will start and the distance* to the intersection will also be displayed.

*: The distance indication will disappear when the vehicle passes through the intersection.

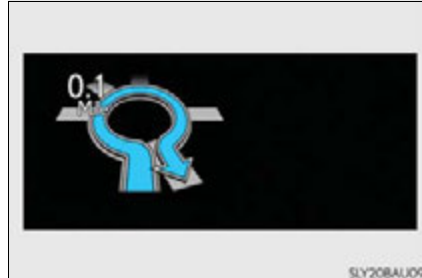

2

Speed limit display (vehicles with navigation system)

Displays the speed limit for the current road.

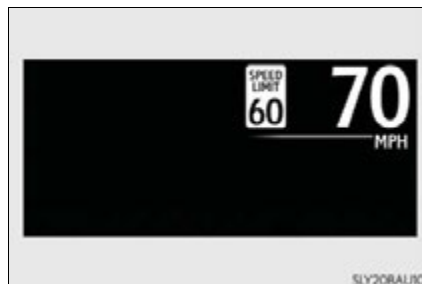

Instrument cluster

Display customization

The audio display and speed limit display can be shown or hidden.

When customizing vehicle features, ensure that the vehicle is parked in a safe place with the shift lever in P and the parking brake set.

- 1 Until the screen changes, continue pressing the "DISP" button, and it will repeat until the item desired to be changed is displayed.

Customization can be performed when the head-up display is on.

- 2 Press the "DISP" button to switch between on and off.



On and off will be switched between each time the button is pressed.

If the button is left alone without being operated for a short time, setting will be finished automatically.

■ Head-up display

- The head-up display may seem dark and hard to see when viewed through sunglasses, especially polarized sunglasses.
Adjust the brightness of the head-up display or remove your sunglasses.
- When the head-up display is turned off, it will not display anything until it is turned on again.

■ When the 12-volt battery is disconnected

The customize settings of the head-up display will be reset.

⚠ WARNING**■ Before using the head-up display**

Check that the position and brightness of the head-up display image does not interfere with safe driving. Incorrect adjustment of the image's position or brightness may obstruct the driver's view and lead to an accident, resulting in death or serious injury.

⚠ NOTICE**■ To prevent damage to components**

- Do not place any drinks near the head-up display projector. If the projector gets wet, electrical malfunctions may result.
- Do not place anything on or put stickers onto the head-up display projector.
Doing so could interrupt head-up display indications.
- Do not touch the inside of the head-up display projector or thrust sharp edges or the like into the projector.
Doing so could cause mechanical malfunctions.

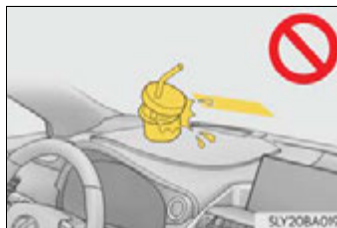

Energy monitor/consumption screen

You can view the status of your hybrid system on the multi-information display and the navigation system (if equipped)/Lexus Display Audio system (if equipped).

- ① Multi-information display
- ② Navigation system screen/Lexus Display Audio screen (if equipped)
- ③ "DISP" switch/Meter control switches
 - ▶ Vehicles with a navigation system
- ④ "MENU" button
- ⑤ Touchpad*
 - ▶ Vehicles with a Lexus Display Audio system
- ⑥ "MENU" button
- ⑦ Lexus Display Audio controller (→P. 338)

*: For use of the Remote Touch, refer to "NAVIGATION SYSTEM OWNER'S MANUAL".

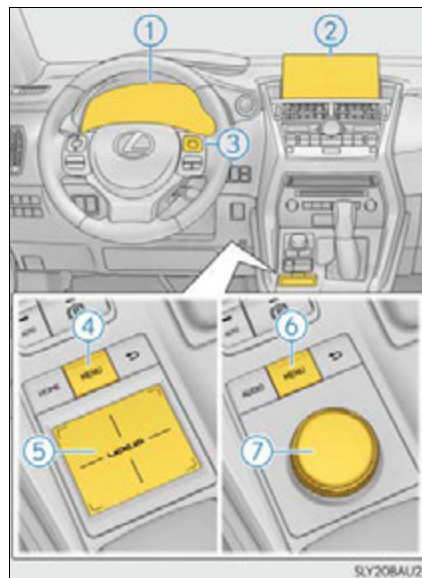

2

Instrument cluster

Energy monitor

▶ Navigation system screen

Press the “MENU” button on the Remote Touch, then select “Info” on the “Menu” screen, and then select “Fuel Consumption”.

If the “Trip Information” or “Past Record” screen is displayed, select “Energy”.



▶ Lexus Display Audio screen

Press the “MENU” button on the Lexus Display Audio controller, then select “Info” on the “Menu” screen, and then select “Fuel Consumption”.







If the “Energy Monitor” screen does not appear, move the controller to the right and select “Energy”.

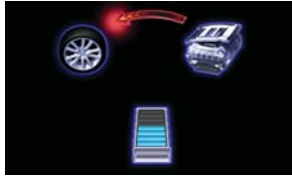

▶ Multi-information display

Press **<** or **>** of the meter control switches and select **i**, and then **^** or **v** to select the energy monitor display.

	Navigation system screen or Lexus Display Audio screen	Multi-information display
When the vehicle is powered by the electric motor (traction motor)		
When the vehicle is powered by both the gasoline engine and the electric motor (traction motor)		

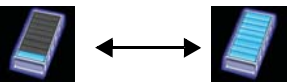
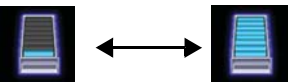
	Navigation system screen or Lexus Display Audio screen	Multi-information display
When the vehicle is powered by the gasoline engine		
When the vehicle is charging the hybrid battery (traction battery)		
		
When there is no energy flow		
Hybrid battery (traction battery) status	<p>Low Full</p> 	<p>Low Full</p> 

These images are examples only, and may vary slightly from actual conditions.

Fuel consumption (vehicles with a navigation system or Lexus Display Audio system)

■ Trip information

- ▶ Navigation system screen

Press the “MENU” button on the Remote Touch, then select “Info” on the “Menu” screen, and then select “Fuel Consumption”.

If the “Energy Monitor” or “Past Record” screen is displayed, select “Trip Information”.

- ① Resetting the consumption data
- ② Fuel consumption in the past 15 minutes
- ③ Current fuel consumption
- ④ Regenerated energy in the past 15 minutes

One symbol indicates 50 Wh. Up to 5 symbols are shown.



- ⑤ Average vehicle speed since the hybrid system was started.
- ⑥ Elapsed time since the hybrid system was started.
- ⑦ Cruising range (→P. 116)

► Lexus Display Audio screen

Press the “MENU” button on the Lexus Display Audio controller, then select “Info” on the “Menu” screen, and then select “Fuel Consumption”.

If the “Trip Information” screen does not appear, move the controller to the right and select “Trip Information”.

- ① Fuel consumption in the past 15 minutes
- ② Current fuel consumption
- ③ Regenerated energy in the past 15 minutes
- ④ Average vehicle speed since the hybrid system was started.
- ⑤ Elapsed time since the hybrid system was started.
- ⑥ Cruising range (→P. 116)



One symbol indicates 50 Wh. Up to 5 symbols are shown.

Average fuel consumption for the past 15 minutes is divided by color into past averages and averages attained since the power switch was last turned to ON mode. Use the displayed average fuel consumption as a reference.

The image is an example only, and may vary slightly from actual conditions.

■ Past record

► Navigation system screen

Press the “MENU” button on the Remote Touch, then select “Info” on the “Menu” screen, and then select “Fuel Consumption”.

If the “Energy Monitor” or “Trip Information” screen is displayed, select “Past Record”.

- ① Resetting the past record data
- ② Best recorded fuel consumption
- ③ Average fuel consumption
- ④ Previous fuel consumption record
- ⑤ Updating the average fuel consumption data



- ▶ Lexus Display Audio screen

Press the “MENU” button on the Lexus Display Audio controller, then select “Info” on the “Menu” screen, and then select “Fuel Consumption”.

If the “Past Record” screen does not appear, move the controller to the right and select “Past Record”.

- ① Previous fuel consumption record
- ② Current fuel consumption
- ③ Best recorded fuel consumption



The average fuel consumption history is divided by color into past averages and the average fuel consumption since the last updated. Use the displayed average fuel consumption as a reference.

The image is an example only, and may vary slightly from actual conditions.

■ Updating the past record data

- ▶ Vehicles with a navigation system

Update the average fuel consumption by selecting “Update” to measure the current fuel consumption again.

- ▶ Vehicles with a Lexus Display Audio system

Update the average fuel consumption by moving the controller to the left and select “Update” to measure the current fuel consumption again.

■ Resetting the data

- ▶ Vehicles with a navigation system

The fuel consumption data can be deleted by selecting “Clear”.

- ▶ Vehicles with a Lexus Display Audio system

The fuel consumption data can be deleted by moving the controller to the left and select “Clear”.

■ Cruising range

Displays the estimated maximum distance that can be driven with the quantity of fuel remaining.

This distance is computed based on your average fuel consumption.

As a result, the actual distance that can be driven may differ from that displayed.

3-1. Key information	
Keys	118
3-2. Opening, closing and locking the doors	
Side doors	124
Back door	129
Smart access system with push-button start	140
3-3. Adjusting the seats	
Front seats	146
Rear seats	147
Driving position memory	154
Head restraints	158
3-4. Adjusting the steering wheel and mirrors	
Steering wheel	160
Inside rear view mirror	161
Outside rear view mirrors	163
3-5. Opening, closing the windows and moon roof	
Power windows	166
Moon roof	169

Keys

The keys

The following keys are provided with the vehicle.

- ① Electronic keys
 - Operating the smart access system with push-button start (→P. 140)
 - Operating the wireless remote control function
- ② Mechanical keys
- ③ Key number plate
- ④ Card key (electronic key) (if equipped)
 - Operating the smart access system with push-button start (→P. 140)

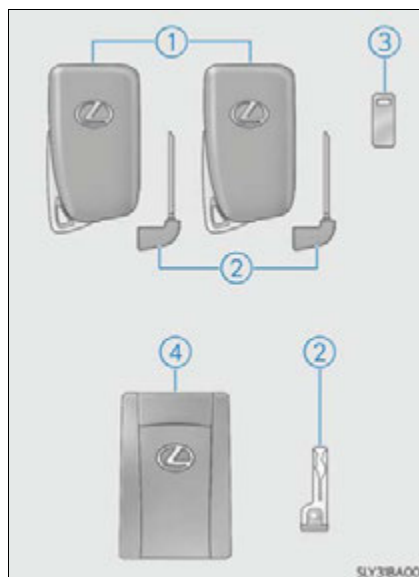

Wireless remote control

- ① Locks all the doors (→P. 124)
- ② Unlocks all the doors (→P. 124)
- ③ Opens the windows and moon roof^{*1, 2} (→P. 124)
- ④ Opens and closes the power back door^{*1} (→P. 129)
- ⑤ Sounds the alarm (→P. 119)

*1: If equipped

*2: This setting must be customized at your Lexus dealer.

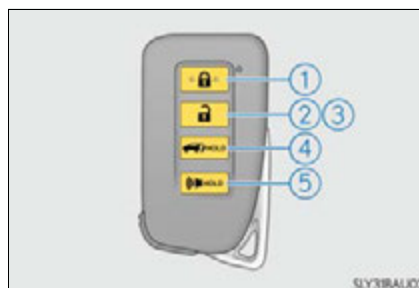

Using the mechanical key

To take out the mechanical key, push the release button and take the key out.

The mechanical key can only be inserted in one direction, as the key only has grooves on one side. If the key cannot be inserted in a lock cylinder, turn it over and re-attempt to insert it.

After using the mechanical key, store it in the electronic key. Carry the mechanical key together with the electronic key. If the electronic key battery is depleted or the entry function does not operate properly, you will need the mechanical key. (→P. 591)

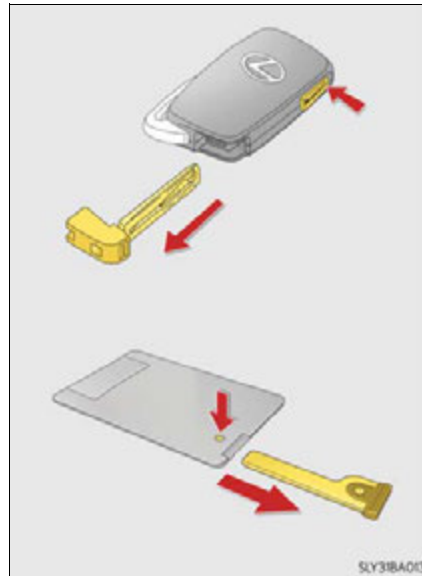

■ Panic mode

When **HOLD** is pressed for longer than about 1 second, an alarm will sound intermittently and the vehicle lights will flash to deter any person from trying to break into or damage your vehicle.

To stop the alarm, press any button on the electronic key.



3

Operation of each component

■ **Card key (if equipped)**

- The mechanical key that is stored inside the card key should be used only if a problem arises, such as when the card key does not operate properly.
- If it is difficult to take out the mechanical key, push down the release button using a pen tip, etc. If it is still difficult to pull it out, use a coin, etc.
- To store the mechanical key in the card key, insert it while pressing the release button.

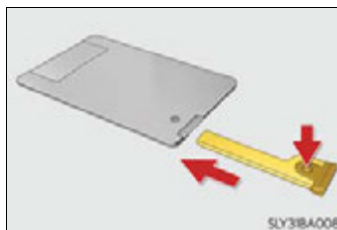

- If the battery cover is not installed and the battery falls out or if the battery was removed because the key got wet, reinstall the battery with the positive terminal facing the Lexus emblem.

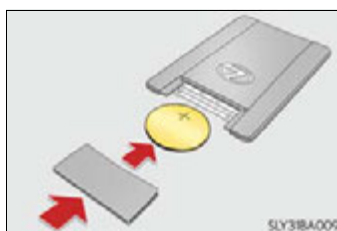

- The card key is not waterproof.

■ **When required to leave the vehicle's key with a parking attendant**

Lock the glove box as circumstances demand. (→P. 447)
Remove the mechanical key for your own use and provide the attendant with the electronic key only.

■ **If you lose your mechanical keys**

New genuine mechanical keys can be made by your Lexus dealer using another mechanical key and the key number stamped on your key number plate. Keep the plate in a safe place such as your wallet, not in the vehicle.

■ **When riding in an aircraft**

When bringing an electronic key onto an aircraft, make sure you do not press any buttons on the electronic key while inside the aircraft cabin. If you are carrying an electronic key in your bag, etc., ensure that the buttons are not likely to be pressed accidentally. Pressing a button may cause the electronic key to emit radio waves that could interfere with the operation of the aircraft.

■ Electronic key battery depletion

- The standard battery life is 1 to 2 years. (The card key battery life is about a year and a half.)
- If the battery becomes low, an alarm will sound in the cabin when the hybrid system stops.
- As the electronic key always receives radio waves, the battery will become depleted even if the electronic key is not used. The following symptoms indicate that the electronic key battery may be depleted. Replace the battery when necessary. (→P. 532)
 - The smart access system with push-button start or the wireless remote control does not operate.
 - The detection area becomes smaller.
 - The LED indicator on the key surface does not turn on.
- To avoid serious deterioration, do not leave the electronic key within 3 ft. (1 m) of the following electrical appliances that produce a magnetic field:
 - TVs
 - Personal computers
 - Cellular phones, cordless phones and battery chargers
 - Recharging cellular phones or cordless phones
 - Induction cookers
 - Table lamps

■ Replacing the battery

→P. 532

■ Confirmation of the registered key number

The number of keys already registered to the vehicle can be confirmed. Ask your Lexus dealer for details.

■ If a wrong key is used

The key cylinder rotates freely to isolate inside mechanism.

 NOTICE**■ To prevent key damage**

- Do not drop the keys, subject them to strong shocks or bend them.
- Do not expose the keys to high temperatures for long periods of time.
- Do not get the keys wet or wash them in an ultrasonic washer, etc.
- Do not attach metallic or magnetic materials to the keys or place the keys close to such materials.
- Do not disassemble the keys.
- Do not attach a sticker or anything else to the surface of the electronic key.
- Do not place the keys near objects that produce magnetic fields, such as TVs, audio systems and induction cookers, or medical electrical equipment, such as low-frequency therapy equipment.

■ Carrying the electronic key on your person

Carry the electronic key 3.9 in. (10 cm) or more away from electric appliances that are turned on. Radio waves emitted from electric appliances within 3.9 in. (10 cm) of the electronic key may interfere with the key, causing the key to not function properly.

■ In case of a smart access system with push-button start malfunction or other key-related problems

Take your vehicle with all the electronic keys provided with your vehicle, including the card key, to your Lexus dealer.

■ When an electronic key is lost

If the electronic key remains lost, the risk of vehicle theft increases significantly. Visit your Lexus dealer immediately with all remaining electronic keys and the card key that were provided with your vehicle.

 NOTICE

■ Handling the card key

- Do not apply excess force when inserting the mechanical key into the card key. Doing so may damage the card key.
- If the battery or card key terminals get wet, the battery may corrode and the card key may stop working.
If the key is dropped into water, or if drinking water, etc., is spilled on the key, immediately remove the battery cover and wipe the battery and terminals. (To remove the battery cover, lightly grasp and pull it.) If the battery is corroded, have your Lexus dealer replace the battery.
- Do not crush the battery cover or use a screwdriver to remove the battery cover. Forcibly removing the battery cover may bend or damage the key.
- If the battery cover is frequently removed, the battery cover may become loose.
- When installing the battery, make sure to check the direction of the battery. Installing the battery in the wrong direction may cause the battery to deplete rapidly.
- The surface of the card key may be damaged, or its coating may peel off in the following situations:
 - The card key is carried together with hard objects, such as coins and keys.
 - The card key is scraped with a sharp object, such as the tip of a mechanical pencil.
 - The surface of the card key is wiped with thinner or benzene.

Side doors

The vehicle can be locked and unlocked using the entry function, wireless remote control or door lock switch.

Locking and unlocking the doors from the outside

◆ Smart access system with push-button start

Carry the electronic key to enable this function.

- ① Grip the driver's door handle to unlock the door. Grip any passenger door handle to unlock all the doors.*

Make sure to touch the sensor on the back of the handle.

The doors cannot be unlocked for 3 seconds after the doors are locked.

*: The door unlock settings can be changed. (→P.127, 633)

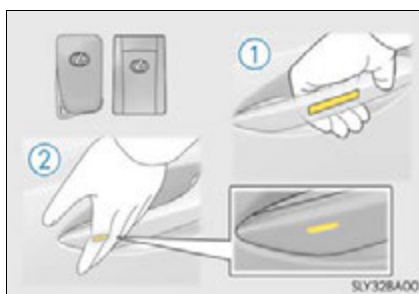

- ② Touch the lock sensor (the indentation on the surface of the door handle) to lock all the doors.

Check that the door is securely locked.

◆ Wireless remote control

- ① Locks all the doors

Check that the door is securely locked.

- ② Unlocks all the doors

Pressing the button unlocks the driver's door. Pressing the button again within 3 seconds unlocks the other doors.

Press and hold to open the windows and moon roof*^{1,2}

*¹: If equipped

*²: This setting must be customized at your Lexus dealer.



■ Operation signals

Doors:

A buzzer sounds and the emergency flashers flash to indicate that the doors have been locked/unlocked. (Locked: Once; Unlocked: Twice)

Windows:

A buzzer sounds to indicate that all windows are opening.

■ Security feature

If a door is not opened within approximately 60 seconds after the vehicle is unlocked, the security feature automatically locks the vehicle again.

■ Welcome light illumination control

The side marker, parking, tail and license plate lights automatically turn on at night when the doors are unlocked using the entry function or wireless remote control if the light switch is in the "AUTO" position.

■ When the door cannot be locked by the lock sensor on the surface of the door handle

When the door cannot be locked even if the lock sensor on the surface of the door handle is touched by a finger, touch the lock sensor with the palm.

When gloves are being worn, remove the gloves.



■ Door lock buzzer

If an attempt to lock the doors is made when a door is not fully closed, a buzzer sounds continuously for 5 seconds. Fully close the door to stop the buzzer, and lock the vehicle once more.

■ Setting the alarm

Locking the doors will set the alarm system. (→P. 88)

■ If the smart access system with push-button start or the wireless remote control does not operate properly

- Use the mechanical key to lock and unlock the doors. (→P. 591)
- Replace the key battery with a new one if it is depleted. (→P. 532)

Locking and unlocking the doors from the inside

◆ Door lock switch

- ① Locks all the doors
- ② Unlocks all the doors

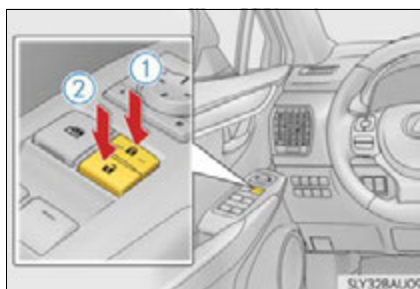

◆ Inside lock buttons

- ① Locks the door
- ② Unlocks the door

The front doors can be opened by pulling the inside handle even if the lock buttons are in the lock position.

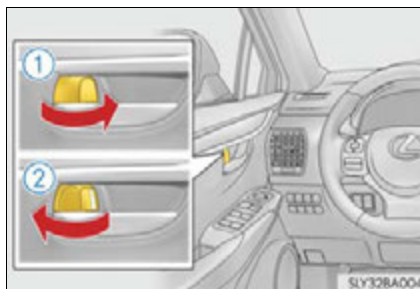

Locking the doors from the outside without a key

- 1 Move the inside lock button to the lock position.
- 2 Close the door.

The door cannot be locked if the power switch is in ACCESSORY or ON mode, or the electronic key is left inside the vehicle.

The key may not be detected correctly and the door may be locked.

Rear door child-protector lock

The door cannot be opened from inside the vehicle when the lock is set.

- ① Unlock
- ② Lock

These locks can be set to prevent children from opening the rear doors. Push down on each rear door switch to lock both rear doors.

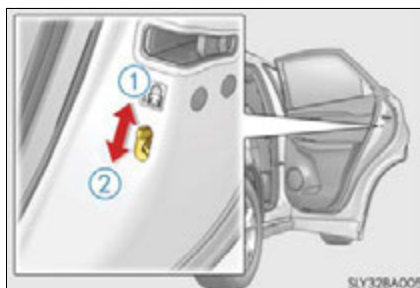

Automatic door locking and unlocking systems





The following functions can be set or canceled:

For instructions on customizing, refer to P. 632.



Function	Operation
Speed linked door locking function	All doors are automatically locked when vehicle speed is approximately 12 mph (20 km/h) or higher.
Shift position linked door locking function	All doors are automatically locked when shifting the shift lever out of P.
Shift position linked door unlocking function	All doors are automatically unlocked when shifting the shift lever to P.
Driver's door linked door unlocking function	All doors are automatically unlocked when driver's door is opened.

■ Switching the door unlock function

It is possible to set which doors the entry function unlocks using the wireless remote control.

- 1 Turn the power switch off.
- 2 When the indicator light on the key surface is not on, press and hold  ,  or  for approximately 5 seconds while pressing and holding .

The setting changes each time an operation is performed, as shown below. (When changing the setting continuously, release the buttons, wait for at least 5 seconds, and repeat step [2](#).)

Multi-information display	Unlocking function	Beep
	Holding the driver's door handle unlocks only the driver's door.	Exterior: Beeps 3 times Interior: Pings once
	Holding any of the passenger door handles unlocks all the doors.	
	Holding a door handle unlocks all the doors.	Exterior: Beeps twice Interior: Pings once

For vehicles with an alarm: To prevent unintended triggering of the alarm, unlock the doors using the wireless remote control and open and close a door once after the settings have been changed. (If a door is not opened within 60 seconds after  is pressed, the doors will be locked again and the alarm will automatically be set.)

In a case that the alarm is triggered, immediately stop the alarm. (→P. 88)

■ **Impact detection door lock release system**

In the event that the vehicle is subject to a strong impact, all the doors are unlocked. Depending on the force of the impact or the type of accident, however, the system may not operate.

■ **Using the mechanical key**

The doors can also be locked and unlocked with the mechanical key. (→P. 591)

■ **Open door warning buzzer**

If the vehicle speed reaches 3 mph (5 km/h), the master warning light flashes and a buzzer sounds to indicate that door(s) or the hood is not fully closed. The open door(s) or hood is displayed on the multi-information display.

■ **Conditions affecting the operation of the smart access system with push-button start or wireless remote control**

→P. 142

■ **Customization**

Settings (e.g. unlocking function using a key) can be changed. (Customizable features: →P. 631)

 **WARNING**

■ **To prevent an accident**

Observe the following precautions while driving the vehicle. Failure to do so may result in a door opening and an occupant falling out, resulting in death or serious injury.

● Ensure that all doors are properly closed and locked.

● Do not pull the inside handle of the doors while driving.

Be especially careful for the front doors, as the doors may be opened even if the inside lock buttons are in locked position.

● Set the rear door child-protector locks when children are seated in the rear seats.

■ **When opening or closing a door**

Check the surroundings of the vehicle such as whether the vehicle is on an incline, whether there is enough space for a door to open and whether a strong wind is blowing. When opening or closing the door, hold the door handle tightly to prepare for any unpredictable movement.

Back door

The back door can be locked/unlocked and opened/closed by the following procedures.

Locking and unlocking the back door

◆ Smart access system with push-button start

Carry the electronic key to enable this function.

- ① Locks all the doors
Check that the door is securely locked.
- ② Unlocks all the doors
The doors cannot be unlocked for 3 seconds after the doors are locked.

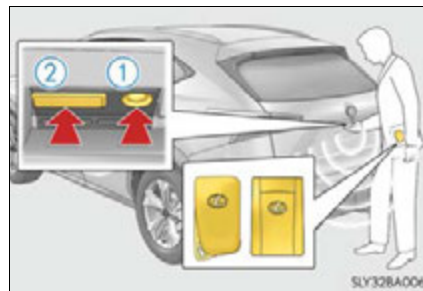

◆ Wireless remote control

→P. 124

◆ Door lock switch

→P. 126

Opening/closing the back door with the wireless remote control (vehicles with a power back door)

Press the switch for 1 second.

With the customization feature, it can be set up so that it can operate even when the back door is unlocked. (→P. 634)



Opening/closing the back door from inside the vehicle (vehicles with a power back door)

Press the switch for 1 second.

A buzzer sounds and the back door automatically opens and closes.

Pressing the switch while the back door is opening/closing stops the operation.

When the switch is pressed again for 1 second during the halted operation, the back door will perform the reverse operation.



Opening the back door from outside the vehicle

■ Back door opener

- ▶ Vehicles without a power back door

Raise the back door while pressing up the back door opener switch.

- ▶ Vehicles with a power back door

When the back door is unlocked: Press the back door opener switch.

When the back door is locked:

While carrying the electronic key on your person, press the back door opener switch.

A buzzer sounds and the back door automatically opens.

Pressing the switch while the back door is opening stops the operation.

■ Wireless remote control (vehicles with a power back door)

→P. 129

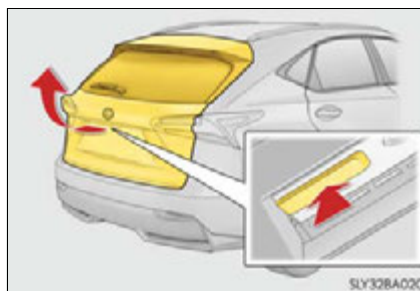

Closing the back door from outside the vehicle (vehicles with a power back door)

Pressing the switch.

A buzzer sounds and the back door automatically closes.

Pressing the switch while the back door is closing stops the operation. Pressing the switch again will reverse the operation.

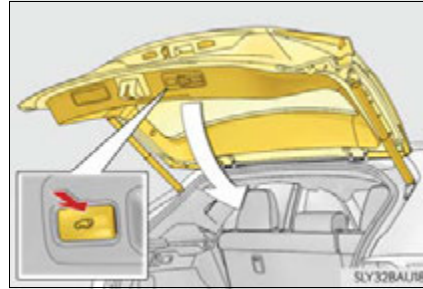

When closing the back door

- ▶ Vehicles without a power back door

Lower the back door using the back door handle, and make sure to push the back door down from the outside to close it.

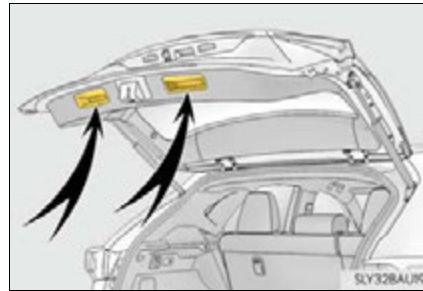

- ▶ Vehicles with a power back door

Lower the back door using the back door handle, then a buzzer sounds and the back door automatically closes.

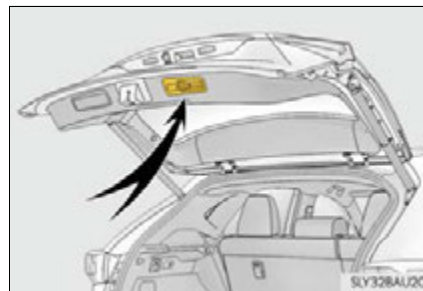





3

Operation of each component

Canceling the power back door system (vehicles with a power back door)

ON (operate) and OFF (stop) can be switched between by the “settings display” (→P.102) of the multi-information display.

- 1 Pressing  or  of the meter control switches (→P.103), selects .
- 2 ON and OFF will be switched over with presses of  on the meter control switch.

When OFF is selected and the operations of the power back door is made to stop, select  and turn ON from the “settings display” of multi-information display, and unless it is put in a system operating state, the operation of the power back door will not return. (No return in the power switch operation)

Adjusting the open position of the back door (vehicles with a power back door)

The open position of the power back door can be adjusted.

- ▶ When setting with the  switch

- 1 Stop the back door in the desirable position. (→P.130, 131)
- 2 Press and hold the power back door switch on the back door for 2 seconds.
 - When the settings are completed, the buzzer sounds 4 times.
 - When opening the back door the next time, the back door will stop at that position.

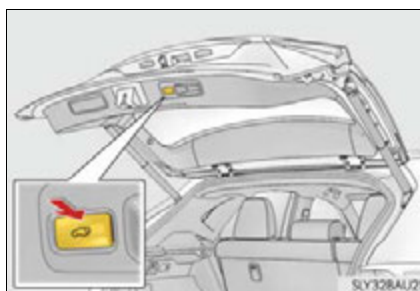

- ▶ When setting by the navigation system

The opening position can be set with the navigation system. (→P.639)

Priority for the stop position is given to the last position set by either the  switch or with navigation system.

To return the adjusted open position to the initial settings position. (→P.134)

■ Power back door operating conditions (vehicles with a power back door)

With the power back door operations set to ON, it can automatically open and close for the following conditions:

- When the electronic key is being carried and the power back door switch is pushed*
- When the wireless remote control is used*
- When the power switch is in ON mode, in addition to the above for the opening operations, the back door operates for any of the following conditions:
 - Parking brake is engaged
 - The brake pedal is depressed
 - The shift lever is in P

*: When configured with the customization function so that it can be operated after being unlocked, operate the back door after it has been unlocked.

■ Luggage compartment light

The luggage compartment light turns on when the back door is opened with the luggage compartment light switch on.

- ① Off
- ② On

When the power switch is turned off, the light will go off automatically after 20 minutes.

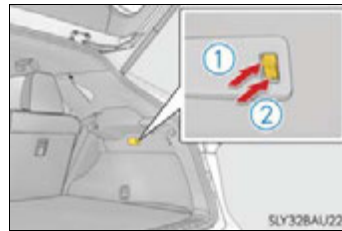

■ If the back door opener is inoperative

The back door can be unlocked from the inside.

- 1 Remove the cover.

To protect the cover, place a rag between the flathead screwdriver and the cover as shown in the illustration.

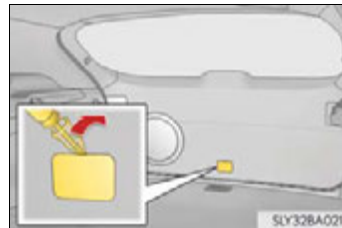

- 2 Move the lever.

▶ Vehicles without a power back door

▶ Vehicles with a power back door

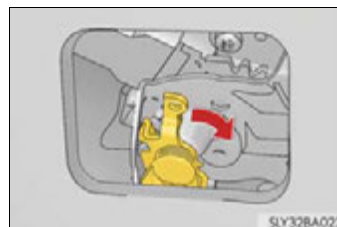
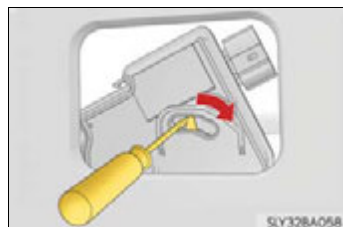

■ **Back door closer (vehicles with a power back door)**

In the event that the back door is left slightly open, the back door closer will automatically close it to the fully closed position.

Whatever the state of the power switch, the back door closer operates.

■ **Operation of the power back door (vehicles with a power back door)**

- A buzzer sounds and the emergency flashers flash twice to indicate that the back door is opening/closing.
- When the power back door operations are OFF, the power back door does not operate but it can be opened and closed by hand.
- When the power back door automatically opens, if an abnormality due to people or objects is detected, operation will stop.

■ **Back door reserve lock function (vehicles with a power back door)**

This function is a function which reserves locking of all doors, beforehand, when the back door is open. When the follow is done, all the doors except the back door are locked and then back door will also be locked at the same time it is closed.

- 1 Close all doors, except the back door.
- 2 Push the wireless lock button during the automatic closing operation of the back door.

■ **When reconnecting the 12-volt battery (vehicles with a power back door)**

To enable the power back door to operate properly, close the back door manually.

■ **Jam protection function (vehicles with a power back door)**

Sensors are installed in the right and left sides of the power back door. When the door is automatically closing and the sensors are pushed due to an object being clamped, etc., the jam protection function operates.

From that position the door automatically moves a little in the opposite direction and then the function stops.

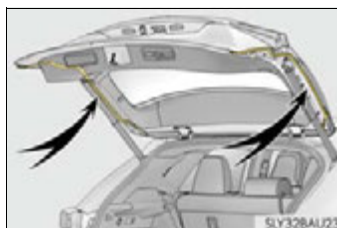

■ **Returning the back door automatic stop position to the initial settings (vehicles with a power back door)**

Press and hold the power back door switch on the back door for 7 seconds.

After the buzzer sounds 4 times, it sounds twice more. When the power back door does the opening operation the next time, the door will open to the initial settings position.

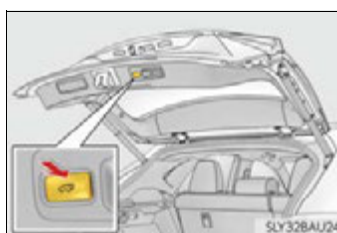

■ **Customization (vehicles with a power back door)**

Settings (e.g. back door automatic open and stop position) can be changed. (Customizable features: →P. 639)

 **WARNING****■ Caution while driving**

- Keep the back door closed while driving.
If the back door is left open, it may hit nearby objects while driving or luggage may be unexpectedly thrown out, causing an accident.
In addition, exhaust gases may enter the vehicle, causing death or a serious health hazard. Make sure to close the back door before driving.
- Before driving the vehicle, make sure that the back door is fully closed. If the back door is not fully closed, it may open unexpectedly while driving, causing an accident.
- Never let anyone sit in the luggage compartment. In the event of sudden braking, sudden swerving or a collision, they are susceptible to death or serious injury.

■ When children are in the vehicle

Observe the following precautions.

Failure to do so may result in death or serious injury.

- Do not allow children to play in the luggage compartment.
If a child is accidentally locked in the luggage compartment, they could have heat exhaustion or other injuries.
- Do not allow a child to open or close the back door.
Doing so may cause the back door to move unexpectedly, or cause the child's hands, head, or neck to be caught by the closing back door.

⚠ WARNING

■ **Operating the back door**

Observe the following precautions.

Failure to do so may cause parts of the body to be caught, resulting in death or serious injury.

- Remove any heavy loads, such as snow and ice, from the back door before opening it. Failure to do so may cause the back door to suddenly shut again after it is opened.
- When opening or closing the back door, thoroughly check to make sure the surrounding area is safe.
- If anyone is in the vicinity, make sure they are safe and let them know that the back door is about to open or close.
- Use caution when opening or closing the back door in windy weather as it may move abruptly in strong wind.

- Vehicles without a power back door: The back door may suddenly shut if it is not opened fully. It is more difficult to open or close the back door on an incline than on a level surface, so beware of the back door unexpectedly opening or closing by itself. Make sure that the back door is fully open and secured before using the luggage compartment.



- Vehicles with a power back door: The back door may suddenly shut if it is not opened fully, while on a steep incline. Make sure that the back door is secured before using the luggage compartment.

- When closing the back door, take extra care to prevent your fingers, etc., from being caught.
- When closing the back door, make sure to press it lightly on its outer surface. If the back door handle is used to fully close the back door, it may result in hands or arms being caught.

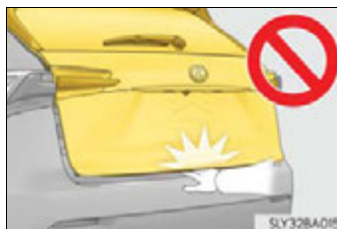

- Do not pull on the back door damper stay (vehicles without a power back door) (→P. 138) or back door spindle (vehicles with a power back door) (→P. 139) to close the back door, and do not hang on the back door damper stay (vehicles without a power back door) or back door spindle (vehicles with a power back door). Doing so may cause hands to be caught or the back door damper stay (vehicles without a power back door) or back door spindle (vehicles with a power back door) to break, causing an accident.
- If a bicycle carrier or similar heavy object is attached to the back door, it may suddenly shut closed again after being opened, causing someone's hands, head or neck to be caught and injured. When installing an accessory part to the back door, using a genuine Lexus part is recommended.

⚠ WARNING**■ Back door closer (vehicles with a power back door)**

- In the event that the back door is left slightly open, the back door closer will automatically close it to the fully closed position. It takes several seconds before the back door closer begins to operate. Be careful not to get fingers caught or anything else in the back door, as this may cause bone fractures or other serious injuries.



- Use caution when using the back door closer as it still operates when the power back door system is canceled.

■ Power back door (if equipped)

Observe the following precautions when operating the power back door. Failure to do so may cause death or serious injury.

- Check the safety of the surrounding area to make sure there are no obstacles or anything that could cause any of your belongings to get caught.
- If anyone is in the vicinity, make sure they are safe and let them know that the back door is about to open or close.
- If the power back door system is canceled while the back door is operating during automatic operation, the back door stops operating. Take extra care when on an incline, as the back door may open or close suddenly.
- If the operating conditions of the power back door are no longer met, a buzzer may sound and the back door may stop opening or closing. The back door then has to be operated manually. Take extra care in this situation, as the back door may move abruptly.
- On an incline, the back door may suddenly shut after it opens automatically. Make sure the back door is secured.
- In the following situations, the power back door may detect an abnormality and automatic operation may be stopped. In this case, the back door has to be operated manually. Take extra care in this situation, as the stopped back door may suddenly open or close, causing an accident.
 - When the back door contacts an obstacle
 - When the 12-volt battery voltage suddenly drops, such as when the power switch is turned to ON mode or the engine is started during automatic operation
- If a bicycle carrier or similar heavy object is attached to the back door, the power back door may not operate, causing itself to malfunction, or the back door may move slightly in the closing direction after being opened, causing someone's hands, head or neck to be caught and injured. When installing an accessory part to the back door, ask your Lexus dealer for details.

⚠ WARNING**■ Jam protection function (vehicles with a power back door)**

Observe the following precautions.

Failure to do so may cause death or serious injury.

- Never use any part of your body to intentionally activate the jam protection function.
- The jam protection function may not work if something gets caught just before the back door fully closes. Be careful not to get fingers caught or anything else.
- The jam protection function may not work depending on the shape of the object that is caught. Be careful not to catch fingers or anything else.

⚠ NOTICE**■ Back door damper stays (vehicles without a power back door)**

The back door is equipped with damper stays that hold the back door in place.

Observe the following precautions.

Failure to do so may cause damage to the back door damper stay, resulting in malfunction.

- Do not attach any foreign objects, such as stickers, plastic sheets, or adhesives to the damper stay rod.
- Do not touch the damper stay rod with gloves or other fabric items.
- Do not attach any accessories other than genuine Lexus parts to the back door.
- Do not place your hand on the damper stay or apply lateral forces to it.

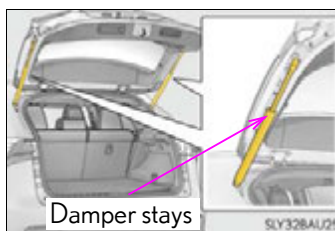

 NOTICE

■ **Back door spindles (vehicles with a power back door)**

The back door is equipped with spindles that hold the back door in place.

Observe the following precautions.

Failure to do so may cause damage to the back door spindle, resulting in malfunction.

- Do not attach any foreign objects, such as stickers, plastic sheets, or adhesives to the spindle rod.
- Do not touch the spindle rod with gloves or other fabric items.
- Do not attach heavy accessories to the back door. When attaching, ask your Lexus dealer for details.

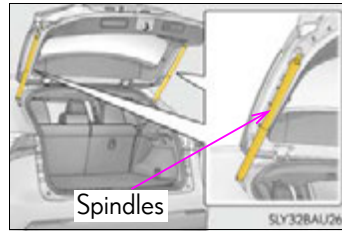

- Do not place your hand on the spindle or apply lateral forces to it.

■ **To prevent back door closer malfunction (vehicles with a power back door)**

Do not apply excessive force to the back door while the back door closer is operating.

■ **To prevent damage to the power back door (if equipped)**

- Make sure that there is no ice between the back door and frame that would prevent movement of the back door. Operating the power back door when excessive load is present on the back door may cause a malfunction.
- Do not apply excessive force to the back door while the power back door is operating.
- Take care not to damage the sensors (installed on the right and left edges of the power back door) with a knife or other sharp object. If the sensor is disconnected, the power back door will not close automatically.

Smart access system with push-button start

The following operations can be performed simply by carrying the electronic key (including the card key) on your person, for example in your pocket. The driver should always carry the electronic key.

- Locks and unlocks the doors (→P. 124)
- Locks and unlocks the back door (→P. 129)
- Starts and stops the hybrid system (→P. 201)

■ Antenna location

- ① Antennas outside the cabin
- ② Antennas inside the cabin
- ③ Antenna inside the luggage compartment
- ④ Antenna outside the luggage compartment

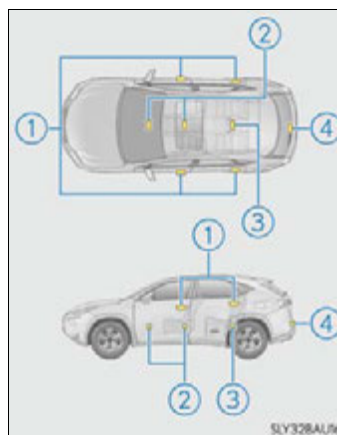

■ Effective range (areas within which the electronic key is detected)

- When locking or unlocking the doors
The system can be operated when the electronic key is within about 2.3 ft. (0.7 m) of an outside door handle. (Only the doors detecting the key can be operated.)
- When starting the hybrid system or changing power switch modes
The system can be operated when the electronic key is inside the vehicle.

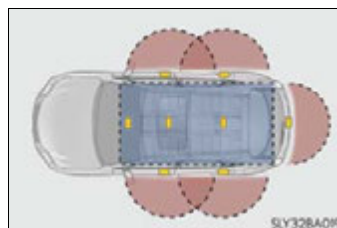

■ Alarms and warning messages

A combination of exterior and interior alarms as well as warning messages shown on the multi-information display are used to prevent theft of the vehicle and accidents resulting from erroneous operation. Take appropriate measures in response to any warning message on the multi-information display. (→P. 572)

The following table describes circumstances and correction procedures when only alarms are sounded.

Alarm	Situation	Correction procedure
Exterior alarm sounds once for 5 seconds	An attempt was made to lock the vehicle while a door was open.	Close all of the doors and lock the doors again.
Interior alarm pings repeatedly	The power switch was turned to ACCESSORY mode while the driver's door was open (The driver's door was opened when the power switch was in ACCESSORY mode).	Turn the power switch off and close the driver's door.

■ When "Smart Access System Malfunction See Owner's Manual" will be displayed on the multi-information display

The system may be malfunctioning. Have the vehicle inspected by your Lexus dealer immediately.



■ Battery-saving function

The battery-saving function will be activated in order to prevent the electronic key battery and the 12-volt battery from being discharged while the vehicle is not in operation for a long time.

- In the following situations, the smart access system with push-button start may take some time to unlock the doors.
 - The electronic key has been left in an area of approximately 6 ft. (2 m) of the outside of the vehicle for 10 minutes or longer.
 - The smart access system with push-button start has not been used for 5 days or longer.
- If the smart access system with push-button start has not been used for 14 days or longer, the doors cannot be unlocked at any doors except the driver's door. In this case, take hold of the driver's door handle, or use the wireless remote control or the mechanical key, to unlock the doors.

■ **Electronic Key battery-Saving Function**

When battery-saving mode is set, battery depletion is minimized by stopping the electronic key from receiving radio waves.

Press  twice while pressing and holding . Confirm that the electronic key indicator flashes 4 times.

While the battery-saving mode is set, the smart access system with push-button start cannot be used. To cancel the function, press any of the electronic key buttons.



■ **Conditions affecting operation**

The smart access system with push-button start, wireless remote control and immobilizer system use weak radio waves. In the following situations, the communication between the electronic key and the vehicle may be affected, preventing the smart access system with push-button start, wireless remote control and immobilizer system from operating properly. (Ways of coping: →P. 591)

- When the electronic key battery is depleted
- Near a TV tower, electric power plant, gas station, radio station, large display, airport or other facility that generates strong radio waves or electrical noise
- When the electronic key is in contact with, or is covered by the following metallic objects
 - Cards to which aluminum foil is attached
 - Cigarette boxes that have aluminum foil inside
 - Metallic wallets or bags
 - Coins
 - Hand warmers made of metal
 - Media such as CDs and DVDs
- When other wireless keys (that emit radio waves) are being used nearby
- When carrying the electronic key together with the following devices that emit radio waves
 - Portable radio, cellular phone, cordless phone or other wireless communication devices
 - Another vehicle's electronic key or a wireless key that emits radio waves
 - Personal computers or personal digital assistants (PDAs)
 - Digital audio players
 - Portable game systems
- If window tint with a metallic content or metallic objects are attached to the rear window
- When the electronic key is placed near a battery charger or electronic devices

■ Note for the entry function

- Even when the electronic key is within the effective range (detection areas), the system may not operate properly in the following cases:
 - The electronic key is too close to the window or outside door handle, near the ground, or in a high place when the doors are locked or unlocked.
 - The electronic key is near the ground or in a high place, or too close to the rear bumper center when the back door is opened.
 - The electronic key is on the instrument panel, luggage room, floor, or in the door pockets or glove box when the hybrid system is started or power switch modes are changed.
- Do not leave the electronic key on top of the instrument panel or near the door pockets when exiting the vehicle. Depending on the radio wave reception conditions, it may be detected by the antenna outside the cabin and the door will become lockable from the outside, possibly trapping the electronic key inside the vehicle.
- As long as the electronic key is within the effective range, the doors may be locked or unlocked by anyone.
- Even if the electronic key is not inside the vehicle, it may be possible to start the hybrid system if the electronic key is near the window.
- The doors may unlock if a large amount of water splashes on the door handle, such as in the rain or in a car wash when the electronic key is within the effective range. (The door will automatically be locked after approximately 60 seconds if the doors are not opened and closed.)
- If the wireless remote control is used to lock the doors when the electronic key is near the vehicle, there is a possibility that the door may not be unlocked by the entry function. (Use the wireless remote control to unlock the doors.)
- Touching the door lock sensor while wearing gloves may delay or prevent lock operation. Remove the gloves and touch the lock sensor again.
- When the lock operation is performed using the lock sensor, recognition signals will be shown up to two consecutive times. After this, no recognition signals will be given.
- If the door handle becomes wet while the electronic key is within the effective range, the door may lock and unlock repeatedly. In that case, follow the following correction procedures to wash the vehicle:
 - Place the electronic key in a location 6 ft. (2 m) or more away from the vehicle. (Take care to ensure that the key is not stolen.)
 - Set the electronic key to battery-saving mode to disable the smart access system with push-button start. (→P. 142)
- If the electronic key is inside the vehicle and a door handle becomes wet during a car wash, a message may be shown on the multi-information display and a buzzer will sound outside the vehicle. To turn off the alarm, lock all the doors.
- The lock sensor may not work properly if it comes into contact with ice, snow, mud, etc. Clean the lock sensor and attempt to operate it again.

- A sudden approach to the effective range or door handle may prevent the doors from being unlocked. In this case, return the door handle to the original position and check that the doors unlock before pulling the door handle again.
- If there is another electronic key in the detection area, it may take slightly longer to unlock the doors after the door handle is gripped.

■ **When the vehicle is not driven for extended periods**

- To prevent theft of the vehicle, do not leave the electronic key within 6 ft. (2 m) of the vehicle.
- The smart access system with push-button start can be deactivated in advance. (→P. 633)

■ **To operate the system properly**

Make sure to carry the electronic key when operating the system. Do not get the electronic key too close to the vehicle when operating the system from the outside of the vehicle.

Depending on the position and holding condition of the electronic key, the key may not be detected correctly and the system may not operate properly. (The alarm may go off accidentally, or the door lock prevention may not operate.)

■ **If the smart access system with push-button start does not operate properly**

- Locking and unlocking the doors: Use the mechanical key. (→P. 591)
- Starting the hybrid system: →P. 592

■ **Customization**

Settings (e.g. smart access system with push-button start) can be changed. (Customizable features: →P. 631)

■ **If the smart access system with push-button start has been deactivated in a customized setting**

- Locking and unlocking the doors:
Use the wireless remote control or mechanical key. (→P. 124, 591)
- Starting the hybrid system and changing power switch modes: →P. 592
- Stopping the hybrid system: →P. 202

■ Certification for the smart access system with push-button start

- ▶ For vehicles sold in the U.S.A.

FCC ID: HYQ23AAB

FCC ID: HYQ14FBA

FCC ID: HYQ14CBB

FCC ID: NI4TMLF12-3

NOTE:

This device complies with part 15 of the FCC Rules. Operation is subject to the following two conditions: (1) This device may not cause harmful interference, and (2) this device must accept any interference received, including interference that may cause undesired operation.

FCC WARNING:

Changes or modifications not expressly approved by the party responsible for compliance could void the user's authority to operate the equipment.

- ▶ For vehicles sold in Canada

NOTE:

This device complies with Industry Canada's licence-exempt RSSs. Operation is subject to the following two conditions: (1) This device may not cause interference; and (2) This device must accept any interference, including interference that may cause undesired operation of the device.



WARNING

■ Caution regarding interference with electronic devices

- People with implantable cardiac pacemakers, cardiac resynchronization therapy-pacemakers or implantable cardioverter defibrillators should keep away from the smart access system with push-button start antennas. (→P. 140)

The radio waves may affect the operation of such devices. If necessary, the entry function can be disabled. Ask your Lexus dealer for details, such as the frequency of radio waves and timing of the emitted radio waves. Then, consult your doctor to see if you should disable the entry function.

- Users of any electrical medical device other than implantable cardiac pacemakers, cardiac resynchronization therapy-pacemakers or implantable cardioverter defibrillators should consult the manufacturer of the device for information about its operation under the influence of radio waves.

Radio waves could have unexpected effects on the operation of such medical devices.

Ask your Lexus dealer for details on disabling the entry function.

Front seats

Adjustment procedure

- ① Seat position adjustment switch
- ② Seat cushion (front) angle adjustment switch
- ③ Vertical height adjustment switch
- ④ Seatback angle adjustment switch
- ⑤ Lumbar support adjustment switch (for driver's side)

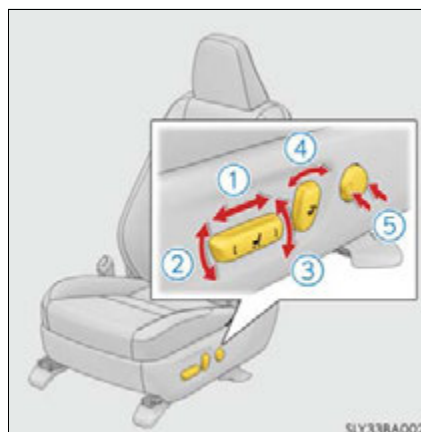

■ Power easy access system

The driver's seat and steering wheel move in accordance with power switch mode and the driver's seat belt condition. (→P. 154)

▲ WARNING

■ When adjusting the seat position

- Take care when adjusting the seat position to ensure that other passengers are not injured by the moving seat.
- Do not put your hands under the seat or near the moving parts to avoid injury. Fingers or hands may become jammed in the seat mechanism.

■ Seat adjustment

To reduce the risk of sliding under the lap belt during a collision, do not recline the seat more than necessary.

If the seat is too reclined, the lap belt may slide past the hips and apply restraint forces directly to the abdomen, or your neck may contact the shoulder belt, increasing the risk of death or serious injury in the event of an accident.

Adjustments should not be made while driving as the seat may unexpectedly move and cause the driver to lose control of the vehicle.

Rear seats

Adjustment procedure

- ▶ Manual seat

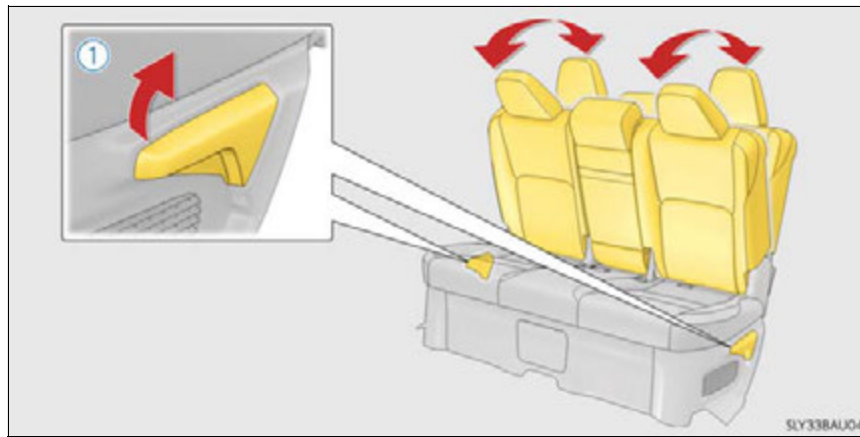

- ① Reclining adjustment

- ▶ Power seat

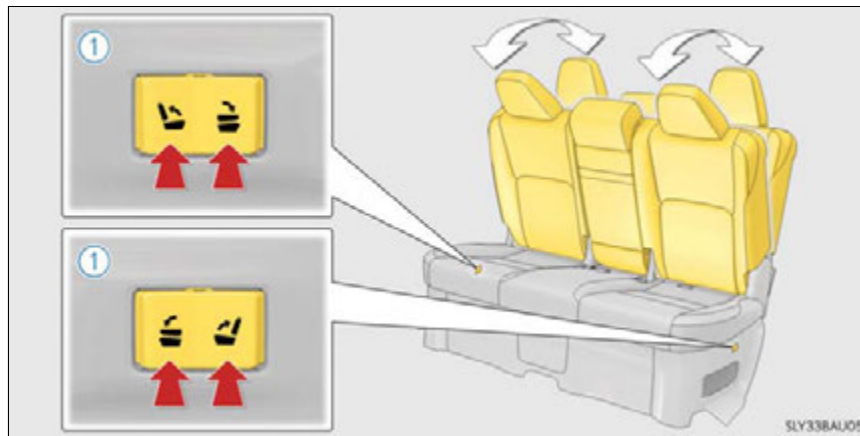

- ① Reclining adjustment (only rear seat switch)

3

Operation of each component

Folding down the rear seatbacks

■ Before folding down the rear seatbacks

- 1 Stow the rear center seat belt and seat belt buckles. (→P. 34)
- 2 Lower the head restraint of the rear seat. (→P. 158)

■ Folding down rear seatbacks (manual seat)

Pull the seatback angle adjustment lever and fold down the seatback.

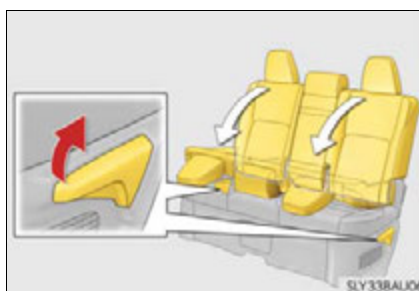

■ Folding down rear seatbacks (power seat)

Press and hold the switch to fold down the seatback.

The buzzer sounds and operations start. The buzzer sounds again when the operation is complete.

To stop the operation of a seat partway, press either seat operation switch for that seat, once more. Switches for that seat in other locations can be used to stop the operations. (buzzer sounds depending on stopping position of the seatback)

▶ Instrument panel switch

▶ Rear seat switch

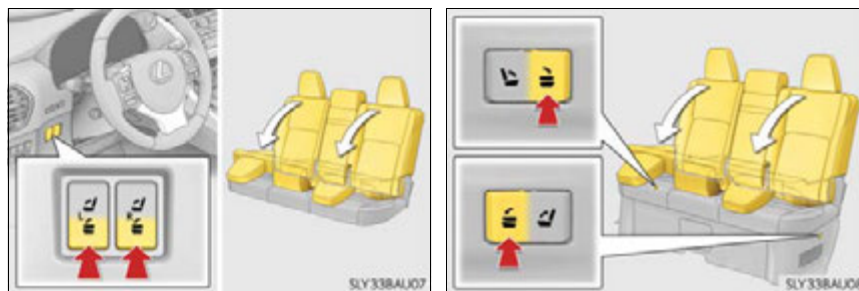

When the seatback is collapsed to the rear, put the seatback in the most upright position and press the switch once again.

▶ Luggage room switch

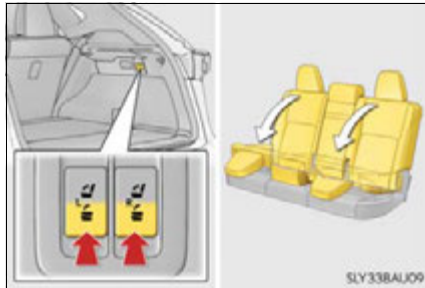

■ Returning the rear seatbacks (manual seat)

- 1 Raise the rear seatback until it locks.



- 2 Check that the plate for the seat belt is on the front side of the seat.

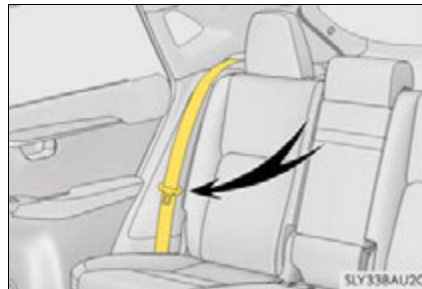

3

Operation of each component

■ Returning the rear seatbacks (power seat)

- 1 Press and hold the switch to return the seatback.

The buzzer sounds and operations start. The buzzer sounds again when the operation is complete.

To stop the operation of a seat partway, press either seat operation switch for that seat, once more. Switches for that seat in other locations can be used to stop the operations. (buzzer sounds depending on stopping position of the seatback)

- ▶ Instrument panel switch



- ▶ Rear seat switch

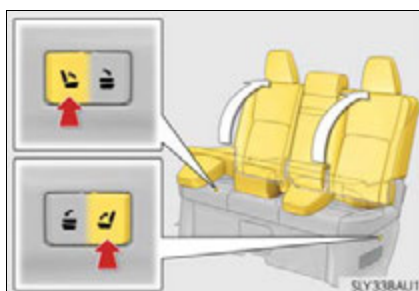

- ▶ Luggage room switch

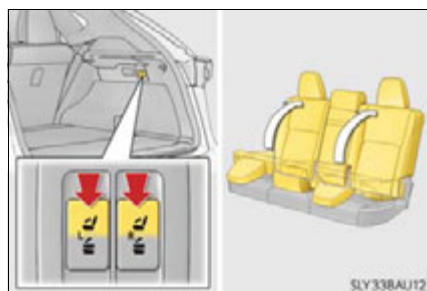

- 2 Check that the plate for the seat belt is on the front side of the seat.



■ Operating conditions for reclining adjustment (power seat)

When the following conditions are met, switch operations are possible.

- When the seatback position is within the range of illustration A.
- When the operating switches for the seat to be operate are not being pressed.

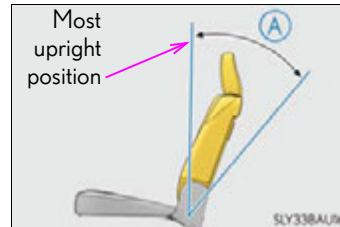

■ Operating conditions for folding down the seatback (power seat)

When the following conditions are met, switch operations are possible.

- When operating the rear seat switch: The seatback position is within the range of illustration A.
- When operating the instrument panel switch or luggage compartment switch: The seatback position is within the range of illustration B.
- When operating the rear seat switch: When the rear door for the seat to be operated is open.

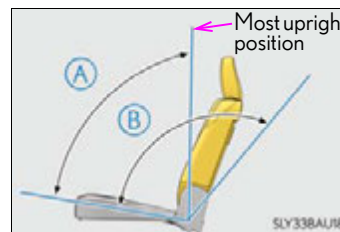

- When operating the luggage compartment switch: When the back door is open.
- When the operating switches for the seat to be operate are not being pressed.

When the power switch is in ON mode, in addition to the above, the power seat operates for any of the following conditions:

- Parking brake is engaged
- The brake pedal is depressed
- The shift lever is in P

■ Operating conditions for returning the seatback (power seat)

When the following conditions are met, switch operations are possible.

- When operating the rear seat switch: When the seatback position is within the range of illustration A.
- When operating the rear seat switch: When the rear door for the seat to be operated is open.
- When operating the luggage compartment switch: When the back door is open.
- When the operating switches for the seat to be operate are not being pressed.

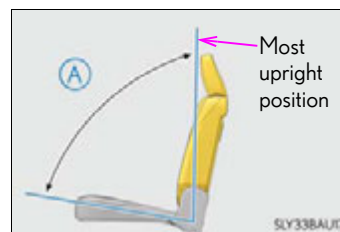

When the power switch is in ON mode, in addition to the above, the power seat operates for any of the following conditions:

- Parking brake is engaged
- The brake pedal is depressed
- The shift lever is in P

■ **Reclining adjustment (power seat)**

Stop the seatback partway. To set the seatback to the rearmost position, press the button again.



■ **Power seat operations (if equipped)**

If the seat has a cover or seat cushion, it may not operate properly. Also, when folding down the seat, check that there is nothing on the rear seat that would interfere with the operation.

■ **Seatback jam protection function (power seat)**

When folding down the seatback, if a foreign object is perceived between the seatback and seat cushion, the seatback will reverse operations and then stops operations.

The buzzer sounds intermittently during reverse operations and sounds continuously when operations are stopped.

⚠ WARNING

■ **When folding the rear seatbacks down and after folded**

Observe the following precautions.
Failure to do so may result in death or serious injury.

- Do not fold the seatbacks down while driving.
- Stop the vehicle on level ground, set the parking brake and shift the shift lever to P.
- Do not allow anyone to sit on a folded seatback or in the luggage compartment while driving.
- Do not allow children to enter the luggage compartment.

■ **When operating the seatback**

Observe the following precautions.
Failure to do so may cause death or serious injury.

- Keep other passengers from being hit with the seatback.
- Do not bring your hands close to the moving parts or between the seats, as well as do not let any part of your body get caught.
- Vehicles with a power seat: Do not let children operate the seatback as other passengers may get caught in seat.
- Vehicles with a power seat: Check that there are no passengers sitting in the seat before folding that seat forward. Also, do not let other passengers sit in the seat while the seat is forward folding.

⚠ WARNING**■ Seat adjustment**

To reduce the risk of sliding under the lap belt during a collision, do not recline the seat more than necessary.

If the seat is too reclined, the lap belt may slide past the hips and apply restraint forces directly to the abdomen, or your neck may contact the shoulder belt, increasing the risk of death or serious injury in the event of an accident.

Adjustments should not be made while driving as the seat may unexpectedly move and cause the driver to lose control of the vehicle.

■ After returning the rear seatback to the upright position

Observe the following precautions.

Failure to do so may result in death or serious injury.

- Make sure that the seatback is securely locked in position by lightly pushing it back and forth.

- Check that the seat belts are not twisted or caught in the seatback.

■ Jam protection function (vehicles with a power seat)

Observe the following precautions.

Failure to do so may cause death or serious injury.

- Never use any part of your body to intentionally activate the jam protection function.
- The jam protection function may not work if something gets caught just before the seatback is fully folded forward. Be careful not to get fingers caught or anything else.
- The jam protection function may not work depending on the shape of the object that is caught. Be careful not to catch fingers or anything else.

⚠ NOTICE**■ Stowing the seat belts**

The seat belts and the buckles for the rear center seat, as well as the armrest, must be stowed before you fold down the rear seatbacks. (→P. 34, 465)

Driving position memory*

This feature automatically adjusts the front seats, steering wheel and outside rear view mirrors to make entering and exiting the vehicle easier or to suit your preferences.

Power easy access system

The seat and steering wheel are automatically adjusted to allow the driver to enter and exit the vehicle easily.

When all of the following have been performed, the driver's seat and steering wheel are automatically adjusted to a position that allows driver to enter and exit the vehicle easily.

- The shift lever has been shifted to P.
- The power switch has been turned off.
- The driver's seat belt has been unfastened.



When any of the following has been performed, the driver's seat and steering wheel automatically return to their original positions.

- The power switch has been turned to ACCESSORY mode or ON mode.
- The driver's seat belt has been fastened.

■ Operation of the power easy access system

When exiting the vehicle, the power easy access system may not operate if the seat is already close to the rearmost position, etc.

■ Customization

The seat movement amount settings of the power easy access system can be customized. (Customizable features: →P. 631)

*: If equipped

Driving position memory

Your preferred driving position (the position of the driver's seat, steering wheel and outside rear view mirrors) can be recorded and recalled by pressing a button.

Three different driving positions can be recorded into memory.

■ Recording procedure

- 1 Check that the shift lever is in P.
- 2 Turn the power switch to ON mode.
- 3 Adjust the driver's seat, steering wheel and outside rear view mirrors to the desired positions.
- 4 While pressing the "SET" button, or within 3 seconds after the "SET" button is pressed, press button "1", "2" or "3" until the buzzer sounds.

If the selected button has already been preset, the previously recorded position will be overwritten.

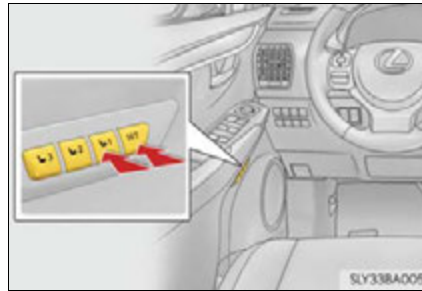

■ Recall procedure

- 1 Check that the shift lever is in P.
- 2 Turn the power switch to ON mode.
- 3 Press one of the buttons for the driving position you want to recall until the buzzer sounds.

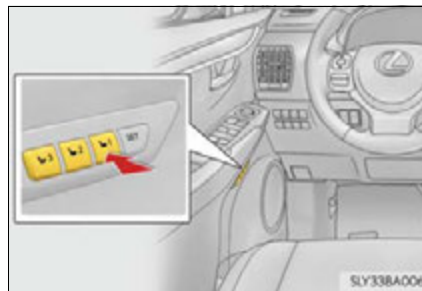

3

Operation of each component

■ **To stop the position recall operation part-way through**

Perform any of the following:

- Press the "SET" button.
- Press button "1", "2" or "3".
- Operate any of the seat adjustment switches (only cancels seat position recall).
- Operate the tilt and telescopic steering control switch (only cancels steering wheel position recall).

■ **Seat positions that can be memorized (→P. 146)**

The adjusted positions other than the position adjusted by lumbar support switch can be recorded.

■ **Operating the driving position memory after turning the power switch off**

Recorded seat positions can be activated up to 180 seconds after the driver's door is opened and another 60 seconds after it is closed again.

■ **In order to correctly use the driving position memory function**

If a seat position is already in the furthest possible position and the seat is operated in the same direction, the recorded position may be slightly different when it is recalled.

Memory recall function

Each electronic key (including a card key) can be registered to recall your preferred driving position.

■ **Registering procedure**

Record your driving position to button "1", "2" or "3" before performing the following:

Carry only the key you want to register, and then close the driver's door.

If 2 or more keys are in the vehicle, the driving position cannot be recorded properly.

- 1 Check that the shift lever is in P.
- 2 Turn the power switch to ON mode.
- 3 Recall the driving position that you want to record.
- 4 While pressing the recalled button, press and hold the door lock switch (either lock or unlock) until the buzzer sounds.

If the button could not be registered, the buzzer sounds continuously for approximately 3 seconds.

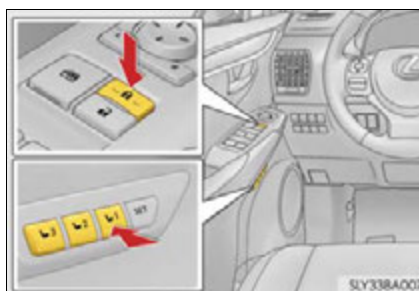

■ Recall procedure

- 1** Carry the electronic key that has been registered to the driving position, and then unlock and open the driver's door using the smart access system with push-button start or wireless remote control.

The driving position will move to the recorded position (not including the steering wheel). However, the seat will move to a position slightly behind the recorded position in order to make entering the vehicle easier.

If the driving position is in a position that has already been recorded, the seat and outside rear view mirrors will not move.

- 2** Turn the power switch to ACCESSORY mode or ON mode, or fasten a seat belt.

The seat and steering wheel will move to the recorded position.

■ Cancellation procedure

Carry only the key you want to cancel and then close the driver's door.

If 2 or more keys are in the vehicle, the driving position cannot be canceled properly.

- 1** Turn the power switch to ON mode.
- 2** While pressing the "SET" button, press and hold the door lock switch (either lock or unlock) until the buzzer sounds twice.

If it could not be canceled, the buzzer sounds continuously for approximately 3 seconds.

■ Recalling the driving position using the memory recall function

- Different driving positions can be registered for each electronic key. Therefore, the driving position that is recalled may be different depending on the key being carried.
- If a door other than the driver's door is unlocked with the smart access system with push-button start, the driving position cannot be recalled. In this case, press the driving position button which has been set.

■ Customization

The unlock door settings of the memory recall function can be customized. (Customizable features: →P. 631)

⚠ WARNING**■ Seat adjustment caution**

Take care during seat adjustment so that the seat does not strike the rear passenger or squeeze your body against the steering wheel.

Head restraints

Head restraints are provided for all seats.

Front seats

- ① Up
Pull the head restraints up.
- ② Down
Push the head restraint down while pressing the lock release button.

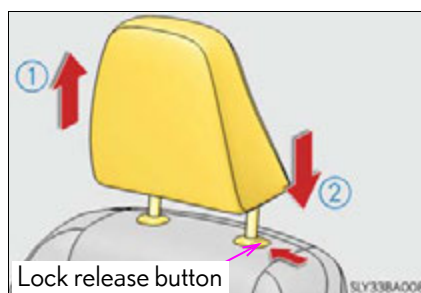

Rear seats

- ① Up
Pull the head restraints up.
- ② Down
Push the head restraint down while pressing the lock release button.

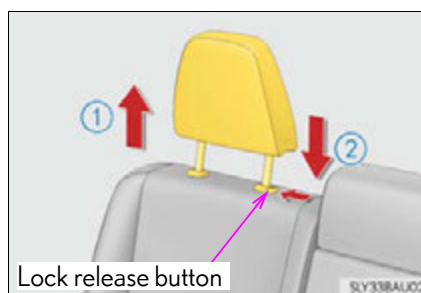

■ Removing the head restraints

Pull the head restraint up while pressing the lock release button.

If the head restraint touches the ceiling, making the removal difficult, change the seat height or angle. (→P. 146, 147)

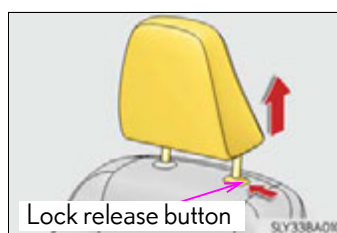

■ Installing the head restraints

Align the head restraint with the installation holes and push it down to the lock position.

Press and hold the lock release button when lowering the head restraint.

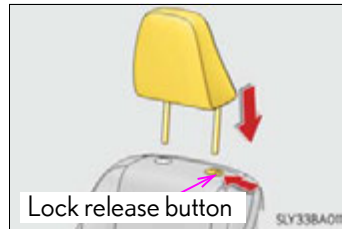

■ Adjusting the height of the head restraints (front seats)

Make sure that the head restraints are adjusted so that the center of the head restraint is closest to the top of your ears.



■ Adjusting the center rear seat head restraint

Always raise the head restraint one level from the stowed position when using.

WARNING

■ Head restraint precautions

Observe the following precautions regarding the head restraints. Failure to do so may result in death or serious injury.

- Use the head restraints designed for each respective seat.
- Adjust the head restraints to the correct position at all times.
- After adjusting the head restraints, push down on them and make sure they are locked in position.
- Do not drive with the head restraints removed.

Steering wheel

Adjustment procedure

Operating the switch moves the steering wheel in the following directions:

- ① Up
- ② Down
- ③ Toward the driver
- ④ Away from the driver

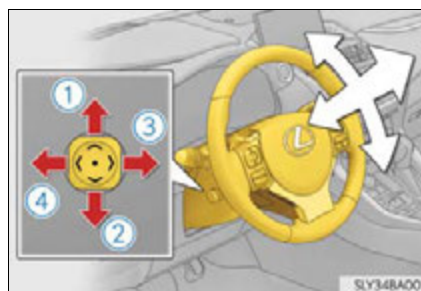

Horn

To sound the horn, press on or close to the  mark.

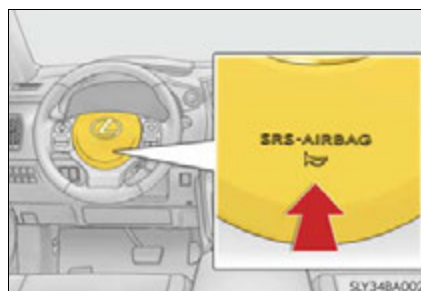

■ The steering wheel can be adjusted when

The power switch is in ACCESSORY or ON mode*.

*: If the driver's seat belt is fastened, the steering wheel can be adjusted regardless of power switch mode.

■ Automatic adjustment of the steering position (if equipped)

A desired steering position can be entered to memory and recalled automatically by the driving position memory system. (→P. 155)

■ Power easy access system

The steering wheel and driver's seat move in accordance with power switch mode and the driver's seat belt condition. (→P. 154)

⚠ WARNING

Do not adjust the steering wheel while driving.
Doing so may cause the driver to mishandle the vehicle and cause an accident, resulting in death or serious injury.

Inside rear view mirror

The rear view mirror's position can be adjusted to enable sufficient confirmation of the rear view.

Adjusting the height of rear view mirror

The height of the rear view mirror can be adjusted to suit your driving posture.

Adjust the height of the rear view mirror by moving it up and down.



Anti-glare function

► Type A

Responding to the level of brightness of the headlights of vehicles behind, the reflected light is automatically reduced.

Changing automatic anti-glare function mode

On/off

When the automatic anti-glare function is in ON mode, the indicator illuminates. The function will set to ON mode each time the power switch is turned to ON mode.

Pressing the button turns the function to OFF mode. (The indicator also turns off.)

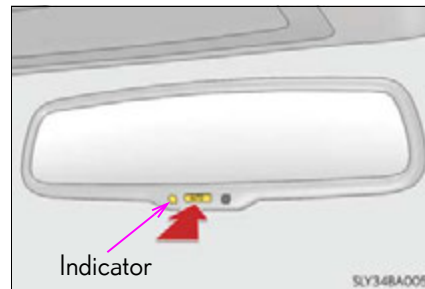

► Type B

Responding to the level of brightness of the headlights of vehicles behind, the reflected light is automatically reduced.

Changing automatic anti-glare function mode

On/off

When the automatic anti-glare function is in ON mode, the indicator illuminates. The function will set to ON mode each time the power switch is turned to ON mode.

Pressing the button turns the function to OFF mode. (The indicator also turns off.)

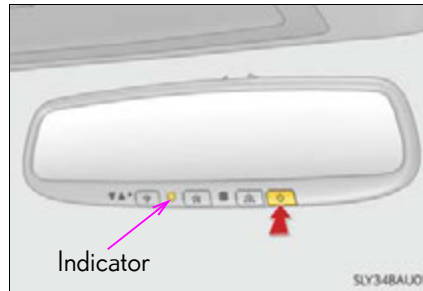

■ To prevent sensor error

To ensure that the sensors operate properly, do not touch or cover them.

► Type A



► Type B



⚠ WARNING

Do not adjust the position of the mirror while driving. Doing so may lead to mishandling of the vehicle and cause an accident, resulting in death or serious injury.

Outside rear view mirrors

Adjustment procedure

1 To select a mirror to adjust, press the switch.

- ① Left
- ② Right

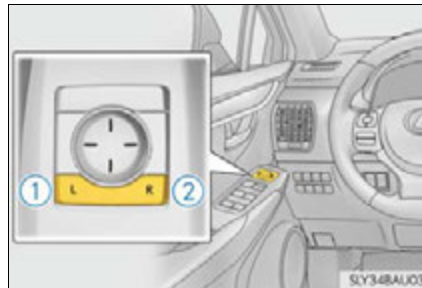

2 To adjust the mirror, press the switch.

- ① Up
- ② Right
- ③ Down
- ④ Left

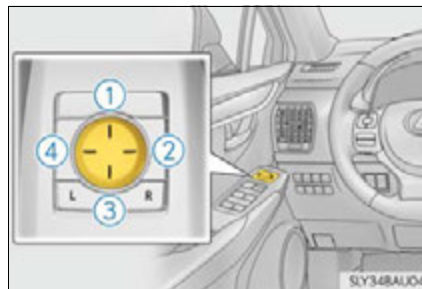

Folding the mirrors

Push the mirror back in the direction of the vehicle's rear.



3

Operation of each component

Linked mirror function when reversing (vehicles with driving position memory)

When the mirror select switch is in the “L” or “R” position, the outside rear view mirrors will automatically angle downwards when the vehicle is reversing in order to give a better view of the ground.

To disable this function, move the mirror select switch to the neutral position (between “L” or “R”)

■ Adjusting the mirror angle when the vehicle is reversing

With the shift lever in R, adjust the mirror angle at a desired position.

The adjusted angle will be memorized and the mirror will automatically tilt to the memorized angle whenever the shift lever is shifted to R from next time.

The memorized downward tilt position of the mirror is linked to the normal position (angle adjusted with the shift lever in other than R). Therefore, if the normal position is changed after adjustment, the tilt position will also change.

When the normal position is changed, readjust the angle in reversing.

■ Mirror angle can be adjusted when

The power switch is in ACCESSORY or ON mode.

■ When the mirrors are fogged up

The outside rear view mirrors can be cleared using the mirror defoggers. Turn on the rear window defogger to turn on the outside rear view mirror defoggers. (→P. 435)

■ Automatic adjustment of the mirror angle (vehicles with driving position memory)

A desired mirror face angle can be entered to memory and recalled automatically by the driving position memory. (→P. 154)

■ Auto anti-glare function (if equipped)

When the anti-glare inside rear view mirror is set to automatic mode, the outside rear view mirrors will activate in conjunction with the anti-glare inside rear view mirror to reduce reflected light. (→P. 161)

■ Linked mirror function when reversing (vehicles with driving position memory)

When used in cold weather during reverse driving, the door mirror could be frozen and may not automatically point the mirror surface downward. In this event, remove any ice and snow from the mirror surface.

 **WARNING****■ When driving the vehicle**

Observe the following precautions while driving. Failing to do so may result in loss of control of the vehicle and cause an accident, resulting in death or serious injury.

- Do not adjust the mirrors while driving.
- Do not drive with the mirrors folded.
- Both the driver and passenger side mirrors must be extended and properly adjusted before driving.

■ When a mirror is moving

To avoid personal injury and mirror malfunction, be careful not to get your hand caught by the moving mirror.

■ When the mirror defoggers are operating

Do not touch the rear view mirror surfaces, as they can become very hot and burn you.

Power windows

Opening and closing procedures

The power windows can be opened and closed using the switches.

Operating the switch moves the windows as follows:

- ① Closing
- ② One-touch closing*
- ③ Opening
- ④ One-touch opening*

*: To stop the window partway, operate the switch in the opposite direction.

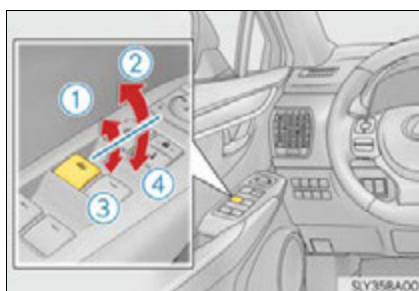

Window lock switch

Press the switch down to lock the passenger window.

Use this switch to prevent children from accidentally opening or closing a passenger window.

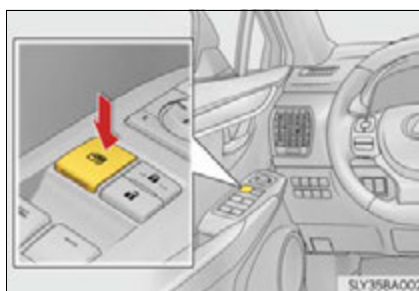

■ **The power windows can be operated when**

The power switch is in ON mode.

■ **Operating the power windows after turning the hybrid system off**

The power windows can be operated for approximately 45 seconds even after the power switch is turned to ACCESSORY mode or turned off. They cannot, however, be operated once either front door is opened.

■ **Up jam protection function**

If an object becomes caught between the window and the window frame, window travel is stopped and the window is opened slightly.

■ **Down jam protection function**

When the window is opening, if a foreign object malfunctions within the door causes it to be clamped, the operation stops.

■ **When opening and closing the window cannot be done**

When the up or down jam protection function operates unusually or the door window cannot be fully opened and closed, perform the following operations with the power window switch of that door.

- Stop the vehicle, with the power switch in ON mode, continually operate the power window switch in the one-touch closing position within 4 seconds after the up jam or down jam protection function was activated. Otherwise, by continually operating the power window switch in the one-touch opening position, the door window can be opened and closed.
- If the door window cannot be opened and closed even when performing the above operations, implement the following procedure for function initialization.
 - 1 Turn the power switch to ON mode.
 - 2 Pull and hold the power window switch in the one-touch closing position and completely close the door window.
 - 3 Release the power window switch for a moment and then resume pulling and holding the switch in the one-touch closing position for approximately 4 seconds.
 - 4 Press and hold the power window switch in the one-touch opening position and after the door window is completely opened, continue holding the switch for a further 1 second or more.
 - 5 Pull and hold the power window switch in the one-touch closing position, once more, and after the door window is completely closed, continue holding the switch for a further 1 second or more.

If you release the switch while the window is moving, start again from the beginning.

If the window reverses and cannot be closed or completely open, have the vehicle inspected by your Lexus dealer.

■ **Door lock linked window operation**

- The power windows can be opened and closed using the mechanical key.* (→P. 592)
- The power windows can be opened using the wireless remote control.* (→P. 124)

*: These settings must be customized at your Lexus dealer.

■ Power windows open warning buzzer

The buzzer sounds and a message is shown on the multi-information display in the instrument cluster when the power switch is turned off and the driver's door is opened with the power windows open.

■ Customization

Setting (e.g. linked door lock operation) can be changed.
(Customizable features: →P. 631)

**WARNING**

Observe the following precautions.
Failing to do so may result in death or serious injury.

■ Closing the windows

- The driver is responsible for all the power window operations, including the operation for the passengers. In order to prevent accidental operation, especially by a child, do not let a child operate the power windows. It is possible for children and other passengers to have body parts caught in the power window. Also, when riding with a child, it is recommended to use the window lock switch. (→P. 166)
- Check to make sure that all passengers do not have any part of their body in a position where it could be caught when a window is being operated.
- When using the mechanical key and operating the power windows, operate the power window after checking to make sure that there is no possibility of any passenger having any of their body parts caught in the window. Also do not let a child operate window by the mechanical key. It is possible for children and other passengers to get caught in the power window.
- When exiting the vehicle, turn the power switch off, carry the key and exit the vehicle along with the child. There may be accidental operation, due to mischief, etc., that may possibly lead to an accident.

■ Up jam protection function

- Never use any part of your body to intentionally activate the up jam protection function.
- The up jam protection function may not work if something gets caught just before the window fully closes.

■ Down jam protection function

- Never allow passengers to use hands, arms, cloths, etc., to intentionally activate the down jam protection function.
- The down jam protection function may not work if a foreign object gets caught just before the window completely opens. Be careful not to get hands, arms, clothes, etc., caught in the window.

Moon roof*

Use the overhead switches to open and close the moon roof and tilt it up and down.

Opening and closing

- ① Opens the moon roof
Press and hold the "OPEN" switch. The moon roof tilts up and then fully opens automatically.*
- ② Closes the moon roof
Press and hold the "CLOSE" switch. The moon roof fully closes automatically.*
*: Lightly press either end of the moon roof switch to stop the moon roof partway.



Tilting up and down

- ① Tilts the moon roof up
Press and hold the "UP" switch. It automatically opens until the tilt up stop position.*
- ② Tilts the moon roof down
Press and hold the "DOWN" switch. The moon roof full close automatically.*
*: Lightly press either end of the moon roof switch to stop the moon roof partway.

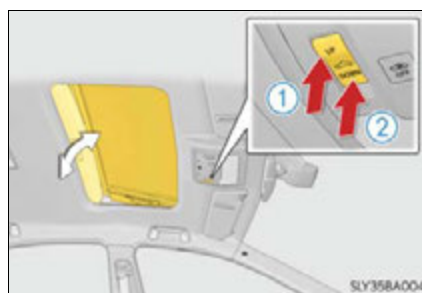

3

Operation of each component

*: If equipped

■ The moon roof can be operated when

The power switch is in ON mode.

■ Jam protection function

If an object is detected between the moon roof and the frame while the moon roof is closing or tilting down, travel is stopped and the moon roof opens slightly.

■ Sunshade

The sunshade can be opened and closed manually. However, the sunshade will open automatically when the moon roof is opened.

■ Door lock linked moon roof operation

● The moon roof can be opened and closed using the mechanical key. * (→P. 592)

● The moon roof can be opened using the wireless remote control. * (→P. 124)

*: These settings must be customized at your Lexus dealer.

■ When the moon roof does not close normally

Perform the following procedure:

● If the moon roof closes but then re-opens slightly

1 Stop the vehicle.

2 Press and hold the "CLOSE" switch. *1

The moon roof will close, reopen and pause for approximately 10 seconds. *2 Then it will close again and tilt down. Finally it will stop.

3 Check to make sure that the moon roof completely stops and then release the switch.

● If the moon roof tilts down but then tilts back up

1 Stop the vehicle.

2 Press and hold the "DOWN" switch. *1

The moon roof will close, reopen and pause for approximately 10 seconds in the tilt up position. *2 Then it will close again. Finally it will stop.

3 Check to make sure that the moon roof has completely stopped and then release the switch.

*1: If the switch is released at the incorrect time, the procedure will have to be performed again from the beginning.

*2: If the switch is released after the above mentioned 10 second pause, automatic operation will be disabled. In that case, perform the moon roof initialization by referring to "When tilt up/down or moon roof opening and closing can be done but automatic full opening and closing cannot be done" on P. 171.

If the moon roof does not fully close even after performing the above procedure correctly, have the vehicle inspected by your Lexus dealer.

■ When the moon roof does not move normally

When the opening and closing operation or automatic opening function of the moon roof does not move normally, perform the following initialization procedures.

- 1 Turn the power switch to ON mode.
- 2 Operate the moon roof.
The initialization method changes depending on the contents that can be operated.
- If only the tilt up operations can be done when the moon roof is closed
 - 3 Press and hold the "DOWN" or "CLOSE" switch.
Open until the tilt up stop position. After that the moon roof opens and completely closes.
After that tilt up once again and stop at the completely closed position.
 - 4 Confirm that moon roof has completely stopped and release the switch.
- If the moon roof can only be closed when the moon roof is partially opened
 - 3 Press and hold the "DOWN" or "CLOSE" switch.
Fully close the moon roof, tilt up and open it close to the fully open position. After that, fully close the moon roof and tilt up once again, then stop the moon roof in the fully closed position.
 - 4 Confirm that moon roof has completely stopped and release the switch.
- When tilt up/down or moon roof opening and closing can be done but automatic full opening and closing cannot be done
 - 3 Press the "OPEN" switch and fully open.
 - 4 Press the "CLOSE" switch and fully close.
 - 5 Press the "UP" switch and tilt up until the tilt up stop position.
 - 6 Press the "DOWN" switch and tilt down.

If the switch is released before any step is completes, the procedure will have to be performed again from the beginning.

If the opening and closing operations or automatic opening function does not move as normal, even after performing the above mentioned operations, have the vehicle inspected by your Lexus dealer.

■ Moon roof open warning buzzer

The buzzer sounds and a message is shown on the multi-information display in the instrument cluster when the power switch is turned off and the driver's door is opened with the moon roof open.

■ Customization

Setting (e.g. linked door lock operation) can be changed.
(Customizable features: →P. 631)

 **WARNING**

Observe the following precautions.
Failing to do so may cause death or serious injury.

■ Opening the moon roof

- Do not allow any passengers to put their hands or heads outside the vehicle while it is moving.
- Do not sit on top of the moon roof.

■ Closing the moon roof

- The driver is responsible for moon roof opening and closing operations.
In order to prevent accidental operation, especially by a child, do not let a child operate the moon roof. It is possible for children and other passengers to have body parts caught in the moon roof.
- Check to make sure that all passengers do not have any part of their body in a position where it could be caught when the moon roof is being operated.
- When using the mechanical key and operating the moon roof, operate the moon roof after checking to make sure that there is no possibility of any passenger having any of their body parts caught in the moon roof. Also, do not let a child operate moon roof by the mechanical key. It is possible for children and other passengers to get caught in the moon roof.
- When exiting the vehicle, turn the power switch off, carry the key and exit the vehicle along with the child. There may be accidental operation, due to mischief, etc., that may possibly lead to an accident.

■ Jam protection function

- Never use any part of your body to intentionally activate the jam protection function.
- The jam protection function may not work if something gets caught just before the moon roof is fully closed. Also, the jam protection function is not designed to operate while the moon roof switch is being pressed. Take care so that your fingers, etc. do not get caught.

4-1. Before driving	
Driving the vehicle.....	174
Cargo and luggage.....	182
Vehicle load limits	186
Trailer towing (vehicles with towing package).....	187
Trailer towing (vehicles without towing package)	199
Dinghy towing.....	200
4-2. Driving procedures	
Power (ignition) switch.....	201
EV drive mode	206
Hybrid transmission	208
Turn signal lever	212
Parking brake.....	213
Brake Hold.....	216
ASC (Active Sound Control).....	218
4-3. Operating the lights and wipers	
Headlight switch.....	219
Automatic High Beam	223
Fog light switch.....	227
Windshield wipers and washer.....	228
Rear window wiper and washer.....	234
4-4. Refueling	
Opening the fuel tank cap	236
4-5. Using the driving support systems	
Dynamic radar cruise control	240
Dynamic radar cruise control with full-speed range	253
Cruise control	267
LDA (Lane Departure Alert with steering control)	270
Intuitive parking assist	279
Lexus parking assist monitor	287
Driving mode select switch	303
Driving assist systems.....	305
PCS (Pre-Collision System).....	310
BSM (Blind Spot Monitor).....	316
4-6. Driving tips	
Hybrid vehicle driving tips	324
Winter driving tips	326
Utility vehicle precautions.....	330

Driving the vehicle

The following procedures should be observed to ensure safe driving:

Starting the hybrid system

→P. 201

Driving

- 1 With the brake pedal depressed, shift the shift lever to D. (→P. 208)
- 2 Release the parking brake. (→P. 214)
If the parking brake is in automatic mode, the parking brake is released automatically when shifting the shift lever to any position other than P. (→P. 213)
- 3 Gradually release the brake pedal and gently depress the accelerator pedal to accelerate the vehicle.

Stopping

- 1 With the shift lever in D, depress the brake pedal.
- 2 If necessary, set the parking brake. (→P. 214)
If the vehicle is to be stopped for an extended period of time, shift the shift lever to P. (→P. 208)

Parking the vehicle

- 1 With the shift lever in D, depress the brake pedal.
- 2 Shift the shift lever to P. (→P. 208)
- 3 Set the parking brake. (→P. 214)
If the parking brake is in automatic mode, the parking brake is set automatically when shifting the shift lever to P. (→P. 213)
- 4 Press the power switch to stop the hybrid system.
- 5 Lock the door, making sure that you have the electronic key on your person.
If parking on a hill, block the wheels as needed.

Starting off on an uphill

- 1 With the brake pedal depressed, shift the shift lever to D. (→P. 208)
- 2 Pull the parking brake switch and parking brake is set manually. (→P. 214)
- 3 Release the brake pedal and gently depress the accelerator pedal to accelerate the vehicle.
- 4 Press the parking brake switch and parking brake is released manually. (→P. 214)

■ When starting off on an uphill

The hill-start assist control will activate. (→P. 305)

■ For fuel-efficient driving

Keep in mind that hybrid vehicles are similar to conventional vehicles, and it is necessary to refrain from activities such as sudden acceleration. (→P. 324)

■ Driving in the rain

- Drive carefully when it is raining, because visibility will be reduced, the windows may become fogged-up, and the road will be slippery.
- Drive carefully when it starts to rain, because the road surface will be especially slippery.
- Refrain from high speeds when driving on an expressway in the rain, because there may be a layer of water between the tires and the road surface, preventing the steering and brakes from operating properly.

■ Restraining the hybrid system output (Brake Override System)

- When the accelerator and brake pedals are depressed at the same time, the hybrid system output may be restrained.
- A warning message is displayed on the multi-information display while the system is operating. If a warning message is shown on the multi-information display, read the message and follow the instructions.

■ Restraining sudden start (Drive-Start Control)

- When the following unusual operation is performed, the hybrid system output may be restrained.
 - When the shift lever is shifted from R to D, D to R, N to R, P to D, or P to R (D includes S) with the accelerator pedal depressed, a warning message appears on the multi-information display. If a warning message is shown on the multi-information display, read the message and follow the instructions.
 - When the accelerator pedal is depressed too while the vehicle is in reverse.
- While Drive-Start Control is being activated, your vehicle may have trouble escaping from the mud or fresh snow. In such case, deactivate TRAC (→P. 307) to cancel Drive-Start Control so that the vehicle may become able to escape from the mud or fresh snow.

■ **Breaking in your new Lexus**

To extend the life of the vehicle, observing the following precautions is recommended:

- For the first 200 miles (300 km):
Avoid sudden stops.
- For the first 1000 miles (1600 km):
 - Do not drive at extremely high speeds.
 - Avoid sudden acceleration.
 - Do not drive continuously in low gears.
 - Do not drive at a constant speed for extended periods.
- ▶ Vehicles with towing package
- For the first 500 miles (800 km):
Do not tow a trailer.

■ **Operating your vehicle in a foreign country**

Comply with the relevant vehicle registration laws and confirm the availability of the correct fuel. (→P. 616)

■ **Eco-friendly driving**

→P. 100

 WARNING
<p>Observe the following precautions. Failure to do so may result in death or serious injury.</p> <p>■ When starting the vehicle</p> <p>Always keep your foot on the brake pedal while stopped with the “READY” indicator is illuminated. This prevents the vehicle from creeping.</p> <p>■ When driving the vehicle</p> <ul style="list-style-type: none"> ● Do not drive if you are unfamiliar with the location of the brake and accelerator pedals to avoid depressing the wrong pedal. <ul style="list-style-type: none"> • Accidentally depressing the accelerator pedal instead of the brake pedal will result in sudden acceleration that may lead to an accident. • When backing up, you may twist your body around, leading to difficulty in operating the pedals. Make sure to operate the pedals properly. • Make sure to keep a correct driving posture even when moving the vehicle only slightly. This allows you to depress the brake and accelerator pedals properly. • Depress the brake pedal using your right foot. Depressing the brake pedal using your left foot may delay response in an emergency, resulting in an accident. ● The driver should pay extra attention to pedestrians when the vehicle is powered only by the electric motor (traction motor). As there is no engine noise, the pedestrians may misjudge the vehicle’s movement. ● Do not drive the vehicle over or stop the vehicle near flammable materials. The exhaust system and exhaust gases can be extremely hot. These hot parts may cause a fire if there is any flammable material nearby.

⚠ WARNING

Observe the following precautions.
Failure to do so may result in death or serious injury.

■ When driving the vehicle

- During normal driving, do not turn off the hybrid system. Turning the hybrid system off while driving will not cause loss of steering or braking control, however, power assist to the steering will be lost. This will make it more difficult to steer smoothly, so you should pull over and stop the vehicle as soon as it is safe to do so.
In the event of an emergency, such as if it becomes impossible to stop the vehicle in the normal way: →P. 557
- Use engine braking (downshift) to maintain a safe speed when driving down a steep hill.
Using the brakes continuously may cause the brakes to overheat and lose effectiveness. (→P. 208)
- Do not adjust the positions of the steering wheel, the seat, or the inside or outside rear view mirrors while driving.
Doing so may result in a loss of vehicle control.
- Always check that all passengers' arms, heads or other parts of their body are not outside the vehicle.
- AWD models: Do not drive the vehicle off-road.
This is not an AWD vehicle designed for off-road driving. Proceed with all due caution if it becomes unavoidable to drive off-road.
- Do not drive across a river or through other bodies of water.
This may cause electric/electronic components to short circuit, damage the hybrid system or cause other serious damage to the vehicle.
- Do not drive in excess of the speed limit. Even if the legal speed limit permits it, do not drive over 85 mph (140 km/h) unless your vehicle has high-speed capability tires. Driving over 85 mph (140 km/h) may result in tire failure, loss of control and possible injury. Be sure to consult a tire dealer to determine whether the tires on your vehicle are high-speed capability tires or not before driving at such speeds.

 **WARNING**

Observe the following precautions.
Failure to do so may result in death or serious injury.

■ When driving on slippery road surfaces

- Sudden braking, acceleration and steering may cause tire slippage and reduce your ability to control the vehicle.
- Sudden acceleration, engine braking due to shifting, or changes in engine speed could cause the vehicle to skid.
- After driving through a puddle, lightly depress the brake pedal to make sure that the brakes are functioning properly. Wet brake pads may prevent the brakes from functioning properly. If the brakes on only one side are wet and not functioning properly, steering control may be affected.

■ When shifting the shift lever

- Do not let the vehicle roll backward while the shift lever is in a driving position, or roll forward while the shift lever is in R.
Doing so may result in an accident or damage to the vehicle.
- Do not shift the shift lever to P while the vehicle is moving.
Doing so can damage the transmission and may result in a loss of vehicle control.
- Do not shift the shift lever to R while the vehicle is moving forward.
Doing so can damage the transmission and may result in a loss of vehicle control.
- Do not shift the shift lever to a driving position while the vehicle is moving backward.
Doing so can damage the transmission and may result in a loss of vehicle control.
- Shifting the shift lever to N while the vehicle is moving will disengage the hybrid system. Engine braking is not available when N is selected.
- Be careful not to shift the shift lever with the accelerator pedal depressed.
Shifting the shift lever to any position other than P or N may lead to unexpected rapid acceleration of the vehicle that may cause an accident and result in death or serious injury.

⚠ WARNING

Observe the following precautions.
Failure to do so may result in death or serious injury.

■ **If you hear a squealing or scraping noise (brake pad wear limit indicators)**

Have the brake pads checked and replaced by your Lexus dealer as soon as possible.
Rotor damage may result if the pads are not replaced when needed.

It is dangerous to drive the vehicle when the wear limits of the brake pads and/or those of the brake discs are exceeded.

■ **When the vehicle is stopped**

- Do not depress the accelerator pedal unnecessarily.
If the shift lever is in any position other than P or N, the vehicle may accelerate suddenly and unexpectedly, causing an accident.
- In order to prevent accidents due to the vehicle rolling away, always keep depressing the brake pedal while stopped with the "READY" indicator is illuminated, and apply the parking brake as necessary.
- If the vehicle is stopped on an incline, in order to prevent accidents caused by the vehicle rolling forward or backward, always depress the brake pedal and securely apply the parking brake as needed.
- Avoid revving or racing the engine.
Running the engine at high speed while the vehicle is stopped may cause the exhaust system to overheat, which could result in a fire if combustible material is nearby.

■ **When the vehicle is parked**

- Do not leave glasses, cigarette lighters, spray cans, or soft drink cans in the vehicle when it is in the sun.
Doing so may result in the following:
 - Gas may leak from a cigarette lighter or spray can, and may lead to a fire.
 - The temperature inside the vehicle may cause the plastic lenses and plastic material of glasses to deform or crack.
 - Soft drink cans may fracture, causing the contents to spray over the interior of the vehicle, and may also cause a short circuit in the vehicle's electrical components.
- Do not leave cigarette lighters in the vehicle. If a cigarette lighter is in a place such as the glove box or on the floor, it may be lit accidentally when luggage is loaded or the seat is adjusted, causing a fire.
- Do not attach adhesive discs to the windshield or windows. Do not place containers such as air fresheners on the instrument panel or dashboard. Adhesive discs or containers may act as lenses, causing a fire in the vehicle.
- Do not leave a door or window open if the curved glass is coated with a metallized film such as a silver-colored one. Reflected sunlight may cause the glass to act as a lens, causing a fire.
- Always shift the shift lever to P, apply the parking brake, stop the hybrid system and lock the vehicle.
Do not leave the vehicle unattended while the "READY" indicator is illuminated.
- Do not touch the exhaust pipes while the "READY" indicator is illuminated or immediately after turning the hybrid system off.
Doing so may cause burns.

 **WARNING**

Observe the following precautions.
Failure to do so may result in death or serious injury.

■ **When taking a nap in the vehicle**

Always turn the hybrid system off. Otherwise, if you accidentally move the shift lever or depress the accelerator pedal, this could cause an accident or fire due to hybrid system overheating. Additionally, if the vehicle is parked in a poorly ventilated area, exhaust gases may collect and enter the vehicle, leading to death or a serious health hazard.

■ **When braking**

- When the brakes are wet, drive more cautiously.

Braking distance increases when the brakes are wet, and this may cause one side of the vehicle to brake differently than the other side. Also, the parking brake may not securely hold the vehicle.

- If the electronically controlled brake system does not operate, do not follow other vehicles closely and avoid hills or sharp turns that require braking.
In this case, braking is still possible, but the brake pedal should be depressed more firmly than usual. Also, the braking distance will increase. Have your brakes fixed immediately.

- The brake system consists of 2 or more individual hydraulic systems; if one of the systems fails, the other(s) will still operate. In this case, the brake pedal should be depressed more firmly than usual and the braking distance will increase. Have your brakes fixed immediately.

■ **If the vehicle becomes stuck (AWD models)**

Do not spin the wheels excessively when any of the tires is up in the air, or the vehicle is stuck in sand, mud, etc. This may damage the driveline components or propel the vehicle forward or backward, causing an accident.

 NOTICE

■ **When driving the vehicle**

- Do not depress the accelerator and brake pedals at the same time during driving, the hybrid system output may be restrained.
- Do not use the accelerator pedal or depress the accelerator and brake pedals at the same time to hold the vehicle on a hill.

■ **When parking the vehicle**

Always shift the shift lever to P, set the parking brake. Failure to do so may cause the vehicle to move or the vehicle may accelerate suddenly if the accelerator pedal is accidentally depressed.

■ **Avoiding damage to vehicle parts**

- Do not turn the steering wheel fully in either direction and hold it there for an extended period of time.
Doing so may damage the power steering motor.
- When driving over bumps in the road, drive as slowly as possible to avoid damaging the wheels, underside of the vehicle, etc.

■ **If you get a flat tire while driving**

A flat or damaged tire may cause the following situations. Hold the steering wheel firmly and gradually depress the brake pedal to slow down the vehicle.

- It may be difficult to control your vehicle.
- The vehicle will make abnormal sounds or vibrations.
- The vehicle will lean abnormally.

Information on what to do in case of a flat tire (→P. 575)

■ **When encountering flooded roads**

Do not drive on a road that has flooded after heavy rain, etc. Doing so may cause the following serious damage to the vehicle:

- Engine stalling
- Short in electrical components
- Engine damage caused by water immersion

In the event that you drive on a flooded road and the vehicle is flooded, be sure to have your Lexus dealer check the following:

- Brake function
- Changes in quantity and quality of oil and fluid used for the engine, hybrid transmission, etc.
- Lubricant condition for the bearings and suspension joints (where possible), and the function of all joints, bearings, etc.

Cargo and luggage

Take notice of the following information about storage precautions, cargo capacity and load.

Capacity and distribution

Cargo capacity depends on the total weight of the occupants.

(Cargo capacity) = (Total load capacity) – (Total weight of occupants)

Steps for Determining Correct Load Limit—

- (1) Locate the statement “The combined weight of occupants and cargo should never exceed XXX kg or XXX lbs.” on your vehicle’s placard.
- (2) Determine the combined weight of the driver and passengers that will be riding in your vehicle.
- (3) Subtract the combined weight of the driver and passengers from XXX kg or XXX lbs.
- (4) The resulting figure equals the available amount of cargo and luggage load capacity.
For example, if the “XXX” amount equals 1400 lbs. and there will be five 150 lb passengers in your vehicle, the amount of available cargo and luggage load capacity is 650 lbs. $(1400 - 750 (5 \times 150) = 650 \text{ lbs.})$
- (5) Determine the combined weight of luggage and cargo being loaded on the vehicle. That weight may not safely exceed the available cargo and luggage load capacity calculated in Step 4.
- (6) If your vehicle will be towing a trailer, load from your trailer will be transferred to your vehicle. Consult this manual to determine how this reduces the available cargo and luggage load capacity of your vehicle. (→P.186)

Vehicles without towing package: Lexus does not recommend towing a trailer with your vehicle. Your vehicle is not designed for trailer towing.

Calculation formula for your vehicle

- ① Cargo capacity
- ② Total load capacity (vehicle capacity weight) (→P. 606)

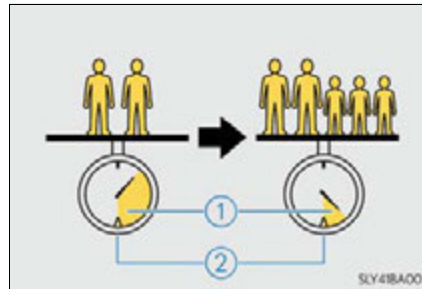

When 2 people with the combined weight of A lb. (kg) are riding in your vehicle, which has a total load capacity (vehicle capacity weight) of B lb. (kg), the available amount of cargo and luggage load capacity will be C lb. (kg) as follows:

$$B^{*2} \text{ lb. (kg)} - A^{*1} \text{ lb. (kg)} = C^{*3} \text{ lb. (kg)}$$

- *1: A = Weight of people
- *2: B = Total load capacity
- *3: C = Available cargo and luggage load

In this condition, if 3 more passengers with the combined weight of D lb. (kg) get on, the available cargo and luggage load will be reduced E lb. (kg) as follows:

$$C \text{ lb. (kg)} - D^{*4} \text{ lb. (kg)} = E^{*5} \text{ lb. (kg)}$$

- *4: D = Additional weight of people
- *5: E = Available cargo and luggage load

As shown in the example above, if the number of occupants increases, the cargo and luggage load will be reduced by an amount that equals the increased weight due to the additional occupants. In other words, if an increase in the number of occupants causes an excess of the total load capacity (combined weight of occupants plus cargo and luggage load), you must reduce the cargo and luggage on your vehicle.

 **WARNING****■ Things that must not be carried in the luggage compartment**

The following things may cause a fire if loaded in the luggage compartment:

- Receptacles containing gasoline
- Aerosol cans

■ Storage precautions

Observe the following precautions.

Failure to do so may prevent the pedals from being depressed properly, may block the driver's vision, or may result in items hitting the driver or passengers, possibly causing an accident.

- Stow cargo and luggage in the luggage compartment whenever possible.
- Do not stack cargo and luggage in the luggage compartment higher than the seat-backs.
- When you fold down the rear seats, long items should not be placed directly behind the front seats.
- Never allow anyone to ride in the luggage compartment. It is not designed for passengers. They should ride in their seats with their seat belts properly fastened.
- Do not place cargo or luggage in or on the following locations.
 - At the feet of the driver
 - On the front passenger or rear seats (when stacking items)
 - On the luggage cover
 - On the instrument panel
 - On the dashboard
- Secure all items in the occupant compartment.

■ Capacity and distribution

- Do not exceed the maximum axle weight rating or the total vehicle weight rating.
- Even if the total load of occupant's weight and the cargo load is less than the total load capacity, do not apply the load unevenly. Improper loading may cause deterioration of steering or braking control which may cause death or serious injury.

■ When using a roof luggage carrier (vehicles with roof rails)

Observe the following precautions:

- Place the cargo so that its weight is distributed evenly between the front and rear axles.
- If loading long or wide cargo, never exceed the vehicle overall length or width. (→P. 606)
- Before driving, make sure the cargo is securely fastened on the roof luggage carrier.
- Loading cargo on the roof luggage carrier will make the center of gravity of the vehicle higher. Avoid high speeds, sudden starts, sharp turns, sudden braking or abrupt maneuvers, otherwise it may result in loss of control or vehicle rollover due to failure to operate this vehicle correctly and result in death or serious injury.
- If driving for a long distance, on rough roads, or at high speeds, stop the vehicle now and then during the trip to make sure the cargo remains in its place.
- Do not exceed 176.3 lb. (80 kg) cargo weight on the roof luggage carrier.

 NOTICE**■ When loading cargo (vehicles with a moon roof)**

Do not set luggage on the moon roof. Failure to observe so may lead to cause damage.

Vehicle load limits

Vehicle load limits include total load capacity, seating capacity, towing capacity and cargo capacity.

◆ **Total load capacity (vehicle capacity weight):** →P. 606

Total load capacity means the combined weight of occupants, cargo and luggage.

◆ **Seating capacity: 5 occupants (Front 2, Rear 3)**

Seating capacity means the maximum number of occupants whose estimated average weight is 150 lb. (68 kg) per person.

◆ **TWR (Trailer Weight Rating) (Vehicles with towing package):**
→P. 190, 606

TWR means the maximum gross trailer weight (trailer weight plus its cargo weight) that your vehicle is able to tow.

◆ **TWR (Trailer Weight Rating) (Vehicles without towing package)**

Lexus does not recommend towing a trailer with your vehicle.

◆ **Cargo capacity**

Cargo capacity may increase or decrease depending on the weight and the number of occupants.

■ **Total load capacity and seating capacity**

These details are also described on the tire and loading information label. (→P. 525)

 **WARNING**

■ **Overloading the vehicle**

Do not overload the vehicle.

It may not only cause damage to the tires, but also degrade steering and braking ability, resulting in an accident.

Trailer towing (vehicles with towing package)

Your vehicle is designed primarily as a passenger-and-load-carrying vehicle. Towing a trailer can have an adverse impact on handling, performance, braking, durability, and fuel consumption. For your safety and the safety of others, you must not overload your vehicle or trailer. You must also ensure that you are using appropriate towing equipment, that the towing equipment has been installed correctly and used properly, and that you employ the requisite driving habits.

Vehicle-trailer stability and braking performance are affected by trailer stability, brake performance and setting, trailer brakes, the hitch and hitch systems (if equipped).

To tow a trailer safely, use extreme care and drive the vehicle in accordance with your trailer's characteristics and operating conditions.

Lexus warranties do not apply to damage or malfunction caused by towing a trailer for commercial purposes.

Contact your Lexus dealer for further information about additional requirements such as a towing kit, etc.

Towing related terms

■ **GCWR (Gross Combination Weight Rating)**

The maximum allowable gross combination weight. The gross combination weight is the sum of the total vehicle weight (including the occupants, cargo and any optional equipment installed on the vehicle) and the weight of the trailer being towed (including the cargo in the trailer).

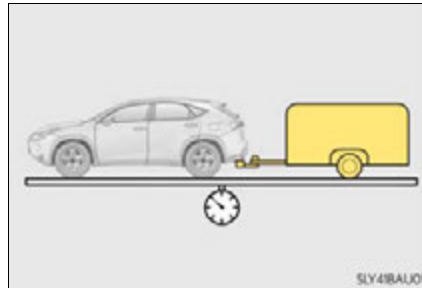

■ **GVWR (Gross Vehicle Weight Rating)**

The maximum allowable gross vehicle weight. The gross vehicle weight is the total weight of the vehicle. When towing a trailer, it is the sum of the vehicle weight (including the occupants, cargo and any optional equipment installed on the vehicle) and the tongue weight.

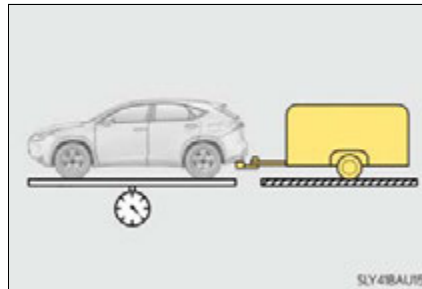

■ **GAWR (Gross Axle Weight Rating)**

The maximum allowable gross axle weight. The gross axle weight is the load placed on each axle (front and rear).

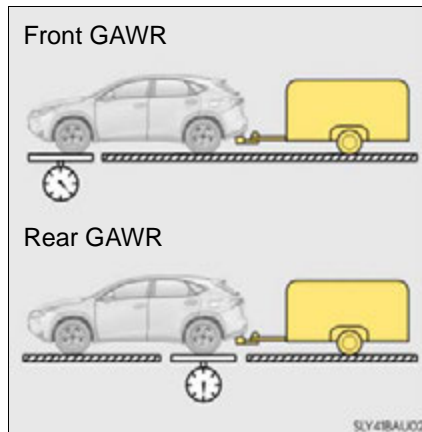

■ **TWR (Trailer Weight Rating)**

The maximum allowable gross trailer weight. The gross trailer weight is the sum of the trailer weight and the weight of the cargo in the trailer.

TWR is calculated assuming base vehicle with one driver, one front passenger, towing package (if available), hitch and hitch systems (if required).

Additional optional equipment, passengers and cargo in the vehicle will reduce the trailer weight rating so as not to exceed GCWR, GVWR and GAWR.

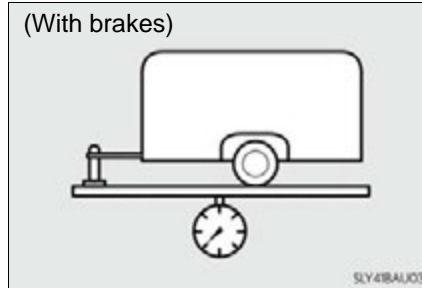

■ **Unbraked TWR (Unbraked Trailer Weight Rating)**

The trailer weight rating for towing a trailer without a trailer service brake system.

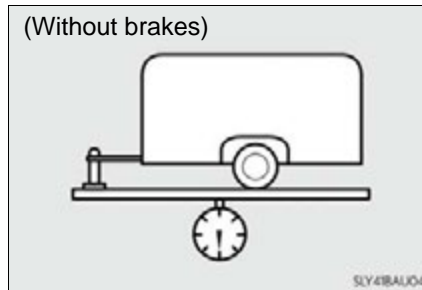

■ **Tongue Weight**

The load placed on the trailer hitch ball. (→P.191)

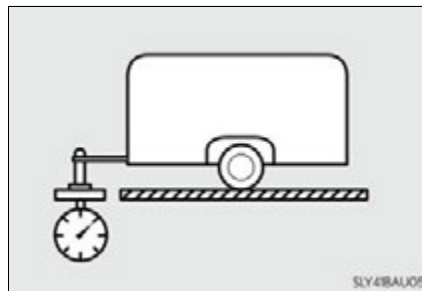

Weight limits

- The gross trailer weight must never exceed 1500 lb. (685 kg).
 - The gross combination weight must never exceed 6835 lb. (3100 kg).
 - The gross vehicle weight must never exceed the GVWR indicated on the Certification Label.
 - The gross axle weight on each axle must never exceed the GAWR indicated on the Certification Label.
- 
- If the gross trailer weight is over the unbraked TWR, trailer service brakes are required.

GCWR, TWR and Unbraked TWR

Confirm that the gross trailer weight, gross combination weight, gross vehicle weight, gross axle weight and tongue weight are all within the limits.

- **GCWR***
6835 lb. (3100 kg)
- **TWR***
1500 lb. (685 kg)
- **Unbraked TWR***
1000 lb. (450 kg)

*: These models meet the tow-vehicle trailering requirement of SAE International per SAE J2807.

Trailer Tongue Weight

- A recommended tongue weight varies in accordance with the types of trailers or towing as described below.
- To ensure the recommended values shown below, the trailer must be loaded by referring to the following instructions.

- Tongue Weight

The gross trailer weight should be distributed so that the tongue weight is 9% to 11%.

(Tongue weight / Gross trailer weight x 100 = 9% to 11%)

- ① Gross trailer weight
- ② Tongue weight

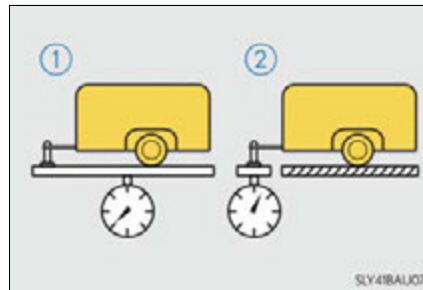

The gross trailer weight, gross axle weight and tongue weight can be measured with platform scales found at a highway weighing station, building supply company, trucking company, junk yard, etc.

Hitch

Trailer hitch assemblies have different weight capacities. Lexus recommends the use of Lexus hitch/bracket for your vehicle. For details, contact your Lexus dealer.

- If you wish to install a trailer hitch, contact your Lexus dealer.
- Use only a hitch that conforms to the gross trailer weight requirement of your vehicle.
- Follow the directions supplied by the hitch manufacturer.
- Lubricate the hitch ball with a light coating of grease.
- Remove the trailer hitch whenever you are not towing a trailer. After removing the hitch, seal any mounting hole in the vehicle body to prevent entry of any substances into the vehicle.

Positions for towing hitch receiver and hitch ball

- ① Weight carrying ball position:
42.1 in. (1069.9 mm)
- ② Hitch receiver pin hole position:
33.7 in. (855.6 mm)

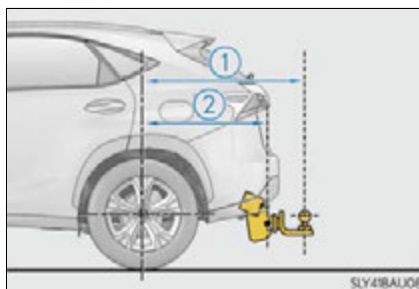

Connecting trailer lights

Please consult your dealer when installing trailer lights, as incorrect installation may cause damage to the vehicle's lights. Please take care to comply with your state's laws when installing trailer lights.

Trailer towing tips

Your vehicle will handle differently when towing a trailer. Help to avoid an accident, death or serious injury, keep the following in mind when towing:

- Speed limits for towing a trailer vary by state or province. Do not exceed the posted towing speed limit.
- Lexus recommends that the vehicle-trailer speed limit is 65 mph (104 km/h) on a flat, straight, dry road. Do not exceed this limit, the posted towing speed limit or the speed limit for your trailer as set forth in your trailer owner's manual, whichever is lowest. Instability of the towing vehicle-trailer combination (trailer sway) increases as speed increases. Exceeding speed limits may cause loss of control.
- Before starting out, check the trailer lights, tires and the vehicle-trailer connections. Recheck after driving a short distance.
- Practice turning, stopping and reversing with the trailer attached in an area away from traffic until you become accustomed to the feel of the vehicle-trailer combination.

- Reversing with a trailer attached is difficult and requires practice. Grip the bottom of the steering wheel and move your hand to the left to move the trailer to the left. Move your hand to the right to move the trailer to right. (This is generally opposite to reversing without a trailer attached.) Avoid sharp or prolonged turning. Have someone guide you when reversing to reduce the risk of an accident.
- As stopping distance is increased when towing a trailer, vehicle-to-vehicle distance should be increased. For each 10 mph (16 km/h) of speed, allow at least one vehicle and trailer length.
- Avoid sudden braking as you may skid, resulting in the trailer jackknifing and a loss of vehicle control. This is especially true on wet or slippery surfaces.
- Avoid jerky starts or sudden acceleration.
- Avoid jerky steering and sharp turns, and slow down before making turn.
- Note that when making a turn, the trailer wheels will be closer than the vehicle wheels to the inside of the turn. Compensate by making a wider than normal turning radius.
- Slow down before making a turn, in cross winds, on wet or slippery surfaces, etc.
Increasing vehicle speed can destabilize the trailer.
- Take care when passing other vehicles. Passing requires considerable distance. After passing a vehicle, do not forget the length of your trailer, and be sure you have plenty of room before changing lanes.
- To maintain engine braking efficiency and charging system performance when using engine braking, do not put the transmission in D. (→P. 208)
- Instability happens more frequently when descending steep or long downhill grades. Before descending, slow down and downshift. Do not make sudden downshifts while descending steep or long downhill grades.
- Avoid holding the brake pedal down too long or applying the brakes too frequently. This could cause the brakes to overheat and result in reduced braking efficiency.
- Due to the added load of the trailer, your vehicle's engine may overheat on hot days (at temperatures over 85°F [30°C]) when driving up a long or steep grade. If the engine coolant temperature gauge indicates overheating, immediately turn off the air conditioning (if in use), pull your vehicle off the road and stop in a safe spot. (→P. 599)

- Always place wheel blocks under both the vehicle's and the trailer's wheels when parking. Put the transmission in P and apply the parking brake. Avoid parking on a slope, but if unavoidable, do so only after performing the following:
 - 1 Apply the brakes and keep them applied.
 - 2 Have someone place wheel blocks under both the vehicle's and trailer's wheels.
 - 3 When the wheel blocks are in place, release the brakes slowly until the blocks absorb the load.
 - 4 Shift into P and apply the parking brake.
 - 5 Turn off the hybrid system.
- When restarting after parking on a slope:
 - 1 With the transmission in P, start the hybrid system. Be sure to keep the brake pedal depressed.
 - 2 Shift into a forward gear. If reversing, shift into R.
 - 3 If the parking brake is in manual mode, release the parking brake. (→P. 214)
 - 4 Release the brake pedal, and slowly pull or back away from the wheel blocks. Stop and apply the brakes.
 - 5 Have someone retrieve the blocks.

■ Matching trailer ball height to trailer coupler height

No matter which class of tow hitch applies, for a more safe trailer hookup, the trailer ball setup must be the proper height for the coupler on the trailer.



- ① Coupler
- ② Trailer ball

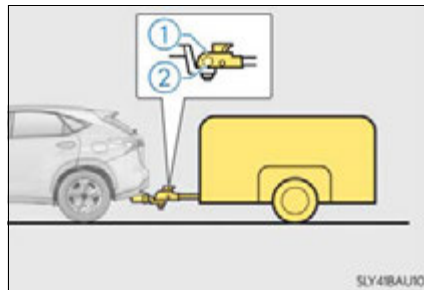

■ Before towing

Check that the following conditions are met:

- Ensure that your vehicle's tires are properly inflated. (→P. 613)
- Trailer tires are inflated according to the trailer manufacturer's recommendation.
- All trailer lights work as required by law.
- All lights work each time you connect them.
- The trailer ball is set at the proper height for the coupler on the trailer.
- The trailer is level when it is hitched.
Do not drive if the trailer is not level, and check for improper tongue weight, overloading, worn suspension, or other possible causes.
- The trailer cargo is securely loaded.
- The rear view mirrors conform to all applicable federal, state/provincial or local regulations. If they do not, install rear view mirrors appropriate for towing purposes.

■ **Break-in schedule**

If your vehicle is new or equipped with any new power train components (such as an engine, transmission, differential or wheel bearing), Lexus recommends that you do not tow a trailer until the vehicle has been driven for over 500 miles (800 km).

After the vehicle has been driven for over 500 miles (800 km), you can start towing. However, for the next 500 miles (800 km), drive the vehicle at a speed of less than 50 mph (80 km/h) when towing a trailer, and avoid full throttle acceleration.

■ **Maintenance**

● If you tow a trailer, your vehicle will require more frequent maintenance due to the additional load. (See “Warranty and Services Guide”, “Owner’s Manual Supplement” or “Scheduled Maintenance”.)

● Retighten the fixing bolts of the towing ball and bracket after approximately 600 miles (1000 km) of trailer towing.

■ **If trailer sway occurs**

One or more factors (crosswinds, passing vehicles, rough roads, etc.) can adversely affect handling of your vehicle and trailer, causing instability.

● If trailer swaying occurs:

- Firmly grip the steering wheel. Steer straight ahead.
Do not try to control trailer swaying by turning the steering wheel.
- Begin releasing the accelerator pedal immediately but very gradually to reduce speed.
Do not increase speed. Do not apply vehicle brakes.

If you make no extreme correction with the steering or brakes, your vehicle and trailer should stabilize.

● After the trailer swaying has stopped:

- Stop in a safe place. Get all occupants out of the vehicle.
- Check the tires of the vehicle and the trailer.
- Check the load in the trailer.
Make sure the load has not shifted.
Make sure the tongue weight is appropriate, if possible.
- Check the load in the vehicle.

Make sure the vehicle is not overloaded after occupants get in.

If you cannot find any problems, the speed at which trailer swaying occurred is beyond the limit of your particular vehicle-trailer combination. Drive at a lower speed to prevent instability. Remember that swaying of the towing vehicle-trailer increases as speed increases.

⚠ WARNING**■ Trailer towing precautions**

To tow a trailer safely, use extreme care and drive the vehicle in accordance with the trailer's characteristics and operating conditions. Failure to do so could cause an accident resulting in death or serious injury. Vehicle stability and braking performance are affected by trailer stability, brake setting and performance, and the hitch. Your vehicle will handle differently when towing a trailer.

■ To avoid accident or injury

- Do not exceed the TWR, unbraked TWR, GCWR, GVWR or GAWR.
- Adjust the tongue weight within the appropriate range. Place heavier loads as close to the trailer axle as possible.
- Do not exceed 65 mph (104 km/h), the posted towing speed limit or the speed limit for your trailer as set forth in your trailer owner's manual, whichever is lowest. Slow down sufficiently before making a turn, in cross winds, on wet or slippery surface, etc. to help avoid an accident. If you experience a vehicle-trailer instability from reducing a certain speed, slow down and make sure you keep your vehicle speed under the speed of which you experience the instability.
- Do not make jerky, abrupt or sharp turns.
- Do not apply the brakes suddenly as you may skid, resulting in jackknifing and loss of vehicle control. This is especially true on wet or slippery surfaces.
- Do not exceed the trailer hitch assembly weight, gross vehicle weight, gross axle weight and trailer tongue weight capacities.
- Do not use the following systems when trailer towing.
 - Cruise control (if equipped)
 - Dynamic radar cruise control (if equipped)
 - Dynamic cruise control with full-speed range (if equipped)
- Slow down and downshift before descending steep or long downhill grades. Do not make sudden downshifts while descending steep or long downhill grades.
- Vehicle-trailer instability is more likely on steep long downhills. Before descending steep or long downhill grades, slow down and downshift. Do not make sudden downshifts when descending steep or long downhill grades. Avoid holding the brake pedal down too long or applying the brakes too frequently. This could cause the brakes to overheat and result in reduced braking efficiency.
- Vehicles with a compact spare tire: Do not tow a trailer when the compact spare tire is installed on your vehicle.

■ Hitch

Trailer hitch assemblies have different weight capacities established by the hitch manufacturer. Even though the vehicle may be physically capable of towing a higher weight, the operator must determine the maximum weight rating of the particular hitch assembly and never exceed the maximum weight rating specified for the trailer-hitch. Exceeding the maximum weight rating set by the trailer-hitch manufacturer can cause an accident resulting in death or serious personal injuries.

 **WARNING****■ When towing a trailer**

Lexus recommends trailers with brakes that conform to any applicable federal and state/provincial regulations.

- If the gross trailer weight exceeds unbraked TWR, trailer brakes are required. Lexus recommends trailers with brakes that conform to all applicable federal and state/provincial regulations.
- Never tap into your vehicle's hydraulic system, as this will lower the vehicle's braking effectiveness.
- Never tow a trailer without using a safety chain securely attached to both the trailer and the vehicle. If damage occurs to the coupling unit or hitch ball, there is danger of the trailer wandering into another lane.

 **NOTICE****■ When installing a trailer hitch**

Use only the position recommended by your Lexus dealer. Do not install the trailer hitch on the bumper; this may cause body damage.

■ Do not directly splice trailer lights

Do not directly splice trailer lights. Directly splicing trailer lights may damage your vehicle's electrical system and cause a malfunction.

Trailer towing (vehicles without towing package)

Lexus does not recommend towing a trailer with your vehicle. Lexus also does not recommend the installation of a tow hitch or the use of a tow hitch carrier for a wheelchair, scooter, bicycle, etc. Your vehicle is not designed for trailer towing or for the use of tow hitch mounted carriers.



4

Driving

Dinghy towing

Your vehicle is not designed to be dinghy towed (with 4 wheels on the ground) behind a motor home.



⚠ NOTICE

■ **To avoid serious damage to your vehicle**

Do not tow your vehicle with the four wheels on the ground.

■ **To prevent causing serious damage to the hybrid transmission and AWD system (AWD models)**

2WD models: Never tow this vehicle from the rear with the front wheels on the ground. This may cause serious damage to the hybrid transmission.



AWD models: Never tow this vehicle with any of the wheels on the ground. This may cause serious damage to the hybrid transmission and AWD system.



Power (ignition) switch

Performing the following operations when carrying the electronic key on your person starts the hybrid system or changes power switch modes.

Starting the hybrid system

- 1 Check that the parking brake is set.
- 2 Check that the shift lever is in P.
- 3 Firmly depress the brake pedal.

 and a message will be displayed on the multi-information display. If it is not displayed, the hybrid system cannot be started.



- 4 Press the power switch.

If the "READY" indicator turns on, the hybrid system will operate normally.

Continue depressing the brake pedal until the "READY" indicator is illuminated.

The hybrid system can be started from any power switch mode.



- 5 Check that the "READY" indicator is illuminated.

The vehicle will not move when the "READY" indicator is off.

Stopping the hybrid system

- 1 Stop the vehicle completely.
- 2 Shift the shift lever to P. (→P. 208)
- 3 Set the parking brake. (→P. 214)
If the parking brake is in automatic mode, the parking brake is set automatically when shifting the shift lever to P. (→P. 213)
- 4 Press the power switch.
- 5 Release the brake pedal and check that the display on the instrument cluster is off.

Changing power switch modes

Modes can be changed by pressing the power switch with brake pedal released. (The mode changes each time the switch is pressed.)

- 1 Off*
The emergency flashers can be used.
- 2 ACCESSORY mode
Some electrical components such as the audio system can be used.
"ACCESSORY" will be displayed on the multi-information display.
- 3 ON mode
All electrical components can be used.
"IGNITION ON" will be displayed on the multi-information display.

*: If the shift lever is in a position other than P when turning off the hybrid system, the power switch will be turned to ACCESSORY mode, not to off.

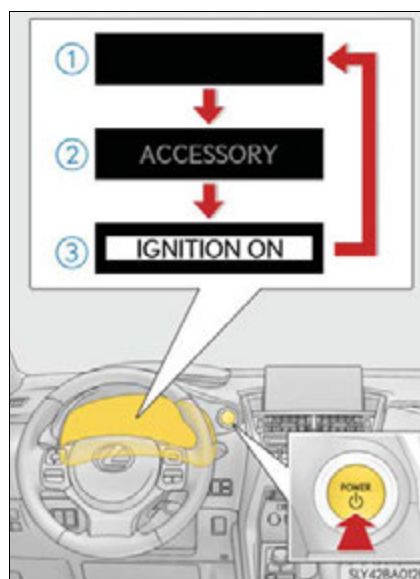

When stopping the hybrid system with the shift lever in a position other than P

If the hybrid system is stopped with the shift lever in a position other than P, the power switch will not be turned off but instead be turned to ACCESSORY mode. Perform the following procedure to turn the switch off:

- 1 Check that the parking brake is set.
- 2 Shift the shift lever to P.
- 3 Check that "Turn Off Vehicle" is displayed on the multi-information display and then press the power switch once.
- 4 Check that "Turn Off Vehicle" on the multi-information display is off.

■ Auto power off function

If the vehicle is left in ACCESSORY mode for more than 20 minutes or ON mode (the hybrid system is not operating) for more than an hour with the shift lever in P, the power switch will automatically turn off. However, this function cannot entirely prevent 12-volt battery discharge. Do not leave the vehicle with the power switch in ACCESSORY or ON mode for long periods of time when the hybrid system is not operating.

■ Sounds and vibrations specific to a hybrid vehicle

→P. 80

■ Electronic key battery depletion

→P. 121

■ When the ambient temperature is low, such as during winter driving conditions

When starting the hybrid system, the flashing time of the "READY" indicator may be long. Leave the vehicle as it is until the "READY" indicator is steady on, as steady means the vehicle is able to move.

■ Conditions affecting operation

→P. 142

■ Note for the entry function

→P. 143

■ If the hybrid system does not start

- The immobilizer system may not have been deactivated. (→P. 86)
Contact your Lexus dealer.
- Check that the shift lever is securely set in P. The hybrid system may not start if the shift lever is displaced out of P. "To Start Vehicle, Put Shift Lever into P" will be displayed on the multi-information display.

■ Steering lock

After turning the power switch off and opening and closing the doors, the steering wheel will be locked due to the steering lock function. Operating the power switch again automatically cancels the steering lock.

■ **When the steering lock cannot be released**

A message will be displayed on the multi-information display.

Check that the shift lever is in P. Press the power switch while turning the steering wheel left and right.

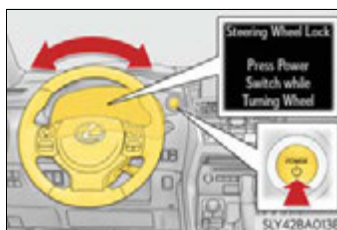

■ **Steering lock motor overheating prevention**

To prevent the steering lock motor from overheating, operation of the motor may be suspended if the hybrid system is turned on and off repeatedly in a short period of time. In this case, refrain from operating the hybrid system. After about 10 seconds, the steering lock motor will resume functioning.

■ **When “Smart Access System Malfunction See Owner’s Manual” is displayed on the multi-information display**

The system may be malfunctioning. Have the vehicle inspected by your Lexus dealer immediately.

■ **If the “READY” indicator does not come on**

In the event that the “READY” indicator does not come on even after performing the proper procedures for starting the vehicle, contact your Lexus dealer immediately.

■ **If the hybrid system is malfunctioning**

→P. 82

■ **If the electronic key battery is depleted**

→P. 532

■ **Operation of the power switch**

- When operating the power switch, one short, firm press is enough. If the switch is pressed improperly, the hybrid system may not start or the power switch mode may not change. It is not necessary to press and hold the switch.
- If attempting to restart the hybrid system immediately after turning the power switch off, the hybrid system may not start in some cases. After turning the power switch off, please wait a few seconds before restarting the hybrid system.

■ **If the smart access system with push-button start has been deactivated by a customized setting**

→P. 592

⚠ WARNING**■ When starting the hybrid system**

Always start the hybrid system while sitting in the driver's seat. Do not depress the accelerator pedal while starting the hybrid system under any circumstances. Doing so may cause an accident resulting in death or serious injury.

■ Caution while driving

If hybrid system failure occurs while the vehicle is moving, do not lock or open the doors until the vehicle reaches a safe and complete stop. The steering lock function will activate and this may lead to an accident, resulting in death or serious injury.

■ Stopping the hybrid system in an emergency

If you want to stop the hybrid system in an emergency while driving the vehicle, press and hold the power switch for more than 2 seconds, or press it briefly 3 times or more in succession. (→P. 557)

However, do not touch the power switch while driving except in an emergency. Turning the hybrid system off while driving will not cause loss of steering or braking control, however, power assist to the steering will be lost. This will make it more difficult to steer smoothly, so you should pull over and stop the vehicle as soon as it is safe to do so.

⚠ NOTICE**■ To prevent 12-volt battery discharge**

- Do not leave the power switch in ACCESSORY or ON mode for long periods of time without the hybrid system on.
- If "ACCESSORY" or "IGNITION ON" is displayed on the multi-information display while the hybrid system is not operating, the power switch is not off. Exit the vehicle after turning the power switch off.
- Do not stop the hybrid system when the shift lever is in a position other than P. If the hybrid system is stopped in another shift lever position, the power switch will not be turned off but instead be turned to ACCESSORY mode. If the vehicle is left in ACCESSORY mode, 12-volt battery discharge may occur.

■ When starting the hybrid system

If the hybrid system becomes difficult to start, have your vehicle checked by your Lexus dealer immediately.

■ Symptoms indicating a malfunction with the power switch

If the power switch seems to be operating somewhat differently than usual, such as the switch sticking slightly, there may be a malfunction. Contact your Lexus dealer immediately.

EV drive mode

In EV drive mode, electric power is supplied by the hybrid battery (traction battery), and only the electric motor (traction motor) is used to drive the vehicle.

This mode allows you to drive in residential areas early in the morning and late at night, or in indoor parking lots, etc., without concern for noises and gas emissions.

Turns EV drive mode on/off

When EV drive mode is turned on, the EV drive mode indicator will come on.

Pressing the switch when in EV drive mode will return the vehicle to normal driving (using the gasoline engine and electric motor [traction motor]).

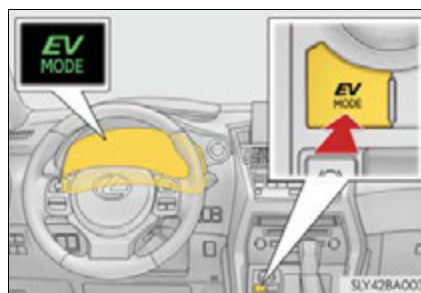

■ Situations in which EV drive mode cannot be turned on

It may not be possible to turn EV drive mode on in the following situations. If it cannot be turned on, a buzzer will sound and a message will be shown on the multi-information display.

- The temperature of the hybrid system is high.
The vehicle has been left in the sun, driven on a hill, driven at high speeds, etc.
- The temperature of the hybrid system is low.
The vehicle has been left in temperatures lower than about 32 °F (0 °C) for a long period of time, etc.
- The gasoline engine is warming up.
- The hybrid battery (traction battery) is low.
The remaining battery level indicated in the “Energy Monitor” display is low. (→P. 112)
- Vehicle speed is high.
- The accelerator pedal is depressed firmly or the vehicle is on a hill, etc.
- The windshield defogger is in use.

■ Switching to EV drive mode when the gasoline engine is cold

If the hybrid system is started while the gasoline engine is cold, the gasoline engine will start automatically after a short period of time in order to warm up. In this case, you will become unable to switch to EV drive mode.

After the hybrid system has started and the "READY" indicator has illuminated, press the EV drive mode switch before the gasoline engine starts to switch to EV drive mode.

■ Automatic cancelation of EV drive mode

When driving in EV drive mode, the gasoline engine may automatically restart in the following situations. When EV drive mode is canceled, a buzzer will sound, the EV drive mode indicator will go off after flashing, and a message is displayed on the multi-information display.

- The hybrid battery (traction battery) becomes low.
The remaining battery level indicated in the "Energy Monitor" display is low. (→P. 112)
- Vehicle speed is high.
- The accelerator pedal is depressed firmly or the vehicle is on a hill, etc.

■ Possible driving distance when driving in EV drive mode

EV drive mode's possible driving distance ranges from a few hundred meters to approximately 0.6 mile (1 km). However, depending on vehicle conditions, there are situations when EV drive mode cannot be used. (The distance that is possible depends on the hybrid battery [traction battery] level and driving conditions.)

■ Fuel economy

The hybrid system is designed to achieve the best possible fuel economy during normal driving (using the gasoline engine and electric motor [traction motor]). Driving in EV drive mode more than necessary may lower fuel economy.

WARNING

■ Caution while driving

When driving in EV drive mode, pay special attention to the area around the vehicle. Because there is no engine noise, pedestrians, people riding bicycles or other people and vehicles in the area may not be aware of the vehicle starting off or approaching them, so take extra care while driving.

Hybrid transmission

Shifting the shift lever

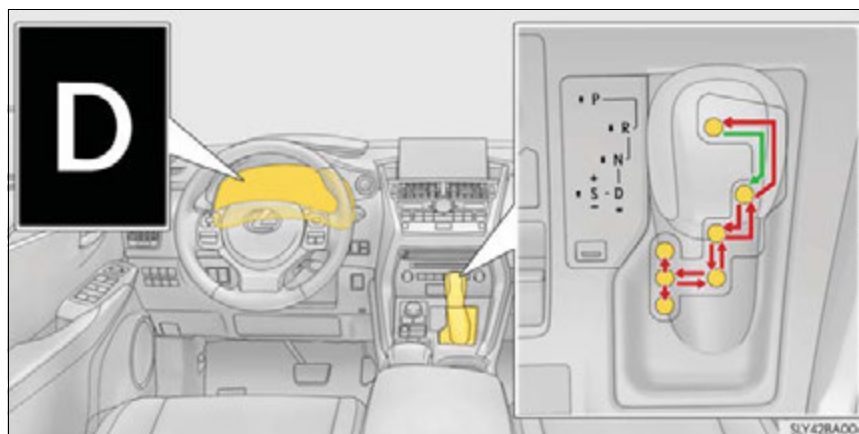

← While the power switch is in ON mode, move the shift lever with the brake pedal depressed.

When shifting the shift lever between P and D, make sure that the vehicle is completely stopped.

Shift position purpose

Shift position	Objective or function
P	Parking the vehicle/starting the hybrid system
R	Reversing
N	Neutral
D	Normal driving ^{*1}
S	S mode driving ^{*2} (→P. 209)

^{*1}: To improve fuel efficiency and reduce noise, shift the shift lever to D for normal driving.

^{*2}: By selecting shift ranges using S mode, you can control accelerating force and engine braking force.

Selecting the driving mode

→P. 303

Selecting shift ranges in the S position

To enter S mode, shift the shift lever to S. Shift ranges can be selected by operating the shift lever, allowing you to drive in the shift range of your choice. The shift range can be selected by operating the shift lever.

- ① Upshifting
- ② Downshifting

The selected shift range, from 1 to 6, will be displayed.

The initial shift range in S mode is 4.

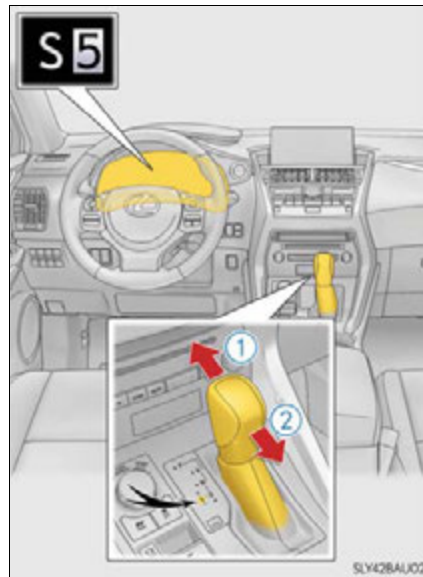
**■ Shift ranges and their functions**

- You can choose from 6 levels of accelerating force and engine braking force.
- A lower shift range will provide greater accelerating force and engine braking force than a higher shift range, and the engine revolutions will also increase.

■ S mode

- When the shift range is 4 or lower, holding the shift lever toward “+” sets the shift range to 6.
- Automatically selects a higher shift range before the engine speed becomes too high.

■ Downshifting restriction warning buzzer

To help ensure safety and driving performance, downshifting operation may sometimes be restricted. In some circumstances, downshifting may not be possible even when the shift lever is operated. (A buzzer will sound twice.)

■ When driving with cruise control (if equipped), dynamic radar cruise control (if equipped) or dynamic radar cruise control with full-speed range (if equipped) activated

Even when performing the following actions with the intent of enabling engine braking, engine braking will not activate because cruise control, dynamic radar cruise control or dynamic radar cruise control with full-speed range will not be canceled.

- While driving in S mode, downshifting to 5 or 4. (→P. 209)
- When switching the driving mode to sport mode while driving in D position. (→P. 303)

■ Restraining sudden start (Drive-Start Control)

When the following unusual operation is performed, the hybrid system output may be restrained.

- When the shift lever is shifted from R to D, D to R, N to R, P to D, or P to R (D includes S) with the accelerator pedal depressed, a warning message appears on the multi-information display. If a warning message is shown on the multi-information display, read the message and follow the instructions.
- When the accelerator pedal is depressed too while the vehicle is in reverse.

■ If the shift lever cannot be shifted from P

→P. 590

 **WARNING****■ When driving on slippery road surfaces**

Be careful of downshifting and sudden acceleration, as this could result in the vehicle skidding to the side or spinning.

 **NOTICE****■ Hybrid battery (traction battery) charge**

If the shift lever is in N, the hybrid battery (traction battery) will not be charging, even when the engine is running. Therefore, if the vehicle is left with the shift lever in N for a long period of time, the hybrid battery (traction battery) will discharge, and this may result in the vehicle not being able to start.

Turn signal lever

Operating instructions

- ① Right turn
- ② Lane change to the right (move the lever partway and release it)
The right hand signals will flash 3 times.
- ③ Lane change to the left (move the lever partway and release it)
The left hand signals will flash 3 times.
- ④ Left turn

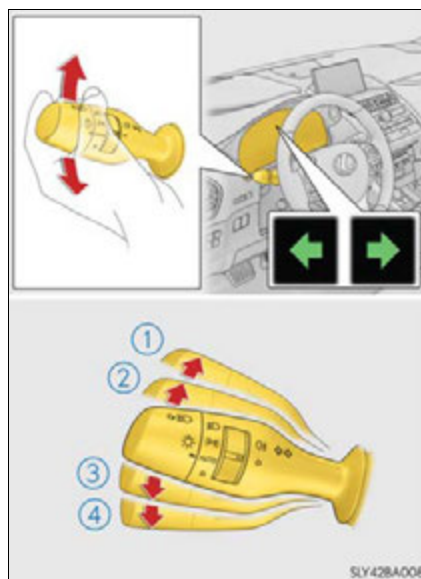

- **Turn signals can be operated when**
The power switch is in ON mode.
- **If the indicator flashes faster than usual**
Check that a light bulb in the front or rear turn signal lights has not burned out.

Parking brake

A selections can be made as desired from the following modes.

Automatic mode

The parking brake is set or released automatically according to shift lever operation.

Even when in automatic mode, the parking brake can be set and released manually. (→P. 214)

- ① Turns automatic mode on (while the vehicle is stopped, pull and hold the parking brake switch until the automatic mode lamp turns on)
 - When the shift lever is moved out of P, the parking brake will be released, and the parking brake indicator light and parking brake lamp turn off.
 - When the shift lever is moved into P, the parking brake will be set, and the parking brake indicator light and parking brake lamp turn on.

Operate the shift lever with the brake pedal depressed.

- ② Turns automatic mode off (while the vehicle is stopped, press and hold the parking brake switch until the automatic mode lamp turns off)

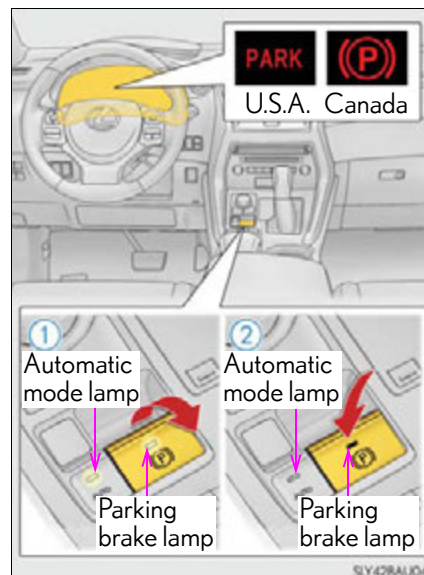

Manual mode

The parking brake can be set and released manually.

① Sets the parking brake

The parking brake indicator light and parking brake lamp will turn on.

Pull and hold the parking brake switch if an emergency occurs and it is necessary to operate the parking brake while driving.

② Releases the parking brake

Operate the parking brake switch while depressing the brake pedal. Make sure that the parking brake indicator light and parking brake lamp turn off.

If the parking brake indicator light and parking brake lamp flashes, operate the switch again. (→P. 566)

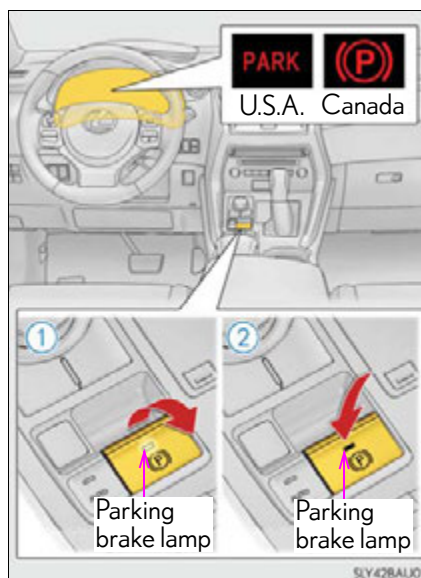

■ Parking brake operation

- When the power switch is not in ON mode, the parking brake cannot be released using the parking brake switch.
- When the power switch is not in ON mode, automatic mode (automatic brake setting and releasing) is not available.

■ If "Parking Brake Overheated Parking Brake Unavailable" is displayed on the multi-information display

If the parking brake is operated repeatedly over a short period of time, the system may restrict operation to prevent overheating. If this happens, refrain from operating the parking brake. Normal operation will return after about 1 minute.

■ Parking brake operation sound

When the parking brake operates, a motor sound (whirring sound) may be heard. This does not indicate a malfunction.

■ Parking brake indicator light and parking brake lamp

- Depending on the power switch mode, the parking brake indicator light and parking brake lamp will turn on and stay on as described below:
ON mode: Comes on until the parking brake is released.
Not in ON mode: Stays on for approximately 15 seconds.
- When the power switch is turned off with the parking brake set, the parking brake indicator light and parking brake lamp will stay on for about 15 seconds. This does not indicate a malfunction.

- **Changing the mode**
When changing the automatic mode on/off, the message will be shown on the multi-information display and the buzzer sounds.
- **Parking brake engaged warning buzzer**
A buzzer will sound if the vehicle is driven with the parking brake engaged. "Release Parking Brake" is displayed on the multi-information display.
- **Warning messages and buzzers**
Warning messages and buzzers are used to indicate a system malfunction or to inform the driver of the need for caution. If a warning message is shown on the multi-information display, read the message and follow the instructions.
- **If the brake system warning light comes on**
→P. 565
- **Usage in winter time**
→P. 327

 WARNING
<ul style="list-style-type: none"> ■ When parking the vehicle Do not leave a child in the vehicle alone. The parking brake may be released unintentionally and there is the danger of the vehicle moving that may lead to an accident resulting in death or serious injury.

 NOTICE
<ul style="list-style-type: none"> ■ When parking the vehicle Before you leave the vehicle, shift the shift lever to P, set the parking brake and make sure that the vehicle does not move. ■ When the system malfunctions Stop the vehicle in a safe place and check the warning messages. ■ When the parking brake cannot be released due to a malfunction Driving the vehicle with the parking brake set will lead to brake components overheating, which may affect braking performance and increase brake wear. Have the vehicle inspected by contact your Lexus dealer immediately if this occurs.

Brake Hold

The brake hold system keeps the brake applied when the shift lever is in D, S or N with the system on and the brake pedal has been depressed to stop the vehicle. The system releases the brake when the accelerator pedal is depressed with the shift lever in D or S to allow smooth start off.

Turns the brake hold system on

The brake hold standby indicator (green) comes on. While the system is holding the brake, the brake hold operated indicator (yellow) comes on.

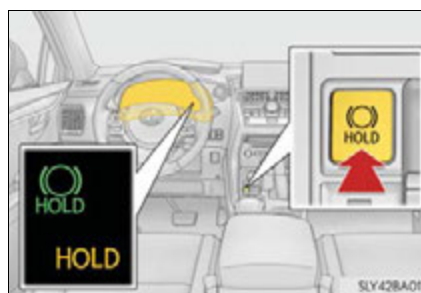

■ Brake hold system operating conditions

The brake hold system cannot be turned on in the following conditions:

- The back door or hood is not closed.
- The driver's door is not closed.
- The driver is not wearing the seat belt.

If any of the conditions above are detected when the brake hold system is enabled, the system will turn off and the brake hold standby indicator light will go off. In addition, if any of the conditions are detected while the system is holding the brake, a warning buzzer will sound and a message will be shown on the multi-information display. The parking brake will then be set automatically.

■ Brake hold function

- If the brake pedal is left released for a period of about 3 minutes after the system has started holding the brake, the parking brake will be set automatically. In this case, a warning buzzer sounds and a message is shown on the multi-information display.
- To turn the system off while the system is holding the brake, firmly depress the brake pedal and press the button again.
- The brake hold function may not hold the vehicle when the vehicle is on a steep incline. In this situation, it may be necessary for the driver to apply the brakes. A warning buzzer will sound and the multi-information display will inform the driver of this situation. If a warning message is shown on the multi-information display, read the message and follow the instructions.

■ When the parking brake is set automatically while the system is holding the brakes

The parking brake will not be released automatically. With the brake pedal depressed, release the parking brake by operating the parking brake switch, making sure that the parking brake indicator light goes off. (→P. 213)

■ If “Brake Hold Fault Depress Brake to Deactivate Visit Your Dealer” is displayed on the multi-information display

The system may be malfunctioning. Have the vehicle inspected by your Lexus dealer.

■ **Warning messages and buzzers**

Warning messages and buzzers are used to indicate a system malfunction or to inform the driver of the need for caution. If a warning message is shown on the multi-information display, read the message and follow the instructions.

■ **If the brake hold operated indicator flashes**

→P. 566

 **WARNING**

■ **When the vehicle is on a steep incline**

When using the brake hold system on a steep incline exercise caution. The brake hold function may not hold the vehicle in such a situation.

■ **When stopped on a slippery road**

The system cannot stop the vehicle when the gripping ability of the tires has been exceeded. Do not use the system when stopped on a slippery road.

 **NOTICE**

■ **When parking the vehicle**

The brake hold system is not designed for use when parking the vehicle for a long period of time. Turning the power switch off while the system is holding the brake may release the brake, which would cause the vehicle to move. When operating the power switch, depress the brake pedal, shift the shift lever to P and set the parking brake.

ASC (Active Sound Control)*

The ASC system is an electronic sound system that generates engine sound, conveying the kinetic situations of the vehicle's acceleration and deceleration to the driver through the speakers inside the instrument panel.

The vehicle's response to the driver's acceleration behavior and shift operations are also conveyed in sound.

When sport mode is selected, the sound conveyed to the driver will be louder.

Controlling volume

① Louder

② Lower

The indicator comes on when the ASC system is on.

When the dial is turned to the lowest volume, the ASC system will be turned off and the indicator will go off.



■ The ASC system can be operated when

The driving mode select switch is in normal mode or sport mode.

■ Temporary cancelation of the ASC system functions

The ASC system may be temporarily canceled depending on the driving conditions, such as when the tires slip due to sudden acceleration.

*: If equipped



Headlight switch

The headlights can be operated manually or automatically.

Operating instructions



Turning the end of the lever turns on the lights as follows:

► Type A

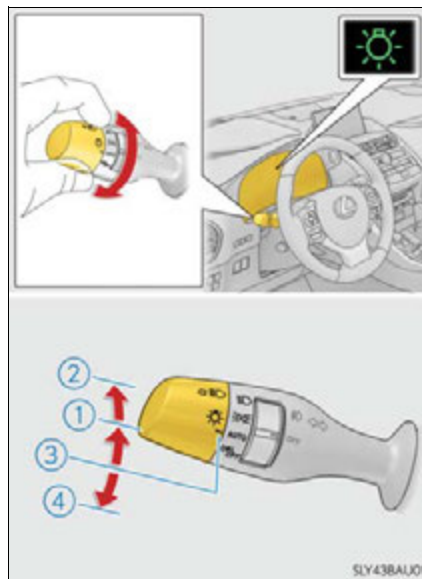
- ①  The side marker, parking, tail, license plate, daytime running lights (→P. 221), instrument panel and switch lights turn on.
- ②  The headlights and all the lights listed above (except daytime running lights) turn on.
- ③ AUTO The headlights, daytime running lights (→P. 221) and all the lights listed above turn on and off automatically (when the power switch is in ON mode).
- ④  The daytime running lights turn off.



► Type B

- ①  The side marker, parking, tail, license plate, daytime running lights (→P. 221), instrument panel and switch lights turn on.
- ②  The headlights and all the lights listed above (except daytime running lights) turn on.
- ③ AUTO The headlights, daytime running lights (→P. 221) and all the lights listed above turn on and off automatically (when the power switch is in ON mode).
- ④  The daytime running lights turn on.

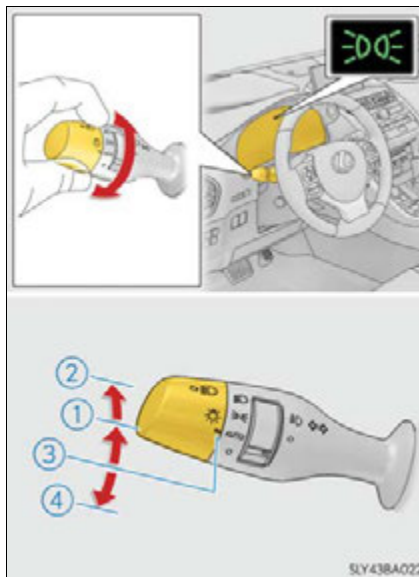

Turning on the high beam headlights

- ① With the headlights on, push the lever away from you to turn on the high beams.
Pull the lever toward you to the center position to turn the high beams off.
- ② Pull the lever toward you and release it to flash the high beams once.
You can flash the high beams with the headlights on or off.

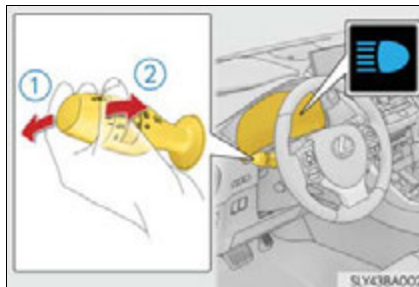

■ Daytime running light system

- To make your vehicle more visible to other drivers during daytime driving, the daytime running lights turn on automatically (at an increased intensity) whenever the hybrid system is started and the parking brake is released with the headlight switch off or in the "AUTO" position. (Illuminate brighter than the front parking lights.) Daytime running lights are not designed for use at night.

Type A only: Daytime running lights can be turned off by operating the switch.

- If a turn signal light is in use, the daytime running light, on the same side, is turned off. For emergency flashers, both are turned off.
- Compared to turning on the headlights, the daytime running light system offers greater durability and consumes less electricity, so it can help improve fuel economy.



■ Headlight control sensor

The sensor may not function properly if an object is placed on the sensor, or anything that blocks the sensor is affixed to the windshield.

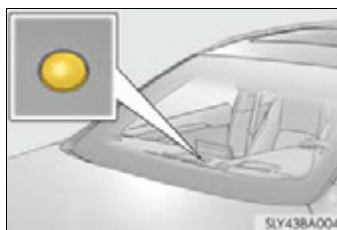
Doing so interferes with the sensor detecting the level of ambient light and may cause the automatic headlight system to malfunction.

**■ Automatic light off system**

- When the headlights come on: The headlights and tail lights turn off 30 seconds after a door is opened and closed if the power switch is turned to ACCESSORY mode or turned off. (The lights turn off immediately if  on the key is pressed after all the doors are locked.)
- When only the tail lights come on: The tail lights turn off automatically if the power switch is turned to ACCESSORY mode or turned off and the driver's door is opened.

To turn the lights on again, turn the power switch to ON mode, or turn the light switch off once and then back to  or .

■ Automatic headlight leveling system (if equipped)

The level of the headlights is automatically adjusted according to the number of passengers and the loading condition of the vehicle to ensure that the headlights do not interfere with other road users.

■ Light reminder buzzer

A buzzer sounds when the power switch is turned off or turned to ACCESSORY mode and the driver's door is opened while the lights are turned on.

■ 12-volt battery-saving function

In order to prevent the 12-volt battery of the vehicle from discharging, if the headlights and/or tail lights are on when the power switch is turned off the 12-volt battery saving function will operate and automatically turn off all the lights after approximately 20 minutes. When the power switch is turned to ON mode, the 12-volt battery-saving function will be disabled.

When any of the following are performed, the 12-volt battery-saving function is canceled once and then reactivated. All the lights will turn off automatically 20 minutes after the 12-volt battery-saving function has been reactivated:

- When the headlight switch is operated
- When a door is opened or closed

222 4-3. Operating the lights and wipers

■ Customization

Settings (e.g. light sensor sensitivity) can be changed.
(Customizable features: →P. 634)



NOTICE

■ To prevent 12-volt battery discharge

Do not leave the lights on longer than necessary when the hybrid system is off.

Automatic High Beam*

The Automatic High Beam uses an in-vehicle camera sensor to assess the brightness of streetlights, the lights of oncoming and preceding vehicles, etc., and automatically turns high beam on or off as necessary.

Activating the Automatic High Beam system

- 1 Push the lever away from you with the headlight switch in AUTO or  position.

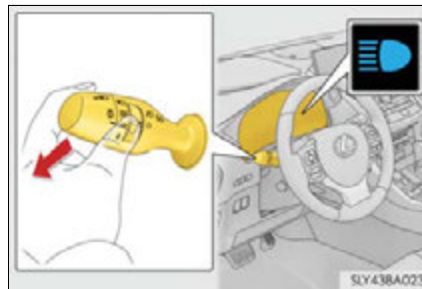

- 2 Press the Automatic High Beam switch.

The Automatic High Beam indicator will come on when the headlights are turned on automatically to indicate that the system is active.



4

Driving

*: If equipped

High beam automatic turning on or off conditions

When all of the following conditions are fulfilled, high beam will be automatically turned on:

- Vehicle speed is above approximately 21 mph (34 km/h).
- The area ahead of the vehicle is dark.
- There are no oncoming or preceding vehicles with headlights or tail lights turned on.
- There are few streetlights on the road ahead.

If any of the following conditions are fulfilled, high beam will be automatically turned off:

- Vehicle speed drops below approximately 17 mph (27 km/h).
- The area ahead of the vehicle is not dark.
- Oncoming or preceding vehicles have headlights or tail lights turned on.
- There are many streetlights on the road ahead.

Turning the high beam on/off manually

■ Switching to low beam

Pull the lever to original position.

The Automatic High Beam indicator will turn off.

Push the lever away from you to activate the Automatic High Beam system again.

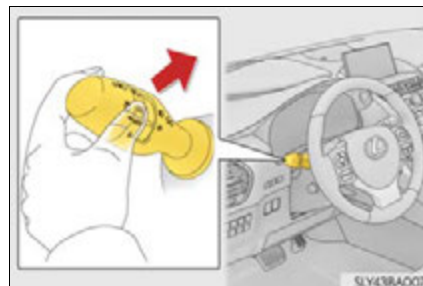

■ Switching to high beam

Press the Automatic High Beam switch.

The Automatic High Beam indicator will turn off and the high beam indicator will turn on.

Press the switch to activate the Automatic High Beam system again.



■ The Automatic High Beam can be operated when

The power switch is in ON mode.

■ Camera sensor detection information

- High beam may not be automatically turned off in the following situations:
 - When oncoming vehicles suddenly appear from a curve
 - When the vehicle is cut in front of by another
 - When oncoming or preceding vehicles are hidden from sight due to repeated curves, road dividers or roadside trees
- High beam may be turned off if an oncoming vehicle that is using fog lights without using the headlights is detected.
- House lights, street lights, red traffic signals, and illuminated billboards or signs may cause the high beam to turn off.
- The following factors may affect the amount of time taken to turn high beam on or off:
 - The brightness of headlights, fog lights, and tail lights of oncoming and preceding vehicles
 - The movement and direction of oncoming and preceding vehicles
 - When a oncoming or preceding vehicle only has operational lights on one side
 - When a oncoming or preceding vehicle is a two-wheeled vehicle
 - The condition of the road (gradient, curve, condition of the road surface, etc.)
 - The number of passengers and amount of luggage
- High beam may be turned on or off when unexpected by the driver.
- In the situations below, the system may not be able to correctly detect the surrounding brightness levels, and may flash or expose nearby pedestrians to the high beam. Therefore, you should consider turning the high beams on or off manually rather than relying on the Automatic High Beam system.
 - In bad weather (rain, snow, fog, sandstorms, etc.)
 - The windshield is obscured by fog, mist, ice, dirt, etc.
 - The windshield is cracked or damaged.
 - The camera sensor is deformed or dirty.
 - The camera sensor temperature is extremely high.
 - Surrounding brightness levels are equal to those of headlights, tail lights or fog lights.
 - Vehicles ahead have headlights or tail lights that are either switched off, dirty, are changing color, or are not aimed properly.
 - When driving through an area of intermittently changing brightness and darkness.
 - When frequently and repeatedly driving ascending/descending roads, or roads with rough, bumpy or uneven surfaces (such as stone-paved roads, gravel tracks, etc.).
 - When frequently and repeatedly taking curves or driving on a winding road.
 - There is a highly reflective object ahead of the vehicle, such as a sign or a mirror.
 - The back of a vehicle ahead is highly reflective, such as a container on a truck.
 - The vehicle's headlights are damaged or dirty.
 - The vehicle is listing or titling, due to a flat tire, a trailer being towed, etc.
 - The driver believes that the high beam may be causing problems or distress to other drivers or pedestrians nearby.

⚠ WARNING**■ Limitations of the Automatic High Beam**

Do not rely on the Automatic High Beam. Always drive safely, taking care to observe your surroundings and turning high beam on or off manually if necessary.

⚠ NOTICE**■ Notes when using the Automatic High Beam system**

Observe the following to ensure that the Automatic High Beam functions correctly.

- Do not touch the camera sensor.
- Do not subject the camera sensor to a strong impact.
- Do not disassemble the camera sensor.
- Do not spill liquids onto the camera sensor.
- Do not apply window tinting or stickers to the camera sensor or the area of windshield near the camera sensor.
- Do not place items on the dashboard. There is a possibility that the camera sensor will mistake items reflected in the windshield for streetlights, the headlights of other vehicles, etc.
- Do not install a parking tag or any other accessories near or around the camera sensor.
- Do not overload the vehicle.
- Do not modify the vehicle.
- Do not replace windshield with non-genuine windshield. Contact your Lexus dealer.



Fog light switch

The fog lights secure excellent visibility in difficult driving conditions, such as in rain and fog.

Operating instructions

- ① ○ Turns the fog lights off
- ② ㊦ Turns the fog lights on

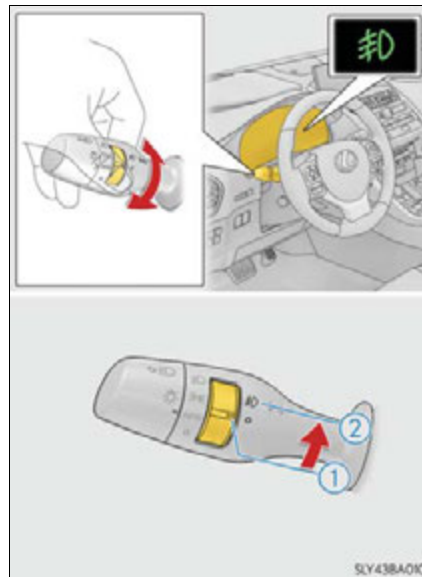

4

Driving

- **Fog lights can be used when**
The headlights are on in low beam.

 NOTICE

- **To prevent 12-volt battery discharge**
Do not leave the lights on longer than necessary when the hybrid system is off.

Windshield wipers and washer

Operating the wiper lever

The wiper operation is selected by moving the lever as follows.

■ Intermittent windshield wipers with interval adjuster (if equipped)

▶ Type A

- ① ○ Off
- ②  Intermittent operation
- ③ ▼ Low speed operation
- ④ ▽ High speed operation
- ⑤ ▲ Temporary operation

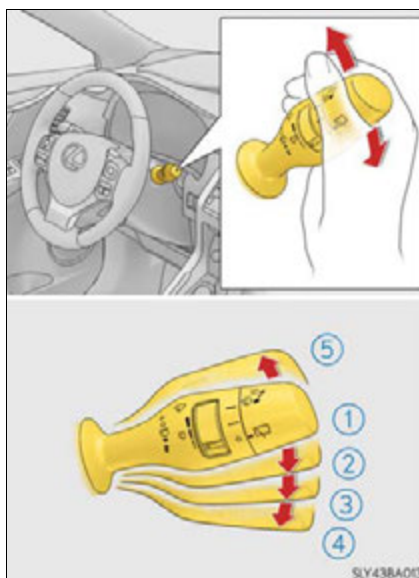

Wiper intervals can be adjusted when intermittent operation is selected.

- ⑥ Increases the intermittent windshield wiper frequency
- ⑦ Decreases the intermittent windshield wiper frequency

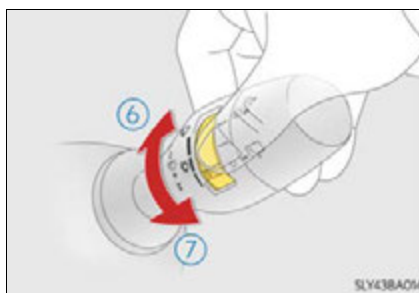

⑧ Washer/wiper dual operation

The wipers will automatically operate a couple of times after the washer squirts.

Vehicles with headlight cleaners:
When the headlights are on and the lever is pulled and held, the headlight cleaners will operate once. After this, the headlight cleaners will operate every 5th time the lever is pulled.

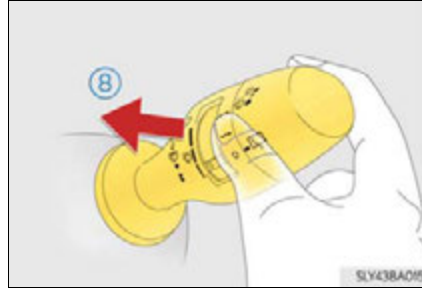

► Type B

- ① **OFF** Off
- ② **INT** Intermittent operation
- ③ **LO** Low speed operation
- ④ **HI** High speed operation
- ⑤ **MIST** Temporary operation

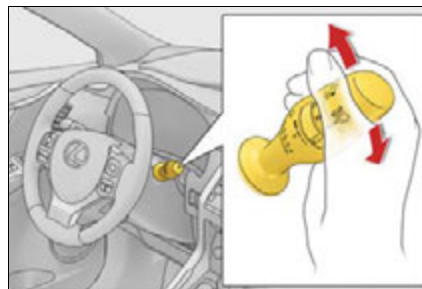

Wiper intervals can be adjusted when intermittent operation is selected.

- ⑥ Increases the intermittent windshield wiper frequency
- ⑦ Decreases the intermittent windshield wiper frequency

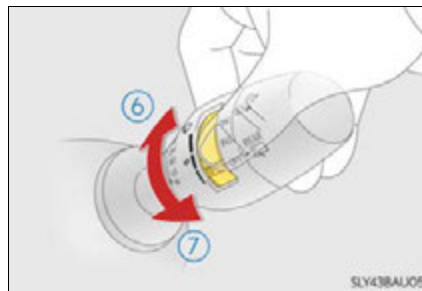

⑧ Washer/wiper dual operation

The wipers will automatically operate a couple of times after the washer squirts.

Vehicles with headlight cleaners:

When the headlights are on and the lever is pulled and held, the headlight cleaners will operate once. After this, the headlight cleaners will operate every 5th time the lever is pulled.

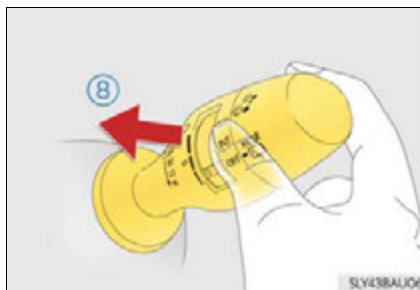

■ Rain-sensing windshield wipers (if equipped)

▶ Type A

- ① ○ Off
- ② AUTO Rain-sensing operation
- ③ ▼ Low speed operation
- ④ ▼ High speed operation
- ⑤ ▲ Temporary operation

When "AUTO" is selected, the wipers will operate automatically when the sensor detects falling rain. The system automatically adjusts wiper timing in accordance with rain volume and vehicle speed.

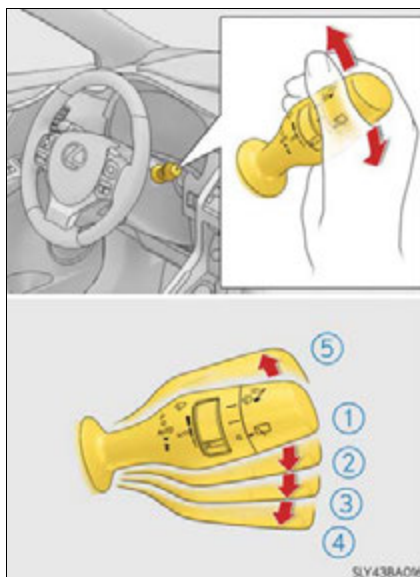

The sensor sensitivity can be adjusted when "AUTO" is selected.

- ⑥ Increases the sensitivity
- ⑦ Decreases the sensitivity

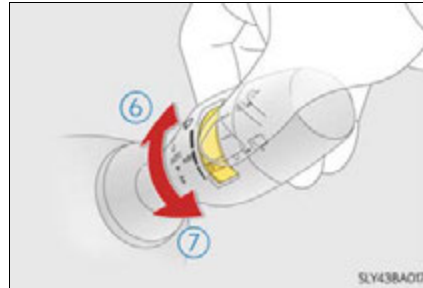

⑧ Washer/wiper dual operation

The wipers will automatically operate a couple of times after the washer squirts.

Vehicles with headlight cleaners:
When the headlights are on and the lever is pulled and held, the headlight cleaners will operate once. After this, the headlight cleaners will operate every 5th time the lever is pulled.

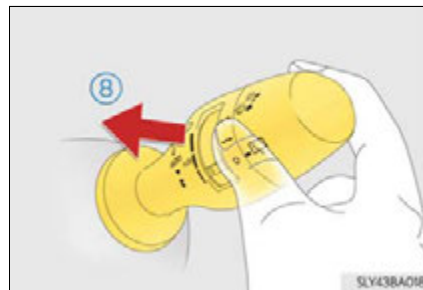

► Type B

- ① **OFF** Off
- ② **AUTO** Rain-sensing operation
- ③ **LO** Low speed operation
- ④ **HI** High speed operation
- ⑤ **MIST** Temporary operation

When "AUTO" is selected, the wipers will operate automatically when the sensor detects falling rain. The system automatically adjusts wiper timing in accordance with rain volume and vehicle speed.

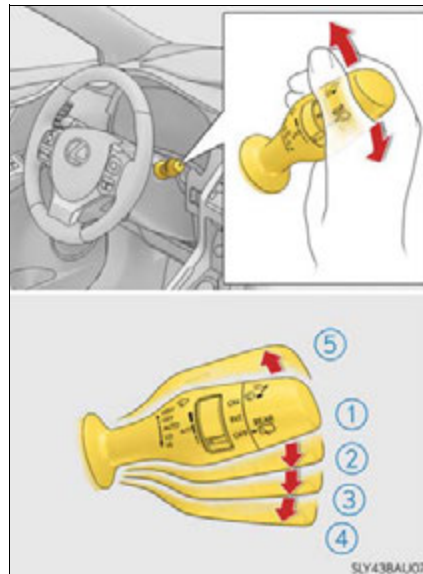

The sensor sensitivity can be adjusted when "AUTO" is selected.

- ⑥ Increases the sensitivity
- ⑦ Decreases the sensitivity

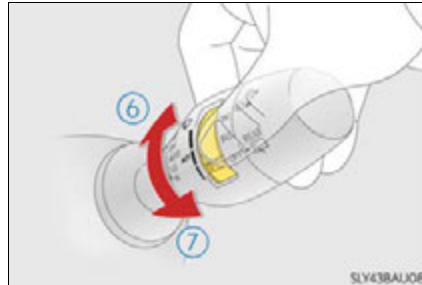

- ⑧ Washer/wiper dual operation

The wipers will automatically operate a couple of times after the washer squirts.

Vehicles with headlight cleaners:
When the headlights are on and the lever is pulled and held, the headlight cleaners will operate once. After this, the headlight cleaners will operate every 5th time the lever is pulled.



■ The windshield wipers and washer can be operated when

The power switch is in ON mode.

■ Dripping prevention wiper sweep (vehicles with rain-sensing windshield wipers)

After washing and wiping operation several times, the wipers operate one more time after a short delay to prevent dripping. However, this function will not operate while driving.

■ Effects of vehicle speed on wiper operation (vehicles with rain-sensing windshield wipers)

Vehicle speed affects the Intermittent wiper interval.

■ Raindrop sensor (vehicles with rain-sensing windshield wipers)

- The raindrop sensor judges the amount of raindrops.

An optical sensor is adopted. It may not operate properly when sunlight from the rising or setting of the sun intermittently strikes the windshield, or if bugs, etc. are present on the windshield.



- If the wiper switch is turned to the "AUTO" position while the power switch is in ON mode, the wipers will operate once to show that AUTO mode is activated.
- If the temperature of the raindrop sensor is 194°F (90°C) or higher, or 5°F (-15°C) or lower, automatic operation may not occur. In this case, operate the wipers in any mode other than AUTO mode.

■ **If no windshield washer fluid sprays**

Check that the washer nozzles are not blocked, if there is washer fluid in the washer fluid tank.

 **WARNING**

■ **Caution regarding the use of windshield wipers in AUTO mode (vehicles with rain-sensing windshield wipers)**

The windshield wipers may operate unexpectedly if the sensor is touched or the windshield is subject to vibration in AUTO mode. Take care that your fingers, etc. do not become caught in the windshield wipers.

■ **Caution regarding the use of washer fluid**

When it is cold, do not use the washer fluid until the windshield becomes warm. The fluid may freeze on the windshield and cause low visibility. This may lead to an accident, resulting in death or serious injury.

 **NOTICE**

■ **When the windshield is dry**

Do not use the wipers, as they may damage the windshield.

■ **When the washer fluid tank is empty**

Do not operate the switch continually as the washer fluid pump may overheat.

■ **When a nozzle becomes blocked**

In this case, contact your Lexus dealer.

Do not try to clear it with a pin or other object. The nozzle will be damaged.

■ **To prevent 12-volt battery discharge**

Do not leave the wipers on longer than necessary when the hybrid system is off.

Rear window wiper and washer

Operating the wiper lever

Turning the end of the lever turns on the rear window wiper and washer.

► Type A

- ① ○ Off
- ② - - - Intermittent operation
- ③ — Normal operation

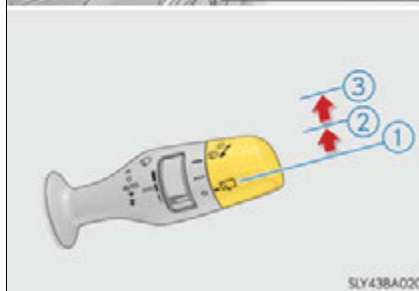
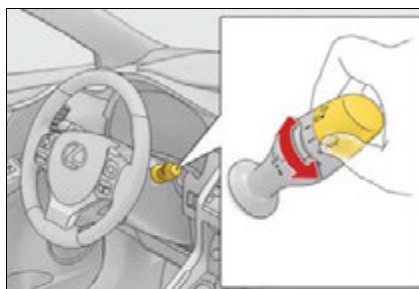

- ④ Washer/wiper dual operation
The wipers will automatically operate a couple of times after the washer squirts.

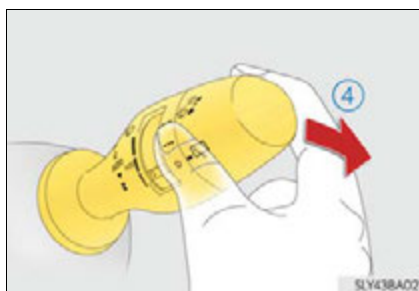

▶ Type B

- ① **OFF** Off
- ② **INT** Intermittent operation
- ③ **ON** Normal operation

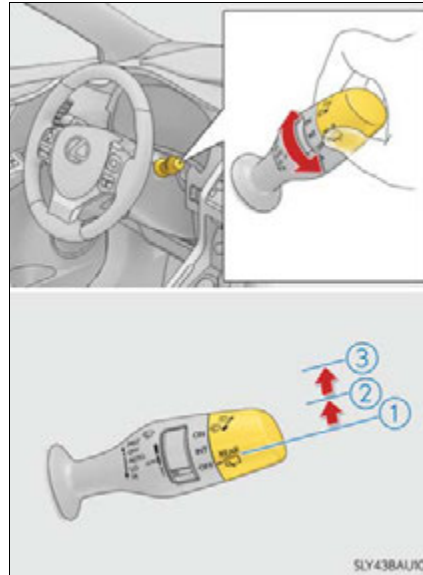

- ④ **Washer/wiper dual operation**
The wipers will automatically operate a couple of times after the washer squirts.

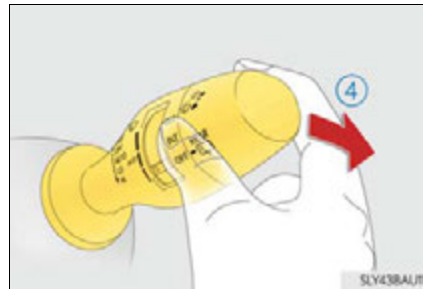

- **The rear window wiper and washer can be operated when**
The power switch is in ON mode.

 **NOTICE**

- **When the rear window is dry**
Do not use the wiper, as it may damage the rear window.
- **When the washer fluid tank is empty**
Do not operate the switch continually as the washer fluid pump may overheat.
- **When a nozzle becomes blocked**
In this case, contact your Lexus dealer.
Do not try to clear it with a pin or other object. The nozzle will be damaged.
- **To prevent 12-volt battery discharge**
Do not leave the wipers on longer than necessary when the hybrid system is off.

Opening the fuel tank cap

Perform the following steps to open the fuel tank cap.

Before refueling the vehicle

- Turn the power switch off and ensure that all the doors and windows are closed.
- Confirm the type of fuel. (→P. 616)

■ Fuel types

→P. 616

■ Fuel tank opening for unleaded gasoline

To help prevent incorrect fueling, your vehicle has a fuel tank opening that only accommodates the special nozzle on unleaded fuel pumps.

WARNING

■ When refueling the vehicle

Observe the following precautions while refueling the vehicle. Failure to do so may result in death or serious injury.

- After exiting the vehicle and before opening the fuel door, touch an unpainted metal surface to discharge any static electricity. It is important to discharge static electricity before refueling because sparks resulting from static electricity can cause fuel vapors to ignite while refueling.
- Always hold the grips on the fuel tank cap and turn it slowly to remove it.
A whooshing sound may be heard when the fuel tank cap is loosened. Wait until the sound cannot be heard before fully removing the cap. In hot weather, pressurized fuel may spray out of the filler neck and cause injury.
- Do not allow anyone that has not discharged static electricity from their body to come close to an open fuel tank.
- Do not inhale vaporized fuel.
Fuel contains substances that are harmful if inhaled.
- Do not smoke while refueling the vehicle.
Doing so may cause the fuel to ignite and cause a fire.
- Do not return to the vehicle or touch any person or object that is statically charged.
This may cause static electricity to build up, resulting in a possible ignition hazard.

■ When refueling

Observe the following precautions to prevent fuel overflowing from the fuel tank:

- Securely insert the fuel nozzle into the fuel filler neck.
- Stop filling the tank after the fuel nozzle automatically clicks off.
- Do not top off the fuel tank.

 NOTICE■ **Refueling**

Do not spill fuel during refueling. Doing so may damage the vehicle, such as causing the emission control system to operate abnormally, damaging fuel system components or the vehicle's painted surface.

Opening the fuel tank cap

- 1** With the doors unlocked, press the center of the rear edge of the fuel filler door.

Push inward and take your hand away to slightly open the fuel filler door. Then open the door fully by hand.



- 2** Turn the fuel tank cap slowly to open and put it into the holder on the fuel filler door.

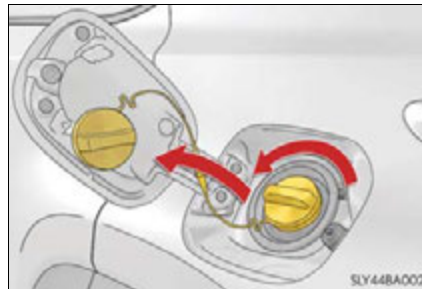

■ When the fuel filler door cannot be opened

Remove the cover inside the luggage compartment by inserting a screwdriver. After removing the cover, pull the lever to unlock the fuel filler door and it will be ready to open as usual.

When removing the cover, to prevent damage, cover the tip of the screwdriver with a rag.

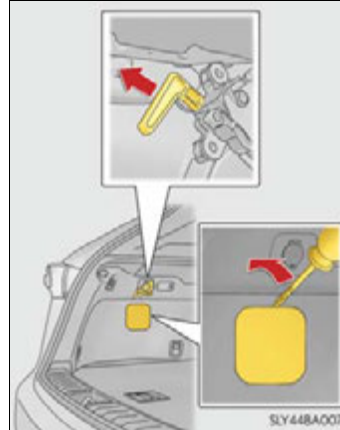

Closing the fuel tank cap

- 1 After refueling, turn the fuel tank cap until you hear a click. Once the cap is released, it will turn slightly in the opposite direction.

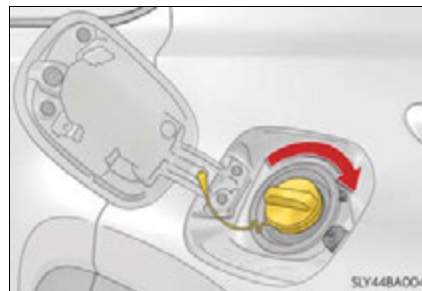

- 2 Close the fuel filler door, and press the center of the rear edge of the fuel filler door.

When you lock the doors, the fuel filler door will lock also.

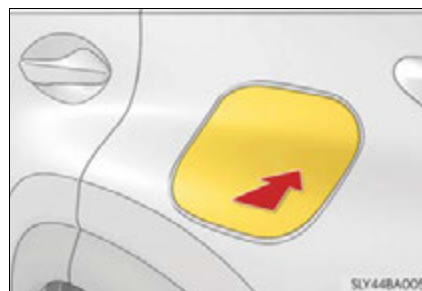

■ Fuel filler door lock condition

The fuel filler door may not be locked even when the vehicle's doors are locked in the following conditions:

- When operating the door lock button inside the vehicle
- When the automatic door locking system is operated (→P.127)
- When the fuel filler door is closed after the vehicle's doors are locked

⚠ WARNING**■ When replacing the fuel tank cap**

Do not use anything but a genuine Lexus fuel tank cap designed for your vehicle. Doing so may cause a fire or other incident which may result in death or serious injury.

Dynamic radar cruise control*

Summary of functions

Without accelerator pedal operation by the driver, in vehicle-to-vehicle distance control mode, the vehicle automatically accelerates and decelerates in accordance to the changes in speed of the preceding vehicle. In constant speed control mode, the vehicle runs at a fixed speed.

Use the dynamic radar cruise control on freeways and highways.

- Vehicle-to-vehicle distance control mode (→P. 241)
- Constant speed control mode (→P. 246)

- ① Indicators
- ② Display
- ③ Set speed
- ④ Vehicle-to-vehicle distance button
- ⑤ Cruise control switch

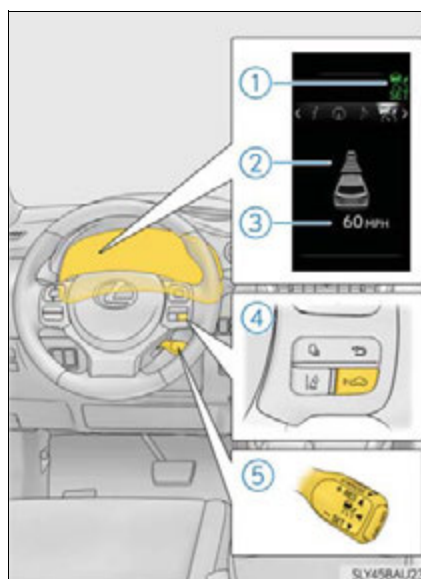

*: If equipped

Driving in vehicle-to-vehicle distance control mode

This mode employs a radar sensor to detect the presence of vehicles up to approximately 400 ft. (120 m) ahead, determines the current vehicle-to-vehicle following distance, and operates to maintain a suitable following distance from the vehicle ahead.

Note that vehicle-to-vehicle distance will close in when traveling on long downhill slopes.

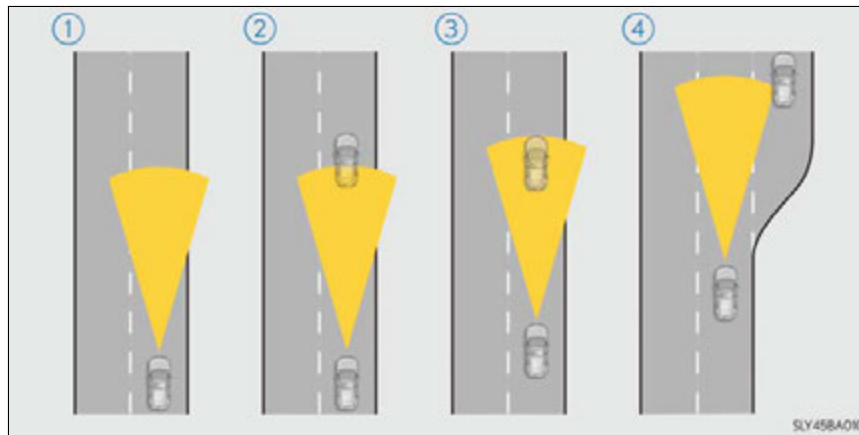

① Example of constant speed cruising

When there are no vehicles ahead

The vehicle travels at the speed set by the driver. The desired vehicle-to-vehicle distance can also be set by operating the vehicle-to-vehicle distance control.

② Example of deceleration cruising

When a preceding vehicle is driving slower than the set speed appears

When a vehicle is detected running ahead of you, the system automatically decelerates your vehicle. When a greater reduction in vehicle speed is necessary, the system applies the brakes (the stop lights will come on at this time). A warning tone warns you when the system cannot decelerate sufficiently to prevent your vehicle from closing in on the vehicle ahead.

③ Example of follow-up cruising

When following a preceding vehicle is driving slower than the set speed

The system continues follow-up cruising while adjusting for changes in the speed of the vehicle ahead in order to maintain the vehicle-to-vehicle distance set by the driver.

④ Example of acceleration

When there are no longer any preceding vehicles driving slower than the set speed

The system accelerates until the set speed is reached. The system then returns to constant speed cruising.

Setting the vehicle speed (vehicle-to-vehicle distance control mode)

- 1 Press the "ON/OFF" button to activate the cruise control.

Radar cruise control indicator will come on and a message will be displayed on the multi-information display.

Press the button again to deactivate the cruise control.



- 2 Accelerate or decelerate, with accelerator pedal operation, to the desired vehicle speed (above approximately 30 mph [50 km/h]) and push the lever down to set the speed.

Cruise control "SET" indicator will come on.

The vehicle speed at the moment the lever is released becomes the set speed.



Adjusting the set speed

To change the set speed, operate the lever until the desired set speed is displayed.

- ① Increases the speed
- ② Decreases the speed

Fine adjustment: Momentarily move the lever in the desired direction.

Large adjustment: Hold the lever in the desired direction.

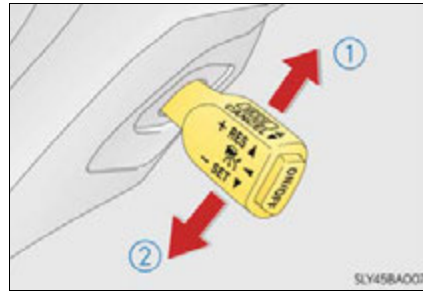

In the vehicle-to-vehicle distance control mode, the set speed will be increased or decreased as follows:

- When the set speed is shown in "MPH"

Fine adjustment: By approximately 1 mph (1.6 km/h) each time the lever is operated

Large adjustment: By approximately 5 mph (8 km/h) for each 0.75 seconds the lever is held

- When the set speed is shown in "km/h"

Fine adjustment: By approximately 1 km/h (0.6 mph) each time the lever is operated

Large adjustment: By approximately 5 km/h (3.1 mph) for each 0.75 seconds the lever is held

In the constant speed control mode (→P. 246), the set speed will be increased or decreased as follows:

Fine adjustment: By approximately 1 mph (1.6 km/h) each time the lever is operated

Large adjustment: The set speed can be increased or decreased continually until the lever is released.

Changing the vehicle-to-vehicle distance (vehicle-to-vehicle distance control mode)

Pressing the button changes the vehicle-to-vehicle distance as follows:

- ① Long
- ② Medium
- ③ Short

The vehicle-to-vehicle distance is set automatically to long mode when the power switch is turned to ON mode.

If a vehicle is running ahead of you, the preceding vehicle mark will also be displayed.

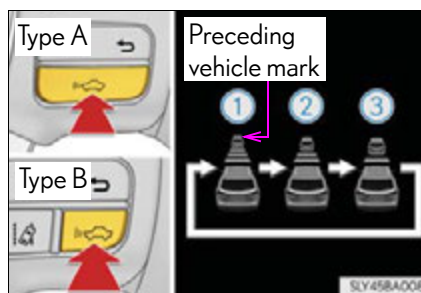

Vehicle-to-vehicle distance settings (vehicle-to-vehicle distance control mode)

Select a distance from the table below. Note that the distances shown correspond to a vehicle speed of 50 mph (80 km/h). Vehicle-to-vehicle distance increases/decreases in accordance with vehicle speed.

Distance options	Vehicle-to-vehicle distance
Long	Approximately 160 ft. (50 m)
Medium	Approximately 130 ft. (40 m)
Short	Approximately 100 ft. (30 m)

Canceling and resuming the speed control

- ① Pulling the lever toward you cancels the speed control.
The speed setting is also canceled when the brake pedal is depressed.
- ② Pushing the lever up resumes the speed control and returns vehicle speed to the set speed.



However, resuming is available when the vehicle speed is more than approximately 25 mph (40 km/h).

Approach warning (vehicle-to-vehicle distance control mode)

When your vehicle is too close to a vehicle ahead, and sufficient automatic deceleration via the cruise control is not possible, the display will flash and the buzzer will sound to alert the driver. An example of this would be if another driver cuts in front of you while you are following a vehicle. Depress the brake pedal to ensure an appropriate vehicle-to-vehicle distance.



4

Driving

■ Warnings may not occur when

In the following instances, there is a possibility that the warnings will not occur:

- When the speed of the preceding vehicle matches or exceeds your vehicle speed
- When the preceding vehicle is traveling at an extremely slow speed
- Immediately after the cruise control speed was set
- When depressing the accelerator pedal

Selecting constant speed control mode

When constant speed control mode is selected, your vehicle will maintain a set speed without controlling the vehicle-to-vehicle distance. Select this mode only when vehicle-to-vehicle distance control mode does not function correctly due to dirt, etc.

- ① Press the "ON/OFF" button to activate the cruise control.

Press the button again to deactivate the cruise control.

- ② Switch to constant speed control mode.

(Push the lever forward and hold for approximately 1 second.)

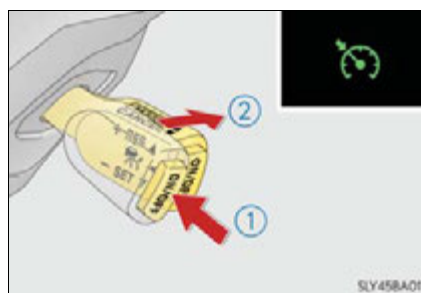

Cruise control indicator will come on.

When in constant speed control mode, to return to vehicle-to-vehicle distance control mode, push the lever forward again and hold for approximately 1 second.

After the desired speed has been set, it is not possible to return to vehicle-to-vehicle distance control mode.

If the power switch is turned off and then turned to ON mode again, the vehicle will automatically return to vehicle-to-vehicle distance control mode.

Adjusting the speed setting: →P. 243

Canceling and resuming the speed setting: →P. 245

■ Dynamic radar cruise control can be set when

- The shift lever is in D or range 4 or higher of S has been selected.
- Vehicle speed is above approximately 30 mph (50 km/h).

■ Accelerating after setting the vehicle speed

The vehicle can accelerate by operating the accelerator pedal. After accelerating, the set speed resumes. However, during vehicle-to-vehicle distance control mode, the vehicle speed may decrease below the set speed in order to maintain the distance to the preceding vehicle.

■ Automatic cancelation of vehicle-to-vehicle distance control mode

Vehicle-to-vehicle distance control mode is automatically canceled in the following situations:

- VSC is activated.
- TRAC is activated for a period of time.
- When the VSC or TRAC system is turned off by pressing the VSC OFF switch.
- The sensor cannot detect properly because it is obstructed in some way.
- Pre-collision braking is activated.

When vehicle-to-vehicle distance control mode is automatically canceled in the following situations, "Radar Cruise Control Unavailable" will be displayed on the multi-information display:

- Actual vehicle speed falls below approximately 25 mph (40 km/h).
- The windshield wipers are operating at high speed (when the wiper switch is set to the "AUTO" mode or the high speed wiper operation position).

If vehicle-to-vehicle distance control mode is automatically canceled for any other reason, there may be a malfunction in the system. Contact your Lexus dealer.

■ Automatic cancelation of constant speed control mode

Constant speed control mode is automatically canceled in the following situations:

- Actual vehicle speed is more than approximately 10 mph (16 km/h) below the set vehicle speed.
- Actual vehicle speed falls below approximately 25 mph (40 km/h).
- VSC is activated.
- TRAC is activated for a period of time.
- When the VSC or TRAC system is turned off by pressing the VSC OFF switch.
- Pre-collision braking is activated.

■ **Radar sensor and grille cover**

Always keep the sensor and grille cover clean to ensure that the vehicle-to-vehicle distance control mode operates properly. (Some obstructions, such as snow, ice and plastic objects, cannot be detected by the obstruction sensor.)

Dynamic radar cruise control is canceled if an obstruction is detected.

- ① Grille cover
- ② Radar sensor

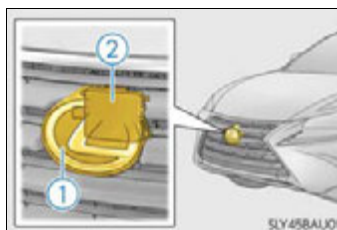

■ **Warning messages and buzzers for dynamic radar cruise control**

Warning messages and buzzers are used to indicate a system malfunction or to inform the driver of the need for caution while driving. If a warning message is shown on the multi-information display, read the message and follow the instructions.

■ **Certification for the radar sensor**

- For vehicles sold in the U.S.A.

FCC ID: HYQDNMWR007

This device complies with part 15 of the FCC Rules. Operation is subject to the following two conditions: (1) This device may not cause harmful interference, and (2) this device must accept any interference received, including interference that may cause undesired operation.

FCC WARNING

Changes or modifications not expressly approved by the party responsible for compliance could void the user's authority to operate the equipment.

Radio frequency radiation exposure Information:

This equipment complies with FCC radiation exposure limits set forth for an uncontrolled environment.

This equipment should be installed and operated with minimum distance of 20 cm between the radiator (antenna) and your body.

This transmitter must not be co-located or operating in conjunction with any other antenna or transmitter.

- For vehicles sold in Canada

This device complies with Industry Canada licence-exempt RSS standard(s).

Operation is subject to the following two conditions:

- (1) this device may not cause interference, and
- (2) this device must accept any interference, including interference that may cause undesired operation of the device.

 **WARNING****■ Before using dynamic radar cruise control**

Do not overly rely on vehicle-to-vehicle distance control mode.

Be aware of the set speed. If automatic deceleration/acceleration is not appropriate, adjust the vehicle speed, as well as the distance between your vehicle and vehicles ahead by applying the brakes, etc.

■ Cautions regarding the driving assist systems

Observe the following precautions.

Failure to do so may cause an accident resulting in death or serious injury.

● Assisting the driver to measure following distance

The dynamic radar cruise control is only intended to help the driver in determining the following distance between the driver's own vehicle and a designated vehicle traveling ahead. It is not a mechanism that allows careless or inattentive driving, and it is not a system that can assist the driver in low-visibility conditions. It is still necessary for driver to pay close attention to the vehicle's surroundings.

● Assisting the driver to judge proper following distance

The dynamic radar cruise control determines whether the following distance between the driver's own vehicle and a designated vehicle traveling ahead is appropriate or not. It is not capable of making any other type of judgement. Therefore, it is absolutely necessary for the driver to remain vigilant and to determine whether or not there is a possibility of danger in any given situation.

● Assisting the driver to operate the vehicle

The dynamic radar cruise control has no capability to prevent or avoid a collision with a vehicle traveling ahead. Therefore, if there is ever any danger, the driver must take immediate and direct control of the vehicle and act appropriately in order to ensure the safety of all involved.

■ To avoid inadvertent dynamic radar cruise control activation

Switch the dynamic radar cruise control off using the "ON/OFF" button when not in use.

⚠ WARNING

■ **Situations unsuitable for dynamic radar cruise control**

Do not use dynamic radar cruise control in any of the following situations. Doing so may result in inappropriate speed control and could cause an accident resulting in death or serious injury.

- Roads where there are pedestrians, cyclers, etc.
- In heavy traffic
- On roads with sharp bends
- On winding roads
- On slippery roads, such as those covered with rain, ice or snow
- On sharp inclines or declines
Vehicle speed may exceed the set speed when driving down a steep hill.
- Roads with continuous inclines and declines
- At entrances to freeways and highways
- When weather conditions are bad enough that they may prevent the sensors from detecting correctly (fog, snow, sandstorm, heavy rain, etc.)
- When an approach warning buzzer is heard often
- When your vehicle is towing a trailer or during emergency towing

■ **When the sensor may not be correctly detecting the vehicle ahead**

In the case of the following and depending on the conditions, operate the brake pedal when deceleration of the system is insufficient or operate the accelerator pedal when acceleration is required.

As the sensor may not be able to correctly detect these types of vehicles, the approach warning (→P. 245) will not be activated, which may lead to an accident resulting in death or serious injury.

- Vehicles that cut in suddenly
- Vehicles traveling at low speeds
- Vehicles that are not moving in the same lane
- Vehicles with small rear ends (trailers with no load on board, etc.)

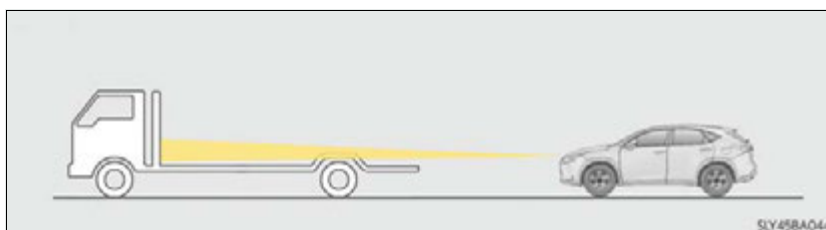

- Motorcycles traveling in the same lane
- When water or snow thrown up by the surrounding vehicles hinders the detecting of the sensor

⚠ WARNING

- When your vehicle is pointing upwards (caused by a heavy load in the luggage compartment, etc.)

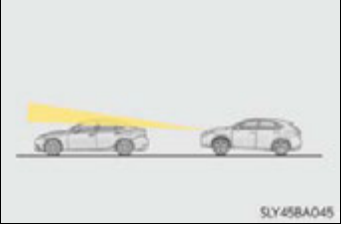

■ Conditions under which the vehicle-to-vehicle distance control mode may not function correctly

Operate the brake pedal (or accelerator pedal operation depending on the situation) as necessary in the following conditions as the radar sensor may not be able to correctly detect vehicles ahead, which may lead to an accident resulting in death or serious injury.

- When the road curves or when the lanes are narrow

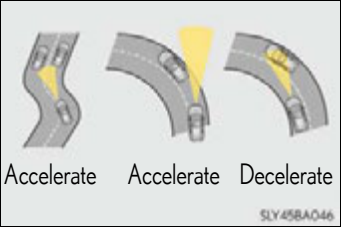

- When steering wheel operation or your position in the lane is unstable

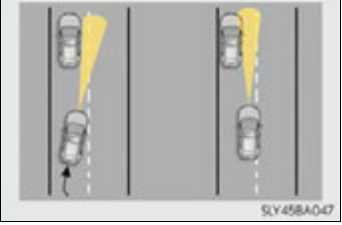

- When the vehicle ahead of you decelerates suddenly

 **WARNING****■ Handling the radar sensor**

Observe the following to ensure the dynamic radar cruise control can function effectively.

Otherwise, the radar sensor may not detect correctly and could result in an accident.

- Keep the sensor and grille cover clean at all times.
Clean the sensor and grille cover with a soft cloth so you do not mark or damage them.
- Do not subject the sensor or surrounding area to a strong impact.
If the sensor moves even slightly off position, the system may malfunction. If the sensor or surrounding area is subject to a strong impact, always have the area inspected and adjusted by your Lexus dealer.
- Do not disassemble the sensor.
- Do not attach accessories or stickers to the sensor, grille cover or surrounding area.
- Do not modify or paint the sensor and grille cover.
- If the radar sensor needs to be replaced, contact your Lexus dealer.

Dynamic radar cruise control with full-speed range*

Summary of functions

Without accelerator pedal operation by the driver, in vehicle-to-vehicle distance control mode, the vehicle automatically accelerates, decelerates and stops in accordance to the changes in speed of the preceding vehicle. In constant speed control mode, the vehicle runs at a fixed speed.

Use the dynamic radar cruise control with full-speed range on freeways and highways.

- Vehicle-to-vehicle distance control mode (→P. 254)
- Constant speed control mode (→P. 260)

- ① Indicators
- ② Display
- ③ Set speed
- ④ Vehicle-to-vehicle distance button
- ⑤ Cruise control switch

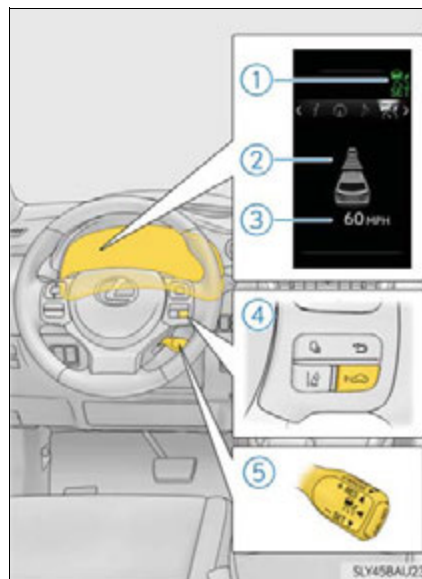

4

Driving

*: If equipped

Driving in vehicle-to-vehicle distance control mode

This mode employs a radar sensor to detect the presence of vehicles up to approximately 400 ft. (120 m) ahead, determines the current vehicle-to-vehicle following distance, and operates to maintain a suitable following distance from the vehicle ahead.

Note that vehicle-to-vehicle distance will close in when traveling on long downhill slopes.

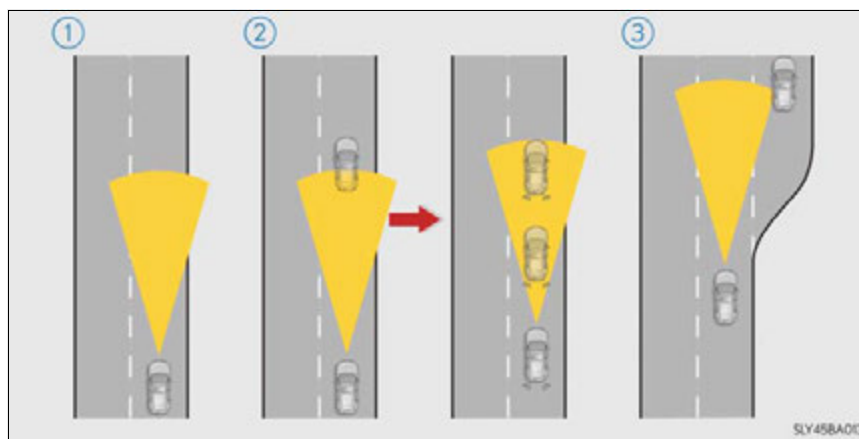

- ① Example of constant speed cruising
When there are no vehicles ahead

The vehicle travels at the speed set by the driver. The desired vehicle-to-vehicle distance can also be set by operating the vehicle-to-vehicle distance control.

- ② Example of deceleration cruising and follow-up cruising
When a preceding vehicle is driving slower than the set speed appears

When a vehicle is detected running ahead of you, the system automatically decelerates your vehicle. When a greater reduction in vehicle speed is necessary, the system applies the brakes (the stop lights will come on at this time). The system will respond to changes in the speed of the vehicle ahead in order to maintain the vehicle-to-vehicle distance set by the driver. A warning tone warns you when the system cannot decelerate sufficiently to prevent your vehicle from closing in on the vehicle ahead.

When the vehicle ahead of you stops, your vehicle will also stop (vehicle is stopped by system control). After the vehicle ahead starts off, pushing the cruise control lever up or depressing the accelerator pedal will resume follow-up cruising.

- ③ Example of acceleration
When there are no longer any preceding vehicles driving slower than the set speed

The system accelerates until the set speed is reached. The system then returns to constant speed cruising.

Setting the vehicle speed (vehicle-to-vehicle distance control mode)

- 1 Press the "ON/OFF" button to activate the cruise control.

Radar cruise control indicator will come on and a message will be displayed on the multi-information display.

Press the button again to deactivate the cruise control.



- 2 Accelerate or decelerate, with accelerator pedal operation, to the desired vehicle speed (above approximately 30 mph [50 km/h]) and push the lever down to set the speed.

Cruise control "SET" indicator will come on.

The vehicle speed at the moment the lever is released becomes the set speed.

While the vehicle is in vehicle-to-vehicle distance control mode, if the lever is released when vehicle speed is less than 30 mph (50 km/h) and a vehicle ahead can be detected, the vehicle will start following the vehicle ahead at a set speed of 30 mph (50 km/h).

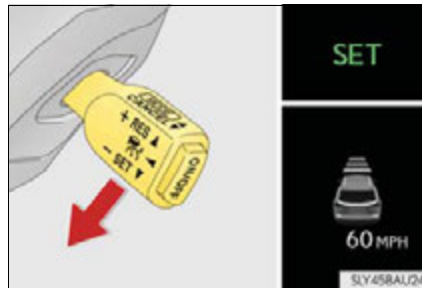

Adjusting the set speed

To change the set speed, operate the lever until the desired set speed is displayed.

① Increases the speed

(Except when the vehicle has been stopped by system control in vehicle-to-vehicle distance control mode)

② Decreases the speed

Fine adjustment: Momentarily move the lever in the desired direction.

Large adjustment: Hold the lever in the desired direction.

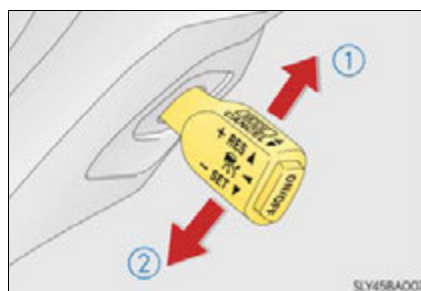

In the vehicle-to-vehicle distance control mode, the set speed will be increased or decreased as follows:

- When the set speed is shown in "MPH"

Fine adjustment: By approximately 1 mph (1.6 km/h) each time the lever is operated

Large adjustment: By approximately 5 mph (8 km/h) for each 0.75 seconds the lever is held

- When the set speed is shown in "km/h"

Fine adjustment: By approximately 1 km/h (0.6 mph) each time the lever is operated

Large adjustment: By approximately 5 km/h (3.1 mph) for each 0.75 seconds the lever is held

In the constant speed control mode (→P. 260), the set speed will be increased or decreased as follows:

Fine adjustment: By approximately 1 mph (1.6 km/h) each time the lever is operated

Large adjustment: The set speed can be increased or decreased continually until the lever is released.

Changing the vehicle-to-vehicle distance (vehicle-to-vehicle distance control mode)

Pressing the button changes the vehicle-to-vehicle distance as follows:

- ① Long
- ② Medium
- ③ Short

The vehicle-to-vehicle distance is set automatically to long mode when the power switch is turned to ON mode.

If a vehicle is running ahead of you, the preceding vehicle mark will also be displayed.

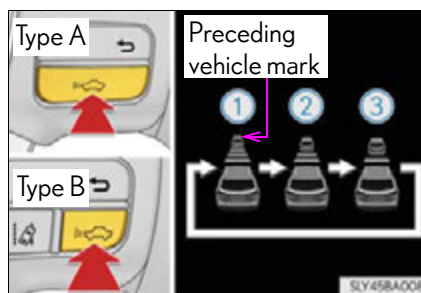

Vehicle-to-vehicle distance settings (vehicle-to-vehicle distance control mode)

Select a distance from the table below. Note that the distances shown correspond to a vehicle speed of 50 mph (80 km/h). Vehicle-to-vehicle distance increases/decreases in accordance with vehicle speed. When the vehicle is stopped by system control, the vehicle-to-vehicle distance will be about 10 ft. (3 m) to 16 ft. (5 m) regardless of the vehicle-to-vehicle distance setting.

Distance options	Vehicle-to-vehicle distance
Long	Approximately 160 ft. (50 m)
Medium	Approximately 130 ft. (40 m)
Short	Approximately 100 ft. (30 m)

4
Driving

Resuming follow-up cruising when the vehicle has been stopped by system control (vehicle-to-vehicle distance control mode)

After the vehicle ahead of you starts off, push the lever up.

Your vehicle will also resume follow-up cruising if the accelerator pedal is depressed after the vehicle ahead of you starts off.

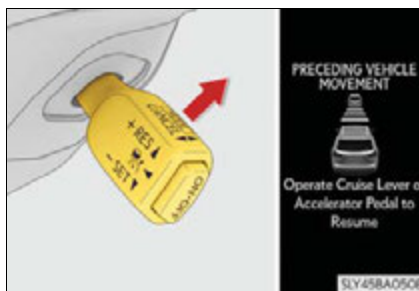

Canceling and resuming the speed control

- ① Pulling the lever toward you cancels the speed control.

The speed setting is also canceled when the brake pedal is depressed.

(When the vehicle has been stopped by system control, depressing the brake pedal does not cancel the setting.)

- ② Pushing the lever up resumes the cruise control and returns vehicle speed to the set speed.



However, when a vehicle ahead is not detected in vehicle-to-vehicle distance control mode, cruise control does not resume when the actual vehicle speed is approximately 25 mph (40 km/h) or less. Also, when the vehicle is in constant speed control mode and the actual vehicle speed is approximately 25 mph (40 km/h) or less, cruise control does not resume as the set speed is cleared.

Approach warning (vehicle-to-vehicle distance control mode)

When your vehicle is too close to a vehicle ahead, and sufficient automatic deceleration via the cruise control is not possible, the display will flash and the buzzer will sound to alert the driver. An example of this would be if another driver cuts in front of you while you are following a vehicle. Depress the brake pedal to ensure an appropriate vehicle-to-vehicle distance.

**■ Warnings may not occur when**

In the following instances, there is a possibility that the warnings will not occur:

- When the speed of the preceding vehicle matches or exceeds your vehicle speed
- When the preceding vehicle is traveling at an extremely slow speed
- Immediately after the cruise control speed was set
- When depressing the accelerator pedal

Selecting constant speed control mode

When constant speed control mode is selected, your vehicle will maintain a set speed without controlling the vehicle-to-vehicle distance. Select this mode only when vehicle-to-vehicle distance control mode does not function correctly due to dirt, etc.

- ① Press the "ON/OFF" button to activate the cruise control.

Press the button again to deactivate the cruise control.

- ② Switch to constant speed control mode.

(Push the lever forward and hold for approximately 1 second.)

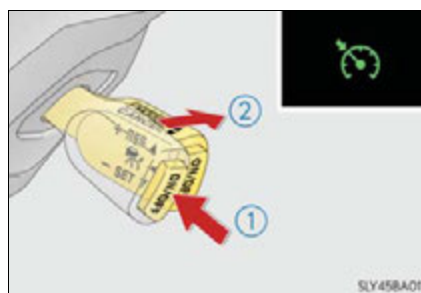

Cruise control indicator will come on.

When in constant speed control mode, to return to vehicle-to-vehicle distance control mode, push the lever forward again and hold for approximately 1 second.

After the desired speed has been set, it is not possible to return to vehicle-to-vehicle distance control mode.

If the power switch is turned off and then turned to ON mode again, the vehicle will automatically return to vehicle-to-vehicle distance control mode.

Adjusting the speed setting: →P. 256

Canceling and resuming the speed setting: →P. 258

■ Dynamic radar cruise control with full-speed range can be set when

- The shift lever is in D or range 4 or higher of S has been selected.
- Vehicle speed is above approximately 30 mph (50 km/h).

■ Accelerating after setting the vehicle speed

The vehicle can accelerate by operating the accelerator pedal. After accelerating, the set speed resumes. However, during vehicle-to-vehicle distance control mode, the vehicle speed may decrease below the set speed in order to maintain the distance to the preceding vehicle.

■ Automatic cancelation of vehicle-to-vehicle distance control mode

Vehicle-to-vehicle distance control mode is automatically canceled in the following situations:

- VSC is activated.
- TRAC is activated for a period of time.
- When the VSC or TRAC system is turned off by pressing the VSC OFF switch.
- The sensor cannot detect properly because it is obstructed in some way.
- The parking brake is operated.
- The vehicle is stopped by system control on a steep incline.
- Pre-collision braking is activated.
- The following are detected when the vehicle has been stopped by system control:
 - The driver is not wearing a seat belt.
 - The driver's door is opened.
 - The back door or hood is opened.

When vehicle-to-vehicle distance control mode is automatically canceled in the following situations, "Radar Cruise Control Unavailable" will be displayed on the multi-information display:

- Actual vehicle speed falls below approximately 25 mph (40 km/h) when there are no vehicles ahead.
- The preceding vehicle leaves the lane when your vehicle is following at a vehicle speed below 25 mph (40 km/h). Otherwise, the sensor cannot properly detect the vehicle.
- The windshield wipers are operating at high speed (when the wiper switch is set to the "AUTO" mode or the high speed wiper operation position).

If vehicle-to-vehicle distance control mode is automatically canceled for any other reason, there may be a malfunction in the system. Contact your Lexus dealer.

■ **Automatic cancelation of constant speed control mode**

Constant speed control mode is automatically canceled in the following situations:

- Actual vehicle speed is more than approximately 10 mph (16 km/h) below the set vehicle speed.
- Actual vehicle speed falls below approximately 25 mph (40 km/h).
- VSC is activated.
- TRAC is activated for a period of time.
- When the VSC or TRAC system is turned off by pressing the VSC OFF switch.
- Pre-collision braking is activated.

■ **Radar sensor and grille cover**

Always keep the sensor and grille cover clean to ensure that the vehicle-to-vehicle distance control mode operates properly. (Some obstructions, such as snow, ice and plastic objects, cannot be detected by the obstruction sensor.)

Dynamic radar cruise control with full-speed range is canceled if an obstruction is detected.

- ① Grille cover
- ② Radar sensor

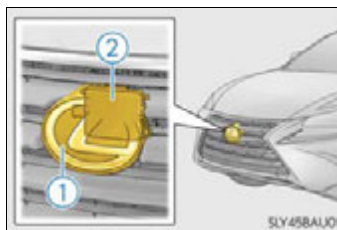

■ **Warning messages and buzzers for dynamic radar cruise control with full-speed range**

Warning messages and buzzers are used to indicate a system malfunction or to inform the driver of the need for caution while driving. If a warning message is shown on the multi-information display, read the message and follow the instructions.

■ **Certification for the radar sensor**

→P. 248

 **WARNING****■ Before using dynamic radar cruise control with full-speed range**

Do not overly rely on vehicle-to-vehicle distance control mode.

Be aware of the set speed. If automatic deceleration/acceleration is not appropriate, adjust the vehicle speed, as well as the distance between your vehicle and vehicles ahead by applying the brakes, etc.

■ Cautions regarding the driving assist systems

Observe the following precautions.

Failure to do so may cause an accident resulting in death or serious injury.

● Assisting the driver to measure following distance

The dynamic radar cruise control with full-speed range is only intended to help the driver in determining the following distance between the driver's own vehicle and a designated vehicle traveling ahead. It is not a mechanism that allows careless or inattentive driving, and it is not a system that can assist the driver in low-visibility conditions. It is still necessary for driver to pay close attention to the vehicle's surroundings.

● Assisting the driver to judge proper following distance

The dynamic radar cruise control with full-speed range determines whether the following distance between the driver's own vehicle and a designated vehicle traveling ahead is appropriate or not. It is not capable of making any other type of judgement. Therefore, it is absolutely necessary for the driver to remain vigilant and to determine whether or not there is a possibility of danger in any given situation.

● Assisting the driver to operate the vehicle

The dynamic radar cruise control with full-speed range has no capability to prevent or avoid a collision with a vehicle traveling ahead. Therefore, if there is ever any danger, the driver must take immediate and direct control of the vehicle and act appropriately in order to ensure the safety of all involved.

■ To avoid inadvertent dynamic radar cruise control with full-speed range activation

Switch the dynamic radar cruise control with full-speed range off using the "ON/OFF" button when not in use.

⚠ WARNING

■ **Situations unsuitable for dynamic radar cruise control with full-speed range**

Do not use dynamic radar cruise control with full-speed range in any of the following situations.

Doing so may result in inappropriate speed control and could cause an accident resulting in death or serious injury.

- Roads where there are pedestrians, cyclers, etc.
- In heavy traffic
- On roads with sharp bends
- On winding roads
- On slippery roads, such as those covered with rain, ice or snow
- On sharp inclines or declines
Vehicle speed may exceed the set speed when driving down a steep hill.
- Roads with continuous inclines and declines
- At entrances to freeways and highways
- When weather conditions are bad enough that they may prevent the sensors from detecting correctly (fog, snow, sandstorm, heavy rain, etc.)
- When an approach warning buzzer is heard often
- When your vehicle is towing a trailer or during emergency towing

■ **When the sensor may not be correctly detecting the vehicle ahead**

In the case of the following and depending on the conditions, operate the brake pedal when deceleration of the system is insufficient or operate the accelerator pedal when acceleration is required.

As the sensor may not be able to correctly detect these types of vehicles, the approach warning (→P. 259) will not be activated, which may lead to an accident resulting in death or serious injury.

- Vehicles that cut in suddenly
- Vehicles traveling at low speeds
- Vehicles that are not moving in the same lane
- Vehicles with small rear ends (trailers with no load on board, etc.)

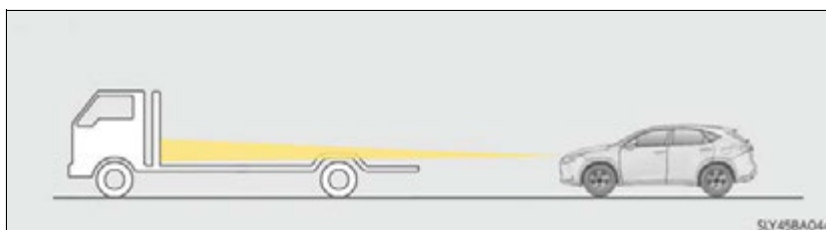

- Motorcycles traveling in the same lane
- When water or snow thrown up by the surrounding vehicles hinders the detecting of the sensor

⚠ WARNING

- When your vehicle is pointing upwards (caused by a heavy load in the luggage compartment, etc.)

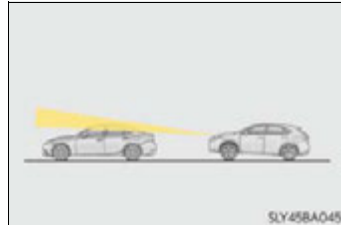

■ **Conditions under which the vehicle-to-vehicle distance control mode may not function correctly**

Operate the brake pedal (or accelerator pedal operation depending on the situation) as necessary in the following conditions as the radar sensor may not be able to correctly detect vehicles ahead, which may lead to an accident resulting in death or serious injury.

- When the road curves or when the lanes are narrow

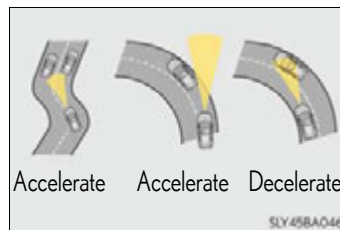

- When steering wheel operation or your position in the lane is unstable

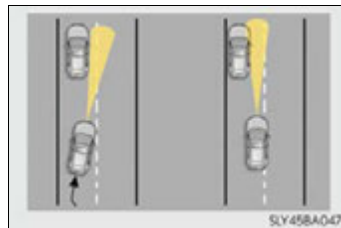

- When the vehicle ahead of you decelerates suddenly

 **WARNING****■ Handling the radar sensor**

Observe the following to ensure the dynamic radar cruise control with full-speed range can function effectively.

Otherwise, the radar sensor may not detect correctly and could result in an accident.

- Keep the sensor and grille cover clean at all times.
Clean the sensor and grille cover with a soft cloth so you do not mark or damage them.
- Do not subject the sensor or surrounding area to a strong impact.
If the sensor moves even slightly off position, the system may malfunction. If the sensor or surrounding area is subject to a strong impact, always have the area inspected and adjusted by your Lexus dealer.
- Do not disassemble the sensor.
- Do not attach accessories or stickers to the sensor, grille cover or surrounding area.
- Do not modify or paint the sensor and grille cover.
- If the radar sensor needs to be replaced, contact your Lexus dealer.

Cruise control*

Summary of functions

Use the cruise control to maintain a set speed without operating the accelerator pedal.

Use the cruise control on freeways and highways.

- ① Indicators
- ② Cruise control switch

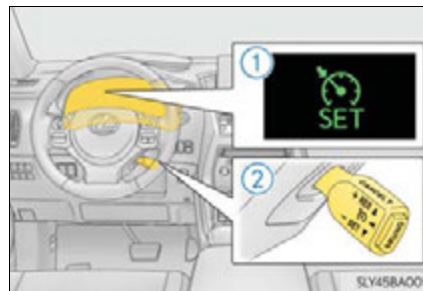

Setting the vehicle speed

- 1 Press the "ON/OFF" button to activate the cruise control.

Cruise control indicator will come on.
Press the button again to deactivate the cruise control.

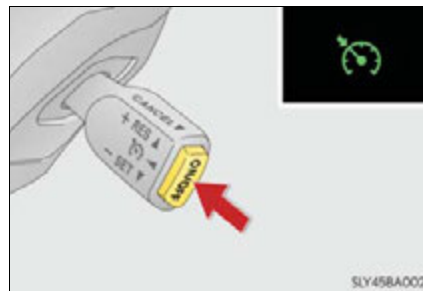

- 2 Accelerate or decelerate, with accelerator pedal operation, to the desired vehicle speed (above approximately 25 mph [40 km/h]) and push the lever down to set the speed.

Cruise control "SET" indicator will come on.

The vehicle speed at the moment the lever is released becomes the set speed.

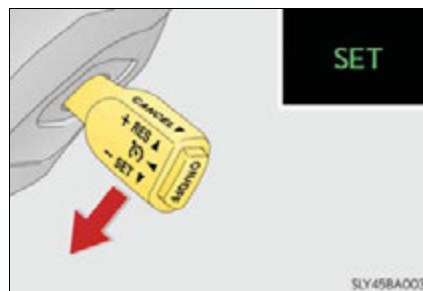

4

Driving

*: If equipped

Adjusting the set speed

To change the set speed, operate the lever until the desired set speed is obtained.

- ① Increases the speed
- ② Decreases the speed

Fine adjustment: Momentarily move the lever in the desired direction.

Large adjustment: Hold the lever in the desired direction.

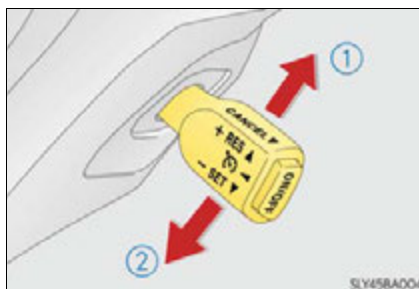

The set speed will be increased or decreased as follows:

Fine adjustment: By approximately 1 mph (1.6 km/h) each time the lever is operated

Large adjustment: The set speed can be increased or decreased continually until the lever is released.

Canceling and resuming the constant speed control

- ① Pulling the lever toward you cancels the constant speed control.

The speed setting is also canceled when the brake pedal is depressed.

- ② Pushing the lever up resumes the constant speed control.

However, resuming is available when the vehicle speed is more than approximately 25 mph (40 km/h).



■ Cruise control can be set when

- The shift lever is in D or range 4 or higher of S has been selected.
- Vehicle speed is above approximately 25 mph (40 km/h).

■ Accelerating after setting the vehicle speed

- The vehicle can be accelerated by operating accelerator pedal. After accelerating, the set speed resumes.
- Even without canceling the cruise control, the set speed can be increased by first accelerating the vehicle to the desired speed and then pushing the lever down to set the new speed.

■ Automatic cancelation of cruise control

Cruise control is automatically canceled in any of the following situations.

- Actual vehicle speed falls more than approximately 10 mph (16 km/h) below the set speed.
- Actual vehicle speed is below approximately 25 mph (40km/h).
- VSC is activated.
- TRAC is activated for a period of time.
- When the VSC or TRAC system is turned off by pressing the VSC OFF switch.

■ If “Cruise Control Malfunction Visit Your Dealer” is displayed on the multi-information display

Press the “ON/OFF” button once to deactivate the system, and then press the button again to reactivate the system.

If the cruise control speed cannot be set or if the cruise control cancels immediately after being activated, there may be a malfunction in the cruise control system. Have the vehicle inspected by your Lexus dealer.



WARNING

■ To avoid operating the cruise control by mistake

Switch the cruise control off using the “ON/OFF” button when not in use.

■ Situations unsuitable for cruise control

Do not use cruise control in any of the following situations.

Doing so may result in loss of control and could cause an accident resulting in death or serious injury.

- Roads where there are pedestrians, cyclers, etc.
- In heavy traffic
- On roads with sharp bends
- On winding roads
- On slippery roads, such as those covered with rain, ice or snow
- On sharp inclines or declines
Vehicle speed may exceed the set speed when driving down a steep hill.
- When your vehicle is towing a trailer or during emergency towing

LDA (Lane Departure Alert with steering control)*

Summary of function

While driving on a highway or freeway that has white (or yellow) lane markers and few curves, a camera, which is located on the upper part of the windshield, uses this system to recognize the white (yellow) lane markers and when the driver has deviated from the lane. If the system judges that the vehicle has deviated from the current traffic lane, along with alerting the driver with a buzzer and indications in the multi-information display, it will provide assistance by operating the steering wheel to avoid further deviation from the marker lines.

Lane recognition camera



- ① Indicators
- ② Display
- ③ LDA switch

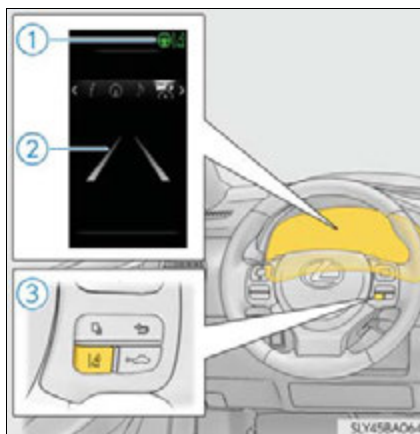

*: If equipped

Functions included with LDA

◆ Lane deviation alert function

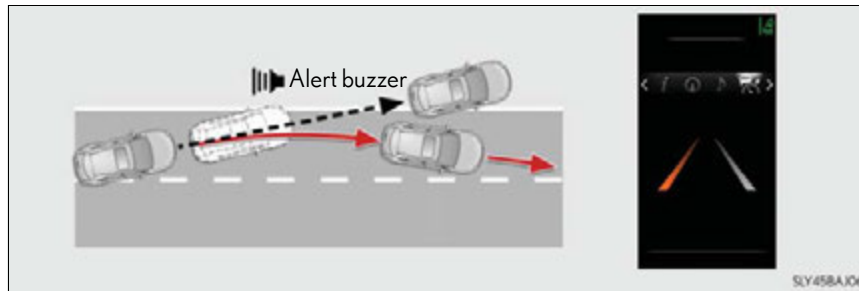

When the system judges that the vehicle is deviating from the current traffic lane, an alert buzzer sounds and it prompts cautions from the display screen of the multi-information display.

When the alert buzzer sounds, please check the surrounding road situation and return near the center of the white (yellow) lane markers by safely operating the steering wheel.

◆ Steering control function

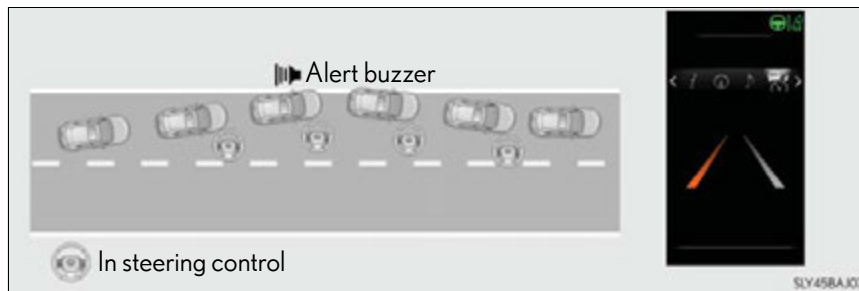

If the system judges that the vehicle has deviated from the current traffic lane, it is displayed in the multi-information display and steering force is supplied to the steering wheel by the steering control, providing required assistance in steering wheel operation to avoid further deviation from the marker lines.

In order to prevent over relying on the system, when the system does not operate the steering wheel and driving where hands are lightly supporting the steering wheel continues, a warning message is displayed on the multi-information display.

Turning the LDA on

Press the LDA switch to activate the LDA.

LDA indicator will come on and lane lines will be displayed on the multi-information display.

Press the switch again to deactivate the LDA.

When the power switch is turned off, the LDA returns to off.

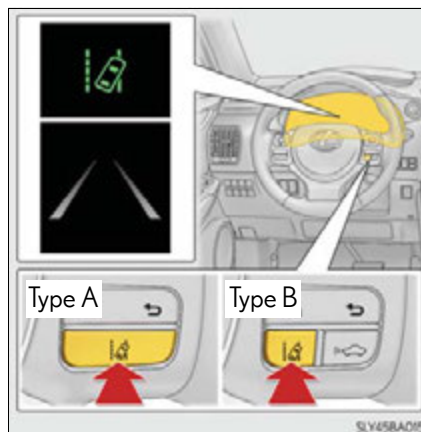

Operating conditions for each function

■ Lane deviation alert function

When the following conditions are satisfied, the function operates.

When the lane deviation alert function operates, lane lines is displayed on the multi-information display. (→P. 274)

- When the LDA is on. (→P. 272)
- When the vehicle speed is approximately 32 mph (50 km/h) or more.
- When the system recognizes white (yellow) lane markers.
- When the lane width is more than approximately 8.2 ft. (2.5 m).
- When turn signal lever is not operating.
- When the emergency flashers are not operating.
- When driving on a straight road or through a curve with a radius of more than approximately 328 ft. (100 m)
- When a system abnormality is not detected. (→P. 275)

■ Steering control function

In addition to the operation conditions for the lane deviation alert function, when all of the following conditions are fulfilled, it operates.

- When settings for the “Steering Assist” in the “Settings display” of the multi-information display is set to “On” (→P. 276)
- When the vehicle has not slowed down more than a defined setting.
- When the steering wheel is operated with a steering force level that is not equivalent to changing lanes.
- When the ABS, VSC, TRAC, or PCS (if equipped) is not operating.
- When intentional accelerator pedal operations are not performed.

Temporary cancelation of the functions

■ Lane deviation alert function

In any of the following cases, the lane deviation alert function will be temporarily canceled. When the conditions, in which the cancelation occurred improves, the function will resume operations.

- The vehicle speed deviates from the operating ranges of the function
- The turn signal lever is operated
- When the emergency flashers are operated
- When the lane markers cannot be recognized while driving
- When the system malfunctions
- Immediately after the lane deviation alert operates

The lane deviation alert function will not operate again for a several seconds after it has been activated, even if the vehicle leaves the lane again.

- When more than half of the vehicle body straddles the lane

■ Steering control function

In addition to the temporary cancelation conditions of the lane deviation alert function, in any of the following cases the steering control function is temporarily canceled. When the conditions for which the cancelation occurred improves, the function will restart operations.

- When the vehicle has slowed down more than a defined setting.
- When the steering wheel is operated with a steering force level that is equivalent to changing lanes.
- When the ABS, VSC, TRAC, or PCS (if equipped) is operating.
- When intentional accelerator pedal operations are performed.
- Operations of the VSC and TRAC have been turned off (→P. 307)

When the steering control function was canceled

When it is judged that there is a malfunction in the system relating to steering control function, the steering control function is canceled and "LDA Steering Assist Deactivated Warnings Available" is displayed on the multi-information display. However, it is possible that the lane deviation alert function operates.

When the steering control function is canceled, it will not return unless "Steering Assist" is turned "On" again from the "Settings display" of the multi-information display (→P. 276) or the LDA switch is turned on again.

Indication on the multi-information display

When the both lane lines turn white:

Indicates that both right and left lane markers are recognized.

If the vehicle deviates from the traffic lane, the lane display on the side the vehicle has deviated from will flash in orange. (→P. 271)



When the either lane line turns white:

Indicates that the lane marker on the white-marked side is recognized.

If the vehicle deviates from the side of a lane with recognized lane markers, the lane line will flash in orange. (→P. 271)



When the inside of both lane lines are black:

Indicates that no lane markers are recognized or the LDA is temporarily canceled.



Display while in steering control

In steering control, the steering control indicator will come on.



■ If “Lane Departure Alert Malfunction Visit Your Dealer” is displayed on the multi-information display

Even if the LDA switch is pressed, when the LDA indicator does not come on the system may have a malfunction. Have the vehicle inspected by your Lexus dealer immediately.

■ The steering control function

There are cases where it may be difficult to sense the steering force on the steering wheel by the steering control, according to speed, the deviation situation, conditions of a road, etc.

■ Alert buzzer for lane deviation alert

Depending on the audio system sound level or air conditioning fan noise while the audio system or air conditioning system is in use, it may be difficult to hear the alert buzzer.

■ After the vehicle has been parked in the sun

The LDA may not be available and a warning message will be displayed for a while after driving has started. When the temperature in the cabin decreases and the temperature around the lane recognition camera (→P. 270) becomes suitable for its operation, turn the LDA switch on again after a short time.

■ If there are lane markers on only one side of the vehicle

The lane deviation alert will not operate for the side on which lane markers could not be recognized.

■ Conditions in which the function may not operate correctly

In the following situations, the lane recognition camera may be unable to recognize lane markers causing the lane deviation alert function to operate incorrectly. However, this does not indicate a malfunction.

- When there are shadows on the road running parallel with lane markers, or if a shadow covers the lane markers
- When driving through an area with no lane markers, such as a toll booth, a crossing or before a ticket checkpoint
- When the lane markers are broken, Botts' dots (raised pavement markers) or stones
- When lane markers are obscured or partially obscured by sand, dirt, etc.
- When driving on a road surface that is wet due to rain, previous rainfall, standing water, etc.
- When the lane markers are yellow (These may be more difficult for the system to recognize compared to white markers.)

- When the lane markers are on a curb, etc.
- When driving on a particularly bright road surface, such as concrete
- When driving on a road surface that is bright due to reflected light
- When driving in a location where the light level changes rapidly, such as the entrance to or exit from a tunnel
- When sunlight or the headlights of oncoming vehicles are shining directly into the camera lens
- When driving on roads that are branching or merging
- When driving on a hill
- When driving on winding roads or roads that are uneven
- When driving on rough or unpaved roads
- When driving on a sharp curve
- When lane markers are extremely narrow or extremely wide
- When the vehicle leans to one side an unusual amount due to a heavy load or improper tire inflation pressure
- When the following distance between your vehicle and the vehicle ahead is extremely short
- When the vehicle experiences strong up-and-down motion such as when driving on an extremely rough road or on a seam in the pavement
- When headlight brightness at nighttime is reduced due to dirt on the lenses, or when the headlights are misaligned
- When receiving a side wind

■ **When changing the tires**

Depending on the tires used such as snow tires, etc., sufficient performance may not be maintainable.





■ **Warning messages for the LDA**

Warning messages are used to indicate a system malfunction or to inform the driver of the need for caution while driving. If a warning message is shown on the multi-information display, read the message and follow the instructions.

Also, even if a warning message is displayed, it will not impede normal driving.





■ **When turning on/off the steering control function**

From  "Settings display" (→P. 103) of the multi-information display, the steering control function can be turned on/off.

- 1 Pressing the  or  meter control switches (→P. 103), selects 
- 2 With each press of  meter control switches, the control switches between "On" and "Off"

■ **Sensitivity adjustment for the lane deviation alert buzzer**

From  "Settings display" (→P. 103) of the multi-information display, the alert sensitivity for the alert buzzer when deviating from the lane can be adjusted.

- 1 Pressing the  or  meter control switches (→P. 103), selects 
- 2 With each press of  meter control switches, the control switches between "High" and "Standard"

⚠ WARNING**■ Before using the LDA**

Do not over rely on the LDA. The LDA does not drive the vehicle automatically, nor does it reduce the amount of care you need to take. As such, the driver must always assume full responsibility for understanding his/her surroundings, for operating the steering wheel to correct the driving line, and for driving safely. Also, take occasional rests from fatigue due to driving over long periods of time, etc.

Inappropriate or negligent driving could lead to an unexpected accident.

■ Do not drive without holding the steering wheel

While the steering control function is operating, when the system judges that the vehicle is being driven without holding the steering wheel, a warning message is displayed. (→P. 271)

Inappropriate steering wheel operations and/or negligent driving could lead to an unexpected accident. When driving, firmly hold the steering wheel and keep safe driving in mind.

■ To avoid operating the LDA by mistake

Switch the LDA off using the LDA switch when not in use. (→P. 272)

■ Situations unsuitable for LDA

Do not use the LDA in any of the following situations.

Otherwise, the system may not function correctly and could result in an accident.

- When driving with tire chains, a spare tire, or similar equipment
- When a tire with a different structure, maker, brand, or tread pattern is used.
- When remain tread of the tire or the air pressure is insufficient
- When restructuring the suspension
- When there are objects or structures along the roadside that might be misinterpreted as lane markers (such as guardrails, a curb, reflector posts, etc.)
- When driving on snowy roads
- When pavement lane markers are difficult to see due to rain, snow, fog, sand, dust, etc.
- When there are visible lines on the pavement from road repairs, or if the remains of old lane markers are still visible on the road
- When driving on a road with lane closures due to maintenance, or when driving in a temporary lane
- When driving on road surfaces that are slippery from rain, snow, etc.
- When driving in traffic lanes other than highways and freeway
- When driving through construction areas

 NOTICE

■ **To prevent damage to or incorrect operation of the LDA**

Observe the following to ensure that the LDA system functions correctly

- Do not modify the headlights or attach stickers to the surface of the lights.
- Do not modify the suspension or replace it with non-genuine parts.
- Do not install or place anything on the hood or the grille. Also, do not install a grille guard (bull bars, kangaroo bar, etc.).
- If your windshield needs repairs, contact your Lexus dealer.
- Do not overload with luggage

■ **Lane recognition camera**

Observe the following to ensure that the LDA system functions correctly

- Keep the windshield clean at all times.
Performance could be affected if the windshield is dirty, or if raindrops, condensation or ice are adhering to the windshield.
- Do not attach a sticker or other items to the windshield near the lane recognition camera.



- Do not spill liquids onto the lane recognition camera.
- Do not attach window tinting to the windshield.
- Do not install an antenna in front of the lane recognition camera.
- If the windshield area in front of the lane recognition camera is fogged up, use the windshield defogger to remove the fog from that area. (→P. 435)
When it is cold, using the heater with air blowing to the feet may allow the upper part of the windshield to fog up. This will have a negative effect on the images.
- Do not scratch the camera lens, or let it get dirty.
When cleaning the inside of the windshield, be careful not to get any glass cleaner, etc., on the lens. Also, do not touch the lens.
For lens repair, contact your Lexus dealer.
- Do not change the installation position or direction of the lane recognition camera or remove it.
The direction of the lane recognition camera is precisely adjusted.
- Do not subject the lane recognition camera to strong impact or force, and do not disassemble the lane recognition camera.
- Do not replace windshield with non-genuine windshield.
Contact your Lexus dealer.

Intuitive parking assist*

The distance from your vehicle to nearby obstacles when parallel parking or maneuvering into a garage is measured by the sensors and communicated via the displays and a buzzer. Always check the surrounding area when using this system.

Types of sensors

- ① Front corner sensors
- ② Front center sensors
- ③ Rear corner sensors
- ④ Rear center sensors

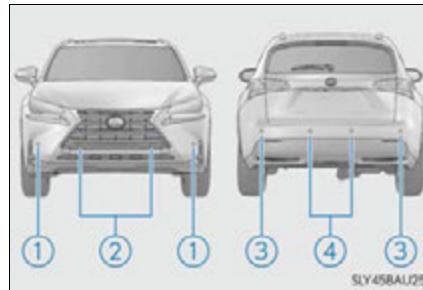

Intuitive parking assist switch

Turns the intuitive parking assist on/off. When on, the indicator light comes on to inform the driver that the system is operational.

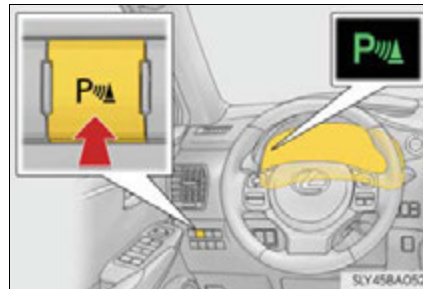

*: If equipped

Display

When the sensors detect an obstacle, the following displays inform the driver of the position and distance to the obstacle.

■ Multi-information display

- ① Front corner sensor operation
- ② Front center sensor operation
- ③ Rear corner sensor operation
- ④ Rear center sensor operation



■ Lexus Display Audio or navigation system screen

- ① Intuitive parking assist display

When the Lexus parking assist monitor is not displayed.

A graphic is automatically displayed when an obstacle is detected. The screen can be set so that the graphic is not displayed. (→P. 283)

: Select to mute the buzzer sounds.



- ② Insert display









When the Lexus parking assist monitor is displayed.

A simplified image is displayed on the right upper corner of the Lexus Display Audio and the navigation system screen when an obstacle is detected.

Sensor detection display, obstacle distance

■ **Distance display**

Sensors that detect an obstacle will illuminate continuously or blink.

Display *1	Insert display	Approximate distance to obstacle	
		Front and rear center sensor	Front and rear corner sensor
 (continuous)	 (blinking slowly)	Front center sensor: 3.3 ft. (100 cm) to 2.0 ft. (60 cm) Rear center sensor: 4.9 ft. (150 cm) to 2.0 ft. (60 cm)	—
 (continuous)	 (blinking)	2.0 ft. (60 cm) to 1.5 ft. (45 cm)	2.0 ft. (60 cm) to 1.5 ft. (45 cm)
 (continuous)	 (blinking rapidly)	Front center sensor: 1.5 ft. (45 cm) to 1.0 ft. (30 cm) Rear center sensor: 1.5 ft. (45 cm) to 1.2 ft. (35 cm)	1.5 ft. (45 cm) to 1.0 ft. (30 cm)
 (blinking *2 or continuous *3)	 (continuous)	Front center sensor: Less than 1.0 ft. (30 cm) Rear center sensor: Less than 1.2 ft. (35 cm)	Less than 1.0 ft. (30 cm)

*1: The images may differ from that shown in the illustrations. (→P. 280)

*2: Multi-information display

*3: Lexus Display Audio or navigation system screen

■ **Buzzer operation and distance to an obstacle**

A buzzer sounds when the sensors are operating.

- The buzzer sounds faster as the vehicle approaches an obstacle.
 - When the vehicle comes within the following distance of the obstacle, the buzzer sounds continuously.
 - Front corner sensors: Approximately 1.0 ft. (30 cm)
 - Front center sensors: Approximately 1.0 ft. (30 cm)
 - Rear corner sensors: Approximately 1.0 ft. (30 cm)
 - Rear center sensors: Approximately 1.2 ft. (35 cm)
- When 2 or more obstacles are detected simultaneously, the buzzer system responds to the nearest obstacle. If one or both come within the above distances, the beep will repeat a long tone, followed by fast beeps.

Detection range of the sensors

- ① Approximately 3.3 ft. (100 cm)
- ② Approximately 4.9 ft. (150 cm)
- ③ Approximately 2.0 ft. (60 cm)

The diagram shows the detection range of the sensors. Note that the sensors cannot detect obstacles that are extremely close to the vehicle.

The range of the sensors may change depending on the shape of the object etc.

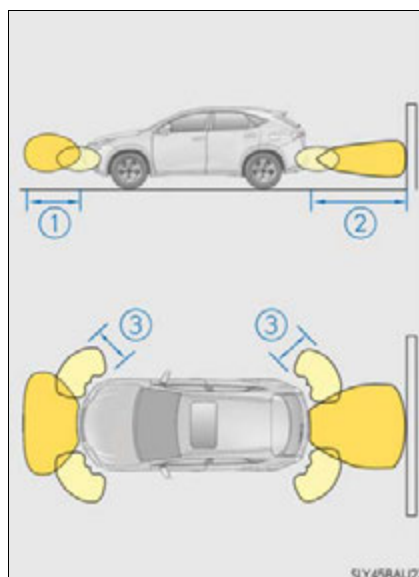

Setting up intuitive parking assist (vehicles with a Lexus Display Audio or navigation system)

You can change the buzzer sounds volume and the screen operating conditions when the power switch is in ON mode.

▶ Lexus Display Audio system

- 1 Press the "MENU" button on the Lexus Display Audio controller, and then select "Setup" on the screen.
- 2 Select "Vehicle", and then select "LEXUS Park Assist" on the screen.
- 3 Select the desired item.

▶ Navigation system

- 1 Press the "MENU" button on the Remote Touch, and then select "Setup" on the screen.
- 2 Select "Vehicle", and then select "LEXUS Park Assist" on the screen.
- 3 Select the desired item.

▶ Lexus Display Audio screen

▶ Navigation system screen



- ① The buzzer sounds volume can be adjusted.
- ② On or off can be selected for intuitive parking assist display.
- ③ Both the front or rear center sensors display and tone indication can be set.

■ The intuitive parking assist can be operated when

- Front corner sensors:
 - The power switch is in ON mode.
 - The shift lever is in other than P.
 - The vehicle speed is less than about 6 mph (10 km/h).
(At any speed when the shift lever is in R)
- Front center sensors:
 - The power switch is in ON mode.
 - The shift lever is in other than P or R.
 - The vehicle speed is less than about 6 mph (10 km/h).
- Rear corner and rear center sensors:
 - The power switch is in ON mode.
 - The shift lever is in R.

■ Intuitive parking assist display

When an obstacle is detected while the Lexus parking assist monitor is in use, the warning indicator will appear in the upper corner of the screen even if the display setting has been set to off.

■ Sensor detection information

- The sensor's detection areas are limited to the areas around the vehicle's bumper.
- Certain vehicle conditions and the surrounding environment may affect the ability of a sensor to correctly detect an obstacle. Particular instances where this may occur are listed below.
 - There is dirt, snow or ice on the sensor. (Wiping the sensors will resolve this problem.)
 - The sensor is frozen. (Thawing the area will resolve this problem.)
In especially cold weather, if a sensor is frozen the screen may show an abnormal display, or obstacles may not be detected.
 - The sensor is covered in any way.
 - The vehicle is leaning considerably to one side.
 - On an extremely bumpy road, on an incline, on gravel, or on grass.
 - The vicinity of the vehicle is noisy due to vehicle horns, motorcycle engines, air brakes of large vehicles, or other loud noises producing ultrasonic waves.
 - There is another vehicle equipped with parking assist sensors in the vicinity.
 - The sensor is coated with a sheet of spray or heavy rain.
 - The vehicle is equipped with a fender pole or wireless antenna.
 - Towing eyelets are installed.
 - The bumper or sensor receives a strong impact.
 - The vehicle is approaching a tall or curved curb.
 - In harsh sunlight or intense cold weather.
 - The area directly under the bumpers is not detected.
 - If obstacles draw too close to the sensor.
 - A non-genuine Lexus suspension (lowered suspension etc.) is installed.
 - People may not be detected if they are wearing certain types of clothing.In addition to the examples above, there are instances in which, because of their shape, signs and other objects may be judged by a sensor to be closer than they are.

- The shape of the obstacle may prevent a sensor from detecting it. Pay particular attention to the following obstacles:
 - Wires, fences, ropes, etc.
 - Cotton, snow and other materials that absorb sound waves
 - Sharply-angled objects
 - Low obstacles
 - Tall obstacles with upper sections projecting outwards in the direction of your vehicle
- The following situations may occur during use.
 - Depending on the shape of the obstacle and other factors, the detection distance may shorten, or detection may be impossible.
 - Obstacles may not be detected if they are too close to the sensor.
 - There will be a short delay between obstacle detection and display. Even at slow speeds, there is a possibility that the obstacle will come within the sensor's detection areas before the display is shown and the buzzer sounds.
 - Thin posts or objects lower than the sensor may not be detected when approached, even if they have been detected once.
 - It might be difficult to hear beeps due to the volume of audio system or air flow noise of the air conditioning system.
- **“Clean Parking Assist Sensor” is displayed on the multi-information display**

A sensor may be dirty or covered with snow or ice. In such cases, if it is removed from the sensor, the system should return to normal.

Also, due to the sensor being frozen at low temperatures, a malfunction display may appear or an obstacle may not be detected. If the sensor thaws out, the system should return to normal.
- **“Parking Assist Malfunction” is displayed on the multi-information display**

Depending on the malfunction of the sensor, the device may not be working normally. Have the vehicle inspected by your Lexus dealer.
- **Certification**
 - ▶ For vehicles sold in the U.S.A.

This device complies with Part 15 of the FCC Rules. Operation is subject to the following two conditions; (1) this device may not cause harmful interference, and (2) this device must accept any interference received, including interference that may cause undesired operation.
 - ▶ For vehicles sold in Canada

This ISM device complies with Canadian ICES-001.
Cet appareil ISM est conforme a la norme NMB-001 du Canada.
- **Customization**

Settings (e.g. buzzer sounds volume) can be changed. (→P. 283)

 **WARNING****■ When using the intuitive parking assist**

Observe the following precautions.

Failing to do so may result in the vehicle being unable to be driven safely and possibly cause an accident.

- Do not use the sensor at speeds in excess of 6 mph (10 km/h).
- The sensors' detection areas and reaction times are limited. When moving forward or reversing, check the areas surrounding the vehicle (especially the sides of the vehicle) for safety, and drive slowly, using the brake to control the vehicle's speed.
- Do not install accessories within the sensors' detection areas.

 **NOTICE****■ When using intuitive parking assist**

In the following situations, the system may not function correctly due to a sensor malfunction, etc. Have the vehicle checked by your Lexus dealer.

- The intuitive parking assist operation display flashes, and a buzzer sounds when no obstacles are detected.
- If the area around a sensor collides with something, or is subjected to strong impact.
- If the bumper collides with something.
- If the display shows continuously without beeping, except when the buzzer mute switch has been turned on.
- If a display error occurs, first check the sensor.
If the error occurs even if there is no ice, snow or mud on the sensor, it is likely that the sensor is malfunctioning.

■ Notes when washing the vehicle

Do not apply intensive bursts of water or steam to the sensor area.

Doing so may result in the sensor malfunctioning.

Lexus parking assist monitor

The parking assist monitor assists the driver by displaying an image of the view behind the vehicle while backing up, for example while parking.

Owners of models equipped with a navigation system should refer to the "NAVIGATION SYSTEM OWNER'S MANUAL".

The screen illustrations used in this text are intended as examples, and may differ from the image that is actually displayed on the screen.

The rear view image is displayed when the shift lever is in R and the power switch is in ON mode.

The parking assist monitor system will be deactivated when the shift lever is in any position other than R.

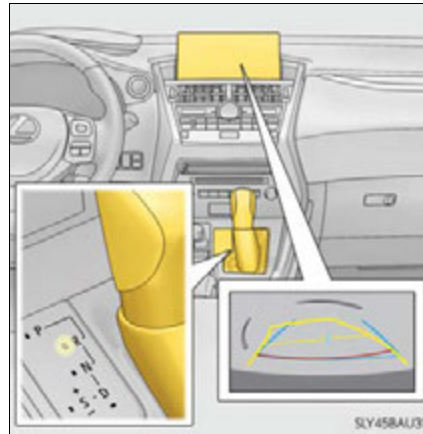

4

Driving

Using the Lexus parking assist monitor

■ Screen display

The parking assist monitor screen will be displayed if the shift position is shifted to R while the power switch is in ON mode.

Ⓐ Intuitive parking assist display (if equipped)

If an obstacle is detected while the intuitive parking assist is on, a display is shown in the top right corner of the screen.

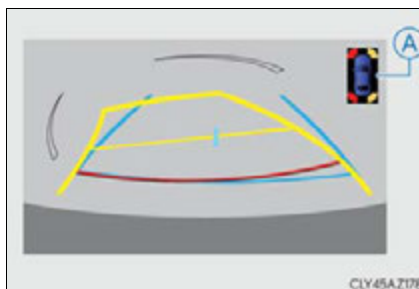

■ Using the system

Use any of the following modes.



● Estimated course line display mode (→P. 290)

Estimated course lines are displayed which move in accordance with the operation of the steering wheel.

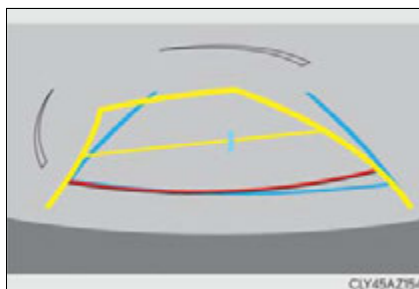

- Parking assist guide line display mode (→P. 292)

The steering wheel return points (parking assist guide lines) are displayed.

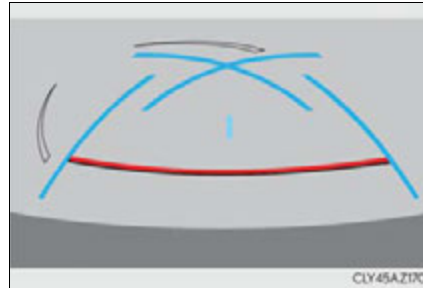

- Distance guide line display mode

Distance guide lines only are displayed.

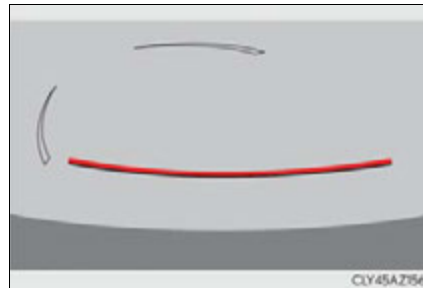

Switching the display mode

When the shift lever is in any position other than R, the display mode can be changed in the following procedure.

- 1 Press the "MENU" button on the Lexus Display Audio controller, and then select "Setup" on the screen.
- 2 Select "Vehicle", and then select "Back Camera Guide Line Setting" on the screen.
- 3 Select the desired display mode.
 - ① Estimated course line display mode (→P. 290)
 - ② Parking assist guide line display mode (→P. 292)
 - ③ Distance guide line display mode
Distance guide lines only are displayed.

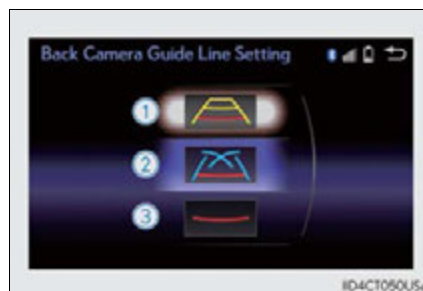

Estimated course line display mode

■ Screen description

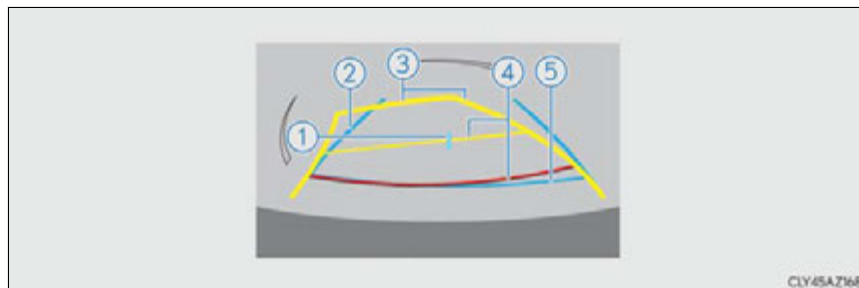

- ① Vehicle center guide line
The line indicates the estimated vehicle center on the ground.
- ② Vehicle width guide line
The line indicates a guide path when the vehicle is being backed straight up. The displayed width is wider than the actual vehicle width. The line aligns with the estimated course lines when the steering wheel is straight.
- ③ Estimated course lines
The lines show an estimated course when the steering wheel is turned.
- ④ Distance guide line
The line moves, together with the estimated course lines, in sync with the steering wheel. The line shows points approximately 1.5 ft. (0.5 m) (red) and approximately 3 ft. (1 m) (yellow) from the center of the edge of the bumper.
- ⑤ Distance guide line
The line shows distance behind the vehicle, a point approximately 1.5 ft. (0.5 m) (blue) from the edge of the bumper.

■ Parking operation

When parking in a space which is in the reverse direction to the space described in the procedure below, the steering directions will be reversed.

- 1 Shift the shift lever to R.
- 2 Turn the steering wheel so that the estimated course lines are within the parking space, and back up slowly.
 - ① Parking space
 - ② Estimated course lines

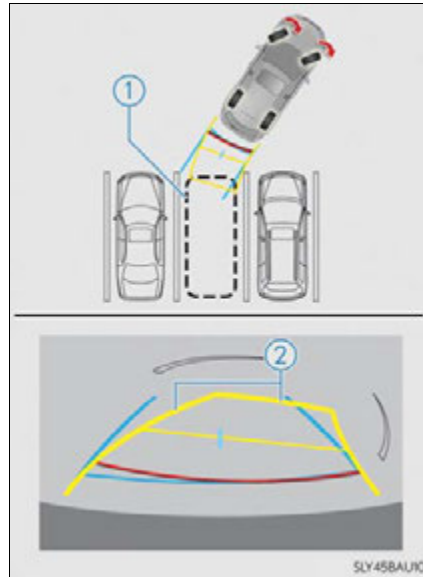

- 3 When the rear position of the vehicle has entered the parking space, turn the steering wheel so that the vehicle width guide lines are within the left and right dividing lines of the parking space.
 - ③ Vehicle width guide line

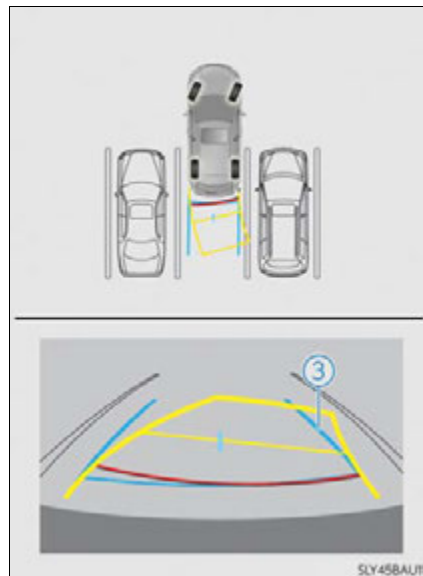

- 4 Once the vehicle width guide lines and the parking space lines are parallel, straighten the steering wheel and back up slowly until the vehicle has completely entered the parking space.
- 5 Stop the vehicle in an appropriate place, and finish parking.

Parking assist guide line display mode

■ Screen description

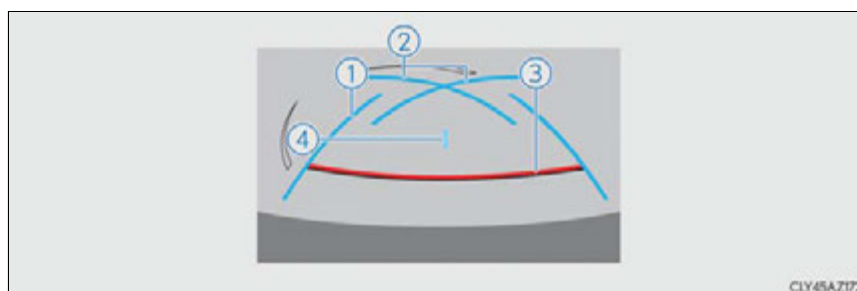

- ① Vehicle width guide lines
These lines indicate a guide path when the vehicle is being backed straight up. The displayed width is wider than the actual vehicle width.
- ② Parking assist guide lines
These lines indicate the path of the smallest turn possible behind the vehicle.
These lines also indicate the approximate position of the steering wheel when parking.
- ③ Distance guide line
This line (red) indicates points approximately 1.5 ft. (0.5 m) behind the rear bumper of your vehicle.
- ④ Vehicle center guide line
The line indicates the estimated vehicle center on the ground.

■ Parking operation

When parking in a space which is in the reverse direction to the space described in the procedure below, the steering directions will be reversed.

- 1** Shift the shift lever to R.
- 2** Back up until the parking assist guide line meets the edge of the left-hand dividing line of the parking space.
 - ① Parking assist guide line
 - ② Parking space dividing line

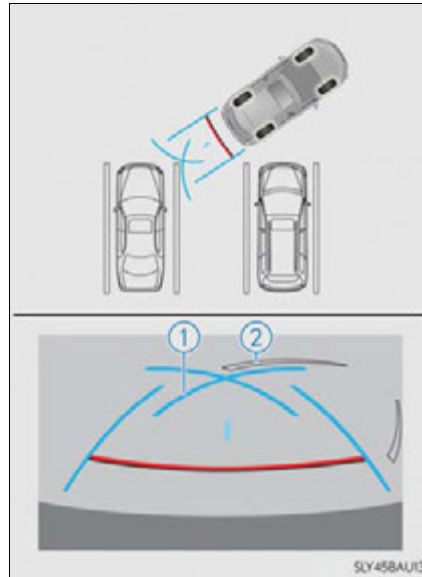

- 3** Turn the steering wheel all the way to the right, and back up slowly.
- 4** Once the vehicle is parallel with the parking space, straighten the steering wheel and back up slowly until the vehicle has completely entered the parking space.
- 5** Stop the vehicle in an appropriate place, and finish parking.

Lexus parking assist monitor precautions

■ Area displayed on screen

The parking assist monitor displays an image of the view from the bumper of the rear area of the vehicle.

The image of the Lexus parking assist monitor can be adjusted.

(→P. 352)

- The area displayed on the screen may vary according to vehicle orientation conditions.
- Objects which are close to either corner of the bumper or under the bumper cannot be seen on the screen.
- The camera uses a special lens. The distance of the image that appears on the screen differs from the actual distance.
- Items which are located higher than the camera may not be displayed on the monitor.
- If your vehicle is equipped with a backlit license plate, it may interfere with the display.

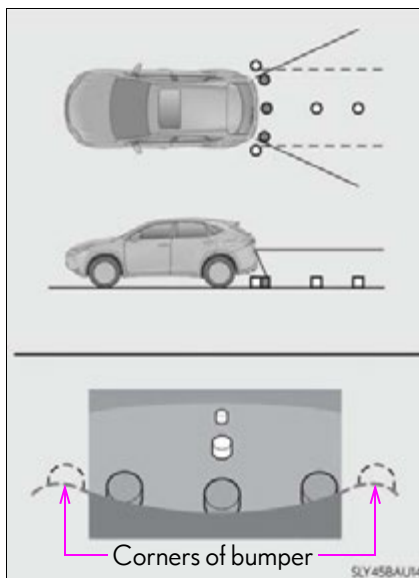

■ Lexus parking assist monitor camera

The camera for the parking assist monitor is located above the license plate.

**● Using the camera**

If dirt or foreign matter (such as water droplets, snow, mud, etc.) is adhering to the camera, it cannot transmit a clear image. In this case, flush it with a large quantity of water and wipe the camera lens clean with a soft and wet cloth.

■ Differences between the screen and the actual road

The distance guide lines and the vehicle width guide lines may not actually be parallel with the dividing lines of the parking space, even when they appear to be so. Be sure to check visually.

The distances between the vehicle width guide lines and the left and right dividing lines of the parking space may not be equal, even when they appear to be so. Be sure to check visually.

The distance guide lines give a distance guide for flat road surfaces. In any of the following situations, there is a margin of error between the guide lines on the screen and the actual distance/course on the road.

- When the ground behind the vehicle slopes up sharply

The distance guide lines will appear to be closer to the vehicle than the actual distance. Because of this, objects will appear to be farther away than they actually are. In the same way, there will be a margin of error between the guidelines and the actual distance/course on the road.

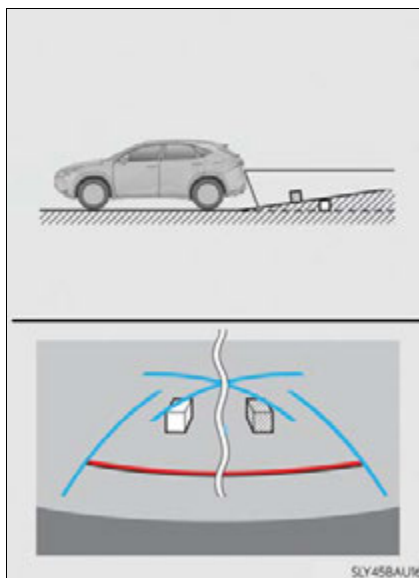

- When the ground behind the vehicle slopes down sharply

The distance guide lines will appear to be further from the vehicle than the actual distance. Because of this, objects will appear to be closer than they actually are. In the same way, there will be a margin of error between the guidelines and the actual distance/course on the road.

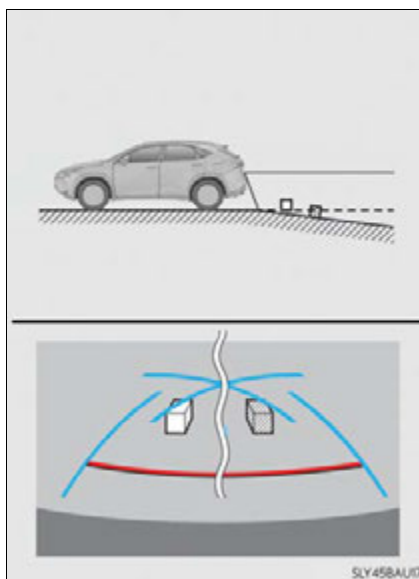

- When any part of the vehicle sags

When any part of the vehicle sags due to the number of passengers or the distribution of the load, there is a margin of error between the guide lines on the screen and the actual distance/course on the road.

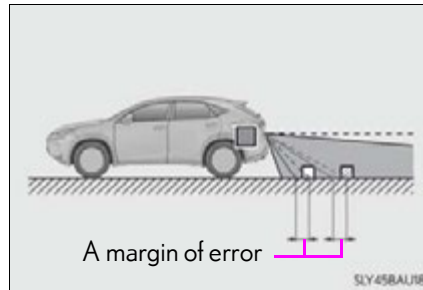

- When approaching three-dimensional objects

The estimated course lines target a flat surfaced objects (such as the road). It is not possible to determine the position of three-dimensional objects (such as vehicles) using the estimated course lines and distance guide lines. When approaching a three-dimensional object that extends outward (such as the flatbed of a truck), be careful of the following.

- Estimated course lines

Visually check the surroundings and the area behind the vehicle. In the case shown in the illustration, the truck appears to be outside of the estimated course lines and the vehicle does not look as if it will hit the truck. However, the rear body of the truck may actually cross over the estimated course lines. In reality if you back up as guided by the estimated course lines, the vehicle may hit the truck.

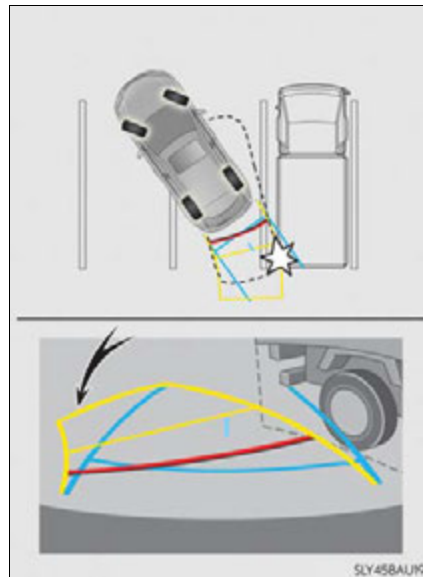

● Distance guidelines

Visually check the surroundings and the area behind the vehicle. On the screen, it appears that a truck is parking at point ②. However, in reality if you back up to point ①, you will hit the truck. On the screen, it appears that ① is closest and ③ is farthest away. However, in reality, the distance to ① and ③ is the same and ② is farther than ① and ③.

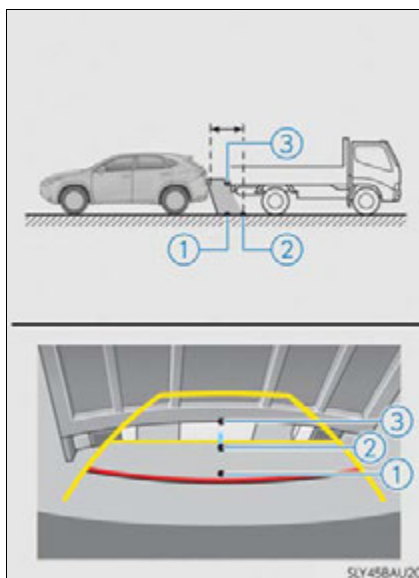

Things you should know

■ If you notice any symptoms

If you notice any of the following symptoms, refer to the likely cause and the solution, and re-check.

If the symptom is not resolved by the solution, have the vehicle inspected by your Lexus dealer.

Likely cause	Solution
□ The image is difficult to see	
<ul style="list-style-type: none"> • The vehicle is in a dark area • The temperature around the lens is either high or low • The outside temperature is low • There are water droplets on the camera • It is raining or humid • Foreign matter (mud, etc.) is adhering to the camera • Sunlight or headlights are shining directly into the camera • The vehicle is under fluorescent lights, sodium lights, mercury lights etc. 	<p>If this happens due to these causes, it does not indicate a malfunction. Back up while visually checking the vehicle's surroundings. (Use the monitor again once conditions have been improved.)</p> <p>The image on the Lexus parking assist monitor system screen can be adjusted. (→P. 352)</p>
□ The image is blurry	
Dirt or foreign matter (such as water droplets, snow, mud, etc.) is adhering to the camera.	Flush the camera with a large quantity of water and wipe the camera lens clean with a soft and wet cloth.
□ The image is out of alignment	
The camera or surrounding area has received a strong impact.	Have the vehicle inspected by your Lexus dealer.
□ The guide lines are very far out of alignment	
The camera position is out of alignment.	Have the vehicle inspected by your Lexus dealer.
<ul style="list-style-type: none"> • The vehicle is tilted (there is a heavy load on the vehicle, tire pressure is low due to a tire puncture, etc.) • The vehicle is used on an incline. 	<p>If this happens due to these causes, it does not indicate a malfunction. Back up while visually checking the vehicle's surroundings.</p>

Likely cause	Solution
❑ The estimated course lines move even though the steering wheel is straight	
There is a malfunction in the signals being output by the steering sensor.	Have the vehicle inspected by your Lexus dealer.
❑ Guide lines are not displayed	
The back door is open.	Close the back door. If this does not resolve the symptom, have the vehicle inspected by your Lexus dealer.
❑ The estimated course lines are not displayed	
<ul style="list-style-type: none"> • The steering wheel has been moved while the battery was being reinstalled. • Battery power is low. • The steering sensor has been reinstalled. • There is a malfunction in the signals being output by the steering sensor. 	Stop the vehicle, and turn the steering wheel as far as it will go to the left and right. If this does not resolve the symptom, have the vehicle inspected by your Lexus dealer.

⚠ WARNING**■ When using the Lexus parking assist monitor system**

The parking assist monitor is a supplemental device intended to assist the driver when backing up. When backing up, be sure to check visually behind and all around the vehicle before proceeding.

Observe the following precautions to avoid an accident that could result in death or serious injuries.

- Never depend on the parking assist monitor entirely when backing up. The image and the position of the guide lines displayed on the screen may differ from the actual state.
Use caution, just as you would when backing up any vehicle.
- Be sure to back up slowly, depressing the brake pedal to control vehicle speed.
- If you seem likely to hit nearby vehicles, obstacles, people or mount the shoulder, depress the brake pedal to stop the vehicle.
- The instructions given are only guidelines.
When and how much to turn the steering wheel will vary according to traffic conditions, road surface conditions, vehicle condition, etc. when parking. It is necessary to be fully aware of this before using the parking assist system.
- When parking, be sure to check that the parking space will accommodate your vehicle before maneuvering into it.
- Do not use the parking assist monitor in the following cases:
 - On icy or slick road surfaces, or in snow
 - When using tire chains or emergency tires
 - When the back door is not closed completely
 - On roads that are not flat or straight, such as curves or slopes.
- In low temperatures, the screen may darken or the image may become faint. The image could distort when the vehicle is moving, or you may become unable to see the image on the screen. Be sure to check direct visually and with the mirrors all around the vehicle before proceeding.
- If the tire sizes are changed, the position of the guide lines displayed on the screen may change.
- The camera uses a special lens. The distances between objects and pedestrians that appear in the image displayed on the screen will differ from the actual distances. (→P. 295)
- Estimated course line display mode: If the steering wheel is straight and the vehicle width guide lines and the estimated course lines are not in alignment, have the vehicle inspected by your Lexus dealer.

 NOTICE

■ **How to use the camera**

- The parking assist monitor may not operate properly in the following cases.
 - If the back of the vehicle is hit, the position and mounting angle of the camera may change.
 - As the camera has a water proof construction, do not detach, disassemble or modify it. This may cause incorrect operation.
 - When cleaning the camera lens, flush the camera with a large quantity of water and wipe it with a soft and wet cloth. Strongly rubbing the camera lens may cause the camera lens to be scratched and unable to transmit a clear image.
 - Do not allow organic solvent, car wax, window cleaner or glass coat to adhere to the camera. If this happens, wipe it off as soon as possible.
 - If the temperature changes rapidly, such as when hot water is poured on the vehicle in cold weather, the system may not operate normally.
 - When washing the vehicle, do not apply intensive bursts of water to the camera or camera area. Doing so may result in the camera malfunctioning.
- Do not expose the camera to strong impact as this could cause a malfunction. If this happens, have the vehicle inspected by your Lexus dealer as soon as possible.

Driving mode select switch

The driving modes can be selected to suit driving conditions.

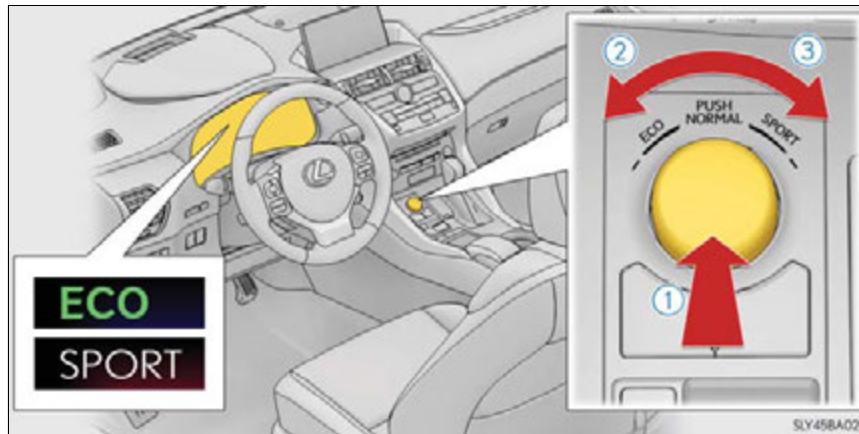

- ① Normal mode
For normal driving.
Press the switch to change the driving mode to normal mode when selected to Eco drive mode or sport mode.
- ② Eco drive mode
Use Eco drive mode to help achieve low fuel consumption during trips that involve frequent accelerating.
When not in Eco drive mode and the driving mode select switch is turned to the left, "ECO" indicator will be shown on the multi-information display.
- ③ Sport mode
Assists acceleration response by controlling the hybrid system and steering. Suitable for when precise handling is desirable, for example when driving on mountain roads.
When not in sport mode and the driving mode select switch is turned to the right, "SPORT" indicator will be shown on the multi-information display and the hybrid system indicator changes to the tachometer. (→P. 97)

■ **Operation of the air conditioning system in Eco drive mode**

Eco drive mode controls the heating/cooling operations and fan speed of the air conditioning system to enhance fuel efficiency. To improve air conditioning performance, adjust the fan speed or turn off Eco drive mode.

■ **Sport mode automatic deactivation**

Sport mode is automatically deactivated if the power switch is turned off after driving in sport mode.

Driving assist systems

To help enhance driving safety and performance, the following systems operate automatically in response to various driving situations. Be aware, however, that these systems are supplementary and should not be relied upon too heavily when operating the vehicle.

◆ ECB (Electronically Controlled Brake System)

The electronically controlled system generates braking force corresponding to the brake operation

◆ ABS (Anti-lock Brake System)

Helps to prevent wheel lock when the brakes are applied suddenly, or if the brakes are applied while driving on a slippery road surface

◆ Brake assist

Generates an increased level of braking force after the brake pedal is depressed when the system detects a panic stop situation

◆ VSC (Vehicle Stability Control)

Helps the driver to control skidding when swerving suddenly or turning on slippery road surfaces

◆ Enhanced VSC (Enhanced Vehicle Stability Control)

Provides cooperative control of the ABS, TRAC, VSC and EPS. Helps to maintain directional stability when swerving on slippery road surfaces by controlling steering performance.

◆ TRAC (Traction Control)

Helps to maintain drive power and prevent the drive wheels from spinning when starting the vehicle or accelerating on slippery roads

◆ Hill-start assist control

Helps to prevent the vehicle from rolling backward when starting on an incline.

◆ EPS (Electric Power Steering)

Employs an electric motor to reduce the amount of effort needed to turn the steering wheel

◆ **E-Four (if equipped)**

Electronic On-Demand AWD system. Automatically switches from front-wheel drive to all-wheel drive (AWD) according to the driving conditions, helping to ensure reliable handling and stability. Examples of conditions where the system will switch to AWD are when cornering, going uphill, starting off or accelerating, and when the road surface is slippery due to snow, rain, etc.

◆ **PCS (Pre-Collision System) (if equipped)**

→P. 310

◆ **BSM (Blind Spot Monitor) (if equipped)**

→P. 316

When the TRAC/VSC/ABS systems are operating

The slip indicator light will flash while the TRAC/VSC/ABS systems are operating.



Disabling the TRAC system

If the vehicle gets stuck in mud, dirt or snow, the TRAC system may reduce power from the hybrid system to the wheels. Pressing  to turn the system off may make it easier for you to rock the vehicle in order to free it.

To turn the TRAC system off, quickly press and release .

The "Traction Control Turned Off" will be shown on the multi-information display. Press  again to turn the system back on.



4

Driving

■ Turning off both TRAC and VSC systems

To turn the TRAC and VSC systems off, press and hold  for more than 3 seconds while the vehicle is stopped.

The VSC OFF indicator will come on and the "Traction Control Turned Off" will be shown on the multi-information display.*

Press  again to turn the systems back on.

*: On vehicles with pre-collision system, pre-collision brake assist and pre-collision braking will also be disabled. The PCS warning light will come on and the message will be shown on the multi-information display. (→P. 313)

■ When the message is displayed on the multi-information display showing that TRAC has been disabled even if the has not been pressed

TRAC and hill-start assist control cannot be operated. Contact your Lexus dealer.

■ Sounds and vibrations caused by the ABS, brake assist, TRAC, VSC and hill-start assist control systems

Any of the following conditions may occur when the above systems are operating. None of these indicates that a malfunction has occurred.

- Vibrations may be felt through the vehicle body and steering.
- A motor sound may be heard after the vehicle comes to a stop.
- The brake pedal may pulsate slightly after the ABS is activated.
- The brake pedal may move down slightly after the ABS is activated.

■ ECB operating sound

ECB operating sound may be heard in the following cases, but it does not indicate that a malfunction has occurred.

- Operating sound heard from the engine compartment when the brake pedal is operated.
- Motor sound of the brake system heard from the front part of the vehicle when the driver's door is opened.
- Operating sound heard from the engine compartment when 1 or 2 minutes passed after the stop of the hybrid system.

■ EPS operation sound

When the steering wheel is operated, a motor sound (whirring sound) may be heard. This does not indicate a malfunction.

■ Reduced effectiveness of the EPS system

The effectiveness of the EPS system is reduced to prevent the system from overheating when there is frequent steering input over an extended period of time. The steering wheel may feel heavy as a result. Should this occur, refrain from excessive steering input or stop the vehicle and turn the hybrid system off. The EPS system should return to normal within 10 minutes.

■ Automatic reactivation of TRAC and VSC systems

After turning the TRAC and VSC systems off, the systems will be automatically re-enabled in the following situations:

- When the power switch is turned off
- If only the TRAC system is turned off, the TRAC will turn on when vehicle speed increases

If both the TRAC and VSC systems are turned off, automatic re-enabling will not occur when vehicle speed increases.

■ Operating conditions of hill-start assist control

When the following four conditions are met, the hill-start assist control will operate:

- The shift lever is in a position other than P or N (when starting off forward/backward on an upward incline).
- The vehicle is stopped.
- The accelerator pedal is not depressed.
- The parking brake is not engaged.

■ Automatic system cancelation of hill-start assist control

The hill-start assist control will turn off in any of the following situations:

- The shift lever is moved to P or N.
- The accelerator pedal is depressed.
- The parking brake is engaged.
- Approximately 2 seconds elapse after the brake pedal is released.

⚠ WARNING**■ The ABS does not operate effectively when**

- The limits of tire gripping performance have been exceeded (such as excessively worn tires on a snow covered road).
- The vehicle hydroplanes while driving at high speed on wet or slick road.

■ Stopping distance when the ABS is operating may exceed that of normal conditions

The ABS is not designed to shorten the vehicle's stopping distance. Always maintain a safe distance from the vehicle in front of you, especially in the following situations:

- When driving on dirt, gravel or snow-covered roads
- When driving with tire chains
- When driving over bumps in the road
- When driving over roads with potholes or uneven surfaces

■ TRAC may not operate effectively when

Directional control and power may not be achievable while driving on slippery road surfaces, even if the TRAC system is operating.

Drive the vehicle carefully in conditions where stability and power may be lost.

■ Hill-start assist control does not operate effectively when

- Do not overly rely on the hill-start assist control. The hill-start assist control may not operate effectively on steep inclines and roads covered with ice.
- Unlike the parking brake, hill-start assist control is not intended to hold the vehicle stationary for an extended period of time. Do not attempt to use hill-start assist control to hold the vehicle on an incline, as doing so may lead to an accident.

■ When the TRAC/VSC are activated

The slip indicator light flashes. Always drive carefully. Reckless driving may cause an accident. Exercise particular care when the indicator light flashes.

■ When the TRAC/VSC systems are turned off

Be especially careful and drive at a speed appropriate to the road conditions. As these are the systems to help ensure vehicle stability and driving force, do not turn the TRAC/VSC systems off unless necessary.

■ Replacing tires

Make sure that all tires are of the specified size, brand, tread pattern and total load capacity. In addition, make sure that the tires are inflated to the recommended tire inflation pressure level.

The ABS, TRAC and VSC systems will not function correctly if different tires are installed on the vehicle.

Contact your Lexus dealer for further information when replacing tires or wheels.

■ Handling of tires and the suspension

Using tires with any kind of problem or modifying the suspension will affect the driving assist systems, and may cause a system to malfunction.

PCS (Pre-Collision System)*

When the radar sensor detects possibility of a frontal collision, brakes are automatically engaged to lessen impact as well as vehicle damage.

The alert timing for the pre-collision system can be changed or turned ON/OFF, as necessary, by operating the switch. (→P. 311)

◆ Pre-collision warning

When a high possibility of a frontal collision is detected, a buzzer sounds and a message is shown on the multi-information display to urge the driver to take evasive action.

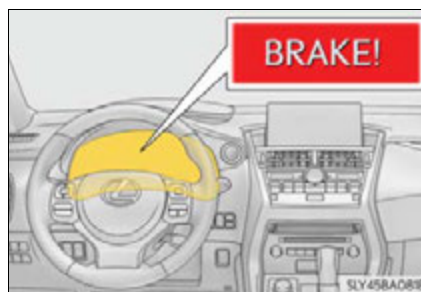

◆ Pre-collision brake assist

When there is a high possibility of a frontal collision, the system applies greater braking force in relation to how strongly the brake pedal is depressed.

◆ Pre-collision braking

When there is a high possibility of a frontal collision, the system warns the driver using warning display and buzzer. If the system determines that a collision is unavoidable, the brakes are automatically applied to reduce the collision speed.

*: If equipped

Changing the pre-collision system

■ Changing the alert timing of the pre-collision system

Each time the PCS switch is pressed, the response to the distance changes as follows.

- ① Far
- ② Middle*
- ③ Near

*: Default setting

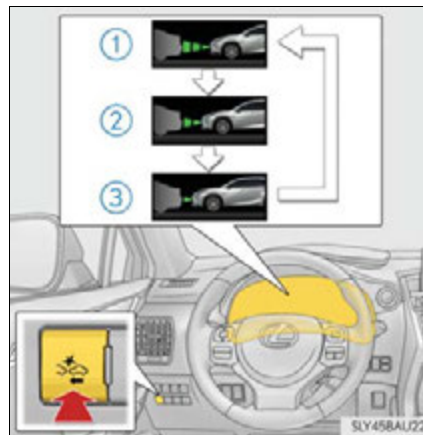

■ Turning off the pre-collision system

Press the PCS switch for 3 seconds or more seconds.

The PCS warning light turns on and a message is shown on the multi-information display.

To turn on the system, press the PCS switch again. The system is set to ON each time the power switch is turned to ON mode.

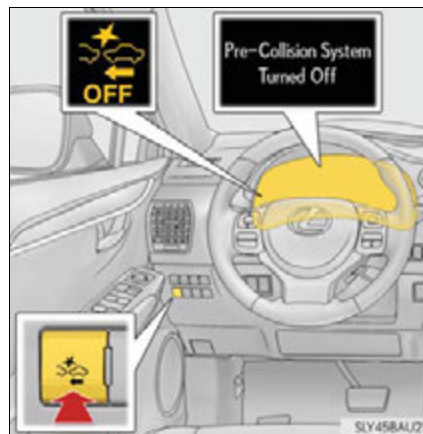

Radar sensor

The radar sensor detects vehicles or other obstacles on or near the road ahead and determines whether a collision is imminent based on the position, speed, and heading of the obstacles.

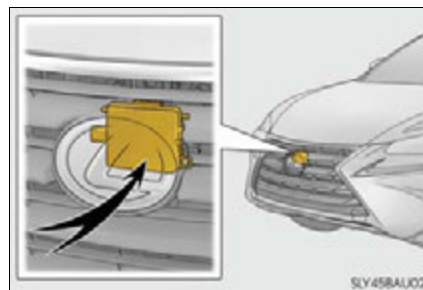

■ The pre-collision system is operational when

The pre-collision system is on (→P. 311) and the following conditions are met:

- Pre-collision warning:
 - Vehicle speed is greater than about 10 mph (15 km/h).
 - The speed at which your vehicle is approaching the obstacle or the vehicle running ahead of you is greater than about 7 mph (10 km/h).
- Pre-collision brake assist:
 - The VSC is not turned off.
 - Vehicle speed is greater than about 19 mph (30 km/h).
 - The speed at which your vehicle is approaching the obstacle or the vehicle running ahead of you is greater than about 19 mph (30 km/h).
 - The brake pedal is depressed.
- Pre-collision braking:
 - The VSC is not turned off.
 - Vehicle speed is greater than about 10 mph (15 km/h).
 - The speed at which your vehicle is approaching the obstacle or the vehicle running ahead of you is greater than about 7 mph (10 km/h).

■ Conditions that may trigger the system even if there is no possibility of a collision

In any of the following situations where the frontal area of the radar sensor is interrupted, the radar sensor may detect possibility of a frontal collision and the system may be activated.

- When passing by an oncoming vehicle in a curve or a turn to the right or the left
- When rapidly approaching an obstacle ahead (e.g. preceding vehicle, toll gate barrier, etc.)
- When there is a structural object (billboard, low ceiling, fluorescent light, etc.) above the uphill road ahead
- When driving on a narrow road or through under a low overhead structure (bridge, tunnel, fly-under, etc.)
- When driving on an uneven road surface
- When there is a metal object, bump, or protrusion on the road surface
- When vehicle's front part is raised or lowered depending on loading conditions
- When the direction of radar sensor is misaligned by strong impact applied on an area around the radar sensor, etc.
- When there is an obstacle (guard rail, etc.) by the roadside at the entrance to a curve
- When the front of your vehicle is pointing upwards (caused by towing a trailer or putting a heavy load in the luggage compartment, etc.)

When the system is activated in the situations described above, there is also a possibility that the brakes may be applied with a force greater than normal.

■ Obstacles not detected

The sensor cannot detect plastic obstacles such as traffic cones. There may also be occasions when the sensor cannot detect pedestrians, animals, bicycles, motorcycles, trees, or snowdrifts.

■ Situations in which the pre-collision system does not function properly

The system may not function effectively in situations such as the following:

- On roads with sharp bends or uneven surfaces
- If a vehicle suddenly moves in front of your vehicle, such as at an intersection
- If a vehicle suddenly cuts in front of your vehicle, such as when overtaking
- In inclement weather such as heavy rain, fog, snow or sand storms
- When your vehicle is skidding with the VSC system off
- When an extreme change in vehicle height occurs
- When the radar sensor moves off position due to its surrounding area being subjected to a strong impact
- Due to greatly turning the wheel when an obstacle suddenly appears ahead

■ Automatic cancelation of the pre-collision system

When a malfunction occurs due to sensor contamination, etc., that results in the sensors being unable to detect obstacles, the pre-collision system will be automatically disabled. In this case, the system will not activate even if there is a collision possibility.

■ When there is a malfunction in the system, or if the system is temporarily unavailable

The PCS warning light flashes and a warning message is shown on the multi-information display. If a warning message is shown on the multi-information display, read the message and follow the instructions.

■ When the TRAC and VSC are turned off

- When the TRAC and VSC operations are turned off (→P. 307), the pre-collision brake assist and pre-collision braking are also turned off. However, the alert function operates.
- The PCS warning light turns on and the “VSC Turned Off Pre-Collision Brake System Unavailable” is shown on the multi-information display.

■ Certification

- ▶ For vehicles sold in the U.S.A.

FCC ID: HYQDNMWR007

This device complies with part 15 of the FCC Rules. Operation is subject to the following two conditions: (1) This device may not cause harmful interference, and (2) this device must accept any interference received, including interference that may cause undesired operation.

FCC WARNING

Changes or modifications not expressly approved by the party responsible for compliance could void the user's authority to operate the equipment.

Radio frequency radiation exposure Information:

This equipment complies with FCC radiation exposure limits set forth for an uncontrolled environment.

This equipment should be installed and operated with minimum distance of 20 cm between the radiator (antenna) and your body.

This transmitter must not be co-located or operating in conjunction with any other antenna or transmitter.

- ▶ For vehicles sold in Canada

This device complies with Industry Canada licence-exempt RSS standard(s).

Operation is subject to the following two conditions: (1) this device may not cause interference, and (2) this device must accept any interference, including interference that may cause undesired operation of the device.

 **WARNING****■ Limitations of the pre-collision system**

The driver is solely responsible for safe driving. Always drive safely, taking care to observe your surroundings.

Do not use the pre-collision system instead of normal braking operations under any circumstances. This system will not prevent collisions or lessen damage or injuries in all cases. Do not overly rely on this system. Failure to do so may cause an accident, resulting in death or serious injury.

This system has been designed to help avoid and reduce the impact of collision.

However, the system operates differently depending on the situation (→P. 312). As a result, the same level of performance may not be expected in all cases. Also, the pre-collision system brakes may not operate if the driver is depressing the brake pedal or turning the steering wheel, as the system will determine such conditions as collision avoidance operations.

■ Handling the radar sensor

Observe the following to ensure the pre-collision system can function effectively. Otherwise, the system may not function correctly and could result in an accident.

- Keep the sensor and front grille cover clean at all times.
Clean the sensor and front grille cover with a soft cloth so you do not mark or damage them.
- Do not subject the sensor or surrounding area to a strong impact.
If the sensor moves even slightly off position, the system may not work normally or malfunction. If the sensor or surrounding area is subject to a strong impact, always have the area inspected and adjusted by your Lexus dealer.
- Do not disassemble the sensor.
- Do not attach accessories or stickers to the sensor, grille cover or surrounding area.
- Do not modify or paint the sensor and grille cover.
- If the radar sensor needs to be replaced, contact your Lexus dealer.

 **WARNING****■ Cautions regarding the assist contents of the system**

By means of alarms and brake control, the pre-collision system is intended to assist the driver in avoiding collisions through the process of LOOK-JUDGE-ACT. There are limits to the degree of assistance the system can provide, so please keep in mind the following important points.

- **Assisting the driver in watching the road**
The pre-collision system is only able to detect obstacles directly in front of the vehicle, and only within a limited range. It is not a mechanism that allows careless or inattentive driving, and it is not a system that can assist the driver in low-visibility conditions. It is still necessary for the driver to pay close attention to the vehicle's surroundings.
- **Assisting the driver in making correct judgement**
When attempting to estimate the possibility of a collision, the only data available to the pre-collision system is that from obstacles it has detected directly in front of the vehicle. Therefore, it is absolutely necessary for the driver to remain vigilant and to determine whether or not there is a possibility of collision in any given situation.
- **Assisting the driver in taking action**
The pre-collision system's braking assist feature is designed to help reduce the severity of a collision, and so only acts when the system has judged that a collision is unavoidable. This system is not capable of automatically avoiding a collision or bringing the vehicle to a stop safely without appropriate operations performed by the driver. For this reason, when encountering a dangerous situation the driver must take direct and immediate action in order to ensure the safety of all involved.

BSM (Blind Spot Monitor)*

Summary of the Blind Spot Monitor

The Blind Spot Monitor is a system that has 2 functions;

- The Blind Spot Monitor function
Assists the driver in making the decision when changing lanes
- The Rear Cross Traffic Alert function
Assists the driver when backing up

These functions use the same sensors.

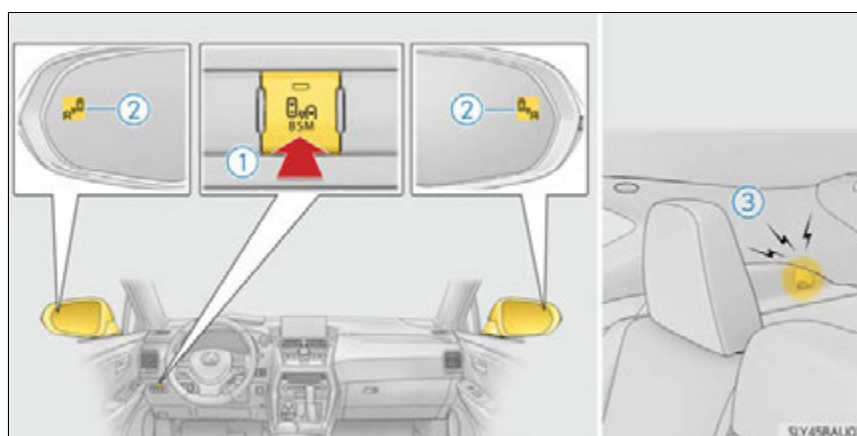

① BSM main switch

Pressing the switch turns the system on or off. When the switch is set to on, the switch's indicator illuminates and the buzzer sounds. This switch is for both Blind Spot Monitor function and Rear Cross Traffic Alert function.

② BSM outside rear view mirror indicators

Blind Spot Monitor function:

When a vehicle is detected in the blind spot, the BSM outside rear view mirror indicator on the detected side illuminates. If the turn signal lever is operated when a vehicle is in the blind spot, the BSM outside rear view mirror indicator flashes.

Rear Cross Traffic Alert function:

When a vehicle approaching from the right or left rear of the vehicle is detected, the BSM outside rear view mirror indicators flash.

③ Rear Cross Traffic Alert buzzer (Rear Cross Traffic Alert function only)

When a vehicle approaching from the right or left rear of the vehicle is detected, a buzzer sounds from behind the right-hand rear seat.

*: If equipped

■ The BSM outside rear view mirror indicators visibility

When under strong sunlight, the BSM outside rear view mirror indicator may be difficult to see.

■ Rear Cross Traffic Alert buzzer hearing

Rear Cross Traffic Alert function may be difficult to hear over loud noises such as high audio volume.

■ When “Blind Spot Monitor Unavailable” is shown on the multi-information display

Water, snow mud, etc., may be built up in the vicinity of the sensor area of bumper. (→P. 318) Removing the water, snow, mud, etc., from the vicinity of the sensor area bumper should return it to normal. Also, the sensor may not function normally when used in extremely hot or cold weather.

■ When “Blind Spot Monitor System Malfunction” is shown on the multi-information display

There may be a sensor malfunction or voltage abnormality. Have the vehicle inspected at a Lexus dealer.

■ Certification for the Blind Spot Monitor system

- ▶ For vehicles sold in the U.S.A.

FCC ID: OAYSRR2A

This device complies with part 15 of the FCC Rules. Operation is subject to the following two conditions:

- (1) This device may not cause harmful interference, and
- (2) this device must accept any interference received, including interference that may cause undesired operation.

FCC Warning

Changes or modifications not expressly approved by the party responsible for compliance could void the user's authority to operate the equipment.

- ▶ For vehicles sold in Canada

Applicable law: Canada 310

This device complies with Industry Canada licence-exempt RSS standard(s). Operation is subject to the following two conditions: (1) this device may not cause interference, and (2) this device must accept any interference, including interference that may cause undesired operation of the device.

Frequency bands: 24.05-24.25 GHz

Output power: less than 20 milliwatts

⚠ WARNING

■ **Handling the radar sensor**

One Blind Spot Monitor sensor is installed inside the left and right side of the vehicle rear bumper respectively. Observe the following to ensure the Blind Spot Monitor system can function correctly.

- Keep the sensor and its surrounding area on the bumper clean at all times.

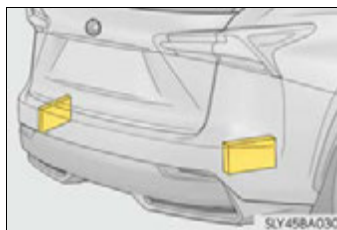

- Do not subject the sensor or surrounding area on the bumper to a strong impact. If the sensor moves even slightly off position, the system may malfunction and vehicles that enter the detection area may not be detected. If the sensor or surrounding area is subject to a strong impact, always have the area inspected by your Lexus dealer.
- Do not disassemble the sensor.
- Do not attach accessories or stickers to the sensor or surrounding area on the bumper.
- Do not modify the sensor or surrounding area on the bumper.
- Do not paint the sensor or surrounding area on the bumper.
- If the radar sensor needs to be replaced, contact your Lexus dealer.

The Blind Spot Monitor function

The Blind Spot Monitor function uses radar sensors to detect vehicles that are traveling in an adjacent lane in the area that is not reflected in the outside rear view mirror (the blind spot), and advises the driver of the vehicles existence via the BSM outside rear view mirror indicator.

The Blind Spot Monitor function detection areas

The areas that vehicles can be detected in are outlined below.

The range of the detection area extends to:

- ① Approximately 11.5 ft. (3.5 m) from the side of the vehicle
The first 1.6 ft. (0.5 m) from the side of the vehicle is not in the detection area
- ② Approximately 9.8 ft. (3 m) from the rear bumper
- ③ Approximately 3.3 ft. (1 m) forward of the rear bumper

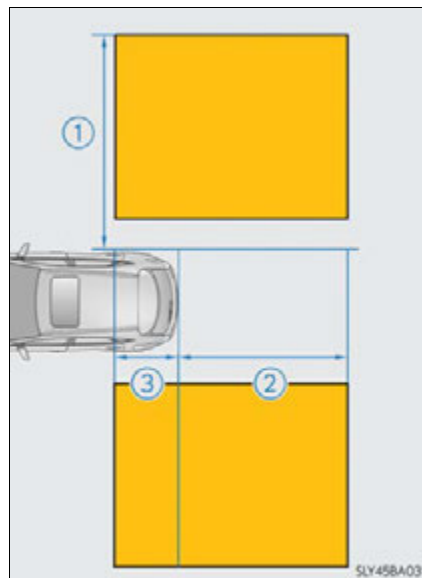

4

Driving

⚠ WARNING

■ Cautions regarding the use of the system

The driver is solely responsible for safe driving. Always drive safely, taking care to observe your surroundings.

The Blind Spot Monitor function is a supplementary function which alerts the driver that a vehicle is present in the blind spot. Do not overly rely on the Blind Spot Monitor function. The function cannot judge if it is safe to change lanes, therefore over reliance could cause an accident resulting in death or serious injury.

According to conditions, the system may not function correctly. Therefore the driver's own visual confirmation of safety is necessary.

■ The Blind Spot Monitor function is operational when

- The BSM main switch is set to on
- Vehicle speed is greater than approximately 10 mph (16 km/h).

■ The Blind Spot Monitor function will detect a vehicle when

- A vehicle in an adjacent lane overtakes your vehicle.
- Another vehicle enters the detection area when it changes lanes.

■ Conditions under which the Blind Spot Monitor function will not detect a vehicle

The Blind Spot Monitor function is not designed to detect the following types of vehicles and/or objects:

- Small motorcycles, bicycles, pedestrians, etc. *
- Vehicles traveling in the opposite direction
- Guardrails, walls, signs, parked vehicles and similar stationary objects *
- Following vehicles that are in the same lane *
- Vehicles driving 2 lanes across from your vehicle *

*: Depending on conditions, detection of a vehicle and/or object may occur.

■ Conditions under which the Blind Spot Monitor function may not function correctly

- The Blind Spot Monitor function may not detect vehicles correctly in the following conditions:
 - During bad weather such as heavy rain, fog, snow, etc.
 - When ice or mud, etc., is attached to the rear bumper
 - When driving on a road surface that is wet due to rain, standing water, etc.
 - When there is a significant difference in speed between your vehicle and the vehicle that enters the detection area
 - When a vehicle is in the detection area from a stop and remains in the detection area as your vehicle accelerates
 - When driving up or down consecutive steep inclines, such as hills, a dip in the road, etc.
 - When multiple vehicles approach with only a small gap between each vehicle
 - When vehicle lanes are wide, and the vehicle in the next lane is too far away from your vehicle
 - When the vehicle that enters the detection area is traveling at about the same speed as your vehicle
 - When there is a significant difference in height between your vehicle and the vehicle that enters the detection area
 - Directly after the BSM main switch is set to on
- Instances of the Blind Spot Monitor function unnecessarily detecting a vehicle and/or object may increase under the following conditions:
 - When there is only a short distance between your vehicle and a guardrail, wall, etc.
 - When there is only a short distance between your vehicle and a following vehicle
 - When vehicle lanes are narrow and a vehicle driving 2 lanes across from your vehicle enters the detection area
 - When items such as a bicycle carrier are installed on the rear of the vehicle

The Rear Cross Traffic Alert function

The Rear Cross Traffic Alert function operates when your vehicle is in reverse. It can detect other vehicles approaching from the right or left rear of the vehicle. It uses radar sensors to alert the driver of the other vehicle's existence through flashing the BSM outside rear view mirror indicators and sounding a buzzer.

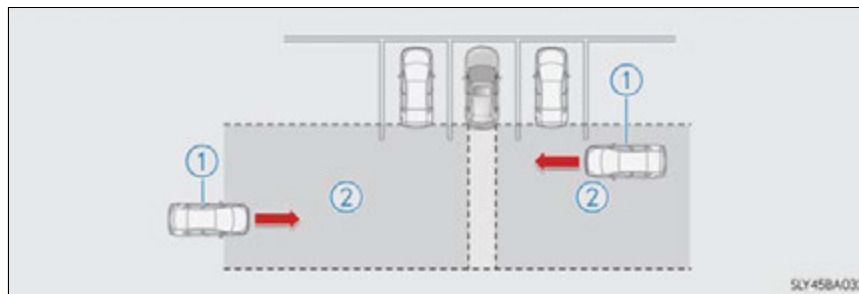

① Approaching vehicles

② Detection areas

⚠ WARNING

■ Cautions regarding the use of the system

The driver is solely responsible for safe driving. Always drive safely, taking care to observe your surroundings.

The Rear Cross Traffic Alert function is only an assist and is not a replacement for careful driving. Driver must be careful when backing up, even when using Rear Cross Traffic Alert function. The driver's own visual confirmation of behind you and your vehicle is necessary and be sure there are no pedestrians, other vehicles, etc., before backing up. Failure to do so could cause death or serious injury.

According to conditions, the system may not function correctly. Therefore the driver's own visual confirmation of safety is necessary.

The Rear Cross Traffic Alert function detection areas

The areas that vehicles can be detected in are outlined below.

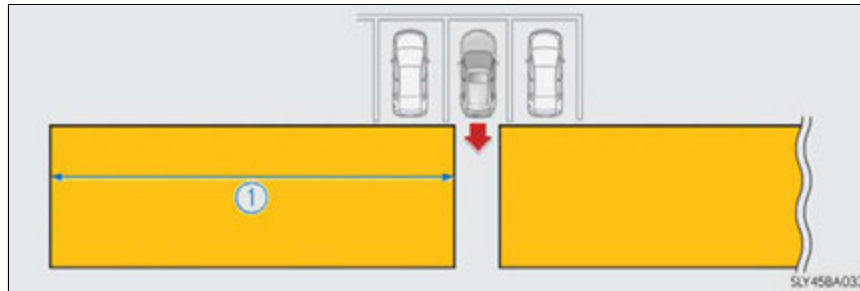

To give the driver a more consistent time to react, the buzzer can alert for faster vehicles from farther away.

Example:

Approaching vehicle	Speed	① Approximate alert distance
Fast	18 mph (28 km/h)	65 ft. (20 m)
Slow	5 mph (8 km/h)	18 ft. (5.5 m)

■ **The Rear Cross Traffic Alert function is operational when**

- The BSM main switch is set to on.
- The shift lever is in R.
- Vehicle speed is less than approximately 5 mph (8 km/h).
- Approaching vehicle speed is between approximately 5 mph (8 km/h) and 18 mph (28 km/h).

■ **Conditions under which the Rear Cross Traffic Alert function will not detect a vehicle**

The Rear Cross Traffic Alert function is not designed to detect the following types of vehicles and/or objects.

- Small motorcycles, bicycles, pedestrians, etc. *
- Vehicles approaching from directly behind
- Guardrails, walls, signs, parked vehicles and similar stationary objects *
- Vehicles moving away from your vehicle
- Vehicles approaching from the parking spaces next to your vehicle *
- Vehicles backing up in the parking space next to your vehicle *

*: Depending on conditions, detection of a vehicle and/or object may occur.

■ Conditions under which the Rear Cross Traffic Alert function may not function correctly

The Rear Cross Traffic Alert function may not detect vehicles correctly in the following conditions:

- During bad weather such as heavy rain, fog, snow, etc.
- When ice or mud, etc., is attached to the rear bumper
- When multiple vehicles approach continuously
- Shallow angle parking
- When a vehicle is approaching at high speed
- When parking on a steep incline, such as hills, a dip in the road, etc.
- Directly after the BSM main switch is set to on
- Directly after the hybrid system is started with the BSM main switch on
- Vehicles that the sensors cannot detect because of obstacles

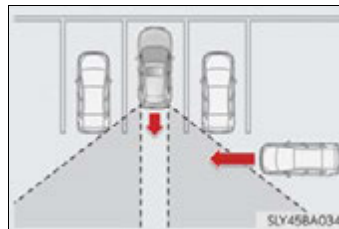

Hybrid vehicle driving tips

For economical and ecological driving, pay attention to the following points:

◆ Using Eco drive mode

When using Eco drive mode, the torque corresponding to the accelerator pedal depression amount can be generated more smoothly than it is in normal conditions. In addition, the operation of the air conditioning system (heating/cooling) will be minimized, improving the fuel economy. (→P. 303)

◆ Use of Hybrid System Indicator

The Eco-friendly driving is possible by keeping the indicator needle of Hybrid System Indicator within Eco area. (→P. 100)

◆ Shift lever operation

Shift the shift lever to D when stopped at a traffic light, or driving in heavy traffic, etc. Shift the shift lever to P when parking. When using the N, there is no positive effect on fuel consumption. In the N, the gasoline engine operates but electricity cannot be generated. Also, when using the air conditioning system, etc., the hybrid battery (traction battery) power is consumed.

◆ Accelerator pedal/brake pedal operation

- Drive your vehicle smoothly. Avoid abrupt acceleration and deceleration. Gradual acceleration and deceleration will make more effective use of the electric motor (traction motor) without having to use gasoline engine power.
- Avoid repeated acceleration. Repeated acceleration consumes hybrid battery (traction battery) power, resulting in poor fuel consumption. Battery power can be restored by driving with the accelerator pedal slightly released.

◆ When braking

Make sure to operate the brakes gently and in a timely manner. A greater amount of electrical energy can be regenerated when slowing down.

◆ Delays

Repeated acceleration and deceleration, as well as long waits at traffic lights, will lead to bad fuel economy. Check traffic reports before leaving and avoid delays as much as possible. When driving in a traffic jam, gently release the brake pedal to allow the vehicle to move forward slightly while avoiding overuse of the accelerator pedal. Doing so can help control excessive gasoline consumption.

◆ Highway driving

Control and maintain the vehicle at a constant speed. Before stopping at a toll booth or similar, allow plenty of time to release the accelerator and gently apply the brakes. A greater amount of electrical energy can be regenerated when slowing down.

◆ Air conditioning

Use the air conditioning only when necessary. Doing so can help reduce excessive gasoline consumption.

In summer: When the ambient temperature is high, use the recirculated air mode. Doing so will help to reduce the burden on the air conditioning system and reduce fuel consumption as well.

In winter: Because the gasoline engine will not automatically cut out until it and the interior of the vehicle are warm, it will consume fuel. Also, fuel consumption can be improved by avoiding overuse of the heater.

◆ Checking tire inflation pressure

Make sure to check the tire inflation pressure frequently. Improper tire inflation pressure can cause poor fuel economy.

Also, as snow tires can cause large amounts of friction, their use on dry roads can lead to poor fuel economy. Use tires that are appropriate for the season.

◆ Luggage

Carrying heavy luggage will lead to poor fuel economy. Avoid carrying unnecessary luggage. Installing a large roof rack will also cause poor fuel economy.

◆ Warming up before driving

Since the gasoline engine starts up and cuts out automatically when cold, warming up the engine is unnecessary. Moreover, frequently driving short distances will cause the engine to repeatedly warm up, which can lead to excess fuel consumption.

Winter driving tips

Carry out the necessary preparations and inspections before driving the vehicle in winter. Always drive the vehicle in a manner appropriate to the prevailing weather conditions.

Preparation for winter

- Use fluids that are appropriate to the prevailing outside temperatures.
 - Engine oil
 - Engine/power control unit coolant
 - Washer fluid
- Have a service technician inspect the condition of the 12-volt battery.
- Have the vehicle fitted with four snow tires or purchase a set of tire chains for the front tires*.

Ensure that all tires are the same size and brand, and that chains match the size of the tires.

*: Tire chains cannot be mounted on the 225/60R18 tires.

Before driving the vehicle

Perform the following according to the driving conditions:

- Do not try to forcibly open a window or move a wiper that is frozen. Pour warm water over the frozen area to melt the ice. Wipe away the water immediately to prevent it from freezing.
- To ensure proper operation of the climate control system fan, remove any snow that has accumulated on the air inlet vents in front of the windshield.
- Check for and remove any excess ice or snow that may have accumulated on the exterior lights, vehicle's roof, chassis, around the tires or on the brakes.
- Remove any snow or mud from the bottom of your shoes before getting in the vehicle.

When driving the vehicle

Accelerate the vehicle slowly, keep a safe distance between you and the vehicle ahead, and drive at a reduced speed suitable to road conditions.

When parking the vehicle

- Park the vehicle and shift the shift lever to P and block the wheel under the vehicle without setting the parking brake. The parking brake may freeze up, preventing it from being released.

When the parking brake is in automatic mode, release the parking brake after shifting the shift lever to P. (→P. 213)

- If the vehicle is left parked with the brakes damp in cold temperatures, there is a possibility of the brakes freezing.

Selecting tire chains

Use the correct tire chain size when mounting the tire chains. Chain size is regulated for each tire size.

- ▶ Vehicles with 225/65R17 tires

Side chain:

- ① 3 mm (0.12 in.) in diameter
- ② 10 mm (0.39 in.) in width
- ③ 25 mm (0.98 in.) in length

Cross chain:

- ④ 4 mm (0.16 in.) in diameter
- ⑤ 14 mm (0.55 in.) in width
- ⑥ 25 mm (0.98 in.) in length

- ▶ Vehicles with 225/60R18 tires

Tire chains cannot be mounted on the 225/60R18 tires. Snow tires should be used instead.

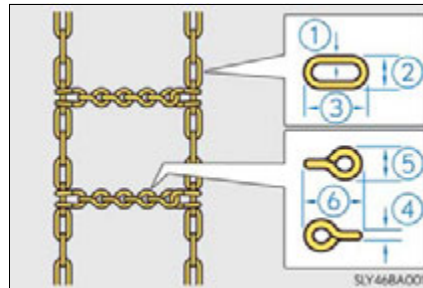
**Regulations on the use of tire chains**

Regulations regarding the use of tire chains vary depending on location and type of road. Always check local regulations before installing chains.

■ Tire chain installation

Observe the following precautions when installing and removing chains:

- Install and remove tire chains in a safe location.
- Install tire chains on the front tires only. Do not install tire chains on the rear tires.
- Install tire chains on front tires as tightly as possible. Retighten chains after driving 1/4 - 1/2 mile (0.5 - 1.0 km).
- Install tire chains following the instructions provided with the tire chains.

⚠ WARNING**■ Driving with snow tires**

Observe the following precautions to reduce the risk of accidents.

Failure to do so may result in a loss of vehicle control and cause death or serious injury.

- Use tires of the specified size.
- Maintain the recommended level of air pressure.
- Do not drive in excess of 75 mph (120 km/h), regardless of the type of snow tires being used.
- Use snow tires on all, not just some wheels.

■ Driving with tire chains

Observe the following precautions to reduce the risk of accidents.

Failure to do so may result in the vehicle being unable to be driven safely, and may cause death or serious injury.

- Do not drive in excess of the speed limit specified for the tire chains being used, or 30 mph (50 km/h), whichever is lower.
- Avoid driving on bumpy road surfaces or over potholes.
- Avoid sudden acceleration, abrupt steering, sudden braking and shifting operations that cause sudden engine braking.
- Slow down sufficiently before entering a curve to ensure that vehicle control is maintained.

■ When parking the vehicle

When parking the vehicle without applying the parking brake, make sure to chock the wheels. If you do not chock the wheels, the vehicle may move unexpectedly, possibly resulting in an accident.

 NOTICE**■ Repairing or replacing snow tires**

Request repairs or replacement of snow tires from Lexus dealers or legitimate tire retailers.

This is because the removal and attachment of snow tires affects the operation of the tire pressure warning valves and transmitters.

■ Fitting tire chains

The tire pressure warning valves and transmitters may not function correctly when tire chains are fitted.

Utility vehicle precautions

This vehicle belongs to the utility vehicle class, which has higher ground clearance and narrower tread in relation to the height of its center of gravity.

Utility vehicle feature

- Specific design characteristics give it a higher center of gravity than ordinary passenger cars. This vehicle design feature causes this type of vehicle to be more likely to rollover. Utility vehicles have a significantly higher rollover rate than other types of vehicles.
- It is not designed for cornering at the same speeds as ordinary passenger cars any more than low-slung sports cars designed to perform satisfactorily under off-road conditions. Therefore, sharp turns at excessive speeds may cause rollover.

WARNING

■ Utility vehicle precautions

Always observe the following precautions to minimize the risk of death or serious injury or damage to your vehicle:

- In a rollover crash, an unbelted person is significantly more likely to die than a person wearing a seat belt. Therefore, the driver and all passengers should always fasten their seat belts.
- Avoid sharp turns or abrupt maneuvers, if at all possible.
Failure to operate this vehicle correctly may result in loss of control or vehicle rollover causing death or serious injury.
- Loading cargo on the roof luggage carrier (if equipped) will make the center of the vehicle gravity higher. Avoid high speeds, sudden starts, sharp turns, sudden braking or abrupt maneuvers, otherwise it may result in loss of control or vehicle rollover due to failure to operate this vehicle correctly.
- Always slow down in gusty crosswinds. Because of its profile and higher center of gravity, your vehicle is more sensitive to side winds than an ordinary passenger car. Slowing down will allow you to have better control.
- Do not drive horizontally across steep slopes. Driving straight up or straight down is preferred. Your vehicle (or any similar off-road vehicle) can tip over sideways much more easily than forward or backward.

Off-road driving

Your vehicle is not designed to be driven off-road. However, in the event that off-road driving cannot be avoided, please observe the following precautions to help avoid the areas prohibited to vehicles.

- Drive your vehicle only in areas where off-road vehicles are permitted to travel.
- Respect private property. Get owner's permission before entering private property.
- Do not enter areas that are closed. Honor gates, barriers and signs that restrict travel.
- Stay on established roads. When conditions are wet, driving techniques should be changed or travel delayed to prevent damage to roads.
- AWD models: Avoid driving on very steep, slippery roads and other surfaces, such as sand, where the tires are liable to lose traction. Your vehicle may not perform as well as conventional AWD on-road vehicles on these surfaces.

■ Additional information for off-road driving

- ▶ For owners in U.S. mainland, Hawaii and Puerto Rico:

To obtain additional information pertaining to driving your vehicle off-road, consult the following organizations.

- State and Local Parks and Recreation Departments
- State Motor Vehicle Bureau
- Recreational Vehicle Clubs
- U.S. Forest Service and Bureau of Land Management

 **WARNING****■ Off-road driving precautions**

Always observe the following precautions to minimize the risk of death or serious injury or damage to your vehicle:

- Drive carefully when off the road. Do not take unnecessary risks by driving in dangerous places.
- Do not grip the steering wheel spokes when driving off-road. A bad bump could jerk the wheel and injure your hands. Keep both hands and especially your thumbs on the outside of the rim.
- Always check your brakes for effectiveness immediately after driving in sand, mud, water or snow.
- After driving through tall grass, mud, rock, sand, water, etc., check that there is no grass, bush, paper, rags, stone, sand, etc. adhering or trapped to the underbody. Clear off any such matter from the underbody. If the vehicle is used with these materials trapped or adhering to the underbody, a breakdown or fire could occur.
- When driving off-road or in rugged terrain, do not drive at excessive speeds, jump, make sharp turns, strike objects, etc. This may cause loss of control or vehicle rollover causing death or serious injury. You are also risking expensive damage to your vehicle's suspension and chassis.

 **NOTICE****■ To prevent water damage**

Take all necessary safety measures to ensure that water damage to the hybrid battery (traction battery), hybrid system or other components does not occur.

- Water entering the engine compartment may cause severe damage to the hybrid system. Water entering the interior may cause the hybrid battery stowed under the rear seats to short circuit.
- Water entering the hybrid transmission and rear electric motor (traction motor) will cause deterioration in transmission quality. The malfunction indicator may come on, and the vehicle may not be drivable.
- Water can wash the grease from wheel bearings, causing rusting and premature failure, and may also enter the hybrid transmission case, reducing the gear oil's lubricating qualities.

■ When you drive through water

If driving through water, such as when crossing shallow streams, first check the depth of the water and the bottom of the riverbed for firmness. Drive slowly and avoid deep water.

■ Inspection after off-road driving

- Sand and mud that has accumulated around brake discs may affect braking efficiency and may damage brake system components.
- Always perform a maintenance inspection after each day of off-road driving that has taken you through rough terrain, sand, mud, or water. For scheduled maintenance information, refer to the "Warranty and Services Guide/Owner's Manual Supplement/Scheduled Maintenance".

5-1. Basic Operations	
Lexus Display Audio System	336
Steering wheel audio switches.....	342
Mobile Assistant.....	343
USB/AUX ports	345
5-2. Setup	
Setup menu.....	347
General settings	348
Voice settings.....	351
Display settings	352
5-3. Using the audio system	
Selecting the audio source	353
Optimal use of the audio system	354
Audio settings.....	355
Audio menu screen operation	358
5-4. Using the radio	
Radio operation.....	361
5-5. Playing an audio CD and MP3/WMA/AAC discs	
CD player operation	367

5-6. Using an external device	
Listening to an iPod	374
Using USB memory device	377
Using the AUX port	381
5-7. Connecting Bluetooth®	
Steps for using Bluetooth® devices	382
Registering a Bluetooth® device	384
Selecting a Bluetooth® device	385
Connecting a Bluetooth® audio player	386
Connecting a Bluetooth® phone	387
Displaying a Bluetooth® device details	388
Detailed Bluetooth® settings	389
5-8. Bluetooth® Audio	
Listening to Bluetooth® Audio	390
5-9. Bluetooth® Phone	
Using a Bluetooth® Phone	392
Making a call	394
Receiving a call	397
Speaking on the phone	398
Using a Bluetooth® phone message	400
Using the steering wheel switches	402
Bluetooth® phone settings	403
5-10. Phonebook	
Contact settings	405
Messaging setting	408
5-11. Bluetooth®	
What to do if... (Troubleshooting)	409
Bluetooth®	413
5-12. Other function	
"Information" screen	418
USB photo	420
Weather information	422
Voice command system	423
LEXUS Enform Remote	427

Lexus Display Audio System *

Use the following buttons to start listening to the audio system.

Lexus Display Audio operation buttons

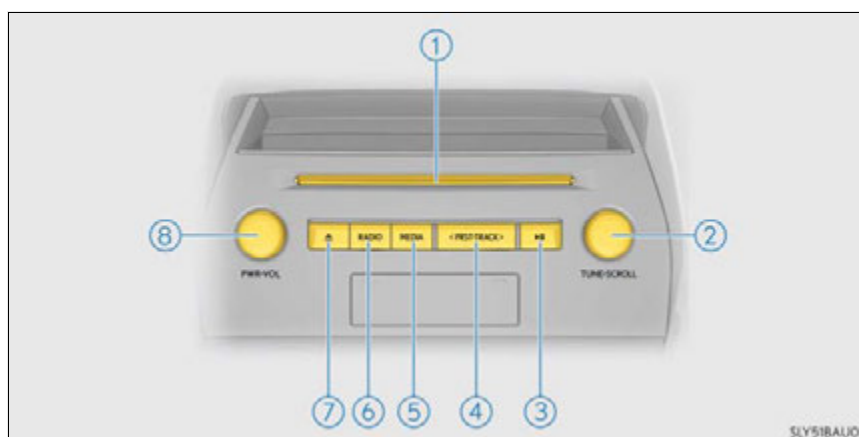

- ① Disc slot
- ② “TUNE•SCROLL” knob
Select a radio station band, track or file.
- ③ Except radio and A/V mode: Pause or resume playing a track or file.
Radio and A/V mode: Turn mute on/off.
- ④ Select preset radio stations, or access a desired track or file.
- ⑤ Display the media top screen.
- ⑥ Display the radio top screen.
- ⑦ Eject a disc.
- ⑧ “PWR•VOL” knob
Press to turn the audio system on/off, and turn to adjust the volume.

*: If equipped

■ **“Menu” screen**

To display the “Menu” screen, press the “MENU” button on the controller unit.

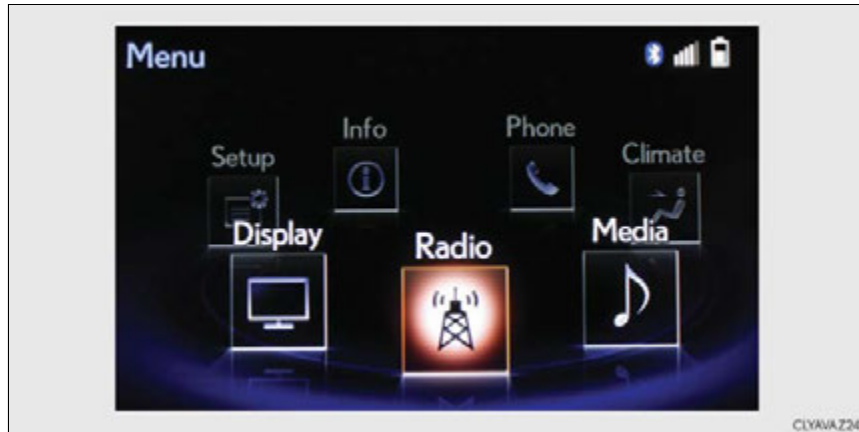

Button	Function
“Radio”	Display the radio top screen (→P. 361)
“Media”	Display the media top screen (→P. 367, 374, 377, 381, 386)
“Climate”	Automatic air conditioning system (→P. 430)
“Phone”	Display the phone top screen (→P. 392)
“Info”	Display the “Information” screen (→P. 418)
“Setup”	Setup menu (→P. 347)
“Display”	Display settings (→P. 352)

Lexus Display Audio controller

By using the Lexus Display Audio controller, you can control the audio system, hands-free system, etc.

- ① Display the "Source" screen or audio top screen (→P. 353)
- ② Display the "Menu" screen (→P. 337)
- ③ Back button
Display the previous screen
- ④ Turn or move the controller to select a function and number.



Move the controller to display the left or right side of the screen.

Push the controller to enter the selected function and number.

■ Using the Lexus Display Audio controller

- ① Select: Turn or move the controller.
- ② Enter: Push the controller.



Basic screen operation

When a list is displayed, use the appropriate button to scroll through the list.

- ① Indicator turns on when you can select the list by turning the controller.
- ② Indicator turns on when you can return to the previous screen by pressing the back button.
- ③ Indicator turns on when you can move the controller left to view additional screen text.
- ④ Indicator turns on when you can move the controller right to view additional screen text.



Inputting letters and numbers

■ Input mode

Letters and numbers are inputted via the screen.

- ① Turn the controller to select the desired character and press the controller to input the character.
- ② When this indicator is shown, you can change input fields by moving the controller forward.
- ③ When this indicator is shown, you can change character types by moving the controller to the right and then selecting the desired character type.
- ④ Select to erase characters one by one. Select and hold to erase all characters.
- ⑤ Select to complete data input.

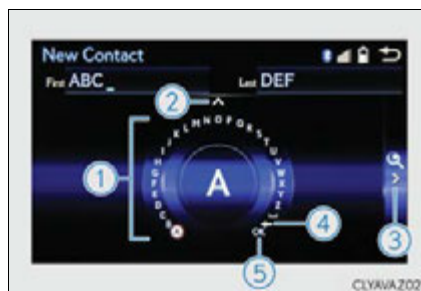

■ Input field mode

When in the input field you can move the cursor to the desired position.

- ① Turn the controller to move the cursor left or right.
- ② When this indicator is shown, you can move the cursor to the right input field by moving the controller to the right.
- ③ When this indicator is shown, you can move the cursor to the left input field by moving the controller to the left.
- ④ When this indicator is shown, you can change to input mode by moving the controller backward.

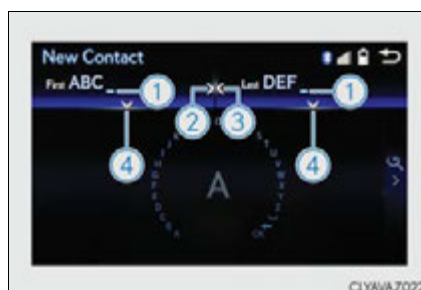



■ **When using the screen**

- Under extremely cold conditions, the Lexus Display Audio controller may react slowly.
- If the screen is cold, the display may be dark, or the system may seem to be operating slightly slower than normal.
- The screen may seem dark and hard to see when viewed through sunglasses. Change your angle of viewing, adjust the display on the "Display" screen (→P. 352) or remove your sunglasses.

■ **Using cellular phones**

Interference may be heard through the audio system's speakers if a cellular phone is being used inside or close to the vehicle while the audio system is operating.

 WARNING
<p>■ Using the Lexus Display Audio controller Be careful when touching the Lexus Display Audio controller in extreme temperatures as it may become very hot or cold due to the temperature inside the vehicle.</p> <p>■ Laser product</p> <ul style="list-style-type: none"> ● CAUTION USE OF CONTROL OR ADJUSTMENT OR PERFORMANCE OF PROCEDURES OTHER THAN THOSE SPECIFIED HEREIN MAY RESULT IN HAZARDOUS RADIATION EXPOSURE. ● CAUTION THE USE OF OPTICAL INSTRUMENTS WITH THIS PRODUCT WILL INCREASE EYE HAZARD.

 NOTICE
<p>■ To prevent Lexus Display Audio controller malfunction</p> <ul style="list-style-type: none"> ● Do not allow the Lexus Display Audio controller to come into contact with food, liquid, stickers or lit cigarettes as doing so may cause it to change color, emit a strange odor or stop functioning. ● Do not subject the Lexus Display Audio controller to excessive pressure or strong impact as the controller may bend or break off. <p>■ To prevent 12-volt battery discharge Do not leave the audio system on longer than necessary when the hybrid system is off.</p> <p>■ To avoid damaging the audio system Take care not to spill drinks or other fluids on the audio system.</p>

Steering wheel audio switches

Some audio features can be controlled using the switches on the steering wheel.

Operation may differ depending on the type of audio system or navigation system. For details, refer to the manual provided with the audio system or navigation system.

Operating the audio system using the steering wheel switches

- ① Volume switch
 - Increases/decreases volume
 - Press and hold: Continuously increases/decreases volume
- ② Radio mode:
 - Press: Select a radio station
 - Press and hold: Seek up/down



CD, MP3/WMA/AAC disc, Bluetooth[®], iPod or USB mode:

- Press: Select a track/file/video
 - Press and hold: Quickly move up/down through tracks/files/videos.
- ③ "MODE" switch
 - Turns the power on, selects audio source
 - Press and hold this switch to mute or pause the current operation. To cancel the mute or pause, press and hold.

WARNING

To reduce the risk of an accident

Exercise care when operating the audio switches on the steering wheel.

Mobile Assistant

The Mobile Assistant feature will activate Apple's Siri® Eyes Free mode via the steering wheel switches. To operate the Mobile Assistant, a compatible cellular phone must be registered and connected to this system via Bluetooth®. (→P.382)

- 1 Press and hold the off hook switch until you hear the beeps that indicate the system is listening.

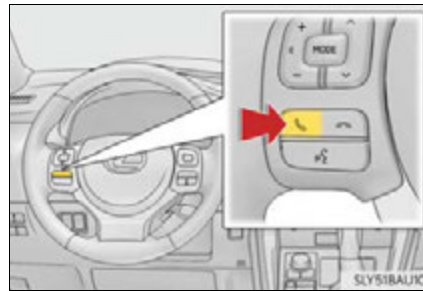

- 2 The Mobile Assistant can be used only when the neighboring screen is displayed.

To cancel the Mobile Assistant, select "Cancel", or press and hold the off hook switch.

To restart the Mobile Assistant for additional commands, press the off hook switch. Mobile Assistant can only be restarted after the system responds to a voice command. After some phone and music commands, the Mobile Assistant feature will automatically end to complete the requested action.

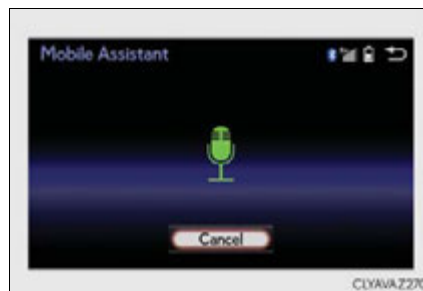

■ Adjusting the volume

The volume of the Mobile Assistant can be adjusted using the “PWR·VOL” knob or steering wheel volume switches. The Mobile Assistant and phone call volumes are synchronized.

■ Microphone

It is not necessary to speak directly into the microphone when using the Mobile Assistant.

- Wait for the listening beeps before using the Mobile Assistant.
- The Mobile Assistant may not recognize commands in the following situations:
 - When spoken too quickly.
 - When spoken at a low or high volume.
 - When the roof or windows are open.
 - When passengers are talking while the Mobile Assistant is being used.
 - When the air conditioning system’s fan speed is set high.
 - When the air conditioning vents are turned toward the microphone.

■ Mobile Assistant precautions

- The available features and functions may vary based on the iOS version installed on the connected device.
- Some Siri features are limited in Eyes Free mode. If you attempt to use an unavailable function, Siri will inform you that the function is not available.
- If Siri is not enabled on the cellular phone connected via Bluetooth[®], an error message will be displayed on the screen.
- While a phone call is active, the Mobile Assistant cannot be used.
- If using the navigation feature of the cellular phone, ensure the active audio source is Bluetooth[®] audio or iPod in order to hear turn by turn direction prompts.

USB/AUX ports

Connect an iPod, USB memory device or portable audio player to the USB/AUX port as indicated below. Select "iPod", "USB", "AUX" or "A/V" on the audio source selection screen and the device can be operated via Lexus Display Audio system.

Connecting using the USB/AUX port

- 1 Lift the lid while pushing the button to release the lock.

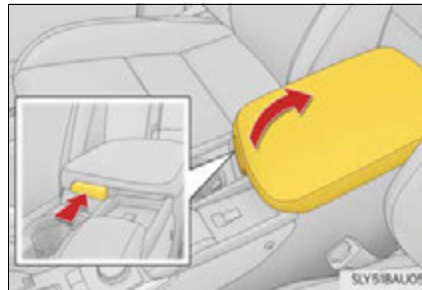

- 2 Open the cover.

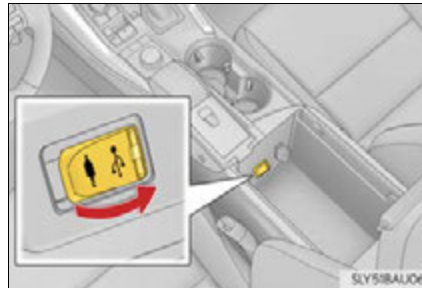

■ iPod

Open the cover and connect an iPod using an iPod cable.

Turn on the power of the iPod if it is not turned on.

■ USB memory

Open the cover and connect the USB memory device.

Turn on the power, if applicable, of the USB memory device if it is not turned on.

■ Portable audio player

Open the cover and connect the portable audio player.

Turn on the power of the portable audio player if it is not turned on.

Using a 4-pole AUX cable

To view a video on an iPod video or VTR, it is necessary to use a 4-pole AUX cable to connect the portable audio device.

When connecting a portable audio device to the AUX port, use a 4-pole AUX cable with a plug that matches the exact layout shown in the illustration.

- ① Connected device (portable audio device, etc.)
- ② Left audio
- ③ Right audio
- ④ Ground
- ⑤ Video

When using an iPod video, a cable that has a 4-pole AUX plug and a USB connector is necessary. Connect the plug and connector to the AUX and USB ports.

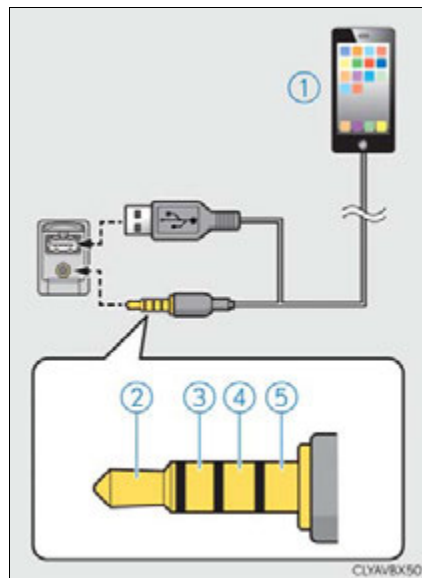

■ **When using a 4-pole AUX cable**

If a 4-pole AUX cable with a different layout is used, audio and/or video may not be output properly.

■ **When using the USB/AUX port**

The notch in console box allows audio cables to be passed through even when the console box is closed.



⚠ WARNING

■ **While driving**

Do not connect a device or operate the device controls.

Setup menu

The Lexus Display Audio system can be adjusted to the desired settings.

Display "Setup" screen

"Setup" screen: "MENU" button → "Setup"

- ① Change the settings for operation sounds, screen animation, etc. (→P. 348)
- ② Adjust the settings for voice guidance volume and voice recognition prompts. (→P. 351)
- ③ Change the settings for registering, removing, connecting and disconnecting Bluetooth® devices. (→P. 384, 385, 386, 387)
- ④ Change the settings for FM radio, iPod, etc. (→P. 355)
- ⑤ Change the settings for vehicle customization. (→P. 631)
- ⑥ Change the settings for phone sound, phonebook, etc. (→P. 403)

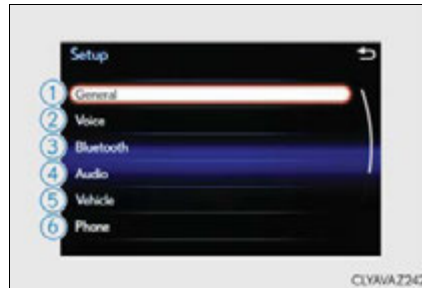

General settings

Settings are available for adjusting the operation sounds, screen animation, etc.

Screen for general settings

“General Settings” screen: “MENU” button → “Setup” → “General”

- ① Change language.
The selectable languages may differ depending on the model or region.
- ② Set the beep sound on/off.
- ③ Change the button color.
- ④ Change the startup image and screen off image. (→P. 349)
- ⑤ Set the animation effect on/off.
- ⑥ Delete personal data (→P. 350)
- ⑦ Update program versions.
For details, contact your Lexus dealer.
- ⑧ Update gracenote database versions.
For details, contact your Lexus dealer.
- ⑨ Display the open source license.



Customizing images

- 1 Go to “Customize Images”: “MENU” button → “Setup” → “General” → “Customize Images”
- 2 Select “Set Images” and then select the desired image.
 - ① Set as startup image.
 - ② Set as screen off image.
 - ③ Set as startup image and screen off image.

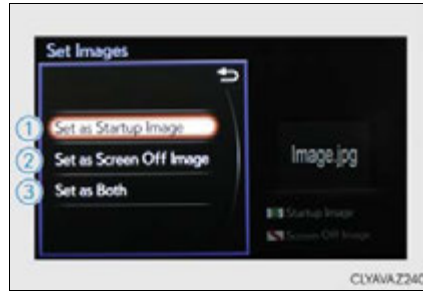

■ Adding an image

- 1 Connect a USB memory device. (→P. 345)
- 2 Select “Copy from USB” on the “Customize Images” screen and then select the desired image.
- 3 Move the controller to the left and then select “Copy”.
Up to 10 images can be downloaded.

■ Deleting images

Select “Delete Images” on the “Customize Images” screen and then select the desired images.

■ USB memory

When saving the images to a USB memory device, name the folder that the images are saved to “Image”.

● Compatible device formats

The following device format can be used:

- USB communication format: USB2.0 FS (480 Mbps)
- File system format: FAT16/32 (Windows)
- Correspondence class: Mass storage class

The following types of files can be used:

- The image’s file format must be JPEG.
- The file name may only contain ASCII characters.

● JPEG file compatibility

Compatible image size: Maximum 5MB

 NOTICE

- To prevent damage to the USB memory device or its terminals
→P. 380

Deleting personal data

- 1 "MENU" button → "Setup" → "General" → "Delete Personal Data"
- 2 Select "Delete".

Check carefully beforehand, as data cannot be retrieved once deleted.

The following personal data will be deleted or changed to its default settings.

- Phonebook data
- Call history data
- Favorite data
- Bluetooth[®] devices data
- Phone sound settings
- Detailed Bluetooth[®] settings
- Audio/video setting
- Preset switch data
- Last used radio station
- Customized image data
- FM info setting
- iPod tagging information
- Software update history
- Software update detail information
- Phone display setting
- Contact/call history setting
- Messaging setting
- Traffic information map
- Weather information
- Phonebook data for voice recognition
- Music data for voice recognition

Voice settings

You can adjust the guidance volume setting.

Go to "Voice Settings": "MENU" button → "Setup" → "Voice"

- ① Adjust the voice guidance volume setting.
- ② Set the voice recognition prompts on/off.



■ Return to the default settings

Move the controller to the left and select "Default".

Display settings

Settings are available for adjusting the contrast and brightness of the screen. The display can also be turned off.

Screen for display settings

Go to "Display": "MENU" button → "Display"

- ① Turn off screen.
- ② Adjust screen quality.
- ③ Adjust screen quality of the rear view monitor camera.
- ④ Change to day mode.

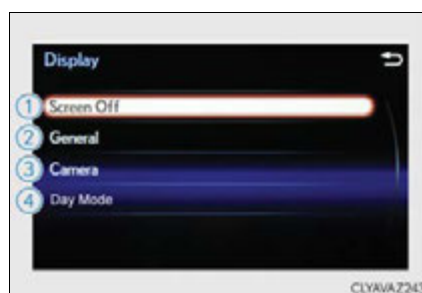

Screen off

This setting turns the screen off. To turn it on, press any button such as the "AUDIO" button or "MENU" button.

If a screen off image has been set, the set image will be displayed.

Day mode

When the headlights are turned on, the screen dims.

However, the screen can be switched to day mode by selecting "Day Mode".

The screen will stay in day mode when the headlights are turned on until "Day Mode" is selected again.

Adjusting the screen quality

- 1 Select "General" or "Camera" on the "Display" screen or select "Display" on each audio menu screen. (→P. 358)
- 2 Adjust the display as desired by turning the controller clockwise (+) or counterclockwise (-).
To select "Contrast", "Brightness", "Color" or "Tone", move the controller to the left. ("Color" and "Tone" are available when "Display" on the audio settings screen for each audio source is selected.)

■ Changing the sample image (when "General" is selected)

Move the controller to the right and select the desired sample image.

Selecting the audio source

Switching between audio sources, such as the radio and CD, is explained in this section.

Changing audio source

- 1 Press the "AUDIO" button to display the "Source" screen.
If the "Source" screen is not displayed, press the button again.
- 2 Select the desired audio source.
The audio source can be selected by pressing the "RADIO" or "MEDIA" button.

Using the steering wheel switches to change audio sources

Press the "MODE" switch when the audio system is turned on. The audio source changes each time the "MODE" switch is pressed.

■ Rearranging the list

The listing order of the source list can be rearranged.

- 1 Move the controller to the left while on the "Source" screen.
- 2 Select "Audio Source Select".
- 3 Select an item you wish to move and then select where to move the item to.

Optimal use of the audio system

On the “Sound Settings” screen, sound quality (Treble/Mid/Bass), volume balance and DSP settings can be adjusted.

How to adjust the sound settings and sound quality

1 Audio menu screen. (→P. 358)

2 Select “Sound Settings”.

To change between the sound setting screen and DSP setting screen, move the controller to the right then select the desired screen.

▶ “Sound Settings”

① ② ③ Adjusts the treble, mid or bass.

④ Adjusts the front/rear audio balance.

⑤ Adjusts the left/right audio balance.

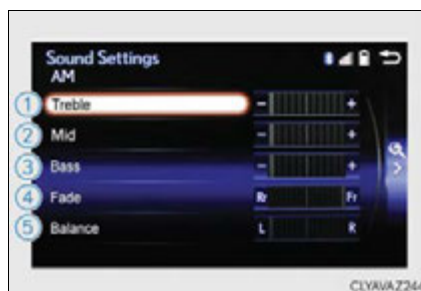

▶ “DSP”

① Sets the automatic sound levelizer (ASL) on/off

② Sets the surround function on/off

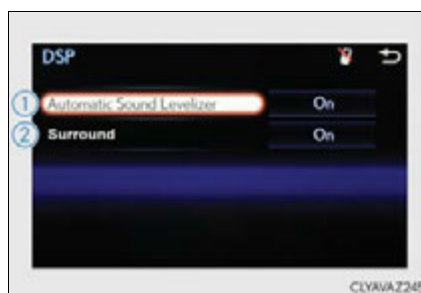

■ **The sound quality level is adjusted individually**

The treble, mid and bass levels can be adjusted for each audio mode separately.

■ **About Automatic Sound Levelizer (ASL)**

ASL automatically adjusts the volume and tone quality according to the vehicle speed.

Audio settings

Screen for audio settings

Go to "Audio Settings": "MENU" button → "Setup" → "Audio"

- ① Change radio settings (→P. 355)
- ② Change iPod settings (→P. 356)
- ③ Change A/V settings (→P. 356)
- ④ Change the cover art settings (→P. 357)
- ⑤ Change USB settings (→P. 357)

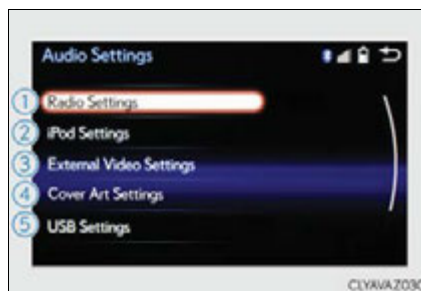

Changing radio settings

To change radio settings, select "Radio Settings" on the "Audio Settings" screen or radio menu screen. (→P. 358)

- ① Set the displaying RBDS text message on/off
- ② Change the number of radio presets

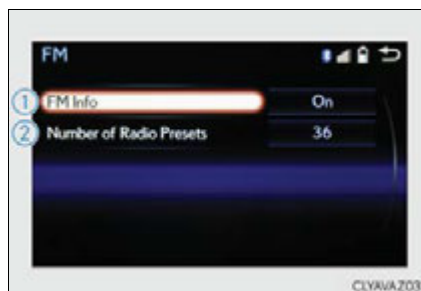

Changing iPod settings

To change iPod settings, select “iPod Settings” on the “Audio Settings” screen or iPod menu screen. (→P. 358)

- ① Change the screen size (video mode)
- ② Change the cover art settings (→P. 357)
- ③ Adjust the screen quality (video mode) (→P. 352)
- ④ Change video sound input port

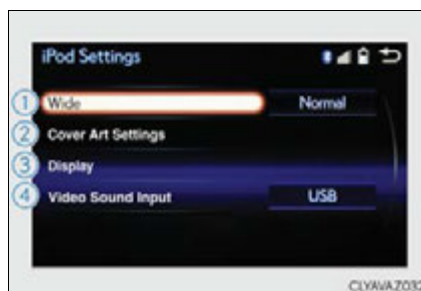

Changing A/V settings

To change A/V settings, select “External Video Settings” on the “Audio Settings” screen or A/V menu screen. (→P. 358)

- ① Change the screen size
- ② Change the video signal
- ③ Adjust the screen quality (video mode) (→P. 352)

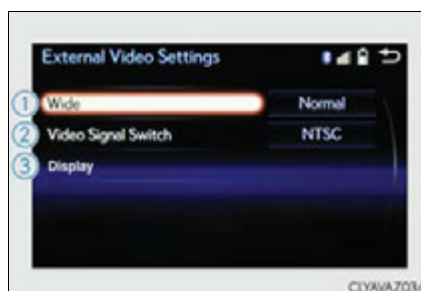

Changing the cover art settings

To change the cover art settings, select “Cover Art Settings” on the “Audio Settings” screen, CD or MP3/WMA/AAC disc menu screen. (→P. 358)

- ① Select to set the cover art display of the DISC mode on/off.
- ② Select to set the cover art display of the USB mode on/off.
- ③ Change the priority of the Gracenote database of the USB mode.
- ④ Select to set the cover art display of the iPod mode on/off.
- ⑤ Change the priority of the Gracenote database of the iPod mode.



Changing USB settings

To change USB settings, select “USB Settings” on the “Audio Settings” screen or USB menu screen. (→P. 358)

- ① Change the cover art settings (→P. 357)

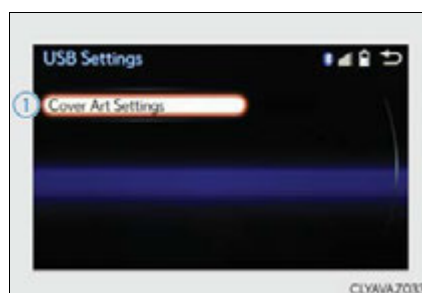

Audio menu screen operation

You can change the settings and control functions for each audio source.

Audio menu screen

To display the audio menu screen, move the controller to the left while on an audio top screen.

▶ AM, FM radio or XM Satellite Radio

- ① Scans for receivable stations (AM, FM radio)
- ② Seeks a station of the nearest frequency (stops when a station is found) (AM, FM radio)
- ③ Captures the song title and artist name information for potential purchase (when the "HD" indicator on the selected station is appears) (FM radio)
- ④ Changes the channel of HD Radio (HD2, HD3, HD4 where applicable) (FM radio)
- ⑤ Seeks a station of the traffic announcement (FM radio)
- ⑥ Selects to set the station list shows of HD radio on/off (AM, FM radio)
- ⑦ Changes radio settings (→P. 355)
- ⑧ Changes sound settings (→P. 354)



► CD, MP3/WMA/AAC disc, iPod, USB or Bluetooth®

- ① Plays or pauses a track/file
- ② Selects a track/file
- ③ Selects a folder/album (MP3/WMA/AAC disc or USB)
- ④ Selects and hold: Fast-forward or rewind a track/file
- ⑤ Selects a repeat mode. (→P. 360)
- ⑥ Selects a random/shuffle play mode. (→P. 360)
- ⑦ Selects a full screen mode (iPod video mode)
- ⑧ Changes iPod settings (iPod) (→P. 356)
- ⑨ Changes USB settings (USB) (→P. 357)
- ⑩ Connects a Bluetooth device (Bluetooth®) (→P. 385)
- ⑪ Changes the cover art settings (CD or MP3/WMA/AAC disc) (→P. 357)
- ⑫ Changes sound settings (→P. 354)





► A/V

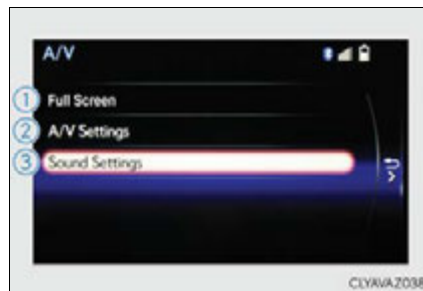

- ① Selects full screen mode
- ② Changes A/V settings (→P. 356)
- ③ Changes sound settings (→P. 354)



Repeat play

Mode	Action	Target audio source
	File/track repeat	All media
	Folder repeat	MP3/WMA/AAC disc, USB
	Album repeat	USB, Bluetooth®

Random/shuffle playback

Mode	Action	Target audio source
	Random/shuffle play of the disc/ folder/album	All media
	Random play of all folders	MP3/WMA/AAC disc, USB
	Random/shuffle play of all albums	iPod, USB, Bluetooth®

Radio operation

Select “AM”, “FM” or “SAT” on the audio source selection screen to begin listening to the radio.

Radio top screen

Pressing the “RADIO” button displays the radio top screen from any screen of the selected source.

- **Menu screen**

→P. 358

Selecting a station (AM or FM radio)

Tune in to the desired station using one of the following methods.

- **Seek tuning**

Press and hold then release “<” or “>” on the “PRST•TRACK” button.

Seek tuning can also be operated on the menu screen. (→P. 358)

The radio will begin seeking up or down for a station of the nearest frequency and will stop when a station is found.

- **Manual tuning**

Turn the “TUNE•SCROLL” knob.

- **Preset stations**

Select the desired preset station by pressing “<” or “>” on the “PRST•TRACK” button or controller.

- **Station list**

- 1 Move the controller to the right and selecting “Station List”.

- 2 AM radio: Selecting a desired station.

FM radio: Selecting a desired type of station and selecting a desired station.

To refreshing the station list, select “Refresh”. Select “Source” on the refresh screen, can be change to the other audio source while refreshing.

Selecting an HD Radio channel

When "HD Radio" is set to "On", available stations with HD Radio channels are marked with "HD)".

- 1 In AM or FM mode, select a station marked with "HD)".
- 2 Turn the "TUNE•SCROLL" knob to select an HD Radio channel.
HD Radio channels can also be selected by selecting "Multicast" on the menu screen. (→P. 358)

Selecting a channel (XM Satellite Radio)

Select in to the desired channel using one of the following methods.

■ Turning up/down the channel

Press and hold "<" or ">" on the "PRST•TRACK" button or turn the "TUNE•SCROLL" knob.

■ Preset channels

Select the desired preset channel by pressing "<" or ">" on the "PRST•TRACK" button or controller.

■ Channel list

- 1 Move the controller to the right and selecting "Select a SAT Category".
- 2 Selecting a desired category of channel and selecting a desired channel.

Setting presets

- 1 Search for desired stations or channel.
- 2 Select and hold one of the preset until you hear a beep.

Display the text message

■ Display the song information

Move the controller to the right and selecting "Text".

■ Display the Additional information (AM, FM radio)

Move the controller to the right and selecting "Additional Information".

HD Radio™ Technology

HD Radio™ Technology is the digital evolution of analog AM/FM radio. Your radio product has a special receiver which allows it to receive digital broadcasts (where available) in addition to the analog broadcasts it already receives.

Digital broadcasts have better sound quality than analog broadcasts as digital broadcasts provide free, crystal clear audio with no static or distortion. For more information, and a guide to available radio stations and programming, refer to www.hdradio.com.

“HD Radio features included in Lexus radios:

Digital Sound - HD Radio broadcasts deliver crystal-clear, digital audio quality to listeners.

HD2/HD3 Channels - FM stations can provide additional digital only audio programming with expanded content and format choices on HD2/HD3 channels.

PSD - Program Service Data (PSD) gives you on-screen information such as artist name and song title.

iTunes Tagging - Listeners can tag (store) songs they like for later review and purchase through iTunes.

Artist Experience - Images related to the broadcast are displayed on the radio screen, such as album cover art and station logos.”



HD Radio Technology manufactured under license from iBiquity Digital Corporation. U.S. and Foreign Patents. HD Radio™ and the HD, HD Radio, and “Arc” logos are proprietary trademarks of iBiquity Digital Corp.

■ HD Radio™ Technology troubleshooting guide

Experience	Cause	Action
Mismatch of time alignment- a user may hear a short period of programming replayed or an echo, stutter or skip.	The radio stations analog and digital volume are not properly aligned or the station is in ballgame mode.	None, radio broadcast issue. A user can contact the radio station.
Sound fades, blending in and out.	Radio is shifting between analog and digital audio.	Reception issue, may clear-up as the vehicle continues to be driven. Set "HD Radio" to off, can force radio in an analog audio.
Audio mute condition when an HD2/HD3 multicast channel had been playing.	The radio does not have access to digital signals at the moment.	This is normal behavior, wait until the digital signal returns. If out of the coverage area, seek a new station.
Audio mute delay when selecting an HD2/HD3 multicast channel preset.	The digital multicast content is not available until HD Radio™ broadcast can be decoded and make the audio available. This takes up to 7 seconds.	This is normal behavior, wait for the audio to become available.
Text information does not match the present song audio.	Data service issue at the radio broadcaster.	Broadcaster should be notified. Complete the form: www.ibequality.com/automotive/report_radio_station_experiences .
No text information shown for the present selected frequency.	Data service issue by the radio broadcaster.	Broadcaster should be notified. Complete the form: www.ibequality.com/automotive/report_radio_station_experiences .

■ Reception sensitivity

- Maintaining perfect radio reception at all times is difficult due to the continually changing position of the antenna, differences in signal strength and surrounding objects, such as trains, transmitters, etc.
- The radio antenna is mounted inside the rear window. To maintain clear radio reception, do not attach metallic window tinting or other metallic objects to the antenna wire mounted inside the rear window.

■ XM Radio Services – Descriptions

● Radio and Entertainment

XM offers more than 170 satellite radio channels of commercial-free music and premier sports, news, talk, and entertainment. XM is broadcast via satellites to millions of listeners across the continental United States. XM subscribers listen to XM on satellite radio receivers for the car, home, and portable use. More information about XM is available online at www.siriusxm.com (U.S.A.) or www.xmradio.ca (Canada).

● Satellite tuner

The tuner supports only Audio Services (Music and Talk) and the accompanying Text Information of XM[®] Satellite Radio.

■ XM Radio Services – Subscription Instructions

For XM Services requiring a subscription (such as XM Radio), the following paragraph shall be included.

Required XM Radio monthly subscriptions sold separately after trial period. Subscription fee is consumer only. All fees and programming subject to change. Subscriptions are subject to the Customer Agreement available at www.siriusxm.com (U.S.A.) or www.xmradio.ca (Canada) XM service only available in the 48 contiguous United States and 10 Canadian provinces. © 2011 Sirius XM Radio Inc. Sirius, XM and all related marks and logos are trademarks of Sirius XM Radio Inc. All other marks, channel names and logos are the property of their respective owners.

For more information, program schedules, and to subscribe or extend subscription after complimentary trial period; more information is available at:

▶ U.S.A. Customers:

Visit www.siriusxm.com or call 1-877-515-3987

▶ Canadian Customers:

Visit www.xmradio.ca or call 1-877-438-9677

● Radio ID

You will need the radio ID when activating XM service or reporting a problem. If "Ch000" is selected using the "TUNE•SCROLL" knob, the ID code, which is 8 alphanumeric characters, will be displayed. If another channel is selected, the ID code will no longer be displayed. The channel (000) alternates between displaying the radio ID and the specific radio code.

■ XM Radio Services – Legal Disclaimers and Warnings

- Fees and Taxes – Subscription fee, taxes, one time activation fee, and other fees may apply. Subscription fee is consumer only. All fees and programming subject to change. Subscriptions subject to Customer Agreement available at www.siriusxm.com (U.S.A.) or www.xmradio.ca (Canada) XM service only available in the 48 contiguous United States and Canada*.

*: Canada – some deterioration of service may occur in extreme northern latitudes.

This is beyond the control of XM Satellite Radio.

Explicit Language Notice – Channels with frequent explicit language are indicated with an "XL" preceding the channel name. Channel blocking is available for XM Satellite Radio receivers by notifying XM at;

▶ U.S.A. Customers:

Visit www.siriusxm.com or calling 1-877-515-3987

▶ Canadian Customers:

Visit www.xmradio.ca or calling 1-877-438-9677

It is prohibited to copy, decompile, disassemble, reverse engineer, hack, manipulate, or otherwise make available any technology or software incorporated in receivers compatible with the XM Satellite Radio System or that support the XM website, the Online Service or any of its content. Furthermore, the AMBE[®] voice compression software included in this product is protected by intellectual property rights including patent rights, copyrights, and trade secrets of Digital Voice Systems, Inc.

Note: this applies to XM receivers only and not XM Ready devices.

■ **If the satellite radio does not operate normally**

If a problem occurs with the XM tuner, a message will appear on the screen. Refer to the table below to identify the problem, and take the suggested corrective action.

SAT Check Antenna	The XM antenna is not connected. Check whether the XM antenna cable is attached securely.
	There is a short-circuit in the antenna or the surrounding antenna cable. See a Lexus certified dealer.
SAT Ch Unauthorized	You have not subscribed to XM Satellite Radio. The radio is being updated with the latest encryption code. Contact XM Satellite Radio for subscription information. When a contract is canceled, you can choose "Ch000" and all free-to-air channels.
	The premium channel you selected is not authorized. Wait for about 2 seconds until the radio returns to the previous channel or "Ch001". If it does not change automatically, select another channel. To listen to the premium channel, contact XM Satellite Radio.
SAT No Signal	The XM signal is too weak at the current location. Wait until your vehicle reaches a location with a stronger signal.
SAT Loading	The unit is acquiring audio or program information. Wait until the unit has received the information.
SAT Channel Off Air	The channel you selected is not broadcasting any programming. Select another channel.
-----	There is no song/program title or artist name/feature associated with the channel at that time. No action is required.
SAT Chan Unavailable	The channel you selected is no longer available. Wait for about 2 seconds until the radio returns to the previous channel or "Ch001". If it does not change automatically, select another channel.

Contact the XM Listener Care Center at 1-877-515-3987 (U.S.A.) or 1-877-438-9677 (Canada).

CD player operation

Insert a disc, press the "MEDIA" button or select "DISC" on the "Source" screen with a disc inserted to begin listening to a CD.

CD top screen

Pressing the "MEDIA" button displays the CD top screen from any screen of the selected source.

■ Menu screen

→P. 358

■ Selecting a track/file

Press the "<" or ">" on the "PRST•TRACK" button or turn the "TUNE•SCROLL" knob to select the desired track/file number.

To fast-forward or rewind, press and hold the "<" or ">" on the "PRST•TRACK" button.

■ Selecting the track by the list (CD)

Move the controller to the right and then select the desired track.

■ Selecting a folder (MP3/WMA/AAC disc)

1 Move the controller to the right and then select "Folders".

2 Select the desired folder. Then select a file to begin using the selected folder.

■ Selecting a file by the selected folder (MP3/WMA/AAC disc)

1 Move the controller to the right and then select "Files".

2 Select the desired file.

■ Error messages

If the following error messages appear on the screen, refer to the table and take the appropriate measures. If the problem is not rectified, take the vehicle to your Lexus dealer.

Message	Cause	Correction procedures
"Check disc"	<ul style="list-style-type: none"> • The disc is dirty or damaged. • The disc is inserted upside down. • The disc is not playable with the player. 	<ul style="list-style-type: none"> • Clean the disc. • Insert the disc correctly. • Confirm the disc is playable with the player.
"DISC Error"	There is a malfunction within the system.	Eject the disc.
"No music files found."	No playable data is included on the disc.	Eject the disc.

■ Discs that can be used

Discs with the marks shown below can be used.

Playback may not be possible depending on recording format or disc features, or due to scratches, dirt or deterioration.



CDs with copy-protection features may not play correctly.

■ CD player protection feature

To protect the internal components, playback is automatically stopped when a problem is detected.

■ If a disc is left inside the CD player or in the ejected position for extended periods

Disc may be damaged and may not play properly.

■ Lens cleaners

Do not use lens cleaners. Doing so may damage the CD player.

■ MP3, WMA and AAC files

MP3 (MPEG Audio LAYER3) is a standard audio compression format.

Files can be compressed to approximately 1/10 of their original size by using MP3 compression.

WMA (Windows Media Audio) is a Microsoft audio compression format.

This format compresses audio data to a size smaller than that of the MP3 format.

AAC is short for Advanced Audio Coding and refers to an audio compression technology standard used with MPEG2 and MPEG4.

MP3, WMA and AAC file and media/formats compatibility are limited.

- MP3 file compatibility
 - Compatible standards
MP3 (MPEG1 LAYER3, MPEG2 LSF LAYER3)
 - Compatible sampling frequencies
MPEG1 LAYER3: 32, 44.1, 48 (kHz)
MPEG2 LSF LAYER3: 16, 22.05, 24 (kHz)
 - Compatible bit rates (compatible with VBR)
MPEG1 LAYER3: 32-320 (kbps)
MPEG2 LSF LAYER3: 8-160 (kbps)
 - Compatible channel modes: stereo, joint stereo, dual channel and monaural
- WMA file compatibility
 - Compatible standards
WMA Ver. 7, 8, 9 (only compatible with Window Media Audio Standard)
 - Compatible sampling frequencies
32, 44.1, 48 (kHz)
 - Compatible bit rates (only compatible with 2-channel playback)
Ver. 7, 8: CBR 48-192 (kbps)
Ver. 9: CBR 48-320 (kbps)
- AAC file compatibility
 - Compatible standards
MPEG4/AAC-LC
 - Compatible sampling frequencies
11.025/12/16/22.05/24/32/44.1/48 (kHz)
 - Compatible bit rates
16-320 (kbps)
 - Compatible channel modes: 1 ch and 2 ch
- Compatible media
Media that can be used for MP3, WMA and AAC playback are CD-Rs and CD-RWs. Playback in some instances may not be possible if the CD-R or CD-RW is not finalized. Playback may not be possible or the audio may jump if the disc is scratched or marked with fingerprints.
- Compatible disc formats
The following disc formats can be used.
 - Disc formats: CD-ROM Mode 1 and Mode 2
CD-ROM XA Mode 2, Form 1 and Form 2
 - File formats: ISO9660 Level 1, Level 2, (Romeo, Joliet)
UDF (2.01 or lower)

MP3, WMA and AAC files written in any format other than those listed above may not play correctly, and their file names and folder names may not be displayed correctly.

Items related to standards and limitations are as follows.

 - Maximum directory hierarchy: 8 levels (including the root)
 - Maximum length of folder names/file names: 32 characters
 - Maximum number of folders: 192 (including the root)
 - Maximum number of files per disc: 255

- File names
The only files that can be recognized as MP3/WMA/AAC and played are those with the extension .mp3, .wma or .m4a.
- Discs containing multi-session recordings
As the audio system is compatible with multi session discs, it is possible to play discs that contain MP3, WMA and AAC files. However, only the first session can be played.
- ID3, WMA and AAC tags
ID3 tags can be added to MP3 files, making it possible to record the track title, artist name, etc.
The system is compatible with ID3 Ver. 1.0, 1.1, and Ver. 2.2, 2.3 ID3 tags. (The number of characters is based on ID3 Ver. 1.0 and 1.1.)
WMA tags can be added to WMA files, making it possible to record the track title and artist name in the same way as with ID3 tags.
AAC tags can be added to AAC files, making it possible to record the track title and artist name in the same way as with ID3 tags.
- MP3, WMA and AAC playback
When a disc containing MP3, WMA or AAC files is inserted, all files on the disc are first checked. Once the file check is finished, the first MP3, WMA or AAC file is played. To make the file check finish more quickly, we recommend you do not write any files to the disc other than MP3, WMA or AAC files or create any unnecessary folders.
Discs that contain a mixture of music data and MP3, WMA or AAC format data cannot be played.
- Extensions
If the file extensions .mp3, .wma and .m4a are used for files other than MP3, WMA and AAC files, they may be mistakenly recognized and played as MP3, WMA and AAC files. This may result in large amounts of interference and damage to the speakers.
- Playback
 - To play MP3 files with steady sound quality, we recommend a fixed bit rate of at least 128 kbps and a sampling frequency of 44.1 kHz.
 - CD-R or CD-RW playback may not be possible in some instances, depending on the characteristics of the disc.
 - There is a wide variety of freeware and other encoding software for MP3, WMA and AAC files on the market, and depending on the status of the encoding and the file format, poor sound quality or noise at the start of playback may result. In some cases, playback may not be possible at all.
 - When files other than MP3, WMA or AAC files are recorded on a disc, it may take more time to recognize the disc and in some cases, playback may not be possible at all.
 - Microsoft, Windows, and Windows Media are the registered trademarks of Microsoft Corporation in the U.S.A. and other countries.

■ The Gracenote® media database

- Music recognition technology and related data are provided by Gracenote®. Gracenote is the industry standard in music recognition technology and related content delivery. For more information visit www.gracenote.com.
- CD and music-related data from Gracenote, Inc., copyright © 2000 to present Gracenote. Gracenote Software, copyright © 2000 to present Gracenote. One or more patents owned by Gracenote apply to this product and service. See the Gracenote website for a non-exhaustive list of applicable Gracenote patents. Gracenote, CDDDB, MusicID, MediaVOCS, the Gracenote logo and logotype, and the "Powered by Gracenote" logo are either registered trademarks or trademarks of Gracenote in the United States and/or other countries.



Gracenote® End User License Agreement

This application or device contains software from Gracenote, Inc. of Emeryville, California ("Gracenote"). The software from Gracenote (the "Gracenote Software") enables this application to perform disc and/or file identification and obtain music-related information, including name, artist, track, and title information ("Gracenote Data") from online servers or embedded databases (collectively, "Gracenote Servers") and to perform other functions. You may use Gracenote Data only by means of the intended End-User functions of this application or device.

You agree that you will use Gracenote Data, the Gracenote Software, and Gracenote Servers for your own personal non-commercial use only. You agree not to assign, copy, transfer or transmit the Gracenote Software or any Gracenote Data to any third party. YOU AGREE NOT TO USE OR EXPLOIT GRACENOTE DATA, THE GRACENOTE SOFTWARE, OR GRACENOTE SERVERS, EXCEPT AS EXPRESSLY PERMITTED HEREIN.

You agree that your non-exclusive license to use the Gracenote Data, the Gracenote Software, and Gracenote Servers will terminate if you violate these restrictions. If your license terminates, you agree to cease any and all use of the Gracenote Data, the Gracenote Software, and Gracenote Servers. Gracenote reserves all rights in Gracenote Data, the Gracenote Software, and the Gracenote Servers, including all ownership rights. Under no circumstances will Gracenote become liable for any payment to you for any information that you provide. You agree that Gracenote, Inc. may enforce its rights under this Agreement against you directly in its own name.

The Gracenote service uses a unique identifier to track queries for statistical purposes. The purpose of a randomly assigned numeric identifier is to allow the Gracenote service to count queries without knowing anything about who you are. For more information, see the web page for the Gracenote Privacy Policy for the Gracenote service.

The Gracenote Software and each item of Gracenote Data are licensed to you "AS IS." Gracenote makes no representations or warranties, express or implied, regarding the accuracy of any Gracenote Data from in the Gracenote Servers. Gracenote reserves the right to delete data from the Gracenote Servers or to change data categories for any cause that Gracenote deems sufficient. No warranty is made that the Gracenote Software or Gracenote Servers are error-free or that functioning of Gracenote Software or Gracenote Servers will be uninterrupted. Gracenote is not obligated to provide you with new enhanced or additional data types or categories that Gracenote may provide in the future and is free to discontinue its services at any time.

GRACENOTE DISCLAIMS ALL WARRANTIES EXPRESS OR IMPLIED, INCLUDING, BUT NOT LIMITED TO, IMPLIED WARRANTIES OF MERCHANTABILITY, FITNESS FOR A PARTICULAR PURPOSE, TITLE, AND NON-INFRINGEMENT. GRACENOTE DOES NOT WARRANT THE RESULTS THAT WILL BE OBTAINED BY YOUR USE OF THE GRACENOTE SOFTWARE OR ANY GRACENOTE SERVER. IN NO CASE WILL GRACENOTE BE LIABLE FOR ANY CONSEQUENTIAL OR INCIDENTAL DAMAGES OR FOR ANY LOST PROFITS OR LOST REVENUES.

© Gracenote, Inc. 2009

 NOTICE

■ **Discs and adapters that cannot be used**

Do not use the following types of discs.

Also, do not use 3 in. (8 cm) disc adapters, DualDiscs or printable discs.

Doing so may damage the player and/or disc insert/eject function.

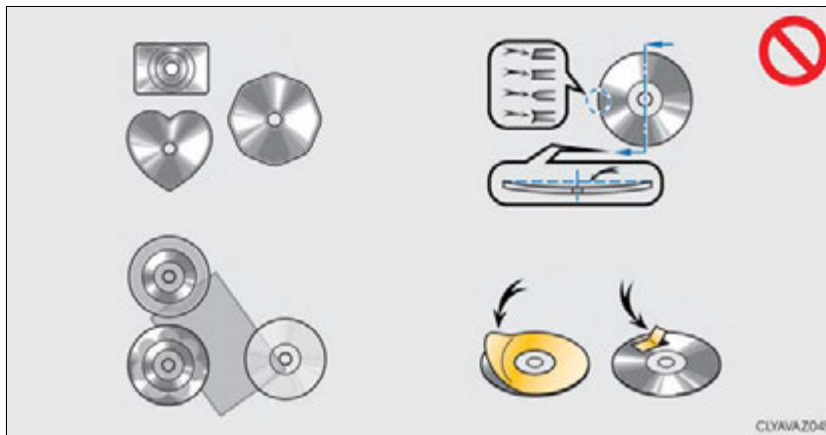

- Discs that have a diameter that is not 4.7 in. (12 cm).
- Low-quality or deformed discs.
- Discs with a transparent or translucent recording area.
- Discs that have tape, stickers or CD-R labels attached to them, or that have had the label peeled off.

■ **Player precautions**

Failure to follow the precautions below may result in damage to the discs or the player itself.

- Do not insert anything other than discs into the disc slot.
- Do not apply oil to the player.
- Store discs away from direct sunlight.
- Never try to disassemble any part of the player.

Listening to an iPod

Connecting an iPod enables you to enjoy music from the vehicle speakers. Press the “MEDIA” button or select “iPod” on the audio source selection screen.

Connecting an iPod

→P. 345

iPod top screen

Pressing the “MEDIA” button displays the iPod top screen from any screen of the selected source.

- **Menu screen**

→P. 358

- **Selecting a song**

Press the “<” or “>” on the “PRST•TRACK” button or turn the “TUNE•SCROLL” knob to select the desired song number.

To fast-forward or rewind, press and hold the “<” or “>” on the “PRST•TRACK” button.

- **Selecting a play mode**

- 1 Move the controller to the right and then select “Browse”.
- 2 Select the desired play mode, and then select a song to begin using the selected play mode.

- **Displaying the now playing list**

Move the controller to the right and then select “Now Playing List”.

- **About iPod**



- “Made for iPod” and “Made for iPhone” mean that an electronic accessory has been designed to connect specifically to an iPod, or iPhone, respectively, and has been certified by the developer to meet Apple performance standards.
- Apple is not responsible for the operation of this device or its compliance with safety and regulatory standards. Please note that the use of this accessory with iPod or iPhone may affect wireless performance.
- iPhone, iPod, iPod classic, iPod nano and iPod touch are trademarks of Apple Inc., registered in the U.S. and other countries.

■ **iPod cover art**

- Depending on the iPod and songs in the iPod, iPod cover art may be displayed.
- This function can be changed to on/off. (→P. 357)
- It may take time to display iPod cover art, and the iPod may not be operated while the cover art display is in process.

■ **iPod functions**

- When an iPod is connected and the audio source is changed to iPod mode, the iPod will resume play from the same point in which it was last used.
- Depending on the iPod that is connected to the system, certain functions may not be available. If a function is unavailable due to a malfunction (as opposed to a system specification), disconnecting the device and reconnecting it may resolve the problem.
- Depending on the iPod, while connected to the system, the iPod cannot be operated with its own controls. It is necessary to use the controls of the vehicle’s audio system instead.
- When the battery level of an iPod is very low, the iPod may not operate. If so, charge the iPod before use.
- Compatible models (→P. 376)

■ **iPod problems**

To resolve most problems encountered when using your iPod, disconnect your iPod from the vehicle iPod connection and reset it. For instructions on how to reset your iPod, refer to your iPod Owner’s Manual.

■ **Error messages**

If the following error messages appear on the screen, refer to the table and take the appropriate measures. If the problem is not rectified, take the vehicle to your Lexus dealer.

Message	Cause/Correction procedures
“Connection error.”	This indicates a problem in the iPod or its connection.
“There are no songs available for playback.”	This indicates that there is no music data in the iPod.
“No items available.”	This indicates that songs are not found in a selected playlist.
“Please check the iPod firmware version.”	This indicates that the software version is not compatible. Please check the compatible models. (→P. 376)
“iPod authorization failed.”	This indicates that the Lexus Display Audio system failed to authorize the iPod. Please check your iPod.

■ **Compatible models**

The following iPod[®], iPod nano[®], iPod classic[®], iPod touch[®] and iPhone[®] devices can be used with this system.

- Made for
 - iPod touch (5th generation)
 - iPod touch (4th generation)
 - iPod touch (3rd generation)
 - iPod touch (2nd generation)
 - iPod touch (1st generation)
 - iPod classic
 - iPod with video
 - iPod nano (7th generation)
 - iPod nano (6th generation)
 - iPod nano (5th generation)
 - iPod nano (4th generation)
 - iPod nano (3rd generation)
 - iPod nano (2nd generation)
 - iPod nano (1st generation)
 - iPhone 5
 - iPhone 4S
 - iPhone 4
 - iPhone 3GS
 - iPhone 3G
 - iPhone

Depending on differences between models or software versions, etc., some models might be incompatible with this system.

 **NOTICE**

■ **To prevent damage to the iPod or its terminals**

- Do not leave the iPod in the vehicle. The temperature inside the vehicle may become high.
- Do not push down on or apply unnecessary pressure to the iPod while it is connected.
- Do not insert foreign objects into the port.

Using USB memory device

Connecting a USB memory device enables you to enjoy music from the vehicle speakers.

Select "USB1" or "USB2" on the audio source selection screen.

Connecting a USB memory device

→P. 345

USB top screen

Pressing the "MEDIA" button displays the USB top screen from any screen of the selected source.

■ Menu screen

→P. 358

■ Selecting a file

Press the "<" or ">" on the "PRST•TRACK" button or turn the "TUNE•SCROLL" knob to select the desired file number.

To fast-forward or rewind, press and hold the "<" or ">" on the "PRST•TRACK" button.

■ Selecting a play mode

- 1 Move the controller to the right and select "Browse".
- 2 Select the desired play mode, then select a file to begin the selected play mode.

■ Displaying the now playing list

Move the controller to the right and select "Now Playing List".

■ **USB memory functions**

- Depending on the USB memory device that is connected to the system, the device itself may not be operable and certain functions may not be available. If the device is inoperable or a function is unavailable due to a malfunction (as opposed to a system specification), disconnecting the device and reconnecting it may resolve the problem.
- If the USB memory device still does not begin operation after being disconnected and reconnected, format the device.

■ **Error messages for USB memory**

If the following error messages appear on the screen, refer to the table and take the appropriate measures. If the problem is not rectified, take the vehicle to your Lexus dealer.

Message	Cause/Correction procedures
“Connection error.”	This indicates a problem with the USB memory device or its connection.
“There are no files available for playback.”	This indicates that no MP3/WMA/AAC files are included on the USB memory device.

■ **USB memory**

- **Compatible devices**
USB memory devices that can be used for MP3, WMA and AAC playback.
- **Compatible device formats**
The following device format can be used:
 - USB communication format: USB2.0 FS (480 Mbps)
 - File system format: FAT16/32 (Windows)
 - Correspondence class: Mass storage class
 MP3, WMA and AAC files written to a device with any format other than those listed above may not play correctly, and their file names and folder names may not be displayed correctly.
 Items related to standards and limitations are as follows:
 - Maximum directory hierarchy: 8 levels
 - Maximum number of folders in a device: 3000 (including the root)
 - Maximum number of files in a device: 9999
 - Maximum number of files per folder: 255

- MP3, WMA and AAC files

MP3 (MPEG Audio LAYER 3) is a standard audio compression format.

Files can be compressed to approximately 1/10 of their original size using MP3 compression.

WMA (Windows Media Audio) is a Microsoft audio compression format. This format compresses audio data to a size smaller than that of the MP3 format.

AAC is short for Advanced Audio Coding and refers to an audio compression technology standard used with MPEG2 and MPEG4.

MP3, WMA and AAC file and media/formats compatibility are limited.

- MP3 file compatibility

- Compatible standards
MP3 (MPEG1 AUDIO LAYERIII, MPEG2 AUDIO LAYERIII)
- Compatible sampling frequencies
MPEG1 AUDIO LAYERIII: 32, 44.1, 48 (kHz)
MPEG2 AUDIO LAYERIII: 16, 22.05, 24 (kHz)
- Compatible bit rates (compatible with VBR)
MPEG1 AUDIO LAYERIII: 32-320 (kbps)
MPEG2 AUDIO LAYERIII: 8-160 (kbps)
- Compatible channel modes: stereo, joint stereo, dual channel and monaural

- WMA file compatibility

- Compatible standards
WMA Ver. 7, 8, 9 (only compatible with Window Media Audio Standard)
- Compatible sampling frequencies
32, 44.1, 48 (kHz)
- Compatible bit rates (only compatible with 2-channel playback)
Ver. 7, 8: CBR 48-192 (kbps)
Ver. 9: CBR 48-320 (kbps)

- AAC file compatibility

- Compatible standards
MPEG4/AAC-LC
- Compatible sampling frequencies
11.025/12/16/22.05/24/32/44.1/48 (kHz)
- Compatible bit rates
16-320 (kbps)
- Compatible channel modes: 1 ch and 2 ch

- File names

The only files that can be recognized as MP3/WMA/AAC and played are those with the extension .mp3, .wma or .m4a.

- ID3, WMA and AAC tags

ID3 tags can be added to MP3 files, making it possible to record the track title, artist name, etc.

The system is compatible with ID3 Ver. 1.0, 1.1, and Ver. 2.2, 2.3 ID3 tags. (The number of characters is based on ID3 Ver. 1.0 and 1.1.)

WMA tags can be added to WMA files, making it possible to record the track title and artist name in the same way as with ID3 tags.

AAC tags can be added to AAC files, making it possible to record the track title and artist name in the same way as with ID3 tags.

- MP3, WMA and AAC playback
 - When a device containing MP3, WMA or AAC files is connected, all files in the USB memory device are checked. Once the file check is finished, the first MP3, WMA or AAC file is played. To make the file check finish more quickly, we recommend that you do not include any files other than MP3, WMA or AAC files or create any unnecessary folders.
 - When a USB memory device is connected and the audio source is changed to USB memory mode, the USB memory device will start playing the first file in the first folder. If the same device is removed and reconnected (and the contents have not been changed), the USB memory device will resume play from the same point in which it was last used.
- Extensions

If the file extensions .mp3, .wma and .m4a are used for files other than MP3, WMA and AAC files, they will be skipped (not played).
- Playback
 - To play MP3 files with steady sound quality, we recommend a fixed bit rate of at least 128 kbps and a sampling frequency of 44.1 kHz.
 - There is a wide variety of freeware and other encoding software for MP3, WMA and AAC files on the market, and depending on the status of the encoding and the file format, poor sound quality or noise at the start of playback may result. In some cases, playback may not be possible at all.
 - Microsoft, Windows, and Windows Media are the registered trademarks of Microsoft Corporation in the U.S.A. and other countries.



NOTICE

■ **To prevent damage to the USB memory device or its terminals**

- Do not leave the USB memory device in the vehicle. The temperature inside the vehicle may become high.
- Do not push down on or apply unnecessary pressure to the USB memory device while it is connected.
- Do not insert foreign objects into the port.

Using the AUX port

To use the AUX port, connect a portable player, press the “MEDIA” button or select “AUX” or “A/V” on the “Source” screen.

Connecting a portable player

→P. 345

Top screen

Pressing the “MEDIA” button displays the top screen from any screen of the selected source.

■ Menu screen

→P. 358

■ Operating portable players connected to the audio system

Volume can be adjusted using the vehicle’s audio controls. All other adjustments must be made on the portable player itself.

■ When using a portable player connected to the power outlet

Noise may occur during playback. Use the power source of the portable player.



NOTICE

■ To prevent damage to the portable player or its terminal

- Do not leave portable player in the vehicle. The temperature inside the vehicle may become high.
- Do not push down on or apply unnecessary pressure to the portable player while it is connected.
- Do not insert foreign objects into the port.

Steps for using Bluetooth® devices

The following can be performed using Bluetooth® wireless communication:

- A portable audio player can be operated and listened to via the Lexus Display Audio system
- Hands-free phone calls can be made via a cellular phone

In order to use wireless communication, register and connect a Bluetooth® device by performing the following procedures.

Device registration/connection flow

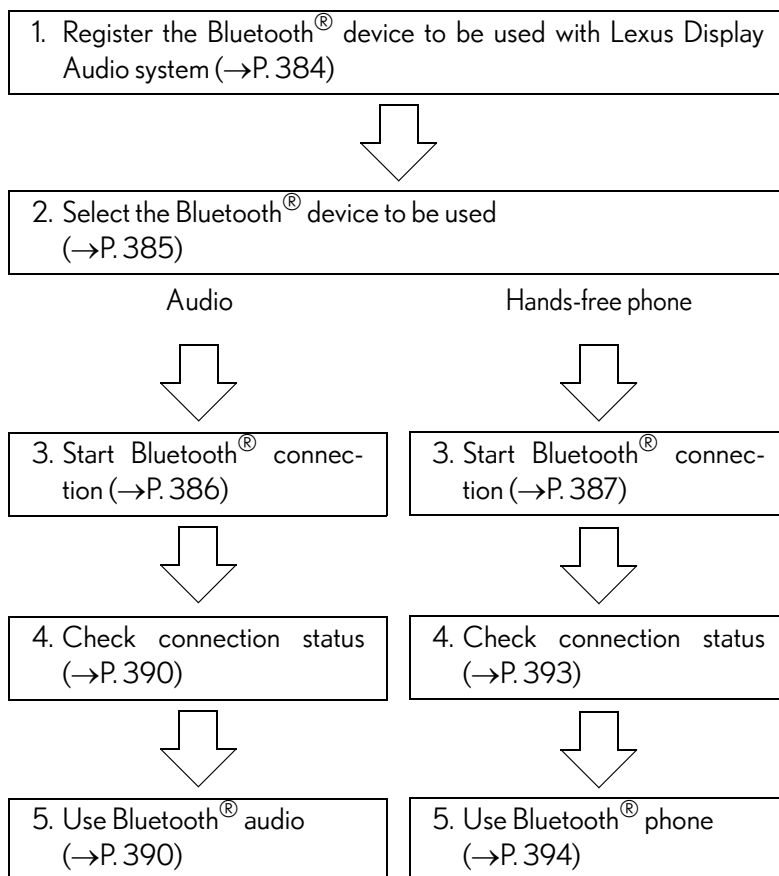

“Bluetooth* Setup” screen

Go to “Bluetooth* Setup”: “MENU” button → “Setup” → “Bluetooth*”

*: Bluetooth is a registered trademark of Bluetooth SIG, Inc.

■ When displaying “Bluetooth* Setup” screen from the “Bluetooth* Audio” screen

- 1 Display the “Bluetooth* Audio” screen. (→P. 390)
- 2 Move the controller to the left and select “Connect”.

■ When displaying “Bluetooth* Setup” screen from the phone top screen

- 1 Display the phone top screen. (→P. 392)
- 2 Move the controller to the left and select “Connect Phone”.

*: Bluetooth is a registered trademark of Bluetooth SIG, Inc.

Registering a Bluetooth® device

Bluetooth® compatible phones (HFP) and portable audio players (AVP) can be registered simultaneously. You can register up to 5 Bluetooth® devices.

How to register a Bluetooth® device

- 1 Turn the Bluetooth® connection setting of your device set to on.
- 2 Go to "Bluetooth* Setup": "MENU" button → "Setup" → "Bluetooth*"
- 3 Move the controller to the left and then select "Add Device"

- 4 When this screen is displayed, input the passcode displayed on the screen into your Bluetooth® device.

For operation of the Bluetooth® device, see the manual that comes with your Bluetooth® device.

- 5 Register the Bluetooth® device using your Bluetooth® device.

A PIN code are not required for SSP (Secure Simple Pairing) compatible Bluetooth® devices. Depending on the device, you may need to select Yes to register, or No to cancel on the device.

If an error message is displayed, follow the guidance on the screen to try again.

*: Bluetooth is a registered trademark of Bluetooth SIG, Inc.

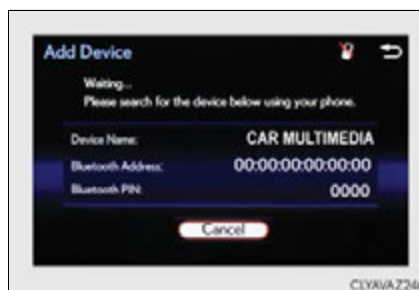

Removing a Bluetooth® device

- 1 Go to "Bluetooth* Setup": "MENU" button → "Setup" → "Bluetooth*"
- 2 Move the controller to the left and then select "Remove Device".
- 3 Select the device to remove.

*: Bluetooth is a registered trademark of Bluetooth SIG, Inc.

Selecting a Bluetooth® device

If multiple Bluetooth® devices are registered, follow the procedure below to select the Bluetooth® device to be used. You may only use one device at a time.

How to select a Bluetooth® device

- 1 Go to "Bluetooth* Setup": "MENU" button → "Setup" → "Bluetooth*"
- 2 Select the device to connect.
- 3 Select "Connect All", "Connect as a Phone" or "Connect as an Audio Player".
"Connect All" means connect both the telephone and audio functions of one device.

If the desired Bluetooth® device is not displayed, register the device.
(→P. 384)

*: Bluetooth is a registered trademark of Bluetooth SIG, Inc.

Connecting a Bluetooth® audio player

There are 2 portable audio player connection settings available: connecting from the vehicle and connecting from the portable player.

Connecting method is set to “Vehicle”

When the portable audio player is in standby for a connection, it will be automatically connected whenever the power switch is in either ACCESSORY or ON mode.

Connecting method is set to “Device”

Operate the portable player and connect it to the Bluetooth® audio system.

- 1 Go to “Bluetooth* Setup”: “MENU” button → “Setup” → “Bluetooth*”
- 2 Select the device to connect.
- 3 Select “Connect All” or “Connect as an Audio player”.

If the desired Bluetooth® device is not displayed, register the device.
(→P. 384)

*: Bluetooth is a registered trademark of Bluetooth SIG, Inc.

Connecting a Bluetooth® phone

There are two connecting methods available: automatic and manual.

Auto connection

When you register a phone, auto connection will be activated. It is recommended to have the system set to this mode and leave the Bluetooth® phone in a place where a good connection can be established.

When the power switch is turned to ACCESSORY or ON mode, the system will search for a nearby cellular phone you have registered.

Next, the system automatically connects with the most recent phone that was connected. The connected result is displayed.

Manual connection

When auto connection has failed or "Bluetooth* Power" is turned off, you must connect the Bluetooth® device manually.

- 1 Go to "Bluetooth* Setup": "MENU" button → "Setup" → "Bluetooth*"
- 2 Select the device to connect.
- 3 Select "Connect All", "Connect as a Phone" or "Connect as an Audio player".

If the desired Bluetooth® device is not displayed, register the device. (→P. 384)

*: Bluetooth is a registered trademark of Bluetooth SIG, Inc.

■ Reconnecting a Bluetooth® phone

If the system cannot connect due to poor signal strength with the power switch in ACCESSORY or ON mode, the system will automatically attempt to reconnect.

If the phone is turned off, the system will not attempt to reconnect. In this case, the connection must be made manually, or the phone must be reselected.

■ Connecting a phone while Bluetooth® audio is playing

- Bluetooth® audio will stop temporarily.
- It may take time to connect.

Displaying a Bluetooth® device details

You can confirm and change the registered device details.

Bluetooth® device registration status

- 1 Go to "Bluetooth* Setup": "MENU" button → "Setup" → "Bluetooth*"
- 2 Select the desired device and then select "Device Info".

- 1 Change the name of the device
- 2 Change the connection method
 "Vehicle": Connect the audio system to the portable audio player.
 "Device": Connect the portable audio player to the audio system

- 3 Device address
- 4 Device telephone number

Depending on the model of phone, the number may not be displayed.

- 5 Compatibility profile of the device

*: Bluetooth is a registered trademark of Bluetooth SIG, Inc.

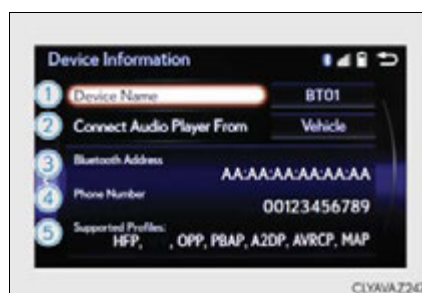

Restoring the default settings

Move the controller to the left and select "Default" on the "Device Information" screen.

Detailed Bluetooth® settings

You can confirm and change the detailed Bluetooth® settings.

How to check and change detailed Bluetooth® settings

- 1 Go to “Bluetooth* Setup”: “MENU” button → “Setup” → “Bluetooth*”
- 2 Move the controller to the left and then select “System Settings”.

① Select to set the Bluetooth® function on/off.

② Change the name of the device.

③ Change the PIN-code.

You can change the PIN-code that is used to register your Bluetooth® devices in the system.

④ Device address

⑤ Select to set the display of the telephone status on/off

You can set the system to show the status confirmation display when connecting a telephone.

⑥ Select to set the display of the audio player status on/off

You can set the system to show the status confirmation display when connecting an audio player.

⑦ Compatibility profile of the system

*: Bluetooth is a registered trademark of Bluetooth SIG, Inc.

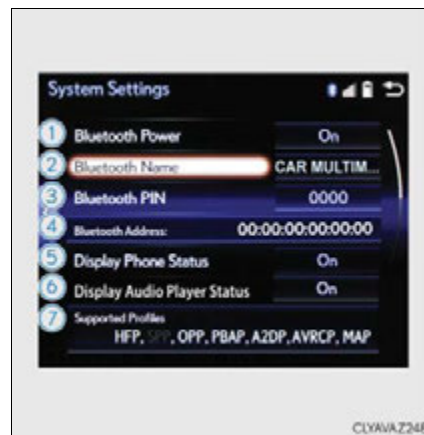

5

Lexus Display Audio system

Restoring the default settings

Move the controller to the left and select “Default” on the “System Settings” screen.

Listening to Bluetooth® Audio

The Bluetooth® audio system enables the user to enjoy music played on a portable player from the vehicle speakers via wireless communication.

When a Bluetooth® device cannot be connected, check the connection status on the “Bluetooth* Audio” screen. If the device is not connected, either register or reconnect the device. (→P. 384, 386)

*: Bluetooth is a registered trademark of Bluetooth SIG, Inc.





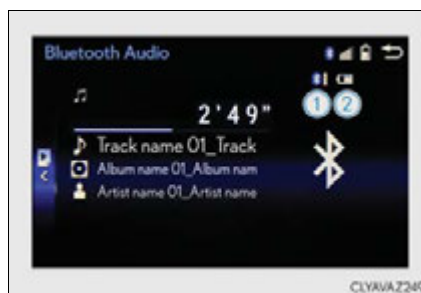

Status display

You can check indicators, such as signal strength and battery charge on the screen.

- ① Connection status
- ② Battery charge

Depending on the type of portable audio player used, some titles may not be displayed.



Indicators	Conditions
Connection status	Good ←————→ Not connected   
Battery charge	Full ←————→ Empty   

Bluetooth® audio top screen

Pressing the "MEDIA" button displays the Bluetooth® audio top screen from any screen of the selected source.

■ Menu screen

→P. 358

■ Selecting a song

Press the "<" or ">" on the "PRST•TRACK" button or turn the "TUNE•SCROLL" knob to select the desired song number.

To fast-forward or reverse, press and hold the "<" or ">" on the "PRST•TRACK" button.

■ Selecting a play mode

- 1** Move the controller to the right and then select "Browse".
- 2** Select the desired play mode, and then select a song to begin using the selected play mode.

■ Displaying the now playing list

Move the controller to the right and then select "Now Playing List".

Using a Bluetooth® Phone

The hands-free system is a function that allows you to use your cellular phone without touching it.

This system supports Bluetooth®. Bluetooth® is a wireless data system that allows the cellular phone to wirelessly connect to the hands-free system and make/receive calls.

Before making a phone call, check the connection status, battery charge, call area and signal strength. (→P. 393)

If a Bluetooth® device cannot be connected, check the connection status. If the device is not connected, either register or reconnect it. (→P. 384, 387)

Phone top screen

To display the screen shown below, press the off-hook switch on the steering wheel or select "Phone" on the "Menu" screen.

- ① Phone name
- ② Bluetooth® connection status (→P. 393)
- ③ Displays the call history screen (→P. 396)
- ④ Displays the favorites screen (→P. 396)
- ⑤ Displays the contacts screen (→P. 394)
- ⑥ Displays the dial pad screen (→P. 394)
- ⑦ Displays the message inbox screen (→P. 400)



◆ Telephone switch (→P. 402)

◆ Microphone

The vehicle's built-in microphone is used when talking on the phone.

The person to whom you are speaking to can be heard from the front speakers.

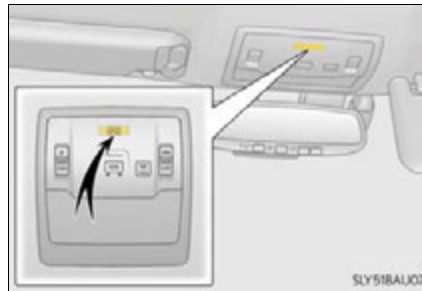

To use the hands-free system, you must register your Bluetooth® phone in the system. (→P. 384)

Status display

You can check indicators such as signal strength and battery charge on any screen.

- ① Connection status
- ② Signal strength
- ③ Battery charge

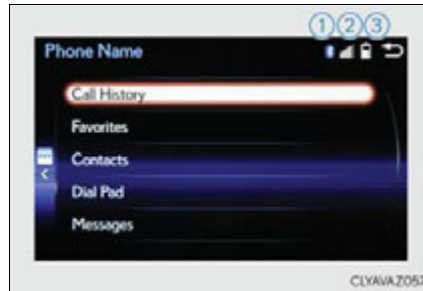

Indicators	Conditions		
	Good	Poor	Not connected
Connection status			
Battery charge			
Signal strength			

Making a call

Once a Bluetooth® phone is registered, you can make a call using the following procedure:

Dialing

- 1 Go to "Dial Pad": "MENU" button → "Phone" → "Dial Pad"
- 2 Input a phone number. (→P. 340)
- 3 Press the off-hook switch on the steering wheel or select .

Dialing from the phonebook

You can dial a number from the phonebook data imported from your cellular phone. The system has one phonebook for each registered telephone. Up to 2500 contacts may be stored in each phonebook. (→P. 395)

- 1 Go to "Contacts": "MENU" button → "Phone" → "Contacts"
- 2 Choose the desired contact to call from the list.
- 3 Choose the number and then press the off-hook switch on the steering wheel or press the controller.

When the phonebook is empty

You can transfer the phone numbers in a Bluetooth® phone to the system. Operation methods differ between PBAP (Phone Book Access Profile) compatible and PBAP incompatible Bluetooth® phones. If the cellular phone does not support either PBAP or OPP (Object Push Profile) service, you cannot transfer contacts.

- 1** Press the off-hook switch on the steering wheel.

If the phonebook is empty, a message will be displayed.

- ▶ For a PBAP compatible Bluetooth® phone and “Automatic Transfer” is off

- 2** To transfer new contacts from a cellular phone, select “Always” and then enable “Automatic Transfer”. (→P. 405)
Select “Once” if you want to transfer new contacts from a cellular phone.

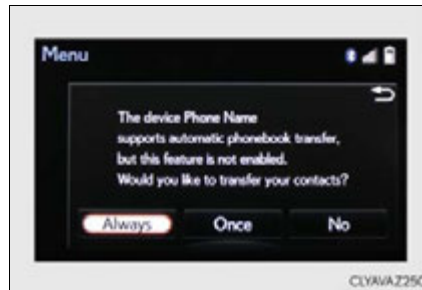

- ▶ For a PBAP incompatible and OPP compatible Bluetooth® phone

- 2** Select “Transfer” and operate your cellular phone to transfer new contacts from a cellular phone.
Select “Add” if you want to add a new contact manually.

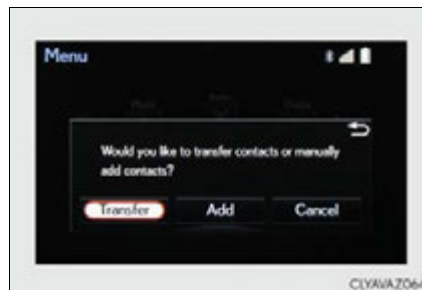

5

Lexus Display Audio system

Dialing from favorites

You can make a call using numbers registered in the favorites.

- 1 Go to "Favorites": "MENU" button → "Phone" → "Favorites"
- 2 Choose the desired contact to call from the list.
- 3 Choose the number and then press the off-hook switch on the steering wheel or press the controller.

Dialing from history

You can make a call using the call history.

- 1 Go to "Call History": "MENU" button → "Phone" → "Call History"
- 2 Select the desired entry from the list.
- 3 Press the off-hook switch on the steering wheel or select .

■ Call history list

- If you make a call to or receive a call from a number registered in the phonebook, the name is displayed in the call history.
- If you make multiple calls to the same number, only the last call made is displayed in the call history.

■ International calls

Depending on the mobile phone in use, you may not be able to make international calls.

■ Calling by using the latest call history entry

- 1 Press the off-hook switch on the steering wheel to display the phone top screen.
- 2 Press the switch again switch on the steering wheel to display the "Call History" screen.
- 3 Press the switch again switch on the steering wheel to select the latest call history entry.

Receiving a call

When a call is received, the following screen is displayed together with a sound.

To answer the phone

Press the off-hook switch on the steering wheel or select .

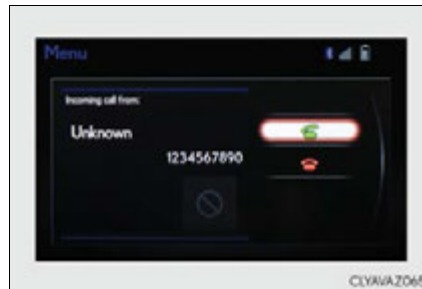

To refuse a call

Press the on-hook switch on the steering wheel or select .

■ International calls

Depending on the cellular phone in use, received international calls may not be displayed correctly.

Speaking on the phone

The following screen is displayed when speaking on the phone.

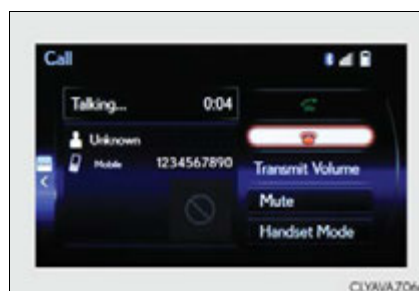

To adjust the transmit volume

Select "Transmit Volume". To restore default volume, move the controller to the left on the "Transmit Volume" screen and then select "Default".

To adjust in call volume

Move the controller to the left and then select "In-call Volume". You can also adjust the volume using the "PWR•VOL" knob or the steering switches.

To prevent the other party from hearing your voice

Select "Mute".

Inputting tones

When using phone services such as an answering service or a bank, you can store phone numbers and code numbers in the contacts using "p" or "w" symbols (eg. 056133 w 0123p#1).

- ▶ Contact including a phone number only

- 1 Move the controller to the left and then select "0-9".
- 2 Input the number.

- ▶ Phone number containing a "p" symbol

When the "p" symbol is dialed in an outgoing call, there will be a pause for 2 seconds before the following digits are dialed automatically.

- ▶ Phone number containing a “w” symbol

When the “w” symbol is dialed in an outgoing call, you need to go to the “Release Tones” screen to dial the following digits. Move the controller to the left and then select “Release Tones”.

To transfer a call

Select “Handset Mode” to change from a hands-free call to a cellular phone call or vice versa.

To hang up

Press the on-hook switch on the steering wheel or select .

Call waiting

When a call is interrupted by a third party while talking, an incoming call message will be displayed.

To talk with the other party:

Press the off-hook switch on the steering wheel or select .

To refuse the call:

Press the on-hook switch on the steering wheel or select .

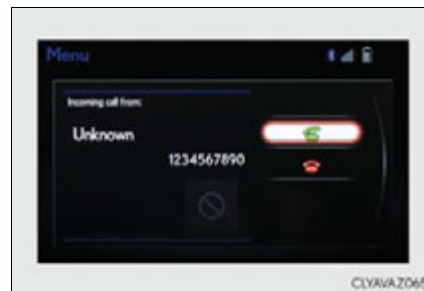

Every time you press the off-hook switch on the steering wheel or select  during call waiting, you will be switched to the other party.

■ Transferring calls

- It is not possible to transfer from hands-free to the cellular phone while driving.
- If you transfer from the cellular phone to hands-free, the hands-free screen will be displayed, and you can operate the system using the screen.
- Transfer method and operation may vary according to the cellular phone used.
- For operation of the cellular phone in use, see the phone’s manual.

■ Call waiting operation

Call waiting operation may differ depending on your phone company and cellular phone.

Using a Bluetooth® phone message

Once a MAP-profile compatible Bluetooth phone is registered, you can check the E-mail/SMS/MMS and reply to a message using the following procedures:

Checking messages

- 1 Go to message screen: "MENU" button → "Phone" → "Messages"
- 2 Select a message.

Moving the controller to the left while on the message list screen displays the setting screen. (→P. 408)

Move the controller to the right while on the message screen and then select an account to display a message list for the selected account.

Message screen

Selecting "Next" or "Previous" displays the next or previous message.
If a message is too long, select "Read More" to display the full text.

■ Option menu

Move the controller to the left while on the message screen.

- 1 Select a prepared message and send a reply message.
- 2 Call a sender.

If more than one phone number is registered for a sender, a phone number selection screen will be displayed.

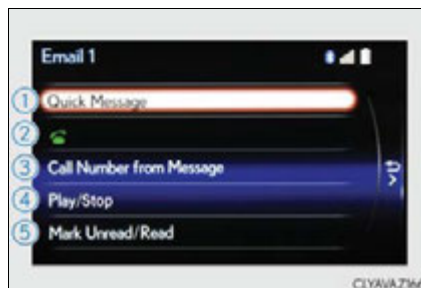

- 3 Call a phone number written in a message.
- 4 Select "Play" to have a message read out loud. Select "Stop" to stop this function.
- 5 Select "Mark Unread" to mark mail that has been read as unread. Select "Mark Read" to mark mail that has not been read as read.

Replying to a message

- 1 Move the controller to the left while on the message screen.
- 2 Select "Quick Message" to display the "Quick Message" screen.
- 3 Select the desired message and then select "Send".

■ **Editing a quick message**

- 1 Move the controller to the left while on the message screen.
- 2 Select "Quick Message" and move the cursor to the desired message.
- 3 Move the controller to the left and select "Edit".

To return to the default message after editing, select "Default".

Receiving a message popup function

This function is available when the "E-mail Notification Popup" or "SMS/MMS Notification Popup" are set to on. (→P. 408)

- ▶ "Incoming E-mail Display" or "Incoming SMS/MMS Display" are set to "Drop-Down"

When E-mail/ SMS/MMS are received, the incoming message is displayed on the upper side of the screen with a sound.

- ▶ "Incoming E-mail Display" or "Incoming SMS/MMS Display" are set to "Full Screen"

When E-mail/ SMS/MMS are received, the incoming message screen is displayed with a sound and it can be operated on the screen.

- 1 Check the message.
- 2 Refuse to check the message.
- 3 Call to receive the message sender's phone number.

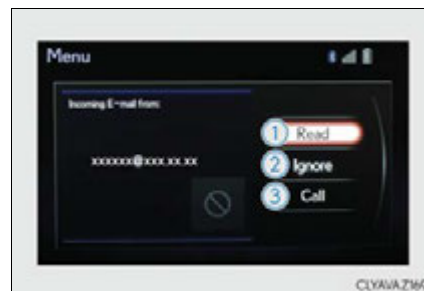

Using the steering wheel switches

The steering wheel switches can be used to operate a connected cellular phone.

Operating a telephone using the steering wheel switches

① Volume switch

During an incoming call: Adjusts the ring tone volume

During speaking on the phone: Adjusts in call volume

The voice guidance volume cannot be adjusted using this button.

② Off-hook switch

- Start call
- Receiving
- Phone top screen display

③ On-hook switch

- End call
- Refuse call

④ Talk switch

Press: Turns the voice command system on

Press and hold: Turns the voice command system off

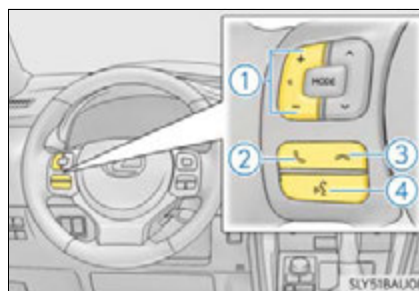

Bluetooth® phone settings

You can adjust the hands-free system to your desired settings.

“Phone/Message Settings” screen

Go to “Phone/Message Settings”: “MENU” button → “Setup” → “Phone”

- ① Register and connect a Bluetooth® device. (→P. 384)
- ② Adjust the call volume and message readout volume. (→P. 403)
- ③ Change the contact/call history settings. (→P. 405)
- ④ Change messaging settings. (→P. 408)
- ⑤ Change phone display settings. (→P. 404)

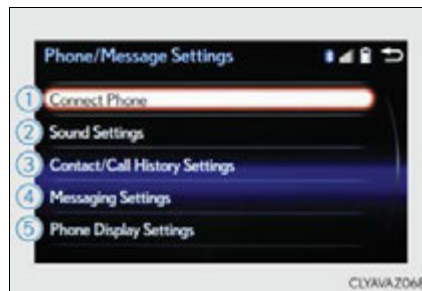

Sound settings

Go to “Sound Settings”: “MENU” button → “Setup” → “Phone” → “Sound Settings”

- ① Change the ring tone type
- ② Adjust the ring tone volume
- ③ Adjust the message readout volume
- ④ Change the incoming SMS/MMS tone type
- ⑤ Adjust the incoming SMS/MMS tone volume
- ⑥ Change the incoming e-mail tone type
- ⑦ Adjust the incoming e-mail tone volume
- ⑧ Adjust in call tone volume



Phone display settings

Go to “Phone Display Settings”: “MENU” button → “Setup” → “Phone” → “Phone Display Settings”

- ① Change the incoming call display
- ② Set the phonebook/history transfer status notification display on/off

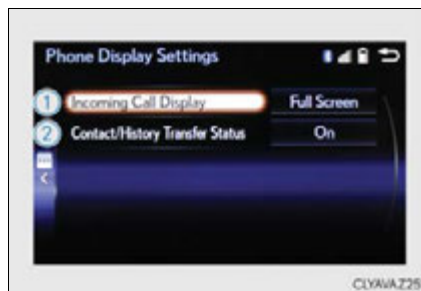

■ **To return to the default volume settings**

Move the controller to the left and then select “Default”.

Contact settings

Individual phonebooks from up to 5 phones can be registered to the system. The data for 2500 contacts (up to 4 numbers per contact) can be registered into the system's phonebook.

"Contact/Call History Settings" screen

Go to "Contact/Call History Settings": "MENU" button → "Setup" → "Phone" → "Contact/Call History Settings"

- ① Select to set the automatic phonebook download on/off
With this setting on, phonebook data will be automatically transferred.
Depending on the cellular phone, call history will be also transferred.
- ② Update contacts
- ③ Change the sort contacts mode
- ④ Add a favorite (→P. 406)
- ⑤ Delete a favorite (→P. 407)
- ⑥ Select to set the display of contact images on/off
- ⑦ Delete call history. (PBAP incompatible Bluetooth[®] phones, or compatible phones with "Automatic Transfer" off)
- ⑧ Add a new contact (PBAP incompatible Bluetooth[®] phones, or compatible phones with "Automatic Transfer" off)
Input the name, phone number and phone number type to add a new contact.
- ⑨ Edit a contact (PBAP incompatible Bluetooth[®] phones, or compatible phones with "Automatic Transfer" off)
Select the desired contact to edit.
- ⑩ Delete contacts (→P. 407) (PBAP incompatible Bluetooth[®] phones, or compatible phones with "Automatic Transfer" off)



■ Return to the default settings

Move the controller to the left and select "Default".

Transferring a phone number

You can transfer the phone numbers in your Bluetooth[®] phone to the system. Operation methods differ between PBAP compatible and PBAP incompatible Bluetooth[®] phones. If your cellular phone does not support either PBAP or OPP services, you cannot transfer contacts.

Go to "Transfer Contacts": "MENU" button → "Setup" → "Phone" → "Contact/Call History Settings" → "Update Contacts from Phone"

- ▶ For PBAP compatible Bluetooth[®] phones when "Automatic Transfer" is set to on

Start the update automatically.

- ▶ For PBAP compatible Bluetooth[®] phones when "Automatic Transfer" is set to off and PBAP incompatible Bluetooth[®] phones

- ① Select to transfer the contact from the connected cellular phone and replace the current one.
- ② Select to transfer the desired contact data from the connected cellular phone to add to the current one.

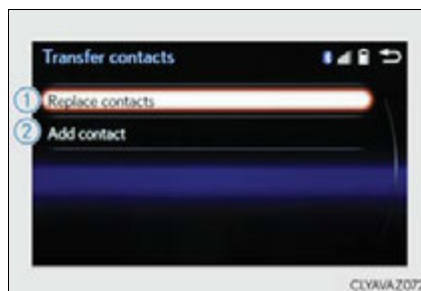

Registering favorites

You can register the desired contact from the phonebook. Up to 15 contacts per phone can be registered.

- ① Go to "Add Favorite": "MENU" button → "Setup" → "Phone" → "Contact/Call History Settings" → "Add Favorite"
- ② Choose the contact to register.

Removing favorites

- 1 Go to "Remove Favorite": "MENU" button → "Setup" → "Phone" → "Contact/Call History Settings" → "Remove Favorite"
- 2 Select the desired contacts.
You can select all contacts by selecting "Select All".
- 3 Move the controller to the left and select "Remove".

Deleting the contacts data

- 1 Go to "Delete Contacts": "MENU" button → "Setup" → "Phone" → "Contact/Call History Settings" → "Delete Contacts"
- 2 Select the desired contacts.
You can select all contacts by selecting "Select All".
- 3 Move the controller to the left and select "Delete".

■ Phonebook data

Phonebook data is managed separately for every registered phone. When one phone is connected, you cannot read the registered data of the other phones.

■ When transferring contacts

Transfer contacts while the hybrid system is operating.

If the cellular phone is OPP or PBAP compatible, you may need to input "1234" on the cellular phone for OBEX certification.

■ When you have selected "Replace contacts" or "Add contact" to transfer contacts

If the cellular phone does not support OPP service, you cannot use these functions. You can transfer the phonebook data only by operating your phone.

■ Transferring contacts while Bluetooth[®] audio is playing

Bluetooth[®] audio will disconnect. It will reconnect automatically when data transfer finishes. It may not reconnect depending on the phone which is connected.

Messaging setting

Go to "Messaging Settings": "MENU" button → "Setup" → "Phone" → "Messaging Settings"

- ① Set the message forwarding from cellular phones on/off
- ② Set the automatic message read out function on/off
- ③ Set the new SMS/MMS notification display on/off
- ④ Set the new e-mail notification display on/off
- ⑤ Set the signature function on/off
- ⑥ Set the cellular phone's message read and unread status update function on/off.
- ⑦ Change the incoming SMS/MMS display.
- ⑧ Change the incoming e-mail display.
- ⑨ Change the account name to "Service name" (names from the connected device) or "Fixed name" (pre-defined names).



■ Restoring the default settings

Move the controller to the left then select "Default" on the "Messaging Settings" screen.

What to do if... (Troubleshooting)

If there is a problem with the hands-free system or a Bluetooth® device, first check the table below.

- ▶ When using the hands-free system with a Bluetooth® device

The hands-free system or Bluetooth® device does not work.
The connected device may not be a compatible Bluetooth® cellular phone. → For a list of specific devices which operation has been confirmed on this system, check with your Lexus dealer or the following website: http://www.lexus.com/MobileLink
The Bluetooth® version of the connected cellular phone may be older than the specified version. → Use a cellular phone with Bluetooth® version 2.0 or higher (recommended: Ver. 3.0 with EDR or higher). (→P. 415)

▶ When registering/connecting a cellular phone

A cellular phone cannot be registered.
An incorrect passcode was entered on the cellular phone. → Enter the correct passcode on the cellular phone.
The registration operation has not been completed on the cellular phone side. → Complete the registration operation on the cellular phone (approve registration on the phone).
Old registration information remains on either this system or the cellular phone. → Delete the existing registration information from both this system and the cellular phone, then register the cellular phone you wish to connect to this system. (→P. 384)
A Bluetooth® connection cannot be made.
Another Bluetooth® device is already connected. → Manually connect the cellular phone you wish to use to this system. (→P. 387)
Bluetooth® function is not enabled on the cellular phone. → Enable the Bluetooth® function on the cellular phone.

▶ When making/receiving a call

A call cannot be made/received.
Your vehicle is in a "No Service" area. → Move to where "No Service" no longer appears on the display.

▶ When using the phonebook

Phonebook data cannot be transferred manually/automatically.
The profile version of the connected cellular phone may not be compatible with transferring phonebook data. → For a list of specific devices which operation has been confirmed on this system, check with your Lexus dealer or the following website: http://www.lexus.com/MobileLink
Automatic phonebook transfer function on this system is set to off. → Set automatic phonebook transfer function on this system to on. (→P. 405)
Passcode has not been entered on the cellular phone. → Enter the passcode on the cellular phone if requested (default passcode: 1234).
Transfer operation on the cellular phone has not completed. → Complete transfer operation on the cellular phone (approve transfer operation on the phone).
Phonebook data cannot be edited.
Automatic phonebook transfer function on this system is set to on. → Set automatic phonebook transfer function on this system to off. (→P. 405)

▶ When using the Bluetooth® message function

Messages cannot be viewed.
Message transfer is not enabled on the cellular phone. → Enable message transfer on the cellular phone (approve message transfer on the phone).
Automatic transfer function on this system is set to off. → Set automatic transfer function on this system to on. (→P. 405)
New message notifications are not displayed.
Notification of SMS/MMS/E-mail reception on this system is set to off. → Set notification of SMS/MMS/E-mail reception on this system to on. (→P. 408)
Automatic message transfer function is not enabled on the cellular phone. → Enable automatic transfer function on the cellular phone.

► In other situations

Even though all conceivable measures have been taken, the symptom status does not change.

The cellular phone is not close enough to this system.
→ **Bring the cellular phone closer to this system.**

The cellular phone is the most likely cause of the symptom.
→ **Turn the cellular phone off, remove and reinstall the battery pack, and then restart the cellular phone.**
→ **Enable the cellular phone's Bluetooth® connection.**
→ **Stop the cellular phone's security software and close all applications.**
→ **Before using an application installed on the cellular phone, carefully check its source and how its operation might affect this system.**

Bluetooth®

■ When using the Bluetooth® audio system

- In the following situations, the system may not function.
 - If the portable audio player is turned off
 - If the portable audio player is not connected
 - If the portable audio player's battery is low
- There may be a delay if a cellular phone connection is made during Bluetooth® audio play.
- Depending on the type of portable audio player that is connected to the system, operation may differ slightly and certain functions may not be available.

■ When using the hands-free system

- The audio system is muted when making a call.
- If both parties speak at the same time, it may be difficult to hear.
- If the received call volume is overly loud, an echo may be heard.
If the Bluetooth® phone is too close to the system, quality of the sound may deteriorate and connection status may deteriorate.
- In the following situations, it may be difficult to hear the other party:
 - When driving on unpaved roads
 - When driving at high speeds
 - If a window is open
 - If the air conditioning is blowing directly on the microphone
 - If there is interference from the network of the cellular phone
- Depending on the type phone, certain functions may not be available.

■ Conditions under which the system will not operate

- If using a cellular phone that does not support Bluetooth®
- If the cellular phone is turned off
- If you are outside of cellular phone service coverage
- If the cellular phone is not connected
- If the cellular phone's battery is low
- When outgoing calls are controlled, due to heavy traffic on telephone lines, etc.
- When the cellular phone itself cannot be used
- When transferring phonebook data from the cellular phone

■ **Bluetooth® antenna**

The antenna is built into the display.

If the portable audio player is behind the seat or in the glove box or console box, or is touching or covered by metal objects, the connection status may deteriorate.

If the cellular phone is behind the seat or in the console box, or touching or covered by metal objects, the connection status may deteriorate.

■ **Battery charge/signal status**

● This display may not correspond exactly with the portable audio player or cellular phone itself.

● This system does not have a charging function.

● The portable audio player or cellular phone battery will be depleted quickly when the device is connected to Bluetooth®.

■ **When using the Bluetooth® audio and hands-free system at the same time**

The following problems may occur.

● The Bluetooth® audio connection may be interrupted.

● Noise may be heard during Bluetooth® audio playback.

■ **About the contact in this system**

The following data is stored for every registered cellular phone. When another phone is connecting, you cannot read the registered data.

● Contact data

● Call history

● Favorite

● Message

When removing a Bluetooth® phone from the system, the above-mentioned data is also deleted.

■ **About Bluetooth®**

The Bluetooth® word mark and logos are registered trademarks owned by Bluetooth SIG, Inc. and any use of such marks by PIONEER Corporation is under license. Other trademarks and trade names are those of their respective owners.



■ Compatible models

The Bluetooth® audio system supports portable audio players with the following specifications

- Bluetooth® specifications:
Ver. 2.0 or higher (Recommended: Ver. 3.0 +EDR or higher)
- Profiles:
 - A2DP (Advanced Audio Distribution Profile) Ver. 1.0, or higher
(Recommended: Ver. 1.2 or higher)
This is a profile to transmit stereo audio or high quality sound to the audio system.
 - AVRCP (Audio/Video Remote Control Profile) Ver. 1.0 or higher
(Recommended: Ver. 1.4 or higher)
This is a profile to allow remote control the A/V equipment.

However, please note that some functions may be limited depending on the type of portable audio player connected.

The hands-free system supports cellular phones with the following specifications.

- Bluetooth® specification:
Ver. 2.0 or higher (Recommended: Ver. 3.0 +EDR or higher)
- Profiles:
 - HFP (Hands Free Profile) Ver. 1.0 or higher (Recommended: Ver. 1.6 or higher)
This is a profile to allow hands-free phone calls using a cellular phone or head set. It has outgoing and incoming call functions.
 - OPP (Object Push Profile) Ver. 1.1 or higher (Recommended: Ver. 1.2)
This is a profile to transfer phonebook data. When a Bluetooth® compatible cellular phone has both PBAP and OPP, OPP cannot be used.
 - PBAP (Phone Book Access Profile) Ver. 1.0 or higher (Recommended: Ver. 1.1)
This is a profile to transfer phonebook data.
 - MAP (Message Access Profile) Ver.1.0 or higher
This is a profile to using phone message.

If the cellular phone does not support HFP, you cannot register it with the hands-free system. OPP, PBAP or MAP services must be selected individually.

■ Reconnecting the portable audio player

If the portable audio player is disconnected due to poor reception when the power switch is in ACCESSORY or ON mode, the system automatically reconnects the portable audio player.

If you have switched off the portable audio player yourself, follow the instructions below to reconnect:

- Select the portable audio player again
- Enter the portable audio player

■ When you sell your car

Be sure to delete your personal data. (→P. 350)

■ Certification

FCC ID:AJDK066

IC:775E-K066

NOTE:

This device complies with Part 15 of FCC Rules and Industry Canada licence-exempt RSS standard(s). Operation is subject to the following two conditions: (1) this device may not cause interference, and (2) this device must accept any interference, including interference that may cause undesired operation of this device.

Le présent appareil est conforme aux la partie 15 des règles de la FCC et CNR d'Industrie Canada applicables aux appareils radio exempts de licence. L'exploitation est autorisée aux deux conditions suivantes : (1) l'appareil ne doit pas produire de brouillage, et (2) l'utilisateur de l'appareil doit accepter tout brouillage radioélectrique subi, même si le brouillage est susceptible d'en compromettre le fonctionnement.

FCC WARNING:

Changes or modifications not expressly approved by the party responsible for compliance could void the user's authority to operate the equipment.

CAUTION:

This equipment complies with FCC/IC radiation exposure limits set forth for an uncontrolled environment and meets the FCC radio frequency (RF) Exposure Guidelines in Supplement C to OET65 and RSS-102 of the IC radio frequency (RF) Exposure rules. This equipment has very low levels of RF energy that it deemed to comply without maximum permissive exposure evaluation (MPE). But it is desirable that it should be installed and operated keeping the radiator at least 20 cm or more away from person's body (excluding extremities: hands, wrists, feet and ankles).

Cet équipement est conforme aux limites d'exposition aux rayonnements énoncées pour un environnement non contrôlé et respecte les règles les radioélectriques (RF) de la FCC lignes directrices d'exposition dans le Supplément C à OET65 et d'exposition aux fréquences radioélectriques (RF) CNR-102 de l'IC. Cet équipement émet une énergie RF très faible qui est considérée conforme sans évaluation de l'exposition maximale autorisée. Cependant, cet équipement doit être installé et utilisé en gardant une distance de 20 cm ou plus entre le dispositif rayonnant et le corps (à l'exception des extrémités : mains, poignets, pieds et chevilles).

Co-Location:

This transmitter must not be co-located or operated in conjunction with any other antenna or transmitter.

Under Industry Canada regulations, this radio transmitter may only operate using an antenna of a type and maximum (or lesser) gain approved for the transmitter by Industry Canada. To reduce potential radio interference to other users, the antenna type and its gain should be so chosen that the equivalent isotropically radiated power (e.i.r.p.) is not more than that necessary for successful communication.

Conformément à la réglementation d'Industrie Canada, le présent émetteur radio peut fonctionner avec une antenne d'un type et d'un gain maximal (ou inférieur) approuvé pour l'émetteur par Industrie Canada. Dans le but de réduire les risques de brouillage radioélectrique à l'intention des autres utilisateurs, il faut choisir le type d'antenne et son gain de sorte que la puissance isotrope rayonnée équivalente (p.i.r.e.) ne dépasse pas l'intensité nécessaire à l'établissement d'une communication satisfaisante.

 **WARNING****■ While driving**

Do not operate the portable audio player, cellular phone or connect a device to the Bluetooth® system.

■ Caution regarding interference with electronic devices

- Your audio unit is fitted with Bluetooth® antennas. People with implantable cardiac pacemakers, cardiac resynchronization therapy-pacemakers or implantable cardioverter defibrillators should maintain a reasonable distance between themselves and the Bluetooth® antennas. The radio waves may affect the operation of such devices.
- Before using Bluetooth® devices, users of any electrical medical device other than implantable cardiac pacemakers, cardiac resynchronization therapy-pacemakers or implantable cardioverter defibrillators should consult the manufacturer of the device for information about its operation under the influence of radio waves. Radio waves could have unexpected effects on the operation of such medical devices.

 **NOTICE****■ When leaving the vehicle**

Do not leave your portable audio player or cellular phone in the vehicle. The inside of the vehicle may become hot, causing damage to the portable audio player or cellular phone.

“Information” screen

Display “Information” screen

Go to “Information”: “MENU” button → “Info”

- ① Display the fuel consumption.
(→P.114)
- ② Display the “USB Photo” screen.
(→P.420)
- ③ Display the weather information.
(→P.422)
- ④ Display the Traffic Map picture.

Available when in a traffic supported HD Radio coverage area

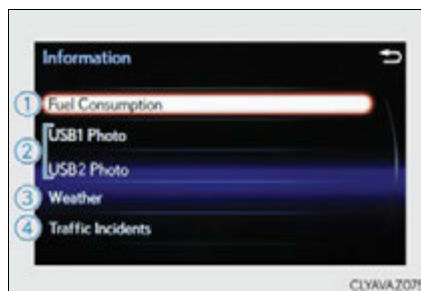

Traffic information map

Go to “Traffic Map”: “MENU” button → “Info” → “Traffic Incidents”

- ① Current position of your car
- ② Traffic information line

The line color means the following:

Red: Heavy congestion

Yellow: Moderate traffic

Green: Free flowing traffic

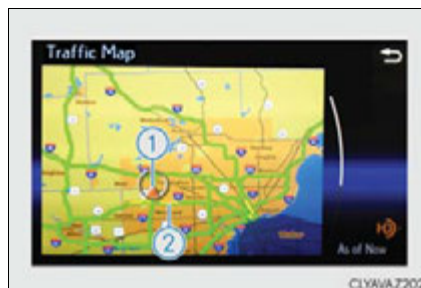

■ Disclaimers

I. Clear Channel Disclaimers

"Total Traffic Network, a division of Clear Channel Broadcasting, Inc., owns or holds the rights to the traffic, news, sports, weather, stocks and other data (the "TOTAL TRAFFIC-HD+ Data") and TOTAL TRAFFIC-HD+ network through which it is delivered, together the "TTN Service". Use of the TTN Service is subject to the terms of these Device End User Terms.

"The TTN Service is informational only. User assumes all risk of use. Total Traffic Network and its suppliers and licensors make no representations about the accuracy or timeliness of any of the TOTAL TRAFFIC-HD+ Data, including traffic and road conditions, route usability, or speed."

"TOTAL TRAFFIC-HD+ NETWORK DATA IS PROVIDED "AS IS," AND "WHERE IS". TOTAL TRAFFIC NETWORK AND ITS SUPPLIERS AND LICENSORS EXPRESSLY DISCLAIM ALL WARRANTIES WITH RESPECT TO THE DATA (INCLUDING, WITHOUT LIMITATION, THAT THE DATA WILL BE ERROR-FREE, WILL OPERATE WITHOUT INTERRUPTION OR THAT THE DATA WILL BE ACCURATE), EXPRESS, IMPLIED OR STATUTORY, INCLUDING, WITHOUT LIMITATION, THE IMPLIED WARRANTIES OF MERCHANTABILITY, NON-INFRINGEMENT, FITNESS FOR A PARTICULAR PURPOSE, OR THOSE ARISING FROM A COURSE OF DEALING OR USAGE OF TRADE."

"TOTAL TRAFFIC NETWORK AND ITS SUPPLIERS AND LICENSORS WILL NOT BE LIABLE TO YOU FOR ANY INDIRECT, SPECIAL, CONSEQUENTIAL, EXEMPLARY, OR INCIDENTAL DAMAGES (INCLUDING, WITHOUT LIMITATION, LOST REVENUES, ANTICIPATED REVENUES, OR PROFITS RELATING TO THE SAME) ARISING FROM ANY CLAIM RELATING DIRECTLY OR INDIRECTLY TO USE OF THE DATA, WHETHER A CLAIM FOR SUCH DAMAGES IS BASED ON WARRANTY, CONTRACT, TORT (INCLUDING, WITHOUT LIMITATION, NEGLIGENCE OR STRICT LIABILITY) OR ANY OTHER LEGAL THEORY."

II. The Weather Channel's (TWC's) Disclaimers

THE FOLLOWING TERMS APPLY TO THE USE OF ANY MATERIAL, DATA OR INFORMATION PROVIDED BY THE WEATHER CHANNEL, LLC ("THE WEATHER CHANNEL"), INCLUDING WEATHER-RELATED INFORMATION AND REPORTS, OBTAINED BY YOU OR OTHERS THROUGH THE TTN SERVICE ("THE WC DATA").

DISCLAIMER OF WARRANTIES.

YOUR USE OF THE WC DATA IS AT YOUR SOLE RISK. THE WC DATA IS PROVIDED ON AN "AS IS" AND "AS AVAILABLE" BASIS. THE WEATHER CHANNEL EXPRESSLY DISCLAIMS ALL WARRANTIES OF ANY KIND, WHETHER EXPRESS OR IMPLIED, INCLUDING, BUT NOT LIMITED TO THE IMPLIED WARRANTIES OF MERCHANTABILITY, FITNESS FOR A PARTICULAR PURPOSE AND NON-INFRINGEMENT. THE WEATHER CHANNEL MAKES NO REPRESENTATION OR WARRANTY THAT (i) THE WC DATA WILL MEET YOUR REQUIREMENTS, (ii) THE WC DATA WILL BE UNINTERRUPTED, TIMELY, SECURE, OR ERROR-FREE, (iii) THE RESULTS THAT MAY BE OBTAINED FROM THE USE OF THE WC DATA WILL BE ACCURATE OR RELIABLE, OR (iv) ANY ERRORS OR BUGS IN THE WC DATA WILL BE CORRECTED. ACCORDINGLY, THE WEATHER CHANNEL SHALL NOT BE RESPONSIBLE OR LIABLE FOR THE ACCURACY, USEFULNESS OR AVAILABILITY OF THE WC DATA.

LIMITATION OF LIABILITY.

YOU EXPRESSLY UNDERSTAND AND AGREE THAT THE WEATHER CHANNEL, ITS SUPPLIERS, ITS LICENSORS AND ITS AFFILIATE COMPANIES SHALL NOT BE LIABLE, UNDER ANY LEGAL THEORY, INCLUDING CONTRACT, TORT, NEGLIGENCE OR STRICT LIABILITY, FOR ANY DIRECT, INDIRECT, INCIDENTAL, SPECIAL, PUNITIVE, CONSEQUENTIAL OR EXEMPLARY DAMAGES, INCLUDING BUT NOT LIMITED TO, DAMAGES FOR LOSS OF PROFITS, GOODWILL, USE, DATA OR OTHER INTANGIBLE LOSSES (EVEN IF THE WEATHER CHANNEL HAS BEEN ADVISED OF THE POSSIBILITY OF SUCH DAMAGES), RESULTING FROM OR ARISING OUT OF YOUR USE OF, OR YOUR INABILITY TO USE, THE WC DATA, THIS AGREEMENT, OR ANY OTHER MATTER RELATING TO THE WC DATA. YOUR SOLE AND EXCLUSIVE REMEDY FOR ANY DISPUTE WITH THE WEATHER CHANNEL RELATED TO THE WC DATA OR CONTENT SHALL BE CANCELLATION OF RECEIPT OF THE WC DATA.

SOME JURISDICTIONS DO NOT ALLOW THE EXCLUSION OF CERTAIN WARRANTIES OR THE LIMITATION OR EXCLUSION OF LIABILITY FOR INCIDENTAL OR CONSEQUENTIAL DAMAGES. ACCORDINGLY, SOME OF THE ABOVE LIMITATIONS MAY NOT APPLY TO YOU.

USB photo

Connecting a USB memory device enables you to enjoy photo on the Lexus Display Audio display.

USB photo screen

Go to “USB Photo”: “MENU” button → “Info” → “USB1 Photo” or “USB2 Photo”

Connecting a USB memory device

→P. 345

Menu screen

Move the controller to the left to display the menu screen.

- ① Change the full screen mode.
- ② Select to set the slide show display on/off.
Start the slide show at a selected folder.
- ③ Change the play speed.
- ④ Change the play mode.

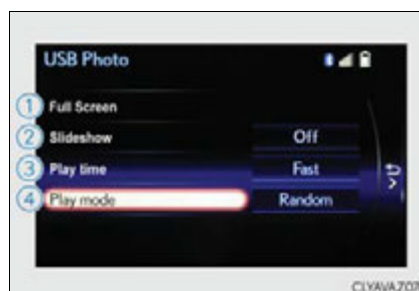

Selecting a folder and a file

- 1 Move the controller to the right and select “Browse”.
- 2 Select the desired folder, and then select a desired file to begin using the selected folder.

■ USB memory functions

→P. 378

■ USB memory**● Compatible devices**

USB memory device that can be used for JPEG display.

● Compatible device formats

The following device format can be used:

- USB communication format: USB2.0 FS (480 Mbps)
- File system format: FAT16/32 (Windows)
- Correspondence class: Mass storage class

● JPEG file compatibility

- Compatible image size: Maximum 10MB
- Compatible pixel size: Maximum 10,000,000 pixels

**NOTICE****■ To prevent damage to the USB memory device or its terminals**

→P. 380

Weather information

Weather information for the selected city is displayed.
Available when in weather supported HD Radio coverage area

How to check the weather information

1 Go to "Weather": "MENU" button → "Info" → "Weather"

2 Select the desired city/location.

① Current location of your car

② Select of the recently checked location list

Select the desired location on the recently checked location list.

③ Select of the National City list.

Select the region on the region list and then select the city on the National City list.

④ Select of the local location list

Select the location on the local location list.

3 Select the time

① Display the current weather information.

② Display the 3 days weather information.

You can display detail of a week, move the controller right and then select the desired week.

③ Display the 6/12 hour weather information.

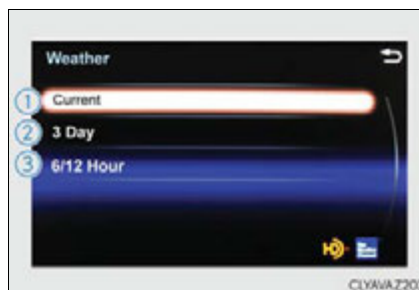
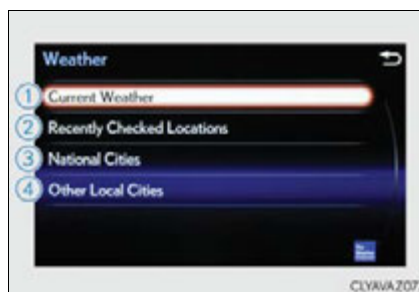

Voice command system

The voice command system enables the audio and hands-free systems to be operated using voice commands.

Operations of the voice command system can be performed by selecting the menu corresponding to each function on the right part of the screen. Even if any menu is selected, commands displayed on all menus can be operated.

Using the voice command system

- 1 Press the talk switch.
To cancel the voice command system, press and hold the talk switch.
- 2 After a beep sounds, say the desired command.
On the list screen, you can select the desired command.

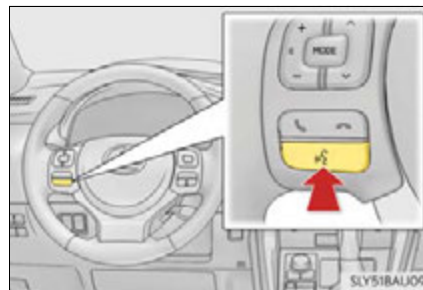

■ Menu screen

To display the menu screen, move the controller to the left.

- 1 Offer examples of commands and operation methods
- 2 Adjust the settings for voice guidance volume and voice recognition prompts. ("Hints" screen) (→P. 351)
- 3 Start over voice recognition (except "Hints" screen)
- 4 Cancel voice recognition

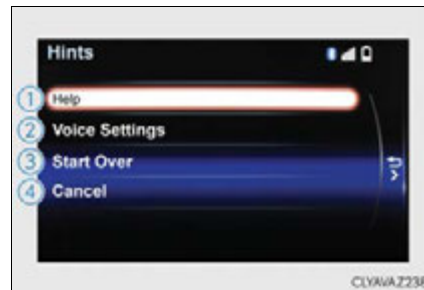

5

Lexus Display Audio system

■ Microphone

→P. 393

■ When using the microphone

- It is unnecessary to speak directly into the microphone when giving a command.
- Wait for the confirmation beep before speaking a command.

- Voice commands may not be recognized if:
 - Spoken too quickly.
 - Spoken at a low or high volume.
 - The roof or windows are open.
 - Passengers are talking while voice commands are spoken.
 - The air conditioning speed is set high.
 - The air conditioning vents are turned towards the microphone.
- In the following conditions, the system may not recognize the command properly and using voice commands may not be possible:
 - The command is incorrect or unclear. Note that certain words, accents or speech patterns may be difficult for the system to recognize.
 - There is excessive background noise, such as wind noise.

■ When searching for a track

- A USB memory or iPod must be connected to enable track searching and playback. (→P. 345)
- When a USB memory or iPod is connected, recognition data is created so tracks can be searched using voice commands.
- Recognition data is updated under the following conditions:
 - When the USB memory or iPod data has changed.
 - When the voice recognition language is changed. (→P. 348)
- While the recognition data is being created or being updated, a track search cannot be performed using a voice command.

■ The Gracenote® media database

→P. 371

Casual speech recognition

Due to natural language speech recognition technology, this system enables recognition of a command when spoken naturally. However, the system cannot recognize every variation of each command.

In some situations, it is possible to omit the command for the procedure and directly state the desired operation.

This function is available in English, Spanish and French.

■ Expression examples for each function

Command	Expression examples
“Call <name> <type>”	Get me <Robert Brown>. I need to call <Robert Brown> at <Work> right away.
“Dial <number>”	Please dial the number <3334445555>. Ring <3334445555>.
“Play Artist <name>”	Play the artist <XXXXX>. I'd like to hear the band <XXXXX>.*
“Play Album <name>”	Play album <XXXXX>. Music from album <XXXXX>.*

*: Say the desired artist name or album name in the place of the “<>”.

Command list

Some recognizable voice commands and their actions are shown below as examples.

► Basic

Command	Action
“Help”	Prompts voice guidance to offer examples of commands or operation methods
“Go Back”	Returns to the previous screen
“Go to <tab>”	Displays the command list of the selected tab

► Phone

Command	Action
"Redial"	Places a call to the phone number of the latest outgoing call
"Call Back"	Places a call to the phone number of latest incoming call
"Show Recent Calls"	Displays the call history screen
"Dial <phone number>"	Places a call to the said phone number
"Call <contacts> <phone types>"	Place a call to the said phone type of the contact from the phone book

► Audio

Command	Action
"Play Playlist <playlists>"	Plays tracks from the selected playlist
"Play Artist <artist>"	Plays tracks from the selected artist
"Play Song <songs>"	Plays the selected track
"Play Album <albums>"	Plays tracks from the selected album
"Turn Music On/Off"	Turns the audio system on/off
"Play the <audio sources>"	Selects audio source

► Info

Command	Action
"Show Forecast"	Displays weather information
"Show Traffic"	Displays traffic information

LEXUS Enform Remote*

Lexus Enform Remote is a cellular phone application that lets you view and remotely control certain aspects of your vehicle.

For details about the functions and services of this application, refer to <http://www.lexus.com/enform/>.

Function of the Lexus Enform Remote is achieved by using an embedded cellular device in the vehicle (DCM: Data Communication Module).

Subscription

After you sign the Telematics Subscription Service Agreement, download the Lexus Enform Remote app from your cellular phone's app store, and register within the app (or enroll and complete registration at the dealer), you can begin using these services. (→P. 477)

A variety of subscription terms are available. Contact your Lexus dealer, or call 1-800-25-LEXUS (1-800-255-3987) for further subscription details.

5

Lexus Display Audio system

*: If equipped

■ Availability of service

Lexus Enform Remote is available in the contiguous United States, Washington D.C. and Alaska.

■ Lexus Enform Remote Information

- Lexus Enform Remote should only be used by authorized users.
- Laws in some communities may require that the vehicle be within view of the user when operating Lexus Enform Remote.
In some states, use of Lexus Enform Remote may violate state or local laws. Before using Lexus Enform Remote, check your state and local laws.
- Any malfunction of the Lexus should be repaired by your Lexus dealer.
- Lexus Enform Remote is designed to work at temperatures above -22°F (-30°C). This specification is related to the Lexus Enform Remote operation, but is dependent on the vehicle's operating temperature range which may be different.
- Content is subject to change without notice.
- Some features of the Lexus Enform Remote may not be available on some models.
- Additional information can be found at www.lexus.com/enform/.
- Availability of functions of the Lexus Enform service is dependent on network reception level.

■ Safety information for Lexus Enform Remote

Refer to safety information for Safety Connect: →P. 481

Interior features

6

- | | |
|--|--|
| <p>6-1. Using the air conditioning system and defogger</p> <p>Automatic air conditioning system 430</p> <p>Heated steering wheel/ seat heaters/ seat ventilators..... 440</p> <p>6-2. Using the interior lights</p> <p>Interior lights list.....443</p> <ul style="list-style-type: none"> • Front interior light444 • Personal lights.....444 • Rear interior light445 | <p>6-3. Using the storage features</p> <p>List of storage features 446</p> <ul style="list-style-type: none"> • Glove box 447 • Console box..... 447 • Cup holders/ bottle holders.....448 • Sunglass holder 449 <p>Luggage compartment features.....450</p> <p>6-4. Other interior features</p> <p>Other interior features 455</p> <ul style="list-style-type: none"> • Sun visors 455 • Vanity mirrors 455 • Clock 456 • Power outlet (12 VDC)..... 456 • Power outlet (120 VAC) ... 457 • Wireless charger458 • Armrest.....465 • Assist grips.....465 • Coat hooks466 <p>Garage door opener..... 467</p> <p>Compass473</p> <p>Safety Connect477</p> |
|--|--|

Automatic air conditioning system

Air outlets and fan speed are automatically adjusted according to the temperature setting.



Vehicles with a Lexus Display Audio system: Press the "MENU" button on the Lexus Display Audio controller, then select "Climate" to display the air conditioning control screen.

For details on the Lexus Display Audio controller, refer to "Lexus Display Audio controller" on P. 338.



Vehicles with a navigation system: Press the "MENU" button on the Remote Touch, then select "Climate" to display the air conditioning control screen.

For details on the Remote Touch, refer to the "NAVIGATION SYSTEM OWNER'S MANUAL".

Control panel**■ Adjusting the temperature setting**

Press  to increase the temperature and  to decrease the temperature.

■ Adjusting the fan speed setting

Press  to increase the fan speed and  to decrease the fan speed.

Press the "OFF" button to turn the fan off.

■ Change the airflow mode

To change the air outlets, press



The air outlets used are switched each time the button is pressed.

- ① Air flows to the upper body.
- ② Air flows to the upper body and feet.
- ③ Air flows to the feet.
- ④ Air flows to the feet and the windshield defogger operates.



■ S-FLOW mode

Priority for airflow is given to the front seats, and the airflow and air conditioning for the rear seats is effectively controlled.



The indicator comes on when S-FLOW mode is on.

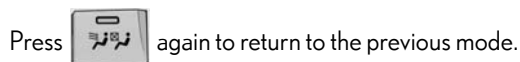

■ Other functions

- Switching between outside air and recirculated air modes (→P. 435)
- Defogging the windshield (→P. 435)
- Defogging the rear window and outside rear view mirrors (→P. 435)

Control screen

▶ Vehicles with a Lexus Display Audio system

- ① Adjust the left-hand side temperature setting
- ② Adjust the fan speed setting
- ③ Select to set auto mode on/off, fan off and displaying the option control screen (→P. 434)
- ④ Select the air flow mode
- ⑤ Adjust the right-hand side temperature setting



- 1 Move the Lexus Display Audio controller left/right to select the desired item (① to ⑤).

- 2 When ①, ② or ⑤ is selected:

Move the controller forward/backward or turn it left/right for adjusting.

When ③ or ④ is selected:

Move the controller forward/backward or turn it left/right to select a screen button, then press the controller.

▶ Vehicles with a navigation system

- ① Adjust the left-hand side temperature setting
- ② Adjust the fan speed setting
- ③ Select the air flow mode
- ④ Adjust the right-hand side temperature setting
- ⑤ Display the option control screen (→P. 434)
- ⑥ Turn the fan off
- ⑦ Select to set automatic mode on/off



Using the touchpad of the Remote Touch, select the button on the screen and then activate it by pressing on or double tapping the touchpad.

■ **Option control screen**

Select ******* on the climate screen to display the option control screen. The functions can be switched on and off.

- ▶ Vehicles with a Lexus Display Audio
- ▶ Vehicles with a navigation system



- ① Select to set cooling and dehumidification function on/off
- ② Adjust the temperature for driver and passenger seats separately (“DUAL” mode) (→P. 435)
- ③ Prevent ice from building up on the windshield and wiper blades (→P. 436)
- ④ Remove pollen from the air (Micro dust and pollen filter) (→P. 436)

Air conditioning controls

■ **Using the automatic mode**

- ① Press the “AUTO” button.
- ② Adjust the temperature setting.
- ③ To stop the operation, press the “OFF” button.

■ **Automatic mode indicator**

If the fan speed setting or air flow modes are operated, the automatic mode indicator goes off. However, automatic mode for functions other than that operated are maintained.

■ Adjusting the temperature for driver and passenger seats separately (“DUAL” mode)

To turn on the “DUAL” mode, perform any of the following procedures:



- Press the “DUAL” button.
- Select “DUAL” on the option control screen.
- Adjust the temperature setting of the passenger side with the passenger side temperature adjustment button.

The indicator comes on when the “DUAL” mode is on.

Other functions

■ Switching between outside air and recirculated air modes

Press  .

The mode switches between  (recirculated air mode) and  (outside air mode) modes each time the button is pressed.

■ Defogging the windshield

Defoggers are used to defog the windshield and front side windows.

Press  .

Set  to outside air mode if the recirculated air mode is used. (It may switch automatically.)

To defog the windshield and the side windows early, turn the air flow and temperature up.

To return to the previous mode, press  again when the windshield is defogged.

■ Defogging the rear window and outside rear view mirrors

Defoggers are used to defog the rear window and to remove raindrops, dew and frost from the outside rear view mirrors.

Press  .

The defoggers will automatically turn off after a period of time.

■ **Micro dust and pollen filter**

Pollen is removed from the air and the air flows to the upper part of the body.

Select  on the option control screen.

When the micro dust and pollen filter is on,  is displayed on the air conditioning control screen.

In order to prevent the windshield from fogging up when the outside air is cold, the dehumidification function may operate.

The pollens are filtered out even if the micro dust and pollen filter is turned off.

■ **Windshield wiper de-icer**

This feature is used to prevent ice from building up on the windshield and wiper blades.

Select  on the option control screen.

When the windshield wiper de-icer is on,  is displayed on the air conditioning control screen.

The windshield wiper de-icer will automatically turn off after a period of time.

Air outlets

■ **Location of air outlets**

The air outlets and air volume changes according to the selected air flow mode.

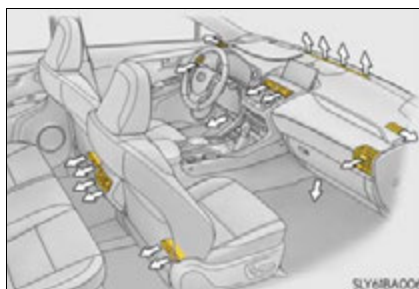

■ Adjusting the position of and opening and closing the air outlets

▶ Front

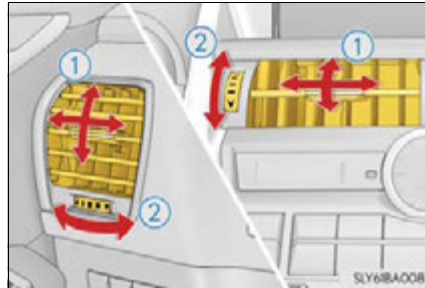

▶ Rear

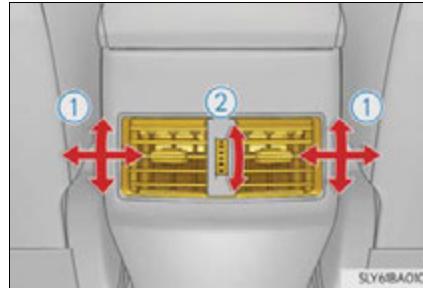

- ① Direct air flow to the left or right, up or down
- ② Turn the knob to open or close the vent

■ Registering air conditioning settings to electronic keys (vehicles with driving position memory)

- Unlocking the vehicle using an electronic key and turning the power switch to ON mode will recall that key's registered air conditioning settings.
- When the power switch is turned off, the current air conditioning settings will automatically be registered to the electronic key that was used to unlock the vehicle.
- The system may not operate correctly if more than one electronic key is in the vicinity or if the smart access system with push-button start is used to unlock a passenger door.
- The doors that can recall the air conditioning setting when unlocked using the smart access system with push-button start can be changed.* For details, contact your Lexus dealer.

*: The doors that can recall the driving position memory are changed at the same time.

■ Using automatic mode

Fan speed is adjusted automatically according to the temperature setting and the ambient conditions.

Therefore, the fan may stop for a while until warm or cool air is ready to flow immediately after the "AUTO" button is pressed or "AUTO" is selected.

■ When the outside temperature exceeds 75°F (24°C) and the air conditioning system is on

- In order to reduce the air conditioning power consumption, the air conditioning system may switch to recirculated air mode automatically. This may also reduce fuel consumption.
- Recirculated air mode is selected as a default mode when the power switch is turned to ON mode.

- It is possible to switch to outside air mode at any time by pressing



■ **Fogging up of the windows**

- The windows will easily fog up when the humidity in the vehicle is high. Pressing "A/C" button or selecting "A/C" will dehumidify the air from the outlets and defog the windshield effectively.
- If you turn "A/C" off, the windows may fog up more easily.
- The windows may fog up if the recirculated air mode is used.

■ **Windshield fog detection function**

When automatic mode is set, the humidity sensor (→P. 439) detects fog on the windshield and controls the air conditioning system to prevent fog.

■ **Outside/recirculated air mode**

- When driving on dusty roads such as tunnels or in heavy traffic, set  to the recirculated air mode. This is effective in preventing outside air from entering the vehicle interior. During cooling operation, setting the recirculated air mode will also cool the vehicle interior effectively.
- Outside/recirculated air mode may automatically switch depending on the temperature setting or the inside temperature.

■ **When the outside temperature is low**

The dehumidification function may not operate even when "A/C" is pressed or "A/C" is selected.

■ **Operation of the air conditioning system in Eco drive mode**

- In the Eco drive mode, the air conditioning system is controlled as follows to prioritize fuel efficiency
 - Engine speed and compressor operation controlled to restrict heating/cooling capacity
 - Fan speed restricted when automatic mode is selected
- To improve air conditioning performance, perform the following operations
 - Adjust the fan speed
 - Turn off Eco drive mode

■ **Ventilation and air conditioning odors**

- To let fresh air in, set the air conditioning system to the outside air mode.
- During use, various odors from inside and outside the vehicle may enter into and accumulate in the air conditioning system. This may then cause odor to be emitted from the vents.
- To reduce potential odors from occurring:
 - It is recommended that the air conditioning system be set to outside air mode prior to turning the vehicle off.
 - The start timing of the blower may be delayed for a short period of time immediately after the air conditioning system is started in automatic mode.

■ **Air conditioning filter**

→P. 530

■ **Customization**

Settings (e.g. A/C automatic mode switch operation) can be changed. (Customizable features: →P. 637)

⚠ WARNING**■ To prevent the windshield from fogging up**

- Do not use  during cool air operation in extremely humid weather. The difference between the temperature of the outside air and that of the windshield can cause the outer surface of the windshield to fog up, blocking your vision.
- Do not place anything on the instrument panel which may cover the air outlets. Otherwise, air flow may be obstructed, preventing the windshield defoggers from defogging.

**■ To prevent burns**

- Do not touch the rear view mirror surfaces when the outside rear view mirror defoggers are on.
- Do not touch the glass at lower part of the windshield or to the side of the front pillars when the windshield wiper de-icer is on.

⚠ NOTICE**■ Humidity sensor**

In order to detect fog on the windshield, a sensor which monitors the temperature of the windshield, the surround humidity, etc., is installed. (→P. 438)

Follow these points to avoid damaging the sensor:

- Do not disassemble the sensor
- Do not spray the glass cleaner on the sensor or subject it to strong impacts
- Do not stick anything on the sensor

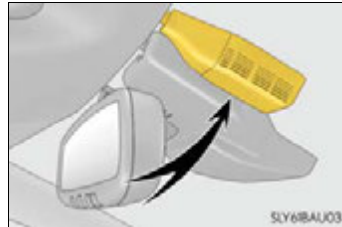
**■ To prevent 12-volt battery discharge**

Do not leave the air conditioning system on longer than necessary when the hybrid system is off.

Heated steering wheel^{*}/seat heaters^{*}/seat ventilators^{*}

Heated steering wheel and seat heaters heat the side grips of the steering wheel and seats, respectively. Seat ventilators maintain good airflow by blowing air from the seats.

WARNING

- Care should be taken to prevent injury if anyone in the following categories comes in contact with the steering wheel and seats when the heater is on:
 - Babies, small children, the elderly, the sick and the physically challenged
 - Persons with sensitive skin
 - Persons who are fatigued
 - Persons who have taken alcohol or drugs that induce sleep (sleeping drugs, cold remedies, etc.)
- Observe the following precautions to prevent minor burns or overheating:
 - Do not cover the seat with a blanket or cushion when using the seat heater.
 - Do not use seat heater more than necessary.

NOTICE

- Do not put heavy objects that have an uneven surface on the seat and do not stick sharp objects (needles, nails, etc.) into the seat.
- To prevent 12-volt battery discharge, do not use the functions when the hybrid system is off.

*: If equipped

Heated steering wheel

Turns the heated steering wheel on/off

The indicator light comes on when the heated steering wheel is operating.



■ Operation condition

- The heated steering wheel can be used when the power switch is in ON mode.

■ Timer

- The heated steering wheel will automatically turn off after about 30 minutes.

Seat heaters

▶ Vehicles without seat ventilators

Each time the switch is pressed, the operation condition changes as follows.
Hi (3 segments lit) → Mid (2 segments lit) → Lo (1 segment lit) → Off

The level indicator (amber) light up during operation.

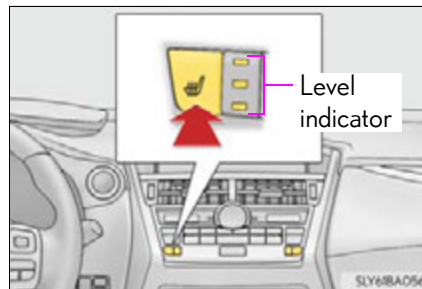

▶ Vehicles with seat ventilators

Each time the switch is pressed, the operation condition changes as follows.
Hi (3 segments lit) → Mid (2 segments lit) → Lo (1 segment lit) → Off

The indicator (amber) and level indicator (green) light up during operation.

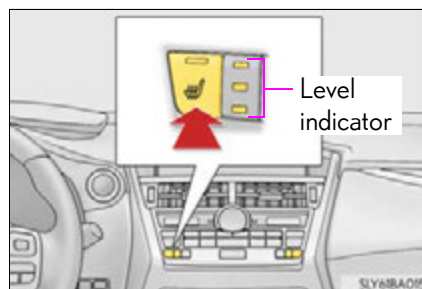

■ Operation condition

The seat heaters can be used when the power switch is in ON mode.

Seat ventilators

Each time the switch is pressed, the operation condition changes as follows.
Hi (3 segments lit) → Mid (2 segments lit) → Lo (1 segment lit) → Off

The indicator (green) and level indicator (green) light up during operation.

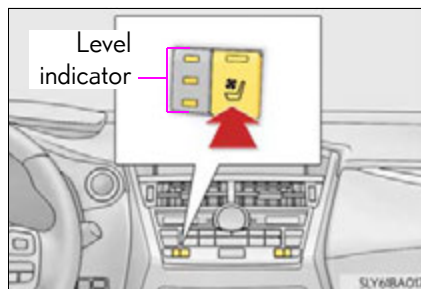

■ Operation condition

The seat ventilators can be used when the power switch is in ON mode.

Interior lights list

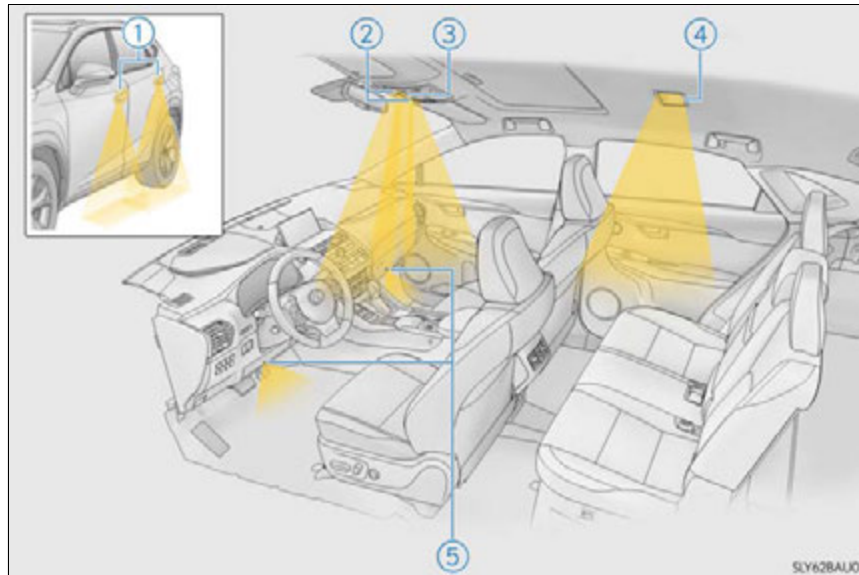

- ① Outer foot lights
- ② Personal lights (→P. 444)
- ③ Front interior light (→P. 444)
- ④ Rear interior light (→P. 445)
- ⑤ Footwell lights
 - When the power switch is in ON mode, the footwell lights will turn on. However, if the instrument panel light control switch is turned to minimum, the footwell lights will turn off. (→P. 99)
 - When shifting the shift lever is in a position other than P, the brightness of the footwell light will reduce intensity.

Front interior light

Turns the light on/off (touch the light)

The rear interior light also turns on/off. However, when the rear interior light has already been turned on, it will not be controlled by front interior light operations.

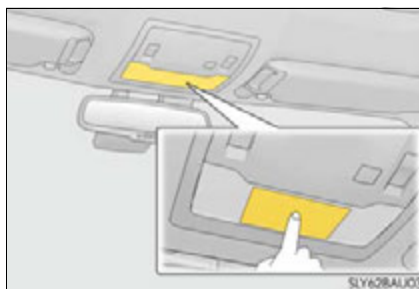

Turns the door position on/off

- ① On

The front and rear interior lights turn on/off when a door is opened/closed.

- ② Off

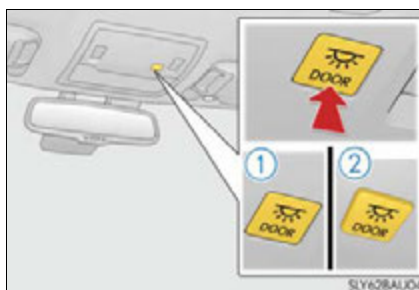

Personal lights

Turns the lights on/off (touch the lights)

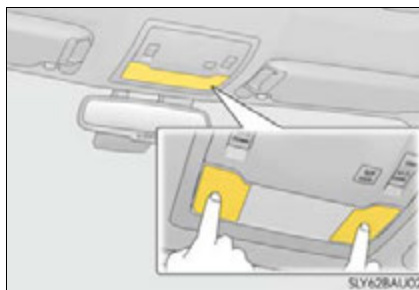

Rear interior light

Turns the light on/off

The rear interior light is also turned on/off by the front interior light operations. If the light is turned on by front interior light operation, the rear interior light cannot turn off by pressing the switch.



- Illuminated entry system: The lights automatically turn on/off according to power switch mode, the presence of the electronic key, whether the doors are locked/unlocked, and whether the doors are opened/closed.
- If the interior lights remain on when the power switch is turned off, the lights will go off automatically after 20 minutes.
- In the following cases, the front interior lights and personal lights may not respond as normal.
 - When water, dirt, etc., have adhered to the lens surface
 - When operated with a wet hand
 - When wearing gloves, etc.
- Settings (e.g. the time elapsed before the lights turn off) can be changed. (Customizable features: →P. 635)

NOTICE

- Never remove the lens for the front interior light and personal lights. Otherwise, the lights will be damaged. If the lens needs to be removed, contact your Lexus dealer.
- To prevent 12-volt battery discharge, do not leave the lights on longer than necessary when the hybrid system is off.

List of storage features

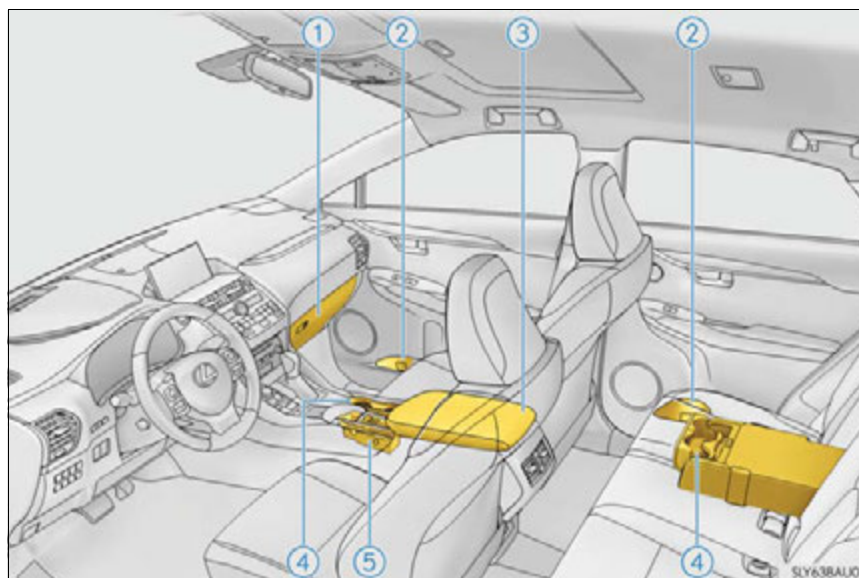

- ① Glove box (→P. 447)
- ② Bottle holders (→P. 448)
- ③ Console box (→P. 447)
- ④ Cup holders (→P. 448)
- ⑤ Sunglass holder (→P. 449)

WARNING

- Do not leave glasses, lighters or spray cans in the storage spaces, as this may cause the following when cabin temperature becomes high:
 - Glasses may be deformed by heat or cracked if they come into contact with other stored items.
 - Lighters or spray cans may explode. If they come into contact with other stored items, the lighter may catch fire or the spray can may release gas, causing a fire hazard.
- When driving or when the glove box and the console box are not in use, keep it closed.
In the event of sudden braking or sudden swerving, an accident may occur due to an occupant being struck by an open lid or the items stored inside.

Glove box

- ① Open (press the button)
- ② Unlock with the mechanical key
- ③ Lock with the mechanical key

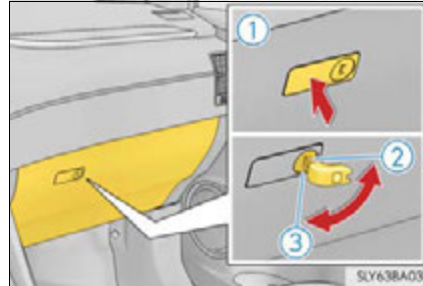

The glove box light turns on when the tail lights are on.

Console box

- ① Lift the lid while pushing the button to release the lock.

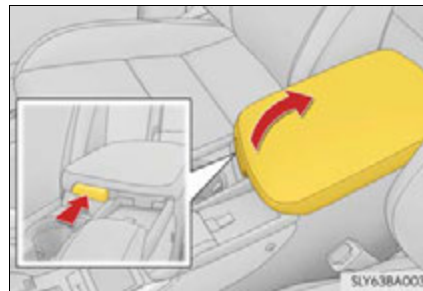

- ② Vehicles with the wireless charger:
Lift the wireless charger.

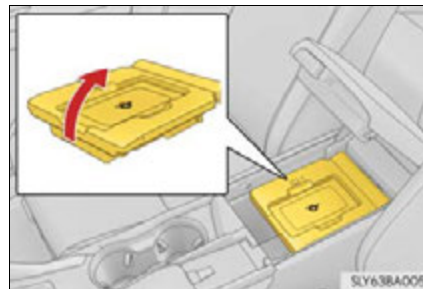

- Vehicles without the wireless charger:
The tray slides forward/backward and can be removed.

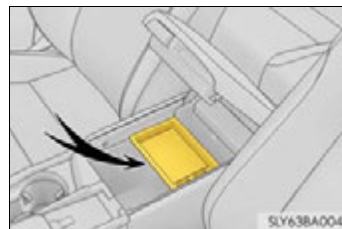

- The console box light turns on when the tail lights are on.

Cup holders/bottle holders

■ Cup holders

► Front



► Rear

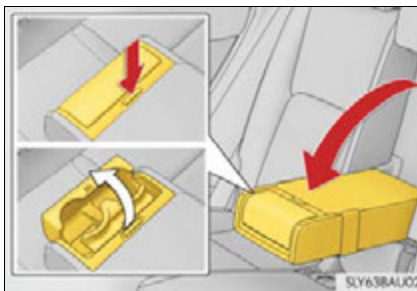

Fold down the armrest and release the button.

■ Bottle holders

► Front



► Rear

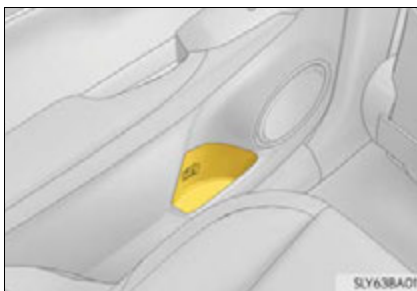

- When storing a bottle, close the cap.
- The bottle may not be stored depending on its size or shape.

⚠ WARNING

Do not place anything other than cups or aluminum cans in the cup holders. Other items may be thrown out of the holders in the event of an accident or sudden braking, causing injury. If possible, cover hot drinks to prevent burns.

 NOTICE

- To prevent damage to the rear cup holder, stow the cup holder before stowing the armrest.
- Do not place open bottles or glass and paper cups containing liquid in the bottle holders. The contents may spill and glasses may break.

Sunglass holder

Remove the lid using the strap.

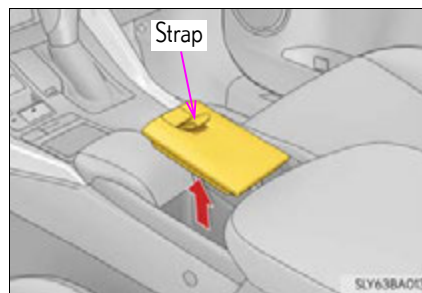

- The removed lid of the sunglasses holder can be stored on the tray in the console box.

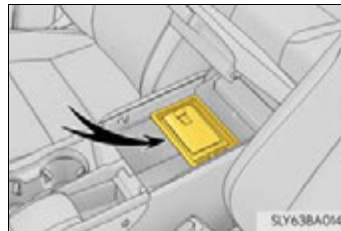

- The back side of the lid for the sunglasses holder can be used as a vanity mirror. (→P. 455)

Luggage compartment features

Cargo hooks

Raise the hook to use.

The cargo hooks are provided for securing loose items.



⚠ WARNING

To avoid injury, always return the hooks to their stowed positions when not in use.

Cargo net hooks

Raise the hook to use.

The cargo net can be hung, using the hook.

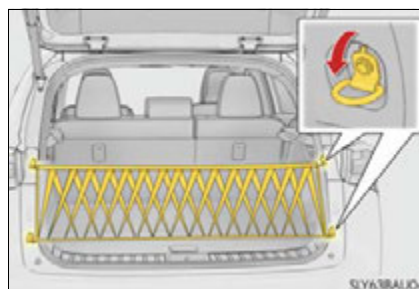

⚠ WARNING

To avoid injury, always return the hooks to their stowed positions when not in use.

Grocery bag hooks

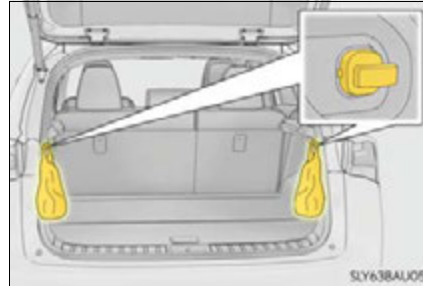

NOTICE

Do not hang any object heavier than 11 lb. (5 kg) on the grocery bag hooks.

Deck under tray

Lift the deck board and attach the hook. (→P. 452) The following item can be stowed.

- ① First-aid kit and other items
- ② Accessories
- ③ Warning reflector*

*: The warning reflector itself is not included as an original equipment.

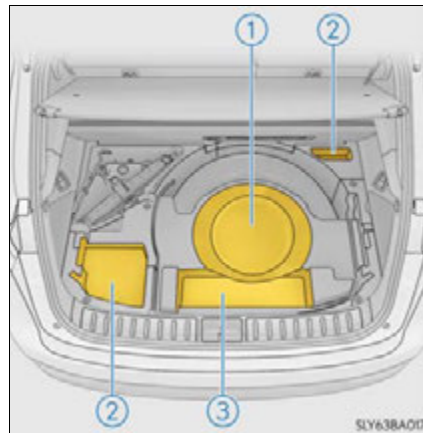

Deck board

- 1 If the luggage cover is used: Unhook the cords.

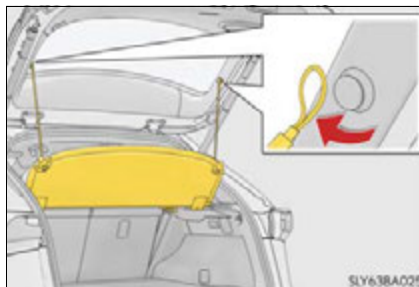

- 2 If the luggage cover is used: Fold up the luggage cover.

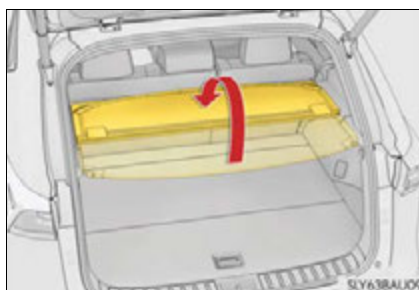

- 3 Pull the lever upwards and open the deck board.

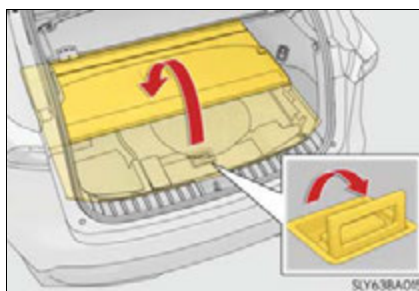

- 4 Lift the deck board and remove the hook on the backside of the deck board.

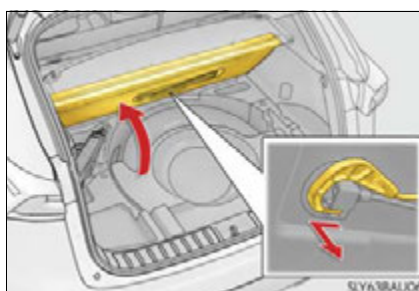

- 5 Attach the hook to the upper edge of the back door opening as shown.

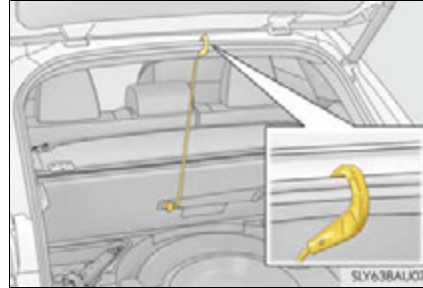

When attaching the side deck board, attach it so that the "↑FRONT" mark points to the front side of the vehicle.

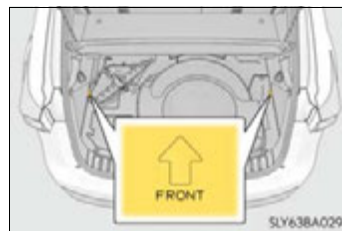

⚠ WARNING

If the deck boards are opened or removed, return them to their original positions before driving. In the event of sudden braking, an accident may occur due to an occupant being struck by the deck boards or the items stored in the deck under tray.

Stowing the luggage cover

- 1 Unhook the cords.

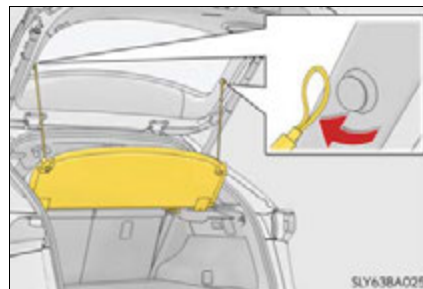

- 2 Fold up the luggage cover.

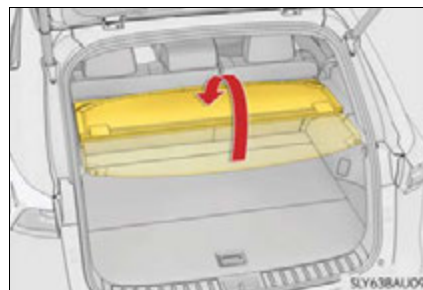

454 6-3. Using the storage features

- 3** Pull the lever upwards and open the deck board.

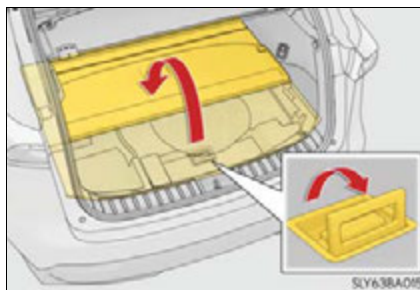

- 4** Remove the luggage cover.
When the seatback for the rear seat is collapsed to the rear, remove the cover after the cover most upright position. (→P.147)

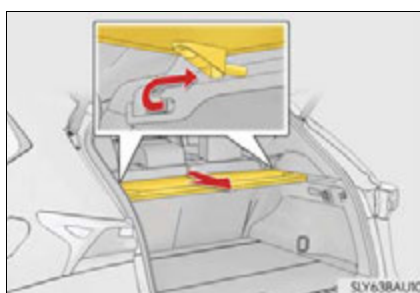

- 5** Stow the luggage cover in the deck under tray while lifting the deck board.

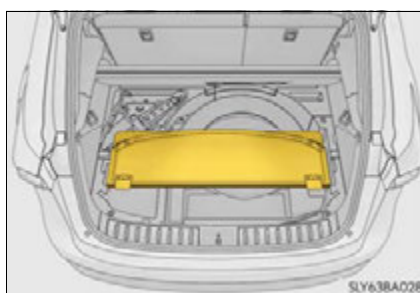

⚠ WARNING

- Do not place anything on the luggage cover. In the event of sudden braking or turning, the item may go flying and strike an occupant. This could lead to an unexpected accident, resulting in death or serious injury.
- Do not allow children to climb on the luggage cover. Climbing on the luggage cover could result in damage to the luggage cover, possibly causing death or serious injury to the child.

Other interior features

Sun visors

- ① To set the visor in the forward position, flip it down.
- ② To set the visor in the side position, flip down, unhook, and swing it to the side.
- ③ To use the side extender, place the visor in the side position, then slide it backward.

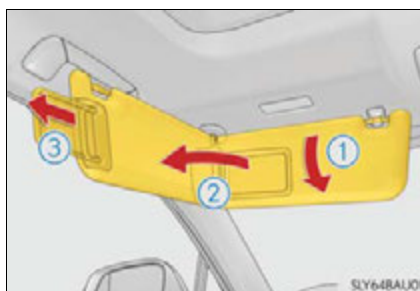

Vanity mirrors

▶ On the sun visors

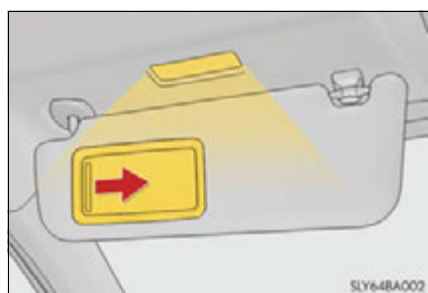

Slide the cover to open.

The light turns on when the cover is opened.

▶ On the sunglasses holder

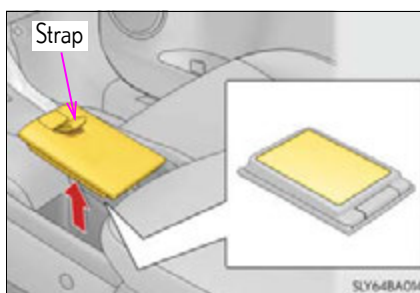

Remove the lid of sunglasses holder using the strap. (→P. 449)

There is a vanity mirror on the back side of the lid.

If the vanity lights remain on when the power switch is turned off, the light will go off automatically after 20 minutes.

⚠ NOTICE

- To prevent damage to the vanity mirror, when the lid of sunglasses holder is removed, do not subject it to strong impacts or set heavy objects on top of it.
- To prevent 12-volt battery discharge, do not leave the vanity lights on for extended periods while the hybrid system is off.

Clock

The clock can be adjusted by pressing the buttons.

- ① Pressing and holding will move the clock hands backward.
- ② Pressing and holding will move the clock hands forward.

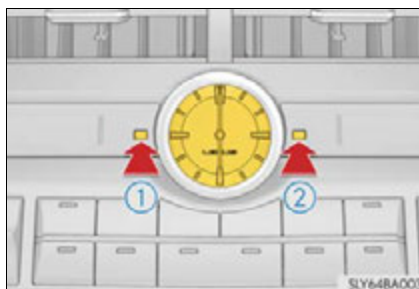

Power outlet (12 VDC)

Please use a power supply for electronic goods that use less than 12 VDC /10 A (power consumption of 120 W).

When using electronic goods, make sure that the power consumption of all the connected power outlets is less than 120 W.

► Inside the console box

► In the luggage compartment

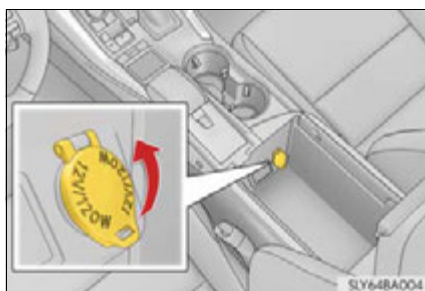

Open the lid.



Open the lid.

- The power outlet can be used when the power switch is in ACCESSORY or ON mode.
- The notch in console box allows power cables to be passed through even when the console box is closed.



⚠ NOTICE

- To avoid damaging the power outlet, close the power outlet lid when the power outlet is not in use.
Foreign objects or liquids that enter the power outlet may cause a short circuit.
- To prevent 12-volt battery discharge, do not use the power outlet longer than necessary when the hybrid system is off.

Power outlet (120 VAC) (if equipped)

Please use a power supply for electronic goods that use less than 120 VAC (power consumption of 100 W).

Open the lid.



The power outlet can be used when the power switch is in ON mode.

⚠ NOTICE

- To avoid damaging the power outlet, close the power outlet lid when the power outlet is not in use.
Foreign objects or liquids that enter the power outlet may cause a short circuit.
- To prevent blown fuse, do not use a 120 VAC appliance that requires more than 100 W.
If a 120 VAC appliance that consumes more than 100 W is used, the protection circuit will cut the power supply.
- To prevent 12-volt battery discharge, do not use the power outlet longer than necessary when the hybrid system is off.
- The following 120 VAC appliances may not operate properly even if their power consumption is under 100W:
 - Appliances with high initial peak wattage
 - Measuring devices that process precise data
 - Other appliances that require an extremely stable power supply

Wireless charger (if equipped)

A portable device can be charged by just placing Qi standard wireless charge compatible portable devices according to the Wireless Power Consortium, such as smart phones and mobile batteries, etc., on the charge area.

This function cannot be used with portable devices that are larger than the charging area. Also, depending on the portable device, it may not operate as normal. Please read the operation manual for portable devices to be used.

■ The “Qi” symbol

The “Qi” symbol is a trademark of the Wireless Power Consortium.



■ Name for all parts

- ① Power supply switch
- ② Operation indicator light
- ③ Charge area

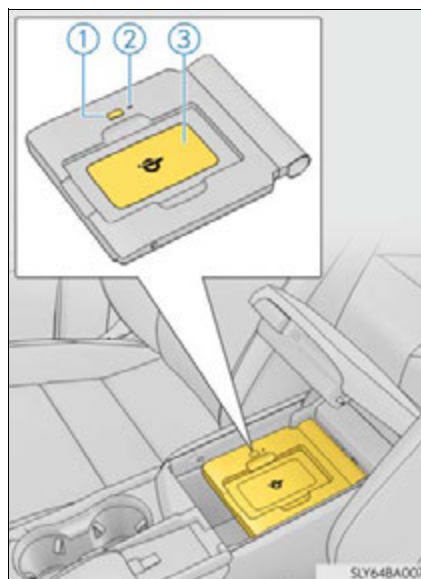

■ Using the wireless charger

1 Open the console box. (→P. 447)

2 Press the power supply switch of the wireless charger.

Switches on and off with each press of the power supply switch.

When turned on, the operation indicator light (green) comes on.

Even with the hybrid system off, the on/off state of the power supply switch is memorized.



3 Place the charging side of the portable device down.

When charging, the operation indicator light (orange) comes on.

If charging is not occurring, try placing the portable device as close to the center of the charging area as possible.

When charging is complete, the operation indicator light (green) comes on.

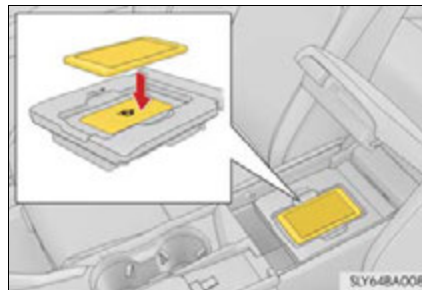

● Recharging function

- When charging is complete and after a fixed time in the charge suspension state, charging restarts.
- When the portable device is moved, charging is stopped for a moment and then it restarts.

■ Lighting conditions of operation indicator light

Operation indicator light	Conditions
Turning off	When the Wireless charger power supply is off
Green (comes on)	On Standby (charging possible state)
	When charging is complete*
Orange (comes on)	When placing the portable device on the charging area (detecting the portable device)
	Charging

*: Depending on the portable device, there are cases where the operation indicator light will continue being lit up orange even after the charging is complete.

● When the operation indicator light flashes

When an error occurs, the operation indicator light flashes an orange color. Handle the error based on the following table.

Operation indicator light	Suspected causes	Handling method
Flashing repeatedly once every second (Orange)	Vehicle to charger communication failure.	Contact your Lexus dealer.
Repeatedly flashes 3 times continuously (Orange)	A foreign substance is between the portable device and charge area.	Remove the foreign substance from between portable device and the charge area.
	The portable device is out of sync due to the device being shifted from its position.	Place the portable device near the center of the charge area.
Repeatedly flashes 4 times continuously (Orange)	Temperature rising within the wireless charger.	Stop charging at once and start charging again after for a while.

■ The wireless charger can be operated when

The power switch is in ACCESSORY or ON mode.

■ Usable portable devices

Qi standard wireless charge standard can be used on compatible devices. However, not all Qi standard devices and compatibility are guaranteed.

Starting with mobile phones and smart phones, it is aimed for low power electrically supplied portable devices of no more than 5W.

■ When covers and accessories are attached to portable devices

Do not charge in situations where cover and accessories not able to handle Qi are attached to the portable device. Depending on the type of cover and accessory, it may not be possible to charge. When charging is not performed even with the portable device placed on the charge area, remove the cover and accessories.

■ **While charging, noise enters the AM radio**

Turn off the wireless charger and confirm that the noise has decreased. If the noise decreases, continuously pushing the power supply switch of the wireless charger for 2 seconds, the frequency of the charger can be changed and the noise can be reduced. Also, on that occasion, the operation indicator light will flash orange 2 times.

■ **Important points of the wireless charger**

- If the electronic key cannot be detected within the vehicle interior, charging cannot be done. When the door is opened and closed, charging may be temporarily suspended.
- When charging, the wireless charging device and portable device will get warmer, however this is not a malfunction.
When a portable device gets warm while charging, charging may stop due to the protection function on the portable device side. In this case, when the temperature of the portable device drops significantly, charge again.

■ **Operation sounds**

When the power supply is turned on, while searching for the portable device a sound will be produced, however this is not a malfunction.

■ **Certification for the wireless charger**

FCC Note: This equipment has been tested and found to comply with Part 18 of the FCC Rules. These limits are designed to provide reasonable protection against harmful interference in a residential installation.

FCC Caution: Any changes or modifications not expressly approved by the party responsible for compliance could void the user's authority to operate this equipment.

Declaration of Conformity

Trade Name: Panasonic
 Model Numbers: CA-QS03J1AJ, CA-QS04H0AJ and CA-QS54H0AJ
 Responsible Party: Panasonic Corporation of North America
 Two Riverfront Plaza, Newark, NJ 07102-5490

This device complies with Part 18 of the FCC Rules. Operation is subject to the following two conditions:
 (1) This device may not cause harmful interference, and (2) this device must accept any interference received, including interference that may cause undesired operation.



Panasonic Corporation of North America
Two Riverfront Plaza Newark, NJ 07102-5490
Tel/Fax: 201-348-7738
Richard.Mullen@us.panasonic.com

FCC Declaration of Conformity

Product Name & Model Number	Panasonic In-Vehicle Wireless Charger Models CA-QS03J1AJ, CA-QS04H0AJ and CA-QS54H0AJ
FCC Rule Part	<ul style="list-style-type: none"> 47 CFR, FCC Part 18 for ISM Equipment FCC's KDB 0680106 D01 RF Exposure Wireless Charging Apps v02
Product Description	<ul style="list-style-type: none"> All In-Vehicle Wireless Chargers contain the same primary coil, type YEFXU90276 with rated power transfer operating frequency of 105-140 kHz, charge operating voltage of 100V peak-to-peak and output rating of DC 10.5-16.0V, 1A and 13.2 watts This product receives its operating power from host vehicle it is installed into and enables wireless battery charging of any mobile device with Qi mark placed onto its charging pad.
Special Conditions	<ul style="list-style-type: none"> Must be provided with product label with FCC logo. Must be provided with User Manual with responsible party's name, address and telephone number or website address. The subject In-Vehicle Wireless Charger must be installed and used exclusively within transportation vehicle.
Responsible Applicant	<p>Panasonic Corporation Automotive & Industrial Systems Company 4261, Honobe-cho, Tonzaki-ku Yokohama-shi, 224-8520, Japan Shuji Horii / Email: horii.shuji@jp.panasonic.com</p>
FCC Test Report	UL Japan EMI Test Report 10120384Y, dated December 24, 2013. This test report demonstrated compliance with FCC Part 18, Subpart C and Section 18.305(b) and was tested in accordance with test procedure ANSI C63.4-2003.
RF Exposure Evaluation	<p>UL Japan MPE Test Report 101971578-E, dated March 19, 2014.</p> <ul style="list-style-type: none"> Wireless Charging Pad complies with KDB 0680106 D01 RF Exposure Wireless Charging Apps v02. Test results for magnetic field strength is 0.391 (A/m) at 118 kHz charging mode and 30% of MPE limits for frequency range 110-200 kHz is 0.489 (A/m). Test results for electro-magnetic field strength is 147.40 (V/m) at 118 kHz charging mode and 30% of MPE limits for frequency range 110-200 kHz is 184.2 (V/m). <p>MPE limits comply with limits in Table 1(B), refer Test Report Section 5.</p>
Responsible Sales Company	<p>Panasonic Consumer Electronics Company Division of Panasonic Corporation of North America Two Riverfront Plaza, Newark, NJ 07102-5490 Support Contact: http://www.panasonic.com/contactinfo</p>

PSCD Ref No.: DoC 2014-008
Applicant Ref No.: PAS-14-F004

PSCD Issue Date:
March 25, 2014

Richard Mullen
Richard Mullen
Group Manager

 **WARNING****■ Caution while driving**

When charging a portable device, for safety reasons, the driver should not operate the main the part of the portable device while driving.

■ Caution regarding interference with electronic devices

People with implantable cardiac pacemakers, cardiac resynchronization therapy-pacemakers or implantable cardioverter defibrillators, as well as any other electrical medical device, should consult their physician about the usage of the wireless charger. The operations of the wireless charger may have an affect on medical devices.

■ To prevent damage or burns

Observe the following precautions.

Failure to do so may result in a possibility of equipment failure and damage, catch fire, burns due to overheat.

- Do not insert any metallic objects between the charging area and the portable device while charging
- Do not attach stickers, metallic objects, etc., to the charger area or portable device
- Do not cover with cloth, etc., and charge
- Do not charge portable devices other than designated
- Do not attempt to dismantle for disassembly or modifications
- Do not hit or apply a strong force

 NOTICE**■ Conditions in which the function may not operate correctly**

In the following conditions, it may not operate correctly

- The portable device is fully charged
- There is foreign matter between the charge area and portable device
- The temperature of the portable device gets higher from charging
- The charging surface of the portable device is facing up
- The placement of the portable device is out of alignment with the charge area
- Near a TV tower, electric power plant, gas station, radio station, large display, airport or other facility that generates strong radio waves or electrical noise
- When the electronic key is in contact with, or is covered by the following metallic objects
 - Cards to which aluminum foil is attached
 - Cigarette boxes that have aluminum foil inside
 - Metallic wallets or bags
 - Coins
 - Hand warmers made of metal
 - Media such as CDs and DVDs
- When other wireless keys (that emit radio waves) are being used nearby

In addition, excluding the above-mentioned, when the charger does not perform normally or the operation display lamp is flashing continuously, it is considered that the wireless charger is malfunctioning. Contact your Lexus dealer.

■ To prevent failure or damage to data

- Do not bring magnetic cards, such as credit cards, or magnetic recording media, etc., close to the charger while charging, otherwise, data may disappear under the influence of magnetism. Also, do not bring precision instruments such as wrist watches, etc., close to the charger, as such objects may break.
- Do not leave portable devices in the cabin. The temperature inside the cabin may become high, when under the sun, and cause damage to the device.

■ To prevent 12-volt battery discharge

When the hybrid system is stopped, do not use the wireless charger for a long time.

Armrest

Fold down the armrest for use.

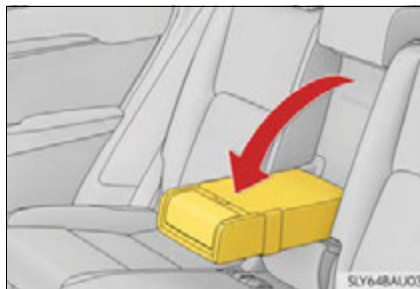

NOTICE

To prevent damage to the armrest, do not apply too much load on the armrest.

Assist grips

An assist grip installed on the ceiling can be used to support your body while sitting on the seat.

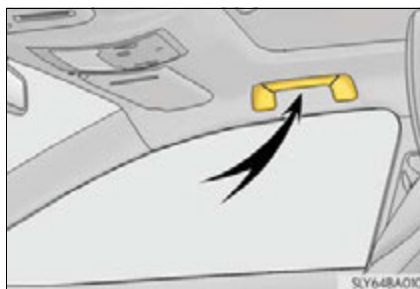

WARNING

Do not use the assist grip when getting in or out of the vehicle or rising from your seat.

NOTICE

To prevent damage to the assist grip, do not hang any heavy object or put a heavy load on the assist grip.

Coat hooks

The coat hooks are provided with the rear assist grips.

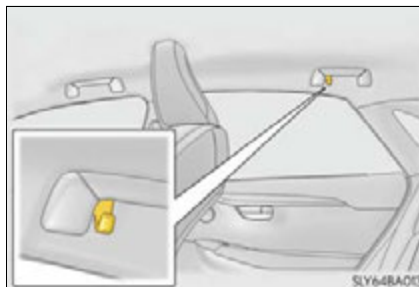

WARNING

Do not hang coat hangers or other hard or sharp objects on the hook. If the SRS curtain shield airbags deploy, these items may become projectiles, causing death or serious injury.

Garage door opener*

The garage door opener can be programmed to operate garage doors, gates, entry doors, door locks, home lighting systems, security systems, and other devices.

HomeLink®

The HomeLink® wireless control system in your vehicle has 3 buttons which can be programmed to operate 3 different devices. Refer to the programming methods on the following pages to determine the method which is appropriate for the device.

- ① HomeLink® indicator light
- ② Garage door operation indicators
- ③ Buttons

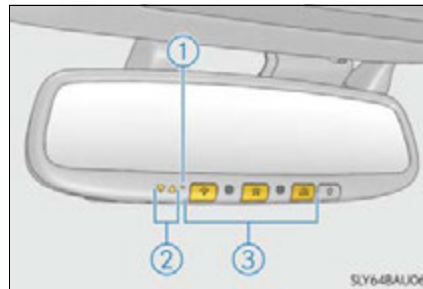

■ Before programming the HomeLink®

- During programming, it is possible that garage doors, gates, or other devices may operate. For this reason, make sure that people and objects are clear of the garage door or other devices to prevent injury or other potential harm.
- It is recommended that a new battery be placed in the remote control transmitter for more accurate programming.
- Garage door opener motors manufactured after 1995 may be equipped with rolling code protection. If this is the case, you may need a stepladder or other sturdy, safe device to reach the “Learn” or “Smart” button on the garage door opener motor.

*: If equipped

■ Programming HomeLink®

- 1 Press and release the HomeLink® button you want to program and check that the HomeLink® indicator light flashes orange.

Perform 3 within 60 seconds of 1, or the indicator light will stop flashing and programming will not be able to be completed.

- 2 Point the remote control transmitter for the device at the rear view mirror, 1 to 3 in. (25 to 75 mm) from the HomeLink® buttons.

Keep the HomeLink® indicator light in view while programming.

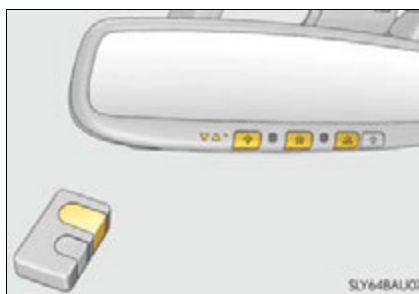

► For U.S.A. owners

- 3 Press and hold the remote control transmitter button until the HomeLink® indicator light changes from slowly flashing orange to rapidly flashing green (rolling code) or continuously lit green (fixed code), then release the button.



► Programming an entry gate (for U.S.A. owners)/Programming a device in the Canadian market

- 3 Press and release the remote control transmitter button at 2 second intervals, repeatedly, until the HomeLink® indicator light changes from slowly flashing orange to rapidly flashing green (rolling code) or continuously lit green (fixed code).

- 4 Test the HomeLink® operation by pressing the newly programmed button and observing the indicator light:

- Device with fixed code: If the indicator light is solid/continuous, programming has been completed and your garage door or other device should operate when the HomeLink® button is pressed and released.
- Device with rolling code: If the indicator light flashes rapidly, your garage door opener motor (or other device) is equipped with a rolling code. Complete the programming process by firmly pressing and holding the programmed HomeLink® button for 2 seconds and then release the button.

- If the garage door or other device does not operate, proceed to “Programming a rolling code system”.

- 5 Repeat the steps above to program another device for any of the remaining HomeLink® buttons.

■ Programming a rolling code system

- 1 Locate the “Learn” or “Smart” button on the garage door opener motor in the garage.

This button can usually be found where the hanging antenna wire is attached to the unit. The name and color of the button may vary by manufacturer. Refer to the Owner’s manual supplied with the garage door opener motor for details.

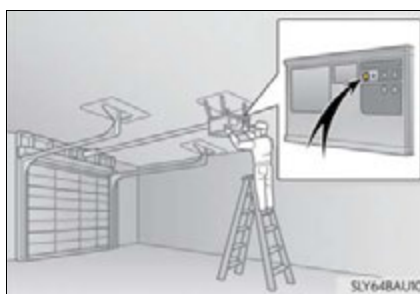

- 2 Press and release the “Learn” or “Smart” button.

Perform **3** within 30 seconds after performing **2**.

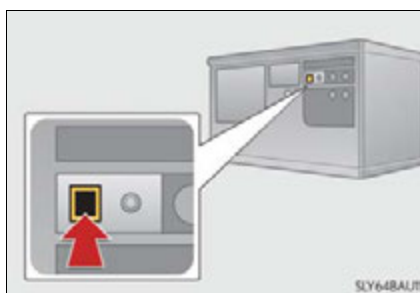

- 3 Press and hold the desired HomeLink® button (inside the vehicle) for 2 seconds and release it. Repeat this sequence (press/hold/release) up to 3 times to complete programming.

If the garage door opener motor operates when the HomeLink® button is pressed, the garage door opener motor recognizes the HomeLink® signal.



■ Enabling 2-way communication with a garage door (only available for compatible devices)

When enabled, 2-way communication allows you to check the status of the opening and closing of a garage door through indicators in your vehicle.

2-way communication is only available if the garage door opener motor used is a compatible device. (To check device compatibility, refer to www.HomeLink.com.)

- 1 Within 5 seconds after programming the garage door opener has been completed, if the garage door opener motor is trained to HomeLink[®], both garage door operation indicators will flash rapidly green and the light on the garage door opener motor will blink twice, indicating that 2-way communication is enabled.

If the indicators do not flash, perform **2** and **3** within the first 10 presses of the HomeLink[®] button after programming has been completed.

- 2 Press a programmed HomeLink[®] button to operate a garage door.
- 3 Within 1 minute of pressing the HomeLink[®] button, after the garage door operation has stopped, press the “Learn” or “Smart” button on the garage door opener motor. Within 5 seconds of the establishment of 2-way communication with the garage door opener, both garage door operation indicators in the vehicle will flash rapidly green and the light on the garage door opener motor will blink twice, indicating that 2-way communication is enabled.

■ Reprogramming a single HomeLink[®] button

When the following procedure is performed, buttons which already have devices registered to them can be overwritten:

- 1 With one hand, press and hold the desired HomeLink[®] button.
- 2 When the HomeLink[®] indicator starts flashing orange, continue to hold the HomeLink[®] button and perform “Programming HomeLink[®]” **1** (it takes 20 seconds for the HomeLink[®] indicator to start flashing).

Operating the HomeLink[®]

Press the appropriate HomeLink[®] button. The HomeLink[®] indicator light should turn on.

Garage door operation indicators

The status of the opening and closing of a garage door is shown by the indicators.

- ① Opening
- ② Closing

This function is only available if the garage door opener motor used is a compatible device. (To check device compatibility, refer to www.HomeLink.com.)

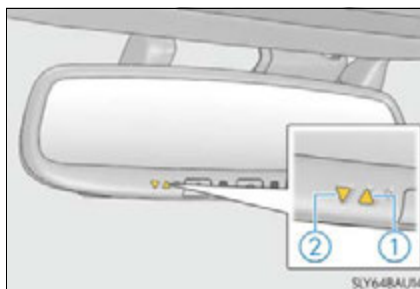

Color	Status
Orange (flashing)	Currently opening/closing
Green	Opening/closing has completed
Red (flashing)	Feedback signals cannot be received

The indicators can operate within approximately 820 ft. (250 m) of the garage door. However, if there are obstructions between the garage door and the vehicle, such as houses and trees, feedback signals from the garage door may not be received.

To recall the previous door operation status, press and release either HomeLink® buttons and or and simultaneously. The last recorded status will be displayed for 3 seconds.

Erasing the entire HomeLink® memory (all three codes)

Press and hold the 2 outside buttons for 10 seconds until the HomeLink® indicator light changes from continuously lit orange to rapidly flashing green.

If you sell your vehicle, be sure to erase the programs stored in the HomeLink® memory.

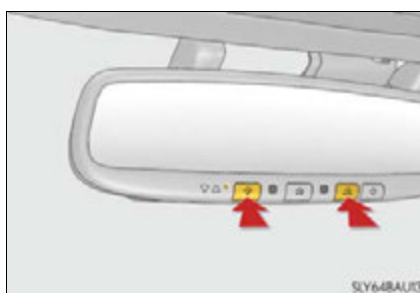

■ **Codes stored in the HomeLink® memory**

- The registered codes are not erased even if the battery cable is disconnected.
- If learning failed when registering a different code to a HomeLink® button that already has a code registered to it, the already registered code will not be erased.

■ **Before programming**

- Install a new battery in the transmitter.
- The battery side of the transmitter must be pointed away from the HomeLink®.

■ **Certification for the garage door opener**

- ▶ For vehicles sold in the U.S.A.

FCC ID: NZLAECHL5

NOTE:

This device complies with part 15 of the FCC Rules. Operation is subject to the following two conditions: (1) This device may not cause harmful interference, and (2) this device must accept any interference received, including interference that may cause undesired operation.

FCC WARNING:

Changes or modifications not expressly approved by the party responsible for compliance could void the user's authority to operate the equipment.

- ▶ For vehicles sold in Canada

NOTE:

This device complies with Industry Canada licence-exempt RSS standard(s).

Operation is subject to the following two conditions: (1) this device may not cause interference, and (2) this device must accept any interference, including interference that may cause undesired operation of the device.

REMARQUE:

Le présent appareil est conforme aux CNR d'Industrie Canada applicables aux appareils radio exempts de licence. L'exploitation est autorisée aux deux conditions suivantes: (1) l'appareil ne doit pas produire de brouillage, et (2) l'utilisateur de l'appareil doit accepter tout brouillage radioélectrique subi, même si le brouillage est susceptible d'en compromettre le fonctionnement.

■ **When support is necessary**

Visit on the web at www.homelink.com or call 1-800-355-3515.

 **WARNING**

- **When programming a garage door or other remote control device**
The garage door or other device may operate, so ensure people and objects are out of danger to prevent potential harm.
- **Conforming to federal safety standards**
Do not use the HomeLink® compatible transceiver with any garage door opener or device that lacks safety stop and reverse features as required by federal safety standards.
This includes any garage door that cannot detect an interfering object. A door or device without these features increases the risk of death or serious injury.
- **When operating or programming HomeLink®**
Never allow a child to operate or play with the HomeLink® buttons.

Compass*

The compass on the inside rear view mirror indicates the direction in which the vehicle is heading.

Operation

To turn the compass on or off, press the button for more than 3 seconds.

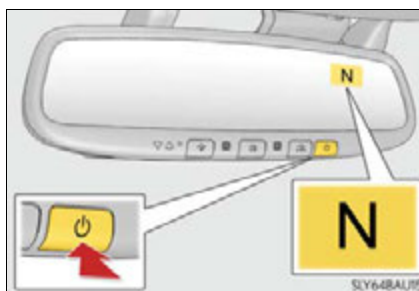

Displays and directions

Display	Direction
"N"	North
"NE"	Northeast
"E"	East
"SE"	Southeast
"S"	South
"SW"	Southwest
"W"	West
"NW"	Northwest

*: If equipped

Calibrating the compass



The direction display deviates from the true direction determined by the earth's magnetic field. The amount of deviation varies depending on the geographic position of the vehicle.

If you cross over one of the map boundaries shown in illustration, the compass will deviate.

To obtain higher precision or perfect calibration, refer to "Deviation calibration".

■ Deviation calibration

- 1 Stop the vehicle.
- 2 Press and hold the button for 6 seconds. A number (1 to 15) appears on the compass display.

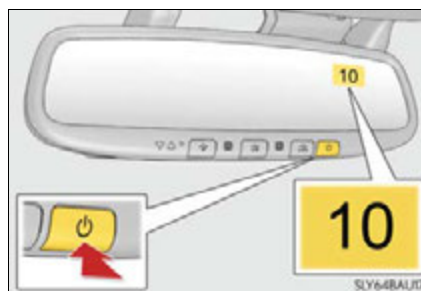

- 3 Referring to the map above, press the button to select the number of the zone you are in.

If the direction is displayed several seconds after adjustment, the calibration is complete.

■ Circling calibration

- 1 Stop the vehicle in a place where it is safe to drive in a circle.
- 2 Press and hold the button for 9 seconds.
"C" appears on the compass display.

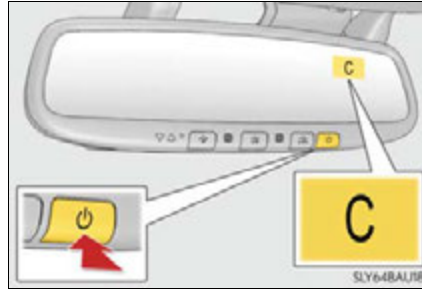

- 3 Drive the vehicle at 5 mph (8 km/h) or less in a circle until a direction is displayed.

If there is not enough space to drive in a circle, drive around the block until a direction is displayed.



■ Conditions unfavorable to correct operation

The compass may not show the correct direction in the following conditions:

- The vehicle is stopped immediately after turning.
- The vehicle is on an inclined surface.
- The vehicle is in a place where the earth's magnetic field is subject to interference by artificial magnetic fields (underground car park/parking lot, under a steel tower, between buildings, roof car park/parking lot, near an intersection, near a large vehicle, etc.).
- The vehicle has become magnetized. (There is a magnet or metal object near the inside rear view mirror.)
- The 12-volt battery has been disconnected.
- A door is open.

 **WARNING**

- **While driving the vehicle**
Do not adjust the display. Adjust the display only when the vehicle is stopped.
- **When doing the circling calibration**
Secure a wide space, and watch out for people and vehicles in the vicinity. Do not violate any local traffic rules while performing circling calibration.

 **NOTICE**

- **To avoid compass malfunctions**
Do not place magnets or any metal objects near the inside rear view mirror. Doing this may cause the compass sensor to malfunction.
- **To ensure normal operation of the compass**
 - Do not perform a circling calibration of the compass in a place where the earth's magnetic field is subject to interference by artificial magnetic fields.
 - During calibration, do not operate electric systems (moon roof, power windows, etc.) as they may interfere with the calibration.

Safety Connect*

Safety Connect is a subscription-based telematics service that uses Global Positioning System (GPS) data and embedded cellular technology to provide safety and security features to subscribers. Safety Connect is supported by Lexus' designated response center, which operates 24 hours per day, 7 days per week.

Safety Connect service is available by subscription on select, telematics hardware-equipped vehicles.

By using the Safety Connect service, you are agreeing to be bound by the Telematics Subscription Service Agreement and its Terms and Conditions, as in effect and amended from time to time, a current copy of which is available at Lexus.com. All use of the Safety Connect service is subject to such then-applicable Terms and Conditions.

System components

- ① Microphone
- ② "SOS" button
- ③ LED light indicators

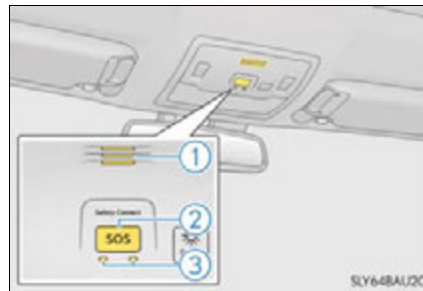

6

Interior features

*: If equipped

Services

Subscribers have the following Safety Connect services available:

- Automatic Collision Notification*
Helps drivers receive necessary response from emergency service providers.
(→P. 480)

*: U.S. Patent No. 7,508,298 B2

- Stolen Vehicle Location
Helps drivers in the event of vehicle theft. (→P. 480)
- Emergency Assistance Button (SOS)
Connects drivers to response-center support. (→P. 480)
- Enhanced Roadside Assistance
Provides drivers various on-road assistance. (→P. 480)

Subscription

After you have signed the Telematics Subscription Service Agreement and are enrolled, you can begin receiving services.

A variety of subscription terms is available for purchase. Contact your Lexus dealer, call 1-800-25-LEXUS (1-800-255-3987) or push the “SOS” button in your vehicle for further subscription details.

■ Safety Connect Services Information

- Phone calls using the vehicles Bluetooth® technology will not be possible during Safety Connect.
- Safety Connect is available beginning Fall 2009 on select Lexus models. Contact with the Safety Connect response center is dependent upon the telematics device being in operative condition, cellular connection availability, and GPS satellite signal reception, which can limit the ability to reach the response center or receive emergency service support. Enrollment and Telematics Subscription Service Agreement required. A variety of subscription terms is available; charges vary by subscription term selected.
- Automatic Collision Notification, Emergency Assistance and Stolen Vehicle Location will function in the United States, including Hawaii and Alaska, and in Canada, and Enhanced Roadside Assistance will function in the United States (except Hawaii) and in Canada. No Safety Connect services will function outside of the United States in countries other than Canada.
- Safety Connect services are not subject to section 255 of the Telecommunications Act and the device is not TTY compatible.

■ Languages

The Safety Connect response center will offer support in multiple languages. The Safety Connect system will offer voice prompts in English and Spanish. Please indicate your language of choice when enrolling.

■ When contacting the response center

You may be unable to contact the response center if the network is busy.

Safety Connect LED light Indicators

When the power switch is turned to ON mode, the red indicator light comes on for 2 seconds then turns off. Afterward, the green indicator light comes on, indicating that the service is active.

The following indicator light patterns indicate specific system usage conditions:

- Green indicator light on = Active service
- Green indicator light flashing = Safety Connect call in process
- Red indicator light (except at vehicle start-up) = System malfunction (contact your Lexus dealer)
- No indicator light (off) = Safety Connect service not active

Safety Connect services

■ Automatic Collision Notification

In case of either airbag deployment or severe rear-end collision, the system is designed to automatically call the response center. The responding agent receives the vehicle's location and attempts to speak with the vehicle occupants to assess the level of emergency. If the occupants are unable to communicate, the agent automatically treats the call as an emergency, contacts the nearest emergency services provider to describe the situation, and requests that assistance be sent to the location.

■ Stolen Vehicle Location

If your vehicle is stolen, Safety Connect can work with local authorities to assist them in locating and recovering the vehicle. After filing a police report, call the Safety Connect response center at 1-800-25-LEXUS (1-800-255-3987) and follow the prompts for Safety Connect to initiate this service.

In addition to assisting law enforcement with recovery of a stolen vehicle, Safety-Connect-equipped vehicle location data may, under certain circumstances, be shared with third parties to locate your vehicle. Further information is available at Lexus.com.

■ Emergency Assistance Button ("SOS")

In the event of an emergency on the road, push the "SOS" button to reach the Safety Connect response center. The answering agent will determine your vehicle's location, assess the emergency, and dispatch the necessary assistance required.

If you accidentally press the "SOS" button, tell the response-center agent that you are not experiencing an emergency.

■ Enhanced Roadside Assistance

Enhanced Roadside Assistance adds GPS data to the already included warranty-based Lexus roadside service.

Subscribers can press the "SOS" button to reach a Safety Connect response-center agent, who can help with a wide range of needs, such as: towing, flat tire, fuel delivery, etc. For a description of the Roadside Assistance services and their limitations, please see the Safety Connect Terms and Conditions, which are available at Lexus.com.

Safety information for Safety Connect

Important! Read this information before using Safety Connect.

■ Exposure to radio frequency signals

The Safety Connect system installed in your vehicle is a low-power radio transmitter and receiver. It receives and also sends out radio frequency (RF) signals.

In August 1996, the Federal Communications Commission (FCC) adopted RF exposure guidelines with safety levels for mobile wireless phones. Those guidelines are consistent with the safety standards previously set by the following U.S. and international standards bodies.

- ANSI (American National Standards Institute) C95.1 [1992]
- NCRP (National Council on Radiation Protection and Measurement) Report 86 [1986]
- ICNIRP (International Commission on Non-Ionizing Radiation Protection) [1996]

Those standards were based on comprehensive and periodic evaluations of the relevant scientific literature. Over 120 scientists, engineers, and physicians from universities, and government health agencies and industries reviewed the available body of research to develop the ANSI Standard (C95.1).

The design of Safety Connect complies with the FCC guidelines in addition to those standards.

■ Certification for Lexus Enform with Safety Connect

FCC ID: O6Y-CDMRF101
FCC ID: XOECDMRF101B
FCC ID: N7NGTM2

FCC WARNING:

This equipment complies with FCC radiation exposure limits set forth for an uncontrolled environment and meets the FCC radio frequency (RF) Exposure Guidelines in Supplement C to OET65. This equipment should be installed and operated keeping the radiator at least 20 cm or more away from person's body (excluding extremities: hands, wrists, feet and ankles).

7-1. Maintenance and care

- Cleaning and protecting the vehicle exterior.....484
- Cleaning and protecting the vehicle interior..... 488

7-2. Maintenance

- Maintenance requirements..... 491
- General maintenance..... 494
- Emission inspection and maintenance (I/M) programs497

7-3. Do-it-yourself maintenance

- Do-it-yourself service precautions.....498
- Hood 500
- Positioning a floor jack..... 501
- Engine compartment502
- 12-volt battery..... 512
- Tires..... 516
- Tire inflation pressure 525
- Wheels 528
- Air conditioning filter530
- Electronic key battery 532
- Checking and replacing fuses.....534
- Light bulbs.....538

Cleaning and protecting the vehicle exterior

Perform the following to protect the vehicle and maintain it in prime condition:

- Working from top to bottom, liberally apply water to the vehicle body, wheel wells and underside of the vehicle to remove any dirt and dust.
- Wash the vehicle body using a sponge or soft cloth, such as a chamois.
- For hard-to-remove marks, use car wash soap and rinse thoroughly with water.
- Wipe away any water.
- Wax the vehicle when the waterproof coating deteriorates.

If water does not bead on a clean surface, apply wax when the vehicle body is cool.

■ Self-restoring coat

The vehicle body has a self-restoring coating that is resistant to small surface scratches caused in a car wash etc.

- The coating lasts for 5 to 8 years after the coating has been performed.
- The restoration time differs depending on the depth of the scratch and outside temperature. The restoration time may become shorter when the coating is warmed by applying warm water.
- Deep scratches caused by keys or coins cannot be restored.
- Do not use wax that contain abrasives.

■ Automatic car washes

- Before washing the vehicle:
 - Fold the mirrors
 - Turn off the power back door (if equipped)Start washing from the front of the vehicle. Extend the mirrors before driving.
- Brushes used in automatic car washes may scratch the vehicle surface and harm your vehicle's paint.
- Rear spoiler may not be washable in some automatic car washes. There may also be an increased risk of damage to vehicle.

■ High pressure car washes

- Do not allow the nozzles of the car wash to come within close proximity of the windows.
- Before using the car wash, check that the fuel filler door on your vehicle is closed properly.

■ Note for a smart access system with push-button start

- If the door handle becomes wet while the electronic key is within the effective range, the door may lock and unlock repeatedly. Place the key in a position 6 ft. (2 m) or more separate from the vehicle while the vehicle is being washed. (Take care to ensure that the key is not stolen.)
- If the electronic key is inside the vehicle and a door handle becomes wet during a car wash, a buzzer will sound outside the vehicle. To turn off the alarm, lock all the doors.
- Set the electronic key to battery-saving mode to disable the smart access system with push-button start. (→P. 141)

■ Aluminum wheels

- Remove any dirt immediately by using a neutral detergent. Do not use hard brushes or abrasive cleaners. Do not use strong or harsh chemical cleaners. Use the same mild detergent and wax as used on the paint.
- Do not use detergent on the wheels when they are hot, for example after driving for long distance in the hot weather.
- Wash detergent from the wheels immediately after use.

■ Bumpers

Do not scrub with abrasive cleaners.

■ Front side windows water-repellent coating (vehicles with water-repellent coating)

- The following precautions can extend the effectiveness of the water-repellent coating.
 - Remove any dirt, etc. from the front side windows regularly.
 - Do not allow dirt and dust to accumulate on the windows for a long period. Clean the windows with a soft, damp cloth as soon as possible.
 - Do not use wax or glass cleaners that contain abrasives when cleaning the windows.
 - Do not use any metallic objects to remove condensation build up.
- When the water-repellent performance has become insufficient, the coating can be repaired. Contact your Lexus dealer.

⚠ WARNING

■ **When washing the vehicle**
Do not apply water to the inside of the engine compartment. Doing so may cause the electrical components etc. to catch fire.

■ **When cleaning the windshield (vehicles with rain-sensing windshield wipers)**
Set the wiper switch to off.
If the switch is in "AUTO", the wipers may operate unexpectedly in the following situations, and may result in hands being caught or other serious injuries and cause damage to the wiper blades.

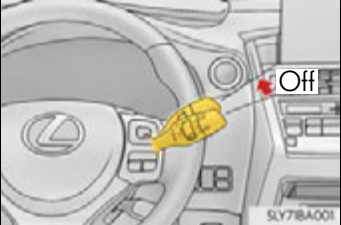

- When the upper part of the windshield where the raindrop sensor is located is touched by hand
- When a wet rag or similar is held close to the raindrop sensor
- If something bumps against the windshield
- If you directly touch the raindrop sensor body or if something bumps into the raindrop sensor

■ **Precautions regarding the exhaust pipe**
Exhaust gasses cause the exhaust pipe to become quite hot.
When washing the vehicle, be careful not to touch the pipe until it has cooled sufficiently, as touching a hot exhaust pipe can cause burns.

■ **Precautions regarding the rear bumper with Blind Spot Monitor (if equipped)**
If the paint of the rear bumper is chipped or scratched, the system may malfunction. If this occurs, consult your Lexus dealer.

 NOTICE**■ To prevent paint deterioration and corrosion on the body and components (aluminum wheels etc.)**

- Wash the vehicle immediately in the following cases:
 - After driving near the sea coast
 - After driving on salted roads
 - If coal tar or tree sap is present on the paint surface
 - If dead insects, insect droppings or bird droppings are present on the paint surface
 - After driving in an area contaminated with soot, oily smoke, mine dust, iron powder or chemical substances
 - If the vehicle becomes heavily soiled with dust or mud
 - If liquids such as benzene and gasoline are spilled on the paint surface
- If the paint is chipped or scratched, have it repaired immediately.
- To prevent the wheels from corroding, remove any dirt and store in a place with low humidity when storing the wheels.

■ Cleaning the exterior lights

- Wash carefully. Do not use organic substances or scrub with a hard brush. This may damage the surfaces of the lights.
- Do not apply wax to the surfaces of the lights. Wax may cause damage to the lenses.

■ To prevent damage to the windshield wiper arms

When lifting the wiper arms away from the windshield, pull the driver side wiper arm upward first, and repeat for the passenger side. When returning the wipers to their original position, do so from the passenger side first.

■ When using an automatic car wash (vehicles with rain-sensing windshield wipers)

Set the wiper switch to the off position.
If the wiper switch is in "AUTO", the wipers may operate and the wiper blades may be damaged.

■ When using a high pressure car wash

- When washing the vehicle, do not let water of the high pressure washer hit directly or the vicinity of the camera. Due to the shock from the high pressure water, it is possible the device may not operate as normal.
- Do not bring the nozzle tip close to boots (rubber or resin manufactured cover), connectors or the following parts. The parts may be damaged if they come into contact with high-pressure water.
 - Traction related parts
 - Steering parts
 - Suspension parts
 - Brake parts

Cleaning and protecting the vehicle interior

The following procedures will help protect your vehicle's interior and keep it in top condition:

Protecting the vehicle interior

Remove dirt and dust using a vacuum cleaner. Wipe dirty surfaces with a cloth dampened with lukewarm water.

Cleaning the leather areas

- Remove dirt and dust using a vacuum cleaner.
- Wipe off any excess dirt and dust with a soft cloth dampened with diluted detergent.
Use a diluted water solution of approximately 5% neutral wool detergent.
- Wring out any excess water from the cloth and thoroughly wipe off all remaining traces of detergent.
- Wipe the surface with a dry, soft cloth to remove any remaining moisture. Allow the leather to dry in a shaded and ventilated area.

Cleaning the synthetic leather areas

- Remove loose dirt using a vacuum cleaner.
- Apply a mild soap solution to the synthetic leather using a sponge or soft cloth.
- Allow the solution to soak in for a few minutes. Remove the dirt and wipe off the solution with a clean, damp cloth.

■ Caring for leather areas

Lexus recommends cleaning the interior of the vehicle at least twice a year to maintain the quality of the vehicle's interior.

■ Shampooing the carpets

There are several commercial foaming-type cleaners available. Use a sponge or brush to apply the foam. Rub in overlapping circles. Do not use water. Wipe dirty surfaces and let them dry. Excellent results are obtained by keeping the carpet as dry as possible.

■ Seat belts

Clean with mild soap and lukewarm water using a cloth or sponge. Also check the belts periodically for excessive wear, fraying or cuts.

■ Front side windows with UV protective coating

The front side windows have UV protective coating. To prevent any damage to the UV protective coating, observe the following:

- If the windows are dirty, gently wipe them with a cloth soaked in water or lukewarm water as soon as possible.
- If the windows are very dirty, do not open and close them repeatedly.



WARNING

■ Water in the vehicle

- Do not splash or spill liquid in the vehicle, such as on the floor, in the hybrid battery (traction battery) air vents, and in the luggage compartment. Doing so may cause the hybrid battery, electrical components, etc. to malfunction or catch fire.
- Do not get any of the SRS components or wiring in the vehicle interior wet. (→P. 42)
An electrical malfunction may cause the airbags to deploy or not function properly, resulting in death or serious injury.

■ Cleaning the interior (especially instrument panel)

Do not use polish wax or polish cleaner. The instrument panel may reflect off the windshield, obstructing the driver's view and leading to an accident, resulting in death or serious injury.

 NOTICE**■ Cleaning detergents**

- Do not use the following types of detergent, as they may discolor the vehicle interior or cause streaks or damage to painted surfaces:
 - Non-seat portions: Organic substances such as benzene or gasoline, alkaline or acidic solutions, dye, and bleach
 - Seats: Alkaline or acidic solutions, such as thinner, benzene, and alcohol
- Do not use polish wax or polish cleaner. The instrument panel's or other interior part's painted surface may be damaged.

■ Preventing damage to leather surfaces

Observe the following precautions to avoid damage to and deterioration of leather surfaces:

- Remove any dust or dirt from leather surfaces immediately.
- Do not expose the vehicle to direct sunlight for extended periods of time. Park the vehicle in the shade, especially during summer.
- Do not place items made of vinyl, plastic, or containing wax on the upholstery, as they may stick to the leather surface if the vehicle interior heats up significantly.

■ Water on the floor

Do not wash the vehicle floor with water.

Vehicle systems such as the audio system may be damaged if water comes into contact with electrical components such as the audio system above or under the floor of the vehicle. Water may also cause the body to rust.

■ When cleaning the inside of the windshield (vehicles with LDA [Lane Departure Alert] or Automatic High Beam)

Be careful not to touch the camera sensor (→P. 270).

If the camera is accidentally scratched or hit, LDA and Automatic High Beam may not operate properly or may cause a malfunction.

■ Cleaning the inside of the rear window

- Do not use glass cleaner to clean the rear window, as this may cause damage to the rear window defogger heater wires or antenna. Use a cloth dampened with lukewarm water to gently wipe the window clean. Wipe the window in strokes running parallel to the heater wires or antenna.
- Be careful not to scratch or damage the heater wires or antenna.

■ Cleaning the front side windows

Do not use any compound or abrasive product (e.g., glass cleaner, detergent, wax) to clean the windows. It may damage the coating.

Maintenance requirements

To ensure safe and economical driving, day-to-day care and regular maintenance are essential. It is the owner's responsibility to perform regular checks. Lexus recommends the following maintenance:

General maintenance

General maintenance should be performed on a daily basis. This can be done by yourself or by a Lexus dealer.

Scheduled maintenance

Scheduled maintenance should be performed at specified intervals according to the maintenance schedule.

For details about maintenance items and schedules, refer to the "Warranty and Service Guide", "Owner's Manual Supplement" or "Scheduled Maintenance".

Do-it-yourself maintenance

You can perform some maintenance procedures by yourself.

Please be aware that do-it-yourself maintenance may affect warranty coverage.

The use of Lexus repair manuals is recommended.

For details about warranty coverage, refer to the separate "Owner's Guide", "Warranty and Service Guide", "Owner's Manual Supplement" or "Warranty Booklet".

■ **Repair and replacement**

It is recommended that genuine Lexus parts be used for repairs to ensure performance of each system. If non-Lexus parts are used in replacement or if a repair shop other than a Lexus dealer performs repairs, confirm the warranty coverage.





■ **Resetting the message indicating maintenance is required (U.S.A. only)**

After the required maintenance is performed according to the maintenance schedule, please reset the message.



To reset the message, follow the procedures described below:

- 1 Press  of the meter control switch.

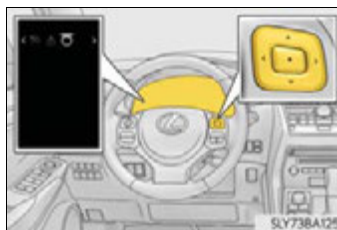

- 2 Press  or  of the meter control switch, select , and then press .



- 3 Press  or  of the meter control switch, select the "Scheduled Maintenance" screen and then press and hold the .



- 4 Select the "Yes" and push .

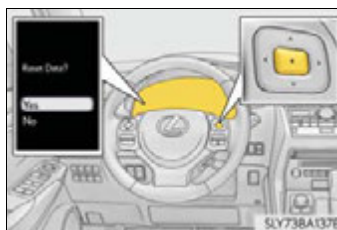

- 5 A message is displayed on the multi-information display.



■ **Allow inspection and repairs to be performed by a Lexus dealer**

- Lexus technicians are well-trained specialists and are kept up to date with the latest service information. They are well informed about the operation of all systems on your vehicle.
- Keep a copy of the repair order. It proves that the maintenance that has been performed is under warranty coverage. If any problem should arise while your vehicle is under warranty, your Lexus dealer will promptly take care of it.

⚠ WARNING

■ **If your vehicle is not properly maintained**

Improper maintenance could result in serious damage to the vehicle and possible serious injury or death.

■ **Handling of the 12-volt battery**

- Engine exhaust, some of its constituents, and a wide variety of automobile components contain or emit chemicals known to the State of California to cause cancer and birth defects and other reproductive harm. Work in a well ventilated area.
- Oils, fuels and fluids contained in vehicles as well as waste produced by component wear contain or emit chemicals known to the State of California to cause cancer and birth defects or other reproductive harm. Avoid exposure and wash any affected area immediately.
- 12-volt battery posts, terminals and related accessories contain lead and lead compounds which are known to cause brain damage. Wash your hands after handling. (→P. 512)

General maintenance

Listed below are the general maintenance items that should be performed at the intervals specified in the “Warranty and Service Guide” or “Owner’s Manual Supplement”. It is recommended that any problem you notice should be brought to the attention of your Lexus dealer or qualified service shop for advice.

Engine compartment

Items	Check points
Brake fluid	Is the brake fluid at the correct level? (→P. 510)
Engine/power control unit coolant	Is the engine coolant at the correct level? (→P. 508)
Engine oil	Is the engine oil at the correct level? (→P. 504)
Exhaust system	There should not be any fumes or strange sounds.
Radiator/condenser	The radiator and condenser should be free from foreign objects. (→P. 509)
Washer fluid	Is there sufficient washer fluid? (→P. 511)

Luggage compartment

Items	Check points
12-volt battery	Check the connections. (→P. 512)

Vehicle interior

Items	Check points
Accelerator pedal	<ul style="list-style-type: none"> The accelerator pedal should move smoothly (without uneven pedal effort or catching).
Brake pedal	<ul style="list-style-type: none"> Does the brake pedal move smoothly? Does the brake pedal have appropriate clearance from the floor? (→P. 612) Does the brake pedal have the correct amount of free play? (→P. 612)
Brakes	<ul style="list-style-type: none"> The vehicle should not pull to one side when the brakes are applied. The brakes should work effectively. The brake pedal should not feel spongy. The brake pedal should not get too close to the floor when the brakes are applied.
Head restraints	<ul style="list-style-type: none"> Do the head restraints move smoothly and lock securely?
Hybrid transmission "Park" mechanism	<ul style="list-style-type: none"> When parked on a slope and the shift lever is in P, is the vehicle securely stopped?
Indicators/buzzers	<ul style="list-style-type: none"> Do the indicators and buzzers function properly?
Lights	<ul style="list-style-type: none"> Do all the lights come on?
Parking brake	<ul style="list-style-type: none"> Does the parking brake switch operate normally? When parked on a slope and the parking brake is on, is the vehicle securely stopped?
Seat belts	<ul style="list-style-type: none"> Do the seat belts operate smoothly? The seat belts should not be damaged.
Seats	<ul style="list-style-type: none"> Do the seat controls operate properly?
Steering wheel	<ul style="list-style-type: none"> Does the steering wheel rotate smoothly? Does the steering wheel have the correct amount of free play? There should not be any strange sounds coming from the steering wheel.

Vehicle exterior

Items	Check points
Doors	<ul style="list-style-type: none"> Do the doors operate smoothly?
Engine hood	<ul style="list-style-type: none"> Does the engine hood lock system work properly?
Fluid leaks	<ul style="list-style-type: none"> There should not be any signs of fluid leakage after the vehicle has been parked.
Tires	<ul style="list-style-type: none"> Is the tire inflation pressure correct? The tires should not be damaged or excessively worn. Have the tires been rotated according to the maintenance schedule? The wheel nuts should not be loose.
Windshield wipers/ rear window wiper	<ul style="list-style-type: none"> The wiper blades should not show any signs of cracking, splitting, wear, contamination or deformation. The wiper blades should clear the windshield/rear window without streaking or skipping.

 **WARNING**

■ If the hybrid system is operating

Turn the hybrid system off and ensure that there is adequate ventilation before performing maintenance checks.

Emission inspection and maintenance (I/M) programs

Some states have vehicle emission inspection programs which include OBD (On Board Diagnostics) checks. The OBD system monitors the operation of the emission control system.

If the malfunction indicator lamp comes on

The OBD system determines that a problem exists somewhere in the emission control system. Your vehicle may not pass the I/M test and may need to be repaired. Contact your Lexus dealer to service the vehicle.

Your vehicle may not pass the I/M test in the following situations:

- When the 12-volt battery is disconnected or discharged
Readiness codes that are set during ordinary driving are erased. Also, depending on your driving habits, the readiness codes may not be completely set.
- When the fuel tank cap is loose
The malfunction indicator lamp comes on indicating a temporary malfunction and your vehicle may not pass the I/M test.

When the malfunction indicator lamp still remains on after several driving trips

The error code in the OBD system will not be cleared unless the vehicle is driven 40 or more times.

If your vehicle does not pass the I/M test

Contact your Lexus dealer to prepare the vehicle for re-testing.

Do-it-yourself service precautions

If you perform maintenance by yourself, be sure to follow the correct procedure as given in these sections.

Items	Parts and tools
12-volt battery condition (→P. 512)	<ul style="list-style-type: none"> • Grease • Conventional wrench (for terminal clamp bolts)
Brake fluid level (→P. 510)	<ul style="list-style-type: none"> • FMVSS No.116 DOT 3 or SAE J1703 brake fluid • Rag or paper towel • Funnel (used only for adding brake fluid)
Engine/power control unit coolant level (→P. 508)	<ul style="list-style-type: none"> • "Toyota Super Long Life Coolant" or a similar high quality ethylene glycol-based non-silicate, non-amine, non-nitrite and non-borate coolant with long-life hybrid organic acid technology For the U.S.A.: "Toyota Super Long Life Coolant" is pre-mixed with 50% coolant and 50% deionized water. For Canada: "Toyota Super Long Life Coolant" is pre-mixed with 55% coolant and 45% deionized water. • Funnel (used only for adding coolant)
Engine oil level (→P. 504)	<ul style="list-style-type: none"> • "Toyota Genuine Motor Oil" or equivalent • Rag or paper towel • Funnel (used only for adding engine oil)
Fuses (→P. 534)	<ul style="list-style-type: none"> • Fuse with same amperage rating as original
Light bulbs (→P. 538)	<ul style="list-style-type: none"> • Bulb with same number and wattage rating as original • Phillips-head screwdriver • Flathead screwdriver • Wrench
Radiator and condenser (→P. 509)	—
Tire inflation pressure (→P. 525)	<ul style="list-style-type: none"> • Tire pressure gauge • Compressed air source
Washer fluid (→P. 511)	<ul style="list-style-type: none"> • Water or washer fluid containing antifreeze (for winter use) • Funnel (used only for adding water or washer fluid)

 **WARNING**

The engine compartment contains many mechanisms and fluids that may move suddenly, become hot, or become electrically energized. To avoid death or serious injury, observe the following precautions.

■ When working on the engine compartment

- Make sure that the indicator on the power switch and the "READY" indicator are both off.
- Keep hands, clothing and tools away from the moving fan and engine drive belt.
- Be careful not to touch the engine, power control unit, radiator, exhaust manifold, etc. right after driving as they may be hot. Oil and other fluids may also be hot.
- Do not leave anything that may burn easily, such as paper and rags, in the engine compartment.
- Do not smoke, cause sparks or expose an open flame to fuel. Fuel fumes are flammable.

■ When working near the electric cooling fans or radiator grille

Be sure the power switch is off.

With the power switch in ON mode, the electric cooling fans may automatically start to run if the air conditioning is on and/or the coolant temperature is high. (→P. 509)

■ Safety glasses

Wear safety glasses to prevent flying or falling material, fluid spray, etc. from getting in your eyes.

 **NOTICE****■ If you remove the air cleaner filter**

Driving with the air cleaner filter removed may cause excessive engine wear due to dirt in the air.

Hood

Release the lock from the inside of the vehicle to open the hood.

- 1 Pull the hood lock release lever.
The hood will pop up slightly.

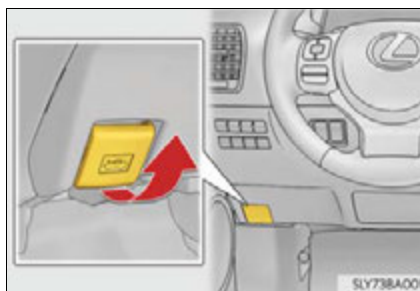

- 2 Pull up the auxiliary catch lever and lift the hood.

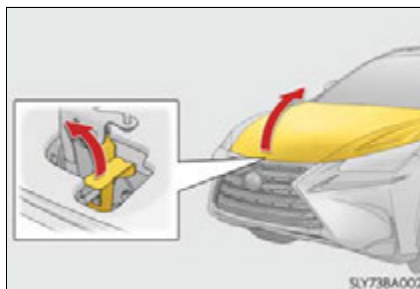

WARNING

■ Pre-driving check

Check that the hood is fully closed and locked.
If the hood is not locked properly, it may open while the vehicle is in motion and cause an accident, which may result in death or serious injury.

Positioning a floor jack

When using a floor jack, follow the instructions in the manual provided with the jack and perform the operation safely.

When raising your vehicle with a floor jack, position the jack correctly. Improper placement may damage your vehicle or cause injury.

◆ Front

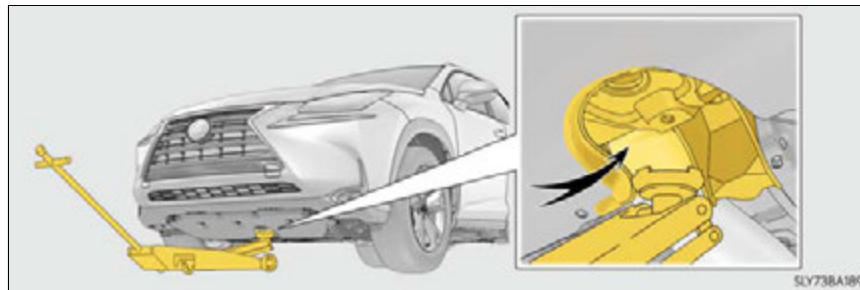

◆ Rear

1 Before raising your vehicle with a floor jack: Remove the cover.

- ① Remove the bolt
- ② Remove the cover

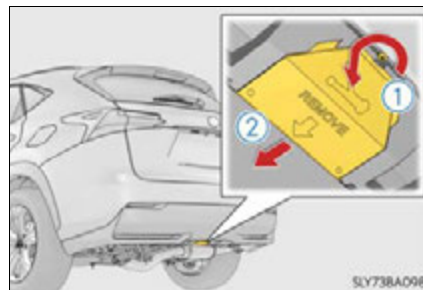

2 Raising your vehicle with a floor jack.

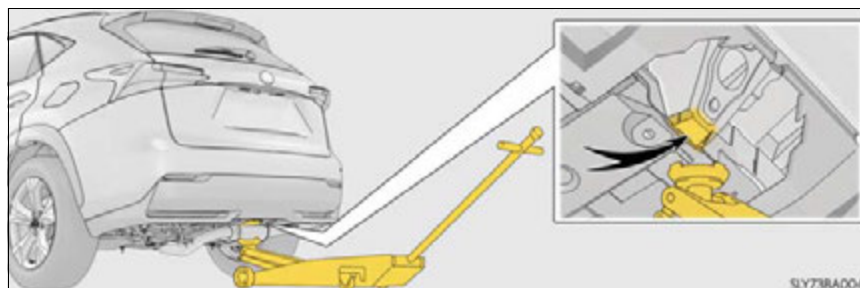

Engine compartment

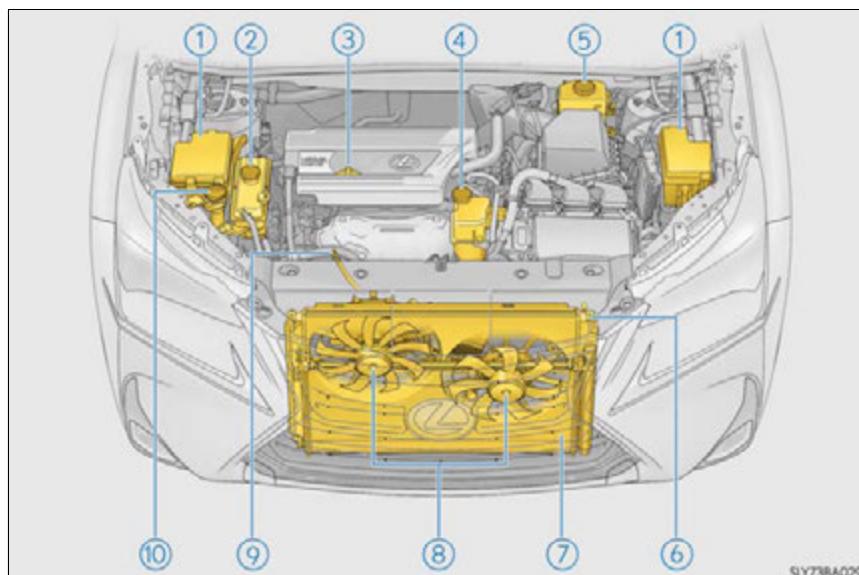

- | | | | |
|--|-----------|-----------------------------|-----------|
| ① Fuse box | (→P. 534) | ⑥ Radiator | (→P. 509) |
| ② Engine coolant reservoir | (→P. 508) | ⑦ Condenser | (→P. 509) |
| ③ Engine oil filler cap | (→P. 505) | ⑧ Electric cooling fans | |
| ④ Power control unit coolant reservoir | (→P. 508) | ⑨ Engine oil level dipstick | (→P. 504) |
| ⑤ Brake fluid reservoir | (→P. 510) | ⑩ Washer fluid tank | (→P. 511) |

■ 12-volt battery
→P. 512

Engine compartment cover

■ Removing the engine compartment cover

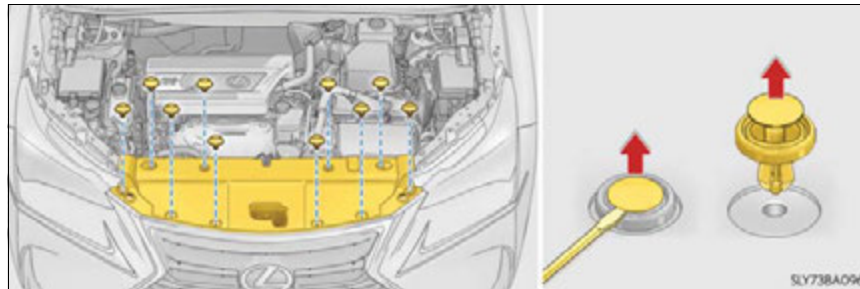

■ Installing the clips

- ① Insert
- ② Press



⚠ NOTICE

- **After installing an engine compartment cover**
Make sure that the cover is securely installed in its original position.

Engine oil

With the engine at operating temperature and turned off, check the oil level on the dipstick.

■ Checking the engine oil

- 1 Park the vehicle on level ground. After warming up the engine and turning off the hybrid system, wait more than 5 minutes for the oil to drain back into the bottom of the engine.
- 2 Holding a rag under the end, pull the dipstick out.

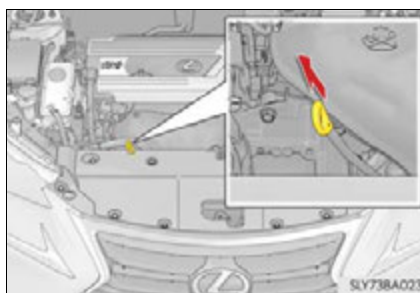

- 3 Wipe the dipstick clean.
- 4 Reinsert the dipstick fully with its protruding areas (1 in the illustration) pointing towards engine.



- 5 Holding a rag under the end, pull the dipstick out and check the oil level.
 - 1 Low
 - 2 Normal
 - 3 Excessive

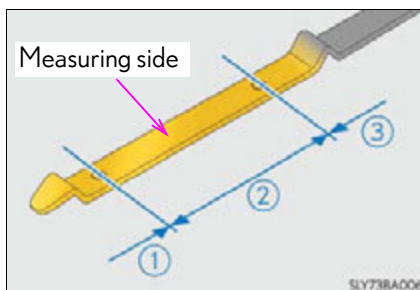

- 6 Wipe the dipstick and reinsert it fully.

■ Adding engine oil

If the oil level is below or near the low level mark, add engine oil of the same type as that already in the engine.



Make sure to check the oil type and prepare the items needed before adding oil.

Engine oil selection	→P. 610
Oil quantity (Low → Full)	1.6 qt. (1.5 L, 1.3 Imp.qt.)
Items	Clean funnel

- 1 Remove the oil filler cap by turning it counterclockwise.
- 2 Add engine oil slowly, checking the dipstick.
- 3 Install the oil filler cap by turning it clockwise.

■ Engine oil consumption

A certain amount of engine oil will be consumed while driving. In the following situations, oil consumption may increase, and engine oil may need to be refilled in between oil maintenance intervals.





- When the engine is new, for example directly after purchasing the vehicle or after replacing the engine
- If low quality oil or oil of an inappropriate viscosity is used
- When driving at high engine speeds or with a heavy load, when towing, or when driving while accelerating or decelerating frequently
- When leaving the engine idling for a long time, or when driving frequently through heavy traffic

■ After changing the engine oil



The engine oil maintenance data should be reset. Perform the following procedures:

- 1 Press  of the meter control switch.

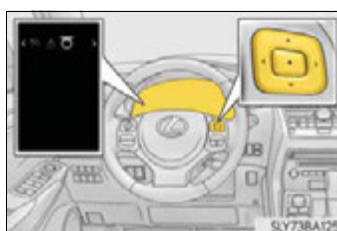

- 2 Press  or  of the meter control switch, select , and then press .



- 3 Press  or  of the meter control switch, select the "Oil Maintenance" screen and then press and hold the .



- 4 Select the "Yes" and push .



- 5 A message is displayed on the multi-information display.

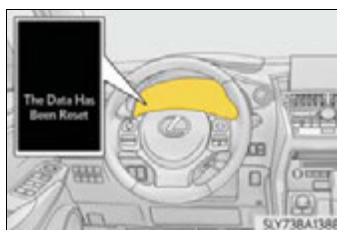

 **WARNING****■ Used engine oil**

- Used engine oil contains potentially harmful contaminants which may cause skin disorders such as inflammation and skin cancer, so care should be taken to avoid prolonged and repeated contact. To remove used engine oil from your skin, wash thoroughly with soap and water.
- Dispose of used oil and filters only in a safe and acceptable manner. Do not dispose of used oil and filters in household trash, in sewers or onto the ground. Call your Lexus dealer, service station or auto parts store for information concerning recycling or disposal.
- Do not leave used engine oil within the reach of children.

 **NOTICE****■ To prevent serious engine damage**

Check the oil level on a regular basis.

■ When replacing the engine oil

- Be careful not to spill engine oil on the vehicle components.
- Avoid overfilling, or the engine could be damaged.
- Check the oil level on the dipstick every time you refill the vehicle.
- Be sure the engine oil filler cap is properly tightened.

Coolant

The coolant level is satisfactory if it is between the “FULL” and “LOW” lines on the reservoir when the hybrid system is cold.

■ Engine coolant reservoir

- ① Reservoir cap
- ② “FULL” line
- ③ “LOW” line

If the level is on or below the “LOW” line, add coolant up to the “FULL” line. (→P. 599)

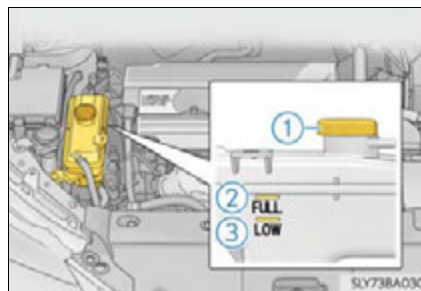

■ Power control unit coolant reservoir

- ① Reservoir cap
- ② “FULL” line
- ③ “LOW” line

If the level is on or below the “LOW” line, add coolant up to the “FULL” line.

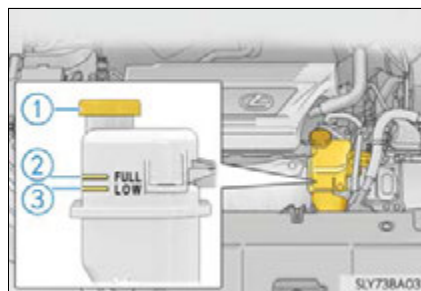

■ Coolant selection

Only use “Toyota Super Long Life Coolant” or a similar high quality ethylene glycol based non-silicate, non-amine, non-nitrite, and non-borate coolant with long-life hybrid organic acid technology.

U.S.A.:

“Toyota Super Long Life Coolant” is a mixture of 50% coolant and 50% deionized water. (Minimum temperature: -31°F [-35°C])

Canada:

“Toyota Super Long Life Coolant” is a mixture of 55% coolant and 45% deionized water. (Minimum temperature: -44°F [-42°C])

For more details about coolant, contact your Lexus dealer.

■ If the coolant level drops within a short time of replenishing

Visually check the radiator, hoses, engine/power control unit coolant reservoir caps, drain cock and water pump.

If you cannot find a leak, have your Lexus dealer test the cap and check for leaks in the cooling system.

⚠ WARNING**■ When the hybrid system is hot**

Do not remove the engine/power control unit coolant reservoir caps. The cooling system may be under pressure and may spray hot coolant if the cap is removed, causing serious injuries, such as burns.

⚠ NOTICE**■ When adding coolant**

Coolant is neither plain water nor straight antifreeze. The correct mixture of water and antifreeze must be used to provide proper lubrication, corrosion protection and cooling. Be sure to read the antifreeze or coolant label.

■ If you spill coolant

Be sure to wash it off with water to prevent it from damaging parts or paint.

Radiator and condenser

Check the radiator and condenser and clear away any foreign objects. If either of the above parts is extremely dirty or you are not sure of their condition, have your vehicle inspected by your Lexus dealer.

⚠ WARNING**■ When the hybrid system is hot**

Do not touch the radiator or condenser as they may be hot and cause serious injuries, such as burns.

■ When the electric cooling fans are operating

Do not touch the engine compartment. With the power switch in ON mode, the electric cooling fans may automatically start to run if the air conditioning is on and/or the coolant temperature is high. Be sure the power switch is off when working near the electric cooling fans or radiator grille.

Brake fluid

■ Checking fluid level

The brake fluid level should be between the “MAX” and “MIN” lines on the tank.

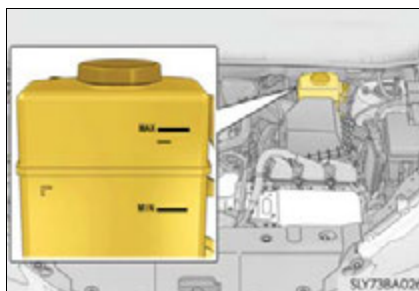

■ Adding fluid

Make sure to check the fluid type and prepare the necessary item.

Fluid type	FMVSS No.116 DOT 3 or SAE J1703 brake fluid
Items	Clean funnel

■ Brake fluid can absorb moisture from the air

Excess moisture in the brake fluid can cause a dangerous loss of braking efficiency. Use only newly opened brake fluid.

⚠ WARNING

■ When filling the reservoir

Take care as brake fluid can harm your hands and eyes and damage painted surfaces. If fluid gets on your hands or in your eyes, flush the affected area with clean water immediately.

If you still experience discomfort, see a doctor.

⚠ NOTICE

■ If the fluid level is low or high

It is normal for the brake fluid level to go down slightly as the brake pads wear out or when the fluid level in the accumulator is high.

If the reservoir needs frequent refilling, there may be a serious problem.

Washer fluid

If none of the washer do not work or the “Windshield Washer Fluid Low” on the multi-information display, the washer tank may be empty. Add washer fluid.



WARNING

■ When adding washer fluid

Do not add washer fluid when the hybrid system is hot or operating as washer fluid contains alcohol and may catch fire if spilled on the engine etc.

NOTICE

■ Do not use any fluid other than washer fluid

Do not use soapy water or engine antifreeze instead of washer fluid. Doing so may cause streaking on the vehicle's painted surfaces.

■ Diluting washer fluid

Dilute washer fluid with water as necessary. Refer to the freezing temperatures listed on the label of the washer fluid bottle.

12-volt battery

Location

The 12-volt battery is located in the left-hand side of luggage compartment.

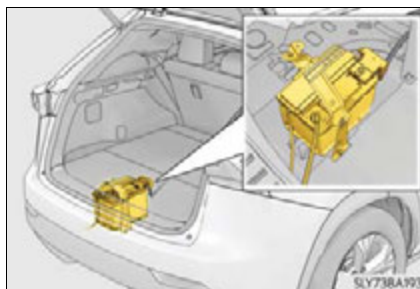

Removing the 12-volt battery maintenance cover

- 1 Lift the deck board and attach the hook. (→P. 452)
- 2 Remove the left side deck board.

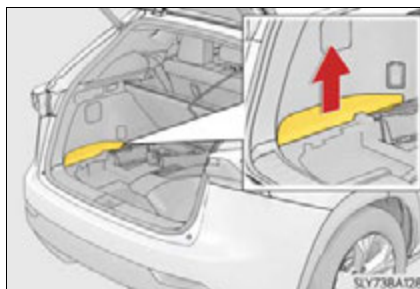

- 3 Remove the cover after removing the chip.
 - 1 Press
 - 2 Pull out

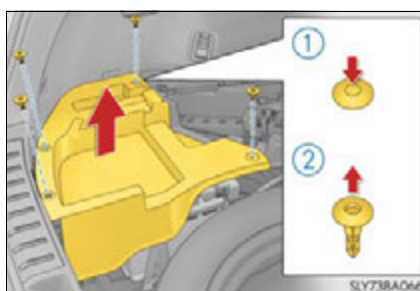

Exterior

Make sure that the 12-volt battery terminals are not corroded and that there are no loose connections, cracks, or loose clamps.

- ① Terminals
- ② Hold-down clamp

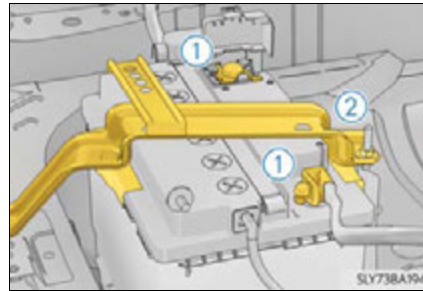

Installing the 12-volt battery maintenance cover

Insert the left side auxiliary box.

- ① Push up center position
- ② Insert
- ③ Press

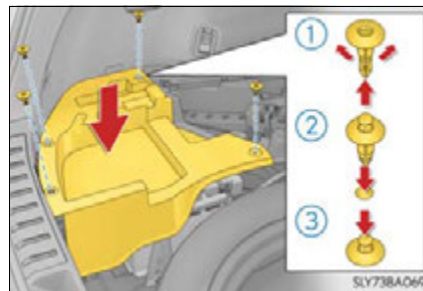

■ Before recharging

When recharging, the 12-volt battery produces hydrogen gas which is flammable and explosive. Therefore, observe the following precautions before recharging:

- If recharging with the 12-volt battery installed on the vehicle, be sure to disconnect the ground cable.
- Make sure the power switch on the charger is off when connecting and disconnecting the charger cables to the 12-volt battery.

■ After recharging/reconnecting the 12-volt battery

- The hybrid system may not start. Follow the procedure below to initialize the system.
 - ① Shift the shift lever to P.
 - ② Open and close any of the doors.
 - ③ Restart the hybrid system.
- Unlocking the doors using the smart access system with push-button start may not be possible immediately after reconnecting the 12-volt battery. If this happens, use the wireless remote control or the mechanical key to lock/unlock the doors.
- Start the hybrid system with the power switch in ACCESSORY mode. The hybrid system may not start with the power switch turned off. However, the hybrid system will operate normally from the second attempt.

- The power switch mode is recorded by the vehicle. If the 12-volt battery is reconnected, the vehicle will return the power switch mode to the status it was in before the 12-volt battery was disconnected. Make sure to turn off the power before disconnect the 12-volt battery. Take extra care when connecting the 12-volt battery if the power switch mode prior to discharge is unknown.

If the system will not start even after multiple attempts at all methods above, contact your Lexus dealer.

 **WARNING**

■ **Chemicals in the 12-volt battery**

The 12-volt battery contains poisonous and corrosive sulfuric acid and may produce hydrogen gas which is flammable and explosive. To reduce the risk of death or serious injury, take the following precautions while working on or near the 12-volt battery:

- Do not cause sparks by touching the 12-volt battery terminals with tools.
- Do not smoke or light a match near the 12-volt battery.
- Avoid contact with eyes, skin and clothes.
- Never inhale or swallow electrolyte.
- Wear protective safety glasses when working near the 12-volt battery.
- Keep children away from the 12-volt battery.

■ **Where to safely charge the 12-volt battery**

Always charge the 12-volt battery in an open area. Do not charge the 12-volt battery in a garage or closed room where there is insufficient ventilation.

■ **How to recharge the 12-volt battery**

Only perform a slow charge (5 A or less). The 12-volt battery may explode if charged at a quicker rate.

■ **Emergency measures regarding electrolyte**

- If electrolyte gets in your eyes
Flush your eyes with clean water for at least 15 minutes and get immediate medical attention. If possible, continue to apply water with a sponge or cloth while traveling to the nearest medical facility.
- If electrolyte gets on your skin
Wash the affected area thoroughly. If you feel pain or burning, get medical attention immediately.
- If electrolyte gets on your clothes
It can soak through clothing on to your skin. Immediately take off the clothing and follow the procedure above if necessary.
- If you accidentally swallow electrolyte
Drink a large quantity of water or milk. Get emergency medical attention immediately.

⚠ WARNING**■ When handling the 12-volt battery**

→P. 598

■ When disconnecting the 12-volt battery

Do not disconnect the negative (-) terminal on the body side as shown. The disconnected negative (-) terminal may touch the positive (+) terminal, which may cause a short and result in death or serious injury.

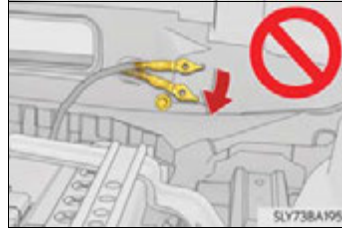
**⚠ NOTICE****■ When recharging the 12-volt battery**

Never recharge the 12-volt battery while the hybrid system is operating. Also, be sure all accessories are turned off.

Tires

Replace or rotate tires in accordance with maintenance schedules and treadwear.

Checking tires

Check if the treadwear indicators are showing on the tires. Also check the tires for uneven wear, such as excessive wear on one side of the tread.

Check the spare tire condition and pressure if not rotated.

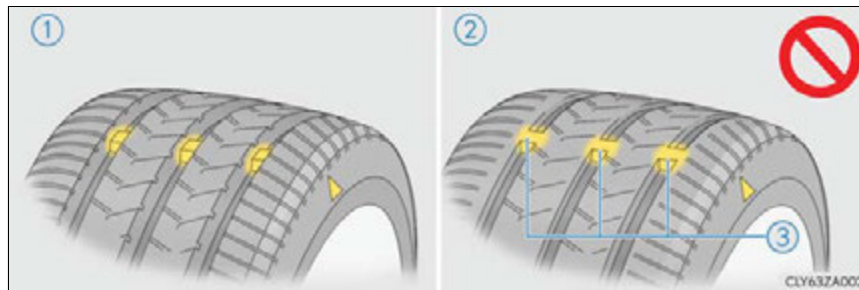

- ① New tread
- ② Worn tread
- ③ Treadwear indicator

The location of treadwear indicators is shown by the "TWI" or "Δ" marks, etc., molded into the sidewall of each tire.

Replace the tires if the treadwear indicators are showing on a tires.

Tire rotation

Rotate the tires in the order shown.

To equalize tire wear and extend tire life, Lexus recommends that tire rotation is carried out at the same interval as tire inspection.

Do not fail to initialize the tire pressure warning system after tire rotation.

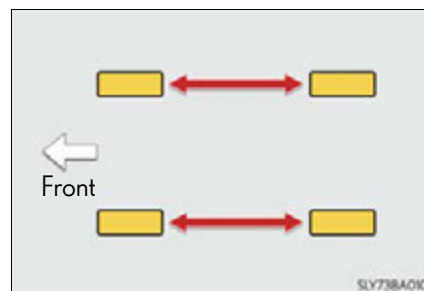

Tire pressure warning system

Your vehicle is equipped with a tire pressure warning system that uses tire pressure warning valves and transmitters to detect low tire inflation pressure before serious problems arise.

- If the tire pressure drops below a predetermined level, the driver is warned by a warning light. (→P. 567)
- The tire pressure detected by the tire pressure warning system can be displayed on the multi-information display.



◆ Installing tire pressure warning valves and transmitters

When replacing tires or wheels, tire pressure warning valves and transmitters must also be installed.

When new tire pressure warning valves and transmitters are installed, new ID codes must be registered in the tire pressure warning computer and the tire pressure warning system must be initialized. Have tire pressure warning valve and transmitter ID codes registered by your Lexus dealer. (→P. 519)

◆ Initializing the tire pressure warning system

- **The tire pressure warning system must be initialized in the following circumstances:**
 - When adjusting the tire inflation pressure
 - When the tire inflation pressure is changed such as when changing traveling speed.
 - When rotating the tires
 - When changing the tire.

When the tire pressure warning system is initialized, the current tire inflation pressure is set as the benchmark pressure.

■ How to initialize the tire pressure warning system

- 1 Park the vehicle in a safe place and turn the power switch off.

Initialization cannot be performed while the vehicle is moving.





- 2 Adjust the tire inflation pressure to the specified cold tire inflation pressure level. (→P. 613)

Make sure to adjust the tire pressure to the specified cold tire inflation pressure level. The tire pressure warning system will operate based on this pressure level.



- 3 Turn the power switch to ON mode.

- 4 Press  of the meter control switch.

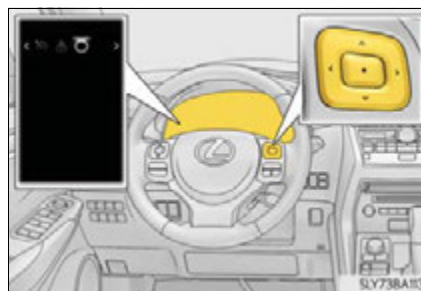

- 5 Press  or  of the meter control switch, select , and then press .



- 6 Press  or  of the meter control switch, select the "TPMS" screen and then press and hold the .



- 7 A message and an indicator are displayed by the multi-information display, and initialization is completed.



◆ Registering ID codes

The tire pressure warning valve and transmitter is equipped with a unique ID code. When replacing a tire pressure warning valve and transmitter, it is necessary to register the ID code. Have the ID code registered by your Lexus dealer.

■ When to replace your vehicle's tires

Tires should be replaced if:

- The treadwear indicators are showing on a tire.
- You have tire damage such as cuts, splits, cracks deep enough to expose the fabric, and bulges indicating internal damage.
- A tire goes flat repeatedly or cannot be properly repaired due to the size or location of a cut or other damage.

If you are not sure, consult with your Lexus dealer.

■ Replacing tires and wheels

If the ID code of the tire pressure warning valve and transmitter is not registered, the tire pressure warning system will not work properly. After driving for about 20 minutes, the tire pressure warning light blinks for 1 minute and stays on to indicate a system malfunction.

■ Tire life

Any tire over 6 years old must be checked by a qualified technician even if it has seldom or never been used or damage is not obvious.

■ Routine tire inflation pressure checks

The tire pressure warning system does not replace routine tire inflation pressure checks. Make sure to check tire inflation pressure as part of your routine of daily vehicle checks.

■ Maximum load of tire

Check that the maximum load of the replacement tire is greater than 1/2 of the Gross Axle Weight Ratings (GAWR) of either the front axle or the rear axle, whichever is greater.

For the GAWR, see the Certification Label. For the maximum load of the tire, see the load limit at maximum cold tire inflation pressure mentioned on the sidewall of the tire. (→P. 619)



■ Tire types

● Summer tires

Summer tires are high-speed performance tires best suited to highway driving under dry conditions. Since summer tires do not have the same traction performance as snow tires, summer tires are inadequate for driving on snow-covered or icy roads. For driving on snow-covered roads or icy roads, the use of snow tires is recommended. When installing snow tires, be sure to replace all four tires.

● All season tires

All season tires are designed to provide better traction in snow and to be adequate for driving in most winter conditions as well as for use year-round. All season tires, however, do not have adequate traction performance compared with snow tires in heavy or loose snow. Also, all season tires fall short in acceleration and handling performance compared with summer tires in highway driving.

● Snow tires

For driving on snow-covered roads or icy roads, we recommend using snow tires. If you need snow tires, select tires of the same size, construction and load capacity as the originally installed tires. Since your vehicle has radial tires as original equipment, make sure your snow tires also have radial construction. Do not install studded tires without first checking local regulations for possible restrictions. Snow tires should be installed on all wheels. (→P. 326)

■ Initializing the tire pressure warning system

Initialize the system with the tire inflation pressure adjusted to the specified level.

■ If the tread on snow tires wears down below 0.16 in. (4 mm)

The effectiveness of the tires as snow tires is lost.

■ Situations in which the tire pressure warning system may not operate properly

- In the following cases, the tire pressure warning system may not operate properly.
 - If non-genuine Lexus wheels are used.
 - A tire has been replaced with a tire that is not an OE (Original Equipment) tire.
 - A tire has been replaced with a tire that is not of the specified size.
 - Tire chains etc. are equipped.
 - An auxiliary-supported run-flat tire is equipped.
 - If a window tint that affects the radio wave signals is installed.
 - If there is a lot of snow or ice on the vehicle, particularly around the wheels or wheel housings.
 - If the tire inflation pressure is extremely higher than the specified level.
 - If wheel without the tire pressure warning valve and transmitter is used.
 - If the ID code on the tire pressure warning valves and transmitters is not registered in the tire pressure warning computer.
- Performance may be affected in the following situations.
 - Near a TV tower, electric power plant, gas station, radio station, large display, airport or other facility that generates strong radio waves or electrical noise
 - When carrying a portable radio, cellular phone, cordless phone or other wireless communication device
- When the vehicle is parked, the time taken for the warning to start or go off could be extended.
- When tire inflation pressure declines rapidly for example when a tire has burst, the warning may not function.

■ The initialization operation

- Make sure to carry out initialization after adjusting the tire inflation pressure. Also, make sure the tires are cold before carrying out initialization or tire inflation pressure adjustment.
- If you have accidentally turned the power switch off during initialization, it is not necessary to press the reset switch again as initialization will restart automatically when the power switch has been turned to ON mode for the next time.
- If you accidentally press the reset switch when initialization is not necessary, adjust the tire inflation pressure to the specified level when the tires are cold, and conduct initialization again.

■ Warning performance of the tire pressure warning system

The warning of the tire pressure warning system will change in accordance with the conditions under which it was initialized. For this reason, the system may give a warning even if the tire pressure does not reach a low enough level, or if the pressure is higher than the pressure that was adjusted to when the system was initialized.

■ When initialization of the tire pressure warning system has failed

Initialization can be completed in a few minutes. However, in the following cases, the settings have not been recorded and the system will not operate properly. If repeated attempts to record tire inflation pressure settings are unsuccessful, have the vehicle inspected by your Lexus dealer.

- When operating the tire pressure warning reset switch, the tire pressure warning light does not blink 3 times.
- After carrying out the initialization procedure, the tire pressure warning light blinks for 1 minute then stays on after driving for 20 minutes.

■ **Certification for tire pressure warning system**

- ▶ For vehicles sold in the U.S.A.

FCC ID: PAXPMVC010

FCC ID: HYQ22AAA

NOTE:

This device complies with part 15 of the FCC Rules. Operation is subject to the following two conditions: (1) This device may not cause harmful interference, and (2) this device must accept any interference received, including interference that may cause undesired operation.

FCC WARNING:

Changes or modifications not expressly approved by the party responsible for compliance could void the user's authority to operate the equipment.

- ▶ For vehicles sold in Canada

NOTE:

Operation is subject to the following two conditions; (1) this device may not cause interference, and (2) this device must accept any interference, including interference that may cause undesired operation of the device.

NOTE:

L'utilisation de ce dispositif est autorisée seulement aux deux conditions suivantes: (1) il ne doit pas produire de brouillage, et (2) l'utilisateur du dispositif doit être prêt à accepter tout brouillage radioélectrique reçu, même si ce brouillage est susceptible de compromettre le fonctionnement du dispositif.

NOTE:

This device complies with Industry Canada license-exempt RSS standard(s).

Operation is subject to the following two conditions: (1) this device may not cause interference, and (2) this device must accept any interference, including interference that may cause undesired operation of the device.

NOTE:

Le présent appareil est conforme aux CNR d'Industrie Canada applicables aux appareils radio exempts de licence. L'exploitation est autorisée aux deux conditions suivantes: (1). l'appareil ne doit pas produire de brouillage, et (2). l'utilisateur de l'appareil doit accepter tout brouillage radioélectrique subi, même si le brouillage est susceptible d'en compromettre le fonctionnement.

⚠ WARNING**■ When inspecting or replacing tires**

Observe the following precautions to prevent accidents.

Failure to do so may cause damage to parts of the drive train as well as dangerous handling characteristics, which may lead to an accident resulting in death or serious injury.

- Do not mix tires of different makes, models or tread patterns.
Also, do not mix tires of remarkably different treadwear.
- Do not use tire sizes other than those recommended by Lexus.
- Do not mix differently constructed tires (radial, bias-belted or bias-ply tires).
- Do not mix summer, all season and snow tires.
- Do not use tires that have been used on another vehicle.
Do not use tires if you do not know how they were used previously.
- Vehicles with a compact spare tire: Do not tow if your vehicle has a compact spare tire installed.

■ When initializing the tire pressure warning system

Do not initialize tire inflation pressure without first adjusting the tire inflation pressure to the specified level. Otherwise, the tire pressure warning light may not come on even if the tire inflation pressure is low, or it may come on when the tire inflation pressure is actually normal.

■ Caution regarding interference with electronic devices

- People with implantable cardiac pacemakers, cardiac resynchronization therapy pacemakers or implantable cardioverter defibrillators should not come within 17.7 in. (450 mm) of the tire pressure warning system initiators. The radio waves may affect the operation of such devices.

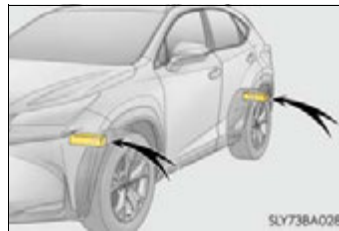

- Users of any electrical medical device other than implantable cardiac pacemakers, cardiac resynchronization therapy-pacemakers or implantable cardioverter defibrillators should consult the manufacturer of the device for information about its operation under the influence of radio waves. Radio waves could have unexpected effects on the operation of such medical devices.

 NOTICE**■ Repairing or replacing tires, wheels, tire pressure warning valves, transmitters and tire valve caps**

- When removing or fitting the wheels, tires or the tire pressure warning valves and transmitters, contact your Lexus dealer as the tire pressure warning valves and transmitters may be damaged if not handled correctly.
- Make sure to install the tire valve caps. If the tire valve caps are not installed, water could enter the tire pressure warning valves and the tire pressure warning valves could be bound.
- When replacing tire valve caps, do not use tire valve caps other than those specified. The cap may become stuck.

■ To avoid damage to the tire pressure warning valves and transmitters

When a tire is repaired with liquid sealants, the tire pressure warning valve and transmitter may not operate properly. If a liquid sealant is used, contact your Lexus dealer or other qualified service shop as soon as possible. After use of liquid sealant, make sure to replace the tire pressure warning valve and transmitter when repairing or replacing the tire. (→P. 517, 529)

■ Driving on rough roads

Take particular care when driving on roads with loose surfaces or potholes. These conditions may cause losses in tire inflation pressure, reducing the cushioning ability of the tires. In addition, driving on rough roads may cause damage to the tires themselves, as well as the vehicle's wheels and body.

■ If tire inflation pressure of each tire becomes low while driving

Do not continue driving, or your tires and/or wheels may be ruined.

Tire inflation pressure

Tire inflation pressure

The recommended cold tire inflation pressure and tire size are displayed on the tire and loading information label.
(→P. 613)

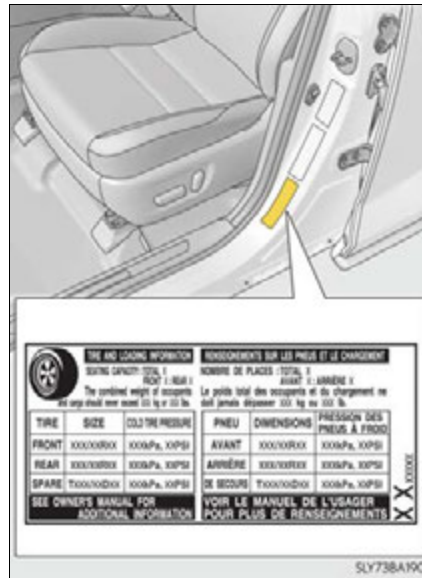

Inspection and adjustment procedure

- ① Tire valve
- ② Tire pressure gauge

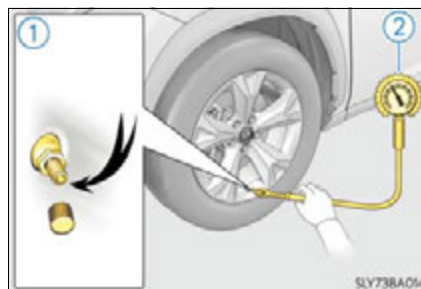

- 1 Remove the tire valve cap.
- 2 Press the tip of the tire pressure gauge onto the tire valve.
- 3 Read the pressure using the gauge gradations.
- 4 If the tire inflation pressure is not at the recommended level, adjust the pressure.
If you add too much air, press the center of the valve to deflate.
- 5 After completing the tire inflation pressure measurement and adjustment, apply soapy water to the valve and check for leakage.
- 6 Put the tire valve cap back on.

■ Tire inflation pressure check interval

You should check tire inflation pressure every two weeks, or at least once a month. Do not forget to check the spare.

■ Effects of incorrect tire inflation pressure

Driving with incorrect tire inflation pressure may result in the following:

- Reduced fuel economy
- Reduced driving comfort and poor handling
- Reduced tire life due to wear
- Reduced safety
- Damage to the drive train

If a tire needs frequent inflating, have it checked by your Lexus dealer.

■ Instructions for checking tire inflation pressure

When checking tire inflation pressure, observe the following:

- Check only when the tires are cold.
If your vehicle has been parked for at least 3 hours or has not been driven for more than 1 mile or 1.5 km, you will get an accurate cold tire inflation pressure reading.
- Always use a tire pressure gauge.
It is difficult to judge if a tire is properly inflated based only on its appearance.
- It is normal for the tire inflation pressure to be higher after driving as heat is generated in the tire. Do not reduce tire inflation pressure after driving.
- Never exceed the vehicle capacity weight.
Passengers and luggage weight should be placed so that the vehicle is balanced.

WARNING

■ Proper inflation is critical to save tire performance

Keep your tires properly inflated.

If the tires are not properly inflated, the following conditions may occur which could lead to an accident resulting in death or serious injury:

- Excessive wear
- Uneven wear
- Poor handling
- Possibility of blowouts resulting from overheated tires
- Air leaking from between tire and wheel
- Wheel deformation and/or tire damage
- Greater possibility of tire damage while driving (due to road hazards, expansion joints, sharp edges in the road, etc.)

NOTICE

■ When inspecting and adjusting tire inflation pressure

Be sure to put the tire valve caps back on.

If a valve cap is not installed, dirt or moisture may get into the valve and cause an air leak, resulting in decreased tire inflation pressure.

Wheels

If a wheel is bent, cracked or heavily corroded, it should be replaced. Otherwise, the tire may separate from the wheel or cause a loss of handling control.

Wheel selection

When replacing wheels, care should be taken to ensure that they are equivalent to those removed in load capacity, diameter, rim width and inset*.

Replacement wheels are available at your Lexus dealer.

*: Conventionally referred to as "offset".

Lexus does not recommend using the following:

- Wheels of different sizes or types
- Used wheels
- Bent wheels that have been straightened

Aluminum wheel precautions

- Use only Lexus wheel nuts and wrenches designed for use with your aluminum wheels.
- When rotating, repairing or changing your tires, check that the wheel nuts are still tight after driving 1000 miles (1600 km).
- Be careful not to damage the aluminum wheels when using tire chains.
- Use only Lexus genuine balance weights or equivalent and a plastic or rubber hammer when balancing your wheels.

■ When replacing wheels

The wheels of your vehicle are equipped with tire pressure warning valves and transmitters that allow the tire pressure warning system to provide advance warning in the event of a loss in tire inflation pressure. Whenever wheels are replaced, tire pressure warning valves and transmitters must be installed. (→P. 517, 529)

 **WARNING****■ When replacing wheels**

- Do not use wheels that are a different size from those recommended in the Owner's Manual, as this may result in a loss of handling control.
- Never use an inner tube in a leaking wheel which is designed for a tubeless tire. Doing so may result in an accident, causing death or serious injury.

■ Use of defective wheels prohibited

Do not use cracked or deformed wheels.
Doing so could cause the tire to leak air during driving, possibly causing an accident.

 **NOTICE****■ Replacing tire pressure warning valves and transmitters**

- Because tire repair or replacement may affect the tire pressure warning valves and transmitters, make sure to have tires serviced by your Lexus dealer or other qualified service shop. In addition, make sure to purchase your tire pressure warning valves and transmitters at your Lexus dealer.
- Ensure that only genuine Lexus wheels are used on your vehicle.
Tire pressure warning valves and transmitters may not work properly with non-genuine wheels.

Air conditioning filter

The air conditioning filter must be changed regularly to maintain air conditioning efficiency.

Removal method

- 1 Turn the power switch off.
- 2 Open the glove box. Slide off the damper.
- 3 Push in the glove box on the vehicle's outer side to disconnect the claws. Then pull out the glove box and disconnect the lower claws.
- 4 Remove the filter cover.

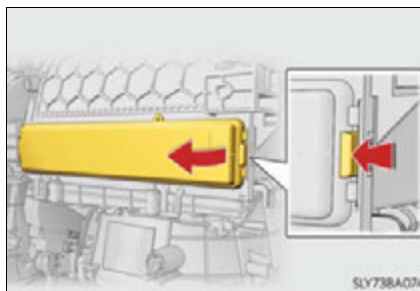
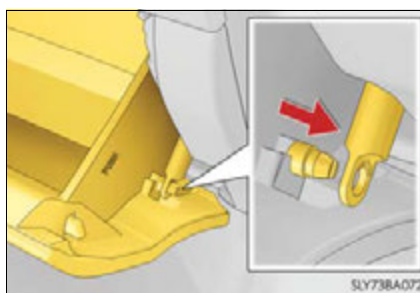

- 5 Remove the air conditioning filter and replace it with a new one.

The “↑UP” marks shown on the filter should be pointing up.

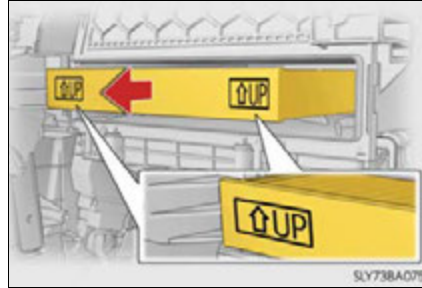

■ Checking interval

Inspect and replace the air conditioning filter according to the maintenance schedule. In dusty areas or areas with heavy traffic flow, early replacement may be required. (For scheduled maintenance information, please refer to the “Owner’s Manual Supplement” or “Scheduled Maintenance”.)

■ If air flow from the vents decreases dramatically

The filter may be clogged. Check the filter and replace if necessary.

⚠ NOTICE

■ When using the air conditioning system

Make sure that a filter is always installed.

Using the air conditioning system without a filter may cause damage to the system.

Electronic key battery

Replace the battery with a new one if it is depleted.

You will need the following items:

- Flathead screwdriver
- Lithium battery CR2032

Replacing the battery

- 1 Take out the mechanical key.

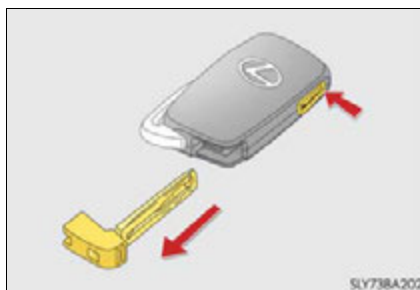

- 2 Remove the cover.

To prevent damage to the key, cover the tip of the flathead screwdriver with a tape.

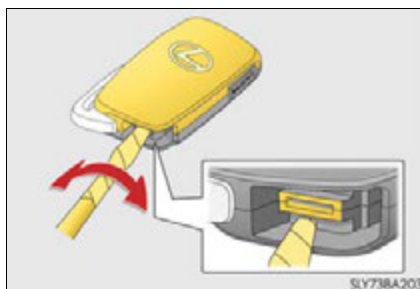

- 3 Remove the depleted battery.

Insert a new battery with the "+" terminal facing up.

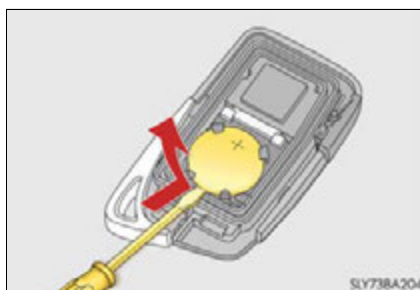

■ Use a CR2032 lithium battery

- Batteries can be purchased at your Lexus dealer, local electrical appliance shops or camera stores.
- Replace only with the same or equivalent type recommended by the manufacturer.
- Dispose of used batteries according to the local laws.

■ When the card key battery needs to be replaced (if equipped)

The battery for the card key is available only at Lexus dealers. Your Lexus dealer can replace the battery for you.

■ If the electronic key battery is depleted

The following symptoms may occur:

- The smart access system with push-button start and wireless remote control will not function properly.
- The operational range will be reduced.

⚠ WARNING**■ Removed battery and other parts**

These parts are small and if swallowed by a child, they can cause choking. Keep away from children. Failure to do so could result in death or serious injury.

⚠ NOTICE**■ For normal operation after replacing the battery**

Observe the following precautions to prevent accidents:

- Always work with dry hands.
Moisture may cause the battery to rust.
- Do not touch or move any other component inside the remote control.
- Do not bend either of the battery terminals.

Checking and replacing fuses

If any of the electrical components do not operate, a fuse may have blown. If this happens, check and replace the fuses as necessary.

1 Turn the power switch off.

2 Open the fuse box cover.

► Engine compartment: type A fuse box

► Engine compartment: type B fuse box



Push the tab in and lift the lid off.

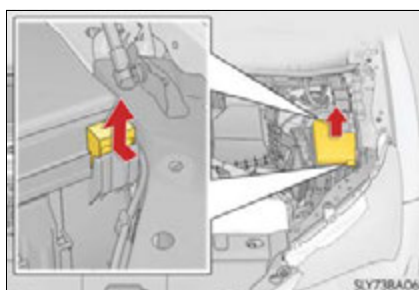

Push the tab in and lift the lid off.

► Left side instrument panel

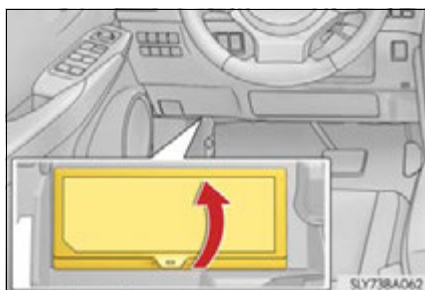

Remove the lid.

► Luggage compartment

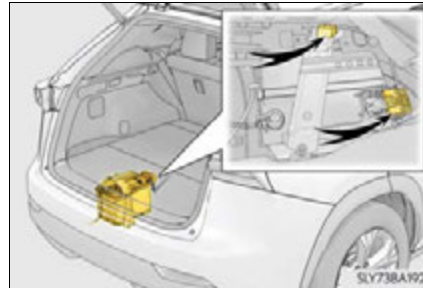

3 Remove the fuse.

Only type A fuse can be removed using the pullout tool.



4 Check if the fuse is blown.

- ① Normal fuse
- ② Blown fuse

Replace the blown fuse with a new fuse of an appropriate amperage rating. The amperage rating can be found on the fuse box lid.

▶ Type A

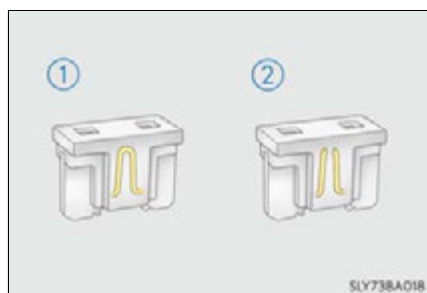

▶ Type B

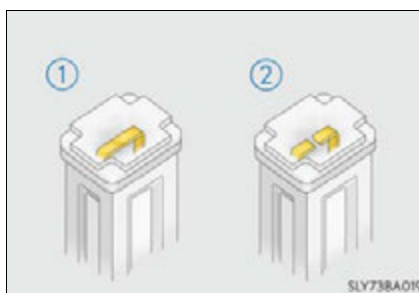

▶ Type C

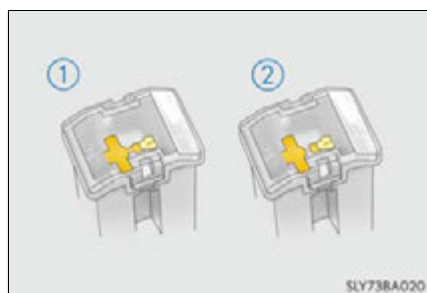

▶ Type D

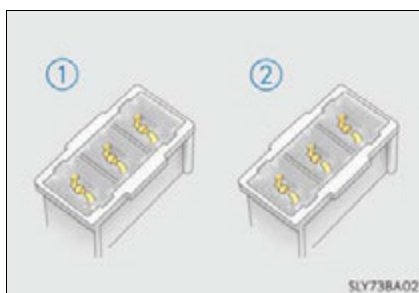

■ After a fuse is replaced

- If the lights do not turn on even after the fuse has been replaced, a bulb may need replacement. (→P. 538)
- If the replaced fuse blows again, have the vehicle inspected by your Lexus dealer.

■ If there is an overload in a circuit

The fuses are designed to blow, protecting the wiring harness from damage.

■ When replacing light bulbs

Lexus recommends that you use genuine Lexus products designed for this vehicle. Because certain bulbs are connected to circuits designed to prevent overload, nongenuine parts or parts not designed for this vehicle may be unusable.

 **WARNING****■ To prevent system breakdowns and vehicle fire**

Observe the following precautions.

Failure to do so may cause damage to the vehicle, and possibly a fire or injury.

- Never use a fuse of a higher amperage rating than that indicated, or use any other object in place of a fuse.
- Always use a genuine Lexus fuse or equivalent.
Never replace a fuse with a wire, even as a temporary fix.
- Do not modify the fuses or fuse boxes.

■ Fuse box near the power control unit

Never check or replace the fuses as there are high voltage parts and wiring near the fuse box.

Doing so may cause electric shock, resulting in death or serious injury.

 **NOTICE****■ Before replacing fuses**

Have the cause of electrical overload determined and repaired by your Lexus dealer as soon as possible.

Light bulbs

You may replace the following bulbs by yourself. The difficulty level of replacement varies depending on the bulb. If necessary bulb replacement seems difficult to perform, contact your Lexus dealer.

For more information about replacing other light bulbs, contact your Lexus dealer.

Preparing for light bulb replacement

Check the wattage of the light bulb to be replaced. (→P. 615)

Removing the engine compartment cover

→P. 503

Canceling the power back door system

→P. 132

Bulb locations

■ Front

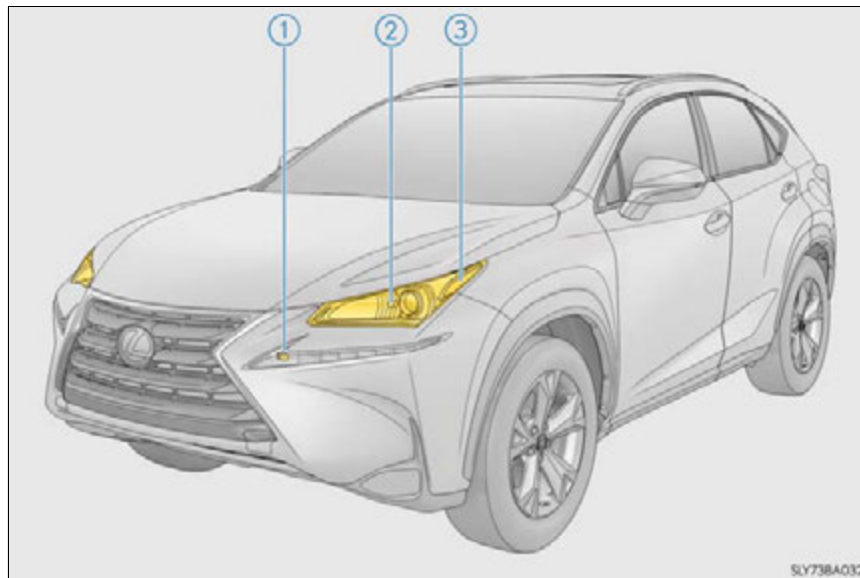

- ① Front turn signal light (bulb type)
- ② Headlight high beam (halogen bulbs)
- ③ Front side marker light (bulb type)

■ Rear

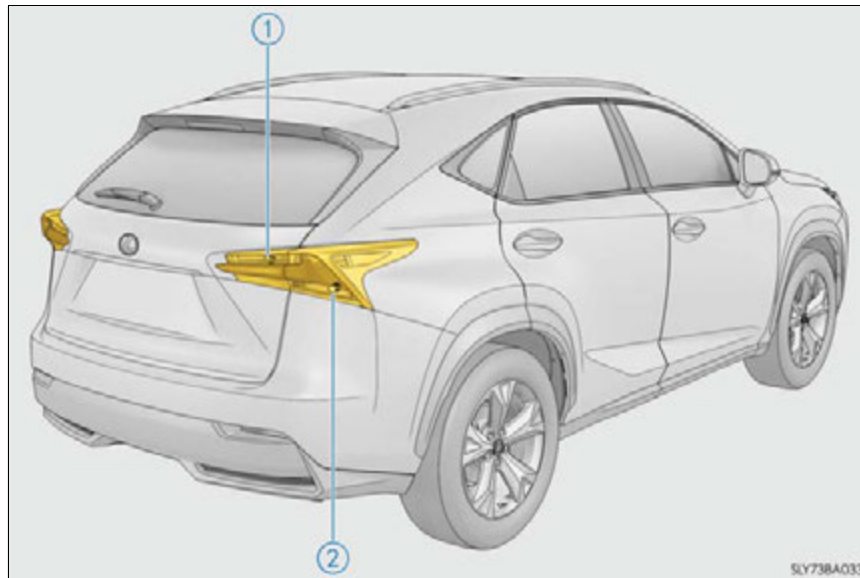

- ① Back-up light
- ② Rear turn signal light

Replacing light bulbs

■ Headlight high beams (halogen bulbs)

► For the right side only:

- 1 Remove the bolt, and move the washer fluid supply opening.



When it is difficult to work, remove the washer fluid supply opening.

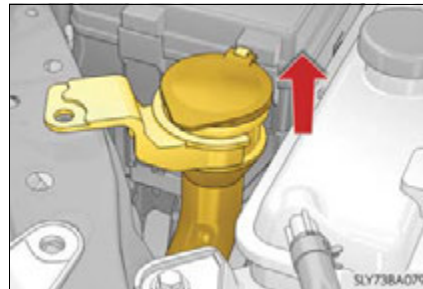

- 2 Turn the cover counterclockwise and remove it.



- 3 Turn the bulb base counterclockwise.

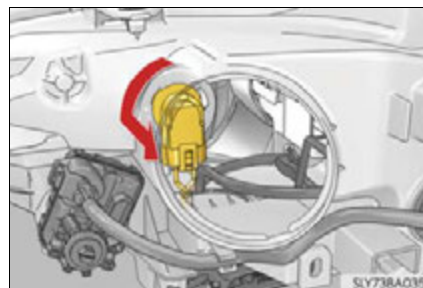

542 7-3. Do-it-yourself maintenance

- 4** Unplug the connector while pulling the lock release.

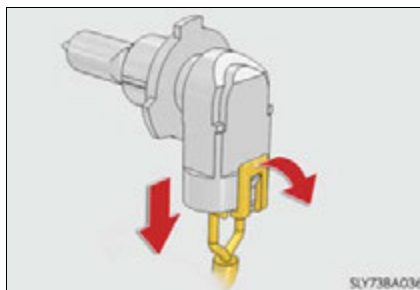

- 5** Confirm whether the O-ring of the cover has not come off.
If the O-ring come off, attached to the proper position.



- 6** Replace the light bulb, and set the connector

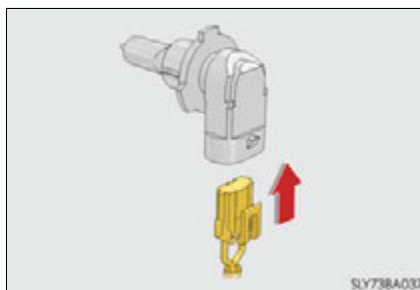

- 7** Install the bulb base.
Align the 3 tabs on the light bulb with the mounting, and insert. Turn it clockwise to set.

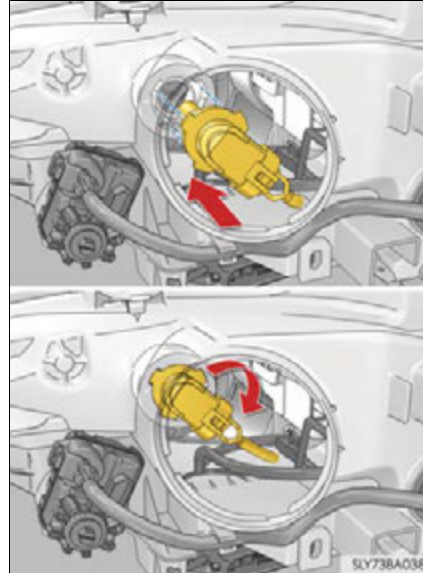

- 8** Confirm the installation of the bulb base.
Shake the bulb base gently to check that it is not loose, turn the headlight high beams on once and visually confirm that no light is leaking through the mounting.

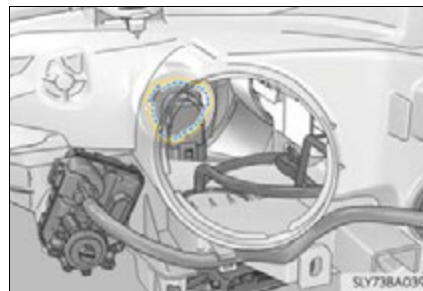

- 9** Install the cover and turn it clockwise.
Align the ▲ of the cover to the positioning mark of the lamp body and insert and turn it.
There is the positioning mark on the outer side of the light unit.



- 10** When removing the washer fluid supply opening:
Installing the washer fluid supply opening.
Align the washer tank with the washer fluid opening position.

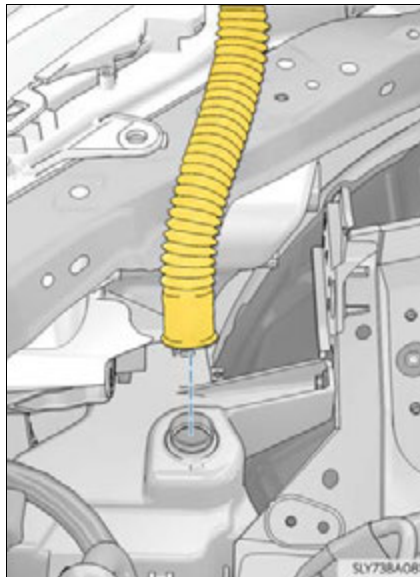

- 11** Fix the washer fluid supply opening.
① Align the tab position and install washer fluid opening.
② Fasten the bolt.

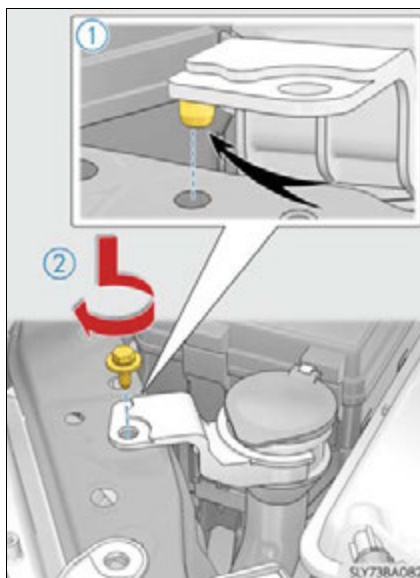

■ Front side marker light (bulb type)

- 1 Turn the bulb base counterclockwise.



- 2 Remove the light bulb.

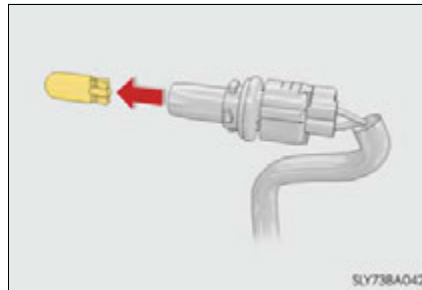

- 3 When installing, reverse the steps listed.

■ Front turn signal lights (bulb type)

- 1 Open the hood and remove the cover for engine compartment cover. (→P. 500, 503)

- 2 Remove the cover.
 - 1 Push the center of the clip.
 - 2 Remove the clip and cover.

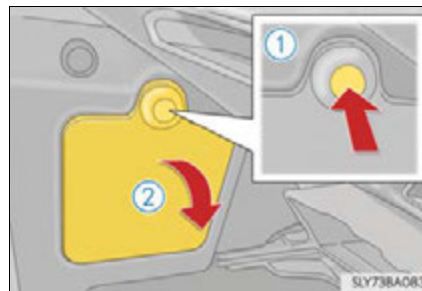

- 3 Turn the bulb base counterclockwise.

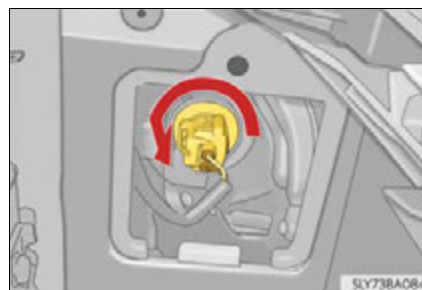

- 4** Remove the light bulb.

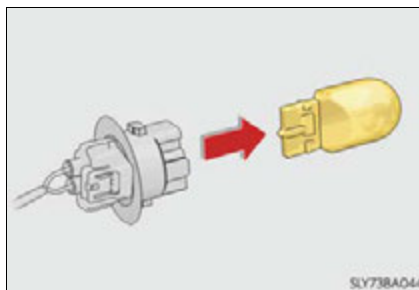

- 5** Replace the light bulb.

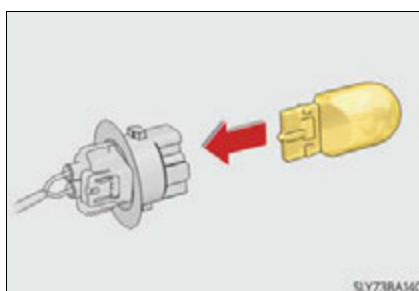

- 6** Turn clockwise and set the bulb base.



- 7** Attach the clip to the cover.
- ① Push up on the center of the clip.
 - ② Attach the clip.

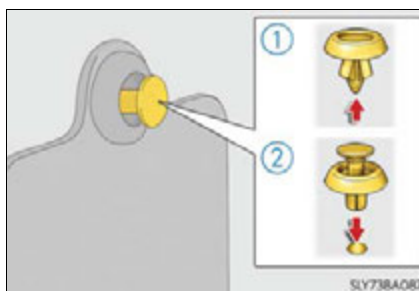

8 Attach the cover.

- ① Align the 2 tabs positions and close the cover.
- ② Fix the cover by pushing the center of the clip.

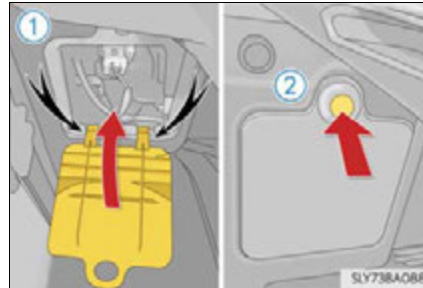
**9** Install the engine compartment cover. (→P. 503)**■ Rear turn signal lights**

- 1** Open the back door and attach protective tape around the lamp body. (Use masking tape, do not use Duct tape, as duct tape may leave markings.)

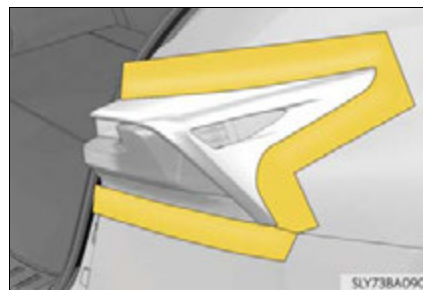

- 2** Remove the cover.

It is recommended for safeguarding to wrap the tip of the screwdriver with a cloth, etc., in order to prevent scratches to the vehicle.

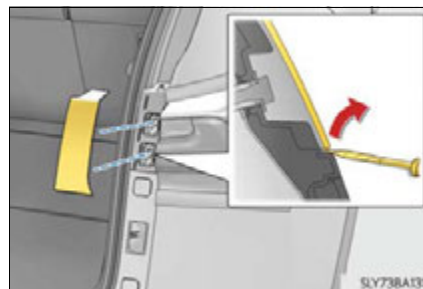

- 3** Remove the 2 bolts.

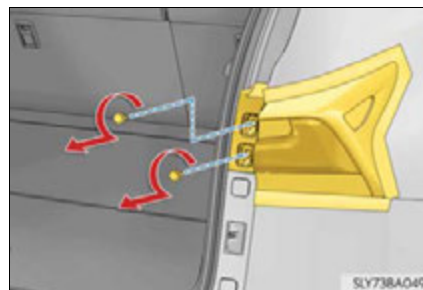

4 Remove the light unit.

- ① Attach 2 long pieces of the masking tape and fold the excess portion over in half.
- ② Hold the section folded in half, pull toward the rear of the lens and remove.

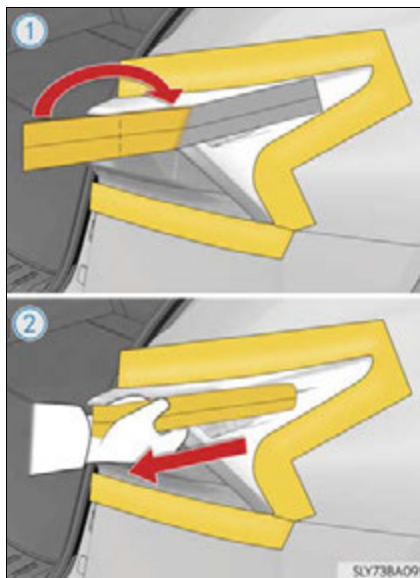

5 Turn the bulb base counterclockwise.

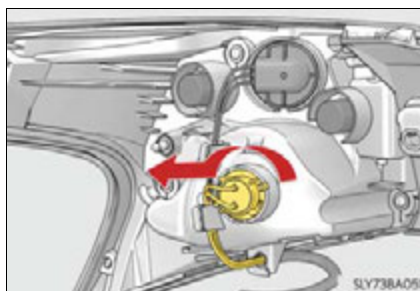

6 Remove the light bulb.

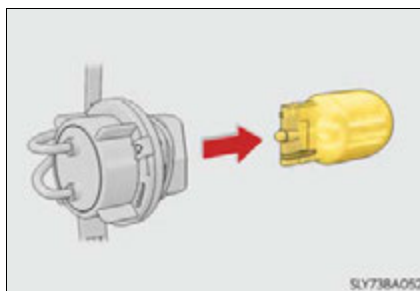

- 7** Replace the light bulb.

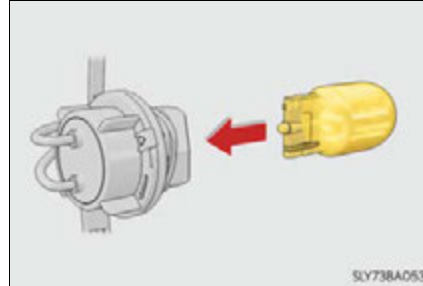

- 8** Turn clockwise and set the bulb base.
Confirm that cable is fixed to the tab.

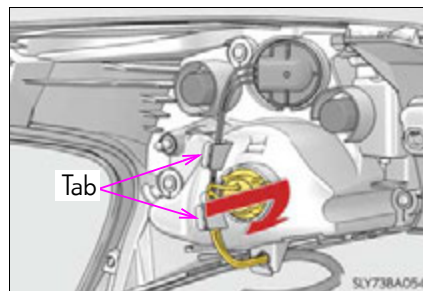

- 9** Set the light unit.

- ① Align the light unit with the 2 tabs on the rear bumper.
- ② Push the light unit forward while pushing A.

Confirm that the grommet fits into the bolt installation hole on the light unit.

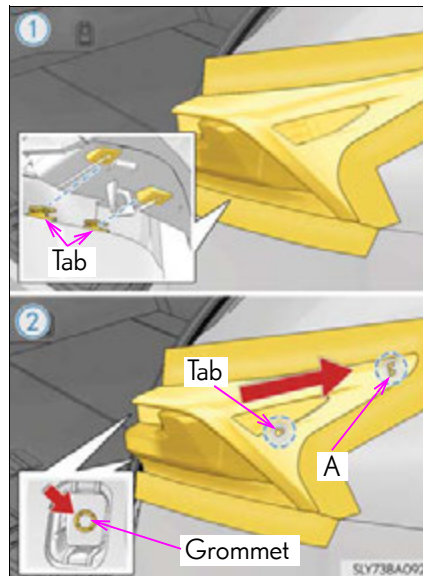

- 10 Install the 2 bolts.

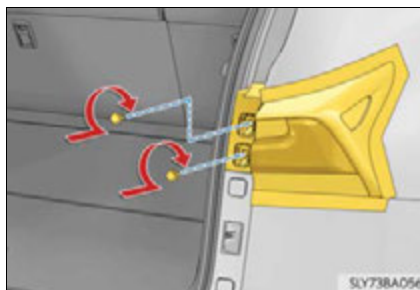

- 11 Install the cover.



■ Back-up lights

- 1 Open the back door and remove the cover.

Press down on the notch on the cover and remove the cover.

It is recommended for safeguarding to wrap the tip of the screwdriver with a cloth, etc., in order to prevent scratches to the vehicle.

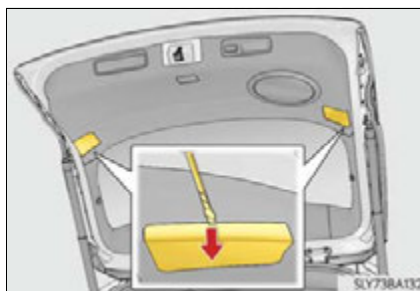

- 2 Turn the bulb base counterclockwise.

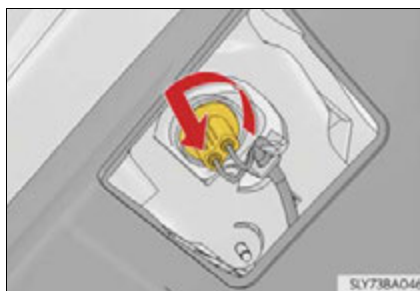

- 3** Remove the light bulb.

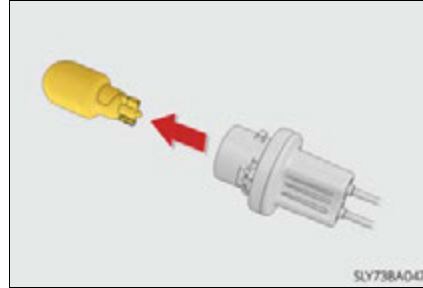

- 4** Replace the light bulb, and install the bulb base.

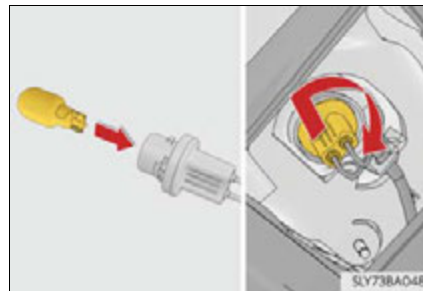

- 5** Install the back door cover
Align the 2 tabs on the cover and install.

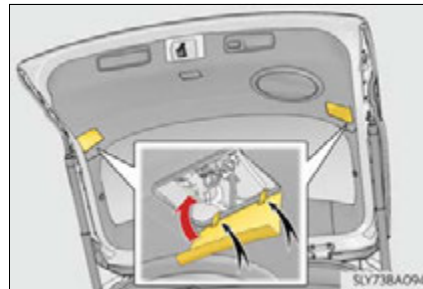

■ Replacing the following bulbs

If any of the lights listed below has burnt out, have it replaced by your Lexus dealer.

- Headlight low beams
- Headlight high beams (LED type)
- Front turn signal lights (LED type)
- Parking lights and Daytime running lights
- Front fog lights
- Front side marker lights (LED type)
- Side turn signal lights
- Stop/tail lights
- Rear side marker lights
- High mounted stoplight
- License plate lights
- Outer foot lights

■ After replacing the bulbs

After removing the engine compartment cover, return the cover to original position with the clips.

- ① Insert
- ② Press



■ LED lights

The headlight low beams, headlight high beams (LED Type), front turn signal lights (LED Type), parking lights, daytime running lights, front fog lights, front side marker lights (LED Type), side turn signal lights, rear side marker lights, stop/tail lights, rear side marker lights, high mounted stoplight and license plate lights, outer foot lights consist of a number of LEDs. If any of the LEDs burn out, take your vehicle to your Lexus dealer to have the light replaced.

■ Condensation build-up on the inside of the lens

Temporary condensation build-up on the inside of the headlight lens does not indicate a malfunction. Contact your Lexus dealer for more information in the following situations:

- Large drops of water have built up on the inside of the lens.
- Water has built up inside the headlight.

■ When replacing light bulbs

→P. 536

 **WARNING****■ Replacing light bulbs**

- Be sure to stop the hybrid system and turn off the lights. Do not attempt to replace the bulb immediately after turning off the lights.
The bulbs become very hot and may cause burns.
- Do not touch the glass portion of the light bulb with bare hands. When it is unavoidable to hold the glass portion, use and hold with a clean dry cloth to avoid getting moisture and oils on the bulb.
Also, if the bulb is scratched or dropped, it may blow out or crack.
- Fully install light bulbs and any parts used to secure them. Failure to do so may result in heat damage, fire, or water entering the headlight unit. This may damage the headlights or cause condensation to build up on the lens.
- Do not attempt to repair or disassemble light bulbs, connectors, electric circuits or component parts.
Doing so may result in death or serious injury due to electric shock.

■ To prevent damage or fire

- Make sure bulbs are fully seated and locked.
- Check the wattage of the bulb before installing to prevent heat damage.

8-1. Essential information

Emergency flashers 556

If your vehicle has to
be stopped in an
emergency..... 557**8-2. Steps to take in an emergency**If your vehicle needs to
be towed 558If you think something is
wrong 564If a warning light turns on
or a warning buzzer
sounds..... 565If a warning message is
displayed..... 572

If you have a flat tire..... 575

If the hybrid system will not
start 588If the shift lever cannot be
shifted from P..... 590If the electronic key does not
operate properly 591If the 12-volt battery is
discharged 594

If your vehicle overheats 599

If the vehicle becomes
stuck 603

Emergency flashers

The emergency flashers are used to warn other drivers when the vehicle has to be stopped in the road due to a breakdown, etc.

Press the switch.

All the turn signal lights will flash. To turn them off, press the switch once again.

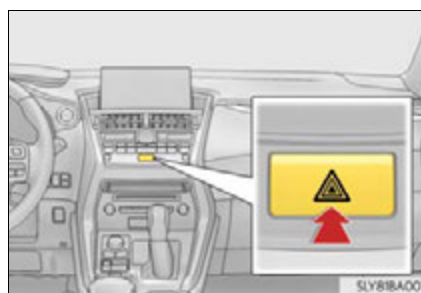

■ Emergency flashers

If the emergency flashers are used for a long time while the hybrid system is not operating (while the "READY" indicator is not illuminated), the 12-volt battery may discharge.

If your vehicle has to be stopped in an emergency

Only in an emergency, such as if it becomes impossible to stop the vehicle in the normal way, stop the vehicle using the following procedure:

- 1 Steadily step on the brake pedal with both feet and firmly depress it.
Do not pump the brake pedal repeatedly as this will increase the effort required to slow the vehicle.
- 2 Shift the shift lever to N.
 - ▶ If the shift lever is shifted to N
- 3 After slowing down, stop the vehicle in a safe place by the road.
- 4 Stop the hybrid system.
 - ▶ If the shift lever cannot be shifted to N
- 3 Keep depressing the brake pedal with both feet to reduce vehicle speed as much as possible.
- 4 To stop the hybrid system, press and hold the power switch for 2 consecutive seconds or more, or press it briefly 3 times or more in succession.

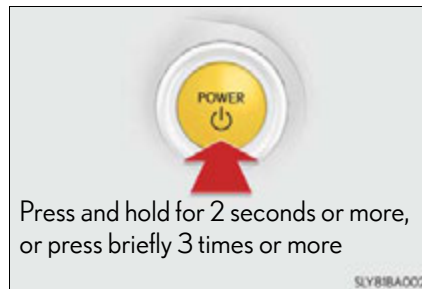

- 5 Stop the vehicle in a safe place by the road.

WARNING

■ If the hybrid system has to be turned off while driving

Power assist for the steering wheel will be lost, making the steering wheel heavier to turn. Decelerate as much as possible before turning off the hybrid system.

If your vehicle needs to be towed

If towing is necessary, we recommend having your vehicle towed by your Lexus dealer or commercial towing service, using a wheel-lift type truck or flatbed truck.

Use a safety chain system for all towing, and abide by all state/provincial and local laws.

2WD models: If towing your vehicle with a wheel-lift type truck from the front, the vehicle's rear wheels and axles must be in good conditions. (→P. 559, 562)
If they are damaged, use a towing dolly or flatbed truck.

AWD models: If towing your vehicle with a wheel-lift type truck, use a towing dolly. (→P. 559, 562)

Situations when it is necessary to contact dealers before towing

The following may indicate a problem with your hybrid transmission. Contact your Lexus dealer or commercial towing service before towing. (→P. 562)

- The hybrid warning message shows on the multi-information display and the vehicle does not move.
- The vehicle makes an abnormal sound.

Towing with a sling-type truck

Do not tow with a sling-type truck to prevent body damage.



Towing with a wheel-lift type truck

- ▶ From the front (2WD models)

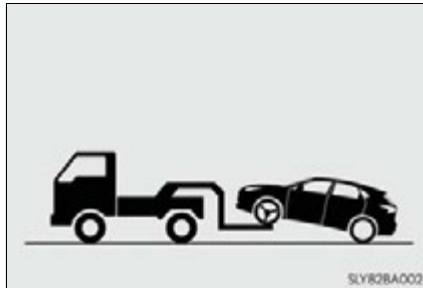

Release the parking brake.

- ▶ From the front (AWD models)

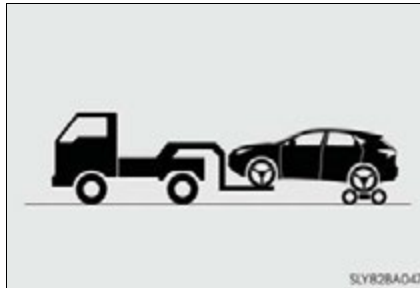

Use a towing dolly under the rear wheels.

- ▶ From the rear

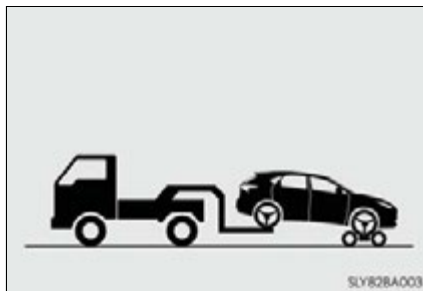

Use a towing dolly under the front wheels.

Using a flatbed truck

If your vehicle is transported by a flatbed truck, it should be tied down at the locations shown in the illustration.

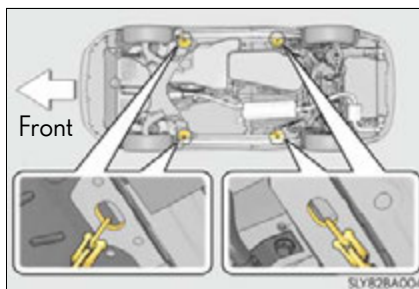

If you use chains or cables to tie down your vehicle, the angles shaded in black must be 45°.

Do not overly tighten the tie downs or the vehicle may be damaged.

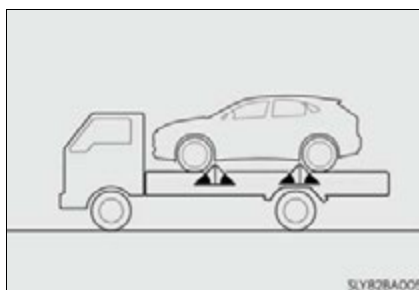

Emergency towing

If a tow truck is not available in an emergency, your vehicle may be temporarily towed using cables or chains secured to the emergency towing eyelets. This should only be attempted on hard surfaced roads for short distances at under 3 mph (5 km/h).

A driver must be in the vehicle to steer and operate the brakes. The vehicle's wheels, drivetrain, axles, steering and brakes must be in good condition.

Installing towing eyelets

- 1 Take out the towing eyelet. (→P. 576)

- 2 Remove the eyelet cover using a flat-head screwdriver.

To protect the bodywork, place a rag between the screwdriver and the vehicle body as shown in the illustration.

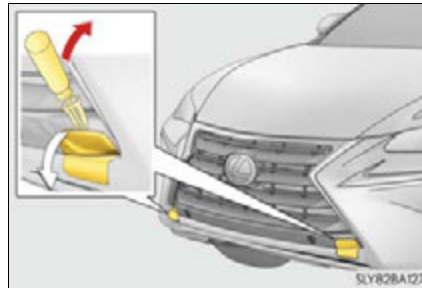

- 3 Insert the towing eyelet into the hole and tighten partially by hand.

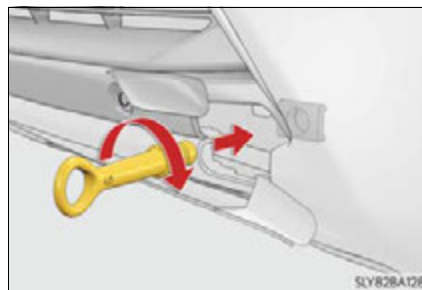

- 4 Tighten down the towing eyelet securely using a wheel nut wrench.

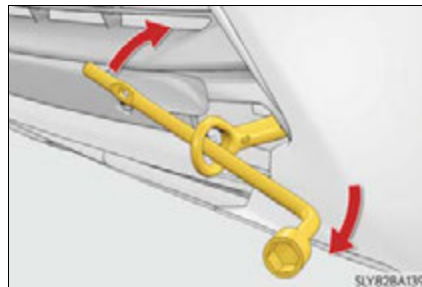

- 5 Securely attach cables or chains to the towing eyelet.

Take care not to damage the vehicle body.

- 6 Enter the vehicle being towed and start the hybrid system.

If the hybrid system does not start, turn the power switch to ON mode.

- 7 Shift the shift lever to N and release the parking brake.

When the shift lever cannot be shifted: →P. 590

■ While towing

If the hybrid system is off, the power assist for the brakes and steering will not function, making steering and braking more difficult.

■ Wheel nut wrench

Wheel nut wrench is installed in luggage compartment. (→P. 576)

⚠ WARNING

Observe the following precautions.
Failure to do so may result in death or serious injury.

■ **When towing the vehicle**

▶ **2WD models**

Be sure to transport the vehicle with the front wheels raised or with all four wheels raised off the ground. If the vehicle is towed with the front wheels contacting the ground, the drivetrain and related parts may be damaged or electricity generated by the operation of the motor may cause a fire to occur depending on the nature of the damage or malfunction.

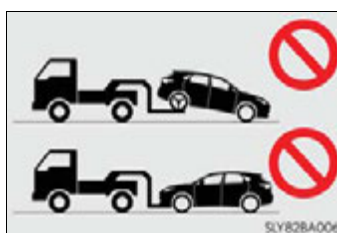

▶ **AWD models**

Be sure to transport the vehicle with all four wheels raised off the ground. If the vehicle is towed with the tires contacting the ground, the drivetrain or related parts may be damaged, the vehicle may fly off the truck, or electricity generated by the operation of the motor may cause a fire to occur depending on the nature of the damage or malfunction.

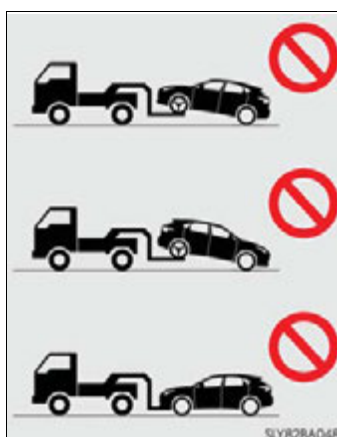

■ **While towing**

- When towing using a cables or chains, avoid sudden starts, etc. which place excessive stress on the towing eyelets, cables or chains. The towing eyelets, cables or chains may become damaged, broken debris may hit people, and cause serious damage.
- Do not turn the power switch off.
There is a possibility that the steering wheel is locked and cannot be operated.

■ **Installing towing eyelets to the vehicle**

Make sure that towing eyelets are installed securely.
If not securely installed, towing eyelets may come loose during towing.

 NOTICE**■ To prevent damage to the vehicle when towing using a wheel-lift type truck**

- Do not tow the vehicle from the rear when the power switch is off. The steering lock mechanism is not strong enough to hold the front wheels straight.
- When raising the vehicle, ensure adequate ground clearance for towing at the opposite end of the raised vehicle. Without adequate clearance, the vehicle could be damaged while being towed.

■ To prevent body damage when towing with a sling-type truck

Do not tow with a sling-type truck, either from the front or rear.

■ Recreational towing (behind motor home, etc)

Never dinghy tow your vehicle to prevent causing serious damage to the Hybrid AWD system (AWD models) and transmission. (→P. 200)

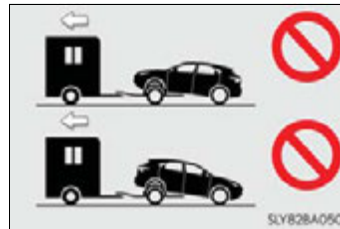

If you think something is wrong

If you notice any of the following symptoms, your vehicle probably needs adjustment or repair. Contact your Lexus dealer as soon as possible.

Visible symptoms

- Fluid leaks under the vehicle
(Water dripping from the air conditioning after use is normal.)
- Flat-looking tires or uneven tire wear
- Engine coolant temperature gauge needle continually points higher than normal

Audible symptoms

- Changes in exhaust sound
- Excessive tire squeal when cornering
- Strange noises related to the suspension system
- Pinging or other noises related to the hybrid system









Operational symptoms











- Engine misfire or misses, stumbling or running roughly
- Appreciable loss of power
- Vehicle pulls heavily to one side when braking
- Vehicle pulls heavily to one side when driving on a level road
- Loss of brake effectiveness, spongy feeling, pedal almost touches the floor





If a warning light turns on or a warning buzzer sounds

Calmly perform the following actions if any of the warning lights comes on or flashes. If a light comes on or flashes, but then goes off, this does not necessarily indicate a malfunction in the system. However, if this continues to occur, have the vehicle inspected by your Lexus dealer.

Warning light and warning buzzer list

Warning light	Warning light/Details/Actions
 (U.S.A.)  (Canada)	Brake system warning light Indicates that: <ul style="list-style-type: none"> • The brake fluid level is low; or • The brake system is malfunctioning → Immediately stop the vehicle in a safe place and contact your Lexus dealer. Continuing to drive the vehicle may be dangerous.
*1 	Charging system warning light Indicates a malfunction in the vehicle's charging system → Immediately stop the vehicle in a safe place and contact your Lexus dealer. Continuing to drive the vehicle may be dangerous.
*1 	Low engine oil pressure warning light (warning buzzer) Indicates that the engine oil pressure is too low → Immediately stop the vehicle in a safe place and contact your Lexus dealer. Continuing to drive the vehicle may be dangerous.
*1 	High coolant temperature warning light (warning buzzer) Indicates that the engine is overheating → Immediately stop the vehicle in a safe place. Continuing to drive the vehicle may be dangerous. Handling method (→P. 599)
	Brake system warning light Indicates a malfunction in: <ul style="list-style-type: none"> • The regenerative braking system; • The electronically controlled brake system; or • The electric parking brake → Have the vehicle inspected by your Lexus dealer immediately.
 (U.S.A.)  (Canada)	Malfunction indicator lamp Indicates a malfunction in: <ul style="list-style-type: none"> • The hybrid system; • The electronic engine control system; • The electronic throttle control system; or • The emission control system → Have the vehicle inspected by your Lexus dealer immediately.

Warning light	Warning light/Details/Actions
	<p>SRS warning light Indicates a malfunction in:</p> <ul style="list-style-type: none"> • The SRS airbag system; • The front passenger occupant classification system; or • The seat belt pretensioner system <p>→ Have the vehicle inspected by your Lexus dealer immediately.</p>
 (U.S.A.)  (Canada)	<p>ABS warning light Indicates a malfunction in:</p> <ul style="list-style-type: none"> • The ABS; or • The brake assist system <p>→ Have the vehicle inspected by your Lexus dealer immediately.</p>
 	<p>Electric power steering system warning light (warning buzzer) Indicates a malfunction in the EPS (Electric Power Steering) system</p> <p>→ Have the vehicle inspected by your Lexus dealer immediately.</p>
 (Flashes) (If equipped)	<p>PCS warning light Indicates a malfunction in the pre-collision system The warning light will operate as follows, even when the system is not malfunctioning:</p> <ul style="list-style-type: none"> • The light will come on when the TRAC and VSC systems are turned off. (→P. 307) • The light will come on when the pre-collision system is turned off. (→P. 311) • The light will flash when the system cannot temporarily be used. <p>→ Have the vehicle inspected by your Lexus dealer immediately.</p>
	<p>Slip indicator light Indicates a malfunction in:</p> <ul style="list-style-type: none"> • The VSC system; • The TRAC system; or • The hill-start assist control system <p>The light will flash when the ABS, VSC or TRAC system is operating.</p> <p>→ Have the vehicle inspected by your Lexus dealer immediately.</p>
 (Flashes)	<p>Brake hold operated indicator Indicates a malfunction in the brake hold system</p> <p>→ Have the vehicle inspected by your Lexus dealer immediately.</p>
 (Flashes) (U.S.A.)  (Flashes) (Canada)	<p>Parking brake indicator It is possible that the parking brake is not fully engaged or released</p> <p>→ Operate the parking brake switch once again. This light comes on when the parking brake is not released. If the light turns off after the parking brake is fully released, the system is operating normally.</p>

Warning light	Warning light/Details/Actions
	<p>Low fuel level warning light Indicates that remaining fuel is approximately 2.2 gal. (8.4 L, 1.8 Imp.gal.) or less → Refuel the vehicle.</p>
	<p>Driver's and front passenger's seat belt reminder light (warning buzzer)*2 Warns the driver and/or front passenger to fasten their seat belts → Fasten the seat belt. If the front passenger's seat is occupied, the front passenger's seat belt also needs to be fastened to make the warning light (warning buzzer) turn off.</p>
	<p>Master warning light A buzzer sounds and the warning light comes on and flashes to indicate that the master warning system has detected a malfunction. → P. 572</p>
	<p>Tire pressure warning light When the light comes on: Low tire inflation pressure such as • Natural causes (→P. 569) • Flat tire (→P. 575) → Adjust the tire inflation pressure to the specified level. The light will turn off after a few minutes. In case the light does not turn off even if the tire inflation pressure is adjusted, have the system checked by your Lexus dealer.</p> <p>When the light comes on after blinking for 1 minute: Malfunction in the tire pressure warning system (→P. 569) → Have the system checked by your Lexus dealer.</p>
	<p>Brake Override System/Drive-Start Control warning light Indicates that: • The Brake Override System is operating; • The Brake Override System is malfunctioning (with warning buzzer); • The Drive-Start Control is operating (with warning buzzer); or • The Drive-Start Control is malfunctioning (with warning buzzer) → Follow the instruction that are displayed on the multi-information display.</p>

*1: This light illuminates on the multi-information display.

*2: Driver's and front passenger's seat belt warning buzzer:

The driver's seat belt warning buzzer sounds to alert the driver that his or her seat belt is not fastened. Once the power switch is turned to ON mode, the buzzer sounds for 6 seconds. If the vehicle reaches a speed of 12 mph (20 km/h), the buzzer sounds once. If the seat belt is still unfastened after 24 seconds, the buzzer will sound intermittently for 10 seconds. Then, if the seat belt is still unfastened, the buzzer will sound in a different tone for 20 more seconds.

The front passenger's seat belt warning buzzer sounds to alert the front passenger that his or her seat belt is not fastened. The buzzer sounds once if the vehicle reaches a speed of 12 mph (20 km/h). If the seat belt is still unfastened after 24 seconds, the buzzer will sound intermittently for 10 seconds. Then, if the seat belt is still unfastened, the buzzer will sound in a different tone for 20 more seconds.

■ SRS warning light

This warning light system monitors the airbag sensor assembly, front impact sensors, side impact sensors (front), side impact sensors (rear), driver's seat position sensor, driver's seat belt buckle switch, front passenger occupant classification system (ECU and sensors), "AIR BAG ON" indicator light, "AIR BAG OFF" indicator light, front passenger's seat belt buckle switch, driver's seat belt pretensioner, front passenger's seat belt pretensioner and force limiter, airbags, interconnecting wiring and power sources. (→P. 40)

■ Front passenger detection sensor, seat belt reminder and warning buzzer

- If luggage is placed on the front passenger seat, the front passenger detection sensor may cause the warning light to flash and the warning buzzer to sound even if a passenger is not sitting in the seat.
- If a cushion is placed on the seat, the sensor may not detect a passenger, and the warning light may not operate properly.

■ Electric power steering system warning light (warning buzzer)

When the 12-volt battery charge becomes insufficient of the voltage temporarily drops, the electric power steering system warning light may come on and the warning buzzer may sound.

■ If the malfunction indicator lamp comes on while driving

First check the following:

- Is the fuel tank empty?
If it is, fill the fuel tank immediately.
- Is the fuel tank cap loose?
If it is, tighten it securely.

The light will go off after several driving trips.

If the light does not go off even after several trips, contact your Lexus dealer as soon as possible.

■ When the tire pressure warning light comes on

Inspect the appearance of the tire to check that the tire is not punctured.

If the tire is punctured: →P. 575

If the tire is not punctured:

Carry out the following procedure after the tire temperature has lowered sufficiently.

- Check the tire inflation pressure and adjust to the appropriate level.
- If the warning light does not go out even after several minutes, check that the tire inflation pressure is at the specified level and carry out initialization. (→P. 518)

The warning light may come on again if the above operations are conducted without first allowing the tire temperature to lower sufficiently.

■ The tire pressure warning light may come on due to natural causes

The tire pressure warning light may come on due to natural causes such as natural air leaks and tire inflation pressure changes caused by temperature. In this case, adjusting the tire inflation pressure will turn off the warning light (after a few minutes).

■ When a tire is replaced with a spare tire

Vehicles with a compact spare tire: The compact spare tire is not equipped with a tire pressure warning valve and transmitter. If a tire goes flat, the tire pressure warning light will not turn off even though the flat tire has been replaced with the spare tire. Replace the spare tire with the repaired tire and adjust the tire inflation pressure. The tire pressure warning light will go off after a few minutes.

Vehicles with a full-size spare tire: The spare tire is also equipped with a tire pressure warning valve and transmitter. The tire pressure warning light will turn on if the tire inflation pressure of the spare tire is low. If a tire goes flat, the tire pressure warning light will not turn off even though the flat tire has been replaced with the spare tire. Replace the spare tire with the repaired tire and adjust the tire inflation pressure. The tire pressure warning light will go off after a few minutes.

■ Conditions that the tire pressure warning system may not function properly

→P. 521

■ If the tire pressure warning light frequently comes on after blinking for 1 minute

If the tire pressure warning light frequently comes on after blinking for 1 minute when the power switch is turned to ON mode, have it checked by your Lexus dealer.

■ Warning buzzer

In some cases, the buzzer may not be heard due to being in a noisy location or audio sound.

 **WARNING****■ If both the ABS and the brake system warning lights remain on**

Stop your vehicle in a safe place immediately and contact your Lexus dealer. The vehicle will become extremely unstable during braking, and the ABS system may fail, which could cause an accident resulting in death or serious injury.

■ When the electric power steering system warning light comes on

When the light comes on yellow, the assist to the power steering is restricted. When the light comes on red, the assist to the power steering is lost and handling operations of the steering wheel become extremely heavy. When steering wheel operations are heavier than usual, grip the steering wheel firmly and operate it using more force than usual.

■ If the tire pressure warning light comes on

Be sure to observe the following precautions. Failure to do so could cause a loss of vehicle control and result in death or serious injury.

- Stop your vehicle in a safe place as soon as possible. Adjust the tire inflation pressure immediately.
- If the tire pressure warning light comes on even after tire inflation pressure adjustment, it is probable that you have a flat tire. Check the tires. If a tire is flat, change it with the spare tire and have the flat tire repaired by the nearest Lexus dealer.
- Avoid abrupt maneuvering and braking. If the vehicle tires deteriorate, you could lose control of the steering wheel or the brakes.

■ If a blowout or sudden air leakage should occur

The tire pressure warning system may not activate immediately.

 **WARNING****■ Maintenance of the tires**

Each tire, including the spare (if provided), should be checked monthly when cold and inflated to the inflation pressure recommended by the vehicle manufacturer on the vehicle placard or tire inflation pressure label (tire and load information label). (If your vehicle has tires of a different size than the size indicated on the vehicle placard or tire inflation pressure label [tire and load information label], you should determine the proper tire inflation pressure for those tires.)

As an added safety feature, your vehicle has been equipped with a tire pressure monitoring system (TPMS-tire pressure warning system) that illuminates a low tire pressure telltale (tire pressure warning light) when one or more of your tires is significantly under-inflated. Accordingly, when the low tire pressure telltale (tire pressure warning light) illuminates, you should stop and check your tires as soon as possible, and inflate them to the proper pressure. Driving on a significantly under-inflated tire causes the tire to overheat and can lead to tire failure. Under-inflation also reduces fuel efficiency and tire tread life, and may affect the vehicle's handling and stopping ability.

Please note that the TPMS (tire pressure warning system) is not a substitute for proper tire maintenance, and it is the driver's responsibility to maintain correct tire pressure, even if under-inflation has not reached the level to trigger illumination of the TPMS low tire pressure telltale (tire pressure warning light).

Your vehicle has also been equipped with a TPMS (tire pressure warning system) malfunction indicator to indicate when the system is not operating properly. The TPMS (tire pressure warning system) malfunction indicator is combined with the low tire pressure telltale (tire pressure warning light). When the system detects a malfunction, the telltale will flash for approximately one minute and then remain continuously illuminated. This sequence will continue upon subsequent vehicle start-ups as long as the malfunction exists. When the malfunction indicator is illuminated, the system may not be able to detect or signal low tire pressure as intended.

TPMS (tire pressure warning system) malfunctions may occur for a variety of reasons, including the installation of replacement or alternate tires or wheels on the vehicle that prevent the TPMS (tire pressure warning system) from functioning properly. Always check the TPMS (tire pressure warning system) malfunction telltale after replacing one or more tires or wheels on your vehicle to ensure that the replacement or alternate tires and wheels allow the TPMS (tire pressure warning system) to continue to function properly.

 **NOTICE****■ To ensure the tire pressure warning system operates properly**

Do not install tires with different specifications or makers, as the tire pressure warning system may not operate properly.

If a warning message is displayed

The multi-information display shows warnings of system malfunctions, incorrectly performed operations, and messages that indicate a need for maintenance. When a message is shown, perform the correction procedure appropriate to the message.

① Master warning light

The master warning light also comes on or flashes in order to indicate that a message is currently being displayed on the multi-information display.

② Multi-information display

③ Handling Method

Follow the instructions of the message on the multi-information display.

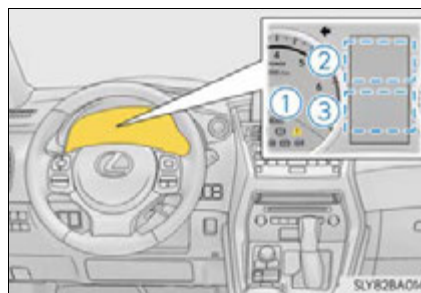

If any of the warning messages are shown again after the following actions have been performed, contact your Lexus dealer.

Messages and warnings

The warning lights and warning buzzers operate as follows depending on the content of the message. If a message indicates the need for inspection by a dealer, have the vehicle inspected by your Lexus dealer immediately.

	System warning light	Warning buzzer*	Warning
Comes on	—	Sounds	Indicates an important situation, such as when a system related to driving is malfunctioning or that danger may result if the correction procedure is not performed
—	Comes on or flashes	Sounds	Indicates an important situation, such as when the systems shown on the multi-information display may be malfunctioning
Flashes	—	Sounds	Indicates a situation, such as when damage to the vehicle or danger may result

	System warning light	Warning buzzer*	Warning
Comes on	—	Does not sound	Indicates a condition, such as malfunction of electrical components, their condition, or indicates the need for maintenance
Flashes	—	Does not sound	Indicates a situation, such as when an operation has been performed incorrectly, or indicates how to perform an operation correctly

*: A buzzer sounds the first time a message is shown on the multi-information display.

■ **System warning lights**

The master warning light does not come on or flash in the following cases. Instead, a separate system warning light will come on along with a message shown on the multi-information display.

- Malfunction of the ABS
The ABS warning light comes on. (→P. 566)
- Malfunction of the charging system
The charging system warning light comes on. (→P. 565)

■ **If “Hybrid System Overheated Reduced Output Power” is shown**

This message may be displayed when driving under severe operating conditions. (For example, when driving up a long steep hill.)
Handling method: →P. 599

■ **If “Cooling Performance of The Hybrid Battery Is Low” is shown**

The filter may be clogged, or the air intake vents or ducts may be blocked. Have the vehicle inspected by your Lexus dealer.

■ **If “Hybrid Battery Low Shift Out of N to Recharge” is shown**

Message is displayed when the remaining charge for the hybrid battery (traction battery) is low.
As the hybrid battery (traction battery) cannot be charged when the shift lever is in N, when stopped for long periods of time shift the shift lever to P.

■ **If “Hybrid Battery Low Hybrid System Stopped Shift to P and Restart” is shown**

Message is displayed when the remaining charge for the hybrid battery (traction battery) is low, because vehicle has been shifted N for a long period of time.
When operating the vehicle, restart the hybrid system.

■ **If “Shift to P Before Exiting Vehicle” is shown**

Message is displayed when the driver’s door is opened without turning the power switch to OFF with the shift lever in any position other than P.
Shift the shift lever to P.

■ **If “Shift Is in N Release Accelerator Before Shifting” is shown**

Message is displayed when the accelerator pedal has been depressed and the shift lever is in N. Release the accelerator pedal and shift the shift lever to D or R.

- **“Depress Brake When Vehicle Is Stopped Hybrid System May Overheat” is shown**
 Message is displayed when the accelerator pedal is depressed to maintain the vehicle position when stopped on an upward slope, etc.
 If this continues, the hybrid system may overheat.
 Release the accelerator pedal and depress the brake pedal.
- **“Oil Maintenance Required Soon” is shown**
 Indicates that the engine oil is scheduled to be changed. (The indicator will not work properly unless the oil maintenance data has been reset.)
 Check the engine oil, and change if necessary. After changing the engine oil, the oil change system should be reset. (→P. 506)
- **“Oil Maintenance Required” is shown**
 Indicates that the engine oil should be changed. (After the engine oil is changed and the oil maintenance data has been reset.)
 Check and change the engine oil, and oil filter by your Lexus dealer. After changing the engine oil, the oil change system should be reset. (→P. 506)
- **“See Owner’s Manual” is shown**
 - If the following messages are shown, following the instructions, accordingly.
 - “Engine Coolant Temp High” (→P. 599)
 - If the following messages are shown, there may be a malfunction. Immediately have the vehicle inspected by your Lexus dealer.
 - “Hybrid System Malfunction”
 - “Check Engine”
 - “Hybrid Battery System Malfunction”
 - “Accelerator System Malfunction”
 - “Braking Power Low”
 - “Smart Access System Malfunction”
 - If the following messages are shown, there may be a malfunction. Immediately stop the vehicle in a safe place and contact your Lexus dealer. Continuing to drive the vehicle may be dangerous.
 - “Low Oil Pressure”
 - “Charging System Malfunction”
- **Warning buzzer**
 →P. 569

 NOTICE

- **“High Power Consumption Partial Limit On AC/Heater Operation” is frequently shown**
 There is a possible malfunction relating to the charging system or the 12-volt battery may be deteriorating. Have the vehicle inspected by your Lexus dealer.

If you have a flat tire

Your vehicle is equipped with a spare tire. The flat tire can be replaced with the spare tire.

For details about tires: →P. 516

WARNING

■ If you have a flat tire

Do not continue driving with a flat tire.

Driving even a short distance with a flat tire can damage the tire and the wheel beyond repair, which could result in an accident.

Before jacking up the vehicle

- Stop the vehicle on a hard, flat surface.
- Set the parking brake.
- Shift the shift lever to P.
- Stop the hybrid system.
- Turn on the emergency flashers. (→P. 556)

Location of the spare tire, jack and tools

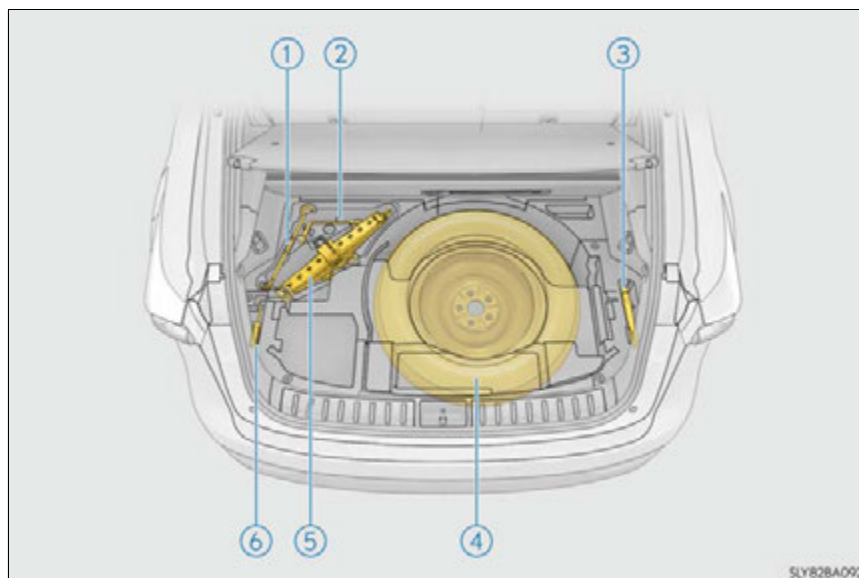

- | | |
|--------------------|---------------|
| ① Jack handle | ④ Spare tire |
| ② Wheel nut wrench | ⑤ Jack |
| ③ Towing eyelet | ⑥ Screwdriver |

 **WARNING****■ Using the tire jack**

Observe the following precautions.

Improper use of the tire jack may cause the vehicle to suddenly fall off the jack, leading to death or serious injury.

- Do not use the tire jack for any purpose other than replacing tires or installing and removing tire chains.
- Only use the tire jack that comes with this vehicle for replacing a flat tire.
Do not use it on other vehicles, and do not use other tire jacks for replacing tires on this vehicle.
- Put the jack properly in its jack point.
- Do not put any part of your body under the vehicle while it is supported by the jack.
- Do not start the hybrid system or drive the vehicle while the vehicle is supported by the jack.
- Do not raise the vehicle while someone is inside.
- When raising the vehicle, do not put an object on or under the jack.
- Do not raise the vehicle to a height greater than that required to replace the tire.
- Use a jack stand if it is necessary to get under the vehicle.
- When lowering the vehicle, make sure that there is no-one near the vehicle. If there are people nearby, warn them vocally before lowering.

Taking out the jack

- 1** If the luggage cover is used: Unhook the cords.

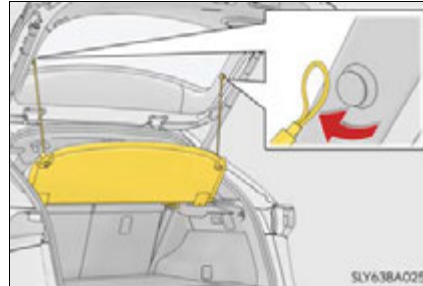

- 2** If the luggage cover is used: Fold up the luggage cover.



- 3** Pull the lever upwards and open the deck board.

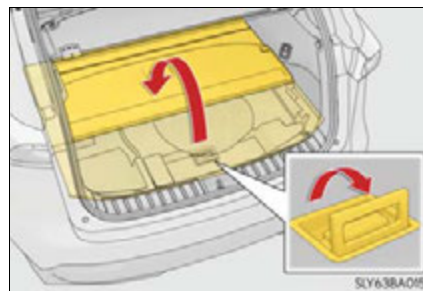

- 4** Lift the deck board and remove the hook on the backside of the deck board.

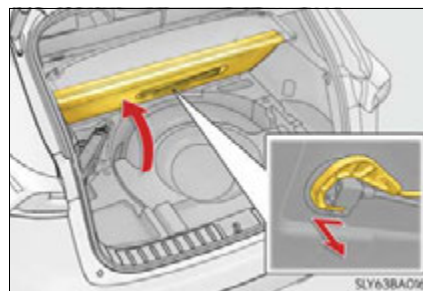

- 5 Attach the hook to the upper edge of the back door opening as shown.



- 6 Removing the Jack.

- 1 Remove the rubber band.
- 2 Remove the cover and the jack.

When stowing the jack, close it by turning the handle indicated by A until it does not move anymore, stow the jack and the cover, and press on the jack to fix with the rubber band.

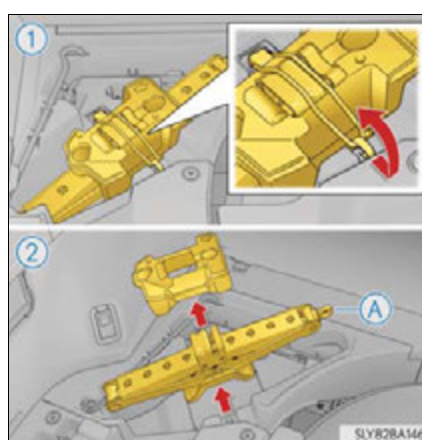

Taking out the spare tire

- 1 Remove the deck under tray.

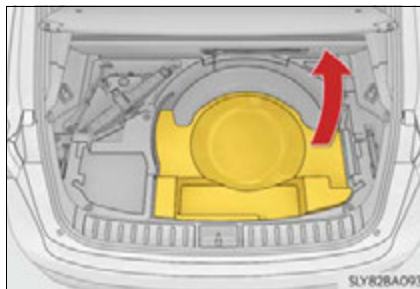

- 2 Loosen the center fastener that secures the spare tire.

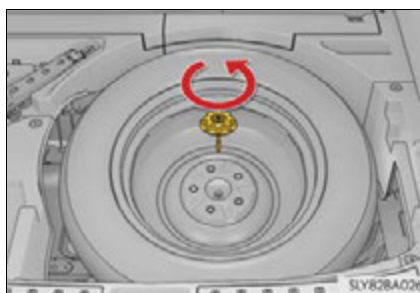

WARNING

■ **When storing the spare tire**

Be careful not to catch fingers or other body parts between the spare tire and the body of the vehicle.

Replacing a flat tire

- 1 Chock the tires.

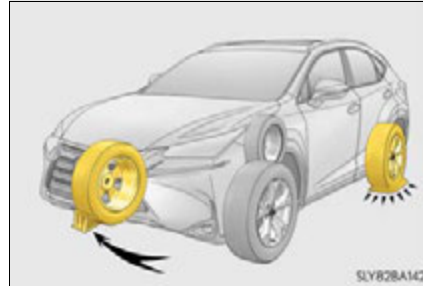

Flat tire		Wheel chock positions
Front	Left-hand side	Behind the rear right-hand side tire
	Right-hand side	Behind the rear left-hand side tire
Rear	Left-hand side	In front of the front right-hand side tire
	Right-hand side	In front of the front left-hand side tire

- 2 Slightly loosen the wheel nuts (one turn).

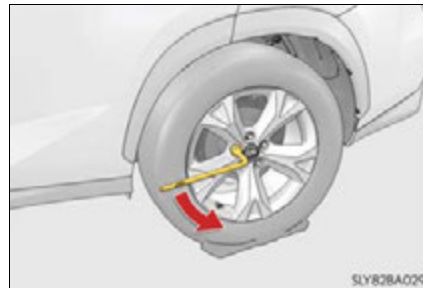

- 3 Turn the tire jack portion (A) by hand until the notch of the jack is in contact with the jack point.

The jack point guides are located under the rocker panel. They indicate the jack point positions.

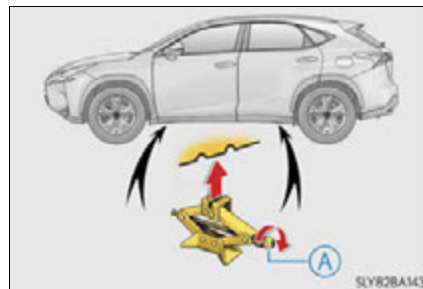

582 8-2. Steps to take in an emergency

- 4** Install the wheel nut wrench in jack handle.

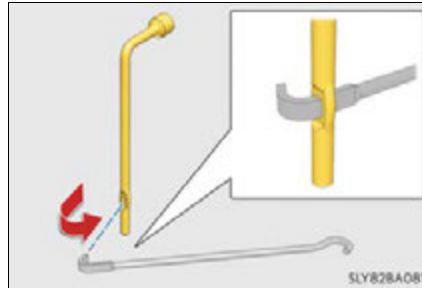

- 5** Raise the vehicle until the tire is slightly raised off the ground.

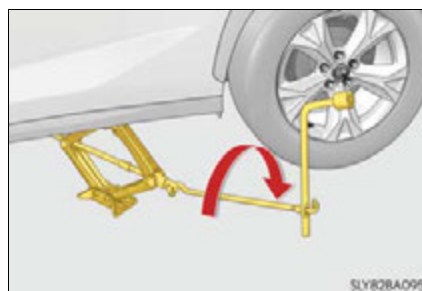

- 6** Remove all the wheel nuts and the tire.

When resting the tire on the ground, place the tire so that the wheel design faces up to avoid scratching the wheel surface.



 **WARNING****■ Replacing a flat tire**

- Observe the following precautions.

Failure to do so may result in serious injury:

- Do not try to remove the wheel ornament by hand. Take due care in handling the ornament to avoid unexpected personal injury.
- Do not touch the disc wheels or the area around the brakes immediately after the vehicle has been driven.

After the vehicle has been driven the disc wheels and the area around the brakes will be extremely hot. Touching these areas with hands, feet or other body parts while changing a tire, etc. may result in burns.

- Failure to follow these precautions could cause the wheel nuts to loosen and the tire to fall off, resulting in death or serious injury.
 - Never use oil or grease on the wheel bolts or wheel nuts.
Oil and grease may cause the wheel nuts to be excessively tightened, leading to bolt or disc wheel damage. In addition, the oil or grease can cause the wheel nuts to loosen and the wheel may fall off, causing a serious accident.
Remove any oil or grease from the wheel bolts or wheel nuts.
 - Have the wheel nuts tightened with a torque wrench to 76 ft•lbf (103 N•m, 10.5 kgf•m) as soon as possible after changing wheels.
 - When installing a tire, only use wheel nuts that have been specifically designed for that wheel.
 - If there are any cracks or deformations in the bolt screws, nut threads or bolt holes of the wheel, have the vehicle inspected by your Lexus dealer.
 - Do not attach a heavily damaged wheel ornament, as it may fly off the wheel while the vehicle is moving.

■ Replacing a flat tire for vehicles with power back door

In cases such as when replacing tires, make sure to turn off the power back door main switch (→P. 132). Failure to do so may cause the back door to operate unintentionally if the power back door switch is accidentally touched, resulting in hands and fingers being caught and injured.

Installing the spare tire

- 1 Remove any dirt or foreign matter from the wheel contact surface.

If foreign matter is on the wheel contact surface, the wheel nuts may loosen while the vehicle is in motion, causing the tire to come off.

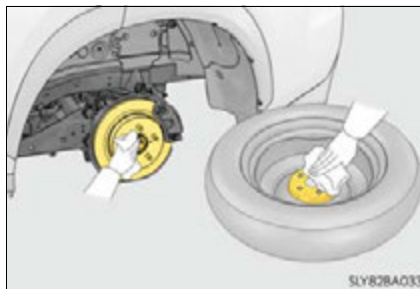

- 2 Install the spare tire and loosely tighten each wheel nut by hand by approximately the same amount.

Tighten the wheel nuts until the tapered portion comes into loose contact with the disc wheel seat.

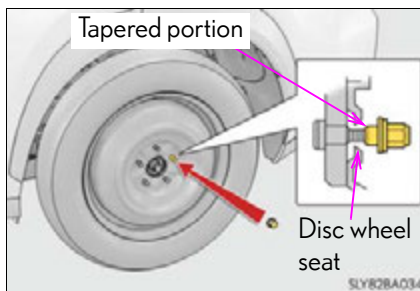

- 3 Install the wheel nut wrench in jack handle.

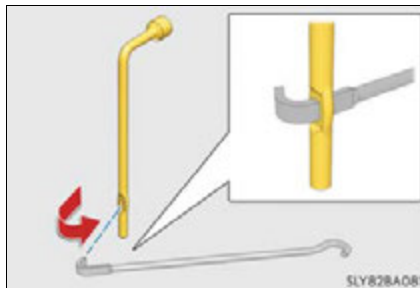

- 4 Lower the vehicle.

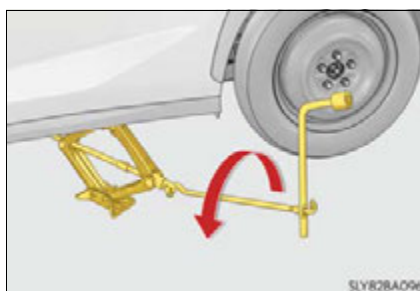

- 5 Firmly tighten each wheel nut two or three times in the order shown in the illustration.

Tightening torque:
76 ft•lbf (103 N•m, 10.5 kgf•m)

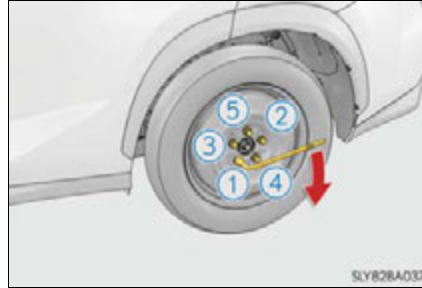

- 6 Stow the flat tire, tire jack and all tools.

■ **The compact spare tire**

- The compact spare tire is identified by the label “TEMPORARY USE ONLY” on the tire sidewall.
Use the compact spare tire temporarily, and only in an emergency.
- Make sure to check the tire inflation pressure of the compact spare tire. (→P. 613)

■ **After completing the tire change**

The tire pressure warning system must be reset. (→P. 518)

■ **When using the compact spare tire**

As the compact spare tire is not equipped with a tire pressure warning valve and transmitter, low inflation pressure of the spare tire will not be indicated by the tire pressure warning system. Also, if you replace the compact spare tire after the tire pressure warning light comes on, the light remains on.

■ **When the compact spare tire is equipped**

The vehicle becomes lower when driving with the compact spare tire compared to when driving with standard tires.

■ **If you have a flat front tire on a road covered with snow or ice (except for 225/60R18 tires)**

Install the compact spare tire on one of the rear wheels of the vehicle. Perform the following steps and fit tire chains to the front tires:

- 1 Replace a rear tire with the compact spare tire.
- 2 Replace the flat front tire with the tire removed from the rear of the vehicle.
- 3 Fit tire chains to the front tires.

 **WARNING****■ When using the compact spare tire**

- Remember that the spare tire provided is specifically designed for use with your vehicle. Do not use your spare tire on another vehicle.
- Do not use more than one spare tire simultaneously.
- Replace the spare tire with a standard tire as soon as possible.
- Avoid sudden acceleration, deceleration and braking, as well as sharp cornering.

■ When the compact spare tire is attached

The vehicle speed may not be correctly detected, and the following systems may not operate correctly:

- | | |
|---|---|
| • ABS & Brake assist | • AVS (if equipped) |
| • VSC | • LDA (Lane Departure Alert)
(if equipped) |
| • TRAC | • Intuitive parking assist (if equipped) |
| • Cruise control | • Navigation system (if equipped) |
| • Dynamic radar cruise control
(if equipped) | • BSM (Blind spot monitor)
(if equipped) |
| • Pre-collision system (if equipped) | • Automatic high Beam (if equipped) |
| • EPS | |

Also, not only can the following system not be utilized fully, but it may even negatively affect the drive-train components:

- E-Four (if equipped)

■ Speed limit when using the compact spare tire

Do not drive at speeds in excess of 50 mph (80 km/h) when a compact spare tire is installed on the vehicle.

The compact spare tire is not designed for driving at high speeds. Failure to observe this precaution may lead to an accident causing death or serious injury.

■ After using the tools and jack

Before driving, make sure all the tools and jack are securely in place in their storage location to reduce the possibility of personal injury during a collision or sudden braking.

 NOTICE

■ **Be careful when driving over bumps with the compact spare tire installed on the vehicle**

The vehicle becomes lower when driving with the compact spare tire compared to when driving with standard tires. Be careful when driving over uneven road surfaces.

■ **Driving with tire chains and the compact spare tire**

Do not fit tire chains to the compact spare tire.

Tire chains may damage the vehicle body and adversely affect driving performance.

■ **When replacing the tires**

When removing or fitting the wheels, tires or the tire pressure warning valve and transmitter, contact your Lexus dealer as the tire pressure warning valve and transmitter may be damaged if not handled correctly.

If the hybrid system will not start

Reasons for the hybrid system not starting vary depending on the situation. Check the following and perform the appropriate procedure:

The hybrid system will not start even though the correct starting procedure is being followed. (→P. 201)

One of the following may be the cause of the problem:

- The electronic key may not be functioning properly. (→P. 591)
- There may not be sufficient fuel in the vehicle's tank.
Refuel the vehicle. (→P. 83)
- There may be a malfunction in the immobilizer system. (→P. 86)
- There may be a malfunction in the steering lock system.
- The hybrid system may be malfunctioning due to an electrical problem such as electronic key battery depletion or a blown fuse. However, depending on the type of malfunction, an interim measure is available to start the hybrid system. (→P. 589)

The interior lights and headlights are dim, or the horn does not sound or sounds at a low volume.

One of the following may be the cause of the problem:

- The 12-volt battery may be discharged. (→P. 594)
- The 12-volt battery terminal connections may be loose or corroded.
(→P. 512)

The interior lights and headlights do not turn on, or the horn does not sound.

One of the following may be the cause of the problem:

- The 12-volt battery may be discharged. (→P. 594)
- One or both of the 12-volt battery terminals may be disconnected. (→P. 512)

Contact your Lexus dealer if the problem cannot be repaired, or if repair procedures are unknown.

Emergency start function

When the hybrid system does not start, the following steps can be used as an interim measure to start the hybrid system if the power switch is functioning normally:

Do not use this starting procedure except in cases of emergency.

- 1** Set the parking brake.
- 2** Shift the shift lever to P.
- 3** Turn the power switch to ACCESSORY mode.
- 4** Press and hold the power switch for about 15 seconds while depressing the brake pedal firmly.

Even if the hybrid system can be started using the above steps, the system may be malfunctioning. Have the vehicle inspected by your Lexus dealer.

If the shift lever cannot be shifted from P

If the shift lever cannot be shifted with your foot on the brake pedal, there may be a problem with the shift lock system (a system to prevent accidental operation of the shift lever). Have the vehicle inspected by your Lexus dealer immediately.

The following steps may be used as an emergency measure to ensure that the shift lever can be shifted:

- 1 Set the parking brake.
- 2 Turn the power switch to ACCESSORY mode.
- 3 Depress the brake pedal.

- 4 Pry the cover up with a flathead screwdriver or equivalent tool.

To prevent damage to the cover, cover the tip of the screwdriver with a rag.

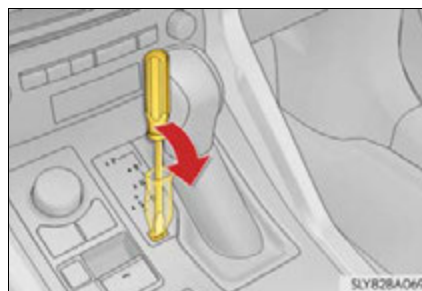

- 5 Press the shift lock override button.

The shift lever can be shifted while the button is pressed

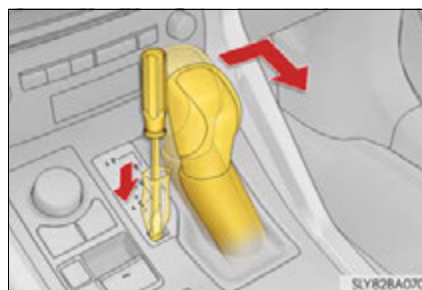

If the electronic key does not operate properly

If communication between the electronic key and vehicle is interrupted (→P. 142) or the electronic key cannot be used because the battery is depleted, the smart access system with push-button start and wireless remote control cannot be used. In such cases, the doors can be opened and the hybrid system can be started by following the procedure below.

Locking and unlocking the doors

Use the mechanical key (→P. 119) to perform the following operation

■ Unlocking the door

- 1 Insert the mechanical key while pulling on the driver's door handle.



- 2 Unlocking the door.



- 3 Remove the key, return the handle, and then pull the handle again.

■ Locking the door

- 1 Move the inside lock button to the lock position.

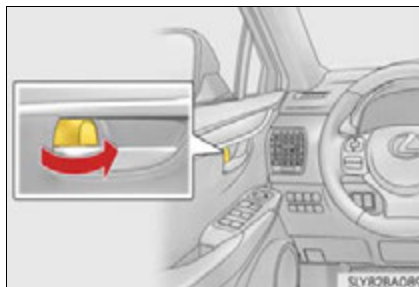

- 2 Close the door.

■ Key linked functions

- 1 Closes the windows and moon roof* (turn and hold)
 - 2 Opens the windows and moon roof* (turn and hold)
- *: These settings must be customized at your Lexus dealer.



Starting the hybrid system

- 1 Ensure that the shift lever is in P and depress the brake pedal.

- 2 Touch the Lexus emblem side of the electronic key to the power switch.

When the electronic key is detected, a buzzer sounds and the power switch will turn to ON mode.

When the smart access system with push-button start is deactivated in customization setting, the power switch will turn to ACCESSORY mode.

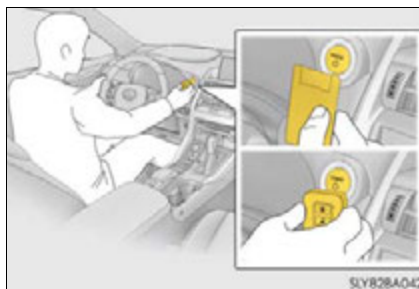

- 3 Firmly depress the brake pedal and check that message shown on the multi-information display.

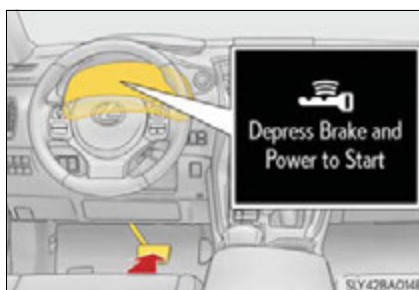

- 4 Press the power switch.

In the event that the hybrid system still cannot be operated, contact your Lexus dealer.

■ Stopping the hybrid system

Set the parking brake, shift the shift lever to P and press the power switch as you normally do when stopping the hybrid system.

■ Replacing the key battery

As the above procedure is a temporary measure, it is recommended that the electronic key battery be replaced immediately when the battery is depleted. (→P. 532)

■ Alarm (if equipped)

Using the mechanical key to lock the doors will not set the alarm system. If a door is unlocked using the mechanical key when the alarm system is set, the alarm may be triggered.

■ Changing power switch modes

Release the brake pedal and press the power switch in step 3 above. The hybrid system does not start and modes will be changed each time the switch is pressed. (→P. 202)

■ When the electronic key does not work properly

- Make sure that the smart access system with push-button start has not been deactivated in the customization setting. If it is off, turn the function on. (Customizable features →P. 633)
- Check if battery-saving mode is set. If it is set, cancel the function. (→P. 142)

WARNING

■ When using the mechanical key and operating the power windows or moon roof

Operate the power window or moon roof after checking to make sure that there is no possibility of any passenger having any of their body parts caught in the window or moon roof.

Also, do not allow children to operate the mechanical key. It is possible for children and other passengers to get caught in the power window or moon roof.

If the 12-volt battery is discharged

The following procedures may be used to start the hybrid system if the vehicle's 12-volt battery is discharged.

You can also call your Lexus dealer or a qualified repair shop.

If you have a set of jumper (or booster) cables and a second vehicle with a 12-volt battery, you can jump start your vehicle by following the steps below.

- 1 Confirm that the electronic key is being carried.

When connecting the jumper (or booster) cables, depending on the situation, the alarm may activate and the doors may lock. (→P. 89)

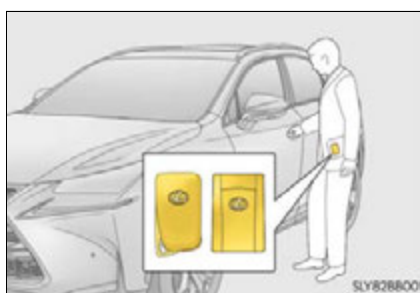

- 2 Open the hood (→P. 500) and fuse box cover.

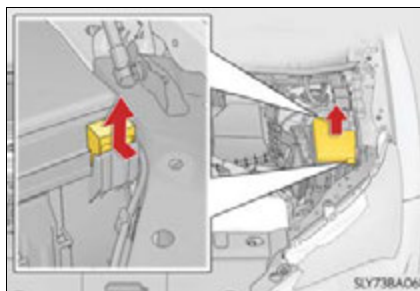

- 3 Open the exclusive jump starting terminal cover.

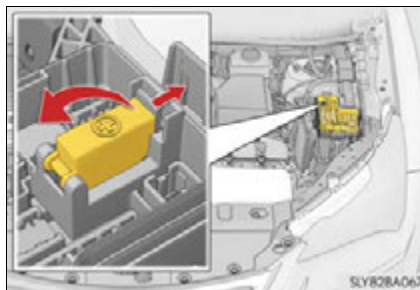

- 4 Remove the engine cover.

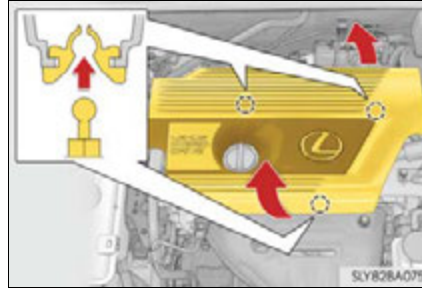

- 5 Connect the jumper cables according to the following procedure:

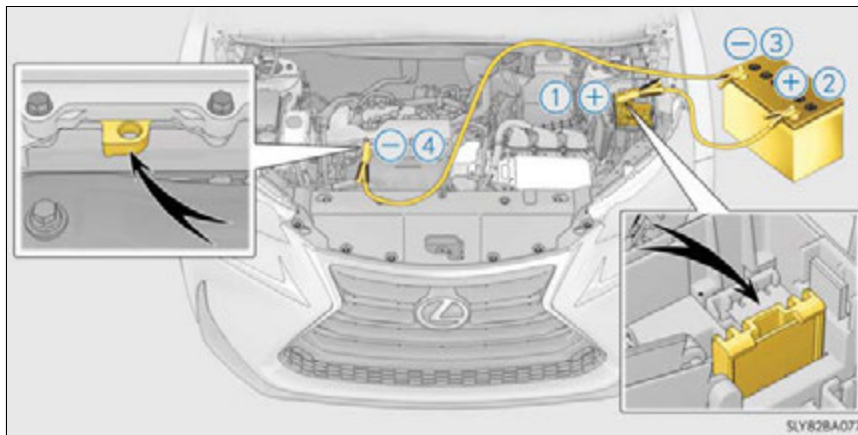

- ① Connect a positive jumper cable clamp to the exclusive jump starting terminal on your vehicle.
- ② Connect the clamp on the other end of the positive cable to the positive (+) battery terminal on the second vehicle.
- ③ Connect a negative cable clamp to the negative (-) battery terminal on the second vehicle.
- ④ Connect the clamp at the other end of the negative cable to a solid, stationary, unpainted metallic point away from the exclusive jump starting terminal and any moving parts, as shown in the illustration.

- 6 Start the engine of the second vehicle. Increase the engine speed slightly and maintain at that level for approximately 5 minutes to recharge the 12-volt battery of your vehicle.
- 7 Open and close any of the doors of your vehicle with the power switch off.
- 8 Maintain the engine speed of the second vehicle and start the hybrid system of your vehicle by turning the power switch to ON mode.
- 9 Make sure the "READY" indicator comes on. If the indicator light does not come on, contact your Lexus dealer.
- 10 Once the hybrid system has started, remove the jumper cables in the exact reverse order from which they were connected.
- 11 Close the exclusive jump starting terminal cover, and reinstall the fuse box cover to its original position.

Once the hybrid system starts, have the vehicle inspected at your Lexus dealer as soon as possible.

■ Starting the hybrid system when the 12-volt battery is discharged

The hybrid system cannot be started by push-starting.

■ To prevent 12-volt battery discharge

- Turn off the headlights and the audio system while the hybrid system is off.
- Turn off any unnecessary electrical components when the vehicle is running at a low speed for an extended period, such as in heavy traffic.

■ Charging the 12-volt battery

The electricity stored in the 12-volt battery will discharge gradually even when the vehicle is not in use, due to natural discharge and the draining effects of certain electrical appliances. If the vehicle is left for a long time, the 12-volt battery may discharge, and the hybrid system may be unable to start. (The 12-volt battery recharges automatically while the hybrid system is operating.)

■ When the 12-volt battery is removed or discharged

- In some cases, it may not be possible to unlock the doors using the smart access system with push-button start when the 12-volt battery is discharged. Use the wireless remote control or the mechanical key to lock or unlock the doors.
- The hybrid system may not start on the first attempt after the 12-volt battery has recharged but will start normally after the second attempt. This is not a malfunction.
- The power switch mode is memorized by the vehicle. When the 12-volt battery is reconnected, the system will return to the mode it was in before the 12-volt battery was discharged. Before disconnecting the 12-volt battery, turn the power switch off. If you are unsure what mode the power switch was in before the 12-volt battery discharged, be especially careful when reconnecting the 12-volt battery.
- The power back door must be initialized. (→P. 134)

■ When exchanging the 12-volt battery

- Use a Central Degassing type 12-volt battery (European Regulations). Also, use 12-volt batteries with case sizes similar to one prior the exchange and an equivalent 20 hour rate capacity (20HR) or greater.
 - If the sizes differ, the 12-volt battery cannot be properly secured.
 - If the 20 hour rate capacity is low, even if the time period where the vehicle is not used is a short time, the 12-volt battery may discharge and hybrid system may not be able to start.
- After exchanging, firmly attach the following items to the exhaust hole of the 12-volt battery.
 - Use the exhaust hose that was attached to the 12-volt battery before exchanging and confirm that it is firmly connected to the hole section of the vehicle.
 - Use the exhaust hole plug included with the 12-volt battery exchanged or the one installed on the battery prior to the exchange. (Depending on the 12-volt battery to be exchanged, the exhaust hole may be plugged.)

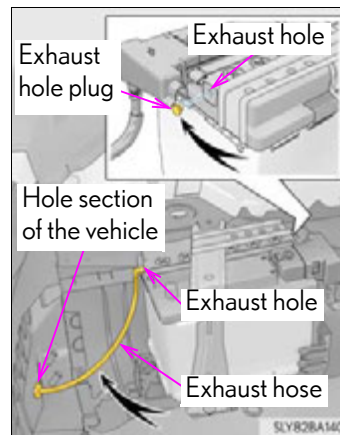

For details, consult your Lexus dealer.

⚠ WARNING

■ Avoiding 12-volt battery fires or explosions

Observe the following precautions to prevent accidentally igniting the flammable gas that may be emitted from the 12-volt battery:

- Make sure each jumper cable is connected to the correct terminal and that it is not unintentionally in contact with any other than the intended terminal.
- Do not allow the other end of the jumper cable connected to the "+" terminal to come into contact with any other parts or metal surfaces in the area, such as brackets or unpainted metal.
- Do not allow the + and - clamps of the jumper cables to come into contact with each other.
- Do not smoke, use matches, cigarette lighters or allow open flame near the 12-volt battery.

 **WARNING****■ 12-volt battery precautions**

The 12-volt battery contains poisonous and corrosive acidic electrolyte, while related parts contain lead and lead compounds. Observe the following precautions when handling the 12-volt battery:

- When working with the 12-volt battery, always wear safety glasses and take care not to allow any battery fluids (acid) to come into contact with skin, clothing or the vehicle body.
- Do not lean over the 12-volt battery.
- In the event that battery fluid comes into contact with the skin or eyes, immediately wash the affected area with water and seek medical attention.
Place a wet sponge or cloth over the affected area until medical attention can be received.
- Always wash your hands after handling the 12-volt battery support, terminals, and other battery-related parts.
- Do not allow children near the 12-volt battery.

■ After recharging the 12-volt battery

Have the 12-volt battery inspected at your Lexus dealer as soon as possible. If the 12-volt battery is deteriorating, continued use may cause the 12-volt battery to emit a malodorous gas, which may be detrimental to the health of passengers.

■ When exchanging the 12-volt battery

After exchanging, securely attach the exhaust hose and exhaust hole plug to the exhaust hole of the exchanged 12-volt battery. If not properly installed, gases (hydrogen) may leak into the vehicle interior, and there is the possible danger of the gas igniting and exploding.

 **NOTICE****■ When handling jumper cables**

When connecting the jumper cables, ensure that they do not become entangled in the cooling fans or belt.

■ To prevent damaging the vehicle

The exclusive jump starting terminal is to be used when charging the 12-volt battery from another vehicle in an emergency. It cannot be used to jump start another vehicle.

If your vehicle overheats

The following may indicate that your vehicle is overheating.

- The needle of the engine coolant temperature gauge (→P. 97) enters the red zone, or a loss of hybrid system power is experienced. (For example, the vehicle speed does not increase.)
- “Engine Coolant Temp High” or “Hybrid System Overheated” is shown on the multi-information display.
- Steam comes out from under the hood.

Correction procedures

■ “Engine Coolant Temp High” is shown on the multi-information display

- 1 Stop the vehicle in a safe place and turn off the air conditioning system, and then stop the hybrid system.
- 2 If you see steam:
Carefully lift the hood after the steam subsides.
If you do not see steam:
Carefully lift the hood.
- 3 After the hybrid system has cooled down sufficiently, inspect the hoses and radiator core (radiator) for any leaks.
 - 1 Radiator
 - 2 Cooling fansIf a large amount of coolant leaks, immediately contact your Lexus dealer.

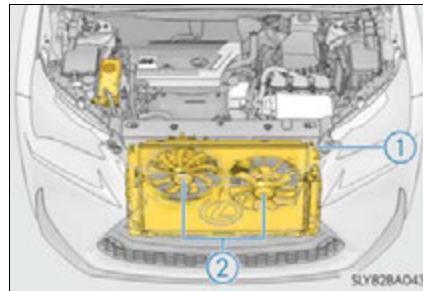

- 4** The coolant level is satisfactory if it is between the “FULL” and “LOW” lines on the reservoir.

- ① Reservoir
- ② “FULL” line
- ③ “LOW” line



- 5** Add coolant if necessary.
Water can be used in an emergency if coolant is unavailable.

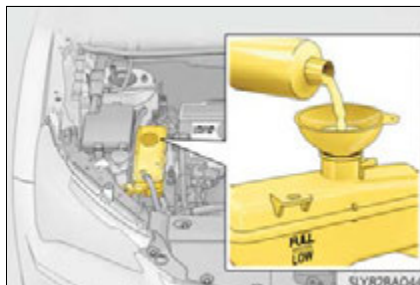

- 6** Start the hybrid system and turn the air conditioning system on to check that the radiator cooling fans operate and to check for coolant leaks from the radiator or hoses.

The fans operate when the air conditioning system is turned on immediately after a cold start. Confirm that the fans are operating by checking the fan sound and air flow. If it is difficult to check these, turn the air conditioning system on and off repeatedly. (The fans may not operate in freezing temperatures.)

- 7** If the fans are not operating:

Stop the hybrid system immediately and contact your Lexus dealer.

If the fans are operating:

Have the vehicle inspected at the nearest Lexus dealer.

- 8** Check if “Engine Coolant Temp High” is shown on the multi-information display.

If the message does not disappear:

Stop the hybrid system and contact your Lexus dealer.

If the message is not displayed:

Have the vehicle inspected at the nearest Lexus dealer.

■ If “Hybrid System Overheated” is shown on the multi-information display

- 1 Stop the vehicle in a safe place.
- 2 Stop the hybrid system and carefully lift the hood.
- 3 After the hybrid system has cooled down, inspect the hoses and radiator core (radiator) for any leaks.

- ① Radiator
- ② Cooling fans

If a large amount of coolant leaks, immediately contact your Lexus dealer.

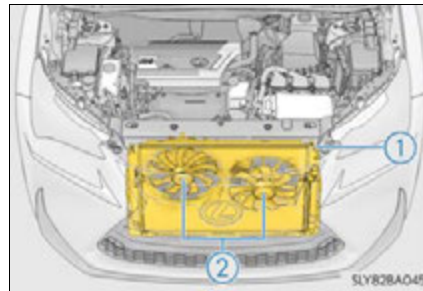

- 4 The coolant level is satisfactory if it is between the “FULL” and “LOW” lines on the reservoir.

- ① Reservoir
- ② “FULL” line
- ③ “LOW” line

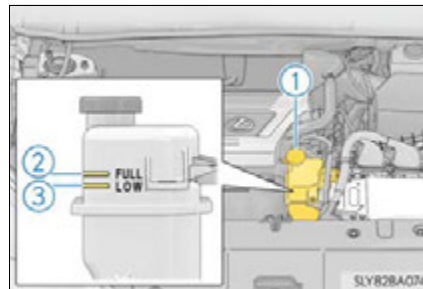

- 5 Add coolant if necessary.

Water can be used in an emergency if coolant is unavailable.

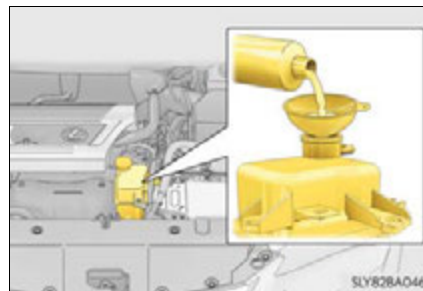

- 6 Start the hybrid system and check if “Hybrid System Overheated” is shown on the multi-information display.

If the message does not disappear:

Stop the hybrid system and contact your Lexus dealer.

If the message is not displayed:

Have the vehicle inspected at the nearest Lexus dealer.

 **WARNING**

■ **To prevent an accident or injury when inspecting under the hood of your vehicle**

Observe the following precautions.

Failure to do so may result in serious injury such as burns.

- If steam is seen coming from under the hood, do not open the hood until the steam has subsided. The engine compartment may be very hot.
- After the hybrid system has been turned off, check that the “READY” indicator is off. When the hybrid system is operating, the gasoline engine may automatically start, or the cooling fan may suddenly operate even if the gasoline engine stops. Do not touch or approach rotating parts such as the fan, which may lead to fingers or clothing (especially a tie, a scarf or a muffler) getting caught, resulting in serious injury.
- Do not loosen the coolant reservoir cap while the hybrid system and radiator are hot. High temperature steam or coolant could spray out.

 **NOTICE**

■ **When adding engine/power control unit coolant**

Add coolant slowly after the hybrid system has cooled down sufficiently. Adding cool coolant to a hot hybrid system too quickly can cause damage to the hybrid system.

■ **To prevent damage to the cooling system**

Observe the following precautions:

- Avoid contaminating the coolant with foreign matter (such as sand or dust etc.).
- Do not use any coolant additive.

If the vehicle becomes stuck

Carry out the following procedures if the tires spin or the vehicle becomes stuck in mud, dirt or snow:

- 1 Stop the hybrid system. Shift the shift lever to P and set the parking brake.
- 2 Remove the mud, snow or sand from around the front wheels.
- 3 Place wood, stones or some other material under the front wheels to help provide traction.
- 4 Restart the hybrid system.
- 5 Shift the shift lever to D or R, release the parking brake. Then, while exercising caution, depress the accelerator pedal.

■ When it is difficult to free the vehicle

Press  to turn off TRAC. (→P. 307)

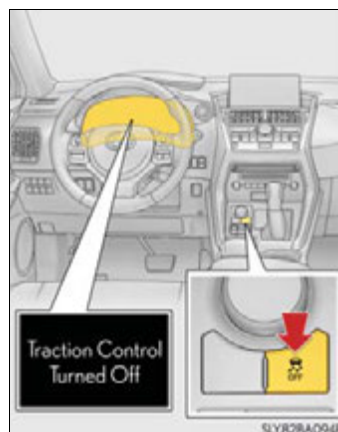

 **WARNING****■ When attempting to free a stuck vehicle**

If you choose to push the vehicle back and forth to free it, make sure the surrounding area is clear to avoid striking other vehicles, objects or people. The vehicle may also lunge forward or lunge back suddenly as it becomes free. Use extreme caution.

■ When shifting the shift lever

Be careful not to shift the shift lever with the accelerator pedal depressed. This may lead to unexpected rapid acceleration of the vehicle that may cause an accident resulting in death or serious injury.

 **NOTICE****■ To avoid damage to the hybrid transmission and other components**

- Avoid spinning the front wheels and depressing the accelerator pedal more than necessary.
- If the vehicle remains stuck even after these procedures are performed, the vehicle may require towing to be freed.

- 9-1. Specifications**
 - Maintenance data
(fuel, oil level, etc.).....606
 - Fuel information.....616
 - Tire information.....619
- 9-2. Customization**
 - Customizable features 631
- 9-3. Initialization**
 - Items to initialize641

Maintenance data (fuel, oil level, etc.)

Dimensions and weight

Overall length		182.3 in. (4630 mm)
Overall width		72.6 in. (1845 mm)
Overall height ^{*1}		64.8 in. (1645 mm)
Wheelbase		104.7 in. (2660 mm)
Tread	Front	62.2 in. (1580 mm)
	Rear	62.2 in. (1580 mm)
Vehicle capacity weight (Occupants + luggage)		895 lb. (405 kg)
Trailer Weight Rating ^{*2} (Trailer weight + cargo weight)		1500 lb. (685 kg)

*1: Unladen vehicle

*2: Vehicles with towing package

Vehicle identification

■ Vehicle identification number

The vehicle identification number (VIN) is the legal identifier for your vehicle. This is the primary identification number for your Lexus. It is used in registering the ownership of your vehicle.

This number is stamped on the top left of the instrument panel.



This number is also on the Certification Label.



This number is also stamped under the right-hand front seat.

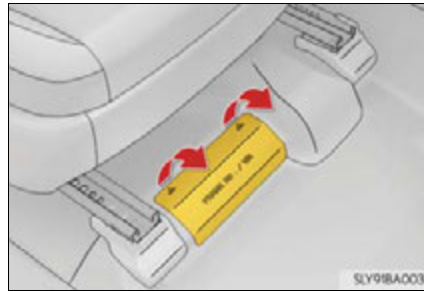

■ Engine number

The engine number is stamped on the engine block as shown.

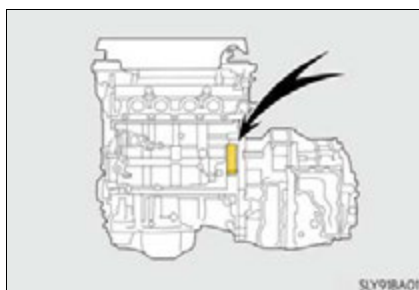

Engine

Model	2.5 L 4-cylinder (2AR-FXE)
Type	4-cylinder in line, 4-cycle, gasoline
Bore and stroke	3.54 × 3.86 in. (90.0 × 98.0 mm)
Displacement	152.2 cu.in. (2494 cm ³)
Valve clearance (engine cold)	Automatic adjustment
Drive belt tension	Automatic adjustment

Fuel

Fuel type	Unleaded gasoline only
Octane Rating	87 (Research Octane Number 91) or higher
Fuel tank capacity (Reference)	14.8 gal. (56 L, 12.3 Imp.gal.)

Electric motor (traction motor)

► Front

Type	Permanent magnet synchronous motor
Maximum output	105 kW
Maximum torque	199 ft•lbf (270 N•m, 27.5 kgf•m)

► Rear (AWD models)

Type	Permanent magnet synchronous motor
Maximum output	50 kW
Maximum torque	103 ft•lbf (139 N•m, 14.2 kgf•m)

Hybrid battery (traction battery)

Type	Nickel-Metal hydride battery
Voltage	7.2 V/module
Capacity	6.5 Ah (3HR)
Quantity	34 modules
Overall voltage	244.8 V

Lubrication system

Oil capacity (Drain and refill – reference *)	
With filter	4.6 qt. (4.4 L, 3.9 Imp.qt.)
Without filter	4.2 qt. (4.0 L, 3.5 Imp.qt.)

*: The engine oil capacity is a reference quantity to be used when changing the engine oil. Warm up the engine and turn off the hybrid system, wait more than 5 minutes, and check the oil level on the dipstick.

■ Engine oil selection

“Toyota Genuine Motor Oil” is used in your Lexus vehicle. Use Lexus approved “Toyota Genuine Motor Oil” or equivalent to satisfy the following grade and viscosity.

Oil grade: ILSAC GF-5 multigrade engine oil

Recommended viscosity: SAE 0W-20

SAE 0W-20 is the best choice for good fuel economy and good starting in cold weather.

If SAE 0W-20 is not available, SAE 5W-20 oil may be used. However, it must be replaced with SAE 0W-20 at the next oil change.

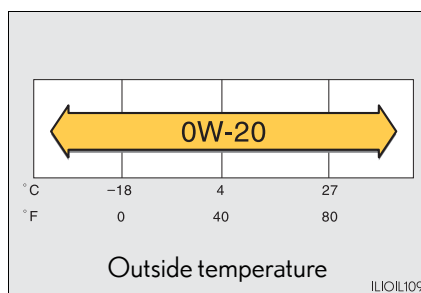

Oil viscosity (0W-20 is explained here as an example):

- The 0W in 0W-20 indicates the characteristic of the oil which allows cold startability. Oils with a lower value before the W allow for easier starting of the engine in cold weather.
- The 20 in 0W-20 indicates the viscosity characteristic of the oil when the oil is at high temperature. An oil with a higher viscosity (one with a higher value) may be better suited if the vehicle is operated at high speeds, or under extreme load conditions.

How to read oil container label:

The International Lubricant Specification Advisory Committee (ILSAC) Certification Mark is added to some oil containers to help you select the oil you should use.



Cooling system

Capacity*	Gasoline engine	<ul style="list-style-type: none"> ▶ Vehicles with towing package 7.7 qt. (7.3 L, 6.4 Imp.qt.) ▶ Vehicles without towing package 7.1 qt. (6.7 L, 5.9 Imp.qt.)
	Power control unit	3.3 qt. (3.1 L, 2.7 Imp.qt.)
Coolant type		Use either of the following: <ul style="list-style-type: none"> • "Toyota Super Long Life Coolant" • Similar high-quality ethylene glycol-based non-silicate, non-amine, non-nitrite, and non-borate coolant with long-life hybrid organic acid technology Do not use plain water alone.

*: The coolant capacity is the quantity of reference.
If replacement is necessary, contact your Lexus dealer.

Ignition system (spark plug)

Make	DENSO FK16HR-A8
Gap	0.03 in. (0.8 mm)

NOTICE

■ Iridium-tipped spark plugs

Use only iridium-tipped spark plugs. Do not adjust the spark plug gap.

Electrical system

12-volt battery	
Open voltage at 68°F (20°C):	12.6 V or higher: Fully charged 12.2 – 12.4 V: Half charged 12.0 V or lower: Discharged (Voltage is checked 20 minutes after the hybrid system and all lights are turned off.)
Charging rates	5 A max.

Hybrid transmission

Fluid capacity*	▶ Front 4.0 qt. (3.8 L, 3.3 Imp.qt.)
Fluid type	Toyota Genuine ATF WS

*: The fluid capacity is the quantity of reference.
If replacement is necessary, contact your Lexus dealer.

 NOTICE

■ **Transmission fluid type**

Using transmission fluid other than “Toyota Genuine ATF WS” may cause deterioration in shift quality, locking up of your transmission accompanied by vibration, and ultimately damage the transmission of your vehicle.

Rear differential (Rear electric motor) (AWD models)

Fluid capacity*	1.9 qt. (1.8 L, 1.6 Imp.qt.)
Fluid type	Toyota Genuine ATF WS

*: The fluid capacity is the quantity of reference.
If replacement is necessary, contact your Lexus dealer.

 NOTICE

■ **Transmission fluid type**

Using transmission fluid other than “Toyota Genuine ATF WS” may cause deterioration in shift quality, locking up of your transmission accompanied by vibration, and ultimately damage the transmission of your vehicle.

Brakes

Pedal clearance*	4.13 in. (105 mm) Min.
Brake pad wear limit	0.04 in. (1.0 mm)
Pedal free play	0.04 – 0.24 in. (1.0 – 6.0 mm)
Fluid type	FMVSS No. 116 DOT 3 or SAE J1703

*: Minimum pedal clearance when depressed with a force of 110 lbf (490 N, 50.0 kgf) while the hybrid system is operating.

Steering

Free play	Less than 1.2 in. (30 mm)
-----------	---------------------------

Tires and wheels

▶ Type A

Tire size	225/65R17 102H
Tire inflation pressure (Recommended cold tire inflation pressure)	<p>Driving under normal conditions</p> <ul style="list-style-type: none"> ▶ Front 35 psi (240 kPa, 2.4 kgf/cm² or bar) ▶ Rear 35 psi (240 kPa, 2.4 kgf/cm² or bar) <p>Driving at high speeds (above 100 mph [160 km/h]) (in countries where such speeds are permitted by law) Add 1 psi (10 kPa, 0.1 kgf/cm² or bar) to the front and rear tires. Never exceed the maximum cold tire inflation pressure indicated on the tire sidewall.</p>
Wheel size	17 × 7 J
Wheel nut torque	76 ft•lbf (103 N•m, 10.5 kgf•m)

▶ Type B

Tire size	225/60R18 100H
Tire inflation pressure (Recommended cold tire inflation pressure)	<p>Driving under normal conditions</p> <ul style="list-style-type: none"> ▶ Front 32 psi (220 kPa, 2.2 kgf/cm² or bar) ▶ Rear 32 psi (220 kPa, 2.2 kgf/cm² or bar) <p>Driving at high speeds (above 100 mph [160 km/h]) (in countries where such speeds are permitted by law) Add 9 psi (60 kPa, 0.6 kgf/cm² or bar) to the front and rear tires. Never exceed the maximum cold tire inflation pressure indicated on the tire sidewall.</p>
Wheel size	18 × 7 1/2 J
Wheel nut torque	76 ft•lbf (103 N•m, 10.5 kgf•m)

► Compact spare tire

Tire size	T165/80D17 104M
Spare tire inflation pressure (Recommended cold tire inflation pressure)	60 psi (420 kPa, 4.2 kgf/cm ² or bar)
Wheel size	17 × 4 T
Wheel nut torque	76 ft•lbf (103 N•m, 10.5 kgf•m)

Light bulbs

	Light bulbs	Bulb No.	W	Type
Exterior	Headlights High beam (halogen bulbs)*	9005	60	A
	Front side marker lights*	W5W	5	C
	Front turn signal lights (bulb type)*	585 (WY21W)	21	B
	Rear turn signal lights	585 (WY21W)	21	B
	Back-up lights	921 (W16W)	16	C
Interior	Vanity lights	—	8	C
	Luggage compartment light	—	5	C

A: HB3 halogen bulbs

B: Wedge base bulbs (amber)

C: Wedge base bulbs (clear)

*: If equipped

Fuel information

You must only use unleaded gasoline in your vehicle.

Select octane rating 87 (Research Octane Number 91) or higher. Use of unleaded gasoline with an octane rating lower than 87 may result in engine knocking. Persistent knocking can lead to engine damage.

At minimum, the gasoline you use should meet the specifications of ASTM D4814 in the U.S.A.

■ Gasoline quality

In very few cases, driveability problems may be caused by the brand of gasoline you are using. If driveability problems persist, try changing the brand of gasoline. If this does not correct the problem, consult your Lexus dealer.

■ Gasoline quality standards

- Automotive manufacturers in the U.S.A., Europe and Japan have developed a specification for fuel quality called the World-Wide Fuel Charter (WWFC), which is expected to be applied worldwide.
- The WWFC consists of four categories that are based on required emission levels. In the U.S., category 4 has been adopted.
- The WWFC improves air quality by lowering emissions in vehicle fleets, and improves customer satisfaction through better performance.

■ Recommendation of the use of gasoline containing detergent additives

- Lexus recommends the use of gasoline that contains detergent additives to avoid the build-up of engine deposits.
- All gasoline sold in the U.S.A. contains minimum detergent additives to clean and/or keep clean intake systems, per EPA's lowest additives concentration program.
- Lexus strongly recommends the use of Top Tier Detergent Gasoline. For more information on Top Tier Detergent Gasoline and a list of marketers, please go to the official website www.toptiergas.com.

■ Recommendation of the use of low emissions gasoline

Gasolines containing oxygenates such as ethers and ethanol, as well as reformulated gasolines, are available in some cities. These fuels are typically acceptable for use, providing they meet other fuel requirements.

Lexus recommends these fuels, since the formulations allow for reduced vehicle emissions.

■ Non-recommendation of the use of blended gasoline

- Use only gasoline containing up to 15% ethanol.

DO NOT use any flex-fuel or gasoline that could contain more than 15% ethanol, including from any pump labeled E30, E50, E85 (which are only some examples of fuel containing more than 15% ethanol).

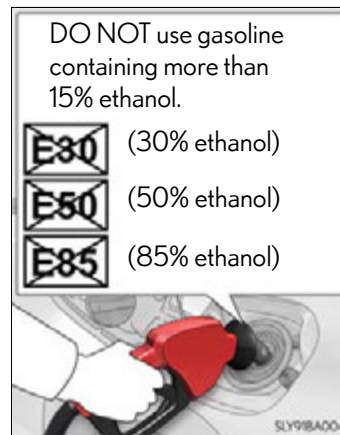

- If you use gasohol in your vehicle, be sure that it has an octane rating no lower than 87.
- Lexus does not recommend the use of gasoline containing methanol.

■ Non-recommendation of the use of gasoline containing MMT

Some gasoline contains an octane enhancing additive called MMT (Methylcyclopentadienyl Manganese Tricarbonyl).

Lexus does not recommend the use of gasoline that contains MMT. If fuel containing MMT is used, your emission control system may be adversely affected.

The malfunction indicator lamp on the instrument cluster may come on. If this happens, contact your Lexus dealer for service.

■ If your engine knocks

- Consult your Lexus dealer.
- You may occasionally notice light knocking for a short time while accelerating or driving uphill. This is normal and there is no need for concern.

 NOTICE

■ **Notice on fuel quality**

- Do not use improper fuels. If improper fuels are used, the engine will be damaged.
- Do not use leaded gasoline.
Leaded gasoline can cause damage to your vehicle's three-way catalytic converters causing the emission control system to malfunction.
- Do not use gasohol other than the type previously stated.
Other gasohol may cause fuel system damage or vehicle performance problems.
- Using unleaded gasoline with an octane number or rating lower than the level previously stated will cause persistent heavy knocking.
At worst, this will lead to engine damage.

■ **Fuel-related poor driveability**

If poor driveability (poor hot starting, vaporization, engine knocking, etc.) is encountered after using a different type of fuel, discontinue the use of that type of fuel.

■ **When refueling with gasohol**

Take care not to spill gasohol. It can damage your vehicle's paint.

Tire information

Typical tire symbols

► Full-size tire

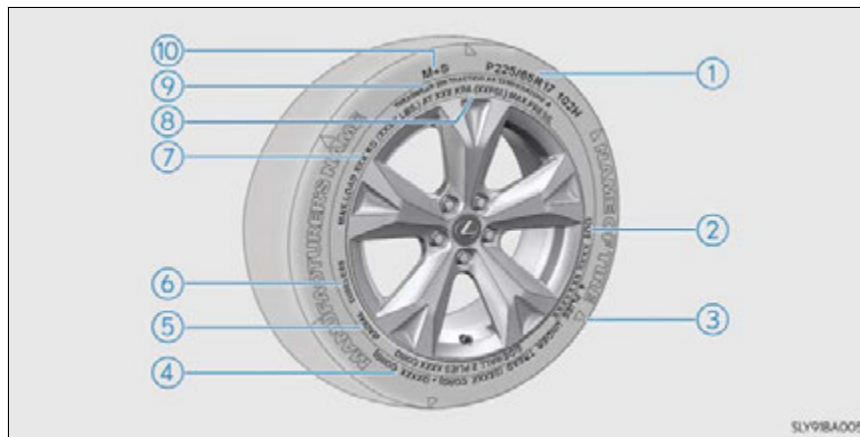

► Compact spare tire

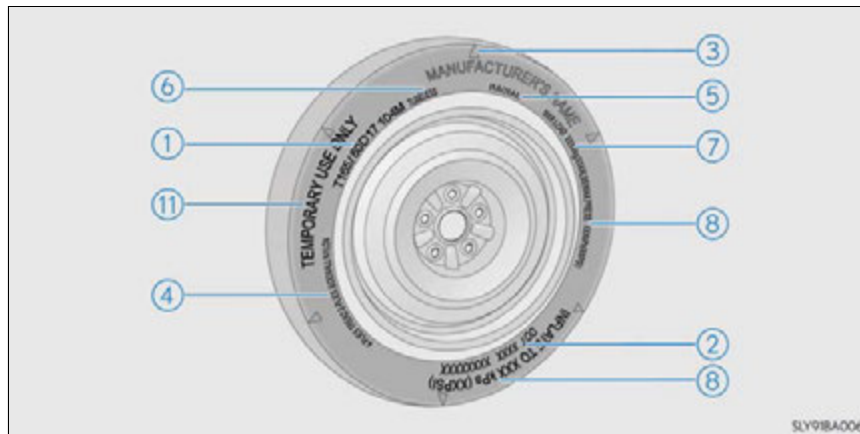

-
- ① Tire size (→P. 622)
 - ② DOT and Tire Identification Number (TIN) (→P. 621)
 - ③ Location of treadwear indicators (→P. 516)
 - ④ Tire ply composition and materials
Plies are layers of rubber-coated parallel cords. Cords are the strands which form the plies in a tire.
 - ⑤ Radial tires or bias-ply tires
A radial tire has "RADIAL" on the sidewall. A tire not marked "RADIAL" is a bias-ply tire.
 - ⑥ TUBELESS or TUBE TYPE
A tubeless tire does not have a tube and air is directly put into the tire. A tube type tire has a tube inside the tire and the tube maintains the air pressure.
 - ⑦ Load limit at maximum cold tire inflation pressure (→P. 520)
 - ⑧ Maximum cold tire inflation pressure (→P. 613)
This means the pressure to which a tire may be inflated.
 - ⑨ Uniform tire quality grading
For details, see "Uniform Tire Quality Grading" that follows.
 - ⑩ Summer tires or all season tires (→P. 520)
An all season tire has "M+S" on the sidewall. A tire not marked "M+S" is a summer tire.
 - ⑪ "TEMPORARY USE ONLY"
A compact spare tire is identified by the phrase "TEMPORARY USE ONLY" molded on its sidewall. This tire is designed for temporary emergency use only.

Typical DOT and Tire Identification Number (TIN)

- ① DOT symbol*
- ② Tire Identification Number (TIN)
- ③ Tire manufacturer's identification mark
- ④ Tire size code
- ⑤ Manufacturer's optional tire type code (3 or 4 letters)
- ⑥ Manufacturing week
- ⑦ Manufacturing year

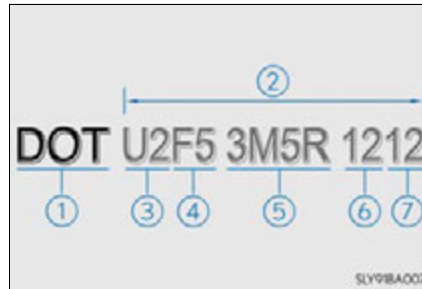

*: The DOT symbol certifies that the tire conforms to applicable Federal Motor Vehicle Safety Standards.

Tire size

■ Typical tire size information

The illustration indicates typical tire size.

- ① Tire use
(P = Passenger car,
T = Temporary use)
- ② Section width (millimeters)
- ③ Aspect ratio
(tire height to section width)
- ④ Tire construction code
(R = Radial, D = Diagonal)
- ⑤ Wheel diameter (inches)
- ⑥ Load index (2 digits or 3 digits)
- ⑦ Speed symbol (alphabet with one letter)

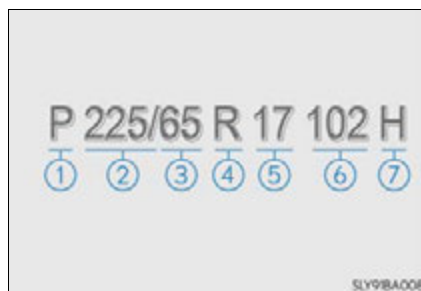

■ Tire dimensions

- ① Section width
- ② Tire height
- ③ Wheel diameter

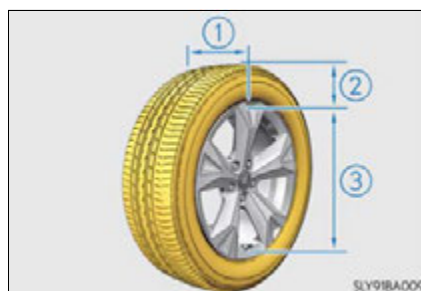

Tire section names

- ① Bead
- ② Sidewall
- ③ Shoulder
- ④ Tread
- ⑤ Belt
- ⑥ Inner liner
- ⑦ Reinforcing rubber
- ⑧ Carcass
- ⑨ Rim lines
- ⑩ Bead wires
- ⑪ Chafer

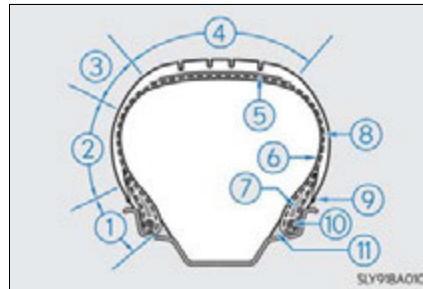

Uniform Tire Quality Grading

This information has been prepared in accordance with regulations issued by the National Highway Traffic Safety Administration of the U.S. Department of Transportation.

It provides the purchasers and/or prospective purchasers of Lexus vehicles with information on uniform tire quality grading.

Your Lexus dealer will help answer any questions you may have as you read this information.

■ DOT quality grades

All passenger vehicle tires must conform to Federal Safety Requirements in addition to these grades. Quality grades can be found where applicable on the tire sidewall between tread shoulder and maximum section width.

For example: Treadwear 200 Traction AA Temperature A

■ **Treadwear**

The treadwear grade is a comparative rating based on the wear rate of the tire when tested under controlled conditions on a specified government test course.

For example, a tire graded 150 would wear one and a half (1 - 1/2) times as well on the government course as a tire graded 100.

The relative performance of tires depends upon the actual conditions of their use, however, and may depart significantly from the norm due to variations in driving habits, service practices and differences in road characteristics and climate.

■ **Traction AA, A, B, C**

The traction grades, from highest to lowest, are AA, A, B and C, and they represent the tire's ability to stop on wet pavement as measured under controlled conditions on specified government test surfaces of asphalt and concrete.

A tire marked C may have poor traction performance.

Warning: The traction grade assigned to this tire is based on braking (straight ahead) traction tests and does not include cornering (turning) traction.

■ **Temperature A, B, C**

The temperature grades are A (the highest), B, and C, representing the tire's resistance to the generation of heat and its ability to dissipate heat when tested under controlled conditions on a specified indoor laboratory test wheel.

Sustained high temperature can cause the material of the tire to degenerate and reduce tire life, and excessive temperature can lead to sudden tire failure.

Grade C corresponds to a level of performance which all passenger car tires must meet under the Federal Motor Vehicle Safety Standard No. 109.

Grades B and A represent higher levels of performance on the laboratory test wheel than the minimum required by law.

Warning: The temperature grades for this tire are established for a tire that is properly inflated and not overloaded.

Excessive speed, underinflation, or excessive loading, either separately or in combination, can cause heat buildup and possible tire failure.

Glossary of tire terminology

Tire related term	Meaning
Cold tire inflation pressure	Tire pressure when the vehicle has been parked for three hours or more, or has not been driven more than 1 mile or 1.5 km under that condition
Maximum inflation pressure	The maximum cold inflated pressure to which a tire may be inflated, shown on the sidewall of the tire
Recommended inflation pressure	Cold tire inflation pressure recommended by a manufacturer
Accessory weight	The combined weight (in excess of those standard items which may be replaced) of transmission, power steering, power brakes, power windows, power seats, radio and heater, to the extent that these items are available as factory-installed equipment (whether installed or not)
Curb weight	The weight of a motor vehicle with standard equipment, including the maximum capacity of fuel, oil and coolant, and if so equipped, air conditioning and additional weight optional engine
Maximum loaded vehicle weight	The sum of: (a) Curb weight (b) Accessory weight (c) Vehicle capacity weight (d) Production options weight
Normal occupant weight	150 lb. (68 kg) times the number of occupants specified in the second column of Table 1* that follows
Occupant distribution	Distribution of occupants in a vehicle as specified in the third column of Table 1* below

Tire related term	Meaning
Production options weight	The combined weight of installed regular production options weighing over 5 lb. (2.3 kg) in excess of the standard items which they replace, not previously considered in curb weight or accessory weight, including heavy duty brakes, ride levelers, roof rack, heavy duty 12-volt battery, and special trim
Rim	A metal support for a tire or a tire and tube assembly upon which the tire beads are seated
Rim diameter (Wheel diameter)	Nominal diameter of the bead seat
Rim size designation	Rim diameter and width
Rim type designation	The industry manufacturer's designation for a rim by style or code
Rim width	Nominal distance between rim flanges
Vehicle capacity weight (Total load capacity)	The rated cargo and luggage load plus 150 lb. (68 kg) times the vehicle's designated seating capacity
Vehicle maximum load on the tire	The load on an individual tire that is determined by distributing to each axle its share of the maximum loaded vehicle weight, and dividing by two
Vehicle normal load on the tire	The load on an individual tire that is determined by distributing to each axle its share of curb weight, accessory weight, and normal occupant weight (distributed in accordance with Table 1* below), and dividing by two
Weather side	The surface area of the rim not covered by the inflated tire
Bead	The part of the tire that is made of steel wires, wrapped or reinforced by ply cords and that is shaped to fit the rim

Tire related term	Meaning
Bead separation	A breakdown of the bond between components in the bead
Bias ply tire	A pneumatic tire in which the ply cords that extend to the beads are laid at alternate angles substantially less than 90 degrees to the centerline of the tread
Carcass	The tire structure, except tread and sidewall rubber which, when inflated, bears the load
Chunking	The breaking away of pieces of the tread or sidewall
Cord	The strands forming the plies in the tire
Cord separation	The parting of cords from adjacent rubber compounds
Cracking	Any parting within the tread, sidewall, or innerliner of the tire extending to cord material
CT	A pneumatic tire with an inverted flange tire and rim system in which the rim is designed with rim flanges pointed radially inward and the tire is designed to fit on the underside of the rim in a manner that encloses the rim flanges inside the air cavity of the tire
Extra load tire	A tire designed to operate at higher loads and at higher inflation pressures than the corresponding standard tire
Groove	The space between two adjacent tread ribs
Innerliner	The layer(s) forming the inside surface of a tubeless tire that contains the inflating medium within the tire
Innerliner separation	The parting of the innerliner from cord material in the carcass

Tire related term	Meaning
Intended outboard sidewall	(a) The sidewall that contains a whitewall, bears white lettering, or bears manufacturer, brand, and/or model name molding that is higher or deeper than the same molding on the other sidewall of the tire, or (b) The outward facing sidewall of an asymmetrical tire that has a particular side that must always face outward when mounted on a vehicle
Light truck (LT) tire	A tire designated by its manufacturer as primarily intended for use on lightweight trucks or multipurpose passenger vehicles
Load rating	The maximum load that a tire is rated to carry for a given inflation pressure
Maximum load rating	The load rating for a tire at the maximum permissible inflation pressure for that tire
Maximum permissible inflation pressure	The maximum cold inflation pressure to which a tire may be inflated
Measuring rim	The rim on which a tire is fitted for physical dimension requirements
Open splice	Any parting at any junction of tread, sidewall, or innerliner that extends to cord material
Outer diameter	The overall diameter of an inflated new tire
Overall width	The linear distance between the exteriors of the sidewalls of an inflated tire, including elevations due to labeling, decorations, or protective bands or ribs
Passenger car tire	A tire intended for use on passenger cars, multipurpose passenger vehicles, and trucks, that have a gross vehicle weight rating (GVWR) of 10,000 lb. or less.
Ply	A layer of rubber-coated parallel cords
Ply separation	A parting of rubber compound between adjacent plies

Tire related term	Meaning
Pneumatic tire	A mechanical device made of rubber, chemicals, fabric and steel or other materials, that, when mounted on an automotive wheel, provides the traction and contains the gas or fluid that sustains the load
Radial ply tire	A pneumatic tire in which the ply cords that extend to the beads are laid at substantially 90 degrees to the centerline of the tread
Reinforced tire	A tire designed to operate at higher loads and at higher inflation pressures than the corresponding standard tire
Section width	The linear distance between the exteriors of the sidewalls of an inflated tire, excluding elevations due to labeling, decoration, or protective bands
Sidewall	That portion of a tire between the tread and bead
Sidewall separation	The parting of the rubber compound from the cord material in the sidewall
Snow tire	A tire that attains a traction index equal to or greater than 110, compared to the ASTM E-1136 Standard Reference Test Tire, when using the snow traction test as described in ASTM F-1805-00, Standard Test Method for Single Wheel Driving Traction in a Straight Line on Snow-and Ice-Covered Surfaces, and which is marked with an Alpine Symbol () on at least one sidewall
Test rim	The rim on which a tire is fitted for testing, and may be any rim listed as appropriate for use with that tire
Tread	That portion of a tire that comes into contact with the road
Tread rib	A tread section running circumferentially around a tire

Tire related term	Meaning
Tread separation	Pulling away of the tread from the tire carcass
Treadwear indicators (TWI)	The projections within the principal grooves designed to give a visual indication of the degrees of wear of the tread
Wheel-holding fixture	The fixture used to hold the wheel and tire assembly securely during testing

*: Table 1— Occupant loading and distribution for vehicle normal load for various designated seating capacities

Designated seating capacity, Number of occupants	Vehicle normal load, Number of occupants	Occupant distribution in a normally loaded vehicle
2 through 4	2	2 in front
5 through 10	3	2 in front, 1 in second seat
11 through 15	5	2 in front, 1 in second seat, 1 in third seat, 1 in fourth seat
16 through 20	7	2 in front, 2 in second seat, 2 in third seat, 1 in fourth seat

Customizable features

Your vehicle includes a variety of electronic features that can be personalized to suit your preferences. The settings of these features can be changed using the multi-information display, the Remote Touch or Lexus Display Audio controller, or at your Lexus dealer.

Some function settings are changed simultaneously with other functions being customized. Contact your Lexus dealer.

Customizing vehicle features

When customizing vehicle features, ensure that the vehicle is parked in a safe place with the shift lever in P and the parking brake set.

■ Changing using the Remote Touch

- 1 Press the "MENU" button on the Remote Touch.
- 2 Select "Setup" on the "MENU" screen and select "Vehicle".











Various setting can be changed. Refer to the list of settings that can be changed for details.

■ Changing using the Lexus Display Audio controller

- 1 Press the "MENU" button on the Lexus Display Audio controller.
- 2 Select "Setup" on the "MENU" screen and select "Vehicle".

Various setting can be changed. Refer to the list of settings that can be changed for details.

■ Changing using the multi-information display

- 1 Press  or  of the meter control switches, select , and then press .
- 2 Press  or  of the meter control switches, select the item, and then press .
- 3 Press  or  of the meter control switches, select the desired setting, and then press .

To go back to the previous screen or exit the customize mode, press .

Customizable Features

- ① Settings that can be changed using the Remote Touch or Lexus Display Audio controller
- ② Settings that can be changed using the multi-information display
- ③ Settings that can be changed by your Lexus dealer
- ④ Settings that can be changed using the vehicle switch

Definition of symbols: ○ = Available, - =Not available

■ Door lock (→P.124, 591)

Function	Default setting	Customized setting	①	②	③	④
Unlocking using a mechanical key	Driver's door unlocked in first step, all doors unlocked in second step	All doors unlocked in first step	-	-	○	-
Automatic door locking function	Shift position linked door locking operation	Off	○	-	○	-
		Speed linked door locking operation	○	-	○	-
Automatic door unlocking function	Shift position linked door unlocking operation	Off	○	-	○	-
		Driver's door linked door unlocking operation	○	-	○	-

■ **Smart access system with push-button start and wireless remote control**
 (→P. 124, 140)

Function	Default setting	Customized setting	①	②	③	④
Operation signal (emergency flashers)	On	Off	<input type="radio"/>	-	<input type="radio"/>	-
Operation buzzer volume	5	Off	<input type="radio"/>	-	<input type="radio"/>	-
		1 to 7				
Time elapsed before the automatic door lock function is activated if a door is not opened after being unlocked	60 seconds	Off				
		30 seconds	<input type="radio"/>	-	<input type="radio"/>	-
		120 seconds				
Open door reminder buzzer (When locking the vehicle)	On	Off	-	-	<input type="radio"/>	-

■ **Smart access system with push-button start** (→P. 140)

Function	Default setting	Customized setting	①	②	③	④
The doors that are unlocked using the smart access system with push-button start can be selected	Driver's door	All the doors	<input type="radio"/>	-	<input type="radio"/>	<input type="radio"/>
Smart access system with push-button start	On	Off	-	-	<input type="radio"/>	-
Number of consecutive door lock operations	2 times	As many as desired	-	-	<input type="radio"/>	-

■ Wireless remote control (→P. 124)

Function	Default setting	Customized setting	①	②	③	④
Wireless remote control	On	Off	-	-	○	-
Unlocking operation	Driver's door unlocked in first step, all doors unlocked in second step	All doors unlocked in first step	○	-	○	-
Panic function	On	Off	-	-	○	-
The function that validates the  switch of the wireless remote control when locking the door (→P. 129)	When locking the door	When unlocking the door	-	-	○	-

■ Automatic light control system (→P. 219)

Function	Default setting	Customized setting	①	②	③	④
Light sensor sensitivity	Standard	-2 to 2	○	-	○	-
Adjust the time elapsed before the headlights automatically turn off	30 seconds	Off	○	-	○	-
		60 seconds				
		90 seconds				





■ Lights (→P. 219)

Function	Default setting	Customized setting	①	②	③	④
Daytime Running Lights (Daytime running lights can be disabled)	On	Off	○	-	○	-

■ Illumination (→P. 443)

Function	Default setting	Customized setting	①	②	③	④
Time elapsed before the interior lights turn off	15 seconds	Off				
		7.5 seconds	○	-	○	-
		30 seconds				
Time elapsed before the exterior lights turn off	15 seconds	Off				
		7.5 seconds	○	-	○	-
		30 seconds				
Operation after the power switch is turned off	On	Off	-	-	○	-
Operation when the doors are unlocked	On	Off	-	-	○	-
Operation when you approach the vehicle with the electronic key on your person	On	Off	-	-	○	-
Footwell lighting	On	Off	-	-	○	-
Fading out of the outer foot lights when they turn off	Long	Short	-	-	○	-

■ Multi-information display (→P. 97, 102)

Function	Default setting	Customized setting	①	②	③	④
Changeover to tachometer when sport mode is selected	Auto	Hybrid system indicator (always)	-	○	-	-
		Tachometer (always)	-	○	-	-
EV indicator	On	Off	-	○	-	-
Language*1	English	French	-	○	-	-
		Spanish	-	○	-	-
Units*1	miles (MPG US)	miles (MPG Imperial)	-	○	-	-
		km (L/100km)	-	○	-	-
		km (km/L)	-	○	-	-
 switch settings	Drive information 1	Desired status screen*2	-	○	-	-
Drive information screen displayed on the first screen of  (Drive information 1)	Current fuel consumption	*3	-	○	-	-
	Average fuel consumption (after reset)		-	○	-	-
Drive information screen displayed on the second screen of  (Drive information 2)	Distance (range)	*3	-	○	-	-
	Average speed (after reset)		-	○	-	-
Pop-up display*4	On	Off	-	○	-	-
Accent color	Color 1 	Color 2 	○	○	-	-

*1: The default setting varies according to countries.

*2: Some status screens cannot be registered (indicated on the multi-information display)

*3: 2 of the following items: current fuel consumption, average fuel economy (after reset), average fuel economy (after refuel), average fuel economy (after start), average vehicle speed (after reset), average vehicle speed (after start), distance (driving range), distance (after start), elapsed time (after reset), elapsed time (after start), blank

*4: Intersection guidance, Incoming calls, Adjust brightness

■ Automatic air conditioning system (→P. 430)

Function	Default setting	Customized setting	①	②	③	④
Switching between outside air and recirculated air mode linked to "AUTO" switch operation	On	Off	○	-	○	-
A/C Auto switch operation	On	Off	○	-	○	-

■ Eco drive mode (→P. 303)

Function	Default setting	Customized setting	①	②	③	④
Heating/cooling operation minimized in Eco drive mode	On	Off	-	-	○	-

■ Power windows (→P. 166)

Function	Default setting	Customized setting	①	②	③	④
Mechanical key linked operation	Off	On	-	-	○	-
Wireless remote control linked open operation	Off	On	-	-	○	-

■ Moon roof*1 (→P. 169)

Function	Default setting	Customized setting	①	②	③	④
Mechanical key linked operation*2	Off	On	-	-	○	-
Wireless remote control linked open or Tilt up operations*2	Off	On	-	-	○	-

*1: If equipped

*2: This function cannot be customized unless power window operations, using the wireless remote control or mechanical key, is enabled.

■ Intuitive parking assist* (→P. 279)

Function	Default setting	Customized setting	①	②	③	④
Detection distance of the front center sensor	Long	Short	<input type="radio"/>	-	<input type="radio"/>	-
Detection distance of the rear center sensor	Long	Short	<input type="radio"/>	-	<input type="radio"/>	-
Display setting (When intuitive parking assist is operating)	On	Off	<input type="radio"/>	-	<input type="radio"/>	-
Buzzer volume	3	1 to 5	<input type="radio"/>	-	<input type="radio"/>	-

*: If equipped

■ Driving position memory* (→P. 154)

Function	Default setting	Customized setting	①	②	③	④
Driver's seat movement when exiting the vehicle	Standard	Off	<input type="radio"/>	-	<input type="radio"/>	-
		Partial				
Selection the door linking driving position memory with door unlock operation	Driver's door	All doors	-	-	<input type="radio"/>	-

*: If equipped

■ Outside rear view mirrors (→P. 163)

Function	Default setting	Customized setting	①	②	③	④
Linked mirror function when reversing	On	Off	-	-	<input type="radio"/>	-

■ LDA (Lane Departure Alert with steering control)* (→P. 270)

Function	Default setting	Customized setting	①	②	③	④
Steerage assist	On	Off	-	<input type="radio"/>	-	-
Sensitivity adjustment for the lane deviation alert buzzer	Standard	High	-	<input type="radio"/>	-	-

*: If equipped

■ **Power back door**^{*1} (→P. 129)

Function	Default setting	Customized setting	①	②	③	④
▶ Set at the desired Position (height) ^{*2} Back Door Automatic Open and Stop Position	Initial settings Position	Stop at the desired position (height)	-	-	-	○
▶ 5 step configuration Back Door Automatic Open and Stop Position	5	1 to 5	○	-	○	-
Back door opener switch operations	When the back door is locked ^{*3}	When the back door is unlocked	-	-	○	-
Power back door operations	On	Off	-	○	-	-

*1: If equipped

*2: Configured by operating the  switch of the lower back door. (→P. 132)

*3: While carrying the electronic key on your person, press the back door opener switch.

■ **Vehicle customization**

- When the speed linked door locking function and shift position linked door locking function are both on, the door lock operates as follows.
 - When shifting the shift lever to any position other than P, all the doors will be locked.
 - If the vehicle is started with all the doors locked, the speed linked door locking function would not operate.
 - If the vehicle is started with any door unlocked, the speed linked door locking function will operate.
 - When the smart access system with push-button start is off, smart door unlocking cannot be customized.
 - When the doors remain closed after unlocking the doors and the automatic door lock function is activated, the signals will be generated in accordance with the Operation signal (buzzer) and the Operation signal (emergency flashers) settings.
- **In the following situations, customize mode in which the settings can be changed through the multi-information display will automatically be turned off.**
- A warning message appears after the customize mode screen is displayed.
 - The power switch is turned off.
 - The vehicle begins to move while the customize mode screen is displayed.

 **WARNING**

■ **Cautions during customization**

As the hybrid system needs to be operating during customization, ensure that the vehicle is parked in a place with adequate ventilation. In a closed area such as a garage, exhaust gases including harmful carbon monoxide (CO) may collect and enter the vehicle. This may lead to death or a serious health hazard.

 **NOTICE**

■ **During customization**

To prevent 12-volt battery discharge, ensure that the hybrid system is operating while customizing features.

Items to initialize

The following items must be initialized for normal system operation after such cases as the 12-volt battery being reconnected, or maintenance being performed on the vehicle.

Item	When to initialize	Reference
Message indicating maintenance is required (U.S.A. only)	<ul style="list-style-type: none"> • After the maintenance is performed 	P. 492
Tire pressure warning system	<ul style="list-style-type: none"> • When rotating the tires on vehicles with differing front and rear tire inflation pressures • When changing the tire inflation pressure by changing traveling speed or load weight, etc. • When changing the tire size 	P. 518
Oil maintenance	<ul style="list-style-type: none"> • After the maintenance is performed 	P. 506
Power back door*	<ul style="list-style-type: none"> • After reconnecting or changing the 12-volt battery • After changing a fuse 	P. 134
Power window	<ul style="list-style-type: none"> • When functioning abnormally normally 	P. 167
Moon roof*		P. 170

*: If equipped

For owners

10

643

Reporting safety defects for
U.S. owners..... 644

Seat belt instructions for
Canadian owners (in French) 645

SRS airbag instructions for
Canadian owners (in French) 647

Reporting safety defects for U.S. owners

If you believe that your vehicle has a defect which could cause a crash or could cause injury or death, you should immediately inform the National Highway Traffic Safety Administration (NHTSA) in addition to notifying the Lexus Division of Toyota Motor Sales, U.S.A., Inc. (Toll-free: 1-800-25-LEXUS).

If NHTSA receives similar complaints, it may open an investigation, and if it finds that a safety defect exists in a group of vehicles, it may order a recall and remedy campaign. However, NHTSA cannot become involved in individual problems between you, your dealer, or Lexus Division of Toyota Motor Sales, U.S.A., Inc.

To contact NHTSA, you may call the Vehicle Safety Hotline toll-free at 1-888-327-4236 (TTY: 1-800-424-9153); go to <http://www.safercar.gov>; or write to: Administrator, NHTSA, 1200 New Jersey Ave, S.E., Washington, DC 20590. You can also obtain other information about motor vehicle safety from <http://www.safercar.gov>.

Seat belt instructions for Canadian owners (in French)

The following is a French explanation of seat belt instructions extracted from the seat belt section in this manual.

See the seat belt section for more detailed seat belt instructions in English.

Utilisation correcte des ceintures de sécurité

- Déroulez la sangle diagonale de telle sorte qu'elle passe bien sur l'épaule, sans pour autant être en contact avec le cou ou glisser de l'épaule.
- Placez la sangle abdominale le plus bas possible sur les hanches.
- Réglez la position du dossier de siège. Asseyez-vous le dos le plus droit possible et calez-vous bien dans le siège.
- Ne pas vriller la ceinture de sécurité.



Entretien et soin

■ Ceintures de sécurité

Nettoyez avec un chiffon ou une éponge humectée d'eau savonneuse tiède. Par ailleurs, vérifiez régulièrement que les ceintures ne sont pas effilochées, entaillées, ou ne paraissent pas exagérément usées.

⚠ AVERTISSEMENT

Respectez les précautions suivantes afin de réduire le risque de blessure en cas de freinage brusque, d'embarquée ou d'accident.

À défaut, des blessures graves, voire mortelles, pourraient s'ensuivre.

■ Port de la ceinture de sécurité

- Ne pas passer la sangle diagonale sous le bras.
- Faites toujours passer votre ceinture de sécurité au plus bas sur vos hanches et bien dans l'axe.

■ État et usure des ceintures de sécurité

Inspectez les ceintures de sécurité périodiquement. Contrôlez qu'elles ne sont pas entaillées, effilochées, et que leurs ancrages ne sont pas desserrés. Ne pas utiliser une ceinture de sécurité défectueuse avant qu'elle ne soit remplacée. Une ceinture de sécurité défectueuse n'apporte aucune garantie de protection de l'occupant contre des blessures graves, voire mortelles.

■ Lorsque vous utilisez la ceinture de sécurité du siège central arrière

Ne pas utiliser la ceinture de sécurité du siège central arrière avec une de ses deux boucles déverrouillée. Si une seule des boucles est verrouillée, tout freinage brusque ou collision peut entraîner des blessures graves, voire mortelles.



SRS airbag instructions for Canadian owners (in French)

The following is a French explanation of SRS airbag instructions extracted from the seat belt section in this manual.

See the SRS airbag section for more detailed seat belt instructions in English.

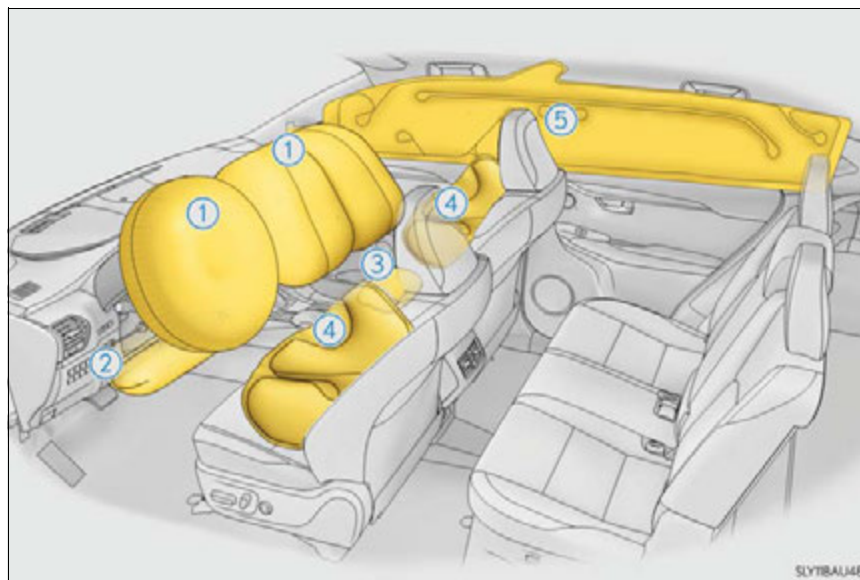

◆ Coussins gonflables SRS frontaux

- ① Coussins gonflables SRS conducteur/passager avant
Participent à la protection de la tête et du thorax du conducteur et du passager avant contre les chocs avec les éléments de l'habitacle
- ② Coussin gonflable SRS de genoux
Participe à la protection du conducteur
- ③ Coussin gonflable SRS d'assise de siège
Participe à la retenue du passager avant

◆ Coussins gonflables SRS latéraux et rideau

- ④ Coussins gonflables SRS latéraux
Participent à la protection du haut du corps des occupants des sièges avant
- ⑤ Coussins gonflables SRS rideau
 - Participent principalement à la protection de la tête des occupants assis dans les sièges des places extérieures
 - Peuvent empêcher les occupants d'être éjectés du véhicule en cas de retournement de celui-ci

Composition du système de coussins gonflables SRS

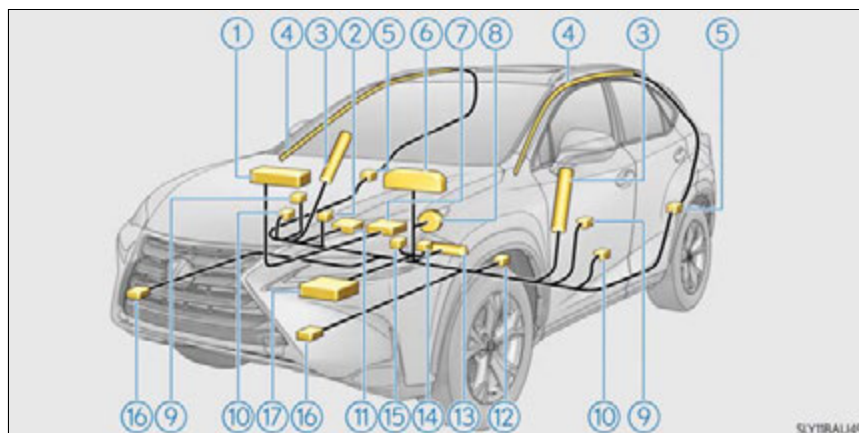

- | | |
|--|---|
| ① Coussin gonflable passager avant | ⑩ Prétensionneurs et limiteurs d'effort de ceinture de sécurité |
| ② Témoins indicateurs "AIR BAG ON" et "AIR BAG OFF" | ⑪ Coussin gonflable d'assise de siège |
| ③ Coussins gonflables latéraux | ⑫ Capteur de position du siège conducteur |
| ④ Coussins gonflables rideau | ⑬ Coussin gonflable de genoux conducteur |
| ⑤ Capteurs d'impact latéral (arrière) | ⑭ Contacteur de boucle de ceinture de sécurité conducteur |
| ⑥ Témoin d'alerte SRS | ⑮ Contacteur de boucle de ceinture de sécurité passager avant |
| ⑦ Système de classification d'occupant du siège passager avant (ECU et capteurs) | ⑯ Capteurs d'impact avant |
| ⑧ Coussin gonflable conducteur | ⑰ Boîtier électronique de coussins gonflables |
| ⑨ Capteurs d'impact latéral (avant) | |

Votre véhicule est équipé de COUSSINS GONFLABLES INTELLIGENTS (ADVANCED AIRBAGS) conçus selon les normes de sécurité américaines applicables aux véhicules à moteur (FMVSS208). Le boîtier électronique de coussins gonflables (ECU) utilise les informations reçues des capteurs, etc. détaillés dans le schéma ci-dessus de composition du système pour commander le déploiement des coussins gonflables. Ces informations comprennent des informations sur la gravité de la collision et les occupants. Le déploiement rapide des coussins gonflables est obtenu au moyen d'une réaction chimique dans les dispositifs pyrotechniques, qui produit un gaz inoffensif permettant d'amortir le mouvement des occupants.

AVERTISSEMENT

■ Précautions avec les coussins gonflables SRS

Respectez les précautions suivantes concernant les coussins gonflables SRS. À défaut, des blessures graves, voire mortelles, pourraient s'ensuivre.

- Le conducteur et tous les passagers à bord du véhicule doivent porter leur ceinture de sécurité correctement. Les coussins gonflables SRS sont des dispositifs de protection complémentaires aux ceintures de sécurité.

- Le coussin gonflable SRS conducteur se déploie avec une puissance considérable et peut occasionner des blessures graves, voire mortelles, notamment lorsque le conducteur se trouve très près du coussin gonflable. L'autorité fédérale chargée de la sécurité routière aux États-Unis, la NHTSA (National Highway Traffic Safety Administration) conseille:

Sachant que la zone à risque du coussin gonflable conducteur se trouve dans les premiers 2 à 3 in. (50 - 75 mm) de déploiement, vous disposez d'une marge de sécurité confortable en vous plaçant à 10 in. (250 mm) du coussin gonflable conducteur. Cette distance est à mesurer entre le moyeu du volant de direction et le sternum. Si vous vous tenez à moins de 10 in. (250 mm), vous pouvez changer votre position de conduite de plusieurs façons:

- Reculez votre siège le plus possible, tout en continuant à pouvoir atteindre confortablement les pédales.
- Inclinez légèrement le dossier du siège. Même si les véhicules sont conçus différemment, la plupart des conducteurs peuvent maintenir une distance de 10 in. (250 mm), même si le siège se trouve complètement vers l'avant, simplement en inclinant un peu le dossier du siège vers l'arrière. Si vous avez des difficultés à voir la route après avoir incliné votre siège, utilisez un coussin ferme et antidérapant pour vous rehausser ou, si votre véhicule est équipé du réglage en hauteur du siège, remontez-le.
- Si votre volant de direction est réglable, inclinez-le vers le bas. Cela vous permet d'orienter le coussin gonflable vers votre buste plutôt que vers la tête et le cou.

Le siège doit être réglé selon les recommandations de la NHTSA ci-dessus, tout en conservant le contrôle des pédales et du volant, et la vue des commandes au tableau de bord.

AVERTISSEMENT

■ Précautions avec les coussins gonflables SRS

- Si vous attachez une rallonge de ceinture de sécurité aux boucles des ceintures de sièges avant, mais pas au pêne de la ceinture de sécurité proprement dite, les coussins gonflables SRS frontaux déterminent que le conducteur et le passager avant portent leur ceinture de sécurité, alors même qu'elle n'est pas attachée. Dans ce cas, les coussins gonflables SRS frontaux risquent de ne pas se déployer correctement en cas de collision, causant des blessures graves, voire mortelles. Veillez à porter la ceinture de sécurité avec la rallonge de ceinture de sécurité.



- Le coussin gonflable SRS passager avant se déploie également avec une puissance considérable et peut occasionner des blessures graves, voire mortelles, notamment lorsque le passager avant se trouve très près du coussin gonflable. Le siège du passager avant doit se trouver le plus loin possible du coussin gonflable et le dossier doit être réglé de manière à ce que le passager avant soit assis bien droit.
- Le déploiement d'un coussin gonflable peut infliger des blessures graves, voire mortelles, aux nourrissons et aux enfants mal assis et/ou mal attachés. Installez dans un siège de sécurité enfant les enfants trop jeunes pour pouvoir utiliser la ceinture de sécurité. Lexus recommande vivement d'installer tous les nourrissons et enfants aux places arrière du véhicule et de prévoir pour eux des systèmes de retenue adaptés. Les sièges arrière sont plus sûrs pour les nourrissons et les enfants que le siège passager avant.
- N'installez jamais un siège de sécurité enfant type dos à la route sur le siège passager avant, même si le témoin indicateur "AIR BAG OFF" est allumé. En cas d'accident, la force exercée par le déploiement rapide du coussin gonflable passager avant peut causer des blessures graves, voire mortelles à un enfant, si le siège de sécurité enfant type dos à la route est installé sur le siège passager avant.

⚠ AVERTISSEMENT**■ Précautions avec les coussins gonflables SRS**

- Ne pas s'asseoir sur le bord du siège et ne pas s'appuyer contre la planche de bord.

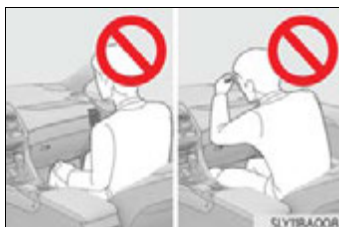

- Ne pas laisser un enfant rester debout devant le coussin gonflable SRS passager avant ni assis sur les genoux du passager avant.

- Ne pas laisser les occupants des sièges avant voyager avec un objet sur les genoux.



- Ne pas s'appuyer contre la porte, contre le rail latéral de toit ou contre les montants avant, latéraux et arrière.



- Interdisez à quiconque de s'agenouiller sur le siège passager en appui contre la porte ou de sortir la tête ou les mains à l'extérieur du véhicule.



⚠ AVERTISSEMENT

■ Précautions avec les coussins gonflables SRS

- Ne rien fixer ou disposer sur la planche de bord, la garniture centrale du moyeu de volant de direction et la partie inférieure du tableau de bord.

Lors du déploiement des coussins gonflables SRS conducteur, passager avant et de genoux, tout objet risque de se transformer en projectile.

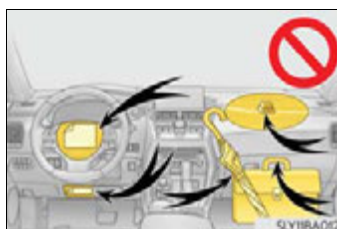

- Ne rien fixer aux portes, à la vitre de pare-brise, aux vitres latérales, aux montants avant et arrière, au rail latéral de toit et à la poignée de maintien.

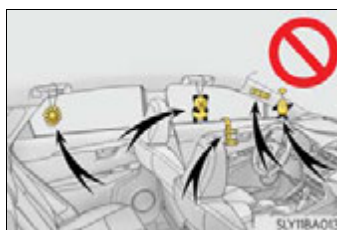

- Ne pas suspendre aux crochets à vêtements un cintre nu ni aucun objet dur ou tranchant. En cas de déploiement des coussins gonflables SRS rideau, tous ces objets pourraient se transformer en projectiles et causer des blessures graves, voire mortelles.
- Si une housse en vinyle recouvre la partie où le coussin gonflable SRS de genoux se déploie, veillez à l'enlever.
- N'utilisez pour les sièges aucun accessoire venant recouvrir les parties où se déploient les coussins gonflables SRS latéraux et le coussin gonflable SRS d'assise de siège, car il risquerait de gêner le déploiement des coussins gonflables SRS. De tels accessoires peuvent empêcher les coussins gonflables SRS latéraux et d'assise de siège de s'activer correctement, neutraliser le système ou provoquer le déploiement accidentel des coussins gonflables SRS latéraux et d'assise de siège, provoquant ainsi des blessures graves, voire mortelles.
- Évitez de faire subir des chocs ou des pressions excessives aux parties renfermant les composants des coussins gonflables SRS.
En effet, cela pourrait entraîner un mauvais fonctionnement des coussins gonflables SRS.
- Ne touchez aucun composant du système immédiatement après le déclenchement (déploiement) des coussins gonflables SRS, car ils sont alors encore très chauds.

⚠ AVERTISSEMENT**■ Précautions avec les coussins gonflables SRS**

- Si vous avez des difficultés à respirer après le déploiement des coussins gonflables SRS, ouvrez une porte ou une vitre pour faire entrer de l'air frais, ou bien descendez du véhicule si cela ne présente pas de danger. Retirez tout résidu dès que possible afin d'éviter d'éventuelles irritations de la peau.
- Si les parties renfermant les coussins gonflables SRS, telles que la garniture du moyeu de volant et les garnitures de montants avant et arrière, apparaissent abîmées ou craquelées, faites-les remplacer par votre concessionnaire Lexus.
- Ne rien poser sur le siège du passager avant, comme un coussin par exemple. Cela a pour conséquence de répartir le poids du passager sur toute la surface du siège, ce qui empêche le capteur de détecter normalement le poids du passager. En conséquence, les coussins gonflables SRS frontaux du passager avant peuvent ne pas se déployer en cas de collision.

■ Modification et élimination en fin de vie des éléments du système de coussins gonflables SRS

Consultez impérativement votre concessionnaire Lexus si vous avez besoin d'intervenir sur votre véhicule ou de procéder à l'une des modifications suivantes. Les coussins gonflables SRS peuvent ne pas fonctionner correctement ou se déployer (se gonfler) accidentellement, provoquant ainsi des blessures graves, voire mortelles.

- Installation, dépose, démontage et réparations des coussins gonflables SRS
- Réparations, modifications, démontage ou remplacement du volant, du tableau de bord, de la planche de bord, des sièges ou de leur garnissage, des montants avant, latéraux et arrière ou des rails latéraux de toit
- Réparation ou modification des ailes avant, du bouclier avant, ou des flancs de l'habitacle
- Installation d'un équipement de protection sur la calandre (pare-buffle, pare-kangourou, etc.), d'un chasse-neige, de treuils ou d'une galerie de toit
- Modification des suspensions du véhicule
- Installation d'appareils électroniques, tels qu'un émetteur/récepteur radio ou lecteur de CD
- Aménagements du véhicule visant à permettre sa conduite par une personne atteinte d'un handicap physique

Index

655

What to do if... (Troubleshooting).....	656
Alphabetical index.....	660

For vehicles with a navigation system, refer to the "NAVIGATION SYSTEM OWNER'S MANUAL" for information regarding the equipment listed below.

- Navigation system
- Lexus parking assist monitor
- Audio/visual system
- Lexus Enform with Safety Connect

What to do if... (Troubleshooting)

If you have a problem, check the following before contacting your Lexus dealer.

The doors cannot be locked, unlocked, opened or closed



You lose your keys

- If you lose your mechanical keys, new genuine mechanical keys can be made by your Lexus dealer. (→P. 120)
- If you lose your electronic keys, the risk of vehicle theft increases significantly. Contact your Lexus dealer immediately. (→P. 122)



The doors cannot be locked or unlocked

- Is the electronic key battery weak or depleted? (→P. 532)
- Is the power switch in ON mode?
When locking the doors, turn the power switch off. (→P. 202)
- Is the electronic key left inside the vehicle?
When locking the doors, make sure that you have the electronic key on your person.
- The function may not operate properly due to the condition of the radio wave. (→P. 142)



The rear door cannot be opened

- Is the child-protector lock set?
The rear door cannot be opened from inside the vehicle when the lock is set. Open the rear door from outside and then unlock the child-protector lock. (→P. 126)

If you think something is wrong**The hybrid system does not start**

- Did you press the power switch while firmly depressing the brake pedal? (→P. 201)
- Is the shift position in P? (→P. 203)
- Is the electronic key anywhere detectable inside the vehicle? (→P. 140)
- Is the steering wheel unlocked? (→P. 203)
- Is the electronic key battery weak or depleted?
In this case, the hybrid system can be started in a temporary way. (→P. 592)
- Is the 12-volt battery discharged? (→P. 594)

**The shift lever cannot be shifted from P even if you depress the brake pedal**

- Is the power switch in ON mode?
If you cannot release the shift lever by depressing the brake pedal with the power switch in ON mode (→P. 590)

**The steering wheel cannot be turned after the hybrid system is stopped**

- It is locked automatically to prevent theft of the vehicle. (→P. 204)

**The windows do not open or close by operating the power window switches**

- Is the window lock switch pressed?
The power window except for the one at the driver's seat cannot be operated if the window lock switch is pressed. (→P. 166)

**The power switch is turned off automatically**

- The auto power off function will be operated if the vehicle is left in ACCESSORY or ON mode (the hybrid system is not operating) for a period of time. (→P. 203)



A warning buzzer sounds during driving

- The seat belt reminder light is flashing
Are the driver and the front passenger wearing the seat belts? (→P. 567)
 - The parking brake indicator is on
Is the parking brake released? (→P. 213)
- Depending on the situation, other types of warning buzzer may also sound.
(→P. 565, 572)



An alarm is activated and the horn sounds

- Did anyone inside the vehicle open a door during setting the alarm?
The sensor detects it and the alarm sounds. (→P. 88)
- To stop the alarm, turn the power switch to ON mode or start the hybrid system.



A warning buzzer sounds when leaving the vehicle

- Is the message displayed on the multi-information display?
Check the message on the multi-information display. (→P. 572)



A warning light turns on or a warning message is displayed

- When a warning light turns on or a warning message is displayed, refer to P. 565, 572.

When a problem has occurred**If you have a flat tire**

- Stop the vehicle in a safe place and replace the flat tire with the spare tire. (→P. 575)

**The vehicle becomes stuck**

- Try the procedure for when the vehicle becomes stuck in mud, dirt, or snow. (→P. 603)

Alphabetical index

A

A/C.....	430	Locations of airbags.....	40
Air conditioning filter.....	530	Modification and disposal of	
Automatic air conditioning		airbags.....	47
system	430	Seat cushion airbag.....	40
Micro dust and pollen filter	436	Side airbag operating	
ABS (Anti-lock Brake System).....	305	conditions	48
Function	305	Side airbag precautions	45
Warning light	566	Side and curtain shield airbags	
Active Sound Control (ASC)	218	operating conditions	48
Air conditioning filter.....	530	Side and curtain shield airbags	
Air conditioning system.....	430	precautions	46
Air conditioning filter.....	530	SRS airbag instructions	
Automatic air conditioning		for Canadian owners.....	647
system	430	SRS airbags	40
Micro dust and pollen filter	436	Alarm	88
S-FLOW mode.....	432	Alarm.....	88
Airbags	40	Warning buzzer.....	569
Airbag operating conditions.....	48	Anchor brackets.....	71, 73
Airbag precautions for your		Antenna	
child.....	43	Radio.....	364
Airbag warning light.....	566	Smart access system	
Correct driving posture	30	with push-button start.....	140
Curtain shield airbag		Anti-lock brake system (ABS).....	305
operating conditions.....	48	Function.....	305
Curtain shield airbag		Warning light.....	566
precautions.....	46	Approach warning	245, 259
Front passenger occupant		Armrest	465
classification system.....	53	ASC (Active Sound Control).....	218
General airbag precautions.....	43	Assist grips.....	465

Audio system
(with navigation system)*

Audio system..... 336

 Antenna364

 Audio input.....345

 AUX port.....345

 Bluetooth® audio.....390

 CD player.....367

 iPod.....374

 MP3/WMA disc367

 Optimal use354

 Portable music player.....381

 Radio.....361

 Setup menu.....347

 Steering wheel audio
 switches.....342

 USB memory.....377

Automatic air conditioning system

 Air conditioning filter.....530

 Automatic air conditioning
 system430

 Micro dust and pollen filter436

 S-FLOW mode.....432

Automatic headlight leveling
system221

Automatic High Beam223

Automatic light control system.....221

AUX port.....345

B

Back door.....129

 Wireless remote control.....129

Back-up lights

 Replacing light bulbs550

 Wattage615

Battery (12-volt battery)

 If the 12-volt battery is
 discharged.....594

 Preparing and checking before
 winter.....326

 Warning light.....565

Battery (traction battery).....81

Bluetooth®413

 Audio system.....390

 Hands-free system
 (for cellular phone)392

Bottle holders448

Brake

 Brake Hold216

 Fluid612

 Parking brake213

 Regenerative braking.....79

 Warning light.....565

Brake assist.....305

Brake Hold.....216

Break-in tips176

Brightness control

 Instrument panel light
 control.....99

BSM (Blind Spot Monitor).....316

 Blind Spot Monitor function.....319

 Rear Cross Traffic Alert
 function.....321

*: Refer to the "NAVIGATION SYSTEM OWNER'S MANUAL".

C

Card key	118	Child safety	59
Care		12-volt battery	
Aluminum wheels	485	precautions	514, 598
Exterior	484	Airbag precautions	43
Interior	488	Back door precautions	135
Seat belts	489	Child restraint system	60
Cargo capacity	182, 606	How your child should	
Cargo hooks	450	wear the seat belt	36
Cargo net hooks	450	Installing child restraints	60
CD player	367	Moon roof precautions	172
Chains	327	Power window lock switch	166
Child-protectors	126	Power window precautions	168
Child restraint system	60	Rear door child-protectors	126
Booster seats installation	68	Removed key battery	
Convertible seats		precautions	533
installation	67	Seat belt extender	
Front passenger occupant		precautions	39
classification system	53	Seat belt precautions	38
Infant seats definition	62	Seat heater precautions	440
Infant seats installation	66	Cleaning	484, 488
Installing CRS with LATCH		Aluminum wheels	485
anchors	71	Exterior	484
Installing CRS with seat		Interior	488
belts	66	Seat belts	489
Installing CRS with top tether		Clock	456
strap	73		
LATCH anchors	71		

Coat hooks.....	466
Compass.....	473
Condenser.....	509
Console box.....	447
Consumption screen.....	111
Coolant	
Capacity.....	611
Checking.....	508
Preparing and checking	
before winter.....	326
Warning light.....	565
Cooling system.....	508
Hybrid system overheating.....	599
Cruise control	
Cruise control.....	267
Dynamic radar cruise	
control.....	240
Dynamic radar cruise control	
with full-speed range.....	253
Cup holders.....	448
Curtain shield airbags.....	40
Customizable features.....	631

D

Daytime running light system.....	221
Deck board.....	452
Deck under tray.....	451
Defogger	
Outside rear view mirrors.....	435
Rear window.....	435
Windshield.....	435
Differential.....	612
Dimension.....	606
Dinghy towing.....	200
Display	
Drive information.....	103
Dynamic radar cruise	
control.....	240
Dynamic radar cruise control	
with full-speed range.....	253
Energy monitor.....	111
LDA (Lane Departure Alert	
with steering control).....	270
Multi-information display.....	102
Warning messages.....	572
Do-it-yourself maintenance.....	498
Doors	
Automatic door locking and	
unlocking system.....	127
Back door.....	129
Door glasses.....	166
Door lock.....	124
Outside rear view mirrors.....	163
Rear door child-protectors.....	126
Side doors.....	124

Drive information	103
Drive-start control	175, 210
Driver's seat belt reminder light.....	567
Driver's seat position memory	154
Driving	
Break-in tips	176
Correct posture.....	30
Driving mode select switch	303
Hybrid vehicle driving tips.....	324
Procedures	174
Winter drive tips.....	326
Driving position memory.....	154
Memory recall function.....	156
Dynamic radar cruise control	
Function	240
Warning message.....	572
Dynamic radar cruise control with full-speed range	
Function	253
Warning message.....	572

E

ECB (Electronically Controlled Brake System).....	305
Eco drive mode.....	303
EDR (Event data recorder).....	11
E-Four	306
Electric motor	
Location	77
Specification.....	608
Electric Power Steering (EPS)	
Function.....	305
Warning light.....	566
Electronic key	
Battery-saving function	141
If the electronic key does not operate properly	591
Replacing the battery	532
Electronically Controlled Brake System (ECB).....	305
Emergency flashers	556
Emergency, in case of	
If a warning buzzer sounds	565
If a warning light turns on	565
If a warning message is displayed.....	572
If the 12-volt battery is discharged.....	594
If the electronic key does not operate properly	591
If the hybrid system will not start	588

If you have a flat tire	575	Engine compartment cover	503
If you lose your keys	120, 122	Engine coolant	
If you think something is wrong	564	Capacity	611
If your vehicle becomes stuck	603	Checking	508
If your vehicle has to be stopped in an emergency	557	Preparing and checking before winter	326
If your vehicle needs to be towed	558	Warning light	565
If your vehicle overheats	599	Engine coolant temperature gauge	97
Energy monitor	111	Engine oil	
Engine		Capacity	609
Accessory mode	202	Checking	504
Compartment	502	Warning light	565
Engine switch	201	Engine oil maintenance data	506
Hood	500	Engine switch	201
How to start the hybrid system	201	EPS (Electronic Power Steering)	
Identification number	608	Function	305
If your vehicle has to be stopped in an emergency	557	Warning light	566
Ignition switch (power switch)	201	EV drive mode	206
Overheating	599	EV indicator	79
Power switch	201	Event data recorder (EDR)	11

F

Flat tire	575
Floor mats	28
Fluid	
Brake.....	612
Transmission.....	612
Washer	511
Fog lights	
Replacing light bulbs.....	552
Switch.....	227
Front passenger occupant classification system.....	53
Front passenger's seat belt reminder light	567
Front seats	146
Adjustment.....	146
Cleaning.....	488
Correct driving posture	30
Driving position memory	154
Head restraints.....	158
Power easy access system	154
Seat heaters	440
Seat position memory.....	154
Front side marker lights	
Light switch	219
Replacing light bulbs.....	545, 552
Wattage.....	615

Front turn signal lights

Replacing light bulbs	545
Turn signal lever.....	212
Wattage	615

Fuel

Capacity.....	608
Fuel gauge	97
Gas station information.....	680
Information.....	616
Refueling	236
Type.....	608

Fuel filler door.....236

Refueling	236
When the fuel filler door cannot be opened.....	238

Fuses.....534

G

Garage door opener.....	467
Gas station information	680
Gauges.....	97
Glove box	447
Grocery bag hooks.....	451

H

- Hands-free system
 - (for cellular phone)..... 392
- Head restraints 158
- Headlights 219
 - Automatic headlight leveling 221
 - Automatic High Beam 223
 - Light switch 219
 - Replacing light bulbs 541, 552
 - Wattage 615
- Head-up display 106
- Heated steering wheel 441
- Heaters
 - Automatic air conditioning
 - system 430
 - Heated steering wheel 440
 - Outside rear view mirrors 435
 - Seat heaters 440
- High mounted stoplight
 - Replacing 552
- Hill-start assist control 305
- Hood 500
 - Warning message 128, 572
- Hooks
 - Cargo hooks 450
 - Retaining hooks (floor mat) 28
- Horn 160
- Hybrid battery (traction battery)
 - Location 81
 - Specification 609
- Hybrid battery air vent 82
- Hybrid system 77
 - Emergency shut off system 82
 - Energy monitor/
 - consumption screen 111
 - EV drive mode 206
 - High voltage components 81
 - Hybrid System Indicator 100
 - Hybrid system precautions 81
 - Hybrid vehicle driving tips 324
 - If the hybrid system will not
 - start 588
 - Overheating 599
 - Power switch 201
 - Regenerative braking 79
 - Starting the hybrid system 201
 - Vehicle proximity notification
 - system 78
- Hybrid System Indicator 100
- Hybrid transmission 208

I

I/M test	497
Identification	
Engine	608
Vehicle	607
Ignition switch (Power switch)	201
Illuminated entry system	445
Immobilizer system	86
Indicators	92
Initialization	
Engine oil maintenance data	506
Items to initialize	641
Tire pressure warning system	518
Inside rear view mirror	161
Instrument panel light control	99
Interior lights	443
Switch	444
Wattage	615
Intuitive parking assist	
Function	279
Warning message	572

J

Jack	
Positioning a floor jack	501
Vehicle-equipped jack	576
Jack handle	576
Jam protection function	
Moon roof	170
Power back door opener and closer	138
Power windows	167

K

Keyless entry	
Smart access system with push-button start	140
Wireless remote control	118
Keys	118
Battery-saving function	141
Electronic key	118
Engine switch	201
If the electronic key does not operate properly	591
If you lose your keys	120, 122
Key number plate	118
Keyless entry	118
Mechanical key	118
Power switch	201
Replacing the battery	532
Warning buzzer	141
Wireless remote control key	118
Knee airbags	40

L

Lane Departure Alert
with steering control (LDA)..... 270

Language (multi-information
display)..... 636

LATCH anchors 71

LDA (Lane Departure Alert
with steering control) 270

Lever
Auxiliary catch lever 500
Hood lock release lever 500
Shift lever 208
Turn signal lever 212
Wiper lever 228

Lexus Display Audio controller 338

Lexus Enform *
Lexus Enform Remote * 427

Lexus parking assist monitor
Display 288
Function 287
Precautions 294

License plate lights
Light switch 219
Replacing light bulbs 552

Light

Automatic High Beam system ... 223

Fog light switch 227

Headlight switch 219

Illuminated entry system 445

Interior light list 443

Interior lights 444

Luggage compartment light 133

Personal lights 444

Replacing light bulbs 538

Turn signal lever 212

Vanity lights 455

Wattage 615

Welcome light illumination
control 125

Light bulbs
Replacing 538
Wattage 615

Luggage cover 453

*: Refer to the "NAVIGATION SYSTEM OWNER'S MANUAL".

M

Maintenance
 Do-it-yourself
 maintenance..... 498
 General maintenance494
 Maintenance data.....606
 Maintenance requirements..... 491
Malfunction indicator lamp565
Meter
 Head-up display.....106
 Indicators.....92
 Instrument panel light
 control.....99
 Meters.....97
 Multi-information display102
 Warning lights565
 Warning messages.....572
Micro dust and pollen filter 436
Microphone.....393
Mirrors
 Inside rear view mirror161
 Outside rear view mirror
 defoggers.....435
 Outside rear view mirrors.....163
 Vanity mirrors.....455

Moon roof
 Jam protection function.....170
 Operation.....169
 Warning message.....171, 572
MP3 disc367
Multi-information display
 Drive information.....103
 Dynamic radar cruise
 control.....240
 Dynamic radar cruise control
 with full-speed range253
 Energy monitor.....111
 Language.....636
 LDA (Lane Departure Alert
 with steering control).....270
 Warning messages572

N

Navigation system*
Noise from under vehicle8

O

Odometer97

Oil

 Engine oil..... 609

 Rear differential oil..... 612

Opener

 Back door130

 Fuel filler door236

 Hood.....500

Outside rear view mirrors163

 Adjusting and folding..... 163

 Blind Spot Monitor (BSM)..... 316

 Linked mirror function

 when reversing..... 164

 Mirror position memory..... 154

 Outside rear view mirror

 defoggers.....435

Outside temperature display97

Overheating 599

P

Panic mode..... 119

Parking brake

 Operation.....213

 Parking brake engaged

 warning buzzer/message215

 Warning light.....566

Parking lights

 Light switch.....219

 Replacing light bulbs 552

PCS (Pre-Collision System)

 Function..... 310

 PCS switch311

 Warning light.....566

 Warning message..... 572

Personal lights443

 Switch444

Power back door opener and

 closer 129

Power control unit coolant

 Capacity..... 611

 Checking..... 508

 Preparing and checking

 before winter..... 326

 Radiator 509

*: Refer to the "NAVIGATION SYSTEM OWNER'S MANUAL".

Power easy access system154
 Power outlets 456
 Power steering (Electric Power Steering system).....305
 Warning light566
 Power switch 201
 Power windows
 Door lock linked window operation167
 Jam protection function167
 Operation 166
 Window lock switch..... 166
 Pre-Collision System (PCS)
 Function 310
 PCS switch.....311
 Warning light 566
 Warning message.....572

R

Radar cruise control (dynamic radar cruise control) 240
 Radar cruise control (dynamic radar cruise control with full-speed range) 253
 Radiator 509
 Radio.....361
 Rear Cross Traffic Alert316
 Rear seat
 Folding down the rear seatbacks..... 148

Rear side marker lights
 Light switch.....219
 Replacing light bulbs 552
 Rear turn signal lights
 Replacing light bulbs 547
 Turn signal lever 212
 Wattage 615
 Rear view mirror
 Inside rear view mirror..... 161
 Outside rear view mirrors163
 Rear window defogger 435
 Rear window wiper234
 Refueling.....236
 Capacity..... 608
 Fuel types..... 608
 Opening the fuel tank cap 236
 When the fuel filler door cannot be opened 238
 Regenerative braking.....79
 Remote Touch*
 Replacing
 Electronic key battery 532
 Fuses 534
 Light bulbs.....538
 Tires 575
 Resetting the message indicating maintenance is required 492
 Reporting safety defects for U.S. owners 644
 Road accident cautions 84

S

Safety Connect *477

Seat belts..... 32

- Adjusting the seat belt shoulder anchor height35
- Automatic Locking Retractor36
- Child restraint system installation.....60
- Cleaning and maintaining the seat belt489
- Emergency Locking Retractor36
- How to wear your seat belt.....30
- How your child should wear the seat belt36
- Pregnant women, proper seat belt use.....37
- Reminder light and buzzer567
- Seat belt extender36
- Seat belt instructions for Canadian owners645
- Seat belt pretensioners35
- SRS warning light..... 566

Seat heaters440

Seat position memory.....154

Seat ventilators442

Seating capacity..... 186

Seats

- Adjustment.....146, 147
- Adjustment precautions..... 146, 153
- Child seats/child restraint system installation60
- Cleaning.....488
- Driving position memory.....154
- Folding down the rear seatbacks147
- Head restraint.....158
- Power easy access system.....154
- Properly sitting in the seat.....30
- Seat heaters.....440
- Seat position memory.....154
- Seat ventilators.....442

Sensor

- Automatic High Beam system ... 223
- Inside rear view mirror.....162
- Intuitive parking assist.....279
- Radar sensor.....248, 262, 311
- Rain-sensing windshield wipers.....232

Service reminder indicators92

S-FLOW mode.....432

Shift lever208

Side airbags40

Side doors124

Side marker lights

- Light switch.....219
- Replacing light bulbs545, 552

*: Refer to the "NAVIGATION SYSTEM OWNER'S MANUAL".

Side mirrors	163	Sunglass holder.....	449
Adjusting and folding.....	163	Sun visors.....	455
Blind Spot Monitor (BSM).....	316	Switch	
Heaters.....	435	ASC (Active Sound Control)	
Side turn signal lights		dial	218
Replacing light bulbs.....	552	Audio remote control	
Turn signal lever	212	switches	342
Smart access system		Automatic High Beam switch.....	223
with push-button start	140	Brake hold switch.....	216
Antenna location.....	140	BSM (Blind Spot Monitor)	
Entry functions.....	124, 129	main switch.....	316
Starting the hybrid system.....	201	Cruise control	
Warning message.....	572	switch	240, 253, 267
Snow tires	326	Door lock switch.....	126
Spare tire		Driving mode select switch.....	303
Inflation pressure.....	614	Driving position memory	
Storage location	576	switches	154
Spark plug	611	Emergency flashers switch.....	556
Specifications	606	EV drive mode switch	206
Speedometer	97	Fog light switch.....	227
Sport mode	303	Garage door opener	
Steering wheel		switches	467
Adjustment.....	160	Heated steering wheel	440
Audio switches.....	342	HUD (Head-up display)	
Heated steering wheel.....	440	switches	106
Power easy access system	154	Ignition switch.....	201
Telephone switches.....	402	Intuitive parking assist switch.....	279
Stop lights		LDA switch.....	270
Replacing light bulbs.....	552	Light switches.....	219
Storage feature	446	Meter control switches.....	103
Storage precautions	446	Moon roof switches	169
Stuck		Outside rear view mirror	
If the vehicle becomes stuck	603	switches	163

Parking brake switch.....213
 PCS switch..... 311
 Power back door opener
 and closer switch..... 130, 131
 Power switch..... 201
 Power window switch..... 166
 Rear window and
 outside rear view mirror
 defoggers switch.....435
 Rear window wiper and
 washer switch.....234
 Seat heater switches..... 440
 "SOS" button.....477
 Talk switch.....402, 423
 Telephone switches.....402
 Vehicle-to-vehicle
 distance button..... 240, 253
 VSC OFF switch.....307
 Window lock switch..... 166
 Windshield wipers and
 washer switch.....228

T

Tachometer 97
Tail lights
 Light switch.....219
 Replacing light bulbs552
Talk switch..... 402, 423
Telephone switch..... 402
Theft deterrent system
 Alarm.....88
 Immobilizer system.....86
Tire inflation pressure
 Maintenance data.....613
 Warning light.....567
Tire information 619
 Glossary.....625
 Size 622
 Tire identification number 621
 Uniform Tire Quality Grading... 623
Tire pressure warning system
 Function.....517
 Initializing 517
 Installing tire pressure warning
 valves and transmitters..... 517
 Registering ID codes.....519
 Warning light.....567

Tires.....516
 Chains.....327
 Checking.....516
 Glossary625
 If you have a flat tire575
 Inflation pressure.....525, 613
 Replacing575
 Rotating tires516
 Size.....613
 Snow tires326
 Spare tire.....575, 614
 Tire identification number.....621
 Tire pressure warning system517
 Uniform Tire Quality Grading...623
 Warning light567
 Tools.....576
 Top tether strap.....73
 Total load capacity606
 Towing
 Dinghy towing200
 Emergency towing.....558
 Towing eyelet.....561
 Trailer towing187, 199
 TRAC (Traction Control).....305
 Trailer towing187, 199

Transmission
 Hybrid transmission208
 Selecting a driving mode.....303
 Trip meters.....97
 Turn signal lights
 Replacing light
 bulbs545, 547, 552
 Turn signal lever.....212
 Wattage615

U

USB memory377
 USB port.....345

V

Vanity lights
 Vanity lights455
 Wattage615
 Vanity mirrors.....455
 Vanity lights455
 Vehicle data recordings.....10
 Vehicle identification number607
 Vehicle Stability Control (VSC)....305
 Voice command system.....423
 VSC (Vehicle Stability Control)....305

W

Warning buzzers

Approach warning..... 245, 259
 Downshifting 210
 Intuitive parking assist.....282
 Light reminder221
 Open door.....128
 Seat belt reminder.....567

Warning lights

ABS..... 566
 Brake hold operated
 indicator 566
 Brake Override System567
 Brake system.....565
 Charging system.....565
 Drive-Start Control.....567
 Electric power steering.....566
 High coolant temperature.....565
 Low engine oil pressure.....565
 Low fuel level567
 Malfunction indicator lamp.....565
 Master warning light.....567
 Parking brake indicator 566
 PCS warning light 566
 Seat belt reminder light.....567
 Slip indicator566
 SRS.....566
 Tire pressure567

Warning messages.....572

Washer

Checking 511
 Low washer fluid
 warning message..... 511, 572
 Preparing and checking
 before winter326
 Switch 228, 234

Washing and waxing 484

Weights

Cargo capacity.....182, 606
 Load limits186, 606
 Weights 606

Wheels 528

Replacing wheels 528
 Size 613

Window glasses..... 166

Window lock switch..... 166

Windows

Power windows.....166
 Rear window defogger435
 Washer 228, 234

Windshield wiper de-icer 436

Windshield wipers

Intermittent windshield wipers... 228
 Rain-sensing windshield
 wipers..... 230

Winter driving tips326

Wireless charger..... 458

Wireless communication 382, 390
Wireless remote control key 118
 Battery-saving function 141
 Locking/Unlocking 118
 Panic mode 119
 Replacing the battery 532
WMA disc 367

X

XM® Satellite Radio 361

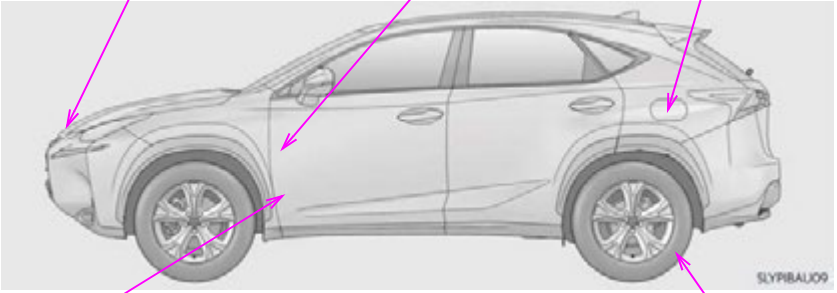

GAS STATION INFORMATION		
Auxiliary catch lever P. 500	Back door opener switch* P. 130	Fuel filler door P. 237
		
Hood lock release lever P. 500	Tire inflation pressure P. 613	
Fuel tank capacity (Reference)	14.8 gal. (56 L, 12.3 Imp.gal.)	
Fuel type	Unleaded gasoline only	P. 608
Cold tire inflation pressure		P. 613
Engine oil capacity (Drain and refill – reference)	With filter Without filter	4.6 qt. (4.4 L, 3.9 Imp.qt.) 4.2 qt. (4.0 L, 3.5 Imp.qt.)
Engine oil type	“Toyota Genuine Motor Oil” or equivalent Oil grade: ILSAC GF-5 multigrade engine oil Recommended viscosity: SAE 0W-20 P. 610	

*: Vehicles with a power back door